



compile systems



PROTECTING THE ENVIRONMENT FOR FUTURE GENERATIONS

Our environmental success story began with the challenge to create an office system that would meet today's business requirements while maintaining a firm commitment to save and protect the environment.

Sustainability became a part of the creative focus and development of Compile that incorporates the latest technology and design features to provide excellent performance at a competitive price.

As government and industry environment ratings such as LEEDS & Greenguard become more prevalent, Compile offers designers and architects functional, attractive, and economical office designs that meet these standards.

Evolve Furniture Group is a leader in reducing waste in the manufacturing of its products as well as utilizing recycled materials wherever possible. We make extensive use of recycled plastic and wood waste from other Global factories.

Evolve Furniture Group is committed to the continuous improvement of our environmental systems, the prevention of pollution, and to comply with both the spirit and the letter of all relevant environmental legislation.

Compile Panels are 100% recyclable at the end of their lifespan. Nothing from an Evolve Panel needs to end up in a landfill.

SUSTAINABILITY INFORMATION

Compile offers fabrics that are made from 100% recycled polyester, which means less waste going to landfills. These fabrics also reduced the demand for petroleum products, and decrease the environmental impacts of processing those petroleum products into polyester.

Compile's epoxy powder coating process involves no liquids and is solvent free. It contains no harmful VOC's or lead. Up to 99% of over sprayed powdered is reclaimed, mixed with virgin powder and reused.

Compile's entire panel is up to 82% recycled.

Compile masonite is up to 85% recycled.

Compile's entire product line is up to 99% recyclable.

REFERENCES

Features, Benefits & General Information	3
Coding an Order	4
Textiles & Finishes	112
Panel COM Form	117
Panel Fabric Specification Sheet	118
Pedestal Cushions COM Form.....	119
Panel Fabric Sample.....	120
Appendix	121
Terms & Conditions.....	122

PANELS

Panels – Technical Information.....	8
Panel – Types	9
Panel Package – Configuration	15
Monolithic Panel Packages.....	16
Segmented Panel Packages.....	18
Acoustic Panel Packages	20
Monolithic Laminate Panel Packages	22
Segmented Laminate Panel Packages.....	26
Segmented Writeboard Panel Packages	30
Single Segmented Open Bottom Panel Packages	34
Glazed Panel Packages	36
Partly Glazed Panel Packages.....	38
12" Top Partly Glazed Panel Packages.....	40
Privacy Glass.....	42
Over Panels	43
Gallery Panels	47
Sliding Doors.....	54
Post Packages	55
Raceway & Knockout Covers	57
Posts & Trim Inserts	58
Post Covers	60
Panel Legs.....	61
Post Separator.....	62

ELECTRICAL

Electrical – Technical Information	64
Electrical – Wire Schematic	65
Electrical – Configuration.....	66
Power Distribution Housing	67
Cables.....	68
I Connector	68
Duplex Receptacle	69
Power Entry	70
Electrical Box.....	70
Post Extension.....	71

ELECTRICAL

Ceiling Feed.....	71
Cable Cover.....	71
Task Lights.....	72

WORKSURFACES

Worksurfaces – Technical Information	74
Worksurfaces – Configuration	75
Rectangular Worksurface	76
Straight Worksurfaces	77
Rectangular Worksurface for Height Adjustable Tables	78
Wedge Worksurfaces	79
Span a Post Rectangular Worksurfaces	79
Curvilinear Worksurface	80
Corner Worksurface	81
Extended Curved Corner.....	82
“D” Worksurface.....	83
Hatchet Worksurface	84
Straight Wedge Worksurfaces	84
Quarter Round Panel Worksurface	84
Transaction Worksurface	85
Accessories.....	86

STORAGE

Storage – Technical Information	92
Storage – Configuration	93
Pedestals.....	94
Overhead Storage	96
Lateral File.....	98
Storage Towers	101
Key Alike Form	103

ACCESSORIES

Tack Board.....	106
White Marker Board	106
Load Bars.....	107
Rail Accessories.....	107



PANELS

- Panel Fabric modules consist of Module Frames, Module Interiors and Fabric Skins.

Fabric

- Fabric offerings include selections woven with 100% recycled yarn.

Panel Frame

- Typical workstation contains up to 62.2% recycled material.
- Panel is made of 82.3% recycled material.
- Acoustic panels are light tackable with 0.70 NRC and a 26 STC rating.
- Non Acoustic panels are not tackable with 0.17 NRC and a 28 STC rating.
- Raceway covers are aluminum.
- Plastic top cap vs Aluminum top cap.

Metal Components/Raceway Finish

- All aluminum components are painted with environmentally friendly epoxy powder.
- Raceway interiors are coated with recycled epoxy powder.
- The entire Compile Panel and the processes used to manufacture it are designed to save and protect the environment. Compile Panels are made from recycled materials and are 99% recyclable.

Panel Options

- Compile Panels come in 4 heights: 30", 42", 54" and 66".
- Panel widths come in 7 sizes including: 24", 30", 36", 42", 48", 54" and 60".
- Panels conform to CGSB and ANSI/BIFMA standards.
 - This is your assurance that the quality, and performance level of these Panels have been tested to equal or exceed the requirements of the US government.
- Rigid, aluminum Panel Frame is 2 3/8" thick.
- Aluminum Panel Frame combined with easy to assemble "Quick Connect" clips, create a rigid Panel Wall.
- Levelling glides extend 2". Enables the client to deal with severe undulations in the flooring levels of a building.
- Compile makes it easy to select a Panel function that is suitable for your application.
- Compile makes it easy to select a Panel type and height that is suitable for your application.

VOICE/DATA AND ELECTRICAL POWER

- Voice/data cables can be inserted at the base. 8 wire, 4 circuit electrical capability, 2 utility + 2 dedicated circuits, each with 10 gauge (oversized) neutrals. All circuits can support up to 20 amps (15 CSA).
- Raceway Cover opening sizes conform to the ANSI/TIA/EIA Furniture Opening Standard of 1.345" x 2.680".
- Panels 24" wide include raceway covers with 2 knockouts.
- Panels 30" – 60" wide include raceway covers with 3 knockouts.

- Panels and electrical components are CSA/UL approved.
- Compile panel raceway is roughly 2.13" x 4.6" without power distribution housing installed. With power distribution housing installed, the dimension is reduced to roughly 2.13" x 2.13
- The base raceway cavity accommodates 50 .25" diameter communication cables without power installed or 30 .25" diameter communication cables with power installed.
- 90-degree posts accommodate 25 .25" diameter communication cables without a ceiling infeed or 20 .25" diameter communication cables with a ceiling infeed installed.
- 120-degree posts may not be utilized for power infeeds or communication cables. 90-degree posts may be utilized at the end of a 120-degree configuration if ceiling infeed of power and/or data cables is required.
- No tools are required to install electrical in the Compile Panel System.

WORKSURFACES

- 1" thick worksurfaces come in a variety of shapes and sizes. Essentially, they are 24" or 30" deep and are available in 6" increments from 24" to 84" wide.
- Cable scoops located at the back of each Worksurface provide routing of power and data cables.
- This convenient feature, together with a 3/8" gap between the Worksurface and the Panel, allows access to cables without having grommet holes in the Worksurface.
- With this choice of product, we can tailor each installation to your requirements. The addition of custom sizes shows a commitment to client satisfaction that not every manufacturer offers.
- Thermally fused laminate tops are standard.
- All Worksurfaces utilize balanced construction.
- Predrilled holes in worksurfaces enable installer to properly align worksurface.

STORAGE

- 19", 23" and 29" deep Pedestals. Freestanding and Worksurface supporting options available.
- Drawer divider and pencil tray included in all Freestanding Pedestals containing box drawers. Drawer divider and pencil tray not included in Worksurface Supporting Pedestals.
- Adjustable glides are accessible from the inside of the cabinet.
- Positive and secure locking system on all Pedestals is standard.
- Full height drawer sides are standard on all file drawers. This enables you to hang files from the drawer side so no extra hardware is necessary. File drawers accept letter sized files. Optional file bars are available to file legal and metric sized files.
- Steel construction guarantees the performance of the product over the long term. Welded joints with a full top, back and base ensure that the Pedestal will sit square and adequately support the Worksurface where necessary.

- Worksurface supporting Pedestals are standard with Compile.
- Shelves feature all metal construction.
- All storage components as well as the Panel Frames are epoxy powder coated.
- Glides enable you to level the cabinet to the floor and or Worksurface. The convenient adjustment feature allows the installer to adjust the height of the cabinet while it is under the Worksurface. This saves time in the installation process.
- For additional security and peace of mind, locks can be keyed alike or master keyed for additional convenience. Standard recessed handle offers uncluttered aesthetic.
- "Environmentally friendly" epoxy powder coat is 15 times more durable in independent testing than a wet paint spray. This helps maintain the look of the product over its many years of service.

WARRANTIES AND PERFORMANCE

- A Lifetime Warranty
- Non Obsolescence Warranty
- Reduced cost of assembly and reconfiguration
- ISO9001:2008 Registered
- ISO14001:2004 Registered
- GreenGuard Certified
- Level 2 Certified
- ANSI/BIFMA CGSB testing on all products
- For piece of mind over the long term, we cover you with a comprehensive warranty that is supported by our dealer network.
- Some installation companies claim that the Compile Panels System can be installed in half the time it takes to install most of our competitor's segmented panels. This cost saving can amount to thousands of dollars over the lifetime of our furniture.
- Your assurance of consistent quality to an international standard. Evolve Furniture Group is committed to design, manufacture and distribute superior quality office furniture, which meets or exceeds the requirements of our customers.
- Confirmation that Evolve Furniture Group is committed (1) to providing product that, through their entire life cycle, minimize negative environmental impacts on the environment, (2) to continuous improvement to our environmental systems and programs and (3) to comply to all relevant environmental legislation and regulations.
- Compile Panel System can help a company meet LEED requirements for office furniture.
- Compile components are tested to the highest standard in the industry. This is your assurance of quality and longevity.
- Panel textiles, adjustable keyboard mechanisms, task lights and electrical devices = five (5) Years
- Other parts = Lifetime Warranty

Compile products have been coded using alphas that correspond with the product name. This creates an easy-to-remember code. The following breaks down the coding logic and highlights the required code components needed to order within each product category.

Panels

Example: **Product:** Compile Fabric Monolithic Panel

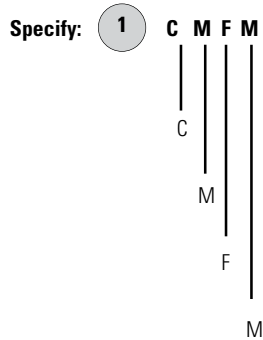

Base Code found on the product page to the left of the product name and a simple product illustration.

CoMpile product line

Fabric-covered Panel

Monolithic panel category

2 CMFM**6648**

Panel size offering. Listed on every product page with price listing.

Note: Additional dimensions are provided for most products on the far right hand side of each page. These dimensions are not required in the ordering code.

3 CMFM6648-**BK**

Standard paint code for frame. See the Fabric & Finish listing in this section.

To specify fabric for a Compile Panel, please note:

4 CMFM6648-BK-**B84A**

Fabric code for all modules on both sides of the Panel*. See the Fabric & Finish listing in this section.

* **NOTE:** If different fabrics are to be included on a Compile Panel, please use the following ordering format. **Start at the bottom** of one side of a Panel and work to the top module of that Panel. Then start the process over on the other side of the Panel. As an example:

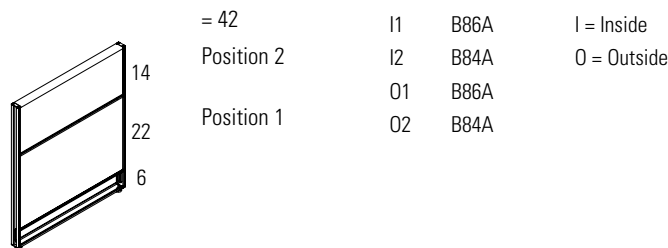

Electrical

Example: **Product:** Flexible Mesh Jumper Cable

Specify: **1** **C E 8 C P 1 7**

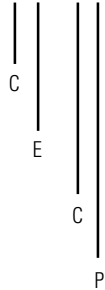

2 CE8CP17

Base Code found on the product page to the left of the product name and a simple product illustration.

Compile product line.

Electrical category.

Cable Panel.

Pass-Through.

Product size offering – length. Listed on every product page with price listing. Note: Additional dimensions are provided for most products on the far right hand side of each page. These dimensions are not required in the ordering code.

Worksurfaces

Example: **Product:** Curvilinear Worksurface – Left

Specify: **1** **C W V L**

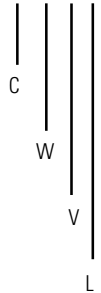

2 CWVL3042

3 CWVL3042–T431

4 CWVL3042–T890–CR

Base Code found on the product page to the left of the product name and a simple product illustration.

Compile product line.

Worksurface category.

Cur**V**ilinear shape.

Left hand configuration.

Worksurface size offering. Listed on every product page with price listing. Note: Additional dimensions are provided for most products on the far right hand side of each page. These dimensions are not required in the ordering code.

Laminate code for surface. See the Fabric & Finish listing in this section.

PVC code for trim. See the Fabric & Finish listing in this section.

Worksurfaces – Hardware

Example: **Product:** End Panel

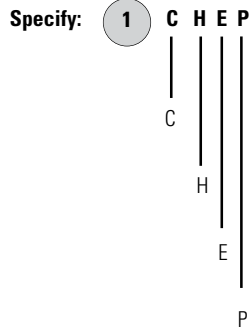

Base Code found on the product page to the left of the product name and a simple product illustration.

Compile product line.

Hardware category.

End Panel.

End **P**anel.

2 CHEP-T431

Laminte code for End Panel. See the Fabric & Finish listing in this section.

Storage

Example: **Product:** Box, Box, File Pedestal

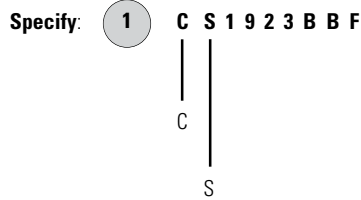

Base Code found on the product page to the left of the product name and a simple product illustration.

Compile product line.

Storage category.

2 CS1923BBF

19 Product Series.

3 CS1923BBF

23" Pedestal depth in inches.

4 CS1923BBF

Box drawer, **B**ox drawer, **F**ile drawer.



panels

THE INFORMATION LISTED BELOW PROVIDES YOU WITH BASIC FEATURES OF COMPILE PANELS:

- Compile Panels are:
 - Available in four (4) heights: 30", 42", 54" and 66"; and seven (7) widths: 24", 30" 36", 42", 48", 54" and 60".
 - 2 3/8" thick.
 - Monolithic, Segmented, Acoustic, and Glazed.
- Acoustic panels are lightly tackable with 0.70 NRC rating and a 26 STC rating.
- Compile Non - Acoustic panels are not tackable.
- Raceway openings are 1.375" x 2.680".
- Panels 24" wide include raceway covers with 2 knockouts.
- Panels 30" – 60" wide include raceway covers with 3 knockouts.
- Opposite sides of each Module may have a different fabric within the same grade at no upcharge.
- If different grades of fabric are used on one panel, the entire panel must be priced at the highest grade.
- Standard with aluminum frame.
- Individual fabric covered acoustic modules incorporated into an aluminum frame.
- Reinforced aluminum raceway covers are included when ordering panel packages or may be ordered and shipped separately. Raceway covers can be replaced in the field to change a panel from non-powered to powered (or vice versa).
- Base raceway lifts up and locks in an upright 90-degree position, or can be removed for open access to base raceway.
- Electric knockouts in the raceway have black plastic covers that snap into place from the outside of the cover, when a duplex is not required. Electric knockout covers must be specified separately. Available in standard paint finishes.
- 3 panel connector brackets per side for 30"h, 42"h and 54"h come installed on panels and universal posts.
- 4 panel connector brackets per side for 66"h panels come installed on panels and universal posts.
- Panel connector brackets are opposite direction of each other per panel side, and can be removed with one screw per bracket.



MONOLITHIC PANEL PACKAGES - PAGES 16 & 17, 22-25

Non-Powered Compile Monolithic Fabric Panel Package

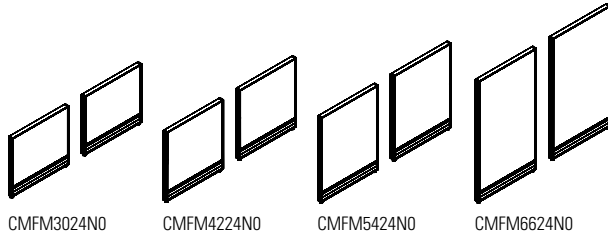

CMFM3024N0 CMFM4224N0 CMFM5424N0 CMFM6624N0

Powered Compile Monolithic Fabric Panel Package

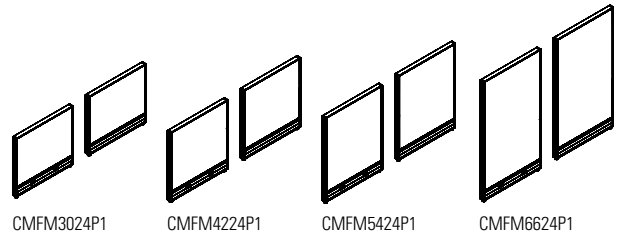

CMFM3024P1 CMFM4224P1 CMFM5424P1 CMFM6624P1

Non-Powered Compile Monolithic Fabric Panel Package

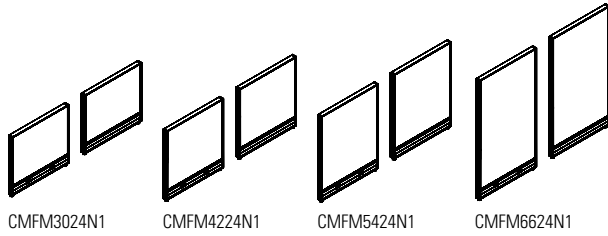

CMFM3024N1 CMFM4224N1 CMFM5424N1 CMFM6624N1

Powered Compile Monolithic Fabric Panel Package

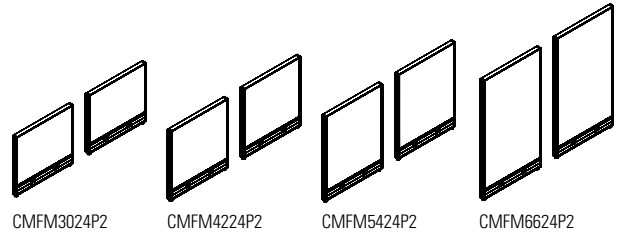

CMFM3024P2 CMFM4224P2 CMFM5424P2 CMFM6624P2

Non-Powered Compile Monolithic Fabric Panel Package

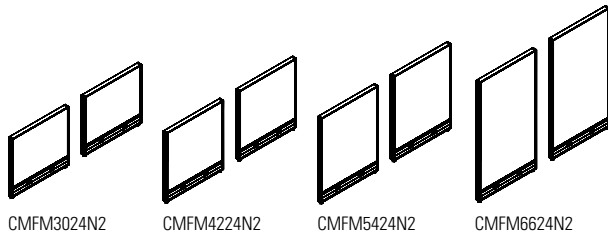

CMFM3024N2 CMFM4224N2 CMFM5424N2 CMFM6624N2

Non-Powered Compile Monolithic Laminate Panel Package

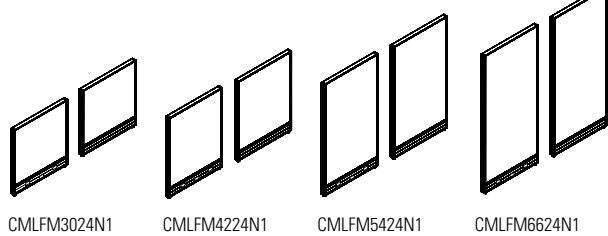

CMLFM3024N1 CMLFM4224N1 CMLFM5424N1 CMLFM6624N1

Non-Powered Compile Monolithic Laminate Panel Package

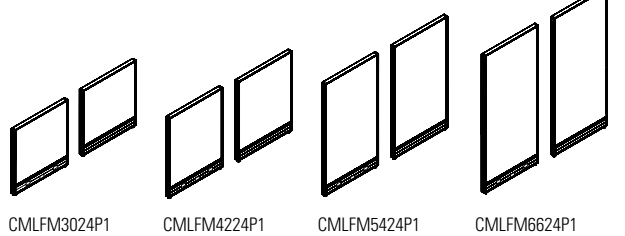

CMLFM3024P1 CMLFM4224P1 CMLFM5424P1 CMLFM6624P1

Model Definitions:

- N0 = No punch outs on raceways.
- N1 = Raceway punch out on one side.
- N2 = Raceway punch out on both sides.
- P1 = Power harness and raceway punch out on one side.
- P2 = Power harness and raceway punch outs on two sides.

RACEWAY COVER OPTIONS (Suffix)

- (N0) No Knockouts Side 1 and Side 2
- (N1) Knockouts Side 1 – No Knockout Side 2
- (N2) Knockouts Side 1 and Side
- (P1) Knockouts Side 1 – No Knockout Side 2
- (P2) Knockouts Side 1 and Side 2

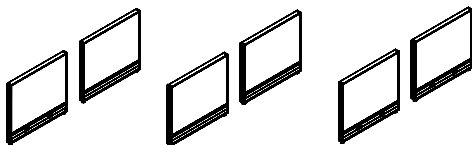

SEGMENTED - PANEL PACKAGES - PAGES 18 & 19, 26-35

Non-Powered Compile Single Segmented Fabric Panel Package

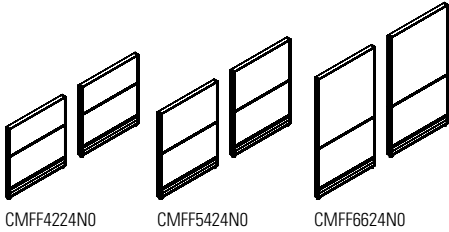

Powered Compile Single Segmented Fabric Panel Package

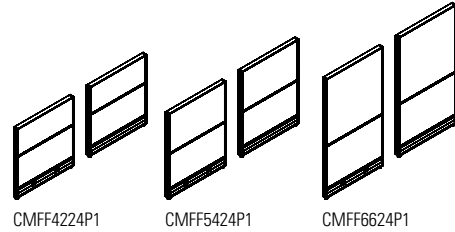

Non-Powered Compile Single Segmented Fabric Panel Package

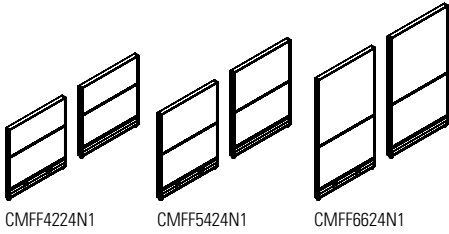

Powered Compile Single Segmented Fabric Panel Package

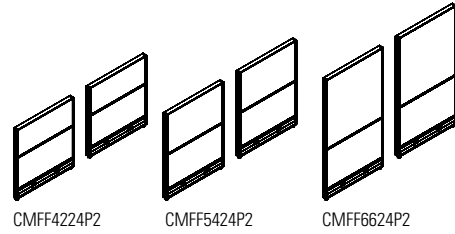

Non-Powered Compile Single Segmented Fabric Panel Package

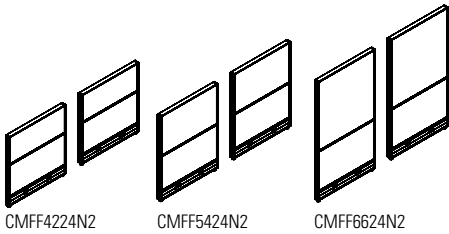

ACOUSTIC PANEL PACKAGES - PAGES 20 & 21

Non-Powered Compile Monolithic Acoustic Panel Package

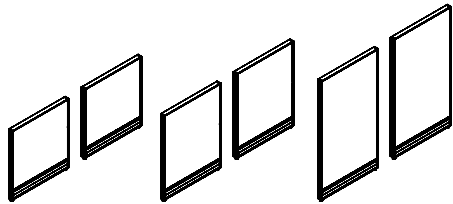

CMFMA4224N0

CMFMA5424N0

CMFMA6624N0

Powered Compile Monolithic Acoustic Panel Package

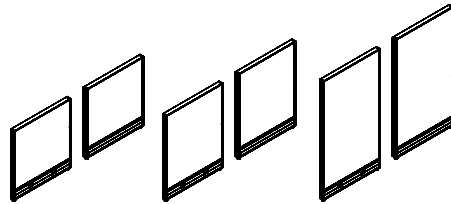

CMFMA4224P1

CMFMA5424P1

CMFMA6624P1

Non-Powered Compile Monolithic Acoustic Panel Package

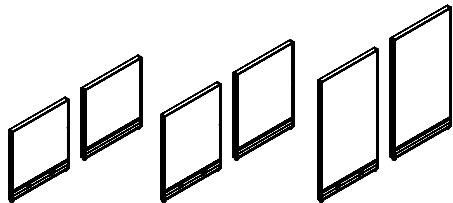

CMFMA4224N1

CMFMA5424N1

CMFMA6624N1

Powered Compile Monolithic Acoustic Panel Package

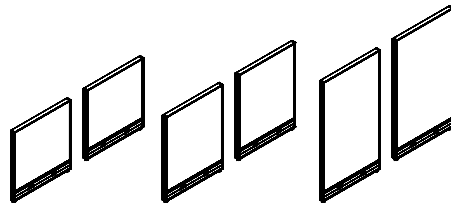

CMFMA4224P2

CMFMA5424P2

CMFMA6624P2

Non-Powered Compile Monolithic Acoustic Panel Package

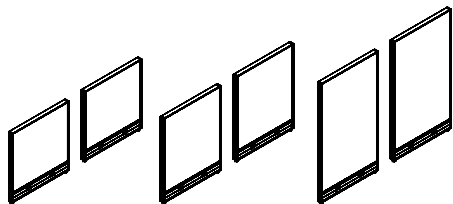

CMFMA4224N2

CMFMA5424N2

CMFMA6624N2

SINGLE SEGMENTED OPEN BOTTOM PANEL PACKAGES - PAGES 34-35

Non-Powered Compile Single Segmented Open Bottom Panel Package

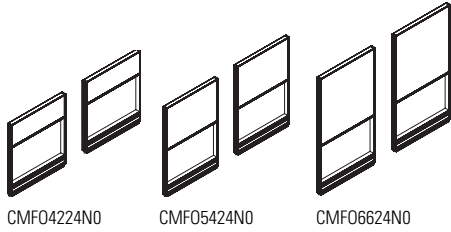

Powered Compile Single Segmented Open Bottom Panel Package

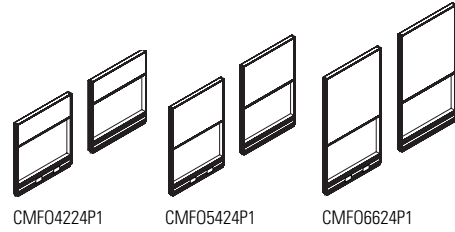

Non-Powered Compile Single Segmented Open Bottom Panel Package

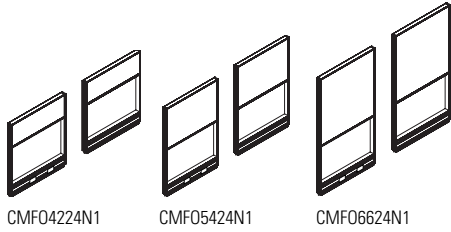

Powered Compile Single Segmented Open Bottom Panel Package

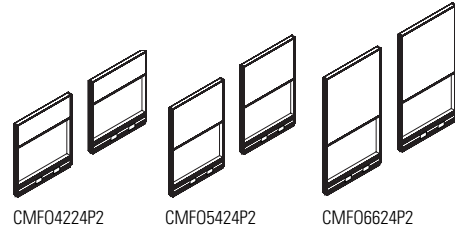

Non-Powered Compile Single Segmented Open Bottom Panel Package

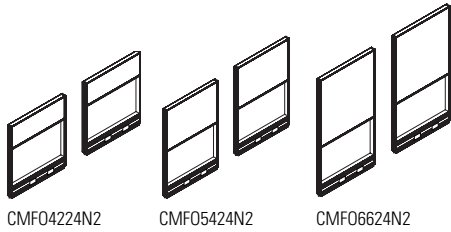

DOOR PANELS - PAGE 42

Sliding Privacy Door

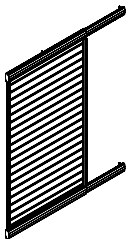

CMPDSL6636/42



GLAZED PANEL PACKAGES - PAGES 36-37

Non-Powered Compile Glazed Panel Package

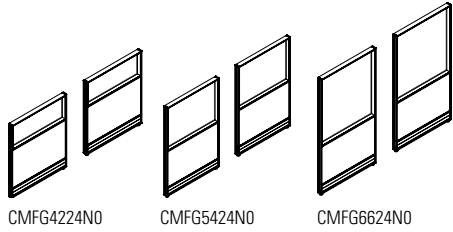

Powered Compile Glazed Panel Package

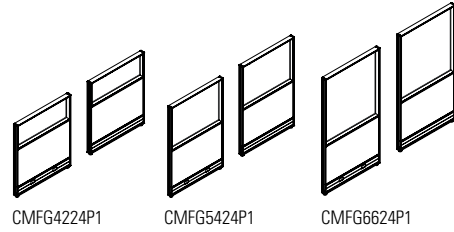

Non-Powered Compile Glazed Panel Package

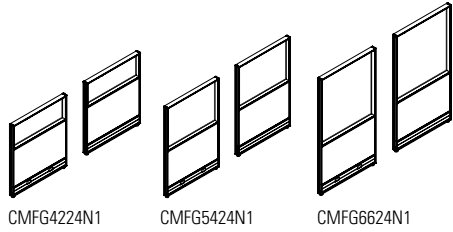

Powered Compile Glazed Panel Package

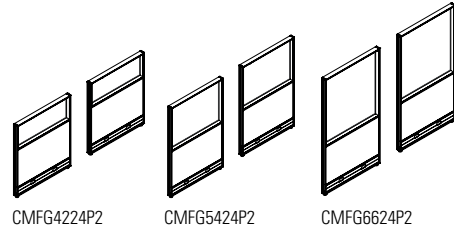

Non-Powered Compile Glazed Panel Package

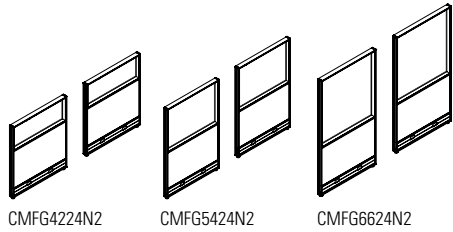

PARTLY GLAZED PANEL PACKAGES - PAGES 38-41

Non-Powered Compile Partly Glazed Panel Package

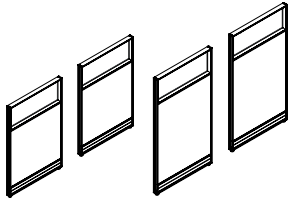

CMPG5424N0 CMPG6624N0

Powered Compile Partly Glazed Panel Package

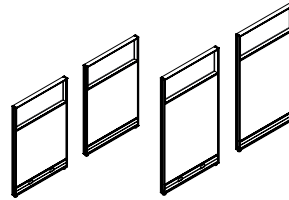

CMPG5424P1 CMPG6624P1

Non-Powered Compile Partly Glazed Panel Package

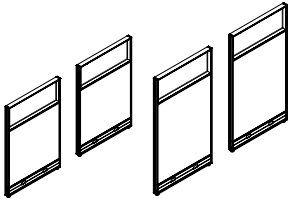

CMPG5424N1 CMPG6624N1

Powered Compile Partly Glazed Panel Package

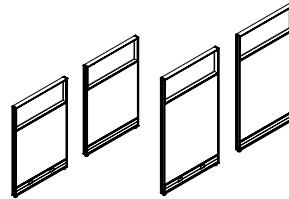

CMPG5424P2 CMPG6624P2

Non-Powered Compile Partly Glazed Panel Package

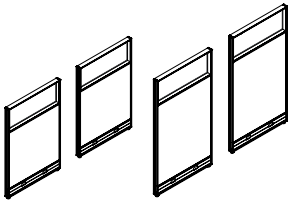

CMPG5424N2 CMPG6624N2

Compile Privacy Glass

Available in widths from 24" to 60".

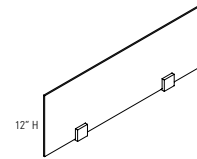

CMPS30

MINI PANEL KIT - PAGE 43

Mini Panel Kit

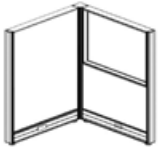

CMFMA2418KIT1



This page provides an exploded view of a sample Panel Package highlighting each **Panel** component included within the package.

Package Components

Package 1 CMFM6636N0

- A. (1) 66" h x 36" w Monolithic Fabric Panel
- B. (2) 36" w Raceway Covers Without Knockouts

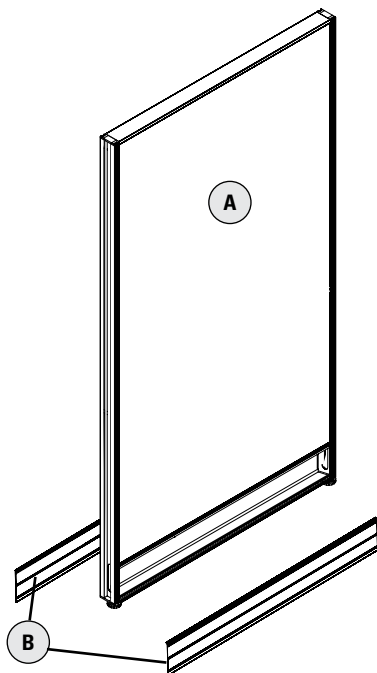

Package 2 CMFF6636P2

- C. (1) 66" h x 36" w Single Segmented Fabric Panel
- D. (2) 36" w Raceway Covers With Knockouts
- E. (1) 36" w Power Distribution Housing

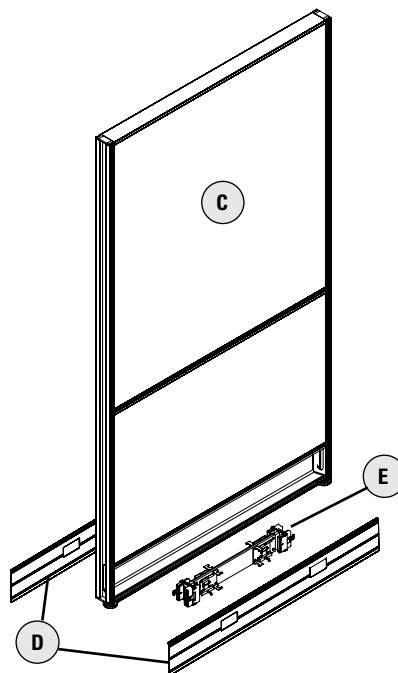

Package 3 CHP66-2

- F. (1) 66" h Universal Corner Post
- G. (2) Trim Inserts for 66" Universal Corner Post
- H. (1) Post Base Cover for 2-Way Application
- I. "Quick Connect" comes standard with Panels and Universal Corner Post

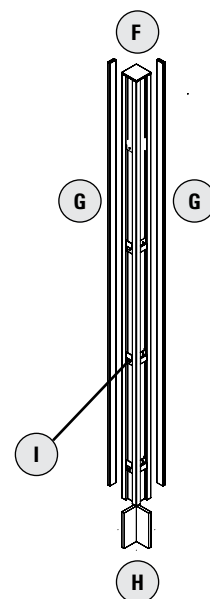

CMFMXXYYN - NON-POWERED COMPILE FABRIC MONOLITHIC PANEL PACKAGE

- Non powered.
- Includes one panel and two raceway covers with no punchouts.
- Individual fabric-covered modules incorporated into an aluminum frame.
- Opposite sides of each module may have a different fabric within the same grade at no upcharge.
- If different grades of fabric are used on one panel, the entire panel must be priced at highest grade.
- Panels are not tackable or acoustical.
- Note: Trim is not required at a straight connection between two panels of the same height.
- 3 Panel connector brackets per side come standard with 30”h, 42”h, 48”h and 54”h panels.
- 4 Panel connector brackets per side come standard with 66”h panels.
- Panels contain leveling glides. Maximum extension of glides is 2”.

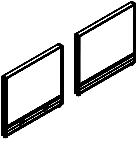
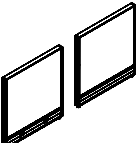
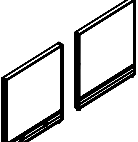
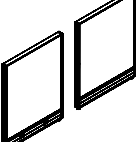
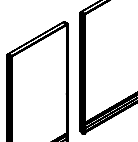
	DESCRIPTION	PRODUCT CODE	LIST PRICE		DIMENSIONS/INCHES		
			Gr1	Gr2	H	W	D
	Non-Powered Compile Fabric Monolithic Panel Package - 30"	CMFM3024N_	331	361	30	24	2 3/8
		CMFM3030N_	374	403	30	30	2 3/8
		CMFM3036N_	406	465	30	36	2 3/8
		CMFM3042N_	449	507	30	42	2 3/8
		CMFM3048N_	477	534	30	48	2 3/8
		CMFM3054N_	528	585	30	54	2 3/8
		CMFM3060N_	557	613	30	60	2 3/8
	Non-Powered Compile Fabric Monolithic Panel Package - 42"	CMFM4224N_	331	361	42	24	2 3/8
		CMFM4230N_	374	403	42	30	2 3/8
		CMFM4236N_	406	465	42	36	2 3/8
		CMFM4242N_	449	507	42	42	2 3/8
		CMFM4248N_	477	534	42	48	2 3/8
		CMFM4254N_	528	585	42	54	2 3/8
		CMFM4260N_	557	613	42	60	2 3/8
	Non-Powered Compile Fabric Monolithic Panel Package - 48"	CMFM4824N_	345	379	48	24	2 3/8
		CMFM4830N_	391	424	48	30	2 3/8
		CMFM4836N_	435	501	48	36	2 3/8
		CMFM4842N_	484	552	48	42	2 3/8
		CMFM4848N_	509	578	48	48	2 3/8
		CMFM4854N_	551	618	48	54	2 3/8
		CMFM4860N_	602	667	48	60	2 3/8
	Non-Powered Compile Fabric Monolithic Panel Package - 54"	CMFM5424N_	346	381	54	24	2 3/8
		CMFM5430N_	391	426	54	30	2 3/8
		CMFM5436N_	436	503	54	36	2 3/8
		CMFM5442N_	484	553	54	42	2 3/8
		CMFM5448N_	510	579	54	48	2 3/8
		CMFM5454N_	552	621	54	54	2 3/8
		CMFM5460N_	602	669	54	60	2 3/8
	Non-Powered Compile Fabric Monolithic Panel Package - 66"	CMFM6624N_	387	431	66	24	2 3/8
		CMFM6630N_	444	489	66	30	2 3/8
		CMFM6636N_	507	591	66	36	2 3/8
		CMFM6642N_	570	654	66	42	2 3/8
		CMFM6648N_	616	701	66	48	2 3/8
		CMFM6654N_	686	770	66	54	2 3/8
		CMFM6660N_	753	838	66	60	2 3/8

Raceway Cover Options (1) Shown

- **RACEWAY COVER OPTIONS (Suffix)**
 - (0) No Knockouts Side 1 and Side 2
 - (1) Knockouts Side 1 – No Knockout Side 2
 - (2) Knockouts Side 1 and Side 2



CMFMXXYP - POWERED COMPILE FABRIC MONOLITHIC PANEL PACKAGE

- With power distribution harness.
- Includes one panel, power harness, one raceway cover with punchout and one raceway cover with no punchout.
- Individual fabric-covered modules incorporated into an aluminum frame.
- Opposite sides of each module may have a different fabric within the same grade at no upcharge.
- If different grades of fabric are used on one panel, the entire panel must be priced at highest grade.
- Panels are not tackable or acoustical.
- Note: Trim is not required at a straight connection between two panels of the same height.
- 3 Panel connector brackets per side come standard with 30" h, 42" h, 48" h and 54" h panels.
- 4 Panel connector brackets per side come standard with 66" h panels.
- Panels contain leveling glides. Maximum extension of glides is 2".

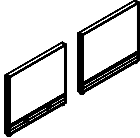
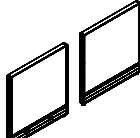
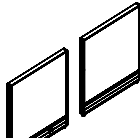
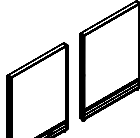
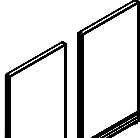
	DESCRIPTION	PRODUCT CODE	LIST PRICE		DIMENSIONS/INCHES		
			Gr1	Gr2	H	W	D
	Powered Compile Fabric Monolithic Panel Package - 30"	CMFM3024P_	471	500	30	24	2 3/8
		CMFM3030P_	562	591	30	30	2 3/8
		CMFM3036P_	604	661	30	36	2 3/8
		CMFM3042P_	650	707	30	42	2 3/8
		CMFM3048P_	694	752	30	48	2 3/8
		CMFM3054P_	745	804	30	54	2 3/8
		CMFM3060P_	776	832	30	60	2 3/8
	Powered Compile Fabric Monolithic Panel Package - 42"	CMFM4224P_	471	500	42	24	2 3/8
		CMFM4230P_	562	591	42	30	2 3/8
		CMFM4236P_	604	661	42	36	2 3/8
		CMFM4242P_	650	707	42	42	2 3/8
		CMFM4248P_	694	752	42	48	2 3/8
		CMFM4254P_	745	804	42	54	2 3/8
		CMFM4260P_	776	832	42	60	2 3/8
	Powered Compile Fabric Monolithic Panel Package - 48"	CMFM4824P_	484	519	48	24	2 3/8
		CMFM4830P_	577	611	48	30	2 3/8
		CMFM4836P_	630	698	48	36	2 3/8
		CMFM4842P_	684	752	48	42	2 3/8
		CMFM4848P_	728	795	48	48	2 3/8
		CMFM4854P_	767	836	48	54	2 3/8
		CMFM4860P_	820	887	48	60	2 3/8
	Powered Compile Fabric Monolithic Panel Package - 54"	CMFM5424P_	484	522	54	24	2 3/8
		CMFM5430P_	577	612	54	30	2 3/8
		CMFM5436P_	632	700	54	36	2 3/8
		CMFM5442P_	685	754	54	42	2 3/8
		CMFM5448P_	728	797	54	48	2 3/8
		CMFM5454P_	768	838	54	54	2 3/8
		CMFM5460P_	820	889	54	60	2 3/8
	Powered Compile Fabric Monolithic Panel Package - 66"	CMFM6624P_	525	570	66	24	2 3/8
		CMFM6630P_	632	677	66	30	2 3/8
		CMFM6636P_	704	788	66	36	2 3/8
		CMFM6642P_	770	854	66	42	2 3/8
		CMFM6648P_	834	918	66	48	2 3/8
		CMFM6654P_	904	989	66	54	2 3/8
		CMFM6660P_	971	1056	66	60	2 3/8

Raceway Cover Options (1) Shown

- **RACEWAY COVER OPTIONS (Suffix)**
 - (1) Knockouts Side 1 – No Knockout Side 2
 - (2) Knockouts Side 1 and Side 2

CMFFXXYYN - NON-POWERED COMPILE SINGLE SEGMENTED FABRIC PANEL PACKAGE

- Non powered.
- Includes one panel, two raceway covers with no punchouts.
- Individual fabric-covered modules incorporated into an aluminum frame.
- Opposite sides of each module may have a different fabric within the same grade at no upcharge.
- If different grades of fabric are used on one panel, the entire panel must be priced at highest grade.
- Panels are not tackable or acoustical.
- Note: Trim is not required at a straight connection between two panels of the same height.
- 3 Panel connector brackets per side come standard with 42”h, 48”h and 54”h panels.
- 4 Panel connector brackets per side come standard with 66”h panels.
- Panels contain leveling glides. Maximum extension of glides is 2”.

	DESCRIPTION	PRODUCT CODE	LIST PRICE		DIMENSIONS/INCHES		
			Gr1	Gr2	H	W	D
	Non-Power Compile Single Segmented Fabric Panel Package - 42"	CMFF4224N_	347	376	42	24	2 3/8
		CMFF4230N_	391	421	42	30	2 3/8
		CMFF4236N_	414	471	42	36	2 3/8
		CMFF4242N_	472	529	42	42	2 3/8
		CMFF4248N_	504	561	42	48	2 3/8
		CMFF4254N_	560	617	42	54	2 3/8
		CMFF4260N_	599	656	42	60	2 3/8
		CMFF4266N_	706	819	42	66	2 3/8
		CMFF4272N_	744	857	42	72	2 3/8
	Non-Powered Compile Single Segmented Fabric Panel Package - 48"	CMFF4824N_	378	412	48	24	2 3/8
		CMFF4830N_	419	453	48	30	2 3/8
		CMFF4836N_	473	541	48	36	2 3/8
		CMFF4842N_	536	604	48	42	2 3/8
		CMFF4848N_	579	647	48	48	2 3/8
		CMFF4854N_	616	683	48	54	2 3/8
		CMFF4860N_	662	730	48	60	2 3/8
	Non-Powered Compile Single Segmented Fabric Panel Package - 54"	CMFF5424N_	379	413	54	24	2 3/8
		CMFF5430N_	420	454	54	30	2 3/8
		CMFF5436N_	474	542	54	36	2 3/8
		CMFF5442N_	536	605	54	42	2 3/8
		CMFF5448N_	580	649	54	48	2 3/8
		CMFF5454N_	616	685	54	54	2 3/8
		CMFF5460N_	662	731	54	60	2 3/8
	Non-Powered Compile Single Segmented Fabric Panel Package - 66"	CMFF6624N_	443	487	66	24	2 3/8
		CMFF6630N_	506	551	66	30	2 3/8
		CMFF6636N_	562	647	66	36	2 3/8
		CMFF6642N_	641	726	66	42	2 3/8
		CMFF6648N_	680	764	66	48	2 3/8
		CMFF6654N_	737	821	66	54	2 3/8
		CMFF6660N_	782	866	66	60	2 3/8

Raceway Cover Options (1) Shown

- **RACEWAY COVER OPTIONS (Suffix)**
 - (0) No Knockouts Side 1 and Side 2
 - (1) Knockouts Side 1 – No Knockout Side 2
 - (2) Knockouts Side 1 and Side 2



CMFFXXYY_P - POWERED COMPILE SINGLE SEGMENTED FABRIC PANEL PACKAGE

- With power distribution harness.
- Includes one panel, power harness, one raceway cover with punchout and one raceway cover with no punchout.
- Individual fabric-covered modules incorporated into an aluminum frame.
- Opposite sides of each module may have a different fabric within the same grade at no upcharge.
- If different grades of fabric are used on one panel, the entire panel must be priced at highest grade.
- Panels are not tackable or acoustical.
- Note: Trim is not required at a straight connection between two panels of the same height.
- 3 Panel connector brackets per side come standard with 42”h, 48”h and 54”h panels.
- 4 Panel connector brackets per side come standard with 66”h panels.
- Panels contain leveling glides. Maximum extension of glides is 2”.

	DESCRIPTION	PRODUCT CODE	LIST PRICE		DIMENSIONS/INCHES		
			Gr1	Gr2	H	W	D
	Powered Compile Single Segmented Fabric Panel Package - 42”	CMFF4224P_	485	516	42	24	2 3/8
		CMFF4230P_	577	607	42	30	2 3/8
		CMFF4236P_	611	667	42	36	2 3/8
		CMFF4242P_	674	731	42	42	2 3/8
		CMFF4248P_	719	777	42	48	2 3/8
		CMFF4254P_	779	837	42	54	2 3/8
		CMFF4260P_	817	874	42	60	2 3/8
		CMFF4266P_	943	1055	42	66	2 3/8
		CMFF4272P_	994	1106	42	72	2 3/8
	Powered Compile Single Segmented Fabric Panel Package - 48”	CMFF4824P_	518	551	48	24	2 3/8
		CMFF4830P_	607	641	48	30	2 3/8
		CMFF4836P_	671	737	48	36	2 3/8
		CMFF4842P_	737	804	48	42	2 3/8
		CMFF4848P_	797	863	48	48	2 3/8
		CMFF4854P_	835	901	48	54	2 3/8
		CMFF4860P_	882	948	48	60	2 3/8
	Powered Compile Single Segmented Fabric Panel Package - 54”	CMFF5424P_	519	553	54	24	2 3/8
		CMFF5430P_	607	642	54	30	2 3/8
		CMFF5436P_	673	740	54	36	2 3/8
		CMFF5442P_	738	807	54	42	2 3/8
		CMFF5448P_	798	866	54	48	2 3/8
		CMFF5454P_	836	903	54	54	2 3/8
		CMFF5460P_	883	950	54	60	2 3/8
	Powered Compile Single Segmented Fabric Panel Package - 66”	CMFF6624P_	581	626	66	24	2 3/8
		CMFF6630P_	693	738	66	30	2 3/8
		CMFF6636P_	758	842	66	36	2 3/8
		CMFF6642P_	842	926	66	42	2 3/8
		CMFF6648P_	895	979	66	48	2 3/8
		CMFF6654P_	953	1037	66	54	2 3/8
		CMFF6660P_	1000	1084	66	60	2 3/8

Raceway Cover Options (1) Shown

- **RACEWAY COVER OPTIONS (Suffix)**
 - (1) Knockouts Side 1 – No Knockout Side 2
 - (2) Knockouts Side 1 and Side 2

CMFMAXYYN_ - NON-POWERED COMPILE MONOLITHIC ACOUSTIC PANEL PACKAGE

- Non powered.
- Includes one panel and two raceway covers with no punchouts.
- Individual fabric-covered acoustic modules incorporated into an aluminum frame.
- Opposite sides of each module may have a different fabric within the same grade at no upcharge.
- If different grades of fabric are used on one panel, the entire panel must be priced at highest grade.
- Panels are lightly tackable.
- Note: Trim is not required at a straight connection between two panels of the same height.
- 3 Panel connector brackets per side come standard with 42”h, 48”h and 54”h panels.
- 4 Panel connector brackets per side come standard with 66”h panels.
- Panels contain leveling glides. Maximum extension of glides is 2”.

	DESCRIPTION	PRODUCT CODE	LIST PRICE		DIMENSIONS/INCHES		
			Gr1	Gr2	H	W	D
	Non-Powered Compile Monolithic Acoustic Panel Package - 42”	CMFMA4224N_	394	423	42	24	2 3/8
		CMFMA4230N_	443	472	42	30	2 3/8
		CMFMA4236N_	482	539	42	36	2 3/8
		CMFMA4242N_	530	588	42	42	2 3/8
		CMFMA4248N_	563	621	42	48	2 3/8
		CMFMA4254N_	623	681	42	54	2 3/8
		CMFMA4260N_	656	713	42	60	2 3/8
	Non-Powered Compile Monolithic Acoustic Panel Package - 48”	CMFMA4824N_	411	445	48	24	2 3/8
		CMFMA4830N_	477	497	48	30	2 3/8
		CMFMA4836N_	511	580	48	36	2 3/8
		CMFMA4842N_	572	641	48	42	2 3/8
		CMFMA4848N_	604	673	48	48	2 3/8
		CMFMA4854N_	648	718	48	54	2 3/8
		CMFMA4860N_	708	778	48	60	2 3/8
	Non-Powered Compile Monolithic Acoustic Panel Package - 54”	CMFMA5424N_	411	446	54	24	2 3/8
		CMFMA5430N_	477	498	54	30	2 3/8
		CMFMA5436N_	511	580	54	36	2 3/8
		CMFMA5442N_	572	641	54	42	2 3/8
		CMFMA5448N_	604	673	54	48	2 3/8
		CMFMA5454N_	649	718	54	54	2 3/8
		CMFMA5460N_	708	778	54	60	2 3/8
	Non-Powered Compile Monolithic Acoustic Panel Package - 66”	CMFMA6624N_	459	505	66	24	2 3/8
		CMFMA6630N_	527	572	66	30	2 3/8
		CMFMA6636N_	602	686	66	36	2 3/8
		CMFMA6642N_	677	761	66	42	2 3/8
		CMFMA6648N_	731	815	66	48	2 3/8
		CMFMA6654N_	811	896	66	54	2 3/8
		CMFMA6660N_	891	975	66	60	2 3/8

Raceway Cover Options (1) Shown

- **RACEWAY COVER OPTIONS (Suffix)**
 - (0) No Knockouts Side 1 and Side 2
 - (1) Knockouts Side 1 – No Knockout Side 2
 - (2) Knockouts Side 1 and Side 2



CMFMAXYYYP - POWERED COMPILE MONOLITHIC ACOUSTIC PANEL PACKAGE

- With power distribution harness.
- Includes one panel, power harness, one raceway cover with punchout and one raceway cover with no punchout.
- Individual fabric-covered acoustic modules incorporated into an aluminum frame.
- Opposite sides of each module may have a different fabric within the same grade at no upcharge.
- If different grades of fabric are used on one panel, the entire panel must be priced at highest grade.
- Panels are lightly tackable.
- Note: Trim is not required at a straight connection between two panels of the same height.
- 3 Panel connector brackets per side come standard with 42”h, 48”h and 54”h panels.
- 4 Panel connector brackets per side come standard with 66”h panels.
- Panels contain leveling glides. Maximum extension of glides is 2”.

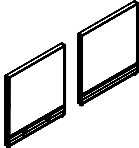
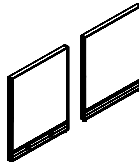
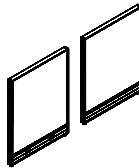
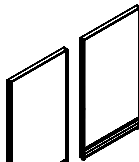
	DESCRIPTION	PRODUCT CODE	LIST PRICE		DIMENSIONS/INCHES		
			Gr1	Gr2	H	W	D
	Powered Compile Monolithic Acoustic Panel Package - 42”	CMFMA4224P_	533	562	42	24	2 3/8
		CMFMA4230P_	630	658	42	30	2 3/8
		CMFMA4236P_	680	737	42	36	2 3/8
		CMFMA4242P_	732	789	42	42	2 3/8
		CMFMA4248P_	780	838	42	48	2 3/8
		CMFMA4254P_	840	897	42	54	2 3/8
		CMFMA4260P_	873	930	42	60	2 3/8
	Powered Compile Monolithic Acoustic Panel Package - 48”	CMFMA4824P_	549	583	48	24	2 3/8
		CMFMA4830P_	649	683	48	30	2 3/8
		CMFMA4836P_	709	778	48	36	2 3/8
		CMFMA4842P_	772	841	48	42	2 3/8
		CMFMA4848P_	820	888	48	48	2 3/8
		CMFMA4854P_	867	936	48	54	2 3/8
		CMFMA4860P_	926	995	48	60	2 3/8
	Powered Compile Monolithic Acoustic Panel Package - 54”	CMFMA5424P_	551	585	54	24	2 3/8
		CMFMA5430P_	650	685	54	30	2 3/8
		CMFMA5436P_	709	779	54	36	2 3/8
		CMFMA5442P_	773	843	54	42	2 3/8
		CMFMA5448P_	820	889	54	48	2 3/8
		CMFMA5454P_	867	937	54	54	2 3/8
		CMFMA5460P_	927	996	54	60	2 3/8
	Powered Compile Monolithic Acoustic Panel Package - 66”	CMFMA6624P_	599	643	66	24	2 3/8
		CMFMA6630P_	715	760	66	30	2 3/8
		CMFMA6636P_	799	884	66	36	2 3/8
		CMFMA6642P_	875	961	66	42	2 3/8
		CMFMA6648P_	947	1031	66	48	2 3/8
		CMFMA6654P_	1029	1114	66	54	2 3/8
		CMFMA6660P_	1108	1192	66	60	2 3/8

Raceway Cover Options (1) Shown

- **RACEWAY COVER OPTIONS (Suffix)**
 - (1) Knockouts Side 1 – No Knockout Side 2
 - (2) Knockouts Side 1 and Side 2

CMLFMXXYYN - MONOLITHIC LAMINATE SINGLE SIDED PANEL – NON-POWERED

- Individual modules, one in fabric and one in laminate, incorporated into an aluminum frame.
- Modules have laminate on one side and fabric on the other.
- Opposite sides of each module may have a different laminate within the same grade at no upcharge.
- Panels are not tackable.
- 3 panel connector brackets per side come standard with 30”h, 42”h, 48”h and 54”h panels.
- 4 panel connector brackets per side come standard with 66”h panels.
- 24” wide panels have two punchouts, one for electrical and one for data.
- 30” wide panels and wider have three punchouts, two for electrical and one for data.
- Note: Trim is not required at a straight connection between two panels of the same height.

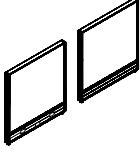
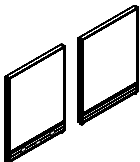
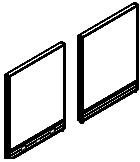
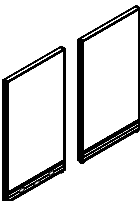
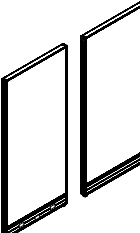
	DESCRIPTION	PRODUCT CODE	LIST PRICE		DIMENSIONS/INCHES		
			Gr1	Gr2	H	W	D
	Non-Powered Compile Monolithic Single Sided Panel Package - 30”	CMLFM3024N_	402	416	30	24	2 3/8
		CMLFM3030N_	467	476	30	30	2 3/8
		CMLFM3036N_	532	544	30	36	2 3/8
		CMLFM3042N_	604	614	30	42	2 3/8
		CMLFM3048N_	658	670	30	48	2 3/8
		CMLFM3054N_	726	740	30	54	2 3/8
		CMLFM3060N_	797	811	30	60	2 3/8
	Non-Powered Compile Monolithic Single Sided Panel Package - 42”	CMLFM4224N_	475	488	42	24	2 3/8
		CMLFM4230N_	557	571	42	30	2 3/8
		CMLFM4236N_	636	656	42	36	2 3/8
		CMLFM4242N_	721	740	42	42	2 3/8
		CMLFM4248N_	786	808	42	48	2 3/8
		CMLFM4254N_	870	895	42	54	2 3/8
		CMLFM4260N_	954	982	42	60	2 3/8
	Non-Powered Compile Monolithic Single Sided Panel Package - 48”	CMLFM4824N_	562	586	48	24	2 3/8
		CMLFM4830N_	660	677	48	30	2 3/8
		CMLFM4836N_	757	779	48	36	2 3/8
		CMLFM4842N_	858	883	48	42	2 3/8
		CMLFM4848N_	936	964	48	48	2 3/8
		CMLFM4854N_	1041	1072	48	54	2 3/8
		CMLFM4860N_	1143	1177	48	60	2 3/8
	Non-Powered Compile Monolithic Single Sided Panel Package - 54”	CMLFM5424N_	563	580	54	24	2 3/8
		CMLFM5430N_	660	681	54	30	2 3/8
		CMLFM5436N_	757	777	54	36	2 3/8
		CMLFM5442N_	859	885	54	42	2 3/8
		CMLFM5448N_	936	965	54	48	2 3/8
		CMLFM5454N_	1041	1071	54	54	2 3/8
		CMLFM5460N_	1143	1177	54	60	2 3/8
	Non-Powered Compile Monolithic Single Sided Panel Package - 66”	CMLFM6624N_	695	717	66	24	2 3/8
		CMLFM6630N_	814	839	66	30	2 3/8
		CMLFM6636N_	939	966	66	36	2 3/8
		CMLFM6642N_	1068	1099	66	42	2 3/8
		CMLFM6648N_	1161	1196	66	48	2 3/8
		CMLFM6654N_	1292	1330	66	54	2 3/8
		CMLFM6660N_	1422	1465	66	60	2 3/8

Raceway Cover Options (1) Shown

- **RACEWAY COVER OPTIONS (Suffix)**
 - (0) No Knockouts Side 1 and Side 2
 - (1) Knockouts Side 1 – No Knockout Side 2
 - (2) Knockouts Side 1 and Side 2



CMLFMXXYP - MONOLITHIC LAMINATE SINGLE SIDED PANEL – POWERED

- Individual modules, one in fabric and one in laminate, incorporated into an aluminum frame.
- Modules have laminate on one side and fabric on the other.
- Opposite sides of each module may have a different laminate within the same grade at no upcharge.
- Panels are not tackable.
- 3 panel connector brackets per side come standard with 30”h, 42”h, 48”h and 54”h panels.
- 4 panel connector brackets per side come standard with 66”h panels.
- 24” wide panels have two punchouts, one for electrical and one for data.
- 30” wide panels and wider have three punchouts, two for electrical and one for data.
- Note: Trim is not required at a straight connection between two panels of the same height.

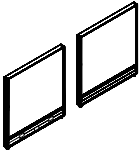
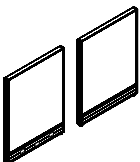
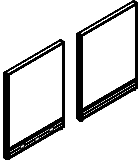
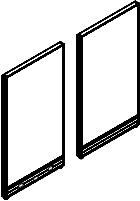
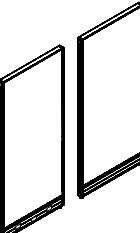
	DESCRIPTION	PRODUCT CODE	LIST PRICE		DIMENSIONS/INCHES		
			Gr1	Gr2	H	W	D
	Non-Powered Compile Monolithic Single Sided Panel Package - 30”	CMLFM3024P_	541	556	30	24	2 3/8
		CMLFM3030P_	653	717	30	30	2 3/8
		CMLFM3036P_	729	801	30	36	2 3/8
		CMLFM3042P_	805	885	30	42	2 3/8
		CMLFM3048P_	873	961	30	48	2 3/8
		CMLFM3054P_	943	1041	30	54	2 3/8
		CMLFM3060P_	1015	1120	30	60	2 3/8
	Non-Powered Compile Monolithic Single Sided Panel Package - 42”	CMLFM4224P_	614	681	42	24	2 3/8
		CMLFM4230P_	744	822	42	30	2 3/8
		CMLFM4236P_	834	925	42	36	2 3/8
		CMLFM4242P_	924	1023	42	42	2 3/8
		CMLFM4248P_	1003	1112	42	48	2 3/8
		CMLFM4254P_	1088	1212	42	54	2 3/8
		CMLFM4260P_	1175	1311	42	60	2 3/8
	Non-Powered Compile Monolithic Single Sided Panel Package - 48”	CMLFM4824P_	702	716	48	24	2 3/8
		CMLFM4830P_	847	867	48	30	2 3/8
		CMLFM4836P_	953	977	48	36	2 3/8
		CMLFM4842P_	1058	1182	48	42	2 3/8
		CMLFM4848P_	1152	1181	48	48	2 3/8
		CMLFM4854P_	1258	1291	48	54	2 3/8
		CMLFM4860P_	1362	1527	48	60	2 3/8
	Non-Powered Compile Monolithic Single Sided Panel Package - 54”	CMLFM5424P_	703	784	54	24	2 3/8
		CMLFM5430P_	847	943	54	30	2 3/8
		CMLFM5436P_	953	1059	54	36	2 3/8
		CMLFM5442P_	1058	1182	54	42	2 3/8
		CMLFM5448P_	1152	1287	54	48	2 3/8
		CMLFM5454P_	1259	1407	54	54	2 3/8
		CMLFM5460P_	1362	1527	54	60	2 3/8
	Non-Powered Compile Monolithic Single Sided Panel Package - 66”	CMLFM6624P_	836	936	66	24	2 3/8
		CMLFM6630P_	1000	1119	66	30	2 3/8
		CMLFM6636P_	1136	1269	66	36	2 3/8
		CMLFM6642P_	1267	1420	66	42	2 3/8
		CMLFM6648P_	1378	1545	66	48	2 3/8
		CMLFM6654P_	1511	1696	66	54	2 3/8
		CMLFM6660P_	1642	1846	66	60	2 3/8

Raceway Cover Options (1) Shown

- **RACEWAY COVER OPTIONS (Suffix)**
 - (0) No Knockouts Side 1 and Side 2
 - (1) Knockouts Side 1 – No Knockout Side 2
 - (2) Knockouts Side 1 and Side 2

CMLLMXXYYN - MONOLITHIC LAMINATE DOUBLE SIDED PANEL - NON-POWERED

- Individual laminate modules incorporated into an aluminum frame.
- Modules have laminate on both sides.
- Opposite sides of each module may have a different laminate within the same grade at no upcharge.
- 3 panel connector brackets per side come standard with 30”h, 42”h, 48”h and 54”h panels.
- 4 panel connector brackets per side come standard with 66”h panels.
- 24” wide panels have two punchouts, one for electrical and one for data.
- 30” wide panels and wider have three punchouts, two for electrical and one for data.
- Note: Trim is not required at a straight connection between two panels of the same height.

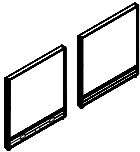
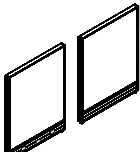
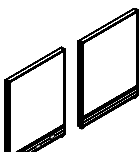
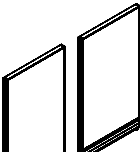
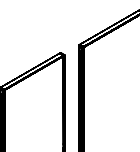
	DESCRIPTION	PRODUCT CODE	LIST PRICE Gr1	DIMENSIONS/INCHES		
				H	W	D
	Non-Powered Compile Monolithic	CMLLM3024N_	443	30	24	2 3/8
	Double Sided Laminate Panel Package - 30”	CMLLM3030N_	524	30	30	2 3/8
		CMLLM3036N_	598	30	36	2 3/8
		CMLLM3042N_	682	30	42	2 3/8
		CMLLM3048N_	763	30	48	2 3/8
		CMLLM3054N_	843	30	54	2 3/8
		CMLLM3060N_	910	30	60	2 3/8
	Non-Powered Compile Monolithic	CMLLM4224N_	524	42	24	2 3/8
	Double Sided Laminate Panel Package - 42”	CMLLM4230N_	616	42	30	2 3/8
		CMLLM4236N_	718	42	36	2 3/8
		CMLLM4242N_	817	42	42	2 3/8
		CMLLM4248N_	916	42	48	2 3/8
		CMLLM4254N_	1009	42	54	2 3/8
		CMLLM4260N_	1095	42	60	2 3/8
	Non-Powered Compile Monolithic	CMLLM4824N_	638	48	24	2 3/8
	Double Sided Laminate Panel Package - 48”	CMLLM4830N_	756	48	30	2 3/8
		CMLLM4836N_	877	48	36	2 3/8
		CMLLM4842N_	1002	48	42	2 3/8
		CMLLM4848N_	1127	48	48	2 3/8
		CMLLM4854N_	1241	48	54	2 3/8
		CMLLM4860N_	1312	48	60	2 3/8
	Non-Powered Compile Monolithic	CMLLM5424N_	638	54	24	2 3/8
	Double Sided Laminate Panel Package - 54”	CMLLM5430N_	756	54	30	2 3/8
		CMLLM5436N_	878	54	36	2 3/8
		CMLLM5442N_	1003	54	42	2 3/8
		CMLLM5448N_	1128	54	48	2 3/8
		CMLLM5454N_	1241	54	54	2 3/8
		CMLLM5460N_	1312	54	60	2 3/8
	Non-Powered Compile Monolithic	CMLLM6624N_	784	66	24	2 3/8
	Double Sided Laminate Panel Package - 66”	CMLLM6630N_	927	66	30	2 3/8
		CMLLM6636N_	1075	66	36	2 3/8
		CMLLM6642N_	1231	66	42	2 3/8
		CMLLM6648N_	1381	66	48	2 3/8
		CMLLM6654N_	1524	66	54	2 3/8
		CMLLM6660N_	1664	66	60	2 3/8

Raceway Cover Options (1) Shown

- **RACEWAY COVER OPTIONS (Suffix)**
 - (0) No Knockouts Side 1 and Side 2
 - (1) Knockouts Side 1 – No Knockout Side 2
 - (2) Knockouts Side 1 and Side 2



CMLLMXXYP - MONOLITHIC LAMINATE DOUBLE SIDED PANEL – POWERED

- Individual laminate modules incorporated into an aluminum frame.
- Modules have laminate on both sides.
- Opposite sides of each module may have a different laminate within the same grade at no upcharge.
- 3 panel connector brackets per side come standard with 30”h, 42”h, 48”h and 54”h panels.
- 4 panel connector brackets per side come standard with 66”h panels.
- 24” wide panels have two punchouts, one for electrical and one for data.
- 30” wide panels and wider have three punchouts, two for electrical and one for data.
- Note: Trim is not required at a straight connection between two panels of the same height.

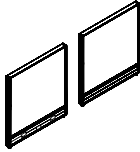
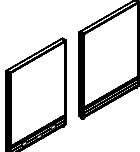
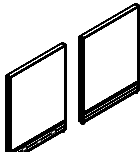
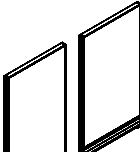
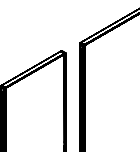
	DESCRIPTION	PRODUCT CODE	LIST PRICE Gr1	DIMENSIONS/INCHES		
				H	W	D
	Powered Compile Monolithic	CMLLM3024P_	579	30	24	2 3/8
	Double Sided Laminate Panel Package - 30”	CMLLM3030P_	706	30	30	2 3/8
		CMLLM3036P_	789	30	36	2 3/8
		CMLLM3042P_	875	30	42	2 3/8
		CMLLM3048P_	971	30	48	2 3/8
		CMLLM3054P_	1054	30	54	2 3/8
		CMLLM3060P_	1123	30	60	2 3/8
	Powered Compile Monolithic	CMLLM4224P_	659	42	24	2 3/8
	Double Sided Laminate Panel Package - 42”	CMLLM4230P_	799	42	30	2 3/8
		CMLLM4236P_	909	42	36	2 3/8
		CMLLM4242P_	1013	42	42	2 3/8
		CMLLM4248P_	1126	42	48	2 3/8
		CMLLM4254P_	1219	42	54	2 3/8
		CMLLM4260P_	1309	42	60	2 3/8
	Powered Compile Monolithic	CMLLM4824P_	777	48	24	2 3/8
	Double Sided Laminate Panel Package - 48”	CMLLM4830P_	943	48	30	2 3/8
		CMLLM4836P_	1075	48	36	2 3/8
		CMLLM4842P_	1204	48	42	2 3/8
		CMLLM4848P_	1344	48	48	2 3/8
		CMLLM4854P_	1460	48	54	2 3/8
		CMLLM4860P_	1525	48	60	2 3/8
	Powered Compile Monolithic	CMLLM5424P_	777	54	24	2 3/8
	Double Sided Laminate Panel Package - 54”	CMLLM5430P_	944	54	30	2 3/8
		CMLLM5436P_	1075	54	36	2 3/8
		CMLLM5442P_	1204	54	42	2 3/8
		CMLLM5448P_	1345	54	48	2 3/8
		CMLLM5454P_	1461	54	54	2 3/8
		CMLLM5460P_	1525	54	60	2 3/8
	Powered Compile Monolithic	CMLLM6624P_	918	66	24	2 3/8
	Double Sided Laminate Panel Package - 66”	CMLLM6630P_	1110	66	30	2 3/8
		CMLLM6636P_	1266	66	36	2 3/8
		CMLLM6642P_	1426	66	42	2 3/8
		CMLLM6648P_	1590	66	48	2 3/8
		CMLLM6654P_	1735	66	54	2 3/8
		CMLLM6660P_	1877	66	60	2 3/8

Raceway Cover Options (1) Shown

- **RACEWAY COVER OPTIONS (Suffix)**
 - (0) No Knockouts Side 1 and Side 2
 - (1) Knockouts Side 1 – No Knockout Side 2
 - (2) Knockouts Side 1 and Side 2

CMFLXXYYN - SEGMENTED LAMINATE SINGLE SIDED PANEL – NON-POWERED

- Individual fabric or laminate covered modules incorporated into an aluminum frame.
- Modules have laminate on one side and fabric on the other.
- Opposite sides of each module may have a different laminate within the same grade at no upcharge.
- If different grades of fabric are used on one panel, the entire panel must be priced at highest grade.
- Panels are not tackable.
- Note: Trim is not required at a straight connection between two panels of the same height.
- 3 Panel connector brackets per side come standard with 42”h, 48h” and 54”h panels.
- 4 Panel connector brackets per side come standard with 66”h panels.
- 24” wide panels have two punchouts, one for electrical and one for data.
- 30” wide panels and wider have three punchouts, two for electrical and one for data.

	DESCRIPTION	PRODUCT CODE	LIST PRICE		DIMENSIONS/INCHES		
			Gr1	Gr2	H	W	D
	Non-Powered Compile Single Segmented Laminate Panel Package - 42"	CMFL4224N_	475	488	42	24	2.38
		CMFL4230N_	557	571	42	30	2.38
		CMFL4236N_	636	656	42	36	2.38
		CMFL4242N_	721	740	42	42	2.38
		CMFL4248N_	786	808	42	48	2.38
		CMFL4254N_	870	895	42	54	2.38
		CMFL4260N_	954	982	42	60	2.38
	Non-Powered Compile Single Segmented Laminate Panel Package - 48"	CMFL4824N_	562	579	48	24	2.38
		CMFL4830N_	660	677	48	30	2.38
		CMFL4836N_	757	779	48	36	2.38
		CMFL4842N_	858	885	48	42	2.38
		CMFL4848N_	936	965	48	48	2.38
		CMFL4854N_	1041	1071	48	54	2.38
		CMFL4860N_	1143	1178	48	60	2.38
	Non-Powered Compile Single Segmented Laminate Panel Package - 54"	CMFL5424N_	563	580	54	24	2.38
		CMFL5430N_	660	681	54	30	2.38
		CMFL5436N_	757	777	54	36	2.38
		CMFL5442N_	859	885	54	42	2.38
		CMFL5448N_	936	965	54	48	2.38
		CMFL5454N_	1041	1071	54	54	2.38
		CMFL5460N_	1143	1177	54	60	2.38
	Non-Powered Compile Single Segmented Lmainate Panel Package - 66"	CMFL6624N_	695	717	66	24	2.38
		CMFL6630N_	814	839	66	30	2.38
		CMFL6636N_	939	966	66	36	2.38
		CMFL6642N_	1068	1099	66	42	2.38
		CMFL6648N_	1161	1196	66	48	2.38
		CMFL6654N_	1292	1330	66	54	2.38
		CMFL6660N_	1422	1465	66	60	2.38

Raceway Cover Options (1) Shown

- **RACEWAY COVER OPTIONS (Suffix)**
 - (0) No Knockouts Side 1 and Side 2
 - (1) Knockouts Side 1 – No Knockout Side 2
 - (2) Knockouts Side 1 and Side 2



CMFLXXYP_ - SEGMENTED LAMINATE SINGLE SIDED PANEL – POWERED

- Individual fabric or laminate covered modules incorporated into an aluminum frame.
- Modules have laminate on one side and fabric on the other.
- Opposite sides of each module may have a different laminate within the same grade at no upcharge.
- If different grades of fabric are used on one panel, the entire panel must be priced at highest grade.
- Panels are not tackable.
- Note: Trim is not required at a straight connection between two panels of the same height.
- 3 Panel connector brackets per side come standard with 42”h, 48h” and 54”h panels.
- 4 Panel connector brackets per side come standard with 66”h panels.
- 24” wide panels have two punchouts, one for electrical and one for data.
- 30” wide panels and wider have three punchouts, two for electrical and one for data.

	DESCRIPTION	PRODUCT CODE	LIST PRICE		DIMENSIONS/INCHES		
			Gr1	Gr2	H	W	D
	Powered Compile Single Segmented Laminate Panel Package - 42”	CMFL4224P_	614	681	42	24	2 3/8
		CMFL4230P_	744	822	42	30	2 3/8
		CMFL4236P_	834	925	42	36	2 3/8
		CMFL4242P_	924	1023	42	42	2 3/8
		CMFL4248P_	1003	1112	42	48	2 3/8
		CMFL4254P_	1088	1212	42	54	2 3/8
		CMFL4260P_	1175	1311	42	60	2 3/8
	Powered Compile Single Segmented Laminate Panel Package - 48”	CMFL4824P_	702	785	48	24	2 3/8
		CMFL4830P_	847	945	48	30	2 3/8
		CMFL4836P_	953	1062	48	36	2 3/8
		CMFL4842P_	1058	1183	48	42	2 3/8
		CMFL4848P_	1152	1288	48	48	2 3/8
		CMFL4854P_	1258	1408	48	54	2 3/8
		CMFL4860P_	1362	1528	48	60	2 3/8
	Powered Compile Single Segmented Laminate Panel Package - 54”	CMFL5424P_	703	784	54	24	2 3/8
		CMFL5430P_	847	943	54	30	2 3/8
		CMFL5436P_	953	1059	54	36	2 3/8
		CMFL5442P_	1058	1182	54	42	2 3/8
		CMFL5448P_	1152	1287	54	48	2 3/8
		CMFL5454P_	1259	1407	54	54	2 3/8
		CMFL5460P_	1362	1527	54	60	2 3/8
	Powered Compile Single Segmented Laminate Panel Package - 66”	CMFL6624P_	836	936	66	24	2 3/8
		CMFL6630P_	836	936	66	30	2 3/8
		CMFL6636P_	1101	1269	66	36	2 3/8
		CMFL6642P_	1267	1420	66	42	2 3/8
		CMFL6648P_	1378	1545	66	48	2 3/8
		CMFL6654P_	1511	1696	66	54	2 3/8
		CMFL6660P_	1642	1846	66	60	2 3/8

Raceway Cover Options (1) Shown

- **RACEWAY COVER OPTIONS (Suffix)**
 - (1) Knockouts Side 1 – No Knockout Side 2
 - (2) Knockouts Side 1 and Side 2

CMLLXXYYN - SEGMENTED LAMINATE DOUBLE SIDED PANEL – NON-POWERED

- Individual laminate covered modules incorporated into an aluminum frame. same height.
- Modules have laminate on one side and fabric on the other.
- Opposite sides of each module may have a different laminate within the same grade at no upcharge.
- If different grades of fabric are used on one panel, the entire panel must be priced at highest grade.
- Note: Trim is not required at a straight connection between two panels of the
- 3 Panel connector brackets per side come standard with 42”h, 48h” and 54”h panels.
- 4 Panel connector brackets per side come standard with 66”h panels.
- 24” wide panels have two punchouts, one for electrical and one for data.
- 30” wide panels and wider have three punchouts, two for electrical and one for data.

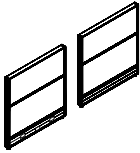
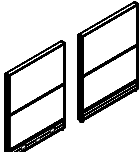
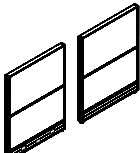
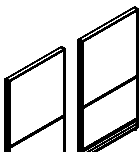
	DESCRIPTION	PRODUCT CODE	LIST PRICE Gr1	DIMENSIONS/INCHES		
				H	W	D
	Non-Powered Compile Single Segmented	CMLL4224N_	540	42	24	2 3/8
	Double Sided Laminate Panel Package - 42”	CMLL4230N_	635	42	30	2 3/8
		CMLL4236N_	740	42	36	2 3/8
		CMLL4242N_	843	42	42	2 3/8
		CMLL4248N_	944	42	48	2 3/8
		CMLL4254N_	1038	42	54	2 3/8
		CMLL4260N_	1129	42	60	2 3/8
	Non-Powered Compile Single Segmented	CMLL4824N_	638	48	24	2 3/8
	Double Sided Laminate Panel Package - 48”	CMLL4830N_	756	48	30	2 3/8
		CMLL4836N_	877	48	36	2 3/8
		CMLL4842N_	1002	48	42	2 3/8
		CMLL4848N_	1127	48	48	2 3/8
		CMLL4854N_	1241	48	54	2 3/8
		CMLL4860N_	1350	48	60	2 3/8
	Non-Powered Compile Single Segmented	CMLL5424N_	638	54	24	2 3/8
	Double Sided Laminate Panel Package - 54”	CMLL5430N_	756	54	30	2 3/8
		CMLL5436N_	878	54	36	2 3/8
		CMLL5442N_	1003	54	42	2 3/8
		CMLL5448N_	1128	54	48	2 3/8
		CMLL5454N_	1241	54	54	2 3/8
		CMLL5460N_	1351	54	60	2 3/8
	Non-Powered Compile Single Segmented	CMLL6624N_	808	66	24	2 3/8
	Double Sided Laminate Panel Package - 66”	CMLL6630N_	954	66	30	2 3/8
		CMLL6636N_	1107	66	36	2 3/8
		CMLL6642N_	1268	66	42	2 3/8
		CMLL6648N_	1422	66	48	2 3/8
		CMLL6654N_	1569	66	54	2 3/8
		CMLL6660N_	1715	66	60	2 3/8

Raceway Cover Options (1) Shown

- **RACEWAY COVER OPTIONS (Suffix)**
 - (0) No Knockouts Side 1 and Side 2
 - (1) Knockouts Side 1 – No Knockout Side 2
 - (2) Knockouts Side 1 and Side 2



CMLLXXYP_ - SEGMENTED LAMINATE DOUBLE SIDED PANEL – POWERED

- Individual laminate covered modules incorporated into an aluminum frame.
- Modules have laminate on one side and fabric on the other.
- Opposite sides of each module may have a different laminate within the same grade at no upcharge.
- If different grades of fabric are used on one panel, the entire panel must be priced at highest grade.
- Note: Trim is not required at a straight connection between two panels of the same height.
- 3 Panel connector brackets per side come standard with 42”h, 48h” and 54”h panels.
- 4 Panel connector brackets per side come standard with 66” panels.
- 24” wide panels have two punchouts, one for electrical and one for data.
- 30” wide panels and wider have three punchouts, two for electrical and one for data.

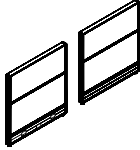
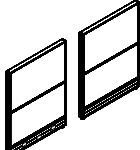
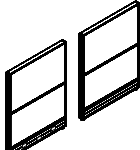
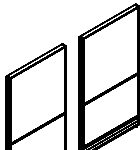

	DESCRIPTION	PRODUCT CODE	LIST PRICE Gr1	DIMENSIONS/INCHES		
				H	W	D
	Powered Compile Single Segmented	CMLL4224P_	680	42	24	2.38
	Double Sided Laminate Panel Package - 42”	CMLL4230P_	823	42	30	2.38
		CMLL4236P_	938	42	36	2.38
		CMLL4242P_	1045	42	42	2.38
		CMLL4248P_	1160	42	48	2.38
		CMLL4254P_	1257	42	54	2.38
		CMLL4260P_	1348	42	60	2.38
	Powered Compile Single Segmented	CMLL4824P_	777	48	24	2.38
	Double Sided Laminate Panel Package - 48”	CMLL4830P_	943	48	30	2.38
		CMLL4836P_	1075	48	36	2.38
		CMLL4842P_	1204	48	42	2.38
		CMLL4848P_	1344	48	48	2.38
		CMLL4854P_	1460	48	54	2.38
		CMLL4860P_	1570	48	60	2.38
	Powered Compile Single Segmented	CMLL5424P_	777	54	24	2.38
	Double Sided Laminate Panel Package - 54”	CMLL5430P_	944	54	30	2.38
		CMLL5436P_	1075	54	36	2.38
		CMLL5442P_	1204	54	42	2.38
		CMLL5448P_	1345	54	48	2.38
		CMLL5454P_	1461	54	54	2.38
		CMLL5460P_	1570	54	60	2.38
	Powered Compile Single Segmented	CMLL6624P_	947	66	24	2.38
	Double Sided Laminate Panel Package - 66”	CMLL6630P_	1143	66	30	2.38
		CMLL6636P_	1304	66	36	2.38
		CMLL6642P_	1470	66	42	2.38
		CMLL6648P_	1638	66	48	2.38
		CMLL6654P_	1787	66	54	2.38
		CMLL6660P_	1934	66	60	2.38

Raceway Cover Options (1) Shown

- **RACEWAY COVER OPTIONS (Suffix)**
 - (0) No Knockouts Side 1 and Side 2
 - (1) Knockouts Side 1 – No Knockout Side 2
 - (2) Knockouts Side 1 and Side 2

CMFWXXYYN_ - SEGMENTED WRITE BOARD SINGLE SIDED PANEL – NON-POWERED

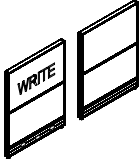
- Individual fabric or write board covered modules incorporated into an aluminum frame.
- Modules have write board on one side and fabric on the other at the top and fabric on two sides at the bottom.
- Opposite sides of each module may have a different fabric within the same grade at no upcharge.
- If different grades of fabric are used on one panel, the entire panel must be priced at highest grade.
- Panels are not tackable.
- Note: Trim is not required at a straight connection between two panels of the same height.
- 3 Panel connector brackets per side come standard with 48”h. and 54”h. panels.
- 4 Panel connector brackets per side come standard with 66”h. panels.
- 24” wide panels have two punchouts, one for electrical and one for data.
- 30” wide panels and wider have three punchouts, two for electrical and one for data.

	DESCRIPTION	PRODUCT CODE	LIST PRICE		DIMENSIONS/INCHES		
			Gr1	Gr2	H	W	D
	Non-Powered Compile Write Board Single Sided Panel Package - 48” No punchouts	CMFW4824N_	504	527	48	24	2 3/8
		CMFW4830N_	609	636	48	30	2 3/8
		CMFW4836N_	675	706	48	36	2 3/8
		CMFW4842N_	761	636	48	42	2 3/8
		CMFW4848N_	856	897	48	48	2 3/8
		CMFW4854N_	951	984	48	54	2 3/8
		CMFW4860N_	1047	1102	48	60	2 3/8
	Non-Powered Compile Write Board Single Sided Panel Package - 54”	CMFW5424N_	505	524	54	24	2 3/8
		CMFW5430N_	610	631	54	30	2 3/8
		CMFW5436N_	676	696	54	36	2 3/8
		CMFW5442N_	762	788	54	42	2 3/8
		CMFW5448N_	857	887	54	48	2 3/8
		CMFW5454N_	951	984	54	54	2 3/8
		CMFW5460N_	1048	1102	54	60	2 3/8
	Non-Powered Compile Write Board Single Sided Panel Package - 66”	CMFW6624N_	617	638	66	24	2 3/8
		CMFW6630N_	734	757	66	30	2 3/8
		CMFW6636N_	816	843	66	36	2 3/8
		CMFW6642N_	925	953	66	42	2 3/8
		CMFW6648N_	1031	1066	66	48	2 3/8
		CMFW6654N_	1146	1182	66	54	2 3/8
		CMFW6660N_	1266	1306	66	60	2 3/8



Raceway Cover Options (1) Shown

- **RACEWAY COVER OPTIONS (Suffix)**
 - (0) No Knockouts Side 1 and Side 2
 - (1) Knockouts Side 1 – No Knockout Side 2
 - (2) Knockouts Side 1 and Side 2



CMFWXXYYP_ - SEGMENTED WRITE BOARD SINGLE SIDED PANEL – POWERED

- Individual fabric or write board covered modules incorporated into an aluminum frame.
- Modules have write board on one side and fabric on the other at the top and fabric on two sides at the bottom.
- Opposite sides of each module may have a different fabric within the same grade at no upcharge.
- If different grades of fabric are used on one panel, the entire panel must be priced at highest grade.
- Panels are not tackable.
- Note: Trim is not required at a straight connection between two panels of the same height.
- 3 Panel connector brackets per side come standard with 48”h. and 54”h. panels.
- 4 Panel connector brackets per side come standard with 66”h. panels.
- 24” wide panels have two punchouts, one for electrical and one for data.
- 30” wide panels and wider have three punchouts, two for electrical and one for data.

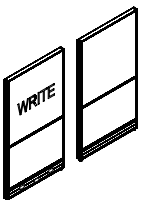

	DESCRIPTION	PRODUCT CODE	LIST PRICE		DIMENSIONS/INCHES		
			Gr1	Gr2	H	W	D
	Powered Compile Write Board Single Sided Panel Package - 48” Punchouts on one side	CMFW4824P_	642	665	48	24	2 3/8
		CMFW4830P_	797	824	48	30	2 3/8
		CMFW4836P_	871	903	48	36	2 3/8
		CMFW4842P_	961	1000	48	42	2 3/8
		CMFW4848P_	1072	1112	48	48	2 3/8
		CMFW4854P_	1170	1200	48	54	2 3/8
		CMFW4860P_	1266	1320	48	60	2 3/8
	Powered Compile Write Board Single Sided Panel Package - 54”	CMFW5424P_	644	663	54	24	2 3/8
		CMFW5430P_	798	819	54	30	2 3/8
		CMFW5436P_	871	892	54	36	2 3/8
		CMFW5442P_	962	988	54	42	2 3/8
		CMFW5448P_	1072	1102	54	48	2 3/8
		CMFW5454P_	1171	1201	54	54	2 3/8
		CMFW5460P_	1266	1303	54	60	2 3/8
	Powered Compile Write Board Single Sided Panel Package - 66”	CMFW6624P_	753	773	66	24	2 3/8
		CMFW6630P_	916	940	66	30	2 3/8
		CMFW6636P_	1009	1035	66	36	2 3/8
		CMFW6642P_	1119	1148	66	42	2 3/8
		CMFW6648P_	1242	1275	66	48	2 3/8
		CMFW6654P_	1357	1394	66	54	2 3/8
		CMFW6660P_	1478	1521	66	60	2 3/8

Raceway Cover Options (1) Shown

- **RACEWAY COVER OPTIONS (Suffix)**
 - (0) No Knockouts Side 1 and Side 2
 - (1) Knockouts Side 1 – No Knockout Side 2
 - (2) Knockouts Side 1 and Side 2

CMWWXXYYN_ - SEGMENTED WRITE BOARD DOUBLE SIDED PANEL – NON-POWERED

- Individual fabric or write board covered modules incorporated into an aluminum frame.
- Modules have write board on two sides at the top and fabric on two sides at the bottom.
- Opposite sides of each module may have a different fabric within the same grade at no upcharge.
- If different grades of fabric are used on one panel, the entire panel must be priced at highest grade.
- Panels are not tackable.
- Note: Trim is not required at a straight connection between two panels of the same height.
- 3 Panel connector brackets per side come standard with 48”h. and 54”h. panels.
- 4 Panel connector brackets per side come standard with 66”h. panels.
- 24” wide panels have two punchouts, one for electrical and one for data.
- 30” wide panels and wider have three punchouts, two for electrical and one for data.

	DESCRIPTION	PRODUCT CODE	LIST PRICE		DIMENSIONS/INCHES		
			Gr1	Gr2	H	W	D
	Non-Powered Compile Write Board Single Segmented Panel Package - 48” No Punchouts	CMWW4824N_	552	565	48	24	2.38
		CMWW4830N_	686	704	48	30	2.38
		CMWW4836N_	742	767	48	36	2.38
		CMWW4842N_	842	868	48	42	2.38
		CMWW4848N_	986	1015	48	48	2.38
		CMWW4854N_	1094	1127	48	54	2.38
		CMWW4860N_	1206	1240	48	60	2.38
	Non-Powered Compile Write Board Single Segmented Panel Package - 54”	CMWW5424N_	553	580	54	24	2.38
		CMWW5430N_	686	716	54	30	2.38
		CMWW5436N_	742	800	54	36	2.38
		CMWW5442N_	843	898	54	42	2.38
		CMWW5448N_	986	1042	54	48	2.38
		CMWW5454N_	1095	1151	54	54	2.38
		CMWW5460N_	1206	1263	54	60	2.38
	Non-Powered Compile Write Board Single Segmented Panel Package - 66”	CMWW6624N_	682	711	66	24	2.38
		CMWW6630N_	836	863	66	30	2.38
		CMWW6636N_	842	897	66	36	2.38
		CMWW6642N_	1034	1091	66	42	2.38
		CMWW6648N_	1189	1244	66	48	2.38
		CMWW6654N_	1327	1384	66	54	2.38
		CMWW6660N_	1463	1519	66	60	2.38



Raceway Cover Options (1) Shown

- **RACEWAY COVER OPTIONS (Suffix)**
 - (0) No Knockouts Side 1 and Side 2
 - (1) Knockouts Side 1 – No Knockout Side 2
 - (2) Knockouts Side 1 and Side 2



CMWWXYYP_ - SEGMENTED WRITE BOARD DOUBLE SIDED PANEL – POWERED

- Individual fabric or write board covered modules incorporated into an aluminum frame.
- Modules have write board on two sides at the top and fabric on two sides at the bottom.
- Opposite sides of each module may have a different fabric within the same grade at no upcharge.
- If different grades of fabric are used on one panel, the entire panel must be priced at highest grade.
- Panels are not tackable.
- Note: Trim is not required at a straight connection between two panels of the same height.
- 3 Panel connector brackets per side come standard with 48”h. and 54”h. panels.
- 4 Panel connector brackets per side come standard with 66”h. panels.
- 24” wide panels have two punchouts, one for electrical and one for data.
- 30” wide panels and wider have three punchouts, two for electrical and one for data.

	DESCRIPTION	PRODUCT CODE	LIST PRICE		DIMENSIONS/INCHES		
			Gr1	Gr2	H	W	D
	Powered Compile Write Board	CMWW4824P_	691	705	48	24	2 3/8
	Single Segmented Panel Package - 48"	CMWW4830P_	873	891	48	30	2 3/8
	Punchouts on one side	CMWW4836P_	940	963	48	36	2 3/8
		CMWW4842P_	1044	1068	48	42	2 3/8
		CMWW4848P_	1201	1231	48	48	2 3/8
		CMWW4854P_	1312	1345	48	54	2 3/8
		CMWW4860P_	1425	1457	48	60	2 3/8
	Powered Compile Write Board	CMWW5424P_	691	719	54	24	2 3/8
	Single Segmented Panel Package - 54"	CMWW5430P_	873	903	54	30	2 3/8
		CMWW5436P_	940	996	54	36	2 3/8
		CMWW5442P_	1045	1101	54	42	2 3/8
		CMWW5448P_	1201	1259	54	48	2 3/8
		CMWW5454P_	1313	1369	54	54	2 3/8
		CMWW5460P_	1425	1480	54	60	2 3/8
	Powered Compile Write Board	CMWW6624P_	820	848	66	24	2 3/8
	Single Segmented Panel Package - 66"	CMWW6630P_	1022	1052	66	30	2 3/8
		CMWW6636P_	1108	1164	66	36	2 3/8
		CMWW6642P_	1234	1291	66	42	2 3/8
		CMWW6648P_	1406	1463	66	48	2 3/8
		CMWW6654P_	1545	1601	66	54	2 3/8
		CMWW6660P_	1682	1737	66	60	2 3/8

Raceway Cover Options (1) Shown

- **RACEWAY COVER OPTIONS (Suffix)**
 - (0) No Knockouts Side 1 and Side 2
 - (1) Knockouts Side 1 – No Knockout Side 2
 - (2) Knockouts Side 1 and Side 2

CMFOXXYYN_ - COMPILE SINGLE SEGMENTED OPEN BOTTOM PANEL PACKAGE – NON-POWERED

- Non powered.
- Includes one panel and two raceways covers with no punchouts and a integrated aluminum top cap.
- Individual fabric-covered module in upper position incorporated into an aluminum frame. Bottom is open.
- Opposite sides of each module may have a different fabric within the same grade at no upcharge.
- If different grades of fabric are used on one panel, the entire panel must be priced at highest grade.
- Panels are not tackable or acoustical.
- Trim is not required at a straight connection between two panels of the same height.
- 3 Panel connector brackets per side come standard with 42”h, 48”h and 54”h panels.
- 4 Panel connector brackets per side come standard with 66”h panels.
- Panels contain leveling glides. Maximum extension of glides is 2”.

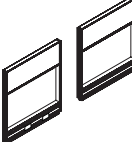
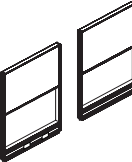
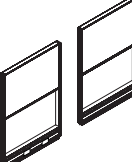
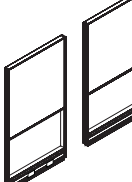
	DESCRIPTION	PRODUCT CODE	LIST PRICE		DIMENSIONS/INCHES		
			Gr1	Gr2	H	W	D
	Non-Powered Compile Single Segmented Open Bottom Panel Package - 42"	CMFO4224N_	322	336	42	24	2 3/8
		CMFO4230N_	361	372	42	30	2 3/8
		CMFO4236N_	383	405	42	36	2 3/8
		CMFO4242N_	438	460	42	42	2 3/8
		CMFO4248N_	466	489	42	48	2 3/8
		CMFO4254N_	520	549	42	54	2 3/8
		CMFO4260N_	555	578	42	60	2 3/8
	Non-Powered Compile Single Segmented Open Bottom Panel Package - 48"	CMFO4824N_	348	367	48	24	2 3/8
		CMFO4830N_	390	406	48	30	2 3/8
		CMFO4836N_	438	455	48	36	2 3/8
		CMFO4842N_	497	530	48	42	2 3/8
		CMFO4848N_	536	570	48	48	2 3/8
		CMFO4854N_	570	604	48	54	2 3/8
		CMFO4860N_	613	647	48	60	2 3/8
	Non-Powered Compile Single Segmented Open Bottom Panel Package - 54"	CMFO5424N_	349	368	54	24	2 3/8
		CMFO5430N_	390	407	54	30	2 3/8
		CMFO5436N_	439	456	54	36	2 3/8
		CMFO5442N_	497	531	54	42	2 3/8
		CMFO5448N_	536	571	54	48	2 3/8
		CMFO5454N_	570	605	54	54	2 3/8
		CMFO5460N_	614	649	54	60	2 3/8
	Non-Powered Compile Single Segmented Open Bottom Panel Package - 66"	CMFO6624N_	409	438	66	24	2 3/8
		CMFO6630N_	469	497	66	30	2 3/8
		CMFO6636N_	521	571	66	36	2 3/8
		CMFO6642N_	593	643	66	42	2 3/8
		CMFO6648N_	628	679	66	48	2 3/8
		CMFO6654N_	682	732	66	54	2 3/8
		CMFO6660N_	723	772	66	60	2 3/8



Raceway Cover Options (1) Shown

- **RACEWAY COVER OPTIONS (Suffix)**
 - (0) No Knockouts Side 1 and Side 2
 - (1) Knockouts Side 1 – No Knockout Side 2
 - (2) Knockouts Side 1 and Side 2

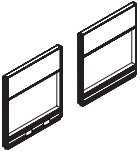
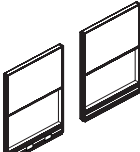
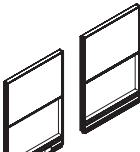

CMFOXXYP - COMPILE SINGLE SEGMENTED - OPEN BOTTOM PANEL PACKAGE – POWERED

- With power distribution harness.
- Includes one panel, power harness, one raceway cover with punchout, one raceway cover without punchout and a integrated aluminum top cap.
- Individual fabric-covered module in upper position incorporated into an aluminum frame. Bottom is open.
- Opposite sides of each module may have a different fabric within the same grade at no upcharge.
- If different grades of fabric are used on one panel, the entire panel must be priced at highest grade.
- Panels are not tackable or acoustical.
- Trim is not required at a straight connection between two panels of the same height.
- 3 Panel connector brackets per side come standard with 42”h, 48”h and 54”h panels.
- 4 Panel connector brackets per side come standard with 66”h panels.
- Panels contain leveling glides. Maximum extension of glides is 2”.
- 24” wide panels have one punchout, 30” wide panels or wider have two punchouts.

	DESCRIPTION	PRODUCT CODE	LIST PRICE		DIMENSIONS/INCHES		
			Gr1	Gr2	H	W	D
	Powered Compile Single Segmented Open Bottom Panel Package - 42”	CMFO4224P_	449	464	42	24	2 3/8
		CMFO4230P_	534	549	42	30	2 3/8
		CMFO4236P_	563	587	42	36	2 3/8
		CMFO4242P_	622	645	42	42	2 3/8
		CMFO4248P_	663	687	42	48	2 3/8
		CMFO4254P_	719	731	42	54	2 3/8
	Powered Compile Single Segmented Open Bottom Panel Package - 48”	CMFO4824P_	477	496	48	24	2 3/8
		CMFO4830P_	560	577	48	30	2 3/8
		CMFO4836P_	621	638	48	36	2 3/8
		CMFO4842P_	681	715	48	42	2 3/8
		CMFO4848P_	735	769	48	48	2 3/8
		CMFO4854P_	770	804	48	54	2 3/8
	Powered Compile Single Segmented Open Bottom Panel Package - 54”	CMFO5424P_	477	496	54	24	2 3/8
		CMFO5430P_	562	579	54	30	2 3/8
		CMFO5436P_	621	640	54	36	2 3/8
		CMFO5442P_	682	717	54	42	2 3/8
		CMFO5448P_	737	772	54	48	2 3/8
		CMFO5454P_	772	807	54	54	2 3/8
	Powered Compile Single Segmented Open Bottom Panel Package - 66”	CMFO6624P_	537	565	66	24	2 3/8
		CMFO6630P_	640	668	6	30	2 3/8
		CMFO6636P_	702	753	66	36	2 3/8
		CMFO6642P_	777	826	66	42	2 3/8
		CMFO6648P_	825	876	66	48	2 3/8
		CMFO6654P_	882	931	66	54	2 3/8
CMFO6660P_	926	977	66	60	2 3/8		

Raceway Cover Options (1) Shown

- **RACEWAY COVER OPTIONS (Suffix)**
 - (1) Knockouts Side 1 – No Knockout Side 2
 - (2) Knockouts Side 1 and Side 2

CMFGXXYYN - COMPILE GLAZED PANEL PACKAGE – NON-POWERED

- Non powered.
- Includes one panel and two raceway covers with no punchouts.
- Individual fabric-covered module in lower position incorporated into a solid steel frame.
- Opposite sides of each module may have a different fabric within the same grade at no upcharge.
- If different grades of fabric are used on one panel, the entire panel must be priced at highest grade.
- Panels are not tackable or acoustical.
- Trim is not required at a straight connection between two panels of the same height.
- 3 Panel connector brackets per side come standard with 42”h, 48”h and 54”h panels.
- 4 Panel connector brackets per side come standard with 66”h panels.
- Panels contain leveling glides. Maximum extension of glides is 2”.
- Standard clear (CLR) plexi.
- Optional Smoked Plexi-Glass or Frosted Plexi with 15% upcharge. Please note the smoked glass has 51% light transmittance.
- PVC glass retainer in matching paint color.
- Glazing starts at 29” high to the top of the panel.

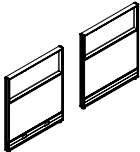
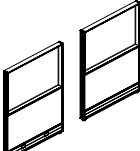
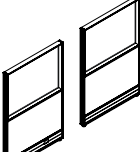
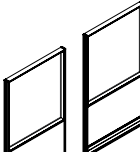
	DESCRIPTION	PRODUCT CODE	LIST PRICE		DIMENSIONS/INCHES		
			Gr1	Gr2	H	W	D
	Non-Powered Compile Glazed Panel Package - 42"	CMFG4224N_	436	450	42	24	2.38
		CMFG4230N_	497	514	42	30	2.38
		CMFG4236N_	556	578	42	36	2.38
		CMFG4242N_	621	645	42	42	2.38
		CMFG4248N_	680	706	42	48	2.38
		CMFG4254N_	764	792	42	54	2.38
		CMFG4260N_	842	873	42	60	2.38
	Non-Powered Compile Glazed Panel Package - 48"	CMFG4824N_	469	485	48	24	2.38
		CMFG4830N_	549	568	48	30	2.38
		CMFG4836N_	624	647	48	36	2.38
		CMFG4842N_	700	724	48	42	2.38
		CMFG4848N_	763	790	48	48	2.38
		CMFG4854N_	889	919	48	54	2.38
		CMFG4860N_	1005	1040	48	60	2.38
	Non-Powered Compile Glazed Panel Package - 54"	CMFG5424N_	470	486	54	24	2.38
		CMFG5430N_	551	570	54	30	2.38
		CMFG5436N_	624	647	54	36	2.38
		CMFG5442N_	702	726	54	42	2.38
		CMFG5448N_	764	791	54	48	2.38
		CMFG5454N_	890	919	54	54	2.38
		CMFG5460N_	1006	1041	54	60	2.38
	Non-Powered Compile Glazed Panel Package - 66"	CMFG6624N_	589	612	66	24	2.38
		CMFG6630N_	684	712	66	30	2.38
		CMFG6636N_	780	810	66	36	2.38
		CMFG6642N_	878	917	66	42	2.38
		CMFG6648N_	952	994	66	48	2.38
		CMFG6654N_	1102	1147	66	54	2.38
		CMFG6660N_	1244	1291	66	60	2.38

Raceway Cover Options (1) Shown

- **RACEWAY COVER OPTIONS (Suffix)**
 - (0) No Knockouts Side 1 and Side 2
 - (1) Knockouts Side 1 – No Knockout Side 2
 - (2) Knockouts Side 1 and Side 2



CMFGXXYP - COMPILE GLAZED PANEL PACKAGE – POWERED

- With power distribution harness.
- Includes one panel, power harness, one raceway cover with punchout and one raceway cover with no punchout.
- Individual fabric-covered modules incorporated into an aluminum frame.
- Opposite sides of each module may have a different fabric within the same grade at no upcharge.
- If different grades of fabric are used on one panel, the entire panel must be priced at highest grade.
- Panels are not tackable or acoustical.
- Trim is not required at a straight connection between two panels of the same height.
- 3 Panel connector brackets per side come standard with 42”h, 48”h and 54”h panels.
- 4 Panel connector brackets per side come standard with 66”h panels.
- Panels contain leveling glides. Maximum extension of glides is 2”.
- Standard clear (CLR) plexi.
- Optional Smoked Plexi-Glass or Frosted Plexi with 15% upcharge. Please note the smoked glass has 51% light transmittance
- PVC glass retainer in matching paint color.
- Glazing starts at 29” high to the top of the panel.

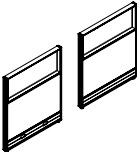
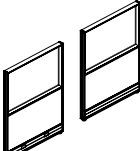
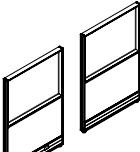
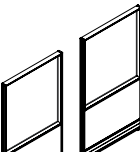
	DESCRIPTION	PRODUCT CODE	LIST PRICE		DIMENSIONS/INCHES		
			Gr1	Gr2	H	W	D
	Powered Compile Glazed Panel Package - 42”	CMFG4224P_	574	589	42	24	2 3/8
		CMFG4230P_	684	701	42	30	2 3/8
		CMFG4236P_	753	774	42	36	2 3/8
		CMFG4242P_	820	846	42	42	2 3/8
		CMFG4248P_	895	922	42	48	2 3/8
		CMFG4254P_	980	1009	42	54	2 3/8
		CMFG4260P_	1059	1093	42	60	2 3/8
	Powered Compile Glazed Panel Package - 48”	CMFG4824P_	607	624	48	24	2 3/8
		CMFG4830P_	735	754	48	30	2 3/8
		CMFG4836P_	820	843	48	36	2 3/8
		CMFG4842P_	901	924	48	42	2 3/8
		CMFG4848P_	978	1006	48	48	2 3/8
		CMFG4854P_	1105	1135	48	54	2 3/8
		CMFG4860P_	1224	1258	48	60	2 3/8
	Powered Compile Glazed Panel Package - 54”	CMFG5424P_	607	624	54	24	2 3/8
		CMFG5430P_	737	757	54	30	2 3/8
		CMFG5436P_	820	844	54	36	2 3/8
		CMFG5442P_	901	925	54	42	2 3/8
		CMFG5448P_	979	1007	54	48	2 3/8
		CMFG5454P_	1106	1136	54	54	2 3/8
		CMFG5460P_	1225	1260	54	60	2 3/8
	Powered Compile Glazed Panel Package - 66”	CMFG6624P_	728	751	66	24	2 3/8
		CMFG6630P_	871	899	66	30	2 3/8
		CMFG6636P_	977	1007	66	36	2 3/8
		CMFG6642P_	1079	1118	66	42	2 3/8
		CMFG6648P_	1171	1211	66	48	2 3/8
		CMFG6654P_	1318	1363	66	54	2 3/8
		CMFG6660P_	1465	1512	66	60	2 3/8

Raceway Cover Options (1) Shown

- **RACEWAY COVER OPTIONS (Suffix)**
 - (1) Knockouts Side 1 – No Knockout Side 2
 - (2) Knockouts Side 1 and Side 2

CMPGXXYYN_ - COMPILER PARTLY GLAZED PANEL PACKAGE – NON-POWERED

- Non powered.
- Includes one panel and two raceway covers with no punchouts.
- Individual fabric-covered module in lower position incorporated into a solid steel frame.
- Opposite sides of each module may have a different fabric within the same grade at no upcharge.
- If different grades of fabric are used on one panel, the entire panel must be priced at highest grade.
- Panels are not tackable or acoustical.
- Trim is not required at a straight connection between two panels of the same height.
- 3 Panel connector brackets per side come standard with 48”h and 54”h panels.
- 4 Panel connector brackets per side come standard with 66”h panels.
- Panels contain leveling glides. Maximum extension of glides is 2”.
- Standard clear (CLR) plexi.
- Optional Smoked Plexi-Glass or Frosted Plexi with 10% upcharge. Please note the smoked glass has 51% light transmittance
- PVC glass retainer in matching paint color.
- Glazing is 14” nominal from the top of the panel.

	DESCRIPTION	PRODUCT CODE	LIST PRICE		DIMENSIONS/INCHES		
			Gr1	Gr2	H	W	D
	Non-Powered Compile Partly Glazed Panel Package - 48"	CMPG4824N_	500	538	48	24	2 3/8
		CMPG4830N_	576	625	48	30	2 3/8
		CMPG4836N_	642	692	48	36	2 3/8
		CMPG4842N_	715	778	48	42	2 3/8
		CMPG4848N_	789	864	48	48	2 3/8
		CMPG4854N_	871	948	48	54	2 3/8
		CMPG4860N_	947	1032	48	60	2 3/8
	Non-Powered Compile Partly Glazed Panel Package - 54"	CMPG5424N_	500	539	54	24	2 3/8
		CMPG5430N_	576	625	54	30	2 3/8
		CMPG5436N_	644	694	54	36	2 3/8
		CMPG5442N_	716	778	54	42	2 3/8
		CMPG5448N_	789	864	54	48	2 3/8
		CMPG5454N_	871	949	54	54	2 3/8
		CMPG5460N_	948	1033	54	60	2 3/8
	Non-Powered Compile Partly Glazed Panel Package - 66"	CMPG6624N_	549	590	66	24	2 3/8
		CMPG6630N_	629	679	66	30	2 3/8
		CMPG6636N_	705	834	66	36	2 3/8
		CMPG6642N_	785	847	66	42	2 3/8
		CMPG6648N_	868	942	66	48	2 3/8
		CMPG6654N_	956	1032	66	54	2 3/8
		CMPG6660N_	1041	1123	66	60	2 3/8

Raceway Cover Options (1) Shown

- **RACEWAY COVER OPTIONS (Suffix)**
 - (0) No Knockouts Side 1 and Side 2
 - (1) Knockouts Side 1 – No Knockout Side 2
 - (2) Knockouts Side 1 and Side 2



CMPGXXYP_ - COMPILER PARTLY GLAZED PANEL PACKAGE – POWERED

- With power distribution harness.
- Includes one panel, power harness, one raceway cover with punchout and one raceway cover with no punchout.
- Individual fabric-covered modules incorporated into an aluminum frame.
- Opposite sides of each module may have a different fabric within the same grade at no upcharge.
- If different grades of fabric are used on one panel, the entire panel must be priced at highest grade.
- Panels are not tackable or acoustical.
- Trim is not required at a straight connection between two panels of the same height.
- 3 Panel connector brackets per side come standard with 48”h and 54”h panels.
- 4 Panel connector brackets per side come standard with 66”h panels.
- Panels contain leveling glides. Maximum extension of glides is 2”.
- Standard clear (CLR) plexi.
- Optional Smoked Plexi-Glass or Frosted Plexi with 15% upcharge. Please note the smoked glass has 51% light transmittance
- PVC glass retainer in matching paint color.
- Glazing is 14” nominal from the top of the panel.

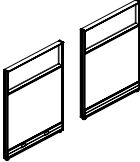
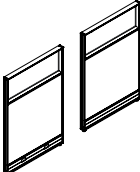
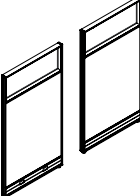
	DESCRIPTION	PRODUCT CODE	LIST PRICE		DIMENSIONS/INCHES		
			Gr1	Gr2	H	W	D
	Powered Compile Partly Glazed Panel Package - 48"	CMPG4824P_	640	678	48	24	2 3/8
		CMPG4830P_	764	813	48	2 3/8	
		CMPG4836P_	839	889	48	36	2 3/8
		CMPG4842P_	916	977	48	42	2 3/8
		CMPG4848P_	1006	1080	48	48	2 3/8
		CMPG4854P_	1088	1166	48	54	2 3/8
		CMPG4860P_	1165	1251	48	60	2 3/8
	Powered Compile Partly Glazed Panel Package - 54"	CMPG5424P_	640	680	54	24	2 3/8
		CMPG5430P_	765	814	54	30	2 3/8
		CMPG5436P_	840	890	54	36	2 3/8
		CMPG5442P_	916	978	54	42	2 3/8
		CMPG5448P_	1007	1081	54	48	2 3/8
		CMPG5454P_	1089	1166	54	54	2 3/8
		CMPG5460P_	1165	1251	54	60	2 3/8
	Powered Compile Partly Glazed Panel Package - 66"	CMPG6624P_	686	728	66	24	2 3/8
		CMPG6630P_	816	866	66	30	2 3/8
		CMPG6636P_	901	1030	66	36	2 3/8
		CMPG6642P_	986	1048	66	42	2 3/8
		CMPG6648P_	1083	1157	66	48	2 3/8
		CMPG6654P_	1175	1250	66	54	2 3/8
		CMPG6660P_	1260	1342	66	60	2 3/8

Raceway Cover Options (1) Shown

- **RACEWAY COVER OPTIONS (Suffix)**
 - (1) Knockouts Side 1 – No Knockout Side 2
 - (2) Knockouts Side 1 and Side 2

CMPLGXXYYN - SINGLE 12" GLAZED AT TOP PANEL - NON-POWERED

- Individual fabric-covered module in lower position with 12" H glazed module in upper position incorporated into an aluminum frame.
- Opposite sides of each module may have a different fabric within the same grade at no upcharge.
- If different grades of fabric are used on one panel, the entire panel must be priced at highest grade.
- Panels are not tackable.
- Note: Trim is not required at a straight connection between two panels of the same height.
- 3 Panel connector brackets per side come standard with 42"h, 48"h and 54"h

- panels.
- 4 Panel connector brackets per side come standard with 66"h. panels.
- Standard clear (CLR) plexi.
- Optional smoked (SMK) plexi-glass or frosted (FRST) plexi.
- 24" wide panels have two punchouts, one for electrical and one for data.
- 30" wide panels and wider have three punchouts, two for electrical and one for data.
- Glazing is 12" nominal from the top of the panel.

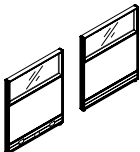
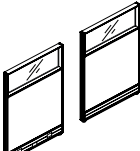
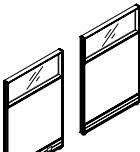
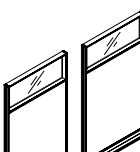
	DESCRIPTION	PRODUCT CODE	LIST PRICE		DIMENSIONS/INCHES		
			Gr1	Gr2	H	W	D
	Non-Powered Compile 12" Top Glazed Single Segmented Panel Package - 42"	CMPLG4224N_	479	496	42	24	2 3/8
		CMPLG4230N_	560	576	42	30	2 3/8
		CMPLG4236N_	642	675	42	36	2 3/8
		CMPLG4242N_	715	746	42	42	2 3/8
		CMPLG4248N_	777	810	42	48	2 3/8
		CMPLG4254N_	868	900	42	54	2 3/8
	Non-Powered Compile 12" Top Glazed Single Segmented Panel Package - 48"	CMPLG4824N_	490	505	48	24	2 3/8
		CMPLG4830N_	564	580	48	30	2 3/8
		CMPLG4836N_	630	662	48	36	2 3/8
		CMPLG4842N_	700	732	48	42	2 3/8
		CMPLG4848N_	766	798	48	48	2 3/8
		CMPLG4854N_	856	886	48	54	2 3/8
	Non-Powered Compile 12" Top Glazed Single Segmented Panel Package - 54"	CMPLG5424N_	492	508	54	24	2 3/8
		CMPLG5430N_	564	580	54	30	2 3/8
		CMPLG5436N_	632	663	54	36	2 3/8
		CMPLG5442N_	702	734	54	42	2 3/8
		CMPLG5448N_	776	809	54	48	2 3/8
		CMPLG5454N_	857	890	54	54	2 3/8
	Non-Powered Compile 12" Top Glazed Single Segmented Panel Package - 66"	CMPLG6624N_	536	569	66	24	2 3/8
		CMPLG6630N_	616	649	66	30	2 3/8
		CMPLG6636N_	692	757	66	36	2 3/8
		CMPLG6642N_	770	837	66	42	2 3/8
		CMPLG6648N_	852	917	66	48	2 3/8
		CMPLG6654N_	939	1006	66	54	2 3/8
		CMPLG6660N_	1021	1088	66	60	2 3/8

Raceway Cover Options (1) Shown

- **RACEWAY COVER OPTIONS (Suffix)**
 - (0) No Knockouts Side 1 and Side 2
 - (1) Knockouts Side 1 – No Knockout Side 2
 - (2) Knockouts Side 1 and Side 2



CMPLGXXYP_ - SINGLE 12" GLAZED AT TOP PANEL – POWERED

- Individual fabric-covered module in lower position with 12" H glazed module in upper position incorporated into an aluminum frame.
- Opposite sides of each module may have a different fabric within the same grade at no upcharge.
- If different grades of fabric are used on one panel, the entire panel must be priced at highest grade.
- Panels are not tackable.
- Note: Trim is not required at a straight connection between two panels of the same height.
- 3 Panel connector brackets per side come standard with 42" h, 48" h and 54" h panels.
- 4 Panel connector brackets per side come standard with 66" h panels.
- Standard clear (CLR) plexi.
- Optional smoked (SMK) plexi-glass or frosted (FRST) plexi.
- 24" wide panels have two punchouts, one for electrical and one for data.
- 30" wide panels and wider have three punchouts, two for electrical and one for data.
- Please specify duplex receptacles separately.
- Glazing is 12" nominal from the top of the panel.

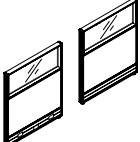
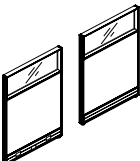
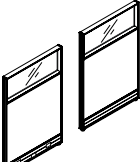
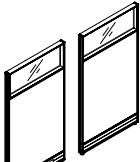
	DESCRIPTION	PRODUCT CODE	LIST PRICE		DIMENSIONS/INCHES		
			Gr1	Gr2	H	W	D
	Powered Compile 12" Top Glazed Single Segmented Panel Package - 42"	CMPLG4224P_	618	635	42	24	2 3/8
		CMPLG4230P_	747	765	42	30	2 3/8
		CMPLG4236P_	839	871	42	36	2 3/8
		CMPLG4242P_	915	948	42	42	2 3/8
		CMPLG4248P_	994	1026	42	48	2 3/8
		CMPLG4254P_	1085	1117	42	54	2 3/8
		CMPLG4260P_	1173	1205	42	60	2 3/8
	Powered Compile 12" Top Glazed Single Segmented Panel Package - 48"	CMPLG4824P_	629	647	48	24	2 3/8
		CMPLG4830P_	752	767	48	30	2 3/8
		CMPLG4836P_	828	859	48	36	2 3/8
		CMPLG4842P_	901	931	48	42	2 3/8
		CMPLG4848P_	975	1005	48	48	2 3/8
		CMPLG4854P_	1073	1104	48	54	2 3/8
		CMPLG4860P_	1150	1180	48	60	2 3/8
	Powered Compile 12" Top Glazed Single Segmented Panel Package - 54"	CMPLG5424P_	630	647	54	24	2 3/8
		CMPLG5430P_	753	769	54	30	2 3/8
		CMPLG5436P_	828	861	54	36	2 3/8
		CMPLG5442P_	901	933	54	42	2 3/8
		CMPLG5448P_	992	1024	54	48	2 3/8
		CMPLG5454P_	1073	1106	54	54	2 3/8
		CMPLG5460P_	1150	1182	54	60	2 3/8
	Powered Compile 12" Top Glazed Single Segmented Panel Package - 66"	CMPLG6624P_	677	709	66	24	2 3/8
		CMPLG6630P_	805	838	66	30	2 3/8
		CMPLG6636P_	890	954	66	36	2 3/8
		CMPLG6642P_	971	1037	66	42	2 3/8
		CMPLG6648P_	1069	1136	66	48	2 3/8
		CMPLG6654P_	1157	1223	66	54	2 3/8
		CMPLG6660P_	1240	1306	66	60	2 3/8

Raceway Cover Options (1) Shown

- **RACEWAY COVER OPTIONS (Suffix)**
 - (1) Knockouts Side 1 – No Knockout Side 2
 - (2) Knockouts Side 1 and Side 2

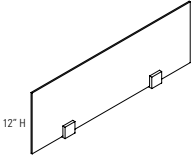
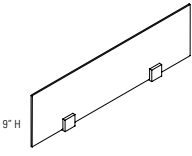
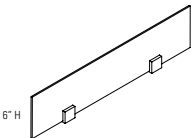

CMPSXX - COMPILE PRIVACY GLASS

- Attaches on top of Compile Panels to add privacy or divide space.
- Standard in clear (CLR) or frosted (FRST) glass.
- Clamps available in satin chrome finish only.
- Width dimensions given are width of glass only.
- Attachment hardware is provided for attaching to panels.
- Please note Privacy Glass in 24" - 54" widths includes 2 clamps and a Privacy Glass in 60" width includes 3 clamps.
- Square profile on clamps and glass corners.

	DESCRIPTION	PRODUCT CODE	LIST PRICE		DIMENSIONS/INCHES		
			CLR	FRST	H	W	D
 <p>12" H</p>	Compile Privacy Glass	CMPS24	268	324	12	24	6
		CMPS30	284	326	12	30	6
		CMPS36	300	330	12	36	6
		CMPS42	310	361	12	42	6
		CMPS48	318	387	12	48	6
		CMPS54	327	411	12	54	6
		CMPS60	341	443	12	60	6
 <p>9" H</p>		CMPS0924	268	324	9	24	6
		CMPS0930	284	326	9	30	6
		CMPS0936	300	330	9	36	6
		CMPS0942	310	361	9	42	6
		CMPS0948	318	387	9	48	6
		CMPS0954	327	411	9	54	6
		CMPS0960	341	443	9	60	6
 <p>6" H</p>		CMPS0624	268	324	6	24	6
		CMPS0630	284	326	6	30	6
		CMPS0636	300	330	6	36	6
		CMPS0642	310	361	6	42	6
		CMPS0648	318	387	6	48	6
		CMPS0654	327	411	6	54	6
		CMPS0660	341	443	6	60	6

CMPSGX - COMPILE PRIVACY GLASS PANEL WIDTH



- Attaches on top of Compile Panels to add privacy or divide space.
- Standard in clear (CLR) or frosted (FRST) glass.
- Width dimensions given are width of glass only.
- Attachment hardware is provided for attaching to panels.

	DESCRIPTION	PRODUCT CODE	LIST PRICE		DIMENSIONS/INCHES		
			CLR	FRST	H	W	D
	Compile Privacy Glass	CMPSEG0624	240	292	6	24	2.41
		CMPSEG0630	261	298	6	30	2.41
		CMPSEG0636	278	304	6	36	2.41
		CMPSEG0642	290	337	6	42	2.41
		CMPSEG0648	308	367	6	48	2.41
		CMPSEG0654	320	395	6	54	2.41
		CMPSEG0660	327	428	6	60	2.41
		CMPSEG0924	240	292	9	24	2.41
		CMPSEG0930	261	298	9	30	2.41
		CMPSEG0936	278	292	9	36	2.41
		CMPSEG0942	290	337	9	42	2.41
		CMPSEG0948	308	367	9	48	2.41
		CMPSEG0954	320	395	9	54	2.41
		CMPSEG0960	327	428	9	60	2.41
		CMPSEG1224	240	292	12	24	2.41
		CMPSEG1230	261	298	12	30	2.41
		CMPSEG1236	278	304	12	36	2.41
		CMPSEG1242	290	337	12	42	2.41
		CMPSEG1248	308	367	12	48	2.41
		CMPSEG1254	320	395	12	54	2.41
		CMPSEG1260	327	428	12	60	2.41



CMPSEF - EMBEDDED FELT DIVIDER OVER PANEL

- Privacy felt panel intergrated with aluminum top trim.
- Attaches on top of panels to add privacy or divide space.
- Includes aluminum trim with channel and felt tile.
- Felt and attachment hardware to ship seperarettly
- 9mm Felt material is tackable and comes in 12 different colors. Please specify color.

DESCRIPTION	PRODUCT CODE	LIST PRICE	DIMENSIONS/INCHES		
			H	W	D
 6" Integrated Felt Divider, Panel Width	CMPSEF0624	97	6	24	2.41
	CMPSEF0630	112	6	30	2.41
	CMPSEF0636	134	6	36	2.41
	CMPSEF0642	148	6	42	2.41
	CMPSEF0648	221	6	48	2.41
	CMPSEF0654	239	6	54	2.41
 9" Integrated Felt Divider, Panel Width	CMPSEF0924	97	9	24	2.41
	CMPSEF0930	112	9	30	2.41
	CMPSEF0936	134	9	36	2.41
	CMPSEF0942	148	9	42	2.41
	CMPSEF0948	221	9	48	2.41
	CMPSEF0954	239	9	54	2.41
 12" Integrated Felt Divider, Panel Width	CMPSEF0960	259	9	60	2.41
	CMPSEF1224	97	12	24	2.41
	CMPSEF1230	112	12	30	2.41
	CMPSEF1236	134	12	36	2.41
	CMPSEF1242	148	12	42	2.41
	CMPSEF1248	221	12	48	2.41
12" Integrated Felt Divider, Panel Width	CMPSEF1254	239	12	54	2.41
	CMPSEF1260	259	12	60	2.41

CMOF - COMPILE FABRIC OVER PANEL

- Fabric-covered modules incorporated into an aluminum frame.
- Opposite sides of each module may have a different fabric within the same grade at no upcharge.
- If different grades of fabric are used on one panel, the entire panel must be priced at highest grade.
- One CSHD Slider Kit for Over Panel included
- Note: Trim is not required at a straight connection between two panels of the same height.
- Maximum stacking one high. Not load bearing.

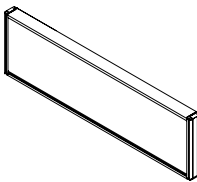
DESCRIPTION	PRODUCT CODE	LIST PRICE		DIMENSIONS/INCHES		
		Gr1	Gr2	H	W	D
 Compile Fabric Over Panel	CMOF1224	186	209	12	24	2.3
	CMOF1230	218	241	12	30	2.3
	CMOF1236	242	266	12	36	2.3
	CMOF1242	274	298	12	42	2.3
	CMOF1248	317	341	12	48	2.3
	CMOF1254	329	353	12	54	2.3
	CMOF1260	390	413	12	60	2.3
	CMOF1624	217	244	16	24	2.3
	CMOF1630	252	280	16	30	2.3
	CMOF1636	267	294	16	36	2.3
	CMOF1642	318	346	16	42	2.3
	CMOF1648	364	392	16	48	2.3
	CMOF1654	381	408	16	54	2.3
	CMOF1660	446	474	16	60	2.3
	CMOF2424	280	319	24	24	2.3
	CMOF2430	323	362	24	30	2.3
	CMOF2436	361	400	24	36	2.3
	CMOF2442	405	444	24	42	2.3
	CMOF2448	437	476	24	48	2.3
	CMOF2454	485	524	24	54	2.3
CMOF2460	558	597	24	60	2.3	

CMOLF - COMPILE LAMINATE ONE SIDE, FABRIC ONE SIDE OVER PANEL

- One side in fabric and one side in laminate, incorporated into an aluminum frame.
- Opposite sides of each module may have a different fabric within the same grade at no upcharge.
- If different grades of fabric are used on one panel, the entire panel must be priced at highest grade.
- One CSHD Slider Kit for Over Panel included
- Note: Trim is not required at a straight connection between two panels of the same height.
- Maximum stacking one high. Not load bearing.

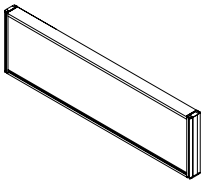
DESCRIPTION	PRODUCT CODE	LIST PRICE		DIMENSIONS/INCHES		
		Gr1	Gr2	H	W	D
 <p>Compile Laminate One Side, Fabric One Side Over Panel</p>	CMOLF1224	208	222	12	24	2.3
	CMOLF1230	245	259	12	30	2.3
	CMOLF1236	278	290	12	36	2.3
	CMOLF1242	315	327	12	42	2.3
	CMOLF1248	362	374	12	48	2.3
	CMOLF1254	382	394	12	54	2.3
	CMOLF1260	447	459	12	60	2.3
	CMOLF1624	249	265	16	24	2.3
	CMOLF1630	298	313	16	30	2.3
	CMOLF1636	329	345	16	36	2.3
	CMOLF1642	373	389	16	42	2.3
	CMOLF1648	426	441	16	48	2.3
	CMOLF1654	450	466	16	54	2.3
	CMOLF1660	523	538	16	60	2.3
	CMOLF2424	326	347	24	24	2.3
	CMOLF2430	390	410	24	30	2.3
	CMOLF2436	432	452	24	36	2.3
	CMOLF2442	486	507	24	42	2.3
	CMOLF2448	529	550	24	48	2.3
	CMOLF2454	590	610	24	54	2.3
CMOLF2460	674	694	24	60	2.3	

CMOLL - COMPILE LAMINATE TWO SIDES OVER PANEL

- Laminate modules incorporated into an aluminum frame.
- Opposite sides of each module may have a different fabric within the same grade at no upcharge.
- If different grades of fabric are used on one panel, the entire panel must be priced at highest grade.
- One CSHD Slider Kit for Over Panel included
- Note: Trim is not required at a straight connection between two panels of the same height.
- Maximum stacking one high. Not load bearing.

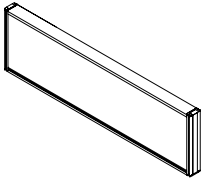
DESCRIPTION	PRODUCT CODE	LIST PRICE		DIMENSIONS/INCHES		
		Gr1	Gr2	H	W	D
 <p>Compile Laminate Two Sides Over Panel</p>	CMOLL1224	231		12	24	2.3
	CMOLL1230	262		12	30	2.3
	CMOLL1236	310		12	36	2.3
	CMOLL1242	352		12	42	2.3
	CMOLL1248	405		12	48	2.3
	CMOLL1254	430		12	54	2.3
	CMOLL1260	500		12	60	2.3
	CMOLL1624	277		16	24	2.3
	CMOLL1630	326		16	30	2.3
	CMOLL1636	371		16	36	2.3
	CMOLL1642	422		16	42	2.3
	CMOLL1648	483		16	48	2.3
	CMOLL1654	514		16	54	2.3
	CMOLL1660	593		16	60	2.3
	CMOLL2424	358		24	24	2.3
	CMOLL2430	435		24	30	2.3
	CMOLL2436	496		24	36	2.3
	CMOLL2442	562		24	42	2.3
	CMOLL2448	614		24	48	2.3
	CMOLL2454	684		24	54	2.3
CMOLL2460	779		24	60	2.3	



CMOG - COMPILE GLAZED OVER PANEL

- Glazed module incorporated into an aluminum frame.
- Opposite sides of each module may have a different fabric within the same grade at no upcharge.
- If different grades of fabric are used on one panel, the entire panel must be priced at highest grade.
- One CSHD Slider Kit for Over Panel included
- Note: Trim is not required at a straight connection between two panels of the same height.
- Maximum stacking one high. Not load bearing.

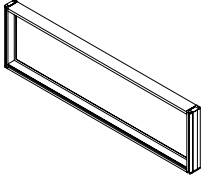
DESCRIPTION	PRODUCT CODE	LIST PRICE		DIMENSIONS/INCHES		
		CLR	FRST	H	W	D
 <p>Compile Glazed Over Panel</p>	CMOG1224	166	174	12	24	2.3
	CMOG1230	193	201	12	30	2.3
	CMOG1236	216	225	12	36	2.3
	CMOG1242	241	250	12	42	2.3
	CMOG1248	277	287	12	48	2.3
	CMOG1254	288	299	12	54	2.3
	CMOG1260	345	357	12	60	2.3
	CMOG1624	193	201	16	24	2.3
	CMOG1630	219	228	16	30	2.3
	CMOG1636	249	259	16	36	2.3
	CMOG1642	278	288	16	42	2.3
	CMOG1648	320	331	16	48	2.3
	CMOG1654	330	342	16	54	2.3
	CMOG1660	390	404	16	60	2.3
	CMOG2424	247	257	24	24	2.3
	CMOG2430	267	277	24	30	2.3
	CMOG2436	314	325	24	36	2.3
	CMOG2442	352	364	24	42	2.3
	CMOG2448	376	390	24	48	2.3
	CMOG2454	416	431	24	54	2.3
	CMOG2460	482	498	24	60	2.3

CMOFW - COMPILE ONE SIDE WRITE BOARD OVER PANEL

- Fabric or write board covered modules incorporated into an aluminum frame.
- Opposite sides of each module may have a different fabric within the same grade at no upcharge.
- If different grades of fabric are used on one panel, the entire panel must be priced at highest grade.
- One CSHD Slider Kit for Over Panel included
- Note: Trim is not required at a straight connection between two panels of the same height.
- Maximum stacking one high. Not load bearing.

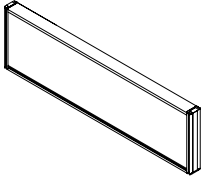
DESCRIPTION	PRODUCT CODE	LIST PRICE		DIMENSIONS/INCHES		
		Gr1	Gr2	H	W	D
 <p>Compile Fabric or Write Board Over Panel</p>	CMOFW1224	234	246	12	24	2.3
	CMOFW1230	278	290	12	30	2.3
	CMOFW1236	315	327	12	36	2.3
	CMOFW1242	359	371	12	42	2.3
	CMOFW1248	397	409	12	48	2.3
	CMOFW1254	438	450	12	54	2.3
	CMOFW1260	510	522	12	60	2.3
	CMOFW1624	282	298	16	24	2.3
	CMOFW1630	332	348	16	30	2.3
	CMOFW1636	380	395	16	36	2.3
	CMOFW1642	432	447	16	42	2.3
	CMOFW1648	494	510	16	48	2.3
	CMOFW1654	527	542	16	54	2.3
	CMOFW1660	606	621	16	60	2.3
	CMOFW2424	364	385	24	24	2.3
	CMOFW2430	420	440	24	30	2.3
	CMOFW2436	514	534	24	36	2.3
	CMOFW2442	575	596	24	42	2.3
	CMOFW2448	605	625	24	48	2.3
	CMOFW2454	723	743	24	54	2.3
	CMOFW2460	803	823	24	60	2.3

CMOWW - COMPILE WRITE BOARD TWO SIDES OVER PANEL

- Write board covered modules incorporated into an aluminum frame.
- Opposite sides of each module may have a different fabric within the same grade at no upcharge.
- If different grades of fabric are used on one panel, the entire panel must be priced at highest grade.
- One CSHD Slider Kit for Over Panel included
- Note: Trim is not required at a straight connection between two panels of the same height.
- Maximum stacking one high. Not load bearing.

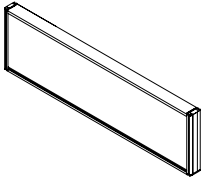
DESCRIPTION	PRODUCT CODE	LIST PRICE	DIMENSIONS/INCHES		
			H	W	D
 Compile Write Board Over Panel	CMOWW1224	285	12	24	2.3
	CMOWW1230	330	12	30	2.3
	CMOWW1236	392	12	36	2.3
	CMOWW1242	438	12	42	2.3
	CMOWW1248	514	12	48	2.3
	CMOWW1254	541	12	54	2.3
	CMOWW1260	626	12	60	2.3
	CMOWW1624	349	16	24	2.3
	CMOWW1630	417	16	30	2.3
	CMOWW1636	481	16	36	2.3
	CMOWW1642	551	16	42	2.3
	CMOWW1648	628	16	48	2.3
	CMOWW1654	679	16	54	2.3
	CMOWW1660	775	16	60	2.3
	CMOWW2424	477	24	24	2.3
	CMOWW2430	570	24	30	2.3
	CMOWW2436	659	24	36	2.3
	CMOWW2442	753	24	42	2.3
	CMOWW2448	833	24	48	2.3
	CMOWW2454	930	24	54	2.3
CMOWW2460	1053	24	60	2.3	

CHSD - SLIDER KIT FOR OVER PANEL

- One kit required for installation of each Over Panel
- Included with each NEW Over Panel Kit

DESCRIPTION	PRODUCT CODE	LIST PRICE	DIMENSIONS/INCHES		
			H	W	D
 One kit required for installation of each Over Panel	CHSDKIT	5	.09	2.28	.43



CMLEPXXXXNC - END OF RUN GALLERY PANEL WITH NO END CONNECTION

- Provides floor standing support while enclosing the end of a panel run.
- Attached at the end of a straight panel run with connectors to form a T configuration.
- No connections at both ends, connection is at the center interior face.
- Includes all attachment hardware and glides.
- Total height is inclusive of panel glides extended to their full height.
- 51" wide gallery panel accommodates two 24" deep surface while the 63" wide accommodates two 30" deep surfaces.
- Please specify LP laminate finish and PVC edge finish.
- If a wood grain laminate is chosen, grain direction run horizontally.
- Gallery panel is edged in PVC on exposed edges and self edged on bottom.

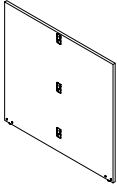
DESCRIPTION	PRODUCT CODE	LIST PRICE	DIMENSIONS/INCHES		
			H	W	D
 End of Run Gallery Panel	CMLEP4251NC	717	42	50.30	1
	CMLEP4263NC	833	42	62.30	1
	CMLEP4851NC	788	48	50.30	1
	CMLEP4863NC	915	48	62.30	1
	CMLEP5451NC	859	54	50.30	1
	CMLEP5463NC	999	54	62.30	1

CMLMPXXXXNC - MIDDLE OF RUN GALLERY PANEL WITH NO END CONNECTION

- Provides floor standing support in the middle of a panel run.
- Attached in the middle of a straight panel run with connectors to form an X configuration.
- No connections at both ends, connection is at center on both faces.
- Includes all attachment hardware and glides.
- Total height is inclusive of panel glides extended to their full height.
- 51" wide gallery panel accommodates two 24" deep surface while the 63" wide accommodates two 30" deep surfaces.
- Please specify LP laminate finish and PVC edge finish.
- If a wood grain laminate is chosen, grain direction run horizontally.
- Gallery panel is edged in PVC on exposed edges and self edged on bottom.

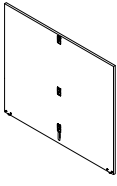
DESCRIPTION	PRODUCT CODE	LIST PRICE	DIMENSIONS/INCHES		
			H	W	D
 Middle of Run Gallery Panel	CMLMP4251NC	834	42	50.30	1
	CMLMP4263NC	949	42	62.30	1
	CMLMP4851NC	905	48	50.30	1
	CMLMP4863NC	1032	48	62.30	1
	CMLMP5451NC	976	54	50.30	1
	CMLMP5463NC	1116	54	62.30	1

CMLSEPLXXXXNC - SINGLE END OF RUN GALLERY PANEL WITH NO END CONNECTION

- Provides floor standing support while enclosing the end of a panel run.
- Attached at the end of a straight panel run with connectors to form an L configuration.
- No connections at both ends, connection is at center on both faces.
- Includes all attachment hardware and glides.
- Total height is inclusive of panel glides extended to their full height.
- 27" wide gallery panel accommodate two 24" deep surface while the 33" wide accommodates two 30" deep surfaces.
- Please specify LP laminate finish and PVC edge finish.
- If a wood grain laminate is chosen, grain direction run horizontally.
- Gallery panel is edged in PVC on exposed edges and self edged on bottom.

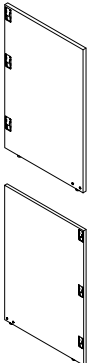
DESCRIPTION	PRODUCT CODE	LIST PRICE	DIMENSIONS/INCHES		
			H	W	D
 Single End of Run Gallery Panel	CMLSEPL4227NC	546	42	26.30	1
	CMLSEPR4227NC	546	42	26.30	1
	CMLSEPL4827NC	597	48	26.30	1
	CMLSEPR4827NC	597	48	26.30	1
	CMLSEPL5427NC	648	54	26.30	1
	CMLSEPR5427NC	648	54	26.30	1
	CMLSEPL4233NC	563	42	32.33	1
	CMLSEPR4233NC	563	42	32.33	1
	CMLSEPL4833NC	615	48	32.33	1
	CMLSEPR4833NC	615	48	32.33	1
	CMLSEPL5433NC	667	54	32.33	1
	CMLSEPR5433NC	667	54	32.33	1

CMLSMPXXXNC - SINGLE MIDDLE OF RUN GALLERY PANEL WITH NO END CONNECTION

- Provides floor standing support at the middle of a panel run.
- Attached in the middle of a straight panel run with connectors to form a T configuration.
- No connections at the exposed end, connection is at both the interior and exterior face near the opposite end.
- Includes all attachment hardware and glides.
- Total height is inclusive of panel glides extended to their full height.
- 27" wide gallery panel accommodates a 24" deep surface while the 33" wide accommodates a 30" deep surface.
- Please specify LP laminate finish and PVC edge finish.
- If a wood grain laminate is chosen, grain direction run horizontally.
- Gallery panel is edged in PVC on exposed edges and self edged on bottom.

	DESCRIPTION	PRODUCT CODE	LIST PRICE	DIMENSIONS/INCHES		
				H	W	D
	Single Middle of Run Gallery Panel	CMLSMP4227NC	663	42	26.30	1
		CMLSMP4827NC	714	48	26.30	1
		CMLSMP5427NC	765	54	26.30	1
		CMLSMP4233NC	683	42	32.30	1
		CMLSMP4833NC	734	48	32.30	1
		CMLSMP5433NC	787	54	32.30	1

CMLEPXXXX - END OF RUN GALLERY PANEL WITH END CONNECTIONS

- Provides floor standing support while enclosing the end of a panel run.
- Attached at the end of a straight panel run with connectors to form a T configuration.
- Connections at both ends as well as the center on the interior face.
- Includes all attachment hardware and glides.
- Total height is inclusive of panel glides extended to their full height.
- 51" wide gallery panel accommodates two 24" deep surface while the 63" wide accommodates two 30" deep surfaces.
- Please specify LP laminate finish and PVC edge finish.
- If a wood grain laminate is chosen, grain direction run horizontally.
- Gallery panel is edged in PVC on exposed edges and self edged on edge connecting to panel and bottom edge.

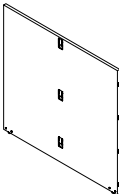
	DESCRIPTION	PRODUCT CODE	LIST PRICE	DIMENSIONS/INCHES		
				H	W	D
	End of Run Gallery Panel	CMLEP4251	746	42	50.30	1
		CMLEP4263	860	42	62.30	1
		CMLEP4851	816	48	50.30	1
		CMLEP4863	943	48	62.30	1
		CMLEP5451	887	54	50.30	1
		CMLEP5463	1027	54	62.30	1

CMLMPXXXX - MIDDLE OF RUN GALLERY PANEL WITH END CONNECTIONS

- Provides floor standing support in the middle of a panel run.
- Attached in the middle of a straight panel run with connectors to form an X configuration.
- Connections at both ends as well as the center on the interior face.
- Includes all attachment hardware and glides.
- Total height is inclusive of panel glides extended to their full height.
- 51" wide gallery panel accommodates two 24" deep surface while the 63" wide accommodates two 30" deep surfaces.
- Please specify LP laminate finish and PVC edge finish.
- If a wood grain laminate is chosen, grain direction run horizontally.
- Gallery panel is edged in PVC on exposed edges and self edged on edge connecting to panel and bottom edge.

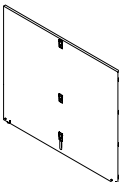
	DESCRIPTION	PRODUCT CODE	LIST PRICE	DIMENSIONS/INCHES		
				H	W	D
	Middle of Run Gallery Panel	CMLMP4251	839	42	50.30	1
		CMLMP4263	953	42	62.30	1
		CMLMP4851	910	48	50.30	1
		CMLMP4863	1037	48	62.30	1
		CMLMP5451	980	54	50.30	1
		CMLMP5463	1122	54	62.30	1



CMLSEPLXXXX - SINGLE END PANEL WITH END CONNECTIONS

- Provides floor standing support while enclosing the end of a panel run.
- Attached at the end of a straight panel run with connectors to form an L configuration.
- Connections are at the exposed end on one side and near the end on the other interior face.
- Total height is inclusive of panel glides extended to their full height.
- 27" wide gallery panel accommodates a 24" deep surface while the 33" wide accommodates a 30" deep surface.
- Please specify LP laminate finish and PVC edge finish.
- If a wood grain laminate is chosen, grain direction run horizontally.
- Gallery panel is edged in PVC on exposed edges and self edged on edge connecting to panel and bottom edge.

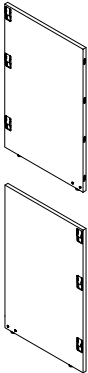
DESCRIPTION	PRODUCT CODE	LIST PRICE	DIMENSIONS/INCHES		
			H	W	D
 Single End of Run Gallery Panel	CMLSEPL4227	559	42	26.30	1
	CMLSEPR4227	559	42	26.30	1
	CMLSEPL4827	611	48	26.30	1
	CMLSEPR4827	611	48	26.30	1
	CMLSEPL5427	661	54	26.30	1
	CMLSEPR5427	661	54	26.30	1
	CMLSEPL4233	577	42	32.33	1
	CMLSEPR4233	577	42	32.33	1
	CMLSEPL4833	628	48	32.33	1
	CMLSEPR4833	628	48	32.33	1
	CMLSEPL5433	681	54	32.33	1
	CMLSEPR5433	681	54	32.33	1

CMLSMPXXXX - SINGLE MIDDLE OF RUN GALLERY PANEL WITH END CONNECTIONS

- Provides floor standing support at the middle of a panel run.
- Attached in the middle of a straight panel run with connectors to form a T configuration
- Connections are at the exposed end and at the interior and exterior near the opposite end.
- Includes all attachment hardware and glides.
- Total height is inclusive of panel glides extended to their full height.
- 27" wide gallery panel accommodates a 24" deep surface while the 33" wide accommodates a 30" deep surface.
- Please specify LP laminate finish and PVC edge finish.
- If a wood grain laminate is chosen, grain direction run horizontally.
- Gallery panel is edged in PVC on exposed edges and self edged on edge connecting to panel and bottom edge.

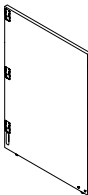
DESCRIPTION	PRODUCT CODE	LIST PRICE	DIMENSIONS/INCHES		
			H	W	D
 Single Middle of Run Gallery Panel	CMLSMP4227	676	42	26.30	1
	CMLSMP4827	728	48	26.30	1
	CMLSMP5427	777	54	26.30	1
	CMLSMP4233	697	42	32.30	1
	CMLSMP4833	749	48	32.30	1
	CMLSMP5433	801	54	32.30	1

CML2PLXXXX - LEFT TWO WAY RETURN END OF RUN GALLERY PANEL WITH END CONNECTIONS

- Provides floor standing support while enclosing the end of a panel run.
- Attached at the end of a gallery panel with connectors to form an L configuration.
- Connections are at one exposed end.
- Includes all attachment hardware and glides.
- Total height is inclusive of panel glides extended to their full height.
- 25" wide gallery panel accommodates a 24" deep surface while the 31" wide accommodates a 30" deep surface.
- Please specify LP laminate finish and PVC edge finish.
- If a wood grain laminate is chosen, grain direction run horizontally.
- Gallery panel is edged in PVC on exposed edges and self edged on edge connecting to panel and bottom edge.

DESCRIPTION	PRODUCT CODE	LIST PRICE	DIMENSIONS/INCHES		
			H	W	D
 Two Way Return End of Run Gallery Panel	CML2PL4225	443	42	25	1
	CML2PL4231	455	42	31	1
	CML2PL4825	493	48	25	1
	CML2PL4831	507	48	31	1
	CML2PL5425	543	54	25	1
	CML2PL5431	559	54	31	1

CML2PRXXXX - RIGHT TWO WAY RETURN END OF RUN GALLERY PANEL WITH END CONNECTIONS

- Provides floor standing support while enclosing the end of a panel run.
- Attached at the end of a gallery panel with connectors to form an L configuration.
- Connections are at one exposed end.
- Includes all attachment hardware and glides.
- Total height is inclusive of panel glides extended to their full height.
- 25" wide gallery panel accommodates a 24" deep surface while the 31" wide accommodates a 30" deep surface.
- Please specify LP laminate finish and PVC edge finish.
- If a wood grain laminate is chosen, grain direction run horizontally.
- Gallery panel is edged in PVC on exposed edges and self edged on edge connecting to panel and bottom edge.

	DESCRIPTION	PRODUCT CODE	LIST PRICE	DIMENSIONS/INCHES		
				H	W	D
	Two Way Return	CML2PR4225	443	42	25	1
	End of Run Gallery Panel	CML2PR4231	455	42	31	1
		CML2PR4825	493	48	25	1
		CML2PR4831	507	48	31	1
		CML2PR5425	543	54	25	1
		CML2PR5431	559	54	31	1

CML3PLXXXX - LEFT THREE WAY RETURN END OF RUN GALLERY PANEL

- Provides floor standing support while enclosing the end of a gallery panel run.
- Attached at the end of a gallery panel with connectors to form a T configuration.
- There are no connections at the exposed ends. Connection is at the center of the interior face.
- Connects to CMLXPLxxxx or CMLSEPLxxxx.
- Includes all attachment hardware and glides.
- Total height is inclusive of panel glides extended to their full height.
- 49" wide gallery panel accommodates two 24" deep surface while the 61" wide accommodates two 30" deep surfaces.
- Please specify LP laminate finish and PVC edge finish.
- If a wood grain laminate is chosen, grain direction run horizontally.
- Gallery panel is edged in PVC on exposed edges and self edged on edge connecting to panel and bottom edge.

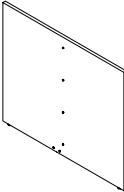
	DESCRIPTION	PRODUCT CODE	LIST PRICE	DIMENSIONS/INCHES		
				H	W	D
	Three Way Return	CML3PL4249	614	42	49	1
	End of Run Gallery Panel	CML3PL4261	729	42	61	1
		CML3PL4849	685	48	49	1
		CML3PL4861	812	48	61	1
		CML3PL5449	754	54	49	1
		CML3PL5461	895	54	61	1

CML3PRXXXX - RIGHT THREE WAY RETURN END OF RUN GALLERY PANEL

- Provides floor standing support while enclosing the end of a gallery panel run.
- Attached at the end of a gallery panel with connectors to form a T configuration.
- There are no connections at the exposed ends. Connection is at the center of the interior face.
- Connects to CMLXPRxxxx or CMLSEPRxxxx.
- Includes all attachment hardware and glides.
- Total height is inclusive of panel glides extended to their full height.
- 49" wide gallery panel accommodates two 24" deep surface while the 61" wide accommodates two 30" deep surfaces.
- Please specify LP laminate finish and PVC edge finish.
- If a wood grain laminate is chosen, grain direction run horizontally.
- Gallery panel is edged in PVC on exposed edges and self edged on edge connecting to panel and bottom edge.

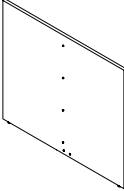
	DESCRIPTION	PRODUCT CODE	LIST PRICE	DIMENSIONS/INCHES		
				H	W	D
	Three Way Return	CML3PR4249	614	42	49	1
	End of Run Gallery Pane	CML3PR4261	729	42	61	1
		CML3PR4849	685	48	49	1
		CML3PR4861	812	48	61	1
		CML3PR5449	754	54	49	1
		CML3PR5461	895	54	61	1



CMLXPLXXXX - LEFT EXTENSION END OF RUN RETURN GALLERY PANEL WITH END CONNECTION

- Provides floor standing support while enclosing the end of a gallery panel run.
- Attached at the end of a panel to allow for extending the gallery panel run.
- Connections at both exposed ends, one to connect to the panel and one to connect to another gallery panel.
- Includes all attachment hardware and glides.
- Total height is inclusive of panel glides extended to their full height.
- Please specify LP laminate finish and PVC edge finish.
- If a wood grain laminate is chosen, grain direction run horizontally.
- Gallery panel is edged in PVC on exposed edged and self edges on edge connecting to panel.

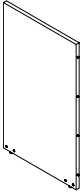
DESCRIPTION	PRODUCT CODE	LIST PRICE	DIMENSIONS/INCHES		
			H	W	D
 Extension End of Run Return Gallery Panel	CMLXPL4224	718	42	24	1
	CMLXPL4230	431	42	30	1
	CMLXPL4236	497	42	35	1
	CMLXPL4242	624	42	42	1
	CMLXPL4248	641	42	48	1
	CMLXPL4824	380	48	24	1
	CMLXPL4830	446	48	30	1
	CMLXPL4836	510	48	36	1
	CMLXPL4842	641	48	42	1
	CMLXPL4848	661	48	48	1
	CMLXPL5424	405	54	24	1
	CMLXPL5430	475	54	30	1
	CMLXPL5436	546	54	36	1
	CMLXPL5442	616	54	42	1
	CMLXPL5448	757	54	48	1

CMLXPRXXXX - RIGHT EXTENSION END OF RUN RETURN GALLERY PANEL WITH END CONNECTION

- Provides floor standing support while enclosing the end of a gallery panel run.
- Attached at the end of a panel to allow for extending the gallery panel run.
- Connections at both exposed ends, one to connect to the panel and one to connect to another gallery panel.
- Includes all attachment hardware and glides.
- Total height is inclusive of panel glides extended to their full height.
- Please specify LP laminate finish and PVC edge finish.
- If a wood grain laminate is chosen, grain direction run horizontally.
- Gallery panel is edged in PVC on exposed edged and self edges on edge connecting to panel.

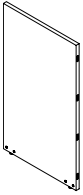
DESCRIPTION	PRODUCT CODE	LIST PRICE	DIMENSIONS/INCHES		
			H	W	D
 Extension End of Run Return Gallery Panel	CMLXPR4224	718	42	24	1
	CMLXPR4230	431	42	30	1
	CMLXPR4236	497	42	35	1
	CMLXPR4242	624	42	42	1
	CMLXPR4248	641	42	48	1
	CMLXPR4824	380	48	24	1
	CMLXPR4830	446	48	30	1
	CMLXPR4836	510	48	36	1
	CMLXPR4842	641	48	42	1
	CMLXPR4848	661	48	48	1
	CMLXPR5424	405	54	24	1
	CMLXPR5430	475	54	30	1
	CMLXPR5436	546	54	36	1
	CMLXPR5442	616	54	42	1
	CMLXPR5448	757	54	48	1

CMLXPLXXXNC - EXTENSION END OF RUN, LEFT, NO CONNECTION

- Provides floor standing support while enclosing the end of a gallery panel run.
- Attached at the end of a gallery panel to extend the gallery panel run.
- Connections only at one exposed end.
- Includes all attachment hardware and glides.
- Total height is inclusive of panel glides extended to their full height.
- Please specify LP laminate finish and PVC edge finish.
- If a wood grain laminate is chosen, grain direction run horizontally.
- Gallery panel is edged in PVC on exposed edges and self edged on edge connecting to panel.

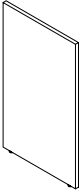
DESCRIPTION	PRODUCT CODE	LIST PRICE	DIMENSIONS/INCHES		
			H	W	D
 Extension End of Run Gallery Panel	CMLXPL4224NC	366	42	24	1
	CMLXPL4230NC	429	42	30	1
	CMLXPL4236NC	493	42	35	1
	CMLXPL4242NC	621	42	42	1
	CMLXPL4248NC	639	42	48	1
	CMLXPL4824NC	377	48	24	1
	CMLXPL4830NC	443	48	30	1
	CMLXPL4836NC	507	48	36	1
	CMLXPL4842NC	639	48	42	1
	CMLXPL4848NC	659	48	48	1
	CMLXPL5424NC	403	54	24	1
	CMLXPL5430NC	473	54	30	1
	CMLXPL5436NC	543	54	36	1
	CMLXPL5442NC	614	54	42	1
	CMLXPL5448NC	754	54	48	1

CMLXPLXXXNC • EXTENSION END OF RUN, RIGHT, NO CONNECTION

- Provides floor standing support while enclosing the end of a gallery panel run.
- Attached at the end of a gallery panel to extend the gallery panel run.
- Connections only at one exposed end.
- Includes all attachment hardware and glides.
- Total height is inclusive of panel glides extended to their full height.
- Please specify LP laminate finish and PVC edge finish.
- If a wood grain laminate is chosen, grain direction run horizontally.
- Gallery panel is edged in PVC on exposed edges and self edged on edge connecting to panel.

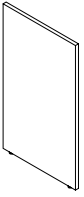
DESCRIPTION	PRODUCT CODE	LIST PRICE	DIMENSIONS/INCHES		
			H	W	D
 Extension End of Run Gallery Panel	CMLXPR4224NC	366	42	24	1
	CMLXPR4230NC	429	42	30	1
	CMLXPR4236NC	493	42	35	1
	CMLXPR4242NC	621	42	42	1
	CMLXPR4248NC	639	42	48	1
	CMLXPR4824NC	377	48	24	1
	CMLXPR4830NC	443	48	30	1
	CMLXPR4836NC	507	48	36	1
	CMLXPR4842NC	639	48	42	1
	CMLXPR4848NC	659	48	48	1
	CMLXPR5424NC	403	54	24	1
	CMLXPR5430NC	473	54	30	1
	CMLXPR5436NC	543	54	36	1
	CMLXPR5442NC	614	54	42	1
	CMLXPR5448NC	754	54	48	1



CMHLPBB01 - GALLERY PANEL BRACKET

- Gallery panel bottom bracket connects two gallery end panels at bottom with screws.
- Available in standard paint colors.
- Screws are included with the bracket.

	DESCRIPTION	PRODUCT CODE	LIST PRICE	DIMENSIONS/INCHES		
				H	W	D
	Bracket	CMHLPBB01	41	1.5	8	1

CMHLPCB01 - GALLERY PANEL CORNER BRACKET

- Gallery panel corner bottom bracket connects two laminate panels at 90 degrees.
- Available in standard paint colors.
- Screws are included with the bracket.

	DESCRIPTION	PRODUCT CODE	LIST PRICE	DIMENSIONS/INCHES		
				H	W	D
	Corner Bracket	CMHLPCB01	40	1.5	4	4

CMPDSL/R - SLIDING PRIVACY DOOR

- Sliding Privacy Door attaches to Compile Panels using standard connectors to add privacy. Brackets that attach to Connectors are included.
- This door must mount on panels of equal width. It is also intended to be used for openings of equal width.
- Left (L) or right-handedness (R) is determined by the direction of door movement (from compressed to expanded position), while facing the door on the panel mounted side.
- Painted frame may match any Compile Standard Paint Finish. The door interior is standard with a louvered acrylic finish.
- STL paint on Compile sliding doors is a smooth finish paint comparable to the standard STL paint offering.”
- Telescoping arms eliminate the need for thresholds, wheels or casters.
- Thickness of louvered acrylic is 6 mm.

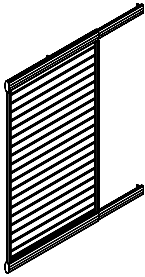
	DESCRIPTION	PRODUCT CODE	LIST PRICE	DIMENSIONS/INCHES		
				H	W	D
	Sliding Privacy Door - 66" High	CMPDSL6636R	2846	66	36	
		CMPDSL6636L	2846	66	36	
		CMPDSL6642R	2921	66	42	
		CMPDSL6642L	2921	66	42	

CMFMA - MINI PANEL KIT

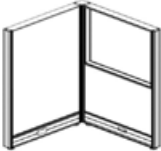

- Compile's Mini Panel Kits are now available to our dealers and their sales staff. The Compile mini panel is an excellent sales tool featuring two panel and samples of various hardware and electrical components and consists of the following:
- One Monolithic Mini Panel (Laminate side one / Acoustic side two).
- One Segmented Glazed Mini panel.
- One 2-way Universal Corner Post Kit.
- Two 24" Raceway Cover with Punch Out.
- Two 24" Raceway Cover with out Punch Out.
- One Raceway Cut Out Cover.
- One 3-way Post Base Cover.
- One End of Run Trim.
- One Pair of Corner Brackets.
- One Mid span Worksurface Support Bracket.
- One Duplex.
- One Power Distribution Harness.
- One Mesh jumper.
- One Carry Bag.

	DESCRIPTION	PRODUCT CODE	LIST PRICE	DIMENSIONS/INCHES		
				H	W	D
	Mini Panel Kit	CMFMA2418KIT1	2212	30	24	2 7/8



CHP POST PACKAGE

- Universal Post with all "Quick-Connection" clips.
- Post trim(s)
- Post base and top cap

DESCRIPTION	PRODUCT CODE	LIST PRICE	DIMENSIONS/INCHES		
			H	W	D
 <p>2 - Way Post</p>	CHP30-2	104	30	2.3	2.3
	CHP42-2	104	42	2.3	2.3
	CHP46-2	151	46	2.3	2.3
	CHP54-2	129	54	2.3	2.3
	CHP58-2	190	58	2.3	2.3
	CHP60-2	190	60	2.3	2.3
	CHP64-2	224	64	2.3	2.3
	CHP66-2	151	66	2.3	2.3
	CHP70-2	219	70	2.3	2.3
	CHP72-2	219	72	2.3	2.3
	CHP78-2	249	78	2.3	2.3
	CHP82-2	261	82	2.3	2.3
	CHP90-2	261	90	2.3	2.3
 <p>3 - Way Post</p>	CHP30-3	91	30	2.3	2.3
	CHP42-3	91	42	2.3	2.3
	CHP46-3	137	46	2.3	2.3
	CHP54-3	114	54	2.3	2.3
	CHP58-3	171	58	2.3	2.3
	CHP60-3	171	60	2.3	2.3
	CHP64-3	182	64	2.3	2.3
	CHP66-3	137	66	2.3	2.3
	CHP70-3	197	70	2.3	2.3
	CHP72-3	197	72	2.3	2.3
	CHP78-3	224	78	2.3	2.3
	CHP82-3	234	82	2.3	2.3
	CHP90-3	260	90	2.3	2.3
 <p>4 - Way Post *No trim or base. Includes top cap only.</p>	CHP30-4	74	30	2.3	2.3
	CHP42-4	74	42	2.3	2.3
	CHP46-4	125	46	2.3	2.3
	CHP54-4	96	54	2.3	2.3
	CHP58-4	140	58	2.3	2.3
	CHP60-4	140	60	2.3	2.3
	CHP64-4	148	64	2.3	2.3
	CHP66-4	114	66	2.3	2.3
	CHP70-4	163	70	2.3	2.3
	CHP72-4	163	72	2.3	2.3
	CHP78-4	185	78	2.3	2.3
	CHP82-4	193	82	2.3	2.3
	CHP90-4	216	90	2.3	2.3

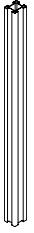

CHPXW - 90 DEGREE CORNER POST KIT FOR OVER PANELS

- Specify the corner post height that matches the height of the over panel
- 2-way kits include 2 trims (CMETPxx), 2 way post base (CMPCxx) and post cap (CMPC).
- 3-way kits include 2 trim (CMETPxx), 3 way post base (CMPCxx) and post cap (CMPC).
- 4-way kits include post cap (CMPC) only.

	DESCRIPTION	PRODUCT CODE	LIST PRICE	DIMENSIONS/INCHES			
				H	W	D	
	90 Degree Corner Post Kit for Over Panels	CHOP12-2	68	12	2.3	2.3	
		CHOP12-3	58	12	2.3	2.3	
		CHOP12-4	40	12	2.3	2.3	
			CHOP16-2	68	16	2.3	2.3
			CHOP16-3	68	16	2.3	2.3
			CHOP16-4	58	16	2.3	2.3
			CHOP24-2	76	24	2.3	2.3
			CHOP24-3	68	24	2.3	2.3
			CHOP24-4	57	24	2.3	2.3

CHPXW - 60 DEGREE POST PACKAGE

- Universal Post with all "Quick-Connection" clips.
- Post trim is incorporated into 2 - Way aluminum post extrusion.
- Post top cap
- Outer part of the post is the full panel height and the inner part of the post is 6" shorter.
- 3 - Way post is 6" shorter than panel height to accommodate electric and base.
- PVC post trims can not be added to 60 degree posts.

	DESCRIPTION	PRODUCT CODE	LIST PRICE	DIMENSIONS/INCHES		
				H	W	D
	2 - Way - 60 Degree Post Package	CHP2W30	74	30	2.3	2.3
		CHP2W42	74	42	2.3	2.3
		CHP2W46	96	46	2.3	2.3
		CHP2W54	96	54	2.3	2.3
		CHP2W58	131	58	2.3	2.3
		CHP2W60	144	60	2.3	2.3
		CHP2W64	156	64	2.3	2.3
		CHP2W66	114	66	2.3	2.3
		CHP2W70	166	70	2.3	2.3
		CHP2W72	166	72	2.3	2.3
		CHP2W78	185	78	2.3	2.3
		CHP2W82	193	82	2.3	2.3
		CHP2W90	212	90	2.3	2.3
			3 - Way - 60 Degree Post Package	CHP3W30	74	30
CHP3W42	74			42	2.3	2.3
CHP3W46	105			46	2.3	2.3
CHP3W54	96			54	2.3	2.3
CHP3W58	131			58	2.3	2.3
CHP3W60	144			60	2.3	2.3
CHP3W64	156			64	2.3	2.3
CHP3W66	114			66	2.3	2.3
CHP3W70	166			70	2.3	2.3
CHP3W72	166			72	2.3	2.3
CHP3W78	185			78	2.3	2.3
CHP3W82	193			82	2.3	2.3
CHP3W90	212			90	2.3	2.3



CMRCXXNP - COMPILE RACEWAY COVER - WITHOUT KNOCKOUTS

- No electrical knockouts included.
- Note: Made of reinforced aluminum.

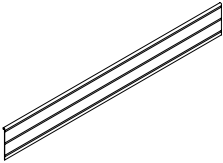
	DESCRIPTION	PRODUCT CODE	LIST PRICE	DIMENSIONS/INCHES		
				H	W	D
	Compile Raceway Cover Without Knockouts	CMRC24NP	16	24		
		CMRC30NP	20	30		
		CMRC36NP	22	36		
		CMRC42NP	24	42		
		CMRC48NP	27	48		
		CMRC54NP	33	54		
		CMRC60NP	35	60		

CMRCXXPO - COMPILE RACEWAY COVER - WITH KNOCKOUTS

- Contains one knockout for 24" w and three knockouts for 30" w+.
- Raceway Knockout Cover must be added to openings where duplex receptacles are not used.
- Note: Made of reinforced aluminum.

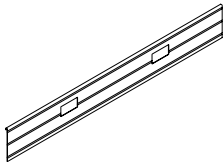
	DESCRIPTION	PRODUCT CODE	LIST PRICE	DIMENSIONS/INCHES		
				H	W	D
	Compile Raceway Cover With Knockouts	CMRC24PO	16	24		
		CMRC30PO	20	30		
		CMRC36PO	22	36		
		CMRC42PO	24	42		
		CMRC48PO	27	48		
		CMRC54PO	33	54		
		CMRC60PO	35	60		

CMRCB01 - COMPILE RACEWAY KNOCKOUT COVER

- Fills knockout when duplex is not used.
- Available in Black, White, Nevada, and Tungsten (Steel)
- Note: Knockout covers are made of plastic.

	DESCRIPTION	PRODUCT CODE	LIST PRICE	DIMENSIONS/INCHES		
				H	W	D
	Compile Raceway Knockout Cover	CMRCB01	15			

CHP - 90-DEGREE UNIVERSAL CORNER POST

- Available in 42", 54" and 66"h.
- Standard Compile paint options.
- Specify the corner post height that matches the tallest or smallest panel connection.
- Can be used for any variation of 90-degree connections: 2-way, 3-way or 4-way.
- Requires post trim inserts to finish off post where there are no panel connections. Post trim inserts are specified separately.
- 6" shorter than panel height to accommodate electric in base.
- Requires a post basecover to finish off post at the base (for 2- or 3-way). Refer to CMPC.
- See Panel Configuration Tips for application.
- Made of aluminum.

	DESCRIPTION	PRODUCT CODE	LIST PRICE	DIMENSIONS/INCHES		
				H	W	D
	90-Degree Universal Corner Post	CHP30	69	30		
		CHP42	69	36		
		CHP54	90	48		
		CHP66	110	60		

CMET - END OF RUN TRIM INSERT FOR PANEL

- Trim inserts are not included with panels.
- Cannot be used for a universal post application.
- Used at the end of each panel run and cannot be used to attach a panel run to a fixed wall.
- Vertical trims must be specified separately. Trim snaps in the panel at the end of run.
- Standard Compile paint options.
- See Panel Configuration Tips for application.
- Trims are PVC.

	DESCRIPTION	PRODUCT CODE	LIST PRICE	DIMENSIONS/INCHES		
				H	W	D
	End of Run Trim Insert for Panel	CMET16	16	16	2.3	0.5
		CMET30	19	30	2.3	0.5
		CMET42	19	42	2.3	0.5
		CMET46	20	46	2.3	0.5
		CMET48	22	48	2.3	0.5
		CMET54	22	54	2.3	0.5
		CMET58	23	58	2.3	0.5
		CMET60	23	60	2.3	0.5
		CMET64	24	64	2.3	0.5
		CMET66	24	66	2.3	0.5
		CMET70	26	70	2.3	0.5
		CMET72	26	72	2.3	0.5
		CMET78	28	78	2.3	0.5
		CMET82	29	82	2.3	0.5
CMET90	34	90	2.3	0.5		



CMETP - TRIM INSERT FOR UNIVERSAL CORNER POST

- Does not come with a post.
- Trim installs on all exposed sides of a Universal Corner Post.
- Specify to equal post height.
- Trims must be specified separately. Trim snaps in the post.
- Available in standard Compile paint options.
- 6" shorter than Universal Corner Post to accommodate Post Base Cover (must be specified separate)
- See Panel Configuration Tips for application.

DESCRIPTION	PRODUCT CODE	LIST PRICE	DIMENSIONS/INCHES		
			H	W	D
 Trim Insert for Universal Corner Post	CMETP30	15	30	2.3	0.5
	CMETP42	15	42	2.3	0.5
	CMETP46	20	46	2.3	0.5
	CMETP48	12	48	2.3	0.5
	CMETP54	16	54	2.3	0.5
	CMETP58	21	58	2.3	0.5
	CMETP60	23	60	2.3	0.5
	CMETP64	24	64	2.3	0.5
	CMETP66	17	66	2.3	0.5
	CMETP70	27	70	2.3	0.5
	CMETP72	27	72	2.3	0.5
	CMETP78	28	78	2.3	0.5
	CMETP82	30	82	2.3	0.5
	CMETP90	34	90	2.3	0.5

CMET - TRIM INSERT FOR STEP DOWN

- Does not come with a post. Trim inserts are not included with Universal Corner Posts.
- Specify to meet the taller post.
- Trim snaps in the post or end of run at a change in height.
- Available in standard Compile paint options.
- Can not be applied to 60 degree posts.
- See Panel Configuration Tips for application.

DESCRIPTION	PRODUCT CODE	LIST PRICE	DIMENSIONS/INCHES		
			H	W	D
 Trim Insert for Step Down	CMET06	10	6		
	CMET12	12	12		
	CMET18	16	18		
	CMET24	21	24		
	CMET36	26	36		

CHWAXX - WALL ADAPTER

- Same profile as vertical extrusion.
- Wall attachment hardware not provided.
- Made of aluminum.

DESCRIPTION	PRODUCT CODE	LIST PRICE	DIMENSIONS/INCHES		
			H	W	D
 Wall Adapter	CHWA30	42	30	2.36	.79
	CHWA42	58	42	2.36	.79
	CHWA46	58	46	2.36	.79
	CHWA48	58	48	2.36	.79
	CHWA54	73	54	2.36	.79
	CHWA58	73	58	2.36	.79
	CHWA60	85	60	2.36	.79
	CHWA64	85	64	2.36	.79
	CHWA66	85	66	2.36	.79
	CHWA70	98	70	2.36	.79
	CHWA72	98	72	2.36	.79
	CHWA78	110	78	2.36	.79
	CHWA82	123	82	2.36	.79
	CHWA90	135	90	2.36	.79

CWMA - VERTICAL CHANNEL

- Used to attach system components to fixed wall.
- Panel frame finish.
- Comes in 60" length only.
- Care should be taken to mount adapters only to wall studs using correct fasteners.
- Does not include mounting hardware. Mounting hardware selection to be based on wall material. Sold in pairs.
- Failure to do this may result in collapse of the unit and subsequent possible personal injury.
- Compile vertical channels cannot be shared.

DESCRIPTION	PRODUCT CODE	LIST PRICE	DIMENSIONS/INCHES		
			H	W	D
Vertical Channel	CWMA60	35	60	0.6	0.7

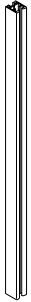

CMPC - UNIVERSAL POST CAP

- Comes standard with universal post.
- Specified separately for reconfiguration purposes.
- Available in standard Compile paint options.
- Made of PVC.

DESCRIPTION	PRODUCT CODE	LIST PRICE	DIMENSIONS/INCHES		
			H	W	D
Universal Post Cap	CMPC	7	2	3	8

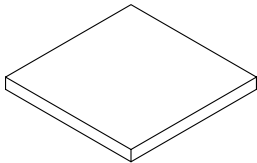

CMPC - POST BASE COVER

- Post Base Covers are not included with Universal Corner Posts.
- Base trim for universal post. These are connected with screws at the base and the trims at the post will slide to meet.
- Available for 2-way and 3-way configurations.
- Finish is smooth plastic.
- Available in standard Compile paint options.

DESCRIPTION	PRODUCT CODE	LIST PRICE	DIMENSIONS/INCHES		
			H	W	D
Post Base Cover - 3-Way Connection	CMPC1	11	6		



Post Base Cover - 2-Way Connection	CMPC2	12	6		
------------------------------------	-------	----	---	--	--

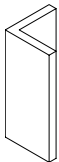

CMHLPF - FLAT LEG FOR FREESTANDING PANELS

- Not intended to add to a run of panels in conjunction with Leveling Glides.
- Kit will contains one legs and all attachment hardware.
- For the installation the customer will have to remove the existing levelers on the panel and replace it with the legs.
- Please specify paint finish.

DESCRIPTION	PRODUCT CODE	LIST PRICE	DIMENSIONS/INCHES		
			H	W	D

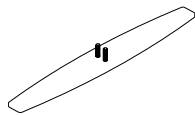

Single Flat Leg	CMHLPF01	114	.31	21	3
-----------------	----------	-----	-----	----	---

CMHLPF - FLAT LEG FOR FREESTANDING PANELS

- Double kit for freestanding applications.
- Kit will contains two legs and all attachment hardware.
- For the installation the customer will have to remove the existing levelers on the panel and replace it with the legs.
- Please specify paint finish.
- Note: Leg is on available for freestanding panels 42" to 60" wide.

DESCRIPTION	PRODUCT CODE	LIST PRICE	DIMENSIONS/INCHES		
			H	W	D

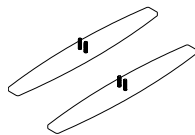

Double Flat Leg	CMHLPF02	226	.31	21	3
-----------------	----------	-----	-----	----	---

CMHLLP01 - LOW PROFILE FOOT

- Provides added support to a panel under load.
- Adjustable glides and connectors included.
- Made of powder coated steel.

DESCRIPTION	PRODUCT CODE	LIST PRICE	DIMENSIONS/INCHES		
			H	W	D

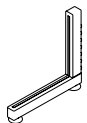

Low Profile Foot	CMHLLP01	169	12	11	1.1
------------------	----------	-----	----	----	-----

CMHLLP02 - LOW PROFILE FOOT

- Provides added support to a panel under load.
- Adjustable glides and connectors included.
- Made of powder coated steel.
- Set includes 2 complete legs.

DESCRIPTION	PRODUCT CODE	LIST PRICE	DIMENSIONS/INCHES		
			H	W	D

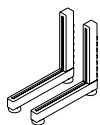

Double Low Profile Foot	CMHLLP02	337	12	11	1.1
-------------------------	----------	-----	----	----	-----

CMPS - POST SEPARATOR

- Creates a diagonal division within a compile post.
- Please specify post height.

DESCRIPTION	PRODUCT CODE	LIST PRICE	DIMENSIONS/INCHES		
			H	W	D
Post Separator	CMPS01	140	96	3.25	14

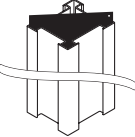

electrical

STEP-BY-STEP SPECIFICATION – 8-WIRE ELECTRICAL SYSTEM

Step 1 Determine the location of the source power entering the Panel Run.

1. At the base of the Panel.
 - (a) Use CE8FR1 Reversible Floor Power Entry (default to CE8FR1).
 - (b) Select the Panel to which the Floor Power Entry will be attached.
 - (c) Select the side of the Panel and the receptacle outlet to which the Floor Power Entry is to be attached.

Note: When using Pass Through Connectors in conditions other than a straight line, you must use a CE8CI-1 I-Connector along with a CE8CP17 Flexible Mesh Jumper Cable through the corner post.

Step 2 Determine which Panels are to be powered.

1. Use CE8PD Power Distribution Housing that corresponds with the width of the Panel.

Step 3 Connect power to the powered Panels.

1. Use CE8CP17 Flexible Mesh Jumper Cable between two adjacent powered Panels.
2. Use CE8CP17 Flexible Mesh Jumper Cable between two adjacent powered Panels separated by a post.
3. Use CE8CP17 Flexible Mesh cable (to turn the post) and a CE8CI-1 "I" Connector to attach the CE8CP Pass Through Cable.
 - (a) The length of the Pass-Through Cable is calculated by adding together the widths of the non-powered Panels that separate the two powered Panels and applying an additional 16" to the total. (CE8PD Power Distribution Housing is positioned 8" in from the ends of the powered Panel.)
 - (b) An additional 3" must be added to the Pass-Through Cable for each post that the cable passes through.
 - (c) Subtract 17" from the total length to find the pass through cable length required.
4. From the price list, select the CE8CP Pass-Through Cable that matches the calculated length. If the length is between listed sizes, use the next size up.

Step 4 Determine the location and circuitry of the receptacles.

1. Each powered Panel has four (4) potential locations for CE8RD Duplex Receptacles – 2 per side. (Exception: 24" wide Panel has only two potential locations – 1 per side.)
2. At each receptacle location there is a choice of four circuit options. Select a circuit option for each location. Circuits one & two are utility circuits; circuits A & B are dedicated circuits.

COMPILE'S 8-WIRE ELECTRICAL SYSTEM

Electrical

This modification allows for the integration of the commonly required "2+2" configuration (2 utility circuits, 2 dedicated circuits) found in the source power of most of today's North American buildings.

This system is rated for connection to:

1. A grounded 120/240V, single phase, 20 A, 60Hz
2. A 120/208V, 3 phase, 20 A, 60Hz branch circuit

EQUIPMENT AMPERAGE

Calculator	0.25
Electric Eraser	0.50
Pencil Sharpener.....	1.00
Radio	0.05
Paper Shredder.....	4.40 - 13.00
Electric Typewriter	1.20
Personal Computer	2.00 - 4.00
Video Display Terminal	0.08
Draft / Letter Quality Printer	1.20 - 3.00
Laser Printer.....	5.00 - 8.00
Processor / Disk Unit.....	1.00 - 10.00

Data/Comm

Compile's duplex receptacle openings (1.345 x 2.80) will conform to the ANSI/TIA/EIA Furniture Opening Standard of 1.38 +/- .035 x 2.71 +/- .04

Desk Top Plotter	1.50
Fan	1.00
Heater	8.50 - 12.50
Coffee Pot.....	15.00
Task Light	1.00
Slide Projector	2.00 - 6.00

Since some equipment, such as large copiers, printers, plotters, heaters and coffee makers would occupy most of the circuit capacity, it is recommended that such devices be supplied with the power directly from the wall or building receptacle.



Wiring Schematic

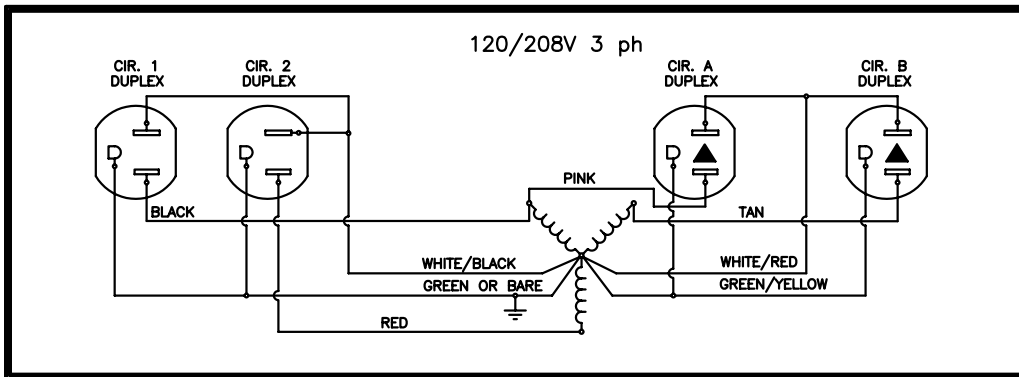
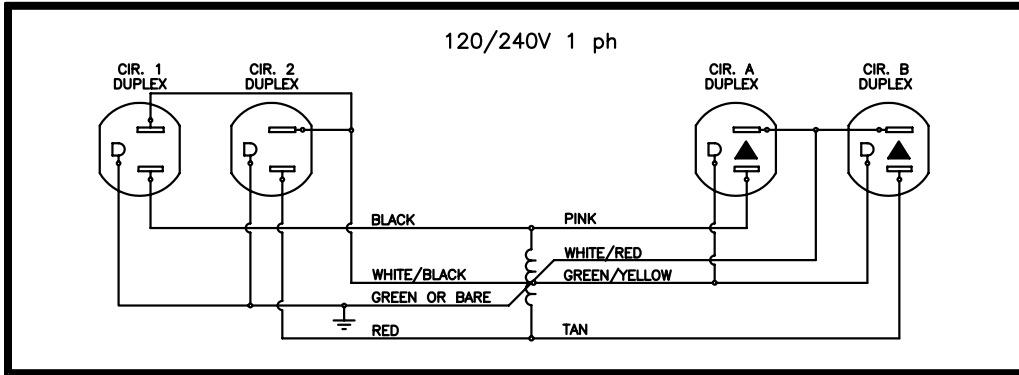

Defining "2 + 2" Wiring Configurations

2 + 2 Configuration (8 wire, 4 circuit)

Two Utility Circuits [Compile's new #1 & #2 circuits] share one neutral wire and one ground wire.
 (2 hot [circuit] wires + 1 neutral wire*** + 1 green ground wire* = 4 wires)

Two Dedicated Circuits [Compile's new "A" & "B" circuits] share one neutral wire and one ground wire.
 (2 hot [circuit] wires + 1 neutral wire*** + 1 green/yellow ground wire** = 4 wires)

Note:

It is the ground wire that makes the difference between "Utility" and "Dedicated" circuits. Refer to Wiring Schematics found above.

* A Green ground wire is a "system" ground. This means it could be grounded to any piece of metal, including the Panel.

** A Green/Yellow ground wire is isolated, within the wiring conduit, all the way back to the box at the source (building ground).

*** All Neutral Wires are 10 gauge rather than 12 gauge meaning they are larger than normal, allowing greater protection against "noise" or interference on the circuit.

This page provides an exploded view of a sample configuration highlighting each **Electrical** component required when specifying this configuration.

Components

- A. CE8PD36 Power Distribution Housing
Note: 8 wire, 4 circuits, 2+2 configuration
- B. CE8CP17 Flexible Mesh Jumper Cable (connects two panels side by side or separated by a post)
- C. CE8RD Duplex Receptacle
- D. CE8CI-1 "I" Connector
- E. CE8CP Pass-Through Cable
Note: Must run in a straight line application only
Note: Pass-Through Extension Cable (CE8CPF154) available – extends power capability beyond 208".

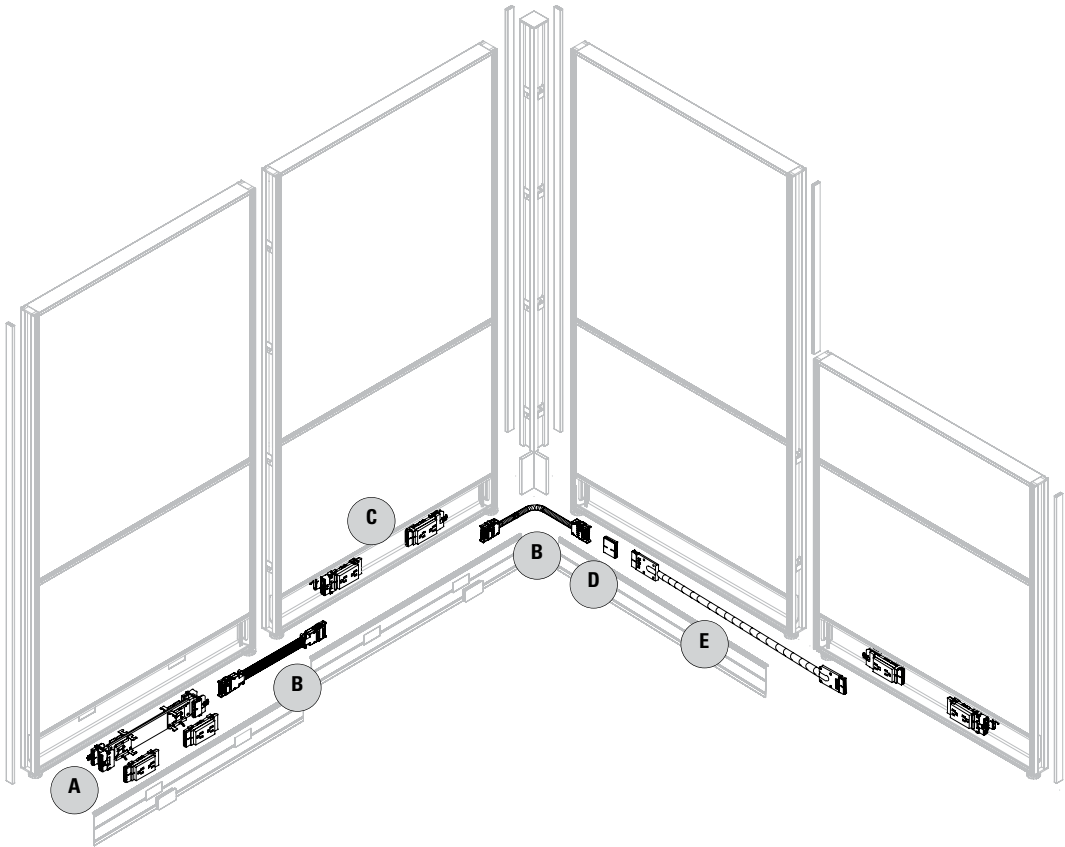

ELECTRICAL

E8PD - POWER DISTRIBUTION HOUSING

- Power housing is specified per panel size (e.g. CE8PD36 is for use in a 36" panel).
- 8 wire, 4 circuits (4th circuit dedicated).
- Power distribution housing is required for each powered panel, the power distribution housing should equal the width of the panel that it is specified in.
- Provides two duplex receptacle ports per panel side on all panel widths except the 24" wide panel.
- 24" wide panel allows for only one (1) duplex receptacle on one panel side.
- Each power distribution housing supports 15-20 amps.
- Must specify Raceway Cover with Knockouts on panels, where Power Distribution Housings will be utilized.

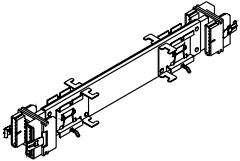
	DESCRIPTION	PRODUCT CODE	LIST PRICE	DIMENSIONS/INCHES		
				H	W	D
	Power Distribution Housing	CE8PD24	140		6 1/4	
		CE8PD30	190		11 1/2	
		CE8PD36	199		17 1/2	
		CE8PD42	203		23 1/2	
		CE8PD48	219		29 1/2	
		CE8PD54	220		39 1/4	
		CE8PD60	221		41 1/2	
		CE8PD66	238		51 1/4	
		CE8PD72	252		57 1/4	

CE8CP17 - FLEXIBLE MESH JUMPER CABLE

- 17" mesh jumper.
- Jumper cable is used to pass through a post or connect two panels together.

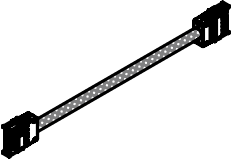
	DESCRIPTION	PRODUCT CODE	LIST PRICE	DIMENSIONS/INCHES		
				H	W	D
	Flexible Mesh Jumper Cable	CE8CP17	109		17	

ELECTRICAL

CE8CP - PASS THROUGH CABLE

- Flexible metal conduit is used to distribute electrical power through non-powered panels.
- Metal conduit pass through cables should be in used in a straight runs. Metal conduit pass through cables cannot pass through a post.
- Flexible conduit is required to turn a post. This only comes as 17" w. If panels at the posts do not all have power distribution housings, they must be added even if duplexes are not specified.
- To calculate the length of a Pass-Through Cable, add the widths of the non-powered panels separating the powered panels (panels with distribution housing attached). To this add 16" (distance from the edge of the panel to the distribution housing x 2).
- Add additional 3" when passing through a corner post. See the Tips at the beginning of the section for more details.

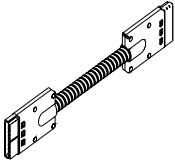
DESCRIPTION	PRODUCT CODE	LIST PRICE	DIMENSIONS/INCHES		
			H	W	D
 Pass Through Cable	CE8CP28	144	28	1/2	
	CE8CP40	151	40	1/2	
	CE8CP46	156	46	1/2	
	CE8CP52	161	52	1/2	
	CE8CP58	170	58	1/2	
	CE8CP64	179	64	1/2	
	CE8CP70	183	70	1/2	
	CE8CP76	186	76	1/2	
	CE8CP82	193	82	1/2	
	CE8CP88	199	88	1/2	
	CE8CP94	204	94	1/2	
	CE8CP100	210	100	1/2	
	CE8CP106	221	106	1/2	
	CE8CP118	232	118	1/2	
	CE8CP130	255	130	1/2	
	CE8CP142	265	142	1/2	
	CE8CP154	279	154	1/2	
	CE8CP172	298	172	1/2	
	CE8CP190	314	190	1/2	
	CE8CP208	324	208	1/2	
Pass Through Extension Cable	CE8CPF154	279	154	1/2	

CE8CI-1 - "I" CONNECTOR

- Female - Female connector connects two Pass-Through Cables.
- Connects 17" Flexible Jumper Cable or ceiling feeds to pass through cables.

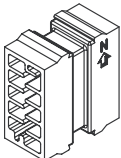
DESCRIPTION	PRODUCT CODE	LIST PRICE	DIMENSIONS/INCHES		
			H	W	D
 "I" Connector	CE8CI-1	80			



ELECTRICAL

CE8RD - DUPLEX RECEPTACLE

- Up to 3 receptacles per circuit
- Up to 6 receptacles per circuit (24 per infeed), not to exceed total of 15 Amps per circuit.
- Duplex Receptacles standard in Black (BLK).

- CE8RD1 = Circuit #1 (utility circuit)
- CE8RD2 = Circuit #2 (utility circuit)
- CE8RDA = Circuit A (dedicated)
- CE8RDB = Circuit B (dedicated)
- CE8RD1 and CE8RD2 (#1 and #2 share common ground)
- CE8RDA and CE8RDB (A and B share common ground)

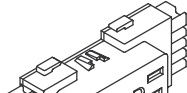
	DESCRIPTION	PRODUCT CODE	LIST PRICE	DIMENSIONS/INCHES		
				H	W	D
	Duplex Receptacle	CE8RD1	30			
		CE8RD2	30			
		CE8RDA	30			
		CE8RDB	30			

CE8RDxca - CALIFORNIA CONTROLLED DUPLEX RECEPTACLE

- California Title 24 meets federal and LEED certification guidelines
- Allows circuit to be controlled or switched off when utility is not in use.
- Duplex receptacles are rated for 15 Amps.
- CE8RD1CA = Circuit #1 (utility circuit)
- CE8RD2CA = Circuit #2 (utility circuit)
- CE8RDACA = Circuit A (dedicated)
- CE8RDBCA = Circuit B (dedicated)

NOTE:

- CE8RD1CA and CE8RD2CA (#1 and #2 share common ground)
- CE8RDACA and CE8RDBCA (A and B share common ground)
- Up to 6 receptacles per circuit (24 per infeed), not to exceed total of 15 Amps per circuit.
- Available in BLK finish only.

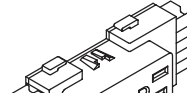
	DESCRIPTION	PRODUCT CODE	LIST PRICE	DIMENSIONS/INCHES		
				H	W	D
	Duplex Receptacle	CE8RD1CA	34	2	4 5/8	1 1/4
		CE8RD2CA	34	2	4 5/8	1 1/4
		CE8RDACA	34	2	4 5/8	1 1/4
		CE8RDBCA	34	2	4 5/8	1 1/4

ELECTRICAL

CE8FR1 - REVERSIBLE FLOOR POWER ENTRY

- Takes the place of a duplex receptacle by snapping into the base power way.
- Includes 72" long flexible metal conduit.
- Must be hard wired to source power by a licensed electrician.
- Diameter is 0.85"

CE8FR2 - REVERSIBLE FLOOR POWER ENTRY

- Takes the place of a duplex receptacle by snapping into the base power way.
- Includes 144" long flexible metal conduit.
- Must be hard wired to source power by a licensed electrician.

DESCRIPTION	PRODUCT CODE	LIST PRICE	DIMENSIONS/INCHES		
			H	W	D

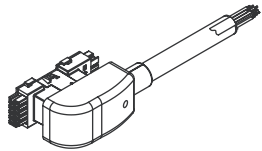

Reversible Floor Power Entry

CE8FR1
CE8FR2

315
406

72
144

CE8F - FLOOR POWER ENTRY

- Snaps in end of power distribution housing.
- Includes flexible vinyl conduit.
- Must be hard wired to source power by a licensed electrician.
- Diameter is 0.85"

DESCRIPTION	PRODUCT CODE	LIST PRICE	DIMENSIONS/INCHES		
			H	L	D

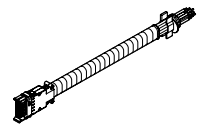

Reversible Floor Power Entry

CE8F1P
CE8F2P

324
419

72
144

CMEB01 - ELECTRICAL BOX - CHICAGO

- Can be retrofitted in any size of panel at the receptacle location.
- Gives access from one side only at each location.
- Customer to supply conduit, wiring, receptacle, and face plate.
- 2 per panel ,except 24" panel only one
- Note: A licensed electrician must provide hardware connection with the junction box.

DESCRIPTION	PRODUCT CODE	LIST PRICE	DIMENSIONS/INCHES		
			H	W	D

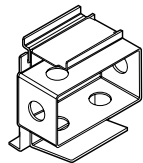

Electrical Box - Chicago

CMEB01

91

CMEB02NY - ELECTRICAL BOX - NEW YORK

- Shipped assembled.
- Comes with pig tail electric.
- Use with 30" wide Panel of larger
- Post extension cable capacities: without electric, 30 with electric, 20
- Includes ceiling bezel and screws.

DESCRIPTION	PRODUCT CODE	LIST PRICE	DIMENSIONS/INCHES		
			H	W	D

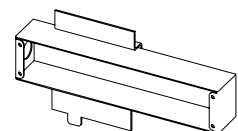

Electrical Box - New York

CMEB02NY

403



ELECTRICAL

CEPEXX - POST EXTENSION

- Same profile as post.
- Includes two post extension brackets, four screws and four trim inserts.
- Includes ceiling bezel and screws.

	DESCRIPTION	PRODUCT CODE	LIST PRICE	DIMENSIONS/INCHES		
				H	W	D
	Post Extension	CEPE64	174	64		
		CEPE82	219	82		

CE8ECX - CEILING FEED

- Snaps into the end of a Power Distribution Housing.
- Flexible metal conduit extends into the ceiling through a corner post and post extension.
- Must be hard wired to source power by a licensed electrician.
- 4" junction box included.
- Post extension ordered separately

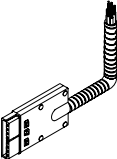
	DESCRIPTION	PRODUCT CODE	LIST PRICE	DIMENSIONS/INCHES		
				H	W	D
	Ceiling Feed	CE8EC1	242	132		
		CE8EC2	426	144		
		CE8EC3	481	180		

CMECC - CABLE COVER

- Attaches to panels vertically between modules to provide enclosures for power or data cords.
- Available in Steel (STL), Black (BLK), Nevada (NEV) only.
- Available in 21" and 36" lengths, 6 per pack.

	DESCRIPTION	PRODUCT CODE	LIST PRICE	DIMENSIONS/INCHES		
				H	W	D
	Cord Cover	CMECC21	29	21	0.5	1
		CMECC36	45	36	0.5	1

ELECTRICAL

CMLEDES - STARTER LED TASK LIGHT

- Undercabinet slim profile LED linear light fixture with lens and On/Off switch.
- May be used as stand-alone or extended with add-on section below (CMLEDES_DSC).
- Plug-in power supply with 72" cord length plus 78" DC cable.
- Includes magnet mounting bracket with optional adhesive metal plate.
- Light enclosure in clear anodizing finish. Color temperature cool white 4000K.
- Lifespan rated 30,000 hours.

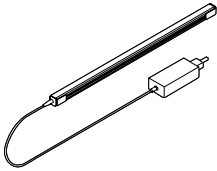
	DESCRIPTION	PRODUCT CODE	LIST PRICE	DIMENSIONS/INCHES		
				H	W	D
	Led Task Light	CMLEDES24	251	1	22.9	1
		CMLEDES30	280	1	33.5	1
		CMLEDES36	289	1	45.5	1

CMLEDES - ADD-ON LED TASK LIGHT

- Undercabinet slim profile LED linear add-on light fixture with lens.
- Daisy chain unit with 39" linking cable, no power supply.
- Add-on units can only be linked up to a total of 48 watts per power supply; this is equivalent to 10 feet of nominal length of light per power supply.
- Includes magnet mounting bracket with optional adhesive metal plate. Light enclosure in clear anodizing finish. Color temperature cool white 4000K. Lifespan rated 30,000 hours.

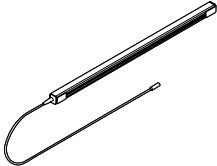
	DESCRIPTION	PRODUCT CODE	LIST PRICE	DIMENSIONS/INCHES		
				H	W	D
	Led Task Light	CMLEDES24DSC	206	1	24	39
		CMLEDES36DSC	242	1	36	39
		CMLEDES48DSC	275	1	48	39

CMLEDESOS - OCCUPANCY SENSOR

- Inline add-on controller for dimming and occupancy sensor.
- Sensor bypass switch.

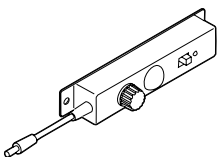
	DESCRIPTION	PRODUCT CODE	LIST PRICE	DIMENSIONS/INCHES		
				H	W	D
	Occupancy Sensor	CMLEDESOS	103	6	2.4	2



worksurfaces

The information listed below provides you with basic features of Compile Worksurfaces.

- Compile thermally fused Worksurfaces are 1" thick and are finished with 3 mm PVC edging on all sides.
- Worksurfaces are predrilled to enable proper alignment with worksurface supports.
- Standard laminate offerings are available in thermally-fused (T). See laminate listings for details.
- Wood grain laminates on corner Worksurfaces up to 42" available in laminate run diagonally for an upcharge. Otherwise, standard horizontal application of laminate will be used.
- Most wood grain laminate Worksurfaces will have matching woodgrain trim unless specified otherwise.
- Depth of the Worksurface scoops are 1 1/8" when measured from the Panel the Worksurface is attached to.
- All Worksurfaces require support items. These are priced separately within this section.
- Grain Direction for Worksurfaces are as follows:

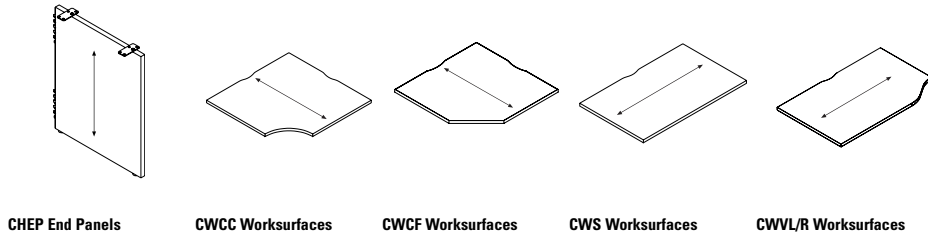

- Communication and electrical wires are routed through a cable scoop located at the back of the Worksurface. When specifying a Straight Worksurface (CWS) or a Curvilinear Worksurface (CWVL), note that the number of cable scoops depends upon the width of the Worksurface. All other Worksurface shapes have one scoop on Panel edges.

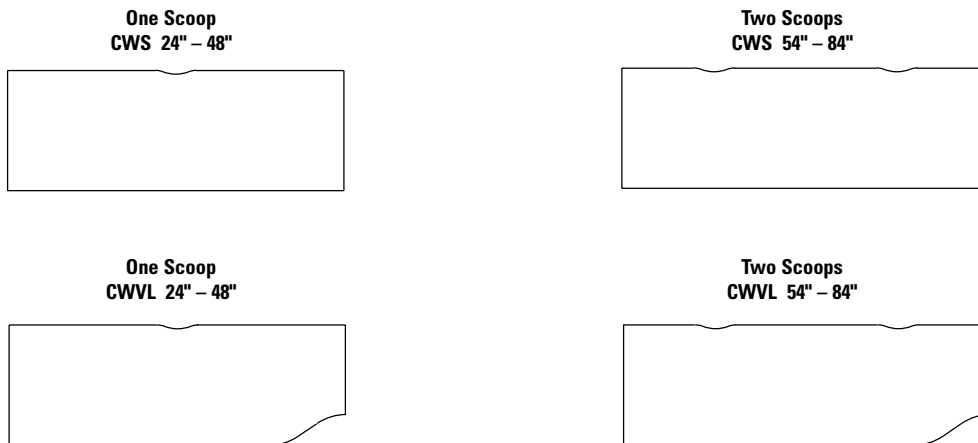

This page provides a three dimensional view of a sample configuration highlighting each **Worksurface** component required when specifying this configuration.

Components

- A.** CWVL2436 Curvilinear Worksurface – Left
 Note: When deepest end equals 24", opposite depth is 18"
 When deepest end equals 30", opposite depth is 24"
- B.** CWCC3618 Corner Curved Worksurface
- C.** CWVR2436 Curvilinear Worksurface – Right

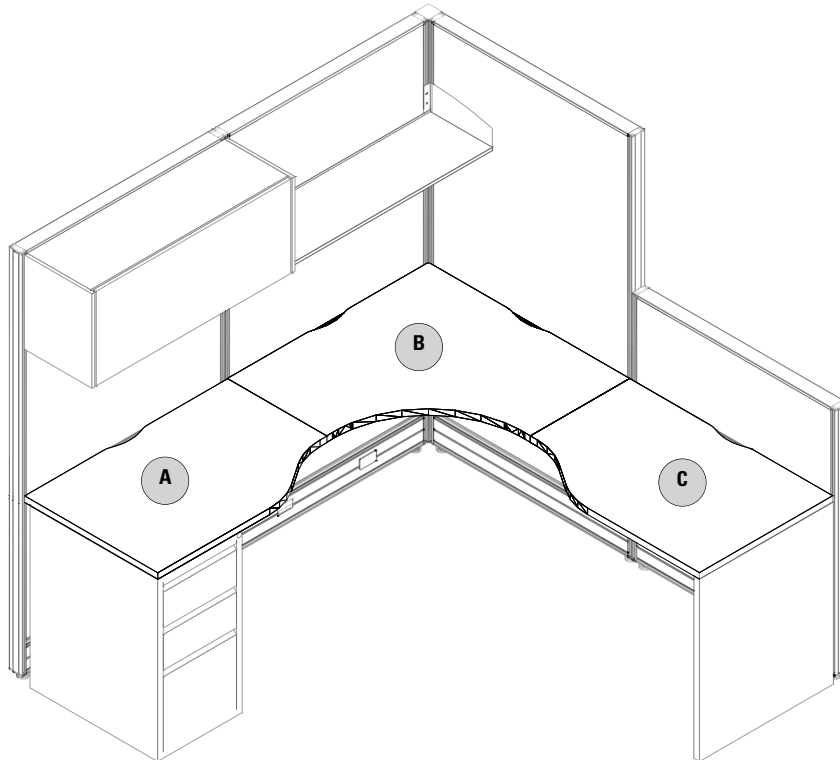

WORKSURFACES

CWS - RECTANGULAR WORKSURFACES

- All tops are thermally fused 1" thick with pilot holes to enable proper alignment with worksurface supports. Wood screws must be used.
- Compile worksurfaces feature a 3mm edge.
- Support hardware must be ordered separately. See the listings in this section.
- Width and depth dimensions listed include a nominal measurement (3/8") to account for wire management between the worksurface and adjoining panel.
- All surfaces over 48" will have two scoops, all others have one.
- Worksurfaces greater than 48" wide require additional structural support.

	DESCRIPTION	PRODUCT CODE	LIST PRICE	DIMENSIONS/INCHES		
				D	W	
	Rectangular Worksurfaces - 24" Deep	CWS2424P	126	24	24	
		CWS2430P	135	24	30	
		CWS2436P	151	24	36	
		CWS2442P	194	24	42	
		CWS2448P	234	24	48	
		CWS2454P	273	24	54	
		CWS2460P	308	24	60	
		CWS2466P	321	24	66	
		CWS2472P	333	24	72	
		CWS2478P	536	24	78	
		CWS2484P	542	24	84	
		CWS2490P	569	24	90	
		CWS2496P	607	24	96	
		Rectangular Worksurfaces - 30" Deep	CWS3024P	148	30	24
			CWS3030P	157	30	30
			CWS3036P	186	30	36
CWS3042P	261		30	42		
CWS3048P	273		30	48		
CWS3054P	300		30	54		
CWS3060P	321		30	60		
CWS3066P	332		30	66		
CWS3072P	352		30	72		
CWS3078P	667		30	78		
CWS3084P	680	30	84			



WORKSURFACES

CWSNSC - STRAIGHT WORKSURFACE NO SCOOP

- There is no scoop on this worksurface.
- Worksurface depth is exact, not nominal.
- Support hardware must be ordered separately. See listing in this section of the price book.
- For use with Bridges II or Princeton style legs.
- Surfaces not available in HPW.
- Worksurfaces greater than 48" wide require additional structural support.

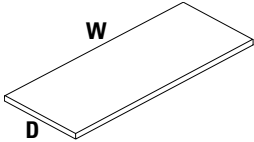
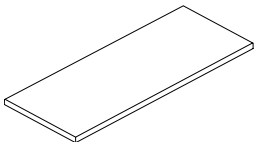
	DESCRIPTION	PRODUCT CODE	LIST PRICE	DIMENSIONS/INCHES	
				D	W
	Straight Worksurface No Scoops - 24" Deep	CWS2424NSC	126	24	24
		CWS2430NSC	135	24	30
		CWS2436NSC	151	24	36
		CWS2442NSC	194	24	42
		CWS2448NSC	234	24	48
		CWS2454NSC	273	24	54
		CWS2460NSC	308	24	60
		CWS2466NSC	321	24	66
		CWS2472NSC	333	24	72
		CWS2478NSC	536	24	78
		CWS2484NSC	542	24	84
		CWS2490NSC	638	24	90
		CWS2496NSC	607	24	96
	Straight Worksurface No Scoops - 30" Deep	CWS3024NSC	148	30	24
		CWS3030NSC	157	30	30
		CWS3036NSC	186	30	36
		CWS3042NSC	261	30	42
		CWS3048NSC	273	30	48
		CWS3054MSC	300	30	54
		CWS3060NSC	321	30	60
		CWS3066NSC	332	30	66
		CWS3072NSC	352	30	72
		CWS3078NSC	667	30	78
		CWS3084NSC	680	30	84

WORKSURFACES

CWSNSCP - RECTANGULAR WORKSURFACE, NO SCOOPS FOR HEIGHT ADJUSTABLE TABLES

- There is no scoop on this work surface.
- Worksurface depth is exact, not nominal.
- Support hardware must be ordered separately. See listing in this section of the price book.
- For use with Height Adjustable Tables
- Surfaces not available in HPW.

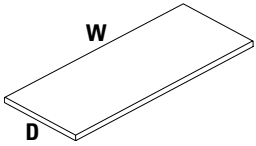
	DESCRIPTION	PRODUCT CODE	LIST PRICE	DIMENSIONS/INCHES		
				H	D	W
	Rectangular Worksurface No Scoops for Height Adjustable Tables	CWS2346NSCP	234	1	23	46
		CWS2352NSCP	273	1	23	52
		CWS2358NSCP	308	1	23	58
		CWS2364NSCP	321	1	23	64
		CWS2370NSCP	333	1	23	70
		CWS2946NSCP	273	1	29	46
		CWS2952NSCP	300	1	29	52
		CWS2958NSCP	321	1	29	58
		CWS2964NSCP	332	1	29	64
		CWS2970NSCP	352	1	29	70

WORKSURFACES

CWSWNSC - WEDGE WORKSURFACE NO SCOOP

- There is no scoop on this worksurface.
- Worksurface depth is exact, not nominal.
- Support hardware must be ordered separately. See listing in this section of the price book.
- For use with Bridges II or Princeton style legs.
- Surfaces not available in HPW.
- Worksurfaces greater than 48" wide require additional structural support.

	DESCRIPTION	PRODUCT CODE	LIST PRICE	DIMENSIONS/INCHES		
				D1	D2	W
	Straight Wedge Worksurface No Scoops - Left	CWSW241848NSC	326	24	18	48
		CWSW241854NSC	368	24	18	54
		CWSW241860NSC	405	24	18	36
		CWSW241866NSC	449	24	18	42
		CWSW241872NSC	489	24	18	48
		CWSW302448NSC	405	30	24	60
		CWSW302454NSC	458	30	24	66
		CWSW302460NSC	509	30	24	72
		CWSW302466NSC	559	30	24	78
		CWSW302472NSC	612	30	24	84
	Straight Wedge Worksurface No Scoops - Right	CWSW182448NSC	326	24	18	24
		CWSW182454NSC	368	24	18	30
		CWSW182460NSC	405	24	18	36
		CWSW182466NSC	449	24	18	42
		CWSW182472NSC	489	24	18	48
		CWSW243048NSC	405	30	24	60
		CWSW243054NSC	458	30	24	66
		CWSW243060NSC	509	30	24	72
		CWSW243066NSC	559	30	24	78
		CWSW243072NSC	612	30	24	84

CWSP - RECTANGULAR WORKSURFACES - SPAN A POST

- All tops are thermally fused 1" thick with pilot holes to enable proper alignment with worksurface supports. Wood screws must be used.
- Compile worksurfaces feature a 3mm edge.
- Support hardware must be ordered separately. See the listings in this section.
- Note: Width and depth dimensions listed include a nominal measurement (3/8") to account for wire management between the worksurface and adjoining panel.

	DESCRIPTION	PRODUCT CODE	LIST PRICE	DIMENSIONS/INCHES		
				D	W	
	Rectangular Worksurfaces - 24" Deep Span a Post	CWSP2426P	151	24	26	
		CWSP2432P	182	24	32	
		CWSP2438P	212	24	38	
		CWSP2444P	240	24	44	
		CWSP2450P	271	24	50	
		CWSP2456P	300	24	56	
		CWSP2462P	397	24	62	
		CWSP2468P	432	24	68	
		CWSP2474P	470	24	74	
		CWSP2480P	505	24	80	
		CWSP2486P	576	24	86	
		Rectangular Worksurfaces - 30" Deep Span a Post	CWSP3026P	190	30	26
			CWSP3032P	227	30	32
			CWSP3038P	269	30	38
			CWSP3044P	300	30	44
CWSP3050P	339		30	50		
CWSP3056P	376		30	56		
CWSP3062P	496		30	62		
CWSP3068P	540		30	68		
CWSP3074P	587		30	74		
CWSP3080P	630		30	80		
CWSP3086P	719	30	86			

WORKSURFACES

CWVR - CURVILINEAR WORKSURFACES - RIGHT

- All tops are thermally fused 1" thick with pilot holes to enable proper alignment with worksurface supports. Wood screws must be used.
- Support hardware must be ordered separately. See the listings in this section.
- Compile worksurfaces feature a 3mm edge.
- Note: Width and depth dimensions listed include a nominal measurement (38") to account for wire management between the worksurface and adjoining panel.
- When deepest end equals 24", the opposite depth is 18". When deepest end equals 30", the opposite depth is 24"
- Worksurfaces greater than 48" wide require additional structural support.

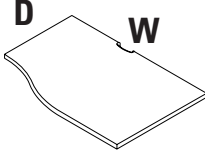
	DESCRIPTION	PRODUCT CODE	LIST PRICE	DIMENSIONS/INCHES		
				D	W	
	Curvilinear Worksurfaces - 24" Deep	CWVR2424P	162	24	24	
		CWVR2430P	168	24	30	
		CWVR2436P	202	24	36	
		CWVR2442P	234	24	42	
		CWVR2448P	268	24	48	
		CWVR2454P	300	24	54	
		CWVR2460P	325	24	60	
		CWVR2466P	360	24	66	
		CWVR2472P	387	24	72	
		CWVR2478P	536	24	78	
		CWVR2484P	542	24	84	
		Curvilinear Worksurfaces - 30" Deep	CWVR3024P	168	30	24
			CWVR3030P	178	30	30
CWVR3036P	210		30	36		
CWVR3042P	288		30	42		
CWVR3048P	300		30	48		
CWVR3054P	332		30	54		
CWVR3060P	360		30	60		
CWVR3066P	387		30	66		
CWVR3072P	411		30	72		
CWVR3078P	667		30	78		
CWVR3084P	680		30	84		

CWVL - CURVILINEAR WORKSURFACES - LEFT

- All tops are thermally fused 1" thick with pilot holes to enable proper alignment with worksurface supports. Wood screws must be used.
- Support hardware must be ordered separately. See the listings in this section.
- Compile worksurfaces feature a 3mm edge.
- Note: Width and depth dimensions listed include a nominal measurement (38") to account for wire management between the worksurface and adjoining panel.
- When deepest end equals 24", the opposite depth is 18". When deepest end equals 30", the opposite depth is 24"

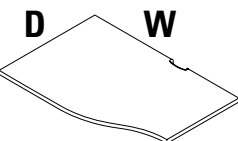
	DESCRIPTION	PRODUCT CODE	LIST PRICE	DIMENSIONS/INCHES		
				D	W	
	Curvilinear Worksurfaces - 24" Deep	CWVL2424P	162	24	24	
		CWVL2430P	168	24	30	
		CWVL2436P	202	24	36	
		CWVL2442P	234	24	42	
		CWVL2448P	268	24	48	
		CWVL2454P	300	24	54	
		CWVL2460P	325	24	60	
		CWVL2466P	360	24	66	
		CWVL2472P	387	24	72	
		CWVL2478P	536	24	78	
		CWVL2484P	542	24	84	
		Curvilinear Worksurfaces - 30" Deep	CWVL3024P	168	30	24
			CWVL3030P	178	30	30
CWVL3036P	210		30	36		
CWVL3042P	288		30	42		
CWVL3048P	300		30	48		
CWVL3054P	332		30	54		
CWVL3060P	360		30	60		
CWVL3066P	387		30	66		
CWVL3072P	411		30	72		
CWVL3078P	667		30	78		
CWVL3084P	680		30	84		



WORKSURFACES

CWCC - CORNER CURVED WORKSURFACES

- All tops are thermally fused 1" thick with pilot holes to enable proper alignment with worksurface supports. Wood screws must be used.
- Compile worksurfaces feature a 3mm edge.
- Support hardware must be ordered separately. See the listings in this section.
- Note: Width and depth dimensions listed include a nominal measurement (3/8") to account for wire management between the worksurface and adjoining panel.
- Note: Wood grain laminates do not run diagonally on corner worksurfaces.
- Worksurfaces greater than 48" wide require additional structural support.

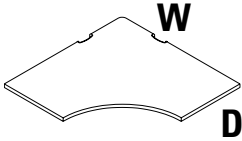
	DESCRIPTION	PRODUCT CODE	LIST PRICE	DIMENSIONS/INCHES	
				D	W
	Corner Curved Worksurfaces - 36"	CWCC3618P	423	18	36
		CWCC3624P	464	24	36
	Corner Curved Worksurfaces - 42"	CWCC4224P	626	24	42
		CWCC4230P	681	30	42
	Corner Curved Worksurfaces - 48"	CWCC4824P	732	24	48
		CWCC4830P	767	30	48

CWCF - FIVE SIDED WORKSURFACES

- All tops are thermally fused 1" thick with pilot holes to enable proper alignment with worksurface supports. Wood screws must be used.
- Compile worksurfaces feature a 3mm edge.
- Support hardware must be ordered separately. See the listings in this section.
- Note: Width and depth dimensions listed include a nominal measurement (3/8") to account for wire management between the worksurface and adjoining panel.
- Note: Wood grain laminates do not run diagonally on corner worksurfaces.

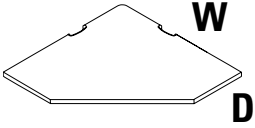
	DESCRIPTION	PRODUCT CODE	LIST PRICE	DIMENSIONS/INCHES	
				D	W
	Five Sided Worksurface - 36"	CWCF3618P	419	18	36
		CWCF3624P	464	24	36
	Five Sided Worksurface - 42"	CWCF4224P	626	24	42
		CWCF4230P	681	30	42
	Five Sided Worksurface - 48"	CWCF4824P	732	24	48
		CWCF4830P	767	30	48

WORKSURFACES

CWC6 - CURVED CORNER WORKSURFACE FOR 60° POST

- All tops are thermally fused 1" thick with pilot holes to enable proper alignment with worksurface supports. Wood screws must be used.
- Compile worksurfaces feature a 3mm edge.
- Support hardware must be ordered separately. See the listings in this section.
- Note: Width and depth dimensions listed include a nominal measurement (3/8") to account for wire management between the worksurface and adjoining panel.
- Note: Wood grain laminates do not run diagonally on corner worksurfaces.
- Worksurfaces greater than 48" wide require additional structural support.

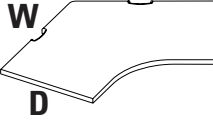
	DESCRIPTION	PRODUCT CODE	LIST PRICE TF	DIMENSIONS/INCHES	
				D	W
	Curved Corner Worksurface for 60° Post - 24"	CWC62424P	395	24	24
		CWC62430P	702	24	30
		CWC62436P	789	24	36
		CWC62442P	1206	24	42
		CWC62448P	1315	24	48
	Curved Corner Worksurface for 60° Post - 30"	CWC63024P	395	30	24
		CWC63030P	702	30	30
		CWC63036P	789	30	36
		CWC63042P	1206	30	42
		CWC63048P	1315	30	48

CWC6L - EXTENDED CURVED CORNER - LEFT

- There are three cable scoops on this worksurface
- Support hardware must be ordered separately. See listing in this section of the price list
- Note: Wood Grain Laminates do not run diagonally on Extended Curved Corners

	DESCRIPTION	PRODUCT CODE	LIST PRICE	DIMENSIONS/INCHES		
				D1	D2	W
	Extended Curved Corner - 36" x 24"	CWC6L362448P	572	36	24	48
		CWC6L362460P	624	36	24	60
		CWC6L362466P	685	36	24	66
		CWC6L362472P	758	36	24	72
		CWC6L362478P	810	36	24	78
		CWC6L362484P	871	36	24	84
	Extended Curved Corner - 42" x 24"	CWC6L422460P	657	42	24	60
		CWC6L422466P	720	42	24	66
		CWC6L422472P	799	42	24	72
		CWC6L422478P	852	42	24	78
		CWC6L422484P	920	42	24	84
	Extended Curved Corner - 42" x 30"	CWC6L423060P	739	42	30	60
		CWC6L423066P	810	42	30	66
		CWC6L423072P	886	42	30	72
		CWC6L423078P	949	42	30	78
		CWC6L423084P	1011	42	30	84
	Extended Curved Corner - 48" x 24"	CWC6L482460P	777	48	24	60
		CWC6L482466P	840	48	24	66
		CWC6L482472P	901	48	24	72
		CWC6L482478P	992	48	24	78
		CWC6L482484P	1031	48	24	84
	Extended Curved Corner - 48" x 30"	CWC6L483060P	822	48	30	60
		CWC6L483066P	895	48	30	66
		CWC6L483072P	971	48	30	72
		CWC6L483078P	1045	48	30	78
		CWC6L483084P	1091	48	30	84



WORKSURFACES

CWCER - EXTENDED CURVED CORNER - RIGHT

- There are three cable scoops on this worksurface
- Support hardware must be ordered separately. See listing in this section of the price list
- Note: Wood Grain Laminates do not run diagonally on Extended Curved Corners
- Worksurfaces greater than 48" wide require additional structural support.

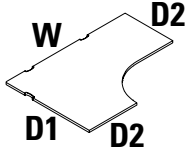
	DESCRIPTION	PRODUCT CODE	LIST PRICE	DIMENSIONS/INCHES		
				D1	D2	W
	Extended Curved Corner - 36" x 24"	CWCER362448P	572	36	24	48
		CWCER362460P	624	36	24	60
		CWCER362466P	685	36	24	66
		CWCER362472P	758	36	24	72
		CWCER362478P	810	36	24	78
		CWCER362484P	871	36	24	84
	Extended Curved Corner - 42" x 24"	CWCER422460P	657	42	24	60
		CWCER422466P	720	42	24	66
		CWCER422472P	799	42	24	72
		CWCER422478P	852	42	24	78
		CWCER422484P	920	42	24	84
	Extended Curved Corner - 42" x 30"	CWCER423060P	739	42	30	60
		CWCER423066P	810	42	30	66
		CWCER423072P	886	42	30	72
		CWCER423078P	949	42	30	78
		CWCER423084P	1011	42	30	84
	Extended Curved Corner - 48" x 24"	CWCER482460P	777	48	24	60
		CWCER482466P	840	48	24	66
		CWCER482472P	901	48	24	72
		CWCER482478P	992	48	24	78
		CWCER482484P	1031	48	24	84
	Extended Curved Corner - 48" x 30"	CWCER483060P	822	48	30	60
		CWCER483066P	895	48	30	66
		CWCER483072P	971	48	30	72
		CWCER483078P	1045	48	30	78
		CWCER483084P	1091	48	30	84

CWD - "D" WORKSURFACE

- Support hardware must be ordered separately. See listing in this section of the price list
- Monoleg is included

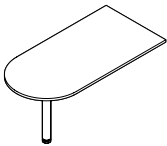
	DESCRIPTION	PRODUCT CODE	LIST PRICE	DIMENSIONS/INCHES	
				D	W
	"D" Worksurface - 24"	CWD2442P	469	24	42
		CWD2448P	481	24	48
		CWD2460P	505	24	60
		CWD2472P	540	24	72
	"D" Worksurface - 30"	CWD3042P	508	30	42
		CWD3048P	514	30	48
		CWD3060P	540	30	60
		CWD3072P	599	30	72

WORKSURFACES

CWH - HATCHET WORKSURFACE (LEFT SHOWN)

- Cable scoop is in the center of the 36" wide edge.
- Support hardware must be ordered separately. See listing in this section of the price list
- Monoleg is included
- Must be specified either left or right handed.
- Note: Wood Grain Laminates do not run diagonally on Hatchet Corners
- Worksurfaces greater than 48" wide require additional structural support.

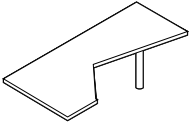
	DESCRIPTION	PRODUCT CODE	LIST PRICE	DIMENSIONS/INCHES		
				D1	D2	W
	Hatchet Worksurface - Left	CWHL3672P	1030	36	30	72
	Hatchet Worksurface - Right	CWHR3672P	1030	36	30	72

Right Shown

CWSW - STRAIGHT WEDGE WORKSURFACES

- Support hardware must be ordered separately. See the listings in this section.
- Must be specified either left or right handed.

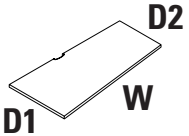
	DESCRIPTION	PRODUCT CODE	LIST PRICE	DIMENSIONS/INCHES		
				D1	D2	W
	Straight Wedge Worksurface - Left	CWSW241848P	326	24	18	48
		CWSW241854P	368	24	18	54
		CWSW241860P	405	24	18	60
		CWSW241866P	449	24	18	66
		CWSW241872P	489	24	18	72
	Straight Wedge Worksurface - Right	CWSW302448P	405	30	24	48
		CWSW302454P	458	30	24	54
		CWSW302460P	509	30	24	60
		CWSW302466P	559	30	24	66
		CWSW302472P	612	30	24	72
	Straight Wedge Worksurface - Right	CWSW182448P	326	18	24	48
		CWSW182454P	368	18	24	54
		CWSW182460P	405	18	24	60
		CWSW182466P	449	18	24	66
CWSW182472P		489	18	24	72	
CWSW243048P		405	24	30	48	
CWSW243054P		458	24	30	54	
CWSW243060P		509	24	30	60	
CWSW243066P		559	24	30	66	
CWSW243072P		612	24	30	72	

CWQR - QUARTER ROUND PANEL WORKSURFACE

- The worksurface edge running along the panel is a slightly different length than that of the worksurface end, causing the surface to be handed.
- Left hand surface shown.
- Support hardware must be ordered separately. See the listings in this section.

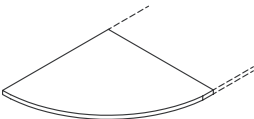
	DESCRIPTION	PRODUCT CODE	LIST PRICE	DIMENSIONS/INCHES	
				D	W
	Quarter Round Panel Worksurface - Left	CWQRL2424	194	24	24
		CWQRL3030	257	30	30
	Quarter Round Panel Worksurface - Right	CWQRR2424	194	24	24
		CWQRR3030	257	30	30



WORKSURFACES

CWQRC - QUARTER ROUND PANEL CORNER WORKSURFACE

- Wraps around a 90° corner post.
- Support hardware must be ordered separately. See the listing in this section.
- Worksurfaces greater than 48" wide require additional structural support.

DESCRIPTION	PRODUCT CODE	LIST PRICE	DIMENSIONS/INCHES	
			D	W
Quarter Round Panel Corner Worksurface	CWQRC2424	233	24	24
	CWQRC3030	287	30	30

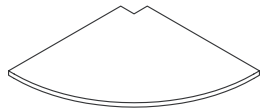

CWT - STRAIGHT TRANSACTION WORKSURFACE

- Support hardware must be ordered separately. See the listings in this section.
- Compile worksurfaces feature a 3mm edge.

DESCRIPTION	PRODUCT CODE	LIST PRICE	DIMENSIONS/INCHES	
			D	W
Straight Transaction Worksurface	CWT1512	58	15	12
	CWT1518	77	15	18
	CWT1524	91	15	24
	CWT1530	110	15	30
	CWT1536	125	15	36
	CWT1542	140	15	42
	CWT1548	159	15	48
	CWT1554	173	15	54
	CWT1560	192	15	60
	CWT1566	206	15	66
	CWT1572	224	15	72
	CWT1578	240	15	78
	CWT1584	256	15	84

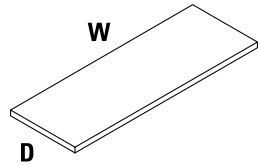

CWTE - END TRANSACTION SURFACE

- Support hardware must be ordered separately. See the listings in this section.
- Extends 1.5" past end of run.
- Compile worksurfaces feature a 3mm edge.

DESCRIPTION	PRODUCT CODE	LIST PRICE	DIMENSIONS/INCHES	
			D	W
End Transaction Surface	CWTE1512	77	15	14
	CWTE1518	91	15	20
	CWTE1524	110	15	26
	CWTE1530	125	15	32
	CWTE1536	140	15	38
	CWTE1542	159	15	44
	CWTE1548	173	15	50
	CWTE1554	192	15	56
	CWTE1560	206	15	62
	CWTE1566	224	15	68
	CWTE1572	240	15	74

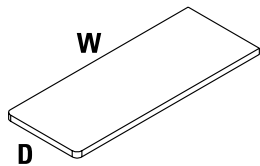

WORKSURFACES

CWTCL - "L" CORNER TRANSACTION SURFACE

- Support hardware must be ordered separately. See the listings in this section.
- When specifying this item along with a straight surface, deduct 12" from each return side.
- Worksurfaces greater than 48" wide require additional structural support.

DESCRIPTION	PRODUCT CODE	LIST PRICE	DIMENSIONS/INCHES	
			D	W
"L" Corner Transaction Surface	CWTCL90	163	15	21

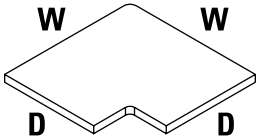

CW9T - CORNER TRANSACTION SURFACE FOR 90° POST

- Support hardware must be ordered separately. See the listing in this section.

DESCRIPTION	PRODUCT CODE	LIST PRICE	DIMENSIONS/INCHES	
			D	W
Corner Transaction Surface for 90° Post	CW9T1524	222	15	32.861
	CW9T1530	265	15	38.861
	CW9T1536	307	15	44.861
	CW9T1542	348	15	50.861
	CW9T1548	394	15	56.861

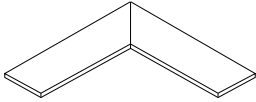

CHCB2 - CORNER BRACKET

- Attaches the corner of any worksurface to a panel connector.
- Priced and shipped in pairs.
- Available in standard paint colors.
- Cannot be used off modular.
- Can be used when a panel is the same depth as the worksurface in the front and back application.

DESCRIPTION	PRODUCT CODE	LIST PRICE	DIMENSIONS/INCHES	
			D	W
Corner Bracket	CHCB2	20	2.5	

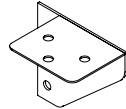

CHWB1 - MID SPAN SUPPORT BRACKET

- Does not need to be on module.
- Used when a panel exceeds the depth of the adjacent worksurface.
- Can only be used with a Segmented Panel.
- Comes in unfinished zinc.

DESCRIPTION	PRODUCT CODE	LIST PRICE	DIMENSIONS/INCHES	
			D	W
Mid Span Support Bracket	CHWB1	12		

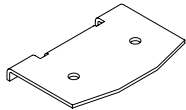

WORKSURFACES

CHC15 & CHC22- CANTILEVER

- Attaches a worksurface to a panel.
- Use one cantilever to support two convergent worksurfaces when specified with 3 Flat Brackets or two cantilevers with one flat bracket to support two convergent worksurfaces.
- Does not include Flat Brackets.
- Priced individually
- Specify handedness of each cantilever
- Available in standard paint colors.
- Right and left Cantilever needs to be specified unless flat brackets are also specified.

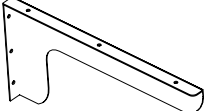
	DESCRIPTION	PRODUCT CODE	LIST PRICE	DIMENSIONS/INCHES	
				D	W
	Cantilever - 15"	CHC15L	45	15	6
		CHC15R	45	15	6
	Cantilever - 22"	CHC22L	70	22	6
		CHC22R	70	22	6

CMHC - WORKSURFACE SUPPORT CHANNEL

- Support channel attaches to underside of worksurface with screws
- Support channel should be 14" shorter than top length.
- Screws are included.
- Only available in Black.
- Tops with post legs should be specified with support channel for structural reinforcement.

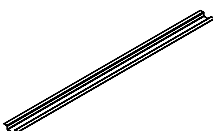
	DESCRIPTION	PRODUCT CODE	LIST PRICE	DIMENSIONS/INCHES	
				L	D
	Worksurface Support Channel	CMHC40 - for 54" wide table	76	40	5
		CMHC46 - for 60" wide table	82	46	5
		CMHC52 - for 66" wide table	91	52	5
		CMHC58 - for 72" wide table	103	58	5
		CMHC64 - for 78" wide table	112	64	5
		CMHC70 - for 84" wide table	125	70	5

CHFB1 - FLAT BRACKET

- Use in conjunction with Cantilever to make it a shared Cantilever to support convergent worksurfaces.
- Used at the front of 2 convergent worksurfaces to keep worksurfaces flush at seams.
- Available in Black only.

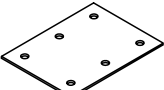
	DESCRIPTION	PRODUCT CODE	LIST PRICE	DIMENSIONS/INCHES	
				D	W
	Flat Bracket	CHFB1	19	3	4

CHTB2 - TRANSACTION TOP BRACKETS

- Securely attaches a transaction surface to the top of a panel.
- One pair must be on each side of transaction surface.
- Priced and shipped in pairs.
- Available in Anodized Aluminum only.

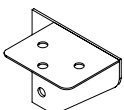
	DESCRIPTION	PRODUCT CODE	LIST PRICE	DIMENSIONS/INCHES	
				D	W
	Flat Bracket	CHTB2	20	2.5	

WORKSURFACES

CHEP - END PANEL

- Supports the worksurface and enhances the stability of connected panels.
- Provides solid support at the end of a run of worksurfaces.
- Finished in thermally-fused laminate.
- Includes flat brackets and hardware.
- End panel height is inclusive of panel glides extended to their fullest height.
- If wood grains is selected, grain runs vertically.

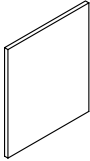
	DESCRIPTION	PRODUCT CODE	LIST PRICE	DIMENSIONS/INCHES	
				D	W
	End Panel - 28"High	CHEP2924	240	28	24
		CHEP2930	282	28	30

CHMSL - MID SUPPORT LEG

- Provides support for a worksurface.
- Includes leveling glide, PVC Sleeve and 4.8" x 4.8" attachment plate.
- 1.5" diameter.
- Available in standard paint colors.

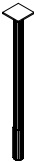
	DESCRIPTION	PRODUCT CODE	LIST PRICE	DIMENSIONS/INCHES
				H
	Mid Support Leg - Round	CHMSL1	82	28
	Mid Support Leg - Square	CHMSL2	82	28

CMHCL & CHHCL - CORNER LEG WITH LEVELER

- Provides support for a worksurface.
- Includes leveling glide, PVC Sleeve and attachment plate.
- 1.5" diameter
- Available in standard paint colors.
- Legs can be used in the corner of a single worksurface or be rotated 45 degrees to support the corners of two worksurfaces.

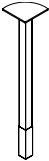
	DESCRIPTION	PRODUCT CODE	LIST PRICE	DIMENSIONS/INCHES
				H
 	Corner Leg Round	CMHCL1	115	28
	Corner Leg Square	CMHCL2	115	28

CHWS - 5" SURFACE TO STORAGE SUPPORT LEG

- Provides support for a worksurface.
- Includes leveling glide, PVC Sleeve and 4.8" x 4.8" attachment plate.
- 1.5" diameter.
- Available in standard paint colors.

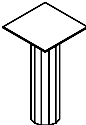
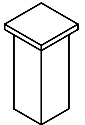
	DESCRIPTION	PRODUCT CODE	LIST PRICE	DIMENSIONS/INCHES
				H
 	5" Surface to Storage Support Leg - Round	CHWSRL01	41	4.5
	5" Surface to Storage Support Leg - Square	CHWSSL01	41	4.5



WORKSURFACES

CHMEGR - METAL END GABLE - RIGHT

- Supports the worksurface and enhances the stability of connected panels.
- Includes a levelling glide and decorative PVC sleeve to cover the glide.
- Available in standard paint colors.

DESCRIPTION	PRODUCT CODE	LIST PRICE	DIMENSIONS/INCHES		
			H	D	W
 Metal End Gable - Right	CHMEG18R	242	28	17	4
	CHMEG24R	259	28	23	4
	CHMEG30R	272	28	29	4

CHMEGL - METAL END GABLE - LEFT

- Supports the worksurface and enhances the stability of connected panels.
- Includes a levelling glide and decorative PVC sleeve to cover the glide.
- Available in standard paint colors.

DESCRIPTION	PRODUCT CODE	LIST PRICE	DIMENSIONS/INCHES		
			H	W	D
 Metal End Gable - Left	CHMEG18L	242	28	17	4
	CHMEG24L	259	28	23	4
	CHMEG30L	272	28	29	4

CHMSL - METAL SUPPORT LEG

- Supports two adjoining worksurfaces and enhances the stability of connected panels.
- Includes a levelling glide and decorative PVC sleeve to cover the glide.
- Available in standard paint colors.
- Flat brackets recommended to ensure alignment of neighboring surface.

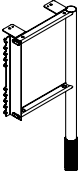
DESCRIPTION	PRODUCT CODE	LIST PRICE	DIMENSIONS/INCHES		
			H	W	D
 Metal Support Leg	CHMSL12	217	28	11	4

PEDESTAL FILLER BRACKET

- Screws to back of pedestal
- Fills the gap between the pedestal and panel when wing pnael is not used.

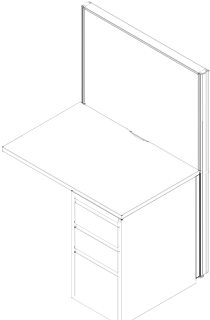
DESCRIPTION	PRODUCT CODE	LIST PRICE	DIMENSIONS/INCHES	
			D	W
 Pedestal Filler Bracket-	CHPBF	54	26.875	1.375

storage

LATERAL FILE FEATURES

DRAWERS/SHELVES

- Drawer interlocking system
- Three-stage, anti-bounceback suspension
- Pre-installed, side-to-side file bars for letter, legal and A4
- Front-to-back file bars – optional
- Full-height dividers – optional
- Angled full pull

CONSTRUCTION

- Top stiffener bar
- Corner gussets
- Four (4) ganging drill points are marked to ensure correct positioning
- Cam lock included
- Leveling glides
- Counterweights are included in 2, 3 and 4 drawer cabinets. BIFMA does not require counterweight in 5 drawer cabinets.

PEDESTAL FEATURES

DRAWERS/SHELVES

- All drawer fronts feature a recessed, angled full pull.
- Drawers feature ball bearing suspension.

CONSTRUCTION

- Central Core removable cam locks.
- Pedestals are 15" wide.
- Counterweight is standard on all Freestanding models.
- Worksurfaces supporting models have holes drilled in top to attach underneath a worksurface.

STANDARD PAINT COLORS

BLACK	BLK
DESIGNER WHITE	DWT
NEVADA	NEV
STEEL	STL

TEXTURED PAINT COLORS

Only available on Compile Storage.

BLIZZARD	BZD
STONE DUST	SDT

GENERAL WARRANTY INFORMATION

- Evolve warrants all components of metal storage and filing for the lifetime of the product to the original purchaser.



This page provides a three dimensional view of a sample configuration highlighting each storage component required when specifying this configuration.

Components

- A. CSOF13XX KD Overhead
- B. CSSL13XX Low-Profile Shelf
- C. CM19XXBBF Worksurface Supporting Box, Box, File Pedestal

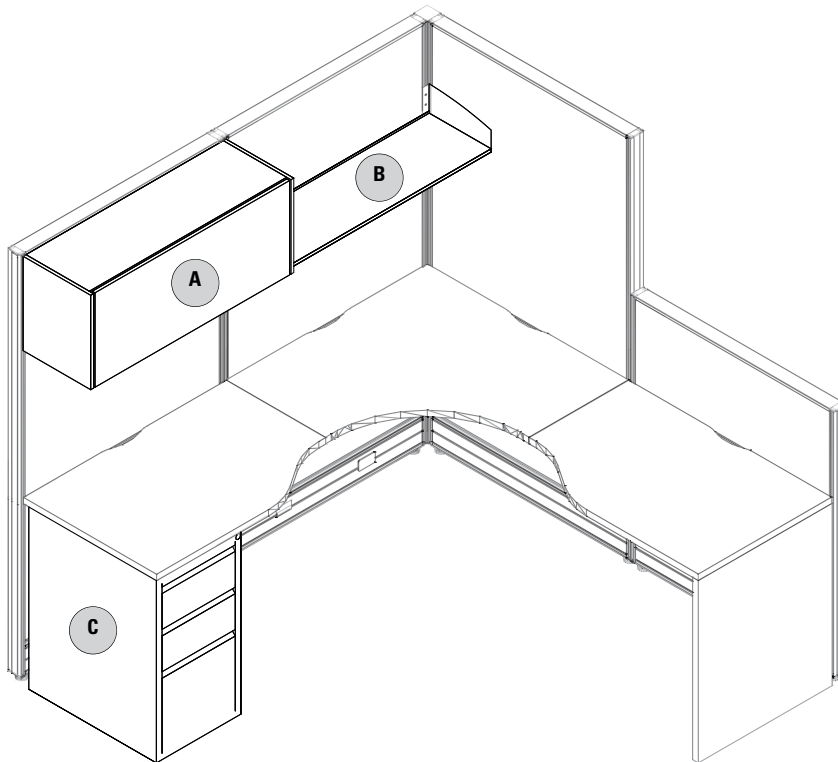

STORAGE

CS19XXBBF - WORKSURFACE SUPPORTING BOX/BOX/FILE 15" PEDESTAL

- Worksurface supporting, with predrilled holes in the top.
- Also available as freestanding with finished top.
- All drawer fronts feature a recessed, angled full pull.
- Pedestal height shown includes glide.
- Pencil tray and Lock included.
- File Bars are not included with Compile pedestals. To order file bars, use product code CSPEDHFB at \$15.00 each list.

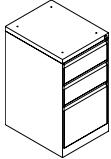
	DESCRIPTION	PRODUCT CODE	LIST PRICE	DIMENSIONS/INCHES		
				H	D	W
	Worksurface Supporting Box/Box/File 15" Pedestal	CS1919BBF	499	27 5/8	18 5/8	15
		CS1923BBF	513	27 5/8	22 5/8	15
		CS1929BBF	582	27 5/8	29 5/8	15

CS19XXFF - WORKSURFACE SUPPORTING FILE/FILE 15" PEDESTAL

- Worksurface supporting, with predrilled holes in the top.
- Also available as freestanding with finished top.
- All drawer fronts feature a recessed, angled full pull.
- Pedestal height shown includes glide.
- Lock included.
- File Bars are not included with Compile pedestals. To order file bars, use product code CSPEDHFB at \$15.00 each list.

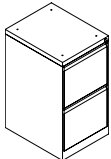
	DESCRIPTION	PRODUCT CODE	LIST PRICE	DIMENSIONS/INCHES		
				H	D	W
	Worksurface Supporting File/File 15" Pedestal	CS1919FF	499	27 5/8	18 5/8	15
		CS1923FF	513	27 5/8	22 5/8	15
		CS1929FF	582	27 5/8	29 5/8	15

CS19FXBBF - FREESTANDING BOX/BOX/FILE 15" PEDESTAL

- All drawer fronts feature a recessed, angled full pull.
- Pedestal height shown includes glide.
- Finished top.
- Counterweight, Pencil tray and Lock included.
- File Bars are not included with Compile pedestals. To order file bars, use product code CSPEDHFB at \$15.00 each list.

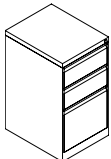
	DESCRIPTION	PRODUCT CODE	LIST PRICE	DIMENSIONS/INCHES		
				H	D	W
	Freestanding Box/Box/File 15" Pedestal	CS19F19BBF	513	27 5/8	18 5/8	15
		CS19F23BBF	529	27 5/8	22 5/8	15
		CS19F29BBF	595	27 5/8	29 5/8	15

CS19FXFF - FREESTANDING FILE/FILE 15" PEDESTAL

- All drawer fronts feature a recessed, angled full pull.
- Pedestal height shown includes glide.
- Finished top.
- Counterweight and Lock included.
- File Bars are not included with Compile pedestals. To order file bars, use product code CSPEDHFB at \$15.00 each list.

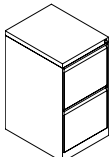
	DESCRIPTION	PRODUCT CODE	LIST PRICE	DIMENSIONS/INCHES		
				H	D	W
	Freestanding File/File 15" Pedestal	CS19F19FF	513	27 5/8	18 5/8	15
		CS19F23FF	529	27 5/8	22 5/8	15
		CS19F29FF	595	27 5/8	29 5/8	15



STORAGE

CS19MPXXBBF - MOBILE BOX/BOX/FILE PEDESTAL

- All drawer fronts feature a recessed, angled full pull.
- Pedestal height shown includes glide.
- Finished top.
- Counterweight, Pencil tray, and Lock included.
- File Bars are not included with Compile pedestals. To order file bars, use product code CSPEDHFB at \$15.00 each list.

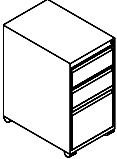
	DESCRIPTION	PRODUCT CODE	LIST PRICE	DIMENSIONS/INCHES		
				H	D	W
	Mobile Box/Box/File Pedestal	CS19MP19BBF	680	27 5/8	18 5/8	15
		CS19MP23BBF	715	27 5/8	22 5/8	15

CS19MPXXFF - MOBILE FILE/FILE PEDESTAL

- All drawer fronts feature a recessed, angled full pull.
- Pedestal height shown includes glide.
- Finished top.
- Counterweight and Lock included.
- File Bars are not included with Compile pedestals. To order file bars, use product code CSPEDHFB at \$15.00 each list.

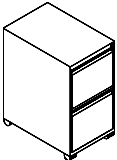
	DESCRIPTION	PRODUCT CODE	LIST PRICE	DIMENSIONS/INCHES		
				H	D	W
	Mobile File/File Pedestal	CS19MP19FF	680	27 5/8	18 5/8	15
		CS19MP23FF	715	27 5/8	22 5/8	15

CSMCPXXBFNC - MOBILE BOX/FILE PEDESTAL WITH 60MM CASTERS

- Mobile pedestal that includes one pencil tray.
- Includes factory installed counterweight.
- Lock is standard.
- 60mm high castors.
- For use with pedestal seat cushion. See model below.
- Casters do not lock.

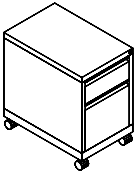
	DESCRIPTION	PRODUCT CODE	LIST PRICE	DIMENSIONS/INCHES		
				H	D	W
	Mobile Box/File Pedestal with 60mm Castors	CSMCP19BFNC	739	23.7/8	18.5/8	15
		CSMCP23BFNC	753	23.7/8	22.5/8	15

STORAGE

CSCUSH15 - PEDESTAL SEAT CUSHIONS

- Cushions will have single stitching at the seams.
- Velcro included for quick attachment to pedestal file.
- 1" Cushion will have a rectilinear design on all sides.
- 2" Cushion will have waterfall edges Front and Back,
- Cushions are for use on CSMCPXXBFNC Mobile Pedestals.
- Please choose a fabric from the standard cushion textiles on pages 94-96

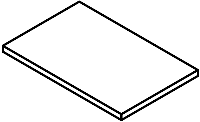
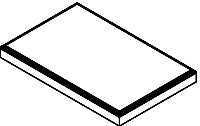
DESCRIPTION	PRODUCT CODE	LIST PRICE/GRADES															DIM./INCH			YRDS		
		1	2	3	4	5	6	7	8	9	10	11	12	13	14	15	16	17	H		D	W
 Pedestal Seat Cushions - 1" Thick	CSCUSH15X18-5/8X1	186	218	242	277	327	351	396	468	525	586	713	849	880	1001	1242	1484	1728	1	18.625	15	1
	CSCUSH15X22-5/8X1	208	241	266	299	351	373	418	492	547	609	735	873	899	1020	1262	1504	1749	1	22.625	15	1
 Pedestal Seat Cushions - 2" Thick	CSCUSH15X18-5/8X2	206	238	261	296	346	370	415	488	544	605	730	871	1132	1293	1615	1937	2263	2	18.625	15	2
	CSCUSH15X22-5/8X2	231	263	292	337	402	431	491	583	654	733	897	1072	1155	1317	1638	1961	2285	2	22.625	15	2

CSSL13 - LOW PROFILE SHELF

- 13" deep panel-mounted storage shelf with backlip.
- Mounting brackets are included.

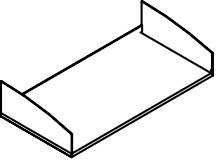
DESCRIPTION	PRODUCT CODE	LIST PRICE	DIMENSIONS/INCHES		
			H	D	W
 Low Profile Shelf - 13"	CSSL1324	123	5	13	24
	CSSL1330	136	5	13	30
	CSSL1336	148	5	13	36
	CSSL1342	159	5	13	42
	CSSL1348	167	5	13	48
	CSSL1354	174	5	13	54
	CSSL1360	180	5	13	60

CSOF13 - KD OVERHEAD

- Mounting brackets are included.
- Door retracts up and over the cabinet.
- Ready for quick assembly on site.
- Quality steel construction.
- 60" unit is reinforced for proper weight distribution.
- Inside dimensions: 12" h x 12.75" d

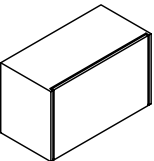
DESCRIPTION	PRODUCT CODE	LIST PRICE	DIMENSIONS/INCHES		
			H	D	W
 KD Overhead - 13"	CSOF1324	324	14.5	13	24
	CSOF1330	356	14.5	13	30
	CSOF1336	392	14.5	13	36
	CSOF1342	415	14.5	13	42
	CSOF1348	439	14.5	13	48
	CSOF1354	497	14.5	13	54
	CSOF1360	537	14.5	13	60

CMSLK13 - LOCK FOR KD OVERHEAD

- Must be specified separately.

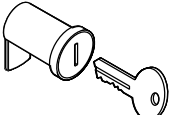
DESCRIPTION	PRODUCT CODE	LIST PRICE	DIMENSIONS/INCHES		
			H	D	W
 Lock for KD Overhead	CMSLK13	40			



STORAGE

CSLOCKKEY - CORE AND KEY

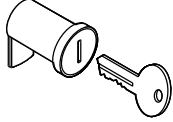
	DESCRIPTION	PRODUCT CODE	LIST PRICE	DIMENSIONS/INCHES		
				H	D	W
	LOCKKEY - Core and Key	CSLOCKKEY	38			

CMEK93 - EXTRA KEY

- Must be specified at time of order.

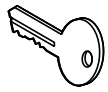
	DESCRIPTION	PRODUCT CODE	LIST PRICE	DIMENSIONS/INCHES		
				H	D	W
	Extra Key	CMEK93	17			

CMDAOHXX - CENTER MOUNT OVERHEAD

- Inside dimensions 13" high x 13" deep.
- Laminate Overhead. No doors.
- Available in standard Compile laminate finishes.
- Top mount on panels.
- Overhead Support Brackets are included.

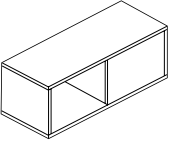
	DESCRIPTION	PRODUCT CODE	LIST PRICE	DIMENSIONS/INCHES		
				H	D	W
	Center Mount Overhead - 13"	CMDAOH36	1019	15	13	36
		CMDAOH42	1105	15	13	42
		CMDAOH48	1157	15	13	48
		CMDAOH54	1244	15	13	54
		CMDAOH60	1293	15	13	60

CMADAXPM - ADA COMPLIANT OVERHEAD STORAGE UNIT

- Panel Mounted Overhead Storage with metal sides and opaque door that retracts on top of the unit
- Meets CSA B651 Barrier Free Design & ADA (American Disabilities Act).
- 16" high units accept standard and A4 binders.
- All shelves are reinforced for proper weight distribution.
- Inside dimensions: 14.25" high x 12" deep.
- Unit includes attachment hardware, lock and mounting brackets. Back not included.
- Shipped partially assembled.
- Available in standard Compile paint colors only. Door made of opaque plastic. **add 10% upcharge for Tungsten

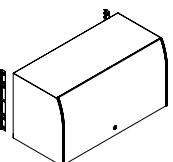
	DESCRIPTION	PRODUCT CODE	LIST PRICE	DIMENSIONS/INCHES		
				H	D	W
	ADA Compliant Overhead Storage Unit	CMADA30PM	1035	16	14.2	30
		CMADA36PM	1118	16	14.2	36
		CMADA42PM	1194	16	14.2	42
		CMADA48PM	1275	16	14.2	48
		CMADA54PM	1354	16	14.2	54
		CMADA60PM	1431	16	14.2	60

STORAGE

CWMA - VERTICAL CHANNEL

- Used to attach system components to fixed wall.
- Panel frame finish.
- Comes in 60" length only.
- Care should be taken to mount adapters only to wall studs using correct fasteners.
- Does not include mounting hardware. Mounting hardware selection to be based on wall material. Sold in pairs.
- Failure to do this may result in collapse of the unit and subsequent possible personal injury.
- Compile vertical channels cannot be shared.

DESCRIPTION	PRODUCT CODE	LIST PRICE	DIMENSIONS/INCHES		
			H	W	D
Vertical Channel	CWMA60	35	60	0.6	0.7

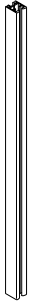

CS19XX-1X1FH - ONE 1/2 HEIGHT FIXED FRONT & ONE 12" FIXED FRONT LATERAL FILE

- 1/2 Height Box Drawer.
- 1 Fixed Drawer Front.
- Includes Lock.
- Lateral File Top is required when not installed under a worksurface.
- Counterweights must be specified on lateral files with pull out drawers, unless worksurface supporting, ganged together or anchored to the floor or wall.

DESCRIPTION	PRODUCT CODE	LIST PRICE	DIMENSIONS/INCHES		
			H	D	W
One 1/2 Height Fixed Front & One 12" Fixed Front Lateral File	CS1930P-1X1FH	1128	21.1875	19.25	30
	CS1936P-1X1FH	1204	21.1875	19.25	36
	CS1942P-1X1FH	1279	21.1875	19.25	42

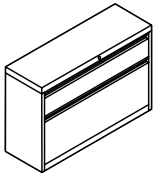

CS19XX-1XSND - ONE 1/2 HEIGHT OPEN SHELF & ONE 12" OPEN SHELF LATERAL CABINET

- 1/2 Height Open Shelf.
- Bottom Open Shelf.

DESCRIPTION	PRODUCT CODE	LIST PRICE	DIMENSIONS/INCHES		
			H	D	W
One 1/2 Height Open Shelf & One 12" Open Shelf Lateral Cabinet	CS1930-1XSND	565	21.1875	19.25	30
	CS1936-1XSND	642	21.1875	19.25	36
	CS1942-1XSND	715	21.1875	19.25	42

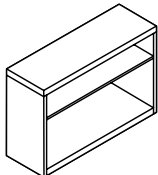

STORAGE

CSCUSH19 - LATERAL SEAT CUSHIONS

- Cushions will have single stitching at the seams,
- Velcro included for quick attachment to lateral file.
- 1" Cushion will have a rectilinear design on all sides.
- 2" Cushion will have waterfall edges Front and Back.
- Please choose a fabric from the standard cushion textiles on pages 244-246.

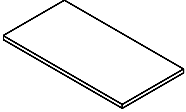
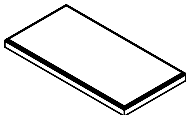
	DESCRIPTION	PRODUCT CODE	LIST PRICE/GRADES														DIM./INCH			YRDS			
			1	2	3	4	5	6	7	8	9	10	11	12	13	14	15	16	17		H	D	W
	Lateral Seat	CSCUSH19-25X30X1	340	382	413	459	529	560	622	721	796	880	1052	1234	1288	1451	1773	2096	2419	1	19	30	1
	Cushions - 1" Thick	CSCUSH19-25X36X1	352	392	424	471	540	571	633	729	806	890	1062	1244	1298	1460	1783	2106	2431	1	19	36	1
		CSCUSH19-25X42X1	365	406	438	484	552	584	646	743	818	903	1074	1258	1244	1406	1729	2051	2375	1	19	42	1
	Lateral Seat	CSCUSH19-25X30X2	377	419	450	496	566	596	658	754	831	915	1087	1270	1254	1416	1740	2061	2387	2	19	30	2
	Cushions - 2" Thick	CSCUSH19-25X36X2	387	429	460	507	575	608	669	765	841	926	1097	1280	1264	1425	1749	2070	2394	2	19	36	2
		CSCUSH19-25X42X2	401	443	473	520	589	620	681	778	854	938	1110	1293	1273	1436	1757	2081	2404	2	18	42	2

CWFT - LATERAL FILE TOPS

- Available in standard Compile finishes.

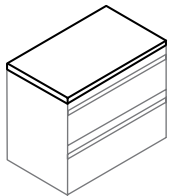
	DESCRIPTION	PRODUCT CODE	LIST PRICE	DIMENSIONS/INCHES		
			LP	H	D	W
	Lateral File Tops	CWFT1930	148	1	19.25	30
		CWFT1936	151	1	19.25	36
		CWFT1942	194	1	19.25	42
	2 Lateral Files SBS Top	CWFT1960	308	1	19.25	60
		CWFT1972	333	1	19.25	72
		CWFT1984	542	1	19.25	84
	4 Lateral File BTB Top	CWFT3860	611	1	38.75	60
		CWFT3872	695	1	38.75	72
		CWFT3884	824	1	38.75	84

CS19XXP - 2F12 - LATERAL FILES - 2 DRAWERS WITH COUNTERWEIGHT

- Counterweight is standard. Two fixed front drawers.
- Side-to-side hanging file bars included.
- Drawers are 12.25" high.
- File cannot be used to store standard three ring binders.
- Lock included.

	DESCRIPTION	PRODUCT CODE	LIST PRICE	DIMENSIONS/INCHES		
				H	D	W
	Lateral Files - 2 Drawers with Counterweight	CS1930P-2F12	895	27.14	19.25	30
		CS1936P-2F12	964	27.14	19.25	36
		CS1942P-2F12	1002	27.14	19.25	42

STORAGE

CS19XXP - 3F12 - LATERAL FILES - 3 DRAWERS WITH COUNTERWEIGHT

- Counterweight is standard. Three fixed front drawers.
- Side-to-side hanging file bars included.
- Drawers are 12.25" high.
- File cannot be used to store standard three ring binders.
- Lock included.

	DESCRIPTION	PRODUCT CODE	LIST PRICE	DIMENSIONS/INCHES		
				H	D	W
	Lateral Files - 3 Drawers with Counterweight	CS1930P-3F12	1114	39.52	19.25	30
		CS1936P-3F12	1174	39.52	19.25	36
		CS1942P-3F12	1226	39.52	19.25	42

CS19XXP - 4F12 - LATERAL FILES - 4 DRAWERS WITH COUNTERWEIGHT

- Counterweight is standard. Four fixed front drawers.
- Side-to-side hanging file bars included.
- Drawers are 12.25" high.
- File cannot be used to store standard three ring binders.
- Posting shelf option NOT available.
- Lock included.

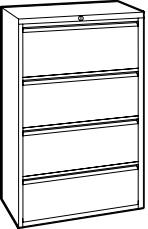
	DESCRIPTION	PRODUCT CODE	LIST PRICE	DIMENSIONS/INCHES		
				H	D	W
	Lateral Files - 4 Drawers with Counterweight	CS1930P-4F12	1422	51.89	19.25	30
		CS1936P-4F12	1490	51.89	19.25	36
		CS1942P-4F12	1603	51.89	19.25	42

CS19XXP - 5F12 - LATERAL FILES - 5 DRAWERS

- Four fixed front drawers plus top drawer with receding door and roll-out shelf.
- Side-to-side hanging file bars included.
- Drawers are 12.25" high.
- File cannot be used to store standard three ring binders.
- Posting shelf option NOT available.
- Lock included.

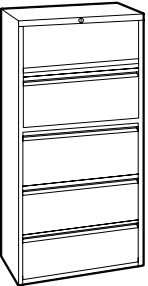
	DESCRIPTION	PRODUCT CODE	LIST PRICE	DIMENSIONS/INCHES		
				H	D	W
	Lateral Files - 5 Drawers	CS1930P-5F12	1693	66.39	19.25	30
		CS1936P-5F12	1768	66.39	19.25	36
		CS1942P-5F12	1865	66.39	19.25	42



STORAGE

CSPT - STORAGE TOWERS

- Model CSPT3-2BFL has wardrobe section on the left and drawers on the right. compartment, 2 box drawers and 1 file drawer. Locker compartment has one fixed shelf.
- Model CSPT3-2BFR has wardrobe section on the right and drawers on the left.
- Includes ventilated 24"D wardrobe section (ventilated on bottom of cabinet), locker • Locking.

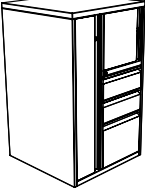
	DESCRIPTION	PRODUCT CODE	LIST PRICE	DIMENSIONS/INCHES		
				H	D	W
	Storage Tower - 2 Box/1 File Drawer	CSPT3-2BFL	2521	39.52	24	24
		CSPT3-2BFR	2521	39.52	24	24

CSPT - STORAGE TOWERS

- Model CSPT3-2FL has wardrobe section on the left and drawers on the right. compartment, 2 box drawers and 1 file drawer. Locker compartment has one fixed shelf.
- Model CSPT3-2FR has wardrobe section on the right and drawers on the left.
- Includes ventilated 24"D wardrobe section (ventilated on bottom of cabinet), locker • Locking.

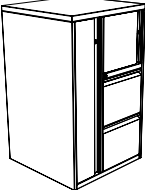
	DESCRIPTION	PRODUCT CODE	LIST PRICE	DIMENSIONS/INCHES		
				H	D	W
	Storage Tower - 2 File Drawers	CSPT3-2FL	2521	39.52	24	24
		CSPT3-2FR	2521	39.52	24	24

CSPT - STORAGE TOWERS

- Model CSPT4-2BFL has wardrobe section on the left and drawers on the right. compartment, 2 box drawers and 1 file drawer. Locker compartment has one fixed shelf.
- Model CSPT4-2BFR has wardrobe section on the right and drawers on the left.
- Includes ventilated 24"D wardrobe section (ventilated on bottom of cabinet), locker • Locking.

	DESCRIPTION	PRODUCT CODE	LIST PRICE	DIMENSIONS/INCHES		
				H	D	W
	Storage Tower - 2 Box/1 File Drawer	CSPT4-2BFL	2535	51.89	24	24
		CSPT4-2BFR	2535	51.89	24	24

STORAGE

CSPT - STORAGE TOWERS

- Model CSPT4-2FL has wardrobe section on the left and drawers on the right. compartment, 2 box drawers and 1 file drawer. Locker compartment has one fixed shelf.
- Model CSPT4-2FR has wardrobe section on the right and drawers on the left.
- Includes ventilated 24"D wardrobe section (ventilated on bottom of cabinet), locker • Locking.

DESCRIPTION	PRODUCT CODE	LIST PRICE	DIMENSIONS/INCHES		
			H	D	W
Storage Tower - 2 File Drawers	CSPT4-2FL	2535	51.89	24	24
	CSPT4-2FR	2535	51.89	24	24

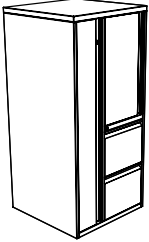

CSPT - STORAGE TOWERS

- Model CSPT5-2BFL has wardrobe section on the left and drawers on the right. compartment, 2 box drawers and 1 file drawer. Locker compartment has one fixed shelf.
- Model CSPT5-2BFR has wardrobe section on the right and drawers on the left.
- Includes ventilated 24"D wardrobe section (ventilated on bottom of cabinet), locker • Locking.

DESCRIPTION	PRODUCT CODE	LIST PRICE	DIMENSIONS/INCHES		
			H	D	W
Storage Tower - 2 Box/1 File Drawe	CSPT5-2BFL	2601	66.39	24	24
	CSPT5-2BFR	2601	66.39	24	24

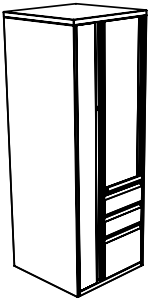

CSPT - STORAGE TOWERS

- Model CSPT5-2FL has wardrobe section on the left and drawers on the right. compartment, 2 box drawers and 1 file drawer. Locker compartment has one fixed shelf.
- Model CSPT5-2FR has wardrobe section on the right and drawers on the left.
- Includes ventilated 24"D wardrobe section (ventilated on bottom of cabinet), locker • Locking.

DESCRIPTION	PRODUCT CODE	LIST PRICE	DIMENSIONS/INCHES		
			H	D	W
Storage Tower - 2 File Drawers	CSPT5-2FL	2601	66.39	24	24
	CSPT5-2FR	2601	66.39	24	24

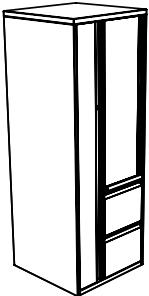

SO# _____ PO# _____ TAG# _____ Date _____

KEY#	SETS REQ'D	KEY#	SETS REQ'D	KEY#	SETS REQ'D	KEY#	SETS REQ'D	KEY#	SETS REQ'D
401		431		461		491		521	
402		432		462		492		522	
403		433		463		493		523	
404		434		464		494		524	
405		435		465		495		525	
406		436		466		496		526	
407		437		467		497		527	
408		438		468		498		528	
409		439		469		499		529	
410		440		470		500		530	
411		441		471		501		531	
412		442		472		502		532	
413		443		473		503		533	
414		444		474		504		534	
415		445		475		505		535	
416		446		476		506		536	
417		447		477		507		537	
418		448		478		508		538	
419		449		479		509		539	
420		450		480		510		540	
421		451		481		511		541	
422		452		482		512		542	
423		453		483		513		543	
424		454		484		514		544	
425		455		485		515		545	
426		456		486		516		546	
427		457		487		517		547	
428		458		488		518		548	
429		459		489		519		549	
430		460		490		520		550	

401-430 =	431-460 =	461-490 =	491-520 =	521-550 =
-----------	-----------	-----------	-----------	-----------

Total: _____

NOTE : If Key Alike Instructions are not submitted to EVOLVE with the Customer's Purchase Order, all components will be keyed randomly.

accessories

ACCESSORIES

CATB - TACK BOARD

- Provide a tackable surface for notes and memos in a work area.
- Includes two pairs of panel-mounting brackets.
- Only fabric must be specified.
- 10" to be installed on 42" h panels.
- 21" specified for use under overhead shelf or storage bin.
- 24" for use without any overheads.

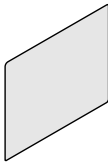
	DESCRIPTION	PRODUCT CODE	LIST PRICE		DIMENSIONS/INCHES		
			Gr1	Gr2	H	W	D
	Tack Board - 10" High	CATB1024	167	175	10	24	
		CATB1030	178	187	10	30	
		CATB1036	196	206	10	36	
		CATB1042	216	228	10	42	
		CATB1048	237	250	10	48	
		CATB1054	261	278	10	54	
		CATB1060	279	297	10	60	
	Tack Board - 21" High	CATB2124	241	250	21	24	
		CATB2130	262	272	21	30	
		CATB2136	298	308	21	36	
CATB2142		341	352	21	42		
CATB2148		381	393	21	48		
CATB2154		417	436	21	54		
Tack Board - 24" High	CATB2424	241	250	21	24		
	CATB2430	262	272	24	30		
	CATB2436	298	308	24	36		
	CATB2442	341	352	24	42		
	CATB2448	381	393	24	48		
	CATB2454	417	436	24	54		
	CATB2460	458	476	24	60		

CAWB - WHITE MARKER BOARD

- Provides a writing surface within a work area.
- Includes two pairs of panel-mounting brackets.
- 10" to be installed on 42" h panels.
- 21" specified for use under overhead shelf or storage bin.
- 24" for use without any overheads.

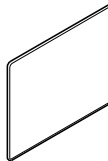
	DESCRIPTION	PRODUCT CODE	LIST PRICE		DIMENSIONS/INCHES		
					H	W	D
	White Marker Board - 10" High	CAWB1030	161		10	30	
		CAWB1036	181		10	36	
		CAWB1042	201		10	42	
		CAWB1048	231		10	48	
White Marker Board - 21" High	White Marker Board - 21" High	CAWB2130	280		21	30	
		CAWB2136	315		21	36	
		CAWB2142	355		21	42	
		CAWB2148	413		21	48	
White Marker Board - 24" High	White Marker Board - 24" High	CAWB2430	280		24	30	
		CAWB2436	315		24	36	
		CAWB2442	355		24	42	
		CAWB2448	413		24	48	



ACCESSORIES

CALB - LOAD BAR

- Frame available in Steel (STL), Black (BLK), and Nevada (NEV) only.
- Mounting brackets and clear end caps are included.

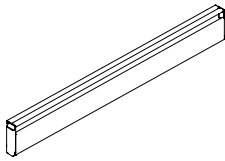
	DESCRIPTION	PRODUCT CODE	LIST PRICE	DIMENSIONS/INCHES		
				H	W	D
	Load Bar	CALB24	136	2.25	24	1
		CALB30	150	2.25	30	1
		CALB36	163	2.25	36	1
		CALB42	190	2.25	42	1
		CALB48	219	2.25	48	1
		CALB54	233	2.25	54	1
		CALB60	250	2.25	60	1

CSABB01 - BINDER BIN

- Must be ordered in conjunction with a load bar option.
- Available in standard and premium paint selections. See "Textile & Finish Listings" in Introduction for complete list of offerings and conditions.

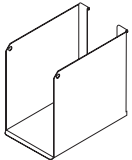
	DESCRIPTION	PRODUCT CODE	LIST PRICE	DIMENSIONS/INCHES		
				H	W	D
	Binder Bin	CSABB01	73	9	4	10.25

CSALT01 - LETTER TRAY

- Must be ordered in conjunction with a load bar option.
- Available in standard and premium paint selections. See "Textile & Finish Listings" in Introduction for complete list of offerings and conditions.

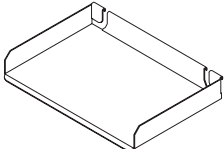
	DESCRIPTION	PRODUCT CODE	LIST PRICE	DIMENSIONS/INCHES		
				H	W	D
	Letter Tray	CSALT01	62	2	13.5	9.25

CSASS01 - SLANT SORTER

- Must be ordered in conjunction with a load bar option.
- Available in standard and premium paint selections. See "Textile & Finish Listings" in Introduction for complete list of offerings and conditions.

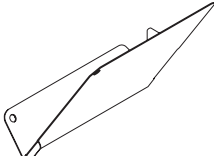
	DESCRIPTION	PRODUCT CODE	LIST PRICE	DIMENSIONS/INCHES		
				H	W	D
	Slant Sorter	CSASS01L	46	9.5	5	10.25
		CSASS01R	46	9.5	5	10.25

ACCESSORIES

EVAMB01 - MEDIA BIN

- Must be ordered in conjunction with a load bar option.
- Available in standard and premium paint selections. See "Textile & Finish Listings" in Introduction for complete list of offerings and conditions.

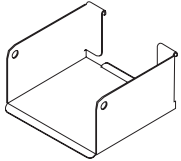
	DESCRIPTION	PRODUCT CODE	LIST PRICE	DIMENSIONS/INCHES		
				H	W	D
	Media Bin	CSAMB01	57	3	5.75	5.25

CSAUT01 - UTILITY TRAY

- Must be ordered in conjunction with a load bar option.
- Available in standard and premium paint selections. See "Textile & Finish Listings" in Introduction for complete list of offerings and conditions.

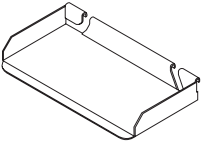
	DESCRIPTION	PRODUCT CODE	LIST PRICE	DIMENSIONS/INCHES		
				H	W	D
	Utility Tray	CSAUT01	39	1	8.5	3.75

CSAFS01 - FLIP SORTER

- Must be ordered in conjunction with a load bar option. in Introduction for complete list of offerings and conditions.
- Comes with nickel plated wire.
- Available in standard and premium paint selections. See "Textile & Finish Listings"

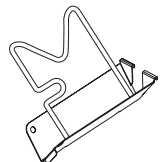
	DESCRIPTION	PRODUCT CODE	LIST PRICE	DIMENSIONS/INCHES		
				H	W	D
	Flip Sorter	CSAFS01	53	9.25	2.75	9.25

CSAPP01 - MAIL BOX

- Must be ordered in conjunction with a load bar option.
- Available in standard and premium paint selections. See "Textile & Finish Listings" in Introduction for complete list of offerings and conditions.

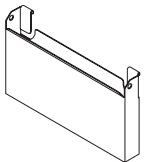
	DESCRIPTION	PRODUCT CODE	LIST PRICE	DIMENSIONS/INCHES		
				H	W	D
	Mail Box	CSAPP01	91	9	12	2.75



ACCESSORIES

CSATH01 - TELEPHONE HOLDER

- Must be ordered in conjunction with a load bar option.
- Available in standard and premium paint selections. See "Textile & Finish Listings" in Introduction for complete list of offerings and conditions.

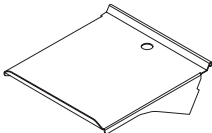
	DESCRIPTION	PRODUCT CODE	LIST PRICE	DIMENSIONS/INCHES		
				H	W	D
	Telephone Holder	CSATH01	87	2	9	10

CPNP01 - NAME PLATE

- Name Plate attached to 1" increment slots.
- Available in single sided (parallel to panel) or double sided (perpendicular to panel) for isle application displaying name on both sides.
- Injection molded frame and die cast base with black rubberized finish.
- Includes two slide-in name cards, steel brackets and fasteners.
- Available in black only.
- Free template for additional slide-in name cards are available at http://www.evolvefurnituregroup.com/Product_Sheets.html

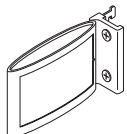
	DESCRIPTION	PRODUCT CODE	LIST PRICE	DIMENSIONS/INCHES		
				H	W	D
	Name Plate	CPNP01	133	3.30	5.3	1.25

CMCH01 - COAT HOOK

- Coat hook for Compile panels.
- Available in standard Compile paint finishes: DWT, BLK, STL, NEV.

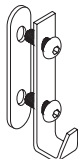
	DESCRIPTION	PRODUCT CODE	LIST PRICE	DIMENSIONS/INCHES		
				H	W	D
	Coat Hook	CMCH01	57	5.5	0.65	1

CATP91 - TOUCH-UP PAINT KIT

- Available in standard paint colors to facilitate easy touch-ups.
- 1/2 fl. ounce bottle (spray not available).
- Specify color.

	DESCRIPTION	PRODUCT CODE	LIST PRICE	DIMENSIONS/INCHES		
				H	W	D
	Touch-Up Paint Kit	CATP91	45			

textiles and finishes

Care and Cleaning

The following guide encompasses the Compile System line.

The guide was compiled using information from our "raw" material suppliers and is relevant only to our standard offering finishes and textiles.

FABRICS

To extend the life of your upholstered panels, regularly dust the panel to prevent airborne particles from penetrating the fabric surface.

For light soiling, use a damp cloth and blot the spot with very slight pressure, taking care never to soak the fabric. Dry with a clean cloth by blotting - never rub fabric. More intense stains can be treated the same way, but with a mild detergent. Always test fabric first in an unseen area before using any cleaning method.

PANEL FRAMES

The panel frames are manufactured out of sturdy aluminum with a powder coated enamel paint finish. To clean the frames of the panels, and all hardware associated with the Evolve line, simply utilize a clean, damp cloth. For stubborn stains on the panel frames, you may consider adding a mild detergent.

GLAZED PANELS

Cleaning of the glazing in panels should only be done with a damp lint-free cloth. A mild detergent can be used if necessary. Do not use paper towels in combination with a window cleaner-this may cause scratches to the glazing.

WORKSURFACES

The worksurfaces are manufactured using primarily Nevamar Brand laminates as the exposed surface. To properly clean these areas, it is best to use a clean, damp cloth and circular motion to prevent streaks. For stubborn stains, you are able to add a mild detergent to the water. Be certain not to use an ammonia-based solution. It will react with the PVC, or wood edge trim, causing permanent damage to the contacted areas.

ACCESSORIES

The accessories sold with the Evolve product line can be simply cleaned with a clean, damp cloth. If they are really dirty, a mild, non-abrasive solution may be added. Wipe with a damp cloth after the solution, and finally, a dry cloth.

LAMINATES – THERMALLY FUSED & HIGH PRESSURE

Absolute Acajou*	ACJ
Asian Night*	ASN
Avant Cherry*	AWC
Avant Honey*	AWH
Black	BLK
Blizzard	BZD
Blizzard Matrix	BMX
Brushed Cobalt*	BRC
Clear Maple*	CMB
Custom Grey	CGY
Dark Espresso*	DES
Designer White	DWT
Grey Matrix	GRX
Hayden Grey	HGT
Hayden Linen	HLN
Noce Biondo	NBL
Noce Grigio	NGL
Noce Leggero	NEL
Noce Medio	NML
Quartered Mahogany*	QTM
Stone Dust	SDT
Stone Linen	SLN
Storm Grey	SOG
Studio White Matrix	SWX
String	STG
Tiger Fruitwood*	TFW
Tiger Walnut*	TWL
Walnut Heights*	WHE
Willow Grey	WGY
Winter Cherry	WCR
White Chocolate*	WHC

Additional paint and laminates may be available. Contact Evolve Customer Care for details.

* Matching Wood Grain PVC edge available.

PVC EDGE TRIM

Absolute Acajou	AAE
Asian Night	ASE
Avant Cherry	ACE
Avant Honey	AHE
Black	BLK
Blizzard	BZD
Brushed Cobalt	BRC
Charcoal	CHR
Clear Maple	CMB
Dark Espresso*	DES
Designer White	DWE
Nevada	NEV
Quartered Mahogany	QTM
Shaker Cherry	SKE
Silver	SIL
Taupe	TPE
Tiger Fruitwood*	TFW
Tiger Maple*	TMP
Tiger Walnut*	TWL
Tungsten	TUN
Walnut Heights	WHE
White Chocolate*	CBE
Winter Cherry	WCR

*1-7/16" HPW PVC Trim for Worksurfaces is not available in Dark Espresso (DES), Tiger Fruitwood (TFW), and Tiger Walnut (TWL).

WOOD VENEER WORKSURFACES*

Almond Cherry	AMW
Cocoa Walnut	CAW
Coral	CRW
Dark Cherry	DCW
Espresso Walnut	EWV
Evening Oak	EVW
Grey on Oak	GRW
Hazelnut	HAW
Honey Maple	SMW
Java	JAW
Latte Walnut	LTW
Milestone	MTW
Mocha	MCW
Natural Maple	MPW
Red Cherry	RCW
Vintage Cherry	VNW
Walnut	WLW
Warm Cherry	WCW
White Maple	WMW

All wood veneer worksurfaces are 1.38" thick.

*Note: Wood veneer options for worksurfaces are available at an upcharge and with an extended lead time. Contact Evolve Customer Care for details.

PAINT & FRAME COLORS

(for application to trim, steel components, PVC, vertical and horizontal members)	
Black	BLK
Designer White	DWT
Fog	FOG
Nevada	NEV

ACCENT PAINTED FINISHES

Crystal Blue	CYB
Lime Green	LMG
Orange Flame	ORF
Steel Blue	STB
Vermilion Red	VLR

Accessory painted finishes are subject to 10% upcharge and minimum order of 50 pieces, orders under 50 pieces subject to \$500 net fee



PANEL FABRICS – GRADE 1

Anchorage - 35% Post - consumer Recycled Polyester and 65% Pre -consumer Recycled Polyester

Birch	AN40
Green Apple	AN41
Lapis	AN42
Straw	AN43
Wolf	AN44
Goose	AN45
Angora	AN46
Cumin	AN47
Asteroid	AN48
Geranium	AN49
Thistle	AN50
Graphite	AN51
Slate	AN52
Quarry Blue	AN53
Onyx	AN54
Pumpkin	AN55
Red Delicious	AN56
Sunshine	AN57
Waterfall	AN59
Vanilla	AN61
Vanilla	AN61
Cobalt	AN62
Cloud	AN64

Aurora - 100% Polyester, 80% minimum Post-Consumer Recycled Polyester

Cloud	AU20
Seal	AU21
Fog	AU22
Pewter	AU23
Granite	AU24
Oat	AU25
Coconut	AU26
Latte	AU27
Lake	AU28
Frost	AU29

Chance - 63% Virgin Polyester, 37% Post-Consumer Recycled Polyester

Mist	CN51
Dill	CN52
Island	CN53
Plaza	CN54
Tranquil	CN55
Malt	CN56
Navajo	CN57
Prairie	CN58
Cinder	CN59
Oasis	CN66

Linea - 100% Post Consumer Recycled Polyester

Queue	LN41
Cord	LN42
Twine	LN43
Thread	LN44
Contour	LN45
Silhouette	LN46
Cable	LN47
Route	LN48

Lisbon - 100% Polyester, 67% Post-Consumer Recycled Polyester

Gesso	LS11
Dusk	LS12
Grey	LS13
Ivory	LS14
Henna	LS15
Nocturnal	LS16
Moss	LS17
Navy	LS18
Buff	LS19
Spa	LS20

Loopy - 100% Recycled Polyester

Oyster	LP60
Putty	LP61
Marble	LP62
Hazelnut	LP63
Latte	LP64
Bay	LP65
Wild Rice	LP66
Harbor	LP67

Melody - 100% Recycled Polyester

Spray	ME40
Pond	ME41
Sand Bar	ME42
Silt	ME43
Pebble	ME44
Lake	ME45
Gravel	ME46
Boulder	ME47

Merge - 100% Polyester, 75% minimum Post-Consumer Recycled Polyester

Fawn	MG20
Marshmallow	MG21
Driftwood	MG22
Dove	MG23
Graphite	MG24
Slate	MG25
Eucalyptus	MG26
Fire Engine	MG27
Mediterranean	MG28
Midnight	MG29

Pinpoint - 100% Post-Consumer Recycled Polyester

Bliss	PN11
Delight	PN12
Dune	PN13
Infusion	PN14
Ebony	PN15
Fresh	PN16
Carrot	PN17
Splash	PN18
Vibe	PN19
Gala	PN20

Streak - 100% Recycled Polyester

Beach	SR81
Shade	SR86
Stretch	SR88
Sprint	SR89
Roll	SR91
Dart	SR92
Zoom	SR93
Splash	SR94
Whiz	SR95
Flash	SR96

Tek - 100% Recycled Polyester

Finesse	TX60
Grain	TX61
Essence	TX62
Warp	TX64
Mesh	TX67
Form	TX69
Spice	TX71
Glacier	TX72
Spring	TX73
Harmony	TX74
Smoke	TX75
Pebble	TX76

Terrace - 100% Post-Consumer Recycled Polyeste

Lotus	TC60
Tigerlily	TC61
Shadow	TC62
Cobble	TC63
Cherry Blossom	TC64
Bluebell	TC65
Apple	TC66
Haze	TC67
Cerise	TC68
Twilight	TC69
Wintergreen	TC70
Ironwork	TC71
Flirt	TC73
Echo	TC74
Glacier	TC75

PANEL FABRICS— GRADE 2

Cyclone - 56% post-consumer recycled polyester and 44% polyester.

Stove Pipe	IM37
Stainless.....	IM40
Polished Pewter	IM41
Welded Steel	IM43
Etched Bronze.....	IM44
Fired Titanium.....	IM46
Chrome.....	IM49
Dark Annealed.....	IM50
Karat.....	IM54
Red Metal.....	IM55
Oxidized Bronze.....	IM56
Bright Ray.....	IM57
Bismuth Crystal.....	IM58
Gallium Blue.....	IM59

Dashing -100% Post-Consumer Recycled Polyester

Classic Silver.....	DS21
Refined Marble.....	DS22
Antique Sage.....	DS23
Polished Slate	DS24
Genteel Beige	DS25
Bespoke Tan	DS26
Dapper Grey.....	DS27

Mesh - 100% Recycled Polyester

Canyon.....	B33A
Napa Valley.....	B34A
Huntington.....	B36A
Huron.....	B37A
Heartland.....	B39A
Oat.....	B81A
Pepper.....	B82A
Limestone.....	B84A
Zinc.....	B86A

Quadrille - 52.5% Polyester / 47.5% Recycled Polyester
*Maximum panel width is 48'

Escapade.....	QU30
Shenanigan	QU31
Revelry	QU32
Spring.....	QU33
Regalia	QU34
Soiree.....	QU35
Zest.....	QU36
Gambol.....	QU37
Leisure	QU38
Fair	QU39
Fiesta.....	QU40
Carnival	QU41
Spree.....	QU42
Opus.....	QU43
Jubilee.....	QU44
Masquerade	QU45
Cabarets.....	QU46

PET PANEL FABRICS

Graphite.....	GPH
Mist.....	MTS
Pewter.....	PWT
Harvest.....	HVT
Shamrock.....	SHR
Brick.....	BRI
Denim.....	DEN
Black.....	BLK
White.....	WHT



GRADE 1

Doobby - 96% Recycled Polyester / 4% Virgin Polyester

Snowcap.....	DB30
Bonsai.....	DB31
Cloud.....	DB32
Sand.....	DB33
Pewter.....	DB34
Sante Fe.....	DB35
Corfu.....	DB36
Medium Taupe.....	DB37
Charcoal.....	DB38
Berry.....	DB39
Royal.....	DB40
Titanium.....	DB41
Black.....	DB42

Fusion - 90% Virgin Polyester/ 10% Post-Consumer Recycled Polyester

Tangerine.....	FU71
Fresh.....	FU72
Moss.....	FU73
TomatoF.....	FU74
Aqua.....	FU75
Sandstone.....	FU76
Granite.....	FU77
Poppy.....	FU78
Cadet.....	FU79
Oasis.....	FU80
Graphite.....	FU81
Viola.....	FU82
Cobalt.....	FU83
Flax.....	FU84
Carbon.....	FU85

Hudson - 100% Post-Consumer Recycled Polyester

Cordovan.....	HD02
Ruby.....	HD03
Orange.....	HD04
Wheat.....	HD05
Meadow.....	HD06
Coffee.....	HD07
Grey.....	HD08
Mocha.....	HD09
Thyme.....	HD10
Carbon.....	HD11
Midnight.....	HD12
Ocean.....	HD13
Cerulean.....	HD14

Illusion - 100% Virgin Polyester

Cappuccino.....	II01
Paprika.....	II02
Tropic.....	II03
Wicker.....	II04
Hemp.....	II05
Cayenne.....	II06
Maui.....	II07
Dusk.....	II08
Smoke.....	II09
Currant.....	II10
Fiji.....	II11
Ozone.....	II12
Ebony.....	II13

Jenny - 100% Polyester

Midnite.....	JN01
Ebony.....	JN02
Slate.....	JN03
Vermilion.....	JN07
Admiral.....	JN08
Charcoal.....	JN11
Silver Lining.....	JN25
Oatmeal.....	JN26
Sunflower.....	JN27
Cascade.....	JN28
Harvest.....	JN29
Mellon.....	JN30
Berry.....	JN31
Green Grass.....	JN32
Roast.....	JN33

Quilt - 100% Polyester

Black.....	QL10
Charcoal Grey.....	QL11
Navy.....	QL14
Wine.....	QL16
Silver.....	QL19
Feather.....	QL20
Dune.....	QL21
Meadow.....	QL22
Cadet.....	QL23
Geranium.....	QL24
Daisy.....	QL25
Quest.....	QL26
Punch.....	QL27
Tangerine.....	QL28
Cocoa.....	QL29

Terrace - 100% Post-Consumer Recycled Polyester

Lotus.....	TC60
Tigerlily.....	TC61
Shadow.....	TC62
Cobble.....	TC63
Cherry Blossom.....	TC64
Bluebell.....	TC65
Apple.....	TC66
Haze.....	TC67
Cerise.....	TC68
Twilight.....	TC69
Wintergreen.....	TC70
Ironwork.....	TC71
Pine Cone.....	TC72
Flirt.....	TC73
Echo.....	TC74

Trak - 100% Recycled Polyester

Taupe.....	TK40
Mustard.....	TK41
Latte.....	TK42
Cement.....	TK43
Silver.....	TK44
Copper.....	TK45
Teal.....	TK46
Apple.....	TK47
Steel.....	TK48
Merlot.....	TK49
Midnight Sky.....	TK50
Mocha.....	TK51
Carbon.....	TK52

Urban - 62% Recycled Polyester / 32% Polyester

Red Rose.....	UR10
Ocean Blue.....	UR11
Blue Bayou.....	UR12
Green Grass.....	UR13
Sandcastle.....	UR14
Beach Day.....	UR15
Boardwalk.....	UR16
Earth.....	UR17
Brown Ridge.....	UR18
White Sand.....	UR19
Granite Rock.....	UR20
Gravel Road.....	UR21
Black Coal.....	UR22

Waterfall - 60% Virgin Polyester /40% Post - Consumer Recycled Polyester

Trance.....	WA40
Tryst.....	WA41
Splash.....	WA42
Victoria.....	WA43
Imagine.....	WA44
Sky.....	WA45
Rainforest.....	WA46
Rumble.....	WA47
Prism.....	WA48
Tranquility.....	WA49
Grand.....	WA50
Rushing.....	WA51
Majestic.....	WA52
Pacific.....	WA53
Dance.....	WA54

Waterfall - 60% Virgin Polyester /40% Post - Consumer Recycled Polyester

Lime.....	WV01
Mint.....	WV02
Stone.....	WV03
Flame.....	WV04
Mykonos.....	WV05
Savannah.....	WV06
Mesa.....	WV07
Plasma.....	WV08
Cancun.....	WV09
Quartz.....	WV10
Moonrock.....	WV11
Rubine.....	WV12
Corfu.....	WV13
Bluejay.....	WV14

GRADE 2 (FABRIC)

Imprint - 100% Post-Consumer Polyester

Almond.....	IM70
Cork.....	IM71
Sand.....	IM72
Currie.....	IM73
Candy Apple.....	IM74
Ocean.....	IM75
Navy.....	IM76
Green Tea.....	IM77
Celery.....	IM78
Oregano.....	IM79
Walnut.....	IM80
Paprika.....	IM81
Graphite.....	IM82
Slate.....	IM83
Licorice.....	IM84

Match - 100% Recycled Polyester

Desert.....	MT20
Sand.....	MT21
Moss.....	MT22
Orange.....	MT23
Blue.....	MT25
Green.....	MT27
Chocolate.....	MT28
Quarry.....	MT31
Arctic.....	MT33

GRADE 2 (FABRIC) - CONTINUED

Replay - 100% Post-Consumer Recycled Polyester

Caramel	RP21
Navy	RP25
Teal	RP29
Autumn	RP30
Slate	RP32
Dove	RP33
Coal	RP34

Silhouette - 100% Nylon with Teflon
Designed to color coordinate with Cumulus and Oxygen fabrics.

Asphalt	SL20
Indigo	SL22
Verdant	SL24
Camel	SL26
Charcoal	SL30

GRADE 2 (VINYL)

For availability of chair series in Vinyl, please contact a Global Sales Representative.

Allante FRee - 100% Vinyl Face / 100% Polyester Backing

Illusion	A01F
Bright White	A02F
White Crush	A03F
Ivory	A04F
Ice	A05F
Bleached Sand	A06F
Taupe Fawn	A07F
Warm Smoke	A08F
Autumn Rain	A09F
Cookie	A10F
Sierra Brick	A11F
Gibraltar	A12F
Chateau Grey	A13F
Golden Green	A14F
Oasis Green	A15F
Ink Black	A16F
Purple impulse	A17F
Italian Rose	A18F
Mountain Sky	A19F
Old Navy.....	A20F
Galaxy	A21F
Red Truffle	A22F
Chocolate Sundae	A23F
Province Blue	A24F
Eclipse	A25F

GRADE 3 (RECYCLED)

Couture - 100% Post-Consumer Polyester

Mocha	CE71
Sapphire.....	CE74
Neptune.....	CE75
Lake.....	CE76
Willow.....	CE77
Sassy.....	CE78
Persimmon.....	CE80
Carbon.....	CE81
Sterling.....	CE82



PANEL COM REQUEST FOR APPLICATION TEST

SEND COMPLETED FORM AND FABRIC TO:

Compile Customer Service
565 Petrolia Road, Doors 6-13
Toronto, Ontario M3J2X8
Phone: 416.739.5000
Attn: Eric Sam

Requested By: _____

Phone #: _____

Fax #: _____

Project Name _____

Dealer/Specifier _____

Dealer Contact: _____

Evolve CSR: _____

Phone #: _____

Fax #: _____

FABRIC INFORMATION

Fabric Manufacturer: _____

Color Name: _____

Color #: _____

Pattern Name: _____

Pattern #: _____

Content: _____

Weight: _____

Width: _____

Repeat Horizontal: _____

Repeat Vertical: _____

Other Comments: _____

REQUEST FOR APPLICATION TEST (THIS REQUIRES 2 YARDS OF FABRIC)

_____ Compile Panel

_____ Compile Tackboard

Total Number of yards for testing: _____

Please Note:

Compile is not responsible for the duty and brokerage fees for C.O.M. Fabric to clear customs. These charges will be billed to the dealer on a separate invoice.

PANEL FABRIC SPECIFICATION SHEET

SEND COMPLETED FORM TO:

Compile Customer Service
 565 Petrolia Road, Doors 6-13
 Toronto, Ontario M3J2X8
 Phone: 416.739.5000
 Attn: Eric Sam

SUPPLIER PATTERN WIDTH CONTENT	REMARKS: _____ _____ _____ _____	
LIGHT FASTNESS FLAMMABILITY TUNNER TEST	REMARKS: _____ _____ _____ _____	
CUT PRICE 1 - 3 ROLLS 4 ROLLS	REMARKS: _____ _____ _____ _____	
DIRECTIONAL PANELS CORNERS RACEWAY COVER RACEWAY CORNERS STRETCH	REMARKS: _____ _____ _____ _____	EASY HARD X-HARD
<p> APPROVED <input type="checkbox"/> NOT APPROVED <input type="checkbox"/> CONDITIONAL APPROVAL <input type="checkbox"/> </p> <p>REMARKS:</p> <p>_____</p> <p>_____</p> <p>_____</p> <p><small>* This fabric is approved for upholster-ability only. The approval does not account for the durability of the fabric at the time of, and after installation of the product</small></p> <p>APPROVAL SIGNATURE: _____ DATE: _____</p>		



C.O.M AUTHORIZATION FORM FOR COMPILE PEDESTAL CUSHIONS

CUSTOMER INFORMATION

To be completed by the dealer/design firm. Use one form per textile. Incomplete information may delay or prevent approval.

A+D/Dealer/Company Name:	Contact:	Date:
Billing Address:	Phone:	
City:	State:	Zip:
	Fax:	
End-User/Project Name:	End-User/Project Registered?	YES NO If YES, The Evolve Quote#:

TEXTILE APPLICATION INFORMATION

MODEL NUMBER	QUANTITY	SPECIAL INSTRUCTIONS

Textile Name (Series/Style #):
Textile Color Name and Description:
Country of Origin:
Mill or Manufacturer's Name:
Textile Content (% Cotton, % Poly, % Wool, etc.):
Textile Width: Pattern Repeat: VERTICAL HORIZONTAL Rail Roaded? YES NO

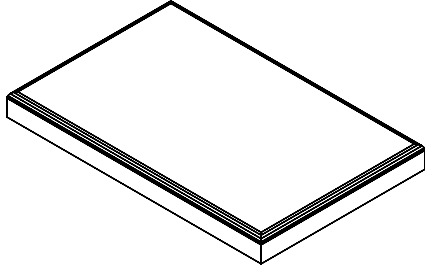
TEXTILE DIRECTION	NEW TEXTILE	PREVIOUSLY APPROVED TEXTILE
 <p>STAPLE FABRIC TO THIS FORM IN THE DIRECTION IN WHICH THE FABRIC IS TO BE UPHOLSTERED WITH THE LEFT SIDE OF THIS PAGE BEING THE SAME LEFT AS THE CUSHION.</p>	<p>Attached textile sample (Minimum 5" x 5" Max 12" x 12") In correct DIRECTION and SIDE.</p>	<p>Fax completed form to: 856.596.5684</p>
<p>MAIL FORM AND TEXTILE SAMPLE ONLY TO: GLOBAL - COM Department 17 West Stow Road Marlton, NJ 08053 856.596.3390</p>		
<p>Please contact your local EVOLVE CustomerCare representative for status of all COM requests. When textile is approved and an authorization number issued, a set of shipping instructions will be faxed or e-mailed to you.</p> <p>Approved textiles are to be shipped to the address that will be included with instructions. Do not ship textiles to the address on this form. Dealer is responsible for the shipping expenses. Brokerage fees will be paid for by Global. However, duties imposed by North American Governments related to textile materials, content and Country of Origin, additional fees may apply and will be billed separately.</p> <p>Please Note: C.O.M Textiles may not be shipped without shipping documents. GLOBAL is not responsible for any material shipped without the authorization number.</p> <p>Please be advised that Global has phased out the use of textiles that contain certain Phthalates, including but not limited to: DEHP (di (2-ethylhexyl) phthalate), DBP (di-n-butyl phthalate), BBP (butyl benzyl phthalate) and DINP (di-isononyl phthalate) (collectively the "Listed Chemicals"). The Listed Chemicals are used in certain types of vinyls. Global cannot accept orders for textiles that contain the Listed Chemicals, if such orders are to be shipped to the U.S.A. or are intended for customer in the U.S.A. If you are not sure if the C.O.M you have selected contains the Listed Chemicals, please contact the manufacturer or supplier of the fabric to verify.</p>		

EVOLVE AUTHORIZATION FORM (TO BE COMPLETED BY CUSTOMERCARE REP.)

CAN#:	TEXTILE YARDAGE (REQUIRED FOR THE ORDER):	GU CODE:
SIGNATURE: _____	PRINT NAME: _____	DATE: _____

PANEL FABRIC SAMPLE

TOP

**STAPLE
MINIMUM 6" X 6"
FABRIC SAMPLE HERE
IN THE DIRECTION IT IS TO BE
APPLIED TO THE PRODUCT**

BOTTOM



APPENDIX

The Evolve Furniture Group has partnered with the software vendors listed below to provide you with an online source for viewing the 2019 Compile Electronic Catalog. Please visit their websites for additional information and download details.

2020 Technologies

www.2020technologies.com
5503 Mile Road NW
Grand Rapids, MI 49544
Phone: 800-638-6002

Ice Edge Business Solutions

www.ice-edge.com
4001 S 700 East, Suite 450
Salt Lake City, UT 84107
Phone: 801-747-0373

KISP

www.kisp.com
Customer Support: 416-499-2457
Cad Services Team: 416-499-2457 x3
Customer Service e-mail: tellmemore@kisp.com
CAD Services requests CadServices@kispstech.com

Project Matrix

www.projectmatrix.com
11655 Lebanon Rd.
Cincinnati, OH 45241
Tech Support Instant Messenger: projectmatrixtech@yahoo.com
Phone: 513.554.1665
Fax: 513.554.1255

Quintero-Smith Incorporated/Midnight Oil

www.midnight-oil.com
10469 Kinnard Avenue
Los Angeles, CA 90024
voice: 800-350-7434 (US Only)
international: 310-478-5140
fax: 310-478-4572
e-mail: jimrsr@q-si.com



TERMS & CONDITIONS

APPLICATION OF STANDARD TERMS

Sales of Evolve products are made only on Evolve standard terms and conditions of sale which are contained in the Price Book and in Evolve's order acknowledgments. These standard terms and conditions may be modified or supplemented only by a separately written document signed by Evolve's authorized personnel at its head office in Marlton, New Jersey. An offer by Purchaser of said terms and conditions shall not be binding until accepted by Evolve in writing.

All illustrations, specifications and prices in this Price List are based on the latest product information available at the time of publication. Evolve reserves the right to make changes, at any time and without prior notice, to prices, colors, materials, specifications and models offered.

PRICES AND PAYMENT

The prices shown in this Price List, as well as those quoted by Evolve, shall be in US dollars for orders shipped to destinations within the continental United States.

Prices listed herein are for standard product. Quotations for special product are available through Evolve Customer Support Department in Marlton, New Jersey.

If shipping date requested is more than 90 days from date of order Evolve shall use published list prices effective at the time of shipment.

Not included in the list price are special or export packing, unpacking and installation. Orders are invoiced at the time of shipment. The Customer agrees to pay a charge of 2% per month of invoices outstanding more than 30 days.

FOR PAYMENTS ONLY, MAIL TO:

Evolve Furniture Group, a division of:
Global Industries, Inc.
17 West Stow Road
P.O. Box 562
Marlton, New Jersey 08053

Any products sold shall remain the property of Evolve until fully paid for in cash. The Purchaser agrees to perform all acts which may be necessary to perfect and assure retention of title to such products to Evolve until such time as the goods have been paid for in full.

Freight charges will be prepaid by Evolve to destinations within the contiguous United States on shipments of \$10,000 list and greater. For shipments less than \$10,000 list, the freight charge will be 5% of the total list price.

Please note exception below:

All showroom and mock-up orders will be subject to actual freight charges.

Evolve shall, in its sole discretion, determine the most appropriate method of shipment routing and carrier. Shipments of less than a full trailer load (LTL) shall ship via common carrier. **These LTL shipments are not subject to specific delivery days or times.** Full trailer loads will provide for dedicated delivery time and schedule. Purchaser may request special packaging or method of shipment at Purchaser's sole expense.

TAXES

All sales, use, excise and other applicable taxes and the collection and reporting thereof (excluding only taxes on the net income of Evolve) are the Purchaser's responsibility and will be invoiced to the Purchaser. If Purchaser claims an exemption from such taxes, it shall be the Purchaser's responsibility to furnish an appropriate exemption certificate to Evolve.

ORDER INFORMATION

Evolve requires that **all orders be submitted in writing** to avoid errors and/or duplication. Orders will be acknowledged with Evolve's acknowledgement forms governing the transaction. The details appearing on the acknowledgement will describe the items to be shipped to Purchaser who must ascertain that they are correct. If not correct, Purchaser should notify Evolve immediately by telephone or fax followed by written confirmation. Acknowledgment shows approximate shipping date of items ordered. **Shipping dates are assigned to orders based on the item having the longest manufacturing lead time.** Orders with Customer's Own Material (C.O.M.), or missing or incorrect information (finish selections, fabric selections, etc.) will be scheduled for manufacturing upon receipt of COM or correct complete information. Purchaser must indicate if multiple shipping schedules are required including noting if the shipping date requested is longer than standard posted lead time. Each shipment will be invoiced at time of shipping and will be subject to payment terms described herein.

C.O.M. CUSTOMER'S OWN MATERIAL

Should Purchaser request a fabric, not standard to the Evolve upholstery line, Purchaser shall submit a sample of not less than two yards for approval. Evolve will determine whether fabric is suitable to manufacturing process and applicable UL or code requirements. Should Evolve be required to test such fabric, it shall so advise Purchaser, and Purchaser shall be responsible for all costs associated therewith. This includes all duty and brokerage fees.

Fabric yardage requirement will be determined by Evolve. An additional charge may be made to cover the cost of cutting, matching or sewing unusual or directional patterns. Evolve shall have no responsibility for condition, quality, performance, physical properties or any other aspect of C.O.M. For panels, price as if grade 1 fabric is used.

Evolve reserves the right to reject any C.O.M. deemed unsuitable.

Evolve reserves the right to cancel an order at any time if C.O.M. is, in the sole judgement of Evolve, inadequate for any reason.

CHANGES AND CANCELLATION

The order may not be changed or cancelled by Purchaser without the written consent of Evolve. This charge can be as much as 100% based upon proximity to scheduled shipment date. Special order items and fabric-covered items already in production are not subject to change or cancellation under any circumstances. Fabric-covered items are considered to be in production once the fabric has been cut.

DEPOSIT ON SPECIAL ORDERS

Orders for nonstandard products may, at Evolve's discretion, require deposit prior to scheduling of production, the amount of the deposit being credited against the total price of the project.

SUSPENSION

In the event that the Purchaser defaults in the payment of any sum due Evolve, or in the event the Purchaser's financial condition becomes unsatisfactory to Evolve, Evolve shall have the right at its option, upon written notice to the Purchaser, to cancel shipment of any goods, unless within ten (10) days of Purchaser's receipt of such notice Purchaser provides assurance of payment to Evolve in such form, content and/or amounts as Evolve, in its sole discretion, deems adequate.

COMBINED SHIPMENTS

Evolve will make every effort to combine shipments and orders on written request. However, acceptance of such request shall be with Evolve's sole discretion.

CODE RESTRICTIONS

Evolve portable furniture may be subject to local fire, electrical and/or building codes applicable to portable furniture. It shall be Purchaser's sole responsibility for the proper application of Evolve items within the limitations of such local codes, which may be different from area to area.

SERVICE

Service problems shall be handled by the authorized Evolve dealer. Where this cannot be accomplished on a local level, service problems should be referred to:

Evolve Furniture Group
Customer Support
17 West Stow Road
Marlton, New Jersey USA 08053
856-552-4000 888-827-2500
Attention: Evolve Operations Manager



TERMS & CONDITIONS

STORAGE

In the event Purchaser requests postponement of delivery beyond the acknowledged shipping date, Evolve may transfer the goods to storage on Purchaser's account and at Purchaser's risk and expense subject to a daily storage rate. Such transfer to storage shall be deemed shipment to Purchaser for all purposes, including invoicing and payment.

DELAYS

Evolve's order acknowledgement will state a shipping date which is Evolve's best estimate at the time the order is acknowledged. However, Evolve shall not incur any obligation or liability to Purchaser for failure to ship by a specified date. In addition, Evolve shall not be liable for any loss or damage resulting from any delay or failure in shipment or other failure to perform all or any part of the agreement between the parties with respect to the goods shown on the face of the order acknowledgement where such delay, failure, loss or damage is the proximate result of any act of any governmental authority or political subdivision thereof, revolution, riot, civil disorder or disturbance, act of enemies, delay or default in transportation, strike disputes among or between unions or other labor disputes, delay or inability in obtaining materials and facilities, fire, flood, act of God or any cause not within the reasonable control of Evolve, whether of the class of causes enumerated or otherwise. Without limiting the generality of the foregoing, Evolve may, without causing any breach or incurring liability, allocate goods which are in short supply, regardless of the reasons therefore, among purchasers, in any manner which Evolve, in its sole discretion, deems advisable.

BACK CHARGES

Evolve will not accept charges for expense incurred by the Purchaser in expediting shipments or otherwise. Evolve will not accept charges for the repair of damage by others.

CLAIMS

All goods are sold F.O.B. Toronto, Canada, unless otherwise agreed to in writing by Evolve. Evolve is not responsible for damage which occurs in transit or in storage. The carrier signs for all goods received in good order. It is the Purchaser's responsibility to examine goods upon receipt and to file any claims with the carrier. Any claims made against Evolve for apparent defects, errors or shortages must be made by the Purchaser in writing, within fifteen (15) working days after any delivery. Failure by the Purchaser to make any claim against Evolve within the above-described fifteen days shall constitute acceptance of the goods and a waiver of any apparent defects, errors or shortages.

RETURNS

No returns of goods will be accepted without written consent and shipping instructions, including Evolve's Return Goods Authorization (R.G.A.) numbers, to Evolve. A minimum restocking charge of 35% is made on all authorized returns for credit or refund, provided goods are received by Evolve in the condition in which they left the factory. No credit will be given if goods cannot be reused. Special order items and fabric-covered items are in no event subject to return. All returns must be approved and authorized in writing by Evolve Customer Support, Marlton, New Jersey.

LIFETIME WARRANTY

Evolve warrants that all commercial products are free from defects in material and workmanship, for the life of the product, to the original purchaser. This warranty is made by Evolve only to original customers acquiring the product directly from Evolve's authorized dealers. The customer's sole remedy pursuant to this warranty is limited to repair or replacement of parts or product at Evolve's option. Consent from Evolve must be obtained before any warranty work is performed. This warranty shall not apply to any products which must be replaced because of normal wear and tear, negligence, abuse or "accident", shipping damage, or product use and installation other than in accordance with written instructions or warnings. It shall also not apply when product has been modified or altered, repaired or refurbished by someone other than Evolve or an authorized dealer or because of natural variations over which Evolve has no control. In the event of repair and/or replacement of any defective product, Evolve does not warrant matching color, grain, texture or dye lots. Evolve's warranty does not cover the cost of transportation or labor. Repair or replacement will be at Evolve's option. Evolve makes no warranty that any of its products are suitable for any particular purpose and makes no other warranties, expressed or implied, other than those set forth in this Price List. As codes and standards vary from one jurisdiction to another, references to compliance are solely for convenience and without any representation as to accuracy or suitability. Users must verify the suitability of such information or product for their specific application. In no event shall Evolve be liable in either tort or contract for any loss or direct, special, incidental, consequential, or exemplary damages.

This Lifetime Warranty is NOT applicable to customers who use Evolve products for rental purposes and is effective only for products, parts or components manufactured after January 1, 2011.

Exceptions to this warranty include:

- Global fabrics and wood veneers, which are warranted for five years from date of delivery.
- Electrical components, which are warranted for ten years from the date of delivery.
- Moving parts such as glides, slides, casters, user-adjustable worksurface mechanisms, which are warranted for five years from date of delivery.

- Fading on fabric and wood veneers can be caused by exposure to U.V. rays/sunlight. Natural wood veneer, being a natural material, will have shade differences between veneer sheers, the difference will be more apparent between dye lots.

Evolve does not warrant color fastness on Customer's Own Material.

Because of natural variations over which Evolve has no control, this warranty does not extend to color, grain or texture of wood, and Evolve does not warrant matching of color, grain or texture.

Evolve makes no warranties, including implied warranties of merchantability and fitness for a particular purpose, other than the express warranties contained herein.

LIMITATION OF REMEDY

Purchaser's sole and exclusive remedy (excluding the repair or replacement of goods for breach of the express warranty above) for any matter or claim arising under or relating to these terms and conditions, the goods covered hereby and any transaction involving or relating to such goods, whether in contract, tort (including negligence) or otherwise, shall be payment of the lesser of the cost to repair or replace said product or the purchase price for the goods to which the claim relates. In no event shall Evolve be liable for any special, indirect, consequential, or incidental damages, including without limitation, damages for loss of business profits, business interruptions, or loss of information.

EVOLVE'S WARRANTY DOES NOT APPLY (FOR ANY PRODUCT CATEGORY) TO THE FOLLOWING:

- Failures due to wear and tear
- Failures which result from negligence, abuse, accident or misuse
- Failure to apply, install or maintain products according to Evolve's written instructions and warnings
- Modifications, attachments or repair methods not approved by Evolve
- Damage caused by a carrier in transit, or delivery/installation contractors
- The matching of colors, grains or textures (wood, leather, etc.) of natural materials and color matching of textiles
- Products exposed to extreme hot or cold temperatures or excessively dry or humid environments
- Colorfastness or the matching of color of textiles
- Damage by markings or staining; damage by sharp objects or imprinting from instruments
- Damage to textiles or laminate and wood surfaces/edges from exposure to sunlight (including UV rays)
- Products used for rental purposes

Evolve's warranty applies to products sold within the United States of America, Mexico, the Commonwealth of Puerto Rico and Canada.

showrooms and distribution centers throughout the united states

SHOWROOMS

Atlanta

10 10th Street
Suite 150
Atlanta, GA 30309
T (404) 879-0998

Chicago

The Merchandise Mart
10th Floor, Suite 1035
Chicago, IL 60654
T 312.755.0843

New Jersey (Southern)

119 Greentree Road
Marlton, NJ 08053
T 856.596.3390

Philadelphia

1735 Market Street
38th Floor
Philadelphia PA, 19103
215.861.0963

Washington, DC

1130 Connecticut
Avenue
Washington, DC 20036
T 202.659.0230

Boston

One Harbor Street,
Suite 104
Boston, MA 02210
T 617.406.5435

Miami

112 NE 41st Street
6th floor
Miami, FL 33137

New York City

386 Park Avenue South,
7th floor
New York, NY 10016
T 212.545.9900

Phoenix

4675 East Cotton
Center Boulevard,
Suite 165
Phoenix, AZ 85040
T 602.426.0666

SHOWROOMS + DISTRIBUTION CENTERS

Atlanta Area

6715 Maple Ave.
Suite 100
Buford, GA 30518
T 678.602.4130

Chicago Area

27W501 North Avenue
West Chicago, IL 60185
T 630.681.2818

Denver Area

16401 E. 33rd Dr., Ste. 50
Aurora, CO 80011
T 303.340.1617

Kansas Area

11617 West 81st Street
Lenexa, KS 66214
T 913.310.9963

Tampa Area

10351 Windhorst Road
Tampa, FL 33619
T 813.621.6272

Baltimore Area

Troy Hill Corporate
Center
7030 Troy Hill Drive
Elkridge, MD 21075
T 410.379.8021

Cincinnati Area

8712 LeSaint Drive
Fairfield, OH 45014
T 513.777.0009

Ft. Lauderdale Area

560 Sawgrass
Corporate Parkway
Sunrise, FL 33325
T 954.846.8888

Los Angeles Area

12320 Bloomfield
Avenue, Unit A
Santa Fe Springs, CA
90670
T 562.484.9686

Boston Area

19 Connector Rd., Unit 1
Andover, MA 01810
T 978.470.8463

Dallas Area

2025 W. Beltline Rd.,
#100
Carrollton, TX 75006
T 972.236.1366

Houston

7865 Northcourt Road,
Building D, Suite 200
Houston, TX 77040
T 713.695.5777

Seattle Area

Oakesdale Commerce
Center
820 Southwest 34th St.
Building W7, Suite A
Renton, WA 98057
T 425.291.9282

Global - USA Headquarters

17 West Stow Road P.O. Box 562
Marlton, New Jersey U.S.A. 08053
Tel (856) 596-3390 (800) 220-1900
Fax (856) 596-5684
www.globalfurnituregroup.com

Global - Canada Headquarters

1350 Flint Road
Downsview, ON Canada M3J 2J7
Sales & Marketing: Tel (1-877) 446-2251
Customer Service: Fax (800) 361-3182
Government Customer Service: Fax (416) 739-6319



Association of Canadian Ergonomists
Association Canadienne d'Ergonomie