

Desking + Tables

Effective July 5, 2022 USA

Revised November 1, 2022



PRICE LIST
desking + tables



think global

THE GLOBAL EDGE

ERGONOMICS IN THE TOTAL OFFICE

- One stop shopping for a full range of office furniture.
- Seating, desks, tables, files, modular furniture, panels and accessories.
- Ergonomics, competitive pricing and built-in value.

STRENGTH AND STABILITY

- Established in 1966.
- One of North America's largest office furniture manufacturers.
- Manufacturing and showrooms worldwide.

QUICK SHIP - INSTOCK

- Hundreds of products in stock for immediate delivery.

STRONG LOCAL REPRESENTATION

- Service and expert advice where you are, when you need it!

MANUFACTURING CAPABILITY

- Vertical integration ensures "start to finish" control.
- Ongoing research and investment in new, innovative production technology.

QUALITY ASSURANCE

- Quality Assurance Program is qualified by C.G.S.B. ISO9001 standards.
- On-site furniture testing facility.
- Product and components are tested to ANSI/BIFMA standards.

ENVIRONMENTAL COMMITMENT

- Continuous development of "earth friendly" programs.
- One of the first molded foam manufacturers to create ozone-friendly, CFC and HFC-free processes.
- Seat and back pans are made from recyclable plastics and wood waste, enabling little waste and cost effective products.

SYMBOL IDENTIFICATION



Global's Certified Products are in compliance with the stringent emission guidelines set by the GREENGUARD Environmental Institute and include all Upholstered Seating. To obtain a GREENGUARD Certificate for any product, please go to the product page on our website www.globalfurnituregroup.com and click on "View GREENGUARD Certificate".

level™ certification, based on the ANSI/BIFMA e3-2012 furniture sustainability standard, sets furniture manufacturers on a path toward greater sustainability over time. Based on environmental and social criteria set forth in the standard, a product's entire supply chain is assessed.



Certification assessment includes an evaluation of specific corporate policies and guidelines and an assessment of associated company manufacturing facilities. Products must meet quantifiable milestones of environmental and social performance at every step of development.

The quantitative assessment addresses four categories: material use, energy and atmosphere impacts, human and ecosystem health and social responsibility.

Manufacturers earn points in each of the four categories. The level™ brand and its numeric rating of 1, 2 or 3 indicate what threshold of certification a product has achieved. level™ 3 is the highest rating.

TABLE OF CONTENTS

WORKPLACE

LAMINATE DESKS

Adaptabilities.....	9
Consumer Education.....	6
Office Accessories.....	498
Desking Comparison Chart.....	4
Genoa.....	48
Laminate Desk Notes.....	8
Princeton.....	61
Zira.....	109
Zira Boardroom + Reception.....	276

METAL DESKS

StreamLINE.....	308
-----------------	-----

BENCHING

Bridges II.....	340
FreeFit.....	607
Intelli Beam.....	424

PANELS + COMPONENTS

Divide.....	442
-------------	-----

PRODUCTIVITY SOLUTIONS by Global

Productivity Solutions.....	482
FOLI Height Adjustable Tables.....	484
FreeFit Height Adjustable Tables.....	607
Keyboard Trays.....	491
Manual Height Adjustable Tables.....	483
Monitor Arms.....	490
Office Accessories.....	498
Power/Data.....	515
Revo + Voyage Task Lights.....	496

STORAGE

Sidebar Storage.....	456
Zira Lockers.....	299

TABLES - CAFE, MEETING + BOARDROOM

Boardroom tables.....	526
Kadin Tables.....	650
Swap tables.....	659
Zira Boardroom + Reception.....	276

TABLES - TRAINING

2gether tables.....	524
Bungee tables.....	547
Bungee SL tables.....	564
Bungee SL power/data management.....	571
ConnecTABLES.....	578
Junction.....	643
Terina.....	704

TABLES - RECEPTION + OCCASIONAL

Citi tables.....	722
Coat trees.....	723
Laminate occasional tables.....	724
Lite Lift II folding tables.....	726
Sirena tables.....	727
Wind tables.....	728

TABLE POWER + TECHNOLOGY SOLUTIONS

Table Power + Technology Solutions524

WELLNESS SOLUTIONS

Consultation Booth.....477

Linking Panels474

Universal Privacy Panels469

Wellness Screens468

ACOUSTIC SOLUTIONS

Priva pods.....478

REFERENCE

Custom Grommet Location Form739

Terms + Conditions746

Warranty.....748

Textiles + Finishes.....732

CLASSROOM

2gether tables524

Bungee tables547

Bungee SL tables564

Bungee SL power/data management571

ConnecTABLES578

Duet tables.....594

CLASSROOM (cont'd)

Edventure597

Junction.....643

StreamLINE308

Terina.....704



Zook.....708

MEETING + COLLABORATIVE



Kadin Tables650

Swap tables659

DESKING COMPARISON CHART

	ADAPTABILITIES	BRIDGES II	GENOA
			
GENERAL FEATURES	<ul style="list-style-type: none"> • Top over end panel design • 400 color combinations • Virtually no loose hardware • Storage height is 66" • 2 handle options 	<ul style="list-style-type: none"> • Beam-based benching system • 8-wire, 4-circuit electrical • Storage height is 21", 25" and 29" 	<ul style="list-style-type: none"> • Top over end panel design • 3/4 pedestal standard • Virtually no loose hardware • Storage height is 66"
GOOD BETTER BEST	Better	Best	Good
STYLE	Transitional	Contemporary	Transitional
PRICE POINT (36 x 72 double pedestal desk)	\$1672	N/A	\$1274
WORKSURFACE THICKNESS	1"	1"	1"
SURFACE TYPE	High performance thermally laminate or HPL	High performance thermally laminate or HPL	High performance thermally laminate
EDGE THICKNESS	2mm	3mm	Self Edge
EDGE OPTIONS	Flat	N/A	N/A
HUTCH CLEARANCE (worksurface to underside of hutch)	17.75" to valance 20" to underside of hutch	N/A	20"
GREENGUARD CERTIFIED	Yes	Yes	Yes
BIFMA e3 LEVEL CERTIFIED	Level 3	Level 3	Level 3
USDA BIO-PREFERRED EDGING	Yes	No	Yes

DESKING COMPARISON CHART

	PRINCETON	STREAMLINE	ZIRA
			
GENERAL FEATURES	<ul style="list-style-type: none"> • Freestanding, modular components with overlapping architectural elements • 14 standard finishes; up to 3 color application on many components available • Optional 6mm tempered glass on hutches and desktop storage. • Storage height is 52" and 66" 	<ul style="list-style-type: none"> • Laminate top over steel end panel / storage design. • All standard Global laminates available on top. • Standard paints, textured and custom paint colors available on steel chassis. 	<ul style="list-style-type: none"> • Top over end panel design • 400 color combinations • Virtually no loose hardware • Storage height is 42", 54", 66", 72" and 84" (nominal). • 9 handle options • 4 glazing options for storage doors and modesty panels
GOOD BETTER BEST	Best	Better	Best
STYLE	Contemporary	Contemporary	Contemporary
PRICE POINT (36 x 72 double pedestal desk)	N/A	\$2714	\$1854
WORKSURFACE THICKNESS	1"	1"	1" or 1.5"
SURFACE TYPE	High performance thermally laminate or HPL	High performance thermally laminate or HPL	High performance thermally laminate or HPL
EDGE THICKNESS	2mm	2mm	2mm
EDGE OPTIONS	N/A	N/A	Flat, Fluted or Bicut
HUTCH CLEARANCE (Worksurface to underside of hutch)	15.75"	24"	20.25" (23.5" Hutch) 17.75" (36" Hutch) 24.25" (42" Hutch) 24.25" (54" Hutch)
GREENGUARD CERTIFIED	Yes	Yes	Yes
BIFMA e3 LEVEL CERTIFIED	Level 3	Level 2	Level 3
USDA BIO-PREFERRED EDGING	No	No	Yes

CONSUMER EDUCATION

How do I buy a desk?



Choose a non-reflective surface. Global uses colors that reduce glare to make your work easier to read while reducing eye strain.



Get a desk that lets you look ahead. A modular desk is easy to set up initially and then reorganize or reconfigure later to adapt to future needs.

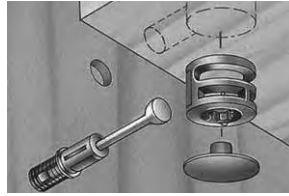

Look for European connectors if you're buying ready-to-assemble furniture. Global makes assembly easy - all you need is a screwdriver.



Give your business an edge. Each Global desk comes with its own attractive edge design.



Avoid tangles. Make sure your desk has at least one grommet hole to keep computer and telephone wires out of the way.



A hutch should have a sweep that manages computer and telephone wires.



Island worksurfaces let you meet with more than two people at once with ample leg room for all.



Choose one of Global's height/angle adjustable keyboard trays to go with your desk. Your arms can maintain a comfortable position, reducing shoulder, back and neck strain.

How do I select the right workstation?

When searching for the right workstation it is important to consider its purpose which will be decided by the nature of your tasks. It is best to look for products that have been designed and engineered to help make your workspace more productive.

Once these patterns have been identified, organize them according to their intended use and frequency of their use. Now you are ready to investigate the pertinent factors that will determine the workspace you eventually select.

This can be achieved in a variety of ways. As a guide, observe how your work flows through your office in a typical day. It is likely that you'll uncover a number of distinctive and repetitive task patterns.

Lighting - Protect yourself

- If you have to setup near a window make sure your computer sits perpendicular to it, minimize eye-strain inducing glare on sunny days.
- If you have fluorescent lights, try to position your set up between the lights.
- Use "Parabolic louvers" to reduce the glare from fluorescent lights
- Use window blinds to control the light source through the day
- Panels or screens may be used to control glare
- Protect your eyes from Ultraviolet A (UVA) and Ultraviolet B (UVB) by using an anti-glare screen

Noise

- Try to set up your office in a separate room if possible and away from the rest of the house

Chair

- Comfort is personal but should be part of the selection
- Seat pan design; deep and wide enough
- Rounded front edge (waterfall)
- Adjustable slope seat
- Able to adjust your chair, to obtain appropriate height
- Sit back in your chair, with your thighs parallel to the floor
- Place feet flat on the floor, a footlocker may be required

Footlocker

- A footlocker helps to prevent possible discomfort resulting from outstretched feet
- The rocking motion creates light activity in the legs and feet and will help stimulate muscles to improve overall circulation

Keyboard

- Has a palm rest
- Easily adjusts the angle of the keyboard
- Easily adjusts the keyboard height

Document Holder

- A curved back document holder reduces glare
- Position document holder in line with the monitor to reduce eyestrain

Monitor

- There should be a direct line from the center of monitor to the, "J" key on your keyboard which should line up with your belt buckle
- Position the monitor at arm's length
- Make sure that the top of your monitor screen is slightly below eye level
- A monitor stand may be used to achieve the desired height

Workstation

- Adequate space beneath the worksurface for your legs
- Depth of the worksurface depends on the task and equipment used to perform this responsibility
- Try to place tasks that are performed regularly within arm's reach
- Avoid unnecessary reaching and bending which leads to fatigue and possible muscle strains and can reduce efficiency
- Keep in mind other related tasks in your planning
- Establish your workflow then design the essential elements to meet your requirements

desking – laminate



Adaptabilities 9



Genoa 48



Princeton 61



Zira 109

LAMINATE DESK NOTES

The following applies to all series EXCEPT the Bridges II, Princeton and StreamLINE series.

For information on the Bridges II series, please refer to page 340, for the Princeton series, please refer to page 61 and for the Streamline II series, please refer to page 308.

- Outside and surface panels are made from 1" thick 45 lb. density particle board and covered on both sides with high performance thermally fused laminate. Modesty panels are 11/16" thick.
- **BOX AND FILE DRAWERS** use FULL EXTENSION STEEL BALL BEARING SLIDES for smooth action.
- **BOX AND FILE PEDESTALS** are standard and are CONSTRUCTED INDEPENDENTLY of the chassis, with fully closed bottoms. This PICTURE FRAME CONSTRUCTION technique prevents racking, and provides a product that lasts for years.
- **FILE DRAWERS** file both legal and letter documents as standard (LETTER FILES will file in BOTH DIRECTIONS, as will LATERAL FILES), except 15" w Zira units (side to side only).
- Drawers and END PANELS are **EDGE BANDED** on ALL FOUR SIDES to protect clothing and the floor covering.
- Locks are standard on all box and file pedestals, lateral files, storage cabinets and combination storage units.
- All locking components within each series can be keyed alike at no additional charge. Please specify the request at time of ordering.
- Drawers are opened with side pulls and are constructed 22" deep (Genoa 18"D) using French dovetail joints at the front and lap joints at the rear. Woodgrain enameled bottoms are routed into the woodgrain (MDF) sides on three edges.
- Full to the floor pedestal configurations can be switched for a **15% upcharge** (Adaptabilities series ONLY).
- Pencil tray included with each desk.
- **LEVELING GLIDES** are standard on ALL UNITS.
- All units are **shipped fully assembled** (except where noted) on 1" x 3" thick wood furniture skids with pedestal supports inside high quality cartons.
- **ALL "L" SHAPED DESKS** have flush backs on the return (modesty panels).
- Additional options available include (add suffix to item number):
FM = Full modesty panel. Available on any desk or credenza. Upcharge applies. See individual series notes.
- Desks with FULL TO FLOOR pedestals CANNOT have ¾ modesty panels.
- Corners must have matching modesty panels (both sides must be either ¾ or full modesty panels).
- **Modesty panels** on CORNERS will be 1" above the floor; **Modesty panels** on RETURNS are flush with the floor. It is recommended that corner units are used for corner spaces when configuring workstations so there is no visible difference if a corner is connected to a return.
- Global Furniture Group will consider custom, specials and product alterations on an individual basis.
- Desk series can only be made in **Standard Global Laminates**.
- **PLEASE REFER TO SERIES FOR FINISHES AVAILABLE.** The following desk finishes are offered:

WOODGRAINS:

Absolute Acajou (ACJ)	Asian Night (ASN)	Avant Cherry (AWC)
Avant Honey (AWH)	Clear Maple (CMB)	Dark Espresso (DES)
Noce Biondo	Noce Grigio	Noce Leggero
Noce Medio	Quartered Mahogany (QTM)	Tiger Fruitwood (TFW)
Tiger Walnut (TWL)	Walnut Heights (WHE)	White Chocolate (WHC)
Winter Cherry (WCR)		

SOLIDS:

Black (BLK)	Designer White (DWT)	Hayden Grey (HGT)
Storm Grey (SOG)	Willow Grey (WGY)	

PATTERNS:

Brushed Cobalt (BRC)

- See **Productivity Solutions** and **Desk Accessories** for additional options



With over 370 components available in 400 color combinations, Adaptabilities provides the ultimate in flexibility and modularity. Rich laminate colors coordinate easily with any office or home decor. All surfaces are constructed from Global's exclusive premium grade, high performance laminate and preferred matching edges.

Adaptabilities features an extensive range of versatile components which can be configured into multi-user workstations suitable for intensive task functions, or for private executive suites requiring stately elegance and work-force functions. All laminate filing cabinets have a safety mechanism that prevents two drawers from being opened at the same time. File drawers have fully progressive ball bearing suspensions and accommodate letter and legal filing. For heavy duty usage, two, three and four drawer laminate files are available with steel drawer interiors.



Tops are 1" thick and a top over side, edge panel design.



¾ modesty panel available at no extra charge.



For heavy duty usage, two, three and four drawer laminate files are available with steel drawer interiors.



Features and Benefits

- 45lb. density particle board substructure with high performance thermally fused laminate
- 1" thick worksurfaces in thermally fused or high pressure laminate
- Worksurfaces feature 2mm edging in matching color.
- Full to floor or ¾ pedestals available on most components
- All desks are size (incrementally) accurate
- 11/16" thick full modesty panel is standard
- 11/16" thick 3/4 modesty panel is available on most components
- Pencil tray included in box drawer
- File drawers can accommodate legal or letter documents
- Full progressive ball bearing suspension on file drawers
- All drawer fronts edge banded with side pull opening pedestals and standard with pedestal locks
- Compatible with **Divide** panel system for increased privacy and storage requirements

GENERAL INFORMATION

- Constructed of 45 lb. density particleboard with high performance thermally fused laminate
- Adaptabilities components are compatible with Divide transaction tops and partitioning panels. See page 442 for Divide specifications and prices.
- See pages 40-41 for keyboard drawers and additional accessory options.
- Adaptabilities desk and storage products have been tested and comply with all BIFMA mechanical tests.
- For environmental certifications, please visit globalfurnituregroup.com.

WORKSURFACES

- 1" thick high performance thermally fused laminate tops sealed with Global's Preferred edging in matching color
- Woodgrain surfaces feature edging with matching printed woodgrain
- High Pressure Tops are available in all Adaptabilities laminate finishes at an extended lead time. Please see model # for pricing and availability.
- Products specified with the high pressure laminate option are finished on the underside of the surface with a kraft paper backing.

CONSTRUCTION

- Constructed of 45 lb. density particleboard with high performance thermally fused laminate.
- Cabinets and Wardrobes are 65" high to match overall height of a worksurface with hutch (worksurface 29" + hutch 36" = 65").
- End Shelves are available as 65" high also to match overall height.
- Models with monoposts are available with a Black (**TBL**) or Tungsten (**TTU**) monoposts. Please specify.
- Models with handles are available with Black (**HX**) or Silver (**HS**) handles; please specify.
- All drawer fronts edge banded with side pull opening pedestals and standard pedestal locks
- Double wall pedestal housing with fully closed bottom

MODESTY PANELS

- 11/16" thick full modesty panel is standard
- 11/16" thick ¾ modesty panel available on most components
- ¾ height modesty panels available on most models at no additional charge. Please specify "**3MP**". (Corners must have both modesty panels as ¾ or full).
- **Note:** Woodgrain modesty panels over 60" wide will have the grain pattern in the horizontal direction. All end panels and modesty panels 60" or less will have the grain pattern in the vertical direction.

STORAGE

- All lateral file drawer fronts feature the woodgrain running in a horizontal direction.
- Pencil tray included in box drawer
- File drawers can accommodate legal or letter documents
- Triple progressive ball bearing suspension on file drawers

LOCKS

- Optional locks available for all straight hutch unit doors. Add **\$126** each lock
- Front-to-back filing bars for all steel drawer files available separately. Order FBB file bars. See "FBB" on page 41.
- Key alike or specific key number optional for all products with locks
- Reserved for new orders greater than \$20,000 list, all Adaptabilities units with locks may be ordered with **CA** cap option and specific lock cores/keys can be ordered separately for field installation rather than specifying duplicate product lines with different key numbers.
- When **CA** option is specified, product will ship with a cap over the empty lock housing.
- Separately order the appropriate number of cores with keys; use product code **SIL-CORE-H-SHOE** for Silver core/key sets or product code **BLK-CORE-H-SHOE** for Black core/key sets. Specify quantity and lock number required. One order line per key number required. Key number range: 401-440. **Must be ordered at the same time product is ordered with CA lock cap option specified.**
- One core removal key is required. Recommend one core removal for every 25 cores ordered. Order as **REMOVE-K-H-SHOE**.
- No charge applies for separate lock cores or core removal keys only when ordered with product. If replacement lock core and key required, contact Customer Care for applicable product code and pricing.

SPECIAL SIZES

- Additional custom sized components available upon request.
- Customer specified printer slots available in all worksurfaces. Contact Global Customer Service for pricing.
- Secretarial height returns (26 ½") available at a 15% upcharge.
- Full to the floor pedestal configurations can be switched for a 15% upcharge.

1. SPECIFY MODEL NUMBER

2. SPECIFY FINISH

One Tone Finishes:

ACJ	Absolute Acajou
ASN	Asian Night
AWC	Avant Cherry
AWH	Avant Honey
BLK	Black
BRC	Brushed Cobalt
CMB	Clear Maple
DES	Dark Espresso
DWT	Designer White
HGT	Hayden Grey
NBL	Noce Biondo
NGL	Noce Grigio
NEL	Noce Leggero
NML	Noce Medio
QTM	Quartered Mahogany
SOG	Storm Grey
TFW	Tiger Fruitwood
TWL	Tiger Walnut
WHE	Walnut Heights
WHC	White Chocolate
WGY	Willow Grey
WCR	Winter Cherry

Top Finishes:

ACJ	Absolute Acajou
ASN	Asian Night
AWC	Avant Cherry
AWH	Avant Honey
BLK	Black
BRC	Brushed Cobalt
CMB	Clear Maple
DES	Dark Espresso
DWT	Designer White
HGT	Hayden Grey
NBL	Noce Biondo
NGL	Noce Grigio
NEL	Noce Leggero
NML	Noce Medio
QTM	Quartered Mahogany
SOG	Storm Grey
TFW	Tiger Fruitwood
TWL	Tiger Walnut
WHE	Walnut Heights
WHC	White Chocolate
WGY	Willow Grey
WCR	Winter Cherry

Body Finishes (including pedestals):

ACJ	Absolute Acajou
ASN	Asian Night
AWC	Avant Cherry
AWH	Avant Honey
BLK	Black
BRC	Brushed Cobalt
CMB	Clear Maple
DES	Dark Espresso
DWT	Designer White
HGT	Hayden Grey
NBL	Noce Biondo
NGL	Noce Grigio
NEL	Noce Leggero
NML	Noce Medio
QTM	Quartered Mahogany
SOG	Storm Grey
TFW	Tiger Fruitwood
TWL	Tiger Walnut
WHE	Walnut Heights
WHC	White Chocolate
WGY	Willow Grey
WCR	Winter Cherry

3. SPECIFY OPTIONS

Grommets

- Additional grommets available in standard worksurface locations (left, center or right).
- Order as: **AG1, AG2 or AG3. Add \$88.**



- Grommet hole dimensions are 3 1/4" wide x 1 7/8" deep.
- Actual grommet locations on the worksurface are depicted in the example drawings shown below. Dimensions shown are actual measurements (in inches).

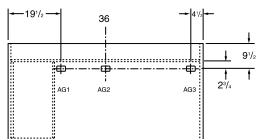

36 x 72 single pedestal left desks (A3672SPL)

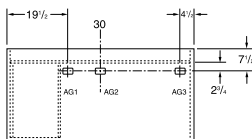

30 x 60 single pedestal left desks (A3060SPL)

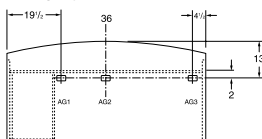

36 x 72 single pedestal left bow top desks (A3672SLB)

- Grommets may be placed at non-standard locations. Order as: **AGS - Add \$88.** A drawing must be supplied with vertical and horizontal dimensions to the center of the cut-out (as in drawing above). Please refer to CUSTOM GROMMET LOCATION FORM in the back reference section.
- Components that come standard with grommet may be ordered without a grommet. **Add \$49.**
- Grommets are available on modesty panels of extended corners and 5-sided corners 6 1/2" in where the two modesty panels meet at a 90° angle. Please specify FOGMPR for right grommet placement and FOGMPL for left grommet (placement is as shown on diagrams below). Cost is **\$88.**
- **Modesty panels are 1" off of ground**

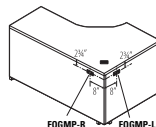

Left Extended Corner Unit

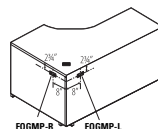

Right Extended Corner Unit

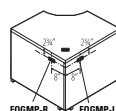

5-Sided Corner Unit

Power Block

- A Power Block (model PMSPDM) may be ordered on all worksurfaces.
- A Power Block is a rectangular worksurface power/data module with one electrical duplex receptacle and includes two data (CAT5) receptacles. 9 foot black cord included. Power Block dimensions are 3 1/2" deep x 6 1/2" wide x 2 3/4" high.
- To purchase a Power Block, you must specify both the Power Block cut-out location and the Power Block model #. Order Power Block as **PMSPDM, Add \$330.** Power Blocks are available in standard worksurface locations (left, center or right). Order as **E1, E2 or E3. Add \$88.**



Power Block **PMSPDM Add \$330**

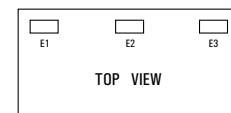

Specify location **E1, E2 or E3 Add \$88**

A ADAPTABILITIES®

DOUBLE PEDESTAL DESKS

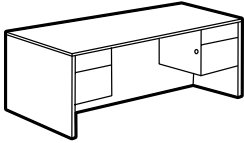

Double Pedestal Desk

MODEL#	DIMENSIONS D x W x H	FREIGHT CLASS	WT./LBS.	CUBIC FT.	LIST PRICE	HP ADD
A3672DP	36 x 72 x 29.5	150	296	52.50	\$1672	\$492
A3072DP	29.69 x 72 x 29.5	125	263	43	\$1642	\$461
A3066DP	29.69 x 66 x 29.5	125	254	39.75	\$1628	\$461
A3060DP	29.69 x 60 x 29.5	125	247	36.25	\$1487	\$429

Standard with box/file pedestals on both sides. Pedestals lock. One pencil tray.

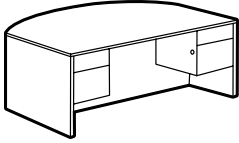

Double Pedestal Bow Top Desk

A3672DPB	30-36 x 72 x 29.5	150	280	52.50	\$1991	\$492
----------	-------------------	-----	-----	-------	---------------	--------------

Standard with box/file pedestals on both sides and bow top. Pedestals lock. One pencil tray.

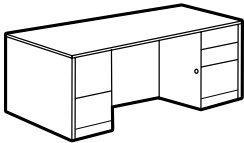

Full to Floor Double Pedestal Desk

A3672D4	36 x 72 x 29.5	125	330	52.50	\$2130	\$492
A3072D4	30 x 72 x 29.5	125	295	41.15	\$2093	\$492
A3066D4	29.69 x 66 x 29.5	125	285	39.75	\$2084	\$461
A3060D4	29.69 x 60 x 29.5	125	276	36.25	\$1941	\$429

Standard with full to floor box/box/file in right pedestal and file/file on left pedestal. Pedestals lock. On box/box/file pedestals, lower box drawer and file drawer lock. One pencil tray. Full to the floor pedestal configurations can be switched for a **15% upcharge**.

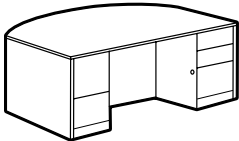

Full to Floor Double Pedestal Bow Top Desk

A3672DB4	32-36 x 72 x 29.5	150	311	52.50	\$2447	\$492
----------	-------------------	-----	-----	-------	---------------	--------------

Standard with full to floor box/box/file in right pedestal and file/file on left pedestal. Bow top. Pedestals lock. On box/box/file pedestals, lower box drawer and file drawer lock. One pencil tray. Full to the floor pedestal configurations can be switched for a **15% upcharge**.

SINGLE PEDESTAL DESKS

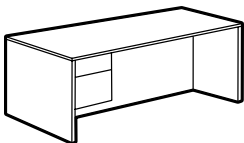

Single Pedestal Desk - LEFT

MODEL#	DIMENSIONS	FREIGHT CLASS	WT./LBS.	CUBIC FT.	LIST PRICE	HP ADD
A3672SPL	36 x 72 x 29.5	150	245	52.50	\$1395	\$492
A3072SPL	29.69 x 72 x 29.5	150	216	43	\$1225	\$461
A3066SPL	29.69 x 66 x 29.5	150	207	39.75	\$1210	\$461
A3060SPL	29.69 x 60 x 29.5	150	197	36.25	\$1205	\$429
A3048SPL	29.69 x 48 x 29.5	125	177	29.25	\$1082	\$364
A2448SPL	24 x 48 x 29.5	125	150	24.25	\$1082	\$237

Standard with box/file pedestal. Pedestal locks. One pencil tray. Pedestal is on the **left**.

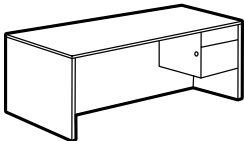

Single Pedestal Desk - RIGHT

A3672SPR	36 x 72 x 29.5	150	245	52.50	\$1395	\$492
A3072SPR	29.69 x 72 x 29.5	150	216	43	\$1225	\$461
A3066SPR	29.69 x 66 x 29.5	150	207	39.75	\$1210	\$461
A3060SPR	29.69 x 60 x 29.5	150	197	36.25	\$1205	\$429
A3048SPR	29.69 x 48 x 29.5	125	177	29.25	\$1082	\$364
A2448SPR	24 x 48 x 29.5	125	150	24.25	\$1082	\$237

Standard with box/file pedestal. Pedestal locks. One pencil tray. Pedestal is on the **right**.

Required Specifications

Top finish
Base finish

Optional Specifications

Key #
Grommet/power block cut-out
HP laminate
Modesty panel

Accessories

Power block
Keyboard tray
Pencil tray

SINGLE PEDESTAL DESKS

MODEL# DIMENSIONS FREIGHT CLASS WT/LBS. CUBIC FT. LIST PRICE HP ADD

D x W x H

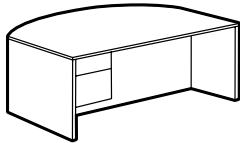

Single Pedestal Bow Top Desk - LEFT

A3672SLB 30-36 x 72 x 29.5 150 233 52.50 \$1708 \$492

Standard with box/file pedestal on **left** and bow top. Pedestal locks. One pencil tray.

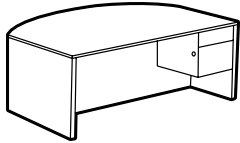

Single Pedestal Bow Top Desk - RIGHT

A3672SRB 30-36 x 72 x 29.5 150 233 52.50 \$1708 \$492

Standard with box/file pedestal on **right** and bow top. Pedestal locks. One pencil tray.

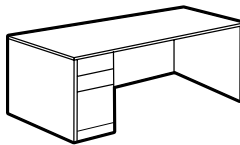

Full to Floor Single Pedestal Desk - LEFT

A3672S4L	36 x 72 x 29.5	150	261	52.50	\$1624	\$492
A3072S4L	29.69 x 72 x 29.5	150	232	43.75	\$1585	\$492
A3066S4L	29.69 x 66 x 29.5	150	221	39.50	\$1575	\$461
A3060S4L	29.69 x 60 x 29.5	150	211	36.25	\$1428	\$429
A3048S4L	29.69 x 48 x 29.5	125	191	29.50	\$1259	\$364
A2448S4L	24 x 48 x 29.5	125	164	24.25	\$1259	\$237

Standard with full to floor box/box/file pedestal on the **left**. One pencil tray. Lower box drawer and file drawer lock. Full to the floor pedestal configurations can be switched for a **15% upcharge**.

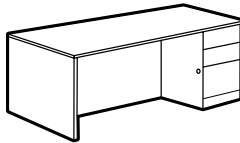

Full to Floor Single Pedestal Desk - RIGHT

A3672S4R	36 x 72 x 29.5	150	261	52.50	\$1624	\$492
A3072S4R	29.69 x 72 x 29.5	150	232	43.75	\$1585	\$492
A3066S4R	29.69 x 66 x 29.5	150	221	39.75	\$1575	\$461
A3060S4R	29.69 x 60 x 29.5	150	211	36.25	\$1428	\$429
A3048S4R	29.69 x 48 x 29.5	125	191	29.50	\$1259	\$364
A2448S4R	24 x 48 x 29.5	125	164	24.25	\$1259	\$237

Standard with full to floor box/box/file pedestal on the **right**. One pencil tray. Lower box drawer and file drawer lock. Full to the floor pedestal configurations can be switched for a **15% upcharge**.

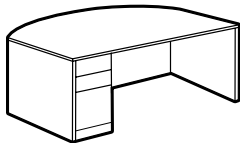

Full to Floor Single Pedestal Bow Top Desk - LEFT

A3672S4LB 32-36 x 72 x 29.5 150 247 52.50 \$1936 \$492

Standard with box/box/file pedestal on **left** and bow top. One pencil tray. Lower box drawer and file drawer lock. One pencil tray. Full to the floor pedestal configurations can be switched for a **15% upcharge**.

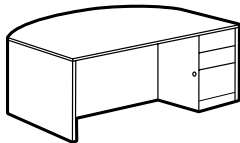

Full to Floor Single Pedestal Bow Top Desk - RIGHT

A3672S4RB 32-36 x 72 x 29.5 150 247 52.50 \$1936 \$492

Standard with box/box/file pedestal on **right** and bow top. One pencil tray. Lower box drawer and file drawer lock. One pencil tray. Full to the floor pedestal configurations can be switched for a **15% upcharge**.

Required Specifications

Top finish
Base finish

Optional Specifications

Key #
Grommet/power block cut-out
HP laminate
Modesty panel

Accessories

Power block
Keyboard tray
Pencil tray

A ADAPTABILITIES®

RETURNS

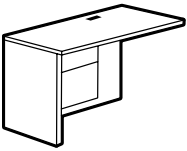

Flush Return - LEFT

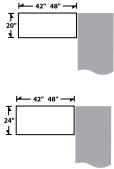

MODEL#	DIMENSIONS D x W x H	FREIGHT CLASS	WT/LBS.	CUBIC FT.	LIST PRICE	HP ADD
A2448FL	24 x 48 x 29.5	150	141	24	\$1020	\$252
A2442FL	24 x 42 x 29.5	125	131	21.25	\$999	\$210
A2048FL	20 x 48 x 29.5	125	128	20.25	\$959	\$210
A2042FL	20 x 42 x 29.5	125	119	18	\$940	\$210

Standard with box/file drawer pedestal. One pencil tray. Pedestal locks. Grommet in worksurface. Pedestal is on the **left**.

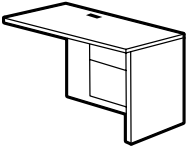

Flush Return - RIGHT

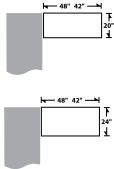

A2448FR	24 x 48 x 29.5	150	141	24	\$1020	\$252
A2442FR	24 x 42 x 29.5	125	131	21.25	\$999	\$210
A2048FR	20 x 48 x 29.5	125	128	20.25	\$959	\$210
A2042FR	20 x 42 x 29.5	125	119	18	\$940	\$210

Standard with box/file drawer pedestal. One pencil tray. Pedestal locks. Grommet in worksurface. Pedestal is on the **right**.

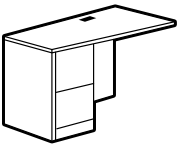

Full to Floor Flush Return - LEFT

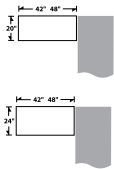

A2448L4	24 x 48 x 29.5	125	156	24.25	\$1247	\$252
A2442L4	24 x 42 x 29.5	125	146	21.50	\$1229	\$210
A2048L4	20 x 48 x 29.5	125	142	20.50	\$1188	\$210
A2042L4	20 x 42 x 29.5	125	133	18	\$1170	\$210

Standard with file/file drawer pedestal. One pencil tray. Pedestal locks. Grommet in worksurface. Pedestal is on the **left**. Full to the floor pedestal configurations can be switched for a **15% upcharge**.

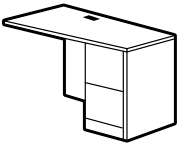

Full to Floor Flush Return - RIGHT

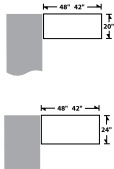

A2448R4	24 x 48 x 29.5	125	156	24.25	\$1247	\$252
A2442R4	24 x 42 x 29.5	125	146	21.50	\$1229	\$210
A2048R4	20 x 48 x 29.5	125	142	20.50	\$1188	\$210
A2042R4	20 x 42 x 29.5	125	133	18	\$1170	\$210

Standard with file/file drawer pedestal. One pencil tray. Pedestal locks. Grommet in worksurface. Pedestal is on the **right**. Full to the floor pedestal configurations can be switched for a **15% upcharge**.

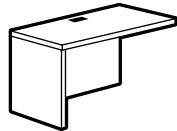

Flush Return - LEFT

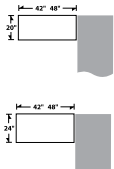

A2448EL	24 x 48 x 29.5	70	92	4.30	\$739	\$252
A2442EL	24 x 42 x 29.5	70	82	3.80	\$715	\$210
A2048EL	20 x 48 x 29.5	70	84	4.30	\$675	\$210
A2042EL	20 x 42 x 29.5	70	75	3.80	\$658	\$210

Return has no pedestal. Grommet in worksurface. Shipped RTA (ready to assemble).

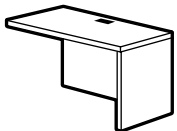

Flush Return - RIGHT

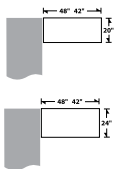

A2448ER	24 x 48 x 29.5	70	92	4.30	\$739	\$252
A2442ER	24 x 42 x 29.5	70	82	3.80	\$715	\$210
A2048ER	20 x 48 x 29.5	70	84	4.30	\$675	\$210
A2042ER	20 x 42 x 29.5	70	75	3.80	\$658	\$210

Return has no pedestal. Grommet in worksurface. Shipped RTA (ready to assemble).

Required Specifications

Top finish
Base finish

Optional Specifications

Key #*
Grommet/power block cut-out
HP laminate

Accessories

Power block
Keyboard tray
Pencil tray

RETURNS

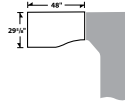
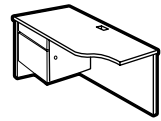

Space Saver Return - LEFT

MODEL#	DIMENSIONS	FREIGHT CLASS	WT/LBS.	CUBIC FT.	LIST PRICE	HP ADD
A3048FSL	29.69 x 48 x 29.5	150	148	29	\$1082	\$364

Standard with box/file pedestal on the **left**, grommet in worksurface. One pencil tray. Pedestal locks. Connects to 24"D 5-sided corner unit and 2466/2472 NFL or NNL extended corner unit.

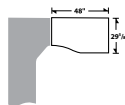
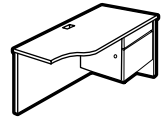

Space Saver Return - RIGHT

A3048FSR	29.69 x 48 x 29.5	150	148	29	\$1082	\$364
----------	-------------------	-----	-----	----	---------------	--------------

Standard with box/file pedestal on the **right**, grommet in worksurface. One pencil tray. Pedestal locks. Connects to 24"D 5-sided corner unit and 2466/2472 FNR or NNR extended corner unit.

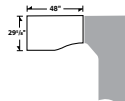
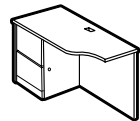

Space Saver Return - LEFT

A3048P4L	29.69 x 48 x 29.5	150	170	29	\$1309	\$364
----------	-------------------	-----	-----	----	---------------	--------------

Standard with file/file pedestal on the **left**, grommet in worksurface. One pencil tray. Pedestal locks. Connects to 24"D 5-sided corner unit and 2466/2472 NFL or NNL extended corner unit. Full to the floor pedestal configurations can be switched for a **15% upcharge**.

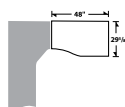
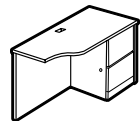

Space Saver Return - RIGHT

A3048P4R	29.69 x 48 x 29.5	150	170	29	\$1309	\$364
----------	-------------------	-----	-----	----	---------------	--------------

Standard with file/file pedestal on the **right**, grommet in worksurface. One pencil tray. Pedestal locks. Connects to 24"D 5-sided corner unit and 2466/2472 FNR or NNR extended corner unit. Full to the floor pedestal configurations can be switched for a **15% upcharge**.

FLUSH BRIDGE

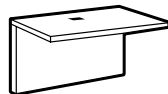

Flush Bridge*

MODEL#	DIMENSIONS	FREIGHT CLASS	WT/LBS.	CUBIC FT.	LIST PRICE	HP ADD
A2448FB	24 x 48 x 29.5	70	75	4.30	\$556	\$252
A2442FB	24 x 42 x 29.5	70	65	3.80	\$534	\$210
A2436FB	24 x 36 x 29.5	70	58	3.30	\$534	\$159
A2048FB	20 x 48 x 29.5	70	71	4.30	\$534	\$210
A2042FB	20 x 42 x 29.5	70	54	3.30	\$512	\$210
A2036FB	20 x 36 x 29.5	70	54	3.30	\$512	\$108

Top surface, back panel and hardware to connect two units. Grommet in worksurface. Shipped RTA (ready to assemble).

CREDENZAS

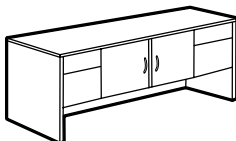

Center Storage Credenza

MODEL#	DIMENSIONS	FREIGHT CLASS	WT/LBS.	CUBIC FT.	LIST PRICE	HP ADD
A2072C	20 x 72 x 29.5	100	243	30	\$2010	\$329

Standard with box/file pedestals on both sides and self-closing hinged center doors covering one adjustable shelf. Pedestals and doors lock. One pencil tray.

Required Specifications

Top finish
Base finish
Handles**

Optional Specifications

Key #
Additional grommet position (not A2072C)
HP laminate
Power block cut-out (not A2072C)

Accessories

Power block
Keyboard tray*
Pencil tray*

A ADAPTABILITIES®

CREDENZAS

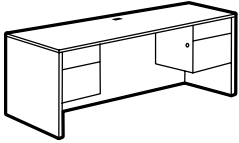

Kneespace Credenza

MODEL#	DIMENSIONS D x W x H	FREIGHT CLASS	WT/LBS.	CUBIC FT.	LIST PRICE	HP ADD
A2472CK	24 x 72 x 29.5	125	234	35.75	\$1682	\$344
A2466CK	24 x 66 x 29.5	125	225	32.75	\$1632	\$344
A2072CK	20 x 72 x 29.5	125	212	30.25	\$1536	\$329
A2066CK	20 x 66 x 29.5	125	204	27.75	\$1513	\$317
A2060CK	20 x 60 x 29.5	125	199	25.25	\$1475	\$290

Standard with box/file pedestals on both sides. Center is open. Pedestals lock. One pencil tray. Grommet in worksurface.

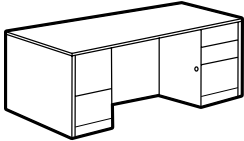

Full to Floor Kneespace Credenza

A2472D4	24 x 72 x 29.5	125	261	35.50	\$2131	\$344
A2466D4	24 x 66 x 29.5	125	252	33	\$2086	\$344
A2072D4	20 x 72 x 29.5	125	236	30	\$1991	\$329
A2066D4	20 x 66 x 29.5	100	228	27.75	\$1971	\$317
A2060D4	20 x 60 x 29.5	100	220	25.25	\$1961	\$290

Standard with full to floor box/box/file in right pedestal and file/file on left pedestal. Pedestals lock on box/box/file pedestals, lower box drawer and file drawer lock. One pencil tray. Grommet in worksurface.

- Full to the floor pedestal configurations can be switched for a **15% upcharge**.

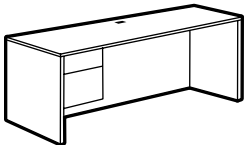

Single Pedestal Credenza - LEFT

A2472CSL	24 x 72 x 29.5	150	190	35.75	\$1425	\$344
A2466CSL	24 x 66 x 29.5	150	181	32.75	\$1376	\$344
A2072CSL	20 x 72 x 29.5	150	172	30.25	\$1285	\$329
A2066CSL	20 x 66 x 29.5	150	163	27.75	\$1264	\$317
A2060CSL	20 x 60 x 29.5	125	155	25.25	\$1222	\$290

Standard with box/file pedestal. Pedestal locks. One pencil tray. Pedestal is on the **left**. Grommet in worksurface.

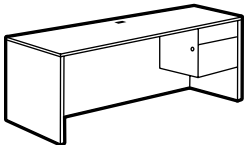

Single Pedestal Credenza - RIGHT

A2472CSR	24 x 72 x 29.5	150	190	35.75	\$1425	\$344
A2466CSR	24 x 66 x 29.5	150	181	32.75	\$1376	\$344
A2072CSR	20 x 72 x 29.5	150	171	30	\$1285	\$329
A2066CSR	20 x 66 x 29.5	150	163	27.75	\$1264	\$317
A2060CSR	20 x 60 x 29.5	125	155	25.25	\$1222	\$290

Standard with box/file pedestal. Pedestal locks. One pencil tray. Pedestal is on the **right**. Grommet in worksurface.

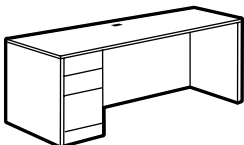

Full to Floor Single Pedestal Credenza - LEFT

A2472S4L	24 x 72 x 29.5	150	205	35.50	\$1624	\$344
A2466S4L	24 x 66 x 29.5	150	196	33	\$1575	\$344
A2072S4L	20 x 72 x 29.5	125	187	30	\$1428	\$329
A2066S4L	20 x 66 x 29.5	125	177	27.75	\$1403	\$329
A2060S4L	20 x 60 x 29.5	125	168	25.25	\$1368	\$290

Standard with full to floor box/box/file pedestal on the **left**. Lower box drawer and file drawer lock. Grommet in worksurface. One pencil tray.

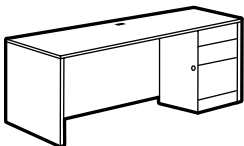

Full to Floor Single Pedestal Credenza - RIGHT

A2472S4R	24 x 72 x 29.5	150	205	35.50	\$1624	\$344
A2466S4R	24 x 66 x 29.5	150	196	33	\$1575	\$344
A2072S4R	20 x 72 x 29.5	125	187	30	\$1428	\$329
A2066S4R	20 x 66 x 29.5	125	177	27.75	\$1403	\$329
A2060S4R	20 x 60 x 29.5	125	168	25.25	\$1368	\$290

Standard with full to floor box/box/file pedestal on the **right**. Lower box drawer and file drawer lock. Grommet in worksurface. One pencil tray.

Required Specifications

Top finish
Base finish

Optional Specifications

Key #
Grommet/power block cut-out
HP laminate

Accessories

Power block
Keyboard tray
Pencil tray

CREDENZAS

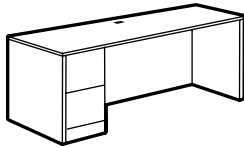

Full to Floor Single Pedestal Credenza - LEFT*

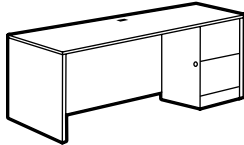

Full to Floor Single Pedestal Credenza - RIGHT*

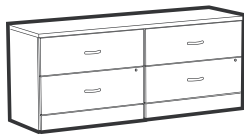

Lateral File Credenza

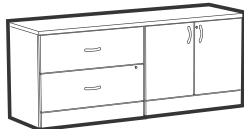

Lateral File/Storage Cabinet Credenza



Kneespace Lateral File Credenza - LEFT*



Kneespace Lateral File Credenza - RIGHT*

MODEL#	DIMENSIONS	FREIGHT CLASS	WT./LBS.	CUBIC FT.	LIST PRICE	HP ADD
--------	------------	---------------	----------	-----------	------------	--------

D x W x H

A2472S2L	24 x 72 x 29.5	150	205	35.50	\$1624	\$344
A2466S2L	24 x 66 x 29.5	150	196	33	\$1575	\$344
A2072S2L	20 x 72 x 29.5	125	187	30	\$1428	\$329
A2066S2L	20 x 66 x 29.5	125	177	27.75	\$1403	\$329
A2060S2L	20 x 60 x 29.5	125	168	25.25	\$1368	\$290

Standard with full to floor file/file pedestal on the **left**. Pedestal Locks. Grommet in worksurface.

A2472S2R	24 x 72 x 29.5	150	205	35.50	\$1624	\$344
A2466S2R	24 x 66 x 29.5	150	196	33	\$1575	\$344
A2072S2R	20 x 72 x 29.5	125	187	30	\$1428	\$329
A2066S2R	20 x 66 x 29.5	125	177	27.75	\$1403	\$329
A2060S2R	20 x 60 x 29.5	125	168	25.25	\$1368	\$290

Standard with full to floor file/file pedestal on the **right**. Pedestal locks. Grommet in worksurface.

A2472LF2	24 x 72 x 29.5	100	322	35.75	\$2455	\$344
A2072LF2	20 x 72 x 29.5	100	296	30.25	\$2406	\$329

Two 2-drawer lateral files side-by-side. Locking drawers, keyed alike. File bars included for side-to-side and front-to-back letter/legal filing capability. Anti-lock tilt suspension.

- Black handles are standard. Silver is available at no charge, please specify as **SI**.
- *File drawer construction is for accommodating hanging files NOT for stacking materials on the drawer bottom.*

A2472LS	24 x 72 x 29.5	100	297	35.75	\$2198	\$344
A2072LS	20 x 72 x 29.5	100	267	30.25	\$2146	\$329

One 2-drawer lateral file and one storage cabinet. Locking doors/drawers, keyed alike. Storage cabinet includes one adjustable shelf. File bars included for side-to-side and front-to-back letter/legal filing capability. Anti-lock tilt suspension.

- Black handles are standard. Silver is available at no charge, please specify as **SI**.
- *File drawer construction is for accommodating hanging files NOT for stacking materials on the drawer bottom.*

A2472LKL	24 x 72 x 29.5	125	239	35.75	\$1931	\$344
A2072LKL	20 x 72 x 29.5	125	216	30.25	\$1882	\$329

One 2-drawer lateral file on the **left**. Locking drawers. File bars included for side-to-side and front-to-back letter/legal filing capability. Anti-lock tilt suspension. Grommet in worksurface.

- Black handles are standard. Silver is available at no charge, please specify as **SI**.
- *File drawer construction is for accommodating hanging files NOT for stacking materials on the drawer bottom.*

A2472LKR	24 x 72 x 29.5	125	239	35.75	\$1931	\$344
A2072LKR	20 x 72 x 29.5	125	216	30.25	\$1882	\$329

One 2-drawer lateral file on the **right**. Locking drawers. File bars included for side-to-side and front-to-back letter/legal filing capability. Anti-lock tilt suspension. Grommet in worksurface.

- Black handles are standard. Silver is available at no charge, please specify as **SI**.
- *File drawer construction is for accommodating hanging files NOT for stacking materials on the drawer bottom.*

Required Specifications

Top finish
Base finish
Handles (not A2xxxS2L/A2xxxS2R)

Optional Specifications

Key #
Additional grommet
HP laminate
Power block cut-out*

Accessories

Power block*
Keyboard tray*
Pencil tray*

A ADAPTABILITIES®

CREDENZAS

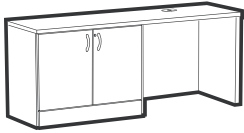

Kneespace Storage Cabinet Credenza - LEFT*

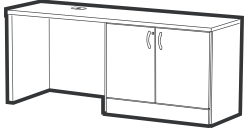

Kneespace Storage Cabinet Credenza - RIGHT*

MODEL#	DIMENSIONS	FREIGHT CLASS	WT/LBS.	CUBIC FT.	LIST PRICE	HP ADD
--------	------------	---------------	---------	-----------	------------	--------

D x W x H

A2472SKL	24 x 72 x 29.5	125	218	35.75	\$1525	\$344
A2072SKL	20 x 72 x 29.5	125	188	30.25	\$1474	\$329

One storage cabinet on the **left**. Locking doors. Storage cabinet has one adjustable shelf. Grommet in worksurface.

- Black handles are standard. Silver is available at no charge, please specify as **SI**.

A2472SKR	24 x 72 x 29.5	125	218	35.75	\$1525	\$344
A2072SKR	20 x 72 x 29.5	125	188	30.25	\$1474	\$329

One storage cabinet on the **right**. Locking doors. Storage cabinet has one adjustable shelf. Grommet in worksurface.

- Black handles are standard. Silver is available at no charge, please specify as **SI**.

5-SIDED CORNERS

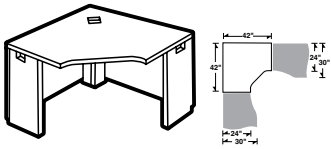

5-Sided Corner

MODEL#	DIMENSIONS	FREIGHT CLASS	WT/LBS.	CUBIC FT.	LIST PRICE	HP ADD
--------	------------	---------------	---------	-----------	------------	--------

A42245C	42 x 42 x 29.5	70	113	5.75	\$954	\$461
---------	----------------	----	-----	------	--------------	--------------

Connects to **30" D** space saver connectable surfaces, **24" D** connectables, returns and bridge. Grommet in worksurface.

Narrow end panels on left and right. Predrilled to accept 22" keyboard trays. **Will not accept keyboard trays wider than 22"**. Shipped RTA (ready to assemble). *Not Freestanding*.

- **Modesty Panel is 1" off of ground.**
- Full End Panel(s) are available - add **15% upcharge**

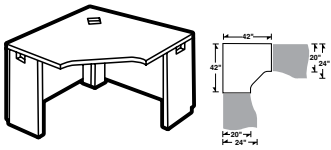

5-Sided Corner

A42205C	42 x 42 x 29.5	70	110	5.75	\$926	\$461
---------	----------------	----	-----	------	--------------	--------------

Connects to **24" D** space saver connectable surfaces, **20" D** returns, lateral files, storage/lateral file credenzas, credenzas, bridges and end shelves. Grommet in worksurface. Narrow end panels on left and right. Predrilled to accept 22-28" keyboard trays. **Will not accept keyboard trays wider than 28"**. Shipped RTA (ready to assemble). *Not freestanding*.

Will not accept keyboard trays wider than 28". Shipped RTA (ready to assemble). *Not freestanding*.

- **Modesty Panel is 1" off of ground.**
- Full End Panel(s) are available - add **15% upcharge**

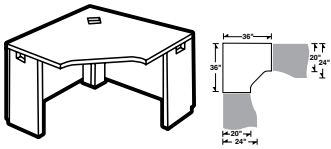

5-Sided Corner

A36205C	36 x 36 x 29.5	70	94	4.80	\$820	\$297
---------	----------------	----	----	------	--------------	--------------

Connects to **24" D** space saver connectable surfaces, **20" D** returns, lateral files, storage/lateral file credenzas, credenzas, bridges and end shelves. Grommet in worksurface. Narrow end panels on left and right. Predrilled to accept 22" keyboard trays. **Will not accept keyboard trays wider than 22"**. Shipped RTA (ready to assemble). *Not freestanding*.

Will not accept keyboard trays wider than 22". Shipped RTA (ready to assemble). *Not freestanding*.

- **Modesty Panel is 1" off of ground.**
- Full End Panel(s) are available - add **15% upcharge**

Required Specifications

Top finish
Base finish
Handles*

Optional Specifications

Key #
Additional grommet position
HP laminate
Power block cut-out

Accessories

Power block
Keyboard tray
Pencil tray

LEFT EXTENDED CORNERS

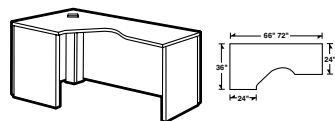

Left Extended Corner - Freestanding

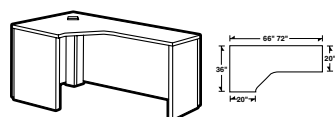

Left Extended Corner

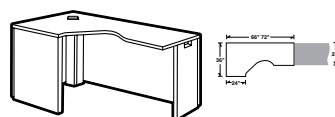

Left Extended Corner

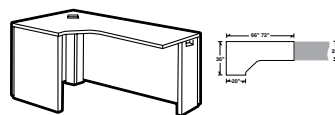

Left Extended Corner

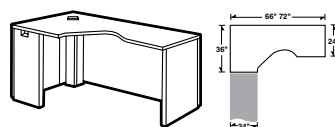

Left Extended Corner

MODEL#	DIMENSIONS	FREIGHT CLASS	WT/LBS.	CUBIC FT.	LIST PRICE	HP ADD
--------	------------	---------------	---------	-----------	------------	--------

D x W x H

A2472FFL	24-36 x 72 x 29.5	70	157	7	\$1225	\$492
A2466FFL	24-36 x 66 x 29.5	70	151	7	\$1225	\$492

Extended worksurface on right. **Full end panels on left and right. Cannot be connected on left or right, due to full end panel.** Corner has one grommet. Predrilled to accept 22" keyboard trays. **Will not accept keyboard trays wider than 22".** Shipped RTA (ready to assemble).

- Modesty Panel is 1" off of ground.
- **A2466FFL** cannot accept pedestals.

A2072FFL	20-36 x 72 x 29.5	70	147	7	\$1172	\$473
A2066FFL	20-36 x 66 x 29.5	70	141	7	\$1172	\$473

Extended worksurface on right. **Full end panels on left and right. Cannot be connected on left or right, due to full end panel.** Corner has one grommet. Predrilled to accept 22" keyboard trays. **Will not accept keyboard trays wider than 22".** Shipped RTA (ready to assemble).

- Modesty Panel is 1" off of ground.

A2472FNL	24-36 x 72 x 29.5	70	149	7	\$1186	\$492
A2466FNL	24-36 x 66 x 29.5	70	142	7	\$1186	\$492

Extended worksurface on right. **Narrow end panel on right. Full end panel on left.** Connects to 30"D space saver connectables, 24"D returns or 24"D connectable tables. **Full end panel cannot be connected.** Corner has one grommet. Predrilled to accept 22" keyboard trays. **Will not accept keyboard trays wider than 22".** Shipped RTA (ready to assemble).

- Modesty Panel is 1" off of ground.
- **A2466FNL** cannot accept pedestals.

A2072FNL	20-36 x 72 x 29.5	70	141	7	\$1129	\$473
A2066FNL	20-36 x 66 x 29.5	70	135	7	\$1129	\$473

Extended worksurface on right. **Narrow end panel on right. Full end panel on left.** Connects to 24"D space saver connectables, 20"D returns or 20"D connectable tables. **Full end panel cannot be connected.** Corner has one grommet. Predrilled to accept 22" keyboard trays. **Will not accept keyboard trays wider than 22".** Shipped RTA (ready to assemble).

- Modesty Panel is 1" off of ground.

A2472NFL	24-36 x 72 x 29.5	70	149	7	\$1186	\$492
A2466NFL	24-36 x 66 x 29.5	70	142	7	\$1186	\$492

Extended worksurface on right. **Narrow end panel on left. Full end panel on right.** Connects to 30"D space saver connectables, 24"D returns or 24"D connectable tables. **Full end panel cannot be connected.** Corner has one grommet. Predrilled to accept 22" keyboard trays. **Will not accept keyboard trays wider than 22".** Shipped RTA (ready to assemble).

- Modesty Panel is 1" off of ground.
- **A2466NFL** cannot accept pedestals.

Required Specifications

Top finish
Base finish

Optional Specifications

Additional grommet position
HP laminate
Power block cut-out

Accessories

Power block
Keyboard tray
Pencil tray

LEFT EXTENDED CORNERS

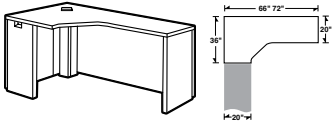

Left Extended Corner

MODEL#	DIMENSIONS	FREIGHT CLASS	WT/LBS.	CUBIC FT.	LIST PRICE	HP ADD
	D x W x H					
A2072NFL	20-36 x 72 x 29.5	70	141	7	\$1129	\$492
A2066NFL	20-36 x 66 x 29.5	70	135	7	\$1129	\$473

Extended worksurface on right. **Narrow end panel on left. Full end panel on right.** Connects to 24"D space saver connectables and 20"D returns. **Full end panel cannot be connected.** Corner has one grommet. Predrilled to accept 22" keyboard trays. **Will not accept keyboard trays wider than 22"**. Shipped RTA (ready to assemble).

- Modesty Panel is 1" off of ground.

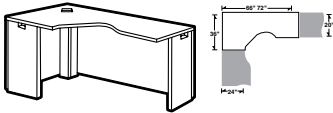

Left Extended Corner

A2472NNL	24-36 x 72 x 29.5	70	140	7	\$1147	\$492
A2466NNL	24-36 x 66 x 29.5	70	134	7	\$1147	\$492

Extended worksurface on right. **Narrow end panels on left and right.** Connects to 30"D space saver connectables, 24"D returns and 24"D connectable tables on either end. Corner has one grommet. Predrilled to accept 22" keyboard trays. **Will not accept keyboard trays wider than 22"**. Shipped RTA (ready to assemble).

- Modesty Panel is 1" off of ground.
- **A2466NNL** cannot accept pedestals.

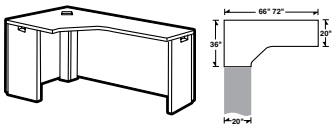

Left Extended Corner

A2072NNL	20-36 x 72 x 29.5	70	136	7	\$1115	\$492
A2066NNL	20-36 x 66 x 29.5	70	130	7	\$1115	\$473

Extended worksurface on right. **Narrow end panels on left and right.** Connects to 24"D space saver connectables and 20"D returns or bridge on either end. Corner has one grommet. Predrilled to accept 22" keyboard trays. **Will not accept keyboard trays wider than 22"**. Shipped RTA (ready to assemble).

- Modesty Panel is 1" off of ground.

RIGHT EXTENDED CORNERS

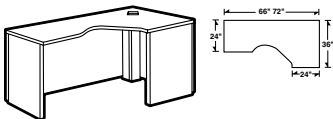

Right Extended Corner - Freestanding

MODEL#	DIMENSIONS	FREIGHT CLASS	WT/LBS.	CUBIC FT.	LIST PRICE	HP ADD
A2472FFR	24-36 x 72 x 29.5	70	157	7	\$1225	\$492
A2466FFR	24-36 x 66 x 29.5	70	151	7	\$1225	\$492

Extended worksurface on left. **Full end panels on left and right. Cannot be connected on left or right, due to full end panel.** Corner has one grommet. Predrilled to accept 22" keyboard trays. **Will not accept keyboard trays wider than 22"**. Shipped RTA (ready to assemble).

- Modesty Panel is 1" off of ground.
- **A2466FFR** cannot accept pedestals.

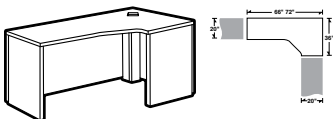

Right Extended Corner

A2072FFR	20-36 x 72 x 29.5	70	147	7	\$1172	\$473
A2066FFR	20-36 x 66 x 29.5	70	141	7	\$1172	\$473

Extended worksurface on left. **Full end panels on left and right. Cannot be connected on left or right, due to full end panel.** Corner has one grommet. Predrilled to accept 22" keyboard trays. **Will not accept keyboard trays wider than 22"**. Shipped RTA (ready to assemble).

- Modesty Panel is 1" off of ground.

Required Specifications

Top finish
Base finish

Optional Specifications

Additional grommet position
HP laminate
Power block cut-out

Accessories

Power block
Keyboard tray
Pencil tray

RIGHT EXTENDED CORNERS

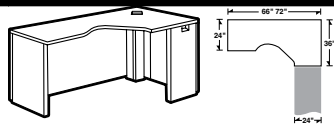

Right Extended Corner

MODEL#	DIMENSIONS	FREIGHT CLASS	WT./LBS.	CUBIC FT.	LIST PRICE	HP ADD
D x W x H						
A2472FNR	24-36 x 72 x 29.5	70	149	7	\$1186	\$507
A2466FNR	24-36 x 66 x 29.5	70	142	7	\$1186	\$492

Extended worksurface on left. **Narrow end panel on right. Full end panel on left.** Connects to 30"D space saver connectables, 24"D returns or 24"D connectable tables. **Full end panel cannot be connected.** Corner has one grommet. Predrilled to accept 22" keyboard trays. **Will not accept keyboard trays wider than 22"**. Shipped RTA (ready to assemble).

- **Modesty Panel is 1" off of ground.**
- **A2466FNR cannot accept pedestals.**

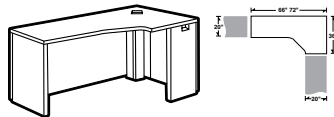

Right Extended Corner

A2072FNR	20-36 x 72 x 29.5	70	141	7	\$1129	\$473
A2066FNR	20-36 x 66 x 29.5	70	135	7	\$1129	\$473

Extended worksurface on left. **Narrow end panel on right. Full end panel on left.** Connects to 24"D space saver connectables, 20"D returns or 20"D connectable tables. **Full end panel cannot be connected.** Corner has one grommet. Predrilled to accept 22" keyboard trays. **Will not accept keyboard trays wider than 22"**. Shipped RTA (ready to assemble).

- **Modesty Panel is 1" off of ground.**

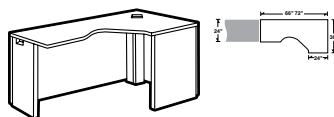

Right Extended Corner

A2472NFR	24-36 x 72 x 29.5	70	149	7	\$1186	\$492
A2466NFR	24-36 x 66 x 29.5	70	142	7	\$1186	\$492

Extended worksurface on left. **Narrow end panel on left. Full end panel on right.** Connects to 30"D space saver connectables, 24"D returns or 24"D connectable tables. **Full end panel cannot be connected.** Corner has one grommet. Predrilled to accept 22" keyboard trays. **Will not accept keyboard trays wider than 22"**. Shipped RTA (ready to assemble).

- **Modesty Panel is 1" off of ground.**
- **A2466NFR cannot accept pedestals.**

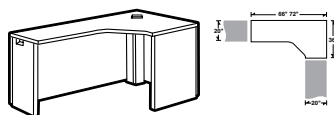

Right Extended Corner

A2072NFR	20-36 x 72 x 29.5	70	141	7	\$1129	\$492
A2066NFR	20-36 x 66 x 29.5	70	135	7	\$1129	\$473

Extended worksurface on left. **Narrow end panel on left. Full end panel on right.** Connects to 24"D space saver connectables and 20"D returns. **Full end panel cannot be connected.** Corner has one grommet. Predrilled to accept 22" keyboard trays. **Will not accept keyboard trays wider than 22"**. Shipped RTA (ready to assemble).

- **Modesty Panel is 1" off of ground.**

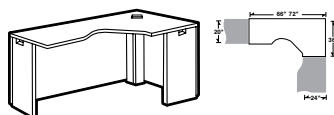

Right Extended Corner

A2472NNR	24-36 x 72 x 29.5	70	140	7	\$1147	\$492
A2466NNR	24-36 x 66 x 29.5	70	133	7	\$1147	\$492

Extended worksurface on left. **Narrow end panels on left and right.** Connects to 30"D space saver connectables, 24"D returns and 24"D connectable tables on either end. Corner has one grommet. Predrilled to accept 22" keyboard trays. **Will not accept keyboard trays wider than 22"**. Shipped RTA (ready to assemble).

- **Modesty Panel is 1" off of ground.**
- **A2466NNR cannot accept pedestals.**

Required Specifications

Top finish
Base finish

Optional Specifications

Additional grommet position
HP laminate
Power block cut-out

Accessories

Power block
Keyboard tray
Pencil tray

RIGHT EXTENDED CORNERS

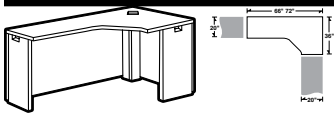

Right Extended Corner

MODEL#	DIMENSIONS	FREIGHT CLASS	WT/LBS.	CUBIC FT.	LIST PRICE	HP ADD
--------	------------	---------------	---------	-----------	------------	--------

D x W x H						
A2072NNR	20-36 x 72 x 29.5	70	136	7	\$1115	\$492
A2066NNR	20-36 x 66 x 29.5	70	130	7	\$1115	\$473

Extended worksurface on left. **Narrow end panels on left and right.** Connects to 24"D space saver connectables and 20"D returns or bridge on either end. Corner has one grommet. Predrilled to accept 22" keyboard trays. **Will not accept keyboard trays wider than 22"**. Shipped RTA (ready to assemble).

- Modesty Panel is 1" off of ground.

FREESTANDING TABLES

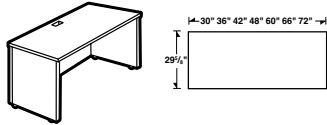

30" Deep Freestanding Table

MODEL#	DIMENSIONS	FREIGHT CLASS	WT/LBS.	CUBIC FT.	LIST PRICE	HP ADD
--------	------------	---------------	---------	-----------	------------	--------

A3072T	29.69 x 72 x 29.5	65	148	6	\$940	\$461
A3066T	29.69 x 66 x 29.5	65	140	6	\$940	\$461
A3060T	29.69 x 60 x 29.5	65	131	5.25	\$859	\$429
A3048T	29.69 x 48 x 29.5	70	116	5.25	\$777	\$364
A3042T	29.69 x 42 x 29.5	70	108	5.25	\$777	\$329
A3036T	29.69 x 36 x 29.5	65	97	4.30	\$698	\$297
A3030T	29.69 x 30 x 29.5	65	88	3.60	\$658	\$264

Two full end panels. Cannot be connected on left or right side. Grommet in worksurface. Shipped RTA (ready to assemble).

- Modesty Panel is 1" off of ground

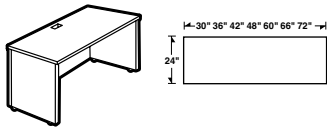

24" Deep Freestanding Table

A2472T	24 x 72 x 29.5	70	130	6	\$859	\$344
A2466T	24 x 66 x 29.5	70	123	6	\$859	\$344
A2460T	24 x 60 x 29.5	70	114	5.25	\$777	\$317
A2448T	24 x 48 x 29.5	65	99	4.30	\$698	\$252
A2442T	24 x 42 x 29.5	70	92	4.30	\$698	\$210
A2436T	24 x 36 x 29.5	70	84	4.20	\$617	\$159
A2430T	24 x 30 x 29.5	70	76	3.60	\$576	\$159

Two full end panels. Cannot be connected on left or right side. Grommet in worksurface. Shipped RTA (ready to assemble).

- Modesty Panel is 1" off of ground

CONNECTABLE TABLES - LEFT

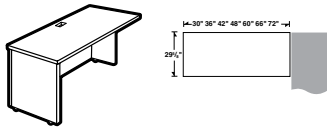

30" Deep Connectable Table - LEFT

MODEL#	DIMENSIONS	FREIGHT CLASS	WT/LBS.	CUBIC FT.	LIST PRICE	HP ADD
--------	------------	---------------	---------	-----------	------------	--------

A3072L	29.69 x 72 x 29.5	65	140	6	\$907	\$461
A3066L	29.69 x 66 x 29.5	70	132	6	\$907	\$461
A3060L	29.69 x 60 x 29.5	65	123	5.25	\$830	\$429
A3048L	29.69 x 48 x 29.5	65	105	4.30	\$747	\$364
A3042L	29.69 x 42 x 29.5	65	98	4.30	\$747	\$329
A3036L	29.69 x 36 x 29.5	70	88	4.20	\$665	\$297
A3030L	29.69 x 30 x 29.5	70	80	3.60	\$626	\$264

Full end panel on left. Right narrow end panel connects to 30"D center/right connectable table, or at 90° angle to a freestanding table; and "D" islands or "P" islands with "T" and "H" bases. Grommet in worksurface. Shipped RTA (ready to assemble).

- Modesty Panel is 1" off of ground.

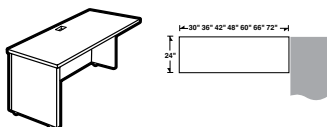

24" Deep Connectable Table - LEFT

A2472L	24 x 72 x 29.5	70	121	6	\$830	\$344
A2466L	24 x 66 x 29.5	70	115	6	\$830	\$344
A2460L	24 x 60 x 29.5	70	106	5.25	\$747	\$317
A2448L	24 x 48 x 29.5	70	90	4.30	\$665	\$252
A2442L	24 x 42 x 29.5	70	82	3.80	\$665	\$210
A2436L	24 x 36 x 29.5	70	74	3.30	\$587	\$159
A2430L	24 x 30 x 29.5	70	68	3.60	\$545	\$159

Full end panel on left. Right narrow end panel connects to 24"D center/right connectable table, or at 90° angle to a freestanding table; 24"D extended corners, 42" 5-sided corners or at the end of a straight run; "D" islands or "P" islands with "T" and "H" bases. Grommet in worksurface. Shipped RTA (ready to assemble).

- Modesty Panel is 1" off of ground.

Required Specifications

Top finish
Base finish

Optional Specifications

Additional grommet position
HP laminate
Power block cut-out

Accessories

Power block
Keyboard tray
Pencil tray

CONNECTABLE TABLES - RIGHT

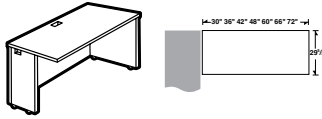

30" Deep Connectable Table - RIGHT

MODEL#	DIMENSIONS	FREIGHT CLASS	WT./LBS.	CUBIC FT.	LIST PRICE	HP ADD
D x W x H						
A3072R	29.69 x 72 x 29.5	65	140	6	\$907	\$461
A3066R	29.69 x 66 x 29.5	70	132	6	\$907	\$461
A3060R	29.69 x 60 x 29.5	65	123	5.25	\$830	\$429
A3048R	29.69 x 48 x 29.5	65	105	4.30	\$747	\$364
A3042R	29.69 x 42 x 29.5	65	98	4.30	\$747	\$329
A3036R	29.69 x 36 x 29.5	70	88	4.30	\$665	\$297
A3030R	29.69 x 30 x 29.5	70	80	3.60	\$626	\$264

Full end panel on **right**. Left narrow end panel connects to 30"D center/left connectable table, or at 90° angle to a freestanding table; "D" islands or "P" islands with "T" and "H" bases. Grommet in worksurface. Shipped RTA (ready to assemble).

- Modesty Panel is 1" off of ground

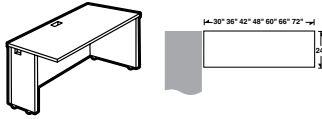

24" Deep Connectable Table - RIGHT

A2472R	24 x 72 x 29.5	70	121	6	\$830	\$355
A2466R	24 x 66 x 29.5	70	115	6	\$830	\$344
A2460R	24 x 60 x 29.5	70	105	5.25	\$747	\$317
A2448R	24 x 48 x 29.5	70	90	4.30	\$665	\$252
A2442R	24 x 42 x 29.5	70	82	3.80	\$665	\$210
A2436R	24 x 36 x 29.5	70	74	3.30	\$587	\$159
A2430R	24 x 30 x 29.5	70	67	3.60	\$545	\$159

Full end panel on **right**. Left narrow end panel connects to 24"D center/left connectable table, or at 90° angle to a freestanding table; 24"D extended corners, 42" 5-sided corners or at the end of a straight run; "D" islands or "P" islands with "T" and "H" bases. Grommet in worksurface. Shipped RTA (ready to assemble).

- Modesty Panel is 1" off of ground

CONNECTABLE TABLES

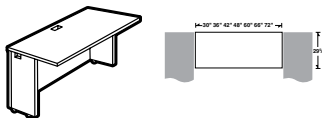

30" Deep Connectable Table

MODEL#	DIMENSIONS	FREIGHT CLASS	WT./LBS.	CUBIC FT.	LIST PRICE	HP ADD
A3072N	29.69 x 72 x 29.5	70	131	6	\$879	\$461
A3066N	29.69 x 66 x 29.5	70	124	6	\$879	\$461
A3060N	29.69 x 60 x 29.5	70	114	5.25	\$795	\$429
A3048N	29.69 x 48 x 29.5	65	97	4.30	\$715	\$364
A3042N	29.69 x 42 x 29.5	65	89	3.80	\$715	\$329
A3036N	29.69 x 36 x 29.5	65	80	3.30	\$635	\$297
A3030N	29.69 x 30 x 29.5	70	71	3.60	\$594	\$264

Narrow end panels on both sides connects to 30"D worksurfaces; "D" islands or "P" islands with "T" and "H" bases; or at 90° angle to freestanding table(s). Grommet in worksurface. Shipped RTA (ready to assemble).

- Modesty Panel is 1" off of ground

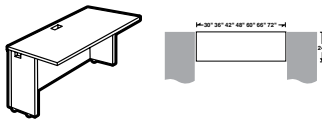

24" Deep Connectable Table

A2472N	24 x 72 x 29.5	70	113	6	\$795	\$344
A2466N	24 x 66 x 29.5	70	105	6	\$795	\$344
A2460N	24 x 60 x 29.5	70	100	4.50	\$715	\$317
A2448N	24 x 48 x 29.5	70	82	4.30	\$635	\$252
A2442N	24 x 42 x 29.5	70	73	3.80	\$635	\$210
A2436N	24 x 36 x 29.5	70	66	3.30	\$556	\$159
A2430N	24 x 30 x 29.5	70	59	3.60	\$512	\$159

Narrow end panels on both sides connects to 24"D worksurfaces; "D" islands or "P" islands with "T" and "H" bases; or at 90° angle to freestanding table(s). Grommet in worksurface. Shipped RTA (ready to assemble).

- Modesty Panel is 1" off of ground

SPACE SAVER CONNECTABLE TABLES - LEFT

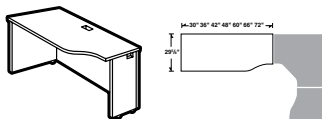

30" Deep Space Saver Connectable Table - LEFT

MODEL#	DIMENSIONS	FREIGHT CLASS	WT./LBS.	CUBIC FT.	LIST PRICE	HP ADD
A3072LK	29.69 x 72 x 29.5	70	133	6	\$917	\$461
A3066LK	29.69 x 66 x 29.5	70	126	6	\$917	\$461
A3060LK	29.69 x 60 x 29.5	70	117	5.25	\$838	\$429
A3048LK	29.69 x 48 x 29.5	65	100	4.30	\$756	\$364
A3042LK	29.69 x 42 x 29.5	65	92	3.80	\$756	\$329
A3036LK	29.69 x 36 x 29.5	70	83	4.30	\$675	\$297
A3030LK	29.69 x 30 x 29.5	70	74	3.60	\$635	\$264

Full end panel on left. Narrow right end panel connects to 24"D 5-sided corner unit. Grommet in worksurface. Shipped RTA (ready to assemble).

- Modesty Panel is 1" off of ground
- Keyboard and pencil trays for use on units 42" and above

Required Specifications

Top finish
Base finish

Optional Specifications

Additional grommet position
HP laminate
Power block cut-out

Accessories

Power block
Keyboard tray
Pencil tray

SPACE SAVER CONNECTABLE TABLES - LEFT

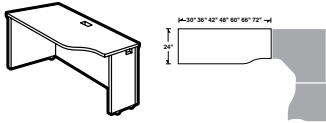

24" Deep Space Saver Connectable Table - LEFT

MODEL#	DIMENSIONS	FREIGHT CLASS	WT/LBS.	CUBIC FT.	LIST PRICE	HP ADD
	D x W x H					
A2472LK	24 x 72 x 29.5	70	120	6	\$838	\$344
A2466LK	24 x 66 x 29.5	70	114	6	\$838	\$344
A2460LK	24 x 60 x 29.5	70	105	5.25	\$756	\$317
A2448LK	24 x 48 x 29.5	70	89	4.30	\$675	\$252
A2442LK	24 x 42 x 29.5	70	81	3.80	\$675	\$210
A2436LK	24 x 36 x 29.5	70	73	3.30	\$594	\$159
A2430LK	24 x 30 x 29.5	70	66	3.60	\$556	\$159

Full end panel on left. Narrow right end panel connects to 20"D 5-sided corner unit. Grommet in worksurface. Shipped RTA (ready to assemble).

- **Modesty Panel is 1" off of ground.**
- Keyboard and pencil trays for use on units 42" and above

SPACE SAVER CONNECTABLE TABLES - RIGHT

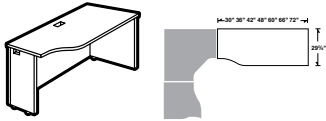

30" Deep Space Saver Connectable Table - RIGHT

MODEL#	DIMENSIONS	FREIGHT CLASS	WT/LBS.	CUBIC FT.	LIST PRICE	HP ADD
A3072RK	29.69 x 72 x 29.5	70	133	6	\$917	\$461
A3066RK	29.69 x 66 x 29.5	70	126	6	\$917	\$461
A3060RK	29.69 x 60 x 29.5	70	117	5.25	\$838	\$429
A3048RK	29.69 x 48 x 29.5	65	100	4.30	\$756	\$364
A3042RK	29.69 x 42 x 29.5	65	91	3.80	\$756	\$329
A3036RK	29.69 x 36 x 29.5	70	83	4.30	\$675	\$297
A3030RK	29.69 x 30 x 29.5	70	74	3.60	\$635	\$264

Full end panel on right. Narrow right end panel connects to 24"D 5-sided corner unit. Grommet in worksurface. Shipped RTA (ready to assemble).

- **Modesty Panel is 1" off of ground**
- Keyboard and pencil trays for use on units 42" and above

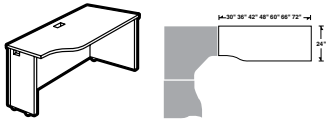

24" Deep Space Saver Connectable Table - RIGHT

A2472RK	24 x 72 x 29.5	70	120	6	\$838	\$344
A2466RK	24 x 66 x 29.5	70	114	6	\$838	\$344
A2460RK	24 x 60 x 29.5	70	105	5.25	\$756	\$317
A2448RK	30 x 48 x 29.5	70	89	4.30	\$675	\$252
A2442RK	24 x 42 x 29.5	70	81	3.80	\$675	\$210
A2436RK	24 x 36 x 29.5	70	73	3.30	\$594	\$159
A2430RK	24 x 30 x 29.5	70	66	3.60	\$556	\$159

Full end panel on right. Narrow right end panel connects to 20"D 5-sided corner unit. Grommet in worksurface. Shipped RTA (ready to assemble).

- **Modesty Panel is 1" off of ground.**
- Keyboard and pencil trays for use on units 42" and above

SPACE SAVER CONNECTABLE TABLES

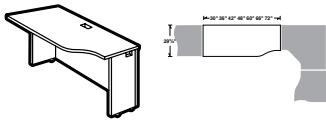

30" Deep Space Saver Connectable Table

MODEL#	DIMENSIONS	FREIGHT CLASS	WT/LBS.	CUBIC FT.	LIST PRICE	HP ADD
A3072LN	29.69 x 72 x 29.5	70	125	6	\$889	\$461
A3066LN	29.69 x 66 x 29.5	70	117	6	\$889	\$461
A3060LN	29.69 x 60 x 29.5	70	108	5.25	\$810	\$429
A3048LN	29.69 x 48 x 29.5	70	91	4.30	\$729	\$364
A3042LN	29.69 x 42 x 29.5	70	83	3.80	\$729	\$329
A3036LN	29.69 x 36 x 29.5	70	74	3.30	\$648	\$297
A3030LN	29.69 x 30 x 29.5	70	66	3.60	\$606	\$264

Narrow end panels on both sides. Connects the **right end only to 24"D 5-sided corner unit.** Left end allows the continuation of additional connectable center or left connectable worksurface. Grommet in worksurface. Shipped RTA (ready to assemble).

- **Modesty Panel is 1" off of ground.**
- Keyboard and pencil trays for use on units 42" and above

Required Specifications

Top finish
Base finish

Optional Specifications

Additional grommet position
HP laminate
Power block cut-out

Accessories

Power block
Keyboard tray
Pencil tray

SPACE SAVER CONNECTABLE TABLES

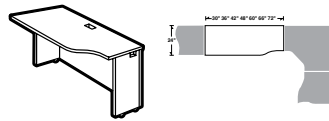

24" Deep Space Saver Connectable Table

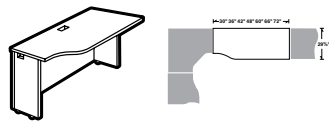

30" Deep Space Saver Connectable Table

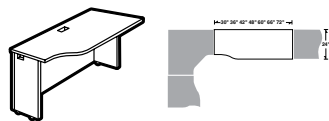

24" Deep Space Saver Connectable Table

MODEL#	DIMENSIONS D x W x H	FREIGHT CLASS	WT/LBS.	CUBIC FT.	LIST PRICE	HP ADD
A2472LN	24 x 72 x 29.5	70	112	6	\$810	\$344
A2466LN	24 x 66 x 29.5	70	105	6	\$810	\$344
A2460LN	24 x 60 x 29.5	70	96	5.25	\$729	\$317
A2448LN	24 x 48 x 29.5	70	81	4.30	\$648	\$252
A2442LN	24 x 42 x 29.5	70	73	3.80	\$648	\$210
A2436LN	24 x 36 x 29.5	70	65	3.30	\$568	\$159
A2430LN	24 x 30 x 29.5	70	58	3.60	\$527	\$159

Narrow end panels on both sides. Connects the **right end only to 20"D 5-sided corner unit**. Left end allows the continuation of additional connectable center or left connectable worksurface. Grommet in worksurface. Shipped RTA (ready to assemble).

- **Modesty Panel is 1" off of ground.**
- *Keyboard and pencil trays for use on units 42" and above*

A3072RN	29.69 x 72 x 29.5	70	125	6	\$889	\$461
A3066RN	29.69 x 66 x 29.5	70	117	6	\$889	\$461
A3060RN	29.69 x 60 x 29.5	70	108	5.25	\$810	\$429
A3048RN	29.69 x 48 x 29.5	70	91	4.30	\$729	\$364
A3042RN	29.69 x 42 x 29.5	70	83	3.80	\$729	\$329
A3036RN	29.69 x 36 x 29.5	70	74	3.30	\$648	\$297
A3030RN	29.69 x 30 x 29.5	70	66	3.60	\$606	\$264

Narrow end panels on both sides. Connects the **left end only to 24"D 5-sided corner unit**. Right end allows the continuation of additional connectable center or right connectable worksurface. Grommet in worksurface. Shipped RTA (ready to assemble).

- **Modesty Panel is 1" off of ground.**
- *Keyboard and pencil trays for use on units 42" and above*

A2472RN	24 x 72 x 29.5	70	112	6	\$810	\$344
A2466RN	24 x 66 x 29.5	70	105	6	\$810	\$344
A2460RN	24 x 60 x 29.5	70	96	5.25	\$729	\$317
A2448RN	24 x 48 x 29.5	70	81	4.30	\$648	\$252
A2442RN	24 x 42 x 29.5	70	72	3.80	\$648	\$210
A2436RN	24 x 36 x 29.5	70	59	3.30	\$568	\$159
A2430RN	24 x 30 x 29.5	85	53	3.60	\$527	\$159

Narrow end panels on both sides. Connects the **left end only to 20"D 5-sided corner unit**. Right end allows the continuation of additional connectable center or right connectable worksurface. Grommet in worksurface. Shipped RTA (ready to assemble).

- **Modesty Panel is 1" off of ground.**
- *Keyboard and pencil trays for use on units 42" and above*

"D" ISLANDS

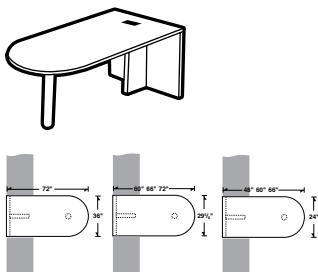

"D" Island - Full End Panel & Post (T-Base)

MODEL#	DIMENSIONS	FREIGHT CLASS	WT/LBS.	CUBIC FT.	LIST PRICE	HP ADD
A3672FI	36 x 72 x 29.5	85	124	8.50	\$999	\$492
A3072FI	29.69 x 72 x 29.5	85	107	7.50	\$970	\$462
A3066FI	29.69 x 66 x 29.5	85	102	7.50	\$917	\$461
A3060FI	29.69 x 60 x 29.5	85	96	6.76	\$869	\$429
A2466FI	24 x 66 x 29.5	85	90	7.50	\$817	\$344
A2460FI	24 x 60 x 29.5	85	84	6.76	\$769	\$317
A2448FI	24 x 48 x 29.5	85	74	5.76	\$715	\$252

Connects to narrow end panel. Attaching hardware included. Not freestanding. Grommet in worksurface. Shipped RTA (ready to assemble).

- Post is shipped in separate carton. Standard in Black (**TBL**); Tungsten is available at no charge, please specify (**TTU**).

Required Specifications

Top finish
Base finish

Optional Specifications

Additional grommet position
HP laminate
Power block cut-out

Accessories

Power block
Keyboard tray
Pencil tray

A ADAPTABILITIES®

"D" ISLANDS

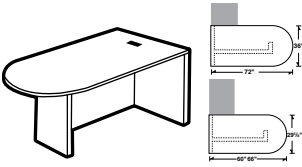

"D" Island LEFT - Full Modesty Panel (H-Base)

MODEL#	DIMENSIONS	FREIGHT CLASS	WT/LBS.	CUBIC FT.	LIST PRICE	HP ADD
	D x W x H					
A3672FIL	36 x 72 x 29.5	70	139	7	\$917	\$492
A3066FIL	29.69 x 66 x 29.5	70	116	6	\$817	\$461
A3060FIL	29.69 x 60 x 29.5	70	106	5.25	\$769	\$429

Connects to the left side of a worksurface. Accommodates all 19" pedestals (freestanding, mobile and hanging pedestals). Grommet in worksurface. Shipped RTA (ready to assemble).

- Modesty Panel is 1" off of ground.

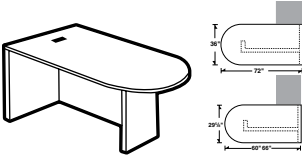

"D" Island RIGHT - Full Modesty Panel (H-Base)

A3672FIR	36 x 72 x 29.5	70	139	7	\$917	\$492
A3066FIR	29.69 x 66 x 29.5	70	116	6	\$817	\$461
A3060FIR	29.69 x 60 x 29.5	70	106	5.25	\$769	\$429

Connects to the right side of a worksurface. Accommodates all 19" pedestals (freestanding, mobile and hanging pedestals). Grommet in worksurface. Shipped RTA (ready to assemble).

- Modesty Panel is 1" off of ground.

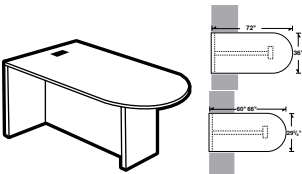

"D" Island Center - Full Modesty Panel (H-Base)

A3672FIC	36 x 72 x 29.5	70	139	7	\$917	\$492
A3066FIC	29.69 x 66 x 29.5	70	116	6	\$817	\$461
A3060FIC	29.69 x 60 x 29.5	70	106	5.25	\$769	\$429

Connects in between two worksurfaces. Will not accommodate pedestals. Grommet in worksurface. Shipped RTA (ready to assemble).

- Modesty Panel is 1" off of ground.

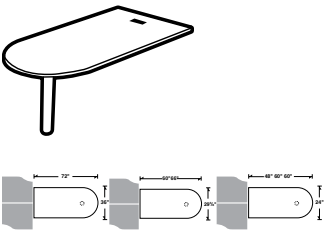

Attachable "D" Island with Post*

A3672I	36 x 72 x 29.5	92.5	88	8.50	\$869	\$492
A3066I	29.69 x 66 x 29.5	100	71	7.50	\$769	\$461
A3060I	29.69 x 60 x 29.5	100	65	6.76	\$715	\$429
A2466I	24 x 66 x 29.5	100	63	7.50	\$665	\$344
A2460I	24 x 60 x 29.5	100	57	6.76	\$617	\$317
A2448I	24 x 48 x 29.5	100	47	5.76	\$568	\$252

Attaches to edge of worksurfaces. Attaching hardware included. Grommet in worksurface. Shipped RTA (ready to assemble).

- Post is shipped in separate carton. Standard in Black (**TBL**); Tungsten is available at no charge, please specify (**TTU**).

EXTENDED CORNER ISLANDS

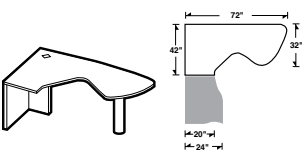

Extended Corner Island - RIGHT*

MODEL#	DIMENSIONS	FREIGHT CLASS	WT/LBS.	CUBIC FT.	LIST PRICE	HP ADD
A4272EIR	42-32 x 72 x 29.5	100	104	11.50	\$1198	\$657

Extended island worksurface on right. Connects to 20"D returns or 24"D space saver connectables on the left. **Not freestanding.** Predrilled to accept 22"-28" keyboard trays. Grommet in worksurface. Shipped RTA (ready to assemble).

- Post is shipped in separate carton. Standard in Black (**TBL**); Tungsten is available at no charge, please specify (**TTU**).

Required Specifications

Top finish
Base finish
Post finish*

Optional Specifications

Additional grommet position
HP laminate
Power block cut-out

Accessories

Power block
Keyboard tray
Pencil tray

EXTENDED CORNER ISLANDS

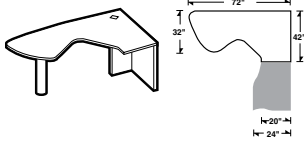

Extended Corner Island - LEFT*

MODEL#	DIMENSIONS	FREIGHT CLASS	WT/LBS.	CUBIC FT.	LIST PRICE	HP ADD
D x W x H						
A4272EIL	42-32 x 72 x 29.5	100	104	11.50	\$1198	\$657

Extended island worksurface on left. Connects to 20"D returns or 24"D space saver connectables on the right. **Not freestanding.** Predrilled to accept 22"-28" keyboard trays. Grommet in worksurface. Shipped RTA (ready to assemble).
 • Post is shipped in separate carton. Standard in Black (TBL); Tungsten is available at no charge, please specify (TTU).

"P" ISLANDS

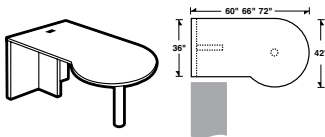

"P" Island LEFT - Full End Panel & Post (T-Base)*

MODEL#	DIMENSIONS	FREIGHT CLASS	WT/LBS.	CUBIC FT.	LIST PRICE	HP ADD
A3672FPL	36-42 x 72 x 29.5	85	128	9.26	\$1173	\$657
A3666FPL	36-42 x 66 x 29.5	85	122	8.76	\$1071	\$657
A3660FPL	36-42 x 60 x 29.5	85	116	8	\$1020	\$558

Connects to left side of worksurface. Attaching hardware included. **Not freestanding.** Grommet in worksurface. Shipped RTA (ready to assemble).
 • Post is shipped in separate carton. Standard in Black (TBL); Tungsten is available at no charge, please specify (TTU).

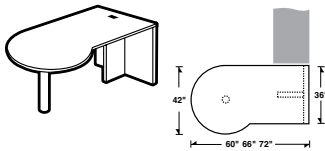

"P" Island RIGHT - Full End Panel & Post (T-Base)*

A3672FPR	36-42 x 72 x 29.5	85	128	9.26	\$1173	\$657
A3666FPR	36-42 x 66 x 29.5	85	122	8.76	\$1071	\$657
A3660FPR	36-42 x 60 x 29.5	85	116	8	\$1020	\$558

Connects to right side of worksurface. Attaching hardware included. **Not freestanding.** Grommet in worksurface. Shipped RTA (ready to assemble).
 • Post is shipped in separate carton. Standard in Black (TBL); Tungsten is available at no charge, please specify (TTU).

"P" ISLANDS WITH FULL MODESTY PANEL

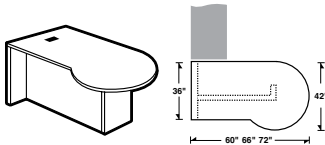

"P" Island LEFT - Full Modesty Panel (H-Base)

MODEL#	DIMENSIONS	FREIGHT CLASS	WT/LBS.	CUBIC FT.	LIST PRICE	HP ADD
A3672PL	36-42 x 72 x 29.5	70	143	7.75	\$1071	\$657
A3666PL	36-42 x 66 x 29.5	70	136	7.25	\$970	\$657
A3660PL	36-42 x 60 x 29.5	70	126	6.50	\$917	\$558

Connects to the left side of a worksurface. Accommodates all 19" pedestals (freestanding, mobile and hanging pedestals). Grommet in worksurface. Shipped RTA (ready to assemble).
 • Modesty Panel is 1" off of ground.

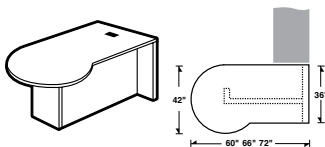

"P" Island RIGHT - Full Modesty Panel (H-Base)

A3672PR	36-42 x 72 x 29.5	70	143	7.75	\$1071	\$657
A3666PR	36-42 x 66 x 29.5	70	136	7.25	\$970	\$657
A3660PR	36-42 x 60 x 29.5	70	126	6.50	\$917	\$558

Connects to the right side of a worksurface. Accommodates all 19" pedestals (freestanding, mobile and hanging pedestals). Grommet in worksurface. Shipped RTA (ready to assemble).
 • Modesty Panel is 1" off of ground.

Required Specifications

Top finish
 Base finish
 Post finish*

Optional Specifications

Additional grommet position
 HP laminate
 Power block cut-out

Accessories

Power block
 Keyboard tray
 Pencil tray

A ADAPTABILITIES®

"P" ISLANDS (ATTACHABLE)

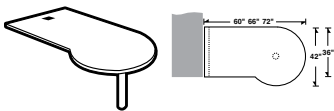

"P" Island LEFT with Post*

MODEL#	DIMENSIONS	FREIGHT CLASS	WT/LBS.	CUBIC FT.	LIST PRICE	HP ADD
A3672IPL	36-42 x 72 x 29.5	100	92	9.26	\$1020	\$657
A3666IPL	36-42 x 66 x 29.5	100	86	8.76	\$917	\$657
A3660IPL	36-42 x 60 x 29.5	92.5	80	8	\$869	\$558

Attaches to edge of worksurfaces. Attaching hardware included. Grommet in worksurface. Shipped RTA (ready to assemble).
 • Post is shipped in separate carton. Standard in Black (TBL); Tungsten is available at no charge, please specify (TTU).

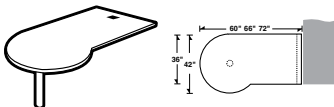

"P" Island RIGHT with Post*

A3672IPR	36-42 x 72 x 29.5	100	92	9.26	\$1020	\$657
A3666IPR	36-42 x 66 x 29.5	100	86	8.76	\$917	\$657
A3660IPR	36-42 x 60 x 29.5	92.5	80	8	\$869	\$558

Attaches to edge of worksurfaces. Attaching hardware included. Grommet in worksurface. Shipped RTA (ready to assemble).
 • Post is shipped in separate carton. Standard in Black (TBL); Tungsten is available at no charge, please specify (TTU).

RADIUS SPANNER ISLANDS

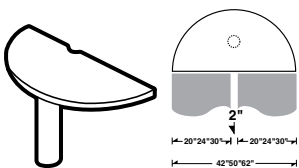

Radius Spanner Island with Panel Cut-Out*

MODEL#	DIMENSIONS	FREIGHT CLASS	WT/LBS.	CUBIC FT.	LIST PRICE	HP ADD
A62RS	31 x 62 x 29.5	100	59	6.76	\$940	\$395
A50RS	25 x 50 x 29.5	125	46	5.76	\$817	\$329
A42RS	21 x 42 x 29.5	125	41	5.26	\$739	\$264

Used to connect two back-to-back units of same depth with a panel. Includes monopost. Requires "L" bracket (model MLB90) for connection to full end panels. Shipped RTA (ready to assemble).

- MLB90 must be ordered separately - see page 505.
- Post is shipped in separate carton. Standard in Black (TBL); Tungsten is available at no charge, please specify (TTU).
- **Cannot accept keyboard trays or pencil tray**

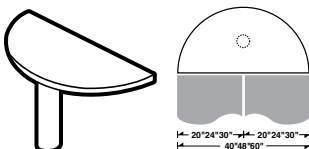

Radius Spanner Island*

A60RS	29.69 x 60 x 29.5	100	56	5.76	\$940	\$329
A48RS	24 x 48 x 29.5	125	43	5.76	\$817	\$264
A40RS	20 x 40 x 29.5	125	40	5.26	\$739	\$264

Used to connect two back-to-back units of same depth. Includes monopost. Requires "L" bracket (model MLB90) for connection to full end panels. Shipped RTA (ready to assemble).

- MLB90 must be ordered separately - see page 505.
- Post is shipped in separate carton. Standard in Black (TBL); Tungsten is available at no charge, please specify (TTU).
- **Cannot accept keyboard trays or pencil tray**

RECEPTION DESKS

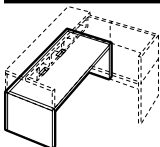

Lower Desk Unit**

MODEL#	DIMENSIONS	FREIGHT CLASS	WT/LBS.	CUBIC FT.	LIST PRICE	HP ADD
A3072RD	29.69 x 72 x 29.5	70	149	7	\$1020	\$461

No pedestals. Two grommets in worksurface. Shipped RTA (ready to assemble).
 • Cannot be used with Divide.

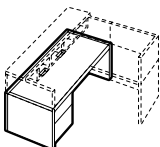

Single Pedestal Lower Desk Unit - LEFT**

A3072RDL	29.69 x 72 x 29.5	150	222	43.75	\$1475	\$461
A3060RDL	29.63 x 60 x 29	150	201	36	\$1274	\$429

Box/file pedestal on **left** with lock. Two grommets in worksurface.
 • Cannot be used with Divide.

Required Specifications

Top finish
 Base finish (not radius spanner islands)
 Post finish*

Optional Specifications

Additional grommet position*
 HP laminate*
 Power block cut-out*

Accessories

Power block*
 Keyboard tray**
 Pencil tray**

RECEPTION DESKS

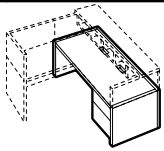

Single Pedestal Lower Desk Unit - RIGHT

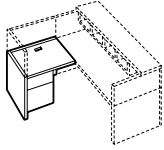

Reception Return - LEFT

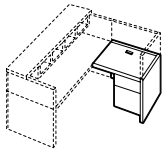

Reception Return - RIGHT



Reception Return - LEFT



Reception Return - RIGHT

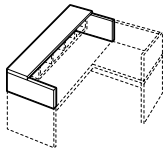

Transaction Counter

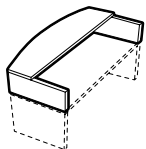

Bow Front Transaction Counter

MODEL#	DIMENSIONS	FREIGHT CLASS	WT/LBS.	CUBIC FT.	LIST PRICE	HP ADD
--------	------------	---------------	---------	-----------	------------	--------

D x W x H

A3072RDR	29.69 x 72 x 29.5	150	222	43.75	\$1475	\$461
A3060RDR	29.63 x 60 x 29	150	201	36	\$1274	\$429

Box/file pedestal on **right** with lock. Two grommets in worksurface.

- Cannot be used with Divide.

A2442RRL	24 x 42 x 29.5	125	131	21.25	\$970	\$210
----------	----------------	-----	-----	-------	--------------	--------------

Box/file pedestal on **left** with lock. Grommet in worksurface.

- Cannot be used with Divide.
- **Cannot accept keyboard trays or pencil tray**

A2442RRR	24 x 42 x 29.5	125	131	21.25	\$970	\$210
----------	----------------	-----	-----	-------	--------------	--------------

Box/file pedestal on **right** with lock. Grommet in worksurface.

- Cannot be used with Divide.
- **Cannot accept keyboard trays or pencil tray**

A2442KRL	24 x 42 x 29.5	70	83	3.80	\$715	\$210
----------	----------------	----	----	------	--------------	--------------

No pedestal. Grommet in worksurface.

- Cannot be used with Divide.

A2442KRR	24 x 42 x 29.5	70	83	3.80	\$715	\$210
----------	----------------	----	----	------	--------------	--------------

No pedestal. Grommet in worksurface.

- Cannot be used with Divide.

A3072URD	29.69 x 72 x 13.75	70	67	4.30	\$617	\$264
A3060URD	29.63 x 60 x 13.75	65	59	2.60	\$579	\$264

For main reception desk. Shipped RTA (ready to assemble). Depth of reception top is 12".

- Reception top units are to be used only with lower reception units. Tops have mini-fix fasteners to attach the reception top units.

A3072URB	29.69-36 x 72 x 13.75	70	72	4.30	\$837	\$329
----------	-----------------------	----	----	------	--------------	--------------

For main reception desk. To be used on A3072RD, A3072RDL or A3072RDR. Shipped RTA (ready to assemble). Depth of reception bow top is 12-15".

- Reception top units are to be used only with desks listed. Tops have mini-fix fasteners to attach the reception top units.

Required Specifications

Top finish
Base finish

Optional Specifications

Additional grommet position*
HP laminate*
Power block cut-out*

Accessories

Power block*
Keyboard tray*
Pencil tray*

A ADAPTABILITIES®

RECEPTION DESKS

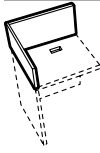

Return Screen Unit - LEFT

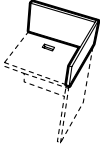

Return Screen Unit - RIGHT

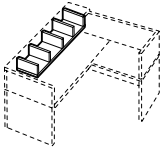

Desk Top Organizer

MODEL#	DIMENSIONS	FREIGHT CLASS	WT/LBS.	CUBIC FT.	LIST PRICE	HP ADD
--------	------------	---------------	---------	-----------	------------	--------

D x W x H

A2442URL	24 x 42 x 12.75	85	27	2	\$312	N/A
----------	-----------------	----	----	---	--------------	-----

To be used on top of left reception return (A2442RRL/KRL). Shipped RTA (ready to assemble).

- Reception top units are to be used only with returns listed. Tops have mini-fix fasteners to attach the reception top units.

A2442URR	24 x 42 x 12.75	85	27	2	\$312	N/A
----------	-----------------	----	----	---	--------------	-----

To be used on top of right reception return (A2442RRR/KRR). Shipped RTA (ready to assemble).

- Reception top units are to be used only with returns listed. Tops have mini-fix fasteners to attach the reception top units.

A1172ORD	11 x 52 x 6	100	22	2.60	\$209	N/A
----------	-------------	-----	----	------	--------------	-----

To be used under transaction counter. Black (BK) finish only. Shipped RTA (ready to assemble).

WALL/PANEL MOUNT OVERSTORAGE UNITS

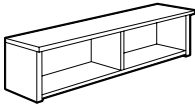

Overstorage Unit*

MODEL#	DIMENSIONS	FREIGHT CLASS	WT/LBS.	CUBIC FT.	LIST PRICE	HP ADD
--------	------------	---------------	---------	-----------	------------	--------

A00S60	15 x 60 x 16	70	86	5.25	\$767	N/A
A00S48	15 x 48 x 16	70	70	4.30	\$626	N/A
A00S42	15 x 42 x 16	70	62	3.80	\$617	N/A
A00S36	15 x 36 x 16	70	56	3.30	\$545	N/A
A00S30	15 x 30 x 16	70	48	3	\$510	N/A

Standard with pre-mounted "J" bracket for wall mount applications. One fixed shelf, closed back. Uses standard Adaptabilities hutch doors. Shipped RTA (ready to assemble).

- **NOTE:** Care should be taken to mount the units. Units should be mounted to wall studs using correct fasteners. Failure to do so may result in collapse of the unit and subsequent personal injury. **Mounting hardware not included.** Mounting hardware used should be based on wall material. Consult an installation professional for proper wall mounting.

OPEN HUTCHES

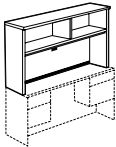

Open Hutch with Closed Back*

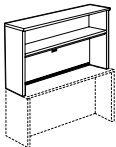
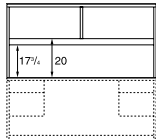

Open Hutch with Closed Back

MODEL#	DIMENSIONS	FREIGHT CLASS	WT/LBS.	CUBIC FT.	LIST PRICE	HP ADD
--------	------------	---------------	---------	-----------	------------	--------

A72HOCB	15 x 72 x 36	125	175	28.25	\$1099	N/A
A71HOCB	15 x 71.69 x 36	125	175	28.25	\$1099	N/A
A66HOCB	15 x 66 x 36	125	164	26	\$1049	N/A
A60HOCB	15 x 60 x 36	125	151	23.75	\$970	N/A

One fixed shelf and fixed shelf divider. Closed back features a grommet and flexible sweep for wire management. All hutches shipped pre-assembled. ***A71HOCB** for use when spanning 30" x 60/66" SPL/R and 20/24" x 42" FL/FR/L4/R4.

- Clearance from worksurface to valance is 17 3/4"; clearance from worksurface to hutch doors is 20".
- Woodgrain runs horizontal on both the upper and lower back panels.

A48HOCB	15 x 48 x 36	125	124	19	\$769	N/A
A42HOCB	15 x 42 x 36	125	111	16.75	\$769	N/A
A36HOCB	15 x 36 x 36	125	99	14.50	\$665	N/A
A30HOCB	15 x 30 x 36	125	88	12.25	\$617	N/A

One fixed shelf. Closed back features a grommet and flexible sweep for wire management. All hutches shipped pre-assembled.

- Clearance from worksurface to valance is 17 3/4"; clearance from worksurface to hutch doors is 20".
- Woodgrain runs horizontal on both the upper and lower back panels.

Required Specifications

Top finish
Base finish

Optional Specifications

Doors*

PIGEON-HOLE STORAGE

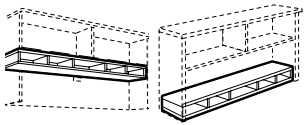

Horizontal Pigeon-Hole Storage

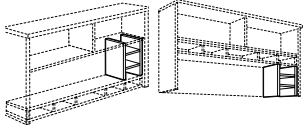

Vertical Pigeon-Hole Storage

MODEL#	DIMENSIONS D x W x H	FREIGHT CLASS	WT./LBS.	CUBIC FT.	LIST PRICE	HP ADD
AHS72	11.25 x 70 x 5.62	85	41	3	\$646	N/A
AHS71	11.25 x 69 x 5.62	70	43.50	2.30	\$646	N/A
AHS66	11.25 x 64 x 5.62	85	38	2.80	\$646	N/A
AHS60	11.25 x 58 x 5.62	85	35	2.50	\$529	N/A
AHS48	11.25 x 46 x 5.62	85	28	2	\$391	N/A
AHS42	11.25 x 40 x 5.62	85	24	2	\$391	N/A
AHS36	11.25 x 34 x 5.62	92.5	22	2	\$320	N/A

For additional storage. Can be **top** or **bottom** mounted. For use inside hutch. Shipped RTA (ready to assemble).

• **Cannot be used on A00S and C00S Overstorage Units.**

• Black finish is standard. Brushed Cobalt is available at no charge, please specify as **BRC**.

AVS14	11.25 x 13.37 x 14.37	85	13	.90	\$403	N/A
-------	-----------------------	----	----	-----	--------------	-----

For use in conjunction with the Horizontal Pigeon-Hole Storage. Can be used under or over horizontal unit. Shipped RTA (ready to assemble).

• Black finish is standard. Brushed Cobalt is available at no charge, please specify as **BRC**.

CORNER HUTCHES

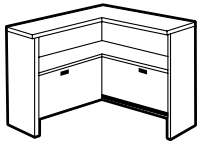

Corner Hutch with Closed Back

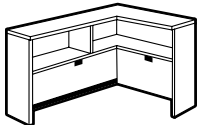

RIGHT Corner Hutch with Closed Back

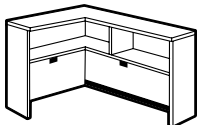

LEFT Corner Hutch with Closed Back

MODEL#	DIMENSIONS	FREIGHT CLASS	WT./LBS.	CUBIC FT.	LIST PRICE	HP ADD
A42CH	15 x 42 x 36	65	144	6.25	\$1294	N/A
A36CH	15 x 36 x 36	65	125	4.80	\$1090	N/A

One fixed shelf. Closed back features a grommet in both back panels and flexible sweep for wire management. Shipped RTA (ready to assemble).

• Woodgrain runs horizontal on both the upper and lower back panels.

A3672CHR	15 x 36-72 x 36	65	186	7	\$1425	N/A
A3666CHR	15 x 36-66 x 36	65	177	7	\$1373	N/A

One fixed shelf and shelf divider on left side. Closed back features a grommet in both back panels and flexible sweep for wire management on the left side. Shipped RTA (ready to assemble).

• Woodgrain runs horizontal on both the upper and lower back panels.

A3672CHL	15 x 36-72 x 36	65	186	7.25	\$1425	N/A
A3666CHL	15 x 36-66 x 36	65	177	7.25	\$1373	N/A

One fixed shelf and shelf divider on right side. Closed back features a grommet in both back panels and flexible sweep for wire management on the right side. Shipped RTA (ready to assemble).

• Woodgrain runs horizontal on both the upper and lower back panels.

Required Specifications

Top finish
Base finish

Optional Specifications

Doors

HUTCH DOORS

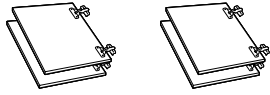

Four-Door Kit

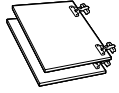

Two-Door Kit

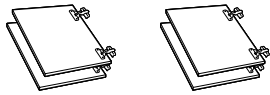

Corner Hutch Four-Door Kit

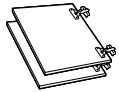

Corner Hutch Two-Door Kit

MODEL#	DIMENSIONS	FREIGHT CLASS	WT/LBS.	CUBIC FT.	LIST PRICE	HP ADD
--------	------------	---------------	---------	-----------	------------	--------

D x W x H

ADOOR72	.69 x 17.75 x 15	85	25	1.80	\$403	N/A
ADOOR71	.69 x 17.12 x 15	85	25	1.80	\$403	N/A
ADOOR66	.69 x 16.75 x 15	85	24	1.80	\$403	N/A
ADOOR60	.69 x 14.75 x 15	85	22	1.80	\$403	N/A

For use on 72", 71", 66" and 60"W straight hutches. Hinges included. Locks available. Add **\$126** each lock. Doors for units 60" wide or more require two locks.

ADOOR48	.69 x 23.5 x 15	92.5	18	1.80	\$262	N/A
ADOOR42	.69 x 20.5 x 15	100	17	1.80	\$262	N/A
ADOOR36	.69 x 17.5 x 15	100	15	1.80	\$262	N/A
ADOOR30	.69 x 14.5 x 15	125	13	1.80	\$262	N/A

For use on 48", 42" 36" and 30"W straight hutches. Hinges included. Locks available, Add **\$126** each lock. Doors for units 48" wide or less require one lock.

ADOOR72C	.69 x 56.5 x 15	70	27	1.80	\$512	N/A
ADOOR66C	.69 x 50.5 x 15	85	25	1.80	\$467	N/A

For use on 72" and 66"W corner hutches. Hinges included. Locks not available on corner hutch doors.

ADOOR42C	.69 x 26.5 x 15	92.5	20	1.80	\$444	N/A
ADOOR36C	.69 x 21.5 x 15	100	17	1.80	\$290	N/A

For use on 42" and 36"W corner hutches. Hinges included. Locks not available on corner hutch doors.

Required Specifications

Finish

TACKBOARDS FOR HUTCHES

MODEL# DIMENSIONS FREIGHT CLASS WT/LBS. CUBIC FT. FABRIC GRADE LIST PRICE

D x W x H

TACKBOARD Notes: Tackboards can be upholstered in all of the following fabrics:

Grade 1: Jenny, Quilt, Terrace, Urban, Waterfall

Grade 2: Couture, Imprint, Lola, Match, Replay, Silhouette

Grade 3: Anchorage, Merge

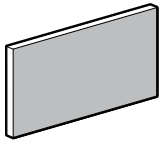

Tackboard

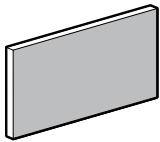

Tackboard

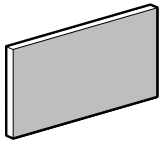

Tackboard

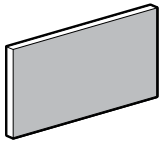

Tackboard

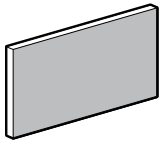

Tackboard

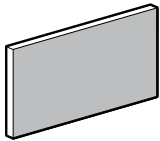

Tackboard

ATB7016	1 x 70 x 15	92.5	7	.65	1	\$409
					2	\$488
					3	\$543
					4	\$635
					5	\$730

For use on **A72HOCB** straight hutch. Includes mounting screws and covers.

ATB6916	1 x 69.5 x 15	92.5	7	.65	1	\$409
					2	\$488
					3	\$544
					4	\$635
					5	\$730

For use on **A71HOCB** straight hutch. Includes mounting screws and covers.

ATB6416	1 x 64 x 15	100	6.40	.65	1	\$402
					2	\$470
					3	\$524
					4	\$601
					5	\$691

For use on **A66HOCB** straight hutch. Includes mounting screws and covers.

ATB5816	1 x 58 x 15	92.5	5.80	.54	1	\$392
					2	\$461
					3	\$512
					4	\$594
					5	\$684

For use on **A60HOCB** straight hutch. Includes mounting screws and covers.

ATB4616	1 x 46 x 15	92.5	4.60	.43	1	\$273
					2	\$328
					3	\$365
					4	\$426
					5	\$491

For use on **A48HOCB** straight hutch. Includes mounting screws and covers.

ATB4016	1 x 40 x 15	100	4	.43	1	\$265
					2	\$310
					3	\$344
					4	\$398
					5	\$456

For use on **A42HOCB** straight hutch. Includes mounting screws and covers.

Required Specifications

Fabric

TACKBOARDS FOR HUTCHES

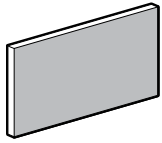

Tackboard

MODEL#	DIMENSIONS D x W x H	FREIGHT CLASS	WT/LBS.	CUBIC FT.	FABRIC GRADE	LIST PRICE
ATB3416	1 x 34 x 15	125	3.40	.43	1	\$257
					2	\$301
					3	\$336
					4	\$384
					5	\$444

For use on **A36HOCB** straight hutch. Includes mounting screws and covers.

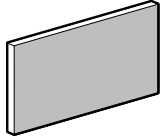

Tackboard

ATB2816	1 x 28 x 15	125	2.80	.43	1	\$247
					2	\$284
					3	\$310
					4	\$347
					5	\$401

For use on **A30HOCB** straight hutch. Includes mounting screws and covers.

TACKBOARDS FOR CORNER HUTCHES

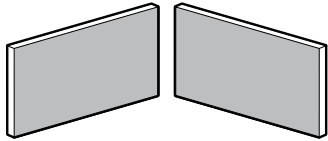

Tackboard

MODEL#	DIMENSIONS	FREIGHT CLASS	WT/LBS.	CUBIC FT.	LIST PRICE	HP ADD
ATB72CH	1 x 33-72 x 15 70 w x 15¾ h	125	9.94	1.30	1	\$631
					2	\$711
					3	\$767
					4	\$858
					5	\$987

For use on **A3672CHR/L corner** hutch. Includes mounting screws and covers.

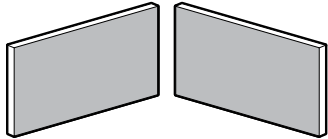

Tackboard

ATB66CH	1 x 33-64 x 15 64 w x 15¾ h	125	9.40	1.30	1	\$621
					2	\$689
					3	\$747
					4	\$822
					5	\$946

For use on **A3666CHR/L corner** hutch. Includes mounting screws and covers.

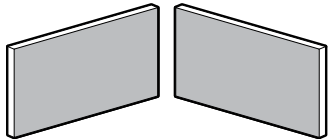

Tackboard

ATB42CH	1 x 39-40 x 15	100	7.70	.85	1	\$496
					2	\$545
					3	\$588
					4	\$649
					5	\$748

For use on **A42CH corner** hutch. Includes mounting screws and covers.

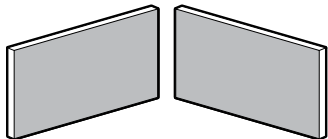

Tackboard

ATB36CH	1 x 33-34 x 15	125	6.60	.85	1	\$475
					2	\$521
					3	\$557
					4	\$625
					5	\$719

For use on **A36CH corner** hutch. Includes mounting screws and covers.

Required Specifications

Fabric - Tackboards
Finish - Transaction Top

WALL MOUNTED TACKBOARDS

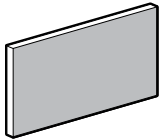

Wall Mounted Tackboard

MODEL# DIMENSIONS FREIGHT CLASS WT/LBS. CUBIC FT. FABRIC GRADE LIST PRICE

	D x W x H					
AWHT3019	1.25 x 30 x 19	125	6.30	1	1	\$317
					2	\$366
					3	\$421
					4	\$483
					5	\$554

For use under **A00S30** overstorage unit. Standard with pre-mounted "J" bracket for wall mount applications. There will be a 1.75" clearance between the top of the tackboard and bottom of the overhead, and a .25" clearance between the bottom of the tackboard and the worksurface.

- **NOTE:** Care should be taken to mount the units. Units should be mounted to wall studs using correct fasteners. Failure to do so may result in collapse of the unit and subsequent personal injury. **Mounting hardware not included.** Mounting hardware used should be based on wall material. Consult an installation professional for proper wall mounting.

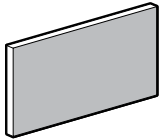

Wall Mounted Tackboard

AWHT3619	1.25 x 36 x 19	125	7.60	1	1	\$353
					2	\$408
					3	\$467
					4	\$536
					5	\$616

For use under **A00S36** overstorage unit. Standard with pre-mounted "J" bracket for wall mount applications. There will be a 1.75" clearance between the top of the tackboard and bottom of the overhead, and a .25" clearance between the bottom of the tackboard and the worksurface.

- **NOTE:** Care should be taken to mount the units. Units should be mounted to wall studs using correct fasteners. Failure to do so may result in collapse of the unit and subsequent personal injury. **Mounting hardware not included.** Mounting hardware used should be based on wall material. Consult an installation professional for proper wall mounting.

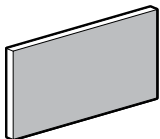

Wall Mounted Tackboard

AWHT4219	1.25 x 42 x 19	100	8.90	1	1	\$410
					2	\$472
					3	\$543
					4	\$624
					5	\$716

For use under **A00S42** overstorage unit. Standard with pre-mounted "J" bracket for wall mount applications. There will be a 1.75" clearance between the top of the tackboard and bottom of the overhead, and a .25" clearance between the bottom of the tackboard and the worksurface.

- **NOTE:** Care should be taken to mount the units. Units should be mounted to wall studs using correct fasteners. Failure to do so may result in collapse of the unit and subsequent personal injury. **Mounting hardware not included.** Mounting hardware used should be based on wall material. Consult an installation professional for proper wall mounting.

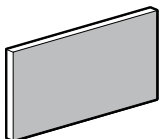

Wall Mounted Tackboard

AWHT4819	1.25 x 48 x 19	92.5	10.10	1	1	\$446
					2	\$513
					3	\$590
					4	\$679
					5	\$777

For use under **A00S48** overstorage unit. Standard with pre-mounted "J" bracket for wall mount applications. There will be a 1.75" clearance between the top of the tackboard and bottom of the overhead, and a .25" clearance between the bottom of the tackboard and the worksurface.

- **NOTE:** Care should be taken to mount the units. Units should be mounted to wall studs using correct fasteners. Failure to do so may result in collapse of the unit and subsequent personal injury. **Mounting hardware not included.** Mounting hardware used should be based on wall material. Consult an installation professional for proper wall mounting.

Required Specifications

Fabric

WALL MOUNTED TACKBOARDS

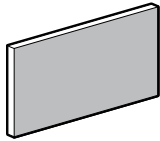

Wall Mounted Tackboard

MODEL#	DIMENSIONS D x W x H	FREIGHT CLASS	WT/LBS.	CUBIC FT.	FABRIC GRADE	LIST PRICE
AWHT6019	1.25 x 60 x 19	125	12.70	1.80	1	\$550
					2	\$635
					3	\$729
					4	\$839
					5	\$962

For use under **A00S60** overstorage unit. Standard with pre-mounted "J" bracket for wall mount applications. There will be a 1.75" clearance between the top of the tackboard and bottom of the overhead, and a .25" clearance between the bottom of the tackboard and the worksurface.

- **NOTE:** Care should be taken to mount the units. Units should be mounted to wall studs using correct fasteners. Failure to do so may result in collapse of the unit and subsequent personal injury. **Mounting hardware not included.** Mounting hardware used should be based on wall material. Consult an installation professional for proper wall mounting.

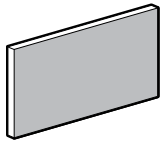

Wall Mounted Tackboard

AWHT6619	1.25 x 66 x 19	125	13.90	1.80	1	\$585
					2	\$675
					3	\$774
					4	\$891
					5	\$1022

For use under **multiple** Adaptabilities wall mounted overstorage units. Standard with pre-mounted "J" bracket for wall mount applications. There will be a 1.75" clearance between the top of the tackboard and bottom of the overhead, and a .25" clearance between the bottom of the tackboard and the worksurface.

- **NOTE:** Care should be taken to mount the units. Units should be mounted to wall studs using correct fasteners. Failure to do so may result in collapse of the unit and subsequent personal injury. **Mounting hardware not included.** Mounting hardware used should be based on wall material. Consult an installation professional for proper wall mounting.

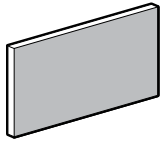

Wall Mounted Tackboard

AWHT7219	1.25 x 72 x 19	100	15.20	1.80	1	\$641
					2	\$738
					3	\$848
					4	\$976
					5	\$1120

For use under **multiple** Adaptabilities wall mounted overstorage units. Standard with pre-mounted "J" bracket for wall mount applications. There will be a 1.75" clearance between the top of the tackboard and bottom of the overhead, and a .25" clearance between the bottom of the tackboard and the worksurface.

- **NOTE:** Care should be taken to mount the units. Units should be mounted to wall studs using correct fasteners. Failure to do so may result in collapse of the unit and subsequent personal injury. **Mounting hardware not included.** Mounting hardware used should be based on wall material. Consult an installation professional for proper wall mounting.

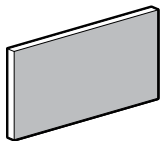

Wall Mounted Tackboard

AWHT7819	1.25 x 78 x 19	100	16.50	1.80	1	\$677
					2	\$778
					3	\$895
					4	\$1029
					5	\$1182

For use under **multiple** Adaptabilities wall mounted overstorage units. Standard with pre-mounted "J" bracket for wall mount applications. There will be a 1.75" clearance between the top of the tackboard and bottom of the overhead, and a .25" clearance between the bottom of the tackboard and the worksurface.

- **NOTE:** Care should be taken to mount the units. Units should be mounted to wall studs using correct fasteners. Failure to do so may result in collapse of the unit and subsequent personal injury. **Mounting hardware not included.** Mounting hardware used should be based on wall material. Consult an installation professional for proper wall mounting.

Required Specifications

Fabric

ACCESSORY PIECES

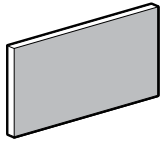

Wall Mounted Tackboard**

MODEL#	DIMENSIONS D x W x H	FREIGHT CLASS	WT/LBS.	CUBIC FT.	LIST PRICE	HP ADD
AWHT8419	1.25 x 84 x 19	100	17.70	1.80	1	\$732
					2	\$845
					3	\$970
					4	\$1115
					5	\$1282

For use under **multiple** Adaptabilities wall mounted overstorage units. Standard with pre-mounted "J" bracket for wall mount applications. There will be a 1.75" clearance between the top of the tackboard and bottom of the overhead, and a .25" clearance between the bottom of the tackboard and the worksurface.

• **NOTE:** Care should be taken to mount the units. Units should be mounted to wall studs using correct fasteners. Failure to do so may result in collapse of the unit and subsequent personal injury. **Mounting hardware not included.** Mounting hardware used should be based on wall material. Consult an installation professional for proper wall mounting.

ACCESSORY PIECES



Mixed Drawer Cabinet - LEFT*

MODEL#	DIMENSIONS	FREIGHT CLASS	WT/LBS.	CUBIC FT.	LIST PRICE	HP ADD
A2036MDL	20 x 36 x 29.5	92.5	162	15.50	\$1938	\$159
A2436MDL	24 x 36 x 29.5	100	176	18.25	\$1968	\$159

Two box drawers on **right**, one file drawer on **left** and one lateral file drawer on bottom. File on lateral file drawers locking. 1 pencil tray. Front-to-back filing bars.

- Black handles are standard. Silver is available at no charge, please specify as **SI**.
- To comply with ANSI/BIFMA stability tests, the Lateral File Counter Weight Kit, model "LFCWKIT36" on page 41 MUST be used.
- *File drawer construction is for accommodating hanging files NOT for stacking materials on the drawer bottom.*
- Top file drawer supports hanging folders only. Does not accept hanging folders with plastic tabs.



Mixed Drawer Cabinet - RIGHT*

A2036MDR	20 x 36 x 29.5	92.5	162	15.50	\$1938	\$159
A2436MDR	24 x 36 x 29.5	100	176	18.25	\$1968	\$159

Two box drawers on **left**, one file drawer on **right** and one lateral file drawer on bottom. File on lateral file drawers locking. 1 pencil tray. Front-to-back filing bars.

- Black handles are standard. Silver is available at no charge, please specify as **SI**.
- To comply with ANSI/BIFMA stability tests, the Lateral File Counter Weight Kit, model "LFCWKIT36" on page 41 MUST be used.
- *File drawer construction is for accommodating hanging files NOT for stacking materials on the drawer bottom.*
- Top file drawer supports hanging folders only. Does not accept hanging folders with plastic tabs.



Mixed Drawer Cabinet Shell - LEFT*

A2036MDLS	19.25 x 36 x 28.5	100	137	15	\$1889	N/A
A2436MDLS	23.25 x 36 x 28.5	100	150	18	\$1921	N/A

For use **under 29"H limited single pedestal desks, workstations or limited single pedestal credenzas. Unfinished top, no back.** Two box drawers on **right**, one file drawer on **left** and one lateral file drawer on bottom. File and lateral file drawers locking. 1 pencil tray. Front-to-back filing bars.

- Black handles are standard. Silver is available at no charge, please specify as **SI**.
- *File drawer construction is for accommodating hanging files NOT for stacking materials on the drawer bottom.*
- *For 24" deep worksurfaces, order **A2436MDLS**. For 20" deep worksurfaces, order **A2036MDLS**.*
- Top file drawer supports hanging folders only. Does not accept hanging folders with plastic tabs.

Required Specifications

Fabric**
Top finish*
Handle finish*
Base finish*

Optional Specifications

Key #*

ACCESSORY PIECES



Mixed Drawer Cabinet Shell - RIGHT

MODEL#	DIMENSIONS D x W x H	FREIGHT CLASS	WT/LBS.	CUBIC FT.	LIST PRICE	HP ADD
A2036MDRS	19.25 x 36 x 28.5	100	137	15	\$1889	N/A
A2436MDRS	23.25 x 36 x 28.5	100	150	18	\$1921	N/A

For use **under 29"H limited single pedestal desks, workstations or limited single pedestal credenzas. Unfinished top, no back.** Two box drawers on **left**, one file drawer on **right** and one lateral file drawer on bottom. File and lateral file drawers locking. 1 pencil tray. Front-to-back filing bars.

- Black handles are standard. Silver is available at no charge, please specify as **SI**.
- File drawer construction is for accommodating hanging files **NOT** for stacking materials on the drawer bottom.
- For 24" deep worksurfaces, order **A2436MDRS**. For 20" deep worksurfaces, order **A2036MDRS**.
- Top file drawer supports hanging folders only. Does not accept hanging folders with plastic tabs.

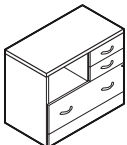

Mixed Storage Cabinet*

A2436MSC	24 x 36 x 29.5	100	163	18.25	\$1450	\$159
A2036MSC	20 x 36 x 29.5	100	147	15.50	\$1339	\$159

Features open storage compartment with access grommet on back. 2 box drawers and 1 lateral file drawer, all locking. 1 pencil tray. Front-to-back filing bars.

- To comply with ANSI/BIFMA stability tests, the Lateral File Counter Weight Kit, model "LFCWKIT36" on page 41 **MUST** be used.
- Black handles are standard. Silver is available at no charge, please specify as **SI**.
- File drawer construction is for accommodating hanging files **NOT** for stacking materials on the drawer bottom.

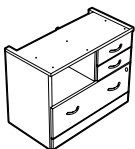

Mixed Storage Cabinet Shell

A2436MSCS	23.25 x 36 x 28	100	121	14.90	\$1413	N/A
A2036MSCS	19.25 x 36 x 28	125	136	17.45	\$1302	N/A

For use **under 29"H limited single pedestal desks, workstations or limited single pedestal credenzas. Unfinished top, no back.** Features open storage compartment with access grommet on back. 2 box drawers and 1 lateral file drawer, all locking. 1 pencil tray. Front-to-back filing bars.

- Black handles are standard. Silver is available at no charge, please specify as **SI**.
- File drawer construction is for accommodating hanging files **NOT** for stacking materials on the drawer bottom.
- For 24" deep worksurfaces, order **A2436MSCS**. For 20" deep worksurfaces, order **A2036MSCS**.



2 Drawer Lateral File*

A2036LF	20 x 36 x 29	100	145	15.50	\$1198	\$159
---------	--------------	-----	-----	-------	---------------	--------------

Two full suspension drawers. Front-to-back and side-to-side letter/legal filing capability with lock. Anti-lock tilt suspension.

- To comply with ANSI/BIFMA stability tests, the Lateral File Counter Weight Kit, model "LFCWKIT36" on page 41 **MUST** be used.
- Black handles are standard. Silver is available at no charge, please specify as **SI**.
- File drawer construction is for accommodating hanging files **NOT** for stacking materials on the drawer bottom.

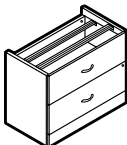

2 Drawer Lateral File Shell

A2436S2	24 x 36 x 28.5	125	114	18	\$1589	N/A
A2036S2	20 x 36 x 28.5	125	104	14.75	\$1589	N/A

For use **under 29"H limited single pedestal desks, workstations or limited single pedestal credenzas. No top or back.** Two full suspension locking drawers with **steel drawer interior**. Side-to-side file bars included. Anti-lock tilt suspension.

- Black handles are standard. Silver is available at no charge, please specify as **SI**.
- To prevent overloading, steel drawers do not include a back panel
- For 24" deep worksurfaces, order **A2436S2**. For 20" deep worksurfaces, order **A2036S2**.
- For front-to-back file bars order **FBB**, "FBB" on page 41.

Required Specifications

Top finish*
Base finish
Handles

Optional Specifications

Key #
HP laminate*

ACCESSORY PIECES

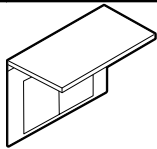

2 Drawer Lateral File Top and Back*

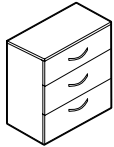

3 Drawer Lateral File*

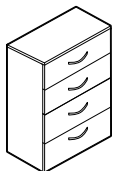

4 Drawer Lateral File*

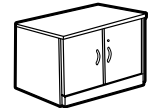

Storage Cabinet*

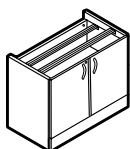

Storage Cabinet Shell

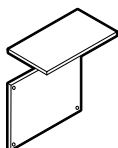

Storage Cabinet Top and Back*

MODEL#	DIMENSIONS	FREIGHT CLASS	WT/LBS.	CUBIC FT.	LIST PRICE	HP ADD
--------	------------	---------------	---------	-----------	------------	--------

D x W x H

ALF24TB	24 x 36 x 29.5	65	82	3.30	\$497	\$199
ALF20TB	20 x 36 x 29.5	65	78	3.30	\$497	\$199

For use with Lateral File Shell. Counterweights included. Shipped RTA (ready to assemble).

- Use **ALF24TB** for model A2436S2. Use **ALF20TB** for model A2036S2.

A2036S3	20 x 36 x 37.75	92.5	219	20	\$2295	\$159
---------	-----------------	------	-----	----	--------	-------

Three full suspension locking drawers with **steel drawer interior**. Side-to-side file bars included. Anti-lock tilt suspension.

- Black handles are standard. Silver is available at no charge, please specify as **SI**.
- For front-to-back file bars order **FBB**; See "FBB" on page 41.
- To prevent overloading, steel drawers do not include a back panel

A2036S4	20 x 36 x 49.5	92.5	267	25.75	\$2909	\$159
---------	----------------	------	-----	-------	--------	-------

Four full suspension locking drawers with **steel drawer interior**. Side-to-side file bars included. Anti-lock tilt suspension.

- Black handles are standard. Silver is available at no charge, please specify as **SI**.
- For front-to-back file bars order **FBB**; See "FBB" on page 41.
- To prevent overloading, steel drawers do not include a back panel

A2036SC	20 x 36 x 29.5	125	121	15.50	\$917	\$159
---------	----------------	-----	-----	-------	-------	-------

Self-closing hinged doors cover one adjustable shelf. Standard with lock.

- Black handles are standard. Silver is available at no charge, please specify as **SI**.

A2436SCS	23.25 x 36 x 28.5	150	106	18	\$792	N/A
A2036SCS	19.25 x 36 x 28.5	125	91	14.75	\$792	N/A

For use **under 29" H limited single pedestal desks, workstations or limited single pedestal credenzas. No top or back**. Self-closing hinged doors cover one adjustable shelf. Standard with lock.

- Black handles are standard. Silver is available at no charge, please specify as **SI**.
- For 24" deep worksurfaces, order **A2436SCS**. For 20" deep worksurfaces, order **A2036SCS**.

ASC24TB	24 x 36 x 29.5	85	49	3.30	\$335	\$199
ASC20TB	20 x 36 x 29.5	85	45	3.30	\$335	\$199

For use with **Storage Cabinet Shell**. Shipped RTA (ready to assemble).

- Use **ASC24TB** for model A2436SCS/MSCS; use **ASC20TB** for model A2036SCS/MSCS.

Required Specifications

Top finish*
Base finish
Handles

Optional Specifications

Key #
HP laminate*

ACCESSORY PIECES

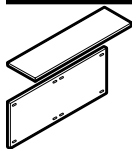

Credenza Top and Back*

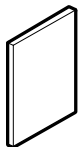

Full Leg



Personal Tower**



Personal Tower**



Vertical Storage/Lateral File Cabinet**

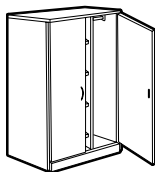

Storage Wardrobe Cabinet**

MODEL#	DIMENSIONS D x W x H	FREIGHT CLASS	WT/LBS.	CUBIC FT.	LIST PRICE	HP ADD
A2472TB	24 x 72 x 29.5	70	95	6	\$686	\$344
A2072TB	20 x 72 x 29.5	85	87	6	\$686	\$329

For use with the following: **two Lateral File Shells**, or **two Storage Cabinet Shells**, or **two Mixed Storage Cabinet Shells**, or any combination. May also be used with **one Lateral File Shell plus one Full Leg**, or **one Storage Cabinet/Mixed Storage Cabinet Shell plus one Full Leg**. Shipped RTA (ready to assemble).

- For 24" deep worksurfaces, order **A2472TB**. For 20" deep worksurfaces, order **A2072TB**.

A24FL	23.4 x 1 x 28.5	92.5	20	1.70	\$241	N/A
A20FL	19.3 x 1 x 28.5	65	16	.60	\$241	N/A

For use at **either end of A24/2072TB Credenza Top and Back** to create a kneespace. Non-handed; can be used left or right. Shipped RTA (ready to assemble).

- For 24" deep worksurfaces, order **A24FL**. For 20" deep worksurfaces, order **A20FL**.

A24PTFF	24 x 24 x 65.5	100	219	27	\$2388	N/A
A20PTFF	20 x 24 x 65.5	100	198	22.75	\$2388	N/A

Includes 7" wardrobe section with a hanging rod; storage section with one adjustable shelf; and file section with **two file drawers**. Locks are keyed alike. Upper lock secures wardrobe and storage section. Lower lock secures both file drawers.

- Black handles are standard. Silver is available at no charge, please specify as **SI**.

A24PTBBF	24 x 24 x 65.5	125	213	27	\$2388	N/A
A20PTBBF	20 x 24 x 65.5	100	193	22.75	\$2388	N/A

Includes 7" wardrobe section with a hanging rod; storage section with one adjustable shelf; and file section with **box-box-file drawers**. Locks are keyed alike. Upper lock secures wardrobe and storage section. Lower lock secures all drawers.

- Black handles are standard. Silver is available at no charge, please specify as **SI**.

A3665VSL	20 x 36 x 65.5	100	273	33	\$2233	N/A
----------	----------------	-----	-----	----	---------------	-----

Contains storage area with one adjustable shelf behind a self-closing hinged door, plus two full suspension file drawers. Lateral file drawers lock.

- File drawer construction is for accommodating hanging files NOT for stacking materials on the drawer bottom.
- Black handles are standard. Silver is available at no charge, please specify as **SI**.

A2436DI	24 x 36 x 65.5	70	254	11.50	\$2761	N/A
A3665DI	20 x 36 x 65.5	70	237	11.50	\$2436	N/A

Includes 16" hanging rod on one side and four adjustable shelves on the other. Lock. Shipped RTA (ready to assemble).

- Black handles are standard. Silver is available at no charge, please specify as **SI**.

Required Specifications

Top finish
Base finish
Handles (only personal towers)

Optional Specifications

Key #**
HP laminate*

ACCESSORY PIECES

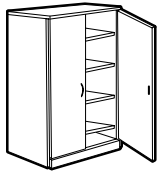

Storage Cabinet**

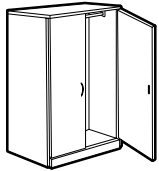

Wardrobe Cabinet**

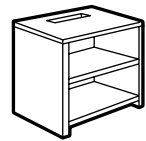

Printer Table*

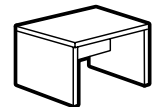

Magazine Table*

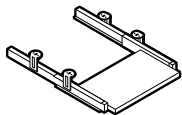

Pull-Out Keyboard

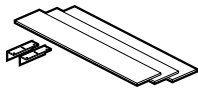

Counter Weight Kit

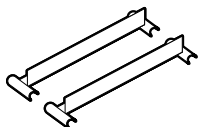

Front-to-Back Hanging File Bars

MODEL#	DIMENSIONS	FREIGHT CLASS	WT/LBS.	CUBIC FT.	LIST PRICE	HP ADD
--------	------------	---------------	---------	-----------	------------	--------

D x W x H

A2436SH	24 x 36 x 65.5	65	280	11.50	\$2431	N/A
A3665SH	20 x 36 x 65.5	65	261	11.50	\$2131	N/A

Includes four adjustable shelves. Lock. Shipped RTA (ready to assemble).

- Black handles are standard. Silver is available at no charge, please specify as **SI**.

A2436ROD	24 x 36 x 65.5	70	205	11.50	\$2631	N/A
A3665ROD	20 x 36 x 65.5	70	198	11.50	\$2233	N/A

Includes full width hanging rod. Lock. Shipped RTA (ready to assemble).

- Black handles are standard. Silver is available at no charge, please specify as **SI**.

A2430PT	24 x 30 x 29.5	65	108	4.30	\$917	\$159
---------	----------------	----	-----	------	--------------	--------------

Includes two fixed shelves, cut-back top shelf allows paper to fall onto lower shelf. Shipped RTA (ready to assemble).

A2248MT	22 x 48 x 18.5	85	61	4.30	\$512	\$226
A2222MT	22 x 22 x 18.5	85	40	3	\$413	\$120

Shipped RTA (ready to assemble).

APOKL28	17 x 28 x 3.5	85	13	.90	\$312	N/A
APOKL22	17 x 22 x 3.5	85	12	.90	\$282	N/A

Constructed of thermofused laminate. **APOKL28** will accommodate keyboard and mousepad. **APOKL28** will only fit on a single pedestal desk, freestanding table, or **A42205C**. Please specify color from available finishes listed on pg. 11.

- **APOKL28** will not fit extended corners or **A42245C**, **A36205C** 5-sided corners.

LFCWKIT36	6 x 33 x 1	60	40	.25	\$698	N/A
-----------	------------	----	----	-----	--------------	-----

3 metal plates. Plates mount to the underside of any 36" wide Lateral File or Mixed Storage/Drawer cabinet. Includes mounting hardware. Must be ordered separately. Field installed.

- To comply with ANSI/BIFMA stability tests, the Lateral File Counter Weight Kit MUST be used with the appropriate Lateral Files and Mixed Storage Cabinets.

FBB	-- x 15.2 x --	70	1	.10	\$27	N/A
FBB-50	-- x 15.2 x --	60	50	.50	\$842	N/A
FBB-100	-- x 15.2 x --	60	100	2.71	\$1542	N/A

Includes two bars. Grey. FBB is one pair; FBB-50 is fifty pairs; FBB-100 is 100 pairs.

- Not recommended for "L" opening with receding door and roll-out shelves.

Required Specifications

Top finish
Base finish
Handles**

Optional Specifications

Key #**
HP laminate*

A ADAPTABILITIES®

BOOKCASES

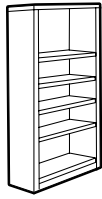

Bookcase - 72" High*

MODEL#	DIMENSIONS D x W x H	FREIGHT CLASS	WT/LBS.	CUBIC FT.	LIST PRICE	HP ADD
ABC72	12 x 36 x 72.5	125	170	23	\$1099	N/A

One fixed heavy duty shelf and **three adjustable shelves**. Shipped fully assembled.

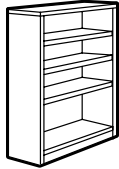

Bookcase - 65" High*

ABC65	12 x 36 x 65.5	125	150	21	\$1071	N/A
-------	----------------	-----	-----	----	---------------	-----

One fixed heavy duty shelf and **two adjustable shelves**. Shipped fully assembled.

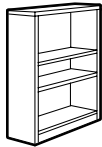

Bookcase - 48" High*

ABC48	12 x 36 x 48.5	125	116	15.75	\$817	N/A
-------	----------------	-----	-----	-------	--------------	-----

Two adjustable shelves. Shipped fully assembled.

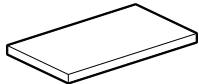

Bookcase Shelf

ABCSELF	12 x 34 x 1	100	13	1.50	\$255	N/A
---------	-------------	-----	----	------	--------------	-----

Extra shelf for bookcases. 1" thick.

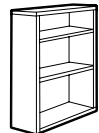
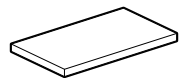

Table Top Bookcase

A3636TBC	15 x 36 x 36	125	111	17	\$702	N/A
ADOOR3636	.69 x 36 x 36	125	35	4.50	\$355	N/A

To be placed on top of 36" w lateral file or storage cabinet. Two adjustable shelves.

- For a set of doors, order **ADOOR3636**
- Locks available on ADOOR3636. Add \$101 each lock.



Bookcase Shelf

ATBC36SH	13.25 x 34 x 1	100	16	1.70	\$196	N/A
----------	----------------	-----	----	------	--------------	-----

Extra shelf for TABLE TOP bookcases. 1" thick.

Required Specifications

Top finish*
Base finish*

END SHELVES

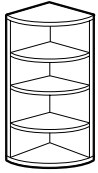

End Shelf - 65" High

MODEL#	DIMENSIONS D x W x H	FREIGHT CLASS	WT/LBS.	CUBIC FT.	LIST PRICE	HP ADD
A2465ESHL	24 x 24 x 65.5	65	136	5	\$1153	N/A
A2065ESHL	20 x 20 x 65.5	65	113	5	\$970	N/A
A2465ESHR	24 x 24 x 65.5	65	136	5	\$1153	N/A
A2065ESHR	20 x 20 x 65.5	65	113	5	\$970	N/A

For use at end of **wardrobe/storage, vertical storage cabinets, and personal towers**. Four fixed shelves. Shipped RTA (ready to assemble). **Specify left or right.**

- For 24" deep cabinet, order **A2465ESH**. For 20" deep cabinet, order **A2065ESH**.

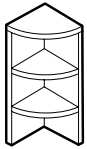

End Shelf - 36" High

A1536ESHL	15 x 15 x 36	85	44	3.30	\$467	N/A
A1536ESHR	15 x 15 x 36	85	44	3.30	\$467	N/A

For use at end of **hutches**. Two fixed shelves. To be used on top of **A3029ESHL/R, A2429ESHL/R or A2029ESHL/R**. Shipped RTA (ready to assemble). **Specify left or right.**

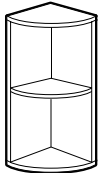

End Shelf - 29" High

A3029ESHL	30 x 30 x 29.5	70	104	5.25	\$817	\$265
A2429ESHL	24 x 24 x 29.5	70	77	4.30	\$665	\$134
A2029ESHL	20 x 20 x 29.5	70	60	3.80	\$568	\$108
A3029ESHR	30 x 30 x 29.5	70	104	5.25	\$817	\$264
A2429ESHR	24 x 24 x 29.5	70	77	4.30	\$665	\$134
A2029ESHR	20 x 20 x 29.5	70	60	3.80	\$568	\$108

For use at end of **worksurfaces**. Two fixed shelves. Shipped RTA (ready to assemble). **Specify left or right.**

- For 30" deep worksurface, order **A3029ESH**. For 24" deep worksurface, order **A2429ESH**.
For 20" deep worksurface, order **A2029ESH**.

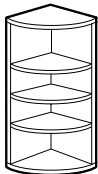

End Shelf - 49 1/2" High

A2049ESHL	20 x 20 x 49.5	65	94	3.80	\$855	N/A
A2049ESHR	20 x 20 x 49.5	65	94	3.80	\$855	N/A

For use at end of **A2036S4 4-high lateral file**. Four fixed shelves. Shipped RTA (ready to assemble). **Specify left or right.**

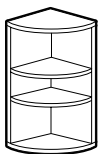

End Shelf - 37 1/2" High

A2037ESHL	20 x 20 x 38.2	70	77	5	\$622	N/A
A2037ESHR	20 x 20 x 38.2	70	77	5	\$622	N/A

For use at end of **A2036S3 3-high lateral file**. Three fixed shelves. Shipped RTA (ready to assemble). **Specify left or right.**

Required Specifications

Top finish
Base finish

Optional Specifications

HP Laminate (End Shelf, 29"h)

PEDESTALS



Freestanding Pedestal

MODEL#	DIMENSIONS D x W x H	FREIGHT CLASS	WT./LBS.	CUBIC FT.	LIST PRICE	HP ADD
AFPBBF19	19 x 16 x 28.5	100	68	7.25	\$999	N/A
AFPBBF22	22 x 16 x 28.5	100	72	8.25	\$1023	N/A
AFPBBF28	28 x 16 x 28.5	100	88	10.25	\$1065	N/A

For use under a freestanding worksurface (20", 24" or 30"); attaches to worksurface top. No top and unfinished back. Two box and one file drawer. One pencil tray. File drawer and lower box drawer are locking.

- Cannot be used with **A2466** extended corners.
- When used with Connectable Tables (e.g. A2472T) bottom rear of pedestal will show because of the modesty on table units

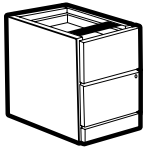

Freestanding Pedestal

AFPFF19	19 x 16 x 28.5	100	67	7.25	\$1082	N/A
AFPFF22	22 x 16 x 28.5	100	75	8.25	\$1095	N/A
AFPFF28	28 x 16 x 28.5	100	89	10.25	\$1157	N/A

For use under a freestanding worksurface (20", 24" or 30"); attaches to worksurface top. No top and unfinished back. Two file drawers. Locking.

- Cannot be used with **A2466** extended corners.
- When used with Connectable Tables (e.g. A2472T) bottom rear of pedestal will show because of the modesty on table units

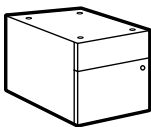

Hanging Pedestal

AHPBF18	18 x 16 x 18	92.5	48	4.50	\$698	N/A
---------	--------------	------	----	------	--------------	-----

For use under a freestanding worksurface (20", 24" or 30"); attaches to worksurface top. No top and unfinished back. One box and one file drawer. One pencil tray. Locking. 18" high.

- Cannot be used with **A2466** extended corners.
- When used with Connectable Tables (e.g. A2472T) bottom rear of pedestal will show because of the modesty on table units



Mobile Pedestal*

AMPBBF19	19 x 16 x 28	85	96	6.50	\$1044	\$199
AMPBBF22	23 x 16 x 28	92.5	92	7.75	\$1055	\$204
AMPBBF28	29 x 16 x 28	92.5	105	9.50	\$1095	\$206

Pedestal on casters. Front casters lock. Fits under worksurfaces and is easily moved. Two box and one file drawer. One pencil tray. File drawer and lower box drawer are locking. Includes counterweight to prevent tipping.

- Cannot be used with **A2466** extended corners.



Mobile Pedestal*

AMPFF19	19 x 16 x 28	85	97	6.50	\$1124	\$199
AMPFF22	23 x 16 x 28	85	95	7.75	\$1139	\$206
AMPFF28	29 x 16 x 28	92.5	106	9.50	\$1198	\$206

Pedestal on casters. Front casters lock. Fits under worksurfaces and is easily moved. Two file drawers. Locking. Includes counterweight to prevent tipping.

- Cannot be used with **A2466** extended corners.

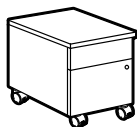

Mobile Pedestal*

AMPBF19	19 x 16 x 22	85	77	5.25	\$917	\$199
AMPBF22	23 x 16 x 22	85	73	6	\$940	\$206
AMPBF28	29 x 16 x 22	92.5	83	7.50	\$965	\$206

Pedestal on casters. Front casters lock. Fits under worksurfaces and is easily moved. One box and one file drawer. One pencil tray. Locking. 22" high. Includes counterweight to prevent tipping.

Required Specifications

Top finish
Base finish*

Optional Specifications

Key #
HP laminate (mobile pedestal)
Handle

BOARDROOM TABLES

MODEL# DIMENSIONS FREIGHT CLASS WT/LBS. CUBIC FT. LIST PRICE HP ADD



Boardroom Table - Round Top*

	D x W x H					
A48R	48 x 48 x 1.5	85	95	7.50	\$594	\$461
A42R	42 x 42 x 1.5	85	73	5.75	\$568	\$461
A36R	36 x 36 x 1.5	92.5	54	4.90	\$413	\$264

A48R may be used with four monoposts. **A36R** and **A42R** may be used only with cross base or drum base.

- Available with the **Bicut Edge** at no upcharge. Please Specify "**CR**".
- **A48R** to be used with four monopost legs only, model **A5L**.
- **A42R** to be used with four monoposts (**A5L**) or cross base **A2727XB**
- **A36R** to be used with four monoposts (**A5L**), drum base **A18Z** or cross base **A2727XB**



Boardroom Table - Rectangular Top*

A48120RE	48 x 120 x 1.5	70	274	13	\$1274	\$1048
A4896RE	48 x 96 x 1.5	65	314	11.50	\$970	\$854
A3672RE	36 x 72 x 1.5	65	175	7	\$715	\$492

For use with two drum bases, two "V" bases, one panel base OR four monoposts. Predrilled for "V" base and panel base.

Top comes in one piece, except for A48120RE (two pieces)

- Available with the **Bicut Edge** at no upcharge. Please Specify "**CR**".
- **A48120RE** uses three drum bases, three "V" bases, one double panel base OR six monoposts.



Boardroom Table - Boat Shape Top*

A48144B	48 x 144 x 1.5	60	237	7.50	\$1475	\$1244
A48120B	48 x 120 x 1.5	60	198	6.30	\$1274	\$1048
A4896B	48 x 96 x 1.5	70	193	9.80	\$999	\$854

For use with three drum bases, three "V" bases, one double panel base OR six monoposts. Predrilled for "V" base and panel base. **Top comes in two pieces, except for A4896B.**

- Available with the **Bicut Edge** at no upcharge. Please Specify "**CR**".
- **A4896B** uses two drum bases, two "V" bases, one panel base OR four monoposts.



Boardroom Table - Racetrack Top*

A48144RT	48 x 144 x 1.5	60	251	7.50	\$1475	\$1244
A48120RT	48 x 120 x 1.5	60	204	6.30	\$1274	\$1048
A4896RT	48 x 96 x 1.5	70	200	9.80	\$999	\$854
A3672RT	36 x 72 x 1.5	70	112	5.80	\$769	\$492

For use with three drum bases, three "V" bases, one double panel base OR six monoposts. Predrilled for "V" base and panel base. **Top comes in two pieces except for A4896RT and A3672RT.**

- Available with the **Bicut Edge** at no upcharge. Please Specify "**CR**".
- **NOTE:** 48" x 120" and 48" x 144" woodgrain finish Adaptabilities tables will not have a perfect match of grain at the center where the two halves meet.
- **A4896RT** and **A3672RT** use two drum bases, two "V" bases, one panel base OR four monoposts.

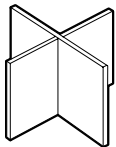

Cross Base

A2727XB	27 x 27 x 28.5	70	63	3.60	\$381	N/A
---------	----------------	----	----	------	-------	-----

Use as the base for **36" or 42" round tops (model A36R or A42R)**. Shipped RTA (ready to assemble).

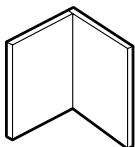

"V" Base

A1616V	16 x 16 x 28.5	60	39	1.10	\$325	N/A
A1616V2	16 x 16 x 28.5	60	74	1.10	\$641	N/A

Use as the base for **rectangular, boat shaped or racetrack tops**. Shipped RTA (ready to assemble).

- **A1616V2** is shipped 2 bases per carton.

Required Specifications

Finish
Edge detail*

Optional Specifications

HP laminate*

A ADAPTABILITIES®

BOARDROOM TABLES

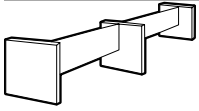

Panel Base

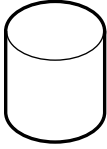

Drum Base

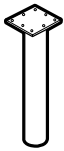

Mono Post

MODEL#	DIMENSIONS	FREIGHT CLASS	WT./LBS.	CUBIC FT.	LIST PRICE	HP ADD
--------	------------	---------------	----------	-----------	------------	--------

D x W x H

A2488PB	24 x 88 x 28.5	70	119	6	\$1020	N/A
A2445PB	24 x 45 x 28.5	70	76	4.30	\$665	N/A

Use as the base for **rectangular, boat shaped or racetrack tops**. Shipped RTA (ready to assemble).

- Use **A2488PB** for 120 - 144" wide tops.
- Use **A2445PB** for 72 - 96" wide tops.

A18Z	18 x 18 x 28.5	250	29	7.50	\$715	N/A
------	----------------	-----	----	------	--------------	-----

Use as the base for **36" or 42" round tops (model A36R or A42R)** and **72", 96", 120" or 144" wide tops**. **Available in Black finish only.**

- All Drum Bases require approx. 125 lb. of sand in each base for adequate stability. Sand not included.

A5L	5 x 5 x 28.5	100	13	1.50	\$312	N/A
-----	--------------	-----	----	------	--------------	-----

Use as the base for **48" (model A48R) round tops** and **72", 96", 120" or 144" wide tops**.

- Post is shipped in separate carton. Standard in Black (**TBL**); Tungsten is available at no charge, please specify (**TTU**).

BOARDROOM ACCESSORIES



Serving Cart*

MODEL#	DIMENSIONS	FREIGHT CLASS	WT./LBS.	CUBIC FT.	LIST PRICE	HP ADD
--------	------------	---------------	----------	-----------	------------	--------

A2036SK	20 x 36 x 36.5	100	179	19	\$2131	\$159
---------	----------------	-----	-----	----	---------------	--------------

Includes **two** side opening, self-closing hinged doors, **two box drawers**, one slide-out tray and storage shelf. On casters.

- Available with the **Bicut Edge** at no upcharge. Please Specify "**AR**".
- Black handles are standard. Silver is available at no charge, please specify as **SI**.

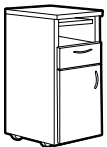

Serving Cart*

A2020SK	20 x 20 x 36	92.5	114	11	\$1337	\$108
---------	--------------	------	-----	----	---------------	--------------

Includes **one** side opening, self-closing hinged door, **one box drawer**, one slide-out tray and storage shelf. On casters.

- Available with the **Bicut Edge** at no upcharge. Please Specify "**CR**".
- Black handles are standard. Silver is available at no charge, please specify as **SI**.

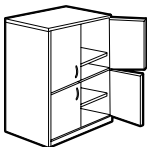

Audio/Visual Cabinet*

A2436AV	24 x 36 x 65.5	65	272	11.25	\$2436	N/A
---------	----------------	----	-----	-------	---------------	-----

Includes **four** side opening doors covering two adjustable and two fixed shelves. Wire access through one grommet on back panel. Holds up to 27"H TV monitor. Shipped RTA (ready to assemble).

- Black handles are standard. Silver is available at no charge, please specify as **SI**.

Required Specifications

Top finish *
Base finish
Handles*

Optional Specifications

Key #*
HP laminate*

BOARDROOM ACCESSORIES

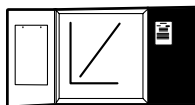

Visual Board

MODEL#	DIMENSIONS	FREIGHT CLASS	WT./LBS.	CUBIC FT.	LIST PRICE	HP ADD
--------	------------	---------------	----------	-----------	------------	--------

D x W x H

AVB4848	4 x 48 x 48	70	135	9	\$1527	N/A
---------	-------------	----	-----	---	---------------	-----

Includes white board and two side opening doors containing cork board on right door and 50-sheet paper writing pad on left door. Marker board can be used for projection. Set of 4 dry markers and eraser included.

- **NOTE:** Care should be taken to mount the units. Units should be mounted to wall studs using correct fasteners. Failure to do so may result in collapse of the unit and subsequent personal injury. Mounting hardware not included. Mounting hardware used should be based on wall material. Consult an installation professional for proper wall mounting.

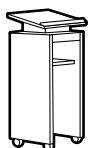

Lectern*

A1844LC	18 x 24 x 44	70	92	4.80	\$817	\$108
---------	--------------	----	----	------	--------------	--------------

Features angled stand, storage shelf and casters. Shipped RTA (ready to assemble).

Required Specifications

Top finish
Base finish

Optional Specifications

HP laminate*



The **Genoa**® series combines the value of laminate furniture with the contemporary styling of top over end panel design. This versatile offering of components and wide selection of laminate finish options is the perfect complement to any office environment.

For added security of confidential material, all desks and credenzas are equipped with one locking pedestal. Genoa's kneespace credenza easily accommodates a computer, books, binders and files to maximize space.

Genoa features quality construction with the added strength of dovetailed box and file drawers. Fully progressive ball bearing suspensions ensure years of smooth, trouble-free drawer service.

Genoa's classic styling and simplicity integrate easily with existing furnishings and any interior decor. For new offices or current office expansions, Genoa is clearly the affordable and practical choice.

Features and Benefits

- 45lb. density particle board substructure with high performance thermally fused laminate
- Available bow front desk provides extra legroom and work area for visitors
- ¾ modesty panel is standard
- Most components shipped fully assembled, 1 per carton
- Pencil tray included in box drawer
- Box drawers mounted on ¾ extension steel ball bearings
- All drawers feature French dovetail joint in front and lapjoint in back
- Drawers open with side pull
- Compatible with **Divide** panel system for increased privacy and storage requirements

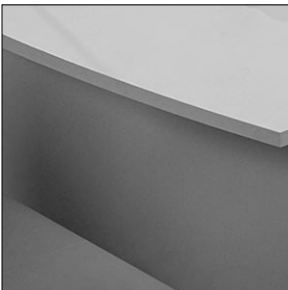

Bow front available on 36" x 72" desks



Contemporary top-over-end panel design



Drawer fronts are edge banded on all sides

GENERAL INFORMATION

- Constructed of 45 lb. density particle board with high performance thermally fused laminate
- Genoa components are compatible with **Divide** partitioning panels.
- Large offering of extended corners, full to floor pedestals, islands and storage options
- Double wall pedestal housing
- Genoa desk and storage products have been tested and comply with all BIFMA mechanical tests.
- For environmental certifications, please visit globalfurnituregroup.com

CONSTRUCTION

- 1" worksurfaces constructed of 45 lb. density particleboard with high performance thermally fused laminate
- Double wall pedestal housing
- Panel end style with top over side panel design
- 1" adjustable leveling glides standard on all units
- Standard with locks

MODESTY PANELS

- Recessed ¾ height modesty panel is standard. Full modesty panel available. **Add \$69.**
- All full to floor units, bridges and returns are standard with a full modesty panel

STORAGE

- All lateral file drawer fronts feature the woodgrain running in a horizontal direction
- Pencil tray included in box drawer
- All drawers feature French dovetail joint in front and lapjoint in back

FINISHES

LAMINATE FINISHES

ACJ Absolute Acajou	NGL Noce Grigio
ASN Asian Night	NEL Noce Leggero
AWC Avant Cherry	NML Noce Medio
AWH Avant Honey	QTM Quartered Mahogany
BLK Black	SOG Storm Grey
BRC Brushed Cobalt	TFW Tiger Fruitwood
CMB Clear Maple	TWL Tiger Walnut
DES Dark Espresso	WHE Walnut Heights
DWT Designer White	WHC White Chocolate
HGT Hayden Grey	WGY Willow Grey
NBL Noce Biondo	WCR Winter Cherry

GROMMETS

- Grommets may be ordered on Genoa hutch back panel
- Additional grommets available in standard worksurface locations (left, center or right). Order as: **AG1, AG2 or AG3. Add \$88.**
- Grommet hole dimensions are 3 ¼" wide x 1 7/8" deep



- Actual grommet locations on the worksurface are depicted in the example drawings shown below. Dimensions shown are actual measurements (in inches).

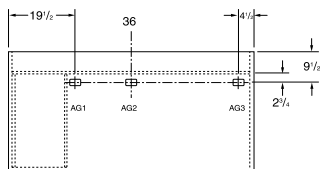

36 x 72 single pedestal left desks (3672SPL)

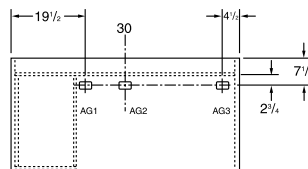

30 x 60 single pedestal left desks (3060SPL)

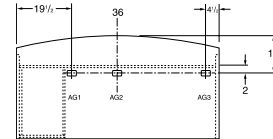

36 x 72 single pedestal left bow top desks (3672SLB)

- Grommets may be placed at non-standard locations. Order as: **AGS - Add \$88.** A drawing must be supplied with vertical and horizontal dimensions to the center of the cut-out (as in drawing above). Please refer to CUSTOM GROMMET LOCATION FORM in the back reference section.
- Components that come standard with grommet may be ordered without a grommet. **Add \$49.**
- Grommets are available on modesty panels of **5-sided corners** 6 ½" in where the two modesty panels meet at a 90° angle. Please specify **FOGMPL** for right grommet placement and **FOGMPL** for left grommet (placement is as shown on diagrams below). Cost is **\$88.**

*Modesty Panels are 1" off of ground

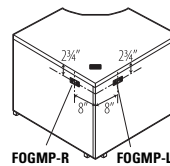

5-Sided Corner Unit

POWER BLOCK

- A Power Block (model **PMSPPDM**) may be ordered on all worksurfaces
- A Power Block is a rectangular worksurface power/data module with one electrical duplex receptacle and two data (RJ45) receptacles. 9 foot black cord included. Power Block dimensions are 3 ½" deep x 6 ½" wide x 2 ¾" high.
- To purchase a Power Block, you must specify both the Power Block cut-out location and the Power Block model #. Order Power Block as **PMSPPDM, Add \$330.** Power Blocks are available in standard worksurface locations (left, center or right). Order as **E1, E2 or E3. Add \$88.**

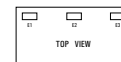

Power Block **PMSPPDM. Add \$330** Specify location **E1, E2 or E3. Add \$88.**

DOUBLE PEDESTAL DESKS

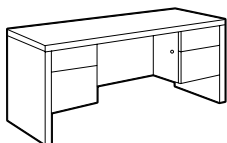

Double Pedestal Desk

MODEL#	DIMENSIONS D x W x H	FREIGHT CLASS	WT/LBS.	CUBIC FT.	LIST PRICE
G3672DP	36 x 72 x 29	150	286	50.50	\$1274
G3072DP	30 x 72 x 29	150	245	43.75	\$1241
G3066DP	29.69 x 66 x 29	150	235	39.25	\$1205
G3060DP	29.69 x 60 x 29	125	226	35.50	\$1011

Standard with box/file pedestals on both sides. Pedestals lock. One pencil tray.

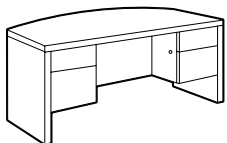

Double Pedestal Bow Top Desk

G3672DPB	32-36 x 72 x 29	150	256	50.50	\$1562
----------	-----------------	-----	-----	-------	---------------

Standard with box/file pedestals on both sides and bow top. Pedestals lock. One pencil tray.

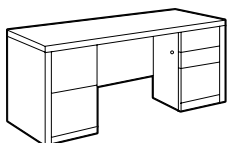

Full to Floor Double Pedestal Desk

G3072D4	29.69 x 72 x 29	125	277	43.75	\$1625
---------	-----------------	-----	-----	-------	---------------

Standard with full to floor box/file on right pedestal and file/file on left pedestal. Pedestals lock. One pencil tray.

SINGLE PEDESTAL DESKS

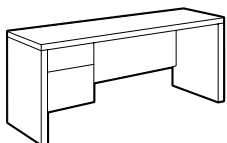

Single Pedestal Desk - LEFT

G3672SPL	36 x 72 x 29	150	235	50.50	\$1158
G3072SPL	30 x 72 x 29	150	192	43.75	\$1099
G3066SPL	29.69 x 66 x 29	150	192	39.25	\$1080
G3060SPL	29.69 x 60 x 29	150	183	35.50	\$893
G3048SPL	29.69 x 48 x 29	150	166	28.75	\$893
G2445SPL	24 x 45 x 29	150	137	23.50	\$698

Standard with box/file pedestal. Pedestal locks. One pencil tray. Pedestal is on the **left**.

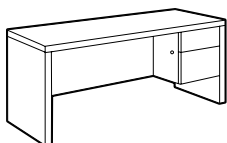

Single Pedestal Desk - RIGHT

G3672SPR	36 x 72 x 29	150	235	50.50	\$1158
G3072SPR	30 x 72 x 29	150	192	43.75	\$1099
G3066SPR	29.69 x 66 x 29	150	192	39.25	\$1080
G3060SPR	29.69 x 60 x 29	150	183	35.50	\$893
G3048SPR	29.69 x 48 x 29	150	166	28.75	\$893
G2445SPR	24 x 45 x 29	150	137	23.50	\$698

Standard with box/file pedestal. Pedestal locks. One pencil tray. Pedestal is on the **right**.

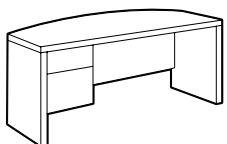

Single Pedestal Bow Top Desk - LEFT

G3672SLB	32-36 x 72 x 29	150	270	50	\$1429
----------	-----------------	-----	-----	----	---------------

Standard with box/file pedestal on **left** and bow top. Pedestal locks. One pencil tray.

Required Specifications

Finish

Optional Specifications

Full modesty
Grommet
Key #

Accessories

Power block
Keyboard tray
Pencil tray

SINGLE PEDESTAL DESKS

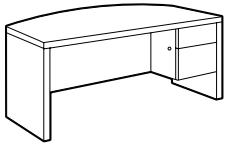

Single Pedestal Bow Top Desk - RIGHT

MODEL#	DIMENSIONS	FREIGHT CLASS	WT/LBS.	CUBIC FT.	LIST PRICE
--------	------------	---------------	---------	-----------	------------

D x W x H

G3672SRB	36 x 72 x 29	150	270	50	\$1429
----------	--------------	-----	-----	----	---------------

Standard with box/file pedestal on **right** and bow top. Pedestal locks. One pencil tray.

RETURNS

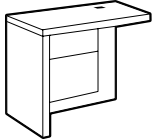

Typing Return - LEFT

G2448SDL	24 x 48 x 26	150	137	23.50	\$719
G2040SDL	20 x 40 x 26	125	111	17.50	\$698

Standard with box/file pedestal and lower **26" height**. Pedestal locks. Grommet in worksurface. Pedestal is on the **left**.

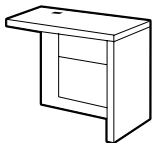

Typing Return - RIGHT

G2448SDR	24 x 48 x 26	150	137	23.50	\$719
G2040SDR	20 x 40 x 26	125	111	17.50	\$698

Standard with box/file pedestal and lower **26" height**. Pedestal locks. Grommet in worksurface. Pedestal is on the **right**.

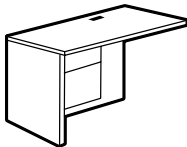

Flush Return - LEFT

G2454FL	24 x 54 x 29	150	127	27	\$873
G2448FL	24 x 48 x 29	125	142	23.50	\$775
G2442FL	24 x 42 x 29	150	111	21.50	\$747
G2054FL	20 x 54 x 29	150	114	23	\$873
G2048FL	20 x 48 x 29	150	107	20.50	\$775
G2042FL	20 x 42 x 29	150	100	18	\$747
G2040FL	20 x 40 x 29	125	115	17.50	\$737
G2036FL	20 x 36 x 29	125	93	15.50	\$737

Standard with box/file drawer pedestal. Pedestal locks. Grommet in worksurface. Pedestal is on the **left**.

- For 24" deep worksurfaces, order **G24__FL**. For 20" deep worksurfaces, order **G20__FL**.
- Keyboard and pencil trays for use on units 42" and above

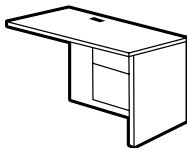

Flush Return - RIGHT

G2454FR	24 x 54 x 29	150	127	27	\$873
G2448FR	24 x 48 x 29	125	142	23.50	\$775
G2442FR	24 x 42 x 29	150	111	21.50	\$747
G2054FR	20 x 54 x 29	150	114	23	\$873
G2048FR	20 x 48 x 29	150	107	20.50	\$775
G2042FR	20 x 42 x 29	150	100	18	\$747
G2040FR	20 x 40 x 29	125	115	17.50	\$737
G2036FR	20 x 36 x 29	125	93	15.50	\$737

Standard with box/file drawer pedestal. Pedestal locks. Grommet in worksurface. Pedestal is on the **right**.

- For 24" deep worksurfaces, order **G24__FR**. For 20" deep worksurfaces, order **G20__FR**.
- Keyboard and pencil trays for use on units 42" and above

Required Specifications

Finish

Optional Specifications

Key #

Accessories

Power block
Keyboard tray
Pencil tray

RETURNS

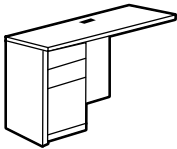

Full to Floor Flush Return - LEFT

MODEL#	DIMENSIONS D x W x H	FREIGHT CLASS	WT./LBS.	CUBIC FT.	LIST PRICE
G2448BL4	24 x 48 x 29	150	136	25	\$1125
G2442BL4	24 x 42 x 29	150	128	21.50	\$1110
G2436BL4	24 x 36 x 29	125	120	18	\$1087
G2048BL4	20 x 48 x 29	150	121	20.50	\$1095
G2042BL4	20 x 42 x 29	125	114	18	\$1068
G2036BL4	20 x 36 x 29	125	108	15.50	\$1049

Standard with box/box/file drawer pedestal. Lower box drawer and file drawer lock. Grommet in worksurface. Pedestal is on the **left**.

- For 24" deep worksurfaces, order **G24__BL4**. For 20" deep worksurfaces, order **G20__BL4**.
- Keyboard and pencil trays for use on units 42" and above

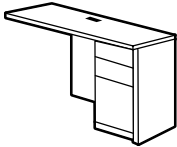

Full to Floor Flush Return - RIGHT

G2448BR4	24 x 48 x 29	150	136	25	\$1125
G2442BR4	24 x 42 x 29	150	128	21.50	\$1110
G2436BR4	24 x 36 x 29	125	120	18	\$1087
G2048BR4	20 x 48 x 29	150	121	20.50	\$1095
G2042BR4	20 x 42 x 29	125	114	18	\$1068
G2036BR4	20 x 36 x 29	125	108	15.50	\$1049

Standard with box/box/file drawer pedestal. Lower box drawer and file drawer lock. Grommet in worksurface. Pedestal is on the **right**.

- For 24" deep worksurfaces, order **G24__BR4**. For 20" deep worksurfaces, order **G20__BR4**.
- Keyboard and pencil trays for use on units 42" and above

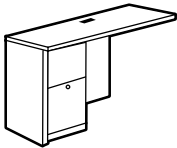

Full to Floor Flush Return - LEFT

G2448L4	24 x 48 x 29	150	132	25	\$1158
G2442L4	24 x 42 x 29	150	124	21.50	\$1136
G2436L4	24 x 36 x 29	125	116	18	\$1117
G2048L4	20 x 48 x 29	150	118	20.50	\$1125
G2042L4	20 x 42 x 29	125	111	18	\$1095
G2036L4	20 x 36 x 29	125	104	15.50	\$1080

Standard with file/file drawer pedestal. Pedestal locks. Grommet in worksurface. Pedestal is on the **left**.

- For 24" deep worksurfaces, order **G24__L4**. For 20" deep worksurfaces, order **G20__L4**.
- Keyboard and pencil trays for use on units 42" and above

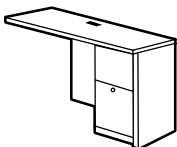

Full to Floor Flush Return - RIGHT

G2448R4	24 x 48 x 29	150	132	25	\$1158
G2442R4	24 x 42 x 29	150	124	21.50	\$1136
G2436R4	24 x 36 x 29	125	116	18	\$1117
G2048R4	20 x 48 x 29	150	118	20.50	\$1125
G2042R4	20 x 42 x 29	125	111	18	\$1095
G2036R4	20 x 36 x 29	125	104	15.50	\$1080

Standard with file/file drawer pedestal. Pedestal locks. Grommet in worksurface. Pedestal is on the **right**.

- For 24" deep worksurfaces, order **G24__R4**. For 20" deep worksurfaces, order **G20__R4**.
- Keyboard and pencil trays for use on units 42" and above

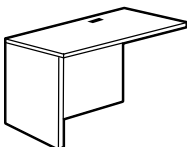

Flush Return - LEFT

G2454EL	24 x 54 x 29	70	87	5.25	\$719
G2448EL	24 x 48 x 29	70	96	4.50	\$622
G2442EL	24 x 42 x 29	70	71	3.80	\$622
G2054EL	20 x 54 x 29	85	78	5.25	\$682
G2048EL	20 x 48 x 29	70	70	4.20	\$641
G2042EL	20 x 42 x 29	70	56	3.30	\$622
G2040EL	20 x 40 x 29	70	78	4.50	\$600
G2036EL	20 x 36 x 29	70	56	3.30	\$600

Return has no pedestal. Grommet in worksurface. Shipped RTA (ready to assemble).

- For 24" deep worksurfaces, order **G24__EL**. For 20" deep worksurfaces, order **G20__EL**.

Required Specifications

Finish

Optional Specifications

Additional grommet
Key #

Accessories

Power block
Keyboard tray
Pencil tray

RETURNS

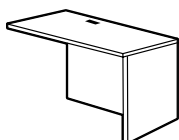

Flush Return - RIGHT

MODEL# DIMENSIONS FREIGHT CLASS WT/LBS. CUBIC FT. LIST PRICE

	D x W x H				
G2454ER	24 x 54 x 29	70	87	5.25	\$719
G2448ER	24 x 48 x 29	70	96	4.50	\$622
G2442ER	24 x 42 x 29	70	71	3.80	\$622
G2054ER	20 x 54 x 29	85	78	5.25	\$682
G2048ER	20 x 48 x 29	70	70	4.20	\$641
G2042ER	20 x 42 x 29	70	63	3.80	\$622
G2040ER	20 x 40 x 29	70	78	4.50	\$600
G2036ER	20 x 36 x 29	70	56	3.30	\$600

Return has no pedestal. Grommet in worksurface. Shipped RTA (ready to assemble).

- For 24" deep worksurfaces, order **G24__ER**. For 20" deep worksurfaces, order **G20__ER**.

FLUSH BRIDGE

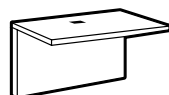

Flush Bridge

G2448FB	24 x 48 x 29	70	78	3.50	\$473
G2442FB	24 x 42 x 29	70	65	3.06	\$457
G2436FB	24 x 36 x 29	70	58	3.50	\$455
G2048FB	20 x 48 x 29	70	71	3.30	\$473
G2042FB	20 x 42 x 29	70	61	4	\$457

Top surface, back panel and hardware to connect two units. Grommet in worksurface. Shipped RTA (ready to assemble).

- **G2448/G2442** models will connect 66" and 72" units plus all D islands.
- **G2048/G2042** models will connect 60", 66" and 72" units plus all D islands and 5 sided corners.

CREDENZAS



Center Storage Credenza*

G2066C	20 x 66 x 29	100	225	27	\$1381
--------	--------------	-----	-----	----	---------------

Standard with box/file pedestals on both sides and self-closing hinged center doors covering one adjustable shelf. Right pedestal and doors lock. One pencil tray.

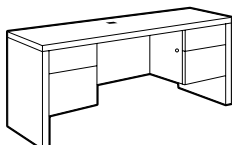

Kneespace Credenza*

G2072CK	20 x 72 x 29	125	209	29.50	\$1274
G2066CK	20 x 66 x 29	125	201	27	\$1205
G2060CK	20 x 60 x 29	125	193	24.50	\$1117

Standard with box/file pedestals on both sides. Center is open. Pedestals lock. One pencil tray. Grommet in worksurface.

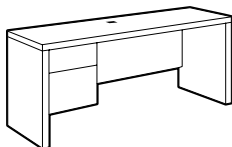

Single Pedestal Credenza - LEFT*

G2072CSL	20 x 72 x 29	150	171	29.50	\$1080
G2066CSL	20 x 66 x 29	150	163	27.75	\$1059
G2060CSL	20 x 60 x 29	125	155	24.50	\$932

Standard with box/file pedestal. Pedestal locks. One pencil tray. Pedestal is on the **left**. Grommet in worksurface.

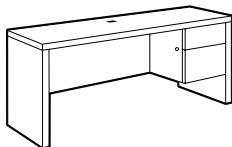

Single Pedestal Credenza - RIGHT*

G2072CSR	20 x 72 x 29	150	150	29.50	\$1080
G2066CSR	20 x 66 x 29	150	150	29.40	\$1059
G2060CSR	20 x 60 x 29	150	136	24.50	\$932

Standard with box/file pedestal. Pedestal locks. One pencil tray. Pedestal is on the **right**. Grommet in worksurface.

Required Specifications

Finish

Optional Specifications

Full modesty*
Grommet
Key #

Accessories

Power block
Keyboard tray
Pencil tray

5-SIDE CORNERS

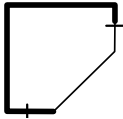
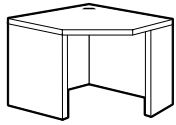

5-Sided Corner

MODEL#	DIMENSIONS D x W x H	FREIGHT CLASS	WT/LBS.	CUBIC FT.	LIST PRICE
G42205C9	42 x 42 x 29	70	123	5.75	\$970
G36205C9	36 x 36 x 29	65	105	4.30	\$823

Connects to lateral file, storage cabinet, single pedestal credenza with half end panel, and flush bridge. Grommet in worksurface. Full and narrow end panels supplied. Can be assembled left or right. Shipped RTA (ready to assemble)

- ¾ Modesty Panel is not available

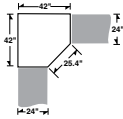
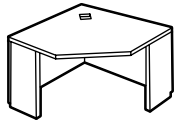

5-Sided Corner

G42245C	42 x 42 x 29	65	114	5	\$984
---------	--------------	----	-----	---	--------------

Connects to **24"** returns, bridges and other **24"** units. Grommet in worksurface. Narrow end panels on left and right. Shipped RTA (ready to assemble).

- ¾ Modesty Panel is not available

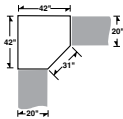
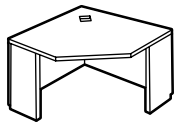

5-Sided Corner

G42205C	42 x 42 x 29	70	108	5	\$953
G36205C	36 x 36 x 29	70	92	4.75	\$844

Connects to **20"** returns, bridges and other **20"** units. Grommet in worksurface. Narrow end panels on left and right. Shipped RTA (ready to assemble).

- ¾ Modesty Panel is not available

"D" ISLANDS

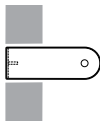
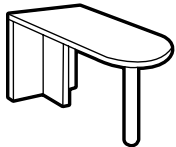

"D" Island - Full End Panel & Post

G3072FI	29.69 x 72 x 29	70	101	5	\$940
G3066FI	29.69 x 66 x 29	70	96	4.60	\$922
G3060FI	29.69 x 60 x 29	70	91	4.20	\$856

Connects to single pedestal credenza with half end panel or bridge to create a "T" grouping. **Not freestanding.** Connecting hardware for flush installation included. Shipped RTA (ready to assemble). Post is Black only.

Required Specifications
Finish

Optional Specifications
Grommet

Accessories
Power Block
Keyboard Tray
Pencil Tray
Doors*

HUTCHES

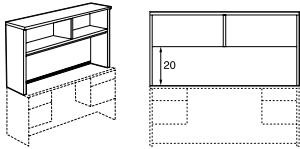

Open Hutch with Closed Back*

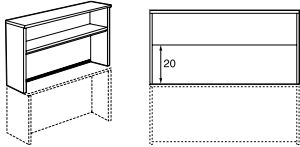

Open Hutch with Closed Back*

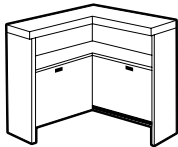

Corner Hutch with Closed Back*

MODEL#	DIMENSIONS	FREIGHT CLASS	WT/LBS.	CUBIC FT.	LIST PRICE
--------	------------	---------------	---------	-----------	------------

D x W x H

G72HOCB	15 x 72 x 36	70	138	7	\$1080
G71HOCB	15 x 71.63 x 36	70	137	7	\$1080
G69HOCB	15 x 69 x 36	70	135	7	\$1080
G66HOCB	15 x 66 x 36	70	133	7	\$1037
G60HOCB	15 x 60 x 36	65	123	5.25	\$932

One 1" thick fixed shelf **and fixed shelf divider**. Closed back features a flexible sweep for wire management. Available in single color only. Rectangular grommet available on back panel - **Add \$88**. Shipped RTA (ready to assemble).

- **G71HOCB** for use when spanning 30" x 60/66" SPL/R and 20/24" x 42" FL/FR/L4/R4.
- **G69HOCB** for use when spanning 30" x 60/66" SPL/R and 20" x 40" FL/FR/EL/ER.
- Clearance from worksurface to hutch doors is 20".
- Woodgrain runs horizontal on both the upper and lower back panels.

G48HOCB	15 x 48 x 36	65	100	4.20	\$747
G42HOCB	15 x 42 x 36	65	91	3.80	\$747
G40HOCB	15 x 40 x 36	65	88	3.80	\$747
G36HOCB	15 x 36 x 36	65	82	3.30	\$659

One 1" thick fixed shelf. Closed back features a flexible sweep for wire management. Available in single color only. Rectangular grommet available on back panel - **Add \$88**. Shipped RTA (ready to assemble).

- Clearance from worksurface to hutch doors is 20".
- Woodgrain runs horizontal on both the upper and lower back panels.

G4242CH	15 x 42 x 36	70	137	6.25	\$1188
G3636CH	15 x 36 x 36	65	119	4.80	\$1080

One 1" thick fixed shelf. Closed back features a flexible sweep for wire management on lower right panel. Available in single color only. Rectangular grommet available on back panel - **Add \$88**. Shipped RTA (ready to assemble).

- Woodgrain runs horizontal on both the upper and lower back panels.

PIGEON HOLE STORAGE

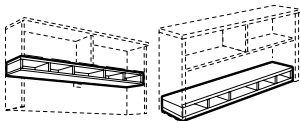

Horizontal Pigeon-Hole Storage

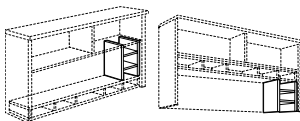

Vertical Pigeon-Hole Storage

AHS72	11.25 x 70 x 5.62	85	41	3	\$646
AHS71	11.25 x 71 x 5.62	70	43.50	2.30	\$646
AHS66	11.25 x 64 x 5.62	85	38	2.80	\$646
AHS60	11.25 x 58 x 5.62	85	35	2.50	\$529
AHS48	11.25 x 46 x 5.62	85	28	2	\$391
AHS42	11.25 x 40 x 5.62	85	24	2	\$391
AHS36	11.25 x 34 x 5.62	92.5	22	2	\$320

For additional storage. Can be **top** or **bottom** mounted. For use inside **straight hutch** (end panels not finished). Shipped RTA (ready to assemble). **Black finish only**.

- Cannot be used on A00S and C00S Overstorage Units.

AVS14	11.25 x 13.37 x 14.37	85	13	.90	\$403
-------	-----------------------	----	----	-----	--------------

For use in conjunction with the Horizontal Pigeon-Hole Storage. Can be used **under** or **over** horizontal unit. Shipped RTA (ready to assemble). **Black finish only**.

Required Specifications

Finish

Accessories

Doors*

HUTCH DOORS

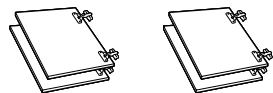

Four-Door Kit

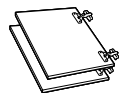

Two-Door Kit

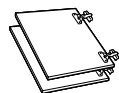

Corner Hutch Two-Door Kit

MODEL#	DIMENSIONS D x W x H	FREIGHT CLASS	WT/LBS.	CUBIC FT.	LIST PRICE
GDOOR72	.69 x 72 x 15	85	24	1.75	\$397
GDOOR71	15.68 x 0 x 15	85	24	1.75	\$397
GDOOR69	15.68 x 0 x 15	85	23	1.75	\$397
GDOOR66	.69 x 66 x 15	85	22	1.75	\$397
GDOOR60	.69 x 60 x 15	92.5	20	1.75	\$397

For use on 72", 71", 69", 66" and 60"W straight hutches. Hinges included. Locks available. Add **\$126** for each lock. Doors for units 60" wide or more require two locks.

GDOOR48	.69 x 48 x 15	100	17	1.75	\$250
GDOOR42	.69 x 42 x 15	100	16	1.75	\$250
GDOOR40	.69 x 40 x 15	100	15	1.75	\$250
GDOOR36	.69 x 36 x 15	100	14	1.75	\$250

For use on 48", 42" 40" and 36"W straight hutches. Hinges included. Locks available. Add **\$126** for each lock. Doors for units 48" wide or less require one lock.

GDOOR42C	15.68 x 0 x 15	92.5	19	1.75	\$426
GDOOR36C	15.68 x 0 x 15	100	16	1.75	\$277

For use on 42" and 36"W corner hutches. Hinges included. **Locks not available on corner hutch doors.**

TACKBOARDS FOR HUTCHES

TACKBOARD Notes: Tackboards can be upholstered in all of the following fabrics:

Grade 1: Jenny, Quilt, Terrace, Urban, Waterfall

Grade 2: Couture, Imprint, Lola, Match, Replay, Silhouette

Grade 3: Anchorage, Merge

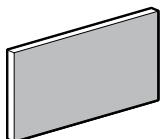

Tackboard

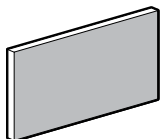

Tackboard

					FABRIC GRADE	LIST PRICE
TB7018	1 x 70 x 18	92.5	12	1.10	1	\$496
					2	\$573
					3	\$631
					4	\$722
					5	\$830

For use on **G72HOCB** straight hutch. Includes mounting screws and covers.

TB6918	1 x 69.5 x 18	92.5	12	1.05	1	\$496
					2	\$573
					3	\$631
					4	\$722
					5	\$830

For use on **G71HOCB** straight hutch. Includes mounting screws and covers.

Required Specifications

Fabric (Tackboards)

TACKBOARDS

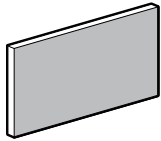

Tackboard

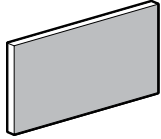

Tackboard

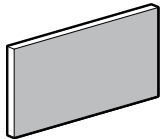

Tackboard

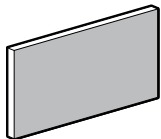

Tackboard

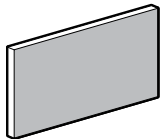

Tackboard

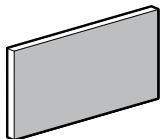

Tackboard

MODEL#	DIMENSIONS	FREIGHT CLASS	WT./LBS.	CUBIC FT.	FABRIC GRADE	LIST PRICE
--------	------------	---------------	----------	-----------	--------------	------------

D x W x H

TB6718	1 x 67.5 x 18	92.5	12	1.05	1	\$496
					2	\$573
					3	\$631
					4	\$722
					5	\$830

For use on **G69HOCB** straight hutch. Includes mounting screws and covers.

TB6418	1 x 64 x 18	92.5	11	1	1	\$446
					2	\$513
					3	\$568
					4	\$649
					5	\$749

For use on **G66HOCB** straight hutch. Includes mounting screws and covers.

TB5818	1 x 58 x 18	92.5	10	.90	1	\$412
					2	\$473
					3	\$523
					4	\$594
					5	\$684

For use on **G60HOCB** straight hutch. Includes mounting screws and covers.

TB4618	1 x 46 x 18	92.5	9	.80	1	\$284
					2	\$336
					3	\$379
					4	\$436
					5	\$502

For use on **G48HOCB** straight hutch. Includes mounting screws and covers.

TB4018	1 x 40 x 18	92.5	8	.70	1	\$275
					2	\$319
					3	\$355
					4	\$407
					5	\$467

For use on **G42HOCB** straight hutch. Includes mounting screws and covers.

TB3818	1 x 38 x 18	92.5	7	.70	1	\$275
					2	\$318
					3	\$353
					4	\$403
					5	\$463

For use on **G40HOCB** straight hutch. Includes mounting screws and covers.

Required Specifications

Fabric

TACKBOARDS

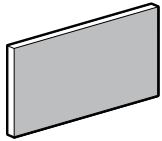

Tackboard

MODEL#	DIMENSIONS D x W x H	FREIGHT CLASS	WT./LBS.	CUBIC FT.	FABRIC GRADE	LIST PRICE
TB3418	1 x 34 x 18	92.5	6	.60	1	\$265
					2	\$306
					3	\$341
					4	\$390
					5	\$448

For use on **G36HOCB** straight hutch. Includes mounting screws and covers.

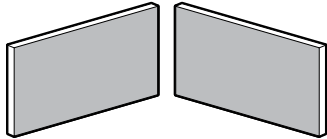

Tackboard

TB42CH	1 x 39-40 x 15	70	16	.85	1	\$496
					2	\$545
					3	\$588
					4	\$649
					5	\$748

For use on **G4242CH corner** hutch. Includes mounting screws and covers.

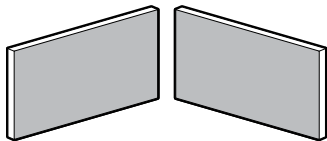

Tackboard

TB36CH	1 x 34 x 15	85	12	.85	1	\$475
					2	\$521
					3	\$557
					4	\$625
					5	\$719

For use on **G3636CH** corner hutch. Includes mounting screws and covers.

ACCESSORY PIECES

LIST PRICE



2 Drawer Lateral File*

G2036LF	20 x 36 x 29	100	145	15	\$1080
---------	--------------	-----	-----	----	---------------

Two full suspension drawers. Front-to-back and side-to-side letter/legal filing capability with lock. Anti-lock tilt suspension.

- To comply with ANSI/BIFMA stability tests, the Lateral File Counter Weight Kit (model "LFCWKIT36") MUST be used.
- *Back of file is always Black.*
- *File drawer construction is for accommodating hanging files NOT for stacking materials on the drawer bottom.*

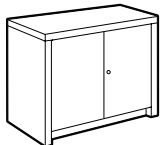

Storage Cabinet*

G2036SC	20 x 36 x 29	100	121	15	\$768
---------	--------------	-----	-----	----	--------------

Hinged doors cover one adjustable shelf. Standard with lock.

- *Back of storage cabinet is always Black.*

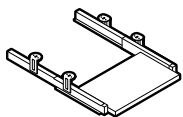

Pull-Out Keyboard

GPOKL28	11 x 28 x 3.5	85	13	.90	\$277
GPOKL22	11 x 22 x 3.5	85	11	.90	\$262

Constructed of thermally fused laminate.

Required Specifications

Fabric (tackboards)
Finish (accessories)

Optional Specifications

Key #*
Grommet (only G2036LF)

ACCESSORIES

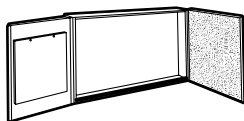

Visual Board

MODEL# DIMENSIONS FREIGHT CLASS WT/LBS. CUBIC FT. LIST PRICE

	D x W x H				
GVB4848	4 x 48 x 48	85	122	9.25	\$1569

Includes white board and two side opening doors containing cork board on right door and 50-sheet paper writing pad on left door. Marker board can be used for projection. Set of 4 dry markers and eraser included.

- **NOTE:** Care should be taken to mount the units. Units should be mounted to wall studs using correct fasteners. Failure to do so may result in collapse of the unit and subsequent personal injury. **Mounting hardware not included.** Mounting hardware used should be based on wall material. Consult an installation professional for proper wall mounting.

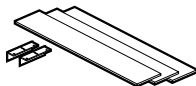

Counter Weight Kit

LFCWKIT36	6 x 33 x 1	60	40	.25	\$698
-----------	------------	----	----	-----	--------------

3 metal plates. Plates mount to the underside of any 36" wide Lateral File or Mixed Storage/Drawer cabinet. Includes mounting hardware. Must be ordered separately. Field installed.

- To comply with ANSI/BIFMA stability tests, the Lateral File Counter Weight Kit MUST be used with the appropriate Lateral Files and Mixed Storage Cabinets.

BOOKCASES

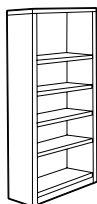

Bookcase - 84" High

MODEL# DIMENSIONS FREIGHT CLASS WT/LBS. CUBIC FT. LIST PRICE

GHBC84	12 x 36 x 84	125	198	26	\$1357
--------	--------------	-----	-----	----	---------------

One fixed heavy duty shelf and **four adjustable shelves**. Shipped fully assembled.

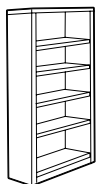

Bookcase - 72" High

GHBC72	12 x 36 x 72	100	173	20	\$1132
--------	--------------	-----	-----	----	---------------

One fixed heavy duty shelf and **four adjustable shelves**. Shipped fully assembled.

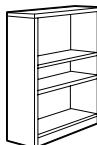

Bookcase - 48½" High

GHBC48	12 x 36 x 48	100	118	13.70	\$832
--------	--------------	-----	-----	-------	--------------

Two adjustable heavy duty shelves. Shipped fully assembled.

Required Specifications

Finish (bookcases)

BOOKCASES

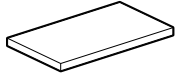

Bookcase Shelf

MODEL# DIMENSIONS FREIGHT CLASS WT/LBS. CUBIC FT. LIST PRICE

	D x W x H				
GHBCSHELF	12 x 34 x 1	100	13	1.60	\$255

Extra shelf for bookcases. 1" thick.

Required Specifications

Finish



The design of Princeton reflects the personality of today's young, dynamic workforce. The freestanding, modular components build out from you and where you work. With over 500 available components, Princeton offers a flexible footprint that's simple to reconfigure. A variety of storage options allows you to do more with less space.

Princeton delivers contemporary design to the workplace; whether it be in Commercial and Corporate offices, Government offices, Small Businesses, Banking, Legal, Accounting, Hospitality or the professional home office. Every element, from the mix of materials and finishes to open storage pieces, floating modesties and overlapping surfaces, has been designed to provide visual appeal and intelligent function. Princeton is a freestanding and fully modular collection offering maximum flexibility; ease of installation and facilitates simple reconfigurations. The overlapping worksurface design also allows the footprint to adapt to smaller spaces by just a few inches.

Features and Benefits

- 1" thick worksurfaces in thermally fused or high pressure laminate
- Worksurfaces feature Global's preferred edging in matching color
- Counterweights standard on all mobile pedestals, lateral files and credenzas
- Handles & pulls in satin anodized finish standard on all credenza, pedestal drawers and cabinet doors
- Monoposts and hutch supports standard in tungsten finish
- Benches double as lateral filing
- Pull-out equipment shelves on select credenzas
- Energy efficient LED lighting for overhead storage cabinets
- Grommets and power blocks to accommodate power/data needs
- Choose glass or fabric equipment screens



Bench doubles as lateral filing



Pull out equipment shelf (printer not included)



Bookshelf with accessory hook

GENERAL INFORMATION

- Over 500 components are available
- No cubicles or panels needed for configurations
- Product can be added and reconfigured as needed
- Princeton desk and storage products have been tested and comply with all BIFMA mechanical tests.
- For environmental certifications, please visit globalfurnituregroup.com.

WORKSURFACES

- 1" thick high performance thermally fused laminate tops sealed with Global's preferred edge detail in matching color
- High Pressure Tops are available in all Princeton laminate finishes at an extended lead time. Please see model # for pricing and availability
- Products specified with the high pressure laminate option are finished on the underside of the surface with a kraft paper backing.
- Worksurfaces with metal legs which have a span of 54" and over are standard with metal support channel. Support channels come in Black (BLK) only. 24"D and 30"D - 1 - 2"H support channel
36"D - 2 - 2"H support channels

CONSTRUCTION

- Laminate end panel and metal leg products are **not intended** to be combined for the most visually compatible design. They are, however, interchangeable if required.
- All components have Global's preferred matching edge
- Leveling glides are standard on all floor units.
- End panels are 1.5" thick on laminate end panel desks and credenzas. Cabinet end panels are 11/16" thick.
- 1" x 2" metal frame legs finished in Tungsten (TTU), Black (TBL) or Designer White (TDW) for desks and returns (closed 'O' style leg)
- 1" x 2.5" metal frame legs finished in Tungsten (TTU), Black (TBL) or Designer White (TDW) for freestanding tables (open 'U' style leg)
- Constructed of 45 lb. density particleboard with high performance thermally fused laminate.
- Mobile pedestals and mobile lateral files come standard with front locking casters
- Counterweights are standard on all pedestals, lateral files, credenzas and cabinets
- Rolling table come standard with non-locking casters
- Laminate shelves are 11/16" thick and edged on all 4 sides.
- Tempered glass is 6mm thick with satin-etched finish on one side.
- Credenzas come standard with file bars for side-to-side and front-to-back letter and legal filing capability.
- Handles and pulls in satin anodized finish are standard on all credenza, pedestal drawers and cabinet doors.
- Pull-out equipment shelves are available on select credenzas.
- Grommets and power blocks are available to accommodate power/data needs.

EDGE DETAILS

- All worksurfaces and components have Global's preferred matching edge detail on all sides
- Edging cannot be specified separately. No substitutions.

STORAGE

- Mobile storage greater than 25.5"H may only be used with 29"H Princeton products with laminate end panels or gables. Princeton products with **metal legs** will not accommodate anything higher than 25.5".
- Roll-out shelf on credenza holds up to 80 lbs
- All cabinets with side open shelf area that aligns with 29"H or 27"H credenzas - fixed shelf is 1" thick
- Recycling/waste drawer accommodates 1 recycling basket and 1 waste basket

LAMINATE MODESTY PANELS

- Standard on all desks with laminate end panels, returns with laminate end panels and bridges for laminate end panel desks.
- Flush on Freestanding Returns with laminate end panels
- Recessed 4"D on 24"D desks with laminate end panels, 5"D on 30"D desks with laminate end panels and 6"D on 36"D desks with laminate end panels.
- Recessed 4"D on 24"D, 5"D on 30"D, and 6"D on 36"D flush and overlapping returns with laminate end panels.
- Recessed 4" on 24"D and 5"D on 30"D flush and overlapping bridges with laminate end panels.
- Desks and returns feature modesty panel that is flush with end panel
- Bottom of laminate modesty panel is 17 3/4" from floor.

GLASS DESKTOP PANELS

- Glass desktop panel is sold separately. See selection on page 77.
- Available for installation onto desks, returns, bridges and conference tops
- Made of 6mm tempered glass with satin-etched finish on one side
- On-site installation is required. Installation instructions will be provided.

FABRIC DESKTOP AND MODESTY PANELS

- Fabric desktop and fabric modesty panels are sold separately. See selection on page 77.
- Available in:
 - Grade 1:** Jenny, Quilt
 - Grade 2:** Lola, Replay, Silhouette
 - Grade 3:** Anchorage, Merge
- On-site installation is required for fabric desktop and fabric modesty panels. Installation instructions will be provided.
- Non-tackable
- Bottom of fabric modesty panel is 15.5" from floor

CREDENZAS

- Available in 29", 27" and 23" heights
- 29"H connect to flush returns, flush conference tops and flush bridges
- 27"H connect to overlapping returns, overlapping conference tops and overlapping bridges
- Fixed drawer widths - see individual models for details
- Upper adjustable shelf must be removed when products with laminate modesty panels are installed (i.e. PN2448RFR flush return with laminate end panel or PN2436BF flush bridge for laminate end panel desk)
- Connection of flush or overlapping surfaces to credenzas is only possible over full height opening
- All credenza tops are 1" thick
- Grommet location is 2.5" from the back edge to the cut out edge

LOCKS

- Standard on all credenzas, storage cabinets, lateral files, pedestals & benches
- Lock on all credenzas, cabinets and pedestals is always on the bottom drawer
- All components within a workstation or private office can be keyed alike. For up to 40 key numbers, the lead times are standard. For projects larger than 40 offices, additional lock numbers are available. Delivery will be extended an additional week at no upcharge.
- To order specified keying, tag each component of each workstation or office with a lock number between 401 and 440.
- Storage cabinets and pedestal with box/box/file drawer - only five drawer and lower box drawer are locking. Credenza file drawer lock secures both drawers.
- Key alike or specific key number optional for all products with locks
- Reserved for new orders greater than \$20,000 list, all Princeton units with locks may be ordered with **CA** cap option and specific lock cores/keys can be ordered separately for field installation rather than specifying duplicate product lines with different key numbers.
- When **CA** option is specified, product will ship with a cap over the empty lock housing.
- Separately order the appropriate number of cores with keys; use product code **SIL-CORE-H-SHOE** for Silver core/key sets or product code **BLK-CORE-H-SHOE** for Black core/key sets. Specify quantity and lock number required. One order line per key number required. Key number range: 401-440. **Must be ordered at the same time product is ordered with CA lock cap option specified.**
- One core removal key is required. Recommend one core removal for every 25 cores ordered. Order as **REMOVE-K-H-SHOE**.
- No charge applies for separate lock cores or core removal keys only when ordered with product. If replacement lock core and key required, contact Customer Care for applicable product code and pricing.

HUTCHES & OVERHEAD STORAGE

- Available in 60", 72" and 84" widths
- Hutches with full back feature one small hole in each corner for wire pass through
- 15.75" height clearance between worksurface and underside of hutch
- Overhead Storage Cabinets have full width lower storage with center divider
- Hutches feature 1" x 2" steel support frame in Black (**TBL**), Designer White (**TDW**) or Tungsten (**TTU**).
- Laminate and tempered glass sliding doors available
- Hutches cannot be placed on desks with laminate end panels
- Wall hung mounting rails are provided; wall fastener hardware is not included.
- Locks are not available
- Energy efficient LED lighting available (page 106)

TABLES

- 1" x 2.5" open metal frame leg. Available finish options: Black (**TBL**), Designer White (**TDW**) or Tungsten (**TTU**).
- Standard with 1" thick top and Global's preferred edging in matching color
- 120" and 144" wide table tops with center leg are shipped in two pieces
- Tables which have a span of 54" or wider are standard with 2"H metal support channel(s)
- Grommets and power block cutouts are available for most tables. Due to support channel location(s) for all 29" high tables, quote request required. Contact our Specials Department.
- Available standard with levelers or locking casters

KEYBOARDS

- Keyboard tray adapter kits are required to accommodate worksurface support channels on the following: freestanding desks with metal legs, returns with metal legs, bridges for desks and returns with metal legs, and returns with bookshelf.

TACKBOARDS

- Tackboards available for hutches and overhead units.
- Available to fit 60", 72" and 84" widths
- Available in:
 - Grade 1:** Jenny, Quilt, Terrace, Urban, Waterfall
 - Grade 2:** Couture, Imprint, Lola, Silhouette
 - Grade 3:** Anchorage, Merge
- Contact customer care for COM selection.

CUSHIONS

- Sold separately.
- Cushions available in all Global seating fabrics. Contact customer care for COM selection and procedure.

CONNECTION

- Metal flat plates and wood screws are provided for connection between two units.

SPECIAL SIZES

- Custom widths, depths and heights are available, but require a custom quote. Please contact Customer Care for more information.
- Custom orders must indicate the "custom quote number" and list price as provided by Customer Care.
- Changes to a custom quote are not permissible. Any revisions will necessitate a new quotation.

TASK LIGHTS

- Optional, energy efficient LED task lights (ultra slim design) are available for mounting under hutches and overheads
- Hutches and overhead storage cabinets are pre-drilled for easy installation
- Available in 12", 20" and 40" widths

WIRE MANAGEMENT

- 2"W x 2"H
- Plastic tray flexes to receive and hold electrical and data wires
- Quickly attaches with double-sided tape (included)

MONOPOST

- Standard support for conference tops; support for select desks and returns
- 4" square post with 10" square base

PLANTERS

- Plastic planter pots provided
- 8½" diameter x 8"H
- Available in Black (**BK**) or White (**WT**). Must specify at time of order.

SHIPPING

- Items are shipped R.T.A. (Ready To Assemble) unless otherwise noted
- Shipped in 1 carton unless otherwise noted
- Connecting hardware included

1. SPECIFY MODEL NUMBER

2. SPECIFY FINISH

Top Finishes:

ACJ	Absolute Acajou
ASN	Asian Night
AWC	Avant Cherry
AWH	Avant Honey
CMB	Clear Maple
DES	Dark Espresso
DWT	Designer White
HGT	Hayden Grey
NBL	Noce Biondo
NGL	Noce Grigio
NEL	Noce Leggero
NML	Noce Medio
TWL	Tiger Walnut
WHE	Walnut Heights
WCR	Winter Cherry
WHC	White Chocolate

Base Finishes:

ACJ	Absolute Acajou
ASN	Asian Night
AWC	Avant Cherry
AWH	Avant Honey
CMB	Clear Maple
DES	Dark Espresso
DWT	Designer White
HGT	Hayden Grey
NBL	Noce Biondo
NGL	Noce Grigio
NEL	Noce Leggero
NML	Noce Medio
TWL	Tiger Walnut
WHE	Walnut Heights
WCR	Winter Cherry
WHC	White Chocolate

Door, Drawer and Cabinet Front Finishes

ACJ	Absolute Acajou
ASN	Asian Night
AWC	Avant Cherry
AWH	Avant Honey
CMB	Clear Maple
DES	Dark Espresso
DWT	Designer White
HGT	Hayden Grey
NBL	Noce Biondo
NGL	Noce Grigio
NEL	Noce Leggero
NML	Noce Medio
TWL	Tiger Walnut
WHE	Walnut Heights
WCR	Winter Cherry
WHC	White Chocolate

Monopost Finishes

4" square monopost is available in Tungsten (TTU), Black (TBL) or Designer White (TDW)

Metal Frame Desk Legs

1" x 2" metal frame legs are available in Tungsten (TTU), Black (TBL) or Designer White (TDW)

For detailed finish specification guidelines, please download the **Princeton Design Guide** at www.globalfurnituregroup.com

Planters

Planter pots are standard in white. Available in Black (BK) at no upcharge. MUST SPECIFY at time of order placement.

Metal Frame Table Legs

1" x 2.5" metal frame legs are available in Tungsten (TTU), Black (TBL) or Designer White (TDW)

3. SPECIFY OPTIONS

GROMMETS

- One grommet in satin anodized finish is standard on many components, as specified
- Additional grommets may be available in other standard worksurface locations (left, center or right)
- Order as: **Left POG1, Center POG2 or Right POG3: Add \$88**

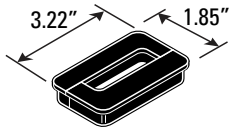

- Worksurface Grommet hole dimensions are 3.22" W x 1.85"D
- Standard grommet position is POG2 in desks, returns, bridges and conference tops
- Modesty panel pass through hole dimensions are 3.43"W x 2"H
- Grommets may be placed at non-standard locations. Order as **PCSG - Add \$88**. A drawing must be supplied with vertical and horizontal dimensions to the center of the cut-out (as in drawing above)
- Components that come standard with grommet may be ordered without a grommet. Order as **RSG - Add \$49**.
- Grommet only available at POG2 on the following 48"W worksurfaces:
 - Desk: PN2448DK, PN3048DK, PN3648DK
 - Return-Flush: PN2448RFR, PN2448RFL

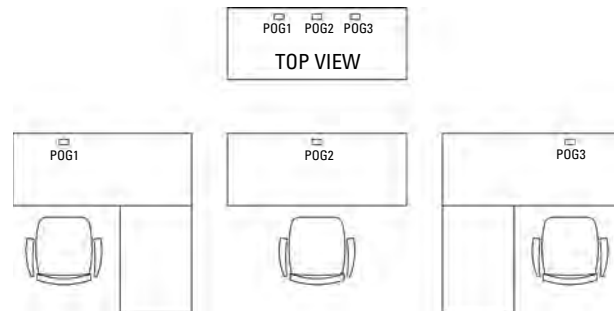

POWER BLOCK

- Power Block (model **PGDPS20**) with 1 power outlet and 1 data opening, 12 foot long power cord, for mounting under worksurfaces or inside of laminate end panels
- Power Block (model **PGDPS21**) with 2 power outlets and 1 data opening, 12 foot long power cord, for mounting under worksurfaces or inside of laminate end panels
- Power Bar (model **PGDPS41**) with 4 power outlets and 1 data opening, 12 foot long power cord, for mounting behind credenza pull-out shelf or at back of credenza opening
- Rectangular shape. Finished in Tungsten (TUN)
- Power Block dimensions:
 - PGDPS20: 2.5"D x 3.5"W x 2.25"H
 - PGDPS21: 2.5"D x 6.75"W x 2.25"H
- Power Bar dimensions:
 - PGDPS41: 2.5"D x 10.25"W x 2.22"H

FREESTANDING DESKS - LAMINATE END PANELS **MODEL#** **DIMENSIONS** **FREIGHT CLASS** **WT./LBS.** **CUBIC FT.** **LIST PRICE** **HP ADD**

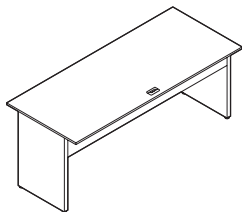

Freestanding Desk

D x W x H							
PN2484DK	24 x 84 x 29	65	117	5	\$956	\$111	
PN2478DK	24 x 78 x 29	70	111	5	\$928	\$110	
PN2472DK	24 x 72 x 29	70	105	5	\$891	\$109	
PN2466DK	24 x 66 x 29	65	101	4	\$880	\$109	
PN2460DK	24 x 60 x 29	65	95	4	\$838	\$109	
PN2454DK	24 x 54 x 29	60	95	3	\$838	\$110	
PN2448DK	24 x 48 x 29	70	84	4	\$803	\$105	
PN3084DK	30 x 84 x 29	70	133	6.50	\$971	\$114	
PN3078DK	30 x 78 x 29	70	127	6	\$945	\$112	
PN3072DK	30 x 72 x 29	70	120	5.50	\$914	\$112	
PN3066DK	30 x 66 x 29	65	114	5	\$887	\$111	
PN3060DK	30 x 60 x 29	70	109	5	\$856	\$109	
PN3054DK	30 x 54 x 29	60	108	3.25	\$856	\$110	
PN3048DK	30 x 48 x 29	65	98	4	\$816	\$109	
PN3684DK	36 x 84 x 29	70	152	8	\$1022	\$126	
PN3678DK	36 x 78 x 29	70	145	7	\$994	\$122	
PN3672DK	36 x 72 x 29	70	138	7	\$976	\$119	
PN3666DK	36 x 66 x 29	70	130	6	\$932	\$112	
PN3660DK	36 x 60 x 29	70	117	6	\$901	\$110	
PN3654DK	36 x 54 x 29	60	120	4	\$901	\$111	
PN3648DK	36 x 48 x 29	70	111.50	6.50	\$825	\$109	

Standard with inset end panel on both ends and 10" h modesty panel with pass through grommet. Connects to flush return with laminate end panel, bridges for laminate end panel desks, flush return with bookshelf, flush conference tops. Can be placed over 27" H freestanding returns or 23" H/27" H credenzas. Grommet in worksurface. Shipped in 2 cartons.

RETURNS - LAMINATE END PANELS **MODEL#** **DIMENSIONS** **FREIGHT CLASS** **WT./LBS.** **CUBIC FT.** **LIST PRICE** **HP ADD**

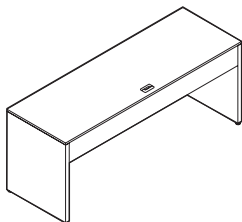

Freestanding Return- 29" H

PN248429R	24 x 84 x 29	65	131	5	\$933	\$125
PN247829R	24 x 78 x 29	65	127	5	\$907	\$120
PN247229R	24 x 72 x 29	65	123	5	\$882	\$114
PN246629R	24 x 66 x 29	65	118	4	\$839	\$111
PN246029R	24 x 60 x 29	65	112	4	\$834	\$109

Standard with flush laminate 1.5" thick end panels. 10" h thick modesty panel without pass through grommet. Connects to flush return with laminate end panel, bridges for laminate end panel desks, flush return with bookshelf, flush conference tops. Can be placed over 27" H freestanding returns or 23" H/27" H credenzas. Grommet in worksurface.

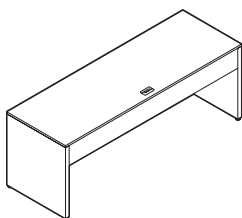

Freestanding Return- 27" H

PN248427R	24 x 84 x 27	65	129	5	\$922	\$121
PN247827R	24 x 78 x 27	65	125	5	\$893	\$117
PN247227R	24 x 72 x 27	65	120	5	\$869	\$112
PN246627R	24 x 66 x 27	65	116	4	\$843	\$110
PN246027R	24 x 60 x 27	65	109	4	\$788	\$108

Standard with flush laminate 1.5" thick end panels. 10" h thick modesty panel without pass through grommet. Supports overlapping return with laminate end panel, overlapping bridge for laminate end panel desks, overlapping return with bookshelf, overlapping conference top. Can be placed under desk. Grommet in worksurface.

Required Specifications

Top finish
Base finish

Optional Specifications

HP laminate
POG1, POG3 - additional grommet
PCSG - custom grommet
RSG - remove grommet

Accessories

Power block Wire manager
Keyboard tray Desktop screen
Keyboard mechanism (not available on 27" H return)

RETURNS - LAMINATE END PANELS

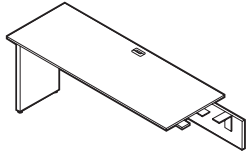

Flush Return - 29" H - LEFT

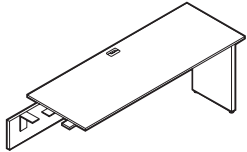

Flush Return - 29" H - RIGHT

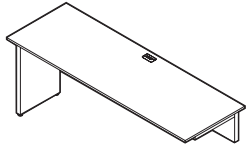

Overlapping Return - 29" H - LEFT

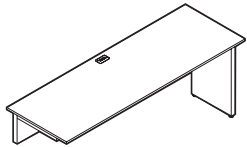

Overlapping Return - 29" H - RIGHT

MODEL#	DIMENSIONS D x W x H	FREIGHT CLASS	WT/LBS.	CUBIC FT.	LIST PRICE	HP ADD
PN2472RFL	24 x 72 x 29	70	95	5.50	\$772	\$119
PN2466RFL	24 x 66 x 29	70	90	5	\$745	\$114
PN2460RFL	24 x 60 x 29	70	84	4.50	\$702	\$110
PN2454RFL	24 x 54 x 29	70	78	4	\$684	\$111
PN2448RFL	24 x 48 x 29	70	72	4	\$653	\$108

Return has no pedestal. Standard with inset end panel on **left**. 10" h modesty panel with pass-through grommet. Connects to Freestanding Desk with laminate end panels, **29" H** Freestanding Returns and **29" H** Credenzas. Grommet in worksurface.

PN2472RFR	24 x 72 x 29	70	95	5.50	\$772	\$119
PN2466RFR	24 x 66 x 29	70	90	5	\$745	\$114
PN2460RFR	24 x 60 x 29	70	84	4.50	\$702	\$110
PN2454RFR	24 x 54 x 29	70	88	4	\$684	\$111
PN2448RFR	24 x 48 x 29	70	72	4	\$653	\$108

Return has no pedestal. Standard with inset end panel on **right**. 10" h modesty panel with pass-through grommet. Connects to Freestanding Desk with laminate end panels, **29" H** Freestanding Returns and **29" H** Credenzas. Grommet in worksurface.

PN2484ROL	24 x 84 x 29	70	118	6	\$856	\$99
PN2478ROL	24 x 78 x 29	65	126	5	\$797	\$98
PN2472ROL	24 x 72 x 29	70	104	5	\$770	\$92

Standard with inset laminate end panel on **left** and 10" h modesty panel with pass-through grommet. Overlaps **27" H** Credenza and **27" H** Freestanding Returns. Grommet in worksurface. 1" spacer included.

PN2484ROR	24 x 84 x 29	70	118	6	\$856	\$99
PN2478ROR	24 x 78 x 29	65	126	5	\$797	\$98
PN2472ROR	24 x 72 x 29	70	104	5	\$770	\$92

Standard with inset laminate end panel on **right** and 10" h modesty panel with pass-through grommet. Overlaps **27" H** Credenza and **27" H** Freestanding Returns. Grommet in worksurface. 1" spacer included.

Required Specifications

Top finish
Base finish

Optional Specifications

HP laminate
POG1, POG3 - additional grommet
PCSG - custom grommet
RSG - remove grommet

Accessories

Power block
Keyboard tray
Desktop screen
Wire manager
Keyboard mechanism

BRIDGES FOR LAMINATE END PANEL DESKS

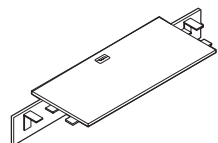

Flush Bridge

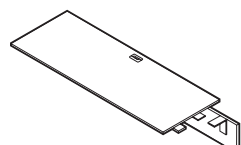

Overlapping Bridge - LEFT*

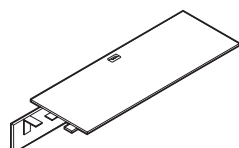

Overlapping Bridge - RIGHT*

MODEL#	DIMENSIONS D x W x H	FREIGHT CLASS	WT/LBS.	CUBIC FT.	LIST PRICE	HP ADD
PN2454BF	24 x 54 x 12	65	97	3.50	\$610	\$98
PN2448BF	24 x 48 x 12	70	77	4.50	\$555	\$85
PN2442BF	24 x 42 x 12	70	70	4	\$529	\$81
PN2436BF	24 x 36 x 12	70	63	4	\$498	\$79

Standard with 10" h modesty panel with pass-through grommet. Connects between any two: Freestanding Desk with laminate end panels, **29" H** Freestanding Returns, Conference top for U configurations or **29" H** Credenzas opening. Subtop finish is Granite with black edge. Grommet in worksurface.

PN2478BOL	24 x 78 x 12	65	119	4	\$729	\$109
PN2472BOL	24 x 72 x 12	70	96	5	\$692	\$100
PN2466BOL	24 x 66 x 12	70	90	4.50	\$668	\$92
PN2460BOL	24 x 60 x 12	70	83	4.50	\$659	\$88

Standard with 10" h modesty panel with pass-through grommet. Connects Freestanding Desk with laminate end panels, **29" H** Freestanding Returns, Conference top for U configurations on one end, and overlaps **27" H** Credenza or **27" H** Freestanding Return on other end. Subtop finish is Granite with black edge. Grommet in worksurface. Includes 1" spacer, one side only.

PN2478BOR	24 x 78 x 12	65	119	4	\$729	\$109
PN2472BOR	24 x 72 x 12	70	96	5	\$692	\$100
PN2466BOR	24 x 66 x 12	70	90	4.50	\$668	\$92
PN2460BOR	24 x 60 x 12	70	83	4.50	\$659	\$88

Standard with 10" h modesty panel with pass-through grommet. Connects Freestanding Desk with laminate end panels, **29" H** Freestanding Returns, Conference top for U configurations on one end, and overlaps **27" H** Credenza or **27" H** Freestanding Return on other end. Subtop finish is Granite with black edge. Grommet in worksurface. Includes 1" spacer, one side only.

Required Specifications

Top finish
Base finish

Optional Specifications

HP laminate
POG1, POG3 - additional grommet*
PCSG - custom grommet
RSG - remove grommet

Accessories

Power block
Keyboard tray
Desktop screen
Wire manager
Keyboard mechanism

FREESTANDING DESKS WITH METAL LEGS

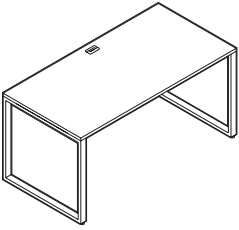

Freestanding Desk with Metal Legs

MODEL#	DIMENSIONS D x W x H	FREIGHT CLASS	WT/LBS.	CUBIC FT.	LIST PRICE	HP ADD
PN2484DM	24 x 84 x 29	250	111	43.41	\$1476	\$234
PN2478DM	24 x 78 x 29	250	109	41.92	\$1365	\$218
PN2472DM	24 x 72 x 29	250	106	38.92	\$1197	\$192
PN2466DM	24 x 66 x 29	250	102	31.44	\$1186	\$190
PN2460DM	24 x 60 x 29	250	91	29.94	\$1160	\$187
PN2454DM	24 x 54 x 29	250	88	29.94	\$1126	\$182
PN2448DM	24 x 48 x 29	250	76	28.44	\$997	\$162
PN3084DM	30 x 84 x 29	250	137	53.89	\$1536	\$242
PN3078DM	30 x 78 x 29	250	124	52.40	\$1427	\$228
PN3072DM	30 x 72 x 29	250	117	47.90	\$1279	\$204
PN3066DM	30 x 66 x 29	250	110	38.92	\$1236	\$197
PN3060DM	30 x 60 x 29	250	104	38.17	\$1197	\$192
PN3054DM	30 x 54 x 29	250	99	37.43	\$1173	\$189
PN3048DM	30 x 48 x 29	250	82	35.93	\$1036	\$168
PN3684DM	36 x 84 x 29	250	154	65.87	\$1743	\$275
PN3678DM	36 x 78 x 29	250	139	62.87	\$1597	\$252
PN3672DM	36 x 72 x 29	250	132	59.88	\$1554	\$244
PN3666DM	36 x 66 x 29	250	123	47.16	\$1362	\$217
PN3660DM	36 x 60 x 29	250	117	46.41	\$1316	\$209
PN3654DM	36 x 54 x 29	250	106	44.91	\$1243	\$198
PN3648DM	36 x 48 x 29	250	92	44.91	\$1125	\$182

Standard with two 1" x 2" metal open frame legs with support channel(s). Connects to flush returns with metal leg, bridges for desks and returns with metal leg, flush return with bookshelf and flush conference tops. Grommet in worksurface. Shipped in 3 cartons.

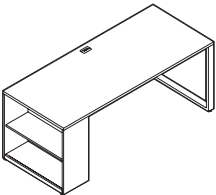

LEFT

Freestanding Desk with Bookshelf*

PN3060DBL	30 x 60 x 29	250	123	51.65	\$1298	\$218
PN3066DBL	30 x 66 x 29	250	129	52.40	\$1434	\$238
PN3072DBL	30 x 72 x 29	250	136	61.38	\$1476	\$241
PN3078DBL	30 x 78 x 29	250	150	65.87	\$1596	\$262
PN3084DBL	30 x 84 x 29	250	156	67.37	\$1682	\$295
PN3672DBL	36 x 72 x 29	250	154	73.35	\$1534	\$241
PN3678DBL	36 x 78 x 29	250	161	76.35	\$1665	\$262
PN3684DBL	36 x 84 x 29	250	176	79.34	\$1876	\$295

12"D Bookcase with adjustable shelf on **left**. One 1" x 2" metal open frame leg with support channel(s). Right side connects to flush returns with metal leg, bridges for desks and returns with metal leg, flush return with bookshelf, flush conference tops. Grommet in worksurface. Shipped in 3 cartons.

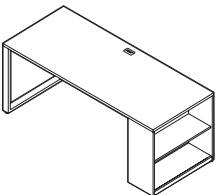

RIGHT

Freestanding Desk with Bookshelf*

PN3060DBR	30 x 60 x 29	250	123	51.65	\$1298	\$201
PN3066DBR	30 x 66 x 29	250	129	52.40	\$1434	\$221
PN3072DBR	30 x 72 x 29	250	136	61.38	\$1476	\$228
PN3078DBR	30 x 78 x 29	250	150	65.87	\$1596	\$240
PN3084DBR	30 x 84 x 29	250	156	67.37	\$1682	\$257
PN3672DBR	36 x 72 x 29	250	154	73.35	\$1534	\$234
PN3678DBR	36 x 78 x 29	250	161	76.35	\$1665	\$252
PN3684DBR	36 x 84 x 29	250	176	79.34	\$1876	\$264

12"D Bookcase with adjustable shelf on **right**. One 1" x 2" metal open frame leg with support channel(s). Left side connects to flush returns with metal leg, bridges for desks and returns with metal leg, flush return with bookshelf, flush conference tops. Grommet in worksurface. Shipped in 3 cartons.

Required Specifications

Top finish
Base finish*
Leg finish*

Optional Specifications

HP laminate
POG1, POG3 - additional grommet
PCSG - custom grommet
RSG - remove grommet

Accessories

Power block Wire manager
Keyboard tray Keyboard mechanism
Desktop screen
Keyboard tray mounting kit*

RETURNS WITH METAL LEGS

MODEL# DIMENSIONS FREIGHT CLASS WT./LBS. CUBIC FT. LIST PRICE HP ADD

D x W x H

PN2448FML	24 x 48 x 29	150	56	12	\$688	\$105
PN2454FML	24 x 54 x 29	150	68	13	\$826	\$126
PN2460FML	24 x 60 x 29	150	71	13	\$867	\$133
PN2466FML	24 x 66 x 29	150	82	14	\$901	\$139
PN2472FML	24 x 72 x 29	150	86	20	\$929	\$144
PN2478FML	24 x 78 x 29	150	89	21	\$1035	\$157

PN3048FML	30 x 48 x 29	150	61	15	\$731	\$112
PN3054FML	30 x 54 x 29	150	78	16	\$862	\$132
PN3060FML	30 x 60 x 29	150	82	16.50	\$903	\$139
PN3066FML	30 x 66 x 29	150	89	17	\$933	\$144
PN3072FML	30 x 72 x 29	150	96	23	\$992	\$151
PN3078FML	30 x 78 x 29	250	103	26	\$1085	\$166

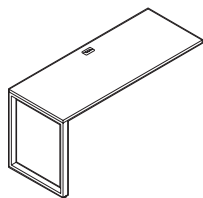

LEFT

Flush Return with Metal Leg

1" x 2" metal frame leg on **left**. Support channel(s) included for units 72"W and above. Connects to freestanding desk with metal legs, freestanding desk with bookshelf and metal leg, 29"H credenza opening. Grommet in worksurface. Shipped in 2 cartons.

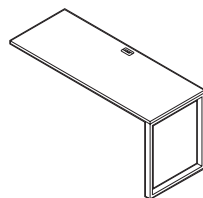

RIGHT

Flush Return with Metal Leg

PN2448FMR	24 x 48 x 29	150	56	12	\$688	\$105
PN2454FMR	24 x 54 x 29	150	68	13	\$826	\$126
PN2460FMR	24 x 60 x 29	150	71	13	\$867	\$133
PN2466FMR	24 x 66 x 29	150	82	14	\$901	\$139
PN2472FMR	24 x 72 x 29	150	86	20	\$929	\$144
PN2478FMR	24 x 78 x 29	150	89	21	\$1035	\$157

PN3048FMR	30 x 48 x 29	150	61	7.50	\$731	\$112
PN3054FMR	30 x 54 x 29	150	78	16	\$862	\$132
PN3060FMR	30 x 60 x 29	150	83	16.50	\$903	\$139
PN3066FMR	30 x 66 x 29	150	89	17	\$933	\$144
PN3072FMR	30 x 72 x 29	150	96	23	\$992	\$151
PN3078FMR	30 x 78 x 29	250	103	26	\$1085	\$166

1" x 2" metal frame leg on **right**. Support channel(s) included for units 72"W and above. Connects to freestanding desk with metal legs, freestanding desk with bookshelf and metal leg, 29"H credenza opening. Grommet in worksurface. Shipped in 2 cartons.

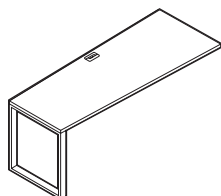

LEFT

Flush Wedge Return w/Metal Leg

PN3048FTL	30 x 48 x 29	150	61	15	\$722	\$111
PN3054FTL	30 x 54 x 29	150	78	16	\$852	\$131
PN3060FTL	30 x 60 x 29	150	83	16.50	\$903	\$139
PN3066FTL	30 x 66 x 29	150	89	17	\$952	\$146
PN3072FTL	30 x 72 x 29	150	96	23	\$992	\$151

1" x 2" metal frame leg on **left**. Support channel(s) included for units 72"W and above. 30"D has 24"D leg. 36"D has 30"D leg. Connects to freestanding desk with metal legs, freestanding desk with bookshelf and metal leg, 29"H credenza opening. Grommet in worksurface. Shipped in 2 cartons.

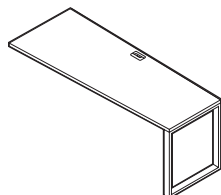

RIGHT

Flush Wedge Return w/Metal Leg

PN3048FTR	30 x 48 x 29	150	61	15	\$722	\$111
PN3054FTR	30 x 54 x 29	150	78	16	\$852	\$131
PN3060FTR	30 x 60 x 29	150	83	16.50	\$903	\$139
PN3066FTR	30 x 66 x 29	150	89	17	\$952	\$146
PN3072FTR	30 x 72 x 29	150	96	23	\$992	\$151

1" x 2" metal frame leg on **right**. Support channel(s) included for units 72"W and above. 30"D has 24"D leg. 36"D has 30"D leg. Connects to freestanding desk with metal legs, freestanding desk with bookshelf and metal leg, 29"H credenza opening. Grommet in worksurface. Shipped in 2 cartons.

Required Specifications

Top finish
Leg finish

Optional Specifications

HP laminate
POG1, POG3 - additional grommet
PCSG - custom grommet
RSG - remove grommet

Accessories

Power block
Keyboard tray
Desktop screen
Keyboard tray mounting kit
Wire manager
Keyboard mechanism

OVERLAPPING RETURNS WITH METAL LEGS

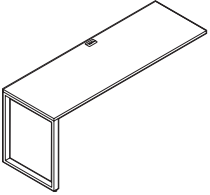

LEFT

Overlapping Return w/Metal Leg

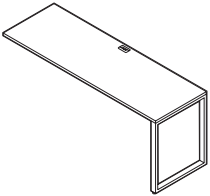

RIGHT

Overlapping Return w/Metal Leg

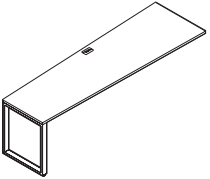

LEFT

Overlapping Wedge Return w/Metal Leg

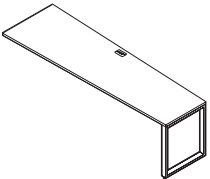

RIGHT

Overlapping Wedge Return w/Metal Leg

MODEL#	DIMENSIONS D x W x H	FREIGHT CLASS	WT./LBS.	CUBIC FT.	LIST PRICE	HP ADD
PN24600ML	24 x 60 x 29	150	71	13	\$773	\$119
PN24660ML	24 x 66 x 29	150	82	14	\$795	\$122
PN24720ML	24 x 72 x 29	150	86	20	\$823	\$126
PN24780ML	24 x 78 x 29	150	89	21	\$980	\$150
PN24840ML	24 x 84 x 29	150	91	22	\$1134	\$173
PN30600ML	30 x 60 x 29	150	83	16.50	\$808	\$123
PN30660ML	30 x 66 x 29	150	89	17	\$837	\$128
PN30720ML	30 x 72 x 29	150	96	23	\$885	\$135
PN30780ML	30 x 78 x 29	250	103	26	\$1050	\$162
PN30840ML	30 x 84 x 29	150	116	27	\$1175	\$179

1" x 2" metal frame leg on **left**. Support channel(s) included for 84"W unit only. Overlaps 27"H credenza opening. Grommet in worksurface. Shipped in 2 cartons.

PN24600MR	24 x 60 x 29	150	71	13	\$773	\$119
PN24660MR	24 x 66 x 29	150	82	14	\$795	\$122
PN24720MR	24 x 72 x 29	150	86	20	\$823	\$126
PN24780MR	24 x 78 x 29	150	89	21	\$980	\$150
PN24840MR	24 x 84 x 29	150	91	22	\$1134	\$173
PN30600MR	30 x 60 x 29	150	83	16.50	\$808	\$123
PN30660MR	30 x 66 x 29	150	89	17	\$837	\$128
PN30720MR	30 x 72 x 29	150	96	23	\$885	\$135
PN30780MR	30 x 78 x 29	250	103	26	\$1050	\$162
PN30840MR	30 x 84 x 29	150	137	27	\$1175	\$179

1" x 2" metal frame leg on **right**. Support channel(s) included for 84"W unit only. Overlaps 27"H credenza opening. Grommet in worksurface. Shipped in 2 cartons.

PN30600TL	30 x 60 x 29	150	83	16.50	\$824	\$126
PN30660TL	30 x 66 x 29	150	89	17	\$854	\$131
PN30720TL	30 x 72 x 29	150	96	23	\$893	\$137
PN30780TL	30 x 78 x 29	250	103	26	\$1068	\$163
PN30840TL	30 x 84 x 29	150	116	27	\$1193	\$182

1" x 2" metal frame leg on **left**. Support channel(s) included for 84"W unit only. 30"D has 24"D leg. 36"D has 30"D leg. Overlaps 27"H credenza opening. Grommet in worksurface. Includes 1" spacer. Shipped in 2 cartons.

PN30600TR	30 x 60 x 29	150	83	16.50	\$824	\$126
PN30660TR	30 x 66 x 29	150	89	17	\$854	\$131
PN30720TR	30 x 72 x 29	150	96	23	\$893	\$137
PN30780TR	30 x 78 x 29	250	103	26	\$1068	\$163
PN30840TR	30 x 84 x 29	150	116	27	\$1193	\$182

1" x 2" metal frame leg on **right**. Support channel(s) included for 84"W unit only. 30"D has 24"D leg. 36"D has 30"D leg. Overlaps 27"H credenza opening. Grommet in worksurface. Includes 1" spacer. Shipped in 2 cartons.

Required Specifications

Top finish
Leg finish

Optional Specifications

HP laminate
POG1, POG3 - additional grommet
PCSG - custom grommet
RSG - remove grommet

Accessories

Power block Wire manager
Keyboard tray Keyboard mechanism
Desktop screen
Keyboard tray mounting kit

OVERLAPPING RETURNS WITH METAL LEGS

MODEL#	DIMENSIONS	FREIGHT CLASS	WT/LBS.	CUBIC FT.	LIST PRICE	HP ADD
D x W x H						
PN2460SOL	24 x 60 x 29	250	83	23.95	\$1135	\$173
PN2466SOL	24 x 66 x 29	250	94	25.45	\$1170	\$179
PN2472SOL	24 x 72 x 29	250	98	34.43	\$1200	\$184
PN2478SOL	24 x 78 x 29	250	101	35.93	\$1304	\$198
PN2484SOL	24 x 84 x 29	250	103	37.43	\$1374	\$209
PN3060SOL	30 x 60 x 29	250	95	26.20	\$1207	\$185
PN3066SOL	30 x 66 x 29	250	101	26.95	\$1243	\$190
PN3072SOL	30 x 72 x 29	250	108	35.93	\$1274	\$193
PN3078SOL	30 x 78 x 29	250	115	40.42	\$1363	\$207
PN3084SOL	30 x 84 x 29	250	128	41.92	\$1454	\$221

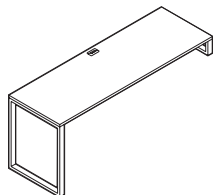

LEFT

Overlapping Return w/Metal Leg and Spacer for 23"H Credenza

1" x 2" metal frame leg on **left** and 5"H metal frame spacer on right. Support channel(s) included for units 78"W and above. Overlaps 23"H credenza. Grommet in worksurface. Shipped in 3 cartons.

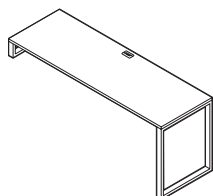

RIGHT

Overlapping Return w/Metal Leg and Spacer for 23"H Credenza

PN2460SOR	24 x 60 x 29	250	83	23.95	\$1135	\$173
PN2466SOR	24 x 66 x 29	250	94	25.45	\$1170	\$179
PN2472SOR	24 x 72 x 29	250	98	34.43	\$1200	\$184
PN2478SOR	24 x 78 x 29	250	101	35.93	\$1304	\$198
PN2484SOR	24 x 84 x 29	250	103	37.43	\$1374	\$209
PN3060SOR	30 x 60 x 29	250	95	26.20	\$1207	\$185
PN3066SOR	30 x 66 x 29	250	101	26.95	\$1243	\$190
PN3072SOR	30 x 72 x 29	250	108	35.93	\$1274	\$193
PN3078SOR	30 x 78 x 29	250	115	40.42	\$1363	\$207
PN3084SOR	30 x 84 x 29	250	128	41.92	\$1454	\$221

1" x 2" metal frame leg on **right** and 5"H metal frame spacer on left. Support channel(s) included for units 78"W and above. Overlaps 23"H credenza. Grommet in worksurface. Shipped in 3 cartons.

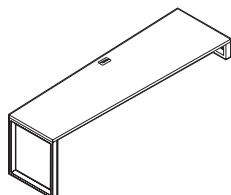

LEFT

Overlapping Wedge Return w/Metal Leg and Spacer for 23"H Credenza

PN3060TSL	30 x 60 x 29	250	95	26.20	\$1186	\$182
PN3066TSL	30 x 66 x 29	250	101	26.95	\$1230	\$189
PN3072TSL	30 x 72 x 29	250	108	35.93	\$1262	\$192
PN3078TSL	30 x 78 x 29	250	115	40.42	\$1351	\$206
PN3084TSL	30 x 84 x 29	250	128	41.92	\$1429	\$218

1" x 2" metal frame leg on **left** and 5"H metal frame spacer on right. Support channel(s) included for units 78"W and above. 24"D leg and 30"D spacer. Overlaps 23"H credenza. Grommet in worksurface. Shipped in 3 cartons.

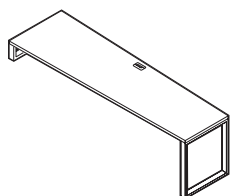

RIGHT

Overlapping Wedge Return w/Metal Leg and Spacer for 23"H Credenza

PN3060TSR	30 x 60 x 29	250	95	26.20	\$1186	\$182
PN3066TSR	30 x 66 x 29	250	101	26.95	\$1230	\$189
PN3072TSR	30 x 72 x 29	250	108	35.93	\$1262	\$192
PN3078TSR	30 x 78 x 29	250	115	40.42	\$1351	\$206
PN3084TSR	30 x 84 x 29	250	128	41.92	\$1429	\$218

1" x 2" metal frame leg on **right** and 5"H metal frame spacer on left. Support channel(s) included for units 78"W and above. 24"D leg and 30"D spacer. Overlaps 23"H credenza. Grommet in worksurface. Shipped in 3 cartons.

Required Specifications

Top finish
Leg finish

Optional Specifications

HP laminate
POG1, POG3 - additional grommet
PCSG - custom grommet
RSG - remove grommet

Accessories

Power block
Keyboard tray
Desktop screen
Keyboard tray mounting kit
Wire manager
Keyboard mechanism

BRIDGES FOR DESKS + RETURNS W/ METAL LEGS

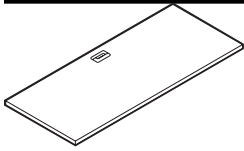

Flush Bridge for Metal Leg Configurations

MODEL#	DIMENSIONS D x W x H	FREIGHT CLASS	WT/LBS.	CUBIC FT.	LIST PRICE	HP ADD
PN2436BFM	24 x 36 x 1	70	31	2	\$325	\$74
PN2442BFM	24 x 42 x 1	70	40	2.50	\$331	\$76
PN2448BFM	24 x 48 x 1	85	44	3	\$348	\$78
PN2454BFM	24 x 54 x 1	70	51	3	\$473	\$104

Connects between any two: freestanding desk with metal legs, freestanding desk with bookshelf and metal leg, conference top for U configurations, 29"H credenza opening. Grommet in worksurface.

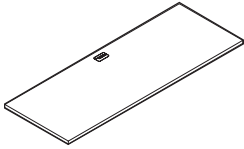

LEFT
Overlapping Bridge for Metal Leg Configurations

PN2460OBL	24 x 60 x 2	70	51	3	\$452	\$94
PN2466OBL	24 x 66 x 2	70	62	3.25	\$467	\$98
PN2472OBL	24 x 72 x 2	92.5	66	6.50	\$476	\$99
PN2478OBL	24 x 78 x 2	92.5	76	6.50	\$645	\$132

Connects freestanding desk with metal legs, freestanding desk with bookshelf and metal leg, conference top for U configurations flush on one end, and overlaps 27"H credenza opening on the other end. Includes 1" spacer. Grommet in worksurface.

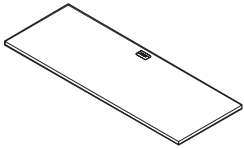

RIGHT
Overlapping Bridge for Metal Leg Configurations

PN2460OBR	24 x 60 x 2	70	51	3	\$452	\$94
PN2466OBR	24 x 66 x 2	70	62	3.25	\$467	\$98
PN2472OBR	24 x 72 x 2	92.5	66	6.50	\$476	\$99
PN2478OBR	24 x 78 x 2	92.5	76	6.50	\$645	\$132

Connects freestanding desk with metal legs, freestanding desk with bookshelf and metal leg, conference top for U configurations flush on one end, and overlaps 27"H credenza opening on the other end. Includes 1" spacer. Grommet in worksurface.

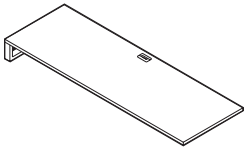

LEFT
Overlapping Bridge with Metal Spacer for 23"H Credenza*

PN2460OSL	24 x 60 x 6	125	63	9	\$746	\$164
PN2466OSL	24 x 66 x 6	125	74	9.50	\$782	\$172
PN2472OSL	24 x 72 x 6	150	78	16	\$809	\$178
PN2478OSL	24 x 78 x 6	150	88	16	\$914	\$199

One 5"H metal frame spacer with support channel(s). Connects flush on **right** side to freestanding desk with metal legs, freestanding desk with bookshelf and metal leg, or conference top for U configurations. Overlaps 23"H credenza opening on the **left**. Grommet in worksurface. Shipped in 2 cartons.

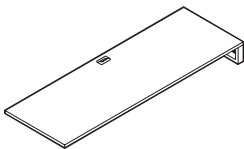

RIGHT
Overlapping Bridge with Metal Spacer for 23"H Credenza*

PN2460OSR	24 x 60 x 6	125	63	9	\$746	\$164
PN2466OSR	24 x 66 x 6	125	74	9.50	\$782	\$172
PN2472OSR	24 x 72 x 6	150	78	16	\$809	\$178
PN2478OSR	24 x 78 x 6	150	88	16	\$914	\$199

One 5"H metal frame spacer with support channel(s). Connects flush on **left** side to freestanding desk with metal legs, freestanding desk with bookshelf and metal leg, or conference top for U configurations. Overlaps 23"H credenza opening on the **right**. Grommet in worksurface. Shipped in 2 cartons.

Required Specifications

Top finish
Leg finish*

Optional Specifications

HP laminate
POG1, POG3 - additional grommet
PCSG - custom grommet
RSG - remove grommet

Accessories

Power block Wire manager
Keyboard tray Keyboard mechanism
Desktop screen
Keyboard tray mounting kit

RETURNS WITH BOOKSHELF

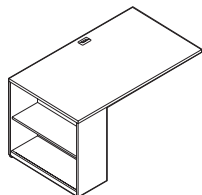

LEFT

Flush Return with Bookshelf

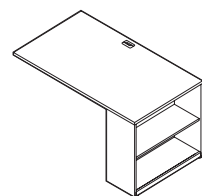

RIGHT

Flush Return with Bookshelf

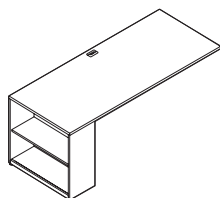

LEFT

Overlapping Return with Bookshelf

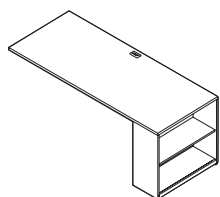

RIGHT

Overlapping Return with Bookshelf

MODEL#	DIMENSIONS D x W x H	FREIGHT CLASS	WT/LBS.	CUBIC FT.	LIST PRICE	HP ADD
PN2460FBL	24 x 60 x 29	150	86	20	\$880	\$134
PN2466FBL	24 x 66 x 29	150	97	20.50	\$1001	\$152
PN2472FBL	24 x 72 x 29	250	101	27	\$1034	\$156
PN2478FBL	24 x 78 x 29	150	111	27	\$1094	\$168
PN2484FBL	24 x 84 x 29	250	106	29	\$1157	\$175
PN3060FBL	30 x 60 x 29	150	102	25.50	\$932	\$144
PN3066FBL	30 x 66 x 29	150	108	26	\$1059	\$162
PN3072FBL	30 x 72 x 29	250	115	32	\$1092	\$167
PN3078FBL	30 x 78 x 29	250	129	35	\$1171	\$179
PN3084FBL	30 x 84 x 29	250	135	36	\$1282	\$194

12"D Bookcase with adjustable shelf on **left**. With support channel(s). Connects on **right** side to freestanding desk with metal legs or laminate end panels, 29"H freestanding returns, 29"H credenza opening. Laminate shelf is standard. Grommet in worksurface. Shipped in 2 cartons.

PN2460FBR	24 x 60 x 29	150	86	20	\$880	\$134
PN2466FBR	24 x 66 x 29	150	97	20.50	\$1001	\$152
PN2472FBR	24 x 72 x 29	250	101	27	\$1034	\$156
PN2478FBR	24 x 78 x 29	150	111	27	\$1094	\$168
PN2484FBR	24 x 84 x 29	250	106	29	\$1157	\$175
PN3060FBR	30 x 60 x 29	150	102	25.50	\$932	\$144
PN3066FBR	30 x 66 x 29	150	108	26	\$1059	\$162
PN3072FBR	30 x 72 x 29	250	115	32	\$1092	\$167
PN3078FBR	30 x 78 x 29	250	129	35	\$1171	\$179
PN3084FBR	30 x 84 x 29	250	135	36	\$1282	\$194

12"D Bookcase with adjustable shelf on **right**. With support channel(s). Connects on **left** side to freestanding desk with metal legs or laminate end panels, 29"H freestanding returns, 29"H credenza opening. Laminate shelf is standard. Grommet in worksurface. Shipped in 2 cartons.

PN2484RBL	24 x 84 x 29	250	106	29	\$1139	\$173
PN2490RBL	24 x 90 x 29	250	110	30	\$1267	\$193
PN2496RBL	24 x 96 x 29	250	123	31	\$1333	\$202
PN3084RBL	30 x 84 x 29	250	135	36	\$1186	\$182
PN3090RBL	30 x 90 x 29	250	142	42	\$1298	\$197
PN3096RBL	30 x 96 x 29	250	146	38.50	\$1368	\$208

12"D Bookcase with adjustable shelf on **left**. With support channel(s). **Right** side overlaps 27"H credenza opening, 27"H freestanding return. Laminate shelf is standard. Grommet in worksurface. Shipped in 2 cartons.

PN2484RBR	24 x 84 x 29	250	106	29	\$1139	\$173
PN2490RBR	24 x 90 x 29	250	110	30	\$1267	\$193
PN2496RBR	24 x 96 x 29	250	123	31	\$1333	\$202
PN3084RBR	30 x 84 x 29	250	135	36	\$1186	\$182
PN3090RBR	30 x 90 x 29	250	142	42	\$1298	\$197
PN3096RBR	30 x 96 x 29	250	146	38.50	\$1368	\$208

12"D Bookcase with adjustable shelf on **right**. With support channel(s). **Left** side overlaps 27"H credenza opening, 27"H freestanding return. Laminate shelf is standard. Grommet in worksurface. Shipped in 2 cartons.

Required Specifications

Top finish
Base finish

Optional Specifications

HP laminate
POG1, POG3 - additional grommet
PCSG - custom grommet
RSG - remove grommet

Accessories

Power block
Keyboard tray
Desktop screen
Keyboard tray mounting kit
Wire manager
Keyboard mechanism

CONFERENCE TOPS - FLUSH

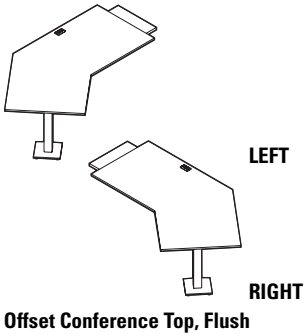

MODEL#	DIMENSIONS D x W x H	FREIGHT CLASS	WT/LBS.	CUBIC FT.	LIST PRICE	HP ADD
PN3066CFL	47 x 66 x 29	150	142	25	\$1132	\$147
PN3072CFL	47 x 72 x 29	92.5	52	5	\$1181	\$139

PN3066CFR	47 x 66 x 29	150	142	25	\$1132	\$147
PN3072CFR	47 x 72 x 29	92.5	52	5	\$1181	\$139

Specify PNxxxxCFL for **LEFT** or PNxxxxCFR for **RIGHT**.

Standard with square monopost and base. Connects to freestanding desks with metal legs or laminate end panels, 29"H freestanding returns, 29"H credenza opening. Subtop finish is Granite with black edge. Grommet in worksurface. Shipped in 2 cartons.

Recommended Maximum Modesty Panel Size:

PN3066CFR/CFL: 36"W (PN3613DMF)
 PN3072CFR/CFL: 42"W (PN4213DMF)

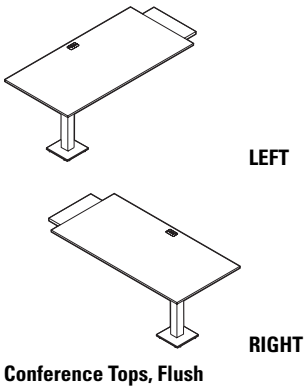

PN2448DFL	24 x 48 x 29	125	55	8.50	\$723	\$104
PN3048DFL	30 x 48 x 29	150	59	5.50	\$772	\$112
PN3060DFL	30 x 60 x 29	125	76	6	\$801	\$117

PN2448DFR	24 x 48 x 29	125	55	8.50	\$723	\$104
PN3048DFR	30 x 48 x 29	150	59	5.50	\$772	\$112
PN3060DFR	30 x 60 x 29	125	76	6	\$801	\$117

Specify PNxxxxDFL for **LEFT** or PNxxxxDFR for **RIGHT**.

Standard with square monopost with base. Connects to Freestanding Desks with metal legs or laminate end panels, 29"H Freestanding Returns or 29"H credenza opening. Subtop finish is Granite with black edge. Grommet in worksurface. Shipped in 2 cartons.

Recommended Maximum Modesty Panel Size:

PN2448DFR/DFL: 30"W (PN3013DMF)
 PN3048DFR/DFL: 30"W (PN3013DMF)
 PN3060DFR/DFL: 36"W (PN3613DMF)

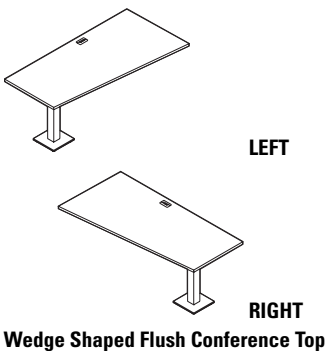

PN3048TFL	30 x 48 x 29	150	59	11	\$772	\$112
PN3060TFL	30 x 60 x 29	125	81	12.50	\$801	\$117

PN3048TFR	30 x 48 x 29	150	59	11	\$772	\$112
PN3060TFR	30 x 60 x 29	125	81	12.50	\$801	\$117

Specify PNxxxxTFL for **LEFT** or PNxxxxTFR for **RIGHT**.

Standard with square monopost with base. 30"D at connecting end, 24"D at monopost end. Connects to Freestanding Desks with metal legs or laminate end panels, 29"H Freestanding Returns or 29"H credenza opening. Subtop finish is Granite with black edge. Grommet in worksurface. Shipped in 2 cartons.

Recommended Maximum Modesty Panel Size:

PN3048TFR/TFL: 30"W (PN3013DMF)
 PN3060TFR/TFL: 36"W (PN3013DMF)

Required Specifications

Top finish
 Monopost finish

Optional Specifications

HP laminate
 PCSG - custom grommet
 RSG - remove grommet

Accessories

Power block
 Keyboard tray
 Desktop screen
 Keyboard tray mounting kit
 Wire manager
 Keyboard mechanism

CONFERENCE TOPS - OVERLAPPING

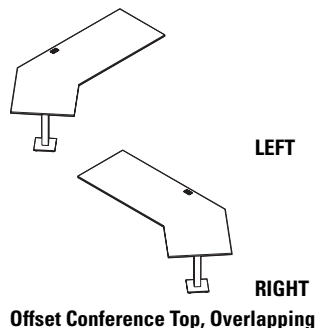

Offset Conference Top, Overlapping

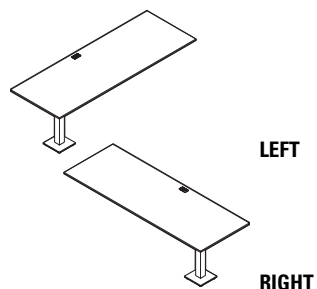

Conference Top, Overlapping

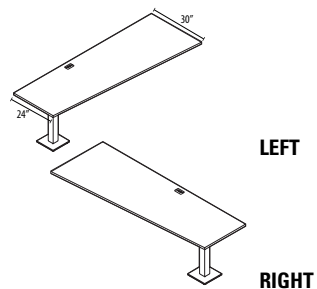

Wedge Shaped Overlapping Conference Top

MODEL#	DIMENSIONS D x W x H	FREIGHT CLASS	WT/LBS.	CUBIC FT.	LIST PRICE	HP ADD
PN3090COL	47 x 90 x 29	150	174	32	\$1276	\$137
PN3096COL	47 x 96 x 29	100	58.50	6.50	\$1289	\$145

PN3090COR	47 x 90 x 29	150	174	32	\$1276	\$137
PN3096COR	47 x 96 x 29	100	58.50	6.50	\$1289	\$145

Specify PNxxxxCOL for **LEFT** or PNxxxxCOR for **RIGHT**.

Standard with square monopost and base. Overlaps **27"H** credenza opening or **27"H** Freestanding Return. Subtop finish is Granite with black edge. Grommet in worksurface. 1" spacer included. Shipped in 2 cartons.

Recommended Maximum Modesty Panel Size:

PN3090COR/COL: 36"W (PN3613DMF)

PN3096COR/COL: 42"W (PN4213DMF)

PN3072DOL	30 x 72 x 29	150	94	19	\$977	\$122
PN3078DOL	30 x 78 x 29	150	101	23	\$996	\$123
PN3084DOL	30 x 84 x 29	92.5	44.50	4	\$1069	\$132

PN3072DOR	30 x 72 x 29	150	94	9.50	\$977	\$122
PN3078DOR	30 x 78 x 29	150	101	23	\$996	\$123
PN3084DOR	30 x 84 x 29	92.5	44.50	4	\$1069	\$132

Specify PNxxxxDOL for **LEFT** or PNxxxxDOR for **RIGHT**.

Standard with square monopost and base. Overlaps **27"H** credenza opening or **27"H** Freestanding Return. Subtop finish is Granite with black edge. Grommet in worksurface. 1" spacer included. Shipped in 2 cartons.

Recommended Maximum Modesty Panel Size:

PN3072DOR/DOL: 30"W (PN3013DMF)

PN3078DOR/DOL: 30"W (PN3013DMF)

PN3084DOR/DOL: 36"W (PN3613DMF)

PN3072TOL	30 x 72 x 29	150	94	19	\$977	\$134
PN3084TOL	30 x 84 x 29	150	114	23	\$1069	\$148

PN3072TOR	30 x 72 x 29	150	94	19	\$977	\$134
PN3084TOR	30 x 84 x 29	150	114	23	\$1069	\$148

Specify PNxxxxDOL for **LEFT** or PNxxxxDOR for **RIGHT**.

Standard with square monopost and base. 30"d at overlapping end, 24"d at monopost end. Overlaps **27"H** Credenza opening or **27"H** Freestanding Return. Grommet in worksurface. 1" spacer included. Shipped in 2 cartons.

Recommended Maximum Modesty Panel Size:

PN3072TOR/TOL: 30"W (PN3013DMF)

PN3084TOR/TOL: 36"W (PN3613DMF)

Required Specifications

Top finish
Monopost finish

Optional Specifications

HP laminate
PCSG - custom grommet
RSG - remove grommet

Accessories

Power block
Keyboard tray
Desktop screen
Keyboard tray mounting kit
Wire manager
Keyboard mechanism

CONFERENCE TOPS FOR U CONFIGURATIONS

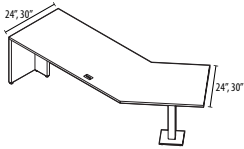

LEFT

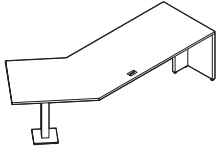

RIGHT

Offset Conference Top, for U Configurations*

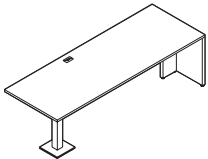

LEFT

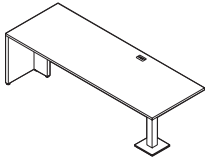

RIGHT

Conference Top for U Configurations*

MODEL#	DIMENSIONS	FREIGHT CLASS	WT/LBS.	CUBIC FT.	LIST PRICE	HP ADD
--------	------------	---------------	---------	-----------	------------	--------

D x W x H						
PN3090CUL	47 x 90 x 29	125	194	32	\$1350	\$186
PN3096CUL	47 x 96 x 29	125	195	32	\$1365	\$187

PN3090CUR	47 x 90 x 29	125	194	32	\$1350	\$186
PN3096CUR	47 x 96 x 29	125	195	32	\$1365	\$187

Specify PNxxxxCUL for **LEFT** or PNxxxxCUR for **RIGHT**.

Standard with T base with square monopost and base. End panel is 1" thick. 1.5" thick support gable extends 12" for end panel. Not freestanding, must be connected. Connects to bridges. Grommet in worksurface. Shipped in 2 cartons.

Recommended Maximum Modesty Panel Size:

PN3090CUR/CUL: 60"W (PN6013DMF)

PN3096CUR/CUL: 66"W (PN6613DMF)

PN3072DUL	30 x 72 x 29	125	114	19	\$1148	\$156
PN3084DUL	30 x 84 x 29	150	134	23	\$1349	\$186

PN3072DUR	30 x 72 x 29	125	114	19	\$1148	\$156
PN3084DUR	30 x 84 x 29	150	134	23	\$1349	\$186

Specify PNxxxxDUL for **LEFT** or PNxxxxDUR for **RIGHT**.

Standard with T base with square monopost and base. End panel is 1" thick. 1.5" thick support gable extends 12" for end panel. Not freestanding, must be connected. Connects to bridges. Grommet in worksurface. Shipped in 2 cartons.

Recommended Maximum Modesty Panel Size:

PN3072DUR/DUL: 48"W (PN4813DMF)

PN3084DUR/DUL: 60"W (PN6013DMF)

DESKTOP/MODESTY PANELS

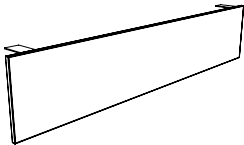

Laminate Modesty Panel

MODEL#	DIMENSIONS	FREIGHT CLASS	WT/LBS.	CUBIC FT.	LIST PRICE
--------	------------	---------------	---------	-----------	------------

PN3013DML	.69 x 30 x 13	85	10	.75	\$376
PN3613DML	.69 x 36 x 13	70	12	.75	\$408
PN4213DML	.69 x 42 x 13	70	14	.75	\$439
PN4813DML	.69 x 48 x 13	70	16	1	\$457
PN5413DML	.69 x 54 x 13	70	18	1	\$512
PN6013DML	.69 x 60 x 13	70	20	1.50	\$600
PN6613DML	.69 x 66 x 13	70	22	1.50	\$618
PN7213DML	.69 x 72 x 13	70	24	1.50	\$639
PN7813DML	.69 x 78 x 13	70	26	1.70	\$750
PN8413DML	.69 x 84 x 13	70	28	1.70	\$929

Attaches to worksurface with black "L" brackets. Laminate modesty panels up to 54"w include two brackets. Panels 60" and wider have three brackets. Specify a nominal size 6" shorter than worksurface size. If using modesty with overlapping worksurface or lower storage, contact Customer Care.

Required Specifications

- Top finish*
- Base finish
- Monopost finish*

Optional Specifications

- HP laminate*
- POG1, POG3 - additional grommet*
- PCSG - custom grommet*
- RSG - remove grommet*

Accessories

- Power block*
- Keyboard tray*
- Desktop screen*
- Keyboard tray mounting kit*
- Wire manager*
- Keyboard mechanism*

DESKTOP AND MODESTY PANELS

Fabric Desktop/Modesty Panel*

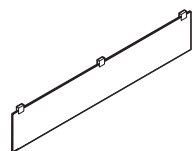

MODEL#	DIMENSIONS D x W x H	FREIGHT CLASS	WT./LBS.	CUBIC FT.	GRADE	LIST PRICE
PN3013DMF	.37 x 30 x 13	250	3	1	1	\$456
					2	\$491
					3	\$517
					4	\$555
PN3613DMF	.37 x 36 x 13	250	3.60	1	1	\$482
					2	\$524
					3	\$556
					4	\$605
PN4213DMF	.37 x 42 x 13	150	4.20	1	1	\$506
					2	\$549
					3	\$583
					4	\$631
PN4813DMF	.37 x 48 x 13	250	4.80	1.50	1	\$519
					2	\$571
					3	\$609
					4	\$667
PN5413DMF	.37 x 54 x 13	250	5.40	1.50	1	\$542
					2	\$600
					3	\$645
					4	\$713
PN6013DMF	.37 x 60 x 13	150	6	1.50	1	\$575
					2	\$634
					3	\$679
					4	\$747
PN6613DMF	.37 x 66 x 13	150	6.60	1.50	1	\$675
					2	\$739
					3	\$794
					4	\$871
PN7213DMF	.37 x 72 x 13	150	7.20	1.75	1	\$718
					2	\$794
					3	\$850
					4	\$937
PN7813DMF	.37 x 78 x 13	150	7.80	1.75	1	\$724
					2	\$806
					3	\$872
					4	\$968

Panels up to 54" w have two clamps. Panels 60" and wider have three clamps. **When used as a modesty panel, specify a nominal size 6" shorter than worksurface size.**

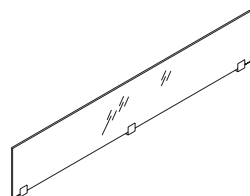

Frosted Glass Desktop Panel

PN3013DG	.25 x 30 x 13	85	10	.75		\$355
PN3613DG	.25 x 36 x 13	70	14	.75		\$371
PN4213DG	.25 x 42 x 13	70	16	.75		\$403
PN4813DG	.25 x 48 x 13	70	20	1		\$419
PN5413DG	.25 x 54 x 13	70	22	1		\$472
PN6013DG	.25 x 60 x 13	70	24	1.50		\$553
PN6613DG	.25 x 66 x 13	70	26	1.50		\$570
PN7213DG	.25 x 72 x 13	70	28	1.50		\$587

Panels up to 54" w have two clamps. Panels 60" and wider have three clamps.

Required Specifications

Fabric*

FELT PANELS **MODEL#** **DIMENSIONS** **FREIGHT CLASS** **WT/LBS.** **CUBIC FT.** **LIST PRICE** **HP ADD**

D x W x H

- 9mm thick panels offered in 9 finishes
- Made from 100% PET (polyester) fiber with a high content (50%) of post-recycled material, free of added chemicals, binders and adhesives
- Lightweight panels are tackable, impact and tear resistant, bacteria resistant, moisture resistant, and installation friendly
- Variation in fiber mix and color are inherent to the character of the product
- Clamps are included. Available in satin anodized finish only.

FELT COLORS

BLK	Black	MTS	Mist
BRI	Brick	PWT	Pewter
DEN	Denim	SHR	Shamrock
GPH	Graphite	WHT	White
HVT	Harvest		

FELT DESKTOP/MODESTY PANELS

MODEL# **DIMENSIONS** **FREIGHT CLASS** **WT/LBS.** **CUBIC FT.** **LIST PRICE**

D x W x H

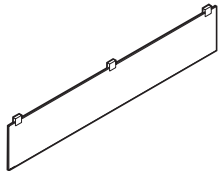

PET Felt Desktop/Modesty Panel, 1 pk.

PN3013PT9-1	.36 x 30 x 12.5	150	2.48	.57	\$183
PN3613PT9-1	.36 x 36 x 12.5	250	2.74	.69	\$192
PN4213PT9-1	.36 x 42 x 12.5	250	2.99	.80	\$261
PN4813PT9-1	.36 x 48 x 12.5	150	3.85	.91	\$272
PN5413PT9-1	.36 x 54 x 12.5	250	4.11	1.03	\$330
PN6013PT9-1	.36 x 60 x 12.5	250	4.36	1.14	\$339
PN6613PT9-1	.36 x 66 x 12.5	150	5.22	1.25	\$408
PN7213PT9-1	.36 x 72 x 12.5	150	5.48	1.36	\$416
PN7813PT9-1	.36 x 78 x 12.5	250	5.73	1.48	\$424

PET Felt Desktop/Modesty Panel available in 9 finishes, please specify. 2, 3 or 4 clamps are included depending on screen size. Clamps available in satin anodized finish only. **When used as a modesty panel, specify a nominal size 6" shorter than worksurface size.**

- Up to 42" w - 2 clamps per panel
- 48"-60" w - 3 clamps per panel
- 66"-78" w - 4 clamps per panel

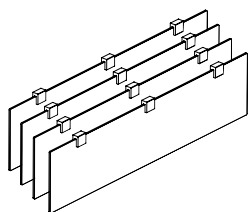

PET Felt Desktop/Modesty Panel, 4 pk.

PN3013PT9-4	0.36 x 30 x 12.5	85	8.93	.60	\$698
PN3613PT9-4	0.36 x 36 x 12.5	85	9.86	.71	\$732
PN4213PT9-4	0.36 x 42 x 12.5	85	10.80	.83	\$1001
PN4813PT9-4	0.36 x 48 x 12.5	85	13.90	.98	\$1036
PN5413PT9-4	0.36 x 54 x 12.5	85	14.80	1.09	\$1267
PN6013PT9-4	0.36 x 60 x 12.5	85	15.70	1.20	\$1298
PN6613PT9-4	0.36 x 66 x 12.5	85	18.80	1.32	\$1566
PN7213PT9-4	0.36 x 72 x 12.5	85	19.70	1.43	\$1597
PN7813PT9-4	0.36 x 78 x 12.5	85	20.60	1.54	\$1628

PET Felt Desktop/Modesty Panel available in 9 finishes, please specify. 2, 3 or 4 clamps are included depending on screen size. Clamps available in satin anodized finish only. **When used as a modesty panel, specify a nominal size 6" shorter than worksurface size.**

- Up to 42" w - 2 clamps per panel
- 48"-60" w - 3 clamps per panel
- 66"-78" w - 4 clamps per panel

Required Specifications

Felt color

FELT DESKTOP/MODESTY PANELS

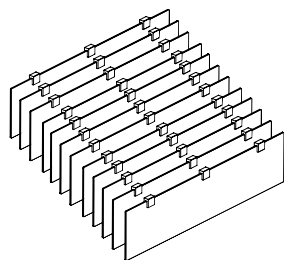

PET Felt Desktop/Modesty Panel, 12 pk.

MODEL# DIMENSIONS FREIGHT CLASS WT/LBS. CUBIC FT. LIST PRICE

	D x W x H				
PN3013PT9-12	0.36 x 30 x 12.5	85	25.30	1.92	\$2049
PN3613PT9-12	0.36 x 36 x 12.5	85	27.90	2.26	\$2148
PN4213PT9-12	0.36 x 42 x 12.5	92.5	30.50	2.60	\$2945
PN4813PT9-12	0.36 x 48 x 12.5	85	39.30	3.05	\$3040
PN5413PT9-12	0.36 x 54 x 12.5	85	41.90	3.39	\$3730
PN6013PT9-12	0.36 x 60 x 12.5	92.5	44.50	3.72	\$3813
PN6613PT9-12	0.36 x 66 x 12.5	85	53.20	4.18	\$4613
PN7213PT9-12	0.36 x 72 x 12.5	85	55.90	4.51	\$4695
PN7813PT9-12	0.36 x 78 x 12.5	85	58.50	4.85	\$4780

PET Felt Desktop/Modesty Panel available in 9 finishes, please specify. 2, 3 or 4 clamps are included depending on screen size. Clamps available in satin anodized finish only. **When used as a modesty panel, specify a nominal size 6" shorter than worksurface size.**

- Up to 42" w - 2 clamps per panel
- 48"-60" w - 3 clamps per panel
- 66"-78" w - 4 clamps per panel

Required Specifications

Felt color

29" H CREDENZAS

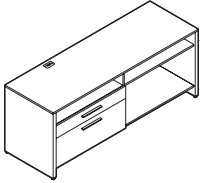

29" H Credenza - LEFT

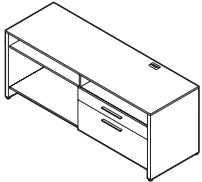

29" H Credenza - RIGHT

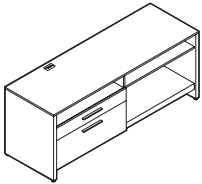

29" H Credenza w/Pull-Out Equipment Tray - LEFT

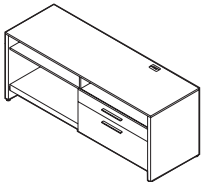

29" H Credenza w/Pull-Out Equipment Tray - RIGHT

MODEL#	DIMENSIONS	FREIGHT CLASS	WT/LBS.	CUBIC FT.	LIST PRICE	HP ADD
--------	------------	---------------	---------	-----------	------------	--------

D x W x H

PN2984CRL	24 x 84 x 29	100	320	33.83	\$1911	\$222
PN2972CRL	24 x 72 x 29	92.5	290	29	\$1811	\$218
PN2966CRL	24 x 66 x 29	100	265	31	\$1792	\$220
PN2960CRL	24 x 60 x 29	92.5	242	24.17	\$1764	\$206

Standard with locking 34"W box and lateral file drawer on **left**. File bars included for front-to-back letter and legal filing capability. Lock on file drawer secures both drawers. Adjustable 5 position shelf. Wire management grommet on surface and internal pass-through behind equipment shelf. Connects to flush returns, flush bridges and flush conference tops. Shipped Fully Assembled.

PN2984CRR	24 x 84 x 29	100	320	33.83	\$1911	\$222
PN2972CRR	24 x 72 x 29	92.5	290	29	\$1811	\$218
PN2966CRR	24 x 66 x 29	100	265	31	\$1792	\$220
PN2960CRR	24 x 60 x 29	92.5	242	24.17	\$1764	\$206

Standard with locking 34"W box and lateral file drawer on **right**. File bars included for front-to-back letter and legal filing capability. Lock on file drawer secures both drawers. Adjustable 5 position shelf. Wire management grommet on surface and internal pass-through behind equipment shelf. Connects to flush returns, flush bridges and flush conference tops. Shipped Fully Assembled.

PN2984CPL	24 x 84 x 29	100	320	33.83	\$2158	\$234
PN2978CPL	24 x 78 x 29	100	310	36	\$2098	\$238
PN2972CPL	24 x 72 x 29	92.5	290	29	\$2047	\$232
PN2966CPL	24 x 66 x 29	100	270	31	\$1969	\$233
PN2960CPL	24 x 60 x 29	92.5	242	24.17	\$1919	\$212

Standard with locking 34"W box and lateral file drawer on **left**. File bars included for front-to-back letter and legal filing capability. Lock on file drawer secures both drawers. Adjustable 5 position shelf. Pull-out equipment shelf can support up to 80lbs. Wire management grommet on surface and internal pass-through behind equipment shelf. Connects to flush returns, flush bridges and flush conference tops. Shipped Fully Assembled.

PN2984CPR	24 x 84 x 29	100	320	33.83	\$2158	\$234
PN2978CPR	24 x 78 x 29	100	310	36	\$2098	\$238
PN2972CPR	24 x 72 x 29	92.5	290	29	\$2047	\$232
PN2966CPR	24 x 66 x 29	100	270	31	\$1969	\$233
PN2960CPR	24 x 60 x 29	92.5	242	24.17	\$1919	\$212

Standard with locking 34"W box and lateral file drawer on **right**. File bars included for front-to-back letter and legal filing capability. Lock on file drawer secures both drawers. Adjustable 5 position shelf. Pull-out equipment shelf can support up to 80lbs. Wire management grommet on surface and internal pass-through behind equipment shelf. Connects to flush returns, flush bridges and flush conference tops. Shipped Fully Assembled.

Required Specifications

Top finish
Base finish
Drawer front finish

Optional Specifications

HP laminate
RSG - remove grommet

29" H CREDENZAS

MODEL#	DIMENSIONS	FREIGHT CLASS	WT/LBS.	CUBIC FT.	LIST PRICE	HP ADD
--------	------------	---------------	---------	-----------	------------	--------

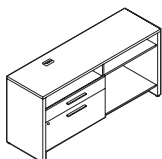

LEFT

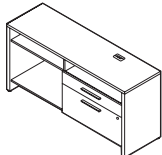

RIGHT

29" H Narrow Credenza*

	D x W x H					
PN2954NCL	20 x 54 x 29	92.5	250	22	\$1745	\$239
PN2960NCL	20 x 60 x 29	92.5	260	24	\$1768	\$241

PN2954NCR	20 x 54 x 29	92.5	250	22	\$1745	\$239
PN2960NCR	20 x 60 x 29	92.5	260	24	\$1768	\$241

Specify PNxxxxNCL for **LEFT** or PNxxxxNCR for **RIGHT**.

20"D. Standard with 30"W box and lateral file drawer. Front-to-back letter and legal filing capability. Lock on file drawer secures both drawers. Adjustable 5 position shelf. Wire management grommet on surface and internal pass-through behind lower shelf. Connects to flush returns, flush bridges and flush conference tops. File bars included. Shipped Fully Assembled.

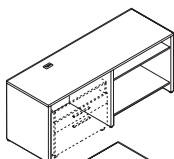

LEFT

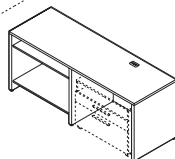

RIGHT

29" H Credenza for Mobile Lateral File

PN2972MCL	24 x 72 x 29	125	252	34	\$1427	\$196
PN2984MCL	24 x 84 x 29	125	268	39.50	\$1540	\$210

PN2972MCR	24 x 72 x 29	125	252	34	\$1427	\$196
PN2984MCR	24 x 84 x 29	125	268	39	\$1540	\$210

Specify PNxxxxMCL for **LEFT** or PNxxxxMCR for **RIGHT**.

Standard with 42" w space for lateral file. Adjustable 5 position shelf. Wire management grommet on surface and internal pass-through behind lower shelf. Connects to flush returns, flush bridges and flush conference tops. Accepts all mobile lateral file units. Shipped Fully Assembled.

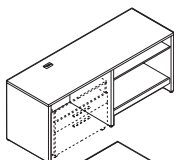

LEFT

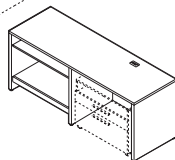

RIGHT

29" H Credenza for Mobile Lateral File w/Pull-Out Equipment Tray*

PN2972MPL	24 x 72 x 29	125	258	34	\$1633	\$222
PN2984MPL	24 x 84 x 29	125	274	39.50	\$1740	\$238

PN2972MPR	24 x 72 x 29	125	258	34	\$1633	\$222
PN2984MPR	24 x 84 x 29	125	274	39.50	\$1740	\$238

Specify PNxxxxMPL for **LEFT** or PNxxxxMPR for **RIGHT**.

Standard with 42" w space for lateral file, adjustable 5 position shelf, and pull-out equipment shelf that can support up to 80lbs. Grommet in worksurface and internal pass-through behind equipment shelf. Connects to flush returns, flush bridges and flush conference tops. Accepts all mobile lateral file units. Shipped Fully Assembled.

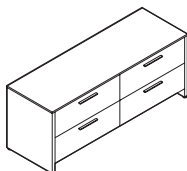

29" H Lateral File Credenza*

PN2972LF	24 x 72 x 29	92.5	290	29	\$2154	\$277
----------	--------------	------	-----	----	--------	-------

Standard with four lateral file drawers. File bars included for front-to-back letter and legal filing capability. Lock on lower drawer secures both drawers. Anti-tip mechanism. Shipped Fully Assembled.

Required Specifications

Top finish
Base finish
Drawer front finish*

Optional Specifications

HP laminate
RSG - remove grommet
Grommet (PN2972LF)

29" H CREDENZAS

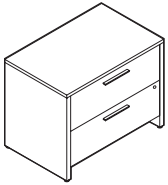

29" H Single Lateral File Credenza*

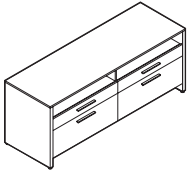

29" H Double Credenza*

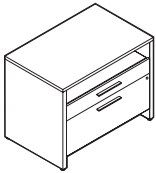

29" H Single Credenza*

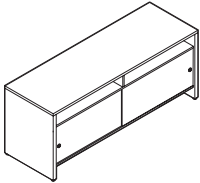

29" H Credenza w/Sliding Laminate Doors*

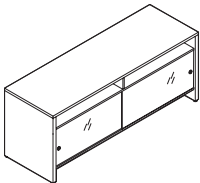

29" H Credenza w/Sliding Glass Doors

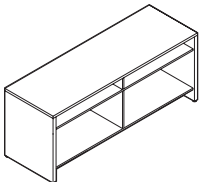

29" H Open Credenza

MODEL#	DIMENSIONS	FREIGHT CLASS	WT/LBS.	CUBIC FT.	LIST PRICE	HP ADD
--------	------------	---------------	---------	-----------	------------	--------

D x W x H

PN2937LFS	24 x 37 x 29	100	155	18	\$1461	\$199
-----------	--------------	-----	-----	----	---------------	--------------

Standard with two lateral file drawers. File bars included for front-to-back letter and legal filing capability. Lock on lower drawer secures both drawers. Anti-tip mechanism. Shipped Fully Assembled.

PN2972CRD	24 x 72 x 29	92.5	290	29	\$2073	\$259
-----------	--------------	------	-----	----	---------------	--------------

Standard with 34" w box and lateral file drawer on each side. File bars included for front-to-back letter and legal filing capability. Lock on file drawer secures both drawers. Shipped Fully Assembled.

PN2937CRS	24 x 37 x 29	100	145	18	\$1461	\$199
-----------	--------------	-----	-----	----	---------------	--------------

Standard with 34" w box and lateral file drawer. File bars included for front-to-back letter and legal filing capability. Lock on file drawer secures both drawers. Shipped Fully Assembled.

PN2960CLS	24 x 60 x 29	100	265	28.25	\$1690	\$232
PN2972CLS	24 x 72 x 29	100	289	34	\$1772	\$241
PN2984CLS	24 x 84 x 29	100	337	39.50	\$1934	\$263

Standard with sliding laminate doors in upper plastic track. Recessed brushed aluminum finger pulls. No lock. Shipped Fully Assembled.

PN2960CGS	24 x 60 x 29	100	265	28.25	\$2133	\$290
PN2972CGS	24 x 72 x 29	100	289	34	\$2360	\$322
PN2984CGS	24 x 84 x 29	100	337	39.50	\$2608	\$355

Standard with sliding glass doors in upper aluminum track. Satin etched 6mm glass. Brushed aluminum finger pulls. No lock. Shipped assembled in 2 cartons. Glass doors shipped separately.

PN2960CO	24 x 60 x 29	92.5	296	28.25	\$1422	\$194
PN2972CO	24 x 72 x 29	100	316	34	\$1507	\$207
PN2984CO	24 x 84 x 29	100	336	39.50	\$1671	\$229

Open storage with adjustable 5 position upper shelves with pass-throughs at back of lower shelves. Connects to flush returns, flush bridges and flush conference tops. Shipped Fully Assembled.

Required Specifications

Top finish
Base finish
Drawer front finish*

Optional Specifications

HP laminate
Grommet

29" H CREDENZAS

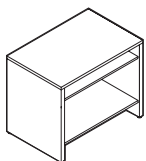

29" H Single Open Credenza**

MODEL#	DIMENSIONS	FREIGHT CLASS	WT./LBS.	CUBIC FT.	LIST PRICE	HP ADD
	D x W x H					
PN2930CO	24 x 30 x 29	92.5	153	15	\$914	\$126
PN2936CO	24 x 36 x 29	100	158	18	\$956	\$132

Open storage with adjustable 5 position upper shelf with pass-through at back of lower shelf. Connects to flush returns, flush bridges and flush conference tops. Shipped Fully Assembled.

27" H CREDENZAS

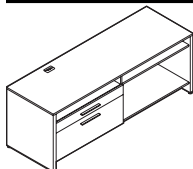

27" H Credenza - LEFT *

MODEL#	DIMENSIONS	FREIGHT CLASS	WT./LBS.	CUBIC FT.	LIST PRICE	HP ADD
PN2760CRL	24 x 60 x 27	92.5	241	22.50	\$1747	\$198
PN2766CRL	24 x 66 x 27	100	262	29	\$1775	\$209
PN2772CRL	24 x 72 x 27	92.5	290	27	\$1792	\$209
PN2778CRL	24 x 78 x 27	100	290	34	\$1847	\$219
PN2784CRL	24 x 84 x 27	92.5	335	31.50	\$1893	\$217

Standard with locking 34"W box and lateral file drawer on **left**. File bars included for front-to-back letter and legal filing capability. Lock on file drawer secures both drawers. Adjustable 5 position shelf. Wire management grommet on surface and internal pass-through behind equipment shelf. Supports overlapping returns, bridges, and conference tops that have a 1" spacer (example: PN24600MR). Cannot nest under 29"H products with metal legs. Shipped Fully Assembled.

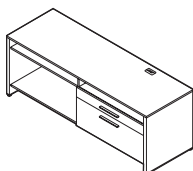

27" H Credenza - RIGHT *

PN2760CRR	24 x 60 x 27	92.5	241	22.50	\$1747	\$198
PN2766CRR	24 x 66 x 27	100	262	29	\$1775	\$209
PN2772CRR	24 x 72 x 27	92.5	290	27	\$1792	\$209
PN2778CRR	24 x 78 x 27	100	290	34	\$1847	\$219
PN2784CRR	24 x 84 x 27	92.5	335	31.50	\$1893	\$217

Standard with locking 34"W box and lateral file drawer on **right**. File bars included for front-to-back letter and legal filing capability. Lock on file drawer secures both drawers. Adjustable 5 position shelf. Wire management grommet on surface and internal pass-through behind equipment shelf. Supports overlapping returns, bridges, and conference tops that have a 1" spacer (example: PN24600MR). Cannot nest under 29"H products with metal legs. Shipped Fully Assembled.

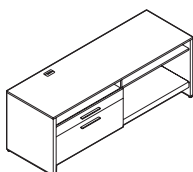

27" H Credenza w/Pull-Out Equipment Tray - LEFT*

PN2760CPL	24 x 60 x 27	92.5	241	22.50	\$1900	\$207
PN2766CPL	24 x 66 x 27	100	267	29	\$1954	\$221
PN2772CPL	24 x 72 x 27	92.5	290	27	\$2031	\$224
PN2778CPL	24 x 78 x 27	100	300	34	\$2082	\$234
PN2784CPL	24 x 84 x 27	92.5	335	31.50	\$2140	\$236

Standard with locking 34"W box and lateral file drawer on **left**. File bars included for front-to-back letter and legal filing capability. Lock on file drawer secures both drawers. Adjustable 5 position shelf. Pull-out equipment tray can support up to 80 lbs. Wire management grommet on surface and internal pass-through behind equipment shelf. Supports overlapping returns, bridges, and conference tops that have a 1" spacer (example: PN24600MR). Cannot nest under 29"H products with metal legs. Shipped Fully Assembled.

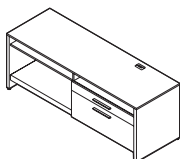

27" H Credenza w/Pull-Out Equipment Tray - RIGHT*

PN2760CPR	24 x 60 x 27	92.5	241	22.50	\$1900	\$207
PN2766CPR	24 x 66 x 27	100	267	29	\$1954	\$221
PN2772CPR	24 x 72 x 27	92.5	290	27	\$2031	\$224
PN2778CPR	24 x 78 x 27	100	300	34	\$2082	\$234
PN2784CPR	24 x 84 x 27	92.5	335	31.50	\$2140	\$236

Standard with locking 34"W box and lateral file drawer on **right**. File bars included for front-to-back letter and legal filing capability. Lock on file drawer secures both drawers. Adjustable 5 position shelf. Pull-out equipment tray can support up to 80 lbs. Wire management grommet on surface and internal pass-through behind equipment shelf. Supports overlapping returns, bridges, and conference tops that have a 1" spacer (example: PN24600MR). Cannot nest under 29"H products with metal legs. Shipped Fully Assembled.

Required Specifications

Top finish
Base finish
Drawer/door front finish*

Optional Specifications

HP laminate
Grommet**
RSG - remove grommet*

27" H CREDENZAS

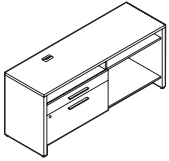

LEFT

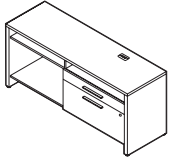

RIGHT

27" H Narrow Credenza*

MODEL#	DIMENSIONS D x W x H	FREIGHT CLASS	WT/LBS.	CUBIC FT.	LIST PRICE	HP ADD
PN2754NCL	20 x 54 x 27	92.5	250	22	\$1699	\$233
PN2760NCL	20 x 60 x 27	92.5	260	24	\$1721	\$236

PN2754NCR	20 x 54 x 27	92.5	250	22	\$1699	\$233
PN2760NCR	20 x 60 x 27	92.5	260	24	\$1721	\$236

Specify PNxxxxNCL for **LEFT** or PNxxxxNCR for **RIGHT**.

20"D. Standard with 30"W box and lateral file drawer. Front-to-back letter and legal filing capability. Lock on file drawer secures both drawers. Adjustable 5 position shelf. Wire management grommet on surface and internal pass-through at back of lower shelf. Supports overlapping returns, bridges, and conference tops that have a 1" spacer (example: PN24600MR). Cannot nest under 29"H products with metal legs. File bars included. Shipped Fully Assembled.

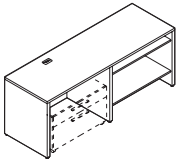

LEFT

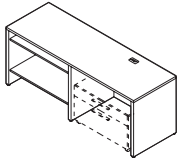

RIGHT

27" H Credenza for Mobile Lateral File

PN2772MCL	24 x 72 x 27	125	252	31.75	\$1409	\$193
PN2784MCL	24 x 84 x 27	125	268	37	\$1522	\$208

PN2772MCR	24 x 72 x 27	125	252	31.75	\$1409	\$193
PN2784MCR	24 x 84 x 27	125	268	37	\$1522	\$208

Specify PNxxxxMCL for **LEFT** or PNxxxxMCR for **RIGHT**.

Standard with 42"W space for lateral file. Adjustable 5 position shelf. Wire management grommet on surface and internal pass-through at back of lower shelf. Supports overlapping returns, bridges, and conference tops that have a 1" spacer (example: PN24600MR). Cannot nest under 29"H products with metal legs. Accepts mobile lateral file units: PN21MLSF and PN22MLBF with and without cushions, and PN25MLSBF without cushions. Shipped Fully Assembled.

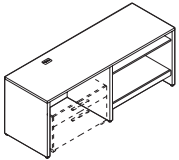

LEFT

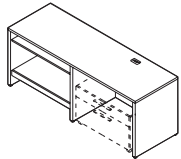

RIGHT

27" H Credenza for Mobile Lateral File w/Pull-Out Equipment Tray

PN2772MPL	24 x 72 x 27	100	258	31.75	\$1618	\$221
PN2784MPL	24 x 84 x 27	125	274	37	\$1721	\$236

PN2772MPR	24 x 72 x 27	100	258	31.75	\$1618	\$221
PN2784MPR	24 x 84 x 27	125	274	37	\$1721	\$236

Specify PNxxxxMPL for **LEFT** or PNxxxxMPR for **RIGHT**.

Standard with 42"W space for lateral file, adjustable 5 position shelf, and pull-out equipment shelf that can support up to 80lbs. Wire management grommet in surface and internal pass-through at back of pull-out equipment shelf. Supports overlapping returns, bridges, and conference tops that have a 1" spacer (example: PN24600MR). Cannot nest under 29"H products with metal legs. Accepts mobile lateral file units: PN21MLSF and PN22MLBF with and without cushions, and PN25MLSBF without cushions. Shipped Fully Assembled.

Required Specifications

Top finish
Base finish
Drawer/door front finish*

Optional Specifications

HP laminate
RSG - remove grommet

27"H CREDENZAS

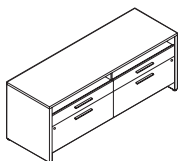

27"H Double Credenza*

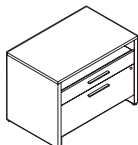

27"H Single Credenza*

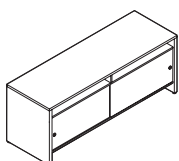

27"H Credenza w/Sliding Laminate Doors*

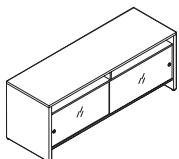

27"H Credenza w/Sliding Glass Doors

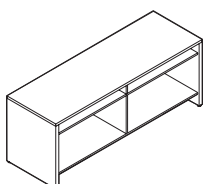

27"H Open Credenza

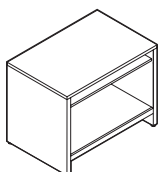

27"H Single Open Credenza

MODEL#	DIMENSIONS	FREIGHT CLASS	WT/LBS.	CUBIC FT.	LIST PRICE	HP ADD
--------	------------	---------------	---------	-----------	------------	--------

D x W x H

PN2772CRD	24 x 72 x 27	100	290	31.75	\$2034	\$259
-----------	--------------	-----	-----	-------	--------	-------

Standard with locking 34"W box and lateral file drawer on each side. File bars included for front-to-back letter and legal filing capability. Lock on file drawer secures both drawers. Shipped Fully Assembled.

PN2737CRS	24 x 37 x 27	100	145	18	\$1420	\$194
-----------	--------------	-----	-----	----	--------	-------

Standard with 34"W box and lateral file drawer. Lock on file drawer secures both drawers. File bars included for front-to-back letter and legal filing capability. Shipped Fully Assembled.

PN2760CLS	24 x 60 x 27	92.5	265	26.50	\$1673	\$229
PN2772CLS	24 x 72 x 27	100	289	31.75	\$1755	\$240
PN2784CLS	24 x 84 x 27	100	337	37	\$1917	\$262

Standard with sliding laminate doors in upper plastic track. Recessed brushed aluminum finger pulls. No lock. Shipped Fully Assembled.

PN2760CGS	24 x 60 x 27	92.5	265	26.50	\$2115	\$288
PN2772CGS	24 x 72 x 27	100	289	31.75	\$2353	\$322
PN2784CGS	24 x 84 x 27	100	337	37	\$2589	\$352

Standard with sliding glass doors in upper aluminum track. Satin etched 6mm glass. Brushed aluminum finger pulls. No lock. Shipped assembled in 2 cartons. Glass doors shipped separately.

PN2760CO	24 x 60 x 27	92.5	296	26.50	\$1422	\$194
PN2772CO	24 x 72 x 27	100	316	31.75	\$1507	\$207
PN2784CO	24 x 84 x 27	100	336	37	\$1671	\$229

Open storage with adjustable 5 position upper shelves with pass-throughs at back of lower shelves. Supports overlapping returns, bridges, and conference tops that have a 1" spacer (example: PN2460OMR). Cannot nest under 29"H products with metal legs. Shipped Fully Assembled.

PN2730CO	24 x 30 x 27	92.5	153	14	\$897	\$123
PN2736CO	24 x 36 x 27	100	158	16	\$939	\$131

Open storage with adjustable 5 position upper shelf with pass-through at back of lower shelf. Supports overlapping returns, bridges, and conference tops that have a 1" spacer (example: PN2460OMR). Cannot nest under 29"H products with metal legs. Shipped Fully Assembled.

Required Specifications

Top finish
Base finish
Drawer/door front finish*

Optional Specifications

HP laminate
Grommet

23"H CREDENZAS

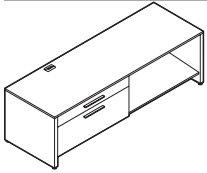

LEFT

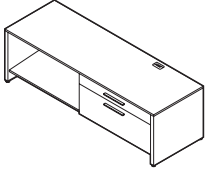

RIGHT

23"H Credenza*

MODEL#	DIMENSIONS D x W x H	FREIGHT CLASS	WT/LBS.	CUBIC FT.	LIST PRICE	HP ADD
PN2360CRL	24 x 60 x 23	100	190	19.17	\$1457	\$184
PN2366CRL	24 x 66 x 23	100	227	25	\$1490	\$192
PN2372CRL	24 x 72 x 23	100	228	23	\$1513	\$190
PN2378CRL	24 x 78 x 23	100	248	30	\$1547	\$197
PN2384CRL	24 x 84 x 23	100	266	26.83	\$1578	\$197

PN2360CRR	24 x 60 x 23	100	190	19.17	\$1457	\$184
PN2366CRR	24 x 66 x 23	100	227	25	\$1490	\$192
PN2372CRR	24 x 72 x 23	100	228	23	\$1513	\$190
PN2378CRR	24 x 78 x 23	100	248	30	\$1547	\$197
PN2384CRR	24 x 84 x 23	100	266	26.83	\$1578	\$197

Standard with 34"W box and lateral file drawer. File bars included for front-to-back letter and legal filing capability. Lock on file drawer secures both drawers. Wire management grommet on surface and internal pass-through at back of lower shelf. Supports Overlapping Return with metal leg and spacer for 23"H credenza, Overlapping Wedge Shaped Return with metal leg and spacer for 23"H credenza, and Overlapping Bridges with metal spacer for 23"H credenza. Shipped Fully Assembled.

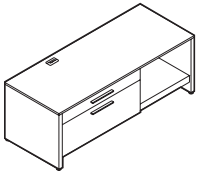

LEFT

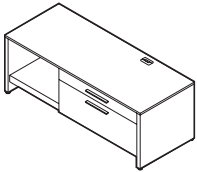

RIGHT

23"H Credenza w/Pull-Out Equipment Tray - RIGHT*

PN2360CPL	24 x 60 x 23	100	190	19.17	\$1652	\$193
PN2366CPL	24 x 66 x 23	100	233	25	\$1707	\$204
PN2372CPL	24 x 72 x 23	100	228	23	\$1761	\$201
PN2378CPL	24 x 78 x 23	100	254	30	\$1802	\$209
PN2384CPL	24 x 84 x 23	100	266	26.83	\$1836	\$209

PN2360CPR	24 x 60 x 23	100	190	19.17	\$1652	\$193
PN2366CPR	24 x 66 x 23	100	233	25	\$1707	\$204
PN2372CPR	24 x 72 x 23	100	228	23	\$1761	\$201
PN2378CPR	24 x 78 x 23	100	254	30	\$1802	\$209
PN2384CPR	24 x 84 x 23	100	266	26.83	\$1836	\$209

Standard with 34"W box and lateral file drawer. Pull-out equipment shelf can support up to 80lbs. Adjustable 5 position shelf. File bars included for front-to-back letter and legal filing capability. Lock on file drawer secures both drawers. Wire management grommet on surface and internal pass-through at back of lower shelf. Supports Overlapping Return with metal leg and spacer for 23"H credenza, Overlapping Wedge Shaped Return with metal leg and spacer for 23"H credenza, and Overlapping Bridges with metal spacer for 23"H credenza. Shipped Fully Assembled.

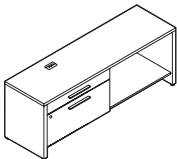

LEFT

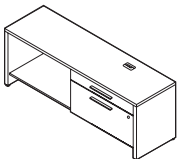

RIGHT

23"H Narrow Credenza

PN2354NCL	20 x 54 x 23	92.5	230	21	\$1425	\$194
PN2360NCL	20 x 60 x 23	92.5	240	23	\$1431	\$196

PN2354NCR	20 x 54 x 23	92.5	230	21	\$1425	\$194
PN2360NCR	20 x 60 x 23	92.5	240	23	\$1431	\$196

Specify PNxxxxNCL for **LEFT** or PNxxxxNCR for **RIGHT**.

20"D. Standard with 30"W box and lateral file drawer. File bars included for front-to-back letter and legal filing capability. Lock on file drawer secures both drawers. Wire management grommet on surface and internal pass-through at back of lower shelf. Supports Overlapping Return with metal leg and spacer for 23"H credenza, Overlapping Wedge Shaped Return with metal leg and spacer for 23"H credenza, and Overlapping Bridges with metal spacer for 23"H credenza. Shipped Fully Assembled.

Required Specifications

Top finish
Base finish
Drawer front finish

Optional Specifications

HP laminate
RSG - remove grommet

Accessories

Cushion

23"H CREDENZAS

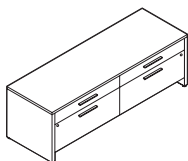

23"H Double Credenza*

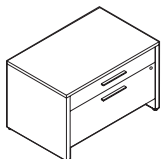

23"H Single Credenza*

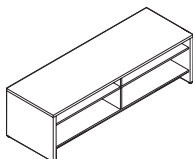

23"H Open Credenza

MODEL#	DIMENSIONS	FREIGHT CLASS	WT/LBS.	CUBIC FT.	LIST PRICE	HP ADD
--------	------------	---------------	---------	-----------	------------	--------

D x W x H

PN2372CRD	24 x 72 x 23	92.5	275	27	\$1876	\$257
-----------	--------------	------	-----	----	---------------	--------------

Standard with locking 34"W box and lateral file drawer on each side. File bars included for front-to-back letter and legal filing capability. Lock on file drawer secures both drawers. Shipped Fully Assembled.

PN2337CRS	24 x 37 x 23	100	125	15	\$1276	\$174
-----------	--------------	-----	-----	----	---------------	--------------

Standard with 34" w box and lateral file drawer. File bars included for front-to-back letter and legal filing capability. Lock on file drawer secures both drawers. Shipped Fully Assembled.

PN2360CO	24 x 60 x 23	85	276	23	\$1256	\$172
PN2372CO	24 x 72 x 23	92.5	296	27.50	\$1362	\$187
PN2384CO	24 x 84 x 23	100	316	32	\$1515	\$208

Open storage with adjustable 5 position upper shelves with pass-throughs at back of lower shelves. Supports Overlapping Return with metal leg and spacer for 23"H credenza, Overlapping Wedge Shaped Return with metal leg and spacer for 23"H credenza, and Overlapping Bridges with metal spacer for 23"H credenza. Shipped Fully Assembled.

Required Specifications

Top finish
Base finish
Drawer front finish*

Optional Specifications

HP laminate
Grommet

Accessories

Cushion

CUSHIONS FOR 23" H CREDENZAS

MODEL#	DIMENSIONS	FREIGHT CLASS	WT/LBS.	CUBIC FT.	GRADE	LIST	GRADE	LIST
PN2430CU	24 x 30 x 2.5	150	13	2.40		D x W x H		
					1	\$286	7	\$616
					2	\$336	8	\$752
					3	\$376	9	\$818
					4	\$432	10	\$946
					5	\$513	11	\$1115
PN2433CU	24 x 33 x 2.5	150	13	2.40	6	\$544	12	\$1333
					1	\$312	7	\$750
					2	\$378	8	\$933
					3	\$429	9	\$1021
					4	\$505	10	\$1189
					5	\$615	11	\$1418
PN2436CU	24 x 36 x 2.5	250	7	2	6	\$656	12	\$1707
					1	\$331	7	\$823
					2	\$405	8	\$1028
					3	\$464	9	\$1129
					4	\$549	10	\$1319
					5	\$674	11	\$1577
PN2439CU	24 x 39 x 2.5	150	14	2.40	6	\$717	12	\$1899
					1	\$353	7	\$845
					2	\$426	8	\$1050
					3	\$485	9	\$1150
					4	\$571	10	\$1339
					5	\$696	11	\$1597
PN2442CU	24 x 42 x 2.5	150	14	2.40	6	\$739	12	\$1921
					1	\$370	7	\$862
					2	\$444	8	\$1067
					3	\$502	9	\$1165
					4	\$588	10	\$1358
					5	\$711	11	\$1616

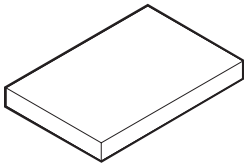

Cushion for 23" H Credenzas

Cushion attaches with Velcro strips. Fits **24" d** credenzas.

PN2027CU	20 x 27 x 2.5	150	12	2.40	1	\$252	7	\$527
					2	\$295	8	\$642
					3	\$328	9	\$698
					4	\$375	10	\$802
					5	\$444	11	\$947
					6	\$469	12	\$1124
PN2030CU	20 x 30 x 2.5	150	12	2.40	1	\$273	7	\$547
					2	\$316	8	\$663
					3	\$346	9	\$718
					4	\$396	10	\$822
					5	\$464	11	\$968
					6	\$490	12	\$1145

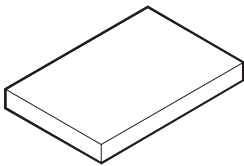

Cushion for 23" H Narrow Credenzas

Cushion attaches with Velcro strips. Fits **20" d** credenzas.

Required Specifications
Fabric

CUSHIONS FOR 23" H CREDENZAS

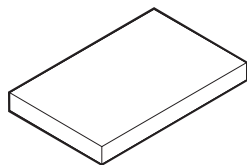

Cushion for 23" H Single Credenza**

MODEL#	DIMENSIONS	FREIGHT CLASS	WT/LBS.	CUBIC FT.	GRADE	LIST	GRADE	LIST
D x W x H								
PN2437CU	24 x 37 x 2.5	150	14	2.40	1	\$349	7	\$841
					2	\$422	8	\$1047
					3	\$481	9	\$1144
					4	\$567	10	\$1335
					5	\$689	11	\$1593
					6	\$733	12	\$1917

Cushion attaches with Velcro strips. Fits **PN2337CRS** credenza.

52" H STORAGE CABINETS

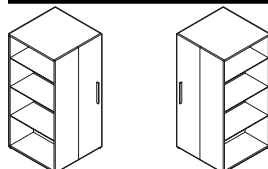

LEFT

RIGHT

52" H Tower Wardrobe w/Full Height Bookcase*

MODEL#	DIMENSIONS	FREIGHT CLASS	WT/LBS.	CUBIC FT.	LIST PRICE
PN52TWBL	24 x 24 x 52	125	129	17.33	\$1671
PN52TWBR	24 x 24 x 52	125	129	17.33	\$1671

Specify PN52TWBL for **LEFT** or PN52TWBR for **RIGHT**.

Locking wardrobe with full height bookcase. Three adjustable laminate shelves with fixed bottom laminate shelf. Coat rail. Shipped Fully Assembled.

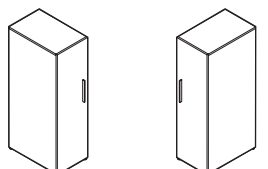

LEFT

RIGHT

52" H Wardrobe*

PN1652WDL	24 x 16 x 52	125	84	11.56	\$995
PN1652WDR	24 x 16 x 52	125	84	11.56	\$995

Specify PN1652WDL for **LEFT** or PN1652WDR for **RIGHT**.

Locking wardrobe with coat rail. Shipped Fully Assembled.

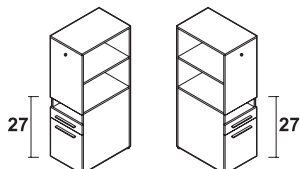

LEFT

RIGHT

52" H Storage Cabinet w/Bookshelf at 27" H*

PN57CSBFL	24 x 16 x 52	100	102	11.56	\$1428
PN57CSBFR	24 x 16 x 52	100	102	11.56	\$1428

Specify PN57CSBFL for **LEFT** or PN57CSBFR for **RIGHT**.

Open Shelf/Box/File Drawer. Lock on file drawer secures both drawers. One adjustable laminate shelf. Fixed bottom shelf aligns with **27" H** surfaces. Outside accessory hook. Shipped Fully Assembled.

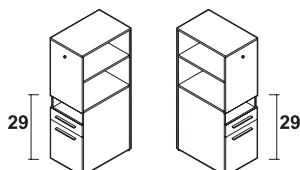

LEFT

RIGHT

52" H Storage Cabinet w/Bookshelf at 29" H

PN59CSBFL	24 x 16 x 52	100	102	11.56	\$1450
PN59CSBFR	24 x 16 x 52	100	102	11.56	\$1450

Specify PN59CSBFL for **LEFT** or PN59CSBFR for **RIGHT**.

Open Shelf/Box/File Drawer. Lock on file drawer secures both drawers. One adjustable laminate shelf. Fixed bottom shelf aligns with **29" H** surfaces. Outside accessory hook. Shipped Fully Assembled.

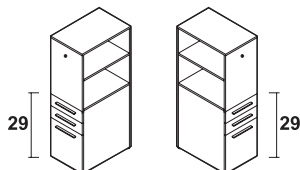

LEFT

RIGHT

52" H Storage Cabinet w/Bookshelf at 29" H

PN59CBBFL	24 x 16 x 52	100	102	11.56	\$1533
PN59CBBFR	24 x 16 x 52	100	102	11.56	\$1533

Specify PN59CBBFL for **LEFT** or PN59CBBFR for **RIGHT**.

Box/Box/File Drawer. Lock on file drawer secures both drawers. One adjustable laminate shelf. Fixed bottom shelf aligns with **29" H** surfaces. Outside accessory hook. Shipped Fully Assembled.

Required Specifications

- Top finish*
- Base finish*
- Drawer/door front finish*
- Fabric**

52" H STORAGE CABINETS

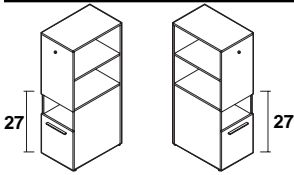

LEFT
52" H Recycling Cabinet
w/Bookshelf at 27" H

RIGHT

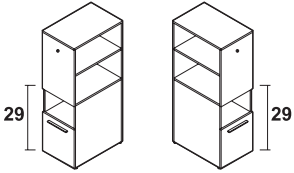

LEFT
52" H Recycling Cabinet
w/Bookshelf at 29" H

RIGHT

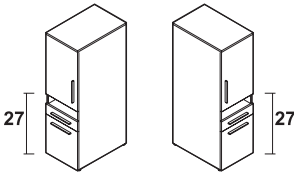

LEFT
52" H Storage Cabinet w/Door at 27" H

RIGHT

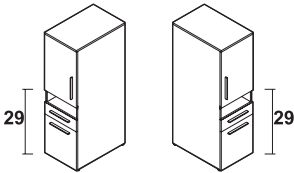

LEFT
52" H Storage Cabinet w/Door at 29" H

RIGHT

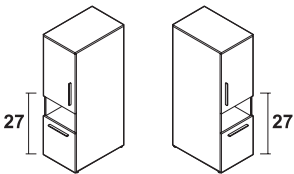

LEFT
52" H Recycling Cabinet w/Door at 27" H

RIGHT

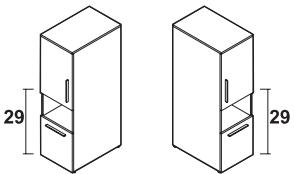

LEFT
52" H Recycling Cabinet w/Door at 29" H

RIGHT

MODEL#	DIMENSIONS D x W x H	FREIGHT CLASS	WT/LBS.	CUBIC FT.	LIST PRICE
PN57RCSL	24 x 16 x 52	100	102	11.56	\$1339
PN57RCSR	24 x 16 x 52	100	102	11.56	\$1339

Specify PN57RCSL for **LEFT** or PN57RCSR for **RIGHT**.

Drawer with one waste bin, one recycling bin and an open shelf above. One adjustable laminate shelf. Fixed bottom shelf aligns with **27" H** surfaces. Outside accessory hook. Shipped Fully Assembled.

PN59RCSL	24 x 16 x 52	100	102	11.56	\$1355
PN59RCSR	24 x 16 x 52	100	102	11.56	\$1355

Specify PN59RCSL for **LEFT** or PN59RCSR for **RIGHT**.

Drawer with one waste bin, one recycling bin and an open shelf above. One adjustable laminate shelf. Fixed bottom shelf aligns with **29" H** surfaces. Outside accessory hook. Shipped Fully Assembled.

PN57DSBFL	24 x 16 x 52	100	102	11.56	\$1572
PN57DSBFR	24 x 16 x 52	100	102	11.56	\$1572

Specify PN57DSBFL for **LEFT** or PN57DSBFR for **RIGHT**.

Open Shelf/Box/File Drawer. Lock on file drawer secures both drawers. Upper storage cabinet with locking door and one adjustable laminate shelf inside. Door aligns with **27" H** surfaces. Shipped Fully Assembled.

PN59DSBFL	24 x 16 x 52	100	102	11.56	\$1602
PN59DSBFR	24 x 16 x 52	100	102	11.56	\$1602

Specify PN59DSBFL for **LEFT** or PN59DSBFR for **RIGHT**.

Open Shelf/Box/File Drawer. Lock on file drawer secures both drawers. Upper storage cabinet with locking door and one adjustable laminate shelf inside. Door aligns with **29" H** surfaces. Shipped Fully Assembled.

PN57DRCSL	24 x 16 x 52	100	102	11.56	\$1392
PN57DRCSR	24 x 16 x 52	100	102	11.56	\$1392

Specify PN57DRCSL for **LEFT** or PN57DRCSR for **RIGHT**.

Upper storage cabinet with locking door. Drawer with one waste bin, one recycling bin, and an open shelf above. One adjustable laminate shelf inside locking cabinet door. Door aligns with **27" H** surfaces. Shipped Fully Assembled.

PN59DRCSL	24 x 16 x 52	100	102	11.56	\$1422
PN59DRCSR	24 x 16 x 52	100	102	11.56	\$1422

Specify PN59DRCSL for **LEFT** or PN59DRCSR for **RIGHT**.

Upper storage cabinet with locking door. Drawer with one waste bin, one recycling bin, and an open shelf above. One adjustable laminate shelf inside locking cabinet door. Door aligns with **29" H** surfaces. Shipped Fully Assembled.

Required Specifications

- Top finish
- Base finish
- Drawer/door front finish

52" H STORAGE CABINETS

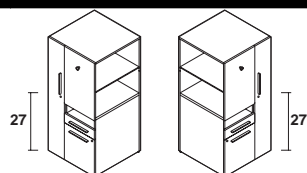

LEFT RIGHT

52" H Storage Tower w/Wardrobe, Shelf and Bookshelf at 27" H

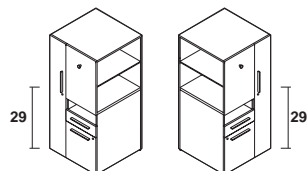

LEFT RIGHT

52" H Storage Tower w/Wardrobe, Shelf and Bookshelf at 29" H

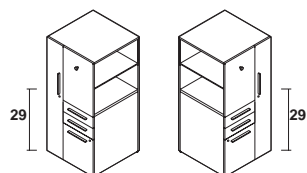

LEFT RIGHT

52" H Storage Tower w/Wardrobe, and Bookshelf at 29" H

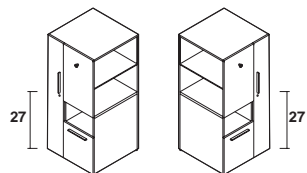

LEFT RIGHT

52" H Storage Tower w/Wardrobe, Shelf, Recycling and Bookshelf at 27" H

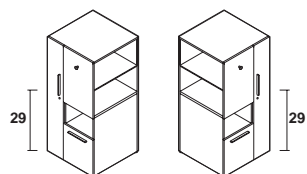

LEFT RIGHT

52" H Storage Tower w/Wardrobe, Shelf, Recycling and Bookshelf at 29" H

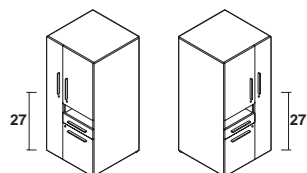

LEFT RIGHT

52" H Storage Tower w/Wardrobe, Shelf/Box/File and Door at 27" H

MODEL# DIMENSIONS FREIGHT CLASS WT/LBS. CUBIC FT. LIST PRICE

D x W x H

PN57TSBFL	24 x 24 x 52	92.5	225	21	\$1717
PN57TSBFR	24 x 24 x 52	92.5	225	21	\$1717

Specify PN57TSBFL for **LEFT** or PN57TSBFR for **RIGHT**.

Open Shelf/Box/File drawer. Lock on file drawer secures both drawers. One adjustable laminate shelf. Fixed bottom shelf aligns with **27" H** surfaces. Outside accessory hook and locking wardrobe with coat rail. Shipped Fully Assembled.

PN59TSBFL	24 x 24 x 52	92.5	225	21	\$1453
PN59TSBFR	24 x 24 x 52	92.5	225	21	\$1453

Specify PN59TSBFL for **LEFT** or PN59TSBFR for **RIGHT**.

Open Shelf/Box/File drawer. Lock on file drawer secures both drawers. One adjustable laminate shelf. Fixed bottom shelf aligns with **29" H** surfaces. Outside accessory hook and locking wardrobe with coat rail. Shipped Fully Assembled.

PN59TBBFL	24 x 24 x 52	92.5	250	21	\$1983
PN59TBBFR	24 x 24 x 52	92.5	250	21	\$1983

Specify PN59TBBFL for **LEFT** or PN59TBBFR for **RIGHT**.

Box/Box/File drawer. Lock on file drawer secures file and lower box drawer. One adjustable laminate shelf. Fixed bottom shelf aligns with **29" H** surfaces. Outside accessory hook and locking wardrobe with coat rail. Shipped Fully Assembled.

PN57RTSL	24 x 24 x 52	92.5	238	21	\$1843
PN57RTSR	24 x 24 x 52	92.5	238	21	\$1843

Specify PN57RTSL for **LEFT** or PN57RTSR for **RIGHT**.

Drawer with one waste and one recycling bin. Open shelf above. One adjustable laminate shelf. Fixed bottom shelf aligns with **27" H** surfaces. Outside accessory hook. Locking wardrobe with coat rail. Shipped Fully Assembled.

PN59RTSL	24 x 24 x 52	92.5	238	21	\$1843
PN59RTSR	24 x 24 x 52	92.5	238	21	\$1843

Specify PN59RTSL for **LEFT** or PN59RTSR for **RIGHT**.

Drawer with one waste and one recycling bin. Open shelf above. One adjustable laminate shelf. Fixed bottom shelf aligns with **29" H** surfaces. Outside accessory hook. Locking wardrobe with coat rail. Shipped Fully Assembled.

PN57SBFTL	24 x 24 x 52	92.5	234	21	\$1930
PN57SBFTR	24 x 24 x 52	92.5	234	21	\$1930

Specify PN57SBFTL for **LEFT** or PN57SBFTR for **RIGHT**.

Open Shelf/Box/File drawer. Lock on file drawer secures both drawers. Upper storage cabinet with locking door and one adjustable laminate shelf inside. Door aligns with **27" H** surfaces. Locking wardrobe with coat rail. Shipped Fully Assembled.

Required Specifications

- Top finish
- Base finish
- Drawer/door front finish

52" H STORAGE CABINETS

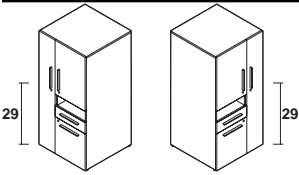

LEFT RIGHT

52" H Storage Tower w/Wardrobe, Shelf/Box/File and Door at 29" H

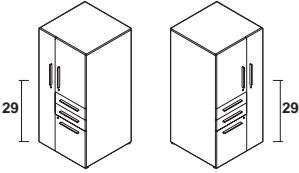

LEFT RIGHT

52" H Storage Tower w/Wardrobe, Shelf, Box/Box/File and Door at 29" H

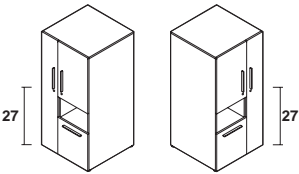

LEFT RIGHT

52" H Storage Tower w/Wardrobe, Shelf, Recycling and Door at 27" H

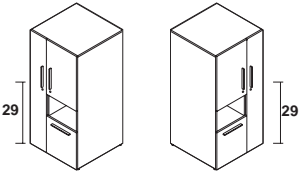

LEFT RIGHT

52" H Storage Tower w/Wardrobe, Shelf, Recycling and Door at 29" H

MODEL#	DIMENSIONS D x W x H	FREIGHT CLASS	WT/LBS.	CUBIC FT.	LIST PRICE
PN59SBFTL	24 x 24 x 52	92.5	234	21	\$1930
PN59SBFTR	24 x 24 x 52	92.5	234	21	\$1930

Specify PN59SBFTL for **LEFT** or PN59SBFTR for **RIGHT**.

Open Shelf/Box/File drawer. Lock on file drawer secures both drawers. Upper storage cabinet with locking door and one adjustable laminate shelf inside. Door aligns with **29" H** surfaces. Locking wardrobe with coat rail. Shipped Fully Assembled.

PN59BBFTL	24 x 24 x 52	92.5	234	21	\$2035
PN59BBFTR	24 x 24 x 52	92.5	234	21	\$2035

Specify PN59BBFTL for **LEFT** or PN59BBFTR for **RIGHT**.

Box/Box/File drawer. Lock on file drawer secures file and lower box drawers. Upper storage cabinet with locking door and one adjustable laminate shelf inside. Door aligns with **29" H** surfaces. Locking wardrobe with coat rail. Shipped Fully Assembled.

PN57DRTSL	24 x 24 x 52	92.5	234	21	\$1964
PN57DRTSR	24 x 24 x 52	92.5	234	21	\$1964

Specify PN57DRTSL for **LEFT** or PN57DRTSR for **RIGHT**.

Drawer with one waste and one recycling bin Open shelf above. Upper storage cabinet with locking door and one adjustable laminate shelf inside. Door aligns with **27" H** surfaces. Locking wardrobe with coat rail. Shipped Fully Assembled.

PN59DRTSL	24 x 24 x 52	92.5	234	21	\$1964
PN59DRTSR	24 x 24 x 52	92.5	234	21	\$1964

Specify PN59DRTSL for **LEFT** or PN59DRTSR for **RIGHT**.

Drawer with one waste and one recycling bin Open shelf above. Upper storage cabinet with locking door and one adjustable laminate shelf inside. Door aligns with **29" H** surfaces. Locking wardrobe with coat rail. Shipped Fully Assembled.

Required Specifications

- Top finish
- Base finish
- Drawer/door front finish

66" H STORAGE CABINETS

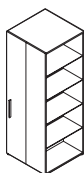
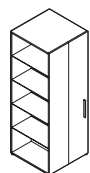

LEFT
66" H Tower Wardrobe w/Full Height Bookcase



LEFT
66" H Wardrobe

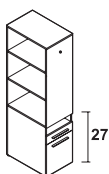
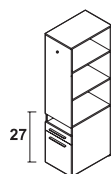

LEFT
66" H Storage Cabinet w/Bookshelf at 27" H

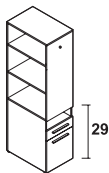
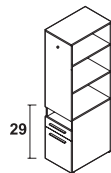

LEFT
66" H Storage Cabinet w/Bookshelf at 29" H

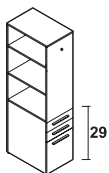
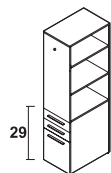

LEFT
66" H Storage Cabinet w/Bookshelf at 29" H

MODEL# DIMENSIONS FREIGHT CLASS WT./LBS. CUBIC FT. LIST PRICE

D x W x H

PN66TWBL	24 x 24 x 66	125	165	22	\$1938
PN66TWBR	24 x 24 x 66	125	165	22	\$1938

Specify PN66TWBL for **LEFT** or PN66TWBR for **RIGHT**.

Locking wardrobe and full height bookcase. Four adjustable laminate shelves with fixed bottom laminate shelf. Coat rail. Shipped Fully Assembled.

PN1666WDL	24 x 16 x 66	125	106	14.67	\$1125
PN1666WDR	24 x 16 x 66	125	106	14.67	\$1125

Specify PN1666WDL for **LEFT** or PN1666WDR for **RIGHT**.

Locking wardrobe with coat rail and fixed shelf above. Shipped Fully Assembled.

PN67CSBFL	24 x 16 x 66	100	130	14.67	\$1536
PN67CSBFR	24 x 16 x 66	100	130	14.67	\$1536

Specify PN67CSBFL for **LEFT** or PN67CSBFR for **RIGHT**.

Open Shelf/Box/File Drawer. Lock on file drawer secures both drawers. Two adjustable laminate shelves. Fixed bottom shelf aligns with **27" H** surfaces. Outside accessory hook. Shipped Fully Assembled.

PN69CSBFL	24 x 16 x 66	100	130	14.67	\$1536
PN69CSBFR	24 x 16 x 66	100	130	14.67	\$1536

Specify PN69CSBFL for **LEFT** or PN69CSBFR for **RIGHT**.

Open Shelf/Box/File Drawer. Lock on file drawer secures both drawers. Two adjustable laminate shelves. Fixed bottom shelf aligns with **29" H** surfaces. Outside accessory hook. Shipped Fully Assembled.

PN69CBBFL	24 x 16 x 66	100	130	14.67	\$1642
PN69CBBFR	24 x 16 x 66	100	130	14.67	\$1642

Specify PN69CBBFL for **LEFT** or PN69CBBFR for **RIGHT**.

Box/Box/File Drawer. Lock on file drawer secures file and lower box drawer. Two adjustable laminate shelves. Fixed bottom shelf aligns with **29" H** surfaces. Outside accessory hook. Shipped Fully Assembled.

Required Specifications

- Top finish
- Base finish
- Drawer/door front finish

66" H STORAGE CABINETS

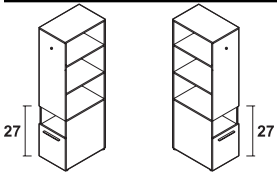

LEFT
RIGHT
66" H Recycling Cabinet
w/Bookshelf at 27" H

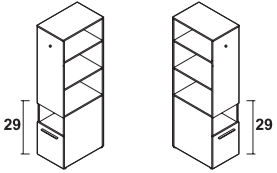

LEFT
RIGHT
66" H Recycling Cabinet
w/Bookshelf at 29" H

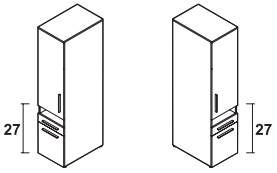

LEFT
RIGHT
66" H Storage Cabinet w/Door at 27" H

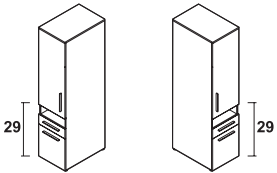

LEFT
RIGHT
66" H Storage Cabinet w/Door at 29" H

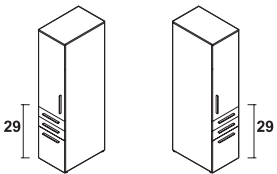

LEFT
RIGHT
66" H Storage Cabinet w/Door at 29" H

MODEL#	DIMENSIONS D x W x H	FREIGHT CLASS	WT/LBS.	CUBIC FT.	LIST PRICE
PN67RCSL	24 x 16 x 66	100	130	14.67	\$1474
PN67RCSR	24 x 16 x 66	100	130	14.67	\$1474

Specify PN67RCSL for **LEFT** or PN67RCSR for **RIGHT**.

Drawer with one waste bin and one recycling bin. Open shelf above. Two adjustable laminate shelves. Fixed bottom shelf aligns with **27" H** surfaces. Outside accessory hook. Shipped Fully Assembled.

PN69RCSL	24 x 16 x 66	100	130	14.67	\$1474
PN69RCSR	24 x 16 x 66	100	130	14.67	\$1474

Specify PN69RCSL for **LEFT** or PN69RCSR for **RIGHT**.

Drawer with one waste bin and one recycling bin. Open shelf above. Two adjustable laminate shelves. Fixed bottom shelf aligns with **29" H** surfaces. Outside accessory hook. Shipped Fully Assembled.

PN67DSBFL	24 x 16 x 66	100	130	14.67	\$1628
PN67DSBFR	24 x 16 x 66	100	130	14.67	\$1628

Specify PN67DSBFL for **LEFT** or PN67DSBFR for **RIGHT**.

Open Shelf/Box/File Drawer. Lock on file drawer secures both drawers. Upper storage cabinet with locking door and two adjustable laminate shelves inside. Door aligns with **27" H** surfaces. Shipped Fully Assembled.

PN69DSBFL	24 x 16 x 66	100	130	14.67	\$1685
PN69DSBFR	24 x 16 x 66	100	130	14.67	\$1685

Specify PN69DSBFL for **LEFT** or PN69DSBFR for **RIGHT**.

Open Shelf/Box/File Drawer. Lock on file drawer secures both drawers. Upper storage cabinet with locking door and two adjustable laminate shelves inside. Door aligns with **29" H** surfaces. Shipped Fully Assembled.

PN69DBBFL	24 x 16 x 66	100	130	14.67	\$1788
PN69DBBFR	24 x 16 x 66	100	130	14.67	\$1788

Specify PN69DBBFL for **LEFT** or PN69DBBFR for **RIGHT**.

Box/Box/File Drawer. Lock on file drawer secures file and lower box drawer. Upper storage cabinet with locking door and two adjustable laminate shelves inside. Door aligns with **29" H** surfaces. Shipped Fully Assembled.

Required Specifications

- Top finish
- Base finish
- Drawer/door front finish

66" H STORAGE CABINETS

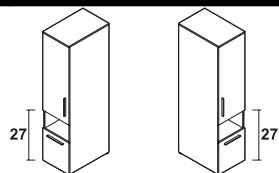

LEFT **RIGHT**

66" H Recycling Cabinet w/Door at 27" H

MODEL#	DIMENSIONS D x W x H	FREIGHT CLASS	WT./LBS.	CUBIC FT.	LIST PRICE
PN67DRCSL	24 x 16 x 66	100	130	14.67	\$1530
PN67DRCSR	24 x 16 x 66	100	130	14.67	\$1530

Specify PN67DRCSL for **LEFT** or PN67DRCSR for **RIGHT**.

Upper storage cabinet with locking door and two adjustable laminate shelves inside. Drawer with one waste bin, one recycling bin, and an open shelf above. Door aligns with **27" H** surfaces. Shipped Fully Assembled.

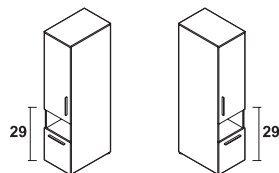

LEFT **RIGHT**

66" H Recycling Cabinet w/Door at 29" H

PN69DRCSL	24 x 16 x 66	100	130	14.67	\$1610
PN69DRCSR	24 x 16 x 66	100	130	14.67	\$1610

Specify PN69DRCSL for **LEFT** or PN69DRCSR for **RIGHT**.

Upper storage cabinet with locking door and two adjustable laminate shelves inside. Drawer with one waste bin, one recycling bin, and an open shelf above. Door aligns with **29" H** surfaces. Shipped Fully Assembled.

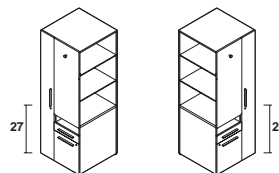

LEFT **RIGHT**

66" H Storage Tower w/Wardrobe, Shelf, Box/File and Bookshelf at 27" H

PN67TSBFL	24 x 24 x 66	92.5	260	26	\$2412
PN67TSBFR	24 x 24 x 66	92.5	260	26	\$2412

Specify PN67TSBFL for **LEFT** or PN67TSBFR for **RIGHT**.

Open Shelf/Box/File drawer. Lock on file drawer secures both drawers. Two adjustable laminate shelves. Fixed bottom shelf aligns with **27" H** surfaces. Outside accessory hook and locking wardrobe with coat rail. Shipped Fully Assembled.

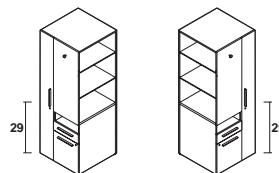

LEFT **RIGHT**

66" H Storage Tower w/Wardrobe, Shelf, Box/File and Bookshelf at 29" H

PN69TSBFL	24 x 24 x 66	92.5	260	26	\$2412
PN69TSBFR	24 x 24 x 66	92.5	260	26	\$2412

Specify PN69TSBFL for **LEFT** or PN69TSBFR for **RIGHT**.

Open Shelf/Box/File drawer. Lock on file drawer secures both drawers. Two adjustable laminate shelves. Fixed bottom shelf aligns with **29" H** surfaces. Outside accessory hook and locking wardrobe with coat rail. Shipped Fully Assembled.

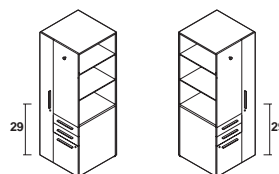

LEFT **RIGHT**

66" H Storage Tower w/Wardrobe, Shelf, Box/Box/File and Bookshelf at 29" H

PN69TBBFL	24 x 24 x 66	92.5	262	26	\$2540
PN69TBBFR	24 x 24 x 66	92.5	262	26	\$2540

Specify PN69TBBFL for **LEFT** or PN69TBBFR for **RIGHT**.

Box/Box/File drawer. Lock on file and lower box drawer. Two adjustable laminate shelves. Fixed bottom shelf aligns with **29" H** surfaces. Outside accessory hook and locking wardrobe with coat rail. Shipped Fully Assembled.

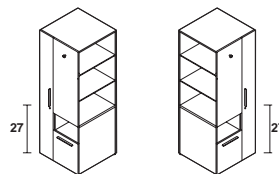

LEFT **RIGHT**

66" H Storage Tower w/Wardrobe, Shelf, Recycling and Bookshelf at 27" H

PN67RTSL	24 x 24 x 66	92.5	260	26	\$2423
PN67RTSR	24 x 24 x 66	92.5	260	26	\$2423

Specify PN67RTSL for **LEFT** or PN67RTSR for **RIGHT**.

Drawer with one waste and one recycling bin. Open shelf above. Two adjustable laminate shelves. Fixed bottom shelf aligns with **27" H** surfaces. Outside accessory hook. Locking wardrobe with coat rail. Shipped Fully Assembled.

Required Specifications

- Top finish
- Base finish
- Drawer/door front finish

66" H STORAGE CABINETS

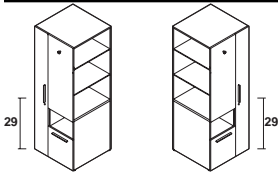

LEFT RIGHT

66" H Storage Tower w/Wardrobe, Shelf, Recycling and Bookshelf at 29" H

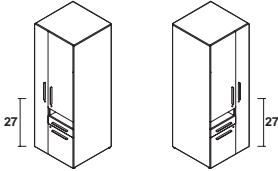

LEFT RIGHT

66" H Storage Tower w/Wardrobe, Shelf, Box/File and Door at 27" H

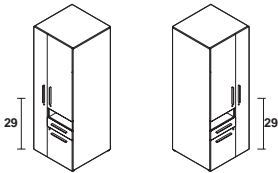

LEFT RIGHT

66" H Storage Tower w/Wardrobe, Shelf, Box/File and Door at 29" H

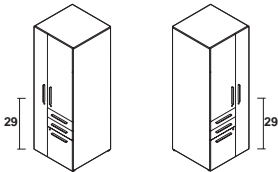

LEFT RIGHT

66" H Storage Tower w/Wardrobe, Box/Box/File and Door at 29" H

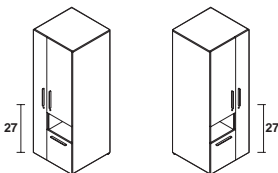

LEFT RIGHT

66" H Storage Tower w/Wardrobe, Large Shelf, Recycling and Door at 27" H

MODEL#	DIMENSIONS D x W x H	FREIGHT CLASS	WT./LBS.	CUBIC FT.	LIST PRICE
PN69RTSL	24 x 24 x 66	92.5	260	26	\$2423
PN69RTSR	24 x 24 x 66	92.5	260	26	\$2423

Specify PN69RTSL for **LEFT** or PN69RTSR for **RIGHT**.

Drawer with one waste and one recycling bin. Open shelf above. Two adjustable laminate shelves. Fixed bottom shelf aligns with **29" H** surfaces. Outside accessory hook. Locking wardrobe with coat rail. Shipped Fully Assembled.

PN67SBFTL	24 x 24 x 66	100	257	26	\$2501
PN67SBFTR	24 x 24 x 66	100	257	26	\$2501

Specify PN67SBFTL for **LEFT** or PN67SBFTR for **RIGHT**.

Open Shelf/Box/File Drawer. Lock on file drawer secures both drawers. Upper storage cabinet with locking door and two adjustable laminate shelves inside. Door aligns with **27" H** surfaces. Outside accessory hook. Locking wardrobe with coat rail. Shipped Fully Assembled.

PN69SBFTL	24 x 24 x 66	100	257	26	\$2501
PN69SBFTR	24 x 24 x 66	100	257	26	\$2501

Specify PN69SBFTL for **LEFT** or PN69SBFTR for **RIGHT**.

Open Shelf/Box/File Drawer. Lock on file drawer secures both drawers. Upper storage cabinet with locking door and two adjustable laminate shelves inside. Door aligns with **29" H** surfaces. Locking wardrobe with coat rail. Shipped Fully Assembled.

PN69BBFTL	24 x 24 x 66	100	257	26	\$2629
PN69BBFTR	24 x 24 x 66	100	257	26	\$2629

Specify PN69BBFTL for **LEFT** or PN69BBFTR for **RIGHT**.

Box/Box/File Drawer. Lock on file drawer secures file and lower box drawer. Upper storage cabinet with locking door and two adjustable laminate shelves inside. Door aligns with **29" H** surfaces. Locking wardrobe with coat rail. Shipped Fully Assembled.

PN67DRTSL	24 x 24 x 66	100	230	26	\$2563
PN67DRTSR	24 x 24 x 66	100	230	26	\$2563

Specify PN67DRTSL for **LEFT** or PN67DRTSR for **RIGHT**.

Drawer with one waste and one recycling bin. Open shelf above. Upper storage cabinet with locking door and two adjustable laminate shelves inside. Door aligns with **27" H** surfaces. Locking wardrobe with coat rail. Shipped Fully Assembled.

Required Specifications

- Top finish
- Base finish
- Drawer/door front finish

66" H STORAGE CABINETS

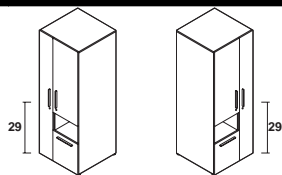

LEFT

RIGHT

66" H Storage Tower w/Wardrobe, Large Shelf, Recycling and Door at 29" H

MODEL#	DIMENSIONS	FREIGHT CLASS	WT/LBS.	CUBIC FT.	LIST PRICE
D x W x H					
PN69DRTSL	24 x 24 x 66	100	230	26	\$2563
PN69DRTSR	24 x 24 x 66	100	230	26	\$2563

Specify PN69DRTSL for **LEFT** or PN69DRTSR for **RIGHT**.

Drawer with one waste and one recycling bin. Open shelf above. Upper storage cabinet with locking door and two adjustable laminate shelves inside. Door aligns with 29" H surfaces. Locking wardrobe with coat rail. Shipped Fully Assembled.

MOBILE PEDESTALS

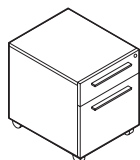

20.9" H Mobile Pedestal



25.4" H Mobile Pedestal



25.4" H Mobile Pedestal

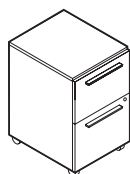

26.8" H Mobile Pedestal

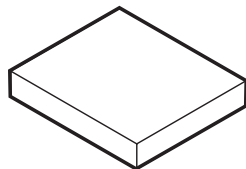

Pedestal Cushion*

MODEL#	DIMENSIONS	FREIGHT CLASS	WT/LBS.	CUBIC FT.	LIST PRICE	HP ADD
PN22MBF	22 x 16 x 20.9	85	79	5.75	\$895	\$94
PN25MSBF	22 x 16 x 25.4	92.5	80	7	\$949	\$101
PN25MBBF	22 x 16 x 25.4	92.5	95	8	\$1000	\$121
PN27MFF	22 x 16 x 26.8	85	101	8	\$979	\$112
PN1622CU	21 x 16 x 2.5	125	6	.90	1 \$178	7 \$398
					2 \$212	8 \$490
					3 \$239	9 \$535
					4 \$276	10 \$617
					5 \$330	11 \$731
					6 \$351	12 \$876

Box/File drawer. Lock on box drawer secures both drawers. Front casters are locking. Shipped Fully Assembled.

Open Shelf/Box/File drawer. Lock on file drawer secures both drawers. Front casters are locking. Shipped Fully Assembled.

Box/Box/File drawer. Lock on file drawer secures file and lower box drawer. Front casters are locking. Shipped Fully Assembled.

File/File. Lock on lower file drawer secures both drawers. Front casters are locking. Shipped assembled in 1 carton.

- 26.8" H mobile storage can only be used with 29" H Princeton products that have laminate end panels/gables. 29" H units with HAT channels have underside clearance of only 25.9" H.

For **PN22MBF** mobile pedestals.

Required Specifications

- Top finish
- Base finish
- Drawer/door front finish
- Fabric*

Optional Specifications

- HP laminate

Accessories

- Pedestal cushion

MOBILE LATERAL FILES

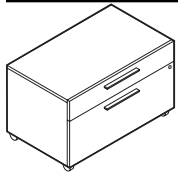

20.5”h Mobile Lateral File*

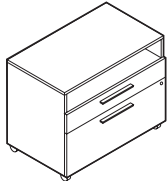

25.5”h Mobile Lateral File

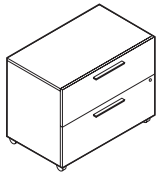

27”H Mobile Lateral File

MODEL#	DIMENSIONS	FREIGHT CLASS	WT/LBS.	CUBIC FT.	LIST PRICE	HP ADD
--------	------------	---------------	---------	-----------	------------	--------

	D x W x H					
PN22MLBF	22 x 35.5 x 20.5	100	132	14	\$1411	\$193

Box/File drawer. Lock on file drawer secures both drawers. File bars included for front-to-back letter and legal filing capability. Front casters are locking. Shipped Fully Assembled. Can fit under 29”H and 27”H credenzas for mobile lateral file with or without a cushion. Can fit under 23”H credenzas without cushion only.

PN25MLSBF	22 x 35.5 x 25.5	100	138	16	\$1476	\$202
-----------	------------------	-----	-----	----	---------------	--------------

Open Shelf/Box/File drawer. Lock on file drawer secures both drawers. File bars included for front-to-back letter and legal filing capability. Front casters are locking. Shipped Fully Assembled. Can fit under 29”H credenzas for mobile lateral file without cushion only.

PN27MLFF	22 x 35.5 x 27	92.5	170	16	\$1540	\$210
----------	----------------	------	-----	----	---------------	--------------

File/File drawer. Lock on bottom file drawer secures both drawers. File bars included for front-to-back letter and legal filing capability. Front casters are locking. Shipped Fully Assembled. Can fit under 29”H credenzas for mobile lateral file without cushion only.

- 27”H mobile pedestals can only be used with 29”H Princeton products that have laminate end panels/gables. Princeton products with metal legs will not accommodate 27”H mobile units.

CUSHIONS FOR MOBILE LATERAL FILE

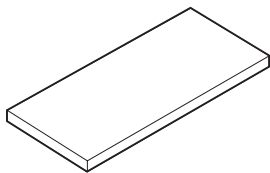

Mobile Lateral File Cushion**

MODEL#	DIMENSIONS	FREIGHT CLASS	WT/LBS.	CUBIC FT.	GRADE	LIST	GRADE	LIST
--------	------------	---------------	---------	-----------	-------	------	-------	------

PN3622CU	21 x 35.5 x 2.5	150	14	2.40	1	\$358	7	\$796
					2	\$424	8	\$979
					3	\$475	9	\$1067
					4	\$551	10	\$1235
					5	\$661	11	\$1464
					6	\$702	12	\$1753

For **PN21MLSF** and **PN22MLBF** mobile lateral files.

Required Specifications

Fabric**
 Top finish (Mobile Laterals)
 Base finish (Mobile Laterals)
 Door/drawer front finish (Mobile Laterals)

Optional Specifications

HP laminate (Mobile Laterals)

Accessories

Cushion*

STOOLS

MODEL# DIMENSIONS FREIGHT CLASS WT/LBS. CUBIC FT. LIST PRICE

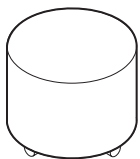

Round Mobile Stool

MODEL#	DIMENSIONS	FREIGHT CLASS	WT/LBS.	CUBIC FT.	LIST PRICE
PN1920ST	D x W x H 19 x 19 x 19.5	250	20	5.50	\$688

Laminate base for use with cushion. **CANNOT BE USED WITHOUT CUSHION. Cushion sold separately.** Six casters.
 • **NOTE: Maximum weight capacity is 200 lbs.**

CUSHION FOR MOBILE STOOL

MODEL# DIMENSIONS FREIGHT CLASS WT/LBS. CUBIC FT. GRADE LIST GRADE LIST



Cushion for Round Mobile Stool*

SEAT-PN1920ST	--	150	8	1.60	1	\$246	7	\$433
					2	\$276	8	\$498
					3	\$295	9	\$546
					4	\$328	10	\$603
					5	\$372	11	\$716
					6	\$391	12	\$838

To be used with PN1920ST.

PLANTERS

MODEL# DIMENSIONS FREIGHT CLASS WT/LBS. CUBIC FT. LIST PRICE

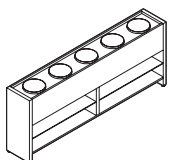

Five Pot Planter**

PN7229PL	12 x 72 x 29	100	124	14.50	\$1305
----------	--------------	-----	-----	-------	---------------

Five plastic pots - specify Black (BK) or White (WT). Adjustable 3 position laminate shelves. Shipped Fully Assembled.

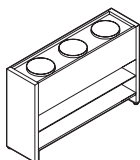

Three Pot Planter**

PN4229PL	12 x 42 x 29	92.5	86	8.46	\$994
----------	--------------	------	----	------	--------------

Three plastic pots - specify Black (BK) or White (WT). Adjustable 3 position laminate shelf. Shipped Fully Assembled.

DIVIDER SHELVES

MODEL# DIMENSIONS FREIGHT CLASS WT/LBS. CUBIC FT. LIST PRICE

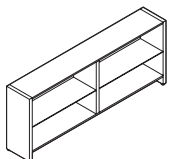

72" w Divider Shelf

PN7229BGS	12 x 72 x 29	125	124	18	\$1080
-----------	--------------	-----	-----	----	---------------

Fixed laminate shelves. Shipped Fully Assembled.

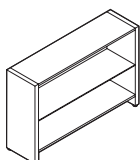

42" w Divider Shelf

PN4229BGS	12 x 42 x 29	125	86	11	\$870
-----------	--------------	-----	----	----	--------------

Fixed laminate shelf. Shipped Fully Assembled.

Required Specifications

- Fabric*
- Planter pot finish**
- Top finish
- Base finish

BOOKSHELVES

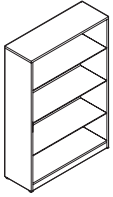

Bookshelf w/Laminate Shelves

MODEL#	DIMENSIONS D x W x H	FREIGHT CLASS	WT./LBS.	CUBIC FT.	LIST PRICE	HP ADD
PN2429BLS	12 x 24 x 29	70	37	2	\$663	\$105
PN2452BLS	12 x 24 x 52	70	60	3	\$840	N/A
PN2466BLS	12 x 24 x 66	70	74	4	\$924	N/A
PN3029BLS	12 x 30 x 29	70	44	2	\$746	\$122
PN3052BLS	12 x 30 x 52	65	68	3	\$871	N/A
PN3066BLS	12 x 30 x 66	70	79	4	\$961	N/A
PN3629BLS	12 x 36 x 29	70	66	3	\$801	\$131
PN3652BLS	12 x 36 x 52	70	80	4	\$917	N/A
PN3666BLS	12 x 36 x 66	70	106	5	\$1010	N/A

66"H models have four adjustable shelves. 52"H models have 3 adjustable shelves. 29"H models have 1 adjustable shelf. Shipped Fully Assembled.

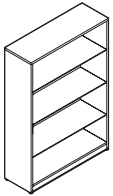

Bookshelf w/Glass Shelves

PN2429BGS	12 x 24 x 29	70	37	2	\$691	\$105
PN2452BGS	12 x 24 x 52	70	60	3	\$1023	N/A
PN2466BGS	12 x 24 x 66	70	74	4	\$1218	N/A
PN3029BGS	12 x 30 x 29	70	44	2	\$799	\$122
PN3052BGS	12 x 30 x 52	65	68	3	\$1103	N/A
PN3066BGS	12 x 30 x 66	70	79	4	\$1271	N/A
PN3629BGS	12 x 36 x 29	70	66	3	\$798	\$131
PN3652BGS	12 x 36 x 52	70	80	4	\$1199	N/A
PN3666BGS	12 x 36 x 66	70	106	5	\$1407	N/A

66"H models have four adjustable shelves. 52"H models have 3 adjustable shelves. 29"H models have 1 adjustable shelf. Shipped Fully Assembled.

DESKTOP AND OVERHEAD STORAGE

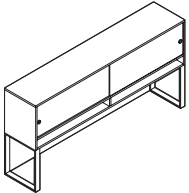

Hutch w/Laminate Doors*

MODEL#	DIMENSIONS	FREIGHT CLASS	WT./LBS.	CUBIC FT.	LIST PRICE
PN3560LCH	16 x 60 x 35	125	131	18	\$1695
PN3572LCH	16 x 72 x 35	125	135	21	\$1754
PN3584LCH	16 x 84 x 35	150	145	25	\$1882

Sliding laminate doors in upper plastic track. Recessed brushed aluminum finger pulls. No lock. Metal hutch supports. Laminate back board. 15.75" clearance between worksurface and underside. Shipped Partially Assembled.

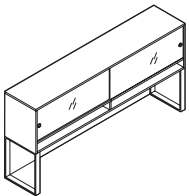

Hutch w/Glass Doors*

PN3560CH	16 x 60 x 35	125	120	19.44	\$2460
PN3572CH	16 x 72 x 35	125	144	23.33	\$2645
PN3584CH	16 x 84 x 35	150	145	25	\$2903

Sliding glass doors in upper aluminum track. Satin etched 6mm glass. Brushed aluminum finger pulls. No lock. Metal hutch supports. Laminate back board. 15.75" clearance between worksurface and underside. Shipped partially assembled in 2 cartons. Glass doors shipped separately.

Required Specifications

- Top finish
- Base finish
- Door finish (laminated doors)
- Hutch support finish*

Optional Specifications

- HP laminate (29"H bookshelves)

DESKTOP AND OVERHEAD STORAGE

MODEL# DIMENSIONS FREIGHT CLASS WT/LBS. CUBIC FT. LIST PRICE

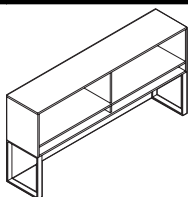

Open Hutch*

	D x W x H				
PN3560CHO	16 x 60 x 35	125	124	18	\$1479
PN3572CHO	16 x 72 x 35	125	128	21	\$1522
PN3584CHO	16 x 84 x 35	150	138	25	\$1643

Metal hutch supports. Laminate back board. 15.75" clearance between worksurface and underside. Shipped Partially Assembled.

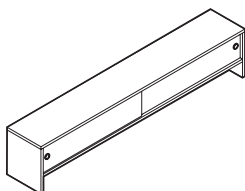

Desktop Storage w/Laminate Doors

PN1160LDS	11 x 60 x 12	100	54	6.50	\$889
PN1172LDS	11 x 72 x 12	100	62	7.75	\$957

Sliding laminate doors in upper plastic track. Recessed brushed aluminum finger pulls. No lock. Shipped Fully Assembled.

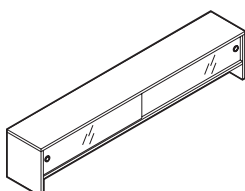

Desktop Storage w/Glass Doors

PN1160DS	11 x 60 x 12	100	43	4.58	\$1428
PN1172DS	11 x 72 x 12	100	51	5.50	\$1610

Sliding glass doors in upper aluminum track. Satin etched 6mm glass. Recessed aluminum finger pulls. No lock. Shipped assembled in 2 cartons. Glass doors shipped separately.

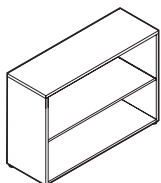

Desktop Shelf - Two High w/Laminate Shelf

PN2423LDB	12 x 24 x 23	60	45	1.50	\$420
PN3023LDB	12 x 30 x 23	60	49	1.50	\$459
PN3623LDB	12 x 36 x 23	65	53	2	\$464
PN2425LDB	12 x 24 x 25	60	47	1.50	\$420
PN3025LDB	12 x 30 x 25	65	51	2	\$459
PN3625LDB	12 x 36 x 25	65	55	2	\$464

One multiple-position adjustable laminate shelf. Shipped Fully Assembled.

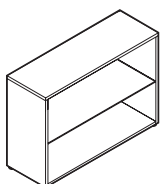

Desktop Shelf - Two High w/Glass Shelf

PN2423GDB	12 x 24 x 23	60	45	1.50	\$484
PN3023GDB	12 x 30 x 23	60	49	1.50	\$529
PN3623GDB	12 x 36 x 23	65	53	2	\$564
PN2425GDB	12 x 24 x 25	60	47	1.50	\$484
PN3025GDB	12 x 30 x 25	65	51	2	\$529
PN3625GDB	12 x 36 x 25	65	55	2	\$564

One multiple-position adjustable glass shelf. Shipped Fully Assembled.

Required Specifications

- Top finish
- Base finish
- Door finish (laminate doors)
- Hutch support finish*

DESKTOP AND OVERHEAD STORAGE

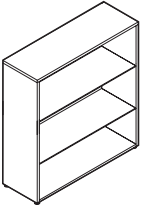

Desktop Shelf - Three High w/Laminate Shelves

MODEL#	DIMENSIONS D x W x H	FREIGHT CLASS	WT./LBS.	CUBIC FT.	LIST PRICE
PN2437LDB	12 x 24 x 37	65	58	2	\$525
PN3037LDB	12 x 30 x 37	70	64	3	\$558
PN3637LDB	12 x 36 x 37	65	71	3	\$580
PN2439LDB	12 x 24 x 39	65	58	2	\$525
PN3039LDB	12 x 30 x 39	70	64	3	\$558
PN3639LDB	12 x 36 x 39	65	71	3	\$580

Two multiple-position adjustable laminate shelves. Shipped Fully Assembled.

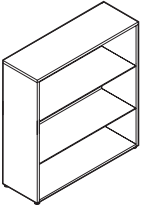

Desktop Shelf - Three High w/Glass Shelves

PN2437GDB	12 x 24 x 37	65	58	2	\$677
PN3037GDB	12 x 30 x 37	70	64	3	\$750
PN3637GDB	12 x 36 x 37	65	71	3	\$780
PN2439GDB	12 x 24 x 39	65	58	2	\$677
PN3039GDB	12 x 30 x 39	70	64	3	\$750
PN3639GDB	12 x 36 x 39	65	71	3	\$780

Two multiple-position adjustable glass shelves. Shipped Fully Assembled.

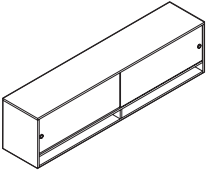

Large Overhead Storage w/Laminate Doors, Wall-Mounted

PN1960LWH	16 x 60 x 19	100	119	13.25	\$1250
PN1972LWH	16 x 72 x 19	100	138	16	\$1306
PN1984LWH	16 x 84 x 19	100	158	19	\$1438

Sliding laminate doors in upper plastic track. Recessed brushed aluminum finger pulls. No lock. Shipped Fully Assembled.
 • **NOTE:** Care should be taken to mount the units. Units should be mounted to wall studs using correct fasteners. Failure to do so may result in collapse of the unit and subsequent personal injury. **Mounting hardware not included.** Mounting hardware used should be based on wall material. Consult an installation professional for proper wall mounting.

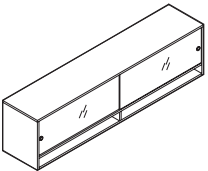

Large Overhead Storage w/Glass Doors Wall-Mounted

PN1960WH	16 x 60 x 19	100	101	10.56	\$1951
PN1972WH	16 x 72 x 19	100	121	12.67	\$2186
PN1984WH	16 x 84 x 19	100	158	19	\$2396

Sliding glass doors in upper aluminum track. Satin etched 6mm glass. Brushed aluminum finger pulls. No lock. Shipped assembled in two cartons. Glass doors shipped separately.
 • **NOTE:** Care should be taken to mount the units. Units should be mounted to wall studs using correct fasteners. Failure to do so may result in collapse of the unit and subsequent personal injury. **Mounting hardware not included.** Mounting hardware used should be based on wall material. Consult an installation professional for proper wall mounting.

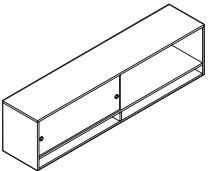

Large Overhead Storage w/Single Laminate Door, Wall-Mounted

PN1960LS	16 x 60 x 19	100	117	13.25	\$1162
PN1972LS	16 x 72 x 19	100	136	16	\$1222
PN1984LS	16 x 84 x 19	100	156	19	\$1341

Sliding laminate door in upper plastic track. Recessed brushed aluminum finger pulls. No lock. Shipped Fully Assembled.
 • **NOTE:** Care should be taken to mount the units. Units should be mounted to wall studs using correct fasteners. Failure to do so may result in collapse of the unit and subsequent personal injury. **Mounting hardware not included.** Mounting hardware used should be based on wall material. Consult an installation professional for proper wall mounting.

Required Specifications

- Top finish
- Base finish
- Door finish (laminate doors)

DESKTOP AND OVERHEAD STORAGE

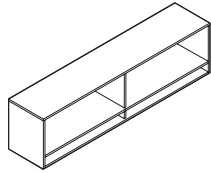

Large Overhead Storage, Wall-Mounted

MODEL# DIMENSIONS FREIGHT CLASS WT/LBS. CUBIC FT. LIST PRICE

D x W x H

PN1960WHO	16 x 60 x 19	100	112	13.25	\$1052
PN1972WHO	16 x 72 x 19	100	131	16	\$1094
PN1984WHO	16 x 84 x 19	125	151	19	\$1217

Open storage with center divider. Shipped Fully Assembled.

• **NOTE:** Care should be taken to mount the units. Units should be mounted to wall studs using correct fasteners. Failure to do so may result in collapse of the unit and subsequent personal injury. **Mounting hardware not included.** Mounting hardware used should be based on wall material. Consult an installation professional for proper wall mounting.

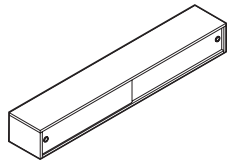

Small Overhead Storage w/Laminate Doors, Wall-Mounted

PN1260LWH	12 x 60 x 8	100	49	5.25	\$916
PN1272LWH	12 x 72 x 8	100	56	6.25	\$994
PN1284LWH	12 x 84 x 8	100	64	8	\$1044

Sliding laminate doors in upper plastic track. Recessed brushed aluminum finger pulls. No lock. Shipped Fully Assembled.

• **NOTE:** Care should be taken to mount the units. Units should be mounted to wall studs using correct fasteners. Failure to do so may result in collapse of the unit and subsequent personal injury. **Mounting hardware not included.** Mounting hardware used should be based on wall material. Consult an installation professional for proper wall mounting.

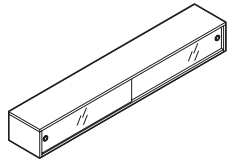

Small Overhead Storage w/Glass Doors, Wall-Mounted

PN1260WH	12 x 60 x 8	100	31	3.33	\$1793
PN1272WH	12 x 72 x 8	100	38	4	\$2021
PN1284WH	12 x 84 x 8	100	64	8	\$2136

Sliding glass doors in upper aluminum track. Satin etched 6mm glass. Brushed aluminum finger pulls. No lock. Shipped assembled in 2 cartons. Glass doors shipped separately.

• **NOTE:** Care should be taken to mount the units. Units should be mounted to wall studs using correct fasteners. Failure to do so may result in collapse of the unit and subsequent personal injury. **Mounting hardware not included.** Mounting hardware used should be based on wall material. Consult an installation professional for proper wall mounting.

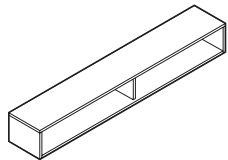

Small Overhead Storage, Wall-Mounted

PN1260WHO	12 x 60 x 8	100	45	5.25	\$703
PN1272WHO	12 x 72 x 8	100	52	6.25	\$790
PN1284WHO	12 x 84 x 8	125	60	8	\$859

Open storage shelf with center divider. Shipped Fully Assembled.

• **NOTE:** Care should be taken to mount the units. Units should be mounted to wall studs using correct fasteners. Failure to do so may result in collapse of the unit and subsequent personal injury. **Mounting hardware not included.** Mounting hardware used should be based on wall material. Consult an installation professional for proper wall mounting.

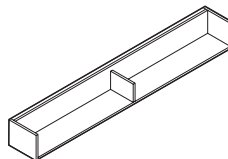

Wall-Mounted Shelf

PN1260WHS	12 x 60 x 8	150	31	5.50	\$522
PN1272WHS	12 x 72 x 8	125	37	6	\$565
PN1284WHS	12 x 84 x 8	125	44	7	\$610

Open storage shelf with center divider. Shipped Fully Assembled.

• **NOTE:** Care should be taken to mount the units. Units should be mounted to wall studs using correct fasteners. Failure to do so may result in collapse of the unit and subsequent personal injury. **Mounting hardware not included.** Mounting hardware used should be based on wall material. Consult an installation professional for proper wall mounting.

Required Specifications

- Top finish
- Base finish
- Door finish (laminated doors)

TACKBOARD NOTES

D x W x H

TACKBOARD Notes: Tackboards can be upholstered in all of the following fabrics:

Grade 1: Hudson, Jenny, Quilt, Terrace, Urban, Waterfall

Grade 2: Imprint, Lola, Silhouette

Grade 3: Anchorage, Merge

TACKBOARDS

MODEL# DIMENSIONS FREIGHT CLASS WT/LBS. CUBIC FT. FABRIC GRD. LIST PRICE

PN1556TBH	1 x 56 x 14.5	100	9.50	1	1	\$539
					2	\$647
					3	\$776
					4	\$930
					5	\$1068

PN1568TBH	1 x 68 x 14.5	92.5	11	1	1	\$561
					2	\$675
					3	\$807
					4	\$969
					5	\$1113

PN1580TBH	1 x 80 x 14.5	125	10	1.50	1	\$892
					2	\$1072
					3	\$1284
					4	\$1541
					5	\$1772

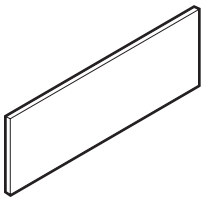

Tackboard for Hutches

Attaches with Velcro to Hutch backboard.

Required Specifications

Fabric

TACKBOARDS

MODEL# DIMENSIONS FREIGHT CLASS WT/LBS. CUBIC FT. FABRIC GRD. LIST PRICE

D x W x H

PN1560TBW	1 x 60 x 14.5	85	14	1	1	\$551
					2	\$662
					3	\$794
					4	\$952
					5	\$1096
PN1566TBW	.62 x 66 x 14.4	85	12	1	1	\$735
					2	\$885
					3	\$1061
					4	\$1273
					5	\$1462
PN1572TBW	1 x 72 x 14.5	70	16.50	1	1	\$643
					2	\$774
					3	\$928
					4	\$1112
					5	\$1278
PN1578TBW	.62 x 78 x 14.4	100	14	1.50	1	\$927
					2	\$1114
					3	\$1332
					4	\$1600
					5	\$1839
PN1584TBW	.62 x 84 x 14.4	92.5	15	1.50	1	\$1009
					2	\$1211
					3	\$1452
					4	\$1742
					5	\$2003

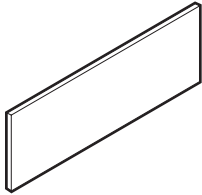

Tackboard for Overhead Storage

Attaches with adhesive-backed Velcro.

Required Specifications

Fabric

ELECTRICAL / DATA

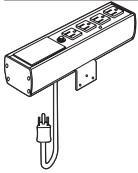

4 Outlet, 1 Telecom Blank Plate

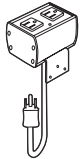

2 Outlet Power Block

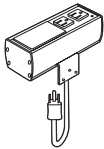

2 Outlet, 1 Telecom Blank Plate

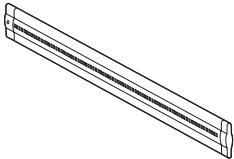

LED Task Light

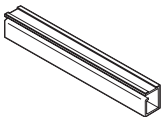

Wire Manager

MODEL#	DIMENSIONS D x W x H	FREIGHT CLASS	WT/LBS.	CUBIC FT.	LIST PRICE
PGDPS41	2.5 x 10.25 x 2.22	70	1.50	.02	\$234
4 power receptacles and 1 telecom blank plate. For mounting behind pull-out shelf or open space credenza. Tungsten (TUN) finish. 12 foot black cord.					
PGDPS20	2.5 x 3.58 x 2.22	70	1	.01	\$168
2 power receptacles. For side mounted installation. Tungsten (TUN) finish. 12 foot black cord.					
PGDPS21	2.5 x 6.75 x 2.22	70	1.25	.01	\$217
2 power receptacles and 1 telecom blank plate. For side mounted installation. Tungsten (TUN) finish. 12 foot black cord.					
PLED30	1.5 x 15.5 x .5	150	2	.50	\$494
PLED50	1.5 x 23.5 x .5	150	2	.50	\$569
PLED100	1.5 x 43.5 x .5	125	3	.50	\$660
Energy efficient LED. Ultra slim design. Suitable for hanging under Hutch or Wallhung units. 6' power cord.					
PEWM5.5	2 x 66 x 2	70	.60	.10	\$198
PEWM5	2 x 60 x 2	70	.60	.10	\$166
PEWM4.5	2 x 54 x 2	70	.50	.10	\$148
PEWM4	2 x 48 x 2	70	.50	.10	\$135
PEWM3.5	2 x 42 x 2	70	.40	.10	\$116
PEWM3	2 x 36 x 2	70	.40	.10	\$104
PEWM2.5	2 x 30 x 2	70	.30	.10	\$85
PEWM2	2 x 24 x 2	70	.30	.10	\$70
PEWM1.5	2 x 18 x 2	70	.20	.10	\$55
PEWM1	2 x 12 x 2	70	.20	.10	\$40

Plastic tray flexes to receive and hold electrical and data wires. Quickly attaches with two strips of double-sided tape. Black (**BLK**) only.

TABLES

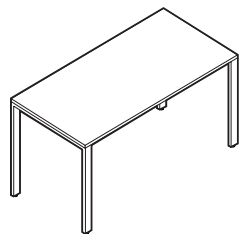

29" H Table

MODEL#	DIMENSIONS	FREIGHT CLASS	WT/LBS.	CUBIC FT.	LIST PRICE	HP ADD
D x W x H						
PN242429	24 x 24 x 29	150	53	10	\$951	\$133
PN482429	24 x 48 x 29	125	71	10.50	\$1015	\$144
PN542429	24 x 54 x 29	125	83	13	\$1205	\$169
PN602429	24 x 60 x 29	125	86	13	\$1225	\$172
PN662429	24 x 66 x 29	125	90	14	\$1251	\$174
PN722429	24 x 72 x 29	150	97	21	\$1260	\$175
PN782429	24 x 78 x 29	150	101	21	\$1381	\$193
PN842429	24 x 84 x 29	150	106	22	\$1492	\$208
PN902429	24 x 90 x 29	150	110	23	\$1568	\$219
PN962429	24 x 96 x 29	150	123	24	\$1624	\$226
PN303029	30 x 30 x 29	150	66	12	\$1047	\$147
PN483029	30 x 48 x 29	150	77	13	\$1115	\$155
PN543029	30 x 54 x 29	150	94	16	\$1313	\$184
PN603029	30 x 60 x 29	125	99	16.50	\$1322	\$185
PN663029	30 x 66 x 29	125	105	17	\$1359	\$190
PN723029	30 x 72 x 29	150	112	23	\$1381	\$193
PN783029	30 x 78 x 29	150	119	26	\$1509	\$210
PN843029	30 x 84 x 29	150	132	27	\$1619	\$226
PN903029	30 x 90 x 29	150	139	33	\$1694	\$237
PN963029	30 x 96 x 29	150	143	29.50	\$1735	\$241
PN363629	36 x 36 x 29	150	80	15	\$1113	\$155
PN603629	36 x 60 x 29	150	113	20	\$1516	\$210
PN663629	36 x 66 x 29	150	119	21	\$1566	\$218
PN723629	36 x 72 x 29	150	128	29	\$1590	\$221
PN783629	36 x 78 x 29	150	135	31	\$1568	\$219
PN843629	36 x 84 x 29	150	150	32	\$1677	\$234
PN903629	36 x 90 x 29	150	161	33.50	\$1802	\$252
PN963629	36 x 96 x 29	150	164	35	\$1822	\$253
PN424229	42 x 42 x 29	150	96	17	\$1285	\$180
PN604229	42 x 60 x 29	150	125	22	\$1585	\$221
PN664229	42 x 66 x 29	150	134	23	\$1636	\$229
PN724229	42 x 72 x 29	150	142	32	\$1668	\$233
PN784229	42 x 78 x 29	150	150	35	\$1853	\$259
PN844229	42 x 84 x 29	150	167	36	\$2022	\$280
PN904229	42 x 90 x 29	150	176	38	\$2166	\$302
PN964229	42 x 96 x 29	150	182	40	\$2210	\$307
PN484829	48 x 48 x 29	150	114	21	\$1327	\$186
PN604829	48 x 60 x 29	150	138	26	\$1643	\$229
PN664829	48 x 66 x 29	150	147	27	\$1700	\$237
PN724829	48 x 72 x 29	150	158	38	\$1723	\$240
PN784829	48 x 78 x 29	150	166	40	\$1950	\$272
PN844829	48 x 84 x 29	150	184	42	\$2115	\$295
PN904829	48 x 90 x 29	150	193	43	\$2258	\$312
PN964829	48 x 96 x 29	150	202	45	\$2294	\$320

Freestanding. 1" x 2.5" open metal frame legs with levelers, finished in Tungsten (TTU), Designer White (TDW) or Black (TBL). Metal support hat channel(s) provided on tables exceeding 54" in width. Shipped in 2 cartons.

Required Specifications

Top finish
Leg finish

Optional Specifications

HP laminate

Accessories

Wire manager
Desktop screen

TABLES **MODEL#** **DIMENSIONS** **FREIGHT CLASS** **WT/LBS.** **CUBIC FT.** **LIST PRICE** **HP ADD**

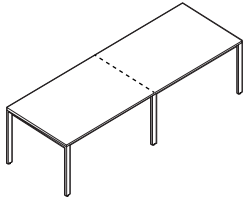

29" H Table with Center Leg

	D x W x H						
PN1203629	36 x 120 x 29	250	221	86.83	\$2773	\$385	
PN1443629	36 x 144 x 29	250	246	97.31	\$2938	\$408	
PN1204229	42 x 120 x 29	250	246	101.8	\$2885	\$399	
PN1444229	42 x 144 x 29	250	287	110.7	\$3042	\$420	
PN1204829	48 x 120 x 29	250	271	113.7	\$3055	\$422	
PN1444829	48 x 144 x 29	250	291	116.7	\$3214	\$444	

Freestanding. 1" x 2.5" open metal frame legs with levelers, finished in Tungsten (TTU), Designer White (TDW) or Black (TBL). 120" and 144"W with 2 piece top. Metal support hat channel(s) provided on tables exceeding 54" in width. Shipped in 3 cartons.

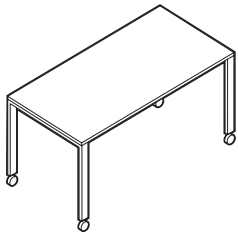

29" H Table with Casters

PN242429C	24 x 24 x 29	92.5	53	4.50	\$982	\$139	
PN482429C	24 x 48 x 29	85	71	5.26	\$1042	\$147	
PN542429C	24 x 54 x 29	85	83	6.50	\$1248	\$174	
PN602429C	24 x 60 x 29	85	86	6.50	\$1271	\$178	
PN662429C	24 x 66 x 29	85	90	7	\$1294	\$182	
PN722429C	24 x 72 x 29	85	97	7	\$1315	\$185	
PN303029C	30 x 30 x 29	92.5	66	6	\$1081	\$151	
PN483029C	30 x 48 x 29	100	77	9.50	\$1140	\$161	
PN543029C	30 x 54 x 29	92.5	94	8	\$1357	\$190	
PN603029C	30 x 60 x 29	92.5	99	8.26	\$1368	\$191	
PN663029C	30 x 66 x 29	85	105	8.50	\$1398	\$194	
PN723029C	30 x 72 x 29	85	112	9	\$1445	\$201	
PN363629C	36 x 36 x 29	92.5	80	7.50	\$1135	\$157	
PN603629C	36 x 60 x 29	92.5	113	10	\$1431	\$199	
PN663629C	36 x 66 x 29	92.5	119	10.50	\$1468	\$204	
PN723629C	36 x 72 x 29	100	124	14.50	\$1677	\$234	
PN424229C	42 x 42 x 29	92.5	96	8.50	\$1314	\$185	
PN484829C	48 x 48 x 29	150	114	21	\$1360	\$190	

Freestanding. 1" x 2.5" open metal frame legs with casters, finished in Tungsten (TTU), Designer White (TDW) or Black (TBL). All casters are locking. Metal support hat channel(s) provided on tables exceeding 54" in width. Shipped in 2 cartons.

Required Specifications

Top finish
Leg finish

Optional Specifications

HP laminate

Accessories

Wire manager
Desktop screen



Zira™ is a contemporary desking solution with extensive options to personalize your workspace. Components can be freestanding for single workstation configurations, or joined together to form multiple work groups. Create a work environment that meets your worksurface needs and storage requirements - then go ahead and personalize it!

Select from the following: hundreds of components for any size or shape office, storage components that can tower to 84" high, 20 laminate finishes, 5 edge options, 9 handle options in silver, black, nickel or brass finishes, 2 glazing options with 2 frame finishes on doors and modesty panels, and lastly, work surface grommets and power blocks for your electrical needs.

Zira is your most functional solution to work environment efficiency and organization.



Tops are available in a choice of 1" or 1/2" thick with a variety of edge details and a top over side, edge panel design
* Shown with 1.5" thick top and Bicut Edge (CR).



Optional Frosted or Ribbed glazing on doors and modesty panels. Available with Tungsten or Black frames.



Collator option is available for the convenient storage of day-to-day documents. Available in Black or Brushed Cobalt finish.



Features and Benefits

- 45 lb. density particle board substructure with high performance thermally fused laminate
- Top over side panel design
- Worksurfaces feature preferred edging in matching color
- Available in 1" or 1.5" thick top with a variety of edge details
- 11/16" thick full modesty panel is standard
- 11/16" thick 3/4 modesty panel available on most components
- Pencil tray included in box drawer
- Lateral file drawers can accommodate legal or letter documents
- Premium full extension progressive ball bearing slides on file drawers & box drawers
- All drawer fronts edge banded with side pull opening pedestals and standard pedestal locks
- Compatible with Divide partitioning system for increased privacy and storage requirements

GENERAL INFORMATION

- Over 5300 different standard components are available
- Zira components are compatible with **Divide** partitioning panels.
- Handles, lock finish and trim color (if applicable) **MUST MATCH**
- Dimensionally compatible with the Adaptabilities series.
- For environmental certification, please visit globalfurnituregroup.com

WORKSURFACES

- Available in 1" or 1.5" thick thermally fused laminate tops with a variety of edge details
- Tops are sealed with Global's preferred edge in matching color. Woodgrain surfaces feature edging with matching printed woodgrain.
- High pressure tops are available in all Zira laminate finishes at an extended lead time. Please see model # for pricing and availability.
- Products specified with the high pressure laminate option are finished on the underside of the surface with a kraft paper backing.

CONSTRUCTION

- Constructed of 45 lb. density particleboard with high performance thermally fused laminate
- All desks are size (incrementally) accurate
- Desk drawers/storage open with side pulls and feature a French dovetail joint in front, lap joint in back. Pulls are available for these units at an upcharge, see below. All other drawers/storage feature built-in pulls available in 9 different styles
- Virtually no loose hardware
- Models with Monopost are standard with 4" Square Monopost. Optional 5" Round and 4" Round Monopost are available at no upcharge. Available in Black (**TBL**) or Tungsten (**TU**) finish. Please Specify
- Leveling glides are standard on all floor units
- Premium full extension progressive ball bearing slides on file drawers & box drawers
- All drawer fronts edge banded with side pull opening pedestals and standard pedestal locks

HEIGHT ADJUSTABLE DESKS

- Zira Height Adjustable Desks include a laminate chassis + height adjustable table frame sold separately.
- Use **FFHATZS** with all **ZAxxxxFxx** and **ZAxxxxNP** models.
- Use **FFHATZ9** with all **ZA60xx24L/R** models.
- Steel constructed leg tubing and cross bar.
- Table frame designed with 3.15" x 2.35" rectangular outer leg with the larger tube attaching to a bracket within the pedestal.
- Select width of base: (**S**) for 60"/66" wide desks, (**M**) for 72"/84" wide desks.
- Powder coat finishes for bases is standard in Black (**BLK**) or Tungsten (**TUN**).
- Wire management channels available in Black (**BLK**) or Silver (**SIL**). Silver (**SIL**) complements Tungsten.
- Zira Height Adjustable desks have 2-stages and feature an adjustment range of 29.5"/30" – 49"/49.5".
- Lifts 265 pounds.
- Operates at 1.5" per second.
- Shadow power draw is 0.45 watts.
- Maximum power draw is 1.3 amps.
- All bases feature a dual actuator system with a motor driving each leg.
- Motors daisy-chain and connect directly to one another, without the need for a control box.

HANDSET

- Standard up/down handset (**SH**) (no digital readout). Black only.
- A Joggle Wheel Digital Handset with five programmable settings is optional, specify Digital Readout Handset (**DH**). Add **\$219**. Silver Only.
 - Digital Readout Handset (**DH**) is recommended when items above or below worksurface might impede full movement of the table. DH includes settings to program Upper and Lower Limits, Collision Detection, Sit Position and Stand Position

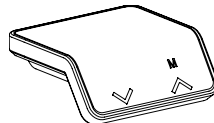

Standard handset (**SH**)

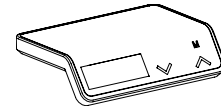

Digital readout handset (**DH**)

NOISE REDUCTION

- Industry leading operating sound level of 55dB is standard (**SI**).
- Optional whisper quiet sound insulation reduces level to operating sound level to 38dB. Specify Whisper Quiet Insulation (**QI**). Add **\$102**.

MODESTY PANELS

- Laminate full modesty panel is standard. Laminate ¾ modesty panel is available on select models at no additional charge. Please specify (**3MP**).
- Glazing options are available on the full modesty panel, ¾ modesty panel and the 12" modesty panel (where available). Please specify. See next page for options and codes.
- 11/16" thick full modesty panel is standard on most components
- 11/16" thick ¾ modesty panel available on most components
- **Note:** Woodgrain modesty panels over 60" wide will have the grain pattern in the horizontal direction. All end panels and modesty panels 60" or less will have the grain pattern in the vertical direction

STORAGE

- All lateral files feature a foolproof interlock device
- Pencil tray included in box drawer
- Lateral file drawers can accommodate legal or letter documents
- All drawers are locking unless otherwise noted
- Front-to-back filing bars for all steel drawer files available separately. Order FBB bars. See "FBB" on page 41.
- All desks, returns and credenzas with fixed storage are shipped standard with box/file, file/file or box/file 16" wide pedestals.
- Storage modules, wardrobe cabinets, personal towers, hutches and table top bookcases have 11/16" thick shelves
- End shelves, bookcases and table top end shelves have 1" thick shelves
- **All shelves are 3 position fixed/height adjustable.**
- Storage cabinets 24" wide and less, 41" high and up are not intended to be freestanding and should be ganged. Ganging hardware and instructions are provided. Interior of all cabinets are pre-drilled for ganging connections.
- Adjustable shelves can be positioned to accept **Binder** storage as follows:
For units **29" to 53" H** where applicable:
 - with 1 shelf - cannot accommodate binder row
 - with 2 shelves - one shelf can accommodate a binder row
 - with 3 shelves - two shelves can accommodate binder rows
 - with 4 shelves - three shelves can accommodate binder rows
 For units **65.5" to 84.5" H** where applicable:
 - with 1 shelf - can accommodate one row of binders
 - with 2 shelves - 65.5" and 72" H can accommodate one row of binders
 - 84" H can accommodate two rows of binders
 - with 3 shelves - can accommodate two rows of binders
 - with 4 shelves - can accommodate three rows of binders
 - with 5 shelves - can accommodate four rows of binders
 - with 6 shelves - can accommodate five rows of binders

LOCKS

- Locks are standard on all storage modules. Finish will coordinate with handles and/or aluminum doors. For desk, return or table components, etc. please specify finish: Black (**BK**) or Silver (**SI**).
- Please note that Flared Brass (**HW**) handle defaults to Black locks, so trim options must be Black to match.
- Key alike or specific key number optional for all products with locks
- Reserved for new orders greater than \$20,000 list, all Zira units with locks may be ordered with **CA** cap option and specific lock cores/keys can be ordered separately for field installation rather than specifying duplicate product lines with different key numbers.
- When **CA** option is specified, product will ship with a cap over the empty lock housing.
- Separately order the appropriate number of cores with keys; use product code **SIL-CORE-H-SHOE** for Silver core/key sets or product code **BLK-CORE-H-SHOE** for Black core/key sets. Specify quantity and lock number required. One order line per key number required. Key number range: 401-440. **Must be ordered at the same time product is ordered with CA lock cap option specified.**
- One core removal key is required. Recommend one core removal for every 25 cores ordered. Order as **REMOVE-K-H-SHOE**.
- No charge applies for separate lock cores or core removal keys only when ordered with product. If replacement lock core and key required, contact Customer Care for applicable product code and pricing.

SHIPPING

- Shipped assembled, 1 per carton, unless otherwise noted. Other components are easy to assemble.

CUSTOM WIDTHS

- Custom widths are available for products that feature a worksurface as follows: desks, credenzas (applies to kneespace and single pedestal credenzas only), islands (excludes spanner islands), returns, bridges, extended corners and corners.
- Desks and credenzas that incorporate drawers and/or doors will be modified by changing the width of the worksurface and modesty panel, drawer and/or door dimensions are not affected.
- No upcharge for next size up
- Custom width does not apply to cabinets, hutches, pedestals or any other units.

HUTCHES

- 71" hutches (actual width 71.69") are for use when a hutch is placed across the back of a 42" wide return and across the depth of a 30" deep surface top (actual depth 29.69").
 - ZxxxxDK, ZxxxxDM and ZxxxxDML/DMR are exactly 30" deep. Therefore 72" hutches may be used.
- Hutches should not be placed on the approach side of any single pedestal and double pedestal desks with an overhang.

1. SPECIFY MODEL NUMBER

2. SPECIFY FINISH AND TOP THICKNESS/EDGE DETAIL

• All units available in solid color (Top and Chassis matching) or Two-Tone combination except for the following units:

- Shells: One Tone in all standard finishes
- Collators: One Tone in Black (K) or Brushed Cobalt (T)
- Horizontal Pigeon Holes: One Tone in all standard finishes
- Vertical and Transitional Pigeon Holes: Two-Tone - Chassis/Shell in all standard finishes, Collator Shelves in Black (K) or Brushed Cobalt (T).

Finishes:

ACJ Absolute Acajou	NGL Noce Grigio
ASN Asian Night	NEL Noce Leggero
AWC Avant Cherry	NML Noce Medio
AWH Avant Honey	QTM Quartered Mahogany
BLK Black	SOG Storm Grey
BRC Brushed Cobalt	TFW Tiger Fruitwood
CMB Clear Maple	TWL Tiger Walnut
DES Dark Espresso	WHE Walnut Heights
DWT Designer White	WHC White Chocolate
HGT Hayden Grey	WGY Willow Grey
NBL Noce Biondo	WCR Winter Cherry

Top Thickness/Edge Detail



A3 1" top, standard flat edge



AR 1" top, bicut edge



C3 1.5" top, standard flat edge



CR 1.5" top, bicut edge



CF 1.5" top, fluted edge

3. SPECIFY OPTIONS

BOX DRAWERS for lateral file drawers (no upcharge)

- Specify **B_** (Drawer Position 1-4 must be specified)

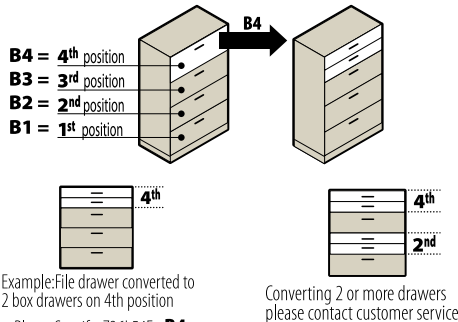

- *Not available on drawers with steel interiors*

HANDLES

- Handles are applied to all lateral drawers and doors, and are included in the published list price. When ordering, please indicate handle choice from the list of options below. Integrated vertical finger pulls are the standard default for mobile pedestals, hanging pedestals, or where BBF or FF pedestals are part of a desk, return credenza or corner desk. Handles are optional on these units with a list upcharge of \$50. If a handle is not desired, select lock finish **BK** for Black or **SI** for Silver.
- General guideline: when handles are shown in individual product line art within the price list, handles are included; and where not shown in line art, \$50 list upcharge applies when handle option is selected.
- To order handles, please specify corresponding code to image as below (**HS, HO, HW, HX, HV, HU, HQ, HZ, or HR**):



HS Flared Silver



HV Square Edge Silver



HO Crescent Black



HW Flared Brass



HU Square Edge Black



HZ Dimpled Nickel



HX Flared Black



HQ Bar Silver



HR Bar Black

MONOPOST



P1 square 4" Tungsten



P2 square 4" Black



P3 round 4" Tungsten



P4 round 4" Black



P5 round 5" Tungsten



P6 round 5" Black

GROMMETS

- Additional grommets available in standard worksurface locations (left, center or right).
- Order as: **AG1, AG2 or AG3. Add \$88**
- Grommets may be placed at non-standard locations. Order as: **AGS - Add \$88**. A drawing must be supplied with vertical and horizontal dimensions to the center of the cut-out (as in drawing above). Please refer to **CUSTOM GROMMET LOCATION FORM** in the back reference section.
- Components that come standard with grommet as stated within the product descriptions or shown in the corresponding price list line art, may be ordered without a grommet. **Add \$49.**
- Option to remove standard grommet when required - specify **RSG - Add \$49.**
- Option to remove standard grommet position and add another position - specify **RSG** and **AG_** or **AGS**, upcharge applies. For **RSG + AG_** combination, **Add \$129**. For **RSG + AGS** combination, **Add \$129**.

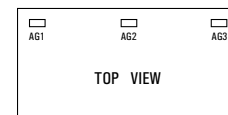
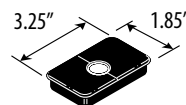

- Grommet hole dimensions are 3 1/4" wide x 1 7/8" deep.
- Actual grommet locations on the worksurface are depicted in the example drawings shown below. Dimensions shown are actual measurements (in inches).

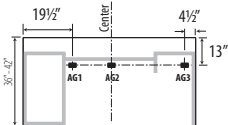

Straight Front

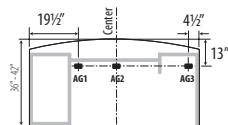

Bow Front

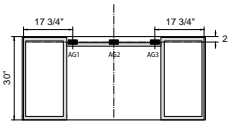

HA Double Ped

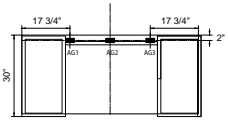
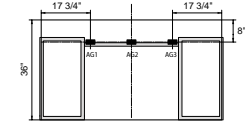

HA Single Ped

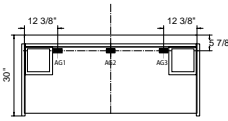
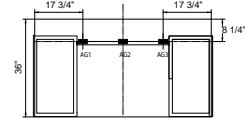

Freestanding HA

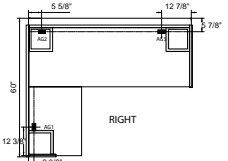
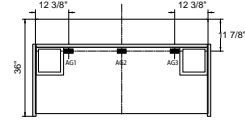

L HA desk

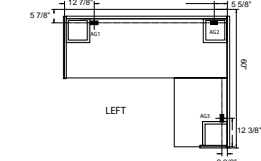

- Grommets are available on modesty panels of **extended corners** and **5-sided corners** 8" in where the two modesty panels meet at a 90° angle. Please specify **FOGMP-R** for right grommet placement and **FOGMP-L** for left grommet (placement is as shown on diagrams below). Cost is **\$88**.

** Modesty Panels are 1" off of ground

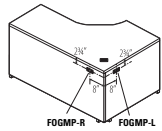

Left Extended Corner Unit

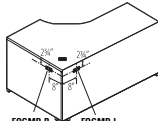

Right Extended Corner Unit

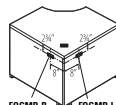

5-Sided Corner Unit

POWER BLOCK

- A Power Block (model **PMSPDM**) may be ordered on all worksurfaces.
- A Power Block is a rectangular worksurface power/data module with one electrical duplex receptacle and two data (RJ45) receptacles. 9 foot black cord included. Power Block dimensions are 3 1/2" deep x 6 1/2" wide x 2 3/4" high.
- To purchase a Power Block, you must specify both the Power Block cut-out location and the Power Block model #. Order Power Block as **PMSPDM**, **Add \$330**. Power Blocks are available in standard worksurface locations (left, center or right). Order as **E1, E2 or E3. Add \$88**.



Power Block **PMSPDM** Add **\$330**

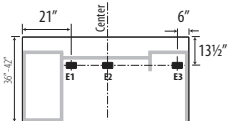

Straight Front

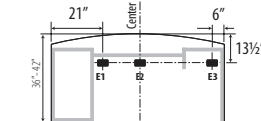

Bow Front

Specify location **E1, E2 or E3** Add **\$88**

GLAZING (Doors and Modesty Panels)



Z1 frosted glazing, Tungsten (TUN) frame



Z2 frosted glazing, Black (BLK) frame



Z3 ribbed glazing, Tungsten (TUN) frame



Z4 ribbed glazing, Black (BLK) frame



Full modesty panel - **Z1** frosted glazing, Tungsten (TUN) frame
3/4 modesty (shown) - **Z1 + 3MP**
ZA - 12"H modesty (select models)



Full modesty panel - **Z2** frosted glazing, Black (BLK) frame
3/4 modesty (shown) - **Z2 + 3MP**
ZB - 12"H modesty (select models)



Full modesty panel - **Z3** ribbed glazing, Tungsten (TUN) frame
3/4 modesty (shown) - **Z3 + 3MP**
ZC - 12"H modesty (select models)



Full modesty panel - **Z4** ribbed glazing, Black (BLK) frame
3/4 modesty (shown) - **Z4 + 3MP**
ZD - 12"H modesty (select models)

Executive Height Adjustable Desks

Available widths: 60", 66", 72", 84"

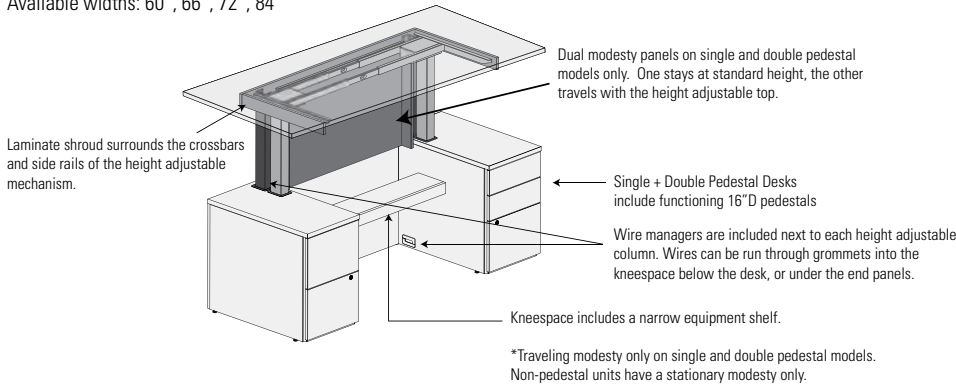

Returns

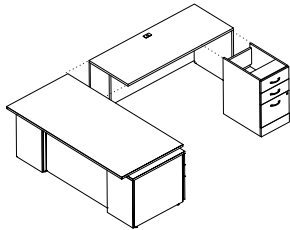

For "L" Shape Layouts

- Pre-configured
- With custom shell storage

Bridges

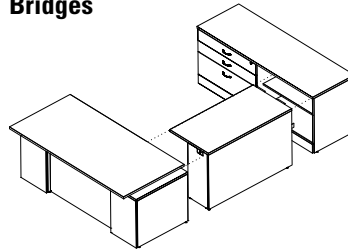

For "U" shape Layouts

Top conditions for Height Adjustable Desks

Top recesses are to minimize potential pinch points when adjacent to fixed surfaces.

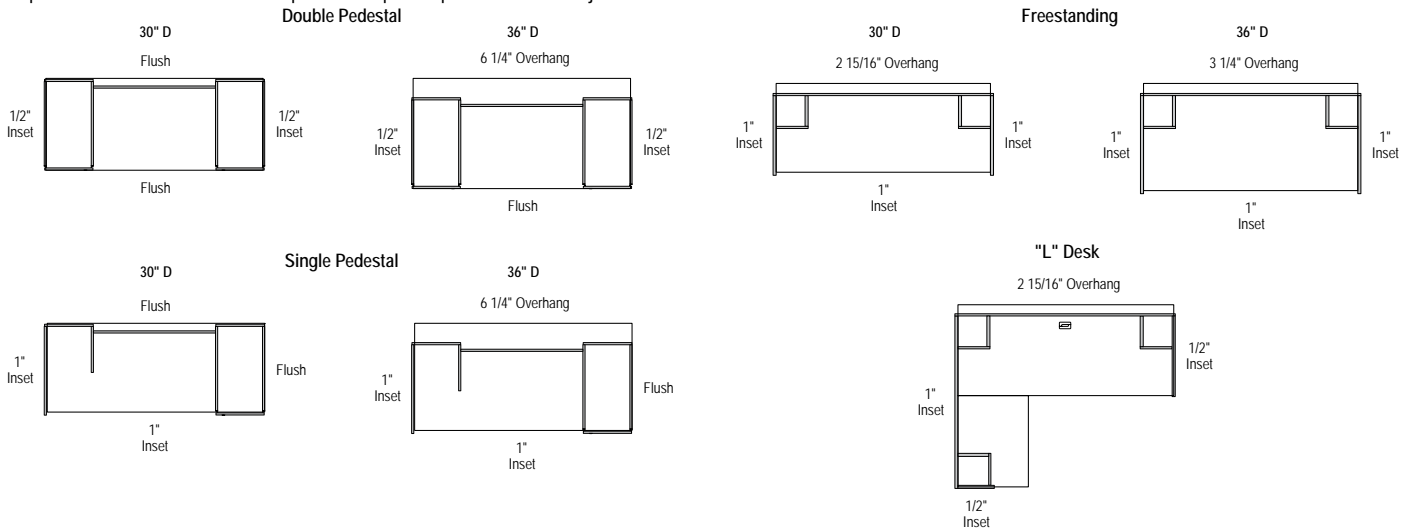

Wall Panels

Weight capacities for wall panels

- When mounting customer supplied flat screen or other to a wall panel, total weight including mounting hardware **should not exceed 140 lbs.** in total. Not approved for use with articulating or extendable mounting arms.
- Wall panels with floating shelves:
 - **24"W** up to 50 lbs.; **30"W** up to 65 lbs.; **36"W** up to 75 lbs.; **42"W** up to 90 lbs. per floating shelf
 - Note: weight should be evenly distributed over surface
- Wall panels with overhead cabinet storage:
 - Note: weight should be evenly distributed over surface
 - **66"H - 24"W**: 30 lbs. top/55 lbs. inside bottom; **30"W**: 40 lbs. top/70 lbs. inside bottom; **36"W**: 45 lbs. top/85 lbs. inside bottom; **42"W**: 55 lbs. top/95 lbs. inside bottom.
 - **72"H - 24"W**: 30 lbs. top/65 lbs. inside bottom; **30"W**: 40 lbs. top/80 lbs. inside bottom; **36"W**: 50 lbs. top/95 lbs. inside bottom; **42"W**: 60 lbs. top/100 lbs. inside bottom.
 - **84"H - 24"W**: 30 lbs. top/65 lbs. shelf & inside bottom; **30"W**: 40 lbs. top/80 lbs. shelf & inside bottom; **36"W**: 50 lbs. top/95 lbs. shelf & inside bottom; **42"W**: 60 lbs. top/100 lbs. shelf & inside bottom.

Wall Panels

*Grommet locations for wall panels

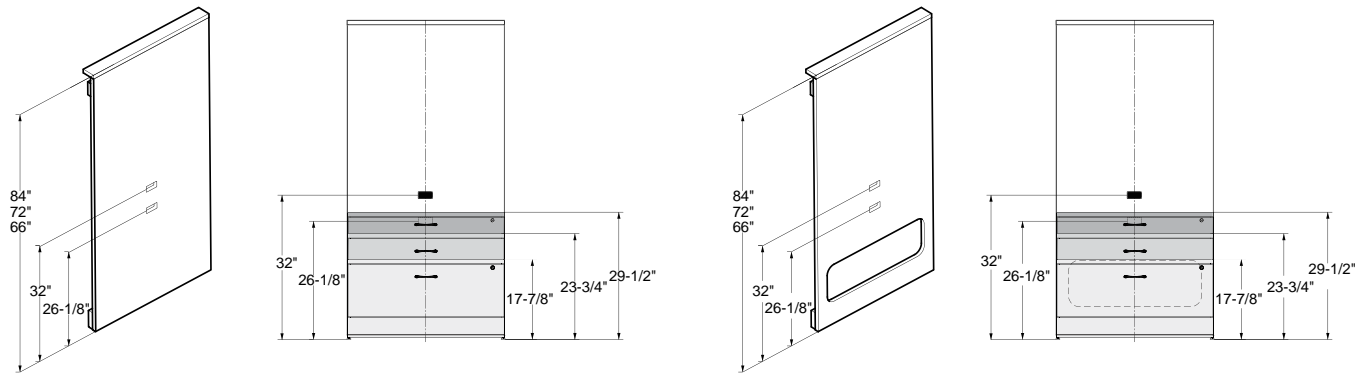

- AG1 grommet sits at 26-1/8" above the floor, just about 1-1/2 high storage, but below standard 29-1/2" storage
- AG2 grommet sits at 32" above the floor, above 29-1/2" storage
- *Cove Mini power units are not for use in this application due to depth.
- When the wall with wire management access is specified, the wire management access opening will sit below all storage heights (see chart below).

Wall Width	Opening Width
42"	35.75"
36"	29.75"
30"	23.75"
24"	17.75"

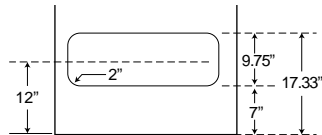

Desks / Extended Corner Desks - available width: 60", 66", 72", 84"

Modesty Treatments

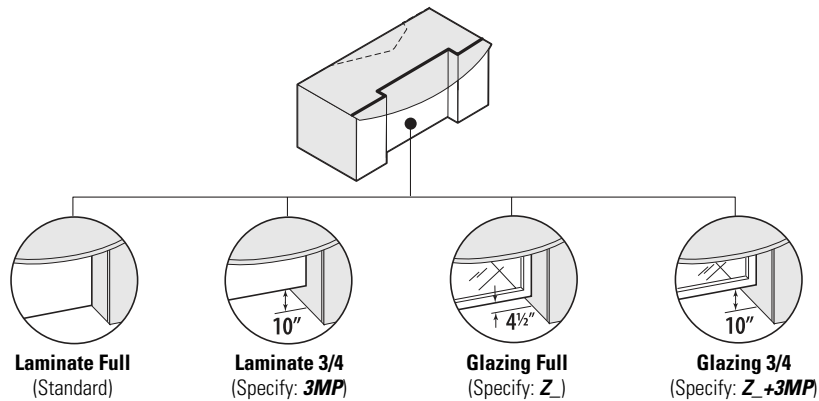

Overhang Dimensions

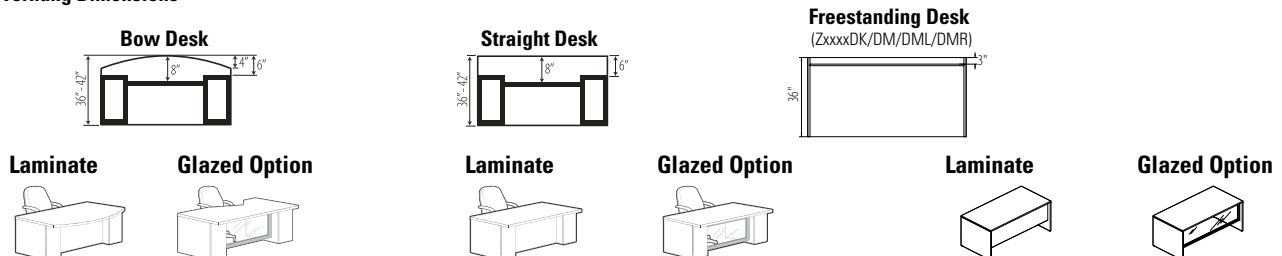

Returns - available width: 36", 42", 48", 54", 60", 66", 72"

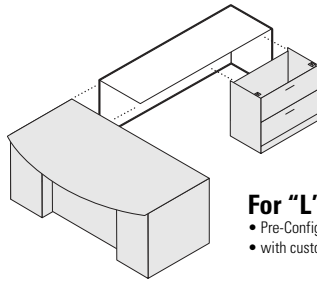

For "L" shape Layouts
 • Pre-Configured
 • with custom shell storage

Transitional Pigeon-Hole
 Accepts all (same width) Transitional Pigeon-Holes.

Table Top Bookcase
 Accepts all (same width) Table Top Bookcases.

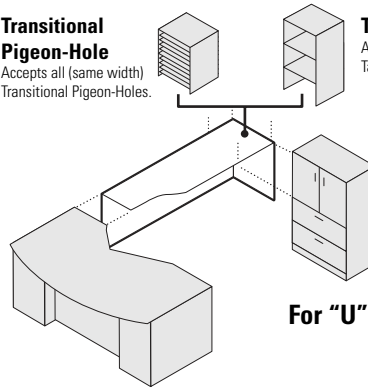

For "U" shape Layouts

Bridges - available width: 42", 48"

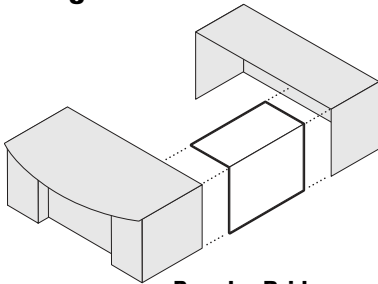

Regular Bridge
 • join worksurface to worksurface

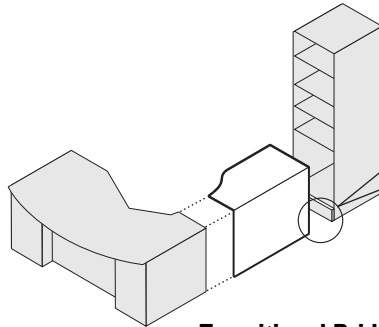

Transitional Bridge
 • join worksurface to storage modules

Remove Existing Kickbase

Replace with supplied Kickbase (shorter)

Extended Corners - available widths: 60", 66", 72", 84"

Modesty Treatments

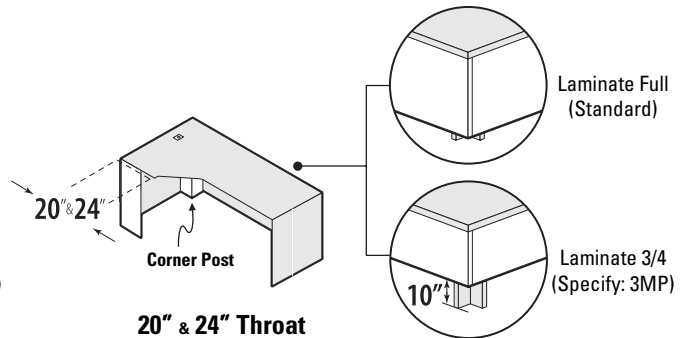
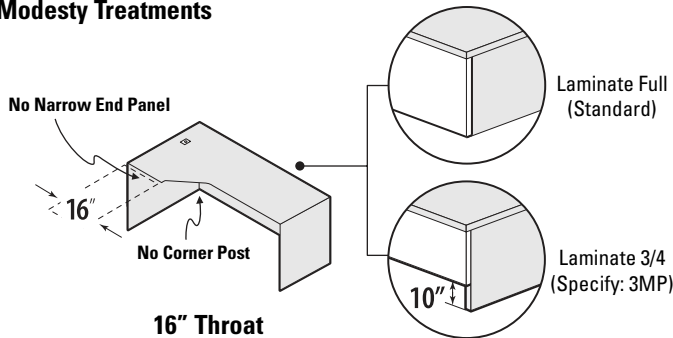

Shells - available width: 12", 15", 16", 18", 21", 30", 36"

For Extended Corners, Space Saver Returns and Connectables

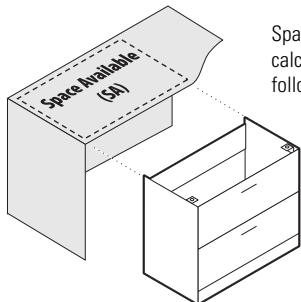

Space Available can be calculated with the following formulas:

Space Saver Returns

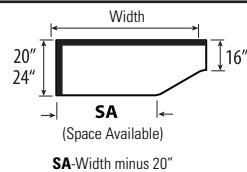

Space Saver Connectables

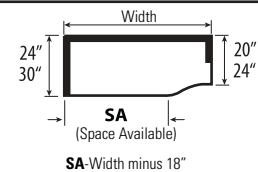

Extended Corners

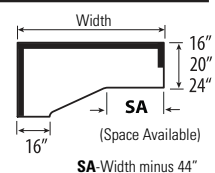
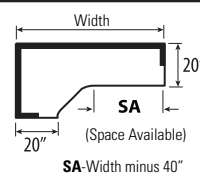
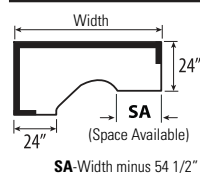

Extended Corner Islands - available width: 60", 66", 72" 84"

Modesty Treatments

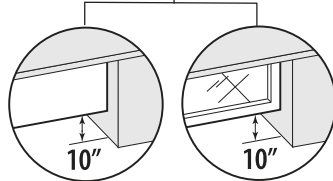
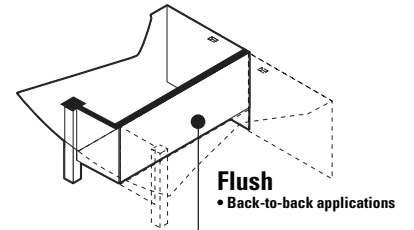
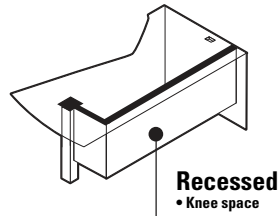
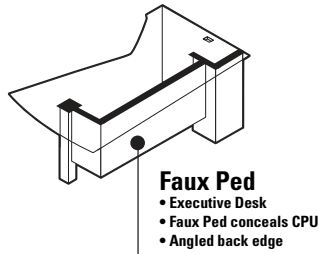
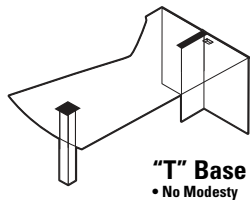

Laminate 3/4** (Standard) Glazing 3/4** (Specify Z_)

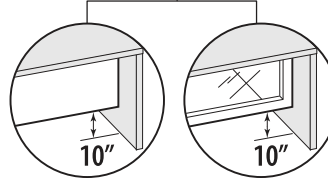

Laminate 3/4** (Standard) Glazing 3/4** (Specify Z_)

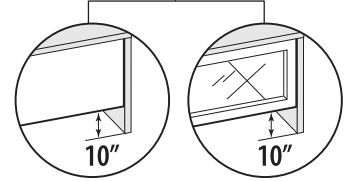

Laminate 3/4** (Standard) Glazing 3/4** (Specify Z_)

** Full modesty not available

Overhang Dimensions

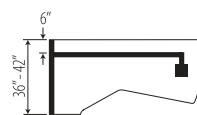
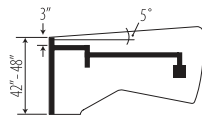

Storage

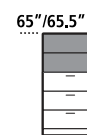
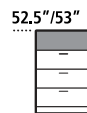
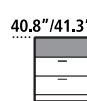
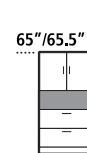
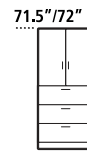
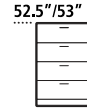
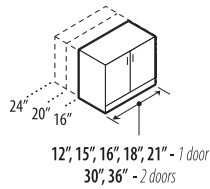
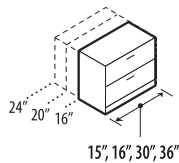
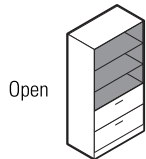
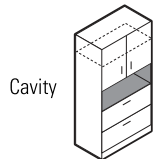
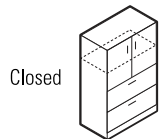

Wardrobe & Personal Towers

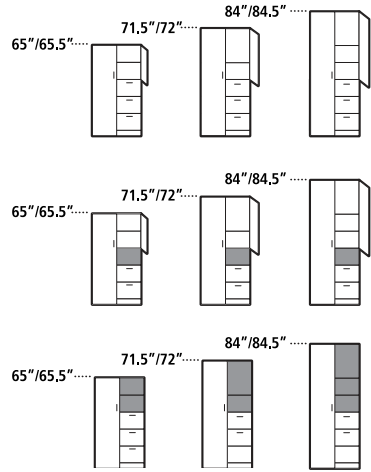
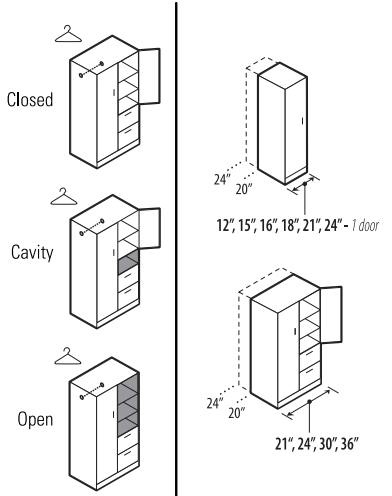

PC Support

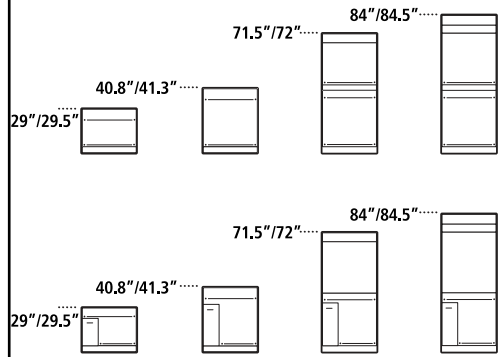
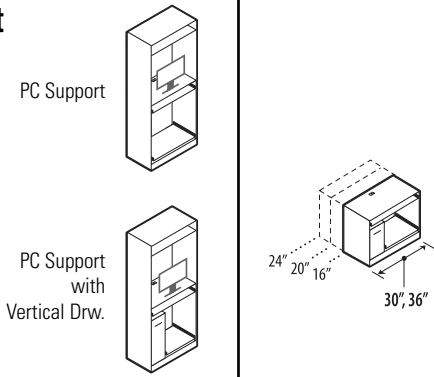

Vertical Utility Drawer

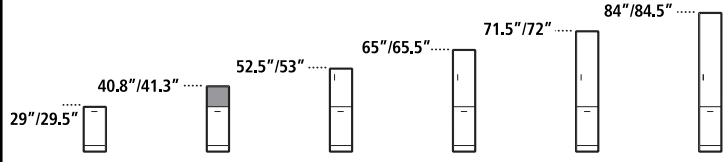
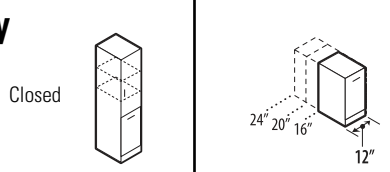

Drawer & Cavity Positions

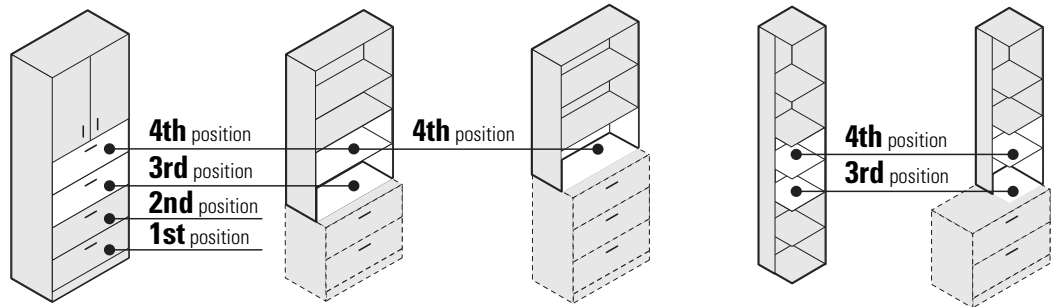

Box Drawer Option

Lateral file drawers can be converted to box/box drawers in any of the four standard positions

- B1** = 2 box drawers on 1st position
- B2** = 2 box drawers on 2nd position
- B3** = 2 box drawers on 3rd position
- B4** = 2 box drawers on 4th position

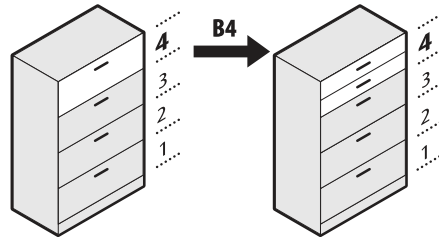

Example
File drawer converted to 2 box drawers on **4th** position

Please specify: Z36L54F - **B4**

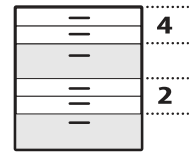

Converting 2 or more drawers please contact customer service.

Collator Positions

All storage units can be specified with an optional collator on 2nd, 3rd and/or 4th position.

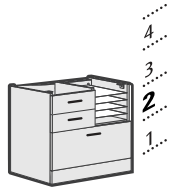

Collator on 2nd position
Specify: 2K - Black or 2T - Brushed Cobalt

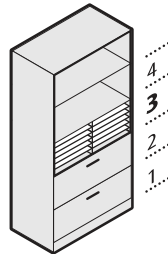

Collator on 3rd position
Specify: 3K - Black or 3T - Brushed Cobalt

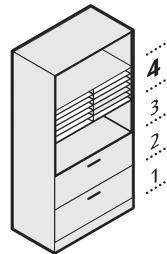

Collator on 4th position
Specify: 4K - Black or 4T - Brushed Cobalt

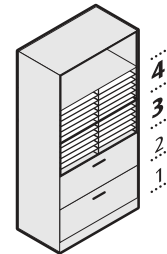

Collator on 3rd & 4th positions
Specify: 7K - Black or 7T - Brushed Cobalt

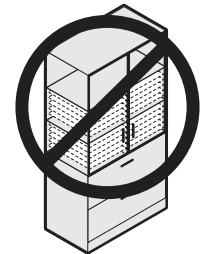

Collators do not fit behind doors

For 2K / 2T, 3K / 3T OR 4K / 4T - Add \$209

For 7K / 7T - Add \$416

Glazing

Glazing is available in the following options:

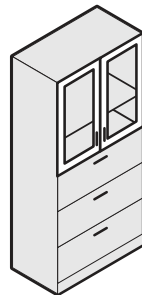

Tungsten Frame
Frosted Glazing
Z1

Please specify:
Z36L73F - **Z1**

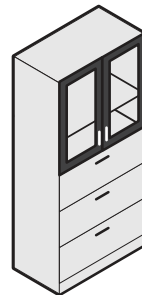

Black Frame
Frosted Glazing
Z2

Please specify:
Z36L73F - **Z2**

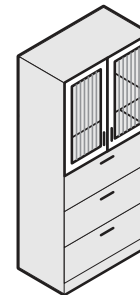

Tungsten Frame
Ribbed Glazing
Z3

Please specify:
Z36L73F - **Z3**

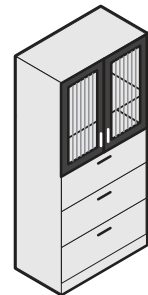

Black Frame
Ribbed Glazing
Z4

Please specify:
Z36L73F - **Z4**

Filing Options - For Filing Components

On 16" deep files, drawer interiors are only 13" deep. On 20" and 24" deep files, drawer interiors are 16" deep.
 Full to floor BBF, FF and BF pedestals are 16" wide with all pedestal desks, returns with pedestals and credenzas with pedestals.
 Full to floor BBF and FF storage shells 15" wide x 28.5" high are required under 36" wide Space Saver Return with 16" deep connection top. re: Zxx3616Rx.

Side-To-Side

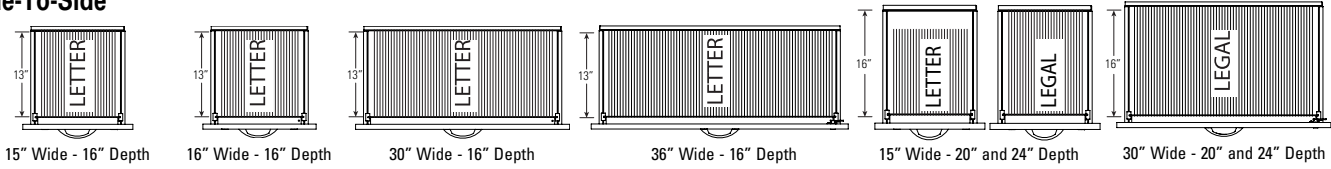

Front-To-Back

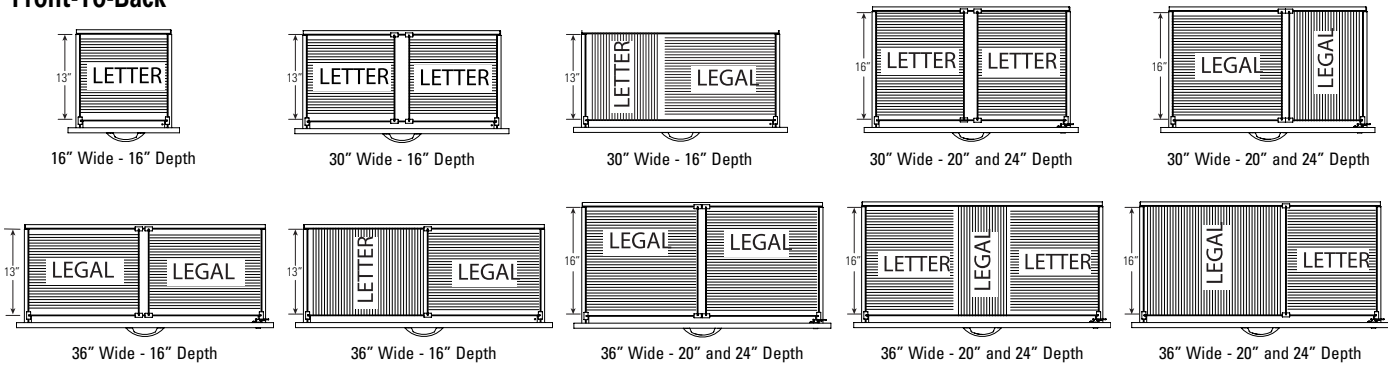

Height Map

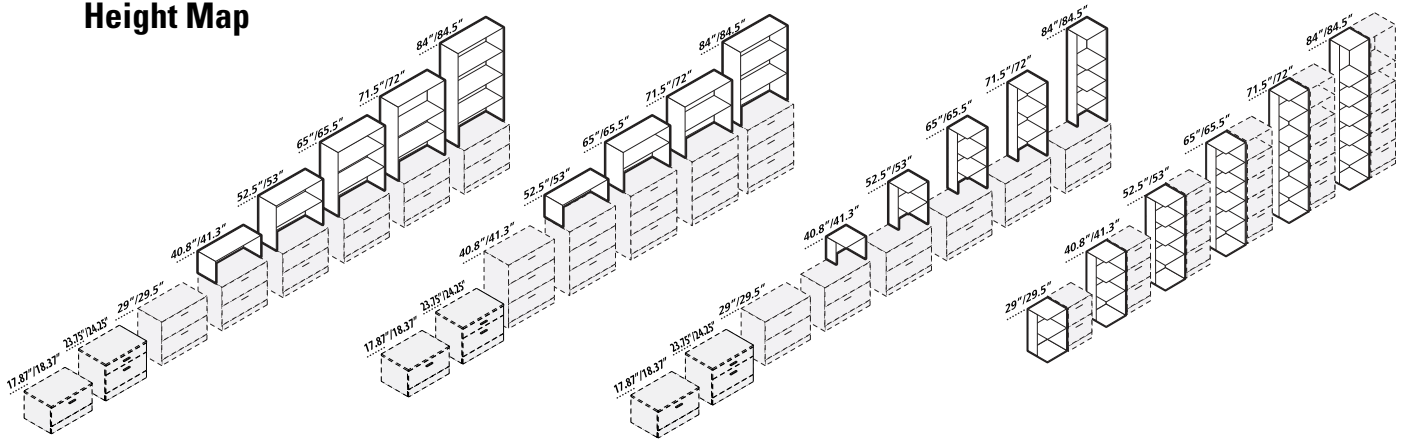

Drawer & Cavity Positions

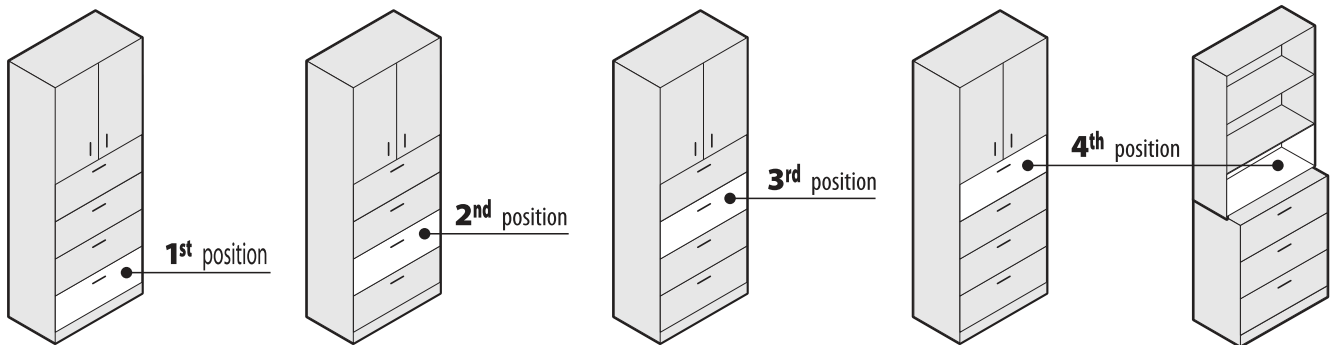

Collator Positions

For 12" to 21" wide units

**If no collator is desired, must specify when placing order.

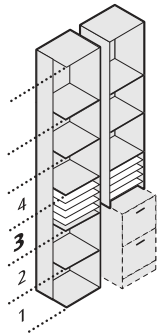

Collator on 3rd position
Specify: 3K - Black or
3T - Brushed Cobalt

For 3K / 3T or 4K / 4T.....Add \$241

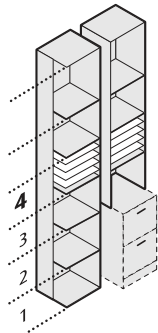

Collator on 4th position
Specify: 4K - Black or
4T - Brushed Cobalt

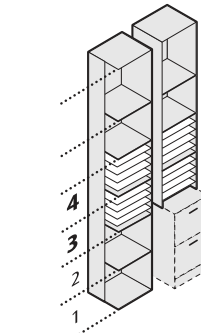

Collator on 3rd & 4th position
Specify: 7K - Black or
7T - Brushed Cobalt

For 7K / 7T.....Add \$426

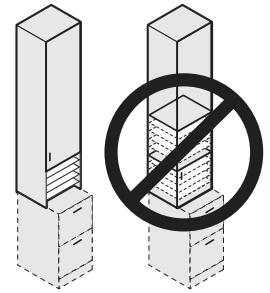

Collators do not fit behind door

Table Top Bookcase

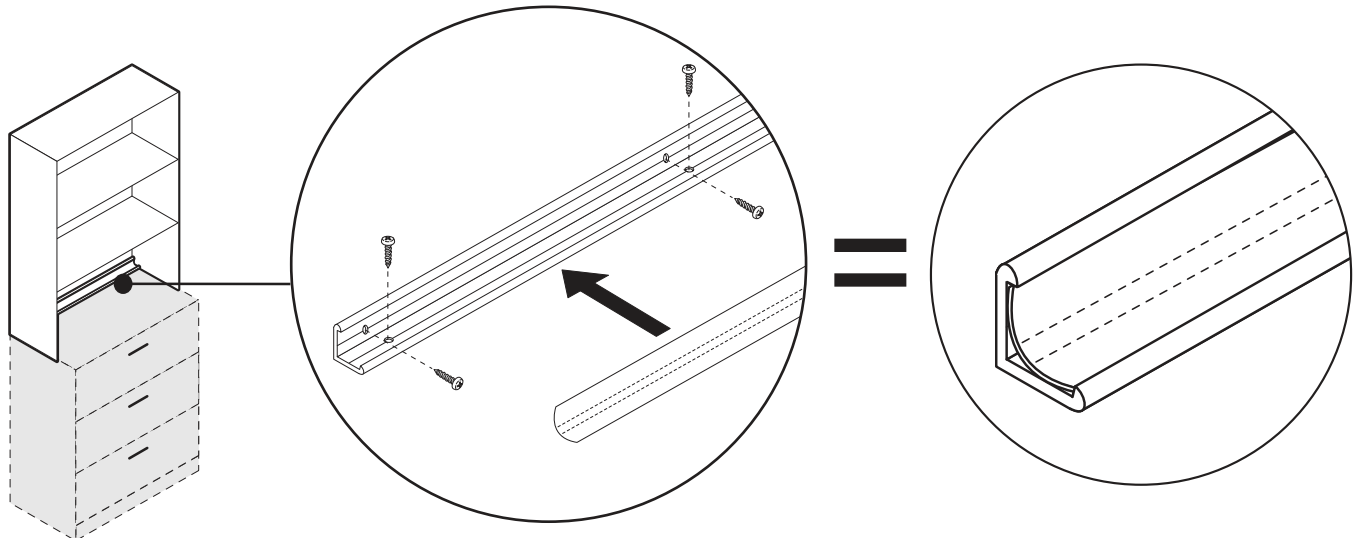

Hutches

Monitor clearance dimensions

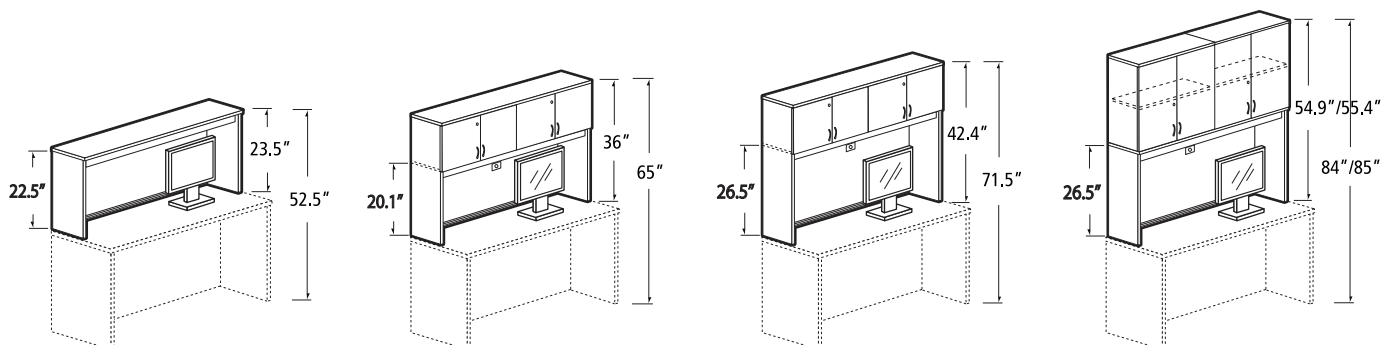

HEIGHT ADJUSTABLE DESKS

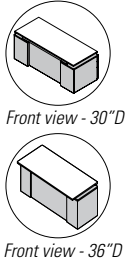
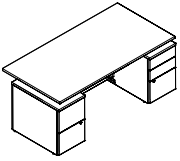

Double Pedestal Desk for Height Adj. Base

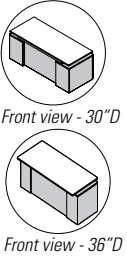
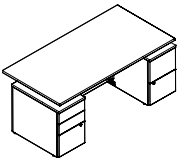

Double Pedestal Desk for Height Adj. Base

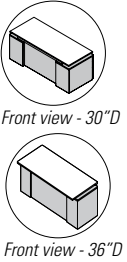
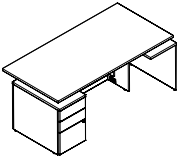

Single Pedestal Desk for Height Adj. Base

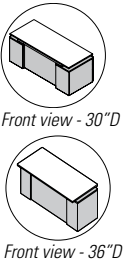
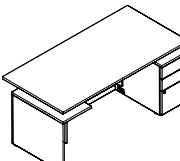

Single Pedestal Desk for Height Adj. Base

MODEL# DIMENSIONS FREIGHT CLASS WT/LBS. CUBIC FT. 1" TOP 1.5" TOP GLAZE ADD HP ADD

D x W x H

ZA3684F23	36 x 84 x 29.5-49.5	85	362	26.68	\$3618	\$3832	\$594	\$634
ZA3672F23	36 x 72 x 29.5-49.5	85	335	26.68	\$3590	\$3780	\$509	\$543
ZA3666F23	36 x 66 x 29.5-49.5	85	321	25.18	\$3493	\$3665	\$458	\$498
ZA3660F23	36 x 60 x 29.5-49.5	85	307	24.70	\$3373	\$3545	\$492	\$452
ZA3084F23	30 x 84 x 29.5-49.5	85	347	25.69	\$3704	\$3889	\$594	\$525
ZA3072F23	30 x 72 x 29.5-49.5	85	321	24.70	\$3527	\$3689	\$509	\$452
ZA3066F23	30 x 66 x 29.5-49.5	85	309	24.19	\$3432	\$3582	\$458	\$417
ZA3060F23	30 x 60 x 29.5-49.5	85	296	23.68	\$3333	\$3466	\$498	\$378

Standard with file/file (FF) pedestal on **left** and box/box/file (BBF) pedestal on **right**. **30"D**: Top is recessed 1/2" on either side over chassis, flush on user and guest side. **36"D**: Top is recessed 1/2" on either side over chassis, flush on user side, 6.25" overhang on guest side. BBF - file drawer and lower box drawer lock. FF - drawers lock. Height adjustable frame sold separately. Unit has dual modesty panels - one stationary/one traveling. See notes on page 114 for illustration.

ZA3684F32	36 x 84 x 29.5-49.5	85	362	26.68	\$3618	\$3832	\$594	\$634
ZA3672F32	36 x 72 x 29.5-49.5	85	335	26.68	\$3590	\$3780	\$509	\$543
ZA3666F32	36 x 66 x 29.5-49.5	85	321	25.18	\$3493	\$3665	\$458	\$498
ZA3660F32	36 x 60 x 29.5-49.5	85	307	24.70	\$3373	\$3545	\$492	\$452
ZA3084F32	30 x 84 x 29.5-49.5	85	347	25.69	\$3704	\$3889	\$594	\$525
ZA3072F32	30 x 72 x 29.5-49.5	85	321	24.70	\$3527	\$3689	\$509	\$452
ZA3066F32	30 x 66 x 29.5-49.5	85	309	24.19	\$3432	\$3582	\$458	\$417
ZA3060F32	30 x 60 x 29.5-49.5	85	296	23.68	\$3333	\$3466	\$498	\$378

Standard with box/box/file (BBF) pedestal on **left** and file/file (FF) pedestal on **right**. **30"D**: Top is recessed 1/2" on either side over chassis, flush on user and guest side. **36"D**: Top is recessed 1/2" on either side over chassis, flush on user side, 6.25" overhang on guest side. BBF - file drawer and lower box drawer lock. FF - drawers lock. Height adjustable frame sold separately. Unit has dual modesty panels - one stationary/one traveling. See notes on page 114 for illustration.

ZA3684F3S	36 x 84 x 29.5-49.5	85	325	26.68	\$3294	\$3501	\$594	\$634
ZA3672F3S	36 x 72 x 29.5-49.5	92.5	298	25.69	\$3248	\$3438	\$509	\$543
ZA3666F3S	36 x 66 x 29.5-49.5	92.5	284	25.18	\$3152	\$3324	\$458	\$498
ZA3660F3S	36 x 60 x 29.5-49.5	92.5	271	24.70	\$3031	\$3193	\$401	\$452
ZA3084F3S	30 x 84 x 29.5-49.5	85	310	25.69	\$3363	\$3548	\$594	\$525
ZA3072F3S	30 x 72 x 29.5-49.5	92.5	285	24.70	\$3186	\$3348	\$509	\$452
ZA3066F3S	30 x 66 x 29.5-49.5	92.5	272	24.19	\$3089	\$3239	\$458	\$417
ZA3060F3S	30 x 60 x 29.5-49.5	92.5	260	23.68	\$2992	\$3125	\$401	\$378

Standard with box/box/file pedestal on **left**. **30"D**: Top is recessed 1" on non-ped side and user side over chassis; flush on ped side and guest side. **36"D**: Top is recessed 1" on non-ped side and user side over chassis; flush on ped side and 6.25" overhang on guest side. File drawer and lower box drawer lock. Height adjustable frame sold separately. Unit has dual modesty panels - one stationary/one traveling. See notes on page 114 for illustration.

ZA3684FS3	36 x 84 x 29.5-49.5	85	325	26.68	\$3294	\$3501	\$594	\$634
ZA3672FS3	36 x 72 x 29.5-49.5	92.5	298	25.69	\$3248	\$3438	\$509	\$543
ZA3666FS3	36 x 66 x 29.5-49.5	92.5	284	25.18	\$3152	\$3324	\$458	\$498
ZA3660FS3	36 x 60 x 29.5-49.5	92.5	271	24.70	\$3031	\$3193	\$401	\$452
ZA3084FS3	30 x 84 x 29.5-49.5	85	310	25.69	\$3363	\$3548	\$594	\$525
ZA3072FS3	30 x 72 x 29.5-49.5	92.5	285	24.70	\$3186	\$3348	\$509	\$452
ZA3066FS3	30 x 66 x 29.5-49.5	92.5	272	24.19	\$3089	\$3239	\$458	\$417
ZA3060FS3	30 x 60 x 29.5-49.5	92.5	260	23.68	\$2992	\$3125	\$406	\$378

Standard with box/box/file pedestal on **right**. **30"D**: Top is recessed 1" on non-ped side and user side over chassis; flush on ped side and guest side. **36"D**: Top is recessed 1" on non-ped side and user side over chassis; flush on ped side and 6.25" overhang on guest side. File drawer and lower box drawer lock. Height adjustable frame sold separately. Unit has dual modesty panels - one stationary/one traveling. See notes on page 114 for illustration.

Required Specifications

Top finish Top/edge detail
Base finish Wire management finish
Default no handle, specify lock finish
Must use with FFHATZS (sold separately)

Optional Specifications

HP laminate Handles
Key # Modesty finish glazed
Modesty Type
Grommet position or power block cut-out

Accessories

Power block
Pencil drawer

HEIGHT ADJUSTABLE DESKS

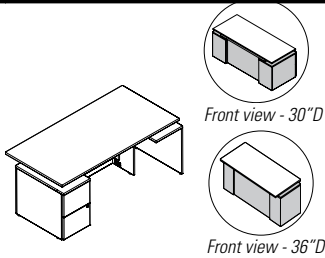

Single Pedestal Desk for Height Adj. Base**

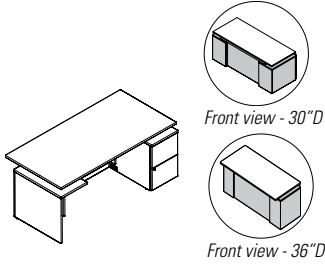

Single Pedestal Desk for Height Adj. Base**

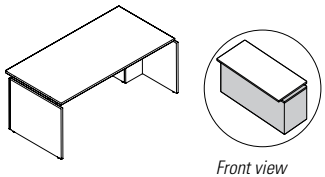

Height Adj. Desk - Freestanding

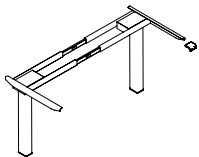

Height Adjustable Frame*

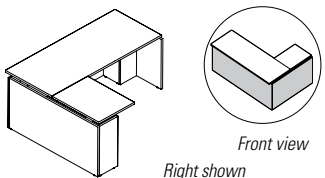

L Desk Shell for Height Adj. Base

MODEL#	DIMENSIONS	FREIGHT CLASS	WT/LBS.	CUBIC FT.	1" TOP	1.5" TOP	GLAZE ADD	HP ADD
	D x W x H							
ZA3684F2S	36 x 84 x 29.5-49.5	85	323	26.68	\$3248	\$3455	\$594	\$634
ZA3672F2S	36 x 72 x 29.5-49.5	92.5	296	26.68	\$3203	\$3388	\$509	\$543
ZA3666F2S	36 x 66 x 29.5-49.5	92.5	282	25.18	\$3100	\$3272	\$458	\$498
ZA3660F2S	36 x 60 x 29.5-49.5	92.5	268	24.70	\$2985	\$3140	\$401	\$452
ZA3084F2S	30 x 84 x 29.5-49.5	92.5	308	25.69	\$3317	\$3502	\$594	\$525
ZA3072F2S	30 x 72 x 29.5-49.5	92.5	283	24.70	\$3140	\$3295	\$509	\$452
ZA3066F2S	30 x 66 x 29.5-49.5	92.5	270	24.19	\$3044	\$3189	\$458	\$417
ZA3060F2S	30 x 60 x 29.5-49.5	92.5	258	23.68	\$2946	\$3079	\$401	\$378

Standard with file/file pedestal on **left. 30"D**: Top is recessed 1" on non-ped side and user side over chassis; flush on ped side and guest side. **36"D**: Top is recessed 1" on non-ped side and user side over chassis; flush on ped side and 6.25" overhang on guest side. Pedestal locks. Height adjustable frame sold separately. Unit has dual modesty panels - one stationary/one traveling. See notes on page 114 for illustration.

ZA3684FS2	36 x 84 x 29.5-49.5	85	323	26.68	\$3248	\$3455	\$594	\$634
ZA3672FS2	36 x 72 x 29.5-49.5	92.5	296	26.68	\$3203	\$3388	\$509	\$543
ZA3666FS2	36 x 66 x 29.5-49.5	92.5	282	25.18	\$3100	\$3272	\$458	\$498
ZA3660FS2	36 x 60 x 29.5-49.5	92.5	268	24.70	\$2985	\$3140	\$401	\$452
ZA3084FS2	30 x 84 x 29.5-49.5	92.5	308	25.69	\$3317	\$3502	\$594	\$525
ZA3072FS2	30 x 72 x 29.5-49.5	92.5	283	24.70	\$3140	\$3295	\$509	\$452
ZA3066FS2	30 x 66 x 29.5-49.5	92.5	270	24.19	\$3044	\$3189	\$458	\$417
ZA3060FS2	30 x 60 x 29.5-49.5	92.5	258	23.68	\$2946	\$3079	\$401	\$378

Standard with file/file pedestal on **right. 30"D**: Top is recessed 1" on non-ped side and user side over chassis; flush on ped side and guest side. **36"D**: Top is recessed 1" on non-ped side and user side over chassis; flush on ped side and 6.25" overhang on guest side. Pedestal locks. Height adjustable frame sold separately. Unit has dual modesty panels - one stationary/one traveling. See notes on page 114 for illustration.

ZA3684NP	36 x 84 x 29.5-49.5	70	231	10.48	\$2247	\$2461	N/A	\$634
ZA3672NP	36 x 72 x 29.5-49.5	125	206	27.69	\$2212	\$2397	N/A	\$543
ZA3666NP	36 x 66 x 29.5-49.5	65	198	8.47	\$2143	\$2315	N/A	\$498
ZA3660NP	36 x 60 x 29.5-49.5	65	198	8.47	\$2093	\$2248	N/A	\$452
ZA3072NP	30 x 72 x 29.5-49.5	70	188	8.71	\$2104	\$2266	N/A	\$452
ZA3066NP	30 x 66 x 29.5-49.5	70	178	7.96	\$2035	\$2185	N/A	\$417
ZA3060NP	30 x 60 x 29.5-49.5	70	168	7.49	\$2001	\$2134	N/A	\$378

Height adjustable frame sold separately. **30"D** - Top is recessed 1" on user and both sides over chassis; 2.9375" overhang on guest side. **36"D** - Top is recessed 1" on user and both sides over chassis; 3.25" overhang on guest side. Shipped RTA (ready to assemble). Unit has a stationary modesty only.

FFHATZS	10 x -- x 26.8	70	50	2.97	\$1775	N/A	N/A	N/A
---------	----------------	----	----	------	--------	-----	-----	-----

- Specify **S** for use with 60" - 66" wide desks. Specify **M** for use with 72" - 84" wide desks.

For use with Zira height adjustable desks. Lifts 265 lbs. Each motor is mounted within the top of the column and will connect directly into one another without the need for a control box. Available in Black or Tungsten. Shipped RTA (ready to assemble).

- Recommended torque range for installing all fasteners is 3-5 foot pounds and should not be exceeded. In addition, no impact drivers or high-torque equipment are to be used for any fasteners included in the table assembly kits, as this creates a high risk for damage that is not covered under warranty. The use of hand tools is highly recommended.**

ZA608424L	60 x 84 x 29.5-49.5	70	294	14.48	\$2964	\$3200	N/A	\$811
ZA607224L	60 x 72 x 29.5-49.5	70	273	13.24	\$2832	\$3046	N/A	\$720
ZA608424R	60 x 84 x 29.5-49.5	70	294	14.48	\$2964	\$3200	N/A	\$811
ZA607224R	60 x 72 x 29.5-49.5	70	273	13.24	\$2832	\$3046	N/A	\$720

Specify ZA60xx24L for **LEFT** with return on the right side or ZA60xx24R for **RIGHT** with return on left side.

Frame sold separately. Top on long return side is recessed 1" over chassis, 1/2" recessed on primary top (non-return side) and 2.9375" overhang on guest side. Return top is 24"D x 30"W. Shipped RTA (ready to assemble).

- Only accepts 2-stage, 3-leg height adjustable base mechanisms.

Required Specifications

Top finish Top/edge detail
Base finish*
Wire management finish
Must use with base (sold separately)

Optional Specifications

HP laminate Handles**
Key #*** Modesty finish glazed
Modesty Type
Grommet position or power block cut-out

Accessories

Power block Pencil drawer

MODESTY PANEL KIT

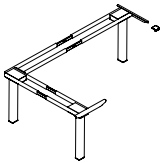

Height Adjustable Base*

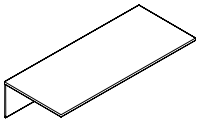

Top and Modesty Panel Kit

MODEL# DIMENSIONS FREIGHT CLASS WT/LBS. CUBIC FT. 1" TOP 1.5" TOP GLAZE ADD HP ADD

	D x W x H								
FFHATZ9	10 x -- x 26.8	125	67	8.40	\$2577	N/A	N/A	N/A	

For use with Zira height adjustable L desks. Lifts 265 lbs. Each motor is mounted within the top of the column and will connect directly into one another without the need for a control box. Available in Black, Designer White or Tungsten. Shipped RTA (ready to assemble).

- Recommended torque range for installing all fasteners is 3-5 foot pounds and should not be exceeded. In addition, no impact drivers or high-torque equipment are to be used for any fasteners included in the table assembly kits, as this creates a high risk for damage that is not covered under warranty. The use of hand tools is highly recommended.

ZA3084TB	29 x 82 x 16-16.5	85	99	6.75	\$1003	\$1272	\$629	\$525
ZA3072TB	29 x 70 x 16-16.5	85	85	6	\$885	\$1116	\$555	\$452
ZA3066TB	29 x 64 x 16-16.5	85	79	5.50	\$827	\$1041	\$514	\$417
ZA3060TB	29 x 58 x 16-16.5	85	71	5	\$737	\$933	\$504	\$378
ZA3054TB	29 x 52 x 16-16.5	85	64	4.50	\$680	\$859	\$440	\$344
ZA3048TB	29 x 46 x 16-16.5	85	57	4	\$623	\$778	\$406	\$304
ZA3042TB	29 x 40 x 16-16.5	85	50	3.75	\$559	\$698	\$367	\$263
ZA2484TB	23 x 82 x 16-16.5	85	74	5	\$895	\$1113	\$537	\$423
ZA2472TB	23 x 70 x 16-16.5	70	86	5.50	\$793	\$983	\$555	\$361
ZA2466TB	23 x 64 x 16-16.5	70	68	4.50	\$737	\$916	\$514	\$332
ZA2460TB	23 x 58 x 16-16.5	85	61	4.25	\$658	\$820	\$504	\$304
ZA2454TB	23 x 52 x 16-16.5	85	55	3.75	\$606	\$751	\$440	\$288
ZA2448TB	23 x 46 x 16-16.5	85	49	3.50	\$555	\$688	\$406	\$241
ZA2442TB	23 x 40 x 16-16.5	85	43	3	\$492	\$619	\$378	\$214

For use with height adjustable mechanisms. Height adjustable frame not included. Shipped RTA (ready to assemble).

- Compatible with FreeFit + FOLI Height Adjustable bases (FOLI compatible with 48" w – 72" w tops)
- Cannot be used with FFHATZS or FFHATZ9

RETURNS COMPATIBLE W/HT ADJ. DESKS

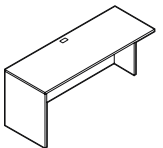

24" Deep Connectable Table - Left

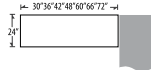

MODEL# DIMENSIONS FREIGHT CLASS WT/LBS. CUBIC FT. 1" TOP 1.5" TOP GLAZE ADD HP ADD

Z2472L	24 x 72 x 29.5-30	65	144	6	\$814	\$958	N/A	\$355
Z2466L	24 x 66 x 29.5-30	65	135	6	\$814	\$939	N/A	\$355
Z2460L	24 x 60 x 29.5-30	65	125	5.25	\$737	\$846	N/A	\$326
Z2448L	24 x 48 x 29.5-30	65	106	4.30	\$671	\$765	N/A	\$260
Z2442L	24 x 42 x 29.5-30	65	95	3.80	\$671	\$753	N/A	\$218
Z2436L	24 x 36 x 29.5-30	65	86	3.30	\$589	\$656	N/A	\$164
Z2430L	24 x 30 x 29.5-30	70	77	3.60	\$555	\$608	N/A	\$164

Full end panel on left. Right narrow end panel connects to 24"D center/right connectable table, or at 90° angle to a freestanding table, height adjustable desk, 24"D extended corners or at the end of a straight run; "D" islands or "P" islands with "T" and "H" bases. Grommet in worksurface. Shipped RTA (ready to assemble).

- Units 48" and under require storage for stability
- Modesty Panel is 1" off of ground.

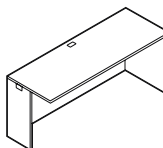

24" Deep Connectable Table - Right

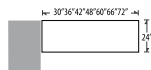

Z2472R	24 x 72 x 29.5-30	65	144	6	\$814	\$958	N/A	\$355
Z2466R	24 x 66 x 29.5-30	65	135	6	\$814	\$939	N/A	\$355
Z2460R	24 x 60 x 29.5-30	65	125	5.25	\$737	\$846	N/A	\$326
Z2448R	24 x 48 x 29.5-30	65	106	4.30	\$671	\$765	N/A	\$260
Z2442R	24 x 42 x 29.5-30	65	95	3.80	\$671	\$753	N/A	\$218
Z2436R	24 x 36 x 29.5-30	65	86	3.30	\$589	\$656	N/A	\$164
Z2430R	24 x 30 x 29.5-30	70	77	3.60	\$555	\$608	N/A	\$164

Full end panel on right. Left narrow end panel connects to 24"D center/right connectable table, or at 90° angle to a freestanding table, height adjustable desk, 24"D extended corners or at the end of a straight run; "D" islands or "P" islands with "T" and "H" bases. Grommet in worksurface. Shipped RTA (ready to assemble).

- Units 48" and under require storage for stability
- Modesty Panel is 1" off of ground.

Required Specifications

- Top finish
- Top/edge detail
- Base finish
- Wire management finish

Optional Specifications

- HP laminate
- Grommet position or power block cut-out

Accessories

- Power block

BRIDGES COMPATIBLE W/ ZXXXXBBOL/R AND ZXXXXBLFL/R CREDENZAS DIMENSIONS FREIGHT CLASS WT/LBS. CUBIC FT. 1"TOP 1.5" TOP GLAZE ADD HP ADD

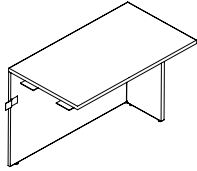

Bridge w/Full Laminate Modesty, Left

	D x W x H								
ZA2448RL	24 x 48 x 29.5-30	70	78	4.30	\$769	\$900	N/A	\$238	
ZA2442RL	24 x 42 x 29.5-30	70	66	3.80	\$669	\$784	N/A	\$212	
ZA2436RL	24 x 36 x 29.5-30	70	59	3.30	\$623	\$723	N/A	\$182	
ZA2048RL	20 x 48 x 29.5-30	70	72	4.30	\$733	\$845	N/A	\$202	
ZA2042RL	20 x 42 x 29.5-30	70	62	3.80	\$639	\$737	N/A	\$175	
ZA2036RL	20 x 36 x 29.5-30	70	56	3.30	\$595	\$680	N/A	\$151	

For use with height adjustable desks - single pedestal. Connects to credenza on **left**. Shipped RTA (ready to assemble).

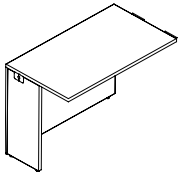

Bridge w/Full Laminate Modesty, Right

ZA2448RR	24 x 48 x 29.5-30	70	78	4.30	\$769	\$900	N/A	\$241	
ZA2442RR	24 x 42 x 29.5-30	70	66	3.80	\$669	\$784	N/A	\$212	
ZA2436RR	24 x 36 x 29.5-30	70	59	3.30	\$623	\$723	N/A	\$182	
ZA2048RR	20 x 48 x 29.5-30	70	72	4.30	\$733	\$845	N/A	\$202	
ZA2042RR	20 x 42 x 29.5-30	70	62	3.80	\$639	\$737	N/A	\$175	
ZA2036RR	20 x 36 x 29.5-30	70	56	3.30	\$595	\$680	N/A	\$151	

For use with height adjustable desks - single pedestal. Connects to credenza on **right**. Shipped RTA (ready to assemble).

CREDENZAS COMPATIBLE W/HT ADJ. BRIDGES MODEL# DIMENSIONS FREIGHT CLASS WT/LBS. CUBIC FT. 1"TOP 1.5" TOP GLAZE ADD HP ADD

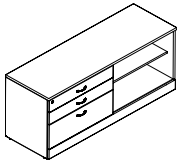

Credenza

Z2472BBOL	24 x 72 x 29.5-30	125	261	35.75	\$2285	\$2408	N/A	\$361	
Z2460BBOL	24 x 60 x 29.5-30	125	231	30	\$2051	\$2153	N/A	\$302	
Z2072BBOL	20 x 72 x 29.5-30	125	234	30.25	\$2183	\$2285	N/A	\$302	
Z2060BBOL	20 x 60 x 29.5-30	100	207	25.25	\$1982	\$2068	N/A	\$252	

Compatible with height adjustable bridges. Box/box/lateral file on **left** with open storage on the **right**. Connects to bridge on **right**. Adjustable shelf. Shipped assembled in 1 carton.

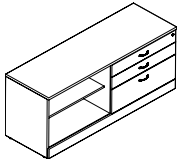

Credenza

Z2472BBOR	24 x 72 x 29.5-30	125	261	35.75	\$2285	\$2408	N/A	\$361	
Z2460BBOR	24 x 60 x 29.5-30	125	231	30	\$2051	\$2153	N/A	\$302	
Z2072BBOR	20 x 72 x 29.5-30	125	234	30.25	\$2183	\$2285	N/A	\$302	
Z2060BBOR	20 x 60 x 29.5-30	100	207	25.25	\$1982	\$2068	N/A	\$252	

Compatible with height adjustable bridges. Box/box/lateral file on **right** with open storage on the **left**. Connects to bridge on **left**. Adjustable shelf. Shipped assembled in 1 carton.

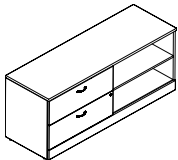

Credenza

Z2472BLFL	24 x 72 x 29.5-30	125	265	35.75	\$2250	\$2373	N/A	\$361	
Z2460BLFL	24 x 60 x 29.5-30	125	235	30	\$2028	\$2130	N/A	\$302	
Z2072BLFL	20 x 72 x 29.5-30	125	239	30.25	\$2148	\$2250	N/A	\$302	
Z2060BLFL	20 x 60 x 29.5-30	100	212	25.25	\$1955	\$2041	N/A	\$252	

Compatible with height adjustable bridges. Two drawer lateral file on **left** with open storage on the **right**. Connects to bridge on **right**. Adjustable shelf. Shipped assembled in 1 carton.

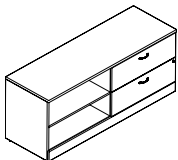

Credenza

Z2472BLFR	24 x 72 x 29.5-30	125	265	35.75	\$2250	\$2373	N/A	\$361	
Z2460BLFR	24 x 60 x 29.5-30	125	235	30	\$2028	\$2130	N/A	\$302	
Z2072BLFR	20 x 72 x 29.5-30	125	239	30.25	\$2148	\$2250	N/A	\$302	
Z2060BLFR	20 x 60 x 29.5-30	100	212	25.25	\$1955	\$2041	N/A	\$252	

Compatible with height adjustable bridges. Two drawer lateral file on **right** with open storage on the **left**. Connects to bridge on **left**. Adjustable shelf. Shipped assembled in 1 carton.

Required Specifications

Top finish
Top/edge detail
Base finish

Optional Specifications

HP laminate
Modesty panel type
Grommet position or power block cut-out

Accessories

Power block
Keyboard
Pencil drawer

DOUBLE PEDESTAL DESKS

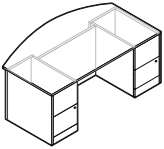

Double Pedestal Bow Top Desk

MODEL#	DIMENSIONS D x W x H	FREIGHT CLASS	WT./LBS.	CUBIC FT.	1" TOP	1.5" TOP	GLAZE ADD	HP ADD
Z4284FB22	42 x 84 x 29.5-30	250	381.15	102.5	\$2632	\$2928	\$848	\$939
Z4272FB22	42 x 72 x 29.5-30	125	377	59	\$2531	\$2790	\$703	\$705
Z3672FB22	36 x 72 x 29.5-30	125	317.10	50.75	\$2363	\$2592	\$703	\$530
Z3666FB22	36 x 66 x 29.5-30	125	305.55	46.75	\$2316	\$2528	\$627	\$530
Z3660FB22	36 x 60 x 29.5-30	125	295.05	42.50	\$2247	\$2441	\$555	\$441

Standard with **Freestanding** file/file pedestals on **left** and **right**. Pedestals lock. Bow top overhangs 2 ¼" at ends and 8" on center.

- 84" wide desks are shipped RTA (ready to assemble) in 3 cartons.

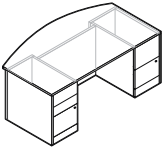

Double Pedestal Bow Top Desk

Z4284FB32	42 x 84 x 29.5-30	250	379.05	102.5	\$2667	\$2963	\$848	\$939
Z4272FB32	42 x 72 x 29.5-30	125	375	59	\$2564	\$2823	\$703	\$705
Z3672FB32	36 x 72 x 29.5-30	125	315	50.75	\$2394	\$2625	\$703	\$530
Z3666FB32	36 x 66 x 29.5-30	125	303.45	46.75	\$2347	\$2557	\$627	\$530
Z3660FB32	36 x 60 x 29.5-30	125	292.95	42.50	\$2282	\$2476	\$555	\$441

Standard with **Freestanding** file/file pedestal on **right** and box/box/file pedestal on **left**. File drawer and lower box drawer lock. File pedestal locks. Bow top overhangs 2 ¼" at ends and 8" on center.

- 84" wide desks are shipped RTA (ready to assemble) in 3 cartons.

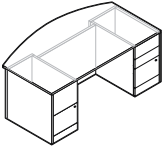

Double Pedestal Bow Top Desk

Z4284FB23	42 x 84 x 29.5-30	250	379.05	102.5	\$2667	\$2963	\$848	\$939
Z4272FB23	42 x 72 x 29.5-30	125	375	59	\$2564	\$2823	\$703	\$705
Z3672FB23	36 x 72 x 29.5-30	125	315	50.75	\$2394	\$2625	\$703	\$530
Z3666FB23	36 x 66 x 29.5-30	125	303.45	46.75	\$2347	\$2557	\$627	\$530
Z3660FB23	36 x 60 x 29.5-30	125	292.95	42.50	\$2282	\$2476	\$555	\$441

Standard with **Freestanding** file/file pedestal on **left** and box/box/file pedestal on **right**. File drawer and lower box drawer lock. File pedestal locks. Bow top overhangs 2 ¼" at ends and 8" on center.

- 84" wide desks are shipped RTA (ready to assemble) in 3 cartons.

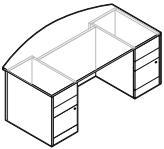

Double Pedestal Bow Top Desk

Z4284FB33	42 x 84 x 29.5-30	250	381.15	102.5	\$2700	\$2996	\$848	\$939
Z4272FB33	42 x 72 x 29.5-30	125	378	59	\$2597	\$2857	\$703	\$705
Z3672FB33	36 x 72 x 29.5-30	125	317.10	50.75	\$2429	\$2660	\$703	\$530
Z3666FB33	36 x 66 x 29.5-30	125	305.55	46.75	\$2382	\$2592	\$627	\$530
Z3660FB33	36 x 60 x 29.5-30	125	295.05	42.50	\$2321	\$2528	\$555	\$441

Standard with **Freestanding** box/box/file pedestals on **left** and **right**. File drawer and lower box drawer lock. Bow top overhangs 2 ¼" at ends and 8" on center.

- 84" wide desks are shipped RTA (ready to assemble) in 3 cartons.

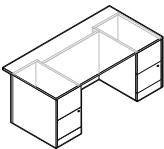

Double Pedestal Desk

Z4284F22	42 x 84 x 29.5-30	250	385.35	102.5	\$2540	\$2792	\$848	\$939
Z4272F22	42 x 72 x 29.5-30	125	373	59	\$2447	\$2664	\$703	\$705
Z3684F22	36 x 84 x 29.5-30	250	366.12	176.6	\$2391	\$2609	\$848	\$705
Z3672F22	36 x 72 x 29.5-30	125	326.01	50.75	\$2282	\$2472	\$703	\$530
Z3666F22	36 x 66 x 29.5-30	125	314.77	46.75	\$2239	\$2413	\$627	\$530
Z3660F22	36 x 60 x 29.5-30	125	294.93	42.50	\$2198	\$2357	\$555	\$441
Z3072F22	29.7 x 72 x 29.5-30	125	326.01	50.75	\$2282	\$2471	\$703	\$530
Z3066F22	29.7 x 66 x 29.5-30	125	314.77	46.75	\$2239	\$2412	\$627	\$530
Z3060F22	29.7 x 60 x 29.5-30	125	294.93	42.50	\$2198	\$2355	\$555	\$441

Standard with **Freestanding** file/file pedestals on **left** and **right**. Pedestals lock.

- 84" wide desks are shipped RTA (ready to assemble) in 3 cartons.
- Hutches may not be placed on this desk

Required Specifications

Top finish
Top/edge detail
Base finish
Lock finish

Optional Specifications

HP laminate Handles
Key # Modesty finish glazed
Modesty Type
Grommet position or power block cut-out

Accessories

Power block
Keyboard
Pencil drawer

DOUBLE PEDESTAL DESKS

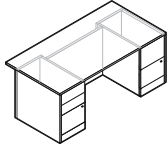

Double Pedestal Desk

MODEL#	DIMENSIONS D x W x H	FREIGHT CLASS	WT/LBS.	CUBIC FT.	1" TOP	1.5" TOP	GLAZE ADD	HP ADD
Z4284F32	42 x 84 x 29.5-30	250	383.25	102.5	\$2574	\$2824	\$848	\$939
Z4272F32	42 x 72 x 29.5-30	125	371	59	\$2480	\$2697	\$703	\$705
Z3684F32	36 x 84 x 29.5-30	250	364.54	176.6	\$2425	\$2643	\$848	\$705
Z3672F32	36 x 72 x 29.5-30	125	324.43	50.75	\$2317	\$2507	\$703	\$530
Z3666F32	36 x 66 x 29.5-30	125	313.18	46.75	\$2273	\$2447	\$627	\$530
Z3660F32	36 x 60 x 29.5-30	125	267.10	42.50	\$2231	\$2392	\$555	\$441
Z3072F32	29.69 x 72 x 29.5-30	125	324.43	50.75	\$2317	\$2507	\$703	\$530
Z3066F32	29.7 x 66 x 29.5-30	125	313.18	46.75	\$2273	\$2447	\$627	\$530
Z3060F32	29.7 x 60 x 29.5-30	125	267.10	42.50	\$2231	\$2390	\$555	\$441

Standard with **Freestanding** box/box/file pedestal on **left** and file/file pedestal on **right**. File drawer and lower box drawer lock. File pedestal locks.

- 84" wide desks are shipped RTA (ready to assemble) in 3 cartons.
- Hutches may not be placed on this desk

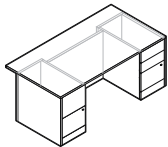

Double Pedestal Desk

Z4284F23	42 x 84 x 29.5-30	250	383.25	102.5	\$2574	\$2824	\$848	\$939
Z4272F23	42 x 72 x 29.5-30	125	371	59	\$2480	\$2697	\$703	\$705
Z3684F23	36 x 84 x 29.5-30	250	364.54	176.6	\$2425	\$2643	\$848	\$705
Z3672F23	36 x 72 x 29.5-30	125	324.43	50.75	\$2317	\$2507	\$703	\$530
Z3666F23	36 x 66 x 29.5-30	125	313.18	46.75	\$2273	\$2447	\$627	\$530
Z3660F23	36 x 60 x 29.5-30	125	267.10	42.50	\$2231	\$2392	\$555	\$441
Z3072F23	29.7 x 72 x 29.5-30	125	324.43	50.75	\$2317	\$2507	\$703	\$530
Z3066F23	29.7 x 66 x 29.5-30	125	313.18	46.75	\$2273	\$2447	\$627	\$530
Z3060F23	29.7 x 60 x 29.5-30	125	267.10	42.50	\$2231	\$2390	\$555	\$441

Standard with **Freestanding** file/file pedestal on **left** and box/box/file pedestal on **right**. File drawer and lower box drawer lock. File pedestal locks.

- 84" wide desks are shipped RTA (ready to assemble) in 3 cartons.
- Hutches may not be placed on this desk

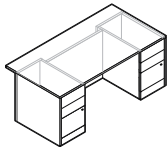

Double Pedestal Desk

Z4284F33	42 x 84 x 29.5-30	250	381.15	102.5	\$2608	\$2858	\$848	\$939
Z4272F33	42 x 72 x 29.5-30	125	370	59	\$2515	\$2731	\$703	\$705
Z3684F33	36 x 84 x 29.5-30	300	341.25	176.6	\$2459	\$2677	\$848	\$705
Z3672F33	36 x 72 x 29.5-30	125	316.05	50.75	\$2348	\$2538	\$703	\$530
Z3666F33	36 x 66 x 29.5-30	125	304.50	46.75	\$2307	\$2481	\$627	\$530
Z3660F33	36 x 60 x 29.5-30	125	261.45	42.50	\$2265	\$2426	\$555	\$441
Z3072F33	29.7 x 72 x 29.5-30	125	316.05	50.75	\$2348	\$2538	\$703	\$530
Z3066F33	29.7 x 66 x 29.5-30	125	304.50	46.75	\$2307	\$2476	\$627	\$530
Z3060F33	29.69 x 60 x 29.5-30	125	261.45	42.50	\$2265	\$2426	\$555	\$441

Standard with **Freestanding** box/box/file pedestals on **left** and **right**. File drawer and lower box drawer lock.

- 84" wide desks are shipped RTA (ready to assemble) in 3 cartons.
- Hutches may not be placed on this desk

Required Specifications

Top finish
Top/edge detail
Base finish
Lock finish

Optional Specifications

HP laminate
Key #
Modesty Type
Grommet position or power block cut-out
Handles
Modesty finish glazed

Accessories

Power block
Keyboard
Pencil drawer

SINGLE PEDESTAL DESKS

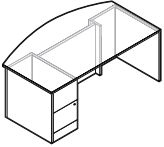

Single Pedestal Bow Top Desk - LEFT

MODEL#	DIMENSIONS D x W x H	FREIGHT CLASS	WT/LBS.	CUBIC FT.	1" TOP	1.5" TOP	GLAZE ADD	HP ADD
Z4284FB2L	42 x 84 x 29.5-30	125	322.35	43.50	\$2013	\$2309	\$848	\$939
Z4272FB2L	42 x 72 x 29.5-30	150	315	59	\$1911	\$2171	\$703	\$705
Z3672FB2L	36 x 72 x 29.5-30	150	281.35	50.75	\$1772	\$2001	\$703	\$530
Z3666FB2L	36 x 66 x 29.5-30	150	274.68	46.75	\$1723	\$1935	\$627	\$530
Z3660FB2L	36 x 60 x 29.5-30	125	259.86	42.50	\$1659	\$1853	\$555	\$441

Standard with **Freestanding** file/file pedestal on **left** and faux pedestal **right**. Pedestal locks. Bow top overhangs 2 ¼" at ends and 8" on center.

- 84" wide desks are shipped RTA (ready to assemble) in 2 cartons.

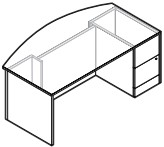

Single Pedestal Bow Top Desk - RIGHT

Z4284FB2R	42 x 84 x 29.5-30	125	322.35	43.50	\$2013	\$2309	\$848	\$939
Z4272FB2R	42 x 72 x 29.5-30	150	315	59	\$1911	\$2171	\$703	\$705
Z3672FB2R	36 x 72 x 29.5-30	150	281.35	50.75	\$1772	\$2001	\$703	\$530
Z3666FB2R	36 x 66 x 29.5-30	150	274.68	46.75	\$1723	\$1935	\$627	\$530
Z3660FB2R	36 x 60 x 29.5-30	125	259.86	42.50	\$1659	\$1853	\$555	\$441

Standard with **Freestanding** faux pedestal **left** and file/file pedestal on **right**. Pedestal locks. Bow top overhangs 2 ¼" at ends and 8" on center.

- 84" wide desks are shipped RTA (ready to assemble) in 2 cartons.

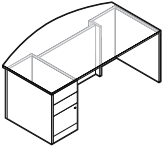

Single Pedestal Bow Top Desk - LEFT

Z4284FB3L	42 x 84 x 29.5-30	125	320.25	43.50	\$2048	\$2343	\$848	\$939
Z4272FB3L	42 x 72 x 29.5-30	150	313	59	\$1943	\$2202	\$703	\$705
Z3672FB3L	36 x 72 x 29.5-30	150	279.77	50.75	\$1805	\$2036	\$703	\$530
Z3666FB3L	36 x 66 x 29.5-30	150	273.10	46.75	\$1759	\$1969	\$627	\$530
Z3660FB3L	36 x 60 x 29.5-30	125	258.27	42.50	\$1711	\$1908	\$555	\$441

Standard with **Freestanding** box/box/file pedestal on **left** and faux pedestal **right**. File drawer and lower box drawer lock. Bow top overhangs 2 ¼" at ends and 8" on center.

- 84" wide desks are shipped RTA (ready to assemble) in 2 cartons.

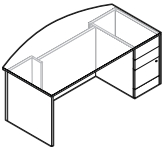

Single Pedestal Bow Top Desk - RIGHT

Z4284FB3R	42 x 84 x 29.5-30	125	320.25	43.50	\$2048	\$2343	\$848	\$939
Z4272FB3R	42 x 72 x 29.5-30	150	313	59	\$1943	\$2202	\$703	\$705
Z3672FB3R	36 x 72 x 29.5-30	150	279.77	50.75	\$1805	\$2036	\$703	\$530
Z3666FB3R	36 x 66 x 29.5-30	150	273.10	46.75	\$1759	\$1969	\$627	\$530
Z3660FB3R	36 x 60 x 29.5-30	125	258.27	42.50	\$1711	\$1908	\$555	\$441

Standard with **Freestanding** faux pedestal **left** and box/box/file pedestal on **right**. File drawer and lower box drawer lock. Bow top overhangs 2 ¼" at ends and 8" on center.

- 84" wide desks are shipped RTA (ready to assemble) in 2 cartons.

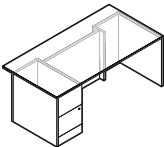

Single Pedestal Desk - LEFT

Z4284F2L	42 x 84 x 29.5-30	125	326.55	43.50	\$1920	\$2172	\$848	\$939
Z4272F2L	42 x 72 x 29.5-30	150	327	59	\$1827	\$2044	\$703	\$705
Z3684F2L	36 x 84 x 29.5-30	250	290.85	118	\$1802	\$2020	\$848	\$705
Z3672F2L	36 x 72 x 29.5-30	150	265.65	50.75	\$1690	\$1880	\$703	\$530
Z3666F2L	36 x 66 x 29.5-30	150	254.10	46.75	\$1649	\$1823	\$627	\$530
Z3660F2L	36 x 60 x 29.5-30	150	243.60	42.50	\$1607	\$1769	\$555	\$441
Z3072F2L	29.69 x 72 x 29.5-30	150	265.65	50.75	\$1690	\$1880	\$703	\$530
Z3066F2L	29.7 x 66 x 29.5-30	150	254.10	46.75	\$1649	\$1822	\$627	\$530
Z3060F2L	29.7 x 60 x 29.5-30	150	243.60	42.50	\$1607	\$1769	\$555	\$441

Standard with **Freestanding** file/file pedestal on **left** and faux pedestal **right**. Pedestal locks.

- 84" wide desks are shipped RTA (ready to assemble) in 2 cartons.
- Hutches may not be placed on this desk

Required Specifications

Top finish
Top/edge detail
Base finish
Lock finish

Optional Specifications

HP laminate Handles
Key # Modesty finish glazed
Modesty Type
Grommet position or power block cut-out

Accessories

Power block
Keyboard
Pencil drawer

SINGLE PEDESTAL DESKS

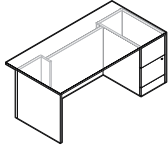

Single Pedestal Desk - RIGHT*

MODEL#	DIMENSIONS D x W x H	FREIGHT CLASS	WT/LBS.	CUBIC FT.	1" TOP	1.5" TOP	GLAZE ADD	HP ADD
Z4284F2R	42 x 84 x 29.5-30	125	326.55	43.50	\$1920	\$2172	\$848	\$939
Z4272F2R	42 x 72 x 29.5-30	150	327	59	\$1827	\$2044	\$703	\$705
Z3684F2R	36 x 84 x 29.5-30	250	290.85	118	\$1802	\$2020	\$848	\$705
Z3672F2R	36 x 72 x 29.5-30	150	265.65	50.75	\$1690	\$1880	\$703	\$530
Z3666F2R	36 x 66 x 29.5-30	150	254.10	46.75	\$1649	\$1823	\$627	\$530
Z3660F2R	36 x 60 x 29.5-30	150	243.60	42.50	\$1607	\$1769	\$555	\$441
Z3072F2R	29.7 x 72 x 29.5-30	150	265.65	50.75	\$1690	\$1880	\$703	\$530
Z3066F2R	29.7 x 66 x 29.5-30	150	254.10	46.75	\$1649	\$1822	\$627	\$530
Z3060F2R	29.7 x 60 x 29.5-30	150	243.60	42.50	\$1607	\$1769	\$555	\$441

Standard with **Freestanding** faux pedestal on **left** and file/file pedestal **right**. Pedestal locks.

- 84" wide desks are shipped RTA (ready to assemble) in 2 cartons.
- Hutches may not be placed on this desk

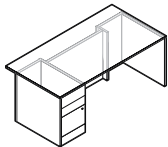

Single Pedestal Desk - LEFT*

Z4284F3L	42 x 84 x 29.5-30	125	324.45	43.50	\$1955	\$2205	\$848	\$939
Z4272F3L	42 x 72 x 29.5-30	150	324	59	\$1862	\$2079	\$703	\$705
Z3684F3L	36 x 84 x 29.5-30	250	288.75	118	\$1802	\$2020	\$848	\$705
Z3672F3L	36 x 72 x 29.5-30	150	263.55	50.75	\$1725	\$1915	\$703	\$530
Z3666F3L	36 x 66 x 29.5-30	150	252	46.75	\$1684	\$1858	\$627	\$530
Z3660F3L	36 x 60 x 29.5-30	150	241.50	42.50	\$1620	\$1779	\$555	\$441
Z3072F3L	29.7 x 72 x 29.5-30	150	253.55	50.75	\$1725	\$1915	\$703	\$530
Z3066F3L	29.7 x 66 x 29.5-30	150	252	46.75	\$1684	\$1857	\$627	\$530
Z3060F3L	29.7 x 60 x 29.5-30	150	241.50	42.50	\$1620	\$1779	\$555	\$441

Standard with **Freestanding** box/box/file pedestal on **left** and faux pedestal **right**. File drawer and lower box drawer lock.

- 84" wide desks are shipped RTA (ready to assemble) in 2 cartons.
- Hutches may not be placed on this desk

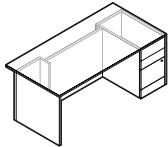

Single Pedestal Desk - RIGHT*

Z4284F3R	42 x 84 x 29.5-30	125	324.45	43.50	\$1955	\$2205	\$848	\$939
Z4272F3R	42 x 72 x 29.5-30	150	324	59	\$1862	\$2079	\$703	\$705
Z3684F3R	36 x 84 x 29.5-30	250	288.75	118	\$1802	\$2020	\$848	\$705
Z3672F3R	36 x 72 x 29.5-30	150	263.55	50.75	\$1725	\$1915	\$703	\$530
Z3666F3R	36 x 66 x 29.5-30	150	252	46.75	\$1684	\$1858	\$627	\$530
Z3660F3R	36 x 60 x 29.5-30	150	241.50	42.50	\$1620	\$1779	\$555	\$441
Z3072F3R	29.7 x 72 x 29.5-30	150	253.55	50.75	\$1725	\$1915	\$703	\$530
Z3066F3R	29.7 x 66 x 29.5-30	150	252	46.75	\$1684	\$1857	\$627	\$530
Z3060F3R	29.7 x 60 x 29.5-30	150	241.50	42.50	\$1620	\$1779	\$555	\$441

Standard with **Freestanding** faux pedestal on **left** and box/box/file pedestal **right**. File drawer and lower box drawer lock.

- 84" wide desks are shipped RTA (ready to assemble) in 2 cartons.
- Hutches may not be placed on this desk

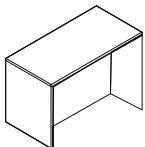

Non-Handed Desk

Z4284NHD	42 x 84 x 29.5-30	65	267	9.5	\$1465	\$1752	n/a	\$737
Z3684NHD	36 x 84 x 29.5-30	70	182	8.3	\$1329	\$1570	n/a	\$634
Z3672NHD	36 x 72 x 29.5-30	70	159	7.2	\$1198	\$1404	n/a	\$543
Z3666NHD	36 x 66 x 29.5-30	65	152	6.7	\$1129	\$1325	n/a	\$498
Z3660NHD	36 x 60 x 29.5-30	65	143	6.1	\$1067	\$1246	n/a	\$452
Z3072NHD	30 x 72 x 29.5-30	65	140	6.2	\$1090	\$1262	n/a	\$452
Z3066NHD	30 x 66 x 29.5-30	65	133	5.7	\$1011	\$1178	n/a	\$417
Z3060NHD	30 x 60 x 29.5-30	65	124	5.2	\$953	\$1097	n/a	\$378

Two laminate end panels + full modesty panel (laminated only). Recessed modesty. Accepts all standard Zira storage shells.

Required Specifications

- Top finish
- Top/edge detail
- Base finish
- Lock finish

Optional Specifications

- HP laminate
- Handles
- Key #
- Modesty finish glazed*
- Modesty Type*
- Grommet position or power block cut-out

Accessories

- Power block
- Keyboard
- Pencil drawer

FREESTANDING DESKS

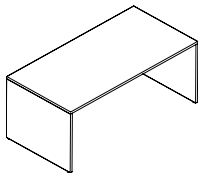

Freestanding Desk

MODEL#	DIMENSIONS D x W x H	FREIGHT CLASS	WT/LBS.	CUBIC FT.	1" TOP	1.5" TOP	GLAZE ADD	HP ADD
Z3684DK	36 x 84 x 29.5-30	70	168	8.25	\$1147	\$1383	\$886	\$630
Z3672DK	36 x 72 x 29.5-30	70	152	7.25	\$1049	\$1256	\$790	\$541
Z3666DK	36 x 66 x 29.5-30	70	144	6.75	\$1003	\$1193	\$722	\$497
Z3660DK	36 x 60 x 29.5-30	65	137	6	\$959	\$1131	\$675	\$451
Z3072DK	30 x 72 x 29.5-30	70	130	6.25	\$936	\$1108	\$790	\$451
Z3066DK	30 x 66 x 29.5-30	70	123	5.75	\$891	\$1063	\$722	\$414
Z3060DK	30 x 60 x 29.5-30	70	117	5.25	\$845	\$1017	\$675	\$376

Two full laminate end panels. 12"H laminate modesty panel. Shipped RTA (ready to assemble).

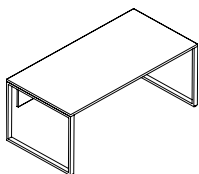

Freestanding Desk - Metal Legs*

Z3684DM	36 x 84 x 29.5-30	100	167	18.44	\$2451	\$2692	\$679	\$630
Z3672DM	36 x 72 x 29.5-30	100	151	17.46	\$2360	\$2567	\$583	\$541
Z3666DM	36 x 66 x 29.5-30	100	143	16.95	\$2314	\$2504	\$514	\$451
Z3660DM	36 x 60 x 29.5-30	100	143	16.95	\$2314	\$2504	\$466	\$451
Z3072DM	30 x 72 x 29.5-30	100	133	14.70	\$2247	\$2419	\$583	\$451
Z3066DM	30 x 66 x 29.5-30	100	126	14.22	\$2201	\$2373	\$514	\$414
Z3060DM	30 x 60 x 29.5-30	100	120	13.95	\$2154	\$2326	\$466	\$376

Double metal legs. 12"H laminate modesty panel. Metal leg available in Black (BLK) or Tungsten (TUN). Shipped RTA (ready to assemble).

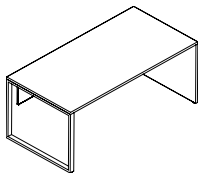

Freestanding Desk - Metal Legs*

Z3684DML	36 x 84 x 29.5-30	85	167	13.50	\$1801	\$2037	\$777	\$630
Z3672DML	36 x 72 x 29.5-30	85	151	12.04	\$1710	\$1912	\$683	\$541
Z3666DML	36 x 66 x 29.5-30	85	144	11.74	\$1665	\$1855	\$614	\$497
Z3660DML	36 x 60 x 29.5-30	85	135	11.24	\$1619	\$1791	\$568	\$451
Z3072DML	30 x 72 x 29.5-30	85	131	10.50	\$1597	\$1769	\$683	\$451
Z3066DML	30 x 66 x 29.5-30	85	125	10	\$1551	\$1723	\$614	\$414
Z3060DML	30 x 60 x 29.5-30	85	118	9.50	\$1507	\$1679	\$568	\$376

Single metal leg on **left** and laminate end panel on **right**. 12"H laminate modesty panel. Metal leg available in Black (BLK) or Tungsten (TUN). Shipped RTA (ready to assemble).

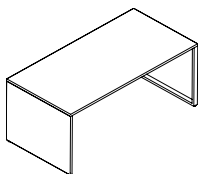

Freestanding Desk - Metal Legs*

Z3684DMR	36 x 84 x 29.5-30	85	167	13.50	\$1801	\$2037	\$777	\$630
Z3672DMR	36 x 72 x 29.5-30	85	151	12.04	\$1710	\$1912	\$683	\$541
Z3666DMR	36 x 66 x 29.5-30	85	144	11.74	\$1665	\$1855	\$614	\$497
Z3660DMR	36 x 60 x 29.5-30	85	135	11.24	\$1619	\$1791	\$568	\$451
Z3072DMR	30 x 72 x 29.5-30	85	131	10.50	\$1597	\$1769	\$683	\$451
Z3066DMR	30 x 66 x 29.5-30	85	125	10	\$1551	\$1723	\$614	\$414
Z3060DMR	30 x 60 x 29.5-30	85	118	9.50	\$1507	\$1679	\$568	\$376

Single metal leg on **right** and laminate end panel on **left**. 12"H laminate modesty panel. Metal leg available in Black (BLK) or Tungsten (TUN). Shipped RTA (ready to assemble).

Required Specifications

- Top finish
- Top/edge detail
- Base finish
- Leg finish* (BLK or TUN)

Optional Specifications

- HP laminate
- Modesty finish glazed
- Modesty type
- Grommet position or power block cut-out

Accessories

- Power block
- Keyboard
- Pencil drawer

TRANSITIONAL TABLES

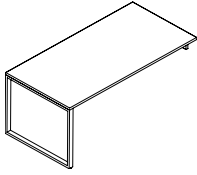

LEFT

Overlapping Table

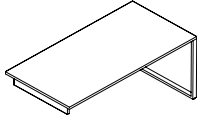

RIGHT

Overlapping Table

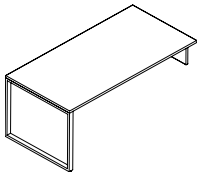

LEFT

Overlapping Table

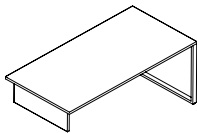

RIGHT

Overlapping Table

MODEL#	DIMENSIONS	FREIGHT CLASS	WT/LBS.	CUBIC FT.	1" TOP	1.5" TOP	GLAZE ADD	HP ADD
	D x W x H							
Z3684OML	36 x 84 x 29.5-30	100	132	13.50	\$1648	\$1884	N/A	\$630
Z3672OML	36 x 72 x 29.5-30	100	120	12.24	\$1574	\$1810	N/A	\$541
Z3666OML	36 x 66 x 29.5-30	100	112	11.74	\$1539	\$1775	N/A	\$497
Z3660OML	36 x 60 x 29.5-30	100	105	11.24	\$1511	\$1742	N/A	\$451
Z3072OML	30 x 72 x 29.5-30	100	104	10.50	\$1489	\$1713	N/A	\$451
Z3066OML	30 x 66 x 29.5-30	100	97	10	\$1454	\$1685	N/A	\$414
Z3060OML	30 x 60 x 29.5-30	100	90	9.50	\$1426	\$1657	N/A	\$376

Metal open frame leg with support channels on **left**. To be placed on top of 23.75"/24.25" high units. Not freestanding. Metal leg available in Black (**BLK**) or Tungsten (**TUN**). Shipped RTA (ready to assemble).

Z3684OMR	36 x 84 x 29.5-30	100	132	13.50	\$1648	\$1884	N/A	\$630
Z3672OMR	36 x 72 x 29.5-30	100	120	12.24	\$1574	\$1810	N/A	\$541
Z3666OMR	36 x 66 x 29.5-30	100	112	11.74	\$1539	\$1775	N/A	\$497
Z3660OMR	36 x 60 x 29.5-30	100	105	11.24	\$1511	\$1742	N/A	\$451
Z3072OMR	30 x 72 x 29.5-30	100	104	10.50	\$1489	\$1713	N/A	\$451
Z3066OMR	30 x 66 x 29.5-30	100	97	10	\$1454	\$1685	N/A	\$414
Z3060OMR	30 x 60 x 29.5-30	100	90	9.50	\$1426	\$1657	N/A	\$376

Metal open frame leg with support channels on **right**. To be placed on top of 23.75"/24.25" high units. Not freestanding. Metal leg available in Black (**BLK**) or Tungsten (**TUN**). Shipped RTA (ready to assemble).

Z3684SOL	36 x 84 x 29.5-30	92.5	139	13.50	\$1665	\$1901	N/A	\$630
Z3672SOL	36 x 72 x 29.5-30	92.5	126	12.24	\$1592	\$1828	N/A	\$541
Z3666SOL	36 x 66 x 29.5-30	92.5	118	11.74	\$1557	\$1793	N/A	\$497
Z3660SOL	36 x 60 x 29.5-30	100	110	11.24	\$1528	\$1759	N/A	\$451
Z3072SOL	30 x 72 x 29.5-30	92.5	108	10.50	\$1507	\$1731	N/A	\$451
Z3066SOL	30 x 66 x 29.5-30	92.5	100	10	\$1472	\$1703	N/A	\$414
Z3060SOL	30 x 60 x 29.5-30	92.5	96	9.50	\$1443	\$1674	N/A	\$376

Metal open frame leg with support channels on **left**. To be placed on top of 17.87"/18.37" high units. Not freestanding. Metal leg available in Black (**BLK**) or Tungsten (**TUN**). Shipped RTA (ready to assemble).

Z3684SOR	36 x 84 x 29.5-30	92.5	139	13.50	\$1665	\$1901	N/A	\$630
Z3672SOR	36 x 72 x 29.5-30	92.5	126	12.24	\$1592	\$1828	N/A	\$541
Z3666SOR	36 x 66 x 29.5-30	92.5	118	11.74	\$1557	\$1793	N/A	\$497
Z3660SOR	36 x 60 x 29.5-30	100	110	11.24	\$1528	\$1759	N/A	\$451
Z3072SOR	30 x 72 x 29.5-30	92.5	108	10.50	\$1507	\$1731	N/A	\$451
Z3066SOR	30 x 66 x 29.5-30	92.5	100	10	\$1472	\$1703	N/A	\$414
Z3060SOR	30 x 60 x 29.5-30	92.5	96	9.50	\$1443	\$1674	N/A	\$376

Metal open frame leg with support channels on **right**. To be placed on top of 17.87"/18.37" high units. Not freestanding. Metal leg available in Black (**BLK**) or Tungsten (**TUN**). Shipped RTA (ready to assemble).

Required Specifications

- Top finish
- Top/edge detail
- Base finish
- Leg finish (BLK or TUN)

Optional Specifications

- HP laminate
- Grommet position or power block cut-out

Accessories

- Power block
- Keyboard
- Pencil drawer

FLUSH RETURNS

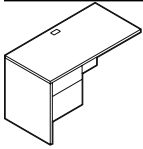

Flush Return - LEFT

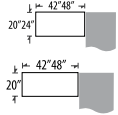

MODEL#	DIMENSIONS D x W x H	FREIGHT CLASS	WT./LBS.	CUBIC FT.	1" TOP	1.5" TOP	GLAZE ADD	HP ADD
Z2448FL	24 x 48 x 29.5-30	125	155	24	\$939	\$1033	N/A	\$260
Z2442FL	24 x 42 x 29.5-30	125	144	21.25	\$939	\$1021	N/A	\$218
Z2048FL	20 x 48 x 29.5-30	125	140	20.25	\$871	\$953	N/A	\$218
Z2042FL	20 x 42 x 29.5-30	125	130	18	\$871	\$953	N/A	\$218

Standard with **box/file** drawer pedestal. One pencil tray. Pedestal locks. Grommet in worksurface. Pedestal is on the **left**. For use with right handed single pedestal desks, 20"/24" deep extended corners with narrow end panel or 20"/24" deep five-sided corners with narrow end panel. Shipped RTA (ready to assemble).

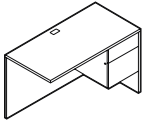

Flush Return - RIGHT

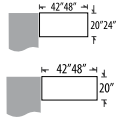

Z2448FR	24 x 48 x 29.5-30	125	155	24	\$939	\$1033	N/A	\$260
Z2442FR	24 x 42 x 29.5-30	125	144	21.25	\$939	\$1021	N/A	\$218
Z2048FR	20 x 48 x 29.5-30	125	140	20.25	\$871	\$953	N/A	\$218
Z2042FR	20 x 42 x 29.5-30	125	130	18	\$871	\$953	N/A	\$218

Standard with **box/file** drawer pedestal. One pencil tray. Pedestal locks. Grommet in worksurface. Pedestal is on the **right**. For use with right handed single pedestal desks, 20"/24" deep extended corners with narrow end panel or 20"/24" deep five-sided corners with narrow end panel. Shipped RTA (ready to assemble).

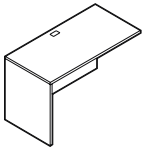

Flush Return - LEFT*

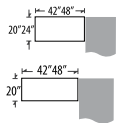

Z2448EL	24 x 48 x 29.5-30	65	107	4.30	\$664	\$758	N/A	\$260
Z2442EL	24 x 42 x 29.5-30	65	96	3.80	\$664	\$746	N/A	\$218
Z2048EL	20 x 48 x 29.5-30	65	97	4.30	\$613	\$697	N/A	\$218
Z2042EL	20 x 42 x 29.5-30	65	86	3.80	\$613	\$697	N/A	\$218

Return has **no pedestal**. Grommet in worksurface. Shipped RTA (ready to assemble). For use with right handed single pedestal desks, 20"/24" deep extended corners with narrow end panel or 20"/24" deep five-sided corners with narrow end panel.

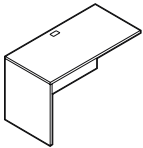

Flush Return - LEFT

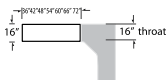

Z1672RL	15.8 x 72 x 29.5-30	70	109.20	6	\$661	\$776	N/A	\$267
Z1666RL	15.8 x 66 x 29.5-30	70	101.85	5.75	\$633	\$741	N/A	\$267
Z1660RL	15.8 x 60 x 29.5-30	70	94.50	5.25	\$597	\$696	N/A	\$222
Z1654RL	15.8 x 54 x 29.5-30	70	87.15	5.25	\$565	\$657	N/A	\$222
Z1648RL	15.8 x 48 x 29.5-30	70	79.80	4.25	\$520	\$601	N/A	\$180
Z1642RL	15.8 x 42 x 29.5-30	70	70.35	4	\$465	\$540	N/A	\$180
Z1636RL	15.8 x 36 x 29.5-30	70	61.95	3.50	\$416	\$482	N/A	\$135

16" Throat. Return has **no pedestal**. Grommet in worksurface. Shipped RTA (ready to assemble). For use with extended corners, desks and islands with 16" throat.

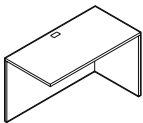

Flush Return - RIGHT**

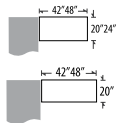

Z2448ER	24 x 48 x 29.5-30	65	107	4.30	\$664	\$758	N/A	\$260
Z2442ER	24 x 42 x 29.5-30	65	96	3.80	\$664	\$746	N/A	\$218
Z2048ER	20 x 48 x 29.5-30	65	97	4.30	\$613	\$697	N/A	\$218
Z2042ER	20 x 42 x 29.5-30	65	86	3.80	\$613	\$697	N/A	\$218

Return has **no pedestal**. Grommet in worksurface. Shipped RTA (ready to assemble). For use with right handed single pedestal desks, 20"/24" deep extended corners with narrow end panel or 20"/24" deep five-sided corners with narrow end panel.

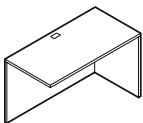

Flush Return - RIGHT

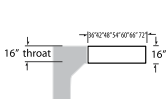

Z1672RR	15.8 x 72 x 29.5-30	70	109.20	6	\$661	\$776	N/A	\$267
Z1666RR	15.8 x 66 x 29.5-30	70	101.85	5.75	\$633	\$741	N/A	\$267
Z1660RR	15.8 x 60 x 29.5-30	70	94.50	5.25	\$597	\$696	N/A	\$222
Z1654RR	15.8 x 54 x 29.5-30	70	87.15	5.25	\$565	\$657	N/A	\$222
Z1648RR	15.8 x 48 x 29.5-30	70	79.80	4.25	\$520	\$601	N/A	\$180
Z1642RR	15.8 x 42 x 29.5-30	70	70.35	4	\$465	\$540	N/A	\$180
Z1636RR	15.8 x 36 x 29.5-30	70	61.95	3.50	\$416	\$482	N/A	\$135

16" Throat. Return has **no pedestal**. Grommet in worksurface. Shipped RTA (ready to assemble). For use with extended corners, desks and islands with 16" throat.

Required Specifications

- Top finish
- Top/edge detail
- Base finish
- Lock finish

Optional Specifications

- HP laminate
- Handles
- Key #
- Modesty Type
- Grommet position or power block cut-out

Accessories

- Power block
- Keyboard
- Pencil drawer

NON-HANDED RETURNS

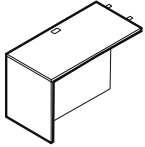

Non-Handed Return

MODEL#	DIMENSIONS	FREIGHT CLASS	WT./LBS.	CUBIC FT.	1"TOP	1.5" TOP	GLAZE ADD	HP ADD
D x W x H								
Z2448NHR	24 x 48 x 29.5-30	70	83	4.3	\$685	\$788	N/A	\$241
Z2442NHR	24 x 42 x 29.5-30	70	75	3.8	\$594	\$704	N/A	\$214
Z2048NHR	20 x 48 x 29.5-30	70	75	4.3	\$623	\$722	N/A	\$202
Z2042NHR	20 x 42 x 29.5-30	70	67	3.8	\$571	\$641	N/A	\$179

Non-handed (reversible) return. 24" d returns accept all standard 23.4" storage shells. 20" d returns accept all standard 19.3" storage shells. Full modesty panel (laminated only). Shipped RTA (ready to assemble).

SPACE SAVER RETURNS

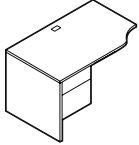

Space Saver Return - LEFT*

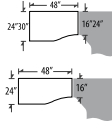

MODEL#	DIMENSIONS	FREIGHT CLASS	WT./LBS.	CUBIC FT.	1"TOP	1.5" TOP	GLAZE ADD	HP ADD
Z3048FSL	29.69 x 48 x 29.5-30	150	166	29	\$1032	\$1158	N/A	\$374
Z2448FSL	24 x 48 x 29.5-30	125	154	24.25	\$1044	\$1156	N/A	\$238

Standard with **box/file** drawer pedestal. Grommet in worksurface. One pencil tray. Pedestal locks. Connects to 24" or 16" component.

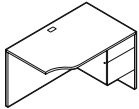

Space Saver Return - RIGHT*

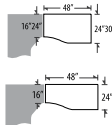

Z3048FSR	29.69 x 48 x 29.5-30	150	166	29	\$1032	\$1158	N/A	\$374
Z2448FSR	24 x 48 x 29.5-30	125	154	24.25	\$1044	\$1156	N/A	\$238

Standard with **box/file** drawer pedestal. Grommet in worksurface. One pencil tray. Pedestal locks. Connects to 24" or 16" component.

Z247216RL	24 x 72 x 29.5-30	65	135.45	6	\$786	\$956	N/A	\$355
Z246616RL	24 x 66 x 29.5-30	70	127.05	5.75	\$751	\$907	N/A	\$355
Z246016RL	24 x 60 x 29.5-30	70	117.60	5.25	\$704	\$850	N/A	\$295
Z245416RL	24 x 54 x 29.5-30	70	108.15	5.25	\$664	\$797	N/A	\$295
Z244816RL	24 x 48 x 29.5-30	65	99.75	4.25	\$610	\$730	N/A	\$238
Z244216RL	24 x 42 x 29.5-30	70	88.20	4	\$546	\$654	N/A	\$238
Z243616RL	24 x 36 x 29.5-30	70	77.70	3.50	\$496	\$593	N/A	\$180
Z207216RL	20 x 72 x 29.5-30	70	122.85	6	\$719	\$863	N/A	\$355
Z206616RL	20 x 66 x 29.5-30	70	114.45	5.75	\$685	\$816	N/A	\$355
Z206016RL	20 x 60 x 29.5-30	70	106.05	5.25	\$644	\$765	N/A	\$295
Z205416RL	20 x 54 x 29.5-30	70	97.65	5.25	\$606	\$716	N/A	\$295
Z204816RL	20 x 48 x 29.5-30	70	90.30	4.25	\$557	\$657	N/A	\$238
Z204216RL	20 x 42 x 29.5-30	70	79.80	4	\$500	\$592	N/A	\$238
Z203616RL	20 x 36 x 29.5-30	70	70.35	3.50	\$451	\$529	N/A	\$180

16" Throat. Return has **no pedestal**. Grommet in worksurface. Shipped RTA (ready to assemble). For use with extended corners, desks and islands with 16" throat. Accepts same depth storage shells under worksurface.

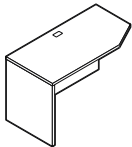
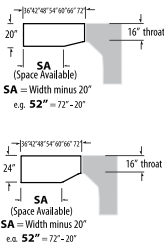

Space Saver Return - LEFT

Required Specifications

- Top finish
- Top/edge detail
- Base finish
- Lock finish

Optional Specifications

- HP laminate
- Handles*
- Key #
- Modesty Type*
- Grommet position or power block cut-out

Accessories

- Power block
- Keyboard
- Pencil drawer

RETURNS

MODEL# DIMENSIONS FREIGHT CLASS WT/LBS. CUBIC FT. 1" TOP 1.5" TOP GLAZE ADD HP ADD

D x W x H

Z247216RR	24 x 72 x 29.5-30	65	135.45	6	\$786	\$956	N/A	\$355
Z246616RR	24 x 66 x 29.5-30	70	127.05	5.75	\$751	\$907	N/A	\$355
Z246016RR	24 x 60 x 29.5-30	70	117.60	5.25	\$704	\$850	N/A	\$295
Z245416RR	24 x 54 x 29.5-30	70	108.15	5.25	\$664	\$797	N/A	\$295
Z244816RR	24 x 48 x 29.5-30	65	99.75	4.25	\$610	\$730	N/A	\$238
Z244216RR	24 x 42 x 29.5-30	70	88.20	4	\$546	\$654	N/A	\$238
Z243616RR	24 x 36 x 29.5-30	70	77.70	3.50	\$496	\$593	N/A	\$180
Z207216RR	20 x 72 x 29.5-30	70	122.85	6	\$719	\$863	N/A	\$355
Z206616RR	20 x 66 x 29.5-30	70	114.45	5.75	\$685	\$816	N/A	\$355
Z206016RR	20 x 60 x 29.5-30	70	106.05	5.25	\$644	\$765	N/A	\$295
Z205416RR	20 x 54 x 29.5-30	70	97.65	5.25	\$606	\$716	N/A	\$295
Z204816RR	20 x 48 x 29.5-30	70	90.30	4.25	\$557	\$657	N/A	\$238
Z204216RR	20 x 42 x 29.5-30	70	79.80	4	\$500	\$592	N/A	\$238
Z203616RR	20 x 36 x 29.5-30	70	70.35	3.50	\$451	\$529	N/A	\$180

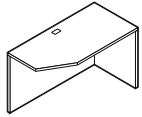
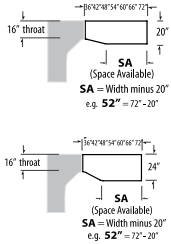

Space Saver Return - RIGHT

16" Throat. Return has **no pedestal**. Grommet in worksurface. Shipped RTA (ready to assemble). For use with extended corners, desks and islands with 16"throat. Accepts same depth storage shells under worksurface.

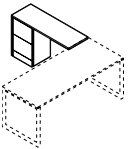

Full to Floor Return, No Modesty - LEFT

Z2448NRL	24 x 48 x 29.5-30	150	127	24.25	\$1083	\$1181	N/A	\$241
Z2442NRL	24 x 42 x 29.5-30	150	123	21.25	\$1072	\$1157	N/A	\$212
Z2048NRL	20 x 48 x 29.5-30	150	114	20.50	\$1020	\$1102	N/A	\$202
Z2042NRL	20 x 42 x 29.5-30	125	111	18	\$996	\$1070	N/A	\$175

Return has no modesty. File/file pedestal on **left**. Pedestal locks. Full to the floor pedestal configurations can be switched for a **15% upcharge**.

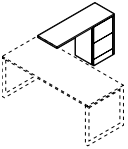

Full to Floor Return, No Modesty - RIGHT

Z2448NRR	24 x 48 x 29.5-30	150	127	24.25	\$1083	\$1181	N/A	\$241
Z2442NRR	24 x 42 x 29.5-30	150	123	21.25	\$1072	\$1158	N/A	\$212
Z2048NRR	20 x 48 x 29.5-30	150	114	20.50	\$1020	\$1102	N/A	\$202
Z2042NRR	20 x 42 x 29.5-30	125	111	18	\$996	\$1070	N/A	\$175

Return has no modesty. File/file pedestal on **right**. Pedestal locks. Full to the floor pedestal configurations can be switched for a **15% upcharge**.

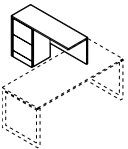

Full to Floor Return - LEFT

Z2448SRL	24 x 48 x 29.5-30	150	135	24.25	\$1177	\$1275	N/A	\$241
Z2442SRL	24 x 42 x 29.5-30	125	130	21.25	\$1158	\$1243	N/A	\$212
Z2048SRL	20 x 48 x 29.5-30	125	123	20.50	\$1115	\$1197	N/A	\$202
Z2042SRL	20 x 42 x 29.5-30	125	119	18	\$1082	\$1156	N/A	\$175

File/file pedestal on **left**. 12"H modesty panel. Pedestal locks. Full to the floor pedestal configurations can be switched for a **15% upcharge**.

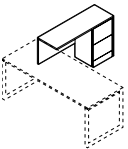

Full to Floor Return - RIGHT

Z2448SRR	24 x 48 x 29.5-30	150	135	24.25	\$1177	\$1275	N/A	\$241
Z2442SRR	24 x 42 x 29.5-30	125	130	21.25	\$1158	\$1243	N/A	\$212
Z2048SRR	20 x 48 x 29.5-30	125	123	20.50	\$1115	\$1197	N/A	\$202
Z2042SRR	20 x 42 x 29.5-30	125	119	18	\$1082	\$1156	N/A	\$175

File/file pedestal on **right**. 12"H modesty panel. Pedestal locks. Full to the floor pedestal configurations can be switched for a **15% upcharge**.

Required Specifications

- Top finish
- Top/edge detail
- Base finish
- Handles

Optional Specifications

- HP laminate
- Key #
- Grommet position or power block cut-out

Accessories

- Power block
- Keyboard
- Pencil drawer

RETURNS

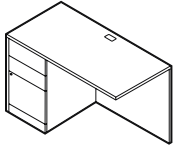

Full to Floor Flush Return - LEFT

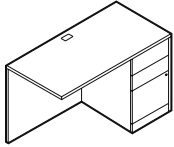

Full to Floor Flush Return - RIGHT

MODEL#	DIMENSIONS	FREIGHT CLASS	WT/LBS.	CUBIC FT.	1" TOP	1.5" TOP	GLAZE ADD	HP ADD
D x W x H								
Z24723L	24 x 72 x 29.5-30	125	171	24.50	\$1561	\$1704	N/A	\$355
Z24663L	24 x 66 x 29.5-30	125	171	24.50	\$1533	\$1661	N/A	\$355
Z24603L	24 x 60 x 29.5-30	125	171	24.50	\$1434	\$1557	N/A	\$326
Z24543L	24 x 54 x 29.5-30	125	171	24.50	\$1385	\$1497	N/A	\$326
Z24483L	24 x 48 x 29.5-30	125	171	24.50	\$1306	\$1406	N/A	\$260
Z20723L	20 x 72 x 29.5-30	65	97	4.30	\$1428	\$1550	N/A	\$355
Z20663L	20 x 66 x 29.5-30	65	97	4.30	\$1381	\$1498	N/A	\$355
Z20603L	20 x 60 x 29.5-30	65	97	4.30	\$1357	\$1462	N/A	\$295
Z20543L	20 x 54 x 29.5-30	65	97	4.30	\$1301	\$1401	N/A	\$295
Z20483L	20 x 48 x 29.5-30	125	154	20.75	\$1271	\$1358	N/A	\$218

Standard with box/box/file pedestal on **left**. Grommet in worksurface. One pencil tray. File drawer and lower box drawer lock. Full to the floor pedestal configurations can be switched for a **15% upcharge**.

- Does not accommodate storage shells.

Z24723R	24 x 72 x 29.5-30	125	171	24.50	\$1561	\$1704	N/A	\$355
Z24663R	24 x 66 x 29.5-30	125	171	24.50	\$1533	\$1661	N/A	\$355
Z24603R	24 x 60 x 29.5-30	125	171	24.50	\$1434	\$1557	N/A	\$326
Z24543R	24 x 54 x 29.5-30	125	171	24.50	\$1385	\$1497	N/A	\$326
Z24483R	24 x 48 x 29.5-30	125	171	24.50	\$1306	\$1406	N/A	\$260
Z20723R	20 x 72 x 29.5-30	65	97	4.30	\$1428	\$1550	N/A	\$355
Z20663R	20 x 66 x 29.5-30	65	97	4.30	\$1381	\$1498	N/A	\$355
Z20603R	20 x 60 x 29.5-30	65	97	4.30	\$1357	\$1462	N/A	\$295
Z20543R	20 x 54 x 29.5-30	65	97	4.30	\$1301	\$1401	N/A	\$295
Z20483R	20 x 48 x 29.5-30	125	154	20.75	\$1271	\$1358	N/A	\$218

Standard with box/box/file pedestal on **right**. Grommet in worksurface. One pencil tray. File drawer and lower box drawer lock. Full to the floor pedestal configurations can be switched for a **15% upcharge**.

- Does not accommodate storage shells.

METAL LEG RETURNS

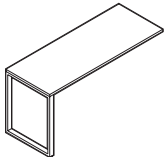

Return w/Metal Legs - LEFT*

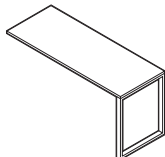

Return w/Metal Legs - RIGHT*

MODEL#	DIMENSIONS	FREIGHT CLASS	WT/LBS.	CUBIC FT.	1" TOP	1.5" TOP	GLAZE ADD	HP ADD
Z3672MRL	36 x 72 x 29	100	116	11.25	\$1019	\$1204	N/A	\$577
Z3072MRL	30 x 72 x 29	92.5	100	10	\$933	\$1094	N/A	\$475
Z3066MRL	30 x 66 x 29	70	94	9.75	\$898	\$1041	N/A	\$475
Z3060MRL	30 x 60 x 29	70	88	9.25	\$856	\$993	N/A	\$441
Z2472MRL	24 x 72 x 29	70	85	8.25	\$856	\$984	N/A	\$355
Z2466MRL	24 x 66 x 29	70	80	8	\$824	\$941	N/A	\$355
Z2460MRL	24 x 60 x 29	70	75	7.75	\$789	\$901	N/A	\$326
Z2448MRL	24 x 48 x 29	70	56	5.75	\$681	\$768	N/A	\$260

Flush return attached to the edge of worksurface. Attaching hardware included. Leg shipped in separate carton. Shipped RTA (ready to assemble). **Not freestanding**. Metal leg available in Black (**BLK**) or Tungsten (**TUN**).

- Please note, glides need to be extended a small amount to accommodate the 29.5" height of standard Zira pieces.

Z3672MRR	36 x 72 x 29	100	116	11.25	\$1019	\$1204	N/A	\$577
Z3072MRR	30 x 72 x 29	92.5	100	10	\$933	\$1094	N/A	\$475
Z3066MRR	30 x 66 x 29	70	94	9.75	\$898	\$1041	N/A	\$475
Z3060MRR	30 x 60 x 29	70	88	9.25	\$856	\$993	N/A	\$441
Z2472MRR	24 x 72 x 29	70	85	8.25	\$856	\$984	N/A	\$355
Z2466MRR	24 x 66 x 29	70	80	8	\$824	\$941	N/A	\$355
Z2460MRR	24 x 60 x 29	70	75	7.75	\$789	\$901	N/A	\$326
Z2448MRR	24 x 48 x 29	70	56	5.75	\$681	\$768	N/A	\$260

Flush return attached to the edge of worksurface. Attaching hardware included. Leg shipped in separate carton. Shipped RTA (ready to assemble). **Not freestanding**. Metal leg available in Black (**BLK**) or Tungsten (**TUN**).

- Please note, glides need to be extended a small amount to accommodate the 29.5" height of standard Zira pieces.

Required Specifications

Top finish
 Top/edge detail
 Base finish
 Leg finish* (BLK or TUN)
 Lock finish

Optional Specifications

HP laminate
 Handles
 Key #
 Modesty type
 Grommet position or power block cut-out

Accessories

Power block
 Pencil drawer

MODESTY FOR METAL LEG RETURNS



Melamine Modesty Panel

MODEL#	DIMENSIONS D x W x H	FREIGHT CLASS	WT./LBS.	CUBIC FT.	1" TOP	1.5" TOP	GLAZE ADD	HP ADD
Z72LMP	.69 x 66 x 18.1	70	28	1.25	\$269	N/A	N/A	N/A
Z66LMP	.69 x 60 x 18.1	65	26	1	\$257	N/A	N/A	N/A
Z60LMP	.69 x 54 x 18.1	65	23	1	\$239	N/A	N/A	N/A
Z48LMP	.69 x 42 x 18.1	65	19	.75	\$202	N/A	N/A	N/A

For returns with metal legs. Modular laminate modesty panel. Specify model # corresponding to worksurface length.

BRIDGES

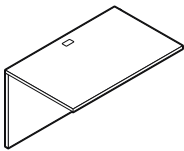

Flush Bridge*

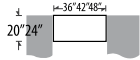

MODEL#	DIMENSIONS	FREIGHT CLASS	WT./LBS.	CUBIC FT.	1" TOP	1.5" TOP	GLAZE ADD	HP ADD
Z2448FB	24 x 48 x 29.5-30	70	91	4.30	\$580	\$674	N/A	\$238
Z2442FB	24 x 42 x 29.5-30	70	79	3.80	\$537	\$619	N/A	\$238
Z2436FB	24 x 36 x 29.5-30	70	69	3.30	\$537	\$619	N/A	\$180
Z2048FB	20 x 48 x 29.5-30	70	83	4.30	\$563	\$645	N/A	\$238
Z2042FB	20 x 42 x 29.5-30	70	72	3.80	\$522	\$604	N/A	\$238
Z2036FB	20 x 36 x 29.5-30	70	63	3.30	\$522	\$604	N/A	\$180

Top surface, back panel and hardware to create a "U" shape by connecting two units with full end panels. Grommet in worksurface. Shipped RTA (ready to assemble).

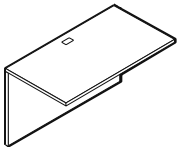

Flush Bridge

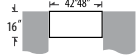

Z1648B	15.8 x 48 x 29.5-30	70	66.15	4.25	\$440	\$521	N/A	\$180
Z1642B	15.8 x 42 x 29.5-30	70	59.85	3.75	\$385	\$460	N/A	\$180

16" Throat. Top surface, back panel and hardware to create a "U" shape by connecting two units with a 16" throat and full end panels. Grommet in worksurface. Shipped RTA (ready to assemble).

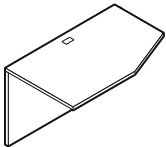

Space Saver Bridge - LEFT

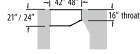

Z244816BL	24 x 48 x 29.5-30	70	82	4.25	\$514	\$634	N/A	\$238
Z244216BL	24 x 42 x 29.5-30	70	71	3.75	\$452	\$560	N/A	\$238
Z214816BL	21 x 48 x 29.5-30	70	76	4.25	\$477	\$577	N/A	\$238
Z214216BL	21 x 42 x 29.5-30	70	65	3.75	\$413	\$505	N/A	\$238

16" Throat. Top surface, back panel and hardware to connect extended corners, desks and islands with a 16" throat. Grommet in worksurface. Shipped RTA (ready to assemble).

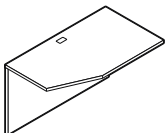

Space Saver Bridge - RIGHT

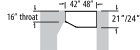

Z244816BR	24 x 48 x 29.5-30	70	82	4.25	\$514	\$634	N/A	\$238
Z244216BR	24 x 42 x 29.5-30	70	71	3.75	\$452	\$560	N/A	\$238
Z214816BR	21 x 48 x 29.5-30	70	76	4.25	\$477	\$577	N/A	\$238
Z214216BR	21 x 42 x 29.5-30	70	65	3.75	\$413	\$505	N/A	\$238

16" Throat. Top surface, back panel and hardware to connect extended corners, desks and islands with a 16" throat. Grommet in worksurface. Shipped RTA (ready to assemble).

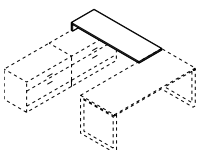

Overlapping Bridge - LEFT*

Z2468TRL	24 x 68 x 5.9	85	64	5.25	\$546	\$689	N/A	\$342
Z2462TRL	24 x 62 x 5.9	85	59	4.70	\$509	\$638	N/A	\$311
Z2472TRL	24 x 72 x 5.9	85	64	5.25	\$555	\$698	N/A	\$361
Z2466TRL	24 x 66 x 5.9	85	62	4.70	\$522	\$653	N/A	\$331

For 20"/24"D, 23.75"/24.25"H Storage with No Modesty. Overlaps storage on left.

- Use Z2462TRR and Z2468TRR for 20"D storage.
- Use Z2466TRR and Z2472TRR for 24"D storage.

Required Specifications

Top finish
Top/edge detail
Base finish

Optional Specifications

HP laminate
Grommet position or power block cut-out

Accessories

Power block
Pencil drawer*

TRANSITIONAL BRIDGES

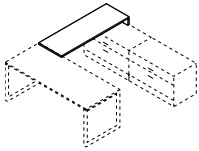

Overlapping Bridge - RIGHT*

MODEL#	DIMENSIONS D x W x H	FREIGHT CLASS	WT/LBS.	CUBIC FT.	1" TOP	1.5" TOP	GLAZE ADD	HP ADD
Z2468TRR	24 x 68 x 5.9	85	64	5.25	\$546	\$689	N/A	\$342
Z2462TRR	24 x 62 x 5.9	85	59	4.70	\$509	\$638	N/A	\$311
Z2472TRR	24 x 72 x 5.9	85	64	5.25	\$555	\$698	N/A	\$361
Z2466TRR	24 x 66 x 5.9	85	62	4.70	\$522	\$653	N/A	\$331

For 20"/24"D, 23.75"/24.25"H Storage with No Modesty. Overlaps storage on right.

- Use Z2462TRR and Z2468TRR for 20"D storage.
- Use Z2466TRR and Z2472TRR for 24"D storage.

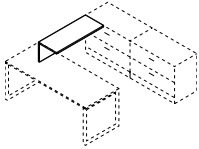

Flush Bridge

Z24483BR	24 x 48 x 13-13.5	70	55	3.50	\$580	\$674	N/A	\$238
Z24423BR	24 x 42 x 13-13.5	70	48	3.10	\$537	\$652	N/A	\$212
Z24363BR	24 x 36 x 13-13.5	70	43	2.70	\$537	\$637	N/A	\$182
Z20483BR	20 x 48 x 13-13.5	70	48	3	\$563	\$673	N/A	\$202
Z20423BR	20 x 42 x 13-13.5	70	43	2.70	\$522	\$620	N/A	\$175
Z20363BR	20 x 36 x 13-13.5	70	38	2.40	\$522	\$607	N/A	\$151

For use with storage models ZxxxxBBOL/R and ZxxxxBLFL/R. 12"H modesty panel..

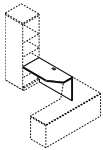

Transitional Bridge - LEFT

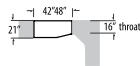

Z2148TRBL	21 x 48 x 29.5-30	70	75.83	4.25	\$497	\$597	N/A	\$238
Z2142TRBL	21 x 42 x 29.5-30	70	64.78	3.75	\$434	\$526	N/A	\$238

For 21" Wide Storage Module. Top surface, back panel, shorter kickplate and hardware to connect 21" wide storage module with 16" throat. Grommet in worksurface. Shipped RTA (ready to assemble).

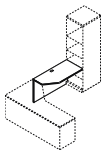

Transitional Bridge - RIGHT

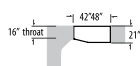

Z2148TRBR	21 x 48 x 29.5-30	70	75.83	4.25	\$497	\$597	N/A	\$238
Z2142TRBR	21 x 42 x 29.5-30	70	64.78	3.75	\$434	\$526	N/A	\$238

For 21" Wide Storage Module. Top surface, back panel, shorter kickplate and hardware to connect 21" wide storage module with 16" throat. Grommet in worksurface. Shipped RTA (ready to assemble).

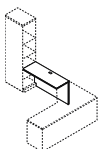

Transitional Bridge - LEFT

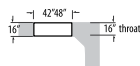

Z1648TRBL	16 x 48 x 29.5-30	70	68.58	4.25	\$459	\$540	N/A	\$180
Z1642TRBL	16 x 42 x 29.5-30	70	58.96	3.75	\$405	\$481	N/A	\$180

For 16" Wide Storage Module. Top surface, back panel and hardware to connect 16" wide storage module with 16" throat. Grommet in worksurface. Shipped RTA (ready to assemble).

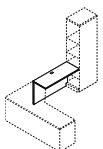

Transitional Bridge - RIGHT

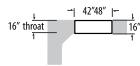

Z1648TRBR	16 x 48 x 29.5-30	70	68.58	4.25	\$459	\$540	N/A	\$180
Z1642TRBR	16 x 42 x 29.5-30	70	58.96	3.75	\$405	\$481	N/A	\$180

For 16" Wide Storage Module. Top surface, back panel and hardware to connect 16" wide storage module with 16" throat. Grommet in worksurface. Shipped RTA (ready to assemble).

Required Specifications

Top finish
Top/edge detail
Base finish

Optional Specifications

HP laminate
Grommet position or power block cut-out

Accessories

Power block
Pencil drawer*

18" H CREDENZAS

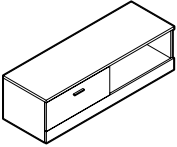

Lateral File Credenza - LEFT

MODEL#	DIMENSIONS D x W x H	FREIGHT CLASS	WT/LBS.	CUBIC FT.	1" TOP	1.5" TOP	GLAZE ADD	HP ADD
Z2472LOFL	24 x 72 x 17.87-18.37	125	181	22.75	\$1505	\$1628	N/A	\$361
Z2460LOFL	24 x 60 x 17.87-18.37	100	160	19.25	\$1337	\$1439	N/A	\$302
Z2072LOFL	20 x 72 x 17.87-18.37	100	164	19.25	\$1402	\$1504	N/A	\$302
Z2060LOFL	20 x 60 x 17.87-18.37	100	143	16.25	\$1236	\$1321	N/A	\$252

1 high lateral file on the **left**, open storage on the **right**.

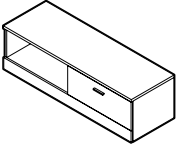

Lateral File Credenza - RIGHT

Z2472LOFR	24 x 72 x 17.87-18.37	125	181	22.75	\$1505	\$1628	N/A	\$361
Z2460LOFR	24 x 60 x 17.87-18.37	100	160	19.25	\$1337	\$1439	N/A	\$302
Z2072LOFR	20 x 72 x 17.87-18.37	100	164	19.25	\$1402	\$1504	N/A	\$302
Z2060LOFR	20 x 60 x 17.87-18.37	100	143	16.25	\$1236	\$1321	N/A	\$252

1 high lateral file on the **right**, open storage on the **left**.

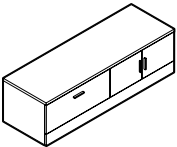

Lateral File Credenza - LEFT*

Z2472LSFL	24 x 72 x 17.87-18.37	100	197	22.75	\$1754	\$1877	\$373	\$361
Z2460LSFL	24 x 60 x 17.87-18.37	100	174	19.25	\$1581	\$1683	\$332	\$302
Z2072LSFL	20 x 72 x 17.87-18.37	100	178	19.25	\$1642	\$1744	\$373	\$302
Z2060LSFL	20 x 60 x 17.87-18.37	100	155	16.25	\$1474	\$1559	\$332	\$252

1 high lateral file on the **left**, closed storage on the **right**.

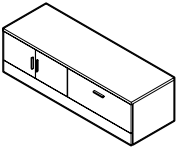

Lateral File Credenza - RIGHT*

Z2472LSFR	24 x 72 x 17.87-18.37	100	197	22.75	\$1754	\$1877	\$373	\$361
Z2460LSFR	24 x 60 x 17.87-18.37	100	174	19.25	\$1581	\$1683	\$332	\$302
Z2072LSFR	20 x 72 x 17.87-18.37	100	178	19.25	\$1642	\$1744	\$373	\$302
Z2060LSFR	20 x 60 x 17.87-18.37	100	155	16.25	\$1474	\$1559	\$332	\$252

1 high lateral file on the **right**, closed storage on the **left**.

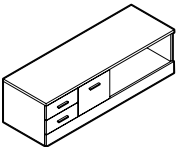

Mixed Storage Credenza - LEFT

Z2472LMOL	24 x 72 x 17.87-18.37	100	197	22.75	\$1734	\$1857	N/A	\$361
Z2460LMOL	24 x 60 x 17.87-18.37	100	176	19.25	\$1582	\$1684	N/A	\$302
Z2072LMOL	20 x 72 x 17.87-18.37	100	178	19.25	\$1624	\$1726	N/A	\$302
Z2060LMOL	20 x 60 x 17.87-18.37	100	157	16.25	\$1476	\$1562	N/A	\$252

1 high mixed drawers on the **left**, open storage on the **right**.

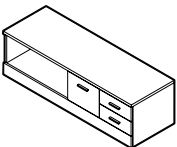

Mixed Storage Credenza - RIGHT

Z2472LMOR	24 x 72 x 17.87-18.37	100	197	22.75	\$1734	\$1857	N/A	\$361
Z2460LMOR	24 x 60 x 17.87-18.37	100	176	19.25	\$1582	\$1684	N/A	\$302
Z2072LMOR	20 x 72 x 17.87-18.37	100	178	19.25	\$1624	\$1726	N/A	\$302
Z2060LMOR	20 x 60 x 17.87-18.37	100	157	16.25	\$1476	\$1562	N/A	\$252

1 high mixed drawers on the **right**, open storage on the **left**.

Required Specifications

- Top finish
- Top/edge detail
- Base finish
- Handles

Optional Specifications

- HP laminate
- Key #
- Glazed doors*
- Box drawer - no upcharge

24"H CREDENZAS

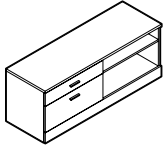

Lateral File Credenza - LEFT

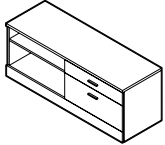

Lateral File Credenza - RIGHT

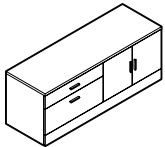

Lateral File Credenza - LEFT

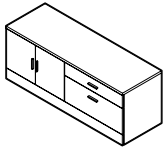

Lateral File Credenza - RIGHT

MODEL#	DIMENSIONS D x W x H	FREIGHT CLASS	WT/LBS.	CUBIC FT.	1" TOP	1.5" TOP	GLAZE ADD	HP ADD
Z2472HBFL	24 x 72 x 23.75-24.25	125	229	29.25	\$1886	\$2009	N/A	\$361
Z2460HBFL	24 x 60 x 23.75-24.25	100	201	24.50	\$1671	\$1773	N/A	\$302
Z2072HBFL	20 x 72 x 23.75-24.25	100	207	24.75	\$1776	\$1878	N/A	\$302
Z2060HBFL	20 x 60 x 23.75-24.25	100	180	20.75	\$1565	\$1651	N/A	\$252

1.5 high box/lateral file on the **left**, open storage on the **right**.

Z2472HBFR	24 x 72 x 23.75-24.25	125	229	29.25	\$1886	\$2009	N/A	\$361
Z2460HBFR	24 x 60 x 23.75-24.25	100	201	24.50	\$1671	\$1773	N/A	\$302
Z2072HBFR	20 x 72 x 23.75-24.25	100	207	24.75	\$1776	\$1878	N/A	\$302
Z2060HBFR	20 x 60 x 23.75-24.25	100	180	20.75	\$1565	\$1651	N/A	\$252

1.5 high box/lateral file on the **right**, open storage on the **left**.

Z2472HFSL	24 x 72 x 23.75-24.25	100	251	29.25	\$2207	\$2330	\$512	\$361
Z2460HFSL	24 x 60 x 23.75-24.25	100	221	24.50	\$1968	\$2070	\$443	\$302
Z2072HFSL	20 x 72 x 23.75-24.25	100	227	24.75	\$2073	\$2175	\$512	\$302
Z2060HFSL	20 x 60 x 23.75-24.25	100	198	20.75	\$1852	\$1938	\$443	\$252

1.5 high box/lateral file on the **left**, closed storage on the **right**.

Z2472HFSL	24 x 72 x 23.75-24.25	100	251	29.25	\$2207	\$2330	\$512	\$361
Z2460HFSL	24 x 60 x 23.75-24.25	100	221	24.50	\$1968	\$2070	\$443	\$302
Z2072HFSL	20 x 72 x 23.75-24.25	100	227	24.75	\$2073	\$2175	\$512	\$302
Z2060HFSL	20 x 60 x 23.75-24.25	100	198	20.75	\$1852	\$1938	\$443	\$252

1.5 high box/lateral file on the **right**, closed storage on the **left**.

Required Specifications

- Top finish
- Top/edge detail
- Base finish
- Handles

Optional Specifications

- HP laminate
- Key #
- Glazed doors*
- Box drawer - no upcharge

CREDENZAS

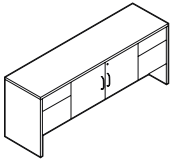

Glazed door option

Center Storage Credenza**

MODEL#	DIMENSIONS	FREIGHT CLASS	WT/LBS.	CUBIC FT.	1" TOP	1.5" TOP	GLAZE ADD	HP ADD
Z2072C	D x W x H 20 x 72 x 29.5-30	100	286	30	\$1906	\$2373	\$626	\$355

Standard with box/file pedestals on both sides and self-closing hinged center doors covering one adjustable shelf. Pedestals and doors lock, keyed alike. One pencil tray.

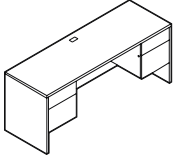

Kneespace Credenza*

Z2472CK	24 x 72 x 29.5-30	125	262	35.50	\$1547	\$1809	N/A	\$355
Z2466CK	24 x 66 x 29.5-30	125	250	33	\$1547	\$1752	N/A	\$355
Z2072CK	20 x 72 x 29.5-30	125	235	30	\$1477	\$1627	N/A	\$355
Z2066CK	20 x 66 x 29.5-30	100	225	27.75	\$1477	\$1594	N/A	\$355
Z2060CK	20 x 60 x 29.5-30	100	219	25.25	\$1421	\$1515	N/A	\$295

Standard with box/file pedestals on both sides. Center is open. Pedestals lock, keyed alike. One pencil tray. Grommet in worksurface.

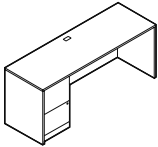

Full to Floor Single Pedestal Credenza- LEFT*

Z2472CS2L	24 x 72 x 29.5-30	100	228	25.75	\$1454	\$1602	N/A	\$355
Z2466CS2L	24 x 66 x 29.5-30	125	217	32.75	\$1427	\$1564	N/A	\$355
Z2072CS2L	20 x 72 x 29-29.5	125	203	30.25	\$1333	\$1456	N/A	\$355
Z2066CS2L	20 x 66 x 29-29.5	125	193	27.75	\$1283	\$1394	N/A	\$355

Standard with full to floor file/file pedestal on the **left**. Pedestal locks. One pencil tray. Grommet in worksurface.

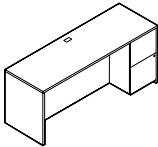

Full to Floor Single Pedestal Credenza- RIGHT*

Z2472CS2R	24 x 72 x 29.5-30	100	228	25.75	\$1454	\$1602	N/A	\$355
Z2466CS2R	24 x 66 x 29.5-30	125	217	32.75	\$1427	\$1564	N/A	\$355
Z2072CS2R	20 x 72 x 29.5-30	125	203	30.25	\$1333	\$1456	N/A	\$355
Z2066CS2R	20 x 66 x 29.5-30	125	193	27.75	\$1283	\$1394	N/A	\$355

Standard with full to floor file/file pedestal on the **right**. Pedestal locks. One pencil tray. Grommet in worksurface.

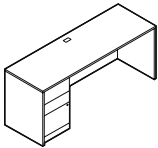

Full to Floor Single Pedestal Credenza- LEFT*

Z2472CS4L	24 x 72 x 29-29.5	125	228	35.75	\$1513	\$1661	N/A	\$355
Z2466CS4L	24 x 66 x 29-29.5	125	217	32.75	\$1489	\$1626	N/A	\$355
Z2072CS4L	20 x 72 x 29-29.5	125	203	30.25	\$1381	\$1501	N/A	\$355
Z2066CS4L	20 x 66 x 29-29.5	125	193	25.75	\$1333	\$1450	N/A	\$355

Standard with full to floor box/box/file pedestal on the **left**. File drawer and lower box drawer lock. One pencil tray. Grommet in worksurface.

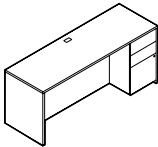

Full to Floor Single Pedestal Credenza- RIGHT*

Z2472CS4R	24 x 72 x 29-29.5	125	228	35.75	\$1513	\$1661	N/A	\$355
Z2466CS4R	24 x 66 x 29-29.5	125	217	32.75	\$1489	\$1626	N/A	\$355
Z2072CS4R	20 x 72 x 29-29.5	125	203	30.25	\$1381	\$1503	N/A	\$355
Z2066CS4R	20 x 66 x 29-29.5	125	193	25.75	\$1333	\$1450	N/A	\$355

Standard with full to floor box/box/file pedestal on the **right**. File drawer and lower box drawer lock. One pencil tray. Grommet in worksurface.

Required Specifications

Top finish
Top/edge detail
Base finish
Lock finish*

Optional Specifications

HP laminate
Key #*
Modesty type (only Z2xxxCK)
Grommet position or power block cut-out

Accessories

Keyboard**
Power block (not Z2072C)
Pencil drawer (Z2472S2L/R only)

CRENZAS

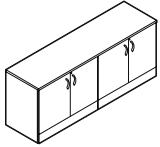

Glazed door option

Storage Cabinet Credenza**

MODEL#	DIMENSIONS D x W x H	FREIGHT CLASS	WT/LBS.	CUBIC FT.	1" TOP	1.5" TOP	GLAZE ADD	HP ADD
Z2472SCSC	24 x 72 x 29.5-30	100	345	35.75	\$2087	\$2231	\$1403	\$355
Z2072SCSC	20 x 72 x 29.5-30	92.5	315	30.25	\$1834	\$1988	\$1403	\$355

Two storage cabinets side-by-side. Hinged doors cover one adjustable shelf. Locking doors keyed alike.

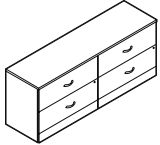

Storage Cabinet Credenza**

Z2472LF2	24 x 72 x 29.5-30	100	345	35.75	\$2407	\$2745	N/A	\$355
Z2072LF2	20 x 72 x 29.5-30	92.5	315	30.25	\$2358	\$2743	N/A	\$355

Two 2-drawer lateral files side-by-side. Locking drawers, keyed alike. File bars included for side-to-side and front-to-back letter and legal filing capability. Anti-lock tilt suspension

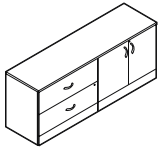

Glazed door option

Lateral File/Storage Cabinet Credenza**

Z2472LS	24 x 72 x 29.5-30	100	321	35.75	\$2153	\$2479	\$703	\$355
Z2072LS	20 x 72 x 29.5-30	100	286	30.25	\$2104	\$2478	\$703	\$355

One 2-drawer lateral file and one storage cabinet. Locking door/drawers, keyed alike. Storage cabinet includes one adjustable shelf. File bars included for side-to-side and front-to-back letter and legal filing capability. Anti-lock tilt suspension.

- File drawer construction is for accommodating hanging files NOT for stacking materials on the drawer bottom.

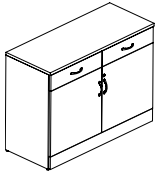

Glazed door option

Buffet Credenza**

Z482036BD	20 x 48 x 36	125	163	22.50	\$2045	\$2164	\$882	\$384
-----------	--------------	-----	-----	-------	---------------	---------------	--------------	--------------

Buffet credenza with one locking storage compartment with two doors. Hinged doors cover one three-position height adjustable shelf. Two 6" drawers above storage compartment are non-locking.

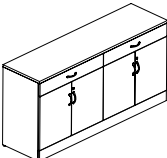
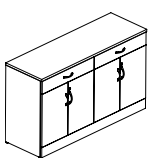

Glazed door option

Buffet Credenza*

Z722036BD	20 x 72 x 36	125	242	33.50	\$2965	\$3110	\$1761	\$618
Z602036BD	20 x 60 x 36	125	188	28	\$2571	\$2703	\$1617	\$501

Buffet credenza with two locking storage compartments side by side. Hinged doors cover 1 three-position height adjustable shelf. Two 6" drawers above storage compartment are non-locking.

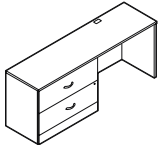

Kneespace Lateral File Credenza - LEFT

Z2472LKL	24 x 72 x 29.5-30	125	262	35.75	\$1893	\$2183	N/A	\$355
Z2072LKL	20 x 72 x 29.5-30	125	235	30.25	\$1845	\$2184	N/A	\$355

One 2-drawer lateral file on the left. Locking drawers. File bars included for side-to-side and front-to-back letter/legal filing capability. Anti-lock tilt suspension. Grommet in worksurface.

- File drawer construction is for accommodating hanging files NOT for stacking materials on the drawer bottom.

Required Specifications

Top finish
Top/edge detail
Base finish
Lock finish*

Optional Specifications

HP laminate Handles*
Key #* Glazed door**
Modesty type (only Z2xxxxCK)
Grommet position or power block cut-out

Accessories

Keyboard**
Power block (not Z2072C)
Pencil drawer (Z2472S2L/R only)

CREDENZAS

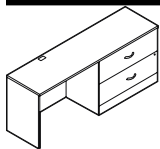

Kneespace Lateral File Credenza - RIGHT

MODEL#	DIMENSIONS D x W x H	FREIGHT CLASS	WT/LBS.	CUBIC FT.	1" TOP	1.5" TOP	GLAZE ADD	HP ADD
Z2472LKR	24 x 72 x 29.5-30	125	262	35.75	\$1893	\$2183	N/A	\$355
Z2072LKR	20 x 72 x 29.5-30	125	235	30.25	\$1845	\$2184	N/A	\$355

One 2-drawer lateral file on the **right**. Locking drawers. File bars included for side-to-side and front-to-back letter/legal filing capability. Anti-lock tilt suspension. Grommet in worksurface.

- File drawer construction is for accommodating hanging files *NOT* for stacking materials on the drawer bottom.

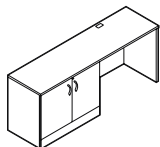

Kneespace Storage Cabinet Credenza- LEFT**



Glazed door option

Z2472SKL	24 x 72 x 29.5-30	125	241	35.75	\$1492	\$1794	\$703	\$355
Z2072SKL	20 x 72 x 29.5-30	125	207	30.25	\$1443	\$1792	\$703	\$355

One storage cabinet on the **left**. Locking doors. Storage cabinet has one adjustable shelf. Grommet in worksurface.

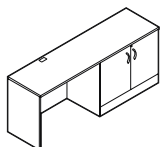

Kneespace Storage Cabinet Credenza- RIGHT**



Glazed door option

Z2472SKR	24 x 72 x 29.5-30	125	241	35.75	\$1492	\$1794	\$703	\$355
Z2072SKR	20 x 72 x 29.5-30	125	207	30.25	\$1443	\$1792	\$703	\$355

One storage cabinet on the **right**. Locking doors. Storage cabinet has one adjustable shelf. Grommet in worksurface.

Required Specifications

Top finish Base finish
 Top/edge detail
 Handles*
 Lock finish*

Optional Specifications

HP laminate Handles
 Key # Glazed door*
 Grommet position or power block cut-out

Accessories

Power block

5-SIDED CORNERS

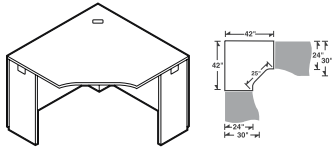

5-Sided Corner, 24" Throat

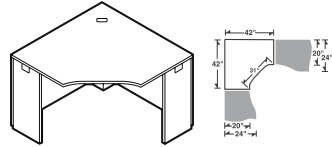

5-Sided Corner, 20" Throat

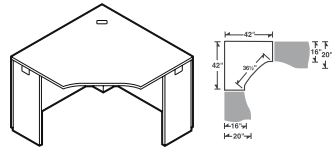

5-Sided Corner, 16" Throat

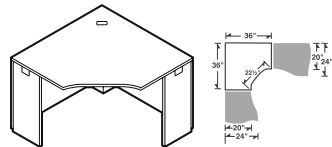

5-Sided Corner, 20" Throat

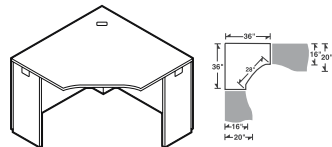

5-Sided Corner, 16" Throat

MODEL#	DIMENSIONS D x W x H	FREIGHT CLASS	WT/LBS.	CUBIC FT.	1" TOP	1.5" TOP	GLAZE ADD	HP ADD
Z42245C	42 x 42 x 29.5-30	65	133	5.75	\$905	\$1098	N/A	\$475
Connects to 30" D space saver connectable surfaces, 24" D connectables, returns and bridge. Grommet in worksurface. Narrow end panels on left and right. Shipped RTA (ready to assemble). <i>Not freestanding.</i>								
<ul style="list-style-type: none"> • Modesty Panel is 1" off of ground. • Full End Panel(s) are available - add 15% upcharge 								
Z42205C	42 x 42 x 29.5-30	70	129	5.75	\$905	\$1098	N/A	\$475
Connects to 24" D space saver connectable surfaces, 20" D returns, lateral files, storage/lateral file credenzas, credenzas, and bridges. Grommet in worksurface. Narrow end panels on left and right. Shipped RTA (ready to assemble). <i>Not freestanding.</i>								
<ul style="list-style-type: none"> • Modesty Panel is 1" off of ground. • Full End Panel(s) are available - add 15% upcharge 								
Z42165C	42 x 42 x 29.5-30	70	124	5.75	\$932	\$1072	N/A	\$472
Connects to 20" D space saver connectable surfaces, 16" D returns, lateral files, storage/lateral file credenzas, credenzas, and bridges. Grommet in worksurface. Narrow end panels on left and right. Shipped RTA (ready to assemble). <i>Not freestanding.</i>								
<ul style="list-style-type: none"> • Modesty Panel is 1" off of ground. • Full End Panel(s) are available - add 15% upcharge 								
Z36205C	36 x 36 x 29.5-30	65	109	4.80	\$765	\$876	N/A	\$307
Connects to 24" D space saver connectable surfaces, 20" D returns, lateral files, storage/lateral file credenzas, credenzas, and bridges. Grommet in worksurface. Narrow end panels on left and right. Shipped RTA (ready to assemble). <i>Not freestanding.</i>								
<ul style="list-style-type: none"> • Modesty Panel is 1" off of ground. • Full End Panel(s) are available - add 15% upcharge 								
Z36165C	36 x 36 x 29.5-30	70	105	4.80	\$815	\$924	N/A	\$267
Connects to 20" D space saver connectable surfaces, 16" D returns, lateral files, storage/lateral file credenzas, credenzas, and bridges. Grommet in worksurface. Narrow end panels on left and right. Shipped RTA (ready to assemble). <i>Not freestanding.</i>								
<ul style="list-style-type: none"> • Modesty Panel is 1" off of ground. • Full End Panel(s) are available - add 15% upcharge 								

Required Specifications

Top finish
Top/edge detail
Base finish

Optional Specifications

HP laminate
Grommet position or power block cut-out

Accessories

Power block
Keyboard (*Not available on Z36165C*)

LEFT EXTENDED CORNER DESKS

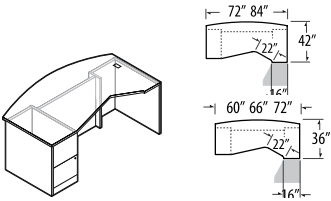

Single Pedestal Bow Top
Extended Corner Desk - LEFT*

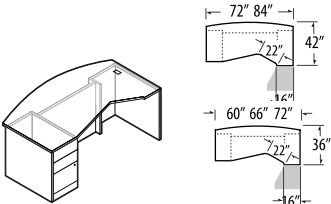

Single Pedestal Bow Top
Extended Corner Desk - LEFT*

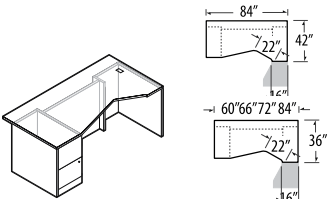

Single Pedestal Extended
Corner Desk - LEFT*

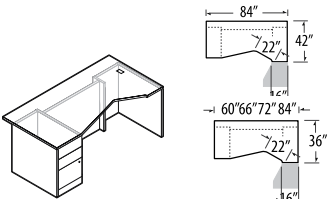

Single Pedestal Extended
Corner Desk - LEFT

MODEL#	DIMENSIONS	FREIGHT CLASS	WT/LBS.	CUBIC FT.	1" TOP	1.5" TOP	GLAZE ADD	HP ADD
D x W x H								
Z4284EB2L	42 x 84 x 29.5-30	70	316.05	20.50	\$1931	\$2199	\$848	\$939
Z4272EB2L	42 x 72 x 29.5-30	150	331	59	\$1906	\$2137	\$703	\$705
Z3672EB2L	36 x 72 x 29.5-30	150	273	50.75	\$1735	\$1937	\$703	\$530
Z3666EB2L	36 x 66 x 29.5-30	150	260.40	46.75	\$1707	\$1893	\$627	\$530
Z3660EB2L	36 x 60 x 29.5-30	125	257.25	42.50	\$1659	\$1828	\$555	\$441

Extended worksurface on right. Standard with **Freestanding** full to floor file/file pedestal on **left** and faux pedestal on **right**. Pedestal locks. Connects to returns or bridges with a 16" throat. Corner has one grommet. Bow top overhangs 2¼" at ends and 6" on center.

- 84" wide desks are shipped RTA (ready to assemble) in 2 cartons.

Z4284EB3L	42 x 84 x 29.5-30	70	315	20.50	\$1950	\$2217	\$848	\$939
Z4272EB3L	42 x 72 x 29.5-30	150	329	59	\$1928	\$2159	\$703	\$705
Z3672EB3L	36 x 72 x 29.5-30	150	270.90	50.75	\$1768	\$1970	\$703	\$530
Z3666EB3L	36 x 66 x 29.5-30	150	259.35	46.75	\$1718	\$1904	\$627	\$530
Z3660EB3L	36 x 60 x 29.5-30	125	255.15	42.50	\$1689	\$1858	\$555	\$441

Extended worksurface on right. Standard with **Freestanding** full to floor box/box/file pedestal on **left** and faux pedestal on **right**. File drawer and lower box drawer lock. Connects to returns or bridges with a 16" throat. Corner has one grommet. Bow top overhangs 2¼" at ends and 6" on center.

- 84" wide desks are shipped RTA (ready to assemble) in 2 cartons.

Z4284E2L	42 x 84 x 29.5-30	70	321.30	20.50	\$2010	\$2265	\$848	\$939
Z3684E2L	36 x 84 x 29.5-30	250	311.85	118	\$1927	\$2182	\$848	\$705
Z3672E2L	36 x 72 x 29.5-30	150	278.25	50.75	\$1728	\$1919	\$703	\$530
Z3666E2L	36 x 66 x 29.5-30	150	265.65	46.75	\$1682	\$1857	\$627	\$530
Z3660E2L	36 x 60 x 29.5-30	125	259.35	42.50	\$1653	\$1812	\$555	\$441

Extended worksurface on right. Standard with **Freestanding** full to floor file/file pedestal on **left** and faux pedestal on **right**. Pedestal locks. Connects to returns or bridges with a 16" throat. Corner has one grommet. Top overhangs 2¼"

- 84" wide desks are shipped RTA (ready to assemble) in 2 cartons.

Z4284E3L	42 x 84 x 29.5-30	70	318.15	20.50	\$1942	\$2197	\$848	\$939
Z3684E3L	36 x 84 x 29.5-30	250	309.75	118	\$1958	\$2212	\$848	\$705
Z3672E3L	36 x 72 x 29.5-30	150	275.10	50.75	\$1763	\$1954	\$703	\$530
Z3666E3L	36 x 66 x 29.5-30	150	263.55	46.75	\$1715	\$1890	\$627	\$530
Z3660E3L	36 x 60 x 29.5-30	125	257.25	42.50	\$1686	\$1843	\$555	\$441

Extended worksurface on right. Standard with **Freestanding** full to floor box/box/file pedestal on **left** and faux pedestal on **right**. File drawer and lower box drawer lock. Connects to returns or bridges with a 16" throat. Corner has one grommet. Top overhangs 2¼"

- 84" wide desks are shipped RTA (ready to assemble) in 2 cartons.

Required Specifications

Top finish
Top/edge detail
Lock finish
Base finish

Optional Specifications

HP laminate
Key #
Grommet position or power block cut-out
Handles
Modesty panel type

Accessories

Power block
Keyboard
Pencil drawer

RIGHT EXTENDED CORNER DESKS

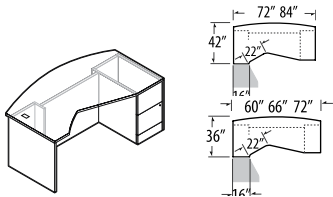

**Single Pedestal Bow Top
Extended Corner Desk - RIGHT**

MODEL#	DIMENSIONS	FREIGHT CLASS	WT/LBS.	CUBIC FT.	1" TOP	1.5" TOP	GLAZE ADD	HP ADD
D x W x H								
Z4284EB2R	42 x 84 x 29.5-30	70	316.05	20.50	\$1931	\$2199	\$848	\$939
Z4272EB2R	42 x 72 x 29.5-30	150	331	59	\$1906	\$2137	\$703	\$705
Z3672EB2R	36 x 72 x 29.5-30	150	273	50.75	\$1735	\$1937	\$703	\$530
Z3666EB2R	36 x 66 x 29.5-30	150	260.40	46.75	\$1707	\$1893	\$627	\$530
Z3660EB2R	36 x 60 x 29.5-30	125	257.25	42.50	\$1659	\$1828	\$555	\$441

Extended worksurface on right. Standard with faux pedestal on **left** and **Freestanding** full to floor file/file pedestal on **right**. Pedestal locks. Connects to returns or bridges with a 16" throat. Corner has one grommet. Bow top overhangs 2¼" at ends and 6" on center.

- 84" wide desks are shipped RTA (ready to assemble) in 2 cartons.

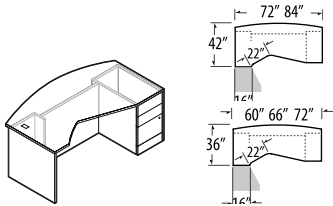

**Single Pedestal Bow Top
Extended Corner Desk - RIGHT**

Z4284EB3R	42 x 84 x 29.5-30	70	315	20.50	\$1950	\$2217	\$848	\$939
Z4272EB3R	42 x 72 x 29.5-30	150	329	59	\$1928	\$2159	\$703	\$705
Z3672EB3R	36 x 72 x 29.5-30	150	270.90	50.75	\$1768	\$1970	\$703	\$530
Z3666EB3R	36 x 66 x 29.5-30	150	259.35	46.75	\$1718	\$1904	\$627	\$530
Z3660EB3R	36 x 60 x 29.5-30	125	255.15	42.50	\$1689	\$1858	\$555	\$441

Extended worksurface on right. Standard with faux pedestal on **left** and **Freestanding** full to floor box/box/file pedestal on **right**. File drawer and lower box drawer lock. Connects to returns or bridges with a 16" throat. Corner has one grommet. Bow top overhangs 2¼" at ends and 6" on center.

- 84" wide desks are shipped RTA (ready to assemble) in 2 cartons.

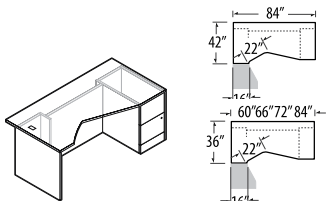

**Single Pedestal Extended
Corner Desk - RIGHT**

Z4284E2R	42 x 84 x 29.5-30	70	321.30	20.50	\$2010	\$2265	\$848	\$939
Z3684E2R	36 x 84 x 29.5-30	250	311.85	118	\$1927	\$2182	\$848	\$705
Z3672E2R	36 x 72 x 29.5-30	150	278.25	50.75	\$1728	\$1919	\$703	\$530
Z3666E2R	36 x 66 x 29.5-30	150	265.65	46.75	\$1682	\$1857	\$627	\$530
Z3660E2R	36 x 60 x 29.5-30	125	259.35	42.50	\$1653	\$1812	\$555	\$441

Extended worksurface on right. Standard with **Freestanding** full to floor file/file pedestal on **right** and faux pedestal on **left**. Pedestal locks. Connects to returns or bridges with a 16" throat. Corner has one grommet. Top overhangs 2¼"

- 84" wide desks are shipped RTA (ready to assemble) in 2 cartons.

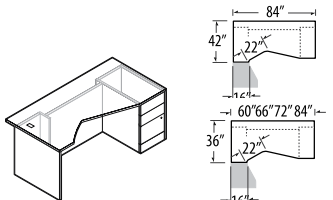

**Single Pedestal Extended
Corner Desk - RIGHT**

Z4284E3R	42 x 84 x 29.5-30	70	318.15	20.50	\$1942	\$2197	\$848	\$939
Z3684E3R	36 x 84 x 29.5-30	250	309.75	118	\$1958	\$2212	\$848	\$705
Z3672E3R	36 x 72 x 29.5-30	150	275.10	50.75	\$1763	\$1954	\$703	\$530
Z3666E3R	36 x 66 x 29.5-30	150	263.55	46.75	\$1715	\$1890	\$627	\$530
Z3660E3R	36 x 60 x 29.5-30	125	257.25	42.50	\$1686	\$1843	\$555	\$441

Extended worksurface on right. Standard with **Freestanding** full to floor box/box/file pedestal on **right** and faux pedestal on **left**. File drawer and lower box drawer lock. Connects to returns or bridges with a 16" throat. Corner has one grommet. Top overhangs 2¼"

- 84" wide desks are shipped RTA (ready to assemble) in 2 cartons.

Required Specifications

Top finish
Top/edge detail
Lock finish
Base finish

Optional Specifications

HP laminate Handles
Key # Modesty panel type
Grommet position or power block cut-out

Accessories

Power block
Keyboard
Pencil drawer

LEFT EXTENDED CORNERS (DOES NOT CONNECT)

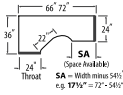
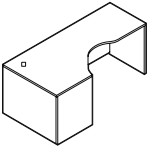

Left Extended Corner, 24" Throat Freestanding

MODEL#	DIMENSIONS D x W x H	FREIGHT CLASS	WT./LBS.	CUBIC FT.	1" TOP	1.5" TOP	GLAZE ADD	HP ADD
Z2472FFL	36 x 72 x 29.5-30	65	184	7	\$1154	\$1306	N/A	\$507
Z2466FFL	36 x 66 x 29.5-30	65	175	7	\$1154	\$1301	N/A	\$507

Extended worksurface on right. **Full end panels on left and right. Cannot be connected on left or right, due to full end panel.** Corner has one grommet. Shipped RTA (ready to assemble).

- Modesty Panel is 1" off of ground.
- Z2466FFL cannot accept pedestals

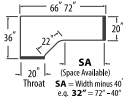
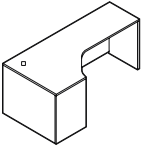

Left Extended Corner, 20" Throat

Z2072FFL	36 x 72 x 29.5-30	65	171	7	\$1122	\$1301	N/A	\$487
Z2066FFL	36 x 66 x 29.5-30	65	164	7	\$1122	\$1268	N/A	\$487

Extended worksurface on right. **Full end panels on left and right. Can be placed next to** lateral files, storage cabinets, wardrobe units, credenzas and end-shelves. Corner has one grommet. Shipped RTA (ready to assemble).

- Modesty Panel is 1" off of ground.

LEFT EXTENDED CORNERS (CONNECTS ON EXTENDED SIDE)

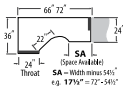
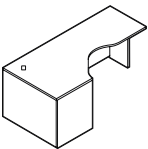

Left Extended Corner, 24" Throat

MODEL#	DIMENSIONS	FREIGHT CLASS	WT./LBS.	CUBIC FT.	1" TOP	1.5" TOP	GLAZE ADD	HP ADD
Z2472FNL	36 x 72 x 29.5-30	65	175	7	\$1122	\$1274	N/A	\$507
Z2466FNL	36 x 66 x 29.5-30	65	167	7	\$1122	\$1268	N/A	\$507

Extended worksurface on right. **Narrow end panel on right. Full end panel on left.** Connects to 30"D space saver connectables, 24"D returns, 24"D connectable tables or "D" and "P" islands with "T" or "H" bases. **Full end panel can be placed next to** lateral files, storage cabinets, wardrobe units, credenzas and end-shelves. Corner has one grommet. Shipped RTA (ready to assemble).

- Modesty Panel is 1" off of ground.
- Z2466FNL cannot accept pedestals.

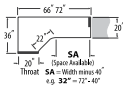
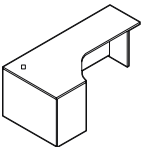

Left Extended Corner, 20" Throat

Z2072FNL	36 x 72 x 29.5-30	65	165	7	\$1088	\$1267	N/A	\$487
Z2066FNL	36 x 66 x 29.5-30	65	158	7	\$1088	\$1234	N/A	\$487

Extended worksurface on right. **Narrow end panel on right. Full end panel on left.** Connects to 24"D space saver connectables, 20"D returns, 20"D connectable tables or "D" and "P" islands with "T" or "H" bases. **Full end panel can be placed next to** lateral files, storage cabinets, wardrobe units, credenzas and end-shelves. Corner has one grommet. Shipped RTA (ready to assemble).

- Modesty Panel is 1" off of ground.
- FNL end panels can be switched to make NFL.

Required Specifications

Top finish
Top/edge detail
Lock finish
Base finish

Optional Specifications

HP laminate Handles
Key # Modesty panel type
Grommet position or power block cut-out

Accessories

Power block
Keyboard
Pencil drawer

LEFT EXTENDED CORNERS (CONNECTS ON THROAT SIDE)

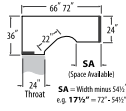
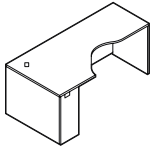

Left Extended Corner, 24" Throat

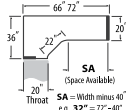
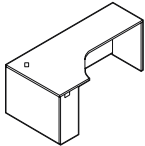

Left Extended Corner, 20" Throat

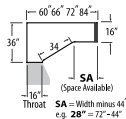
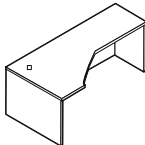
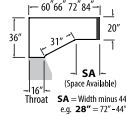
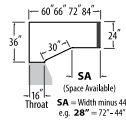

Left Extended Corner, 16" Throat

MODEL#	DIMENSIONS	FREIGHT CLASS	WT/LBS.	CUBIC FT.	1" TOP	1.5" TOP	GLAZE ADD	HP ADD
Z2472NFL	36 x 72 x 29.5-30	65	175	7	\$1122	\$1274	N/A	\$507
Z2466NFL	36 x 66 x 29.5-30	65	167	7	\$1122	\$1268	N/A	\$507

Extended worksurface on right. **Narrow end panel on left. Full end panel on right.** Connects to 30"D space saver connectables, 30"D space saver returns, 24"D returns or 24"D connectable tables. **Full end panel can be placed next to** lateral files, storage cabinets, wardrobe units, credenzas and end-shelves. Corner has one grommet. Shipped RTA (ready to assemble).

- **Modesty Panel is 1" off of ground.**
- **Z2466NFL cannot accept pedestals.**

Z2072NFL	36 x 72 x 29.5-30	65	165	7	\$1088	\$1267	N/A	\$507
Z2066NFL	36 x 66 x 29.5-30	65	158	7	\$1088	\$1234	N/A	\$487

Extended worksurface on right. **Narrow end panel on left. Full end panel on right.** Connects to 24"D space saver connectables and 20"D returns. **Full end panel can be placed next to** lateral files, storage cabinets, wardrobe units, credenzas and end-shelves. Corner has one grommet. Shipped RTA (ready to assemble).

- **Modesty Panel is 1" off of ground.**
- *NFL end panels can be switched to make FNL.*

Z2484ECFL	36 x 84 x 29.5-30	65	196.35	8	\$1125	\$1390	N/A	\$705
Z2472ECFL	36 x 72 x 29.5-30	65	176.40	7.50	\$1006	\$1239	N/A	\$530
Z2466ECFL	36 x 66 x 29.5-30	70	168	7.50	\$957	\$1173	N/A	\$530
Z2460ECFL	36 x 60 x 29.5-30	65	158.55	6	\$910	\$1109	N/A	\$441

Z2084ECFL	36 x 84 x 29.5-30	65	184.80	8	\$1122	\$1389	N/A	\$705
Z2072ECFL	36 x 72 x 29.5-30	70	168	7.50	\$1001	\$1235	N/A	\$530
Z2066ECFL	36 x 66 x 29.5-30	70	159.60	7.50	\$953	\$1170	N/A	\$530
Z2060ECFL	36 x 60 x 29.5-30	65	151.20	6	\$893	\$1087	N/A	\$441

Z1684ECFL	36 x 84 x 29.5-30	70	175.35	8	\$1117	\$1384	N/A	\$705
Z1672ECFL	36 x 72 x 29.5-30	70	159.60	7.50	\$998	\$1232	N/A	\$530
Z1666ECFL	36 x 66 x 29.5-30	70	153.30	7.50	\$950	\$1167	N/A	\$530
Z1660ECFL	36 x 60 x 29.5-30	65	147	6	\$886	\$1079	N/A	\$441

Extended worksurface on right. **No narrow end panel on left. Full end panel on right.** Connects to returns and bridges with 16" throat on the left. **Full end panel can be placed next to** lateral files, storage cabinets, wardrobe units, credenzas and end-shelves. Corner has one grommet. **Does not accept pencil drawers.** Shipped RTA (ready to assemble).

Required Specifications

- Top finish
- Top/edge detail
- Lock finish
- Base finish

Optional Specifications

- HP laminate
- Key #
- Grommet position or power block cut-out
- Handles
- Modesty panel type

Accessories

- Power block
- Keyboard
- Pencil drawer

LEFT EXTENDED CORNERS (CONNECTS ON BOTH SIDES)

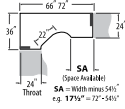
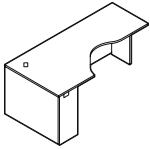

Left Extended Corner, 24" Throat

MODEL#	DIMENSIONS D x W x H	FREIGHT CLASS	WT/LBS.	CUBIC FT.	1" TOP	1.5" TOP	GLAZE ADD	HP ADD
Z2472NNL	36 x 72 x 29.5-30	65	166	7	\$1088	\$1240	N/A	\$507
Z2466NNL	36 x 66 x 29.5-30	65	158	7	\$1088	\$1234	N/A	\$507

Extended worksurface on right. **Narrow end panels on left and right.** Connects to 30"D space saver connectables, 30"D space saver returns, 24"D returns or 24"D connectable tables or "D" and "P" islands with "T" or "H" bases on either end. **Full end panel can be placed next to** lateral files, storage cabinets, wardrobe units, credenzas and end-shelves. Corner has one grommet. Shipped RTA (ready to assemble).

- **Modesty Panel is 1" off of ground.**
- **Z2466NNL cannot accept pedestals.**

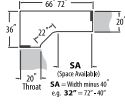
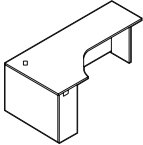

Left Extended Corner, 20" Throat

Z2072NNL	36 x 72 x 29.5-30	65	160	7	\$1055	\$1234	N/A	\$507
Z2066NNL	36 x 66 x 29.5-30	70	152	7	\$1055	\$1202	N/A	\$487

Extended worksurface on right. **Narrow end panels on left and right.** Connects to 24"D space saver connectables and 20"D returns, bridges or "D" and "P" islands with "T" or "H" bases one either end. **Full end panel can be placed next to** lateral files, storage cabinets, wardrobe units, credenzas and end-shelves. Corner has one grommet. Shipped RTA (ready to assemble).

- **Modesty Panel is 1" off of ground.**

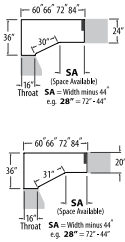
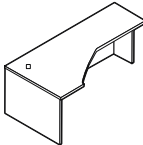

Left Extended Corner, 16" Throat

Z2484ECNL	36 x 84 x 29.5-30	65	186.90	8	\$1092	\$1359	N/A	\$705
Z2472ECNL	36 x 72 x 29.5-30	70	168	7.50	\$973	\$1209	N/A	\$530
Z2466ECNL	36 x 66 x 29.5-30	70	158.55	7.50	\$925	\$1141	N/A	\$530
Z2460ECNL	36 x 60 x 29.5-30	65	150.15	6	\$865	\$1058	N/A	\$441
Z2084ECNL	36 x 84 x 29.5-30	70	178.50	8	\$1088	\$1355	N/A	\$705
Z2072ECNL	36 x 72 x 29.5-30	70	161.70	7.50	\$970	\$1203	N/A	\$530
Z2066ECNL	36 x 66 x 29.5-30	70	153.30	7.50	\$922	\$1138	N/A	\$530
Z2060ECNL	36 x 60 x 29.5-30	65	145.95	6	\$861	\$1055	N/A	\$441

Extended worksurface on right. **No narrow end panel on left. Narrow end panel on right.** Connects to returns and bridges with 16" throat on the left. **Full end panel can be placed next to** lateral files, storage cabinets, wardrobe units, credenzas and end-shelves. Corner has one grommet. **Does not accept pencil drawers.** Shipped RTA (ready to assemble).

RIGHT EXTENDED CORNERS (DOES NOT CONNECT)

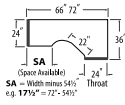
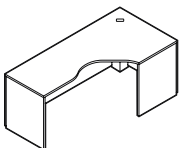

Right Extended Corner, 24" Throat Freestanding

MODEL#	DIMENSIONS	FREIGHT CLASS	WT/LBS.	CUBIC FT.	1" TOP	1.5" TOP	GLAZE ADD	HP ADD
Z2472FFR	36 x 72 x 29.5-30	65	184	7	\$1154	\$1306	N/A	\$507
Z2466FFR	36 x 66 x 29.5-30	65	175	7	\$1154	\$1301	N/A	\$507

Extended worksurface on left. **Full end panels on left and right. Cannot be connected on left or right, due to full end panel.** Corner has one grommet. Shipped RTA (ready to assemble).

- **Modesty Panel is 1" off of ground.**
- **Z2466FFR cannot accept pedestals**

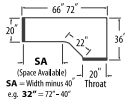
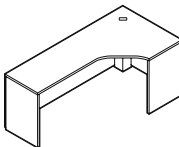

Right Extended Corner, 20" Throat

Z2072FFR	36 x 72 x 29.5-30	65	171	7	\$1122	\$1301	N/A	\$487
Z2066FFR	36 x 66 x 29.5-30	65	164	7	\$1122	\$1268	N/A	\$487

Extended worksurface on left. **Full end panels on left and right. Can be placed next to** lateral files, storage cabinets, wardrobe units, credenzas and end-shelves. Corner has one grommet. Shipped RTA (ready to assemble).

- **Modesty Panel is 1" off of ground.**

Required Specifications

- Top finish
- Top/edge detail
- Base finish

Optional Specifications

- HP laminate
- Modesty panel type
- Grommet position or power block cut-out

Accessories

- Power block
- Keyboard (*Not available on 16" throat*)
- Pencil drawer (*Not available on 16" throat*)

RIGHT EXTENDED CORNERS (CONNECTS ON THROAT SIDE)

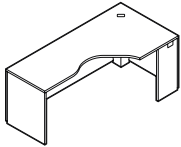

Right Extended Corner, 24" Throat

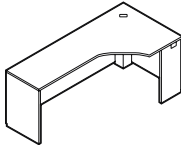

Right Extended Corner, 20" Throat

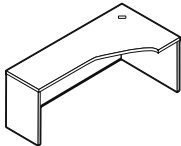
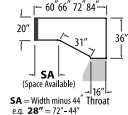
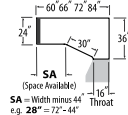
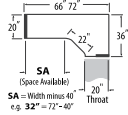
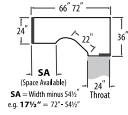

Right Extended Corner, 16" Throat

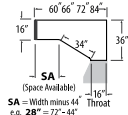

MODEL#	DIMENSIONS	FREIGHT CLASS	WT/LBS.	CUBIC FT.	1" TOP	1.5" TOP	GLAZE ADD	HP ADD
Z2472FNR	36 x 72 x 29.5-30	65	175	7	\$1122	\$1274	N/A	\$507
Z2466FNR	36 x 66 x 29.5-30	65	167	7	\$1122	\$1268	N/A	\$507

Extended worksurface on left. **Narrow end panel on right. Full end panel on left.** Connects to 30"D space saver connectables, 24"D returns, 24"D connectable tables or "D" and "P" islands with "T" or "H" bases. **Full end panel can be placed next to** lateral files, storage cabinets, wardrobe units, credenzas and end-shelves. Corner has one grommet. Shipped RTA (ready to assemble).

- Modesty Panel is 1" off of ground.
- Z2466FNR cannot accept pedestals.

Z2072FNR	36 x 72 x 29.5-30	65	165	7	\$1088	\$1267	N/A	\$487
Z2066FNR	36 x 66 x 29.5-30	65	158	7	\$1088	\$1234	N/A	\$487

Extended worksurface on left. **Narrow end panel on right. Full end panel on left.** Connects to 24"D space saver connectables, 20"D returns, 20"D connectable tables or "D" and "P" islands with "T" or "H" bases. **Full end panel can be placed next to** lateral files, storage cabinets, wardrobe units, credenzas and end-shelves. Corner has one grommet. Shipped RTA (ready to assemble).

- Modesty Panel is 1" off of ground.
- FNR end panels can be switched to make NFR.

Z2484ECFR	36 x 84 x 29.5-30	65	196.35	8	\$1125	\$1390	N/A	\$705
Z2472ECFR	36 x 72 x 29.5-30	65	176.40	7.50	\$1006	\$1239	N/A	\$530
Z2466ECFR	36 x 66 x 29.5-30	70	168	7.50	\$957	\$1173	N/A	\$530
Z2460ECFR	36 x 60 x 29.5-30	65	158.55	6	\$910	\$1109	N/A	\$441

Z2084ECFR	36 x 84 x 29.5-30	65	184.80	8	\$1122	\$1389	N/A	\$705
Z2072ECFR	36 x 72 x 29.5-30	70	168	7.50	\$1001	\$1235	N/A	\$530
Z2066ECFR	36 x 66 x 29.5-30	70	159.60	7.50	\$953	\$1170	N/A	\$530
Z2060ECFR	36 x 60 x 29.5-30	65	151.20	6	\$893	\$1087	N/A	\$441

Z1684ECFR	36 x 84 x 29.5-30	70	175.35	8	\$1117	\$1384	N/A	\$705
Z1672ECFR	36 x 72 x 29.5-30	70	159.60	7.50	\$998	\$1232	N/A	\$530
Z1666ECFR	36 x 66 x 29.5-30	70	153.30	7.50	\$950	\$1167	N/A	\$530
Z1660ECFR	36 x 60 x 29.5-30	65	147	6	\$886	\$1079	N/A	\$441

Extended worksurface on left. **No narrow end panel on right. Full end panel on left.** Connects to returns and bridges with 16" throat on the right. **Full end panel can be placed next to** lateral files, storage cabinets, wardrobe units, credenzas and end-shelves. Corner has one grommet. **Does not accept pencil drawers.** Shipped RTA (ready to assemble).

Required Specifications

Top finish
Top/edge detail
Base finish

Optional Specifications

HP laminate
Modesty panel type
Grommet position or power block cut-out

Accessories

Power block
Keyboard (Not available on 16" throat)
Pencil drawer (Not available on 16" throat)

RIGHT EXTENDED CORNERS (CONNECTS ON EXTENDED SIDE)

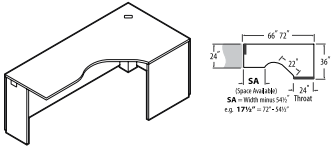

Right Extended Corner, 24" Throat

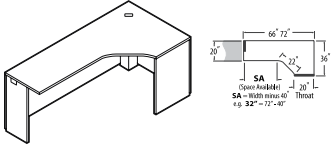

Right Extended Corner, 20" Throat

MODEL#	DIMENSIONS	FREIGHT CLASS	WT/LBS.	CUBIC FT.	1" TOP	1.5" TOP	GLAZE ADD	HP ADD
D x W x H								
Z2472NFR	36 x 72 x 29.5-30	65	175	7	\$1122	\$1274	N/A	\$507
Z2466NFR	36 x 66 x 29.5-30	65	167	7	\$1122	\$1268	N/A	\$507

Extended worksurface on left. **Narrow end panel on left. Full end panel on right.** Connects to 30"D space saver connectables, 24"D returns, 24"D connectable tables, or "D" and "P" islands with "T" or "H" bases. **Full end panel can be placed next to** lateral files, storage cabinets, wardrobe units, credenzas and end-shelves. Corner has one grommet. Shipped RTA (ready to assemble).

- **Modesty Panel is 1" off of ground.**
- **Z2466NFR cannot accept pedestals.**

Z2072NFR	36 x 72 x 29.5-30	65	165	7	\$1088	\$1267	N/A	\$507
Z2066NFR	36 x 66 x 29.5-30	65	158	7	\$1088	\$1234	N/A	\$487

Extended worksurface on left. **Narrow end panel on left. Full end panel on right.** Connects to 24"D space saver connectables, 20"D returns or "D" and "P" islands with "T" or "H" bases. **Full end panel can be placed next to** lateral files, storage cabinets, wardrobe units, credenzas and end-shelves. Corner has one grommet. Shipped RTA (ready to assemble).

- **Modesty Panel is 1" off of ground.**
- *NFR end panels can be switched to make FNR.*

RIGHT EXTENDED CORNERS (CONNECTS ON BOTH SIDES)

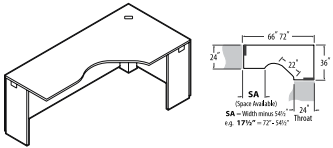

Left Extended Corner, 24" Throat

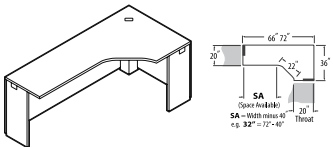

Right Extended Corner, 20" Throat

MODEL#	DIMENSIONS	FREIGHT CLASS	WT/LBS.	CUBIC FT.	1" TOP	1.5" TOP	GLAZE ADD	HP ADD
Z2472NNR	36 x 72 x 29.5-30	65	166	7	\$1088	\$1240	N/A	\$507
Z2466NNR	36 x 66 x 29.5-30	65	158	7	\$1088	\$1234	N/A	\$507

Extended worksurface on left. **Narrow end panels on left and right.** Connects to 30"D space saver connectables, 30"D space saver returns, 24"D returns, 24"D connectable tables or "D" and "P" islands with "T" or "H" bases on either end. Corner has one grommet. Shipped RTA (ready to assemble).

- **Modesty Panel is 1" off of ground.**
- **Z2466NNR cannot accept pedestals.**

Z2072NNR	36 x 72 x 29.5-30	65	160	7	\$1055	\$1234	N/A	\$507
Z2066NNR	36 x 66 x 29.5-30	70	152	7	\$1055	\$1188	N/A	\$487

Extended worksurface on left. **Narrow end panels on left and right.** Connects to 24"D space saver connectables and 20"D returns, bridges or "D" and "P" islands with "T" or "H" bases one either end. **Full end panel can be placed next to** lateral files, storage cabinets, wardrobe units, credenzas and end-shelves. Corner has one grommet. Shipped RTA (ready to assemble).

- **Modesty Panel is 1" off of ground.**

Required Specifications

Top finish
Top/edge detail
Base finish

Optional Specifications

HP laminate
Modesty panel type
Grommet position or power block cut-out

Accessories

Power block
Keyboard
Pencil drawer

RIGHT EXTENDED CORNERS (CONNECTS ON BOTH SIDES)

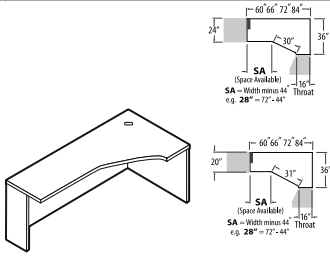

Right Extended Corner, 16" Throat

MODEL#	DIMENSIONS	FREIGHT CLASS	WT/LBS.	CUBIC FT.	1" TOP	1.5" TOP	GLAZE ADD	HP ADD
D x W x H								
Z2484ECNR	36 x 84 x 29.5-30	65	186.90	8	\$1092	\$1359	N/A	\$705
Z2472ECNR	36 x 72 x 29.5-30	70	168	7.50	\$973	\$1209	N/A	\$530
Z2466ECNR	36 x 66 x 29.5-30	70	158.55	7.50	\$925	\$1141	N/A	\$530
Z2460ECNR	36 x 60 x 29.5-30	65	150.15	6	\$865	\$1058	N/A	\$441
Z2084ECNR	36 x 84 x 29.5-30	70	178.50	8	\$1088	\$1355	N/A	\$705
Z2072ECNR	36 x 72 x 29.5-30	70	161.70	7.50	\$970	\$1203	N/A	\$530
Z2066ECNR	36 x 66 x 29.5-30	70	153.30	7.50	\$922	\$1138	N/A	\$530
Z2060ECNR	36 x 60 x 29.5-30	65	145.95	6	\$861	\$1055	N/A	\$441

Extended worksurface on left. **No narrow end panel on right. Narrow end panel on left.** Connects to returns and bridges with 16" throat on the right. **Full end panel can be placed next to lateral files, storage cabinets, wardrobe units, credenzas and end-shelves.** Corner has one grommet. **Does not accept pencil drawers.** Shipped RTA (ready to assemble).

FREESTANDING TABLES

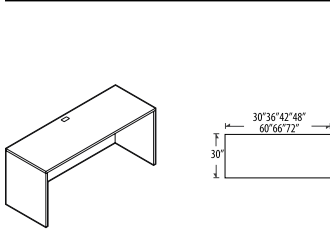

30" Deep Freestanding Table

MODEL#	DIMENSIONS	FREIGHT CLASS	WT/LBS.	CUBIC FT.	1" TOP	1.5" TOP	GLAZE ADD	HP ADD
Z3072T	29.7 x 72 x 29.5-30	65	176	6	\$954	\$1103	N/A	\$475
Z3066T	29.7 x 66 x 29.5-30	65	166	6	\$954	\$1094	N/A	\$475
Z3060T	29.7 x 60 x 29.5-30	60	159	5.25	\$871	\$1003	N/A	\$441
Z3048T	29.7 x 48 x 29.5-30	65	135	5.25	\$788	\$905	N/A	\$374
Z3042T	29.7 x 42 x 29.5-30	65	125	5.25	\$788	\$897	N/A	\$339
Z3036T	29.7 x 36 x 29.5-30	65	111	4.30	\$697	\$797	N/A	\$307
Z3030T	29.7 x 30 x 29.5-30	65	100	3.60	\$653	\$735	N/A	\$274

Two full end panels. Cannot be connected on left or right side. Grommet in worksurface. Shipped RTA (ready to assemble).

- Modesty Panel is 1" off of ground.

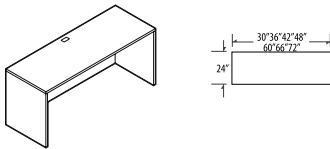

24" Deep Freestanding Table

Z2472T	24 x 72 x 29.5-30	65	152	6	\$857	\$997	N/A	\$355
Z2466T	24 x 66 x 29.5-30	65	144	6	\$857	\$997	N/A	\$355
Z2460T	24 x 60 x 29.5-30	65	133	5.25	\$780	\$888	N/A	\$326
Z2448T	24 x 48 x 29.5-30	65	114	4.30	\$704	\$798	N/A	\$260
Z2442T	24 x 42 x 29.5-30	65	105	4.30	\$704	\$786	N/A	\$218
Z2436T	24 x 36 x 29.5-30	65	95	4.20	\$629	\$698	N/A	\$164
Z2430T	24 x 30 x 29.5-30	65	85	3.60	\$597	\$649	N/A	\$164

Two full end panels. Cannot be connected on left or right side. Grommet in worksurface. Shipped RTA (ready to assemble).

- Modesty Panel is 1" off of ground.

Required Specifications

Top finish
Top/edge detail
Base finish

Optional Specifications

HP laminate
Modesty panel type
Grommet position or power block cut-out

Accessories

Power block
Keyboard (Not available on 16" throat)
Pencil drawer (Not available on 16" throat)

CONNECTABLE TABLES - LEFT

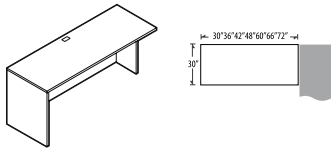

30" Deep Connectable Table - Left

MODEL#	DIMENSIONS D x W x H	FREIGHT CLASS	WT/LBS.	CUBIC FT.	1" TOP	1.5" TOP	GLAZE ADD	HP ADD
Z3072L	29.7 x 72 x 29.5-30	65	168	6	\$922	\$1071	N/A	\$475
Z3066L	29.7 x 66 x 29.5-30	65	158	6	\$922	\$1062	N/A	\$475
Z3060L	29.7 x 60 x 29.5-30	65	150	5.25	\$838	\$970	N/A	\$441
Z3048L	29.7 x 48 x 29.5-30	65	124	4.30	\$754	\$871	N/A	\$374
Z3042L	29.7 x 42 x 29.5-30	65	115	4.30	\$754	\$863	N/A	\$339
Z3036L	29.7 x 36 x 29.5-30	65	103	4.20	\$664	\$765	N/A	\$307
Z3030L	29.7 x 30 x 29.5-30	65	92	3.60	\$622	\$704	N/A	\$274

Full end panel on left. Right narrow end panel connects to **30"D** center/right connectable table, or at 90° angle to a freestanding table; and "D" islands or "P" islands with "T" and "H" bases. Grommet in worksurface. Shipped RTA (ready to assemble).

- Modesty Panel is 1" off of ground.

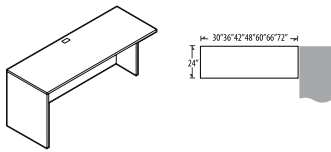

24" Deep Connectable Table - Left

Z2472L	24 x 72 x 29.5-30	65	144	6	\$814	\$958	N/A	\$355
Z2466L	24 x 66 x 29.5-30	65	135	6	\$814	\$939	N/A	\$355
Z2460L	24 x 60 x 29.5-30	65	125	5.25	\$737	\$846	N/A	\$326
Z2448L	24 x 48 x 29.5-30	65	106	4.30	\$671	\$765	N/A	\$260
Z2442L	24 x 42 x 29.5-30	65	95	3.80	\$671	\$753	N/A	\$218
Z2436L	24 x 36 x 29.5-30	65	86	3.30	\$589	\$656	N/A	\$164
Z2430L	24 x 30 x 29.5-30	70	77	3.60	\$555	\$608	N/A	\$164

Full end panel on left. Right narrow end panel connects to **24"D** center/right connectable table, or at 90° angle to a freestanding table; 24"D extended corners or at the end of a straight run; "D" islands or "P" islands with "T" and "H" bases. Grommet in worksurface. Shipped RTA (ready to assemble).

- Modesty Panel is 1" off of ground.

CONNECTABLE TABLES - RIGHT

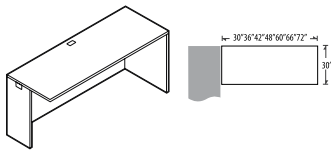

30" Deep Connectable Table - Right

MODEL#	DIMENSIONS D x W x H	FREIGHT CLASS	WT/LBS.	CUBIC FT.	1" TOP	1.5" TOP	GLAZE ADD	HP ADD
Z3072R	29.7 x 72 x 29.5-30	65	168	6	\$922	\$1071	N/A	\$475
Z3066R	29.7 x 66 x 29.5-30	65	158	6	\$922	\$1062	N/A	\$475
Z3060R	29.7 x 60 x 29.5-30	65	150	5.25	\$838	\$970	N/A	\$441
Z3048R	29.7 x 48 x 29.5-30	65	124	4.30	\$754	\$871	N/A	\$374
Z3042R	29.7 x 42 x 29.5-30	65	115	4.30	\$754	\$863	N/A	\$339
Z3036R	29.7 x 36 x 29.5-30	65	103	4.20	\$664	\$765	N/A	\$307
Z3030R	29.7 x 30 x 29.5-30	65	92	3.60	\$622	\$704	N/A	\$274

Full end panel on right. Left narrow end panel connects to **30"D** center/right connectable table, or at 90° angle to a freestanding table; and "D" islands or "P" islands with "T" and "H" bases. Grommet in worksurface. Shipped RTA (ready to assemble).

- Modesty Panel is 1" off of ground.

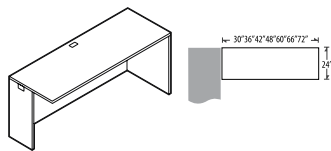

24" Deep Connectable Table - Right

Z2472R	24 x 72 x 29.5-30	65	144	6	\$814	\$958	N/A	\$355
Z2466R	24 x 66 x 29.5-30	65	135	6	\$814	\$939	N/A	\$355
Z2460R	24 x 60 x 29.5-30	65	125	5.25	\$737	\$846	N/A	\$326
Z2448R	24 x 48 x 29.5-30	65	106	4.30	\$671	\$765	N/A	\$260
Z2442R	24 x 42 x 29.5-30	65	95	3.80	\$671	\$753	N/A	\$218
Z2436R	24 x 36 x 29.5-30	65	86	3.30	\$589	\$656	N/A	\$164
Z2430R	24 x 30 x 29.5-30	70	77	3.60	\$555	\$608	N/A	\$164

Full end panel on right. Left narrow end panel connects to **24"D** center/right connectable table, or at 90° angle to a freestanding table; 24"D extended corners or at the end of a straight run; "D" islands or "P" islands with "T" and "H" bases. Grommet in worksurface. Shipped RTA (ready to assemble).

- Modesty Panel is 1" off of ground.

Required Specifications

Top finish
Top/edge detail
Base finish

Optional Specifications

HP laminate
Modesty panel type
Grommet position or power block cut-out

Accessories

Power block
Keyboard
Pencil drawer

CONNECTABLE TABLES

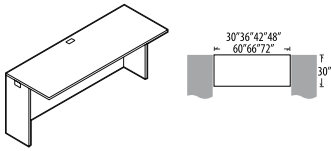

30" Deep Connectable Table

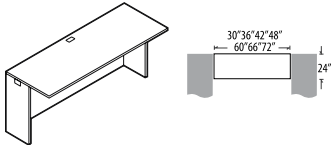

24" Deep Connectable Table

MODEL#	DIMENSIONS	FREIGHT CLASS	WT/LBS.	CUBIC FT.	1" TOP	1.5" TOP	GLAZE ADD	HP ADD
D x W x H								
Z3072N	29.7 x 72 x 29.5-30	65	159	6	\$887	\$1037	N/A	\$475
Z3066N	29.7 x 66 x 29.5-30	65	149	6	\$887	\$1031	N/A	\$475
Z3060N	29.7 x 60 x 29.5-30	65	142	5.25	\$795	\$928	N/A	\$441
Z3048N	29.7 x 48 x 29.5-30	65	116	4.30	\$697	\$813	N/A	\$374
Z3042N	29.7 x 42 x 29.5-30	65	106	3.80	\$697	\$805	N/A	\$339
Z3036N	29.7 x 36 x 29.5-30	65	94	3.30	\$622	\$723	N/A	\$307
Z3030N	29.7 x 30 x 29.5-30	65	83	3.60	\$589	\$671	N/A	\$274

Narrow end panels on both sides connect to **30"D** worksurfaces, "D" islands or "P" islands with "T" and "H" bases; or at 90° angle to freestanding table(s). Grommet in worksurface. Shipped RTA (ready to assemble).

- Modesty Panel is 1" off of ground.

Z2472N	24 x 72 x 29.5-30	65	135	6	\$773	\$913	N/A	\$355
Z2466N	24 x 66 x 29.5-30	70	127	6	\$773	\$896	N/A	\$355
Z2460N	24 x 60 x 29.5-30	65	116	4.50	\$697	\$805	N/A	\$326
Z2448N	24 x 48 x 29.5-30	65	97	4.30	\$629	\$723	N/A	\$260
Z2442N	24 x 42 x 29.5-30	65	87	3.80	\$629	\$706	N/A	\$218
Z2436N	24 x 36 x 29.5-30	65	77	3.30	\$545	\$612	N/A	\$164
Z2430N	24 x 30 x 29.5-30	70	68	3.60	\$512	\$564	N/A	\$164

Narrow end panels on both sides connect to **24"D** worksurfaces, "D" islands or "P" islands with "T" and "H" bases; or at 90° angle to freestanding table(s). Grommet in worksurface. Shipped RTA (ready to assemble).

- Modesty Panel is 1" off of ground.

SPACE SAVER CONNECTABLE TABLES - LEFT

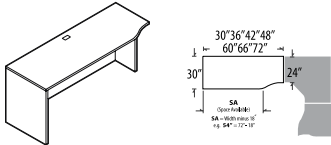

30" Deep Space Saver Connectable Table - Left

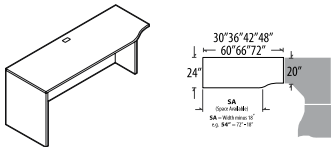

24" Deep Space Saver Connectable Table - Left

MODEL#	DIMENSIONS	FREIGHT CLASS	WT/LBS.	CUBIC FT.	1" TOP	1.5" TOP	GLAZE ADD	HP ADD
Z3072LK	29.7 x 72 x 29.5-30	65	161	6	\$939	\$1100	N/A	\$475
Z3066LK	29.7 x 66 x 29.5-30	65	151	6	\$939	\$1091	N/A	\$475
Z3060LK	29.7 x 60 x 29.5-30	65	144	5.25	\$857	\$1003	N/A	\$441
Z3048LK	29.7 x 48 x 29.5-30	65	118	4.30	\$773	\$900	N/A	\$374
Z3042LK	29.7 x 42 x 29.5-30	65	107	3.80	\$773	\$893	N/A	\$339
Z3036LK	29.7 x 36 x 29.5-30	70	96	4.30	\$681	\$792	N/A	\$307
Z3030LK	29.7 x 30 x 29.5-30	65	85	3.60	\$639	\$737	N/A	\$274

Full end panel on left. Narrow right end panel connects to any corner unit with a 24" throat. Grommet in worksurface. Shipped RTA (ready to assemble).

- Modesty Panel is 1" off of ground.

Z2472LK	24 x 72 x 29.5-30	65	140	6	\$838	\$990	N/A	\$355
Z2466LK	24 x 66 x 29.5-30	70	134	6	\$838	\$975	N/A	\$355
Z2460LK	24 x 60 x 29.5-30	65	123	5.25	\$765	\$885	N/A	\$326
Z2448LK	24 x 48 x 29.5-30	65	104	4.30	\$697	\$800	N/A	\$260
Z2442LK	24 x 42 x 29.5-30	65	94	3.80	\$697	\$794	N/A	\$218
Z2436LK	24 x 36 x 29.5-30	65	85	3.30	\$613	\$693	N/A	\$164
Z2430LK	24 x 30 x 29.5-30	70	75	3.60	\$580	\$644	N/A	\$164

Full end panel on left. Narrow right end panel connects to any corner unit with a 20" throat. Grommet in worksurface. Shipped RTA (ready to assemble).

- Modesty Panel is 1" off of ground.

Required Specifications

Top finish
Top/edge detail
Base finish

Optional Specifications

HP laminate
Modesty panel type
Grommet position or power block cut-out

Accessories

Power block
Keyboard
Pencil drawer

SPACE SAVER CONNECTABLE TABLES - RIGHT

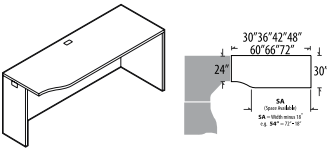

30" Deep Space Saver Connectable Table - Right

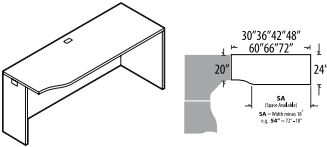

24" Deep Space Saver Connectable Table - Right

MODEL#	DIMENSIONS	FREIGHT CLASS	WT./LBS.	CUBIC FT.	1"TOP	1.5" TOP	GLAZE ADD	HP ADD
Z3072RK	29.7 x 72 x 29.5-30	65	161	6	\$939	\$1100	N/A	\$475
Z3066RK	29.7 x 66 x 29.5-30	65	151	6	\$939	\$1091	N/A	\$475
Z3060RK	29.7 x 60 x 29.5-30	65	144	5.25	\$857	\$1003	N/A	\$441
Z3048RK	29.7 x 48 x 29.5-30	65	119	4.30	\$773	\$900	N/A	\$374
Z3042RK	29.7 x 42 x 29.5-30	65	107	3.80	\$773	\$893	N/A	\$339
Z3036RK	29.7 x 36 x 29.5-30	70	96	4.30	\$681	\$792	N/A	\$307
Z3030RK	29.7 x 30 x 29.5-30	65	85	3.60	\$639	\$737	N/A	\$274

Full end panel on right. Narrow left end panel connects to any corner unit with a 24" throat. Grommet in worksurface. Shipped RTA (ready to assemble).

- Modesty Panel is 1" off of ground.

Z2472RK	24 x 72 x 29.5-30	65	142	6	\$838	\$990	N/A	\$355
Z2466RK	24 x 66 x 29.5-30	70	134	6	\$838	\$975	N/A	\$355
Z2460RK	24 x 60 x 29.5-30	65	123	5.25	\$765	\$885	N/A	\$326
Z2448RK	24 x 48 x 29.5-30	65	104	4.30	\$697	\$800	N/A	\$260
Z2442RK	24 x 42 x 29.5-30	65	94	3.80	\$697	\$794	N/A	\$218
Z2436RK	24 x 36 x 29.5-30	65	85	3.30	\$613	\$693	N/A	\$164
Z2430RK	24 x 30 x 29.5-30	70	75	3.60	\$580	\$644	N/A	\$164

Full end panel on right. Narrow left end panel connects to any corner unit with a 20" throat. Grommet in worksurface. Shipped RTA (ready to assemble).

- Modesty Panel is 1" off of ground.

SPACE SAVER CONNECTABLE TABLES

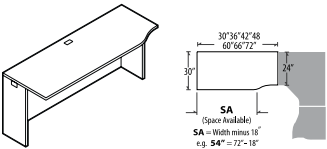

30" Deep Space Saver Connectable Table

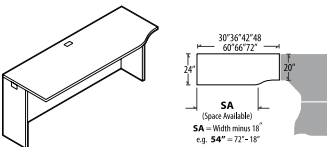

24" Deep Space Saver Connectable Table

MODEL#	DIMENSIONS	FREIGHT CLASS	WT./LBS.	CUBIC FT.	1"TOP	1.5" TOP	GLAZE ADD	HP ADD
Z3072LN	29.7 x 72 x 29.5-30	65	153	6	\$905	\$1066	N/A	\$475
Z3066LN	29.7 x 66 x 29.5-30	65	143	6	\$905	\$1057	N/A	\$475
Z3060LN	29.7 x 60 x 29.5-30	65	136	5.25	\$814	\$961	N/A	\$441
Z3048LN	29.7 x 48 x 29.5-30	65	110	4.30	\$712	\$840	N/A	\$374
Z3042LN	29.7 x 42 x 29.5-30	65	100	3.80	\$712	\$833	N/A	\$339
Z3036LN	29.7 x 36 x 29.5-30	65	88	3.30	\$639	\$751	N/A	\$307
Z3030LN	29.7 x 30 x 29.5-30	70	77	3.60	\$604	\$702	N/A	\$274

Narrow end panels on both sides. Connects the **right end only** to any corner unit with a 24" throat. Left end allows the continuation of additional 30" connectable center or left connectable worksurface. Grommet in worksurface. Shipped RTA (ready to assemble).

- Modesty Panel is 1" off of ground.

Z2472LN	24 x 72 x 29.5-30	70	134	6	\$795	\$949	N/A	\$355
Z2466LN	24 x 66 x 29.5-30	70	125	6	\$795	\$933	N/A	\$355
Z2460LN	24 x 60 x 29.5-30	70	115	5.25	\$722	\$850	N/A	\$326
Z2448LN	24 x 48 x 29.5-30	70	96	4.30	\$653	\$757	N/A	\$260
Z2442LN	24 x 42 x 29.5-30	70	85	3.80	\$653	\$751	N/A	\$218
Z2436LN	24 x 36 x 29.5-30	65	76	3.30	\$572	\$651	N/A	\$164
Z2430LN	24 x 30 x 29.5-30	70	67	3.60	\$537	\$602	N/A	\$164

Narrow end panels on both sides. Connects the **right end only** to any corner unit with a 24" throat. Left end allows the continuation of additional 24" connectable center or left connectable worksurface. Grommet in worksurface. Shipped RTA (ready to assemble).

- Modesty Panel is 1" off of ground.

Required Specifications

- Top finish
- Top/edge detail
- Base finish

Optional Specifications

- HP laminate
- Modesty panel type
- Grommet position or power block cut-out

Accessories

- Power block
- Keyboard
- Pencil drawer

SPACE SAVER CONNECTABLE TABLES

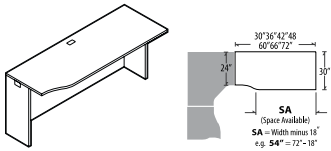

30" Deep Space Saver Connectable Table

MODEL#	DIMENSIONS	FREIGHT CLASS	WT/LBS.	CUBIC FT.	1"TOP	1.5" TOP	GLAZE ADD	HP ADD
Z3072RN	29.7 x 72 x 29.5-30	65	153	6	\$905	\$1066	N/A	\$475
Z3066RN	29.7 x 66 x 29.5-30	65	143	6	\$905	\$1057	N/A	\$475
Z3060RN	29.7 x 60 x 29.5-30	65	136	5.25	\$814	\$961	N/A	\$441
Z3048RN	29.7 x 48 x 29.5-30	65	110	4.30	\$712	\$840	N/A	\$374
Z3042RN	29.7 x 42 x 29.5-30	65	99	3.80	\$712	\$833	N/A	\$339
Z3036RN	29.7 x 36 x 29.5-30	65	88	3.30	\$639	\$751	N/A	\$307
Z3030RN	29.7 x 30 x 29.5-30	70	77	3.60	\$604	\$702	N/A	\$274

Narrow end panels on both sides. Connects the **left end only** to any corner unit with a 24" throat. Right end allows the continuation of additional 30" connectable center or right connectable worksurface. Grommet in worksurface. Shipped RTA (ready to assemble).

- Modesty Panel is 1" off of ground.

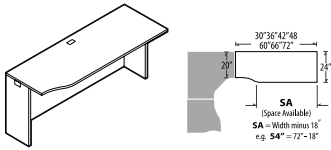

24" Deep Space Saver Connectable Table

Z2472RN	24 x 72 x 29.5-30	70	134	6	\$795	\$949	N/A	\$355
Z2466RN	24 x 66 x 29.5-30	70	125	6	\$795	\$933	N/A	\$355
Z2460RN	24 x 60 x 29.5-30	70	115	5.25	\$722	\$850	N/A	\$326
Z2448RN	24 x 48 x 29.5-30	70	95	4.30	\$653	\$757	N/A	\$260
Z2442RN	24 x 42 x 29.5-30	70	85	3.80	\$653	\$751	N/A	\$218
Z2436RN	24 x 36 x 29.5-30	65	76	3.30	\$572	\$651	N/A	\$164
Z2430RN	24 x 30 x 29.5-30	70	67	3.60	\$537	\$602	N/A	\$164

Narrow end panels on both sides. Connects the **left end only** to any corner unit with a 20" throat. Right end allows the continuation of additional 30" connectable center or right connectable worksurface. Grommet in worksurface. Shipped RTA (ready to assemble).

- Modesty Panel is 1" off of ground.

EXTENDED CORNER ISLANDS

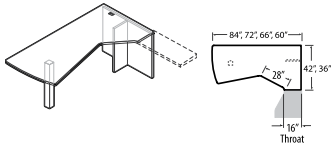

Extended Corner Island - LEFT
Full End Panel & Post (T-Base)*

MODEL#	DIMENSIONS	FREIGHT CLASS	WT/LBS.	CUBIC FT.	1"TOP	1.5" TOP	GLAZE ADD	HP ADD
Z4284EDTL	42 x 84 x 29.5-30	70	180.60	10.76	\$1136	\$1431	N/A	\$939
Z4272EDTL	42 x 72 x 29.5-30	70	164.85	9.50	\$1068	\$1330	N/A	\$705
Z3672EDTL	36 x 72 x 29.5-30	70	139.65	8.76	\$975	\$1159	N/A	\$530
Z3666EDTL	36 x 66 x 29.5-30	70	133.35	8.76	\$933	\$1115	N/A	\$530
Z3660EDTL	36 x 60 x 29.5-30	70	127.05	6.50	\$889	\$1073	N/A	\$441

Extended island worksurface on **left**. Connects to returns or bridges with a 16" throat on the right. **Not freestanding.** Grommet in worksurface. Shipped RTA (ready to assemble).

- Post is shipped in separate carton.

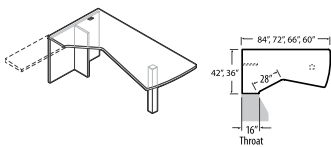

Extended Corner Island - RIGHT
Full End Panel & Post (T-Base)*

Z4284EDTR	42 x 84 x 29.5-30	70	180.60	10.76	\$1136	\$1431	N/A	\$939
Z4272EDTR	42 x 72 x 29.5-30	70	164.85	9.50	\$1068	\$1330	N/A	\$705
Z3672EDTR	36 x 72 x 29.5-30	70	139.65	8.76	\$975	\$1159	N/A	\$530
Z3666EDTR	36 x 66 x 29.5-30	70	133.35	8.76	\$933	\$1115	N/A	\$530
Z3660EDTR	36 x 60 x 29.5-30	70	127.05	6.50	\$889	\$1073	N/A	\$441

Extended island worksurface on **right**. Connects to returns or bridges with a 16" throat on the left. **Not freestanding.** Grommet in worksurface. Shipped RTA (ready to assemble).

- Post is shipped in separate carton.

Required Specifications

Top finish
Top/edge detail
Base finish

Optional Specifications

HP laminate
Modesty panel type
Grommet position or power block cut-out

Accessories

Power block
Keyboard
Pencil drawer

EXTENDED CORNER ISLANDS (WITH FAUX PEDESTAL)

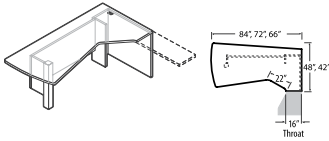

**Extended Corner Island - LEFT
Faux Pedestal and Post**

MODEL#	DIMENSIONS	FREIGHT CLASS	WT/LBS.	CUBIC FT.	1" TOP	1.5" TOP	GLAZE ADD	HP ADD
Z4884EDFL	48 x 84 x 29.5-30	70	214.20	12	\$1421	\$1750	\$638	\$939
Z4872EDFL	48 x 72 x 29.5-30	70	192.15	10.76	\$1317	\$1604	\$527	\$705
Z4284EDFL	42 x 84 x 29.5-30	70	186.90	10.76	\$1334	\$1629	\$638	\$939
Z4272EDFL	42 x 72 x 29.5-30	70	168	8.76	\$1241	\$1498	\$527	\$705
Z4266EDFL	42 x 66 x 29.5-30	70	158.55	8.76	\$1192	\$1431	\$472	\$705

Extended island worksurface on **left**. Connects to returns or bridges with a 16" throat on the right. **Not freestanding**. Faux pedestal on the **right** is ideal for concealing a CPU. ¾ modesty panel is standard. Grommet in worksurface. Shipped RTA (ready to assemble) in 2 cartons.

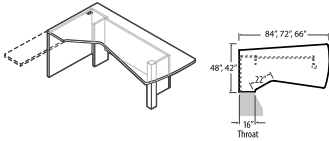

**Extended Corner Island - RIGHT
Faux Pedestal and Post**

Z4884EDFR	48 x 84 x 29.5-30	70	214.20	12	\$1421	\$1750	\$638	\$939
Z4872EDFR	48 x 72 x 29.5-30	70	192.15	10.76	\$1317	\$1604	\$527	\$705
Z4284EDFR	42 x 84 x 29.5-30	70	186.90	10.76	\$1334	\$1629	\$638	\$939
Z4272EDFR	42 x 72 x 29.5-30	70	168	8.76	\$1241	\$1498	\$527	\$705
Z4266EDFR	42 x 66 x 29.5-30	70	158.55	8.76	\$1192	\$1431	\$472	\$705

Extended island worksurface on **right**. Connects to returns or bridges with a 16" throat on the right. **Not freestanding**. Faux pedestal on the **left** is ideal for concealing a CPU. ¾ modesty panel is standard. Grommet in worksurface. Shipped RTA (ready to assemble) in 2 cartons.



EXTENDED CORNER ISLANDS (WITH RECESSED MODESTY)

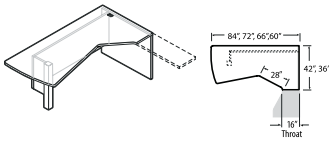

**Extended Corner Island - LEFT
Recessed Modesty and Post**

MODEL#	DIMENSIONS	FREIGHT CLASS	WT/LBS.	CUBIC FT.	1" TOP	1.5" TOP	GLAZE ADD	HP ADD
Z4284EDRL	42 x 84 x 29.5-30	70	199	10.76	\$1260	\$1556	\$750	\$939
Z4272EDRL	42 x 72 x 29.5-30	70	180	9.50	\$1183	\$1444	\$683	\$705
Z3672EDRL	36 x 72 x 29.5-30	70	154	8.76	\$1048	\$1270	\$683	\$530
Z3666EDRL	36 x 66 x 29.5-30	70	144	8.76	\$1010	\$1216	\$627	\$530
Z3660EDRL	36 x 60 x 29.5-30	70	136	6.50	\$970	\$1161	\$574	\$441

Extended island worksurface on **left**. Connects to returns or bridges with a 16" throat on the right. **Not freestanding**. Grommet in worksurface. ¾ **recessed** modesty panel is standard. Shipped RTA (ready to assemble) in 2 cartons.

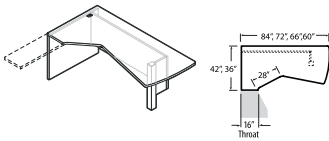

**Extended Corner Island - RIGHT
Recessed Modesty and Post**

Z4284EDRR	42 x 84 x 29.5-30	70	199	10.76	\$1260	\$1556	\$750	\$939
Z4272EDRR	42 x 72 x 29.5-30	70	180	9.50	\$1183	\$1444	\$683	\$705
Z3672EDRR	36 x 72 x 29.5-30	70	154	8.76	\$1048	\$1270	\$683	\$530
Z3666EDRR	36 x 66 x 29.5-30	70	144	8.76	\$1010	\$1216	\$627	\$530
Z3660EDRR	36 x 60 x 29.5-30	70	136	6.50	\$970	\$1161	\$574	\$441

Extended island worksurface on **right**. Connects to returns or bridges with a 16" throat on the left. **Not freestanding**. Grommet in worksurface. ¾ **recessed** modesty panel is standard. Shipped RTA (ready to assemble) in 2 cartons.

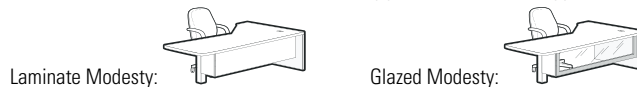

Required Specifications

- Top finish
- Top/edge detail
- Base finish
- Monopost finish*

Optional Specifications

- HP laminate
- Modesty panel type
- Grommet position or power block cut-out

Accessories

- Power block
- Keyboard
- Pencil drawer

EXTENDED CORNER ISLANDS (WITH FLUSH MODESTY) **MODEL#** **DIMENSIONS** **FREIGHT CLASS** **WT/LBS.** **CUBIC FT.** **1" TOP** **1.5" TOP** **GLAZE ADD** **HP ADD**

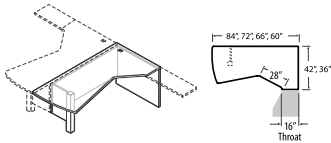

Extended Corner Island - LEFT
Flush Modesty and Post

	D x W x H								
Z4284EDML	42 x 84 x 29.5-30	70	208.95	10.76	\$1278	\$1574	\$750	\$939	
Z4272EDML	42 x 72 x 29.5-30	70	183.75	9.50	\$1197	\$1458	\$683	\$705	
Z3672EDML	36 x 72 x 29.5-30	70	158.55	8.76	\$1059	\$1277	\$683	\$530	
Z3666EDML	36 x 66 x 29.5-30	70	150.15	8.76	\$1015	\$1246	\$627	\$530	
Z3660EDML	36 x 60 x 29.5-30	70	141.75	6.50	\$989	\$1169	\$574	\$441	

Extended island worksurface on **left**. Connects to returns or bridges with a 16" throat on the right. **Not freestanding.** Grommet in worksurface. **¾ flush** modesty panel is standard. Shipped RTA (ready to assemble) in 2 cartons.



Laminate Modesty:

Glazed Modesty:

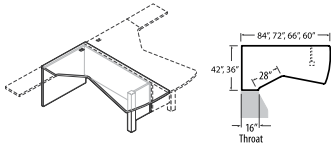

Extended Corner Island - RIGHT
Flush Modesty and Post

Z4284EDMR	42 x 84 x 29.5-30	70	208.95	10.76	\$1278	\$1574	\$750	\$939	
Z4272EDMR	42 x 72 x 29.5-30	70	183.75	9.50	\$1197	\$1458	\$683	\$705	
Z3672EDMR	36 x 72 x 29.5-30	70	158.55	8.76	\$1059	\$1277	\$683	\$530	
Z3666EDMR	36 x 66 x 29.5-30	70	150.15	8.76	\$1015	\$1246	\$627	\$530	
Z3660EDMR	36 x 60 x 29.5-30	70	141.75	6.50	\$989	\$1169	\$574	\$441	

Extended island worksurface on **right**. Connects to returns or bridges with a 16" throat on the left. **Not freestanding.** Grommet in worksurface. **¾ flush** modesty panel is standard. Shipped RTA (ready to assemble) in 2 cartons.

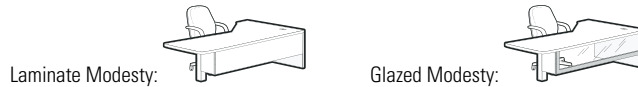

Laminate Modesty:

Glazed Modesty:

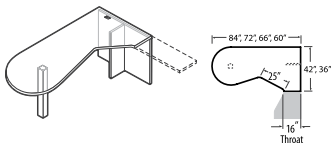

Extended Corner "P" Island - LEFT
Full End Panel & Post (T-Base)

Z4284EPTL	42 x 84 x 29.5-30	70	178.50	10.76	\$1128	\$1423	N/A	\$939	
Z3684EPTL	36 x 84 x 29.5-30	100	153.30	19	\$1040	\$1302	N/A	\$705	
Z3672EPTL	36 x 72 x 29.5-30	70	144.90	8.76	\$959	\$1153	N/A	\$530	
Z3666EPTL	36 x 66 x 29.5-30	70	138.60	8.76	\$920	\$1129	N/A	\$530	
Z3660EPTL	36 x 60 x 29.5-30	70	129.15	6.50	\$886	\$1080	N/A	\$441	

Extended island worksurface on **left**. Connects to returns or bridges with a 16" throat on the right. **Not freestanding.** Grommet in worksurface. Shipped RTA (ready to assemble).

- Post is shipped in separate carton.

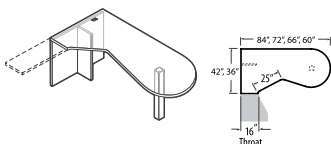

Extended Corner "P" Island - RIGHT
Full End Panel & Post (T-Base)

Z4284EPTR	42 x 84 x 29.5-30	70	178.50	10.76	\$1128	\$1423	N/A	\$939	
Z3684EPTR	36 x 84 x 29.5-30	100	153.30	19	\$1040	\$1302	N/A	\$705	
Z3672EPTR	36 x 72 x 29.5-30	70	144.90	8.76	\$959	\$1153	N/A	\$530	
Z3666EPTR	36 x 66 x 29.5-30	70	138.60	8.76	\$920	\$1129	N/A	\$530	
Z3660EPTR	36 x 60 x 29.5-30	70	129.15	6.50	\$886	\$1080	N/A	\$441	

Extended island worksurface on **right**. Connects to returns or bridges with a 16" throat on the left. **Not freestanding.** Grommet in worksurface. Shipped RTA (ready to assemble).

- Post is shipped in separate carton.

EXTENDED CORNER ISLANDS (WITH FAUX MODESTY) **MODEL#** **DIMENSIONS** **FREIGHT CLASS** **WT/LBS.** **CUBIC FT.** **1" TOP** **1.5" TOP** **GLAZE ADD** **HP ADD**

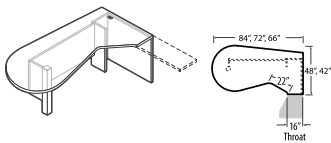

Extended Corner "P" Island - LEFT
Faux Pedestal and Post

Z4884EPFL	48 x 84 x 29.5-30	70	217	12	\$1421	\$1747	\$638	\$939	
Z4872EPFL	48 x 72 x 29.5-30	70	194	10.50	\$1316	\$1602	\$527	\$705	
Z4284EPFL	42 x 84 x 29.5-30	70	191	10.76	\$1334	\$1628	\$638	\$939	
Z4272EPFL	42 x 72 x 29.5-30	70	172	8.76	\$1240	\$1497	\$527	\$705	
Z4266EPFL	42 x 66 x 29.5-30	70	160	8.76	\$1190	\$1428	\$472	\$705	

Extended island worksurface on **left**. Connects to returns or bridges with a 16" throat on the right. **Not freestanding.** Faux pedestal on the **right** is ideal for concealing a CPU. **¾** modesty panel is standard. Grommet in worksurface. Shipped RTA (ready to assemble) in 2 cartons.



Laminate Modesty:

Glazed Modesty:

Required Specifications

- Top finish
- Top/edge detail
- Base finish
- Monopost finish

Optional Specifications

- HP laminate
- Glazing - modesty panel
- Grommet position or power block cut-out

Accessories

- Power block
- Keyboard
- Pencil drawer

EXTENDED CORNER ISLANDS (WITH FAUX MODESTY)

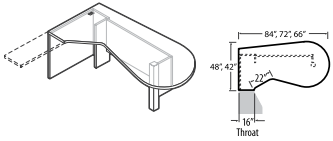

Extended Corner "P" Island - RIGHT Faux Pedestal and Post

MODEL#	DIMENSIONS	FREIGHT CLASS	WT/LBS.	CUBIC FT.	1" TOP	1.5" TOP	GLAZE ADD	HP ADD
D x W x H								
Z4884EPFR	48 x 84 x 29.5-30	70	217	12	\$1421	\$1747	\$638	\$939
Z4872EPFR	48 x 72 x 29.5-30	70	194	10.50	\$1316	\$1602	\$527	\$705
Z4284EPFR	42 x 84 x 29.5-30	70	191	10.76	\$1334	\$1628	\$638	\$939
Z4272EPFR	42 x 72 x 29.5-30	70	172	8.76	\$1240	\$1497	\$527	\$705
Z4266EPFR	42 x 66 x 29.5-30	70	160	8.76	\$1190	\$1428	\$472	\$705

Extended island worksurface on **left**. Connects to returns or bridges with a 16" throat on the right. **Not freestanding.** Faux pedestal on the **right** is ideal for concealing a CPU. ¾ modesty panel is standard. Grommet in worksurface. Shipped RTA (ready to assemble) in 2 cartons.

Laminate Modesty:



Glazed Modesty:

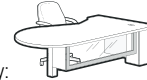

EXTENDED CORNER ISLANDS (WITH RECESSED MODESTY)

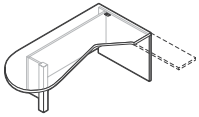

Extended Corner "P" Island - LEFT Recessed Modesty and Post

MODEL#	DIMENSIONS	FREIGHT CLASS	WT/LBS.	CUBIC FT.	1" TOP	1.5" TOP	GLAZE ADD	HP ADD
Z4284EPRL	42 x 84 x 29.5-30	70	199.50	10.76	\$1257	\$1552	\$750	\$939
Z3684EPRL	36 x 84 x 29.5-30	70	173.25	9.50	\$1139	\$1427	\$750	\$705
Z3672EPRL	36 x 72 x 29.5-30	70	156.45	8.76	\$1048	\$1270	\$683	\$530
Z3666EPRL	36 x 66 x 29.5-30	70	149.10	8.76	\$1021	\$1231	\$627	\$530
Z3660EPRL	36 x 60 x 29.5-30	70	140.70	6.50	\$977	\$1171	\$574	\$441

Extended island worksurface on **left**. Connects to returns or bridges with a 16" throat on the right. **Not freestanding.** Grommet in worksurface. ¾ **recessed** modesty panel is standard. Shipped RTA (ready to assemble) in 2 cartons.

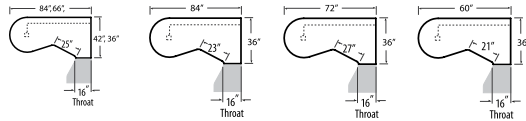

Laminate Modesty:

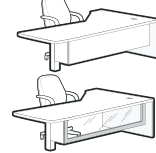

Glazed Modesty:

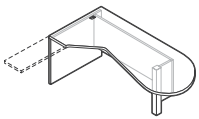

Extended Corner "P" Island - RIGHT Recessed Modesty and Post

Z4284EPRR	42 x 84 x 29.5-30	70	199.50	10.76	\$1257	\$1552	\$750	\$939
Z3684EPRR	36 x 84 x 29.5-30	70	173.25	9.50	\$1139	\$1427	\$750	\$705
Z3672EPRR	36 x 72 x 29.5-30	70	156.45	8.76	\$1048	\$1270	\$683	\$530
Z3666EPRR	36 x 66 x 29.5-30	70	149.10	8.76	\$1021	\$1231	\$627	\$530
Z3660EPRR	36 x 60 x 29.5-30	70	140.70	6.50	\$977	\$1171	\$574	\$441

Extended island worksurface on **right**. Connects to returns or bridges with a 16" throat on the right. **Not freestanding.** Grommet in worksurface. ¾ **recessed** modesty panel is standard. Shipped RTA (ready to assemble) in 2 cartons.

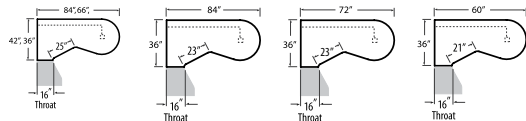

Laminate Modesty:

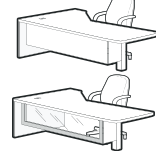

Glazed Modesty:

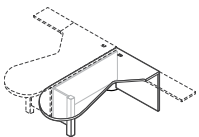

Extended Corner "P" Island - LEFT Flush Modesty and Post

Z4284EPML	42 x 84 x 29.5-30	70	200	10.76	\$1271	\$1566	\$750	\$939
Z3684EPML	36 x 84 x 29.5-30	70	172	9.50	\$1151	\$1413	\$750	\$705
Z3672EPML	36 x 72 x 29.5-30	70	156	8.76	\$1056	\$1277	\$683	\$530
Z3666EPML	36 x 66 x 29.5-30	70	150	8.76	\$1014	\$1199	\$627	\$530
Z3660EPML	36 x 60 x 29.5-30	70	141	6.50	\$984	\$1177	\$574	\$441

Extended island worksurface on **left**. Connects to returns or bridges with a 16" throat on the right. **Not freestanding.** Grommet in worksurface. ¾ **flush** modesty panel is standard. Shipped RTA (ready to assemble) in 2 cartons.

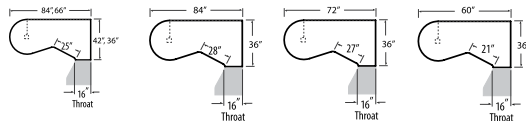

Laminate Modesty:



Glazed Modesty:

Required Specifications

- Top finish
- Top/edge detail
- Base finish
- Monopost finish

Optional Specifications

- HP laminate
- Glazing - modesty panel
- Grommet position or power block cut-out

Accessories

- Power block
- Keyboard
- Pencil drawer

EXTENDED CORNER ISLANDS (WITH RECESSED MODESTY) MODEL# DIMENSIONS FREIGHT CLASS WT/LBS. CUBIC FT. 1" TOP 1.5" TOP GLAZE ADD HP ADD

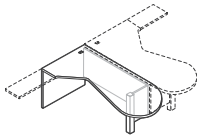

Extended Corner "P" Island - RIGHT Flush Modesty and Post

MODEL#	DIMENSIONS	FREIGHT CLASS	WT/LBS.	CUBIC FT.	1" TOP	1.5" TOP	GLAZE ADD	HP ADD
Z4284EPMR	42 x 84 x 29.5-30	70	200	10.76	\$1271	\$1566	\$750	\$939
Z3684EPMR	36 x 84 x 29.5-30	70	172	9.50	\$1151	\$1413	\$750	\$705
Z3672EPMR	36 x 72 x 29.5-30	70	156	8.76	\$1056	\$1277	\$683	\$530
Z3666EPMR	36 x 66 x 29.5-30	70	150	8.76	\$1014	\$1199	\$627	\$530
Z3660EPMR	36 x 60 x 29.5-30	70	141	6.50	\$984	\$1177	\$574	\$441

Extended island worksurface on **left**. Connects to returns or bridges with a 16" throat on the right. **Not freestanding.** Grommet in worksurface. $\frac{3}{4}$ " flush modesty panel is standard. Shipped RTA (ready to assemble) in 2 cartons.

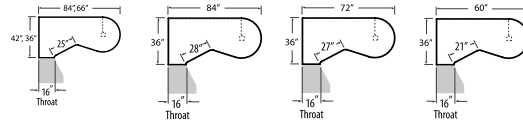

Laminate Modesty:

Glazed Modesty:

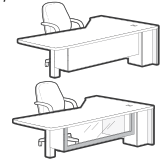

"D" ISLANDS MODEL# DIMENSIONS FREIGHT CLASS WT/LBS. CUBIC FT. 1" TOP 1.5" TOP GLAZE ADD HP ADD

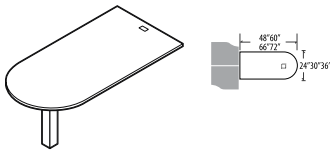

"D" Island with Monopost

Z3672I	36 x 72 x 29.5-30	70	144	8.50	\$730	\$928	N/A	\$507
Z3066I	29.7 x 66 x 29.5-30	70	115	7.50	\$681	\$837	N/A	\$475
Z3060I	29.7 x 60 x 29.5-30	70	104	6.76	\$681	\$830	N/A	\$441
Z2466I	24 x 66 x 29.5-30	85	101	7.50	\$622	\$760	N/A	\$355
Z2460I	24 x 60 x 29.5-30	85	92	6.76	\$589	\$712	N/A	\$326
Z2448I	24 x 48 x 29.5-30	85	74	5.76	\$545	\$654	N/A	\$260

Attaches to edge of worksurfaces. Attaching hardware included. Includes grommet as shown. Shipped RTA (ready to assemble).

- Post is shipped in separate carton.

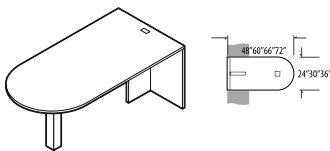

"D" Island - Full End Panel and Monopost (T-Base)

Z3672FI	36 x 72 x 29.5-30	85	123	8.50	\$895	\$1093	N/A	\$507
Z3072FI	29.7 x 72 x 29.5-30	85	106	7.50	\$895	\$1059	N/A	\$476
Z3066FI	29.7 x 66 x 29.5-30	85	101	7.50	\$814	\$970	N/A	\$475
Z3060FI	29.7 x 60 x 29.5-30	85	94	6.76	\$765	\$914	N/A	\$441
Z2466FI	24 x 66 x 29.5-30	85	90	7.50	\$754	\$894	N/A	\$355
Z2460FI	24 x 60 x 29.5-30	85	84	6.76	\$722	\$847	N/A	\$326
Z2448FI	24 x 48 x 29.5-30	85	74	5.76	\$681	\$789	N/A	\$260

Attaches to edge of worksurfaces. Attaching hardware included. Includes grommet as shown. **Not freestanding.** Shipped RTA (ready to assemble).

- Post is shipped in separate carton.

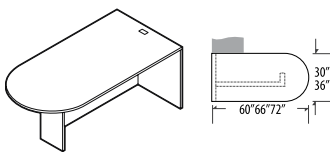

"D" Island LEFT - Full Modesty Panel (H-Base)

Z3672FIL	36 x 72 x 29.5-30	65	171	7	\$845	\$1043	N/A	\$507
Z3066FIL	29.7 x 66 x 29.5-30	65	140	6	\$754	\$966	N/A	\$475
Z3060FIL	29.7 x 60 x 29.5-30	65	128	5.25	\$687	\$836	N/A	\$441

Connects to the left side of a worksurface. Attaching hardware included. Accommodates all 19" pedestals (mobile and hanging pedestals and 19.3" deep storage shells). Includes grommet as shown. Shipped RTA (ready to assemble).

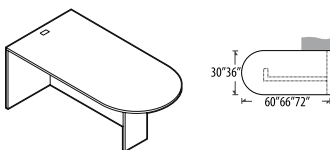

"D" Island RIGHT - Full Modesty Panel (H-Base)

Z3672FIR	36 x 72 x 29.5-30	65	171	7	\$845	\$1043	N/A	\$507
Z3066FIR	29.7 x 66 x 29.5-30	65	140	6	\$754	\$966	N/A	\$475
Z3060FIR	29.7 x 60 x 29.5-30	65	128	5.25	\$687	\$836	N/A	\$441

Connects to the right side of a worksurface. Attaching hardware included. Accommodates all 19" pedestals (mobile and hanging pedestals and 19.3" deep storage shells). Includes grommet as shown. Shipped RTA (ready to assemble).

Required Specifications

- Top finish
- Top/edge detail
- Base finish
- Monopost finish

Optional Specifications

- HP laminate
- Glazing - modesty panel
- Remove standard grommet (RSG)

Accessories

- Power block
- Keyboard
- Pencil drawer

"D" ISLANDS

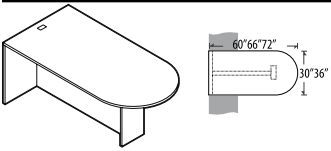

"D" Island CENTER - Full Modesty Panel (H-Base)

MODEL#	DIMENSIONS D x W x H	FREIGHT CLASS	WT./LBS.	CUBIC FT.	1" TOP	1.5" TOP	GLAZE ADD	HP ADD
Z3672FIC	36 x 72 x 29.5-30	65	171	7	\$845	\$1043	N/A	\$507
Z3066FIC	29.7 x 66 x 29.5-30	65	140	6	\$754	\$966	N/A	\$475
Z3060FIC	29.7 x 60 x 29.5-30	65	123	5.25	\$687	\$836	N/A	\$441

Connects in between two worksurfaces. Attaching hardware included. **Will not accommodate pedestals.** Includes grommet as shown. Shipped RTA (ready to assemble).

"P" ISLANDS

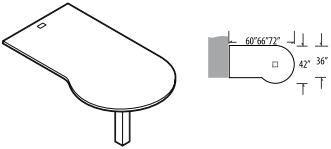

"P" Island LEFT with Post

MODEL#	DIMENSIONS	FREIGHT CLASS	WT./LBS.	CUBIC FT.	1" TOP	1.5" TOP	GLAZE ADD	HP ADD
Z3672IPL	42 x 72 x 29.5-30	85	128	9.26	\$832	\$1034	N/A	\$676
Z3666IPL	42 x 66 x 29.5-30	85	119	8.76	\$832	\$988	N/A	\$676
Z3660IPL	42 x 60 x 29.5-30	85	110	8	\$754	\$910	N/A	\$576

Attaches to edge of worksurfaces. Attaching hardware included. Includes grommet as shown. Shipped RTA (ready to assemble).
 • Post is shipped in separate carton.

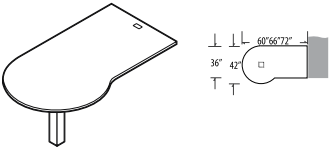

"P" Island RIGHT with Post

Z3672IPR	42 x 72 x 29.5-30	85	128	9.26	\$832	\$1034	N/A	\$676
Z3666IPR	42 x 66 x 29.5-30	85	119	8.76	\$832	\$988	N/A	\$676
Z3660IPR	42 x 60 x 29.5-30	85	110	8	\$754	\$910	N/A	\$576

Attaches to edge of worksurfaces. Attaching hardware included. Includes grommet as shown. Shipped RTA (ready to assemble).
 • Post is shipped in separate carton.

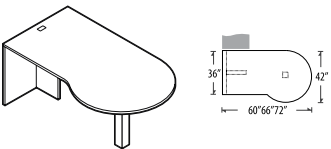

"P" Island LEFT - Full End Panel and Post (T-Base)

Z3672FPL	42 x 72 x 29.5-30	70	163	9.26	\$997	\$1199	N/A	\$676
Z3666FPL	42 x 66 x 29.5-30	70	155	8.76	\$997	\$1161	N/A	\$676
Z3660FPL	42 x 60 x 29.5-30	70	145	8	\$922	\$1078	N/A	\$576

Connects to left side of worksurface. Attaching hardware included. **Not freestanding.** Includes grommet as shown. Shipped RTA (ready to assemble).
 • Post is shipped in separate carton.

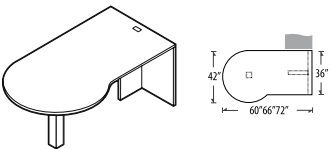

"P" Island RIGHT - Full End Panel and Post (T-Base)

Z3672FPR	42 x 72 x 29.5-30	70	163	9.26	\$997	\$1199	N/A	\$676
Z3666FPR	42 x 66 x 29.5-30	70	155	8.76	\$997	\$1161	N/A	\$676
Z3660FPR	42 x 60 x 29.5-30	70	145	8	\$922	\$1078	N/A	\$576

Connects to right side of worksurface. Attaching hardware included. **Not freestanding.** Includes grommet as shown. Shipped RTA (ready to assemble).
 • Post is shipped in separate carton.

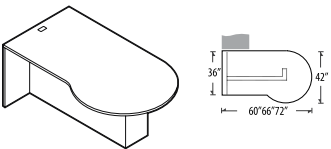

"P" Island LEFT - Full Modesty Panel (H-Base)

Z3672PL	42 x 72 x 29.5-30	65	178	7.75	\$939	\$1140	N/A	\$676
Z3666PL	42 x 66 x 29.5-30	65	167	7.25	\$857	\$1013	N/A	\$676
Z3660PL	42 x 60 x 29.5-30	65	155	6.50	\$788	\$945	N/A	\$576

Connects to the left side of a worksurface. Attaching hardware included. Accommodates all 19" pedestals (freestanding, mobile and hanging pedestals). Includes grommet as shown. Shipped RTA (ready to assemble).

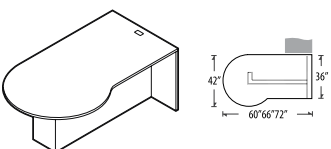

"P" Island RIGHT - Full Modesty Panel (H-Base)

Z3672PR	42 x 72 x 29.5-30	65	178	7.75	\$939	\$1140	N/A	\$676
Z3666PR	42 x 66 x 29.5-30	65	167	7.25	\$857	\$1013	N/A	\$676
Z3660PR	42 x 60 x 29.5-30	65	155	6.50	\$788	\$945	N/A	\$576

Connects to the left side of a worksurface. Attaching hardware included. Accommodates all 19" pedestals (freestanding, mobile and hanging pedestals). Includes grommet as shown. Shipped RTA (ready to assemble).

Required Specifications

- Top finish
- Top/edge detail
- Base finish
- Monopost finish

Optional Specifications

- HP laminate
- Remove standard grommet (RSG)

Accessories

- Power block
- Keyboard
- Pencil drawer

RECTANGULAR ISLANDS

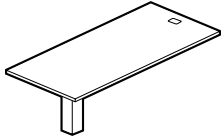

Rectangular Island w/Monopost

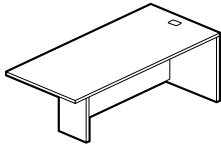

Rectangular Island LEFT - Full Modesty Panel (H-Base)

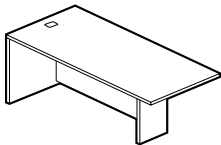

Rectangular Island RIGHT - Full Modesty Panel (H-Base)

MODEL#	DIMENSIONS	FREIGHT CLASS	WT/LBS.	CUBIC FT.	1" TOP	1.5" TOP	GLAZE ADD	HP ADD
D x W x H								
Z3672RI	36 x 72 x 29.5-30	125	90	14.50	\$722	\$919	N/A	\$577
Z3066RI	30 x 66 x 29.5-30	150	72	12.50	\$674	\$828	N/A	\$475
Z3060RI	30 x 60 x 29.5-30	125	66	10.50	\$674	\$822	N/A	\$444
Z2466RI	24 x 66 x 29.5-30	150	63	15	\$614	\$758	N/A	\$355
Z2460RI	24 x 60 x 29.5-30	150	57	13	\$583	\$706	N/A	\$329
Z2448RI	24 x 48 x 29.5-30	150	47	11.50	\$542	\$653	N/A	\$263

Attaches to edge of worksurfaces. Attaching hardware included. Includes grommet as shown. Shipped RTA (ready to assemble). **Not freestanding.**

- Post is shipped in separate carton.

Z3672RFIL	36 x 72 x 29.5-30	70	145	7.25	\$837	\$1034	N/A	\$577
Z3084RFIL	29.69 x 84 x 29.5-30	70	146	7.25	\$833	\$1029	N/A	\$572
Z3066RFIL	29.69 x 66 x 29.5-30	70	121	6.25	\$747	\$962	N/A	\$475
Z3060RFIL	29.69 x 60 x 29.5-30	70	110	5.25	\$681	\$829	N/A	\$444
Z2472RFIL	24 x 72 x 29.5-30	70	116	6.25	\$639	\$791	N/A	\$361
Z2466RFIL	24 x 66 x 29.5-30	70	109	5.75	\$607	\$761	N/A	\$355
Z2460RFIL	24 x 60 x 29.5-30	70	99	5.25	\$577	\$700	N/A	\$329
Z2448RFIL	24 x 48 x 29.5-30	70	85	4.20	\$546	\$642	N/A	\$263

Connects to the **left** side of a worksurface. Attaching hardware included. 36" and 30"D accommodates all 19" pedestals (freestanding, mobile and hanging pedestals). Includes grommet as shown. Shipped RTA (ready to assemble). **Not freestanding.**

Z3672RFIR	36 x 72 x 29.5-30	70	145	7.25	\$837	\$1034	N/A	\$577
Z3084RFIR	29.69 x 84 x 29.5-30	70	146	7.25	\$833	\$1029	N/A	\$572
Z3066RFIR	29.69 x 66 x 29.5-30	70	121	6.25	\$747	\$962	N/A	\$475
Z3060RFIR	29.69 x 60 x 29.5-30	70	110	5.25	\$681	\$829	N/A	\$444
Z2472RFIR	24 x 72 x 29.5-30	70	116	6.25	\$639	\$791	N/A	\$361
Z2466RFIR	24 x 66 x 29.5-30	70	109	5.75	\$607	\$761	N/A	\$355
Z2460RFIR	24 x 60 x 29.5-30	70	99	5.25	\$577	\$700	N/A	\$329
Z2448RFIR	24 x 48 x 29.5-30	70	85	4.20	\$546	\$642	N/A	\$263

Connects to the **right** side of a worksurface. Attaching hardware included. 36" and 30"D accommodates all 19" pedestals (freestanding, mobile and hanging pedestals). Includes grommet as shown. Shipped RTA (ready to assemble). **Not freestanding.**

Required Specifications

Top finish
Top/edge detail
Base finish
Monopost finish

Optional Specifications

HP laminate
Remove standard grommet (RSG)

Accessories

Power block
Keyboard
Pencil drawer

RADIUS SPANNER ISLANDS

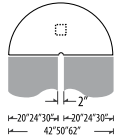
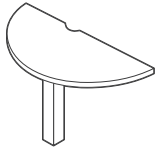

Radius Spanner Island with 2" Panel Cut-Out

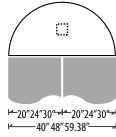
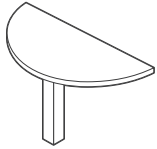

Radius Spanner Island

MODEL#	DIMENSIONS D x W x H	FREIGHT CLASS	WT/LBS.	CUBIC FT.	1" TOP	1.5" TOP	GLAZE ADD	HP ADD
Z62RS	30.57 x 62 x 29.5-30	92.5	79	6.76	\$887	\$1056	N/A	\$408
Z50RS	25 x 50 x 29.5-30	92.5	60	5.76	\$765	\$892	N/A	\$339
Z42RS	25 x 42 x 29.5-30	92.5	53	5.26	\$697	\$824	N/A	\$274

Used to connect two back-to-back units of same depth with a panel. Includes monopost. Requires "L" bracket (model **MLB90**) for connection to full end panels. Shipped RTA (ready to assemble).

- Post is shipped in separate carton.
- **MLB90** must be ordered separately - see page 275.

Z60RS	29.7 x 60 x 29.5-30	85	76	5.76	\$887	\$1041	N/A	\$339
Z48RS	24 x 48 x 29.5-30	100	56	5.76	\$765	\$876	N/A	\$274
Z40RS	24 x 40 x 29.5-30	100	51	5.26	\$697	\$808	N/A	\$274

Used to connect two back-to-back units of same depth with a panel. Includes monopost. Requires "L" bracket (model **MLB90**) for connection to full end panels. Shipped RTA (ready to assemble).

- Post is shipped in separate carton.
- **MLB90** must be ordered separately - see page 275.

Required Specifications

- Top finish
- Top/edge detail
- Leg finish

UNIVERSAL TOPS

MODEL#	DIMENSIONS	FREIGHT CLASS	WT/LBS.	CUBIC FT.	1" TOP	1.5" TOP	GLAZE ADD	HP ADD
D x W x H								
ZUT1696	16 x 96 x 1	100	42	5	\$514	\$686	N/A	\$309
ZUT1690	16 x 90 x 1	100	39	4.75	\$486	\$648	N/A	\$287
ZUT1684	16 x 84 x 1	100	37	4.50	\$440	\$589	N/A	\$269
ZUT1678	16 x 78 x 1	100	34	4.25	\$423	\$561	N/A	\$253
ZUT1672	16 x 72 x 1	85	31	2.25	\$395	\$522	N/A	\$231
ZUT1666	16 x 66 x 1	85	29	2	\$367	\$482	N/A	\$214
ZUT1660	16 x 60 x 1	85	26	1.75	\$339	\$442	N/A	\$196
ZUT1654	16 x 54 x 1	85	24	1.75	\$304	\$403	N/A	\$172
ZUT1648	16 x 48 x 1	85	21	1.50	\$276	\$362	N/A	\$155
ZUT1642	16 x 42 x 1	85	18	1.25	\$247	\$323	N/A	\$139
ZUT1636	16 x 36 x 1	85	16	1.25	\$214	\$278	N/A	\$116
ZUT1630	16 x 30 x 1	85	13	1	\$185	\$237	N/A	\$99
ZUT1896	18 x 96 x 1	100	47	5.50	\$525	\$693	N/A	\$344
ZUT1890	18 x 90 x 1	100	44	5.25	\$498	\$653	N/A	\$326
ZUT1884	18 x 84 x 1	100	41	4.75	\$463	\$613	N/A	\$304
ZUT1878	18 x 78 x 1	100	38	4.50	\$435	\$568	N/A	\$280
ZUT1872	18 x 72 x 1	70	35	2.25	\$406	\$533	N/A	\$259
ZUT1866	18 x 66 x 1	85	32	2.25	\$371	\$487	N/A	\$241
ZUT1860	18 x 60 x 1	85	29	2	\$344	\$448	N/A	\$218
ZUT1854	18 x 54 x 1	85	26	1.75	\$309	\$408	N/A	\$196
ZUT1848	18 x 48 x 1	85	23	1.75	\$287	\$373	N/A	\$172
ZUT1842	18 x 42 x 1	85	20	1.50	\$259	\$335	N/A	\$155
ZUT1836	18 x 36 x 1	85	18	1.25	\$218	\$282	N/A	\$133
ZUT1830	18 x 30 x 1	85	15	1.25	\$190	\$243	N/A	\$110
ZUT2096	20 x 96 x 1	100	52	6	\$532	\$704	N/A	\$384
ZUT2090	20 x 90 x 1	100	49	5.50	\$504	\$666	N/A	\$361
ZUT2084	20 x 84 x 1	100	45	5.25	\$469	\$618	N/A	\$339
ZUT2078	20 x 78 x 1	100	42	4.75	\$413	\$551	N/A	\$315
ZUT2072	20 x 72 x 1	70	39	2.50	\$413	\$540	N/A	\$287
ZUT2066	20 x 66 x 1	70	36	2.25	\$378	\$499	N/A	\$263
ZUT2060	20 x 60 x 1	85	32	2.25	\$349	\$452	N/A	\$241
ZUT2054	20 x 54 x 1	85	29	2	\$322	\$415	N/A	\$218
ZUT2048	20 x 48 x 1	85	26	1.75	\$294	\$374	N/A	\$196
ZUT2042	20 x 42 x 1	70	23	1.50	\$263	\$333	N/A	\$172
ZUT2036	20 x 36 x 1	85	20	1.50	\$224	\$288	N/A	\$145
ZUT2030	20 x 30 x 1	85	16	1.25	\$196	\$249	N/A	\$122
ZUT2496	24 x 96 x 1	100	62	6.75	\$612	\$813	N/A	\$458
ZUT2490	24 x 90 x 1	100	58	6.25	\$577	\$767	N/A	\$430
ZUT2484	24 x 84 x 1	100	55	6	\$537	\$715	N/A	\$401
ZUT2478	24 x 78 x 1	100	51	5.50	\$504	\$671	N/A	\$371
ZUT2472	24 x 72 x 1	100	47	5.25	\$469	\$614	N/A	\$344
ZUT2466	24 x 66 x 1	100	43	4.75	\$435	\$580	N/A	\$315
ZUT2460	24 x 60 x 1	100	39	4.50	\$401	\$527	N/A	\$287
ZUT2454	24 x 54 x 1	100	35	4	\$367	\$482	N/A	\$259
ZUT2448	24 x 48 x 1	70	31	2	\$332	\$435	N/A	\$231
ZUT2442	24 x 42 x 1	70	27	1.75	\$294	\$387	N/A	\$202
ZUT2436	24 x 36 x 1	70	23	1.50	\$259	\$340	N/A	\$172
ZUT2430	24 x 30 x 1	85	20	1.50	\$224	\$288	N/A	\$145

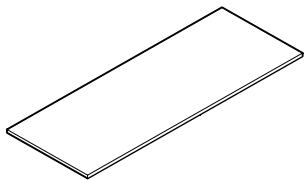

Laminate Tops

1" thick laminate tops for placement over Zira storage.

- Contact Global for pricing on special size tops.

Required Specifications

Top finish
Top/edge detail

Optional Specifications

HP laminate
Grommet position or power block cut-out

Accessories

Power block

UNIVERSAL TOPS

MODEL#	DIMENSIONS D x W x H	FREIGHT CLASS	WT/LBS.	CUBIC FT.	1" TOP	1.5" TOP	GLAZE ADD	HP ADD
ZUT3096	30 x 96 x 1	100	77	8	\$720	\$977	N/A	\$571
ZUT3090	30 x 90 x 1	100	72	7.50	\$680	\$921	N/A	\$537
ZUT3084	30 x 84 x 1	100	67	7.25	\$640	\$864	N/A	\$504
ZUT3078	30 x 78 x 1	100	62	6.75	\$594	\$801	N/A	\$469
ZUT3072	30 x 72 x 1	100	58	6.25	\$577	\$771	N/A	\$430
ZUT3066	30 x 66 x 1	100	53	5.75	\$514	\$686	N/A	\$395
ZUT3060	30 x 60 x 1	100	48	5.25	\$475	\$630	N/A	\$361
ZUT3054	30 x 54 x 1	100	43	4.75	\$435	\$573	N/A	\$326
ZUT3048	30 x 48 x 1	70	38	2.50	\$390	\$523	N/A	\$287
ZUT3042	30 x 42 x 1	70	34	2.25	\$349	\$459	N/A	\$253
ZUT3036	30 x 36 x 1	85	29	2	\$304	\$403	N/A	\$218
ZUT3030	30 x 30 x 1	85	24	1.75	\$263	\$344	N/A	\$185
ZUT3696	36 x 96 x 1	92.5	93	9.25	\$839	\$1142	N/A	\$685
ZUT3690	36 x 90 x 1	100	87	8.75	\$788	\$1075	N/A	\$646
ZUT3684	36 x 84 x 1	100	81	8.25	\$726	\$995	N/A	\$600
ZUT3678	36 x 78 x 1	100	76	7.75	\$692	\$937	N/A	\$559
ZUT3672	36 x 72 x 1	100	70	7.25	\$646	\$875	N/A	\$514
ZUT3666	36 x 66 x 1	100	64	6.75	\$583	\$789	N/A	\$475
ZUT3660	36 x 60 x 1	100	58	6.25	\$543	\$733	N/A	\$430
ZUT3654	36 x 54 x 1	100	52	5.50	\$504	\$671	N/A	\$390
ZUT3648	36 x 48 x 1	100	47	5	\$452	\$607	N/A	\$344
ZUT3642	36 x 42 x 1	100	41	4.50	\$406	\$539	N/A	\$304
ZUT3636	36 x 36 x 1	100	35	4	\$356	\$471	N/A	\$259
ZUT3630	36 x 30 x 1	100	29	3.50	\$304	\$403	N/A	\$218
ZUT4296	42 x 96 x 1	92.5	108	10	\$948	\$1303	N/A	\$800
ZUT4290	42 x 90 x 1	92.5	102	10	\$895	\$1227	N/A	\$754
ZUT4284	42 x 84 x 1	92.5	95	9.50	\$822	\$1131	N/A	\$703
ZUT4278	42 x 78 x 1	92.5	88	8.75	\$788	\$1075	N/A	\$651
ZUT4272	42 x 72 x 1	100	81	8.25	\$731	\$1000	N/A	\$600
ZUT4266	42 x 66 x 1	92.5	75	7.50	\$680	\$921	N/A	\$555
ZUT4260	42 x 60 x 1	100	68	7	\$623	\$847	N/A	\$504
ZUT4254	42 x 54 x 1	100	61	6.25	\$567	\$768	N/A	\$452
ZUT4248	42 x 48 x 1	100	54	5.75	\$514	\$693	N/A	\$401
ZUT4242	42 x 42 x 1	100	48	5.25	\$458	\$613	N/A	\$356
ZUT4236	42 x 36 x 1	100	41	4.50	\$390	\$562	N/A	\$304
ZUT4230	42 x 30 x 1	100	34	4	\$315	\$431	N/A	\$253
ZUT4896	48 x 96 x 1	92.5	124	11.25	\$1067	\$1473	N/A	\$913
ZUT4890	48 x 90 x 1	92.5	116	10.50	\$1011	\$1388	N/A	\$857
ZUT4884	48 x 84 x 1	92.5	108	10.50	\$942	\$1297	N/A	\$800
ZUT4878	48 x 78 x 1	92.5	101	10	\$879	\$1205	N/A	\$742
ZUT4872	48 x 72 x 1	92.5	93	9.25	\$822	\$1126	N/A	\$685
ZUT4866	48 x 66 x 1	92.5	85	8.50	\$758	\$1038	N/A	\$629
ZUT4860	48 x 60 x 1	92.5	77	7.25	\$703	\$956	N/A	\$571
ZUT4854	48 x 54 x 1	100	70	7.25	\$640	\$869	N/A	\$514
ZUT4848	48 x 48 x 1	100	62	6.50	\$571	\$778	N/A	\$458
ZUT4842	48 x 42 x 1	100	54	5.75	\$514	\$693	N/A	\$401
ZUT4836	48 x 36 x 1	100	47	5	\$452	\$602	N/A	\$344
ZUT4830	48 x 30 x 1	100	36	4.25	\$384	\$511	N/A	\$287

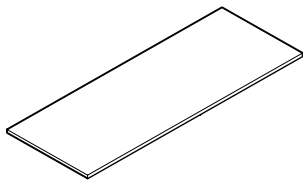

Laminate Tops

1" thick laminate tops for placement over Zira storage.

- Contact Global for pricing on special size tops.

Required Specifications

Top finish
Top/edge detail

Optional Specifications

HP laminate
Grommet position or power block cut-out

Accessories

Power block

UNIVERSAL TOPS

MODEL#	DIMENSIONS	FREIGHT CLASS	WT/LBS.	CUBIC FT.	1" TOP	1.5" TOP	GLAZE ADD	HP ADD
D x W x H								
ZUT5496	54 x 96 x 1	92.5	139	12.50	\$1186	\$1638	N/A	\$1027
ZUT5490	54 x 90 x 1	92.5	131	11.75	\$1118	\$1547	N/A	\$965
ZUT5484	54 x 84 x 1	92.5	122	11	\$1056	\$1456	N/A	\$903
ZUT5478	54 x 78 x 1	92.5	113	10.25	\$994	\$1360	N/A	\$839
ZUT5472	54 x 72 x 1	92.5	105	9.50	\$925	\$1269	N/A	\$770
ZUT5466	54 x 66 x 1	92.5	96	9.50	\$862	\$1171	N/A	\$709
ZUT5460	54 x 60 x 1	100	87	8.75	\$793	\$1079	N/A	\$646
ZUT5454	54 x 54 x 1	100	78	8	\$709	\$966	N/A	\$583
ZUT5448	54 x 48 x 1	100	70	7.25	\$640	\$869	N/A	\$514
ZUT5442	54 x 42 x 1	100	61	6.25	\$567	\$768	N/A	\$452
ZUT5436	54 x 36 x 1	100	52	5.50	\$435	\$602	N/A	\$390
ZUT5430	54 x 30 x 1	100	44	4.75	\$435	\$580	N/A	\$326
ZUT6096	60 x 96 x 1	92.5	155	14	\$1306	\$1808	N/A	\$1140
ZUT6090	60 x 90 x 1	92.5	145	13	\$1231	\$1706	N/A	\$1072
ZUT6084	60 x 84 x 1	92.5	135	12.25	\$1158	\$1604	N/A	\$999
ZUT6078	60 x 78 x 1	92.5	126	11.50	\$1090	\$1502	N/A	\$930
ZUT6072	60 x 72 x 1	92.5	116	10.50	\$999	\$1376	N/A	\$857
ZUT6066	60 x 66 x 1	92.5	106	9.75	\$925	\$1274	N/A	\$788
ZUT6060	60 x 60 x 1	92.5	97	8.75	\$857	\$1172	N/A	\$714
ZUT6054	60 x 54 x 1	100	87	8.75	\$793	\$1079	N/A	\$646
ZUT6048	60 x 48 x 1	100	77	7.75	\$703	\$956	N/A	\$571
ZUT6042	60 x 42 x 1	100	68	7	\$623	\$847	N/A	\$504
ZUT6036	60 x 36 x 1	100	58	6.25	\$571	\$761	N/A	\$430
ZUT6030	60 x 30 x 1	100	49	5.25	\$475	\$630	N/A	\$361

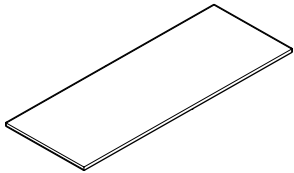

Laminate Tops

1" thick laminate tops for placement over Zira storage.

- Contact Global for pricing on special size tops.

ZPHAT2370	23 x 70 x 1	100	39	4.5	\$463	\$613	N/A	\$322
ZPHAT2364	23 x 64 x 1	100	39	4.5	\$423	\$568	N/A	\$298
ZPHAT2358	23 x 58 x 1	70	35	2.25	\$390	\$517	N/A	\$269
ZPHAT2352	23 x 52 x 1	70	32	2	\$356	\$471	N/A	\$241
ZPHAT2346	23 x 46 x 1	85	29	2	\$322	\$425	N/A	\$214
ZPHAT2340	23 x 40 x 1	85	25	1.75	\$287	\$373	N/A	\$185
ZPHAT2334	23 x 34 x 1	85	21	1.5	\$253	\$329	N/A	\$162
ZPHAT2970	29 x 70 x 1	100	43	5	\$549	\$739	N/A	\$406
ZPHAT2964	29 x 64 x 1	100	49	5.5	\$509	\$680	N/A	\$741
ZPHAT2958	29 x 58 x 1	100	45	5	\$463	\$625	N/A	\$339
ZPHAT2952	29 x 52 x 1	70	40	2.5	\$423	\$568	N/A	\$304
ZPHAT2946	29 x 46 x 1	70	35	2.25	\$384	\$511	N/A	\$269
ZPHAT2940	29 x 40 x 1	70	31	2	\$339	\$454	N/A	\$236
ZPHAT2934	29 x 34 x 1	85	26	1.75	\$298	\$397	N/A	\$202

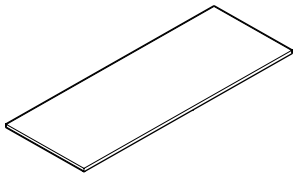

Laminate Tops

1" thick laminate tops for placement over Zira height adjustable tables.

- Contact Global for pricing on special size tops.

Required Specifications

Top finish
Top/edge detail

Optional Specifications

HP laminate
Grommet position or power block cut-out

Accessories

Power block

FILE TOPS

MODEL# DIMENSIONS FREIGHT CLASS WT/LBS. CUBIC FT. 1" TOP 1.5" TOP GLAZE ADD HP ADD

D x W x H

ZUFT1896	18.11 x 96.10 x 1	100	47	5.50	\$525	\$693	N/A	\$349
ZUFT1890	18.11 x 90.12 x 1	100	44	5.25	\$498	\$653	N/A	\$326
ZUFT1884	18.11 x 84.09 x 1	100	41	4.75	\$463	\$613	N/A	\$304
ZUFT1878	18.11 x 78.11 x 1	100	38	4.50	\$435	\$568	N/A	\$287
ZUFT1872	18.11 x 72.13 x 1	70	35	2.25	\$406	\$533	N/A	\$263
ZUFT1866	18.11 x 66.10 x 1	85	32	2.25	\$371	\$487	N/A	\$241
ZUFT1860	18.11 x 60.12 x 1	85	29	2	\$344	\$448	N/A	\$218
ZUFT1854	18.11 x 54.09 x 1	70	27	1.75	\$309	\$408	N/A	\$202
ZUFT1848	18.11 x 48.11 x 1	85	24	1.75	\$276	\$369	N/A	\$179
ZUFT1842	18.11 x 42.13 x 1	85	21	1.50	\$247	\$327	N/A	\$155
ZUFT1836	18.11 x 36.10 x 1	85	18	1.25	\$218	\$271	N/A	\$133
ZUFT1830	18.11 x 30.12 x 1	85	15	1.25	\$190	\$243	N/A	\$110
ZUFT1996	19.25 x 96.10 x 1	100	50	5.75	\$532	\$704	N/A	\$371
ZUFT1990	19.25 x 90.12 x 1	100	47	5.50	\$504	\$666	N/A	\$349
ZUFT1984	19.25 x 84.09 x 1	100	44	5	\$469	\$618	N/A	\$326
ZUFT1978	19.25 x 78.11 x 1	100	41	4.75	\$440	\$578	N/A	\$304
ZUFT1972	19.25 x 72.13 x 1	70	38	2.50	\$413	\$540	N/A	\$280
ZUFT1966	19.25 x 66.10 x 1	70	34	2.25	\$378	\$494	N/A	\$259
ZUFT1960	19.25 x 60.12 x 1	70	31	2	\$349	\$452	N/A	\$236
ZUFT1954	19.25 x 54.09 x 1	85	27	2	\$322	\$415	N/A	\$214
ZUFT1948	19.25 x 48.11 x 1	85	25	1.75	\$287	\$373	N/A	\$190
ZUFT1942	19.25 x 42.13 x 1	85	22	1.50	\$259	\$335	N/A	\$168
ZUFT1936	19.25 x 36.10 x 1	70	19	1.25	\$224	\$288	N/A	\$145
ZUFT1930	19.25 x 30.12 x 1	85	16	1.25	\$196	\$249	N/A	\$122

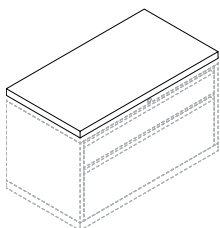

Lateral File Tops

1" thick laminate tops for placement over 1900 Series Lateral Files + Storage.

- Contact Global for pricing on special size tops.

ZUFT3696	36.14 x 96.10 x 1	100	93	9.50	\$839	\$1142	N/A	\$692
ZUFT3690	36.14 x 90.12 x 1	92.5	88	8.75	\$788	\$1075	N/A	\$651
ZUFT3684	36.14 x 84.09 x 1	92.5	82	7.75	\$726	\$995	N/A	\$606
ZUFT3678	36.14 x 78.11 x 1	100	76	7.75	\$692	\$937	N/A	\$567
ZUFT3672	36.14 x 72.13 x 1	100	70	7.25	\$646	\$851	N/A	\$521
ZUFT3666	36.14 x 66.10 x 1	100	64	6.75	\$583	\$789	N/A	\$475
ZUFT3660	36.14 x 60.12 x 1	100	59	6.25	\$543	\$733	N/A	\$435
ZUFT3654	36.14 x 54.09 x 1	100	53	5.50	\$504	\$671	N/A	\$390
ZUFT3648	36.14 x 48.11 x 1	100	47	5	\$452	\$607	N/A	\$349
ZUFT3642	36.14 x 42.13 x 1	100	41	4.50	\$406	\$539	N/A	\$304
ZUFT3636	36.14 x 36.10 x 1	70	35	2.25	\$356	\$471	N/A	\$263
ZUFT3630	36.14 x 30.12 x 1	85	29	2	\$309	\$403	N/A	\$218

ZUFT3896	38.62 x 96.10 x 1	92.5	100	10	\$936	\$1291	N/A	\$737
ZUFT3890	38.62 x 90.12 x 1	100	94	9.50	\$879	\$1211	N/A	\$692
ZUFT3884	38.62 x 84.09 x 1	100	87	8.75	\$827	\$1136	N/A	\$646
ZUFT3878	38.62 x 78.11 x 1	100	81	8.25	\$770	\$1064	N/A	\$600
ZUFT3872	38.62 x 72.13 x 1	100	75	7.75	\$720	\$983	N/A	\$555
ZUFT3866	38.62 x 66.10 x 1	100	69	7	\$663	\$908	N/A	\$509
ZUFT3860	38.62 x 60.12 x 1	100	62	6.50	\$612	\$834	N/A	\$463
ZUFT3854	38.62 x 54.09 x 1	100	56	6	\$559	\$755	N/A	\$417
ZUFT3848	38.62 x 48.11 x 1	100	50	5.25	\$504	\$682	N/A	\$371
ZUFT3842	38.62 x 42.13 x 1	100	44	4.75	\$447	\$608	N/A	\$326
ZUFT3836	38.62 x 36.10 x 1	100	38	4.25	\$395	\$527	N/A	\$280
ZUFT3830	38.62 x 30.12 x 1	100	31	3.75	\$339	\$454	N/A	\$236

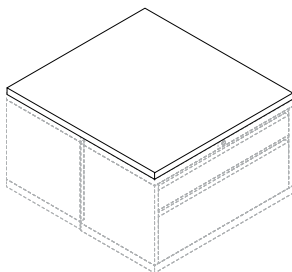

Lateral File Tops - Back to Back

1" thick laminate tops for placement over back-to-back metal filing + storage.

- Use ZUFT36xx models for 18"D laterals back-to-back
- Use ZUFT38xx models for 19.25"D laterals back-to-back
- Contact Global for pricing on special size tops.

Required Specifications

Top finish
Top/edge detail

Optional Specifications

HP laminate
Grommet position or power block cut-out

Accessories

Power block

PEDESTALS



Mobile Pedestal with Overhang*



Mobile Pedestal*



Mobile Pedestal with Overhang*

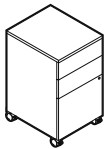

Mobile Pedestal*

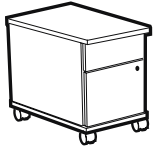

Mobile Pedestal with Overhang*

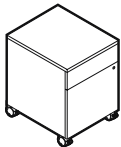

Mobile Pedestal*

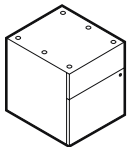

Hanging Pedestal

MODEL#	DIMENSIONS D x W x H	FREIGHT CLASS	WT/LBS.	CUBIC FT.	1" TOP	1.5" TOP	GLAZE ADD	HP ADD
ZMPFF28	29 x 16 x 28	92.5	106	10.25	\$1190	N/A	N/A	\$206
ZMPFF22	23 x 16 x 28	92.5	95	8.25	\$1130	N/A	N/A	\$206

File/File drawers on fully progressive ball bearing slides, accommodate letter and legal size hanging files. Pedestal top features 1" overhang with built-in grip for ease of mobility. Includes counterweight to prevent tipping. Drawers are locking. Only front casters are locking.

ZMPFF19	19 x 16 x 28	85	97	7.25	\$1069	N/A	N/A	\$206
---------	--------------	----	----	------	---------------	-----	-----	--------------

File/File drawers on fully progressive ball bearing slides, accommodate letter and legal size hanging files. Drawers are locking. Only front casters are locking.

ZMPBBF28	29 x 16 x 28	92.5	105	10.25	\$1091	N/A	N/A	\$206
ZMPBBF22	23 x 16 x 28	92.5	92	8.25	\$1050	N/A	N/A	\$204

Box/Box/File drawers on fully progressive ball bearing slides, accommodate letter and legal size hanging files. Pedestal top features 1" overhang with built-in grip for ease of mobility. Includes counterweight to prevent tipping. File drawer and lower box drawer are locking. Only front casters are locking.

ZMPBBF19	19 x 16 x 28	85	96	7.25	\$996	N/A	N/A	\$206
----------	--------------	----	----	------	--------------	-----	-----	--------------

Box/Box/File drawers on fully progressive ball bearing slides, accommodate letter and legal size hanging files. File drawer and lower box drawer are locking. Only front casters are locking.

ZMPBF28	29 x 16 x 22	92.5	83	8.25	\$959	N/A	N/A	\$206
ZMPBF22	23 x 16 x 22	92.5	73	6.75	\$935	N/A	N/A	\$206

Box/File drawers on fully progressive ball bearing slides, accommodate letter and legal size hanging files. Pedestal top features 1" overhang with built-in grip for ease of mobility. Includes counterweight to prevent tipping. Drawers are locking. Only front casters are locking.

ZMPBF19	19 x 16 x 22	85	77	6.25	\$878	N/A	N/A	\$206
---------	--------------	----	----	------	--------------	-----	-----	--------------

Box/File drawers on fully progressive ball bearing slides, accommodate letter and legal size hanging files. Drawers are locking. Only front casters are locking.

ZHPBF18	19 x 16 x 18	92.5	48	4.50	\$653	N/A	N/A	N/A
---------	--------------	------	----	------	--------------	-----	-----	-----

Box/File drawers on fully progressive ball bearing slides, accommodate letter and legal size hanging files. Drawers are locking.

Required Specifications

Top finish
Base finish
Lock finish

Optional Specifications

HP laminate*
Handles

STORAGE SHELLS - 16.87" HIGH

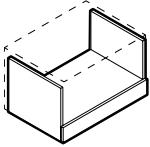

Open Storage Shell

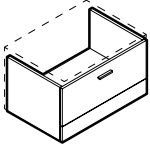

Lateral File Shell

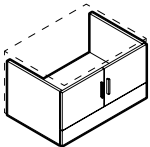

Glazed door option

Closed Storage Shell**

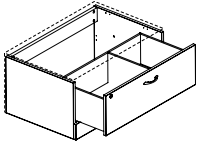

Split Drawer Storage Shell* - LEFT

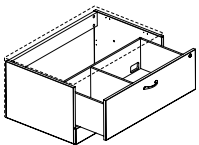

Split Drawer Storage Shell* - RIGHT

MODEL#	DIMENSIONS D x W x H	FREIGHT CLASS	WT/LBS.	CUBIC FT.	1" TOP	1.5" TOP	GLAZE ADD	HP ADD
Z36L21SNS	24 x 36 x 16.87	150	62	11.25	\$591	N/A	N/A	N/A
Z30L21SNS	24 x 30 x 16.87	150	55	9.50	\$530	N/A	N/A	N/A
Z36M21SNS	20 x 36 x 16.87	150	56	9.50	\$545	N/A	N/A	N/A
Z30M21SNS	20 x 30 x 16.87	125	49	8	\$487	N/A	N/A	N/A

For use under **Zxxxx1TB 17.37" H** top and back kit. **No top or back.**

Z36L21ES	24 x 36 x 16.87	125	82	11.25	\$865	N/A	N/A	N/A
Z30L21ES	24 x 30 x 16.87	100	77	9.50	\$755	N/A	N/A	N/A
Z36M21ES	20 x 36 x 16.87	100	78	9.50	\$834	N/A	N/A	N/A
Z30M21ES	20 x 30 x 16.87	100	73	8	\$722	N/A	N/A	N/A

For use under **Zxxxx1TB 17.37" H** top and back kit. **No top or back.** 36" and 30" wide models have front-to-back and side-to-side letter/legal filing capability. Side-to-side file bars included.

- Lateral file drawer construction is for accommodating hanging files NOT for stacking materials on the drawer bottom.

Z36L21SHS	24 x 36 x 16.87	125	71	11.25	\$787	N/A	\$376	N/A
Z30L21SHS	24 x 30 x 16.87	125	62	9.50	\$710	N/A	\$335	N/A
Z36M21SHS	20 x 36 x 16.87	125	65	9.50	\$741	N/A	\$376	N/A
Z30M21SHS	20 x 30 x 16.87	125	57	8	\$668	N/A	\$334	N/A

For use under **Zxxxx1TB 17.37" H** top and back kit. **No top or back.** Laminate doors are standard. Standard with lock.

Z36L21XSL	24 x 36 x 16.87	125	81	11.25	\$801	N/A	N/A	N/A
Z30L21XSL	24 x 30 x 16.87	125	72	9.50	\$731	N/A	N/A	N/A
Z36M21XSL	20 x 36 x 16.87	100	78	9.50	\$769	N/A	N/A	N/A
Z30M21XSL	20 x 30 x 16.87	100	69	8	\$700	N/A	N/A	N/A

For use under **Zxxxx1TB 17.37" H** top and back kit. **No top or back.** Pull out drawer includes filing space on **left** and storage on **right**. Front-to-back letter capability.

- Lateral file drawer construction is for accommodating hanging files NOT for stacking materials on the drawer bottom.

Z36L21XSR	24 x 36 x 16.87	125	81	11.25	\$801	N/A	N/A	N/A
Z30L21XSR	24 x 30 x 16.87	125	72	9.50	\$731	N/A	N/A	N/A
Z36M21XSR	20 x 36 x 16.87	100	78	9.50	\$769	N/A	N/A	N/A
Z30M21XSR	20 x 30 x 16.87	100	69	8	\$700	N/A	N/A	N/A

For use under **Zxxxx1TB 17.37" H** top and back kit. **No top or back.** Pull out drawer includes filing space on **right** and storage on **left**. Front-to-back letter capability.

- Lateral file drawer construction is for accommodating hanging files NOT for stacking materials on the drawer bottom.

Required Specifications

Base finish
Handles*

Optional Specifications

Key #*
Glazed doors**

TOP AND BACK KITS FOR 16.87" H SHELLS

MODEL#	DIMENSIONS D x W x H	FREIGHT CLASS	WT/LBS.	CUBIC FT.	1" TOP	1.5" TOP	GLAZE ADD	HP ADD
Z24961TB	24 x 96 x 17.37-17.87	70	104	6.75	\$742	\$905	N/A	\$481
Z24901TB	24 x 90 x 17.37-17.87	70	97	6.25	\$705	\$857	N/A	\$451
Z24841TB	24 x 84 x 17.37-17.87	70	91	6	\$663	\$807	N/A	\$420
Z24781TB	24 x 78 x 17.37-17.87	70	86	5.50	\$622	\$753	N/A	\$391
Z24721TB	24 x 72 x 17.37-17.87	85	78	5.25	\$577	\$700	N/A	\$361
Z24661TB	24 x 66 x 17.37-17.87	70	72	4.75	\$534	\$648	N/A	\$331
Z24601TB	24 x 60 x 17.37-17.87	85	66	4.50	\$489	\$591	N/A	\$302
Z24541TB	24 x 54 x 17.37-17.87	85	59	4	\$443	\$536	N/A	\$272
Z24481TB	24 x 48 x 17.37-17.87	85	55	3.75	\$408	\$490	N/A	\$241
Z24421TB	24 x 42 x 17.37-17.87	85	47	3.25	\$361	\$435	N/A	\$212
Z24361TB	24 x 36 x 17.37-17.87	85	40	3	\$312	\$375	N/A	\$182
Z24301TB	24 x 30 x 17.37-17.87	85	34	2.50	\$269	\$321	N/A	\$151
Z20961TB	20 x 96 x 17.37-17.87	70	93	6	\$684	\$819	N/A	\$401
Z20901TB	20 x 90 x 17.37-17.87	70	86	5.50	\$641	\$768	N/A	\$376
Z20841TB	20 x 84 x 17.37-17.87	70	76	4.75	\$603	\$723	N/A	\$350
Z20781TB	20 x 78 x 17.37-17.87	70	80	5.25	\$570	\$681	N/A	\$326
Z20721TB	20 x 72 x 17.37-17.87	70	69	4.50	\$527	\$629	N/A	\$302
Z20661TB	20 x 66 x 17.37-17.87	70	64	4.25	\$487	\$581	N/A	\$276
Z20601TB	20 x 60 x 17.37-17.87	70	58	3.75	\$448	\$534	N/A	\$252
Z20541TB	20 x 54 x 17.37-17.87	70	53	3.50	\$409	\$487	N/A	\$227
Z20481TB	20 x 48 x 17.37-17.87	70	50	3.25	\$376	\$445	N/A	\$202
Z20421TB	20 x 42 x 17.37-17.87	70	42	2.75	\$331	\$392	N/A	\$175
Z20361TB	20 x 36 x 17.37-17.87	85	35	2.50	\$286	\$338	N/A	\$151
Z20301TB	20 x 30 x 17.37-17.87	85	28	2.25	\$245	\$288	N/A	\$127

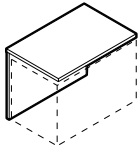

Credenza Top and Back Kit

For use with 16.87" high storage shells. Shipped RTA (ready to assemble).

- Does not include hardware to attach to storage shells.

Required Specifications

Top finish
Top/edge detail
Base finish

Optional Specifications

HP laminate

STORAGE SHELLS - 22.75" HIGH

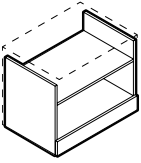

1.5H Open Storage Shell

MODEL#	DIMENSIONS D x W x H	FREIGHT CLASS	WT./LBS.	CUBIC FT.	1" TOP	1.5" TOP	GLAZE ADD	HP ADD
Z36L2HSHNS	24 x 36 x 22.75	150	83	14.50	\$732	N/A	N/A	N/A
Z30L2HSHNS	24 x 30 x 22.75	125	75	12.25	\$662	N/A	N/A	N/A
Z24L2HSHNS	24 x 24 x 22.75	125	66	10	\$588	N/A	N/A	N/A
Z36M2HSHNS	20 x 36 x 22.75	150	73	12.25	\$668	N/A	N/A	N/A
Z30M2HSHNS	20 x 30 x 22.75	125	64	10.50	\$597	N/A	N/A	N/A
Z24M2HSHNS	20 x 24 x 22.75	125	55	8.50	\$533	N/A	N/A	N/A

For use **under ZxxxxHTB 23.25" H** top and back kit. **No top or back.**

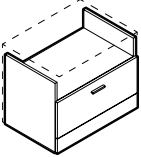

1.5H Open/Lateral File Shell*

Z36L2HFS	24 x 36 x 22.75	125	102	14.50	\$1006	N/A	N/A	N/A
Z30L2HFS	24 x 30 x 22.75	125	97	12.25	\$886	N/A	N/A	N/A
Z36M2HFS	20 x 36 x 22.75	125	95	12.25	\$957	N/A	N/A	N/A
Z30M2HFS	20 x 30 x 22.75	100	88	10.50	\$833	N/A	N/A	N/A

For use **under ZxxxxHTB 23.25" H** top and back kit. **No top or back.** Open shelf and lateral file storage. 36" and 30" wide models have front-to-back and side-to-side letter/legal filing capability. Side-to-side file bars included.

- Lateral file drawer construction is for accommodating hanging files NOT for stacking materials on the drawer bottom

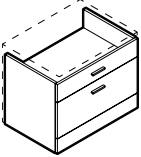

1.5H Box/Lateral File Shell*

Z36L2HES	24 x 36 x 22.75	125	103	14.50	\$1058	N/A	N/A	N/A
Z30L2HES	24 x 30 x 22.75	100	99	12.25	\$939	N/A	N/A	N/A
Z36M2HES	20 x 36 x 22.75	100	98	12.25	\$1023	N/A	N/A	N/A
Z30M2HES	20 x 30 x 22.75	100	92	10.50	\$897	N/A	N/A	N/A

For use **under ZxxxxHTB 23.25" H** top and back kit. **No top or back.** Box drawer and lateral file storage. 36" and 30" wide models have front-to-back and side-to-side letter/legal filing capability. Side-to-side file bars included.

- Lateral file drawer construction is for accommodating hanging files NOT for stacking materials on the drawer bottom

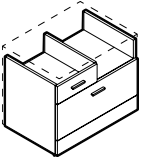

1.5H Mixed Storage Shell - LEFT*

Z36L2HXSL	24 x 36 x 22.75	125	110	14.50	\$1140	N/A	N/A	N/A
Z30L2HXSL	24 x 30 x 22.75	100	105	12.25	\$1022	N/A	N/A	N/A
Z36M2HXSL	20 x 36 x 22.75	100	104	12.25	\$1077	N/A	N/A	N/A
Z30M2HXSL	20 x 30 x 22.75	100	97	10.50	\$953	N/A	N/A	N/A

For use **under ZxxxxHTB 23.25" H** top and back kit. **No top or back.** Open shelf on **right**, box drawer on **left** and lateral file storage below. 36" and 30" wide models have front-to-back and side-to-side letter/legal filing capability. Side-to-side file bars included.

- Lateral file drawer construction is for accommodating hanging files NOT for stacking materials on the drawer bottom

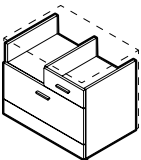

1.5H Mixed Storage Shell - RIGHT*

Z36L2HXSR	24 x 36 x 22.75	125	110	14.50	\$1140	N/A	N/A	N/A
Z30L2HXSR	24 x 30 x 22.75	100	105	12.25	\$1022	N/A	N/A	N/A
Z36M2HXSR	20 x 36 x 22.75	100	104	12.25	\$1077	N/A	N/A	N/A
Z30M2HXSR	20 x 30 x 22.75	100	97	10.50	\$953	N/A	N/A	N/A

For use **under ZxxxxHTB 23.25" H** top and back kit. **No top or back.** Open shelf on **left**, box drawer on **right** and lateral file storage below. 36" and 30" wide models have front-to-back and side-to-side letter/legal filing capability. Side-to-side file bars included.

- Lateral file drawer construction is for accommodating hanging files NOT for stacking materials on the drawer bottom

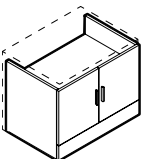

Glazed door option

1.5H Closed Storage Shell**

Z36L2HSHS	24 x 36 x 22.75	125	96	14.50	\$966	N/A	\$467	N/A
Z30L2HSHS	24 x 30 x 22.75	125	86	12.25	\$873	N/A	\$415	N/A
Z36M2HSHS	20 x 36 x 22.75	125	86	12.25	\$903	N/A	\$467	N/A
Z30M2HSHS	20 x 30 x 22.75	125	75	10.50	\$808	N/A	\$415	N/A

For use **under ZxxxxHTB 23.25" H** top and back kit. **No top or back.** Laminate doors are standard. Standard with lock.

Required Specifications

Base finish
Handles*

Optional Specifications

Key #*
Glazed doors**

STORAGE SHELLS - 22.75" HIGH

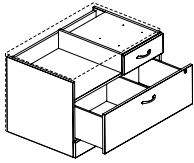

1.5H Split Drawer Storage Shell* - LEFT

MODEL#	DIMENSIONS D x W x H	FREIGHT CLASS	WT/LBS.	CUBIC FT.	1" TOP	1.5" TOP	GLAZE ADD	HP ADD
Z36L2HCSL	24 x 36 x 22.75	125	110	14.50	\$1087	N/A	N/A	N/A
Z30L2HCSL	24 x 30 x 22.75	100	101	12.25	\$1013	N/A	N/A	N/A
Z36M2HCSL	20 x 36 x 22.75	100	104	12.25	\$1022	N/A	N/A	N/A
Z30M2HCSL	20 x 30 x 22.75	100	92	10.50	\$943	N/A	N/A	N/A

For use **under ZxxxxHTB 23.25" H** top and back kit. **No top or back.** Open shelf on **right**, box drawer on **left**. Pull out drawer includes filing space on **left** and storage on **right**. Front-to-back letter capability.

- Lateral file drawer construction is for accommodating hanging files **NOT** for stacking materials on the drawer bottom.

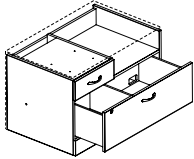

1.5H Split Drawer Storage Shell* - RIGHT

Z36L2HCSR	24 x 36 x 22.75	125	110	14.50	\$1087	N/A	N/A	N/A
Z30L2HCSR	24 x 30 x 22.75	100	101	12.25	\$1013	N/A	N/A	N/A
Z36M2HCSR	20 x 36 x 22.75	100	104	12.25	\$1022	N/A	N/A	N/A
Z30M2HCSR	20 x 30 x 22.75	100	92	10.50	\$943	N/A	N/A	N/A

For use **under ZxxxxHTB 23.25" H** top and back kit. **No top or back.** Open shelf on **left**, box drawer on **right**. Pull out drawer includes filing space on **right** and storage on **left**. Front-to-back letter capability.

- Lateral file drawer construction is for accommodating hanging files **NOT** for stacking materials on the drawer bottom.

TOP AND BACK KITS FOR 22.75" H SHELLS

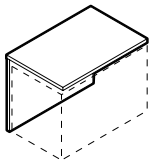

Credenza Top and Back Kit**

MODEL#	DIMENSIONS	FREIGHT CLASS	WT/LBS.	CUBIC FT.	1" TOP	1.5" TOP	GLAZE ADD	HP ADD
Z2496HTB	24 x 96 x 23.25-23.75	70	114	6.75	\$786	\$949	N/A	\$481
Z2490HTB	24 x 90 x 23.25-23.75	70	107	6.25	\$746	\$898	N/A	\$451
Z2484HTB	24 x 84 x 23.25-23.75	70	100	6	\$700	\$844	N/A	\$420
Z2478HTB	24 x 78 x 23.25-23.75	70	94	5.50	\$657	\$790	N/A	\$391
Z2472HTB	24 x 72 x 23.25-23.75	70	87	5.25	\$610	\$733	N/A	\$361
Z2466HTB	24 x 66 x 23.25-23.75	70	80	4.75	\$564	\$678	N/A	\$331
Z2460HTB	24 x 66 x 23.25-23.75	70	72	4.50	\$519	\$621	N/A	\$302
Z2454HTB	24 x 54 x 23.25-23.75	70	65	4	\$469	\$562	N/A	\$272
Z2448HTB	24 x 48 x 23.25-23.75	85	55	3.75	\$428	\$510	N/A	\$241
Z2442HTB	24 x 42 x 23.25-23.75	70	51	3.25	\$380	\$454	N/A	\$212
Z2436HTB	24 x 36 x 23.25-23.75	85	44	3	\$330	\$393	N/A	\$182
Z2430HTB	24 x 30 x 23.25-23.75	85	37	2.50	\$286	\$338	N/A	\$151
Z2096HTB	20 x 96 x 23.25-23.75	70	103	6.25	\$734	\$869	N/A	\$401
Z2090HTB	20 x 90 x 23.25-23.75	70	97	6	\$694	\$821	N/A	\$376
Z2084HTB	20 x 84 x 23.25-23.75	70	91	5.75	\$652	\$772	N/A	\$350
Z2078HTB	20 x 78 x 23.25-23.75	70	86	5.25	\$611	\$722	N/A	\$326
Z2072HTB	20 x 72 x 23.25-23.75	70	78	5	\$570	\$672	N/A	\$302
Z2066HTB	20 x 66 x 23.25-23.75	70	71	4.50	\$522	\$616	N/A	\$276
Z2060HTB	20 x 66 x 23.25-23.75	70	65	4.25	\$481	\$566	N/A	\$252
Z2054HTB	20 x 54 x 23.25-23.75	70	59	3.75	\$438	\$516	N/A	\$227
Z2048HTB	20 x 48 x 23.25-23.75	70	55	3.50	\$401	\$470	N/A	\$202
Z2042HTB	20 x 42 x 23.25-23.75	70	47	3	\$355	\$416	N/A	\$175
Z2036HTB	20 x 36 x 23.25-23.75	85	40	2.75	\$306	\$358	N/A	\$151
Z2030HTB	20 x 30 x 23.25-23.75	85	33	2.25	\$264	\$307	N/A	\$127

For use with 22.75" high storage shells. Shipped RTA (ready to assemble).

- Does not include hardware to attach to storage shells.

Required Specifications

- Top finish**
- Top/edge detail**
- Base finish
- Handles*

Optional Specifications

- HP laminate**

STORAGE SHELLS - 28" HIGH

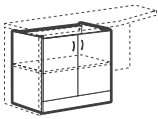

Glazed door option

Storage Shell*

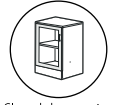
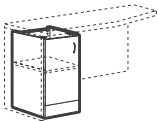

Glazed door option

Storage Shell - LEFT*

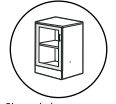
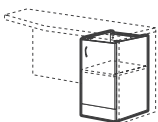

Glazed door option

Storage Shell - RIGHT*

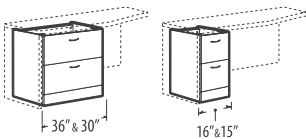

File/File Shell

MODEL#	DIMENSIONS D x W x H	FREIGHT CLASS	WT/LBS.	CUBIC FT.	1" TOP	1.5" TOP	GLAZE ADD	HP ADD
Z36L2SHS	23.4 x 36 x 28-28.5	150	100	18.50	\$905	N/A	\$705	N/A
Z30L2SHS	23.4 x 30 x 28-28.5	150	88	15.50	\$808	N/A	\$647	N/A
Z36M2SHS	19.3 x 36 x 28-28.5	150	89	15.50	\$792	N/A	\$705	N/A
Z30M2SHS	19.3 x 30 x 28-28.5	150	78	13.25	\$719	N/A	\$647	N/A

For use **under 29" H** returns, extended corners, freestanding and connectable tables of the same depth. **No top or back. One adjustable shelf.** Standard with lock.

Z21L2SHSL	23.4 x 21 x 28-28.5	125	70	11	\$624	N/A	\$400	N/A
Z18L2SHSL	23.4 x 18 x 28-28.5	125	64	9.75	\$598	N/A	\$365	N/A
Z16L2SHSL	23.4 x 16 x 28-28.5	125	60	9	\$562	N/A	\$357	N/A
Z15L2SHSL	23.4 x 15 x 28-28.5	125	59	8.25	\$543	N/A	\$322	N/A
Z12L2SHSL	23.4 x 12 x 28-28.5	125	53	6.75	\$507	N/A	\$290	N/A
Z21M2SHSL	19.3 x 21 x 28-28.5	125	61	9.50	\$534	N/A	\$400	N/A
Z18M2SHSL	19.3 x 18 x 28-28.5	125	56	8.25	\$510	N/A	\$365	N/A
Z16M2SHSL	19.3 x 16 x 28-28.5	125	52	7	\$484	N/A	\$357	N/A
Z15M2SHSL	19.3 x 15 x 28-28.5	125	52	6.75	\$458	N/A	\$322	N/A
Z12M2SHSL	19.3 x 12 x 28-28.5	100	47	5.75	\$430	N/A	\$290	N/A

For use **under 29" H** returns, extended corners, freestanding and connectable tables of the same depth. **No top or back. One adjustable shelf.** Standard with lock.

Z21L2SHSR	23.4 x 21 x 28-28.5	125	70	11	\$624	N/A	\$400	N/A
Z18L2SHSR	23.4 x 18 x 28-28.5	125	64	9.75	\$598	N/A	\$365	N/A
Z16L2SHSR	23.4 x 16 x 28-28.5	125	60	9	\$562	N/A	\$357	N/A
Z15L2SHSR	23.4 x 15 x 28-28.5	125	59	8.25	\$543	N/A	\$322	N/A
Z12L2SHSR	23.4 x 12 x 28-28.5	125	53	6.75	\$507	N/A	\$290	N/A
Z21M2SHSR	19.3 x 21 x 28-28.5	125	61	9.50	\$534	N/A	\$400	N/A
Z18M2SHSR	19.3 x 18 x 28-28.5	125	56	8.25	\$510	N/A	\$365	N/A
Z16M2SHSR	19.3 x 16 x 28-28.5	125	52	7	\$484	N/A	\$357	N/A
Z15M2SHSR	19.3 x 15 x 28-28.5	125	52	6.75	\$458	N/A	\$322	N/A
Z12M2SHSR	19.3 x 12 x 28-28.5	100	47	5.75	\$430	N/A	\$290	N/A

For use **under 29" H** returns, extended corners, freestanding and connectable tables of the same depth. **No top or back. One adjustable shelf.** Standard with lock.

Z36L2ES	23.4 x 36 x 28-28.5	125	121	18.50	\$1360	N/A	N/A	N/A
Z30L2ES	23.4 x 30 x 28-28.5	125	110	15.50	\$1247	N/A	N/A	N/A
Z16L2ES	23.4 x 16 x 28-28.5	100	75	9	\$751	N/A	N/A	N/A
Z15L2ES	23.4 x 15 x 28-28.5	100	75	8.25	\$732	N/A	N/A	N/A
Z36M2ES	19.3 x 36 x 28-28.5	125	114	15.50	\$1252	N/A	N/A	N/A
Z30M2ES	19.3 x 30 x 28-28.5	125	102	13.25	\$1171	N/A	N/A	N/A
Z16M2ES	19.3 x 16 x 28-28.5	100	69	7	\$686	N/A	N/A	N/A
Z15M2ES	19.3 x 15 x 28-28.5	92.5	68	6.75	\$669	N/A	N/A	N/A

For use **under 29" H** returns, extended corners, freestanding and connectable tables of the same depth. **No top or back. Two file drawers.** Lock secures all drawers. 36" and 30" wide models have front-to-back and side-to-side letter/legal filing capability. Side-to-side file bars included.

- 15" wide models have only side-to-side filing capability
- Lateral file drawer construction is for accommodating hanging files NOT for stacking materials on the drawer bottom.

Required Specifications

Base finish
Handles

Optional Specifications

Glazed doors - storage shell doors*
Key #

STORAGE SHELLS - 28" HIGH

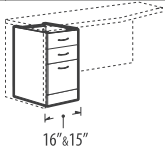

Box/Box/File Shell*

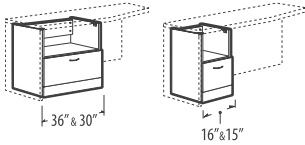

File Shell with Open Shelf*

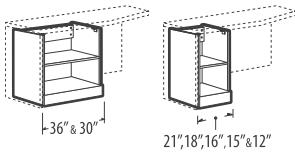

Open Shelving Shell

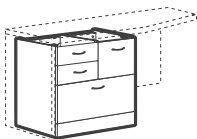

Mixed Storage Shell - LEFT*

MODEL#	DIMENSIONS D x W x H	FREIGHT CLASS	WT/LBS.	CUBIC FT.	1" TOP	1.5" TOP	GLAZE ADD	HP ADD
Z16L2BFS	23.4 x 16 x 28-28.5	100	77	9	\$865	N/A	N/A	N/A
Z15L2BFS	23.4 x 15 x 28-28.5	100	77	8.25	\$847	N/A	N/A	N/A
Z16M2BFS	19.3 x 16 x 28-28.5	92.5	71	7	\$784	N/A	N/A	N/A
Z15M2BFS	19.3 x 15 x 28-28.5	92.5	71	6.75	\$769	N/A	N/A	N/A

For use **under 29"H** returns, extended corners, freestanding and connectable tables of the same depth. **No top or back. Two box and one file drawer.** One pencil tray. Lock secures all drawers.

- 15" wide models have only side-to-side filing capability

Z36L2FS	23.4 x 36 x 28-28.5	150	109	18.50	\$1059	N/A	N/A	N/A
Z30L2FS	23.4 x 30 x 28-28.5	125	98	15.50	\$951	N/A	N/A	N/A
Z16L2FS	23.4 x 16 x 28-28.5	125	68	9	\$633	N/A	N/A	N/A
Z15L2FS	23.4 x 15 x 28-28.5	100	67	8.25	\$625	N/A	N/A	N/A
Z36M2FS	19.3 x 36 x 28-28.5	125	99	15.50	\$942	N/A	N/A	N/A
Z30M2FS	19.3 x 30 x 28-28.5	125	89	13.25	\$867	N/A	N/A	N/A
Z16M2FS	19.3 x 16 x 28-28.5	100	59	7	\$533	N/A	N/A	N/A
Z15M2FS	19.3 x 15 x 28-28.5	100	57	6.75	\$522	N/A	N/A	N/A

For use **under 29"H** returns, extended corners, freestanding and connectable tables of the same depth. **No top or back. One file drawer.** Lock secures file drawer. 36" and 30" wide models have front-to-back and side-to-side letter/legal filing capability. Side-to-side file bars included.

- 15" wide models have only side-to-side filing capability
- Lateral file drawer construction is for accommodating hanging files NOT for stacking materials on the drawer bottom.

Z36L2SHSN	23.4 x 36 x 28-28.5	150	84.03	18.50	\$647	N/A	N/A	N/A
Z30L2SHSN	23.4 x 30 x 28-28.5	150	74.69	15.50	\$574	N/A	N/A	N/A
Z21L2SHSN	23.4 x 21 x 28-28.5	150	60.69	11	\$483	N/A	N/A	N/A
Z18L2SHSN	23.4 x 18 x 28-28.5	150	56.02	9.75	\$465	N/A	N/A	N/A
Z16L2SHSN	23.4 x 16 x 28-28.5	150	52.90	9	\$432	N/A	N/A	N/A
Z15L2SHSN	23.4 x 15 x 28-28.5	125	52.35	8.25	\$422	N/A	N/A	N/A
Z12L2SHSN	23.4 x 12 x 28-28.5	125	47.68	6.75	\$396	N/A	N/A	N/A
Z36M2SHSN	19.3 x 36 x 28-28.5	150	73.03	15.50	\$536	N/A	N/A	N/A
Z30M2SHSN	19.3 x 30 x 28-28.5	150	64.69	13.25	\$487	N/A	N/A	N/A
Z21M2SHSN	19.3 x 21 x 28-28.5	150	51.69	9.50	\$392	N/A	N/A	N/A
Z18M2SHSN	19.3 x 18 x 28-28.5	150	48.02	8.25	\$377	N/A	N/A	N/A
Z16M2SHSN	19.3 x 16 x 28-28.5	125	44.90	7	\$353	N/A	N/A	N/A
Z15M2SHSN	19.3 x 15 x 28-28.5	125	45.35	6.75	\$339	N/A	N/A	N/A
Z12M2SHSN	19.3 x 12 x 28-28.5	125	41.68	5.75	\$318	N/A	N/A	N/A

For use **under 29"H** returns, extended corners, freestanding and connectable tables of the same depth. **No top or back. One adjustable shelf.**

Z36L2XSL	23.4 x 36 x 28-28.5	100	152	18.50	\$1638	N/A	N/A	N/A
Z30L2XSL	23.4 x 30 x 28-28.5	100	136	15.50	\$1499	N/A	N/A	N/A
Z36M2XSL	19.3 x 36 x 28-28.5	100	139	15.50	\$1544	N/A	N/A	N/A
Z30M2XSL	19.3 x 30 x 28-28.5	100	124	13.25	\$1435	N/A	N/A	N/A

For use **under 29"H** returns, extended corners, freestanding and connectable tables of the same depth. **No top or back.** Two box drawers on **left**, one file drawer on **right** and one lateral file drawer on bottom. Right lock secures one file drawer, the left lock secures two box and the lateral file. One pencil tray. Front-to-back and side-to-side letter/legal filing capability. Side-to-side file bars included.

- Lateral file drawer construction is for accommodating hanging files NOT for stacking materials on the drawer bottom.
- Top file drawer supports hanging folders only. Does not accept hanging folders with plastic tabs.

Required Specifications

Base finish
Handles*

Optional Specifications

Box Drawer Option (no upcharge - not available on Open Shelving Shell)
Key #

STORAGE SHELLS - 28" HIGH

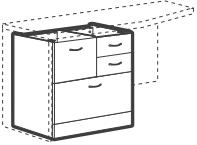

Mixed Storage Shell - RIGHT**

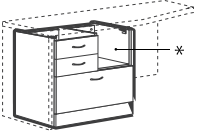

* Accepts collator

Mixed Storage Shell with Open Shelf - LEFT*

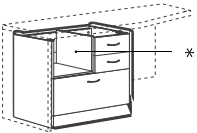

* Accepts collator

Mixed Storage Shell with Open Shelf - RIGHT*

MODEL#	DIMENSIONS D x W x H	FREIGHT CLASS	WT/LBS.	CUBIC FT.	1" TOP	1.5" TOP	GLAZE ADD	HP ADD
Z36L2XSR	23.4 x 36 x 28-28.5	100	152	18.50	\$1638	N/A	N/A	N/A
Z30L2XSR	23.4 x 30 x 28-28.5	100	136	15.50	\$1499	N/A	N/A	N/A
Z36M2XSR	19.3 x 36 x 28-28.5	100	139	15.50	\$1544	N/A	N/A	N/A
Z30M2XSR	19.3 x 30 x 28-28.5	100	124	13.25	\$1435	N/A	N/A	N/A

For use **under 29" H** returns, extended corners, freestanding and connectable tables of the same depth. **No top or back.** Two box drawers on **right**, one file drawer on **left** and one lateral file drawer on bottom. Right lock secures two box and lateral file, the left lock secures one file drawer. One pencil tray. Front-to-back and side-to-side letter/legal filing capability. Side-to-side file bars included.

- Lateral file drawer construction is for accommodating hanging files **NOT** for stacking materials on the drawer bottom.
- Top file drawer supports hanging folders only. Does not accept hanging folders with plastic tabs.

Z36L2XNSL	23.4 x 36 x 28-28.5	125	133	18.50	\$1384	N/A	N/A	N/A
Z30L2XNSL	23.4 x 30 x 28-28.5	125	121	15.50	\$1260	N/A	N/A	N/A
Z36M2XNSL	19.3 x 36 x 28-28.5	125	121	15.50	\$1289	N/A	N/A	N/A
Z30M2XNSL	19.3 x 30 x 28-28.5	100	109	13.25	\$1200	N/A	N/A	N/A

For use **under 29" H** returns, extended corners, freestanding and connectable tables of the same depth. **No top or back.** Two box drawers on **left**, one open shelf on **right** and one lateral file drawer on bottom. Lock secures all drawers. One pencil tray. Front-to-back and side-to-side letter/legal filing capability. Side-to-side file bars included.

- Lateral file drawer construction is for accommodating hanging files **NOT** for stacking materials on the drawer bottom.

Z36L2XNSR	23.4 x 36 x 28-28.5	125	133	18.50	\$1384	N/A	N/A	N/A
Z30L2XNSR	23.4 x 30 x 28-28.5	125	121	15.50	\$1260	N/A	N/A	N/A
Z36M2XNSR	19.3 x 36 x 28-28.5	125	121	15.50	\$1289	N/A	N/A	N/A
Z30M2XNSR	19.3 x 30 x 28-28.5	100	109	13.25	\$1200	N/A	N/A	N/A

For use **under 29" H** returns, extended corners, freestanding and connectable tables of the same depth. **No top or back.** Two box drawers on **right**, one open shelf on **left** and one lateral file drawer on bottom. Lock secures all drawers. One pencil tray. Front-to-back and side-to-side letter/legal filing capability. Side-to-side file bars included.

- Lateral file drawer construction is for accommodating hanging files **NOT** for stacking materials on the drawer bottom.

Required Specifications

Base finish
Handles

Optional Specifications

Box drawer - no upcharge
Collator (open shelves)

TOP AND BACK KITS FOR 28" H STORAGE SHELLS

MODEL#	DIMENSIONS	FREIGHT CLASS	WT/LBS.	CUBIC FT.	1" TOP	1.5" TOP	GLAZE ADD	HP ADD
D x W x H								
Z2496TB	24 x 96 x 29-29.5	70	126	7.75	\$861	\$1024	N/A	\$481
Z2490TB	24 x 90 x 29-29.5	70	118	7.25	\$812	\$964	N/A	\$451
Z2484TB	24 x 84 x 29-29.5	70	111	6.75	\$765	\$909	N/A	\$420
Z2478TB	24 x 78 x 29-29.5	70	104	6.25	\$712	\$845	N/A	\$391
Z2472TB	24 x 72 x 29-29.5	70	117	5.90	\$630	\$779	N/A	\$355
Z2466TB	24 x 66 x 29-29.5	70	117	5.90	\$607	\$744	N/A	\$355
Z2460TB	24 x 60 x 29-29.5	70	117	5.90	\$553	\$676	N/A	\$295
Z2454TB	24 x 54 x 29-29.5	70	72	4.50	\$509	\$602	N/A	\$272
Z2448TB	24 x 48 x 29-29.5	70	66	4	\$465	\$547	N/A	\$241
Z2442TB	24 x 42 x 29-29.5	70	57	3.75	\$415	\$489	N/A	\$212
Z2436TB	24 x 36 x 29-29.5	70	49	3.25	\$350	\$413	N/A	\$182
Z2430TB	24 x 30 x 29-29.5	85	41	2.75	\$311	\$363	N/A	\$151
Z2096TB	20 x 96 x 29-29.5	85	116	7.75	\$812	\$947	N/A	\$401
Z2090TB	20 x 90 x 29-29.5	70	102	6.75	\$766	\$893	N/A	\$376
Z2084TB	20 x 84 x 29-29.5	70	102	6.75	\$720	\$840	N/A	\$350
Z2078TB	20 x 78 x 29-29.5	70	95	6.25	\$671	\$782	N/A	\$326
Z2072TB	20 x 72 x 29-29.5	70	106	6	\$607	\$730	N/A	\$355
Z2066TB	20 x 66 x 29-29.5	70	106	6	\$595	\$699	N/A	\$355
Z2060TB	20 x 60 x 29-29.5	70	106	6	\$522	\$633	N/A	\$295
Z2054TB	20 x 54 x 29-29.5	85	66	4.50	\$482	\$560	N/A	\$227
Z2048TB	20 x 48 x 29-29.5	70	61	4	\$439	\$508	N/A	\$202
Z2042TB	20 x 42 x 29-29.5	85	52	3.75	\$392	\$453	N/A	\$175
Z2036TB	20 x 36 x 29-29.5	85	45	3.25	\$331	\$383	N/A	\$151
Z2030TB	20 x 30 x 29-29.5	85	38	2.75	\$295	\$338	N/A	\$127

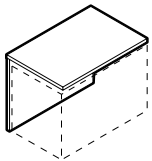

Top and Back Kits - 29"H

For use with 28" high storage shells. Shipped RTA (ready to assemble).

- Does not include hardware to attach to storage shells.

Required Specifications

Top finish
Top/edge detail
Base finish

Optional Specifications

HP laminate

STORAGE MODULES - 17.87"/18.37" HIGH

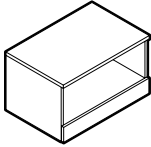

Open Storage

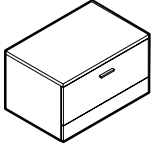

Lateral File*

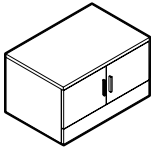

Storage Cabinet*



Glazed door option

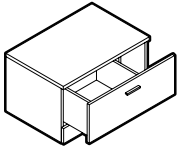

Split Drawer Storage* - LEFT

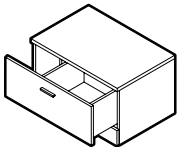

Split Drawer Storage* - RIGHT

MODEL#	DIMENSIONS D x W x H	FREIGHT CLASS	WT/LBS.	CUBIC FT.	1" TOP	1.5" TOP	GLAZE ADD	HP ADD
Z36L21SHN	24 x 36 x 17.87-18.37	125	82	11.75	\$697	\$760	N/A	\$182
Z30L21SHN	24 x 30 x 17.87-18.37	125	74	10	\$639	\$691	N/A	\$151
Z36M21SHN	20 x 36 x 17.87-18.37	125	71	10	\$632	\$684	N/A	\$151
Z30M21SHN	20 x 30 x 17.87-18.37	125	62	8.50	\$569	\$612	N/A	\$127

Open Shelf.

Z36L21E	24 x 36 x 17.87-18.37	100	103	11.75	\$1029	\$1092	N/A	\$182
Z30L21E	24 x 30 x 17.87-18.37	100	97	10	\$879	\$931	N/A	\$151
Z36M21E	20 x 36 x 17.87-18.37	100	95	10	\$977	\$1029	N/A	\$151
Z30M21E	20 x 30 x 17.87-18.37	92.5	88	8.50	\$821	\$864	N/A	\$127

One file drawer. Lock secures drawer. 36" and 30" wide models have front-to-back and side-to-side letter/legal filing capability. Side-to-side file bars included.

- Lateral file drawer construction is for accommodating hanging files NOT for stacking materials on the drawer bottom

Z36L21SH	24 x 36 x 17.87-18.37	125	90	11.75	\$892	\$955	\$376	\$182
Z30L21SH	24 x 30 x 17.87-18.37	100	81	10	\$820	\$872	\$334	\$151
Z36M21SH	20 x 36 x 17.87-18.37	100	80	10	\$826	\$878	\$376	\$151
Z30M21SH	20 x 30 x 17.87-18.37	100	69	8.50	\$750	\$793	\$334	\$127

Laminate doors are standard. Standard with lock.

Z36L21XHL	24 x 36 x 17.87-18.37	100	102	11.75	\$967	\$1030	N/A	\$182
Z30L21XHL	24 x 30 x 17.87-18.37	100	92	10	\$859	\$911	N/A	\$151
Z36M21XHL	20 x 36 x 17.87-18.37	100	95	10	\$915	\$967	N/A	\$151
Z30M21XHL	20 x 30 x 17.87-18.37	100	83	8.50	\$801	\$844	N/A	\$127

Pull out drawer includes filing space on **left** and storage on **right**. Lock secures drawer. 36" and 30" wide models have front-to-back letter filing capability.

- Lateral file drawer construction is for accommodating hanging files NOT for stacking materials on the drawer bottom

Z36L21XHR	24 x 36 x 17.87-18.37	100	102	11.75	\$967	\$1030	N/A	\$182
Z30L21XHR	24 x 30 x 17.87-18.37	100	92	10	\$859	\$911	N/A	\$151
Z36M21XHR	20 x 36 x 17.87-18.37	100	95	10	\$915	\$967	N/A	\$151
Z30M21XHR	20 x 30 x 17.87-18.37	100	83	8.50	\$801	\$844	N/A	\$127

Pull out drawer includes filing space on **right** and storage on **left**. Lock secures drawer. 36" and 30" wide models have front-to-back letter filing capability.

- Lateral file drawer construction is for accommodating hanging files NOT for stacking materials on the drawer bottom

Required Specifications

Top finish
Top/edge detail
Base finish
Handles*

Optional Specifications

HP laminate
Key #

STORAGE MODULES - 23.75" / 24.25" HIGH

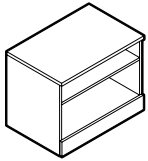

1.5H Open Storage

MODEL#	DIMENSIONS D x W x H	FREIGHT CLASS	WT/LBS.	CUBIC FT.	1" TOP	1.5" TOP	GLAZE ADD	HP ADD
Z36L2HSHN	24 x 36 x 23.75-24.25	125	106	15	\$857	\$920	N/A	\$182
Z30L2HSHN	24 x 30 x 23.75-24.25	125	94	12.75	\$776	\$828	N/A	\$151
Z36M2HSHN	20 x 36 x 23.75-24.25	125	92	12.75	\$772	\$824	N/A	\$151
Z30M2HSHN	20 x 30 x 23.75-24.25	125	80	10.75	\$693	\$736	N/A	\$127

One adjustable shelf.

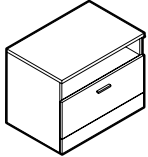

1.5H Open/Lateral File Storage*

Z36L2HFN	24 x 36 x 23.75-24.25	100	127	15	\$1188	\$1251	N/A	\$182
Z30L2HFN	24 x 30 x 23.75-24.25	100	118	12.75	\$1015	\$1067	N/A	\$151
Z36M2HFN	20 x 36 x 23.75-24.25	100	116	12.75	\$1117	\$1169	N/A	\$151
Z30M2HFN	20 x 30 x 23.75-24.25	100	106	10.75	\$944	\$987	N/A	\$127

Open shelf on top. Lateral file below. Lock secures drawer. 36" and 30" wide models have front-to-back and side-to-side letter/legal filing capability. Side-to-side file bars included.

- Lateral file drawer construction is for accommodating hanging files NOT for stacking materials on the drawer bottom

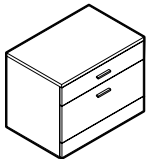

1.5H Box/Lateral File Storage**

Z36L2HE	24 x 36 x 23.75-24.25	100	126	15	\$1256	\$1319	N/A	\$182
Z30L2HE	24 x 30 x 23.75-24.25	100	118	12.75	\$1256	\$1308	N/A	\$151
Z36M2HE	20 x 36 x 23.75-24.25	100	118	12.75	\$1199	\$1251	N/A	\$151
Z30M2HE	20 x 30 x 23.75-24.25	92.5	108	10.75	\$1020	\$1063	N/A	\$127

Box drawer on top. Lateral file below. Lock secures both drawers. 36" and 30" wide models have front-to-back and side-to-side letter/legal filing capability. Side-to-side file bars included.

- Lateral file drawer construction is for accommodating hanging files NOT for stacking materials on the drawer bottom

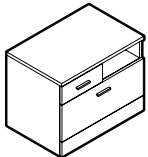

1.5H Mixed Storage - LEFT*

Z36L2HXNL	24 x 36 x 23.75-24.25	100	132	15	\$1297	\$1360	N/A	\$182
Z30L2HXNL	24 x 30 x 23.75-24.25	100	123	12.75	\$1126	\$1178	N/A	\$151
Z36M2HXNL	20 x 36 x 23.75-24.25	100	121	12.75	\$1229	\$1281	N/A	\$151
Z30M2HXNL	20 x 30 x 23.75-24.25	92.5	111	10.75	\$1057	\$1100	N/A	\$127

Open shelf on **right**, box drawer on **left** and lateral file storage below. Lock secures both drawers. 36" and 30" wide models have front-to-back letter filing capability.

- Lateral file drawer construction is for accommodating hanging files NOT for stacking materials on the drawer bottom

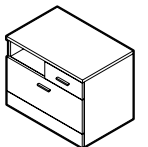

1.5H Mixed Storage - RIGHT*

Z36L2HXNR	24 x 36 x 23.75-24.25	100	132	15	\$1297	\$1360	N/A	\$182
Z30L2HXNR	24 x 30 x 23.75-24.25	100	123	12.75	\$1126	\$1178	N/A	\$151
Z36M2HXNR	20 x 36 x 23.75-24.25	100	121	12.75	\$1229	\$1281	N/A	\$151
Z30M2HXNR	20 x 30 x 23.75-24.25	92.5	111	10.75	\$1057	\$1100	N/A	\$127

Open shelf on **left**, box drawer on **right** and lateral file storage below. Lock secures both drawers. 36" and 30" wide models have front-to-back letter filing capability.

- Lateral file drawer construction is for accommodating hanging files NOT for stacking materials on the drawer bottom

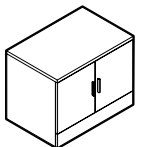

Closed Storage**



Glazed door option

Z36L2HSH	24 x 36 x 23.75-24.25	125	119	15	\$1089	\$1152	\$467	\$182
Z30L2HSH	24 x 30 x 23.75-24.25	100	105	12.75	\$987	\$1039	\$415	\$151
Z36M2HSH	20 x 36 x 23.75-24.25	100	105	12.75	\$1005	\$1057	\$467	\$151
Z30M2HSH	20 x 30 x 23.75-24.25	100	91	10.75	\$904	\$947	\$415	\$127

Laminate doors are standard. Includes one adjustable shelf. Standard with lock.

Required Specifications

- Top finish
- Top/edge detail
- Base finish
- Handles*

Optional Specifications

- HP laminate
- Key #
- Glazed doors**
- Box drawer† - no upcharge

STORAGE MODULES - 23.75" / 24.25" HIGH

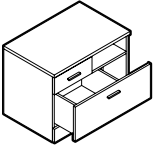

1.5H Split Drawer Storage - LEFT

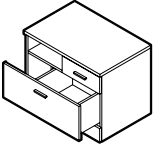

1.5H Split Drawer Storage - RIGHT

MODEL#	DIMENSIONS D x W x H	FREIGHT CLASS	WT/LBS.	CUBIC FT.	1" TOP	1.5" TOP	GLAZE ADD	HP ADD
Z36L2HXHL	24 x 36 x 23.75-24.25	100	132	15	\$1245	\$1308	N/A	\$182
Z30L2HXHL	24 x 30 x 23.75-24.25	100	118	12.75	\$1117	\$1169	N/A	\$151
Z36M2HXHL	20 x 36 x 23.75-24.25	100	121	12.75	\$1177	\$1229	N/A	\$151
Z30M2HXHL	20 x 30 x 23.75-24.25	100	107	10.75	\$1048	\$1091	N/A	\$127

Open shelf on **right**, box drawer on **left**. Pull out drawer includes filing space on **left** and storage on **right**.

Z36L2HXHR	24 x 36 x 23.75-24.25	100	132	15	\$1245	\$1308	N/A	\$182
Z30L2HXHR	24 x 30 x 23.75-24.25	100	118	12.75	\$1117	\$1169	N/A	\$151
Z36M2HXHR	20 x 36 x 23.75-24.25	100	121	12.75	\$1177	\$1229	N/A	\$151
Z30M2HXHR	20 x 30 x 23.75-24.25	100	107	10.75	\$1048	\$1091	N/A	\$127

Open shelf on **left**, box drawer on **right**. Pull out drawer includes filing space on **right** and storage on **left**.

STORAGE MODULES - 29.5" / 30" HIGH

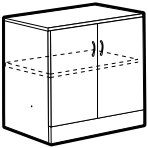

Glazed door option

Storage Cabinet with Doors*

MODEL#	DIMENSIONS	FREIGHT CLASS	WT/LBS.	CUBIC FT.	1" TOP	1.5" TOP	GLAZE ADD	HP ADD
Z36L2SH	24 x 36 x 29.5-30	125	142.80	18.50	\$1208	\$1282	\$705	\$180
Z30L2SH	24 x 30 x 29.5-30	125	123.90	15.50	\$1087	\$1149	\$647	\$150
Z36M2SH	20 x 36 x 29.5-30	100	126	15.50	\$1108	\$1172	\$705	\$180
Z30M2SH	20 x 30 x 29.5-30	100	109.20	13.25	\$1005	\$1058	\$647	\$150
Z36S2SH	16 x 36 x 29.5-30	100	110.25	12.50	\$1023	\$1085	\$705	\$135
Z30S2SH	16 x 30 x 29.5-30	100	93.45	10.50	\$903	\$945	\$647	\$121

Laminate doors are standard. **Includes one adjustable shelf.** Standard with lock.

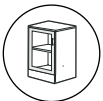
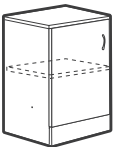

Glazed door option

Storage Cabinet with Door - LEFT*

Z21L2SHL	24 x 21 x 29.5-30	100	94.50	11	\$886	\$937	\$400	\$121
Z18L2SHL	24 x 18 x 29.5-30	100	85.05	9.75	\$836	\$879	\$365	\$93
Z16L2SHL	24 x 16 x 29.5-30	100	79.80	9	\$801	\$843	\$357	\$70
Z15L2SHL	24 x 15 x 29.5-30	100	76.65	8.25	\$741	\$776	\$322	\$70
Z12L2SHL	24 x 12 x 29.5-30	92.5	68.25	6.75	\$702	\$732	\$290	\$63
Z21M2SHL	20 x 21 x 29.5-30	100	84	9.50	\$786	\$829	\$400	\$93
Z18M2SHL	20 x 18 x 29.5-30	100	75.60	8.25	\$744	\$783	\$365	\$93
Z16M2SHL	20 x 16 x 29.5-30	100	69.30	7	\$705	\$743	\$357	\$70
Z15M2SHL	20 x 15 x 29.5-30	100	66.15	6.75	\$671	\$703	\$322	\$63
Z12M2SHL	20 x 12 x 29.5-30	92.5	60	5.75	\$625	\$652	\$290	\$63
Z21S2SHL	16 x 21 x 29.5-30	100	71.40	7.50	\$719	\$753	\$400	\$63
Z18S2SHL	16 x 18 x 29.5-30	100	64.05	6.75	\$687	\$722	\$365	\$63
Z16S2SHL	16 x 16 x 29.5-30	100	58.80	6	\$658	\$693	\$357	\$63
Z15S2SHL	16 x 15 x 29.5-30	100	56.70	5.75	\$621	\$651	\$322	\$63
Z12S2SHL	16 x 12 x 29.5-30	92.5	50.40	4.75	\$577	\$604	\$290	\$63

Laminate doors are standard. **Includes one adjustable shelf.** Standard with lock.

Required Specifications

- Top finish
- Handles
- Top/edge detail
- Base finish

Optional Specifications

- Glazed doors*
- HP laminate
- Key #

STORAGE MODULES - 29.5" / 30" HIGH

MODEL# DIMENSIONS FREIGHT CLASS WT/LBS. CUBIC FT. 1" TOP 1.5" TOP GLAZE ADD HP ADD

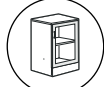
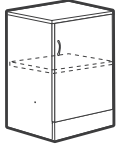

Glazed door option

Storage Cabinet with Door - RIGHT**

	D x W x H								
Z21L2SHR	24 x 21 x 29.5-30	100	94.50	11	\$886	\$937	\$400	\$121	
Z18L2SHR	24 x 18 x 29.5-30	100	85.05	9.75	\$836	\$879	\$365	\$93	
Z16L2SHR	24 x 16 x 29.5-30	100	79.80	9	\$801	\$843	\$357	\$70	
Z15L2SHR	24 x 15 x 29.5-30	100	76.65	8.25	\$741	\$776	\$322	\$70	
Z12L2SHR	24 x 12 x 29.5-30	92.5	68.25	6.75	\$702	\$732	\$290	\$63	
Z21M2SHR	20 x 21 x 29.5-30	100	84	9.50	\$786	\$829	\$400	\$93	
Z18M2SHR	20 x 18 x 29.5-30	100	75.60	8.25	\$744	\$783	\$365	\$93	
Z16M2SHR	20 x 16 x 29.5-30	100	69.30	7	\$705	\$743	\$357	\$70	
Z15M2SHR	20 x 15 x 29.5-30	100	66.15	6.75	\$671	\$703	\$322	\$63	
Z12M2SHR	20 x 12 x 29.5-30	92.5	60	5.75	\$625	\$652	\$290	\$63	
Z21S2SHR	16 x 21 x 29.5-30	100	71.40	7.50	\$719	\$753	\$400	\$63	
Z18S2SHR	16 x 18 x 29.5-30	100	64.05	6.75	\$687	\$722	\$365	\$63	
Z16S2SHR	16 x 16 x 29.5-30	100	58.80	6	\$658	\$693	\$357	\$63	
Z15S2SHR	16 x 15 x 29.5-30	100	56.70	5.75	\$621	\$651	\$322	\$63	
Z12S2SHR	16 x 12 x 29.5-30	92.5	50.40	4.75	\$577	\$604	\$290	\$63	

Laminate doors are standard. Includes one adjustable shelf. Standard with lock

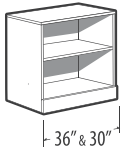

36" & 30"



21", 18", 16", 15" & 12"

Open Storage Cabinet

Z36L2SHN	24 x 36 x 29.5-30	125	127	18.50	\$952	\$1026	N/A	\$180	
Z30L2SHN	24 x 30 x 29.5-30	125	111	15.50	\$856	\$919	N/A	\$150	
Z21L2SHN	24 x 21 x 29.5-30	125	86	11	\$744	\$795	N/A	\$121	
Z18L2SHN	24 x 18 x 29.5-30	100	78	9.75	\$703	\$746	N/A	\$93	
Z16L2SHN	24 x 16 x 29.5-30	100	73	9	\$671	\$713	N/A	\$70	
Z15L2SHN	24 x 15 x 29.5-30	100	71	8.25	\$623	\$658	N/A	\$63	
Z12L2SHN	24 x 12 x 29.5-30	100	63	6.75	\$590	\$620	N/A	\$63	
Z36M2SHN	20 x 36 x 29.5-30	125	111.95	15.50	\$850	\$913	N/A	\$135	
Z30M2SHN	20 x 30 x 29.5-30	125	97.14	13.25	\$773	\$828	N/A	\$121	
Z21M2SHN	20 x 21 x 29.5-30	125	74.40	9.50	\$644	\$687	N/A	\$93	
Z18M2SHN	20 x 18 x 29.5-30	100	67.53	8.25	\$611	\$650	N/A	\$77	
Z16M2SHN	20 x 16 x 29.5-30	100	62.59	7	\$576	\$614	N/A	\$63	
Z15M2SHN	20 x 15 x 29.5-30	100	60.65	6.75	\$551	\$583	N/A	\$63	
Z12M2SHN	20 x 12 x 29.5-30	100	55	5.75	\$511	\$539	N/A	\$63	
Z36S2SHN	16 x 36 x 29.5-30	125	96.24	12.50	\$767	\$829	N/A	\$135	
Z30S2SHN	16 x 30 x 29.5-30	125	82.82	10.50	\$669	\$711	N/A	\$121	
Z21S2SHN	16 x 21 x 29.5-30	100	62.70	7.50	\$576	\$610	N/A	\$93	
Z18S2SHN	16 x 18 x 29.5-30	100	55.99	6.75	\$556	\$594	N/A	\$77	
Z16S2SHN	16 x 16 x 29.5-30	100	52.22	6	\$529	\$564	N/A	\$63	
Z15S2SHN	16 x 15 x 29.5-30	100	50.34	5.75	\$500	\$529	N/A	\$63	
Z12S2SHN	16 x 12 x 29.5-30	100	44.68	4.75	\$464	\$491	N/A	\$63	

One adjustable shelf.

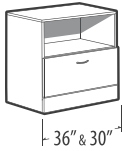

36" & 30"



16" & 15"

File Module with Open Shelf**

Z36L2FN	24 x 36 x 29.5-30	100	153.30	18.50	\$1363	\$1436	N/A	\$180	
Z30L2FN	24 x 30 x 29.5-30	100	134.40	15.50	\$1231	\$1294	N/A	\$150	
Z16L2FN	24 x 16 x 29.5-30	100	87.15	9	\$861	\$903	N/A	\$93	
Z15L2FN	24 x 15 x 29.5-30	92.5	82.95	8.25	\$811	\$846	N/A	\$77	
Z36M2FN	20 x 36 x 29.5-30	100	135.45	15.50	\$1260	\$1323	N/A	\$180	
Z30M2FN	20 x 30 x 29.5-30	100	118.65	13.25	\$1159	\$1212	N/A	\$150	
Z16M2FN	20 x 16 x 29.5-30	92.5	75.60	7	\$768	\$806	N/A	\$93	
Z15M2FN	20 x 15 x 29.5-30	92.5	72.45	6.75	\$734	\$766	N/A	\$77	
Z36S2FN	16 x 36 x 29.5-30	100	114.45	12.50	\$1139	\$1201	N/A	\$135	
Z30S2FN	16 x 30 x 29.5-30	100	97.65	10.50	\$1010	\$1052	N/A	\$121	
Z16S2FN	16 x 16 x 29.5-30	92.5	63	6	\$712	\$747	N/A	\$70	
Z15S2FN	16 x 15 x 29.5-30	92.5	60.90	5.75	\$681	\$710	N/A	\$63	

Open shelf and one file drawer on bottom. Lock secures file drawer. 36" and 30" wide models have front-to-back and side-to-side letter/legal filing capability. Side-to-side file bars included.

- 15" wide models have only side-to-side filing capability
- Lateral file drawer construction is for accommodating hanging files NOT for stacking materials on the drawer bottom

Required Specifications

Top finish
Handles*
Top/edge detail
Base finish

Optional Specifications

Glazed doors**
HP laminate
Key #

Box drawer† - no upcharge (30" - 36" wide models only)

STORAGE MODULES - 29.5" / 30" HIGH



36" & 30"



16" & 15"

Two File Module†



Two File Module†



16" & 15"

Box/Box/File Module†



Mixed Storage Cabinet - LEFT†

MODEL#	DIMENSIONS D x W x H	FREIGHT CLASS	WT./LBS.	CUBIC FT.	1" TOP	1.5" TOP	GLAZE ADD	HP ADD
Z36L2E	24 x 36 x 29.5-30	100	164.85	18.50	\$1671	\$1744	N/A	\$180
Z30L2E	24 x 30 x 29.5-30	100	145.95	15.50	\$1528	\$1591	N/A	\$150
Z16L2E	24 x 16 x 29.5-30	92.5	95.55	9	\$984	\$1026	N/A	\$93
Z15L2E	24 x 15 x 29.5-30	92.5	91.35	8.25	\$928	\$963	N/A	\$77
Z36M2E	20 x 36 x 29.5-30	100	149.10	15.50	\$1579	\$1643	N/A	\$180
Z30M2E	20 x 30 x 29.5-30	92.5	133.35	13.25	\$1464	\$1519	N/A	\$150
Z16M2E	20 x 16 x 29.5-30	85	85.05	7	\$893	\$931	N/A	\$93
Z15M2E	20 x 15 x 29.5-30	85	81.90	6.75	\$862	\$894	N/A	\$77
Z36S2E	16 x 36 x 29.5-30	92.5	128.10	12.50	\$1481	\$1543	N/A	\$135
Z30S2E	16 x 30 x 29.5-30	92.5	110.25	10.50	\$1346	\$1388	N/A	\$121
Z16S2E	16 x 16 x 29.5-30	85	73.50	6	\$886	\$921	N/A	\$70
Z15S2E	16 x 15 x 29.5-30	85	71.40	5.75	\$856	\$886	N/A	\$63

Two file drawers. Lock secures all drawers. 36" and 30" wide models have front-to-back and side-to-side letter/legal filing capability. Side-to-side file bars included.

- 15" wide models have only side-to-side filing capability
- *Lateral file drawer construction is for accommodating hanging files NOT for stacking materials on the drawer bottom*

Z36L2SE	24 x 36 x 29.5-30	100	180	18.50	\$2021	\$2094	N/A	\$180
Z36M2SE	20 x 36 x 29.5-30	92.5	164	15.50	\$1887	\$1951	N/A	\$180

Two lateral file drawers with steel drawer interior. Lock secures all drawers. Front-to-back and side-to-side letter/legal filing capability. Side-to-side file bars included.

- Front-to-back filing bars available separately. Order **FBB** bars. See "FBB" on page 41.
- *Lateral file drawer construction is for accommodating hanging files NOT for stacking materials on the drawer bottom*
- To prevent overloading, steel drawers do not include a back panel

Z16L2BF	24 x 16 x 29.5-30	92.5	97.65	9	\$1108	\$1150	N/A	\$93
Z15L2BF	24 x 15 x 29.5-30	92.5	93.45	8.25	\$1057	\$1092	N/A	\$93
Z16M2BF	20 x 16 x 29.5-30	85	87.15	7	\$1015	\$1053	N/A	\$93
Z15M2BF	20 x 15 x 29.5-30	85	84	6.75	\$989	\$1021	N/A	\$93
Z16S2BF	16 x 16 x 29.5-30	85	73.50	6	\$947	\$982	N/A	\$70
Z15S2BF	16 x 15 x 29.5-30	85	71.40	5.75	\$904	\$934	N/A	\$70

Two box and one file drawer. One pencil tray. Lock secures all drawers.

Z36L2XL	24 x 36 x 29.5-30	92.5	187	18.50	\$1905	\$1971	N/A	\$180
Z30L2XL	24 x 30 x 29.5-30	92.5	166	15.50	\$1737	\$1800	N/A	\$150
Z36M2XL	20 x 36 x 29.5-30	92.5	177	15.50	\$1789	\$1852	N/A	\$180
Z30M2XL	20 x 30 x 29.5-30	92.5	152	13.25	\$1647	\$1702	N/A	\$150
Z36S2XL	16 x 36 x 29.5-30	92.5	145	12.50	\$1535	\$1592	N/A	\$135
Z30S2XL	16 x 30 x 29.5-30	92.5	124	10.50	\$1375	\$1425	N/A	\$121

Two box drawers on **left**, one file drawer on **right** and one lateral file drawer on bottom. Right lock secures one file drawer, the left lock secures two box and lateral file. One pencil tray. Front-to-back and side-to-side letter/legal filing capability. Side-to-side file bars included.

- *Lateral file drawer construction is for accommodating hanging files NOT for stacking materials on the drawer bottom*
- Top file drawer supports hanging folders only. Does not accept hanging folders with plastic tabs.

Required Specifications

Top finish
Top/edge detail
Handles
Base finish

Optional Specifications

HP laminate
Key #
Box drawer† - no upcharge (30"-36" wide models only)

STORAGE MODULES - 29.5" / 30" HIGH



Mixed Storage Cabinet - RIGHT

MODEL#	DIMENSIONS	FREIGHT CLASS	WT/LBS.	CUBIC FT.	1" TOP	1.5" TOP	GLAZE ADD	HP ADD
D x W x H								
Z36L2XR	24 x 36 x 29.5-30	92.5	187	18.50	\$1905	\$1971	N/A	\$180
Z30L2XR	24 x 30 x 29.5-30	92.5	166	15.50	\$1737	\$1800	N/A	\$150
Z36M2XR	20 x 36 x 29.5-30	92.5	177	15.50	\$1789	\$1852	N/A	\$180
Z30M2XR	20 x 30 x 29.5-30	92.5	152	13.25	\$1647	\$1702	N/A	\$150
Z36S2XR	16 x 36 x 29.5-30	92.5	145	12.50	\$1535	\$1592	N/A	\$135
Z30S2XR	16 x 30 x 29.5-30	92.5	124	10.50	\$1375	\$1425	N/A	\$121

Two box drawers on **right**, one file drawer on **left** and one lateral file drawer on bottom. Right lock secures two box and lateral file, the left lock secures one file drawer. One pencil tray. Front-to-back and side-to-side letter/legal filing capability. Side-to-side file bars included.

- Lateral file drawer construction is for accommodating hanging files NOT for stacking materials on the drawer bottom
- Top file drawer supports hanging folders only. Does not accept hanging folders with plastic tabs.

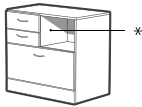

Mixed Drawer Cabinet with Open Shelf - LEFT*



* Accepts collator

Z36L2XNL	24 x 36 x 29.5-30	100	176.40	18.50	\$1649	\$1723	N/A	\$180
Z30L2XNL	24 x 30 x 29.5-30	92.5	155.40	15.50	\$1514	\$1577	N/A	\$150
Z36M2XNL	20 x 36 x 29.5-30	92.5	157.50	15.50	\$1543	\$1606	N/A	\$180
Z30M2XNL	20 x 30 x 29.5-30	92.5	138.60	13.25	\$1427	\$1482	N/A	\$150
Z36S2XNL	16 x 36 x 29.5-30	92.5	128.10	12.50	\$1383	\$1436	N/A	\$135
Z30S2XNL	16 x 30 x 29.5-30	92.5	114.45	10.50	\$1253	\$1291	N/A	\$121

Two box drawers on **left**, open shelf on **right** and one lateral file drawer on bottom. Right lock secures two box and one file drawer, the left lock secures the lateral file. One pencil tray. Front-to-back and side-to-side letter/legal filing capability. Side-to-side file bars included.

- Lateral file drawer construction is for accommodating hanging files NOT for stacking materials on the drawer bottom

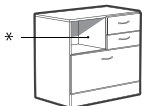

Mixed Drawer Cabinet with Open Shelf - RIGHT*



* Accepts collator

Z36L2XNR	24 x 36 x 29.5-30	100	176.40	18.50	\$1649	\$1723	N/A	\$180
Z30L2XNR	24 x 30 x 29.5-30	92.5	155.40	15.50	\$1514	\$1577	N/A	\$150
Z36M2XNR	20 x 36 x 29.5-30	92.5	157.50	15.50	\$1543	\$1606	N/A	\$180
Z30M2XNR	20 x 30 x 29.5-30	92.5	138.60	13.25	\$1427	\$1482	N/A	\$150
Z36S2XNR	16 x 36 x 29.5-30	92.5	128.10	12.50	\$1383	\$1436	N/A	\$135
Z30S2XNR	16 x 30 x 29.5-30	92.5	114.45	10.50	\$1253	\$1291	N/A	\$121

Two box drawers on **right**, open shelf on **left** and one lateral file drawer on bottom. Right lock secures two box and one file drawer, the left lock secures the lateral file. One pencil tray. Front-to-back and side-to-side letter/legal filing capability. Side-to-side file bars included.

- Lateral file drawer construction is for accommodating hanging files NOT for stacking materials on the drawer bottom



Media Center - LEFT

Z36L2MCL	24 x 36 x 29.5-30	100	171.15	18.50	\$1778	\$1852	N/A	\$180
Z30L2MCL	24 x 30 x 29.5-30	100	152.25	15.50	\$1654	\$1717	N/A	\$150
Z36M2MCL	20 x 36 x 29.5-30	100	153.30	15.50	\$1668	\$1731	N/A	\$180
Z30M2MCL	20 x 30 x 29.5-30	92.5	134.40	13.25	\$1519	\$1574	N/A	\$150
Z36S2MCL	16 x 36 x 29.5-30	92.5	126	12.50	\$1513	\$1575	N/A	\$135
Z30S2MCL	16 x 30 x 29.5-30	92.5	108.15	10.50	\$1368	\$1410	N/A	\$121

Accommodates pc, keyboard, monitor, hanging folders and accessories and/or printer. One vertical drawer on the **left**. Pull out keyboard shelf. Adjustable pull out bottom shelf accommodates pc and/or printer. Grommet in worksurface and back panel. Lock secures vertical drawer.



Media Center - RIGHT

Z36L2MCR	24 x 36 x 29.5-30	100	171.15	18.50	\$1778	\$1852	N/A	\$180
Z30L2MCR	24 x 30 x 29.5-30	100	152.25	15.50	\$1654	\$1717	N/A	\$150
Z36M2MCR	20 x 36 x 29.5-30	100	153.30	15.50	\$1668	\$1731	N/A	\$180
Z30M2MCR	20 x 30 x 29.5-30	92.5	134.40	13.25	\$1519	\$1574	N/A	\$150
Z36S2MCR	16 x 36 x 29.5-30	92.5	126	12.50	\$1513	\$1575	N/A	\$135
Z30S2MCR	16 x 30 x 29.5-30	92.5	108.15	10.50	\$1368	\$1410	N/A	\$121

Accommodates pc, keyboard, monitor, hanging folders and accessories and/or printer. One vertical drawer on the **right**. Pull out keyboard shelf. Adjustable pull out bottom shelf accommodates pc and/or printer. Grommet in worksurface and back panel. Lock secures vertical drawer.

Required Specifications

Top finish
Top/edge detail
Base finish
Handles

Optional Specifications

HP laminate
Key #
Collator*

STORAGE MODULES - 29.5" / 30" HIGH

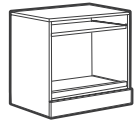

PC Center

MODEL#	DIMENSIONS D x W x H	FREIGHT CLASS	WT/LBS.	CUBIC FT.	1" TOP	1.5" TOP	GLAZE ADD	HP ADD
Z36L2PC	24 x 36 x 29.5-30	100	148.05	18.50	\$1163	\$1236	N/A	\$180
Z30L2PC	24 x 30 x 29.5-30	100	127.05	15.50	\$1049	\$1112	N/A	\$150
Z36M2PC	20 x 36 x 29.5-30	100	132.30	15.50	\$1081	\$1145	N/A	\$135
Z30M2PC	20 x 30 x 29.5-30	100	114.45	13.25	\$966	\$1019	N/A	\$121
Z36S2PC	16 x 36 x 29.5-30	100	110.25	12.50	\$984	\$1046	N/A	\$135
Z30S2PC	16 x 30 x 29.5-30	100	92.40	10.50	\$839	\$881	N/A	\$121

Accommodates pc, keyboard, monitor and/or printer. Pull out keyboard shelf. Adjustable pull out bottom shelf accommodates pc and/or printer. Grommet in worksurface and back panel.

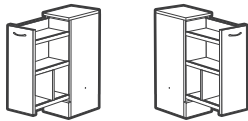

LEFT RIGHT
Vertical Utility Drawer*

Z12L2VDL	24 x 12 x 29.5-30	85	95.55	6.75	\$926	\$956	N/A	\$63
Z12M2VDL	20 x 12 x 29.5-30	85	80.85	5.75	\$808	\$835	N/A	\$63
Z12S2VDL	16 x 12 x 29.5-30	85	68.25	4.75	\$721	\$748	N/A	\$63
Z12L2VDR	24 x 12 x 29.5-30	85	95.55	6.75	\$926	\$956	N/A	\$63
Z12M2VDR	20 x 12 x 29.5-30	85	80.85	5.75	\$808	\$835	N/A	\$63
Z12S2VDR	16 x 12 x 29.5-30	85	68.25	4.75	\$721	\$748	N/A	\$63

Specify **VDL** models for **LEFT** or **VDR** models for **RIGHT**

One vertical drawer. Lock secures vertical drawer.

STORAGE MODULES - 41.3"/41.8" HIGH

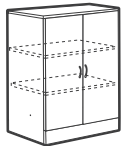

Storage Cabinet with Doors**



Glazed door option

MODEL#	DIMENSIONS	FREIGHT CLASS	WT/LBS.	CUBIC FT.	1" TOP	1.5" TOP	GLAZE ADD	HP ADD
Z36L4SH	24 x 36 x 41.3-41.8	125	185.85	25	\$1473	\$1547	\$940	\$180
Z30L4SH	24 x 30 x 41.3-41.8	125	161.70	21.25	\$1349	\$1411	\$821	\$150
Z36M4SH	20 x 36 x 41.3-41.8	125	165.90	21.25	\$1375	\$1439	\$940	\$180
Z30M4SH	20 x 30 x 41.3-41.8	125	143.85	18	\$1244	\$1299	\$821	\$150
Z36S4SH	16 x 36 x 41.3-41.8	100	142.80	17.50	\$1245	\$1307	\$940	\$135
Z30S4SH	16 x 30 x 41.3-41.8	100	121.80	14.50	\$1117	\$1159	\$821	\$77

Laminate doors are standard. **Includes two 3-position fixed/height adjustable shelves.** Standard with lock.

Required Specifications

Top finish
Top/edge detail
Handles*
Base finish

Optional Specifications

HP laminate
Glazed doors**
Key #

STORAGE MODULES - 41.3"/41.8" HIGH

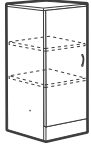

Glazed door option

Storage Cabinet with Door - LEFT*

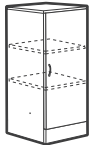

Glazed door option

Storage Cabinet with Door - RIGHT*

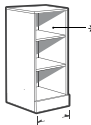

21", 18", 16", 15" & 12"

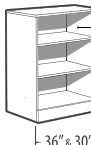

36" & 30"



* Accepts collator 11" high
** Accepts collator 11.3" high

Open Storage Cabinet**

MODEL#	DIMENSIONS	FREIGHT CLASS	WT/LBS.	CUBIC FT.	1" TOP	1.5" TOP	GLAZE ADD	HP ADD
D x W x H								
Z21L4SHL	24 x 21 x 41.3-41.8	100	123.90	15.25	\$1092	\$1144	\$518	\$121
Z18L4SHL	24 x 18 x 41.3-41.8	100	112.35	13.25	\$1029	\$1071	\$465	\$93
Z16L4SHL	24 x 16 x 41.3-41.8	100	105	12	\$967	\$1010	\$459	\$93
Z15L4SHL	24 x 15 x 41.3-41.8	100	100.80	11.25	\$927	\$961	\$408	\$93
Z12L4SHL	24 x 12 x 41.3-41.8	100	89.25	9.25	\$859	\$889	\$368	\$63
Z21M4SHL	20 x 21 x 41.3-41.8	100	116.55	13	\$985	\$1028	\$518	\$121
Z18M4SHL	20 x 18 x 41.3-41.8	100	98.70	11.25	\$932	\$970	\$465	\$93
Z16M4SHL	20 x 16 x 41.3-41.8	100	91.35	10.25	\$875	\$913	\$459	\$77
Z15M4SHL	20 x 15 x 41.3-41.8	100	88.20	9.50	\$838	\$868	\$408	\$77
Z12M4SHL	20 x 12 x 41.3-41.8	100	78.75	8	\$779	\$806	\$368	\$63
Z21S4SHL	16 x 21 x 41.3-41.8	100	94.50	10.50	\$880	\$915	\$518	\$93
Z18S4SHL	16 x 18 x 41.3-41.8	100	84	9.50	\$844	\$879	\$465	\$77
Z16S4SHL	16 x 16 x 41.3-41.8	100	76.65	8.50	\$791	\$826	\$459	\$77
Z15S4SHL	16 x 15 x 41.3-41.8	100	73.50	8	\$749	\$779	\$408	\$77
Z12S4SHL	16 x 12 x 41.3-41.8	92.5	65.10	6.50	\$693	\$719	\$368	\$63

Laminate doors are standard. Includes two 3-position fixed/height adjustable shelves. Standard with lock.

Z21L4SHR	24 x 21 x 41.3-41.8	100	123.90	15.25	\$1092	\$1144	\$518	\$121
Z18L4SHR	24 x 18 x 41.3-41.8	100	112.35	13.25	\$1029	\$1071	\$465	\$93
Z16L4SHR	24 x 16 x 41.3-41.8	100	105	12	\$967	\$1010	\$459	\$93
Z15L4SHR	24 x 15 x 41.3-41.8	100	100.80	11.25	\$927	\$961	\$408	\$93
Z12L4SHR	24 x 12 x 41.3-41.8	100	89.25	9.25	\$859	\$889	\$368	\$63
Z21M4SHR	20 x 21 x 41.3-41.8	100	116.55	13	\$985	\$1028	\$518	\$121
Z18M4SHR	20 x 18 x 41.3-41.8	100	98.70	11.25	\$932	\$970	\$465	\$93
Z16M4SHR	20 x 16 x 41.3-41.8	100	91.35	10.25	\$875	\$913	\$459	\$77
Z15M4SHR	20 x 15 x 41.3-41.8	100	88.20	9.50	\$838	\$868	\$408	\$77
Z12M4SHR	20 x 12 x 41.3-41.8	100	78.75	8	\$779	\$806	\$368	\$63
Z21S4SHR	16 x 21 x 41.3-41.8	100	94.50	10.50	\$880	\$915	\$518	\$93
Z18S4SHR	16 x 18 x 41.3-41.8	100	84	9.50	\$844	\$879	\$465	\$77
Z16S4SHR	16 x 16 x 41.3-41.8	100	76.65	8.50	\$791	\$826	\$459	\$77
Z15S4SHR	16 x 15 x 41.3-41.8	100	73.50	8	\$749	\$779	\$408	\$77
Z12S4SHR	16 x 12 x 41.3-41.8	92.5	65.10	6.50	\$693	\$719	\$368	\$63

Laminate doors are standard. Includes two 3-position fixed/height adjustable shelves. Standard with lock.

Z36L4SHN	24 x 36 x 41.3-41.8	125	162.55	25	\$1160	\$1233	N/A	\$180
Z30L4SHN	24 x 30 x 41.3-41.8	125	142.46	21.25	\$1069	\$1132	N/A	\$150
Z21L4SHN	24 x 21 x 41.3-41.8	125	111.80	15.25	\$917	\$968	N/A	\$121
Z18L4SHN	24 x 18 x 41.3-41.8	125	101.23	13.25	\$867	\$910	N/A	\$93
Z16L4SHN	24 x 16 x 41.3-41.8	125	94.53	12	\$809	\$851	N/A	\$93
Z15L4SHN	24 x 15 x 41.3-41.8	100	91.70	11.25	\$782	\$817	N/A	\$93
Z12L4SHN	24 x 12 x 41.3-41.8	100	81.13	9.25	\$727	\$757	N/A	\$63
Z36M4SHN	20 x 36 x 41.3-41.8	125	141.59	21.25	\$1062	\$1125	N/A	\$180
Z30M4SHN	20 x 30 x 41.3-41.8	125	123.94	18	\$965	\$1020	N/A	\$150
Z21M4SHN	20 x 21 x 41.3-41.8	125	102.19	13	\$811	\$854	N/A	\$121
Z18M4SHN	20 x 18 x 41.3-41.8	125	86.54	11.25	\$773	\$811	N/A	\$93
Z16M4SHN	20 x 16 x 41.3-41.8	125	81.01	10.25	\$715	\$753	N/A	\$93
Z15M4SHN	20 x 15 x 41.3-41.8	100	78.24	9.50	\$694	\$724	N/A	\$93
Z12M4SHN	20 x 12 x 41.3-41.8	100	69.95	8	\$646	\$673	N/A	\$63
Z36S4SHN	16 x 36 x 41.3-41.8	125	119.57	17.50	\$929	\$992	N/A	\$135
Z30S4SHN	16 x 30 x 41.3-41.8	125	111.72	14.50	\$838	\$881	N/A	\$121
Z21S4SHN	16 x 21 x 41.3-41.8	125	81.04	10.50	\$705	\$739	N/A	\$93
Z18S4SHN	16 x 18 x 41.3-41.8	125	72.91	9.50	\$683	\$721	N/A	\$77
Z16S4SHN	16 x 16 x 41.3-41.8	125	67.49	8.50	\$632	\$667	N/A	\$77
Z15S4SHN	16 x 15 x 41.3-41.8	100	64.78	8	\$604	\$633	N/A	\$77
Z12S4SHN	16 x 12 x 41.3-41.8	100	57.71	6.50	\$559	\$586	N/A	\$63

Includes two 3-position fixed/height adjustable shelves.

Required Specifications

- Top finish
- Top/edge detail
- Handles*
- Base finish

Optional Specifications

- Glazed door*
- HP laminate
- Collator**

STORAGE MODULES - 41.3"/41.8" HIGH

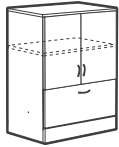

Glazed door option

File Module with Doors*†

MODEL#	DIMENSIONS D x W x H	FREIGHT CLASS	WT./LBS.	CUBIC FT.	1" TOP	1.5" TOP	GLAZE ADD	HP ADD
Z36L4F	24 x 36 x 41.3-41.8	100	204.75	25	\$1828	\$1902	\$733	\$180
Z30L4F	24 x 30 x 41.3-41.8	100	179.55	21.25	\$1689	\$1752	\$647	\$150
Z36M4F	20 x 36 x 41.3-41.8	100	183.75	21.25	\$1723	\$1786	\$733	\$180
Z30M4F	20 x 30 x 41.3-41.8	100	160.65	18	\$1584	\$1639	\$647	\$150
Z36S4F	16 x 36 x 41.3-41.8	100	148.05	17.50	\$1556	\$1618	\$733	\$135
Z30S4F	16 x 30 x 41.3-41.8	100	133.35	14.50	\$1408	\$1450	\$647	\$121

One lateral file drawer. Laminate doors are standard. **Includes one 3-position fixed/height adjustable shelf.** Upper lock secures storage compartment. Lower lock secures one file drawer. Front-to-back and side-to-side letter/legal filing capability. Side-to-side file bars included.

- Lateral file drawer construction is for accommodating hanging files NOT for stacking materials on the drawer bottom.

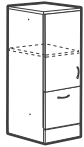

Glazed door option

File Module with Door - LEFT*

Z16L4FL	24 x 16 x 41.3-41.8	100	116.55	12	\$1136	\$1178	\$357	\$93
Z15L4FL	24 x 15 x 41.3-41.8	100	111.30	11.25	\$1092	\$1127	\$322	\$93
Z16M4FL	20 x 16 x 41.3-41.8	100	101.85	10.25	\$1057	\$1095	\$357	\$93
Z15M4FL	20 x 15 x 41.3-41.8	92.5	100.80	9.50	\$1013	\$1043	\$322	\$93
Z16S4FL	16 x 36 x 41.3-41.8	150	84	17.50	\$944	\$979	\$357	\$77
Z15S4FL	16 x 30 x 41.3-41.8	150	82.95	14.50	\$909	\$938	\$322	\$77

One file drawer. Laminate door is standard. **Includes one 3-position fixed/height adjustable shelf.** Upper lock secures storage compartment. Lower lock secures one file drawer.

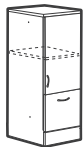

Glazed door option

File Module with Door - RIGHT*

Z16L4FR	24 x 16 x 41.3-41.8	100	116.55	12	\$1136	\$1178	\$357	\$93
Z15L4FR	24 x 15 x 41.3-41.8	100	111.30	11.25	\$1092	\$1127	\$322	\$93
Z16M4FR	20 x 16 x 41.3-41.8	100	101.85	10.25	\$1057	\$1095	\$357	\$93
Z15M4FR	20 x 15 x 41.3-41.8	92.5	100.80	9.50	\$1013	\$1043	\$322	\$93
Z16S4FR	16 x 16 x 41.3-41.8	150	84	17.50	\$944	\$979	\$357	\$77
Z15S4FR	16 x 15 x 41.3-41.8	150	82.95	14.50	\$909	\$938	\$322	\$77

One file drawer. Laminate door is standard. **Includes one 3-position fixed/height adjustable shelf.** Upper lock secures storage compartment. Lower lock secures one file drawer.

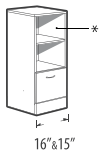
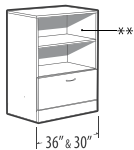

* Accepts collator 11" high
** Accepts collator 11.3" high

File Module with Open Shelves**†

Z36L4FN	24 x 36 x 41.3-41.8	125	189.43	25	\$1572	\$1624	N/A	\$180
Z30L4FN	24 x 30 x 41.3-41.8	125	166.96	21.25	\$1458	\$1501	N/A	\$150
Z16L4FN	24 x 16 x 41.3-41.8	100	109.63	12	\$1001	\$1044	N/A	\$93
Z15L4FN	24 x 15 x 41.3-41.8	100	105.53	11.25	\$973	\$1008	N/A	\$93
Z36M4FN	20 x 36 x 41.3-41.8	125	167.42	21.25	\$1466	\$1529	N/A	\$180
Z30M4FN	20 x 30 x 41.3-41.8	100	147.39	18	\$1352	\$1405	N/A	\$150
Z16M4FN	20 x 16 x 41.3-41.8	100	95.06	10.25	\$926	\$964	N/A	\$93
Z15M4FN	20 x 15 x 41.3-41.8	100	94.17	9.50	\$892	\$924	N/A	\$93
Z36S4FN	16 x 36 x 41.3-41.8	125	132.80	17.50	\$1298	\$1360	N/A	\$135
Z30S4FN	16 x 30 x 41.3-41.8	100	119.42	14.50	\$1173	\$1215	N/A	\$121
Z16S4FN	16 x 16 x 41.3-41.8	100	78.39	8.50	\$784	\$819	N/A	\$77
Z15S4FN	16 x 15 x 41.3-41.8	100	76.51	8	\$766	\$796	N/A	\$77

Two open shelves and one file drawer on bottom. **Includes one 3-position fixed/height adjustable shelf.** Lock secures one file drawer. 36" and 30" wide models have front-to-back and side-to-side letter/legal filing capability. Side-to-side file bars included.

- Lateral file drawer construction is for accommodating hanging files NOT for stacking materials on the drawer bottom.

Required Specifications

Top finish
Top/edge detail
Handles
Base finish

Optional Specifications

Glazed doors*
HP laminate
Collator**

Box drawer† - no upcharge (30" - 36" wide models only)

STORAGE MODULES - 41.3"/41.8" HIGH

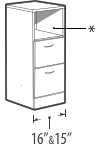
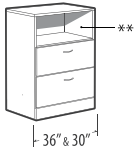

* Accepts collator 11" high
** Accepts collator 11.3" high

Two File Module with Open Shelf**

MODEL#	DIMENSIONS D x W x H	FREIGHT CLASS	WT/LBS.	CUBIC FT.	1" TOP	1.5" TOP	GLAZE ADD	HP ADD
Z36L4EN	24 x 36 x 41.3-41.8	125	199.50	25	\$1875	\$1948	N/A	\$180
Z30L4EN	24 x 30 x 41.3-41.8	100	178.50	21.25	\$1790	\$1852	N/A	\$150
Z16L4EN	24 x 16 x 41.3-41.8	100	116.55	12	\$1125	\$1168	N/A	\$93
Z15L4EN	24 x 15 x 41.3-41.8	100	112.35	11.25	\$1093	\$1128	N/A	\$93
Z36M4EN	20 x 36 x 41.3-41.8	100	182	21.25	\$1788	\$1851	N/A	\$180
Z30M4EN	20 x 30 x 41.3-41.8	100	163	18	\$1695	\$1748	N/A	\$150
Z16M4EN	20 x 16 x 41.3-41.8	92.5	105	10.25	\$1035	\$1073	N/A	\$93
Z15M4EN	20 x 15 x 41.3-41.8	92.5	101	9.50	\$1006	\$1036	N/A	\$93
Z36S4EN	16 x 36 x 41.3-41.8	100	153.30	17.50	\$1639	\$1701	N/A	\$135
Z30S4EN	16 x 30 x 41.3-41.8	100	131.25	14.50	\$1492	\$1534	N/A	\$121
Z16S4EN	16 x 16 x 41.3-41.8	92.5	85.05	8.50	\$950	\$985	N/A	\$77
Z15S4EN	16 x 15 x 41.3-41.8	92.5	82.95	8	\$926	\$955	N/A	\$77

Open fixed shelf and two file drawers on bottom. Lock secures all drawers. 36" and 30" wide models have front-to-back and side-to-side letter/legal filing capability. Side-to-side file bars included.

- Lateral file drawer construction is for accommodating hanging files NOT for stacking materials on the drawer bottom.



Three File Module†

Z36L43F	24 x 36 x 41.3-41.8	100	210	25	\$2203	\$2276	N/A	\$180
Z30L43F	24 x 30 x 41.3-41.8	100	190.05	21.25	\$2093	\$2156	N/A	\$150
Z16L43F	24 x 16 x 41.3-41.8	92.5	126	12	\$1294	\$1336	N/A	\$77
Z15L43F	24 x 15 x 41.3-41.8	92.5	120.75	11.25	\$1259	\$1294	N/A	\$77
Z36M43F	20 x 36 x 41.3-41.8	100	198.45	21.25	\$2144	\$2207	N/A	\$180
Z30M43F	20 x 30 x 41.3-41.8	100	177.45	18	\$2002	\$2057	N/A	\$150
Z16M43F	20 x 16 x 41.3-41.8	92.5	114.45	10.25	\$1207	\$1245	N/A	\$77
Z15M43F	20 x 15 x 41.3-41.8	92.5	110.25	9.50	\$1176	\$1206	N/A	\$77
Z36S43F	16 x 36 x 41.3-41.8	100	165.90	17.50	\$1935	\$1997	N/A	\$135
Z30S43F	16 x 30 x 41.3-41.8	92.5	148.05	14.50	\$1782	\$1825	N/A	\$121
Z16S43F	16 x 16 x 41.3-41.8	92.5	94.50	8.50	\$1141	\$1176	N/A	\$77
Z15S43F	16 x 15 x 41.3-41.8	92.5	91.35	8	\$1104	\$1134	N/A	\$77

Three file drawers. Lock secures all drawers. 36" and 30" wide models have front-to-back and side-to-side letter/legal filing capability. Side-to-side file bars included.

- Lateral file drawer construction is for accommodating hanging files NOT for stacking materials on the drawer bottom.



Three File Module

Z36L4S3F	24 x 36 x 41.3-41.8	100	233	25	\$2713	\$2786	N/A	\$180
Z36M4S3F	20 x 36 x 41.3-41.8	92.5	221	21.25	\$2632	\$2696	N/A	\$150

Three lateral file drawers with steel drawer interior. Lock secures all drawers. Front-to-back and side-to-side letter/legal filing capability. Side-to-side file bars included.

- Front-to-back filing bars available separately. Order **FBB** bars. See "FBB" on page 41
- Lateral file drawer construction is for accommodating hanging files NOT for stacking materials on the drawer bottom.
- To prevent overloading, steel drawers do not include a back panel

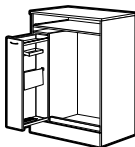

Intended for working while standing

Media Center - LEFT

Z36L4MCL	24 x 36 x 41.3-41.8	100	206.85	25	\$2006	\$2079	N/A	\$180
Z30L4MCL	24 x 30 x 41.3-41.8	100	185.85	21.25	\$1892	\$1955	N/A	\$150
Z36M4MCL	20 x 36 x 41.3-41.8	100	172.20	21.25	\$1755	\$1818	N/A	\$180
Z30M4MCL	20 x 30 x 41.3-41.8	100	153.30	18	\$1638	\$1693	N/A	\$150
Z36S4MCL	16 x 36 x 41.3-41.8	100	172	17.50	\$1683	\$1746	N/A	\$135
Z30S4MCL	16 x 30 x 41.3-41.8	92.5	153	14.50	\$1537	\$1580	N/A	\$121

Standing height unit, accommodates pc, keyboard, monitor, hanging folders and accessories and/or printer. One vertical drawer on the left. Pull out keyboard shelf. Adjustable pull out bottom shelf accommodates pc and/or printer. Grommet in worksurface and back panel. Lock secures vertical drawer.

Required Specifications

- Top finish
- Top/edge detail
- Handles
- Base finish

Optional Specifications

- HP laminate
- Box drawer^a - no upcharge (30" - 36" wide models only)
- Collator*

STORAGE MODULES - 41.3"/41.8" HIGH

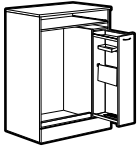

Media Center - RIGHT

MODEL#	DIMENSIONS D x W x H	FREIGHT CLASS	WT/LBS.	CUBIC FT.	1" TOP	1.5" TOP	GLAZE ADD	HP ADD
Z36L4MCR	24 x 36 x 41.3-41.8	100	206.85	25	\$2006	\$2079	N/A	\$180
Z30L4MCR	24 x 30 x 41.3-41.8	100	185.85	21.25	\$1892	\$1955	N/A	\$150
Z36M4MCR	20 x 36 x 41.3-41.8	100	172.20	21.25	\$1755	\$1818	N/A	\$180
Z30M4MCR	20 x 30 x 41.3-41.8	100	153.30	18	\$1638	\$1693	N/A	\$150
Z36S4MCR	16 x 36 x 41.3-41.8	100	172	17.50	\$1683	\$1746	N/A	\$135
Z30S4MCR	16 x 30 x 41.3-41.8	92.5	153	14.50	\$1537	\$1580	N/A	\$121

Standing height unit, accommodates pc, keyboard, monitor, hanging folders and accessories and/or printer. One vertical drawer on the **right**. Pull out keyboard shelf. Adjustable pull out bottom shelf accommodates pc and/or printer. Grommet in worksurface and back panel. Lock secures vertical drawer.

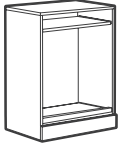

PC Center

Z36L4PC	24 x 36 x 41.3-41.8	125	169.05	25	\$1288	\$1362	N/A	\$180
Z30L4PC	24 x 30 x 41.3-41.8	125	147	21.25	\$1170	\$1233	N/A	\$150
Z36M4PC	20 x 36 x 41.3-41.8	125	152.25	21.25	\$1222	\$1285	N/A	\$180
Z30M4PC	20 x 30 x 41.3-41.8	125	132.30	18	\$1083	\$1138	N/A	\$150
Z36S4PC	16 x 36 x 41.3-41.8	100	150	17.50	\$1084	\$1146	N/A	\$135
Z30S4PC	16 x 30 x 41.3-41.8	100	129	14.50	\$940	\$982	N/A	\$121

Standing height unit, accommodates pc, keyboard, monitor and/or printer. Pull out keyboard shelf. Adjustable pull out bottom shelf accommodates pc and/or printer. Grommet in worksurface and back panel.

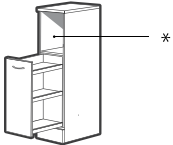

Vertical Utility Drawer - LEFT*

Z12L4VDNL	24 x 12 x 41.3-41.8	85	117.60	9.25	\$1062	\$1094	N/A	\$63
Z12M4VDNL	20 x 12 x 41.3-41.8	85	98.70	8	\$940	\$967	N/A	\$63
Z12S4VDNL	16 x 12 x 41.3-41.8	85	82.95	6.50	\$821	\$848	N/A	\$63

One vertical drawer. Lock secures vertical drawer.

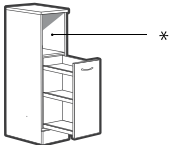

Vertical Utility Drawer - RIGHT*

Z12L4VDNR	24 x 12 x 41.3-41.8	85	117.60	9.25	\$1062	\$1094	N/A	\$63
Z12M4VDNR	20 x 12 x 41.3-41.8	85	98.70	8	\$940	\$967	N/A	\$63
Z12S4VDNR	16 x 12 x 41.3-41.8	85	82.95	6.50	\$821	\$848	N/A	\$63

One vertical drawer. Lock secures vertical drawer.

STORAGE MODULES - 53" / 53.5" HIGH

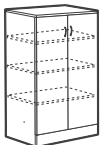

Storage Cabinet with Doors**

MODEL#	DIMENSIONS	FREIGHT CLASS	WT/LBS.	CUBIC FT.	1" TOP	1.5" TOP	GLAZE ADD	HP ADD
Z36L5SH	24 x 36 x 53-53.5	125	229.95	31.25	\$1776	\$1849	\$1153	\$180
Z30L5SH	24 x 30 x 53-53.5	125	199.50	27	\$1618	\$1681	\$1001	\$150
Z36M5SH	20 x 36 x 53-53.5	125	203.70	27	\$1654	\$1717	\$1153	\$180
Z30M5SH	20 x 30 x 53-53.5	100	184.80	22.75	\$1452	\$1505	\$1001	\$150
Z36S5SH	16 x 36 x 53-53.5	100	175.35	21.75	\$1550	\$1612	\$1153	\$135
Z30S5SH	16 x 30 x 53-53.5	100	152.25	18.50	\$1358	\$1400	\$1001	\$121

Laminate doors are standard. **Includes three 3-position fixed/height adjustable shelves.** Standard with lock.

Required Specifications

- Top finish
- Top/edge detail
- Handles
- Base finish

Optional Specifications

- HP laminate
- Collator*
- Glazed doors**

STORAGE MODULES - 53" / 53.5" HIGH

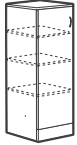

Glazed door option

Storage Cabinet with Door - LEFT**

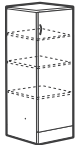

Glazed door option

Storage Cabinet with Door - RIGHT**

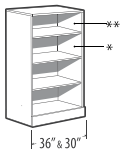

Open Storage Cabinet*

* Accepts collator 11" high
** Accepts collator 11.3" high

MODEL#	DIMENSIONS	FREIGHT CLASS	WT/LBS.	CUBIC FT.	1" TOP	1.5" TOP	GLAZE ADD	HP ADD	
D x W x H									
Z21L5SHL	24 x 21 x 53-53.5	125	154.35	19.50	\$1279	\$1331	\$639	\$121	
Z18L5SHL	24 x 18 x 53-53.5	100	139.65	17	\$1218	\$1261	\$574	\$93	
Z16L5SHL	24 x 16 x 53-53.5	100	130.20	15.50	\$1153	\$1196	\$568	\$93	
Z15L5SHL	24 x 15 x 53-53.5	100	124.95	14.25	\$1100	\$1135	\$499	\$93	
Z12L5SHL	24 x 12 x 53-53.5	100	110.25	11.75	\$1024	\$1054	\$450	\$63	
Z21M5SHL	20 x 21 x 53-53.5	100	142.80	16.50	\$1170	\$1213	\$639	\$121	
Z18M5SHL	20 x 18 x 53-53.5	100	122.85	14.25	\$1108	\$1147	\$574	\$93	
Z16M5SHL	20 x 16 x 53-53.5	100	113.40	13	\$1050	\$1088	\$568	\$93	
Z15M5SHL	20 x 15 x 53-53.5	100	109.20	12.25	\$997	\$1029	\$499	\$93	
Z12M5SHL	20 x 12 x 53-53.5	100	96.60	10	\$925	\$953	\$450	\$63	
Z21S5SHL	16 x 21 x 53-53.5	100	116.55	13.25	\$1088	\$1122	\$639	\$93	
Z18S5SHL	16 x 18 x 53-53.5	100	103.95	11.50	\$1035	\$1070	\$574	\$77	
Z16S5SHL	16 x 16 x 53-53.5	100	96.60	10.50	\$980	\$1015	\$568	\$77	
Z15S5SHL	16 x 15 x 53-53.5	100	91.35	9.75	\$943	\$972	\$499	\$77	
Z12S5SHL	16 x 12 x 53-53.5	100	79.80	8.25	\$867	\$894	\$450	\$63	

Laminate doors are standard. Includes three 3-position fixed/height adjustable shelves. Standard with lock.

Z21L5SHR	24 x 21 x 53-53.5	125	154.35	19.50	\$1279	\$1331	\$639	\$121
Z18L5SHR	24 x 18 x 53-53.5	100	139.65	17	\$1218	\$1261	\$574	\$93
Z16L5SHR	24 x 16 x 53-53.5	100	130.20	15.50	\$1153	\$1196	\$568	\$93
Z15L5SHR	24 x 15 x 53-53.5	100	124.95	14.25	\$1100	\$1135	\$499	\$93
Z12L5SHR	24 x 12 x 53-53.5	100	110.25	11.75	\$1024	\$1054	\$450	\$63
Z21M5SHR	20 x 21 x 53-53.5	100	142.80	16.50	\$1170	\$1213	\$639	\$121
Z18M5SHR	20 x 18 x 53-53.5	100	122.85	14.25	\$1108	\$1147	\$574	\$93
Z16M5SHR	20 x 16 x 53-53.5	100	113.40	13	\$1050	\$1088	\$568	\$93
Z15M5SHR	20 x 15 x 53-53.5	100	109.20	12.25	\$997	\$1029	\$499	\$93
Z12M5SHR	20 x 12 x 53-53.5	100	96.60	10	\$925	\$953	\$450	\$63
Z21S5SHR	16 x 21 x 53-53.5	100	116.55	13.25	\$1088	\$1122	\$639	\$93
Z18S5SHR	16 x 18 x 53-53.5	100	103.95	11.50	\$1035	\$1070	\$574	\$77
Z16S5SHR	16 x 16 x 53-53.5	100	96.60	10.50	\$980	\$1015	\$568	\$77
Z15S5SHR	16 x 15 x 53-53.5	100	91.35	9.75	\$943	\$972	\$499	\$77
Z12S5SHR	16 x 12 x 53-53.5	100	79.80	8.25	\$867	\$894	\$450	\$63

Laminate doors are standard. Includes three 3-position fixed/height adjustable shelves. Standard with lock.

Z36L5SHN	24 x 36 x 53-53.5	125	198.49	31.25	\$1382	\$1456	N/A	\$180
Z30L5SHN	24 x 30 x 53-53.5	125	173.45	27	\$1291	\$1354	N/A	\$150
Z21L5SHN	24 x 21 x 53-53.5	125	136.43	19.50	\$1062	\$1114	N/A	\$121
Z18L5SHN	24 x 18 x 53-53.5	125	124.44	17	\$1020	\$1063	N/A	\$93
Z16L5SHN	24 x 16 x 53-53.5	125	116.10	15.50	\$953	\$995	N/A	\$93
Z15L5SHN	24 x 15 x 53-53.5	125	112.45	14.25	\$922	\$957	N/A	\$93
Z12L5SHN	24 x 12 x 53-53.5	100	100.46	11.75	\$861	\$891	N/A	\$63
Z36M5SHN	20 x 36 x 53-53.5	125	172.27	27	\$1258	\$1322	N/A	\$180
Z30M5SHN	20 x 30 x 53-53.5	125	158.08	22.75	\$1125	\$1180	N/A	\$150
Z21M5SHN	20 x 21 x 53-53.5	125	123.68	16.50	\$950	\$993	N/A	\$121
Z18M5SHN	20 x 18 x 53-53.5	125	106.61	14.25	\$907	\$946	N/A	\$93
Z16M5SHN	20 x 16 x 53-53.5	125	99.43	13	\$848	\$886	N/A	\$93
Z15M5SHN	20 x 15 x 53-53.5	125	95.84	12.25	\$819	\$851	N/A	\$93
Z12M5SHN	20 x 12 x 53-53.5	100	85.07	10	\$761	\$789	N/A	\$63
Z36S5SHN	16 x 36 x 53-53.5	125	145.01	21.75	\$1099	\$1161	N/A	\$135
Z30S5SHN	16 x 30 x 53-53.5	125	126.96	18.50	\$989	\$1031	N/A	\$121
Z21S5SHN	16 x 21 x 53-53.5	125	98.33	13.25	\$835	\$870	N/A	\$93
Z18S5SHN	16 x 18 x 53-53.5	125	88.78	11.50	\$800	\$838	N/A	\$77
Z16S5SHN	16 x 16 x 53-53.5	125	82.76	10.50	\$747	\$782	N/A	\$77
Z15S5SHN	16 x 15 x 53-53.5	100	78.18	9.75	\$735	\$764	N/A	\$77
Z12S5SHN	16 x 12 x 53-53.5	100	69.69	8.25	\$681	\$708	N/A	\$63

Includes three 3-position fixed/height adjustable shelves

Required Specifications

- Top finish
- Top/edge detail
- Handles
- Base finish

Optional Specifications

- HP laminate
- Collator*
- Glazed doors**

STORAGE MODULES - 53" / 53.5" HIGH

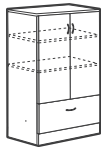

Glazed door option

File Module with Doors**†

MODEL#	DIMENSIONS D x W x H	FREIGHT CLASS	WT./LBS.	CUBIC FT.	1" TOP	1.5" TOP	GLAZE ADD	HP ADD
Z36L5F	24 x 36 x 53-53.5	125	247.80	31.25	\$2126	\$2200	\$940	\$180
Z30L5F	24 x 30 x 53-53.5	100	216.30	27	\$1998	\$2061	\$821	\$150
Z36M5F	20 x 36 x 53-53.5	100	221.55	27	\$2002	\$2065	\$940	\$180
Z30M5F	20 x 30 x 53-53.5	100	204.75	22.75	\$1829	\$1884	\$821	\$150
Z36S5F	16 x 36 x 53-53.5	100	189	21.75	\$1815	\$1878	\$940	\$135
Z30S5F	16 x 30 x 53-53.5	100	163.80	18.50	\$1616	\$1658	\$821	\$121

One lateral file drawer. Laminate doors are standard. **Includes two 3-position fixed/height adjustable shelves.** Upper lock secures storage compartment. Lower lock secures one file drawer. Front-to-back and side-to-side letter/legal filing capability. Side-to-side file bars included.

- Lateral file drawer construction is for accommodating hanging files NOT for stacking materials on the drawer bottom.

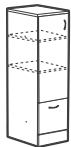

Glazed door option

File Module with Door - LEFT**

Z16L5FL	24 x 16 x 53-53.5	100	140.70	15.50	\$1315	\$1358	\$484	\$93
Z15L5FL	24 x 15 x 53-53.5	100	134.40	14.25	\$1260	\$1295	\$422	\$93
Z16M5FL	20 x 16 x 53-53.5	100	123.90	13	\$1211	\$1249	\$457	\$93
Z15M5FL	20 x 15 x 53-53.5	100	119.70	12.25	\$1159	\$1189	\$422	\$93
Z16S5FL	16 x 16 x 53-53.5	92.5	105	10.50	\$1106	\$1141	\$457	\$77
Z15S5FL	16 x 15 x 53-53.5	92.5	99.75	9.75	\$1080	\$1110	\$422	\$77

One file drawer. Laminate door is standard. **Includes two 3-position fixed/height adjustable shelves.** Upper lock secures storage compartment. Lower lock secures one file drawer.

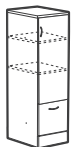

Glazed door option

File Module with Door - RIGHT**

Z16L5FR	24 x 16 x 53-53.5	100	140.70	15.50	\$1315	\$1358	\$484	\$93
Z15L5FR	24 x 15 x 53-53.5	100	134.40	14.25	\$1260	\$1295	\$422	\$93
Z16M5FR	20 x 16 x 53-53.5	100	123.90	13	\$1211	\$1249	\$457	\$93
Z15M5FR	20 x 15 x 53-53.5	100	119.70	12.25	\$1159	\$1189	\$422	\$93
Z16S5FR	16 x 16 x 53-53.5	92.5	105	10.50	\$1106	\$1141	\$457	\$77
Z15S5FR	16 x 15 x 53-53.5	92.5	99.75	9.75	\$1080	\$1110	\$422	\$77

One file drawer. Laminate door is standard. **Includes two 3-position fixed/height adjustable shelves.** Upper lock secures storage compartment. Lower lock secures one file drawer.

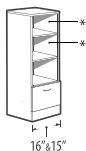
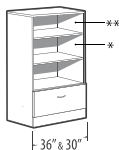

* Accepts collator 11" high
** Accepts collator 11.3" high

File Module with Open Shelves**†

Z36L5FN	24 x 36 x 53-53.5	125	224.32	31.25	\$1800	\$1874	N/A	\$180
Z30L5FN	24 x 30 x 53-53.5	125	196.91	27	\$1718	\$1781	N/A	\$150
Z16L5FN	24 x 16 x 53-53.5	100	130.15	15.50	\$1157	\$1199	N/A	\$93
Z15L5FN	24 x 15 x 53-53.5	100	125.23	14.25	\$1117	\$1152	N/A	\$93
Z36M5FN	20 x 36 x 53-53.5	125	197.05	27	\$1676	\$1739	N/A	\$180
Z30M5FN	20 x 30 x 53-53.5	125	174.19	22.75	\$1551	\$1604	N/A	\$150
Z16M5FN	20 x 16 x 53-53.5	100	113.48	13	\$1052	\$1090	N/A	\$93
Z15M5FN	20 x 15 x 53-53.5	100	109.67	12.25	\$1014	\$1044	N/A	\$93
Z36S5FN	16 x 36 x 53-53.5	125	166.64	21.75	\$1490	\$1553	N/A	\$135
Z30S5FN	16 x 30 x 53-53.5	125	145.17	18.50	\$1335	\$1377	N/A	\$121
Z16S5FN	16 x 16 x 53-53.5	100	94.71	10.50	\$947	\$982	N/A	\$77
Z15S5FN	16 x 15 x 53-53.5	100	89.91	9.75	\$935	\$965	N/A	\$77

Three open shelves and one file drawer on bottom. **Includes two 3-position fixed/height adjustable shelves.** Lock secures file drawer. 36" and 30" wide models have front-to-back and side-to-side letter/legal filing capability. Side-to-side file bars included

- Lateral file drawer construction is for accommodating hanging files NOT for stacking materials on the drawer bottom.

Required Specifications

Top finish
Top/edge detail
Handles
Base finish

Optional Specifications

HP laminate
Collator*
Glazed doors**

Box drawer† - no upcharge (30"- 36" wide models only)

STORAGE MODULES - 53" / 53.5" HIGH

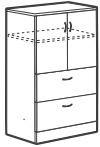

Glazed door option

Two File Module with Doors**

MODEL#	DIMENSIONS D x W x H	FREIGHT CLASS	WT/LBS.	CUBIC FT.	1" TOP	1.5" TOP	GLAZE ADD	HP ADD
Z36L5E	24 x 36 x 53-53.5	100	250.95	31.25	\$2409	\$2483	\$705	\$180
Z30L5E	24 x 30 x 53-53.5	100	222.60	27	\$2247	\$2310	\$618	\$150
Z36M5E	20 x 36 x 53-53.5	100	229.95	27	\$2298	\$2362	\$733	\$180
Z30M5E	20 x 30 x 53-53.5	100	201.60	22.75	\$2093	\$2148	\$647	\$150
Z36S5E	16 x 36 x 53-53.5	100	193.20	21.75	\$2027	\$2089	\$733	\$135
Z30S5E	16 x 30 x 53-53.5	100	170.10	18.50	\$1865	\$1907	\$647	\$121

Two lateral file drawers on bottom. Laminate doors are standard. **Includes one 3-position fixed/height adjustable shelf.** Upper lock secures storage compartment. Lower lock secures two file drawers. Front-to-back and side-to-side letter/legal filing capability. Side-to-side file bars included.

- Lateral file drawer construction is for accommodating hanging files NOT for stacking materials on the drawer bottom.

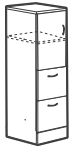

Glazed door option

Two File Module with Door - LEFT

Z16L5EL	24 x 16 x 53-53.5	100	144.90	15.50	\$1400	\$1442	\$358	\$93
Z15L5EL	24 x 15 x 53-53.5	100	139.65	14.25	\$1348	\$1383	\$322	\$93
Z16M5EL	20 x 16 x 53-53.5	92.5	130.20	13	\$1301	\$1339	\$357	\$93
Z15M5EL	20 x 15 x 53-53.5	92.5	126	12.25	\$1250	\$1282	\$322	\$93
Z16S5EL	16 x 16 x 53-53.5	92.5	109.20	10.50	\$1194	\$1229	\$357	\$77
Z15S5EL	16 x 15 x 53-53.5	92.5	105	9.75	\$1172	\$1202	\$322	\$77

Two file drawers on bottom. Laminate door is standard. **Includes one 3-position fixed/height adjustable shelf.** Upper lock secures storage compartment. Lower lock secures two file drawers.

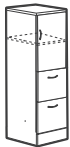

Glazed door option

Two File Module with Door - RIGHT

Z16L5ER	24 x 16 x 53-53.5	100	144.90	15.50	\$1400	\$1442	\$358	\$93
Z15L5ER	24 x 15 x 53-53.5	100	139.65	14.25	\$1348	\$1383	\$322	\$93
Z16M5ER	20 x 16 x 53-53.5	92.5	130.20	13	\$1301	\$1339	\$357	\$93
Z15M5ER	20 x 15 x 53-53.5	92.5	126	12.25	\$1250	\$1282	\$322	\$93
Z16S5ER	16 x 16 x 53-53.5	92.5	109.20	10.50	\$1194	\$1229	\$357	\$77
Z15S5ER	16 x 15 x 53-53.5	92.5	105	9.75	\$1172	\$1202	\$322	\$77

Two file drawers on bottom. Laminate door is standard. **Includes one 3-position fixed/height adjustable shelf.** Upper lock secures storage compartment. Lower lock secures two file drawers.

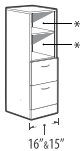
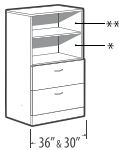

* Accepts collator 11" high
** Accepts collator 11.3" high

Two File Module with Open Shelves**

Z36L5EN	24 x 36 x 53-53.5	125	235.45	31.25	\$2151	\$2225	N/A	\$180
Z30L5EN	24 x 30 x 53-53.5	125	209.86	27	\$2013	\$2075	N/A	\$150
Z16L5EN	24 x 16 x 53-53.5	100	137.89	15.50	\$1268	\$1310	N/A	\$93
Z15L5EN	24 x 15 x 53-53.5	100	133.80	14.25	\$1229	\$1264	N/A	\$93
Z36M5EN	20 x 36 x 53-53.5	125	213.43	27	\$2043	\$2106	N/A	\$180
Z30M5EN	20 x 30 x 53-53.5	100	188.19	22.75	\$1858	\$1913	N/A	\$150
Z16M5EN	20 x 16 x 53-53.5	100	123.33	13	\$1170	\$1208	N/A	\$93
Z15M5EN	20 x 15 x 53-53.5	100	119.29	12.25	\$1129	\$1159	N/A	\$93
Z36S5EN	16 x 36 x 53-53.5	100	178.82	21.75	\$1770	\$1832	N/A	\$135
Z30S5EN	16 x 30 x 53-53.5	100	158.12	18.50	\$1631	\$1673	N/A	\$121
Z16S5EN	16 x 16 x 53-53.5	100	102.46	10.50	\$1062	\$1097	N/A	\$77
Z15S5EN	16 x 15 x 53-53.5	92.5	98.48	9.75	\$1054	\$1083	N/A	\$77

Two open shelves and two file drawers on bottom. **Includes one 3-position fixed/height adjustable shelf.** Lock secures all drawers. 36" and 30" wide models have front-to-back and side-to-side letter/legal filing capability. Side-to-side file bars included.

- Lateral file drawer construction is for accommodating hanging files NOT for stacking materials on the drawer bottom.

Required Specifications

Top finish
Top/edge detail
Handles
Base finish

Optional Specifications

HP laminate
Collator*
Glazed doors**

Box drawer* - no upcharge (30" - 36" wide models only)

STORAGE MODULES - 53" / 53.5" HIGH

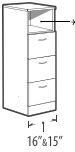
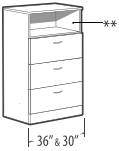

Three File Module with Open Shelf**

MODEL#	DIMENSIONS D x W x H	FREIGHT CLASS	WT./LBS.	CUBIC FT.	1" TOP	1.5" TOP	GLAZE ADD	HP ADD
Z36L53FN	24 x 36 x 53-53.5	125	247.80	31.25	\$2436	\$2510	N/A	\$180
Z30L53FN	24 x 30 x 53-53.5	100	221.55	27	\$2309	\$2372	N/A	\$150
Z16L53FN	24 x 16 x 53-53.5	100	147	15.50	\$1435	\$1477	N/A	\$93
Z15L53FN	24 x 15 x 53-53.5	100	140.70	14.25	\$1393	\$1428	N/A	\$93
Z36M53FN	20 x 36 x 53-53.5	100	227.85	27	\$2342	\$2405	N/A	\$180
Z30M53FN	20 x 30 x 53-53.5	100	203.70	22.75	\$2165	\$2218	N/A	\$150
Z16M53FN	20 x 16 x 53-53.5	92.5	132.30	13	\$1340	\$1378	N/A	\$93
Z15M53FN	20 x 15 x 53-53.5	92.5	128.10	12.25	\$1302	\$1332	N/A	\$93
Z36S53FN	16 x 36 x 53-53.5	100	190.05	21.75	\$2075	\$2137	N/A	\$135
Z30S53FN	16 x 30 x 53-53.5	100	166.95	18.50	\$1889	\$1931	N/A	\$121
Z16S53FN	16 x 16 x 53-53.5	92.5	112.35	10.50	\$1231	\$1266	N/A	\$77
Z15S53FN	16 x 15 x 53-53.5	92.5	107.10	9.75	\$1218	\$1247	N/A	\$77

Fixed open shelf and three file drawers. Lock secures all drawers. 36" and 30" wide models have front-to-back and side-to-side letter/legal filing capability. Side-to-side file bars included.

- Lateral file drawer construction is for accommodating hanging files NOT for stacking materials on the drawer bottom.



Four File Module†

Z36L54F	24 x 36 x 53-53.5	100	256.20	31.25	\$2716	\$2789	N/A	\$180
Z30L54F	24 x 30 x 53-53.5	100	234.15	27	\$2605	\$2668	N/A	\$150
Z16L54F	24 x 16 x 53-53.5	92.5	155.40	15.50	\$1559	\$1601	N/A	\$93
Z15L54F	24 x 15 x 53-53.5	92.5	148.05	14.25	\$1507	\$1542	N/A	\$93
Z36M54F	20 x 36 x 53-53.5	100	239.40	27	\$2632	\$2695	N/A	\$180
Z30M54F	20 x 30 x 53-53.5	100	218.40	22.75	\$2472	\$2527	N/A	\$150
Z16M54F	20 x 16 x 53-53.5	92.5	141.75	13	\$1472	\$1510	N/A	\$93
Z15M54F	20 x 15 x 53-53.5	92.5	136.50	12.25	\$1421	\$1451	N/A	\$93
Z36S54F	16 x 36 x 53-53.5	100	205	21.75	\$2355	\$2417	N/A	\$135
Z30S54F	16 x 30 x 53-53.5	100	180	18.50	\$2146	\$2188	N/A	\$121
Z16S54F	16 x 16 x 53-53.5	92.5	122	10.50	\$1446	\$1481	N/A	\$77
Z15S54F	16 x 15 x 53-53.5	92.5	116	9.75	\$1393	\$1423	N/A	\$77

Four file drawers. Lock secures all drawers. 36" and 30" wide models have front-to-back and side-to-side letter/legal filing capability. Side-to-side file bars included.

- Lateral file drawer construction is for accommodating hanging files NOT for stacking materials on the drawer bottom.



Four File Module†

Z36L5S4F	24 x 36 x 53-53.5	100	286	31.25	\$3248	\$3321	N/A	\$180
Z36M5S4F	20 x 36 x 53-53.5	100	269	27	\$3316	\$3380	N/A	\$180

Four file drawers with steel drawer interior. Lock secures all drawers. Front-to-back and side-to-side letter/legal filing capability. Side-to-side file bars included.

- Front-to-back filing bars available separately. Order **FBB** bars. See "FBB" on page 41.
- Lateral file drawer construction is for accommodating hanging files NOT for stacking materials on the drawer bottom.
- To prevent overloading, steel drawers do not include a back panel

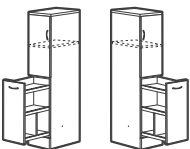

LEFT RIGHT
Vertical Utility Drawer with Door**

Z12L5VDL	24 x 12 x 53-53.5	92.5	137.55	11.75	\$1241	\$1273	\$290	\$63
Z12M5VDL	20 x 12 x 53-53.5	92.5	118.65	10	\$1115	\$1142	\$290	\$63
Z12S5VDL	16 x 12 x 53-53.5	85	100	8.25	\$1006	\$1033	\$290	\$63
Z12L5VDR	24 x 12 x 53-53.5	92.5	137.55	11.75	\$1241	\$1273	\$290	\$63
Z12M5VDR	20 x 12 x 53-53.5	92.5	118.65	10	\$1115	\$1142	\$290	\$63
Z12S5VDR	16 x 12 x 53-53.5	85	100	8.25	\$1006	\$1033	\$290	\$63

Specify **VDL** models for **LEFT** or **VDR** models for **RIGHT**

Laminate doors are standard. Includes one 3-position fixed/height adjustable shelf and one vertical drawer. Upper lock secures storage compartment. Lower lock secures vertical drawer.

Required Specifications

Top finish
Top/edge detail
Handles
Base finish

Optional Specifications

HP laminate
Collator*
Glazed doors**

Box drawer† - no upcharge (30" - 36" wide models only)

STORAGE MODULES - 65.5" / 66" HIGH

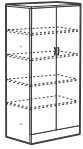

Glazed door option

Storage Cabinet with Doors**

MODEL#	DIMENSIONS	FREIGHT CLASS	WT/LBS.	CUBIC FT.	1" TOP	1.5" TOP	GLAZE ADD	HP ADD	
D x W x H									
Z36L6SH	24 x 36 x 65.5-66	125	273	39	\$2104	\$2178	\$1365	N/A	
Z30L6SH	24 x 30 x 65.5-66	125	238.35	32.75	\$1839	\$1902	\$1181	N/A	
Z36M6SH	20 x 36 x 65.5-66	125	246.75	33.25	\$1952	\$2016	\$1365	N/A	
Z30M6SH	20 x 30 x 65.5-66	125	212.10	27.75	\$1703	\$1756	\$1181	N/A	
Z36S6SH	16 x 36 x 65.5-66	125	210	26.50	\$1766	\$1828	\$1365	N/A	
Z30S6SH	16 x 30 x 65.5-66	100	183.75	22.50	\$1518	\$1561	\$1181	N/A	

Laminate doors are standard. **Includes four 3-position fixed/height adjustable shelves.** Standard with lock.

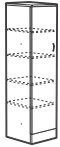

Glazed door option

Storage Cabinet with Door - LEFT**

Z21L6SHL	24 x 21 x 65.5-66	125	185.85	23.50	\$1508	\$1560	\$756	N/A
Z18L6SHL	24 x 18 x 65.5-66	100	168	20.50	\$1408	\$1451	\$681	N/A
Z16L6SHL	24 x 16 x 65.5-66	100	156.45	18.75	\$1327	\$1369	\$674	N/A
Z15L6SHL	24 x 15 x 65.5-66	100	149.10	17.50	\$1287	\$1322	\$589	N/A
Z12L6SHL	24 x 12 x 65.5-66	100	133.35	14.50	\$1169	\$1201	\$529	N/A
Z21M6SHL	20 x 21 x 65.5-66	100	170.10	20	\$1349	\$1392	\$756	N/A
Z18M6SHL	20 x 18 x 65.5-66	100	148.05	17.25	\$1287	\$1325	\$681	N/A
Z16M6SHL	20 x 16 x 65.5-66	100	137.55	15.75	\$1211	\$1249	\$674	N/A
Z15M6SHL	20 x 15 x 65.5-66	100	133.35	14.75	\$1154	\$1186	\$589	N/A
Z12M6SHL	20 x 12 x 65.5-66	100	116.55	12.25	\$1069	\$1097	\$529	N/A
Z21S6SHL	16 x 21 x 65.5-66	100	140.70	16	\$1244	\$1278	\$756	N/A
Z18S6SHL	16 x 18 x 65.5-66	100	126	14	\$1152	\$1187	\$681	N/A
Z16S6SHL	16 x 16 x 65.5-66	100	116.55	13	\$1083	\$1118	\$674	N/A
Z15S6SHL	16 x 15 x 65.5-66	100	111.30	12	\$1029	\$1059	\$589	N/A
Z12S6SHL	16 x 12 x 65.5-66	100	96.60	10	\$944	\$971	\$529	N/A

Laminate doors are standard. **Includes four 3-position fixed/height adjustable shelves.** Standard with lock.

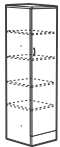

Glazed door option

Storage Cabinet with Door - RIGHT**

Z21L6SHR	24 x 21 x 65.5-66	125	185.85	23.50	\$1508	\$1560	\$756	N/A
Z18L6SHR	24 x 18 x 65.5-66	100	168	20.50	\$1408	\$1451	\$681	N/A
Z16L6SHR	24 x 16 x 65.5-66	100	156.45	18.75	\$1327	\$1369	\$674	N/A
Z15L6SHR	24 x 15 x 65.5-66	100	149.10	17.50	\$1287	\$1322	\$589	N/A
Z12L6SHR	24 x 12 x 65.5-66	100	133.35	14.50	\$1169	\$1201	\$529	N/A
Z21M6SHR	20 x 21 x 65.5-66	100	170.10	20	\$1349	\$1392	\$756	N/A
Z18M6SHR	20 x 18 x 65.5-66	100	148.05	17.25	\$1287	\$1325	\$681	N/A
Z16M6SHR	20 x 16 x 65.5-66	100	137.55	15.75	\$1211	\$1249	\$674	N/A
Z15M6SHR	20 x 15 x 65.5-66	100	133.35	14.75	\$1154	\$1186	\$589	N/A
Z12M6SHR	20 x 12 x 65.5-66	100	116.55	12.25	\$1069	\$1097	\$529	N/A
Z21S6SHR	16 x 21 x 65.5-66	100	140.70	16	\$1244	\$1278	\$756	N/A
Z18S6SHR	16 x 18 x 65.5-66	100	126	14	\$1152	\$1187	\$681	N/A
Z16S6SHR	16 x 16 x 65.5-66	100	116.55	13	\$1083	\$1118	\$674	N/A
Z15S6SHR	16 x 15 x 65.5-66	100	111.30	12	\$1029	\$1059	\$589	N/A
Z12S6SHR	16 x 12 x 65.5-66	100	96.60	10	\$944	\$971	\$529	N/A

Laminate doors are standard. **Includes four 3-position fixed/height adjustable shelves.** Standard with lock.

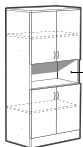

* Accepts collator 11" high

Storage Cabinet with Doors and Cavity*

Z36L6SHC	24 x 36 x 65.5-66	125	266.90	39	\$2166	\$2239	\$1561	N/A
Z30L6SHC	24 x 30 x 65.5-66	125	232.57	32.75	\$1932	\$1995	\$1370	N/A
Z36M6SHC	20 x 36 x 65.5-66	125	238.59	33.25	\$2013	\$2076	\$1561	N/A
Z30M6SHC	20 x 30 x 65.5-66	125	205.65	27.75	\$1796	\$1849	\$1370	N/A
Z36S6SHC	16 x 36 x 65.5-66	125	205.02	26.50	\$1829	\$1891	\$1561	N/A
Z30S6SHC	16 x 30 x 65.5-66	125	178.73	22.50	\$1612	\$1654	\$1370	N/A

Laminate doors are standard. **Includes two 3-position fixed/height adjustable shelves.** Upper and lower locks secure both compartments.

Required Specifications

Top finish
Top/edge detail
Handles
Base finish

Optional Specifications

Collator*
Glazed doors**

STORAGE MODULES - 65.5" / 66" HIGH

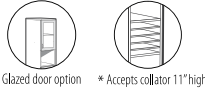
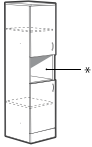

Storage Cabinet with Doors and Cavity - LEFT*

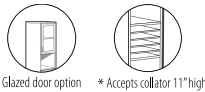
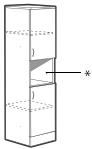

Storage Cabinet with Doors and Cavity - RIGHT*

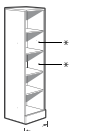
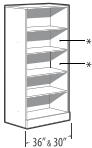

Open Storage Cabinet

MODEL#	DIMENSIONS D x W x H	FREIGHT CLASS	WT./LBS.	CUBIC FT.	1" TOP	1.5" TOP	GLAZE ADD	HP ADD
Z21L6SHCL	24 x 21 x 65.5-66	125	182.12	23.50	\$1543	\$1594	\$860	N/A
Z18L6SHCL	24 x 18 x 65.5-66	100	164.95	20.50	\$1445	\$1488	\$776	N/A
Z16L6SHCL	24 x 16 x 65.5-66	100	154.21	18.75	\$1359	\$1401	\$765	N/A
Z15L6SHCL	24 x 15 x 65.5-66	100	147.78	17.50	\$1328	\$1363	\$681	N/A
Z12L6SHCL	24 x 12 x 65.5-66	100	130.62	14.50	\$1213	\$1245	\$614	N/A
Z21M6SHCL	20 x 21 x 65.5-66	100	165.16	20	\$1383	\$1426	\$860	N/A
Z18M6SHCL	20 x 18 x 65.5-66	100	143.97	17.25	\$1324	\$1363	\$776	N/A
Z16M6SHCL	20 x 16 x 65.5-66	100	134.39	15.75	\$1245	\$1283	\$765	N/A
Z15M6SHCL	20 x 15 x 65.5-66	100	130.12	14.75	\$1195	\$1227	\$681	N/A
Z12M6SHCL	20 x 12 x 65.5-66	100	113.13	12.25	\$1115	\$1143	\$614	N/A
Z21S6SHCL	16 x 21 x 65.5-66	100	136.66	16	\$1306	\$1341	\$860	N/A
Z18S6SHCL	16 x 18 x 65.5-66	100	121.94	14	\$1189	\$1227	\$776	N/A
Z16S6SHCL	16 x 16 x 65.5-66	100	113.52	13	\$1118	\$1153	\$765	N/A
Z15S6SHCL	16 x 15 x 65.5-66	100	108.26	12	\$1068	\$1098	\$681	N/A
Z12S6SHCL	16 x 12 x 65.5-66	100	94.59	10	\$989	\$1015	\$614	N/A

Laminate doors are standard. **Includes two 3-position fixed/height adjustable shelves.** Upper and lower locks secure both compartments.

Z21L6SHCR	24 x 21 x 65.5-66	125	182.12	23.50	\$1543	\$1594	\$860	N/A
Z18L6SHCR	24 x 18 x 65.5-66	100	164.95	20.50	\$1445	\$1488	\$776	N/A
Z16L6SHCR	24 x 16 x 65.5-66	100	154.21	18.75	\$1359	\$1401	\$765	N/A
Z15L6SHCR	24 x 15 x 65.5-66	100	147.78	17.50	\$1328	\$1363	\$681	N/A
Z12L6SHCR	24 x 12 x 65.5-66	100	130.62	14.50	\$1213	\$1245	\$614	N/A
Z21M6SHCR	20 x 21 x 65.5-66	100	165.16	20	\$1383	\$1426	\$860	N/A
Z18M6SHCR	20 x 18 x 65.5-66	100	143.97	17.25	\$1324	\$1363	\$776	N/A
Z16M6SHCR	20 x 16 x 65.5-66	100	134.39	15.75	\$1245	\$1283	\$765	N/A
Z15M6SHCR	20 x 15 x 65.5-66	100	130.12	14.75	\$1195	\$1227	\$681	N/A
Z12M6SHCR	20 x 12 x 65.5-66	100	113.13	12.25	\$1115	\$1143	\$614	N/A
Z21S6SHCR	16 x 21 x 65.5-66	100	136.66	16	\$1306	\$1341	\$860	N/A
Z18S6SHCR	16 x 18 x 65.5-66	100	121.94	14	\$1189	\$1227	\$776	N/A
Z16S6SHCR	16 x 16 x 65.5-66	100	113.52	13	\$1118	\$1153	\$765	N/A
Z15S6SHCR	16 x 15 x 65.5-66	100	108.26	12	\$1068	\$1098	\$681	N/A
Z12S6SHCR	16 x 12 x 65.5-66	100	94.59	10	\$989	\$1015	\$614	N/A

Laminate doors are standard. **Includes two 3-position fixed/height adjustable shelves.** Upper and lower locks secure both compartments.

Z36L6SHN	24 x 36 x 65.5-66	125	234.42	39	\$1630	\$1704	N/A	N/A
Z30L6SHN	24 x 30 x 65.5-66	125	205.50	32.75	\$1444	\$1507	N/A	N/A
Z21L6SHN	24 x 21 x 65.5-66	125	163.17	23.50	\$1253	\$1305	N/A	N/A
Z18L6SHN	24 x 18 x 65.5-66	125	148.71	20.50	\$1176	\$1219	N/A	N/A
Z16L6SHN	24 x 16 x 65.5-66	125	139.77	18.75	\$1095	\$1137	N/A	N/A
Z15L6SHN	24 x 15 x 65.5-66	125	134.25	17.50	\$1084	\$1119	N/A	N/A
Z12L6SHN	24 x 12 x 65.5-66	100	119.79	14.50	\$984	\$1014	N/A	N/A
Z36M6SHN	20 x 36 x 65.5-66	125	206.11	33.25	\$1475	\$1538	N/A	N/A
Z30M6SHN	20 x 30 x 65.5-66	125	178.58	27.75	\$1305	\$1358	N/A	N/A
Z21M6SHN	20 x 21 x 65.5-66	125	146.22	20	\$1095	\$1138	N/A	N/A
Z18M6SHN	20 x 18 x 65.5-66	125	127.73	17.25	\$1057	\$1096	N/A	N/A
Z16M6SHN	20 x 16 x 65.5-66	125	119.95	15.75	\$982	\$1020	N/A	N/A
Z15M6SHN	20 x 15 x 65.5-66	125	116.59	14.75	\$952	\$984	N/A	N/A
Z12M6SHN	20 x 12 x 65.5-66	100	102.30	12.25	\$886	\$913	N/A	N/A
Z36S6SHN	16 x 36 x 65.5-66	125	172.54	26.50	\$1293	\$1355	N/A	N/A
Z30S6SHN	16 x 30 x 65.5-66	125	151.66	22.50	\$1123	\$1166	N/A	N/A
Z21S6SHN	16 x 21 x 65.5-66	125	117.71	16	\$988	\$1023	N/A	N/A
Z18S6SHN	16 x 18 x 65.5-66	125	105.70	14	\$922	\$957	N/A	N/A
Z16S6SHN	16 x 16 x 65.5-66	125	99.09	13	\$857	\$892	N/A	N/A
Z15S6SHN	16 x 15 x 65.5-66	125	94.73	12	\$826	\$856	N/A	N/A
Z12S6SHN	16 x 12 x 65.5-66	100	83.76	10	\$761	\$788	N/A	N/A

Includes four 3-position fixed/height adjustable shelves.

Required Specifications

- Top finish
- Top/edge detail
- Handles
- Base finish

Optional Specifications

- Collator
- Glazed doors*

STORAGE MODULES - 65.5" / 66" HIGH

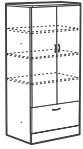

Glazed door option

File Module with Doors**

MODEL#	DIMENSIONS	FREIGHT CLASS	WT/LBS.	CUBIC FT.	1" TOP	1.5" TOP	GLAZE ADD	HP ADD	
D x W x H									
Z36L6F	24 x 36 x 65.5-66	125	290.85	39	\$2428	\$2501	\$1162	N/A	
Z30L6F	24 x 30 x 65.5-66	125	255.15	32.75	\$2200	\$2263	\$1012	N/A	
Z36M6F	20 x 36 x 65.5-66	100	266.70	33.25	\$2320	\$2383	\$1162	N/A	
Z30M6F	20 x 30 x 65.5-66	100	228.90	27.75	\$2045	\$2098	\$1012	N/A	
Z36S6F	16 x 36 x 65.5-66	100	219.45	26.50	\$2044	\$2106	\$1162	N/A	
Z30S6F	16 x 30 x 65.5-66	100	192.15	22.50	\$1837	\$1879	\$1012	N/A	

One lateral file drawer. Laminate doors are standard. **Includes three 3-position fixed/height adjustable shelves.** Upper lock secures storage compartment. Lower lock secures one file drawer. Front-to-back and side-to-side letter/legal filing capability. Side-to-side file bars included.

- Lateral file drawer construction is for accommodating hanging files NOT for stacking materials on the drawer bottom.



Glazed door option

File Module with Door - LEFT*

Z16L6FL	24 x 16 x 65.5-66	100	165.90	18.75	\$1488	\$1531	\$1162	N/A
Z15L6FL	24 x 15 x 65.5-66	100	159.60	17.50	\$1448	\$1483	\$1012	N/A
Z16M6FL	20 x 16 x 65.5-66	100	147	15.75	\$1373	\$1411	\$572	N/A
Z15M6FL	20 x 15 x 65.5-66	100	141.75	14.75	\$1315	\$1347	\$504	N/A
Z16S6FL	16 x 16 x 65.5-66	100	124.95	13	\$1243	\$1278	\$572	N/A
Z15S6FL	16 x 15 x 65.5-66	100	119.70	12	\$1195	\$1225	\$504	N/A

One file drawer. Laminate door is standard. **Includes three 3-position fixed/height adjustable shelves.** Upper lock secures storage compartment. Lower lock secures one file drawer.



Glazed door option

File Module with Door - RIGHT*

Z16L6FR	24 x 16 x 65.5-66	100	165.90	18.75	\$1488	\$1531	\$1162	N/A
Z15L6FR	24 x 15 x 65.5-66	100	159.60	17.50	\$1448	\$1483	\$1012	N/A
Z16M6FR	20 x 16 x 65.5-66	100	147	15.75	\$1373	\$1411	\$572	N/A
Z15M6FR	20 x 15 x 65.5-66	100	141.75	14.75	\$1315	\$1347	\$504	N/A
Z16S6FR	16 x 16 x 65.5-66	100	124.95	13	\$1243	\$1278	\$572	N/A
Z15S6FR	16 x 15 x 65.5-66	100	119.70	12	\$1195	\$1225	\$504	N/A

One file drawer. Laminate door is standard. **Includes three 3-position fixed/height adjustable shelves.** Upper lock secures storage compartment. Lower lock secures one file drawer.

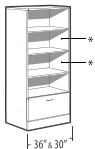

* Accepts collator 11" high

File Module with Open Shelves***

Z36L6FN	24 x 36 x 65.5-66	125	260.25	39	\$2011	\$2084	N/A	N/A
Z30L6FN	24 x 30 x 65.5-66	125	228.95	32.75	\$1827	\$1890	N/A	N/A
Z16L6FN	24 x 16 x 65.5-66	100	152.77	18.75	\$1287	\$1329	N/A	N/A
Z15L6FN	24 x 15 x 65.5-66	100	148.08	17.50	\$1270	\$1305	N/A	N/A
Z36M6FN	20 x 36 x 65.5-66	125	234.04	33.25	\$1905	\$1968	N/A	N/A
Z30M6FN	20 x 30 x 65.5-66	125	202.03	27.75	\$1673	\$1728	N/A	N/A
Z16M6FN	20 x 16 x 65.5-66	100	132.95	15.75	\$1172	\$1210	N/A	N/A
Z15M6FN	20 x 15 x 65.5-66	100	128.32	14.75	\$1138	\$1168	N/A	N/A
Z36S6FN	16 x 36 x 65.5-66	125	189.97	26.50	\$1628	\$1691	N/A	N/A
Z30S6FN	16 x 30 x 65.5-66	125	166.71	22.50	\$1466	\$1508	N/A	N/A
Z16S6FN	16 x 16 x 65.5-66	100	111.03	13	\$1042	\$1077	N/A	N/A
Z15S6FN	16 x 15 x 65.5-66	100	106.46	12	\$1015	\$1044	N/A	N/A

Four open shelves and one file drawer on bottom. **Includes three 3-position fixed/height adjustable shelves.** Lock secures file drawer. 36" and 30" wide models have front-to-back and side-to-side letter/legal filing capability. Side-to-side file bars included.

- Lateral file drawer construction is for accommodating hanging files NOT for stacking materials on the drawer bottom.

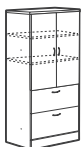

Glazed door option

Two File Module with Doors**

Z36L6E	24 x 36 x 65.5-66	125	294	39	\$2654	\$2728	\$945	N/A
Z30L6E	24 x 30 x 65.5-66	125	260.40	32.75	\$2426	\$2489	\$826	N/A
Z36M6E	20 x 36 x 65.5-66	100	269.85	33.25	\$2541	\$2604	\$945	N/A
Z30M6E	20 x 30 x 65.5-66	100	236.25	27.75	\$2298	\$2353	\$826	N/A
Z36S6E	16 x 36 x 65.5-66	100	225	26.50	\$2175	\$2238	\$945	N/A
Z30S6E	16 x 30 x 65.5-66	100	197	22.50	\$2080	\$2122	\$826	N/A

Two lateral file drawers on bottom. Laminate doors are standard. **Includes two 3-position fixed/height adjustable shelves.** Upper lock secures storage compartment. Lower lock secures two file drawers. Front-to-back and side-to-side letter/legal filing capability. Side-to-side file bars included.

- Lateral file drawer construction is for accommodating hanging files NOT for stacking materials on the drawer bottom.

Required Specifications

Top finish
Top/edge detail
Handles
Base finish

Optional Specifications

Collator**
Glazed doors*
Box drawer† - no upcharge (30"-36" wide models only)

STORAGE MODULES - 65.5" / 66" HIGH

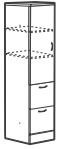

Glazed door option

Two File Module with Door - LEFT

MODEL#	DIMENSIONS D x W x H	FREIGHT CLASS	WT/LBS.	CUBIC FT.	1" TOP	1.5" TOP	GLAZE ADD	HP ADD
Z16L6EL	24 x 16 x 65.5-66	100	171.15	18.75	\$1572	\$1615	\$462	N/A
Z15L6EL	24 x 15 x 65.5-66	100	163.80	17.50	\$1535	\$1570	\$411	N/A
Z16M6EL	20 x 16 x 65.5-66	100	153.30	15.75	\$1462	\$1500	\$462	N/A
Z15M6EL	20 x 15 x 65.5-66	92.5	148.05	14.75	\$1408	\$1440	\$411	N/A
Z16S6EL	16 x 16 x 65.5-66	100	129.15	13	\$1335	\$1370	\$462	N/A
Z15S6EL	16 x 15 x 65.5-66	92.5	123.90	12	\$1293	\$1323	\$411	N/A

Two file drawers on bottom. Laminate door is standard. **Includes two 3-position fixed/height adjustable shelves.** Upper lock secures storage compartment. Lower lock secures two file drawers.

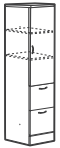

Glazed door option

Two File Module with Door - RIGHT

Z16L6ER	24 x 16 x 65.5-66	100	171.15	18.75	\$1572	\$1615	\$462	N/A
Z15L6ER	24 x 15 x 65.5-66	100	163.80	17.50	\$1535	\$1570	\$411	N/A
Z16M6ER	20 x 16 x 65.5-66	100	153.30	15.75	\$1462	\$1500	\$462	N/A
Z15M6ER	20 x 15 x 65.5-66	92.5	148.05	14.75	\$1408	\$1440	\$411	N/A
Z16S6ER	16 x 16 x 65.5-66	100	129.15	13	\$1335	\$1370	\$462	N/A
Z15S6ER	16 x 15 x 65.5-66	92.5	123.90	12	\$1293	\$1323	\$411	N/A

Two file drawers on bottom. Laminate door is standard. **Includes three 3-position fixed/height adjustable shelves.** Upper lock secures storage compartment. Lower lock secures two file drawers.

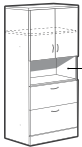

Glazed door option



* Accepts collator 11" high

Two File Module w/Doors & Cavity**

Z36L6EC	24 x 36 x 65.5-66	125	287.90	39	\$2599	\$2672	\$835	N/A
Z30L6EC	24 x 30 x 65.5-66	125	254.62	32.75	\$2379	\$2442	\$727	N/A
Z36M6EC	20 x 36 x 65.5-66	125	261.69	33.25	\$2486	\$2549	\$835	N/A
Z30M6EC	20 x 30 x 65.5-66	100	229.80	27.75	\$2253	\$2308	\$727	N/A
Z36S6EC	16 x 36 x 65.5-66	100	218.67	26.50	\$1953	\$2015	\$835	N/A
Z30S6EC	16 x 30 x 65.5-66	100	191.33	22.50	\$1869	\$1911	\$727	N/A

Two lateral file drawers on bottom. Laminate doors are standard. **Includes one 3-position fixed/height adjustable shelf.** Upper lock secures storage compartment. Lower lock secures all drawers. Front-to-back and side-to-side letter/legal filing capability. Side-to-side file bars included.

• Lateral file drawer construction is for accommodating hanging files NOT for stacking materials on the drawer bottom.

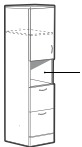

Glazed door option



* Accepts collator 11" high

Two File Module with Doors and Cavity - LEFT*

Z16L6ECL	24 x 16 x 65.5-66	100	168.91	18.75	\$1543	\$1586	\$411	N/A
Z15L6ECL	24 x 15 x 65.5-66	100	162.48	17.50	\$1513	\$1547	\$364	N/A
Z16M6ECL	20 x 16 x 65.5-66	100	150.14	15.75	\$1421	\$1459	\$411	N/A
Z15M6ECL	20 x 15 x 65.5-66	100	144.82	14.75	\$1373	\$1403	\$364	N/A
Z16S6ECL	16 x 16 x 65.5-66	100	126.12	13	\$1305	\$1340	\$411	N/A
Z15S6ECL	16 x 15 x 65.5-66	92.5	120.86	12	\$1270	\$1299	\$364	N/A

Two file drawers on bottom. Laminate doors are standard. **Includes one 3-position fixed/height adjustable shelf.** Upper lock secures storage compartment. Lower lock secures all drawers.

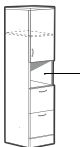

Glazed door option



* Accepts collator 11" high

Two File Module with Doors and Cavity - RIGHT*

Z16L6ECR	24 x 16 x 65.5-66	100	168.91	18.75	\$1543	\$1586	\$411	N/A
Z15L6ECR	24 x 15 x 65.5-66	100	162.48	17.50	\$1513	\$1547	\$364	N/A
Z16M6ECR	20 x 16 x 65.5-66	100	150.14	15.75	\$1421	\$1459	\$411	N/A
Z15M6ECR	20 x 15 x 65.5-66	100	144.82	14.75	\$1373	\$1403	\$364	N/A
Z16S6ECR	16 x 16 x 65.5-66	100	126.12	13	\$1305	\$1340	\$411	N/A
Z15S6ECR	16 x 15 x 65.5-66	92.5	120.86	12	\$1270	\$1299	\$364	N/A

Two file drawers on bottom. Laminate doors are standard. **Includes one 3-position fixed/height adjustable shelf.** Upper lock secures storage compartment. Lower lock secures all drawers.

Required Specifications

Top finish
Top/edge detail
Handles
Base finish

Optional Specifications

Collator*
Glazed doors
Box drawer - no upcharge† (30"-36" wide models only)

STORAGE MODULES - 65.5" / 66" HIGH

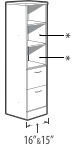
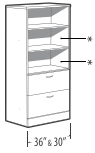

* Accepts collator 11" high

Two File Module with Open Shelves†

MODEL#	DIMENSIONS	FREIGHT CLASS	WT/LBS.	CUBIC FT.	1" TOP	1.5" TOP	GLAZE ADD	HP ADD
Z36L6EN	24 x 36 x 65.5-66	125	271.38	39	\$2318	\$2392	N/A	N/A
Z30L6EN	24 x 30 x 65.5-66	125	240.85	32.75	\$2125	\$2188	N/A	N/A
Z16L6EN	24 x 16 x 65.5-66	100	161.56	18.75	\$1411	\$1453	N/A	N/A
Z15L6EN	24 x 15 x 65.5-66	100	155.60	17.50	\$1391	\$1426	N/A	N/A
Z36M6EN	20 x 36 x 65.5-66	125	243.07	33.25	\$2204	\$2267	N/A	N/A
Z30M6EN	20 x 30 x 65.5-66	125	213.93	27.75	\$1998	\$2053	N/A	N/A
Z16M6EN	20 x 16 x 65.5-66	100	142.80	15.75	\$1302	\$1340	N/A	N/A
Z15M6EN	20 x 15 x 65.5-66	100	137.94	14.75	\$1263	\$1295	N/A	N/A
Z36S6EN	16 x 36 x 65.5-66	125	202.15	26.50	\$1836	\$1899	N/A	N/A
Z30S6EN	16 x 30 x 65.5-66	125	177.56	22.50	\$1778	\$1820	N/A	N/A
Z16S6EN	16 x 16 x 65.5-66	100	118.78	13	\$1173	\$1208	N/A	N/A
Z15S6EN	16 x 15 x 65.5-66	100	113.98	12	\$1150	\$1180	N/A	N/A

Three open shelves and two file drawers on bottom. **Includes two 3-position fixed/height adjustable shelves.** Lock secures all drawers. 36" and 30" wide models have front-to-back and side-to-side letter/legal filing capability. Side-to-side file bars included.

- Lateral file drawer construction is for accommodating hanging files NOT for stacking materials on the drawer bottom.

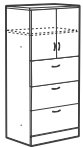

Glazed door option

Three File Module with Doors***

Z36L63F	24 x 36 x 65.5-66	125	297.15	39	\$2927	\$3001	\$835	N/A
Z30L63F	24 x 30 x 65.5-66	100	266.70	32.75	\$2723	\$2786	\$727	N/A
Z36M63F	20 x 36 x 65.5-66	100	275.10	33.25	\$2829	\$2892	\$835	N/A
Z30M63F	20 x 30 x 65.5-66	100	244.65	27.75	\$2597	\$2652	\$727	N/A
Z36S63F	16 x 36 x 65.5-66	100	233.10	26.50	\$2539	\$2601	\$835	N/A
Z30S63F	16 x 30 x 65.5-66	100	204.75	22.50	\$2313	\$2355	\$727	N/A

Three lateral file drawers on bottom. Laminate doors are standard. **Includes one 3-position fixed/height adjustable shelf.** Upper lock secures storage compartment. Lower lock secures three file drawers. Front-to-back and side-to-side letter/legal filing capability. Side-to-side file bars included.

- Lateral file drawer construction is for accommodating hanging files NOT for stacking materials on the drawer bottom.



Glazed door option

Three File Module with Door - LEFT**

Z16L63FL	24 x 16 x 65.5-66	100	176.40	18.75	\$1710	\$1752	\$411	N/A
Z15L63FL	24 x 15 x 65.5-66	100	169.05	17.50	\$1677	\$1712	\$364	N/A
Z16M63FL	20 x 16 x 65.5-66	92.5	159.60	15.75	\$1605	\$1643	\$411	N/A
Z15M63FL	20 x 15 x 65.5-66	92.5	153.30	14.75	\$1558	\$1588	\$364	N/A
Z16S63FL	16 x 16 x 65.5-66	92.5	134.40	13	\$1472	\$1507	\$411	N/A
Z15S63FL	16 x 15 x 65.5-66	92.5	129.15	12	\$1437	\$1467	\$364	N/A

Three file drawers on bottom. Laminate door is standard. **Includes one 3-position fixed/height adjustable shelf.** Upper lock secures storage compartment. Lower lock secures three file drawers.



Glazed door option

Three File Module with Door - RIGHT**

Z16L63FR	24 x 16 x 65.5-66	100	176.40	18.75	\$1710	\$1752	\$411	N/A
Z15L63FR	24 x 15 x 65.5-66	100	169.05	17.50	\$1677	\$1712	\$364	N/A
Z16M63FR	20 x 16 x 65.5-66	92.5	159.60	15.75	\$1605	\$1643	\$411	N/A
Z15M63FR	20 x 15 x 65.5-66	92.5	153.30	14.75	\$1558	\$1588	\$364	N/A
Z16S63FR	16 x 16 x 65.5-66	92.5	134.40	13	\$1472	\$1507	\$411	N/A
Z15S63FR	16 x 15 x 65.5-66	92.5	129.15	12	\$1437	\$1467	\$364	N/A

Three file drawers on bottom. Laminate door is standard. **Includes one 3-position fixed/height adjustable shelf.** Upper lock secures storage compartment. Lower lock secures three file drawers.

Required Specifications

Top finish
Top/edge detail
Handles
Base finish

Optional Specifications

Collator*
Glazed doors**
Box drawer† - no upcharge (30"-36" wide models only)

STORAGE MODULES - 65.5" / 66" HIGH

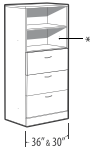

* Accepts collator 11" high

Three File Module w/Open Shelves**

MODEL#	DIMENSIONS D x W x H	FREIGHT CLASS	WT/LBS.	CUBIC FT.	1" TOP	1.5" TOP	GLAZE ADD	HP ADD
Z36L63FN	24 x 36 x 65.5-66	125	282.51	39	\$2647	\$2720	N/A	N/A
Z30L63FN	24 x 30 x 65.5-66	125	253.80	32.75	\$2466	\$2529	N/A	N/A
Z16L63FN	24 x 16 x 65.5-66	100	170.36	18.75	\$1578	\$1620	N/A	N/A
Z15L63FN	24 x 15 x 65.5-66	100	164.18	17.50	\$1556	\$1591	N/A	N/A
Z36M63FN	20 x 36 x 65.5-66	125	258.40	33.25	\$2548	\$2611	N/A	N/A
Z30M63FN	20 x 30 x 65.5-66	100	231.08	27.75	\$2341	\$2396	N/A	N/A
Z16M63FN	20 x 16 x 65.5-66	100	152.64	15.75	\$1474	\$1512	N/A	N/A
Z15M63FN	20 x 15 x 65.5-66	100	146.52	14.75	\$1437	\$1467	N/A	N/A
Z36S63FN	16 x 36 x 65.5-66	100	219.59	26.50	\$2257	\$2320	N/A	N/A
Z30S63FN	16 x 30 x 65.5-66	100	192.61	22.50	\$2055	\$2097	N/A	N/A
Z16S63FN	16 x 16 x 65.5-66	100	127.58	13	\$1338	\$1373	N/A	N/A
Z15S63FN	16 x 15 x 65.5-66	92.5	122.56	12	\$1316	\$1345	N/A	N/A

Two open shelves and three file drawers on bottom. **Includes one 3-position fixed/height adjustable shelf.** Lock secures all drawers. 36" and 30" wide models have front-to-back and side-to-side letter/legal filing capability. Side-to-side file bars included.

• Lateral file drawer construction is for accommodating hanging files NOT for stacking materials on the drawer bottom.

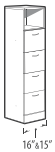
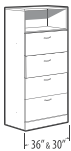

Four File Module with Open Shelf*

Z36L64FN	24 x 36 x 65.5-66	125	300.30	39	\$2950	\$3024	N/A	N/A
Z30L64FN	24 x 30 x 65.5-66	100	271.95	32.75	\$2770	\$2833	N/A	N/A
Z16L64FN	24 x 16 x 65.5-66	100	180.60	18.75	\$1695	\$1738	N/A	N/A
Z15L64FN	24 x 15 x 65.5-66	100	174.30	17.50	\$1662	\$1697	N/A	N/A
Z36M64FN	20 x 36 x 65.5-66	100	271.95	33.25	\$2855	\$2919	N/A	N/A
Z30M64FN	20 x 30 x 65.5-66	100	245.70	27.75	\$2658	\$2711	N/A	N/A
Z16M64FN	20 x 16 x 65.5-66	92.5	161.70	15.75	\$1604	\$1642	N/A	N/A
Z15M64FN	20 x 15 x 65.5-66	92.5	155.40	14.75	\$1554	\$1584	N/A	N/A
Z36S64FN	16 x 36 x 65.5-66	100	228.90	26.50	\$2560	\$2622	N/A	N/A
Z30S64FN	16 x 30 x 65.5-66	100	202.65	22.50	\$2336	\$2378	N/A	N/A
Z16S64FN	16 x 16 x 65.5-66	92.5	134.40	13	\$1468	\$1503	N/A	N/A
Z15S64FN	16 x 15 x 65.5-66	92.5	130.20	12	\$1445	\$1475	N/A	N/A

Open shelf and four file drawers. Lock secures all drawers. 36" and 30" wide models have front-to-back and side-to-side letter/legal filing capability. Side-to-side file bars included.

• Lateral file drawer construction is for accommodating hanging files NOT for stacking materials on the drawer bottom.

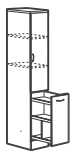
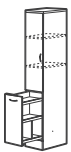

Glazed door option

LEFT RIGHT

Vertical Utility Drawer with Door**

Z12L6VDL	24 x 12 x 65.5-66	92.5	160.65	14.50	\$1368	\$1400	\$370	N/A
Z12M6VDL	20 x 12 x 65.5-66	92.5	139.65	12.25	\$1245	\$1273	\$370	N/A
Z12S6VDL	16 x 12 x 65.5-66	92.5	116.55	10	\$1150	\$1176	\$370	N/A
Z12L6VDR	24 x 12 x 65.5-66	92.5	160.65	14.50	\$1368	\$1400	\$370	N/A
Z12M6VDR	20 x 12 x 65.5-66	92.5	139.65	12.25	\$1245	\$1273	\$370	N/A
Z12S6VDR	16 x 12 x 65.5-66	92.5	116.55	10	\$1150	\$1176	\$370	N/A

Specify **VDL** models for **LEFT** or **VDR** models for **RIGHT**

Laminate doors are standard. **Includes two 3-position fixed/height adjustable shelves** and one vertical drawer. Upper lock secures storage compartment. Lower lock secures vertical drawer.

WARDROBE CABINETS - 65.5" / 66" HIGH

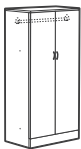

Wardrobe Cabinet

Z36L6WA	24 x 36 x 65.5-66	150	216.30	39	\$1802	\$1875	N/A	N/A
Z30L6WA	24 x 30 x 65.5-66	150	192.15	32.75	\$1623	\$1686	N/A	N/A
Z36M6WA	20 x 36 x 65.5-66	125	200.55	33.25	\$1726	\$1789	N/A	N/A
Z30M6WA	20 x 30 x 65.5-66	125	173.25	27.75	\$1528	\$1583	N/A	N/A

Laminate doors are standard. Full length hanging rod included. Standard with lock.

Required Specifications

Top finish
Top/edge detail
Handles
Base finish

Optional Specifications

Collator*
Glazed doors**
Box drawer† - no upcharge (30"-36" wide models only)

STORAGE MODULES - 65.5" / 66" HIGH



Wardrobe Cabinet - LEFT

MODEL#	DIMENSIONS	FREIGHT CLASS	WT/LBS.	CUBIC FT.	1" TOP	1.5" TOP	GLAZE ADD	HP ADD
D x W x H								
Z24L6WAL	24 x 24 x 65.5-66	125	165.90	26.75	\$1488	\$1540	N/A	N/A
Z21L6WAL	24 x 21 x 65.5-66	125	152.25	23.50	\$1370	\$1421	N/A	N/A
Z18L6WAL	24 x 18 x 65.5-66	125	139.65	20.50	\$1216	\$1259	N/A	N/A
Z16L6WAL	24 x 16 x 65.5-66	125	132.30	18.75	\$1190	\$1233	N/A	N/A
Z15L6WAL	24 x 15 x 65.5-66	125	128.10	17.50	\$1141	\$1176	N/A	N/A
Z12L6WAL	24 x 12 x 65.5-66	125	115.50	14.50	\$1055	\$1085	N/A	N/A
Z24M6WAL	20 x 24 x 65.5-66	125	149.10	22.50	\$1280	\$1323	N/A	N/A
Z21M6WAL	20 x 21 x 65.5-66	125	143.85	20	\$1241	\$1283	N/A	N/A
Z18M6WAL	20 x 18 x 65.5-66	125	124.95	17.25	\$1124	\$1162	N/A	N/A
Z16M6WAL	20 x 16 x 65.5-66	125	116.55	15.75	\$1095	\$1133	N/A	N/A
Z15M6WAL	20 x 15 x 65.5-66	125	113.40	14.75	\$1030	\$1062	N/A	N/A
Z12M6WAL	20 x 12 x 65.5-66	100	102.90	12.25	\$982	\$1009	N/A	N/A

Laminate doors are standard. Full length hanging rod included. Standard with lock.

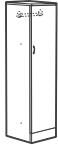

Wardrobe Cabinet - RIGHT

Z24L6WAR	24 x 24 x 65.5-66	125	165.90	26.75	\$1488	\$1540	N/A	N/A
Z21L6WAR	24 x 21 x 65.5-66	125	152.25	23.50	\$1370	\$1421	N/A	N/A
Z18L6WAR	24 x 18 x 65.5-66	125	139.65	20.50	\$1216	\$1259	N/A	N/A
Z16L6WAR	24 x 16 x 65.5-66	125	132.30	18.75	\$1190	\$1233	N/A	N/A
Z15L6WAR	24 x 15 x 65.5-66	125	128.10	17.50	\$1141	\$1176	N/A	N/A
Z12L6WAR	24 x 12 x 65.5-66	125	115.50	14.50	\$1055	\$1085	N/A	N/A
Z24M6WAR	20 x 24 x 65.5-66	125	149.10	22.50	\$1280	\$1323	N/A	N/A
Z21M6WAR	20 x 21 x 65.5-66	125	143.85	20	\$1241	\$1283	N/A	N/A
Z18M6WAR	20 x 18 x 65.5-66	125	124.95	17.25	\$1124	\$1162	N/A	N/A
Z16M6WAR	20 x 16 x 65.5-66	125	116.55	15.75	\$1095	\$1133	N/A	N/A
Z15M6WAR	20 x 15 x 65.5-66	125	113.40	14.75	\$1030	\$1062	N/A	N/A
Z12M6WAR	20 x 12 x 65.5-66	100	102.90	12.25	\$982	\$1009	N/A	N/A

Laminate doors are standard. Full length hanging rod included. Standard with lock.

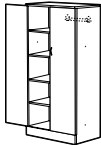

Wardrobe Cabinet/Shelving Combo with Doors - LEFT*



Glazed door option

Z36L6DIL	24 x 36 x 65.5-66	125	269.85	39	\$2152	\$2226	\$1365	N/A
Z30L6DIL	24 x 30 x 65.5-66	125	240.45	32.75	\$1907	\$1969	\$1181	N/A
Z24L6DIL	24 x 24 x 65.5-66	125	208.95	26.75	\$1779	\$1832	\$1067	N/A
Z21L6DIL	24 x 21 x 65.5-66	100	193.20	23.50	\$1671	\$1723	\$1057	N/A
Z36M6DIL	20 x 36 x 65.5-66	125	243.60	33.25	\$2025	\$2088	\$1365	N/A
Z30M6DIL	20 x 30 x 65.5-66	100	226.80	27.75	\$1768	\$1823	\$1181	N/A
Z24M6DIL	20 x 24 x 65.5-66	100	184.80	22.50	\$1586	\$1629	\$1067	N/A
Z21M6DIL	20 x 21 x 65.5-66	100	171.15	20	\$1540	\$1583	\$1057	N/A

Laminate doors are standard. Storage compartment on **left includes four 3-position fixed/height adjustable shelves**. Wardrobe compartment on **right** includes hanging rod. Two locks secure storage and wardrobe compartments.

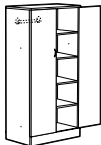

Wardrobe Cabinet/Shelving Combo with Doors - RIGHT*



Glazed door option

Z36L6DIR	24 x 36 x 65.5-66	125	269.85	39	\$2152	\$2226	\$1365	N/A
Z30L6DIR	24 x 30 x 65.5-66	125	240.45	32.75	\$1907	\$1969	\$1181	N/A
Z24L6DIR	24 x 24 x 65.5-66	125	208.95	26.75	\$1779	\$1832	\$1067	N/A
Z21L6DIR	24 x 21 x 65.5-66	100	193.20	23.50	\$1671	\$1723	\$1057	N/A
Z36M6DIR	20 x 36 x 65.5-66	125	243.60	33.25	\$2025	\$2088	\$1365	N/A
Z30M6DIR	20 x 30 x 65.5-66	100	226.80	27.75	\$1768	\$1823	\$1181	N/A
Z24M6DIR	20 x 24 x 65.5-66	100	184.80	22.50	\$1586	\$1629	\$1067	N/A
Z21M6DIR	20 x 21 x 65.5-66	100	171.15	20	\$1540	\$1583	\$1057	N/A

Laminate doors are standard. Storage compartment on **right includes four 3-position fixed/height adjustable shelves**. Wardrobe compartment on **left** includes hanging rod. Two locks secure storage and wardrobe compartments.

Required Specifications

Top finish
Top/edge detail
Handles
Base finish

Optional Specifications

Glazed doors*

WARDROBE CABINETS - 65.5" / 66" HIGH

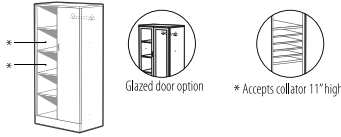

Wardrobe Cabinet/Open Shelving Combo - LEFT*

MODEL#	DIMENSIONS D x W x H	FREIGHT CLASS	WT./LBS.	CUBIC FT.	1" TOP	1.5" TOP	GLAZE ADD	HP ADD
Z36L6DINL	24 x 36 x 65.5-66	125	251.50	39	\$1923	\$1997	\$682	N/A
Z30L6DINL	24 x 30 x 65.5-66	125	224.46	32.75	\$1718	\$1781	\$590	N/A
Z24L6DINL	24 x 24 x 65.5-66	125	196.37	26.75	\$1620	\$1672	\$530	N/A
Z21L6DINL	24 x 21 x 65.5-66	125	183.37	23.50	\$1512	\$1564	\$527	N/A
Z36M6DINL	20 x 36 x 65.5-66	125	223.19	33.25	\$1799	\$1863	\$682	N/A
Z30M6DINL	20 x 30 x 65.5-66	125	197.54	27.75	\$1580	\$1635	\$590	N/A
Z24M6DINL	20 x 24 x 65.5-66	125	174.14	22.50	\$1427	\$1470	\$530	N/A
Z21M6DINL	20 x 21 x 65.5-66	125	159.07	20	\$1381	\$1424	\$527	N/A

Laminate door is standard. Storage compartment on **left includes four 3-position fixed/height adjustable shelves**. Wardrobe compartment on **right** includes hanging rod. Single lock secures storage and wardrobe compartments.



Wardrobe Cabinet/Open Shelving Combo - RIGHT*

Z36L6DINR	24 x 36 x 65.5-66	125	251.50	39	\$1923	\$1997	\$682	N/A
Z30L6DINR	24 x 30 x 65.5-66	125	224.46	32.75	\$1718	\$1781	\$590	N/A
Z24L6DINR	24 x 24 x 65.5-66	125	196.37	26.75	\$1620	\$1672	\$530	N/A
Z21L6DINR	24 x 21 x 65.5-66	125	183.37	23.50	\$1512	\$1564	\$527	N/A
Z36M6DINR	20 x 36 x 65.5-66	125	223.19	33.25	\$1799	\$1863	\$682	N/A
Z30M6DINR	20 x 30 x 65.5-66	125	197.54	27.75	\$1580	\$1635	\$590	N/A
Z24M6DINR	20 x 24 x 65.5-66	125	174.14	22.50	\$1427	\$1470	\$530	N/A
Z21M6DINR	20 x 21 x 65.5-66	125	159.07	20	\$1381	\$1424	\$527	N/A

Laminate door is standard. Storage compartment on **right includes four 3-position fixed/height adjustable shelves**. Wardrobe compartment on **left** includes hanging rod. Single lock secures storage and wardrobe compartments.

PERSONAL TOWERS - 65.5" / 66" HIGH

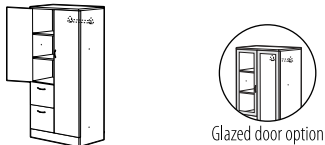

Personal Tower with Doors - LEFT

MODEL#	DIMENSIONS	FREIGHT CLASS	WT./LBS.	CUBIC FT.	1" TOP	1.5" TOP	GLAZE ADD	HP ADD
Z36L6EL	24 x 36 x 65.5-66	125	290.85	39	\$2362	\$2435	\$1147	N/A
Z30L6EL	24 x 30 x 65.5-66	100	266.70	32.75	\$2185	\$2248	\$1044	N/A
Z24L6EL	24 x 24 x 65.5-66	100	243.24	26.75	\$2095	\$2147	\$914	N/A
Z36M6EL	20 x 36 x 65.5-66	125	256.20	33.25	\$2235	\$2298	\$1147	N/A
Z30M6EL	20 x 30 x 65.5-66	100	229.95	27.75	\$2041	\$2096	\$1044	N/A
Z24M6EL	20 x 24 x 65.5-66	100	217	22.50	\$1957	\$2000	\$914	N/A

Two file drawers on bottom. Laminate doors are standard. Storage compartment on **left includes two 3-position fixed/height adjustable shelves**. Wardrobe compartment on **right** includes hanging rod. Two upper locks, one per each hinged door, and one lower lock secures drawers, all keyed alike.

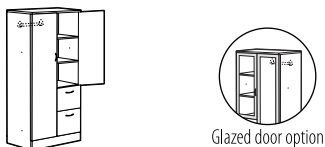

Personal Tower with Doors - RIGHT

Z36L6ER	24 x 36 x 65.5-66	125	290.85	39	\$2362	\$2435	\$1147	N/A
Z30L6ER	24 x 30 x 65.5-66	100	266.70	32.75	\$2185	\$2248	\$1044	N/A
Z24L6ER	24 x 24 x 65.5-66	100	243.24	26.75	\$2095	\$2147	\$914	N/A
Z36M6ER	20 x 36 x 65.5-66	125	256.20	33.25	\$2235	\$2298	\$1147	N/A
Z30M6ER	20 x 30 x 65.5-66	100	229.95	27.75	\$2041	\$2096	\$1044	N/A
Z24M6ER	20 x 24 x 65.5-66	100	217	22.50	\$1957	\$2000	\$914	N/A

Two file drawers on bottom. Laminate doors are standard. Storage compartment on **right includes four 3-position fixed/height adjustable shelves**. Wardrobe compartment on **left** includes hanging rod. Two upper locks, one per each hinged door, and one lower lock secures drawers, all keyed alike.

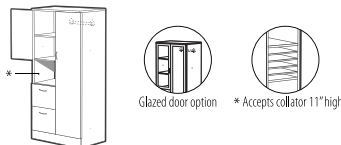

Personal Tower with Doors and cavity - LEFT*

Z36L6ECL	24 x 36 x 65.5-66	125	288.74	39	\$2331	\$2405	\$1093	N/A
Z30L6ECL	24 x 30 x 65.5-66	100	264.24	32.75	\$2155	\$2218	\$994	N/A
Z24L6ECL	24 x 24 x 65.5-66	100	239.24	26.75	\$2066	\$2118	\$862	N/A
Z36M6ECL	20 x 36 x 65.5-66	125	252.03	33.25	\$2195	\$2258	\$1093	N/A
Z30M6ECL	20 x 30 x 65.5-66	100	226.82	27.75	\$2000	\$2053	\$994	N/A
Z24M6ECL	20 x 24 x 65.5-66	100	213	22.50	\$1930	\$1973	\$862	N/A

Two file drawers on bottom. Laminate doors are standard. Storage compartment on **left includes one 3-position fixed/height adjustable shelf**. Wardrobe compartment on **right** includes hanging rod. Two upper locks, one per each hinged door, and one lower lock secures drawers, all keyed alike.

Required Specifications

- Top finish
- Top/edge detail
- Handles
- Base finish

Optional Specifications

- Collator*
- Glazed doors

PERSONAL TOWERS - 65.5" / 66" HIGH

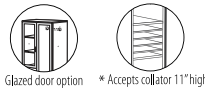
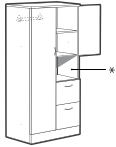

Personal Tower with Doors and cavity - RIGHT*

MODEL#	DIMENSIONS	FREIGHT CLASS	WT./LBS.	CUBIC FT.	1" TOP	1.5" TOP	GLAZE ADD	HP ADD	
D x W x H									
Z36L6ECR	24 x 36 x 65.5-66	125	288.74	39	\$2331	\$2405	\$1093	N/A	
Z30L6ECR	24 x 30 x 65.5-66	100	264.24	32.75	\$2155	\$2218	\$994	N/A	
Z24L6ECR	24 x 24 x 65.5-66	100	239.24	26.75	\$2066	\$2118	\$862	N/A	
Z36M6ECR	20 x 36 x 65.5-66	125	252.03	33.25	\$2195	\$2258	\$1093	N/A	
Z30M6ECR	20 x 30 x 65.5-66	100	226.82	27.75	\$2000	\$2053	\$994	N/A	
Z24M6ECR	20 x 24 x 65.5-66	100	213	22.50	\$1930	\$1973	\$862	N/A	

Two file drawers on bottom. Laminate doors are standard. Storage compartment on right includes one 3-position fixed/height adjustable shelf. Wardrobe compartment on left includes hanging rod. Two upper locks, one per each hinged door, and one lower lock secures drawers, all keyed alike.

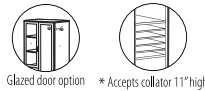
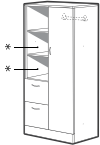

Personal Tower with Open Shelves - LEFT*

Z36L6ENL	24 x 36 x 65.5-66	125	280.48	39	\$2203	\$2276	\$686	N/A
Z30L6ENL	24 x 30 x 65.5-66	125	257.36	32.75	\$2025	\$2088	\$587	N/A
Z24L6ENL	24 x 24 x 65.5-66	100	230.24	26.75	\$1938	\$1990	\$455	N/A
Z36M6ENL	20 x 36 x 65.5-66	125	243.77	33.25	\$2064	\$2127	\$686	N/A
Z30M6ENL	20 x 30 x 65.5-66	125	219.94	27.75	\$1870	\$1925	\$587	N/A
Z24M6ENL	20 x 24 x 65.5-66	100	204	22.50	\$1773	\$1831	\$455	N/A

Two file drawers on bottom. Laminate doors are standard on wardrobe section. Storage compartment on left includes two 3-position fixed/height adjustable shelves. Wardrobe compartment on right includes hanging rod. Upper lock secures storage and wardrobe compartments. Lower lock secures all drawers.

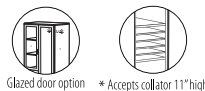
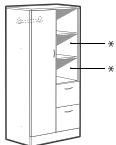

Personal Tower with Open*

Z36L6ENR	24 x 36 x 65.5-66	125	280.48	39	\$2203	\$2276	\$686	N/A
Z30L6ENR	24 x 30 x 65.5-66	125	257.36	32.75	\$2025	\$2088	\$587	N/A
Z24L6ENR	24 x 24 x 65.5-66	100	230.24	26.75	\$1938	\$1990	\$455	N/A
Z36M6ENR	20 x 36 x 65.5-66	125	243.77	33.25	\$2064	\$2127	\$686	N/A
Z30M6ENR	20 x 30 x 65.5-66	125	219.94	27.75	\$1870	\$1925	\$587	N/A
Z24M6ENR	20 x 24 x 65.5-66	100	204	22.50	\$1773	\$1831	\$455	N/A

Two file drawers on bottom. Laminate doors is standard on wardrobe section. Storage compartment on right includes two 3-position fixed/height adjustable shelves. Wardrobe compartment on left includes hanging rod. Upper lock secures storage and wardrobe compartments. Lower lock secures all drawers.

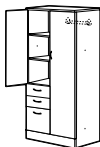

Personal Tower with Doors - LEFT

Z36L6BFL	24 x 36 x 65.5-66	125	294	39	\$2483	\$2556	\$1147	N/A
Z30L6BFL	24 x 30 x 65.5-66	100	268.80	32.75	\$2307	\$2370	\$1044	N/A
Z24L6BFL	24 x 24 x 65.5-66	100	244.24	26.75	\$2192	\$2245	\$914	N/A
Z36M6BFL	20 x 36 x 65.5-66	125	258.30	33.25	\$2364	\$2427	\$1147	N/A
Z30M6BFL	20 x 30 x 65.5-66	100	232.05	27.75	\$2169	\$2224	\$1044	N/A
Z24M6BFL	20 x 24 x 65.5-66	100	218	22.50	\$2057	\$2100	\$914	N/A

Two box and one file drawer on bottom. Laminate doors are standard. Storage compartment on left includes two 3-position fixed/height adjustable shelves. Wardrobe compartment on right includes hanging rod. Two upper locks, one per each hinged door, and one lower lock secures drawers, all keyed alike.

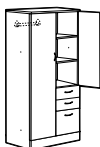

Personal Tower with Doors - RIGHT

Z36L6BFR	24 x 36 x 65.5-66	125	294	39	\$2483	\$2556	\$1147	N/A
Z30L6BFR	24 x 30 x 65.5-66	100	268.80	32.75	\$2307	\$2370	\$1044	N/A
Z24L6BFR	24 x 24 x 65.5-66	100	244.24	26.75	\$2192	\$2245	\$914	N/A
Z36M6BFR	20 x 36 x 65.5-66	125	258.30	33.25	\$2364	\$2427	\$1147	N/A
Z30M6BFR	20 x 30 x 65.5-66	100	232.05	27.75	\$2169	\$2224	\$1044	N/A
Z24M6BFR	20 x 24 x 65.5-66	100	218	22.50	\$2057	\$2100	\$914	N/A

Two box and one file drawer on bottom. Laminate doors are standard. Storage compartment on right includes two 3-position fixed/height adjustable shelves. Wardrobe compartment on left includes hanging rod. Two upper locks, one per each hinged door, and one lower lock secures drawers, all keyed alike.

Required Specifications

Top finish
Top/edge detail
Handles
Base finish

Optional Specifications

Collator*
Glazed doors

PERSONAL TOWERS - 65.5" / 66" HIGH

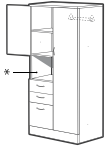

Glazed door option

* Accepts collator 11" high

Personal Tower with Doors*

MODEL#	DIMENSIONS D x W x H	FREIGHT CLASS	WT./LBS.	CUBIC FT.	1" TOP	1.5" TOP	GLAZE ADD	HP ADD
Z36L6BFCL	24 x 36 x 65.5-66	125	291.89	39	\$2455	\$2529	\$1093	N/A
Z30L6BFCL	24 x 30 x 65.5-66	100	266.34	32.75	\$2279	\$2342	\$994	N/A
Z24L6BFCL	24 x 24 x 65.5-66	100	240.24	26.75	\$2164	\$2217	\$862	N/A
Z36M6BFCL	20 x 36 x 65.5-66	125	254.13	33.25	\$2317	\$2380	\$1093	N/A
Z30M6BFCL	20 x 30 x 65.5-66	100	228.92	27.75	\$2120	\$2175	\$994	N/A
Z24M6BFCL	20 x 24 x 65.5-66	100	214	22.50	\$2028	\$2071	\$862	N/A

Two box and one file drawer on bottom. Laminate doors are standard. Storage compartment on **left** includes **one 3-position fixed/height adjustable shelf**. Wardrobe compartment on **right** includes hanging rod. Two upper locks, one per each hinged door, and one lower lock secures drawers, all keyed alike.

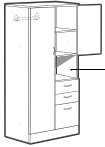

Glazed door option

* Accepts collator 11" high

Personal Tower with Doors and Cavity - RIGHT*

Z36L6BFCL	24 x 36 x 65.5-66	125	291.89	39	\$2455	\$2529	\$1093	N/A
Z30L6BFCL	24 x 30 x 65.5-66	100	266.34	32.75	\$2279	\$2342	\$994	N/A
Z24L6BFCL	24 x 24 x 65.5-66	100	240.24	26.75	\$2164	\$2217	\$862	N/A
Z36M6BFCL	20 x 36 x 65.5-66	125	254.13	33.25	\$2317	\$2380	\$1093	N/A
Z30M6BFCL	20 x 30 x 65.5-66	100	228.92	27.75	\$2120	\$2175	\$994	N/A
Z24M6BFCL	20 x 24 x 65.5-66	100	214	22.50	\$2028	\$2071	\$862	N/A

Two box and one file drawer on bottom. Laminate doors are standard. Storage compartment on **left** includes **one 3-position fixed/height adjustable shelf**. Wardrobe compartment on **right** includes hanging rod. Two upper locks, one per each hinged door, and one lower lock secures drawers, all keyed alike.

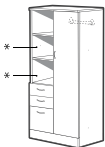

Glazed door option

* Accepts collator 11" high

Personal Tower with Open Shelves - LEFT*

Z36L6BFNL	24 x 36 x 65.5-66	125	280	39	\$2326	\$2399	\$686	N/A
Z30L6BFNL	24 x 30 x 65.5-66	125	257	32.75	\$2150	\$2213	\$587	N/A
Z24L6BFNL	24 x 24 x 65.5-66	100	232	26.75	\$2038	\$2090	\$455	N/A
Z36M6BFNL	20 x 36 x 65.5-66	125	242	33.25	\$2206	\$2269	\$686	N/A
Z30M6BFNL	20 x 30 x 65.5-66	125	219	27.75	\$2011	\$2066	\$587	N/A
Z24M6BFNL	20 x 24 x 65.5-66	100	206	22.50	\$1918	\$1961	\$455	N/A

Two box and one file drawer on bottom. Laminate doors are standard. Storage compartment on **left** includes **two 3-position fixed/height adjustable shelves**. Wardrobe compartment on **right** includes hanging rod. Upper lock secures storage and wardrobe compartments. Lower lock secures all drawers.

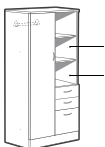

Glazed door option

* Accepts collator 11" high

Personal Tower with Open Shelves - RIGHT*

Z36L6BFNR	24 x 36 x 65.5-66	125	280	39	\$2326	\$2399	\$686	N/A
Z30L6BFNR	24 x 30 x 65.5-66	125	257	32.75	\$2150	\$2213	\$587	N/A
Z24L6BFNR	24 x 24 x 65.5-66	100	232	26.75	\$2038	\$2090	\$455	N/A
Z36M6BFNR	20 x 36 x 65.5-66	125	242	33.25	\$2206	\$2269	\$686	N/A
Z30M6BFNR	20 x 30 x 65.5-66	125	219	27.75	\$2011	\$2066	\$587	N/A
Z24M6BFNR	20 x 24 x 65.5-66	100	206	22.50	\$1918	\$1961	\$455	N/A

Two box and one file drawer on bottom. Laminate doors are standard. Storage compartment on **right** includes **two 3-position fixed/height adjustable shelves**. Wardrobe compartment on **left** includes hanging rod. Upper lock secures storage and wardrobe compartments. Lower lock secures all drawers.

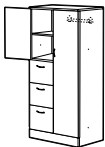

Glazed door option

Personal Tower with Doors - LEFT

Z36L63FL	24 x 36 x 65.5-66	125	295.05	39	\$2488	\$2561	\$1093	N/A
Z30L63FL	24 x 30 x 65.5-66	100	273	32.75	\$2323	\$2386	\$994	N/A
Z24L63FL	24 x 24 x 65.5-66	100	247.24	26.75	\$2200	\$2252	\$862	N/A
Z36M63FL	20 x 36 x 65.5-66	125	262.50	33.25	\$2375	\$2438	\$1093	N/A
Z30M63FL	20 x 30 x 65.5-66	100	236.25	27.75	\$2188	\$2243	\$994	N/A
Z24M63FL	20 x 24 x 65.5-66	100	223	22.50	\$2067	\$2110	\$862	N/A

Three file drawers on bottom. Laminate doors are standard. Storage compartment on **left** includes **one 3-position fixed/height adjustable shelf**. Wardrobe compartment on **right** includes hanging rod. Two upper locks, one per each hinged door, and one lower lock secures drawers, all keyed alike.

Required Specifications

Top finish
Top/edge detail
Handles
Base finish

Optional Specifications

Collator*
Glazed doors

PERSONAL TOWERS - 65.5" / 66" HIGH

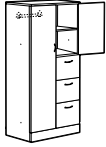

Glazed door option

Personal Tower with Doors - RIGHT

MODEL#	DIMENSIONS D x W x H	FREIGHT CLASS	WT/LBS.	CUBIC FT.	1" TOP	1.5" TOP	GLAZE ADD	HP ADD
Z36L63FR	24 x 36 x 65.5-66	125	295.05	39	\$2488	\$2561	\$1093	N/A
Z30L63FR	24 x 30 x 65.5-66	100	273	32.75	\$2323	\$2386	\$994	N/A
Z24L63FR	24 x 24 x 65.5-66	100	247.24	26.75	\$2200	\$2252	\$862	N/A
Z36M63FR	20 x 36 x 65.5-66	125	262.50	33.25	\$2375	\$2438	\$1093	N/A
Z30M63FR	20 x 30 x 65.5-66	100	236.25	27.75	\$2188	\$2243	\$994	N/A
Z24M63FR	20 x 24 x 65.5-66	100	223	22.50	\$2067	\$2110	\$862	N/A

Three file drawers on bottom. Laminate doors are standard. Storage compartment on right includes one 3-position fixed/height adjustable shelf. Wardrobe compartment on left includes hanging rod. Two upper locks, one per each hinged door, and one lower lock secures drawers, all keyed alike.

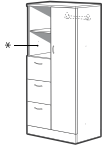

Glazed door option * Accepts collator 11" high

Personal Tower with Open Shelves - LEFT*

Z36L63FNL	24 x 36 x 65.5-66	125	288.67	39	\$2359	\$2433	\$686	N/A
Z30L63FNL	24 x 30 x 65.5-66	100	264.89	32.75	\$2192	\$2255	\$587	N/A
Z24L63FNL	24 x 24 x 65.5-66	100	238.24	26.75	\$2069	\$2122	\$455	N/A
Z36M63FNL	20 x 36 x 65.5-66	125	261.41	33.25	\$2226	\$2289	\$686	N/A
Z30M63FNL	20 x 30 x 65.5-66	100	229.57	27.75	\$2041	\$2096	\$587	N/A
Z24M63FNL	20 x 24 x 65.5-66	100	213	22.50	\$1939	\$1982	\$455	N/A

Three file drawers on bottom. Laminate door is standard on wardrobe section. Storage compartment on left includes one 3-position fixed/height adjustable shelf. Wardrobe compartment on right includes hanging rod. Upper lock secures storage and wardrobe compartments. Lower lock secures all drawers.

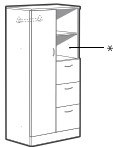

Glazed door option * Accepts collator 11" high

Personal Tower with Open Shelves - RIGHT*

Z36L63FNR	24 x 36 x 65.5-66	125	288.67	39	\$2359	\$2433	\$686	N/A
Z30L63FNR	24 x 30 x 65.5-66	100	264.89	32.75	\$2192	\$2255	\$587	N/A
Z24L63FNR	24 x 24 x 65.5-66	100	238.24	26.75	\$2069	\$2122	\$455	N/A
Z36M63FNR	20 x 36 x 65.5-66	125	261.41	33.25	\$2226	\$2289	\$686	N/A
Z30M63FNR	20 x 30 x 65.5-66	100	229.57	27.75	\$2041	\$2096	\$587	N/A
Z24M63FNR	20 x 24 x 65.5-66	100	213	22.50	\$1939	\$1982	\$455	N/A

Three file drawers on bottom. Laminate door is standard on wardrobe section. Storage compartment on right includes one 3-position fixed/height adjustable shelf. Wardrobe compartment on left includes hanging rod. Upper lock secures storage and wardrobe compartments. Lower lock secures all drawers.

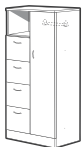

Glazed door option

Personal Tower with Open Shelf - LEFT

Z36L64FNL	24 x 36 x 65.5-66	125	302.40	39	\$2476	\$2549	\$686	N/A
Z30L64FNL	24 x 30 x 65.5-66	100	277.20	32.75	\$2319	\$2382	\$587	N/A
Z24L64FNL	24 x 24 x 65.5-66	100	247.24	26.75	\$2202	\$2255	\$455	N/A
Z36M64FNL	20 x 36 x 65.5-66	125	263.55	33.25	\$2343	\$2406	\$686	N/A
Z30M64FNL	20 x 30 x 65.5-66	100	238.35	27.75	\$2164	\$2219	\$587	N/A
Z24M64FNL	20 x 24 x 65.5-66	100	223	22.50	\$2076	\$2121	\$455	N/A

Four file drawers on bottom. Laminate door is standard on wardrobe section. Storage compartment on left includes one 3-position fixed/height adjustable shelf. Wardrobe compartment on right includes hanging rod. Upper lock secures storage and wardrobe compartments. Lower lock secures all drawers.



Glazed door option

Personal Tower with Open Shelf - RIGHT

Z36L64FNR	24 x 36 x 65.5-66	125	302.40	39	\$2476	\$2549	\$686	N/A
Z30L64FNR	24 x 30 x 65.5-66	100	277.20	32.75	\$2319	\$2382	\$587	N/A
Z24L64FNR	24 x 24 x 65.5-66	100	247.24	26.75	\$2202	\$2255	\$455	N/A
Z36M64FNR	20 x 36 x 65.5-66	125	263.55	33.25	\$2343	\$2406	\$686	N/A
Z30M64FNR	20 x 30 x 65.5-66	100	238.35	27.75	\$2164	\$2219	\$587	N/A
Z24M64FNR	20 x 24 x 65.5-66	100	223	22.50	\$2076	\$2121	\$455	N/A

Four file drawers on bottom. Laminate door is standard on wardrobe section. Storage compartment on right includes one 3-position fixed/height adjustable shelf. Wardrobe compartment on left includes hanging rod. Upper lock secures storage and wardrobe compartments. Lower lock secures all drawers.

Required Specifications

Top finish
Top/edge detail
Handles
Base finish

Optional Specifications

Collator*
Glazed doors

STORAGE MODULES - 72"/72.5" HIGH

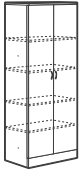

Glazed door option

Storage Cabinet with Doors

MODEL#	DIMENSIONS D x W x H	FREIGHT CLASS	WT./LBS.	CUBIC FT.	1" TOP	1.5" TOP	GLAZE ADD	HP ADD
Z36L7SH	24 x 36 x 71.9-72.4	125	295.05	43.25	\$2198	\$2271	\$1472	N/A
Z30L7SH	24 x 30 x 71.9-72.4	125	253.05	36.25	\$1918	\$1981	\$1274	N/A
Z36M7SH	20 x 36 x 71.9-72.4	125	261.45	36.75	\$2040	\$2103	\$1472	N/A
Z30M7SH	20 x 30 x 71.9-72.4	125	225.75	30.50	\$1768	\$1821	\$1274	N/A
Z36S7SH	16 x 36 x 71.9-72.4	125	225.75	29.50	\$1829	\$1891	\$1472	N/A
Z30S7SH	16 x 30 x 71.9-72.4	125	195.30	25	\$1607	\$1649	\$1274	N/A

Laminate doors are standard. **Includes four 3-position fixed/height adjustable shelves.** Standard with lock.

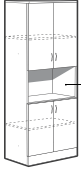

Glazed door option * Accepts collator 11" high

Storage Cabinet with Doors and Cavity

Z36L7SHC	24 x 36 x 71.9-72.4	125	286.85	43.25	\$2282	\$2356	\$1640	N/A
Z30L7SHC	24 x 30 x 71.9-72.4	125	247.27	36.25	\$2028	\$2091	\$1438	N/A
Z36M7SHC	20 x 36 x 71.9-72.4	125	254.34	36.75	\$2126	\$2189	\$1640	N/A
Z30M7SHC	20 x 30 x 71.9-72.4	125	219.30	30.50	\$1880	\$1933	\$1438	N/A
Z36S7SHC	16 x 36 x 71.9-72.4	125	218.67	29.50	\$1916	\$1978	\$1640	N/A
Z30S7SHC	16 x 30 x 71.9-72.4	125	189.23	25	\$1719	\$1761	\$1438	N/A

Laminate doors are standard. **Includes two 3-position fixed/height adjustable shelves.** Upper and lower locks secure both compartments.



Glazed door option

Storage Cabinet with Door - LEFT

Z21L7SHL	24 x 21 x 71.9-72.4	125	196.35	26	\$1588	\$1640	\$817	N/A
Z18L7SHL	24 x 18 x 71.9-72.4	125	178.50	22.75	\$1481	\$1524	\$733	N/A
Z16L7SHL	24 x 16 x 71.9-72.4	100	166.95	20.75	\$1392	\$1435	\$728	N/A
Z15L7SHL	24 x 15 x 71.9-72.4	100	160.65	19.25	\$1332	\$1367	\$632	N/A
Z12L7SHL	24 x 12 x 71.9-72.4	100	136.50	16	\$1223	\$1255	\$568	N/A
Z21M7SHL	20 x 21 x 71.9-72.4	100	174.30	21.25	\$1421	\$1463	\$817	N/A
Z18M7SHL	20 x 18 x 71.9-72.4	100	156.45	19.25	\$1356	\$1395	\$733	N/A
Z16M7SHL	20 x 16 x 71.9-72.4	100	147	17.50	\$1274	\$1312	\$728	N/A
Z15M7SHL	20 x 15 x 71.9-72.4	100	139.65	16.25	\$1215	\$1245	\$632	N/A
Z12M7SHL	20 x 12 x 71.9-72.4	100	123.90	13.25	\$1115	\$1142	\$568	N/A
Z21S7SHL	16 x 21 x 71.9-72.4	100	150.15	18	\$1311	\$1346	\$817	N/A
Z18S7SHL	16 x 18 x 71.9-72.4	100	134.40	15.50	\$1218	\$1256	\$733	N/A
Z16S7SHL	16 x 16 x 71.9-72.4	100	124.95	14	\$1169	\$1204	\$728	N/A
Z15S7SHL	16 x 15 x 71.9-72.4	100	118.65	12.50	\$1124	\$1153	\$632	N/A
Z12S7SHL	16 x 12 x 71.9-72.4	100	103.95	11	\$987	\$1014	\$568	N/A

Laminate doors are standard. **Includes four 3-position fixed/height adjustable shelves.** Standard with lock.



Glazed door option

Storage Cabinet with Door - RIGHT

Z21L7SHR	24 x 21 x 71.9-72.4	125	196.35	26	\$1588	\$1640	\$817	N/A
Z18L7SHR	24 x 18 x 71.9-72.4	125	178.50	22.75	\$1481	\$1524	\$733	N/A
Z16L7SHR	24 x 16 x 71.9-72.4	100	166.95	20.75	\$1392	\$1435	\$728	N/A
Z15L7SHR	24 x 15 x 71.9-72.4	100	160.65	19.25	\$1332	\$1367	\$632	N/A
Z12L7SHR	24 x 12 x 71.9-72.4	100	136.50	16	\$1223	\$1255	\$568	N/A
Z21M7SHR	20 x 21 x 71.9-72.4	100	174.30	21.25	\$1421	\$1463	\$817	N/A
Z18M7SHR	20 x 18 x 71.9-72.4	100	156.45	19.25	\$1356	\$1395	\$733	N/A
Z16M7SHR	20 x 16 x 71.9-72.4	100	147	17.50	\$1274	\$1312	\$728	N/A
Z15M7SHR	20 x 15 x 71.9-72.4	100	139.65	16.25	\$1215	\$1245	\$632	N/A
Z12M7SHR	20 x 12 x 71.9-72.4	100	123.90	13.25	\$1115	\$1142	\$568	N/A
Z21S7SHR	16 x 21 x 71.9-72.4	100	150.15	18	\$1311	\$1346	\$817	N/A
Z18S7SHR	16 x 18 x 71.9-72.4	100	134.40	15.50	\$1218	\$1256	\$733	N/A
Z16S7SHR	16 x 16 x 71.9-72.4	100	124.95	14	\$1169	\$1204	\$728	N/A
Z15S7SHR	16 x 15 x 71.9-72.4	100	118.65	12.50	\$1124	\$1153	\$632	N/A
Z12S7SHR	16 x 12 x 71.9-72.4	100	103.95	11	\$987	\$1014	\$568	N/A

Laminate doors are standard. **Includes four 3-position fixed/height adjustable shelves.** Standard with lock.

Required Specifications

Finishes
Top/Edge Detail
Handles

Optional Specifications

Glazing - Doors
Collator (Open Shelves)

STORAGE MODULES - 72"/72.5" HIGH

MODEL#	DIMENSIONS	FREIGHT CLASS	WT/LBS.	CUBIC FT.	1" TOP	1.5" TOP	GLAZE ADD	HP ADD	
D x W x H									
Z21L7SHCL	24 x 21 x 71.9-72.4	125	193.67	26	\$1636	\$1688	\$903	N/A	
Z18L7SHCL	24 x 18 x 71.9-72.4	125	175.45	22.75	\$1530	\$1573	\$815	N/A	
Z16L7SHCL	24 x 16 x 71.9-72.4	125	163.66	20.75	\$1438	\$1480	\$802	N/A	
Z15L7SHCL	24 x 15 x 71.9-72.4	100	157.23	19.25	\$1380	\$1415	\$712	N/A	
Z12L7SHCL	24 x 12 x 71.9-72.4	100	133.77	16	\$1229	\$1259	\$645	N/A	
Z21M7SHCL	20 x 21 x 71.9-72.4	100	170.41	21.25	\$1466	\$1509	\$903	N/A	
Z18M7SHCL	20 x 18 x 71.9-72.4	125	153.42	19.25	\$1404	\$1442	\$815	N/A	
Z16M7SHCL	20 x 16 x 71.9-72.4	100	143.84	17.50	\$1317	\$1355	\$802	N/A	
Z15M7SHCL	20 x 15 x 71.9-72.4	100	137.47	16.25	\$1260	\$1292	\$712	N/A	
Z12M7SHCL	20 x 12 x 71.9-72.4	100	121.53	13.25	\$1171	\$1198	\$645	N/A	
Z21S7SHCL	16 x 21 x 71.9-72.4	100	146.11	18	\$1358	\$1392	\$903	N/A	
Z18S7SHCL	16 x 18 x 71.9-72.4	100	131.39	15.50	\$1266	\$1304	\$815	N/A	
Z16S7SHCL	16 x 16 x 71.9-72.4	100	121.92	14	\$1212	\$1247	\$802	N/A	
Z15S7SHCL	16 x 15 x 71.9-72.4	100	115.61	12.50	\$1172	\$1201	\$712	N/A	
Z12S7SHCL	16 x 12 x 71.9-72.4	100	101.94	11	\$1044	\$1071	\$645	N/A	

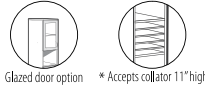
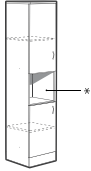

Storage Cabinet with Doors and Cavity - LEFT

Laminate doors are standard. **Includes two adjustable shelves.** Upper and lower locks secure both compartments

Z21L7SHCR	24 x 21 x 71.9-72.4	125	193.67	26	\$1636	\$1688	\$903	N/A
Z18L7SHCR	24 x 18 x 71.9-72.4	125	175.45	22.75	\$1530	\$1573	\$815	N/A
Z16L7SHCR	24 x 16 x 71.9-72.4	125	163.66	20.75	\$1438	\$1480	\$802	N/A
Z15L7SHCR	24 x 15 x 71.9-72.4	100	157.23	19.25	\$1380	\$1415	\$712	N/A
Z12L7SHCR	24 x 12 x 71.9-72.4	100	133.77	16	\$1229	\$1259	\$645	N/A
Z21M7SHCR	20 x 21 x 71.9-72.4	100	170.41	21.25	\$1466	\$1509	\$903	N/A
Z18M7SHCR	20 x 18 x 71.9-72.4	125	153.42	19.25	\$1404	\$1442	\$815	N/A
Z16M7SHCR	20 x 16 x 71.9-72.4	100	143.84	17.50	\$1317	\$1355	\$802	N/A
Z15M7SHCR	20 x 15 x 71.9-72.4	100	137.47	16.25	\$1260	\$1292	\$712	N/A
Z12M7SHCR	20 x 12 x 71.9-72.4	100	121.53	13.25	\$1171	\$1198	\$645	N/A
Z21S7SHCR	16 x 21 x 71.9-72.4	100	146.11	18	\$1358	\$1392	\$903	N/A
Z18S7SHCR	16 x 18 x 71.9-72.4	100	131.39	15.50	\$1266	\$1304	\$815	N/A
Z16S7SHCR	16 x 16 x 71.9-72.4	100	121.92	14	\$1212	\$1247	\$802	N/A
Z15S7SHCR	16 x 15 x 71.9-72.4	100	115.61	12.50	\$1172	\$1201	\$712	N/A
Z12S7SHCR	16 x 12 x 71.9-72.4	100	101.94	11	\$1044	\$1071	\$645	N/A

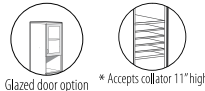
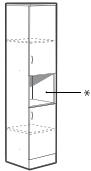

Storage Cabinet with Doors and Cavity - RIGHT

Laminate doors are standard. **Includes two adjustable shelves.** Upper and lower locks secure both compartments

Z36L7SHN	24 x 36 x 71.9-72.4	150	249.61	43.25	\$1717	\$1791	N/A	N/A
Z30L7SHN	24 x 30 x 71.9-72.4	150	216.23	36.25	\$1522	\$1585	N/A	N/A
Z21L7SHN	24 x 21 x 71.9-72.4	125	171.94	26	\$1318	\$1370	N/A	N/A
Z18L7SHN	24 x 18 x 71.9-72.4	125	156.83	22.75	\$1240	\$1283	N/A	N/A
Z16L7SHN	24 x 16 x 71.9-72.4	125	147.10	20.75	\$1151	\$1193	N/A	N/A
Z15L7SHN	24 x 15 x 71.9-72.4	125	141.72	19.25	\$1117	\$1152	N/A	N/A
Z12L7SHN	24 x 12 x 71.9-72.4	125	121.35	16	\$1034	\$1143	N/A	N/A
Z36M7SHN	20 x 36 x 71.9-72.4	150	217.09	36.75	\$1559	\$1622	N/A	N/A
Z30M7SHN	20 x 30 x 71.9-72.4	125	188.26	30.50	\$1372	\$1427	N/A	N/A
Z21M7SHN	20 x 21 x 71.9-72.4	125	148.69	21.25	\$1044	\$1086	N/A	N/A
Z18M7SHN	20 x 18 x 71.9-72.4	125	134.80	19.25	\$1111	\$1150	N/A	N/A
Z16M7SHN	20 x 16 x 71.9-72.4	125	127.29	17.50	\$1030	\$1068	N/A	N/A
Z15M7SHN	20 x 15 x 71.9-72.4	125	121.96	16.25	\$1000	\$1032	N/A	N/A
Z12M7SHN	20 x 12 x 71.9-72.4	100	109.11	13.25	\$925	\$952	N/A	N/A
Z36S7SHN	16 x 36 x 71.9-72.4	125	181.43	29.50	\$1349	\$1412	N/A	N/A
Z30S7SHN	16 x 30 x 71.9-72.4	125	158.19	25	\$1212	\$1254	N/A	N/A
Z21S7SHN	16 x 21 x 71.9-72.4	125	124.38	18	\$1041	\$1075	N/A	N/A
Z18S7SHN	16 x 18 x 71.9-72.4	125	112.77	15.50	\$976	\$1014	N/A	N/A
Z16S7SHN	16 x 16 x 71.9-72.4	125	105.37	14	\$925	\$960	N/A	N/A
Z15S7SHN	16 x 15 x 71.9-72.4	100	100.10	12.50	\$912	\$941	N/A	N/A
Z12S7SHN	16 x 12 x 71.9-72.4	100	89.53	11	\$797	\$824	N/A	N/A

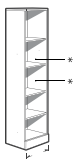
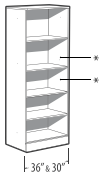

Open Storage Cabinet

Four adjustable shelves.

Required Specifications

- Top finish
- Base finish
- Top/edge detail
- Handles

Optional Specifications

- Glazing - Doors
- Collator (Open Shelves)

STORAGE MODULES - 72"/72.5" HIGH



Glazed door option

File Module with Doors*

MODEL#	DIMENSIONS D x W x H	FREIGHT CLASS	WT./LBS.	CUBIC FT.	1" TOP	1.5" TOP	GLAZE ADD	HP ADD
Z36L7F	24 x 36 x 71.9-72.4	125	310.80	43.25	\$2572	\$2646	\$1370	N/A
Z30L7F	24 x 30 x 71.9-72.4	125	270.90	36.25	\$2298	\$2361	\$1188	N/A
Z36M7F	20 x 36 x 71.9-72.4	125	279.30	36.75	\$2412	\$2475	\$1370	N/A
Z30M7F	20 x 30 x 71.9-72.4	100	244.65	30.50	\$2154	\$2209	\$1188	N/A
Z36S7F	16 x 36 x 71.9-72.4	100	239.40	29.50	\$2166	\$2228	\$1370	N/A
Z30S7F	16 x 30 x 71.9-72.4	100	207.90	25	\$1941	\$1983	\$1188	N/A

One lateral file drawer. Laminate doors are standard. **Includes three adjustable shelves.** Upper lock secures storage compartment. Lower lock secures one file drawer. Front-to-back and side-to-side letter/legal filing capability. Side-to-side file bars included.

- Lateral file drawer construction is for accommodating hanging files NOT for stacking materials on the drawer bottom.



Glazed door option

File Module with Door - LEFT

Z16L7FL	24 x 16 x 71.9-72.4	100	178.50	20.75	\$1572	\$1614	\$660	N/A
Z15L7FL	24 x 15 x 71.9-72.4	100	171.15	19.25	\$1476	\$1511	\$572	N/A
Z16M7FL	20 x 16 x 71.9-72.4	100	157.50	17.50	\$1452	\$1490	\$660	N/A
Z15M7FL	20 x 15 x 71.9-72.4	100	151.20	16.25	\$1387	\$1419	\$572	N/A
Z16S7FL	16 x 16 x 71.9-72.4	100	132.30	14	\$1336	\$1371	\$660	N/A
Z15S7FL	16 x 15 x 71.9-72.4	92.5	127.05	12.50	\$1297	\$1327	\$572	N/A

One file drawer. Laminate door is standard. **Includes three adjustable shelves.** Upper lock secures storage compartment. Lower lock secures one file drawer.



Glazed door option

File Module with Door - RIGHT

Z16L7FR	24 x 16 x 71.9-72.4	100	178.50	20.75	\$1572	\$1614	\$660	N/A
Z15L7FR	24 x 15 x 71.9-72.4	100	171.15	19.25	\$1476	\$1511	\$572	N/A
Z16M7FR	20 x 16 x 71.9-72.4	100	157.50	17.50	\$1452	\$1490	\$660	N/A
Z15M7FR	20 x 15 x 71.9-72.4	100	151.20	16.25	\$1387	\$1419	\$572	N/A
Z16S7FR	16 x 16 x 71.9-72.4	100	132.30	14	\$1336	\$1371	\$660	N/A
Z15S7FR	16 x 15 x 71.9-72.4	92.5	127.05	12.50	\$1297	\$1327	\$572	N/A

One file drawer. Laminate door is standard. **Includes three adjustable shelves.** Upper lock secures storage compartment. Lower lock secures one file drawer.

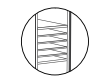
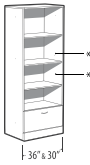

* Accepts collator 11" high

File Module with Open Shelves*

Z36L7FN	24 x 36 x 71.9-72.4	125	275.44	43.25	\$2129	\$2202	N/A	N/A
Z30L7FN	24 x 30 x 71.9-72.4	125	240.73	36.25	\$1911	\$1974	N/A	N/A
Z16L7FN	24 x 16 x 71.9-72.4	125	162.20	20.75	\$1345	\$1387	N/A	N/A
Z15L7FN	24 x 15 x 71.9-72.4	100	155.54	19.25	\$1263	\$1298	N/A	N/A
Z36M7FN	20 x 36 x 71.9-72.4	125	242.92	36.75	\$1964	\$2027	N/A	N/A
Z30M7FN	20 x 30 x 71.9-72.4	125	213.81	30.50	\$1766	\$1819	N/A	N/A
Z16M7FN	20 x 16 x 71.9-72.4	100	141.33	17.50	\$1225	\$1263	N/A	N/A
Z15M7FN	20 x 15 x 71.9-72.4	100	136.83	16.25	\$1174	\$1206	N/A	N/A
Z36S7FN	16 x 36 x 71.9-72.4	125	203.06	29.50	\$1722	\$1784	N/A	N/A
Z30S7FN	16 x 30 x 71.9-72.4	125	177.44	25	\$1551	\$1593	N/A	N/A
Z16S7FN	16 x 16 x 71.9-72.4	100	116.27	14	\$1111	\$1146	N/A	N/A
Z15S7FN	16 x 15 x 71.9-72.4	100	111.82	12.50	\$1100	\$1129	N/A	N/A

Four open shelves and one file drawer on bottom. **Includes three adjustable shelves.** Lock secures file drawer. 36" and 30" wide models have front-to-back and side-to-side letter/legal filing capability. Side-to-side file bars included.

- Lateral file drawer construction is for accommodating hanging files NOT for stacking materials on the drawer bottom.



Glazed door option

Two File Module with Doors*

Z36L7E	24 x 36 x 71.9-72.4	125	316.05	43.25	\$2803	\$2876	\$1159	N/A
Z30L7E	24 x 30 x 71.9-72.4	125	276.15	36.25	\$2560	\$2623	\$1010	N/A
Z36M7E	20 x 36 x 71.9-72.4	125	285.60	36.75	\$2653	\$2716	\$1159	N/A
Z30M7E	20 x 30 x 71.9-72.4	100	249.90	30.50	\$2419	\$2474	\$1010	N/A
Z36S7E	16 x 36 x 71.9-72.4	100	244.65	29.50	\$2425	\$2488	\$1159	N/A
Z30S7E	16 x 30 x 71.9-72.4	100	213.15	25	\$2186	\$2228	\$1010	N/A

Two lateral file drawers. Laminate doors are standard. **Includes two adjustable shelves.** Upper lock secures storage compartment. Lower lock secures two file drawers. Front-to-back and side-to-side letter/legal filing capability. Side-to-side file bars included.

- Lateral file drawer construction is for accommodating hanging files NOT for stacking materials on the drawer bottom.

Required Specifications

Top finish
Base finish
Top/Edge Detail
Handles

Optional Specifications

Glazing - Doors
Collator (Open Shelves)
Box drawer* - no upcharge (30"-36" wide models only)

STORAGE MODULES - 72"/72.5" HIGH



Glazed door option

Two File Module with Door - LEFT

MODEL#	DIMENSIONS D x W x H	FREIGHT CLASS	WT/LBS.	CUBIC FT.	1" TOP	1.5" TOP	GLAZE ADD	HP ADD
Z16L7EL	24 x 16 x 71.9-72.4	100	181.65	20.75	\$1653	\$1696	\$571	N/A
Z15L7EL	24 x 15 x 71.9-72.4	100	176.40	19.25	\$1588	\$1623	\$501	N/A
Z16M7EL	20 x 16 x 71.9-72.4	100	162.75	17.50	\$1536	\$1574	\$571	N/A
Z15M7EL	20 x 15 x 71.9-72.4	100	155.40	16.25	\$1475	\$1507	\$501	N/A
Z16S7EL	16 x 16 x 71.9-72.4	100	137.55	14	\$1429	\$1464	\$571	N/A
Z15S7EL	16 x 15 x 71.9-72.4	92.5	132.30	12.50	\$1398	\$1427	\$501	N/A

Two file drawers on bottom. Laminate door is standard. **Includes two 3-position fixed/height adjustable shelves.** Upper lock secures storage compartment. Lower lock secures two file drawers.



Glazed door option

Two File Module with Door - RIGHT

Z16L7ER	24 x 16 x 71.9-72.4	100	181.65	20.75	\$1653	\$1696	\$571	N/A
Z15L7ER	24 x 15 x 71.9-72.4	100	176.40	19.25	\$1588	\$1623	\$501	N/A
Z16M7ER	20 x 16 x 71.9-72.4	100	162.75	17.50	\$1536	\$1574	\$571	N/A
Z15M7ER	20 x 15 x 71.9-72.4	100	155.40	16.25	\$1475	\$1507	\$501	N/A
Z16S7ER	16 x 16 x 71.9-72.4	100	137.55	14	\$1429	\$1464	\$571	N/A
Z15S7ER	16 x 15 x 71.9-72.4	92.5	132.30	12.50	\$1398	\$1427	\$501	N/A

Two file drawers on bottom. Laminate door is standard. **Includes two 3-position fixed/height adjustable shelves.** Upper lock secures storage compartment. Lower lock secures two file drawers.



Glazed door option



* Accepts collator 11" high

Two File Module with Doors & Cavity*

Z36L7EC	24 x 36 x 71.9-72.4	125	307.85	43.25	\$2746	\$2819	\$912	N/A
Z30L7EC	24 x 30 x 71.9-72.4	125	270.37	36.25	\$2514	\$2577	\$793	N/A
Z36M7EC	20 x 36 x 71.9-72.4	125	278.49	36.75	\$2597	\$2660	\$912	N/A
Z30M7EC	20 x 30 x 71.9-72.4	125	243.45	30.50	\$2374	\$2429	\$793	N/A
Z36S7EC	16 x 36 x 71.9-72.4	100	237.57	29.50	\$2203	\$2265	\$912	N/A
Z30S7EC	16 x 30 x 71.9-72.4	100	207.08	25	\$1974	\$2016	\$793	N/A

Two lateral file drawers on bottom. Laminate doors are standard. **Includes one 3-position fixed/height adjustable shelf.** Upper lock secures storage compartment. Lower lock secures all drawers. Front-to-back and side-to-side letter/legal filing capability. Side-to-side file bars included.

- Lateral file drawer construction is for accommodating hanging files NOT for stacking materials on the drawer bottom.

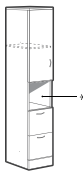

Glazed door option



* Accepts collator 11" high

Two File Module with Doors Cavity - LEFT

Z16L7ECL	24 x 16 x 71.9-72.4	100	178.36	20.75	\$1625	\$1668	\$451	N/A
Z15L7ECL	24 x 15 x 71.9-72.4	100	172.98	19.25	\$1568	\$1603	\$397	N/A
Z16M7ECL	20 x 16 x 71.9-72.4	100	159.59	17.50	\$1495	\$1533	\$451	N/A
Z15M7ECL	20 x 15 x 71.9-72.4	100	153.22	16.25	\$1442	\$1472	\$397	N/A
Z16S7ECL	16 x 16 x 71.9-72.4	100	134.52	14	\$1402	\$1437	\$451	N/A
Z15S7ECL	16 x 15 x 71.9-72.4	92.5	129.26	12.50	\$1373	\$1403	\$397	N/A

Two lateral file drawers on bottom. Laminate doors are standard. **Includes one 3-position fixed/height adjustable shelf.** Upper lock secures storage compartment. Lower lock secures all drawers.

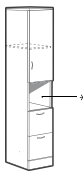

Glazed door option



* Accepts collator 11" high

Two File Module with Doors Cavity - LEFT

Z16L7ECR	24 x 16 x 71.9-72.4	100	178.36	20.75	\$1625	\$1668	\$451	N/A
Z15L7ECR	24 x 15 x 71.9-72.4	100	172.98	19.25	\$1568	\$1603	\$397	N/A
Z16M7ECR	20 x 16 x 71.9-72.4	100	159.59	17.50	\$1495	\$1533	\$451	N/A
Z15M7ECR	20 x 15 x 71.9-72.4	100	153.22	16.25	\$1442	\$1472	\$397	N/A
Z16S7ECR	16 x 16 x 71.9-72.4	100	134.52	14	\$1402	\$1437	\$451	N/A
Z15S7ECR	16 x 15 x 71.9-72.4	92.5	129.26	12.50	\$1373	\$1403	\$397	N/A

Two lateral file drawers on bottom. Laminate doors are standard. **Includes one 3-position fixed/height adjustable shelf.** Upper lock secures storage compartment. Lower lock secures all drawers.

Required Specifications

Top finish
Base finish
Top/Edge Detail
Handles

Optional Specifications

Glazing - Doors
Collator (Open Shelves)
Box drawer - no upcharge* (30"-36" wide models only)

STORAGE MODULES - 72"/72.5" HIGH

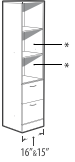
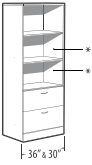

* Accepts collator 11" high

Two File Module with Open Shelves*

MODEL#	DIMENSIONS D x W x H	FREIGHT CLASS	WT./LBS.	CUBIC FT.	1" TOP	1.5" TOP	GLAZE ADD	HP ADD
Z36L7EN	24 x 36 x 71.9-72.4	125	286.57	43.25	\$2433	\$2507	N/A	N/A
Z30L7EN	24 x 30 x 71.9-72.4	125	252.63	36.25	\$2239	\$2302	N/A	N/A
Z16L7EN	24 x 16 x 71.9-72.4	100	168.90	20.75	\$1468	\$1510	N/A	N/A
Z15L7EN	24 x 15 x 71.9-72.4	100	164.12	19.25	\$1425	\$1460	N/A	N/A
Z36M7EN	20 x 36 x 71.9-72.4	125	257.21	36.75	\$2288	\$2352	N/A	N/A
Z30M7EN	20 x 30 x 71.9-72.4	125	225.71	30.50	\$2097	\$2152	N/A	N/A
Z16M7EN	20 x 16 x 71.9-72.4	100	150.13	17.50	\$1350	\$1388	N/A	N/A
Z15M7EN	20 x 15 x 71.9-72.4	100	144.36	16.25	\$1313	\$1343	N/A	N/A
Z36S7EN	16 x 36 x 71.9-72.4	125	216.29	29.50	\$2058	\$2120	N/A	N/A
Z30S7EN	16 x 30 x 71.9-72.4	125	189.34	25	\$1865	\$1907	N/A	N/A
Z16S7EN	16 x 16 x 71.9-72.4	100	125.06	14	\$1245	\$1280	N/A	N/A
Z15S7EN	16 x 15 x 71.9-72.4	100	120.40	12.50	\$1233	\$1263	N/A	N/A

Three open shelves and two file drawers on bottom. **Includes two 3-position fixed/height adjustable shelves.** Lock secures all drawers. 36" and 30" wide models have front-to-back and side-to-side letter/legal filing capability. Side-to-side file bars included.

- Lateral file drawer construction is for accommodating hanging files NOT for stacking materials on the drawer bottom.



Glazed door option

Three File Module with Doors*

Z36L73F	24 x 36 x 71.9-72.4	125	320.25	43.25	\$3070	\$3144	\$912	N/A
Z30L73F	24 x 30 x 71.9-72.4	125	283.50	36.25	\$2814	\$2876	\$793	N/A
Z36M73F	20 x 36 x 71.9-72.4	125	290.85	36.75	\$2941	\$3004	\$912	N/A
Z30M73F	20 x 30 x 71.9-72.4	100	259.35	30.50	\$2684	\$2739	\$793	N/A
Z36S73F	16 x 36 x 71.9-72.4	100	248.85	29.50	\$2665	\$2727	\$912	N/A
Z30S73F	16 x 30 x 71.9-72.4	100	218.40	25	\$2418	\$2460	\$793	N/A

Three lateral file drawers on bottom. Laminate doors are standard. **Includes one 3-position fixed/height adjustable shelf.** Upper lock secures storage compartment. Lower lock secures three file drawers. Front-to-back and side-to-side letter/legal filing capability. Side-to-side file bars included.

- Lateral file drawer construction is for accommodating hanging files NOT for stacking materials on the drawer bottom.



Glazed door option

Three File Module with Door - LEFT

Z16L73FL	24 x 16 x 71.9-72.4	100	187.95	20.75	\$1789	\$1831	\$451	N/A
Z15L73FL	24 x 15 x 71.9-72.4	100	182	19.25	\$1729	\$1764	\$397	N/A
Z16M73FL	20 x 16 x 71.9-72.4	100	169.05	17.50	\$1680	\$1718	\$451	N/A
Z15M73FL	20 x 15 x 71.9-72.4	100	161.70	16.25	\$1627	\$1657	\$397	N/A
Z16S73FL	16 x 16 x 71.9-72.4	92.5	142.80	14	\$1568	\$1603	\$451	N/A
Z15S73FL	16 x 15 x 71.9-72.4	92.5	137.55	12.50	\$1527	\$1557	\$397	N/A

Three file drawers on bottom. Laminate door is standard. **Includes one 3-position fixed/height adjustable shelf.** Upper lock secures storage compartment. Lower lock secures three file drawers.



Glazed door option

Three File Module with Door - RIGHT

Z16L73FR	24 x 16 x 71.9-72.4	100	187.95	20.75	\$1789	\$1831	\$451	N/A
Z15L73FR	24 x 15 x 71.9-72.4	100	182	19.25	\$1729	\$1764	\$397	N/A
Z16M73FR	20 x 16 x 71.9-72.4	100	169.05	17.50	\$1680	\$1718	\$451	N/A
Z15M73FR	20 x 15 x 71.9-72.4	100	161.70	16.25	\$1627	\$1657	\$397	N/A
Z16S73FR	16 x 16 x 71.9-72.4	92.5	142.80	14	\$1568	\$1603	\$451	N/A
Z15S73FR	16 x 15 x 71.9-72.4	92.5	137.55	12.50	\$1527	\$1557	\$397	N/A

Three file drawers on bottom. Laminate door is standard. **Includes one 3-position fixed/height adjustable shelf.** Upper lock secures storage compartment. Lower lock secures three file drawers.

Required Specifications

- Top finish
- Base finish
- Top/Edge Detail
- Handles

Optional Specifications

- Glazing - Doors
- Collator (Open Shelves)
- Box drawer* - no upcharge (30"-36" wide models only)

STORAGE MODULES - 72"/72.5" HIGH

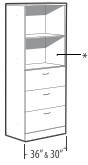

* Accepts collator 11" high

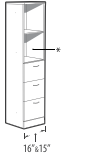

Glazed door option

Three File Module with Open Shelves*

MODEL#	DIMENSIONS D x W x H	FREIGHT CLASS	WT/LBS.	CUBIC FT.	1" TOP	1.5" TOP	GLAZE ADD	HP ADD
Z36L73FN	24 x 36 x 71.9-72.4	125	298.75	43.25	\$2761	\$2834	N/A	N/A
Z30L73FN	24 x 30 x 71.9-72.4	125	266.63	36.25	\$2539	\$2602	N/A	N/A
Z16L73FN	24 x 16 x 71.9-72.4	100	178.75	20.75	\$1630	\$1673	N/A	N/A
Z15L73FN	24 x 15 x 71.9-72.4	100	172.69	19.25	\$1588	\$1623	N/A	N/A
Z36M73FN	20 x 36 x 71.9-72.4	125	270.44	36.75	\$2630	\$2693	N/A	N/A
Z30M73FN	20 x 30 x 71.9-72.4	125	241.81	30.50	\$2412	\$2465	N/A	N/A
Z16M73FN	20 x 16 x 71.9-72.4	100	159.98	17.50	\$1522	\$1560	N/A	N/A
Z15M73FN	20 x 15 x 71.9-72.4	100	153.98	16.25	\$1487	\$1517	N/A	N/A
Z36S73FN	16 x 36 x 71.9-72.4	125	228.47	29.50	\$2348	\$2411	N/A	N/A
Z30S73FN	16 x 30 x 71.9-72.4	100	201.24	25	\$2141	\$2183	N/A	N/A
Z16S73FN	16 x 16 x 71.9-72.4	100	133.86	14	\$1408	\$1443	N/A	N/A
Z15S73FN	16 x 15 x 71.9-72.4	92.5	128.97	12.50	\$1384	\$1414	N/A	N/A

Two open shelves and three file drawers on bottom. **Includes one 3-position fixed/height adjustable shelf.** Lock secures all drawers. 36" and 30" wide models have front-to-back and side-to-side letter/legal filing capability. Side-to-side file bars included.

- Lateral file drawer construction is for accommodating hanging files NOT for stacking materials on the drawer bottom.

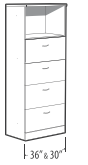

Four File Module with Open Shelf*

Z36L74FN	24 x 36 x 71.9-72.4	125	310.80	43.25	\$3291	\$3365	N/A	N/A
Z30L74FN	24 x 30 x 71.9-72.4	125	277.20	36.25	\$3076	\$3139	N/A	N/A
Z16L74FN	24 x 16 x 71.9-72.4	100	186.90	20.75	\$1757	\$1799	N/A	N/A
Z15L74FN	24 x 15 x 71.9-72.4	100	180.60	19.25	\$1710	\$1744	N/A	N/A
Z36M74FN	20 x 36 x 71.9-72.4	125	283.50	36.75	\$2939	\$3002	N/A	N/A
Z30M74FN	20 x 30 x 71.9-72.4	100	255.15	30.50	\$2763	\$2816	N/A	N/A
Z16M74FN	20 x 16 x 71.9-72.4	100	169.05	17.50	\$1653	\$1691	N/A	N/A
Z15M74FN	20 x 15 x 71.9-72.4	100	161.70	16.25	\$1602	\$1632	N/A	N/A
Z36S74FN	16 x 36 x 71.9-72.4	100	239.40	29.50	\$2632	\$2694	N/A	N/A
Z30S74FN	16 x 30 x 71.9-72.4	100	212.10	25	\$2399	\$2441	N/A	N/A
Z16S74FN	16 x 16 x 71.9-72.4	92.5	140.70	14	\$1519	\$1554	N/A	N/A
Z15S74FN	16 x 15 x 71.9-72.4	92.5	135.45	12.50	\$1460	\$1490	N/A	N/A

Open shelf and four file drawers. Lock secures all drawers. 36" and 30" wide models have front-to-back and side-to-side letter/legal filing capability. Side-to-side file bars included.

- Lateral file drawer construction is for accommodating hanging files NOT for stacking materials on the drawer bottom.



Intended for working while standing

Media Center - LEFT

Z36L7MCL	24 x 36 x 71.9-72.4	125	294	43.25	\$2554	\$2627	N/A	N/A
Z30L7MCL	24 x 30 x 71.9-72.4	125	259.35	36.25	\$2328	\$2391	N/A	N/A
Z36M7MCL	20 x 36 x 71.9-72.4	125	261.45	36.75	\$2379	\$2442	N/A	N/A
Z30M7MCL	20 x 30 x 71.9-72.4	125	229.95	30.50	\$2166	\$2221	N/A	N/A
Z36S7MCL	16 x 36 x 71.9-72.4	125	214.20	29.50	\$2094	\$2156	N/A	N/A
Z30S7MCL	16 x 30 x 71.9-72.4	125	189	25	\$1896	\$1938	N/A	N/A

Unit, accommodates pc, keyboard, monitor, hanging folders and accessories and/or printer. One vertical drawer on the **left**. Pull out keyboard shelf. Adjustable pull out bottom shelf accommodates pc and/or printer. **Includes one 3-position fixed/height adjustable shelf.** Grommet in worksurface and back panel. Lock secures vertical drawer.

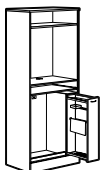

Intended for working while standing

Media Center - RIGHT

Z36L7MCR	24 x 36 x 71.9-72.4	125	294	43.25	\$2554	\$2627	N/A	N/A
Z30L7MCR	24 x 30 x 71.9-72.4	125	259.35	36.25	\$2328	\$2391	N/A	N/A
Z36M7MCR	20 x 36 x 71.9-72.4	125	261.45	36.75	\$2379	\$2442	N/A	N/A
Z30M7MCR	20 x 30 x 71.9-72.4	125	229.95	30.50	\$2166	\$2221	N/A	N/A
Z36S7MCR	16 x 36 x 71.9-72.4	125	214.20	29.50	\$2094	\$2156	N/A	N/A
Z30S7MCR	16 x 30 x 71.9-72.4	125	189	25	\$1896	\$1938	N/A	N/A

Unit, accommodates pc, keyboard, monitor, hanging folders and accessories and/or printer. One vertical drawer on the **right**. Pull out keyboard shelf. Adjustable pull out bottom shelf accommodates pc and/or printer. **Includes one 3-position fixed/height adjustable shelf.** Grommet in worksurface and back panel. Lock secures vertical drawer.

Required Specifications

- Top finish
- Base finish
- Top/Edge Detail
- Handles

Optional Specifications

- Glazing - Doors
- Collator (Open Shelves)
- Box drawer* - no upcharge (30" - 36" wide models only)

STORAGE MODULES - 72"/72.5" HIGH



PC Center



MODEL#	DIMENSIONS D x W x H	FREIGHT CLASS	WT/LBS.	CUBIC FT.	1" TOP	1.5" TOP	GLAZE ADD	HP ADD
Z36L7PC	24 x 36 x 71.9-72.4	150	255.15	43.25	\$1884	\$1957	N/A	N/A
Z30L7PC	24 x 30 x 71.9-72.4	125	221.55	36.25	\$1684	\$1747	N/A	N/A
Z36M7PC	20 x 36 x 71.9-72.4	125	226.80	36.75	\$1731	\$1794	N/A	N/A
Z30M7PC	20 x 30 x 71.9-72.4	125	197.40	30.50	\$1519	\$1574	N/A	N/A
Z36S7PC	16 x 36 x 71.9-72.4	125	187.95	29.50	\$1497	\$1559	N/A	N/A
Z30S7PC	16 x 30 x 71.9-72.4	125	162.75	25	\$1378	\$1420	N/A	N/A

Standing height unit, accommodates pc, keyboard, monitor and/or printer. Pull out keyboard shelf. Adjustable pull out bottom shelf accommodates pc and/or printer. **Includes one 3-position fixed/height adjustable shelf.** Grommet in worksurface and back panel.

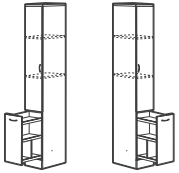

LEFT RIGHT
Vertical Utility Drawer with Door



Z12L7VDL	24 x 12 x 71.9-72.4	92.5	164.85	16	\$1474	\$1506	\$452	N/A
Z12M7VDL	20 x 12 x 71.9-72.4	92.5	147	13.25	\$1363	\$1390	\$452	N/A
Z12S7VDL	16 x 12 x 71.9-72.4	92.5	123.90	11	\$1247	\$1274	\$452	N/A
Z12L7VDR	24 x 12 x 71.9-72.4	92.5	164.85	16	\$1474	\$1506	\$452	N/A
Z12M7VDR	20 x 12 x 71.9-72.4	92.5	147	13.25	\$1363	\$1390	\$452	N/A
Z12S7VDR	16 x 12 x 71.9-72.4	92.5	123.90	11	\$1247	\$1274	\$452	N/A

Specify **VDL** models for **LEFT** or **VDR** models for **RIGHT**

Laminate doors are standard. **Includes two 3-position fixed/height adjustable shelves** and one vertical drawer. Upper lock secures storage compartment. Lower lock secures vertical drawer.

WARDROBE CABINETS - 72"/72.5" HIGH

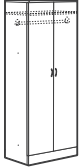

Wardrobe Cabinet

MODEL#	DIMENSIONS	FREIGHT CLASS	WT/LBS.	CUBIC FT.	1" TOP	1.5" TOP	GLAZE ADD	HP ADD
Z36L7WA	24 x 36 x 71.9-72.4	150	252	43.25	\$1998	\$2071	N/A	N/A
Z30L7WA	24 x 30 x 71.9-72.4	125	218.40	36.25	\$1865	\$1928	N/A	N/A
Z36M7WA	20 x 36 x 71.9-72.4	125	226.80	36.75	\$1878	\$1941	N/A	N/A
Z30M7WA	20 x 30 x 71.9-72.4	125	196.35	30.50	\$1667	\$1722	N/A	N/A

Laminate doors are standard. Full length hanging rod included. **Includes one 3-position fixed/height adjustable shelf** above hanging rod. Standard with lock.



Wardrobe Cabinet - LEFT

Z24L7WAL	24 x 24 x 71.9-72.4	125	191.10	29.75	\$1513	\$1565	N/A	N/A
Z21L7WAL	24 x 21 x 71.9-72.4	125	178.50	26	\$1460	\$1512	N/A	N/A
Z18L7WAL	24 x 18 x 71.9-72.4	125	158.55	22.75	\$1340	\$1383	N/A	N/A
Z16L7WAL	24 x 16 x 71.9-72.4	125	149.10	20.75	\$1287	\$1329	N/A	N/A
Z15L7WAL	24 x 15 x 71.9-72.4	125	144.90	19.25	\$1224	\$1259	N/A	N/A
Z12L7WAL	24 x 12 x 71.9-72.4	100	130.20	16	\$1140	\$1170	N/A	N/A
Z24M7WAL	20 x 24 x 71.9-72.4	125	171.15	25.25	\$1400	\$1445	N/A	N/A
Z21M7WAL	20 x 21 x 71.9-72.4	125	154.35	21.25	\$1341	\$1384	N/A	N/A
Z18M7WAL	20 x 18 x 71.9-72.4	125	139.65	19.25	\$1240	\$1278	N/A	N/A
Z16M7WAL	20 x 16 x 71.9-72.4	125	131.25	17.50	\$1183	\$1221	N/A	N/A
Z15M7WAL	20 x 15 x 71.9-72.4	125	126	16.25	\$1124	\$1156	N/A	N/A
Z12M7WAL	20 x 12 x 71.9-72.4	100	113.40	13.25	\$1054	\$1081	N/A	N/A

Laminate doors are standard. Full length hanging rod included. **Includes one 3-position fixed/height adjustable shelf** above hanging rod. Standard with lock.

Required Specifications

Top finish
Base finish
Top/Edge Detail
Handles

Optional Specifications

Glazing - Doors (Vertical Utility)

WARDROBE CABINETS - 72"/72.5" HIGH

MODEL# DIMENSIONS FREIGHT CLASS WT/LBS. CUBIC FT. 1" TOP 1.5" TOP GLAZE ADD HP ADD

D x W x H

Z24L7WAR	24 x 24 x 71.9-72.4	125	191.10	29.75	\$1513	\$1565	N/A	N/A
Z21L7WAR	24 x 21 x 71.9-72.4	125	178.50	26	\$1460	\$1512	N/A	N/A
Z18L7WAR	24 x 18 x 71.9-72.4	125	158.55	22.75	\$1340	\$1383	N/A	N/A
Z16L7WAR	24 x 16 x 71.9-72.4	125	149.10	20.75	\$1287	\$1329	N/A	N/A
Z15L7WAR	24 x 15 x 71.9-72.4	125	144.90	19.25	\$1224	\$1259	N/A	N/A
Z12L7WAR	24 x 12 x 71.9-72.4	100	130.20	16	\$1140	\$1170	N/A	N/A
Z24M7WAR	20 x 24 x 71.9-72.4	125	171.15	25.25	\$1400	\$1445	N/A	N/A
Z21M7WAR	20 x 21 x 71.9-72.4	125	154.35	21.25	\$1341	\$1384	N/A	N/A
Z18M7WAR	20 x 18 x 71.9-72.4	125	139.65	19.25	\$1240	\$1278	N/A	N/A
Z16M7WAR	20 x 16 x 71.9-72.4	125	131.25	17.50	\$1183	\$1221	N/A	N/A
Z15M7WAR	20 x 15 x 71.9-72.4	125	126	16.25	\$1124	\$1156	N/A	N/A
Z12M7WAR	20 x 12 x 71.9-72.4	100	113.40	13.25	\$1054	\$1081	N/A	N/A



Wardrobe Cabinet - RIGHT

Laminate doors are standard. Full length hanging rod included. **Includes one 3-position fixed/height adjustable shelf** above hanging rod. Standard with lock.

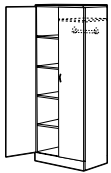

Glazed door option

Wardrobe Cabinet/Shelving Combo with Doors - LEFT

Z36L7DIL	24 x 36 x 71.9-72.4	125	300.30	43.25	\$2355	\$2429	\$1472	N/A
Z30L7DIL	24 x 30 x 71.9-72.4	125	262.50	36.25	\$2058	\$2121	\$1274	N/A
Z24L7DIL	24 x 24 x 71.9-72.4	125	232.05	29.75	\$1872	\$1924	\$1147	N/A
Z21L7DIL	24 x 21 x 71.9-72.4	125	200.55	26	\$1817	\$1868	\$1137	N/A
Z36M7DIL	20 x 36 x 71.9-72.4	125	276.15	36.75	\$2211	\$2274	\$1472	N/A
Z30M7DIL	20 x 30 x 71.9-72.4	125	241.50	30.50	\$1919	\$1974	\$1274	N/A
Z24M7DIL	20 x 24 x 71.9-72.4	100	214.20	25.25	\$1760	\$1803	\$1147	N/A
Z21M7DIL	20 x 21 x 71.9-72.4	100	196.35	21.25	\$1689	\$1732	\$1137	N/A

Laminate doors are standard. Storage compartment on **left includes four 3-position fixed/height adjustable shelves**. Wardrobe compartment on **right** includes hanging rod and one adjustable shelf above rod. Storage and wardrobe compartments lock independently. Each door lock keyed alike.

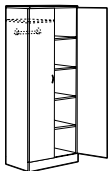

Glazed door option

Wardrobe Cabinet/Shelving Combo with Doors - RIGHT

Z36L7DIR	24 x 36 x 71.9-72.4	125	300.30	43.25	\$2355	\$2429	\$1472	N/A
Z30L7DIR	24 x 30 x 71.9-72.4	125	262.50	36.25	\$2058	\$2121	\$1274	N/A
Z24L7DIR	24 x 24 x 71.9-72.4	125	232.05	29.75	\$1872	\$1924	\$1147	N/A
Z21L7DIR	24 x 21 x 71.9-72.4	125	200.55	26	\$1817	\$1868	\$1137	N/A
Z36M7DIR	20 x 36 x 71.9-72.4	125	276.15	36.75	\$2211	\$2274	\$1472	N/A
Z30M7DIR	20 x 30 x 71.9-72.4	125	241.50	30.50	\$1919	\$1974	\$1274	N/A
Z24M7DIR	20 x 24 x 71.9-72.4	100	214.20	25.25	\$1760	\$1803	\$1147	N/A
Z21M7DIR	20 x 21 x 71.9-72.4	100	196.35	21.25	\$1689	\$1732	\$1137	N/A

Laminate doors are standard. Storage compartment on **right includes four 3-position fixed/height adjustable shelves**. Wardrobe compartment on **left** includes hanging rod and one adjustable shelf above rod. Storage and wardrobe compartments lock independently. Each door lock keyed alike.

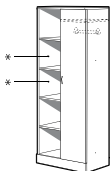

Glazed door option * Accepts collator 11" high

Wardrobe Cabinet/Open Shelving Combo - LEFT

Z36L7DINL	24 x 36 x 71.9-72.4	125	277.47	43.25	\$2125	\$2199	\$734	N/A
Z30L7DINL	24 x 30 x 71.9-72.4	125	244.53	36.25	\$1870	\$1933	\$635	N/A
Z24L7DINL	24 x 24 x 71.9-72.4	125	217.88	29.75	\$1703	\$1755	\$571	N/A
Z21L7DINL	24 x 21 x 71.9-72.4	125	189.33	26	\$1645	\$1697	\$565	N/A
Z36M7DINL	20 x 36 x 71.9-72.4	125	254.41	36.75	\$1980	\$2043	\$734	N/A
Z30M7DINL	20 x 30 x 71.9-72.4	125	222.86	30.50	\$1729	\$1784	\$635	N/A
Z24M7DINL	20 x 24 x 71.9-72.4	100	202.22	25.25	\$1588	\$1631	\$571	N/A
Z21M7DINL	20 x 21 x 71.9-72.4	100	183.93	21.25	\$1519	\$1562	\$565	N/A

Laminate door is standard on wardrobe section. Storage compartment on **left includes four 3-position fixed/height adjustable shelves**. Wardrobe compartment on **right** includes hanging rod and one adjustable shelf above rod. Single lock secures wardrobe compartment.

Required Specifications

- Top finish
- Base finish
- Top/Edge Detail
- Handles

Optional Specifications

- Glazing - Doors
- Collator (Open Shelves)

WARDROBE CABINETS - 72"/72.5" HIGH

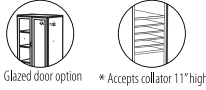
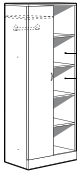

Wardrobe Cabinet/Open Shelving Combo - RIGHT

MODEL#	DIMENSIONS D x W x H	FREIGHT CLASS	WT/LBS.	CUBIC FT.	1" TOP	1.5" TOP	GLAZE ADD	HP ADD
Z36L7DINR	24 x 36 x 71.9-72.4	125	277.47	43.25	\$2125	\$2199	\$734	N/A
Z30L7DINR	24 x 30 x 71.9-72.4	125	244.53	36.25	\$1870	\$1933	\$635	N/A
Z24L7DINR	24 x 24 x 71.9-72.4	125	217.88	29.75	\$1703	\$1755	\$571	N/A
Z21L7DINR	24 x 21 x 71.9-72.4	125	189.33	26	\$1645	\$1697	\$565	N/A
Z36M7DINR	20 x 36 x 71.9-72.4	125	254.41	36.75	\$1980	\$2043	\$734	N/A
Z30M7DINR	20 x 30 x 71.9-72.4	125	222.86	30.50	\$1729	\$1784	\$635	N/A
Z24M7DINR	20 x 24 x 71.9-72.4	100	202.22	25.25	\$1588	\$1631	\$571	N/A
Z21M7DINR	20 x 21 x 71.9-72.4	100	183.93	21.25	\$1519	\$1562	\$565	N/A

Laminate door is standard on wardrobe section. Storage compartment on **right includes four 3-position fixed/height adjustable shelves**. Wardrobe compartment on **left** includes hanging rod and one adjustable shelf above rod. Single lock secures wardrobe compartment.

PERSONAL TOWERS - 72"/72.5" HIGH

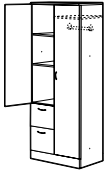

Personal Tower with Doors - LEFT

MODEL#	DIMENSIONS	FREIGHT CLASS	WT/LBS.	CUBIC FT.	1" TOP	1.5" TOP	GLAZE ADD	HP ADD
Z36L7EL	24 x 36 x 71.9-72.4	125	324.45	43.25	\$2581	\$2654	\$1305	N/A
Z30L7EL	24 x 30 x 71.9-72.4	125	289.80	36.25	\$2367	\$2430	\$1198	N/A
Z24L7EL	24 x 24 x 71.9-72.4	100	260.76	29.75	\$2255	\$2308	\$1060	N/A
Z36M7EL	20 x 36 x 71.9-72.4	125	288.75	36.75	\$2413	\$2477	\$1305	N/A
Z30M7EL	20 x 30 x 71.9-72.4	100	259.35	30.50	\$2213	\$2268	\$1198	N/A
Z24M7EL	20 x 24 x 71.9-72.4	100	231.65	25.25	\$2107	\$2150	\$1060	N/A

Two file drawers on bottom. Laminate doors are standard. Storage compartment on **left includes two 3-position fixed/height adjustable shelves**. Wardrobe compartment on **right** includes hanging rod and one adjustable shelf above rod. Two upper locks, one per each hinged door, and one lower lock secures drawers, all keyed alike.

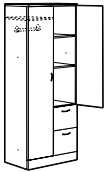

Personal Tower with Doors - RIGHT

Z36L7ER	24 x 36 x 71.9-72.4	125	324.45	43.25	\$2581	\$2654	\$1305	N/A
Z30L7ER	24 x 30 x 71.9-72.4	125	289.80	36.25	\$2367	\$2430	\$1198	N/A
Z24L7ER	24 x 24 x 71.9-72.4	100	260.76	29.75	\$2255	\$2308	\$1060	N/A
Z36M7ER	20 x 36 x 71.9-72.4	125	288.75	36.75	\$2413	\$2477	\$1305	N/A
Z30M7ER	20 x 30 x 71.9-72.4	100	259.35	30.50	\$2213	\$2268	\$1198	N/A
Z24M7ER	20 x 24 x 71.9-72.4	100	231.65	25.25	\$2107	\$2150	\$1060	N/A

Two file drawers on bottom. Laminate doors are standard. Storage compartment on **right includes two 3-position fixed/height adjustable shelves**. Wardrobe compartment on **left** includes hanging rod and one adjustable shelf above rod. Two upper locks, one per each hinged door, and one lower lock secures drawers, all keyed alike.

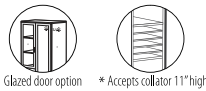
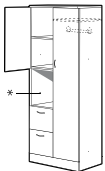

Personal Tower with Doors and cavity - LEFT

Z36L7ECL	24 x 36 x 71.9-72.4	125	320.24	43.25	\$2564	\$2638	\$1188	N/A
Z30L7ECL	24 x 30 x 71.9-72.4	125	287.34	36.25	\$2352	\$2415	\$1079	N/A
Z24L7ECL	24 x 24 x 71.9-72.4	100	257.23	29.75	\$2231	\$2283	\$940	N/A
Z36M7ECL	20 x 36 x 71.9-72.4	125	285.63	36.75	\$2375	\$2438	\$1188	N/A
Z30M7ECL	20 x 30 x 71.9-72.4	100	256.22	30.50	\$2176	\$2229	\$1079	N/A
Z24M7ECL	20 x 24 x 71.9-72.4	100	228.11	25.25	\$2067	\$2110	\$940	N/A

Two file drawers on bottom. Laminate doors are standard. Storage compartment on **left includes one 3-position fixed/height adjustable shelf**. Wardrobe compartment on **right** includes hanging rod and one adjustable shelf above rod. Two upper locks, one per each hinged door, and one lower lock secures drawers, all keyed alike.

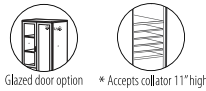
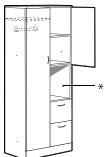

Personal Tower with Doors and cavity - RIGHT

Z36L7ECR	24 x 36 x 71.9-72.4	125	320.24	43.25	\$2564	\$2638	\$1188	N/A
Z30L7ECR	24 x 30 x 71.9-72.4	125	287.34	36.25	\$2352	\$2415	\$1079	N/A
Z24L7ECR	24 x 24 x 71.9-72.4	100	257.23	29.75	\$2231	\$2283	\$940	N/A
Z36M7ECR	20 x 36 x 71.9-72.4	125	285.63	36.75	\$2375	\$2438	\$1188	N/A
Z30M7ECR	20 x 30 x 71.9-72.4	100	256.22	30.50	\$2176	\$2229	\$1079	N/A
Z24M7ECR	20 x 24 x 71.9-72.4	100	228.11	25.25	\$2067	\$2110	\$940	N/A

Two file drawers on bottom. Laminate doors are standard. Storage compartment on **left includes one 3-position fixed/height adjustable shelf**. Wardrobe compartment on **right** includes hanging rod and one adjustable shelf above rod. Two upper locks, one per each hinged door, and one lower lock secures drawers, all keyed alike.

Required Specifications

- Top finish
- Base finish
- Top/Edge Detail
- Handles

Optional Specifications

- Glazing - Doors
- Collator (Open Shelves)

PERSONAL TOWERS - 72"/72.5" HIGH

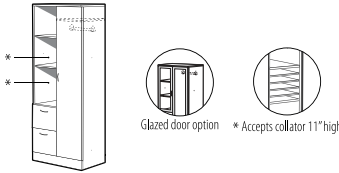

Personal Tower with Open Shelves - LEFT

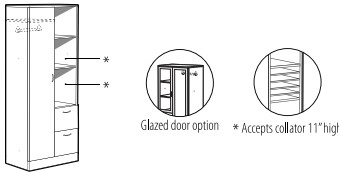

Personal Tower with Open Shelves - RIGHT

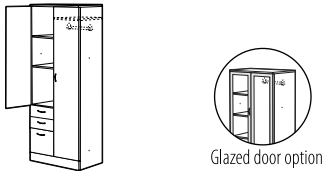

Personal Tower with Doors - LEFT

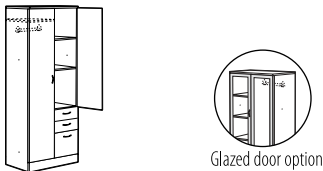

Personal Tower with Doors - RIGHT

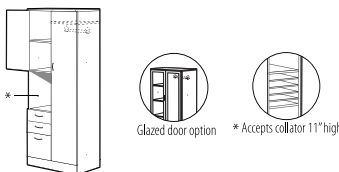

Personal Tower with Doors and Cavity - LEFT

MODEL#	DIMENSIONS D x W x H	FREIGHT CLASS	WT/LBS.	CUBIC FT.	1" TOP	1.5" TOP	GLAZE ADD	HP ADD
Z36L7ENL	24 x 36 x 71.9-72.4	125	309.60	43.25	\$2435	\$2509	\$739	N/A
Z30L7ENL	24 x 30 x 71.9-72.4	125	278.48	36.25	\$2226	\$2289	\$630	N/A
Z24L7ENL	24 x 24 x 71.9-72.4	100	247.90	29.75	\$2116	\$2168	\$493	N/A
Z36M7ENL	20 x 36 x 71.9-72.4	125	274.99	36.75	\$2258	\$2321	\$739	N/A
Z30M7ENL	20 x 30 x 71.9-72.4	100	247.36	30.50	\$2061	\$2116	\$630	N/A
Z24M7ENL	20 x 24 x 71.9-72.4	100	218.79	25.25	\$1966	\$2011	\$493	N/A

Two file drawers on bottom. Laminate door is standard on wardrobe section. Storage compartment on **left** includes **two 3-position fixed/height adjustable shelves**. Wardrobe compartment on **right** includes hanging rod and one adjustable shelf above rod. Single lock secures wardrobe compartment. Lower lock secures all drawers.

Z36L7ENR	24 x 36 x 71.9-72.4	125	309.60	43.25	\$2435	\$2509	\$739	N/A
Z30L7ENR	24 x 30 x 71.9-72.4	125	278.48	36.25	\$2226	\$2289	\$630	N/A
Z24L7ENR	24 x 24 x 71.9-72.4	100	247.90	29.75	\$2116	\$2168	\$493	N/A
Z36M7ENR	20 x 36 x 71.9-72.4	125	274.99	36.75	\$2258	\$2321	\$739	N/A
Z30M7ENR	20 x 30 x 71.9-72.4	100	247.36	30.50	\$2061	\$2116	\$630	N/A
Z24M7ENR	20 x 24 x 71.9-72.4	100	218.79	25.25	\$1966	\$2011	\$493	N/A

Two file drawers on bottom. Laminate door is standard on wardrobe section. Storage compartment on **right** includes **two 3-position fixed/height adjustable shelves**. Wardrobe compartment on **left** includes hanging rod and one adjustable shelf above rod. Single lock secures wardrobe compartment. Lower lock secures all drawers.

Z36L7BFL	24 x 36 x 71.9-72.4	125	326.55	43.25	\$2711	\$2784	\$1305	N/A
Z30L7BFL	24 x 30 x 71.9-72.4	100	292.95	36.25	\$2503	\$2566	\$1198	N/A
Z24L7BFL	24 x 24 x 71.9-72.4	100	262.10	29.75	\$2355	\$2407	\$1060	N/A
Z36M7BFL	20 x 36 x 71.9-72.4	125	291.90	36.75	\$2541	\$2604	\$1305	N/A
Z30M7BFL	20 x 30 x 71.9-72.4	100	262.50	30.50	\$2372	\$2425	\$1128	N/A
Z24M7BFL	20 x 24 x 71.9-72.4	100	232.98	25.25	\$2206	\$2249	\$1060	N/A

Two box and one file drawer on bottom. Laminate doors are standard. Storage compartment on **left** includes **two 3-position fixed/height adjustable shelves**. Wardrobe compartment on **right** includes hanging rod and one adjustable shelf above rod. Two upper locks, one per each hinged door, and one lower lock secures drawers, all keyed alike.

Z36L7BFR	24 x 36 x 71.9-72.4	125	326.55	43.25	\$2711	\$2784	\$1305	N/A
Z30L7BFR	24 x 30 x 71.9-72.4	100	292.95	36.25	\$2503	\$2566	\$1198	N/A
Z24L7BFR	24 x 24 x 71.9-72.4	100	262.10	29.75	\$2355	\$2407	\$1060	N/A
Z36M7BFR	20 x 36 x 71.9-72.4	125	291.90	36.75	\$2541	\$2604	\$1305	N/A
Z30M7BFR	20 x 30 x 71.9-72.4	100	262.50	30.50	\$2372	\$2425	\$1128	N/A
Z24M7BFR	20 x 24 x 71.9-72.4	100	232.98	25.25	\$2206	\$2249	\$1060	N/A

Two box and one file drawer on bottom. Laminate doors are standard. Storage compartment on **right** includes **two 3-position fixed/height adjustable shelves**. Wardrobe compartment on **left** includes hanging rod and one adjustable shelf above rod. Two upper locks, one per each hinged door, and one lower lock secures drawers, all keyed alike.

Z36L7BFCL	24 x 36 x 71.9-72.4	125	317.68	43.25	\$2680	\$2723	\$1188	N/A
Z30L7BFCL	24 x 30 x 71.9-72.4	125	287	36.25	\$2476	\$2511	\$1079	N/A
Z24L7BFCL	24 x 24 x 71.9-72.4	100	258.59	29.75	\$2317	\$2369	\$940	N/A
Z36M7BFCL	20 x 36 x 71.9-72.4	125	288.78	36.75	\$2495	\$2558	\$1188	N/A
Z30M7BFCL	20 x 30 x 71.9-72.4	100	259.37	30.50	\$2323	\$2378	\$1079	N/A
Z24M7BFCL	20 x 24 x 71.9-72.4	100	229.45	25.25	\$2165	\$2208	\$940	N/A

Two box and one file drawer on bottom. Laminate doors are standard. Storage compartment on **left** includes **one 3-position fixed/height adjustable shelves**. Wardrobe compartment on **right** includes hanging rod and one adjustable shelf above rod. Two upper locks, one per each hinged door, and one lower lock secures drawers, all keyed alike.

Required Specifications

Top finish
Base finish
Top/Edge Detail
Handles

Optional Specifications

Glazing - Doors
Collator (Open Shelves)

PERSONAL TOWERS - 72"/72.5" HIGH

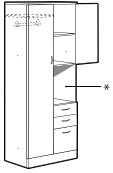

Glazed door option

* Accepts collator 11" high

Personal Tower with Doors and Cavity - RIGHT

MODEL#	DIMENSIONS D x W x H	FREIGHT CLASS	WT./LBS.	CUBIC FT.	1" TOP	1.5" TOP	GLAZE ADD	HP ADD
Z36L7BFCR	24 x 36 x 71.9-72.4	125	317.68	43.25	\$2680	\$2723	\$1188	N/A
Z30L7BFCR	24 x 30 x 71.9-72.4	125	287	36.25	\$2476	\$2511	\$1079	N/A
Z24L7BFCR	24 x 24 x 71.9-72.4	100	258.59	29.75	\$2317	\$2369	\$940	N/A
Z36M7BFCR	20 x 36 x 71.9-72.4	125	288.78	36.75	\$2495	\$2558	\$1188	N/A
Z30M7BFCR	20 x 30 x 71.9-72.4	100	259.37	30.50	\$2323	\$2378	\$1079	N/A
Z24M7BFCR	20 x 24 x 71.9-72.4	100	229.45	25.25	\$2165	\$2208	\$940	N/A

Two box and one file drawer on bottom. Laminate doors are standard. Storage compartment on **left** includes **one 3-position fixed/height adjustable shelves** Wardrobe compartment on **right** includes hanging rod and one adjustable shelf above rod. Two upper locks, one per each hinged door, and one lower lock secures drawers, all keyed alike.

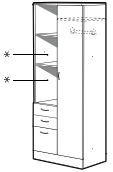

Glazed door option

* Accepts collator 11" high

Personal Tower with Open Shelves - LEFT

Z36L7BFNL	24 x 36 x 71.9-72.4	125	309	43.25	\$2557	\$2607	\$739	N/A
Z30L7BFNL	24 x 30 x 71.9-72.4	125	277	36.25	\$2347	\$2385	\$630	N/A
Z24L7BFNL	24 x 24 x 71.9-72.4	100	249.24	29.75	\$2162	\$2214	\$493	N/A
Z36M7BFNL	20 x 36 x 71.9-72.4	125	274	36.75	\$2363	\$2427	\$739	N/A
Z30M7BFNL	20 x 30 x 71.9-72.4	100	246	30.50	\$2190	\$2245	\$630	N/A
Z24M7BFNL	20 x 24 x 71.9-72.4	100	220.12	25.25	\$2012	\$2055	\$493	N/A

Two box and one file drawer on bottom. Laminate doors are standard. Storage compartment on **left** includes **two 3-position fixed/height adjustable shelves**. Wardrobe compartment on **right** includes hanging rod and **one adjustable shelf** above rod. Upper lock secures wardrobe compartment. Lower lock secures all drawers.

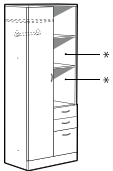

Glazed door option

* Accepts collator 11" high

Personal Tower with Open Shelves - RIGHT

Z36L7BFNR	24 x 36 x 71.9-72.4	125	309	43.25	\$2557	\$2607	\$739	N/A
Z30L7BFNR	24 x 30 x 71.9-72.4	125	277	36.25	\$2347	\$2385	\$630	N/A
Z24L7BFNR	24 x 24 x 71.9-72.4	100	249.24	29.75	\$2162	\$2214	\$493	N/A
Z36M7BFNR	20 x 36 x 71.9-72.4	125	274	36.75	\$2363	\$2427	\$739	N/A
Z30M7BFNR	20 x 30 x 71.9-72.4	100	246	30.50	\$2190	\$2245	\$630	N/A
Z24M7BFNR	20 x 24 x 71.9-72.4	100	220.12	25.25	\$2012	\$2055	\$493	N/A

Two box and one file drawer on bottom. Laminate doors are standard. Storage compartment on **right** includes **two 3-position fixed/height adjustable shelves**. Wardrobe compartment on **left** includes hanging rod and **one adjustable shelf** above rod. Upper lock secures wardrobe compartment. Lower lock secures all drawers.

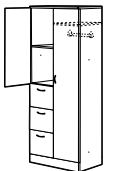

Glazed door option

Personal Tower with Doors - LEFT

Z36L73FL	24 x 36 x 71.9-72.4	125	329.70	43.25	\$2716	\$2790	\$1188	N/A
Z30L73FL	24 x 30 x 71.9-72.4	100	295.05	36.25	\$2517	\$2580	\$1079	N/A
Z24L73FL	24 x 24 x 71.9-72.4	100	264.77	29.75	\$2347	\$2400	\$940	N/A
Z36M73FL	20 x 36 x 71.9-72.4	100	296.10	36.75	\$2574	\$2637	\$1188	N/A
Z30M73FL	20 x 30 x 71.9-72.4	100	266.70	30.50	\$2376	\$2429	\$1079	N/A
Z24M73FL	20 x 24 x 71.9-72.4	100	237.97	25.25	\$2204	\$2249	\$940	N/A

Three file drawers on bottom. Laminate doors are standard. Storage compartment on **left** includes **one 3-position fixed/height adjustable shelf**. Wardrobe compartment on **right** includes hanging rod and **one adjustable shelf** above rod. Two upper locks, one per each hinged door, and one lower lock secures drawers, all keyed alike.

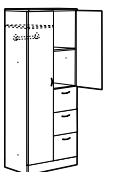

Glazed door option

Personal Tower with Doors - RIGHT

Z36L73FR	24 x 36 x 71.9-72.4	125	329.70	43.25	\$2716	\$2790	\$1188	N/A
Z30L73FR	24 x 30 x 71.9-72.4	100	295.05	36.25	\$2517	\$2580	\$1079	N/A
Z24L73FR	24 x 24 x 71.9-72.4	100	264.77	29.75	\$2347	\$2400	\$940	N/A
Z36M73FR	20 x 36 x 71.9-72.4	100	296.10	36.75	\$2574	\$2637	\$1188	N/A
Z30M73FR	20 x 30 x 71.9-72.4	100	266.70	30.50	\$2376	\$2429	\$1079	N/A
Z24M73FR	20 x 24 x 71.9-72.4	100	237.97	25.25	\$2204	\$2249	\$940	N/A

Three file drawers on bottom. Laminate doors are standard. Storage compartment on **right** includes **one 3-position fixed/height adjustable shelf**. Wardrobe compartment on **left** includes hanging rod and **one adjustable shelf** above rod. Two upper locks, one per each hinged door, and one lower lock secures drawers, all keyed alike.

Required Specifications

- Top finish
- Base finish
- Top/Edge Detail
- Handles

Optional Specifications

- Glazing - Doors
- Collator (Open Shelves)

PERSONAL TOWERS - 72"/72.5" HIGH

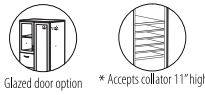
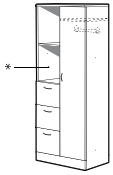

Personal Tower with Open Shelves - LEFT

MODEL#	DIMENSIONS	FREIGHT CLASS	WT/LBS.	CUBIC FT.	1" TOP	1.5" TOP	GLAZE ADD	HP ADD	
D x W x H									
Z36L73FNL	24 x 36 x 71.9-72.4	125	318.84	43.25	\$2581	\$2655	\$739	N/A	
Z30L73FNL	24 x 30 x 71.9-72.4	125	287.05	36.25	\$2381	\$2444	\$630	N/A	
Z24L73FNL	24 x 24 x 71.9-72.4	100	256.34	29.75	\$2195	\$2247	\$493	N/A	
Z36M73FNL	20 x 36 x 71.9-72.4	125	286.33	36.75	\$2435	\$2498	\$739	N/A	
Z30M73FNL	20 x 30 x 71.9-72.4	100	258.03	30.50	\$2236	\$2291	\$630	N/A	
Z24M73FNL	20 x 24 x 71.9-72.4	100	228.38	25.25	\$2051	\$2096	\$493	N/A	

Three file drawers on bottom. Laminate door is standard on wardrobe section. Storage compartment on **left includes one 3-position fixed/height adjustable shelf**. Wardrobe compartment on **right** includes hanging rod and **one 3-position fixed/height adjustable shelf** above rod. Upper lock secures wardrobe compartment. Lower lock secures all drawers.

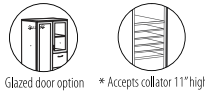
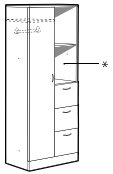

Personal Tower with Open Shelves - RIGHT

Z36L73FNR	24 x 36 x 71.9-72.4	125	318.84	43.25	\$2581	\$2655	\$739	N/A
Z30L73FNR	24 x 30 x 71.9-72.4	125	287.05	36.25	\$2381	\$2444	\$630	N/A
Z24L73FNR	24 x 24 x 71.9-72.4	100	256.34	29.75	\$2195	\$2247	\$493	N/A
Z36M73FNR	20 x 36 x 71.9-72.4	125	286.33	36.75	\$2435	\$2498	\$739	N/A
Z30M73FNR	20 x 30 x 71.9-72.4	100	258.03	30.50	\$2236	\$2291	\$630	N/A
Z24M73FNR	20 x 24 x 71.9-72.4	100	228.38	25.25	\$2051	\$2096	\$493	N/A

Three file drawers on bottom. Laminate door is standard on wardrobe section. Storage compartment on **right includes one 3-position fixed/height adjustable shelf**. Wardrobe compartment on **left** includes hanging rod and **one 3-position fixed/height adjustable shelf** above rod. Upper lock secures wardrobe compartment. Lower lock secures all drawers.

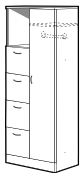

Personal Tower with Open Shelf - LEFT

Z36L74FNL	24 x 36 x 71.9-72.4	125	329.70	43.25	\$2658	\$2731	\$739	N/A
Z30L74FNL	24 x 30 x 71.9-72.4	100	290.85	36.25	\$2478	\$2541	\$630	N/A
Z24L74FNL	24 x 24 x 71.9-72.4	100	264.77	29.75	\$2328	\$2380	\$493	N/A
Z36M74FNL	20 x 36 x 71.9-72.4	100	296.10	36.75	\$2552	\$2616	\$739	N/A
Z30M74FNL	20 x 30 x 71.9-72.4	100	266.70	30.50	\$2352	\$2407	\$630	N/A
Z24M74FNL	20 x 24 x 71.9-72.4	100	237.97	25.25	\$2188	\$2231	\$493	N/A

Four file drawers on bottom. Laminate door is standard on wardrobe section. Storage compartment on **left includes one 3-position fixed/height adjustable shelf**. Wardrobe compartment on **right** includes hanging rod and **one 3-position fixed/height adjustable shelf** above rod. Upper lock secures wardrobe compartment. Lower lock secures all drawers.

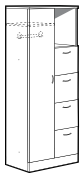

Personal Tower with Open Shelf - RIGHT

Z36L74FNR	24 x 36 x 71.9-72.4	125	329.70	43.25	\$2658	\$2731	\$739	N/A
Z30L74FNR	24 x 30 x 71.9-72.4	100	290.85	36.25	\$2478	\$2541	\$630	N/A
Z24L74FNR	24 x 24 x 71.9-72.4	100	264.77	29.75	\$2328	\$2380	\$493	N/A
Z36M74FNR	20 x 36 x 71.9-72.4	100	296.10	36.75	\$2552	\$2616	\$739	N/A
Z30M74FNR	20 x 30 x 71.9-72.4	100	266.70	30.50	\$2352	\$2407	\$630	N/A
Z24M74FNR	20 x 24 x 71.9-72.4	100	237.97	25.25	\$2188	\$2231	\$493	N/A

Four file drawers on bottom. Laminate door is standard on wardrobe section. Storage compartment on **right includes one 3-position fixed/height adjustable shelf**. Wardrobe compartment on **left** includes hanging rod and **one 3-position fixed/height adjustable shelf** above rod. Upper lock secures storage and wardrobe compartments. Lower lock secures all drawers.

STORAGE MODULES - 84.5"/85" HIGH



Storage Cabinet with Doors

MODEL#	DIMENSIONS	FREIGHT CLASS	WT/LBS.	CUBIC FT.	1" TOP	1.5" TOP	GLAZE ADD	HP ADD
Z36L8SH	24 x 36 x 84.4-84.9	125	332.85	50	\$2514	\$2588	\$1790	N/A
Z30L8SH	24 x 30 x 84.4-84.9	125	290.85	42	\$2230	\$2293	\$1532	N/A
Z36M8SH	20 x 36 x 84.4-84.9	125	299.25	42.25	\$2318	\$2381	\$1790	N/A
Z30M8SH	20 x 30 x 84.4-84.9	125	259.35	35.50	\$2073	\$2128	\$1532	N/A
Z36S8SH	16 x 36 x 84.4-84.9	125	259.35	34	\$2088	\$2150	\$1790	N/A
Z30S8SH	16 x 30 x 84.4-84.9	125	224.70	29	\$1862	\$1905	\$1532	N/A

Laminate doors are standard. **Includes five 3-position fixed/height adjustable shelves**. Standard with lock.

Required Specifications

- Top finish
- Base finish
- Top/Edge Detail
- Handles

Optional Specifications

- Glazing - Doors
- Collator (Open Shelves)

STORAGE MODULES - 84.5"/85" HIGH

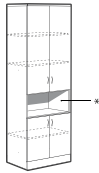

Glazed door option * Accepts collator 11" high

Storage Cabinet with Doors and Cavity

MODEL#	DIMENSIONS D x W x H	FREIGHT CLASS	WT./LBS.	CUBIC FT.	1" TOP	1.5" TOP	GLAZE ADD	HP ADD
Z36L8SHC	24 x 36 x 84.4-84.9	125	326.75	50	\$2563	\$2637	\$1893	N/A
Z30L8SHC	24 x 30 x 84.4-84.9	125	285.07	42	\$2295	\$2358	\$1659	N/A
Z36M8SHC	20 x 36 x 84.4-84.9	125	291.09	42.25	\$2379	\$2443	\$1893	N/A
Z30M8SHC	20 x 30 x 84.4-84.9	125	252.90	35.50	\$2141	\$2196	\$1659	N/A
Z36S8SHC	16 x 36 x 84.4-84.9	125	252.27	34	\$2151	\$2213	\$1893	N/A
Z30S8SHC	16 x 30 x 84.4-84.9	125	218.63	29	\$1931	\$1973	\$1659	N/A

Laminate doors are standard. **Includes three 3-position fixed/height adjustable shelves.** Upper and lower locks secure both compartments.

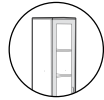

Glazed door option

Storage Cabinet with Door - LEFT

Z21L8SHL	24 x 21 x 84.4-84.9	125	226.80	30.25	\$1819	\$1871	\$999	N/A
Z18L8SHL	24 x 18 x 84.4-84.9	125	205.80	26.25	\$1711	\$1754	\$892	N/A
Z16L8SHL	24 x 16 x 84.4-84.9	125	186.90	24	\$1605	\$1647	\$886	N/A
Z15L8SHL	24 x 15 x 84.4-84.9	100	181.65	22.50	\$1584	\$1619	\$762	N/A
Z12L8SHL	24 x 12 x 84.4-84.9	100	163.80	18.50	\$1475	\$1505	\$681	N/A
Z21M8SHL	20 x 21 x 84.4-84.9	125	201.60	25.50	\$1642	\$1684	\$999	N/A
Z18M8SHL	20 x 18 x 84.4-84.9	100	180.60	22.25	\$1574	\$1612	\$892	N/A
Z16M8SHL	20 x 16 x 84.4-84.9	100	169.05	20.25	\$1475	\$1513	\$886	N/A
Z15M8SHL	20 x 15 x 84.4-84.9	100	162.75	19	\$1413	\$1443	\$762	N/A
Z12M8SHL	20 x 12 x 84.4-84.9	100	144.90	15.75	\$1310	\$1337	\$681	N/A
Z21S8SHL	16 x 21 x 84.4-84.9	100	172.20	21	\$1501	\$1535	\$999	N/A
Z18S8SHL	16 x 18 x 84.4-84.9	100	154.35	18	\$1405	\$1440	\$892	N/A
Z16S8SHL	16 x 16 x 84.4-84.9	100	142.80	16.50	\$1317	\$1352	\$886	N/A
Z15S8SHL	16 x 15 x 84.4-84.9	100	137.55	15.50	\$1256	\$1285	\$762	N/A
Z12S8SHL	16 x 12 x 84.4-84.9	100	120.75	13	\$1159	\$1185	\$681	N/A

Laminate doors are standard. **Includes five 3-position fixed/height adjustable shelves.** Standard with lock.



Glazed door option

Storage Cabinet with Door - RIGHT

Z21L8SHR	24 x 21 x 84.4-84.9	125	226.80	30.25	\$1819	\$1871	\$999	N/A
Z18L8SHR	24 x 18 x 84.4-84.9	125	205.80	26.25	\$1711	\$1754	\$892	N/A
Z16L8SHR	24 x 16 x 84.4-84.9	125	186.90	24	\$1605	\$1647	\$886	N/A
Z15L8SHR	24 x 15 x 84.4-84.9	100	181.65	22.50	\$1584	\$1619	\$762	N/A
Z12L8SHR	24 x 12 x 84.4-84.9	100	163.80	18.50	\$1475	\$1505	\$681	N/A
Z21M8SHR	20 x 21 x 84.4-84.9	125	201.60	25.50	\$1642	\$1684	\$999	N/A
Z18M8SHR	20 x 18 x 84.4-84.9	100	180.60	22.25	\$1574	\$1612	\$892	N/A
Z16M8SHR	20 x 16 x 84.4-84.9	100	169.05	20.25	\$1475	\$1513	\$886	N/A
Z15M8SHR	20 x 15 x 84.4-84.9	100	162.75	19	\$1413	\$1443	\$762	N/A
Z12M8SHR	20 x 12 x 84.4-84.9	100	144.90	15.75	\$1310	\$1337	\$681	N/A
Z21S8SHR	16 x 21 x 84.4-84.9	100	172.20	21	\$1501	\$1535	\$999	N/A
Z18S8SHR	16 x 18 x 84.4-84.9	100	154.35	18	\$1405	\$1440	\$892	N/A
Z16S8SHR	16 x 16 x 84.4-84.9	100	142.80	16.50	\$1317	\$1352	\$886	N/A
Z15S8SHR	16 x 15 x 84.4-84.9	100	137.55	15.50	\$1256	\$1285	\$762	N/A
Z12S8SHR	16 x 12 x 84.4-84.9	100	120.75	13	\$1159	\$1185	\$681	N/A

Laminate doors are standard. **Includes five 3-position fixed/height adjustable shelves.** Standard with lock.

Required Specifications

- Top finish
- Base finish
- Top/Edge Detail
- Handles

Optional Specifications

- Glazing - Doors
- Collator (Open Shelves)

STORAGE MODULES - 84.5"/85" HIGH

MODEL#	DIMENSIONS	FREIGHT CLASS	WT./LBS.	CUBIC FT.	1" TOP	1.5" TOP	GLAZE ADD	HP ADD
--------	------------	---------------	----------	-----------	--------	----------	-----------	--------

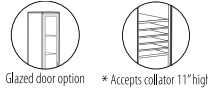
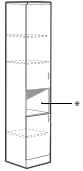

Storage Cabinet with Doors and Cavity - LEFT

D x W x H								
Z21L8SHCL	24 x 21 x 84.4-84.9	125	223.07	30.25	\$1853	\$1905	\$1037	N/A
Z18L8SHCL	24 x 18 x 84.4-84.9	125	202.75	26.25	\$1747	\$1790	\$939	N/A
Z16L8SHCL	24 x 16 x 84.4-84.9	125	185.71	24	\$1638	\$1681	\$926	N/A
Z15L8SHCL	24 x 15 x 84.4-84.9	125	179.28	22.50	\$1623	\$1658	\$820	N/A
Z12L8SHCL	24 x 12 x 84.4-84.9	100	162.12	18.50	\$1456	\$1486	\$739	N/A
Z21M8SHCL	20 x 21 x 84.4-84.9	125	196.66	25.50	\$1671	\$1714	\$1037	N/A
Z18M8SHCL	20 x 18 x 84.4-84.9	125	177.57	22.25	\$1607	\$1645	\$939	N/A
Z16M8SHCL	20 x 16 x 84.4-84.9	100	165.89	20.25	\$1510	\$1548	\$926	N/A
Z15M8SHCL	20 x 15 x 84.4-84.9	100	159.52	19	\$1448	\$1480	\$820	N/A
Z12M8SHCL	20 x 12 x 84.4-84.9	100	141.48	15.75	\$1345	\$1372	\$739	N/A
Z21S8SHCL	16 x 21 x 84.4-84.9	100	168.16	21	\$1535	\$1570	\$1037	N/A
Z18S8SHCL	16 x 18 x 84.4-84.9	100	150.29	18	\$1441	\$1476	\$939	N/A
Z16S8SHCL	16 x 16 x 84.4-84.9	100	139.77	16.50	\$1352	\$1387	\$926	N/A
Z15S8SHCL	16 x 15 x 84.4-84.9	100	134.51	15.50	\$1291	\$1321	\$820	N/A
Z12S8SHCL	16 x 12 x 84.4-84.9	100	117.69	13	\$1194	\$1221	\$739	N/A

Laminate doors are standard. Includes three adjustable shelves. Upper and lower locks secure both compartments

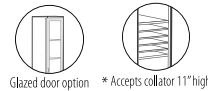
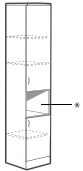

Storage Cabinet with Doors and Cavity - RIGHT

Z21L8SHCR	24 x 21 x 84.4-84.9	125	223.07	30.25	\$1853	\$1905	\$1037	N/A
Z18L8SHCR	24 x 18 x 84.4-84.9	125	202.75	26.25	\$1747	\$1790	\$939	N/A
Z16L8SHCR	24 x 16 x 84.4-84.9	125	185.71	24	\$1638	\$1681	\$926	N/A
Z15L8SHCR	24 x 15 x 84.4-84.9	125	179.28	22.50	\$1623	\$1658	\$820	N/A
Z12L8SHCR	24 x 12 x 84.4-84.9	100	162.12	18.50	\$1456	\$1486	\$739	N/A
Z21M8SHCR	20 x 21 x 84.4-84.9	125	196.66	25.50	\$1671	\$1714	\$1037	N/A
Z18M8SHCR	20 x 18 x 84.4-84.9	125	177.57	22.25	\$1607	\$1645	\$939	N/A
Z16M8SHCR	20 x 16 x 84.4-84.9	100	165.89	20.25	\$1510	\$1548	\$926	N/A
Z15M8SHCR	20 x 15 x 84.4-84.9	100	159.52	19	\$1448	\$1480	\$820	N/A
Z12M8SHCR	20 x 12 x 84.4-84.9	100	141.48	15.75	\$1345	\$1372	\$739	N/A
Z21S8SHCR	16 x 21 x 84.4-84.9	100	168.16	21	\$1535	\$1570	\$1037	N/A
Z18S8SHCR	16 x 18 x 84.4-84.9	100	150.29	18	\$1441	\$1476	\$939	N/A
Z16S8SHCR	16 x 16 x 84.4-84.9	100	139.77	16.50	\$1352	\$1387	\$926	N/A
Z15S8SHCR	16 x 15 x 84.4-84.9	100	134.51	15.50	\$1291	\$1321	\$820	N/A
Z12S8SHCR	16 x 12 x 84.4-84.9	100	117.69	13	\$1194	\$1221	\$739	N/A

Laminate doors are standard. Includes three adjustable shelves. Upper and lower locks secure both compartments

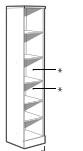
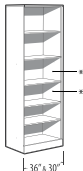

Open Storage Cabinet

Z36L8SHN	24 x 36 x 84.4-84.9	150	281.34	50	\$1954	\$2027	N/A	N/A
Z30L8SHN	24 x 30 x 84.4-84.9	150	247.23	42	\$1740	\$1803	N/A	N/A
Z21L8SHN	24 x 21 x 84.4-84.9	125	227.72	30.25	\$1505	\$1556	N/A	N/A
Z18L8SHN	24 x 18 x 84.4-84.9	125	206.74	26.25	\$1426	\$1469	N/A	N/A
Z16L8SHN	24 x 16 x 84.4-84.9	125	189.25	24	\$1324	\$1367	N/A	N/A
Z15L8SHN	24 x 15 x 84.4-84.9	100	182.61	22.50	\$1302	\$1337	N/A	N/A
Z12L8SHN	24 x 12 x 84.4-84.9	100	164.78	18.50	\$1250	\$1282	N/A	N/A
Z36M8SHN	20 x 36 x 84.4-84.9	150	245.68	42.25	\$1757	\$1820	N/A	N/A
Z30M8SHN	20 x 30 x 84.4-84.9	125	215.06	35.50	\$1584	\$1639	N/A	N/A
Z21M8SHN	20 x 21 x 84.4-84.9	125	170.18	25.50	\$1330	\$1373	N/A	N/A
Z18M8SHN	20 x 18 x 84.4-84.9	125	154.86	22.25	\$1287	\$1326	N/A	N/A
Z16M8SHN	20 x 16 x 84.4-84.9	125	145.71	20.25	\$1195	\$1233	N/A	N/A
Z15M8SHN	20 x 15 x 84.4-84.9	125	140.60	19	\$1163	\$1193	N/A	N/A
Z12M8SHN	20 x 12 x 84.4-84.9	100	126.34	15.75	\$1084	\$1111	N/A	N/A
Z36S8SHN	16 x 36 x 84.4-84.9	125	206.87	34	\$1528	\$1590	N/A	N/A
Z30S8SHN	16 x 30 x 84.4-84.9	125	180.79	29	\$1373	\$1415	N/A	N/A
Z21S8SHN	16 x 21 x 84.4-84.9	125	141.67	21	\$1189	\$1223	N/A	N/A
Z18S8SHN	16 x 18 x 84.4-84.9	125	127.58	18	\$1066	\$1101	N/A	N/A
Z16S8SHN	16 x 16 x 84.4-84.9	125	119.59	16.50	\$1035	\$1070	N/A	N/A
Z15S8SHN	16 x 15 x 84.4-84.9	125	115.59	15.50	\$1007	\$1036	N/A	N/A
Z12S8SHN	16 x 12 x 84.4-84.9	125	102.56	13	\$932	\$959	N/A	N/A

Five adjustable shelves.

Required Specifications

- Top finish
- Base finish
- Top/Edge Detail
- Handles

Optional Specifications

- Glazing - Doors
- Collator (Open Shelves)

STORAGE MODULES - 84.5"/85" HIGH

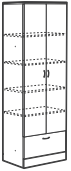

Glazed door option

File Module with Doors*

MODEL#	DIMENSIONS D x W x H	FREIGHT CLASS	WT./LBS.	CUBIC FT.	1" TOP	1.5" TOP	GLAZE ADD	HP ADD
Z36L8F	24 x 36 x 84.4-84.9	125	350.70	50	\$2888	\$2961	\$1548	N/A
Z30L8F	24 x 30 x 84.4-84.9	125	301.35	42	\$2583	\$2646	\$1313	N/A
Z36M8F	20 x 36 x 84.4-84.9	125	319.20	42.25	\$2702	\$2765	\$1548	N/A
Z30M8F	20 x 30 x 84.4-84.9	125	278.25	35.50	\$2435	\$2490	\$1313	N/A
Z36S8F	16 x 36 x 84.4-84.9	100	273	34	\$2422	\$2484	\$1548	N/A
Z30S8F	16 x 30 x 84.4-84.9	100	237.30	29	\$2175	\$2217	\$1313	N/A

One lateral file drawer. Laminate doors are standard. **Includes four adjustable shelves.** Upper lock secures storage shelves. Lower lock secures one file drawer. Front-to-back and side-to-side letter/legal filing capability. Side-to-side file bars included.

- Lateral file drawer construction is for accommodating hanging files NOT for stacking materials on the drawer bottom.



Glazed door option

File Module with Door - LEFT

Z16L8FL	24 x 16 x 84.4-84.9	100	200.55	24	\$1768	\$1810	\$765	N/A
Z15L8FL	24 x 15 x 84.4-84.9	100	189	22.50	\$1722	\$1757	\$663	N/A
Z16M8FL	20 x 16 x 84.4-84.9	100	179.55	20.25	\$1638	\$1676	\$765	N/A
Z15M8FL	20 x 15 x 84.4-84.9	100	173.25	19	\$1582	\$1612	\$663	N/A
Z16S8FL	16 x 16 x 84.4-84.9	100	151.20	16.50	\$1475	\$1510	\$765	N/A
Z15S8FL	16 x 15 x 84.4-84.9	100	145.95	15.50	\$1427	\$1457	\$663	N/A

One file drawer. Laminate door is standard. **Includes four adjustable shelves.** Upper lock secures storage compartment. Lower lock secures one file drawer.



Glazed door option

File Module with Door - RIGHT

Z16L8FR	24 x 16 x 84.4-84.9	100	200.55	24	\$1768	\$1810	\$765	N/A
Z15L8FR	24 x 15 x 84.4-84.9	100	189	22.50	\$1722	\$1757	\$663	N/A
Z16M8FR	20 x 16 x 84.4-84.9	100	179.55	20.25	\$1638	\$1676	\$765	N/A
Z15M8FR	20 x 15 x 84.4-84.9	100	173.25	19	\$1582	\$1612	\$663	N/A
Z16S8FR	16 x 16 x 84.4-84.9	100	151.20	16.50	\$1475	\$1510	\$765	N/A
Z15S8FR	16 x 15 x 84.4-84.9	100	145.95	15.50	\$1427	\$1457	\$663	N/A

One file drawer. Laminate door is standard. **Includes four adjustable shelves.** Upper lock secures storage compartment. Lower lock secures one file drawer.

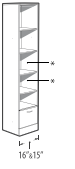
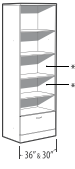

* Accepts collator 11" high

File Module with Open Shelves*

Z36L8FN	24 x 36 x 84.4-84.9	125	307.17	50	\$2362	\$2435	N/A	N/A
Z30L8FN	24 x 30 x 84.4-84.9	125	264.38	42	\$2125	\$2188	N/A	N/A
Z16L8FN	24 x 16 x 84.4-84.9	125	182.72	24	\$1513	\$1556	N/A	N/A
Z15L8FN	24 x 15 x 84.4-84.9	125	171.04	22.50	\$1491	\$1526	N/A	N/A
Z36M8FN	20 x 36 x 84.4-84.9	125	273.61	42.25	\$2177	\$2241	N/A	N/A
Z30M8FN	20 x 30 x 84.4-84.9	125	240.61	35.50	\$1978	\$2033	N/A	N/A
Z16M8FN	20 x 16 x 84.4-84.9	125	159.75	20.25	\$1384	\$1422	N/A	N/A
Z15M8FN	20 x 15 x 84.4-84.9	100	154.43	19	\$1348	\$1380	N/A	N/A
Z36S8FN	16 x 36 x 84.4-84.9	125	228.50	34	\$1811	\$1873	N/A	N/A
Z30S8FN	16 x 30 x 84.4-84.9	125	200.04	29	\$1631	\$1673	N/A	N/A
Z16S8FN	16 x 16 x 84.4-84.9	125	131.54	16.50	\$1222	\$1257	N/A	N/A
Z15S8FN	16 x 15 x 84.4-84.9	100	127.32	15.50	\$1196	\$1226	N/A	N/A

Five open shelves and one file drawer on bottom. **Includes four adjustable shelves.** Lock secures file drawer. 36" and 30" wide models have front-to-back and side-to-side letter/legal filing capability. Side-to-side file bars included.

- Lateral file drawer construction is for accommodating hanging files NOT for stacking materials on the drawer bottom.



Glazed door option

Two File Module with Doors*

Z36L8E	24 x 36 x 84.4-84.9	125	365.40	50	\$3119	\$3192	\$1336	N/A
Z30L8E	24 x 30 x 84.4-84.9	125	306.60	42	\$2840	\$2902	\$1153	N/A
Z36M8E	20 x 36 x 84.4-84.9	125	323.40	42.25	\$2932	\$2995	\$1336	N/A
Z30M8E	20 x 30 x 84.4-84.9	100	284.55	35.50	\$2700	\$2755	\$1153	N/A
Z36S8E	16 x 36 x 84.4-84.9	100	285	34	\$2677	\$2740	\$1336	N/A
Z30S8E	16 x 30 x 84.4-84.9	100	244.65	29	\$2420	\$2462	\$1153	N/A

Two lateral file drawers. Laminate doors are standard. **Includes three adjustable shelves.** Upper lock secures storage compartment. Lower lock secures two file drawers. Front-to-back and side-to-side letter/legal filing capability. Side-to-side file bars included.

- Lateral file drawer construction is for accommodating hanging files NOT for stacking materials on the drawer bottom.

Required Specifications

- Top finish
- Base finish
- Top/Edge Detail
- Handles

Optional Specifications

- Glazing - Doors
- Collator (Open Shelves)
- Box drawer* - no upcharge (30"-36" wide models only)

STORAGE MODULES - 84.5"/85" HIGH



Glazed door option

Two File Module with Door - LEFT

MODEL#	DIMENSIONS	FREIGHT CLASS	WT./LBS.	CUBIC FT.	1" TOP	1.5" TOP	GLAZE ADD	HP ADD	
D x W x H									
Z16L8EL	24 x 16 x 84.4-84.9	100	205.80	24	\$1857	\$1900	\$659	N/A	
Z15L8EL	24 x 15 x 84.4-84.9	100	192.15	22.50	\$1805	\$1840	\$574	N/A	
Z16M8EL	20 x 16 x 84.4-84.9	100	185.85	20.25	\$1740	\$1778	\$659	N/A	
Z15M8EL	20 x 15 x 84.4-84.9	100	179.55	19	\$1673	\$1705	\$574	N/A	
Z16S8EL	16 x 16 x 84.4-84.9	100	156.45	16.50	\$1581	\$1616	\$659	N/A	
Z15S8EL	16 x 15 x 84.4-84.9	100	149.10	15.50	\$1530	\$1559	\$574	N/A	

Two file drawers on bottom. Laminate door is standard. **Includes three 3-position fixed/height adjustable shelves.** Upper lock secures storage compartment. Lower lock secures two file drawers.



Glazed door option

Two File Module with Door - RIGHT

Z16L8ER	24 x 16 x 84.4-84.9	100	205.80	24	\$1857	\$1900	\$659	N/A
Z15L8ER	24 x 15 x 84.4-84.9	100	192.15	22.50	\$1805	\$1840	\$574	N/A
Z16M8ER	20 x 16 x 84.4-84.9	100	185.85	20.25	\$1740	\$1778	\$659	N/A
Z15M8ER	20 x 15 x 84.4-84.9	100	179.55	19	\$1673	\$1705	\$574	N/A
Z16S8ER	16 x 16 x 84.4-84.9	100	156.45	16.50	\$1581	\$1616	\$659	N/A
Z15S8ER	16 x 15 x 84.4-84.9	100	149.10	15.50	\$1530	\$1559	\$574	N/A

Two file drawers on bottom. Laminate door is standard. **Includes three 3-position fixed/height adjustable shelves.** Upper lock secures storage compartment. Lower lock secures two file drawers.

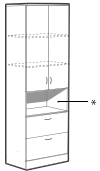

Glazed door option



* Accepts collator 11" high

Two File Module with Doors & Cavity*

Z36L8EC	24 x 36 x 84.4-84.9	125	359.30	50	\$3037	\$3111	\$1163	N/A
Z30L8EC	24 x 30 x 84.4-84.9	125	300.82	42	\$2772	\$2835	\$1013	N/A
Z36M8EC	20 x 36 x 84.4-84.9	125	315.24	42.25	\$2851	\$2914	\$1163	N/A
Z30M8EC	20 x 30 x 84.4-84.9	125	278.10	35.50	\$2634	\$2689	\$1013	N/A
Z36S8EC	16 x 36 x 84.4-84.9	100	276	34	\$2432	\$2494	\$1163	N/A
Z30S8EC	16 x 30 x 84.4-84.9	100	236.48	29	\$2188	\$2230	\$1013	N/A

Two lateral file drawers on bottom. Laminate doors are standard. **Includes two 3-position fixed/height adjustable shelves.** Upper lock secures storage compartment. Lower lock secures all drawers. Front-to-back and side-to-side letter/legal filing capability. Side-to-side file bars included.

- Lateral file drawer construction is for accommodating hanging files NOT for stacking materials on the drawer bottom.

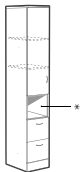

Glazed door option



* Accepts collator 11" high

Two File Module with Doors and Cavity - LEFT

Z16L8ECL	24 x 16 x 84.4-84.9	100	204.61	24	\$1752	\$1795	\$572	N/A
Z15L8ECL	24 x 15 x 84.4-84.9	100	189.78	22.50	\$1771	\$1806	\$504	N/A
Z16M8ECL	20 x 16 x 84.4-84.9	100	182.69	20.25	\$1686	\$1724	\$572	N/A
Z15M8ECL	20 x 15 x 84.4-84.9	100	176.32	19	\$1628	\$1658	\$504	N/A
Z16S8ECL	16 x 16 x 84.4-84.9	100	152.37	16.50	\$1540	\$1575	\$572	N/A
Z15S8ECL	16 x 15 x 84.4-84.9	100	146.06	15.50	\$1493	\$1523	\$504	N/A

Two lateral file drawers on bottom. Laminate doors are standard. **Includes two 3-position fixed/height adjustable shelves.** Upper lock secures storage compartment. Lower lock secures all drawers.

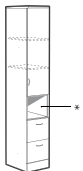

Glazed door option



* Accepts collator 11" high

Two File Module with Doors and Cavity - LEFT

Z16L8ECR	24 x 16 x 84.4-84.9	100	204.61	24	\$1752	\$1795	\$572	N/A
Z15L8ECR	24 x 15 x 84.4-84.9	100	189.78	22.50	\$1771	\$1806	\$504	N/A
Z16M8ECR	20 x 16 x 84.4-84.9	100	182.69	20.25	\$1686	\$1724	\$572	N/A
Z15M8ECR	20 x 15 x 84.4-84.9	100	176.32	19	\$1628	\$1658	\$504	N/A
Z16S8ECR	16 x 16 x 84.4-84.9	100	152.37	16.50	\$1540	\$1575	\$572	N/A
Z15S8ECR	16 x 15 x 84.4-84.9	100	146.06	15.50	\$1493	\$1523	\$504	N/A

Two lateral file drawers on bottom. Laminate doors are standard. **Includes two 3-position fixed/height adjustable shelves.** Upper lock secures storage compartment. Lower lock secures all drawers.

Required Specifications

Top finish
Base finish
Top/Edge Detail
Handles

Optional Specifications

Glazing - Doors
Collator (Open Shelves)
Box drawer - no upcharge* (30"-36" wide models only)

STORAGE MODULES - 84.5"/85" HIGH

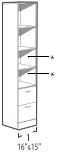
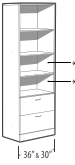

* Accepts collator 11" high

Two File Module with Open Shelves*

MODEL#	DIMENSIONS D x W x H	FREIGHT CLASS	WT./LBS.	CUBIC FT.	1" TOP	1.5" TOP	GLAZE ADD	HP ADD
Z36L8EN	24 x 36 x 84.4-84.9	125	329.85	50	\$2674	\$2747	N/A	N/A
Z30L8EN	24 x 30 x 84.4-84.9	125	276.28	42	\$2448	\$2511	N/A	N/A
Z16L8EN	24 x 16 x 84.4-84.9	125	191.52	24	\$1631	\$1674	N/A	N/A
Z15L8EN	24 x 15 x 84.4-84.9	125	177.51	22.50	\$1607	\$1642	N/A	N/A
Z36M8EN	20 x 36 x 84.4-84.9	125	285.79	42.25	\$2486	\$2549	N/A	N/A
Z30M8EN	20 x 30 x 84.4-84.9	125	253.56	35.50	\$2312	\$2367	N/A	N/A
Z16M8EN	20 x 16 x 84.4-84.9	100	169.60	20.25	\$1514	\$1552	N/A	N/A
Z15M8EN	20 x 15 x 84.4-84.9	100	164.05	19	\$1474	\$1506	N/A	N/A
Z36S8EN	16 x 36 x 84.4-84.9	125	247	34	\$2066	\$2128	N/A	N/A
Z30S8EN	16 x 30 x 84.4-84.9	125	213	29	\$1864	\$1906	N/A	N/A
Z16S8EN	16 x 16 x 84.4-84.9	100	139.28	16.50	\$1356	\$1391	N/A	N/A
Z15S8EN	16 x 15 x 84.4-84.9	100	133.79	15.50	\$1330	\$1359	N/A	N/A

Four open shelves and two file drawers on bottom. **Includes two 3-position fixed/height adjustable shelves.** Lock secures all drawers. 36" and 30" wide models have front-to-back and side-to-side letter/legal filing capability. Side-to-side file bars included.

- Lateral file drawer construction is for accommodating hanging files NOT for stacking materials on the drawer bottom.

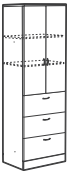

Glazed door option

Three File Module with Doors*

Z36L83F	24 x 36 x 84.4-84.9	125	357	50	\$3364	\$3437	\$1163	N/A
Z30L83F	24 x 30 x 84.4-84.9	125	319.20	42	\$3079	\$3142	\$1013	N/A
Z36M83F	20 x 36 x 84.4-84.9	125	328.65	42.25	\$3193	\$3256	\$1163	N/A
Z30M83F	20 x 30 x 84.4-84.9	100	291.90	35.50	\$2953	\$3008	\$1013	N/A
Z36S83F	16 x 36 x 84.4-84.9	100	289	34	\$2907	\$2969	\$1163	N/A
Z30S83F	16 x 30 x 84.4-84.9	100	246.75	29	\$2642	\$2684	\$1013	N/A

Three lateral file drawers on bottom. Laminate doors are standard. **Includes two 3-position fixed/height adjustable shelves.** Upper lock secures storage compartment. Lower lock secures three file drawers. Front-to-back and side-to-side letter/legal filing capability. Side-to-side file bars included.

- Lateral file drawer construction is for accommodating hanging files NOT for stacking materials on the drawer bottom.



Glazed door option

Three File Module with Door - LEFT

Z16L83FL	24 x 16 x 84.4-84.9	100	215.25	24	\$1988	\$2031	\$572	N/A
Z15L83FL	24 x 15 x 84.4-84.9	100	206.85	22.50	\$1919	\$1954	\$504	N/A
Z16M83FL	20 x 16 x 84.4-84.9	100	192.15	20.25	\$1871	\$1909	\$572	N/A
Z15M83FL	20 x 15 x 84.4-84.9	100	184.80	19	\$1811	\$1841	\$504	N/A
Z16S83FL	16 x 16 x 84.4-84.9	100	161.70	16.50	\$1707	\$1742	\$572	N/A
Z15S83FL	16 x 15 x 84.4-84.9	92.5	155.40	15.50	\$1663	\$1692	\$504	N/A

Three file drawers on bottom. Laminate door is standard. **Includes two 3-position fixed/height adjustable shelves.** Upper lock secures storage compartment. Lower lock secures three file drawers.



Glazed door option

Three File Module with Door - RIGHT

Z16L83FR	24 x 16 x 84.4-84.9	100	215.25	24	\$1988	\$2031	\$572	N/A
Z15L83FR	24 x 15 x 84.4-84.9	100	206.85	22.50	\$1919	\$1954	\$504	N/A
Z16M83FR	20 x 16 x 84.4-84.9	100	192.15	20.25	\$1871	\$1909	\$572	N/A
Z15M83FR	20 x 15 x 84.4-84.9	100	184.80	19	\$1811	\$1841	\$504	N/A
Z16S83FR	16 x 16 x 84.4-84.9	100	161.70	16.50	\$1707	\$1742	\$572	N/A
Z15S83FR	16 x 15 x 84.4-84.9	92.5	155.40	15.50	\$1663	\$1692	\$504	N/A

Three file drawers on bottom. Laminate door is standard. **Includes two 3-position fixed/height adjustable shelves.** Upper lock secures storage compartment. Lower lock secures three file drawers.

Required Specifications

- Top finish
- Base finish
- Top/Edge Detail
- Handles

Optional Specifications

- Glazing - Doors
- Collator (Open Shelves)
- Box drawer* - no upcharge (30"-36" wide models only)

STORAGE MODULES - 84.5"/85" HIGH

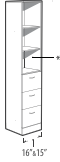
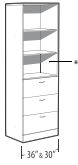

* Accepts collator 11" high

Three File Module with Open Shelves*

MODEL#	DIMENSIONS D x W x H	FREIGHT CLASS	WT/LBS.	CUBIC FT.	1" TOP	1.5" TOP	GLAZE ADD	HP ADD
Z36L83FN	24 x 36 x 84.4-84.9	125	329.44	50	\$2995	\$3069	N/A	N/A
Z30L83FN	24 x 30 x 84.4-84.9	125	295.53	42	\$2756	\$2819	N/A	N/A
Z16L83FN	24 x 16 x 84.4-84.9	100	204.52	24	\$1802	\$1844	N/A	N/A
Z15L83FN	24 x 15 x 84.4-84.9	100	195.54	22.50	\$1755	\$1790	N/A	N/A
Z36M83FN	20 x 36 x 84.4-84.9	125	299.02	42.25	\$2825	\$2888	N/A	N/A
Z30M83FN	20 x 30 x 84.4-84.9	125	267.56	35.50	\$2629	\$2684	N/A	N/A
Z16M83FN	20 x 16 x 84.4-84.9	100	179.45	20.25	\$1685	\$1724	N/A	N/A
Z15M83FN	20 x 15 x 84.4-84.9	100	172.63	19	\$1645	\$1677	N/A	N/A
Z36S83FN	16 x 36 x 84.4-84.9	125	260	34	\$2293	\$2355	N/A	N/A
Z30S83FN	16 x 30 x 84.4-84.9	125	222.79	29	\$2067	\$2110	N/A	N/A
Z16S83FN	16 x 16 x 84.4-84.9	100	149.13	16.50	\$1518	\$1553	N/A	N/A
Z15S83FN	16 x 15 x 84.4-84.9	100	143.42	15.50	\$1497	\$1526	N/A	N/A

Three open shelves and three file drawers on bottom. **Includes two 3-position fixed/height adjustable shelves.** Lock secures all drawers. 36" and 30" wide models have front-to-back and side-to-side letter/legal filing capability. Side-to-side file bars included.

- Lateral file drawer construction is for accommodating hanging files NOT for stacking materials on the drawer bottom.



Four File Module with Open Shelf*

Z36L84FN	24 x 36 x 84.4-84.9	125	340.57	50	\$3291	\$3365	N/A	N/A
Z30L84FN	24 x 30 x 84.4-84.9	125	308.48	42	\$3052	\$3115	N/A	N/A
Z16L84FN	24 x 16 x 84.4-84.9	100	208.06	24	\$1905	\$1947	N/A	N/A
Z15L84FN	24 x 15 x 84.4-84.9	100	200.97	22.50	\$1869	\$1904	N/A	N/A
Z36M84FN	20 x 36 x 84.4-84.9	125	313.30	42.25	\$3137	\$3200	N/A	N/A
Z30M84FN	20 x 30 x 84.4-84.9	125	282.61	35.50	\$2934	\$2987	N/A	N/A
Z16M84FN	20 x 16 x 84.4-84.9	100	187.20	20.25	\$1772	\$1810	N/A	N/A
Z15M84FN	20 x 15 x 84.4-84.9	100	181.21	19	\$1765	\$1797	N/A	N/A
Z36S84FN	16 x 36 x 84.4-84.9	125	265.04	34	\$2476	\$2538	N/A	N/A
Z30S84FN	16 x 30 x 84.4-84.9	100	233.64	29	\$2231	\$2273	N/A	N/A
Z16S84FN	16 x 16 x 84.4-84.9	100	156.88	16.50	\$1645	\$1680	N/A	N/A
Z15S84FN	16 x 15 x 84.4-84.9	100	152	15.50	\$1627	\$1657	N/A	N/A

Two open shelves and four file drawers. **Includes one 3-position fixed/height adjustable shelf.** Lock secures all drawers. 36" and 30" wide models have front-to-back and side-to-side letter/legal filing capability. Side-to-side file bars included.

- Lateral file drawer construction is for accommodating hanging files NOT for stacking materials on the drawer bottom.

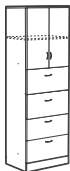

Glazed door option

Four File Module with Doors*

Z36L84F	24 x 36 x 84.4-84.9	125	360.15	50	\$3601	\$3674	\$915	N/A
Z30L84F	24 x 30 x 84.4-84.9	125	325.50	42	\$3329	\$3392	\$798	N/A
Z36M84F	20 x 36 x 84.4-84.9	125	334.95	42.25	\$3445	\$3509	\$915	N/A
Z30M84F	20 x 30 x 84.4-84.9	100	300.30	35.50	\$3211	\$3266	\$798	N/A
Z36S84F	16 x 36 x 84.4-84.9	100	285.60	34	\$3117	\$3179	\$915	N/A
Z30S84F	16 x 30 x 84.4-84.9	100	250.95	29	\$2840	\$2882	\$798	N/A

Four lateral file drawers on bottom. Laminate doors are standard. **Includes one 3-position fixed/height adjustable shelf.** Upper lock secures storage compartment. Lower lock secures four file drawers. Front-to-back and side-to-side letter/legal filing capability. Side-to-side file bars included.

- Lateral file drawer construction is for accommodating hanging files NOT for stacking materials on the drawer bottom.



Glazed door option

Four File Module with Door - LEFT

Z16L84FL	24 x 16 x 84.4-84.9	100	217.35	24	\$2061	\$2104	\$450	N/A
Z15L84FL	24 x 15 x 84.4-84.9	100	208.95	22.50	\$2010	\$2045	\$452	N/A
Z16M84FL	20 x 16 x 84.4-84.9	100	196.35	20.25	\$1931	\$1969	\$450	N/A
Z15M84FL	20 x 15 x 84.4-84.9	92.5	190.05	19	\$1907	\$1939	\$396	N/A
Z16S84FL	16 x 16 x 84.4-84.9	92.5	166.95	16.50	\$1804	\$1839	\$450	N/A
Z15S84FL	16 x 15 x 84.4-84.9	92.5	160.65	15.50	\$1766	\$1796	\$396	N/A

Four file drawers on bottom. Laminate door is standard. **Includes one 3-position fixed/height adjustable shelf.** Upper lock secures storage compartment. Lower lock secures four file drawers.

Required Specifications

Top finish
Base finish
Top/Edge Detail
Handles

Optional Specifications

Glazing - Doors
Collator (Open Shelves)
Box drawer* - no upcharge (30"-36" wide models only)

STORAGE MODULES - 84.5"/85" HIGH

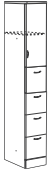

Glazed door option

Four File Module with Door - RIGHT

MODEL#	DIMENSIONS D x W x H	FREIGHT CLASS	WT./LBS.	CUBIC FT.	1" TOP	1.5" TOP	GLAZE ADD	HP ADD
Z16L84FR	24 x 16 x 84.4-84.9	100	217.35	24	\$2061	\$2104	\$450	N/A
Z15L84FR	24 x 15 x 84.4-84.9	100	208.95	22.50	\$2010	\$2045	\$452	N/A
Z16M84FR	20 x 16 x 84.4-84.9	100	196.35	20.25	\$1931	\$1969	\$450	N/A
Z15M84FR	20 x 15 x 84.4-84.9	92.5	190.05	19	\$1907	\$1939	\$396	N/A
Z16S84FR	16 x 16 x 84.4-84.9	92.5	166.95	16.50	\$1804	\$1839	\$450	N/A
Z15S84FR	16 x 15 x 84.4-84.9	92.5	160.65	15.50	\$1766	\$1796	\$396	N/A

Four file drawers on bottom. Laminate door is standard. **Includes one 3-position fixed/height adjustable shelf.** Upper lock secures storage compartment. Lower lock secures four file drawers.

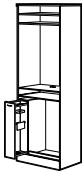

Intended for working while standing

Media Center - LEFT

Z36L8MCL	24 x 36 x 84.4-84.9	125	324.45	50	\$2720	\$2794	N/A	N/A
Z30L8MCL	24 x 30 x 84.4-84.9	125	290.85	42	\$2526	\$2589	N/A	N/A
Z36M8MCL	20 x 36 x 84.4-84.9	125	276.15	42.25	\$2519	\$2582	N/A	N/A
Z30M8MCL	20 x 30 x 84.4-84.9	125	257.25	35.50	\$2316	\$2371	N/A	N/A
Z36S8MCL	16 x 36 x 84.4-84.9	125	246.75	34	\$2235	\$2297	N/A	N/A
Z30S8MCL	16 x 30 x 84.4-84.9	125	212.10	29	\$2036	\$2078	N/A	N/A

Unit, accommodates pc, keyboard, monitor, hanging folders and accessories and/or printer. One vertical drawer on the **left**. Pull out keyboard shelf. Adjustable pull out bottom shelf accommodates pc and/or printer. **Includes two 3-position fixed/height adjustable shelves.** Grommet in worksurface and back panel. Lock secures vertical drawer.



Intended for working while standing

Media Center - RIGHT

Z36L8MCR	24 x 36 x 84.4-84.9	125	324.45	50	\$2720	\$2794	N/A	N/A
Z30L8MCR	24 x 30 x 84.4-84.9	125	290.85	42	\$2526	\$2589	N/A	N/A
Z36M8MCR	20 x 36 x 84.4-84.9	125	276.15	42.25	\$2519	\$2582	N/A	N/A
Z30M8MCR	20 x 30 x 84.4-84.9	125	257.25	35.50	\$2316	\$2371	N/A	N/A
Z36S8MCR	16 x 36 x 84.4-84.9	125	246.75	34	\$2235	\$2297	N/A	N/A
Z30S8MCR	16 x 30 x 84.4-84.9	125	212.10	29	\$2036	\$2078	N/A	N/A

Unit, accommodates pc, keyboard, monitor, hanging folders and accessories and/or printer. One vertical drawer on the **right**. Pull out keyboard shelf. Adjustable pull out bottom shelf accommodates pc and/or printer. **Includes two 3-position fixed/height adjustable shelves.** Grommet in worksurface and back panel. Lock secures vertical drawer.

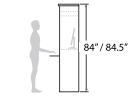

Intended for working while standing

PC Center

Z36L8PC	24 x 36 x 84.4-84.9	150	285.60	50	\$2096	\$2170	N/A	N/A
Z30L8PC	24 x 30 x 84.4-84.9	125	252	42	\$1862	\$1925	N/A	N/A
Z36M8PC	20 x 36 x 84.4-84.9	150	250.95	42.25	\$1929	\$1993	N/A	N/A
Z30M8PC	20 x 30 x 84.4-84.9	125	219.45	35.50	\$1731	\$1786	N/A	N/A
Z36S8PC	16 x 36 x 84.4-84.9	125	218.40	34	\$1670	\$1732	N/A	N/A
Z30S8PC	16 x 30 x 84.4-84.9	125	183.75	29	\$1476	\$1518	N/A	N/A

Standing height unit, accommodates pc, keyboard, monitor and/or printer. Pull out keyboard shelf. Adjustable pull out bottom shelf accommodates pc and/or printer. **Includes two 3-position fixed/height adjustable shelves.** Grommet in worksurface and back panel.

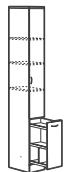
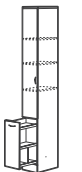

Glazed door option

LEFT RIGHT

Vertical Utility Drawer with Door

Z12L8VDL	24 x 12 x 84.4-84.9	100	184.80	18.50	\$1837	\$1867	\$512	N/A
Z12M8VDL	20 x 12 x 84.4-84.9	92.5	166.95	15.75	\$1497	\$1525	\$512	N/A
Z12S8VDL	16 x 12 x 84.4-84.9	92.5	139.65	13	\$1376	\$1403	\$512	N/A
Z12L8VDR	24 x 12 x 84.4-84.9	100	184.80	18.50	\$1837	\$1867	\$512	N/A
Z12M8VDR	20 x 12 x 84.4-84.9	92.5	166.95	15.75	\$1497	\$1525	\$512	N/A
Z12S8VDR	16 x 12 x 84.4-84.9	92.5	139.65	13	\$1376	\$1403	\$512	N/A

Specify **VDL** models for **LEFT** or **VDR** models for **RIGHT**

Laminate doors are standard. **Includes three 3-position fixed/height adjustable shelves** and one vertical drawer. Upper lock secures storage compartment. Lower lock secures vertical drawer.

Required Specifications

- Top finish
- Base finish
- Top/Edge Detail
- Handles

Optional Specifications

- Glazing - Doors
- Collator (Open Shelves)

WARDROBE CABINETS - 84.5"/85" HIGH



Wardrobe Cabinet

MODEL#	DIMENSIONS	FREIGHT CLASS	WT/LBS.	CUBIC FT.	1" TOP	1.5" TOP	GLAZE ADD	HP ADD
Z36L8WA	24 x 36 x 84.4-84.9	150	290.85	50	\$2332	\$2405	N/A	N/A
Z30L8WA	24 x 30 x 84.4-84.9	125	256.20	42	\$2094	\$2157	N/A	N/A
Z36M8WA	20 x 36 x 84.4-84.9	125	264.60	42.25	\$2179	\$2242	N/A	N/A
Z30M8WA	20 x 30 x 84.4-84.9	125	231	35.50	\$1969	\$2024	N/A	N/A

Laminate doors are standard. Full length hanging rod included. **One adjustable shelf** above hanging rod. Standard with lock.



Wardrobe Cabinet - LEFT

MODEL#	DIMENSIONS	FREIGHT CLASS	WT/LBS.	CUBIC FT.	1" TOP	1.5" TOP	GLAZE ADD	HP ADD
Z24L8WAL	24 x 24 x 84.4-84.9	125	220.50	34.25	\$1748	\$1800	N/A	N/A
Z21L8WAL	24 x 21 x 84.4-84.9	125	192.15	30.25	\$1684	\$1735	N/A	N/A
Z18L8WAL	24 x 18 x 84.4-84.9	125	184.80	26.25	\$1569	\$1612	N/A	N/A
Z16L8WAL	24 x 16 x 84.4-84.9	125	172.20	24	\$1497	\$1539	N/A	N/A
Z15L8WAL	24 x 15 x 84.4-84.9	125	161.70	22.50	\$1454	\$1489	N/A	N/A
Z12L8WAL	24 x 12 x 84.4-84.9	100	150.15	18.50	\$1337	\$1369	N/A	N/A
Z24M8WAL	20 x 24 x 84.4-84.9	125	197.40	28.50	\$1628	\$1671	N/A	N/A
Z21M8WAL	20 x 21 x 84.4-84.9	125	182.70	25.50	\$1568	\$1611	N/A	N/A
Z18M8WAL	20 x 18 x 84.4-84.9	125	164.85	22.25	\$1453	\$1491	N/A	N/A
Z16M8WAL	20 x 16 x 84.4-84.9	125	154.35	20.25	\$1385	\$1423	N/A	N/A
Z15M8WAL	20 x 15 x 84.4-84.9	125	149.10	19	\$1329	\$1361	N/A	N/A
Z12M8WAL	20 x 12 x 84.4-84.9	100	133.35	15.75	\$1241	\$1268	N/A	N/A

Laminate doors are standard. Full length hanging rod included. **One adjustable shelf** above hanging rod. Standard with lock.



Wardrobe Cabinet - RIGHT

MODEL#	DIMENSIONS	FREIGHT CLASS	WT/LBS.	CUBIC FT.	1" TOP	1.5" TOP	GLAZE ADD	HP ADD
Z24L8WAR	24 x 24 x 84.4-84.9	125	220.50	34.25	\$1748	\$1800	N/A	N/A
Z21L8WAR	24 x 21 x 84.4-84.9	125	192.15	30.25	\$1684	\$1735	N/A	N/A
Z18L8WAR	24 x 18 x 84.4-84.9	125	184.80	26.25	\$1569	\$1612	N/A	N/A
Z16L8WAR	24 x 16 x 84.4-84.9	125	172.20	24	\$1497	\$1539	N/A	N/A
Z15L8WAR	24 x 15 x 84.4-84.9	125	161.70	22.50	\$1454	\$1489	N/A	N/A
Z12L8WAR	24 x 12 x 84.4-84.9	100	150.15	18.50	\$1337	\$1369	N/A	N/A
Z24M8WAR	20 x 24 x 84.4-84.9	125	197.40	28.50	\$1628	\$1671	N/A	N/A
Z21M8WAR	20 x 21 x 84.4-84.9	125	182.70	25.50	\$1568	\$1611	N/A	N/A
Z18M8WAR	20 x 18 x 84.4-84.9	125	164.85	22.25	\$1453	\$1491	N/A	N/A
Z16M8WAR	20 x 16 x 84.4-84.9	125	154.35	20.25	\$1385	\$1423	N/A	N/A
Z15M8WAR	20 x 15 x 84.4-84.9	125	149.10	19	\$1329	\$1361	N/A	N/A
Z12M8WAR	20 x 12 x 84.4-84.9	100	133.35	15.75	\$1241	\$1268	N/A	N/A

Laminate doors are standard. Full length hanging rod included. **One adjustable shelf** above hanging rod. Standard with lock.



Glazed door option

Wardrobe Cabinet/Shelving Combo with Doors - LEFT

MODEL#	DIMENSIONS	FREIGHT CLASS	WT/LBS.	CUBIC FT.	1" TOP	1.5" TOP	GLAZE ADD	HP ADD
Z36L8DIL	24 x 36 x 84.4-84.9	125	339	50	\$2697	\$2770	\$1790	N/A
Z30L8DIL	24 x 30 x 84.4-84.9	125	301	42	\$2367	\$2430	\$1532	N/A
Z24L8DIL	24 x 24 x 84.4-84.9	125	269	34.25	\$2141	\$2193	\$1405	N/A
Z21L8DIL	24 x 21 x 84.4-84.9	100	252	30.25	\$2073	\$2103	\$1393	N/A
Z36M8DIL	20 x 36 x 84.4-84.9	125	306	42.25	\$2538	\$2601	\$1790	N/A
Z30M8DIL	20 x 30 x 84.4-84.9	125	266	35.50	\$2237	\$2292	\$1532	N/A
Z24M8DIL	20 x 24 x 84.4-84.9	100	233	28.50	\$2018	\$2063	\$1405	N/A
Z21M8DIL	20 x 21 x 84.4-84.9	100	215	25.50	\$1918	\$1971	\$1393	N/A

Laminate doors are standard. Storage compartment on **left includes five adjustable shelves**. Wardrobe compartment on **right** includes hanging rod and **one adjustable shelf** above rod. Two locks secure storage and wardrobe.



Glazed door option

Wardrobe Cabinet/Shelving Combo with Doors - RIGHT

MODEL#	DIMENSIONS	FREIGHT CLASS	WT/LBS.	CUBIC FT.	1" TOP	1.5" TOP	GLAZE ADD	HP ADD
Z36L8DIR	24 x 36 x 84.4-84.9	125	339	50	\$2697	\$2770	\$1790	N/A
Z30L8DIR	24 x 30 x 84.4-84.9	125	301	42	\$2367	\$2430	\$1532	N/A
Z24L8DIR	24 x 24 x 84.4-84.9	125	269	34.25	\$2141	\$2193	\$1405	N/A
Z21L8DIR	24 x 21 x 84.4-84.9	100	252	30.25	\$2073	\$2103	\$1393	N/A
Z36M8DIR	20 x 36 x 84.4-84.9	125	306	42.25	\$2538	\$2601	\$1790	N/A
Z30M8DIR	20 x 30 x 84.4-84.9	125	266	35.50	\$2237	\$2292	\$1532	N/A
Z24M8DIR	20 x 24 x 84.4-84.9	100	233	28.50	\$2018	\$2063	\$1405	N/A
Z21M8DIR	20 x 21 x 84.4-84.9	100	215	25.50	\$1918	\$1971	\$1393	N/A

Laminate doors are standard. Storage compartment on **right includes five adjustable shelves**. Wardrobe compartment on **left** includes hanging rod and **one adjustable shelf** above rod. Two locks secure storage and wardrobe.

Required Specifications

- Top finish
- Base finish
- Top/Edge Detail
- Handles

Optional Specifications

- Glazing - Doors (Combo Units)

WARDROBE CABINETS - 84.5"/85" HIGH

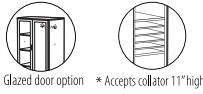
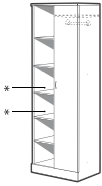

Wardrobe Cabinet/Open Shelving Combo - LEFT

MODEL#	DIMENSIONS D x W x H	FREIGHT CLASS	WT./LBS.	CUBIC FT.	1" TOP	1.5" TOP	GLAZE ADD	HP ADD
Z36L8DINL	24 x 36 x 84.4-84.9	125	312	50	\$2414	\$2487	\$892	N/A
Z30L8DINL	24 x 30 x 84.4-84.9	125	278	42	\$2119	\$2182	\$762	N/A
Z24L8DINL	24 x 24 x 84.4-84.9	125	245	34.25	\$1939	\$1991	\$681	N/A
Z21L8DINL	24 x 21 x 84.4-84.9	125	236	30.25	\$1889	\$1912	\$676	N/A
Z36M8DINL	20 x 36 x 84.4-84.9	125	275	42.25	\$2255	\$2318	\$892	N/A
Z30M8DINL	20 x 30 x 84.4-84.9	125	243	35.50	\$1993	\$2048	\$762	N/A
Z24M8DINL	20 x 24 x 84.4-84.9	125	215	28.50	\$1816	\$1859	\$681	N/A
Z21M8DINL	20 x 21 x 84.4-84.9	125	199	25.50	\$1736	\$1779	\$676	N/A

Laminate door is standard on wardrobe section. Storage compartment on **left includes five adjustable shelves**. Wardrobe compartment on **right** includes hanging rod and **one adjustable shelf** above rod. Single lock secures wardrobe compartment.

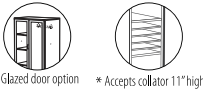
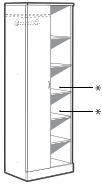

Wardrobe Cabinet/Open Shelving Combo - RIGHT

Z36L8DINR	24 x 36 x 84.4-84.9	125	312	50	\$2414	\$2487	\$892	N/A
Z30L8DINR	24 x 30 x 84.4-84.9	125	278	42	\$2119	\$2182	\$762	N/A
Z24L8DINR	24 x 24 x 84.4-84.9	125	245	34.25	\$1939	\$1991	\$681	N/A
Z21L8DINR	24 x 21 x 84.4-84.9	125	236	30.25	\$1889	\$1912	\$676	N/A
Z36M8DINR	20 x 36 x 84.4-84.9	125	275	42.25	\$2255	\$2318	\$892	N/A
Z30M8DINR	20 x 30 x 84.4-84.9	125	243	35.50	\$1993	\$2048	\$762	N/A
Z24M8DINR	20 x 24 x 84.4-84.9	125	215	28.50	\$1816	\$1859	\$681	N/A
Z21M8DINR	20 x 21 x 84.4-84.9	125	199	25.50	\$1736	\$1779	\$676	N/A

Laminate door is standard on wardrobe section. Storage compartment on **right includes five adjustable shelves**. Wardrobe compartment on **left** includes hanging rod and **one adjustable shelf** above rod. Single lock secures wardrobe compartment.

PERSONAL TOWERS - 84.5"/85" HIGH

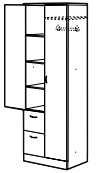

Personal Tower with Doors - LEFT

MODEL#	DIMENSIONS	FREIGHT CLASS	WT./LBS.	CUBIC FT.	1" TOP	1.5" TOP	GLAZE ADD	HP ADD
Z36L8EL	24 x 36 x 84.4-84.9	125	368.55	50	\$2881	\$2955	\$1551	N/A
Z30L8EL	24 x 30 x 84.4-84.9	125	334.95	42	\$2630	\$2693	\$1416	N/A
Z24L8EL	24 x 24 x 84.4-84.9	100	299.24	34.25	\$2542	\$2595	\$1222	N/A
Z36M8EL	20 x 36 x 84.4-84.9	125	332.85	42.25	\$2723	\$2786	\$1551	N/A
Z30M8EL	20 x 30 x 84.4-84.9	100	298.20	35.50	\$2511	\$2566	\$1416	N/A
Z24M8EL	20 x 24 x 84.4-84.9	100	266	29	\$2394	\$2437	\$1222	N/A

Two file drawers on bottom. Laminate doors are standard. Storage compartment on **left includes three adjustable shelves**. Wardrobe compartment on **right** includes hanging rod and **one adjustable shelf** above rod. Two upper locks secure storage and wardrobe compartments. Lower lock secures all drawers.

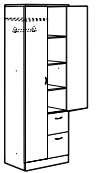

Personal Tower with Doors - RIGHT

Z36L8ER	24 x 36 x 84.4-84.9	125	368.55	50	\$2881	\$2955	\$1551	N/A
Z30L8ER	24 x 30 x 84.4-84.9	125	334.95	42	\$2630	\$2693	\$1416	N/A
Z24L8ER	24 x 24 x 84.4-84.9	100	299.24	34.25	\$2542	\$2595	\$1222	N/A
Z36M8ER	20 x 36 x 84.4-84.9	125	332.85	42.25	\$2723	\$2786	\$1551	N/A
Z30M8ER	20 x 30 x 84.4-84.9	100	298.20	35.50	\$2511	\$2566	\$1416	N/A
Z24M8ER	20 x 24 x 84.4-84.9	100	266	29	\$2394	\$2437	\$1222	N/A

Two file drawers on bottom. Laminate doors are standard. Storage compartment on **right includes three adjustable shelves**. Wardrobe compartment on **left** includes hanging rod and **one adjustable shelf** above rod. Two upper locks secure storage and wardrobe compartments. Lower lock secures all drawers.

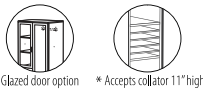
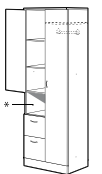

Personal Tower with Doors and cavity - LEFT

Z36L8ECL	24 x 36 x 84.4-84.9	125	366.44	50	\$2853	\$2926	\$1465	N/A
Z30L8ECL	24 x 30 x 84.4-84.9	125	332.49	42	\$2603	\$2666	\$1329	N/A
Z24L8ECL	24 x 24 x 84.4-84.9	100	295.24	34.25	\$2504	\$2556	\$1136	N/A
Z36M8ECL	20 x 36 x 84.4-84.9	125	328.68	42.25	\$2680	\$2743	\$1465	N/A
Z30M8ECL	20 x 30 x 84.4-84.9	100	295.07	35.50	\$2469	\$2522	\$1329	N/A
Z24M8ECL	20 x 24 x 84.4-84.9	100	263	29	\$2355	\$2398	\$1136	N/A

Two file drawers on bottom. Laminate doors are standard. Storage compartment on **left includes two 3-position fixed/height adjustable shelves**. Wardrobe compartment on **right** includes hanging rod and **one adjustable shelf** above rod. Two upper locks secure storage and wardrobe compartments. Lower lock secures all drawers.

Required Specifications

- Top finish
- Base finish
- Top/Edge Detail
- Handles

Optional Specifications

- Glazing - Doors
- Collator (Open Shelves)

PERSONAL TOWERS - 84.5"/85" HIGH

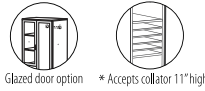
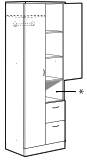

Personal Tower with Doors and cavity - RIGHT

MODEL#	DIMENSIONS D x W x H	FREIGHT CLASS	WT/LBS.	CUBIC FT.	1" TOP	1.5" TOP	GLAZE ADD	HP ADD
Z36L8ECR	24 x 36 x 84.4-84.9	125	366.44	50	\$2853	\$2926	\$1465	N/A
Z30L8ECR	24 x 30 x 84.4-84.9	125	332.49	42	\$2603	\$2666	\$1329	N/A
Z24L8ECR	24 x 24 x 84.4-84.9	100	295.24	34.25	\$2504	\$2556	\$1136	N/A
Z36M8ECR	20 x 36 x 84.4-84.9	125	328.68	42.25	\$2680	\$2743	\$1465	N/A
Z30M8ECR	20 x 30 x 84.4-84.9	100	295.07	35.50	\$2469	\$2522	\$1329	N/A
Z24M8ECR	20 x 24 x 84.4-84.9	100	263	29	\$2355	\$2398	\$1136	N/A

Two file drawers on bottom. Laminate doors are standard. Storage compartment on right includes two 3-position fixed/height adjustable shelves. Wardrobe compartment on left includes hanging rod and one adjustable shelf above rod. Two upper locks secure storage and wardrobe compartments. Lower lock secures all drawers.

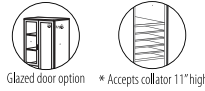
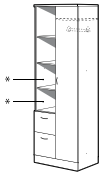

Personal Tower with Open Shelves - LEFT

Z36L8ENL	24 x 36 x 84.4-84.9	125	351.72	50	\$2698	\$2771	\$897	N/A
Z30L8ENL	24 x 30 x 84.4-84.9	125	320.22	42	\$2447	\$2510	\$758	N/A
Z24L8ENL	24 x 24 x 84.4-84.9	100	283.24	34.25	\$2321	\$2373	\$567	N/A
Z36M8ENL	20 x 36 x 84.4-84.9	125	313.96	42.25	\$2526	\$2589	\$892	N/A
Z30M8ENL	20 x 30 x 84.4-84.9	125	282.80	35.50	\$2316	\$2369	\$762	N/A
Z24M8ENL	20 x 24 x 84.4-84.9	100	249	29	\$2175	\$2218	\$567	N/A

Two file drawers on bottom. Laminate door is standard on wardrobe section. Storage compartment on left includes three 3-position fixed/height adjustable shelves. Wardrobe compartment on right includes hanging rod and one adjustable shelf above rod. Upper lock secures wardrobe compartment. Lower lock secures all drawers.

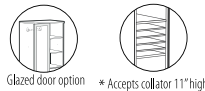
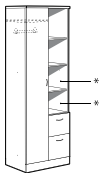

Personal Tower with Open Shelves - RIGHT

Z36L8ENR	24 x 36 x 84.4-84.9	125	351.72	50	\$2698	\$2771	\$897	N/A
Z30L8ENR	24 x 30 x 84.4-84.9	125	320.22	42	\$2447	\$2510	\$758	N/A
Z24L8ENR	24 x 24 x 84.4-84.9	100	283.24	34.25	\$2321	\$2373	\$567	N/A
Z36M8ENR	20 x 36 x 84.4-84.9	125	313.96	42.25	\$2526	\$2589	\$892	N/A
Z30M8ENR	20 x 30 x 84.4-84.9	125	282.80	35.50	\$2316	\$2369	\$762	N/A
Z24M8ENR	20 x 24 x 84.4-84.9	100	249	29	\$2175	\$2218	\$567	N/A

Two file drawers on bottom. Laminate door is standard on wardrobe section. Storage compartment on right includes three 3-position fixed/height adjustable shelves. Wardrobe compartment on right includes hanging rod and one adjustable shelf above rod. Upper lock secures wardrobe compartment. Lower lock secures all drawers.

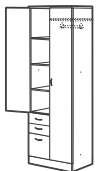

Personal Tower with Doors - LEFT

Z36L8BFL	24 x 36 x 84.4-84.9	125	371.70	50	\$3016	\$3089	\$1551	N/A
Z30L8BFL	24 x 30 x 84.4-84.9	100	337.05	42	\$2778	\$2841	\$1416	N/A
Z24L8BFL	24 x 24 x 84.4-84.9	100	301.24	34.25	\$2644	\$2696	\$1222	N/A
Z36M8BFL	20 x 36 x 84.4-84.9	125	334.95	42.25	\$2846	\$2909	\$1551	N/A
Z30M8BFL	20 x 30 x 84.4-84.9	100	300.30	35.50	\$2644	\$2699	\$1416	N/A
Z24M8BFL	20 x 24 x 84.4-84.9	100	268	29	\$2495	\$2538	\$1222	N/A

Two box and one file drawer on bottom. Laminate doors are standard. Storage compartment on left includes three 3-position fixed/height adjustable shelves. Wardrobe compartment on right includes hanging rod and one adjustable shelf above rod. Two upper locks secure storage and wardrobe compartments. Lower lock secures all drawers.

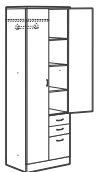

Personal Tower with Doors - RIGHT

Z36L8BFR	24 x 36 x 84.4-84.9	125	371.70	50	\$3016	\$3089	\$1551	N/A
Z30L8BFR	24 x 30 x 84.4-84.9	100	337.05	42	\$2778	\$2841	\$1416	N/A
Z24L8BFR	24 x 24 x 84.4-84.9	100	301.24	34.25	\$2644	\$2696	\$1222	N/A
Z36M8BFR	20 x 36 x 84.4-84.9	125	334.95	42.25	\$2846	\$2909	\$1551	N/A
Z30M8BFR	20 x 30 x 84.4-84.9	100	300.30	35.50	\$2644	\$2699	\$1416	N/A
Z24M8BFR	20 x 24 x 84.4-84.9	100	268	29	\$2495	\$2538	\$1222	N/A

Two box and one file drawer on bottom. Laminate doors are standard. Storage compartment on right includes three 3-position fixed/height adjustable shelves. Wardrobe compartment on left includes hanging rod and one adjustable shelf above rod. Two upper locks secure storage and wardrobe compartments. Lower lock secures all drawers.

Required Specifications

Top finish
Base finish
Top/Edge Detail
Handles

Optional Specifications

Glazing - Doors
Collator (Open Shelves)

PERSONAL TOWERS - 84.5"/85" HIGH

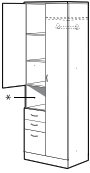

Personal Tower with Doors and Cavity - LEFT

MODEL#	DIMENSIONS D x W x H	FREIGHT CLASS	WT/LBS.	CUBIC FT.	1" TOP	1.5" TOP	GLAZE ADD	HP ADD
Z36L8BFCL	24 x 36 x 84.4-84.9	125	369.59	50	\$2976	\$3050	\$1465	N/A
Z30L8BFCL	24 x 30 x 84.4-84.9	125	334.59	42	\$2736	\$2799	\$1329	N/A
Z24L8BFCL	24 x 24 x 84.4-84.9	100	297.24	34.25	\$2603	\$2656	\$1136	N/A
Z36M8BFCL	20 x 36 x 84.4-84.9	125	330.78	42.25	\$2805	\$2868	\$1465	N/A
Z30M8BFCL	20 x 30 x 84.4-84.9	100	299.27	35.50	\$2603	\$2658	\$1329	N/A
Z24M8BFCL	20 x 24 x 84.4-84.9	100	265	29	\$2455	\$2498	\$1136	N/A

Two box and one file drawer on bottom. Laminate doors are standard. Storage compartment on **left** includes **two 3-position fixed/height adjustable shelves**. Wardrobe compartment on **left** includes hanging rod and **one adjustable shelf** above rod. Two upper locks secure storage and wardrobe compartments. Lower lock secures all drawers.

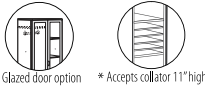
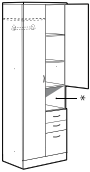

Personal Tower with Doors and Cavity - RIGHT

Z36L8BFCL	24 x 36 x 84.4-84.9	125	369.59	50	\$2976	\$3050	\$1465	N/A
Z30L8BFCL	24 x 30 x 84.4-84.9	125	334.59	42	\$2736	\$2799	\$1329	N/A
Z24L8BFCL	24 x 24 x 84.4-84.9	100	297.24	34.25	\$2603	\$2656	\$1136	N/A
Z36M8BFCL	20 x 36 x 84.4-84.9	125	330.78	42.25	\$2805	\$2868	\$1465	N/A
Z30M8BFCL	20 x 30 x 84.4-84.9	100	299.27	35.50	\$2603	\$2658	\$1329	N/A
Z24M8BFCL	20 x 24 x 84.4-84.9	100	265	29	\$2455	\$2498	\$1136	N/A

Two box and one file drawer on bottom. Laminate doors are standard. Storage compartment on **right** includes **two 3-position fixed/height adjustable shelves**. Wardrobe compartment on **left** includes hanging rod and **one adjustable shelf** above rod. Two upper locks secure storage and wardrobe compartments. Lower lock secures all drawers.

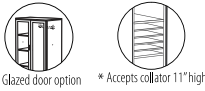
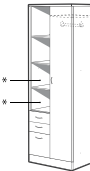

Personal Tower with Open Shelves - LEFT

Z36L8BFNL	24 x 36 x 84.4-84.9	125	354.87	50	\$2818	\$2892	\$897	N/A
Z30L8BFNL	24 x 30 x 84.4-84.9	125	322.32	42	\$2583	\$2646	\$758	N/A
Z24L8BFNL	24 x 24 x 84.4-84.9	100	285.24	34.25	\$2422	\$2474	\$567	N/A
Z36M8BFNL	20 x 36 x 84.4-84.9	125	316.06	42.25	\$2649	\$2725	\$892	N/A
Z30M8BFNL	20 x 30 x 84.4-84.9	100	287	35.50	\$2447	\$2502	\$762	N/A
Z24M8BFNL	20 x 24 x 84.4-84.9	100	251	29	\$2272	\$2315	\$567	N/A

Two box and one file drawer on bottom. Laminate door is standard on wardrobe section. Storage compartment on **left** includes **three 3-position fixed/height adjustable shelves**. Wardrobe compartment on **right** includes hanging rod and **one adjustable shelf** above rod. Upper lock secures wardrobe compartment. Lower lock secures all drawers.

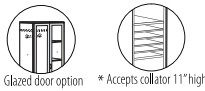
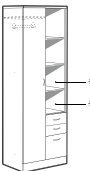

Personal Tower with Open Shelves - RIGHT

Z36L8BFNR	24 x 36 x 84.4-84.9	125	354.87	50	\$2818	\$2892	\$897	N/A
Z30L8BFNR	24 x 30 x 84.4-84.9	125	322.32	42	\$2583	\$2646	\$758	N/A
Z24L8BFNR	24 x 24 x 84.4-84.9	100	285.24	34.25	\$2422	\$2474	\$567	N/A
Z36M8BFNR	20 x 36 x 84.4-84.9	125	316.06	42.25	\$2649	\$2725	\$892	N/A
Z30M8BFNR	20 x 30 x 84.4-84.9	100	287	35.50	\$2447	\$2502	\$762	N/A
Z24M8BFNR	20 x 24 x 84.4-84.9	100	251	29	\$2272	\$2315	\$567	N/A

Two box and one file drawer on bottom. Laminate door is standard on wardrobe section. Storage compartment on **right** includes **three 3-position fixed/height adjustable shelves**. Wardrobe compartment on **left** includes hanging rod and **one adjustable shelf** above rod. Upper lock secures wardrobe compartment. Lower lock secures all drawers.

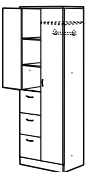

Personal Tower with Doors - LEFT

Z36L83FL	24 x 36 x 84.4-84.9	125	374.85	50	\$3066	\$3140	\$1465	N/A
Z30L83FL	24 x 30 x 84.4-84.9	100	340.20	42	\$2829	\$2892	\$1329	N/A
Z24L83FL	24 x 24 x 84.4-84.9	100	304.24	34.25	\$2716	\$2768	\$1136	N/A
Z36M83FL	20 x 36 x 84.4-84.9	100	339.15	42.25	\$2853	\$2916	\$1465	N/A
Z30M83FL	20 x 30 x 84.4-84.9	100	306.60	35.50	\$2667	\$2722	\$1329	N/A
Z24M83FL	20 x 24 x 84.4-84.9	100	272	29	\$2558	\$2603	\$1136	N/A

Three file drawers on bottom. Laminate doors are standard. Storage compartment on **left** includes **two 3-position fixed/height adjustable shelves**. Wardrobe compartment on **right** includes hanging rod and **one adjustable shelf** above rod. Two upper locks secure storage and wardrobe compartments. Lower lock secures all drawers.

Required Specifications

- Top finish
- Base finish
- Top/Edge Detail
- Handles

Optional Specifications

- Glazing - Doors
- Collator (Open Shelves)

PERSONAL TOWERS - 84.5"/85" HIGH

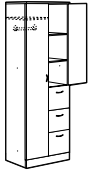

Glazed door option

Personal Tower with Doors - RIGHT

MODEL#	DIMENSIONS D x W x H	FREIGHT CLASS	WT./LBS.	CUBIC FT.	1" TOP	1.5" TOP	GLAZE ADD	HP ADD
Z36L83FR	24 x 36 x 84.4-84.9	125	374.85	50	\$3066	\$3140	\$1465	N/A
Z30L83FR	24 x 30 x 84.4-84.9	100	340.20	42	\$2829	\$2892	\$1329	N/A
Z24L83FR	24 x 24 x 84.4-84.9	100	304.24	34.25	\$2716	\$2768	\$1136	N/A
Z36M83FR	20 x 36 x 84.4-84.9	100	339.15	42.25	\$2853	\$2916	\$1465	N/A
Z30M83FR	20 x 30 x 84.4-84.9	100	306.60	35.50	\$2667	\$2722	\$1329	N/A
Z24M83FR	20 x 24 x 84.4-84.9	100	272	29	\$2558	\$2603	\$1136	N/A

Three file drawers on bottom. Laminate doors are standard. Storage compartment on **right** includes two 3-position fixed/height adjustable shelves. Wardrobe compartment on **left** includes hanging rod and one adjustable shelf above rod. Two upper locks secure storage and wardrobe compartments. Lower lock secures all drawers.

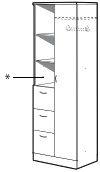

Glazed door option



* Accepts collator 11" high

Personal Tower with Open Shelves - LEFT

Z36L83FNL	24 x 36 x 84.4-84.9	125	362.01	50	\$2910	\$2984	\$897	N/A
Z30L83FNL	24 x 30 x 84.4-84.9	125	328.80	42	\$2674	\$2737	\$758	N/A
Z24L83FNL	24 x 24 x 84.4-84.9	100	291.24	34.25	\$2534	\$2587	\$567	N/A
Z36M83FNL	20 x 36 x 84.4-84.9	125	324.25	42.25	\$2698	\$2761	\$892	N/A
Z30M83FNL	20 x 30 x 84.4-84.9	100	294.53	35.50	\$2512	\$2567	\$762	N/A
Z24M83FNL	20 x 24 x 84.4-84.9	100	258	29	\$2376	\$2419	\$567	N/A

Three file drawers on bottom. Laminate door is standard on wardrobe section. Storage compartment on **left** includes two 3-position fixed/height adjustable shelves. Wardrobe compartment on **right** includes hanging rod and one adjustable shelf above rod. Upper lock secures wardrobe compartment. Lower lock secures all drawers.

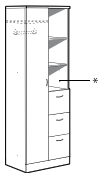

Glazed door option



* Accepts collator 11" high

Personal Tower with Open Shelves - RIGHT

Z36L83FNR	24 x 36 x 84.4-84.9	125	362.01	50	\$2910	\$2984	\$897	N/A
Z30L83FNR	24 x 30 x 84.4-84.9	125	328.80	42	\$2674	\$2737	\$758	N/A
Z24L83FNR	24 x 24 x 84.4-84.9	100	291.24	34.25	\$2534	\$2587	\$567	N/A
Z36M83FNR	20 x 36 x 84.4-84.9	125	324.25	42.25	\$2698	\$2761	\$892	N/A
Z30M83FNR	20 x 30 x 84.4-84.9	100	294.53	35.50	\$2512	\$2567	\$762	N/A
Z24M83FNR	20 x 24 x 84.4-84.9	100	258	29	\$2376	\$2419	\$567	N/A

Three file drawers on bottom. Laminate door is standard on wardrobe section. Storage compartment on **right** includes two 3-position fixed/height adjustable shelves. Wardrobe compartment on **left** includes hanging rod and one adjustable shelf above rod. Upper lock secures wardrobe compartment. Lower lock secures all drawers.

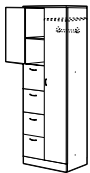

Glazed door option

Personal Tower with Doors - LEFT

Z36L84FL	24 x 36 x 84.4-84.9	125	380.10	50	\$3162	\$3236	\$1340	N/A
Z30L84FL	24 x 30 x 84.4-84.9	100	344.40	42	\$2925	\$2988	\$1204	N/A
Z24L84FL	24 x 24 x 84.4-84.9	100	309.24	34.25	\$2740	\$2792	\$1011	N/A
Z36M84FL	20 x 36 x 84.4-84.9	100	344.40	42.25	\$2954	\$3017	\$1340	N/A
Z30M84FL	20 x 30 x 84.4-84.9	100	312.90	35.50	\$2767	\$2822	\$1204	N/A
Z24M84FL	20 x 24 x 84.4-84.9	100	278	29	\$2614	\$2659	\$1011	N/A

Four file drawers on bottom. Laminate doors are standard. Storage compartment on **left** includes one 3-position fixed/height adjustable shelf. Wardrobe compartment on **right** includes hanging rod and one adjustable shelf above rod. Two upper locks secure wardrobe compartment. Lower lock secures all drawers.



Glazed door option

Personal Tower with Doors - RIGHT

Z36L84FR	24 x 36 x 84.4-84.9	125	380.10	50	\$3162	\$3236	\$1340	N/A
Z30L84FR	24 x 30 x 84.4-84.9	100	344.40	42	\$2925	\$2988	\$1204	N/A
Z24L84FR	24 x 24 x 84.4-84.9	100	309.24	34.25	\$2740	\$2792	\$1011	N/A
Z36M84FR	20 x 36 x 84.4-84.9	100	344.40	42.25	\$2954	\$3017	\$1340	N/A
Z30M84FR	20 x 30 x 84.4-84.9	100	312.90	35.50	\$2767	\$2822	\$1204	N/A
Z24M84FR	20 x 24 x 84.4-84.9	100	278	29	\$2614	\$2659	\$1011	N/A

Four file drawers on bottom. Laminate doors are standard. Storage compartment on **right** includes one 3-position fixed/height adjustable shelf. Wardrobe compartment on **left** includes hanging rod and one adjustable shelf above rod. Two upper locks secure wardrobe compartment. Lower lock secures all drawers.

Required Specifications

Top finish
Base finish
Top/Edge Detail
Handles

Optional Specifications

Glazing - Doors
Collator (Open Shelves)

PERSONAL TOWERS - 84.5"/85" HIGH

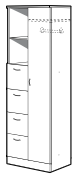

Glazed door option

Personal Tower with Open Shelf - LEFT



Glazed door option

Personal Tower with Open Shelf - RIGHT

MODEL#	DIMENSIONS D x W x H	FREIGHT CLASS	WT/LBS.	CUBIC FT.	1"TOP	1.5" TOP	GLAZE ADD	HP ADD
Z36L84FNL	24 x 36 x 84.4-84.9	125	371.25	50	\$3034	\$3108	\$897	N/A
Z30L84FNL	24 x 30 x 84.4-84.9	100	336.33	42	\$2798	\$2861	\$758	N/A
Z24L84FNL	24 x 24 x 84.4-84.9	100	299.24	34.25	\$2627	\$2692	\$567	N/A
Z36M84FNL	20 x 36 x 84.4-84.9	125	328.24	42.25	\$2829	\$2892	\$892	N/A
Z30M84FNL	20 x 30 x 84.4-84.9	100	297.86	35.50	\$2642	\$2697	\$762	N/A
Z24M84FNL	20 x 24 x 84.4-84.9	100	268	29	\$2501	\$2546	\$567	N/A

Four file drawers on bottom. Laminate door is standard on wardrobe section. Storage compartment on left includes one 3-position fixed/height adjustable shelf. Wardrobe compartment on right includes hanging rod and one adjustable shelf above rod. Upper lock secures wardrobe compartment. Lower lock secures all drawers.

Z36L84FNR	24 x 36 x 84.4-84.9	125	371.25	50	\$3034	\$3108	\$897	N/A
Z30L84FNR	24 x 30 x 84.4-84.9	100	336.33	42	\$2798	\$2861	\$758	N/A
Z24L84FNR	24 x 24 x 84.4-84.9	100	299.24	34.25	\$2627	\$2692	\$567	N/A
Z36M84FNR	20 x 36 x 84.4-84.9	125	328.24	42.25	\$2829	\$2892	\$892	N/A
Z30M84FNR	20 x 30 x 84.4-84.9	100	297.86	35.50	\$2642	\$2697	\$762	N/A
Z24M84FNR	20 x 24 x 84.4-84.9	100	268	29	\$2501	\$2546	\$567	N/A

Four file drawers on bottom. Laminate door is standard on wardrobe section. Storage compartment on right includes one 3-position fixed/height adjustable shelf. Wardrobe compartment on left includes hanging rod and one adjustable shelf above rod. Upper lock secures wardrobe compartment. Lower lock secures all drawers.

CLOSED FRONT OVERHEAD STORAGE - 33"H

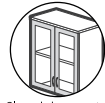
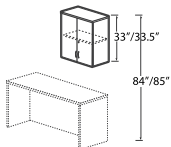

Glazed door option

Closed Front Overhead Storage with Doors - 32.5"/33"H

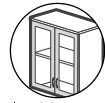
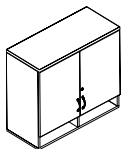

Glazed door option

Closed Front Overhead Storage with Pigeon Hole - 32.5"/33"H

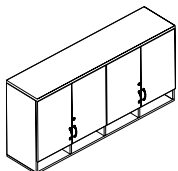

Glazed door option

Closed Front Overhead Storage with Pigeon Hole - 32.5"/33"H

MODEL#	DIMENSIONS	FREIGHT CLASS	WT/LBS.	CUBIC FT.	1"TOP	1.5" TOP	GLAZE ADD	HP ADD
Z42S33OS	16 x 42 x 32.5-33	100	135.98	16.25	\$1055	\$1125	\$1023	N/A
Z36S33OS	16 x 36 x 32.5-33	100	119.70	14	\$957	\$1019	\$924	N/A
Z30S33OS	16 x 30 x 32.5-33	100	104.42	11.75	\$857	\$896	\$805	N/A
Z24S33OS	16 x 24 x 32.5-33	100	81.13	9.75	\$768	\$810	\$704	N/A

Includes steel hanging rail for wall mount applications. Includes one fixed shelf. Doors lock.

• **NOTE:** Care should be taken to mount the units. Units should be mounted to wall studs using correct fasteners. Failure to do so may result in collapse of the unit and subsequent personal injury. **Fastening hardware not included.** Mounting hardware used should be based on wall material. Consult an installation professional for proper wall mounting.

Z42S33OP	16 x 42 x 32.5-33	100	140	16.25	\$1347	\$1420	\$675	N/A
Z36S33OP	16 x 36 x 32.5-33	100	122	14	\$1163	\$1228	\$614	N/A
Z30S33OP	16 x 30 x 32.5-33	100	105	12	\$1042	\$1095	\$546	N/A
Z24S33OP	16 x 24 x 32.5-33	100	88	9.75	\$936	\$986	\$497	N/A

Includes steel hanging rail for wall mount applications. Includes one fixed shelf. Doors lock.

• **NOTE:** Care should be taken to mount the units. Units should be mounted to wall studs using correct fasteners. Failure to do so may result in collapse of the unit and subsequent personal injury. **Fastening hardware not included.** Mounting hardware used should be based on wall material. Consult an installation professional for proper wall mounting.

Z72S33OS	16 x 72 x 32.5-33	100	230	26	\$2181	\$2277	\$1230	N/A
Z66S33OS	16 x 66 x 32.5-33	100	215	24	\$2096	\$2183	\$1208	N/A
Z60S33OS	16 x 60 x 32.5-33	100	199	22	\$1933	\$2013	\$1094	N/A
Z54S33OS	16 x 54 x 32.5-33	100	184	21	\$1837	\$1913	\$1072	N/A

Includes steel hanging rail for wall mount applications. Includes one fixed shelf. Doors lock.

• **NOTE:** Care should be taken to mount the units. Units should be mounted to wall studs using correct fasteners. Failure to do so may result in collapse of the unit and subsequent personal injury. **Fastening hardware not included.** Mounting hardware used should be based on wall material. Consult an installation professional for proper wall mounting.

Required Specifications

- Top finish
- Base finish
- Top/Edge Detail
- Handles

Optional Specifications

- Glazing - Doors

OVERHEAD STORAGE - 33"H

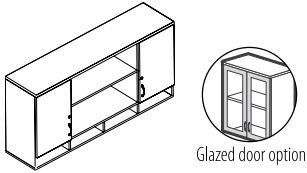

Overhead Storage, 2 Outer Doors with Pigeon Hole - 32.5"/33"H

MODEL#	DIMENSIONS D x W x H	FREIGHT CLASS	WT/LBS.	CUBIC FT.	1"TOP	1.5" TOP	GLAZE ADD	HP ADD
Z72S33SOS	16 x 72 x 32.5-33	100	215	26	\$1973	\$2069	\$616	N/A
Z66S33SOS	16 x 66 x 32.5-33	100	201	24	\$1884	\$1971	\$606	N/A
Z60S33SOS	16 x 60 x 32.5-33	100	187	22	\$1770	\$1850	\$594	N/A
Z54S33SOS	16 x 54 x 32.5-33	100	173	21	\$1647	\$1723	\$537	N/A

6 compartments. **Doors on outer compartments only.** Includes steel hanging rail for wall mount applications. Includes one fixed shelf. Doors lock.

• **NOTE:** Care should be taken to mount the units. Units should be mounted to wall studs using correct fasteners. Failure to do so may result in collapse of the unit and subsequent personal injury. **Fastening hardware not included.** Mounting hardware used should be based on wall material. Consult an installation professional for proper wall mounting.

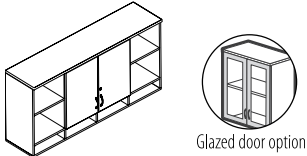

Overhead Storage, 2 Center Doors with Pigeon Hole - 32.5"/33"H

Z72S33OSO	16 x 72 x 32.5-33	100	214	26	\$1935	\$2031	\$616	N/A
Z66S33OSO	16 x 66 x 32.5-33	100	200	24	\$1851	\$1938	\$606	N/A
Z60S33OSO	16 x 60 x 32.5-33	100	186	22	\$1737	\$1817	\$549	N/A
Z54S33OSO	16 x 54 x 32.5-33	100	172	21	\$1642	\$1718	\$537	N/A

6 compartments. **Doors on inner compartments only.** Includes steel hanging rail for wall mount applications. Includes one fixed shelf. Doors lock.

• **NOTE:** Care should be taken to mount the units. Units should be mounted to wall studs using correct fasteners. Failure to do so may result in collapse of the unit and subsequent personal injury. **Fastening hardware not included.** Mounting hardware used should be based on wall material. Consult an installation professional for proper wall mounting.

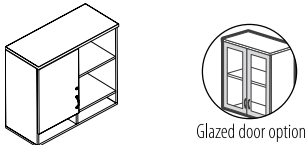

Overhead Storage, 1 Door - LEFT with Pigeon Hole - 32.5"/33"H

Z36S33OSL	16 x 36 x 32.5-33	100	119	14	\$1089	\$1154	\$308	N/A
Z30S33OSL	16 x 30 x 32.5-33	100	104	11.75	\$994	\$1047	\$275	N/A
Z24S33OSL	16 x 24 x 32.5-33	100	88	9.75	\$892	\$942	\$240	N/A

Includes steel hanging rail for wall mount applications. Includes one fixed shelf. Door locks. Open storage on **right.**

• **NOTE:** Care should be taken to mount the units. Units should be mounted to wall studs using correct fasteners. Failure to do so may result in collapse of the unit and subsequent personal injury. **Fastening hardware not included.** Mounting hardware used should be based on wall material. Consult an installation professional for proper wall mounting.

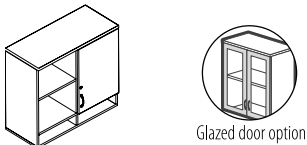

Overhead Storage, 1 Door - RIGHT with Pigeon Hole - 32.5"/33"H

Z36S33OSR	16 x 36 x 32.5-33	100	119	14	\$1089	\$1154	\$308	N/A
Z30S33OSR	16 x 30 x 32.5-33	100	104	11.75	\$994	\$1047	\$275	N/A
Z24S33OSR	16 x 24 x 32.5-33	100	88	9.75	\$892	\$942	\$240	N/A

Includes steel hanging rail for wall mount applications. Includes one fixed shelf. Door locks. Open storage on **left.**

• **NOTE:** Care should be taken to mount the units. Units should be mounted to wall studs using correct fasteners. Failure to do so may result in collapse of the unit and subsequent personal injury. **Fastening hardware not included.** Mounting hardware used should be based on wall material. Consult an installation professional for proper wall mounting.

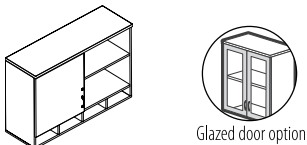

Overhead Storage, 1 Door - LEFT with Pigeon Hole - 32.5"/33"H

Z48S33OSL	16 x 48 x 32.5-33	100	135	16.25	\$1409	\$1485	\$347	N/A
Z42S33OSL	16 x 42 x 32.5-33	100	135	16.25	\$1253	\$1326	\$339	N/A

Includes steel hanging rail for wall mount applications. Includes one fixed shelf. Door locks. Open storage on **right.**

• **NOTE:** Care should be taken to mount the units. Units should be mounted to wall studs using correct fasteners. Failure to do so may result in collapse of the unit and subsequent personal injury. **Fastening hardware not included.** Mounting hardware used should be based on wall material. Consult an installation professional for proper wall mounting.

Required Specifications

- Top finish
- Base finish
- Top/Edge Detail
- Handles

Optional Specifications

- Glazing - Doors (Closed Storage)

CLOSED FRONT OVERHEAD STORAGE - 33"H

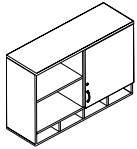

Glazed door option

Overhead Storage, 1 Door - RIGHT with Pigeon Hole - 32.5"/33"H*

MODEL#	DIMENSIONS D x W x H	FREIGHT CLASS	WT./LBS.	CUBIC FT.	1" TOP	1.5" TOP	GLAZE ADD	HP ADD
Z48S33OSR	16 x 48 x 32.5-33	100	135	16.25	\$1409	\$1485	\$347	N/A
Z42S33OSR	16 x 42 x 32.5-33	100	135	16.25	\$1253	\$1326	\$339	N/A

Includes steel hanging rail for wall mount applications. Includes one fixed shelf. Door locks. Open storage on **left**.

• **NOTE:** Care should be taken to mount the units. Units should be mounted to wall studs using correct fasteners. Failure to do so may result in collapse of the unit and subsequent personal injury. **Fastening hardware not included.** Mounting hardware used should be based on wall material. Consult an installation professional for proper wall mounting.

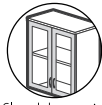
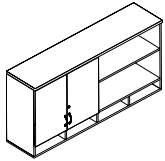

Glazed door option

Overhead Storage, 1 Door - LEFT with Pigeon Hole - 32.5"/33"H*

Z72S33OSL	16 x 72 x 32.5-33	125	207	26	\$1895	\$1991	\$615	N/A
Z66S33OSL	16 x 66 x 32.5-33	100	193	24	\$1808	\$1895	\$607	N/A
Z60S33OSL	16 x 60 x 32.5-33	100	179	22	\$1675	\$1755	\$551	N/A
Z54S33OSL	16 x 54 x 32.5-33	125	166	21	\$1584	\$1660	\$535	N/A

Includes steel hanging rail for wall mount applications. Includes one fixed shelf. Doors lock. Open storage on **right**.

• **NOTE:** Care should be taken to mount the units. Units should be mounted to wall studs using correct fasteners. Failure to do so may result in collapse of the unit and subsequent personal injury. **Fastening hardware not included.** Mounting hardware used should be based on wall material. Consult an installation professional for proper wall mounting.

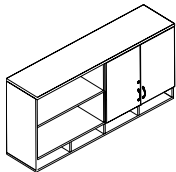

Glazed door option

Overhead Storage, 1 Door - RIGHT with Pigeon Hole - 32.5"/33"H*

Z72S33OSR	16 x 72 x 32.5-33	125	207	26	\$1895	\$1991	\$615	N/A
Z66S33OSR	16 x 66 x 32.5-33	100	193	24	\$1808	\$1895	\$607	N/A
Z60S33OSR	16 x 60 x 32.5-33	100	179	22	\$1675	\$1755	\$551	N/A
Z54S33OSR	16 x 54 x 32.5-33	125	166	21	\$1584	\$1660	\$535	N/A

Includes steel hanging rail for wall mount applications. Includes one fixed shelf. Doors lock. Open storage on **left**.

• **NOTE:** Care should be taken to mount the units. Units should be mounted to wall studs using correct fasteners. Failure to do so may result in collapse of the unit and subsequent personal injury. **Fastening hardware not included.** Mounting hardware used should be based on wall material. Consult an installation professional for proper wall mounting.

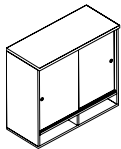

Overhead Storage, Glass Doors with Pigeon Hole - 32.5"/33"H

Z36S33OSD	16 x 36 x 32.5-33	100	127	14	\$2312	\$2377	N/A	N/A
Z30S33OSD	16 x 30 x 32.5-33	100	110	12	\$2034	\$2087	N/A	N/A
Z24S33OSD	16 x 24 x 32.5-33	100	91	9.75	\$1802	\$1852	N/A	N/A

Includes steel hanging rail for wall mount applications. Includes one fixed shelf. Sliding glass doors do not lock.

Shipped easy to assemble in 2 cartons. Glass doors shipped separately.

• **NOTE:** Care should be taken to mount the units. Units should be mounted to wall studs using correct fasteners. Failure to do so may result in collapse of the unit and subsequent personal injury. **Fastening hardware not included.** Mounting hardware used should be based on wall material. Consult an installation professional for proper wall mounting.

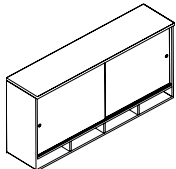

Overhead Storage, Glass Doors with Pigeon Hole - 32.5"/33"H

Z72S33OSD	16 x 72 x 32.5-33	100	224	26	\$4075	\$4171	N/A	N/A
Z66S33OSD	16 x 66 x 32.5-33	100	208	24	\$3810	\$3897	N/A	N/A
Z60S33OSD	16 x 60 x 32.5-33	100	193	22	\$3525	\$3605	N/A	N/A
Z54S33OSD	16 x 54 x 32.5-33	100	178	21	\$3283	\$3359	N/A	N/A
Z48S33OSD	16 x 48 x 32.5-33	100	162	17.70	\$3000	\$3076	N/A	N/A
Z42S33OSD	16 x 42 x 32.5-33	100	145	16.25	\$2680	\$2753	N/A	N/A

Includes steel hanging rail for wall mount applications. Includes one fixed shelf. Sliding glass doors do not lock.

Shipped easy to assemble in 2 cartons. Glass doors shipped separately.

• **NOTE:** Care should be taken to mount the units. Units should be mounted to wall studs using correct fasteners. Failure to do so may result in collapse of the unit and subsequent personal injury. **Fastening hardware not included.** Mounting hardware used should be based on wall material. Consult an installation professional for proper wall mounting.

Required Specifications

Top finish _____ Handles _____
 Top/edge detail _____
 Base finish _____
 Lock finish* _____

Optional Specifications

Glazed doors* _____
 Key #* _____

CLOSED FRONT OVERHEAD STORAGE - 20" H

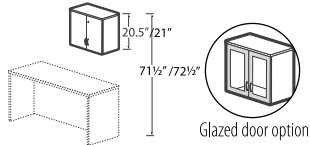

Closed Front Overhead Storage with Doors - 20"/20.5"H*

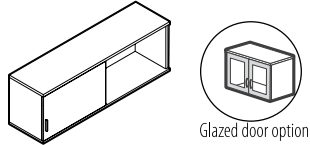

Overhead Storage w/1 door - LEFT* 20"/20.5"H

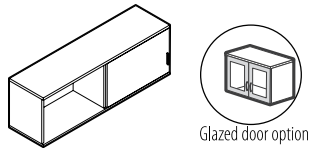

Overhead Storage w/1 door - RIGHT 20"/20.5"H*

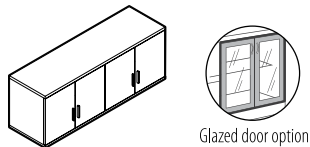

Closed Front Overhead Storage w/Center Divider- 20/20.5"H*

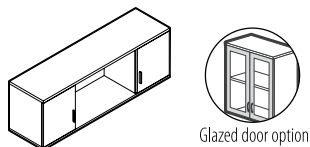

Overhead Storage w/2 Outer Doors 20/20.5"H*

MODEL#	DIMENSIONS	FREIGHT CLASS	WT/LBS.	CUBIC FT.	1" TOP	1.5" TOP	GLAZE ADD	HP ADD
D x W x H								
Z42S200S	16 x 42 x 20-20.5	100	93.99	10.50	\$754	\$823	\$730	N/A
Z36S200S	16 x 36 x 20-20.5	100	82.70	9	\$691	\$753	\$667	N/A
Z30S200S	16 x 30 x 20-20.5	100	72.42	7.50	\$624	\$663	\$592	N/A
Z24S200S	16 x 24 x 20-20.5	100	56.13	6.25	\$586	\$629	\$529	N/A

Includes steel hanging rail for wall mount applications. Doors lock.

• **NOTE:** Care should be taken to mount the units. Units should be mounted to wall studs using correct fasteners. Failure to do so may result in collapse of the unit and subsequent personal injury. **Fastening hardware not included.** Mounting hardware used should be based on wall material. Consult an installation professional for proper wall mounting.

Z48S200SL	16 x 48 x 20-20.5	125	95	12.50	\$857	\$933	\$297	N/A
Z42S200SL	16 x 42 x 20-20.5	100	85	10.50	\$757	\$830	\$275	N/A
Z36S200SL	16 x 36 x 20-20.5	100	76	9	\$694	\$759	\$252	N/A
Z30S200SL	16 x 30 x 20-20.5	100	67	7.60	\$636	\$689	\$216	N/A
Z24S200SL	16 x 24 x 20-20.5	100	58	6.50	\$589	\$639	\$198	N/A

Door on **left**. Includes steel hanging rail for wall mount applications. Includes one fixed shelf. Door locks.

• **NOTE:** Care should be taken to mount the units. Units should be mounted to wall studs using correct fasteners. Failure to do so may result in collapse of the unit and subsequent personal injury. **Fastening hardware not included.** Mounting hardware used should be based on wall material. Consult an installation professional for proper wall mounting.

Z48S200SR	16 x 48 x 20-20.5	125	95	12.50	\$857	\$933	\$297	N/A
Z42S200SR	16 x 42 x 20-20.5	100	85	10.50	\$757	\$830	\$275	N/A
Z36S200SR	16 x 36 x 20-20.5	100	76	9	\$694	\$759	\$252	N/A
Z30S200SR	16 x 30 x 20-20.5	100	67	7.60	\$636	\$689	\$216	N/A
Z24S200SR	16 x 24 x 20-20.5	100	58	6.50	\$589	\$639	\$198	N/A

Door on **right**. Includes steel hanging rail for wall mount applications. Includes one fixed shelf. Door locks.

• **NOTE:** Care should be taken to mount the units. Units should be mounted to wall studs using correct fasteners. Failure to do so may result in collapse of the unit and subsequent personal injury. **Fastening hardware not included.** Mounting hardware used should be based on wall material. Consult an installation professional for proper wall mounting.

Z72S200S	16 x 72 x 20-20.5	100	149	18	\$1444	\$1540	\$996	N/A
Z66S200S	16 x 66 x 20-20.5	100	139	16.50	\$1376	\$1463	\$974	N/A
Z60S200S	16 x 60 x 20-20.5	100	129	15	\$1270	\$1350	\$891	N/A
Z54S200S	16 x 54 x 20-20.5	100	119	13.75	\$1210	\$1286	\$868	N/A

Includes steel hanging rail for wall mount applications. Includes one fixed shelf. Doors lock.

• **NOTE:** Care should be taken to mount the units. Units should be mounted to wall studs using correct fasteners. Failure to do so may result in collapse of the unit and subsequent personal injury. **Fastening hardware not included.** Mounting hardware used should be based on wall material. Consult an installation professional for proper wall mounting.

Z72S20SOS	16 x 72 x 20-20.5	125	137	18	\$1241	\$1337	\$502	N/A
Z66S20SOS	16 x 66 x 20-20.5	125	128	16.50	\$1175	\$1262	\$490	N/A
Z60S20SOS	16 x 60 x 20-20.5	100	120	15	\$1105	\$1185	\$481	N/A
Z54S20SOS	16 x 54 x 20-20.5	100	110	13.75	\$1030	\$1106	\$438	N/A

4 compartments. **Doors on outer compartments only.** Includes steel hanging rail for wall mount applications. Doors lock.

• **NOTE:** Care should be taken to mount the units. Units should be mounted to wall studs using correct fasteners. Failure to do so may result in collapse of the unit and subsequent personal injury. **Fastening hardware not included.** Mounting hardware used should be based on wall material. Consult an installation professional for proper wall mounting.

Required Specifications

Top finish
 Top/edge detail
 Base finish
 Lock finish*
 Handles*

Optional Specifications

Glazed doors*
 Key #*

CLOSED FRONT OVERHEAD STORAGE - 20" H

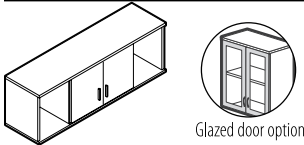

Overhead Storage w/ Inner Doors 20/20.5"H*

MODEL#	DIMENSIONS D x W x H	FREIGHT CLASS	WT/LBS.	CUBIC FT.	1" TOP	1.5" TOP	GLAZE ADD	HP ADD
Z72S200SO	16 x 72 x 20-20.5	125	137	18	\$1256	\$1352	\$499	N/A
Z66S200SO	16 x 66 x 20-20.5	125	128	16.50	\$1190	\$1277	\$487	N/A
Z60S200SO	16 x 60 x 20-20.5	100	120	15	\$1119	\$1199	\$447	N/A
Z54S200SO	16 x 54 x 20-20.5	100	110	13.75	\$1045	\$1121	\$435	N/A

4 compartments. **Doors on inner compartments only.** Includes steel hanging rail for wall mount applications. Doors lock.
NOTE: Care should be taken to mount the units. Units should be mounted to wall studs using correct fasteners. Failure to do so may result in collapse of the unit and subsequent personal injury. **Fastening hardware not included.** Mounting hardware used should be based on wall material. Consult an installation professional for proper wall mounting.

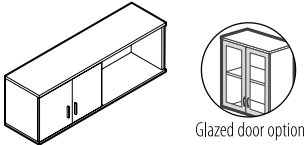

Overhead Storage w/2 Doors - LEFT 20/20.5"H*

Z72S200SL	16 x 72 x 20-20.5	125	132	18	\$1204	\$1300	\$500	N/A
Z66S200SL	16 x 66 x 20-20.5	125	123	16.50	\$1138	\$1225	\$488	N/A
Z60S200SL	16 x 60 x 20-20.5	125	114	15	\$1052	\$1132	\$448	N/A
Z54S200SL	16 x 54 x 20-20.5	125	105	13.75	\$994	\$1070	\$436	N/A

2 doors on **left** cavity. Includes steel hanging rail for wall mount applications. Includes one fixed shelf. Doors lock.
NOTE: Care should be taken to mount the units. Units should be mounted to wall studs using correct fasteners. Failure to do so may result in collapse of the unit and subsequent personal injury. **Fastening hardware not included.** Mounting hardware used should be based on wall material. Consult an installation professional for proper wall mounting.

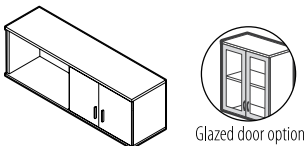

Overhead Storage w/2 Doors - RIGHT 20/20.5"H*

Z72S200SR	16 x 72 x 20-20.5	125	132	18	\$1204	\$1300	\$500	N/A
Z66S200SR	16 x 66 x 20-20.5	125	123	16.50	\$1138	\$1225	\$488	N/A
Z60S200SR	16 x 60 x 20-20.5	125	114	15	\$1052	\$1132	\$448	N/A
Z54S200SR	16 x 54 x 20-20.5	125	105	13.75	\$994	\$1070	\$436	N/A

2 doors on **right** cavity. Includes steel hanging rail for wall mount applications. Includes one fixed shelf. Doors lock.
NOTE: Care should be taken to mount the units. Units should be mounted to wall studs using correct fasteners. Failure to do so may result in collapse of the unit and subsequent personal injury. **Fastening hardware not included.** Mounting hardware used should be based on wall material. Consult an installation professional for proper wall mounting.

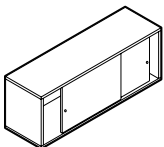

Overhead Storage, w/Glass Doors 20/20.5"H

Z72S200SD	16 x 72 x 20-20.5	100	145	18	\$3047	\$3143	N/A	N/A
Z66S200SD	16 x 66 x 20-20.5	100	135	16	\$2837	\$2924	N/A	N/A
Z60S200SD	16 x 60 x 20-20.5	100	125	15	\$2616	\$2696	N/A	N/A
Z54S200SD	16 x 54 x 20-20.5	100	115	13.75	\$2503	\$2579	N/A	N/A
Z48S200SD	16 x 48 x 20-20.5	100	104	12.50	\$2213	\$2289	N/A	N/A
Z42S200SD	16 x 42 x 20-20.5	100	93	10.50	\$1977	\$2050	N/A	N/A
Z36S200SD	16 x 36 x 20-20.5	100	83	9	\$1748	\$1813	N/A	N/A
Z30S200SD	16 x 30 x 20-20.5	100	75	7.60	\$1565	\$1618	N/A	N/A
Z24S200SD	16 x 24 x 20-20.5	100	63	6.40	\$1450	\$1500	N/A	N/A

Includes steel hanging rail for wall mount applications. Sliding glass doors do not lock. Shipped easy to assemble in 2 cartons. Glass doors shipped separately.
NOTE: Care should be taken to mount the units. Units should be mounted to wall studs using correct fasteners. Failure to do so may result in collapse of the unit and subsequent personal injury. **Fastening hardware not included.** Mounting hardware used should be based on wall material. Consult an installation professional for proper wall mounting.

CLOSED FRONT OVERHEAD STORAGE - 16" H

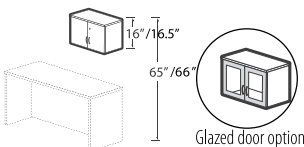

Closed Front Overhead Storage with Doors - 16"/16.5"H*

MODEL#	DIMENSIONS	FREIGHT CLASS	WT/LBS.	CUBIC FT.	1" TOP	1.5" TOP	GLAZE ADD	HP ADD
Z48S160S	15 x 48 x 16-16.5	92.5	98.63	9.25	\$752	\$817	\$704	N/A
Z42S160S	15 x 42 x 16-16.5	92.5	87.42	7.75	\$652	\$709	\$682	N/A
Z36S160S	15 x 36 x 16-16.5	92.5	77.22	6.75	\$595	\$646	\$615	N/A
Z30S160S	15 x 30 x 16-16.5	92.5	64.02	5.75	\$543	\$586	\$540	N/A

Standard with pre-mounted "J" bracket for wall mount applications. Doors lock.
NOTE: Care should be taken to mount the units. Units should be mounted to wall studs using correct fasteners. Failure to do so may result in collapse of the unit and subsequent personal injury. **Fastening hardware not included.** Mounting hardware used should be based on wall material. Consult an installation professional for proper wall mounting.

Required Specifications

Top finish
 Top/edge detail
 Base finish
 Lock finish*

Optional Specifications

Handles
 Glazed doors*
 Key #*

CLOSED FRONT OVERHEAD STORAGE - 16" H

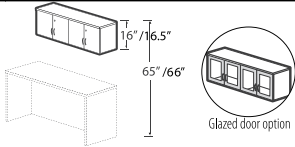

Closed Front Overhead Storage with Doors - 16"/16.5" High, 60" Wide

MODEL#	DIMENSIONS	FREIGHT CLASS	WT/LBS.	CUBIC FT.	1" TOP	1.5" TOP	GLAZE ADD	HP ADD
Z60S160S	15 x 60 x 16-16.5	92.5	118.03	11	\$988	\$1066	\$1073	N/A

Standard with pre-mounted "J" bracket for wall mount applications. Doors lock.

- **NOTE:** Care should be taken to mount the units. Units should be mounted to wall studs using correct fasteners. Failure to do so may result in collapse of the unit and subsequent personal injury. **Fastening hardware not included.** Mounting hardware used should be based on wall material. Consult an installation professional for proper wall mounting.

OVERHEAD STORAGE W/OPEN FRONTS - 33"

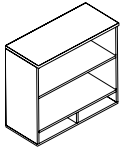

Open Front Overhead Storage w/Pigeon Hole - 32.5"/33"H

MODEL#	DIMENSIONS	FREIGHT CLASS	WT/LBS.	CUBIC FT.	1" TOP	1.5" TOP	GLAZE ADD	HP ADD
Z42S330PN	16 x 42 x 32.5-33	125	116	16.25	\$1034	\$1107	N/A	N/A
Z36S330PN	16 x 36 x 32.5-33	125	101	14	\$880	\$945	N/A	N/A
Z30S330PN	16 x 30 x 32.5-33	125	88	12	\$790	\$843	N/A	N/A
Z24S330PN	16 x 24 x 32.5-33	125	74	9.75	\$705	\$755	N/A	N/A

Includes steel hanging rail for wall mount applications. Includes one fixed shelf.

- **NOTE:** Care should be taken to mount the units. Units should be mounted to wall studs using correct fasteners. Failure to do so may result in collapse of the unit and subsequent personal injury. **Fastening hardware not included.** Mounting hardware used should be based on wall material. Consult an installation professional for proper wall mounting.

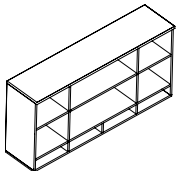

Open Front Overhead Storage w/Pigeon Hole - 32.5"/33"H

Z72S330N	16 x 72 x 32.5-33	125	194	26	\$1709	\$1796	N/A	N/A
Z66S330N	16 x 66 x 32.5-33	125	181	24	\$1605	\$1685	N/A	N/A
Z60S330N	16 x 60 x 32.5-33	125	169	22	\$1488	\$1564	N/A	N/A
Z54S330N	16 x 54 x 32.5-33	125	157	21	\$1395	\$1471	N/A	N/A

6 compartments. Includes steel hanging rail for wall mount applications. Includes one fixed shelf.

- **NOTE:** Care should be taken to mount the units. Units should be mounted to wall studs using correct fasteners. Failure to do so may result in collapse of the unit and subsequent personal injury. **Fastening hardware not included.** Mounting hardware used should be based on wall material. Consult an installation professional for proper wall mounting.

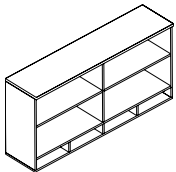

Open Front Overhead Storage w/Pigeon Hole - 32.5"/33"H

Z72S330SN	16 x 72 x 32.5-33	125	187	26	\$1610	\$1697	N/A	N/A
Z66S330SN	16 x 66 x 32.5-33	125	174	24	\$1528	\$1608	N/A	N/A
Z60S330SN	16 x 60 x 32.5-33	125	162	22	\$1427	\$1503	N/A	N/A
Z54S330SN	16 x 54 x 32.5-33	125	149	21	\$1334	\$1410	N/A	N/A

4 compartments. Includes steel hanging rail for wall mount applications. Includes one fixed shelf.

- **NOTE:** Care should be taken to mount the units. Units should be mounted to wall studs using correct fasteners. Failure to do so may result in collapse of the unit and subsequent personal injury. **Fastening hardware not included.** Mounting hardware used should be based on wall material. Consult an installation professional for proper wall mounting.

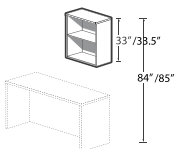

Open Front Overhead Storage 33"/33.5"H

Z42S330SN	16 x 42 x 32.5-33	125	108.98	16.25	\$714	\$784	N/A	N/A
Z36S330SN	16 x 36 x 32.5-33	125	96.70	14	\$648	\$710	N/A	N/A
Z30S330SN	16 x 30 x 32.5-33	125	84.42	11.75	\$580	\$619	N/A	N/A
Z24S330SN	16 x 24 x 32.5-33	125	67.20	9.75	\$535	\$578	N/A	N/A

Includes steel hanging rail for wall mount applications. Includes one fixed shelf.

- **NOTE:** Care should be taken to mount the units. Units should be mounted to wall studs using correct fasteners. Failure to do so may result in collapse of the unit and subsequent personal injury. **Fastening hardware not included.** Mounting hardware used should be based on wall material. Consult an installation professional for proper wall mounting.

Required Specifications

- Top finish
- Top/edge detail
- Base finish
- Lock finish*
- Handles

Optional Specifications

- Glazed doors
- Key #

OVERHEAD STORAGE W/OPEN FRONTS - 20"

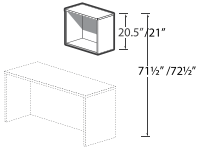

Open Front Overhead Storage
20"/20.5" High

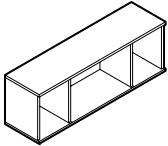

Open Front Overhead Storage
20/20.5"H

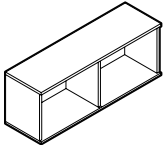

Open Front Overhead Storage
w/Center Divider - 20"/20.5"H

MODEL#	DIMENSIONS D x W x H	FREIGHT CLASS	WT/LBS.	CUBIC FT.	1" TOP	1.5" TOP	GLAZE ADD	HP ADD
Z42S200SN	16 x 42 x 20-20.5	125	77.98	10.50	\$499	\$569	N/A	N/A
Z36S200SN	16 x 36 x 20-20.5	125	69.70	9	\$452	\$514	N/A	N/A
Z30S200SN	16 x 30 x 20-20.5	100	60.42	7.50	\$406	\$445	N/A	N/A
Z24S200SN	16 x 24 x 20-20.5	125	48.13	6.25	\$367	\$410	N/A	N/A

Includes steel hanging rail for wall mount applications.

- **NOTE:** Care should be taken to mount the units. Units should be mounted to wall studs using correct fasteners. Failure to do so may result in collapse of the unit and subsequent personal injury. **Fastening hardware not included.** Mounting hardware used should be based on wall material. Consult an installation professional for proper wall mounting.

Z72S200N	16 x 72 x 20-20.5	125	122	18	\$1002	\$1098	N/A	N/A
Z66S200N	16 x 66 x 20-20.5	125	114	16.50	\$939	\$1026	N/A	N/A
Z60S200N	16 x 60 x 20-20.5	125	106	15	\$875	\$955	N/A	N/A
Z54S200N	16 x 54 x 20-20.5	125	99	13.75	\$817	\$893	N/A	N/A

4 compartments. Includes steel hanging rail for wall mount applications.

- **NOTE:** Care should be taken to mount the units. Units should be mounted to wall studs using correct fasteners. Failure to do so may result in collapse of the unit and subsequent personal injury. **Fastening hardware not included.** Mounting hardware used should be based on wall material. Consult an installation professional for proper wall mounting.

Z72S200SN	16 x 72 x 20-20.5	125	117	18	\$968	\$1064	N/A	N/A
Z66S200SN	16 x 66 x 20-20.5	125	109	16.50	\$903	\$990	N/A	N/A
Z60S200SN	16 x 60 x 20-20.5	125	101	15	\$838	\$918	N/A	N/A
Z54S200SN	16 x 54 x 20-20.5	125	94	13.75	\$780	\$856	N/A	N/A

Standard with pre-mounted "J" bracket for wall mount applications. Shipped RTA (ready to assemble).

- **NOTE:** Care should be taken to mount the units. Units should be mounted to wall studs using correct fasteners. Failure to do so may result in collapse of the unit and subsequent personal injury. **Fastening hardware not included.** Mounting hardware used should be based on wall material. Consult an installation professional for proper wall mounting.

OVERHEAD STORAGE W/OPEN FRONTS - 16" H

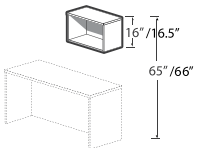

Open Front Overhead Storage
16"/16.5" H

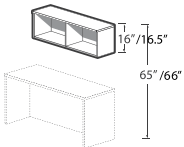

Open Front Overhead Storage
16"/16.5" High, 60" Wide

MODEL#	DIMENSIONS	FREIGHT CLASS	WT/LBS.	CUBIC FT.	1" TOP	1.5" TOP	GLAZE ADD	HP ADD
Z48S160SN	15 x 48 x 16-16.5	100	79.63	9.25	\$499	\$564	N/A	N/A
Z42S160SN	15 x 42 x 16-16.5	100	70.42	7.75	\$435	\$493	N/A	N/A
Z36S160SN	15 x 36 x 16-16.5	100	63.22	6.75	\$400	\$451	N/A	N/A
Z30S160SN	15 x 30 x 16-16.5	100	54.02	5.75	\$365	\$407	N/A	N/A

Standard with pre-mounted "J" bracket for wall mount applications. Shipped RTA (ready to assemble).

- **NOTE:** Care should be taken to mount the units. Units should be mounted to wall studs using correct fasteners. Failure to do so may result in collapse of the unit and subsequent personal injury. **Fastening hardware not included.** Mounting hardware used should be based on wall material. Consult an installation professional for proper wall mounting.

Z60S160SN	15 x 60 x 16-16.5	100	98.03	11	\$615	\$693	N/A	N/A
-----------	-------------------	-----	-------	----	-------	-------	-----	-----

Standard with pre-mounted "J" bracket for wall mount applications. Shipped RTA (ready to assemble).

- **NOTE:** Care should be taken to mount the units. Units should be mounted to wall studs using correct fasteners. Failure to do so may result in collapse of the unit and subsequent personal injury. **Fastening hardware not included.** Mounting hardware used should be based on wall material. Consult an installation professional for proper wall mounting.

Required Specifications

Top finish
Base finish
Top/Edge Detail

Accessories

Tackboard
Pigeon-Hole Storage

OPEN HUTCHES

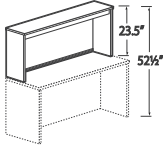

Open Hutch w/Closed Back - 23.5"H

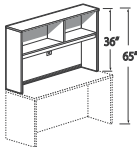

Open Hutch w/Closed Back - 36"H

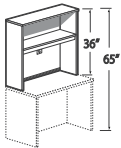

Open Hutch w/Closed Back - 36"H

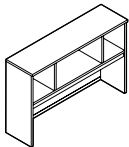

Open Hutch w/Closed Back - 36"H

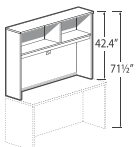

Open Hutch w/Closed Back - 42.4"H

MODEL#	DIMENSIONS D x W x H	FREIGHT CLASS	WT./LBS.	CUBIC FT.	1" TOP	1.5" TOP	GLAZE ADD	HP ADD
Z84S23HN	15 x 84 x 23-23.5	150	129	23	\$901	\$1009	N/A	N/A
Z72S23HN	15 x 72 x 23-23.5	150	114	19.75	\$790	\$895	N/A	N/A
Z71S23HN	15 x 71.7 x 23-23.5	150	113	19.75	\$790	\$884	N/A	N/A
Z66S23HN	15 x 66 x 23-23.5	150	106	18.25	\$726	\$810	N/A	N/A
Z60S23HN	15 x 60 x 23-23.5	125	99	16.50	\$641	\$720	N/A	N/A
Z48S23HN	15 x 48 x 23-23.5	125	84	13.50	\$555	\$620	N/A	N/A
Z42S23HN	15 x 42 x 23-23.5	125	76	11.75	\$516	\$573	N/A	N/A
Z36S23HN	15 x 36 x 23-23.5	125	68	10.25	\$476	\$528	N/A	N/A
Z30S23HN	15 x 30 x 23-23.5	125	61	8.50	\$441	\$491	N/A	N/A

Closed back features one grommet and flexible sweep for wire management. All hutches shipped pre-assembled.

- Clearance from worksurface to valance is 20.25".
- Woodgrain runs horizontal on both the upper and lower back panels.

Z84S36HN	15 x 84 x 35.5-36	125	206	33	\$1169	\$1277	N/A	N/A
Z72S36HN	15 x 72 x 35.5-36	125	181	28.25	\$1070	\$1164	N/A	N/A
Z71S36HN	15 x 71.7 x 35.5-36	125	173	28.25	\$1060	\$1156	N/A	N/A
Z66S36HN	15 x 66 x 35.5-36	125	161	26	\$1001	\$1088	N/A	N/A
Z60S36HN	15 x 60 x 35.5-36	125	150	23.75	\$938	\$1016	N/A	N/A
Z54S36HN	15 x 54 x 35.5-36	125	128	21	\$938	\$1016	N/A	N/A

One fixed shelf **and fixed shelf divider**. Closed back features one grommet and flexible sweep for wire management. All hutches shipped pre-assembled.

- Clearance from worksurface to valance is 17.75".
- Woodgrain runs horizontal on both the upper and lower back panels.

Z48S36HN	15 x 48 x 35.5-36	125	123	19	\$774	\$839	N/A	N/A
Z42S36HN	15 x 42 x 35.5-36	125	112	16.75	\$715	\$772	N/A	N/A
Z36S36HN	15 x 36 x 35.5-36	125	100	14.50	\$656	\$707	N/A	N/A
Z30S36HN	15 x 30 x 35.5-36	125	89	12.25	\$598	\$640	N/A	N/A

One fixed shelf. Closed back features one grommet and flexible sweep for wire management. All hutches shipped pre-assembled.

- Clearance from worksurface to valance is 17.75".
- Woodgrain runs horizontal on both the upper and lower back panels.

Z72S36OHN	15 x 72 x 35.5-36	150	162	27.75	\$1233	\$1332	N/A	N/A
Z66S36OHN	15 x 66 x 35.5-36	150	152	25.50	\$1170	\$1262	N/A	N/A
Z60S36OHN	15 x 60 x 35.5-36	125	142	23.25	\$1100	\$1182	N/A	N/A
Z54S36OHN	15 x 54 x 35.5-36	125	133	21	\$1030	\$1106	N/A	N/A

Four compartments. Closed back features one grommet and flexible sweep for wire management. All hutches shipped pre-assembled.

- Clearance from worksurface to valance is 17.75".
- Woodgrain runs horizontal on both the upper and lower back panels.

Z84S42HN	15 x 84 x 41.9-42.4	150	223	38.50	\$1246	\$1354	N/A	N/A
Z72S42HN	15 x 72 x 41.9-42.4	150	196	33	\$1153	\$1247	N/A	N/A
Z71S42HN	15 x 71.7 x 41.9-42.4	150	188	33	\$1147	\$1241	N/A	N/A
Z66S42HN	15 x 66 x 41.9-42.4	150	175	30.75	\$1079	\$1163	N/A	N/A
Z60S42HN	15 x 60 x 41.9-42.4	150	164	27.75	\$1010	\$1088	N/A	N/A
Z54S42HN	15 x 54 x 41.9-42.4	150	140	24.50	\$1010	\$1088	N/A	N/A

One fixed shelf **and fixed shelf divider**. Closed back features one grommet and flexible sweep for wire management. All hutches shipped pre-assembled.

- Clearance from worksurface to valance is 24.25".
- Woodgrain runs horizontal on both the upper and lower back panels.

Required Specifications

- Top finish
- Base finish
- Top/Edge Detail

Accessories

- Tackboard
- Pigeon-Hole Storage

OPEN HUTCHES

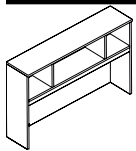

Open Hutch w/Closed Back - 42.4" H

MODEL#	DIMENSIONS D x W x H	FREIGHT CLASS	WT/LBS.	CUBIC FT.	1" TOP	1.5" TOP	GLAZE ADD	HP ADD
Z72S42OHN	15 x 72 x 41.9-42.4	150	177	32.50	\$1376	\$1466	N/A	N/A
Z66S42OHN	15 x 66 x 41.9-42.4	150	166	29.75	\$1262	\$1344	N/A	N/A
Z60S42OHN	15 x 60 x 41.9-42.4	150	155	27.25	\$1186	\$1262	N/A	N/A
Z54S42OHN	15 x 54 x 41.9-42.4	150	145	24.50	\$1112	\$1178	N/A	N/A

Four compartments. Closed back features one grommet and flexible sweep for wire management. All hutches shipped pre-assembled.

- Clearance from worksurface to valance is 24.25".
- Woodgrain runs horizontal on both the upper and lower back panels.

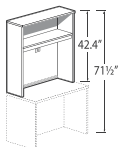

Open Hutch w/Closed Back - 42.4" H

Z48S42HN	15 x 48 x 41.9-42.4	125	134	22.25	\$838	\$903	N/A	N/A
Z42S42HN	15 x 42 x 41.9-42.4	125	123	19.50	\$774	\$832	N/A	N/A
Z36S42HN	15 x 36 x 41.9-42.4	125	110	17	\$709	\$760	N/A	N/A
Z30S42HN	15 x 30 x 41.9-42.4	125	105	14.25	\$642	\$685	N/A	N/A

One fixed shelf. Closed back features one grommet and flexible sweep for wire management. All hutches shipped pre-assembled.

- Clearance from worksurface to valance is 24.25".
- Woodgrain runs horizontal on both the upper and lower back panels.

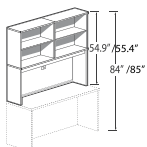

**Open Hutch w/Closed Back
54.9"/55.4" H**

Z84S55HN	15 x 84 x 54.4-54.9	150	306	62.37	\$2044	\$2155	N/A	N/A
Z72S55HN	15 x 72 x 54.4-54.9	150	272	53.65	\$1907	\$2005	N/A	N/A
Z71S55HN	15 x 71.7 x 54.4-54.9	150	271	53.65	\$1897	\$1996	N/A	N/A
Z66S55HN	15 x 66 x 54.4-54.9	150	254	49.40	\$1833	\$1930	N/A	N/A
Z60S55HN	15 x 60 x 54.4-54.9	150	238	45.15	\$1640	\$1721	N/A	N/A
Z54S55HN	15 x 54 x 54.4-54.9	100	190	19.75	\$2109	\$2190	N/A	N/A

One fixed shelf and one adjustable shelf (per compartment). Closed back features one grommet and flexible sweep for wire management. Top portion ships pre-assembled. Lower portion ships RTA.

- Clearance from worksurface to valance is 24.25".
- Woodgrain runs horizontal on both the upper and lower back panels.



**Open Hutch w/Closed Back
54.9"/55.4" H**

Z48S55HN	15 x 48 x 54.4-54.9	150	183	36	\$1235	\$1300	N/A	N/A
Z42S55HN	15 x 42 x 54.4-54.9	150	168	31.50	\$1141	\$1199	N/A	N/A
Z36S55HN	15 x 36 x 54.4-54.9	150	149	27.26	\$1040	\$1091	N/A	N/A
Z30S55HN	15 x 30 x 54.4-54.9	150	132	23	\$944	\$989	N/A	N/A

One fixed shelf and one adjustable shelf. Closed back features one grommet and flexible sweep for wire management. Shipped RTA (ready to assemble).

- Clearance from worksurface to valance is 24.25".
- Woodgrain runs horizontal on both the upper and lower back panels.

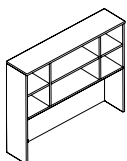

**Open Hutch w/Closed Back
54.9"/55.4" H**

Z72S55OHN	15 x 72 x 54.4-54.9	100	242	26	\$2028	\$2124	N/A	N/A
Z66S55OHN	15 x 66 x 54.4-54.9	100	228	24	\$1911	\$1998	N/A	N/A
Z60S55OHN	15 x 60 x 54.4-54.9	100	214	22	\$1799	\$1878	N/A	N/A
Z54S55OHN	15 x 54 x 54.4-54.9	92.5	199	19.76	\$1688	\$1761	N/A	N/A

Four compartments. Closed back features one grommet and flexible sweep for wire management. Top portion ships pre-assembled. Lower portion ships RTA.

- Clearance from worksurface to valance is 24.25".
- Woodgrain runs horizontal on both the upper and lower back panels.

Required Specifications

Top finish
Base finish
Top/Edge Detail

Accessories

Tackboard
Pigeon-Hole Storage

CLOSED HUTCHES

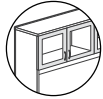
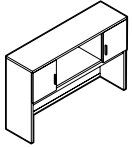

Glazed door option

Hutch w/2 Outer Doors - 36"H*

MODEL#	DIMENSIONS D x W x H	FREIGHT CLASS	WT/LBS.	CUBIC FT.	1" TOP	1.5" TOP	GLAZE ADD	HP ADD
Z72S36HOH	15 x 72 x 35.5-36	125	172	27.75	\$1445	\$1544	\$436	N/A
Z66S36HOH	15 x 66 x 35.5-36	125	161	25.50	\$1381	\$1473	\$424	N/A
Z60S36HOH	15 x 60 x 35.5-36	125	151	23.25	\$1293	\$1377	\$391	N/A
Z54S36HOH	15 x 54 x 35.5-36	125	140	21	\$1222	\$1298	\$379	N/A

4 compartments. **Doors on outer compartments only.** Closed back features one grommet and flexible sweep for wire management. Doors lock. All hutches shipped pre-assembled.

- Clearance from worksurface to valance is 17.75".
- Woodgrain runs horizontal on both the upper and lower back panels.

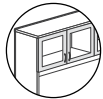
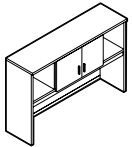

Glazed door option

Hutch w/2 Inner Doors - 36"H*

Z72S36OHO	15 x 72 x 35.5-36	125	173	27.75	\$1443	\$1547	\$440	N/A
Z66S36OHO	15 x 66 x 35.5-36	125	162	25.50	\$1383	\$1475	\$429	N/A
Z60S36OHO	15 x 60 x 35.5-36	125	151	23.25	\$1311	\$1393	\$413	N/A
Z54S36OHO	15 x 54 x 35.5-36	125	141	21	\$1225	\$1301	\$384	N/A

4 compartments. **Doors on inner compartments only.** Closed back features one grommet and flexible sweep for wire management. Doors lock. All hutches shipped pre-assembled.

- Clearance from worksurface to valance is 17.75".
- Woodgrain runs horizontal on both the upper and lower back panels.

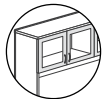
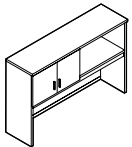

Glazed door option

Hutch w/2 Doors - LEFT, 36"H*

Z72S36HSL	15 x 72 x 35.5-36	125	169	27.75	\$1415	\$1513	\$435	N/A
Z66S36HSL	15 x 66 x 35.5-36	125	157	25.50	\$1348	\$1440	\$420	N/A
Z60S36HSL	15 x 60 x 35.5-36	125	146	23.25	\$1262	\$1346	\$392	N/A
Z54S36HSL	15 x 54 x 35.5-36	125	135	21	\$1190	\$1267	\$380	N/A

4 compartments. Doors on **left** side, open storage on **right**. Closed back features one grommet and flexible sweep for wire management. Doors lock. All hutches shipped pre-assembled.

- Clearance from worksurface to valance is 17.75".
- Woodgrain runs horizontal on both the upper and lower back panels.

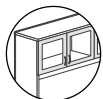
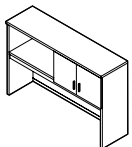

Glazed door option

Hutch w/2 Doors - RIGHT, 36"H*

Z72S36HSR	15 x 72 x 35.5-36	125	169	27.75	\$1415	\$1513	\$435	N/A
Z66S36HSR	15 x 66 x 35.5-36	125	157	25.50	\$1348	\$1440	\$420	N/A
Z60S36HSR	15 x 60 x 35.5-36	125	146	23.25	\$1262	\$1346	\$392	N/A
Z54S36HSR	15 x 54 x 35.5-36	125	135	21	\$1190	\$1267	\$380	N/A

4 compartments. Doors on **right** side, open storage on **left**. Closed back features one grommet and flexible sweep for wire management. Doors lock. All hutches shipped pre-assembled.

- Clearance from worksurface to valance is 17.75".
- Woodgrain runs horizontal on both the upper and lower back panels.

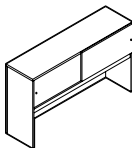

Hutch w/Sliding Glass Doors - 36"H

Z72S36HSD	15 x 72 x 35.5-36	125	178	27.75	\$3085	\$3184	N/A	N/A
Z66S36HSD	15 x 66 x 35.5-36	125	166	25.50	\$2879	\$2971	N/A	N/A
Z60S36HSD	15 x 60 x 35.5-36	125	154	23.25	\$2673	\$2757	N/A	N/A
Z54S36HSD	15 x 54 x 35.5-36	125	143	21	\$2471	\$2555	N/A	N/A

Sliding glass doors do not lock. Closed back features one grommet and flexible sweep for wire management. Shipped easy to assemble in 2 cartons. Glass doors shipped separately.

- Clearance from worksurface to valance is 17.75".
- Woodgrain runs horizontal on both the upper and lower back panels.

Required Specifications

Top finish
Base finish
Top/Edge Detail
Handles - Doors

Optional Specifications

Glazing - Doors*

Accessories

Tackboard
Pigeon-Hole Storage

CLOSED HUTCHES

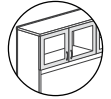
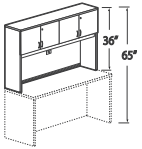

Glazed door option

Closed Hutch with Doors - 36" H

MODEL#	DIMENSIONS D x W x H	FREIGHT CLASS	WT/LBS.	CUBIC FT.	1" TOP	1.5" TOP	GLAZE ADD	HP ADD
Z84S36H	15 x 84 x 35.5-36	125	231	33	\$1602	\$1711	\$1283	N/A
Z72S36H	15 x 72 x 35.5-36	125	201	28.25	\$1492	\$1588	\$1172	N/A
Z71S36H	15 x 71.7 x 35.5-36	125	193	28.25	\$1479	\$1575	\$1170	N/A
Z66S36H	15 x 66 x 35.5-36	125	179	26	\$1406	\$1493	\$1115	N/A
Z60S36H	15 x 60 x 35.5-36	125	167	23.75	\$1311	\$1389	\$1048	N/A

One fixed shelf **and fixed shelf divider**. Closed back features one grommet and flexible sweep for wire management. Doors lock. All hutches shipped pre-assembled.

- Clearance from worksurface to valance is 17.75".
- Woodgrain runs horizontal on both the upper and lower back panels.

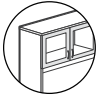
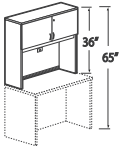

Glazed door option

Closed Hutch with Doors - 36" H

Z48S36H	15 x 48 x 35.5-36	125	136	19	\$1027	\$1092	\$665	N/A
Z42S36H	15 x 42 x 35.5-36	125	124	16.75	\$932	\$990	\$644	N/A
Z36S36H	15 x 36 x 35.5-36	125	110	14.50	\$854	\$905	\$589	N/A
Z30S36H	15 x 30 x 35.5-36	100	98	12.25	\$777	\$820	\$527	N/A

One fixed shelf. Closed back features one grommet and flexible sweep for wire management. Doors lock. All hutches shipped pre-assembled.

- Clearance from worksurface to valance is 17.75".
- Woodgrain runs horizontal on both the upper and lower back panels.

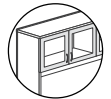
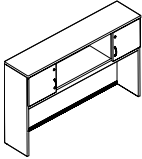

Glazed door option

Hutch w/2 Outer Doors - 42.4" H*

Z72S42HOH	15 x 72 x 41.9-42.4	150	187	32.50	\$1590	\$1680	\$436	N/A
Z66S42HOH	15 x 66 x 41.9-42.4	150	176	29.75	\$1472	\$1554	\$424	N/A
Z60S42HOH	15 x 60 x 41.9-42.4	125	164	27.25	\$1382	\$1458	\$391	N/A
Z54S42HOH	15 x 54 x 41.9-42.4	125	153	24.50	\$1305	\$1372	\$379	N/A

4 compartments. **Doors on outer compartments only**. Closed back features one grommet and flexible sweep for wire management. Doors lock. All hutches shipped pre-assembled.

- Clearance from worksurface to valance is 24.25".
- Woodgrain runs horizontal on both the upper and lower back panels.

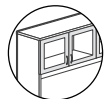
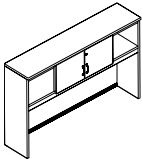

Glazed door option

Hutch w/2 Inner Doors - 42.4" H*

Z72S42HO	15 x 72 x 41.9-42.4	150	188	32.50	\$1593	\$1683	\$440	N/A
Z66S42HO	15 x 66 x 41.9-42.4	150	176	29.75	\$1474	\$1556	\$429	N/A
Z60S42HO	15 x 60 x 41.9-42.4	125	165	27.25	\$1398	\$1473	\$413	N/A
Z54S42HO	15 x 54 x 41.9-42.4	125	153	24.50	\$1309	\$1376	\$384	N/A

4 compartments. **Doors on inner compartments only**. Closed back features one grommet and flexible sweep for wire management. Doors lock. All hutches shipped pre-assembled.

- Clearance from worksurface to valance is 24.25".
- Woodgrain runs horizontal on both the upper and lower back panels.

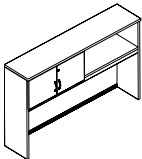

Glazed door option

Hutch w/2 Doors - LEFT, 42.4" H*

Z72S42HSL	15 x 72 x 41.9-42.4	150	184	32.50	\$1558	\$1648	\$435	N/A
Z66S42HSL	15 x 66 x 41.9-42.4	150	171	29.75	\$1438	\$1522	\$420	N/A
Z60S42HSL	15 x 60 x 41.9-42.4	150	159	27.25	\$1349	\$1424	\$392	N/A
Z54S42HSL	15 x 54 x 41.9-42.4	125	148	24.50	\$1271	\$1338	\$380	N/A

4 compartments. Doors on **left** side, open storage on **right**. Closed back features one grommet and flexible sweep for wire management. Doors lock. All hutches shipped pre-assembled.

- Clearance from worksurface to valance is 24.25".
- Woodgrain runs horizontal on both the upper and lower back panels.

Required Specifications

Top finish
Base finish
Top/Edge Detail
Handles - Doors

Optional Specifications

Glazing - Doors*

Accessories

Tackboard
Pigeon-Hole Storage

CLOSED HUTCHES

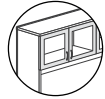
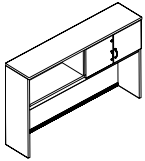

Glazed door option

Hutch w/2 Doors - RIGHT, 42.4" H*

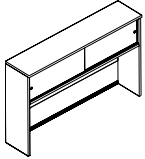

Hutch w/Sliding Glass Doors - 42.4" H

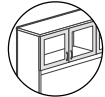
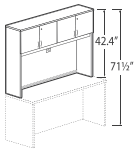

Glazed door option

Closed Hutch with Doors - 42.4" High

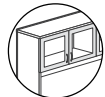
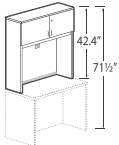

Glazed door option

Closed Hutch with Doors - 42.4" High

MODEL#	DIMENSIONS D x W x H	FREIGHT CLASS	WT/LBS.	CUBIC FT.	1" TOP	1.5" TOP	GLAZE ADD	HP ADD
Z72S42HSR	15 x 72 x 41.9-42.4	150	184	32.50	\$1558	\$1648	\$435	N/A
Z66S42HSR	15 x 66 x 41.9-42.4	150	171	29.75	\$1438	\$1522	\$420	N/A
Z60S42HSR	15 x 60 x 41.9-42.4	150	159	27.25	\$1349	\$1424	\$392	N/A
Z54S42HSR	15 x 54 x 41.9-42.4	125	148	24.50	\$1271	\$1338	\$380	N/A

4 compartments. Doors on **right** side, open storage on **left**. Closed back features one grommet and flexible sweep for wire management. Doors lock. All hutches shipped pre-assembled.

- Clearance from worksurface to valance is 24.25".
- Woodgrain runs horizontal on both the upper and lower back panels.

Z72S42HSD	15 x 72 x 41.9-42.4	150	193	32.50	\$3222	\$3312	N/A	N/A
Z66S42HSD	15 x 66 x 41.9-42.4	125	180	29.75	\$2970	\$3052	N/A	N/A
Z60S42HSD	15 x 60 x 41.9-42.4	125	168	27.25	\$2758	\$2834	N/A	N/A
Z54S42HSD	15 x 54 x 41.9-42.4	125	156	24.50	\$2554	\$2620	N/A	N/A

Sliding glass doors do not lock. Closed back features one grommet and flexible sweep for wire management. Shipped easy to assemble in 2 cartons. Glass doors shipped separately.

- Clearance from worksurface to valance is 24.25".
- Woodgrain runs horizontal on both the upper and lower back panels.

Z84S42H	15 x 84 x 41.9-42.4	125	247	38.50	\$1780	\$1889	\$1283	N/A
Z72S42H	15 x 72 x 41.9-42.4	125	217	33	\$1579	\$1673	\$1172	N/A
Z71S42H	15 x 71.7 x 41.9-42.4	125	207	33	\$1568	\$1662	\$1170	N/A
Z66S42H	15 x 66 x 41.9-42.4	125	194	30.75	\$1481	\$1568	\$1115	N/A
Z60S42H	15 x 60 x 41.9-42.4	125	180	27.75	\$1383	\$1461	\$1048	N/A

One fixed shelf **and fixed shelf divider**. Closed back features one grommet and flexible sweep for wire management. Doors lock. All hutches shipped pre-assembled.

- Clearance from worksurface to valance is 24.25".
- Woodgrain runs horizontal on both the upper and lower back panels.

Z48S42H	15 x 48 x 41.9-42.4	125	148	22.25	\$1092	\$1157	\$665	N/A
Z42S42H	15 x 42 x 41.9-42.4	125	134	19.50	\$989	\$1047	\$644	N/A
Z36S42H	15 x 36 x 41.9-42.4	125	120	17	\$905	\$957	\$589	N/A
Z30S42H	15 x 30 x 41.9-42.4	125	106	14.25	\$832	\$874	\$527	N/A

One fixed shelf. Closed back features one grommet and flexible sweep for wire management. Doors lock. All hutches shipped pre-assembled.

- Clearance from worksurface to valance is 24.25".
- Woodgrain runs horizontal on both the upper and lower back panels.

Required Specifications

Top finish
Base finish
Top/Edge Detail
Handles - Doors

Optional Specifications

Glazing - Doors*

Accessories

Tackboard
Pigeon-Hole Storage

CLOSED HUTCHES

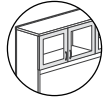
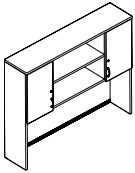

Glazed door option

Hutch w/2 Outer Doors - 55"H*

MODEL#	DIMENSIONS D x W x H	FREIGHT CLASS	WT./LBS.	CUBIC FT.	1" TOP	1.5" TOP	GLAZE ADD	HP ADD
Z72S55HOH	15 x 72 x 54.4-54.9	92.5	262	26	\$2316	\$2410	\$624	N/A
Z66S55HOH	15 x 66 x 54.4-54.9	92.5	246	24	\$2196	\$2283	\$612	N/A
Z60S55HOH	15 x 60 x 54.4-54.9	92.5	229	22	\$2052	\$2196	\$555	N/A
Z54S55HOH	15 x 54 x 54.4-54.9	92.5	213	19.76	\$1939	\$2073	\$544	N/A

4 compartments. **Doors on outer compartments only.** Closed back features one grommet and flexible sweep for wire management. Doors lock. Top portion ships pre-assembled. Lower portion ships RTA.

- Clearance from worksurface to valance is 24.25".
- Woodgrain runs horizontal on both the upper and lower back panels.

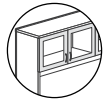
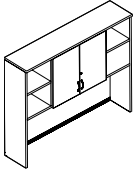

Glazed door option

Hutch w/2 Inner Doors - 55"H*

Z72S55OHO	15 x 72 x 54.4-54.9	92.5	263	26	\$2318	\$2414	\$626	N/A
Z66S55OHO	15 x 66 x 54.4-54.9	92.5	247	24	\$2199	\$2286	\$615	N/A
Z60S55OHO	15 x 60 x 54.4-54.9	92.5	230	22	\$2084	\$2163	\$558	N/A
Z54S55OHO	15 x 54 x 54.4-54.9	92.5	214	19.76	\$1941	\$2014	\$546	N/A

4 compartments. **Doors on inner compartments only.** Closed back features one grommet and flexible sweep for wire management. Doors lock. Top portion ships pre-assembled. Lower portion ships RTA.

- Clearance from worksurface to valance is 24.25".
- Woodgrain runs horizontal on both the upper and lower back panels.

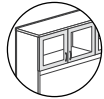
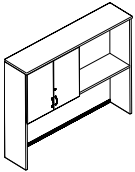

Glazed door option

Hutch w/2 Doors - LEFT, 55"H*

Z72S55HSL	15 x 72 x 54.4-54.9	100	258	26	\$2237	\$2333	\$602	N/A
Z66S55HSL	15 x 66 x 54.4-54.9	100	237	24	\$2136	\$2223	\$591	N/A
Z60S55HSL	15 x 60 x 54.4-54.9	92.5	221	22	\$1982	\$2062	\$555	N/A
Z54S55HSL	15 x 54 x 54.4-54.9	92.5	204	19.76	\$1880	\$1954	\$544	N/A

4 compartments. Doors on **left** side, open storage on **right**. Closed back features one grommet and flexible sweep for wire management. Doors lock. Top portion ships pre-assembled. Lower portion ships RTA.

- Clearance from worksurface to valance is 24.25".
- Woodgrain runs horizontal on both the upper and lower back panels.

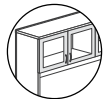
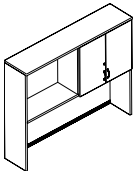

Glazed door option

Hutch w/2 Doors - RIGHT, 55"H*

Z72S55HSR	15 x 72 x 54.4-54.9	100	258	26	\$2237	\$2333	\$602	N/A
Z66S55HSR	15 x 66 x 54.4-54.9	100	237	24	\$2136	\$2223	\$591	N/A
Z60S55HSR	15 x 60 x 54.4-54.9	92.5	221	22	\$1982	\$2062	\$555	N/A
Z54S55HSR	15 x 54 x 54.4-54.9	92.5	204	19.76	\$1880	\$1954	\$544	N/A

4 compartments. Doors on **right** side, open storage on **left**. Closed back features one grommet and flexible sweep for wire management. Doors lock. Top portion ships pre-assembled. Lower portion ships RTA.

- Clearance from worksurface to valance is 24.25".
- Woodgrain runs horizontal on both the upper and lower back panels.

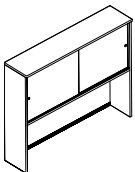

Hutch w/Sliding Glass Doors - 55"H

Z72S55HSD	15 x 72 x 54.4-54.9	92.5	271	26	\$4378	\$4472	N/A	N/A
Z66S55HSD	15 x 66 x 54.4-54.9	92.5	253	24	\$4093	\$4179	N/A	N/A
Z60S55HSD	15 x 60 x 54.4-54.9	92.5	235	22	\$3788	\$3867	N/A	N/A
Z54S55HSD	15 x 54 x 54.4-54.9	92.5	217	19.75	\$3508	\$3581	N/A	N/A

Sliding glass doors do not lock. Closed back features one grommet and flexible sweep for wire management. Shipped easy to assemble in 3 cartons. Glass doors shipped separately.

- Clearance from worksurface to valance is 24.25".
- Woodgrain runs horizontal on both the upper and lower back panels.

Required Specifications

Top finish
Top/edge detail
Base finish
Lock finish

Optional Specifications

HP laminate Handles
Key # Modesty finish glazed
Modesty Type
Grommet position or power block cut-out

Accessories

Power block
Keyboard
Pencil drawer

CLOSED HUTCHES

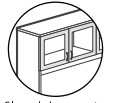
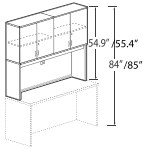

Glazed door option

Closed Hutch w/Doors - 55\"/>

MODEL#	DIMENSIONS D x W x H	FREIGHT CLASS	WT/LBS.	CUBIC FT.	1\"/>			
Z84S55H	15 x 84 x 54.4-54.9	150	349	62.37	\$2700	\$2811	\$1864	N/A
Z72S55H	15 x 72 x 54.4-54.9	150	308	53.65	\$2433	\$2543	\$1685	N/A
Z71S55H	15 x 71.7 x 54.4-54.9	150	307	53.65	\$2425	\$2524	\$1665	N/A
Z66S55H	15 x 66 x 54.4-54.9	150	287	49.40	\$2294	\$2392	\$1586	N/A
Z60S55H	15 x 60 x 54.4-54.9	150	269	45.15	\$2109	\$2190	\$1475	N/A

One fixed shelf and one adjustable shelf (per compartment). Closed back features one grommet and flexible sweep for wire management. Doors lock. Shipped RTA (ready to assemble).

- Clearance from worksurface to valance is 24.25\"/>

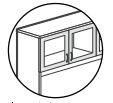
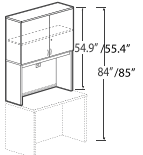

Glazed door option

Closed Hutch w/Doors - 55\"/>

Z48S55H	15 x 48 x 54.4-54.9	150	207	36	\$1569	\$1621	\$1029	N/A
Z42S55H	15 x 42 x 54.4-54.9	150	188	31.50	\$1430	\$1488	\$933	N/A
Z36S55H	15 x 36 x 54.4-54.9	125	167	27.26	\$1303	\$1354	\$844	N/A
Z30S55H	15 x 30 x 54.4-54.9	125	148	23	\$1178	\$1220	\$739	N/A

One fixed shelf and one adjustable shelf. Closed back features one grommet and flexible sweep for wire management. Doors lock. Shipped RTA (ready to assemble).

- Clearance from worksurface to valance is 24.25\"/>

PIGEON-HOLE STORAGE

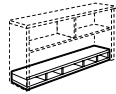
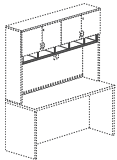

Horizontal Pigeon-Hole Storage

MODEL#	DIMENSIONS	FREIGHT CLASS	WT/LBS.	CUBIC FT.	1\"/>			
ZHS84	12 x 82 x 5.66	70	49	3	\$777	N/A	N/A	N/A
ZHS72	12 x 70 x 5.66	70	49	3	\$700	N/A	N/A	N/A
ZHS71	12 x 69.6 x 5.66	70	49	3	\$700	N/A	N/A	N/A
ZHS66	12 x 63.9 x 5.66	70	46	2.80	\$662	N/A	N/A	N/A
ZHS60	12 x 58 x 5.66	70	42	2.50	\$632	N/A	N/A	N/A
ZHS48	12 x 45.9 x 5.66	70	33	2	\$473	N/A	N/A	N/A
ZHS42	12 x 40 x 5.66	85	29	2	\$443	N/A	N/A	N/A
ZHS36	12 x 33.9 x 5.66	85	26	2	\$416	N/A	N/A	N/A

For additional storage. Can be **top** or **bottom** mounted. For use inside hutch. Shipped RTA (ready to assemble).

- *Cannot be used on overstorage units.*
- Available in all standard laminate finishes (see page 112).

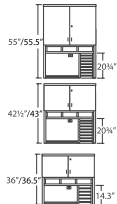
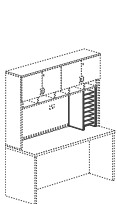

Vertical Pigeon-Hole Storage

ZVS21	11.8 x 13.42 x 20.75	70	30	1.80	\$349	N/A	N/A	N/A
ZVS14	11.8 x 13.42 x 14.3	85	24	1.80	\$284	N/A	N/A	N/A

For use in conjunction with the horizontal pigeon-hole storage. Can be used **under** or **over** horizontal unit. Not freestanding. Shipped RTA (ready to assemble).

- Vertical pigeon-hole shell - available in all standard laminate finishes (see page 112).
- Collator shelves - available in Black (**K**) or Brushed Cobalt (**T**) finish. Please specify. *Use Brushed Cobalt to match Silver finish handles.*
- When used together with tackboard and hutch, reduce tackboard width by 12.5\"/>

Required Specifications

Top finish
Top/edge detail
Base finish
Lock finish

Optional Specifications

HP laminate Handles
Key # Modesty finish glazed
Modesty Type
Grommet position or power block cut-out

Accessories

Power block
Keyboard
Pencil drawer

PIGEON-HOLE STORAGE

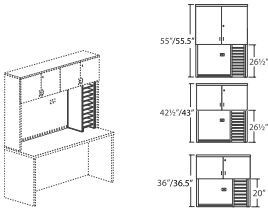

Vertical Pigeon-Hole Storage

MODEL#	DIMENSIONS	FREIGHT CLASS	WT./LBS.	CUBIC FT.	1" TOP	1.5" TOP	GLAZE ADD	HP ADD
D x W x H								
ZVS26	11.8 x 13.42 x 25.4-25.9	70	36	1.80	\$418	N/A	N/A	N/A
ZVS20	11.8 x 13.42 x 19-19.5	70	29	1.80	\$335	N/A	N/A	N/A

- Used alone with a hutch. **Not freestanding.** Shipped easy to assemble in 1 carton.
- Vertical pigeon-hole shell - available in all standard laminate finishes (see page 112).
 - Collator shelves - available in Black (K) or Brushed Cobalt (T) finish. Please specify.
Use Brushed Cobalt to match Silver finish handles.
 - When used together with tackboard and hutch, reduce tackboard width by 12.5"
 - Removal of valance required.

TRANSITIONAL PIGEON-HOLE STORAGE

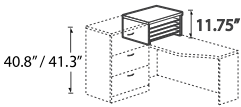

Transitional Pigeon-Hole Storage
11.75" H

MODEL#	DIMENSIONS	FREIGHT CLASS	WT./LBS.	CUBIC FT.	1" TOP	1.5" TOP	GLAZE ADD	HP ADD
Z24L12PH	24 x 24 x 11.25-11.75	65	63	2.70	\$691	\$761	N/A	N/A
Z20L12PH	24 x 20 x 11.25-11.75	70	56	2.70	\$610	\$671	N/A	N/A
Z16L12PH	24 x 16 x 11.25-11.75	65	46	1.60	\$558	\$610	N/A	N/A
Z24M12PH	20 x 24 x 11.25-11.75	70	55	2.70	\$610	\$671	N/A	N/A
Z20M12PH	20 x 20 x 11.25-11.75	70	48	2.70	\$541	\$591	N/A	N/A
Z16M12PH	20 x 16 x 11.25-11.75	65	40	1.60	\$490	\$532	N/A	N/A
Z24S12PH	16 x 24 x 11.25-11.75	65	43	1.60	\$562	\$613	N/A	N/A
Z20S12PH	16 x 20 x 11.25-11.75	65	38	1.60	\$493	\$534	N/A	N/A
Z16S12PH	16 x 16 x 11.25-11.75	70	33	1.60	\$462	\$497	N/A	N/A

- Designed to fit on top of returns and transition worksurface to match 40.8"/41.3" high storage modules. Pigeon-hole shell and four collator shelves. Shipped RTA (ready to assemble).
- Pigeon-Hole Shell - Available in all standard laminate finishes (page 112).
 - Collator Shelves - Available in Black (K) or Brushed Cobalt (T) finish. Please Specify.
Use Brushed Cobalt to match silver finish handles.

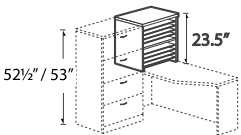

Transitional Pigeon-Hole Storage
23.5" H

Z24L23PH	24 x 24 x 23-23.5	60	101	2.70	\$1244	\$1314	N/A	N/A
Z20L23PH	24 x 20 x 23-23.5	60	88	2.70	\$1088	\$1146	N/A	N/A
Z16L23PH	24 x 16 x 23-23.5	65	76	2.70	\$1021	\$1073	N/A	N/A
Z24M23PH	20 x 24 x 23-23.5	60	87	2.70	\$1091	\$1149	N/A	N/A
Z20M23PH	20 x 20 x 23-23.5	65	76	2.70	\$954	\$1004	N/A	N/A
Z16M23PH	20 x 16 x 23-23.5	60	64	1.60	\$877	\$919	N/A	N/A
Z24S23PH	16 x 24 x 23-23.5	65	74	2.70	\$1032	\$1083	N/A	N/A
Z20S23PH	16 x 20 x 23-23.5	65	65	2.70	\$901	\$943	N/A	N/A
Z16S23PH	16 x 16 x 23-23.5	60	54	1.60	\$824	\$862	N/A	N/A

- Designed to fit on top of returns and transition worksurface to match 52.5"/53" high storage modules. Pigeon-hole shell and eight collator shelves. Shipped RTA (ready to assemble).
- Pigeon-Hole Shell - Available in all standard laminate finishes (page 112).
 - Collator Shelves - Available in Black (K) or Brushed Cobalt (T) finish. Please Specify.
Use Brushed Cobalt to match silver finish handles.

Required Specifications

Finishes
Top/Edge Detail (Hutches)
Handles (Doors)

Optional Specifications

Glazing - Doors

Accessories

Tackboard (Hutches)
Pigeon-Hole Storage (Hutches)

FLOATING SHELVES

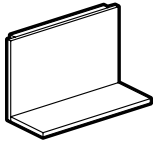

Floating Shelf - 20" H

MODEL#	DIMENSIONS	FREIGHT CLASS	WT/LBS.	CUBIC FT.	1" TOP	1.5" TOP	GLAZE ADD	HP ADD	
D x W x H									
ZFS4220	14.25 x 42 x 20	70	55	2.75	\$564	\$599	N/A	N/A	
ZFS3620	14.25 x 36 x 20	70	47	2.40	\$507	\$538	N/A	N/A	
ZFS3020	14.25 x 30 x 20	70	39	2	\$431	\$458	N/A	N/A	
ZFS2420	14.25 x 24 x 20	70	33	1.90	\$380	\$407	N/A	N/A	

To match 71.9/72.4"H units. Standard with pre-mounted "J" bracket for wall mount applications. End cap required at the end of a run of floating shelves. End cap sold separately, see page 246.

• **NOTE:** Care should be taken to mount the units. Units should be mounted to wall studs using correct fasteners. Failure to do so may result in collapse of the unit and subsequent personal injury. **Fastening hardware not included.** Mounting hardware used should be based on wall material. Consult an installation professional for proper wall mounting.

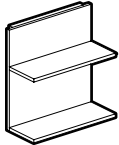

Double Floating Shelf - 32.5" H

ZF2S4232	14.25 x 42 x 32.5	65	85	3.30	\$805	\$840	N/A	N/A
ZF2S3632	14.25 x 36 x 32.5	65	73	2.90	\$721	\$752	N/A	N/A
ZF2S3032	14.25 x 30 x 32.5	65	60	2.50	\$614	\$641	N/A	N/A
ZF2S2432	14.25 x 24 x 32.5	70	50	2.40	\$544	\$571	N/A	N/A

To match 84.4/84.9"H units. Standard with pre-mounted "J" bracket for wall mount applications. End cap required at the end of a run of floating shelves. End cap sold separately, see page 246.

• **NOTE:** Care should be taken to mount the units. Units should be mounted to wall studs using correct fasteners. Failure to do so may result in collapse of the unit and subsequent personal injury. **Fastening hardware not included.** Mounting hardware used should be based on wall material. Consult an installation professional for proper wall mounting.

WALLS W/OVERHEADS

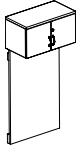

Wall w/Closed Storage - 66" H*

MODEL#	DIMENSIONS	FREIGHT CLASS	WT/LBS.	CUBIC FT.	1" TOP	1.5" TOP	GLAZE ADD	HP ADD
Z4266WS	16 x 42 x 65.5-66	85	122	8.26	\$1356	\$1414	\$476	N/A
Z3666WS	16 x 36 x 65.5-66	85	113	8.80	\$1141	\$1192	\$438	N/A
Z3066WS	16 x 30 x 65.5-66	85	97	7.50	\$1141	\$1174	\$392	N/A
Z2466WS	16 x 24 x 65.5-66	92.5	79	6.60	\$1007	\$1042	\$353	N/A

Standard with pre-mounted "J" bracket for wall mount applications. Doors lock. End cap required at the end of a run of wall units. End cap sold separately, see page 246.

• **NOTE:** Care should be taken to mount the units. Units should be mounted to wall studs using correct fasteners. Failure to do so may result in collapse of the unit and subsequent personal injury. **Mounting hardware not included.** Mounting hardware used should be based on wall material. Consult an installation professional for proper wall mounting.

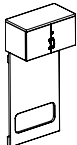

Wall w/Closed Storage - 66" H*

Z4266WSO	16 x 42 x 65.5-66	125	112	18.60	\$1446	\$1504	\$476	N/A
Z3666WSO	16 x 36 x 65.5-66	125	100	16.20	\$1315	\$1366	\$438	N/A
Z3066WSO	16 x 30 x 65.5-66	125	85	13.50	\$1147	\$1194	\$392	N/A
Z2466WSO	16 x 24 x 65.5-66	92.5	70	6.20	\$1017	\$1052	\$353	N/A

Standard with pre-mounted "J" bracket for wall mount applications. Doors lock. Large cutout provides direct access to wall for access to electrical. End cap required at the end of a run of wall units. End cap sold separately, see page 246.

• **NOTE:** Care should be taken to mount the units. Units should be mounted to wall studs using correct fasteners. Failure to do so may result in collapse of the unit and subsequent personal injury. **Mounting hardware not included.** Mounting hardware used should be based on wall material. Consult an installation professional for proper wall mounting.

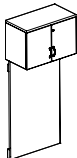

Wall w/Closed Storage - 72" H*

Z4272WS	16 x 42 x 71.9-72.4	85	134	10.20	\$1446	\$1519	\$546	N/A
Z3672WS	16 x 36 x 71.9-72.4	85	119	9.46	\$1393	\$1457	\$499	N/A
Z3072WS	16 x 30 x 71.9-72.4	85	102	8.10	\$1224	\$1277	\$447	N/A
Z2472WS	16 x 24 x 71.9-72.4	85	84	6.60	\$1073	\$1117	\$406	N/A

Standard with pre-mounted "J" bracket for wall mount applications. Doors lock. End cap required at the end of a run of wall units. End cap sold separately, see page 246.

• **NOTE:** Care should be taken to mount the units. Units should be mounted to wall studs using correct fasteners. Failure to do so may result in collapse of the unit and subsequent personal injury. **Mounting hardware not included.** Mounting hardware used should be based on wall material. Consult an installation professional for proper wall mounting.

Required Specifications

Top finish Base/door finish*
Wall finish
Top/Edge Detail
Handles*

Optional Specifications

Glazing - Doors*
Grommet position
Key #
End filler cap

WALLS W/OVERHEADS

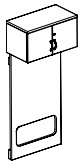

Wall w/Closed Storage - 72"H*

MODEL#	DIMENSIONS D x W x H	FREIGHT CLASS	WT/LBS.	CUBIC FT.	1" TOP	1.5" TOP	GLAZE ADD	HP ADD
Z4272WSO	16 x 42 x 71.9-72.4	85	120	9.30	\$1461	\$1534	\$546	N/A
Z3672WSO	16 x 36 x 71.9-72.4	85	105	8.66	\$1405	\$1469	\$499	N/A
Z3072WSO	16 x 30 x 71.9-72.4	85	91	7.50	\$1234	\$1308	\$447	N/A
Z2472WSO	16 x 24 x 71.9-72.4	92.5	74	6.20	\$1083	\$1127	\$406	N/A

Standard with pre-mounted "J" bracket for wall mount applications. Doors lock. Large cutout provides direct access to wall for access to electrical. End cap required at the end of a run of wall units. End cap sold separately, see page 246.

• **NOTE:** Care should be taken to mount the units. Units should be mounted to wall studs using correct fasteners. Failure to do so may result in collapse of the unit and subsequent personal injury. **Mounting hardware not included.** Mounting hardware used should be based on wall material. Consult an installation professional for proper wall mounting.

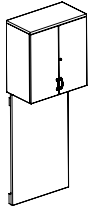

Wall w/Closed Storage - 84"H*

Z4284WS	16 x 42 x 84.4-84.9	85	134	10.20	\$1788	\$1861	\$758	N/A
Z3684WS	16 x 36 x 84.4-84.9	85	119	9.46	\$1699	\$1775	\$692	N/A
Z3084WS	16 x 30 x 84.4-84.9	85	102	8.10	\$1493	\$1546	\$614	N/A
Z2484WS	16 x 24 x 84.4-84.9	85	84	6.60	\$1315	\$1359	\$558	N/A

Standard with pre-mounted "J" bracket for wall mount applications. Doors lock. End cap required at the end of a run of wall units. End cap sold separately, see page 246.

• **NOTE:** Care should be taken to mount the units. Units should be mounted to wall studs using correct fasteners. Failure to do so may result in collapse of the unit and subsequent personal injury. **Mounting hardware not included.** Mounting hardware used should be based on wall material. Consult an installation professional for proper wall mounting.

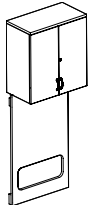

Wall w/Closed Storage - 84"H*

Z4284WSO	16 x 42 x 84.4-84.9	85	120	9.30	\$1801	\$1874	\$758	N/A
Z3684WSO	16 x 36 x 84.4-84.9	85	105	8.66	\$1711	\$1787	\$692	N/A
Z3084WSO	16 x 30 x 84.4-84.9	85	91	7.50	\$1504	\$1557	\$614	N/A
Z2484WSO	16 x 24 x 84.4-84.9	92.5	74	6.20	\$1324	\$1368	\$558	N/A

Standard with pre-mounted "J" bracket for wall mount applications. Doors lock. Large cutout provides direct access to wall for access to electrical. End cap required at the end of a run of wall units. End cap sold separately, see page 246.

• **NOTE:** Care should be taken to mount the units. Units should be mounted to wall studs using correct fasteners. Failure to do so may result in collapse of the unit and subsequent personal injury. **Mounting hardware not included.** Mounting hardware used should be based on wall material. Consult an installation professional for proper wall mounting.

WALLS W/FLOATING SHELVES

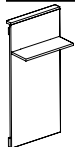

Wall w/Floating Shelf* - 66"H

MODEL#	DIMENSIONS	FREIGHT CLASS	WT/LBS.	CUBIC FT.	1" TOP	1.5" TOP	GLAZE ADD	HP ADD
ZF1S4266	14.25 x 42 x 65.5-66	70	117	7.50	\$1056	\$1091	N/A	N/A
ZF1S3666	14.25 x 36 x 65.5-66	70	103	6.60	\$920	\$951	N/A	N/A
ZF1S3066	14.25 x 30 x 65.5-66	70	86	5.70	\$793	\$824	N/A	N/A
ZF1S2466	14.25 x 24 x 65.5-66	85	69	4.70	\$680	\$706	N/A	N/A

Standard with pre-mounted "J" bracket for wall mount applications. End cap required at the end of a run of floating shelves. End cap sold separately, see page 246.

• **NOTE:** Care should be taken to mount the units. Units should be mounted to wall studs using correct fasteners. Failure to do so may result in collapse of the unit and subsequent personal injury. **Fastening hardware not included.** Mounting hardware used should be based on wall material. Consult an installation professional for proper wall mounting.

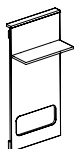

Wall w/Floating Shelf* - 66"H

ZF1S42660	14.25 x 42 x 65.5-66	85	110	7.50	\$1067	\$1102	N/A	N/A
ZF1S36660	14.25 x 36 x 65.5-66	85	97	6.60	\$930	\$961	N/A	N/A
ZF1S30660	14.25 x 30 x 65.5-66	85	81	5.70	\$800	\$831	N/A	N/A
ZF1S24660	14.25 x 24 x 65.5-66	85	66	4.70	\$685	\$711	N/A	N/A

Standard with pre-mounted "J" bracket for wall mount applications. Large cutout provides direct access to wall for access to electrical. End cap required at the end of a run of floating shelves. End cap sold separately, see page 246.

• **NOTE:** Care should be taken to mount the units. Units should be mounted to wall studs using correct fasteners. Failure to do so may result in collapse of the unit and subsequent personal injury. **Fastening hardware not included.** Mounting hardware used should be based on wall material. Consult an installation professional for proper wall mounting.

Required Specifications

Top finish Base/door finish*
Wall finish Handles*
Top/Edge Detail
Shelf finish

Optional Specifications

End filler cap
Grommet*

WALLS W/FLOATING SHELVES

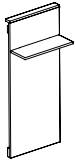

Wall w/Floating Shelf* - 72"H

MODEL#	DIMENSIONS D x W x H	FREIGHT CLASS	WT/LBS.	CUBIC FT.	1" TOP	1.5" TOP	GLAZE ADD	HP ADD
ZF1S4272	14.25 x 42 x 71.9-72.4	70	127	8	\$1112	\$1147	N/A	N/A
ZF1S3672	14.25 x 36 x 71.9-72.4	70	110	7.10	\$971	\$1002	N/A	N/A
ZF1S3072	14.25 x 30 x 71.9-72.4	70	92	6.10	\$857	\$888	N/A	N/A
ZF1S2472	14.25 x 24 x 71.9-72.4	85	74	5	\$726	\$752	N/A	N/A

Standard with pre-mounted "J" bracket for wall mount applications. End cap required at the end of a run of floating shelves. End cap sold separately, see page 246.

- **NOTE:** Care should be taken to mount the units. Units should be mounted to wall studs using correct fasteners. Failure to do so may result in collapse of the unit and subsequent personal injury. **Fastening hardware not included.** Mounting hardware used should be based on wall material. Consult an installation professional for proper wall mounting.

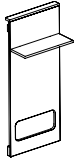

Wall w/Floating Shelf* - 72"H

ZF1S42720	14.25 x 42 x 71.9-72.4	70	120	8	\$1125	\$1160	N/A	N/A
ZF1S36720	14.25 x 36 x 71.9-72.4	85	104	7.10	\$982	\$1013	N/A	N/A
ZF1S30720	14.25 x 30 x 71.9-72.4	85	87	6.10	\$868	\$899	N/A	N/A
ZF1S24720	14.25 x 24 x 71.9-72.4	85	71	5	\$731	\$757	N/A	N/A

Standard with pre-mounted "J" bracket for wall mount applications. Large cutout provides direct access to wall for access to electrical. End cap required at the end of a run of floating shelves. End cap sold separately, see page 246.

- **NOTE:** Care should be taken to mount the units. Units should be mounted to wall studs using correct fasteners. Failure to do so may result in collapse of the unit and subsequent personal injury. **Fastening hardware not included.** Mounting hardware used should be based on wall material. Consult an installation professional for proper wall mounting.

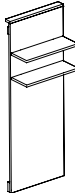

Wall w/Floating Shelves - 84"H

ZF2S4284	14.25 x 42 x 84.4-84.9	70	158	9.50	\$1306	\$1341	N/A	N/A
ZF2S3684	14.25 x 36 x 84.4-84.9	70	136	8.40	\$1125	\$1167	N/A	N/A
ZF2S3084	14.25 x 30 x 84.4-84.9	70	113	7.10	\$994	\$1020	N/A	N/A
ZF2S2484	14.25 x 24 x 84.4-84.9	85	91	6.25	\$862	\$888	N/A	N/A

Standard with pre-mounted "J" bracket for wall mount applications. End cap required at the end of a run of floating shelves. End cap sold separately, see page 246.

- **NOTE:** Care should be taken to mount the units. Units should be mounted to wall studs using correct fasteners. Failure to do so may result in collapse of the unit and subsequent personal injury. **Fastening hardware not included.** Mounting hardware used should be based on wall material. Consult an installation professional for proper wall mounting.

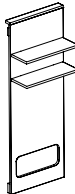

Wall w/Floating Shelves - 84"H

ZF2S42840	14.25 x 42 x 84.4-84.9	70	148	9.50	\$1317	\$1352	N/A	N/A
ZF2S36840	14.25 x 36 x 84.4-84.9	70	128	8.40	\$1140	\$1175	N/A	N/A
ZF2S30840	14.25 x 30 x 84.4-84.9	85	106	7.10	\$1079	\$1105	N/A	N/A
ZF2S24840	14.25 x 24 x 84.4-84.9	85	86	6.25	\$868	\$894	N/A	N/A

Standard with pre-mounted "J" bracket for wall mount applications. Large cutout provides direct access to wall for access to electrical. End cap required at the end of a run of floating shelves. End cap sold separately, see page 246.

- **NOTE:** Care should be taken to mount the units. Units should be mounted to wall studs using correct fasteners. Failure to do so may result in collapse of the unit and subsequent personal injury. **Fastening hardware not included.** Mounting hardware used should be based on wall material. Consult an installation professional for proper wall mounting.

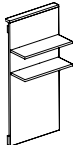

Wall w/Floating Shelves - 66"H

ZF2S4266	14.25 x 42 x 65.5-66	70	132	7.50	\$1089	\$1124	N/A	N/A
ZF2S3666	14.25 x 36 x 65.5-66	70	115	6.60	\$945	\$976	N/A	N/A
ZF2S3066	14.25 x 30 x 65.5-66	70	96	5.70	\$821	\$848	N/A	N/A
ZF2S2466	14.25 x 24 x 65.5-66	70	77	4.70	\$702	\$729	N/A	N/A

Standard with pre-mounted "J" bracket for wall mount applications. End cap required at the end of a run of floating shelves. End cap sold separately, see page 246.

- **NOTE:** Care should be taken to mount the units. Units should be mounted to wall studs using correct fasteners. Failure to do so may result in collapse of the unit and subsequent personal injury. **Fastening hardware not included.** Mounting hardware used should be based on wall material. Consult an installation professional for proper wall mounting.

Required Specifications

- Top finish
- Wall finish
- Top/Edge Detail
- Shelf finish

Optional Specifications

- End filler cap
- Grommet

WALLS W/FLOATING SHELVES

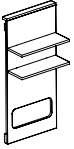

Wall w/Floating Shelves - 66"H

MODEL#	DIMENSIONS D x W x H	FREIGHT CLASS	WT/LBS.	CUBIC FT.	1" TOP	1.5" TOP	GLAZE ADD	HP ADD
ZF2S42660	14.25 x 42 x 65.5-66	70	125	7.50	\$1103	\$1138	N/A	N/A
ZF2S36660	14.25 x 36 x 65.5-66	70	109	6.60	\$956	\$987	N/A	N/A
ZF2S30660	14.25 x 30 x 65.5-66	70	91	5.70	\$832	\$859	N/A	N/A
ZF2S24660	14.25 x 24 x 65.5-66	70	74	4.70	\$709	\$736	N/A	N/A

Standard with pre-mounted "J" bracket for wall mount applications. Large cutout provides direct access to wall for access to electrical. End cap required at the end of a run of floating shelves. End cap sold separately, see page 246.

• **NOTE:** Care should be taken to mount the units. Units should be mounted to wall studs using correct fasteners. Failure to do so may result in collapse of the unit and subsequent personal injury. **Fastening hardware not included.** Mounting hardware used should be based on wall material. Consult an installation professional for proper wall mounting.

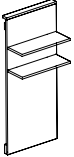

Wall w/Floating Shelves - 72"H

ZF2S4272	14.25 x 42 x 71.9-72.4	70	142	8	\$1147	\$1182	N/A	N/A
ZF2S3672	14.25 x 36 x 71.9-72.4	70	122	7.10	\$997	\$1028	N/A	N/A
ZF2S3072	14.25 x 30 x 71.9-72.4	70	102	6.10	\$883	\$910	N/A	N/A
ZF2S2472	14.25 x 24 x 71.9-72.4	70	82	5	\$747	\$774	N/A	N/A

Standard with pre-mounted "J" bracket for wall mount applications. End cap required at the end of a run of floating shelves. End cap sold separately, see page 246.

• **NOTE:** Care should be taken to mount the units. Units should be mounted to wall studs using correct fasteners. Failure to do so may result in collapse of the unit and subsequent personal injury. **Fastening hardware not included.** Mounting hardware used should be based on wall material. Consult an installation professional for proper wall mounting.

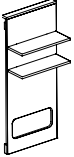

Wall w/Floating Shelves - 72"H

ZF2S42720	14.25 x 42 x 71.9-72.4	70	135	8	\$1160	\$1195	N/A	N/A
ZF2S36720	14.25 x 36 x 71.9-72.4	70	116	7.10	\$1010	\$1041	N/A	N/A
ZF2S30720	14.25 x 30 x 71.9-72.4	70	97	6.10	\$893	\$920	N/A	N/A
ZF2S24720	14.25 x 24 x 71.9-72.4	70	79	5	\$754	\$781	N/A	N/A

Standard with pre-mounted "J" bracket for wall mount applications. Large cutout provides direct access to wall for access to electrical. End cap required at the end of a run of floating shelves. End cap sold separately, see page 246.

• **NOTE:** Care should be taken to mount the units. Units should be mounted to wall studs using correct fasteners. Failure to do so may result in collapse of the unit and subsequent personal injury. **Fastening hardware not included.** Mounting hardware used should be based on wall material. Consult an installation professional for proper wall mounting.

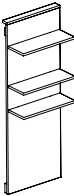

Wall w/Floating Shelves - 84"H

ZF3S4284	14.25 x 42 x 84.4-84.9	70	173	9.50	\$1339	\$1366	N/A	N/A
ZF3S3684	14.25 x 36 x 84.4-84.9	70	148	8.40	\$1160	\$1191	N/A	N/A
ZF3S3084	14.25 x 30 x 84.4-84.9	70	116	7.10	\$1020	\$1047	N/A	N/A
ZF3S2484	14.25 x 24 x 84.4-84.9	70	99	6.25	\$885	\$912	N/A	N/A

Standard with pre-mounted "J" bracket for wall mount applications. End cap required at the end of a run of floating shelves. End cap sold separately, see page 246.

• **NOTE:** Care should be taken to mount the units. Units should be mounted to wall studs using correct fasteners. Failure to do so may result in collapse of the unit and subsequent personal injury. **Fastening hardware not included.** Mounting hardware used should be based on wall material. Consult an installation professional for proper wall mounting.

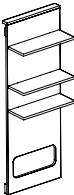

Wall w/Floating Shelves - 84"H

ZF3S42840	14.25 x 42 x 84.4-84.9	70	163	9.50	\$1353	\$1388	N/A	N/A
ZF3S36840	14.25 x 36 x 84.4-84.9	70	140	8.40	\$1173	\$1204	N/A	N/A
ZF3S30840	14.25 x 30 x 84.4-84.9	70	116	7.10	\$1107	\$1134	N/A	N/A
ZF3S24840	14.25 x 24 x 84.4-84.9	70	94	6.25	\$890	\$917	N/A	N/A

Standard with pre-mounted "J" bracket for wall mount applications. Large cutout provides direct access to wall for access to electrical. End cap required at the end of a run of floating shelves. End cap sold separately, see page 246.

• **NOTE:** Care should be taken to mount the units. Units should be mounted to wall studs using correct fasteners. Failure to do so may result in collapse of the unit and subsequent personal injury. **Fastening hardware not included.** Mounting hardware used should be based on wall material. Consult an installation professional for proper wall mounting.

Required Specifications

Top finish
Wall finish
Top/edge detail
Shelf finish

Optional Specifications

End filler cap
Grommet

WALL PANELS



Wall Panel - 66”H

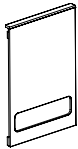

Wall Panel - 66”H



Wall Panel - 72”H



Wall Panel - 72”H



Wall Panel - 84”H

MODEL#	DIMENSIONS D x W x H	FREIGHT CLASS	WT/LBS.	CUBIC FT.	1” TOP	1.5” TOP	GLAZE ADD	HP ADD
ZWHP4266	3.5 x 42 x 65.5-66	85	99	7.50	\$936	\$971	N/A	N/A
ZWHP3666	3.5 x 36 x 65.5-66	85	90	6.60	\$744	\$775	N/A	N/A
ZWHP3066	3.5 x 30 x 65.5-66	85	75	5.70	\$645	\$672	N/A	N/A
ZWHP2466	3.5 x 24 x 65.5-66	85	61	4.70	\$552	\$579	N/A	N/A

Standard with pre-mounted “J” bracket for wall mount applications. End cap required at the end of a run of floating shelves. End cap sold separately, see page 246.

• **NOTE:** Care should be taken to mount the units. Units should be mounted to wall studs using correct fasteners. Failure to do so may result in collapse of the unit and subsequent personal injury. **Fastening hardware not included.** Mounting hardware used should be based on wall material. Consult an installation professional for proper wall mounting.

ZWHP42660	3.5 x 42 x 65.5-66	85	90	7.50	\$950	\$985	N/A	N/A
ZWHP36660	3.5 x 36 x 65.5-66	85	82	6.60	\$755	\$786	N/A	N/A
ZWHP30660	3.5 x 30 x 65.5-66	85	69	5.70	\$656	\$683	N/A	N/A
ZWHP24660	3.5 x 24 x 65.5-66	92.5	56	4.70	\$558	\$585	N/A	N/A

Standard with pre-mounted “J” bracket for wall mount applications. Large cutout provides direct access to wall for access to electrical. End cap required at the end of a run of floating shelves. End cap sold separately, see page 246.

• **NOTE:** Care should be taken to mount the units. Units should be mounted to wall studs using correct fasteners. Failure to do so may result in collapse of the unit and subsequent personal injury. **Fastening hardware not included.** Mounting hardware used should be based on wall material. Consult an installation professional for proper wall mounting.

ZWHP4272	3.5 x 42 x 71.9-72.4	85	113	8	\$914	\$949	N/A	N/A
ZWHP3672	3.5 x 36 x 71.9-72.4	85	97	7.10	\$797	\$828	N/A	N/A
ZWHP3072	3.5 x 30 x 71.9-72.4	85	81	6.10	\$708	\$735	N/A	N/A
ZWHP2472	3.5 x 24 x 71.9-72.4	85	67	5	\$597	\$624	N/A	N/A

Standard with pre-mounted “J” bracket for wall mount applications. End cap required at the end of a run of floating shelves. End cap sold separately, see page 246.

• **NOTE:** Care should be taken to mount the units. Units should be mounted to wall studs using correct fasteners. Failure to do so may result in collapse of the unit and subsequent personal injury. **Fastening hardware not included.** Mounting hardware used should be based on wall material. Consult an installation professional for proper wall mounting.

ZWHP42720	3.5 x 42 x 71.9-72.4	85	104	8	\$928	\$963	N/A	N/A
ZWHP36720	3.5 x 36 x 71.9-72.4	85	89	7.10	\$808	\$839	N/A	N/A
ZWHP30720	3.5 x 30 x 71.9-72.4	85	75	6.10	\$718	\$745	N/A	N/A
ZWHP24720	3.5 x 24 x 71.9-72.4	85	62	5	\$604	\$631	N/A	N/A

Standard with pre-mounted “J” bracket for wall mount applications. Large cutout provides direct access to wall for access to electrical. End cap required at the end of a run of floating shelves. End cap sold separately, see page 246.

• **NOTE:** Care should be taken to mount the units. Units should be mounted to wall studs using correct fasteners. Failure to do so may result in collapse of the unit and subsequent personal injury. **Fastening hardware not included.** Mounting hardware used should be based on wall material. Consult an installation professional for proper wall mounting.

ZWHP4284	3.5 x 42 x 84.4-84.9	85	128	9.50	\$975	\$1010	N/A	N/A
ZWHP3684	3.5 x 36 x 84.4-84.9	85	111	8.40	\$859	\$890	N/A	N/A
ZWHP3084	3.5 x 30 x 84.4-84.9	85	92	7.10	\$765	\$792	N/A	N/A
ZWHP2484	3.5 x 24 x 84.4-84.9	85	75	6.25	\$660	\$687	N/A	N/A

Standard with pre-mounted “J” bracket for wall mount applications. End cap required at the end of a run of floating shelves. End cap sold separately, see page 246.

• **NOTE:** Care should be taken to mount the units. Units should be mounted to wall studs using correct fasteners. Failure to do so may result in collapse of the unit and subsequent personal injury. **Fastening hardware not included.** Mounting hardware used should be based on wall material. Consult an installation professional for proper wall mounting.

Required Specifications

Top finish
Wall finish
Top/edge detail

Optional Specifications

End filler cap
Grommet

WALLS W/FLOATING SHELVES

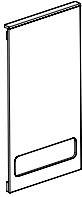

Wall Panel - 84"H

MODEL#	DIMENSIONS D x W x H	FREIGHT CLASS	WT/LBS.	CUBIC FT.	1" TOP	1.5" TOP	GLAZE ADD	HP ADD
ZWHP42840	3.5 x 42 x 84.4-84.9	85	119	9.50	\$988	\$1023	N/A	N/A
ZWHP36840	3.5 x 36 x 84.4-84.9	85	103	8.40	\$870	\$901	N/A	N/A
ZWHP30840	3.5 x 30 x 84.4-84.9	85	92	7.10	\$774	\$801	N/A	N/A
ZWHP24840	3.5 x 24 x 84.4-84.9	92.5	70	6.25	\$667	\$694	N/A	N/A

Standard with pre-mounted "J" bracket for wall mount applications. Large cutout provides direct access to wall for access to electrical. End cap required at the end of a run of floating shelves. End cap sold separately, see page 246.

• **NOTE:** Care should be taken to mount the units. Units should be mounted to wall studs using correct fasteners. Failure to do so may result in collapse of the unit and subsequent personal injury. **Fastening hardware not included.** Mounting hardware used should be based on wall material. Consult an installation professional for proper wall mounting.

END FILLER CAPS



End Cap

MODEL#	DIMENSIONS	FREIGHT CLASS	WT/LBS.	CUBIC FT.	1" TOP	1.5" TOP	GLAZE ADD	HP ADD
ZEFC19	.75 x 2.5 x 17	70	1.50	.25	\$155	N/A	N/A	N/A

For ZFSxxxx 20"H floating shelf.

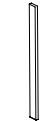

End Cap

ZEFC32	.75 x 2.5 x 30	300	2	2	\$253	N/A	N/A	N/A
--------	----------------	-----	---	---	--------------	-----	-----	-----

For ZF2Sxxxx 32.5"H floating shelf.



End Cap

ZEFC49	.75 x 2.5 x 47	250	3	1.20	\$332	N/A	N/A	N/A
--------	----------------	-----	---	------	--------------	-----	-----	-----

For Zxx66WS/Zxx66WSO 65.5/66"H walls with overhead.



End Cap

ZEFC52	.75 x 2.5 x 50	250	4	1.30	\$356	N/A	N/A	N/A
--------	----------------	-----	---	------	--------------	-----	-----	-----

For Zxx72WS/Zxx72WSO/Zxx84WS/Zxx84WSO 71.9/72.4"H or 84.4/84.9"H walls with overhead.



End Cap

ZEFC66	.75 x 2.5 x 64	300	4	4	\$435	N/A	N/A	N/A
--------	----------------	-----	---	---	--------------	-----	-----	-----

For ZF1Sxx66/ZF1Sxx66O/ZF2Sxx66/ZF2Sxx66O/ZWHPxx66/ZWHPxx66O 65.5/66"H wall panels, with or without shelves.

Required Specifications

- Top finish
- Wall finish
- Top/Edge Detail

Optional Specifications

- End filler cap
- Grommet

END FILLER CAPS

MODEL#	DIMENSIONS	FREIGHT CLASS	WT/LBS.	CUBIC FT.	1" TOP	1.5" TOP	GLAZE ADD	HP ADD
--------	------------	---------------	---------	-----------	--------	----------	-----------	--------

D x W x H

ZEFC72	.75 x 2.5 x 70.5	300	4	4	\$469	N/A	N/A	N/A
--------	------------------	-----	---	---	-------	-----	-----	-----



End Cap

For ZF1Sxx72/ZF1Sxx720/ZF2Sxx72/ZF2Sxx720/ZWHPxx72/ZWHPxx720 71.9/72.4"H wall panels, with or without shelves.

ZEFC84	.75 x 2.5 x 83	300	5	4.50	\$549	N/A	N/A	N/A
--------	----------------	-----	---	------	-------	-----	-----	-----



End Cap

For ZF1Sxx84/ZF1Sxx840/ZF2Sxx84/ZF2Sxx840/ZWHPxx84/ZWHPxx840 84.4/84.9"H wall panels, with or without shelves.

Required Specifications

Base finish

TACKBOARDS FOR HUTCHES - 23.5" / 24" HIGH **MODEL#** **DIMENSIONS** **FREIGHT CLASS** **WT/LBS.** **CUBIC FT.** **FABRIC GRADE** **LIST PRICE**

D x W x H

TACKBOARD Notes: Tackboards can be upholstered in all of the following fabrics:

Grade 1: Jenny, Quilt, Terrace, Urban, Waterfall

Grade 2: Imprint, Lola, Silhouette

Grade 3: Anchorage, Merge

TACKBOARDS FOR HUTCHES - 23.5" / 24" HIGH **MODEL#** **DIMENSIONS** **FREIGHT CLASS** **WT/LBS.** **CUBIC FT.** **FABRIC GRADE** **LIST PRICE**

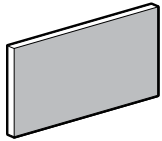

Tackboard

ZTB8217	.62 x 82 x 16.5-17	150	8.20	2	1	\$715
					2	\$859
					3	\$1027
					4	\$1229
					5	\$1412

For use on **Z84S23HN** hutch. Includes mounting screws.

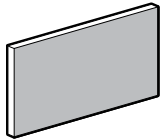

Tackboard

ZTB7017	.62 x 70 x 16.5-17	150	7	1.30	1	\$475
					2	\$573
					3	\$686
					4	\$816
					5	\$940

For use on **Z72S23HN** hutch. Includes mounting screws.

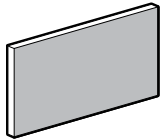

Tackboard

ZTB6917	.62 x 69 x 16.5-17	150	7	1.30	1	\$472
					2	\$568
					3	\$682
					4	\$811
					5	\$931

For use on **Z71S23HN** hutch. Includes mounting screws.

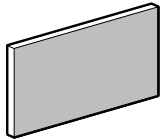

Tackboard

ZTB6417	.62 x 64 x 16.5-17	150	6.40	1.30	1	\$468
					2	\$563
					3	\$670
					4	\$799
					5	\$919

For use on **Z66S23HN** hutch. Includes mounting screws.

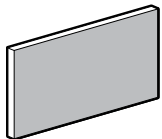

Tackboard

ZTB5817	.62 x 58 x 16.5-17	150	5.80	1.08	1	\$456
					2	\$547
					3	\$658
					4	\$782
					5	\$899

For use on **Z60S23HN** hutch. Includes mounting screws.

Required Specifications

Fabric

TACKBOARDS FOR HUTCHES - 23.5" / 24" HIGH

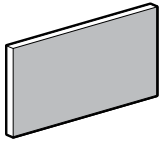

Tackboard

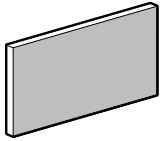

Tackboard

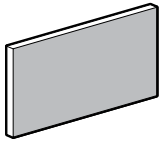

Tackboard

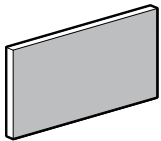

Tackboard

MODEL# DIMENSIONS FREIGHT CLASS WT/LBS. CUBIC FT. FABRIC GRADE LIST PRICE

D x W x H

ZTB4617	.62 x 46 x 16.5-17	150	4.60	.85	1	\$306
					2	\$368
					3	\$440
					4	\$522
					5	\$599

For use on **Z48S23HN** hutch. Includes mounting screws.

ZTB4017	.62 x 40 x 16.5-17	150	4	.85	1	\$294
					2	\$354
					3	\$423
					4	\$500
					5	\$575

For use on **Z42S23HN** hutch. Includes mounting screws.

ZTB3417	.62 x 34 x 16.5-17	150	3.40	.85	1	\$285
					2	\$343
					3	\$410
					4	\$483
					5	\$553

For use on **Z36S23HN** hutch. Includes mounting screws.

ZTB2817	.62 x 28 x 16.5-17	250	2.80	.85	1	\$273
					2	\$331
					3	\$393
					4	\$466
					5	\$537

For use on **Z30S23HN** hutch. Includes mounting screws.

TACKBOARDS FOR HUTCHES - 36" / 36.5" HIGH

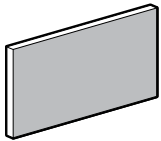

Tackboard

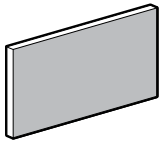

Tackboard

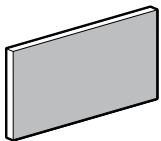

Tackboard

FABRIC GRADE LIST PRICE

ZTB8216	.62 x 82 x 15-15.5	150	8.20	2	1	\$715
					2	\$859
					3	\$1027
					4	\$1229
					5	\$1412

For use on **Z84S36H and Z84S36HN** hutches. Includes mounting screws.

ZTB7016	.62 x 70 x 15-15.5	150	7	1.30	1	\$475
					2	\$573
					3	\$686
					4	\$816
					5	\$940

For use on **Z72S36H and Z72S36HN** hutches. Includes mounting screws.

ZTB6916	.62 x 69.5 x 15-15.5	150	7	1.30	1	\$472
					2	\$568
					3	\$682
					4	\$811
					5	\$931

For use on **Z71S36H and Z71S36HN** hutches. Includes mounting screws.

Required Specifications

Fabric

TACKBOARDS FOR HUTCHES - 36" / 36.5" HIGH

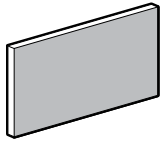

Tackboard

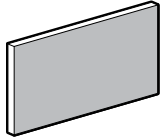

Tackboard

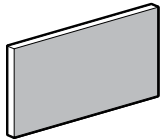

Tackboard

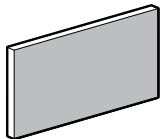

Tackboard

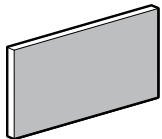

Tackboard

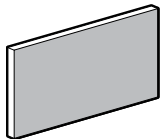

Tackboard

MODEL# DIMENSIONS FREIGHT CLASS WT/LBS. CUBIC FT. FABRIC GRADE LIST PRICE

	D x W x H					
ZTB6416	.62 x 64 x 15-15.5	150	6.40	1.30	1	\$468
					2	\$563
					3	\$670
					4	\$799
					5	\$919

For use on **Z66S36H and Z66S36HN** hutches. Includes mounting screws.

ZTB5816	.62 x 58 x 15-15.5	150	5.80	1.08	1	\$456
					2	\$547
					3	\$658
					4	\$782
					5	\$899

For use on **Z60S36H and Z60S36HN** hutches. Includes mounting screws.

ZTB4616	.62 x 46 x 15-15.5	150	4.60	.85	1	\$306
					2	\$368
					3	\$440
					4	\$522
					5	\$599

For use on **Z48S36H and Z48S36HN** hutches. Includes mounting screws.

ZTB4016	.62 x 40 x 15-15.5	150	4	.85	1	\$294
					2	\$354
					3	\$423
					4	\$500
					5	\$575

For use on **Z42S36H and Z42S36HN** hutch. Includes mounting screws.

ZTB3416	.62 x 34 x 15-15.5	150	3.40	.85	1	\$285
					2	\$343
					3	\$410
					4	\$483
					5	\$553

For use on **Z36S36H and Z36S36HN** hutch. Includes mounting screws.

ZTB2816	.62 x 28 x 15-15.5	250	2.80	.85	1	\$273
					2	\$331
					3	\$393
					4	\$466
					5	\$537

For use on **Z30S36H and Z30S36HN** hutch. Includes mounting screws.

Required Specifications

Fabric

TACKBOARDS FOR HUTCHES - 42.4", 42.9" AND 54.9", 55.4" HIGH

DIMENSIONS FREIGHT CLASS WT/LBS. CUBIC FT. FABRIC GRADE LIST PRICE

D x W x H

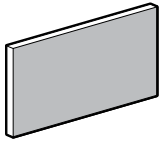

Tackboard

ZTB8221	.62 x 82 x 20.5-21	150	12.80	2.30	1	\$871
					2	\$1043
					3	\$1252
					4	\$1495
					5	\$1717

For use on **Z84S42H, Z84S42HN, Z84S55H and Z84S55HN** hutches. Includes mounting screws.

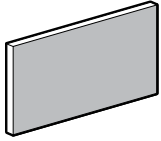

Tackboard

ZTB7021	.62 x 70 x 20.5-21	125	11	1.50	1	\$586
					2	\$700
					3	\$840
					4	\$999
					5	\$1150

For use on **Z72S42H, Z72S42HN, Z72S55H and Z72S55HN** hutches. Includes mounting screws.

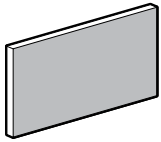

Tackboard

ZTB6921	.62 x 69 x 20.5-21	125	10.70	1.50	1	\$574
					2	\$691
					3	\$827
					4	\$986
					5	\$1135

For use on **Z71S42H, Z71S42HN, Z71S55H and Z71S55HN** hutches. Includes mounting screws.

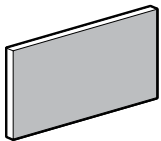

Tackboard

ZTB6421	.62 x 64 x 20.5-21	125	10	1.50	1	\$542
					2	\$652
					3	\$781
					4	\$932
					5	\$1070

For use on **Z66S42H, Z66S42HN, Z66S55H and Z66S55HN** hutches. Includes mounting screws.

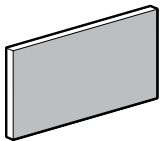

Tackboard

ZTB5821	.62 x 58 x 20.5-21	125	9	1.50	1	\$538
					2	\$649
					3	\$776
					4	\$922
					5	\$1060

For use on **Z60S42H, Z60S42HN, Z60S55H and Z60S55HN** hutches. Includes mounting screws.

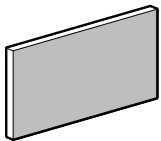

Tackboard

ZTB4621	.62 x 46 x 20.5-21	125	7.20	1	1	\$333
					2	\$402
					3	\$478
					4	\$568
					5	\$653

For use on **Z48S42H, Z48S42HN, Z48S55H and Z48S55HN** hutches. Includes mounting screws.

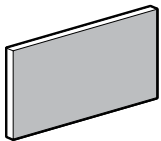

Tackboard

ZTB4021	.62 x 40 x 20.5-21	125	6.20	1	1	\$321
					2	\$385
					3	\$466
					4	\$549
					5	\$633

For use on **Z42S42H, Z42S42HN, Z42S55H and Z42S55HN** hutches. Includes mounting screws.

Required Specifications

Fabric

TACKBOARDS - 42.4", 42.9" & 54.9", 55.4" HIGH

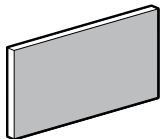

Tackboard

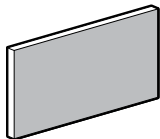

Tackboard

MODEL#	DIMENSIONS	FREIGHT CLASS	WT/LBS.	CUBIC FT.	FABRIC GRADE	LIST PRICE
ZTB3421	.62 x 34 x 20.5-21	150	5.30	1		
					D x W x H	
					1	\$317
					2	\$380
					3	\$455
4	\$540					
5	\$621					

For use on **Z36S42H, Z36S42HN, Z36S55H and Z36S55HN** hutches. Includes mounting screws.

ZTB2821	.62 x 28 x 20.5-21	150	4.50	1		
					1	\$313
					2	\$375
					3	\$448
					4	\$532
5	\$612					

For use on **Z30S42H, Z30S42HN, Z30S55H and Z30S55HN** hutches. Includes mounting screws.

Required Specifications

Fabric

14" WALL MOUNTED TACKBOARDS

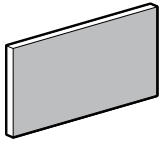

Wall Mounted Tackboard

MODEL# DIMENSIONS FREIGHT CLASS WT/LBS. CUBIC FT. FABRIC GRADE LIST PRICE

	D x W x H						
ZWHT3014	1.25 x 30 x 13.5-14	150	4.70	1	1	\$308	
					2	\$354	
					3	\$407	
					4	\$467	
					5	\$536	

For use under **Z30S200S/OSN** for a finished height of **65"/65.5"**. Standard with pre-mounted "J" bracket for wall mount applications.

- **NOTE:** Care should be taken to mount the units. Units should be mounted to wall studs using correct fasteners. Failure to do so may result in collapse of the unit and subsequent personal injury. **Mounting hardware not included.** Mounting hardware used should be based on wall material. Consult an installation professional for proper wall mounting.

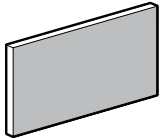

Wall Mounted Tackboard

ZWHT3614	1.25 x 36 x 13.5-14	150	5.60	1	1	\$339	
					2	\$391	
					3	\$450	
					4	\$517	
					5	\$593	

For use under **Z36S200S/OSN** for a finished height of **65"/65.5"**. Standard with pre-mounted "J" bracket for wall mount applications.

- **NOTE:** Care should be taken to mount the units. Units should be mounted to wall studs using correct fasteners. Failure to do so may result in collapse of the unit and subsequent personal injury. **Mounting hardware not included.** Mounting hardware used should be based on wall material. Consult an installation professional for proper wall mounting.

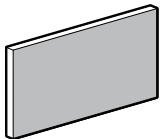

Wall Mounted Tackboard

ZWHT4214	1.25 x 42 x 13.5-14	125	6.50	1	1	\$398	
					2	\$457	
					3	\$524	
					4	\$600	
					5	\$690	

For use under **Z42S200S/OSN** for a finished height of **65"/65.5"**. Standard with pre-mounted "J" bracket for wall mount applications.

- **NOTE:** Care should be taken to mount the units. Units should be mounted to wall studs using correct fasteners. Failure to do so may result in collapse of the unit and subsequent personal injury. **Mounting hardware not included.** Mounting hardware used should be based on wall material. Consult an installation professional for proper wall mounting.

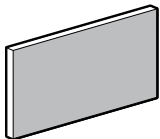

Wall Mounted Tackboard

ZWHT4814	1.25 x 48 x 13.5-14	125	7.50	1	1	\$429	
					2	\$495	
					3	\$566	
					4	\$652	
					5	\$749	

For use under **Z48S200S/OSN** for a finished height of **65"/65.5"**. Standard with pre-mounted "J" bracket for wall mount applications.

- **NOTE:** Care should be taken to mount the units. Units should be mounted to wall studs using correct fasteners. Failure to do so may result in collapse of the unit and subsequent personal injury. **Mounting hardware not included.** Mounting hardware used should be based on wall material. Consult an installation professional for proper wall mounting.

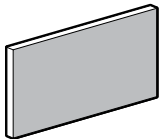

Wall Mounted Tackboard

ZWHT6014	1.25 x 60 x 13.5-14	150	9.30	1.80	1	\$535	
					2	\$615	
					3	\$707	
					4	\$811	
					5	\$933	

For use under **Z60S200S/OSN** for a finished height of **65"/65.5"**. Standard with pre-mounted "J" bracket for wall mount applications.

- **NOTE:** Care should be taken to mount the units. Units should be mounted to wall studs using correct fasteners. Failure to do so may result in collapse of the unit and subsequent personal injury. **Mounting hardware not included.** Mounting hardware used should be based on wall material. Consult an installation professional for proper wall mounting.

Required Specifications

Fabric

14" WALL MOUNTED TACKBOARDS

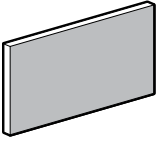

Wall Mounted Tackboard

MODEL#	DIMENSIONS D x W x H	FREIGHT CLASS	WT./LBS.	CUBIC FT.	FABRIC GRADE	LIST PRICE
ZWHT6614	1.25 x 66 x 13.5-14	150	10.30	1.80	1	\$568
					2	\$653
					3	\$750
					4	\$861
					5	\$989

For use under **ZxxS200S/OSN** for a finished height of **65"/65.5"**. Standard with pre-mounted "J" bracket for wall mount applications.

• **NOTE:** Care should be taken to mount the units. Units should be mounted to wall studs using correct fasteners. Failure to do so may result in collapse of the unit and subsequent personal injury. **Mounting hardware not included.** Mounting hardware used should be based on wall material. Consult an installation professional for proper wall mounting.

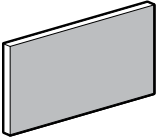

Wall Mounted Tackboard

ZWHT7214	1.25 x 72 x 13.5-14	125	11.20	1.80	1	\$623
					2	\$718
					3	\$824
					4	\$948
					5	\$1089

For use under **ZxxS200S/OSN** for a finished height of **65"/65.5"**. Standard with pre-mounted "J" bracket for wall mount applications.

• **NOTE:** Care should be taken to mount the units. Units should be mounted to wall studs using correct fasteners. Failure to do so may result in collapse of the unit and subsequent personal injury. **Mounting hardware not included.** Mounting hardware used should be based on wall material. Consult an installation professional for proper wall mounting.

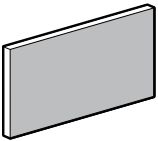

Wall Mounted Tackboard

ZWHT7814	1.25 x 78 x 13.5-14	125	12.10	1.80	1	\$657
					2	\$756
					3	\$868
					4	\$997
					5	\$1147

For use under **ZxxS200S/OSN** for a finished height of **65"/65.5"**. Standard with pre-mounted "J" bracket for wall mount applications.

• **NOTE:** Care should be taken to mount the units. Units should be mounted to wall studs using correct fasteners. Failure to do so may result in collapse of the unit and subsequent personal injury. **Mounting hardware not included.** Mounting hardware used should be based on wall material. Consult an installation professional for proper wall mounting.

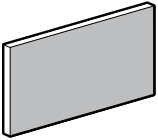

Wall Mounted Tackboard

ZWHT8414	1.25 x 84 x 13.5-14	125	13.10	1.80	1	\$710
					2	\$819
					3	\$939
					4	\$1081
					5	\$1242

For use under **ZxxS200S/OSN** for a finished height of **65"/65.5"**. Standard with pre-mounted "J" bracket for wall mount applications.

• **NOTE:** Care should be taken to mount the units. Units should be mounted to wall studs using correct fasteners. Failure to do so may result in collapse of the unit and subsequent personal injury. **Mounting hardware not included.** Mounting hardware used should be based on wall material. Consult an installation professional for proper wall mounting.

18" WALL MOUNTED TACKBOARDS

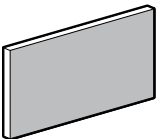

Wall Mounted Tackboard

MODEL#	DIMENSIONS	FREIGHT CLASS	WT./LBS.	CUBIC FT.	FABRIC GRADE	LIST PRICE
ZWHT3018	1.25 x 30 x 17.5-18	125	6	1	1	\$317
					2	\$366
					3	\$421
					4	\$483
					5	\$554

For use under **Z30S160S/OSN** for a finished height of **65"/65.5"**. Standard with pre-mounted "J" bracket for wall mount applications.

• **NOTE:** Care should be taken to mount the units. Units should be mounted to wall studs using correct fasteners. Failure to do so may result in collapse of the unit and subsequent personal injury. **Mounting hardware not included.** Mounting hardware used should be based on wall material. Consult an installation professional for proper wall mounting.

Required Specifications

Fabric

18" WALL MOUNTED TACKBOARDS

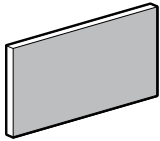

Wall Mounted Tackboard

MODEL# DIMENSIONS FREIGHT CLASS WT/LBS. CUBIC FT. FABRIC GRADE LIST PRICE

	D x W x H					
ZWHT3618	1.25 x 36 x 17.5-18	125	7.20	1	1	\$352
					2	\$405
					3	\$466
					4	\$535
					5	\$614

For use under **Z36S160S/OSN** for a finished height of **65"/65.5"**. Standard with pre-mounted "J" bracket for wall mount applications.

- **NOTE:** Care should be taken to mount the units. Units should be mounted to wall studs using correct fasteners. Failure to do so may result in collapse of the unit and subsequent personal injury. **Mounting hardware not included.** Mounting hardware used should be based on wall material. Consult an installation professional for proper wall mounting.

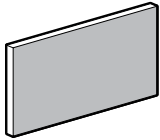

Wall Mounted Tackboard

ZWHT4218	1.25 x 42 x 17.5-18	100	8.40	1	1	\$409
					2	\$471
					3	\$541
					4	\$620
					5	\$713

For use under **Z42S160S/OSN** for a finished height of **65"/65.5"**. Standard with pre-mounted "J" bracket for wall mount applications.

- **NOTE:** Care should be taken to mount the units. Units should be mounted to wall studs using correct fasteners. Failure to do so may result in collapse of the unit and subsequent personal injury. **Mounting hardware not included.** Mounting hardware used should be based on wall material. Consult an installation professional for proper wall mounting.

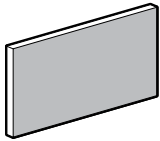

Wall Mounted Tackboard

ZWHT4818	1.25 x 48 x 17.5-18	100	9.60	1	1	\$445
					2	\$512
					3	\$589
					4	\$674
					5	\$775

For use under **Z48S160S/OSN** for a finished height of **65"/65.5"**. Standard with pre-mounted "J" bracket for wall mount applications.

- **NOTE:** Care should be taken to mount the units. Units should be mounted to wall studs using correct fasteners. Failure to do so may result in collapse of the unit and subsequent personal injury. **Mounting hardware not included.** Mounting hardware used should be based on wall material. Consult an installation professional for proper wall mounting.

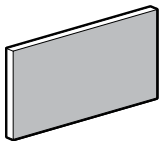

Wall Mounted Tackboard

ZWHT6018	1.25 x 60 x 17.5-18	125	12	1.80	1	\$547
					2	\$630
					3	\$725
					4	\$832
					5	\$956

For use under **Z60S160S/OSN** for a finished height of **65"/65.5"**. Standard with pre-mounted "J" bracket for wall mount applications.

- **NOTE:** Care should be taken to mount the units. Units should be mounted to wall studs using correct fasteners. Failure to do so may result in collapse of the unit and subsequent personal injury. **Mounting hardware not included.** Mounting hardware used should be based on wall material. Consult an installation professional for proper wall mounting.

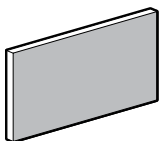

Wall Mounted Tackboard

ZWHT6618	1.25 x 66 x 17.5-18	125	13.20	1.80	1	\$583
					2	\$670
					3	\$772
					4	\$887
					5	\$1019

For use under **ZxxS160S/OSN** for a finished height of **65"/65.5"**. Standard with pre-mounted "J" bracket for wall mount applications.

- **NOTE:** Care should be taken to mount the units. Units should be mounted to wall studs using correct fasteners. Failure to do so may result in collapse of the unit and subsequent personal injury. **Mounting hardware not included.** Mounting hardware used should be based on wall material. Consult an installation professional for proper wall mounting.

Required Specifications

Fabric

18" WALL MOUNTED TACKBOARDS

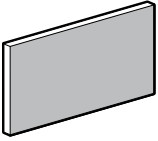

Wall Mounted Tackboard

MODEL#	DIMENSIONS D x W x H	FREIGHT CLASS	WT/LBS.	CUBIC FT.	FABRIC GRADE	LIST PRICE
ZWHT7218	1.25 x 72 x 17.5-18	100	14.40	1.80	1	\$640
					2	\$737
					3	\$846
					4	\$974
					5	\$1117

For use under **ZxxS160S/OSN** for a finished height of **65"/65.5"**. Standard with pre-mounted "J" bracket for wall mount applications.

• **NOTE:** Care should be taken to mount the units. Units should be mounted to wall studs using correct fasteners. Failure to do so may result in collapse of the unit and subsequent personal injury. **Mounting hardware not included.** Mounting hardware used should be based on wall material. Consult an installation professional for proper wall mounting.

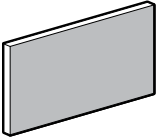

Wall Mounted Tackboard

ZWHT7818	1.25 x 78 x 17.5-18	100	15.60	1.80	1	\$675
					2	\$776
					3	\$892
					4	\$1025
					5	\$1176

For use under **ZxxS160S/OSN** for a finished height of **65"/65.5"**. Standard with pre-mounted "J" bracket for wall mount applications.

• **NOTE:** Care should be taken to mount the units. Units should be mounted to wall studs using correct fasteners. Failure to do so may result in collapse of the unit and subsequent personal injury. **Mounting hardware not included.** Mounting hardware used should be based on wall material. Consult an installation professional for proper wall mounting.

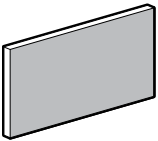

Wall Mounted Tackboard

ZWHT8418	1.25 x 84 x 17.5-18	100	16.80	1.80	1	\$730
					2	\$841
					3	\$967
					4	\$1112
					5	\$1277

For use under **ZxxS160S/OSN** for a finished height of **65"/65.5"**. Standard with pre-mounted "J" bracket for wall mount applications.

• **NOTE:** Care should be taken to mount the units. Units should be mounted to wall studs using correct fasteners. Failure to do so may result in collapse of the unit and subsequent personal injury. **Mounting hardware not included.** Mounting hardware used should be based on wall material. Consult an installation professional for proper wall mounting.

21" WALL MOUNTED TACKBOARDS

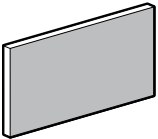

Wall Mounted Tackboard

MODEL#	DIMENSIONS	FREIGHT CLASS	WT/LBS.	CUBIC FT.	FABRIC GRADE	LIST PRICE
ZWHT3021	1.25 x 30 x 20.5-21	125	7	1	1	\$325
					2	\$376
					3	\$430
					4	\$495
					5	\$567

For use under **Z30S210S/OSN** or **Z30S330S/OSN** for a finished height of **71.5"/72"**. Standard with pre-mounted "J" bracket for wall mount applications. For use under **Z30S330S/OSN** for a finished height of **84"/84.5"**

• **NOTE:** Care should be taken to mount the units. Units should be mounted to wall studs using correct fasteners. Failure to do so may result in collapse of the unit and subsequent personal injury. **Mounting hardware not included.** Mounting hardware used should be based on wall material. Consult an installation professional for proper wall mounting.

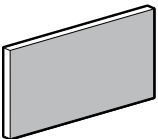

Wall Mounted Tackboard

ZWHT3621	1.25 x 36 x 20.5-21	100	8.40	1	1	\$359
					2	\$414
					3	\$474
					4	\$546
					5	\$627

For use under **Z36S210S/OSN** or **Z36S330S/OSN** for a finished height of **71.5"/72"**. Standard with pre-mounted "J" bracket for wall mount applications. For use under **Z30S330S/OSN** for a finished height of **84"/84.5"**

• **NOTE:** Care should be taken to mount the units. Units should be mounted to wall studs using correct fasteners. Failure to do so may result in collapse of the unit and subsequent personal injury. **Mounting hardware not included.** Mounting hardware used should be based on wall material. Consult an installation professional for proper wall mounting.

Required Specifications

Fabric

21" WALL MOUNTED TACKBOARDS

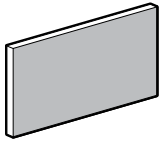

Wall Mounted Tackboard

MODEL# DIMENSIONS FREIGHT CLASS WT./LBS. CUBIC FT. FABRIC GRADE LIST PRICE

	D x W x H					
ZWHT4221	1.25 x 42 x 20.5-21	100	9.80	1	1	\$414
					2	\$477
					3	\$549
					4	\$632
					5	\$725

For use under **Z42S210S/OSN** or **Z42S330S/OSN** for a finished height of **71.5"/72"**. Standard with pre-mounted "J" bracket for wall mount applications. For use under **Z30S330S/OSN** for a finished height of **84"/84.5"**

• **NOTE:** Care should be taken to mount the units. Units should be mounted to wall studs using correct fasteners. Failure to do so may result in collapse of the unit and subsequent personal injury. **Mounting hardware not included.** Mounting hardware used should be based on wall material. Consult an installation professional for proper wall mounting.

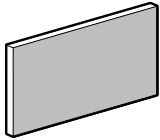

Wall Mounted Tackboard

ZWHT4821	1.25 x 48 x 20.5-21	92.5	11.20	1	1	\$451
					2	\$519
					3	\$596
					4	\$686
					5	\$789

For use under **Z48S210S/OSN** or **Z48S330S/OSN** for a finished height of **71.5"/72"**. Standard with pre-mounted "J" bracket for wall mount applications. For use under **Z30S330S/OSN** for a finished height of **84"/84.5"**

• **NOTE:** Care should be taken to mount the units. Units should be mounted to wall studs using correct fasteners. Failure to do so may result in collapse of the unit and subsequent personal injury. **Mounting hardware not included.** Mounting hardware used should be based on wall material. Consult an installation professional for proper wall mounting.

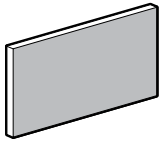

Wall Mounted Tackboard

ZWHT6021	1.25 x 60 x 20.5-21	125	14	1.80	1	\$559
					2	\$642
					3	\$739
					4	\$850
					5	\$977

For use under **Z60S210S/OSN** or **Z60S330S/OSN** for a finished height of **71.5"/72"**. Standard with pre-mounted "J" bracket for wall mount applications. For use under **Z30S330S/OSN** for a finished height of **84"/84.5"**

• **NOTE:** Care should be taken to mount the units. Units should be mounted to wall studs using correct fasteners. Failure to do so may result in collapse of the unit and subsequent personal injury. **Mounting hardware not included.** Mounting hardware used should be based on wall material. Consult an installation professional for proper wall mounting.

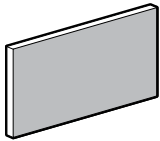

Wall Mounted Tackboard

ZWHT6621	1.25 x 66 x 20.5-21	100	15.40	1.80	1	\$593
					2	\$684
					3	\$784
					4	\$903
					5	\$1038

For use under **ZxxS210S/OSN** or **ZxxS330S/OSN** for a finished height of **71.5"/72"**. Standard with pre-mounted "J" bracket for wall mount applications. For use under **Z30S330S/OSN** for a finished height of **84"/84.5"**

• **NOTE:** Care should be taken to mount the units. Units should be mounted to wall studs using correct fasteners. Failure to do so may result in collapse of the unit and subsequent personal injury. **Mounting hardware not included.** Mounting hardware used should be based on wall material. Consult an installation professional for proper wall mounting.

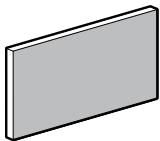

Wall Mounted Tackboard

ZWHT7221	1.25 x 72 x 20.5-21	100	16.80	1.80	1	\$651
					2	\$750
					3	\$861
					4	\$989
					5	\$1138

For use under **ZxxS210S/OSN** or **ZxxS330S/OSN** for a finished height of **71.5"/72"**. Standard with pre-mounted "J" bracket for wall mount applications. For use under **Z30S330S/OSN** for a finished height of **84"/84.5"**

• **NOTE:** Care should be taken to mount the units. Units should be mounted to wall studs using correct fasteners. Failure to do so may result in collapse of the unit and subsequent personal injury. **Mounting hardware not included.** Mounting hardware used should be based on wall material. Consult an installation professional for proper wall mounting.

Required Specifications

Fabric

21" WALL MOUNTED TACKBOARDS

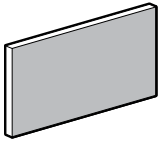

Wall Mounted Tackboard

MODEL#	DIMENSIONS D x W x H	FREIGHT CLASS	WT/LBS.	CUBIC FT.	FABRIC GRADE	LIST PRICE
ZWHT7821	1.25 x 78 x 20.5-21	92.5	18.20	1.80	1	\$685
					2	\$790
					3	\$908
					4	\$1043
					5	\$1197

For use under **ZxxS210S/OSN** or **ZxxS330S/OSN** for a finished height of **71.5"/72"**. Standard with pre-mounted "J" bracket for wall mount applications. For use under **Z30S330S/OSN** for a finished height of **84"/84.5"**

• **NOTE:** Care should be taken to mount the units. Units should be mounted to wall studs using correct fasteners. Failure to do so may result in collapse of the unit and subsequent personal injury. **Mounting hardware not included.** Mounting hardware used should be based on wall material. Consult an installation professional for proper wall mounting.

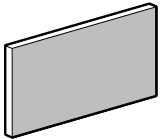

Wall Mounted Tackboard

ZWHT8421	1.25 x 84 x 20.5-21	92.5	19.60	1.80	1	\$746
					2	\$857
					3	\$985
					4	\$1132
					5	\$1302

For use under **ZxxS210S/OSN** or **ZxxS330S/OSN** for a finished height of **71.5"/72"**. Standard with pre-mounted "J" bracket for wall mount applications. For use under **Z30S330S/OSN** for a finished height of **84"/84.5"**

• **NOTE:** Care should be taken to mount the units. Units should be mounted to wall studs using correct fasteners. Failure to do so may result in collapse of the unit and subsequent personal injury. **Mounting hardware not included.** Mounting hardware used should be based on wall material. Consult an installation professional for proper wall mounting.

25" WALL MOUNTED TACKBOARDS

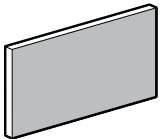

Wall Mounted Tackboard

MODEL#	DIMENSIONS	FREIGHT CLASS	WT/LBS.	CUBIC FT.	FABRIC GRADE	LIST PRICE
ZWHT3025	1.25 x 30 x 24.5-25	100	8.30	1	1	\$334
					2	\$385
					3	\$443
					4	\$506
					5	\$583

For use under **Z30S160S/OSN** for a finished height of **71.5"/72"**. Standard with pre-mounted "J" bracket for wall mount applications.

• **NOTE:** Care should be taken to mount the units. Units should be mounted to wall studs using correct fasteners. Failure to do so may result in collapse of the unit and subsequent personal injury. **Mounting hardware not included.** Mounting hardware used should be based on wall material. Consult an installation professional for proper wall mounting.

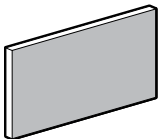

Wall Mounted Tackboard

ZWHT3625	1.25 x 36 x 24.5-25	92.5	10	1	1	\$370
					2	\$428
					3	\$492
					4	\$563
					5	\$645

For use under **Z36S160S/OSN** for a finished height of **71.5"/72"**. Standard with pre-mounted "J" bracket for wall mount applications.

• **NOTE:** Care should be taken to mount the units. Units should be mounted to wall studs using correct fasteners. Failure to do so may result in collapse of the unit and subsequent personal injury. **Mounting hardware not included.** Mounting hardware used should be based on wall material. Consult an installation professional for proper wall mounting.

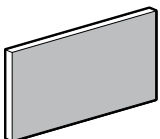

Wall Mounted Tackboard

ZWHT4225	1.25 x 42 x 24.5-25	92.5	11.70	1	1	\$429
					2	\$495
					3	\$566
					4	\$652
					5	\$749

For use under **Z42S160S/OSN** for a finished height of **71.5"/72"**. Standard with pre-mounted "J" bracket for wall mount applications.

• **NOTE:** Care should be taken to mount the units. Units should be mounted to wall studs using correct fasteners. Failure to do so may result in collapse of the unit and subsequent personal injury. **Mounting hardware not included.** Mounting hardware used should be based on wall material. Consult an installation professional for proper wall mounting.

Required Specifications

Fabric

25" WALL MOUNTED TACKBOARDS

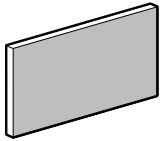

Wall Mounted Tackboard

MODEL# DIMENSIONS FREIGHT CLASS WT/LBS. CUBIC FT. FABRIC GRADE LIST PRICE

	D x W x H						
ZWHT4825	1.25 x 48 x 24.5-25	85	13.30	1	1	\$466	
					2	\$538	
					3	\$617	
					4	\$708	
					5	\$814	

For use under **Z48S160S/OSN** for a finished height of **71.5"/72"**. Standard with pre-mounted "J" bracket for wall mount applications.

- **NOTE:** Care should be taken to mount the units. Units should be mounted to wall studs using correct fasteners. Failure to do so may result in collapse of the unit and subsequent personal injury. **Mounting hardware not included.** Mounting hardware used should be based on wall material. Consult an installation professional for proper wall mounting.

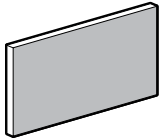

Wall Mounted Tackboard

ZWHT6025	1.25 x 60 x 24.5-25	100	16.70	1.80	1	\$575	
					2	\$662	
					3	\$759	
					4	\$873	
					5	\$1005	

For use under **Z60S160S/OSN** for a finished height of **71.5"/72"**. Standard with pre-mounted "J" bracket for wall mount applications.

- **NOTE:** Care should be taken to mount the units. Units should be mounted to wall studs using correct fasteners. Failure to do so may result in collapse of the unit and subsequent personal injury. **Mounting hardware not included.** Mounting hardware used should be based on wall material. Consult an installation professional for proper wall mounting.

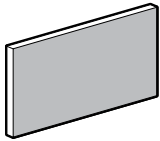

Wall Mounted Tackboard

ZWHT6625	1.25 x 66 x 24.5-25	92.5	18.30	1.80	1	\$612	
					2	\$704	
					3	\$809	
					4	\$929	
					5	\$1068	

For use under **ZxxS160S/OSN** for a finished height of **71.5"/72"**. Standard with pre-mounted "J" bracket for wall mount applications.

- **NOTE:** Care should be taken to mount the units. Units should be mounted to wall studs using correct fasteners. Failure to do so may result in collapse of the unit and subsequent personal injury. **Mounting hardware not included.** Mounting hardware used should be based on wall material. Consult an installation professional for proper wall mounting.

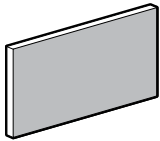

Wall Mounted Tackboard

ZWHT7225	1.25 x 72 x 24.5-25	92.5	20	1.80	1	\$671	
					2	\$771	
					3	\$887	
					4	\$1019	
					5	\$1169	

For use under **ZxxS160S/OSN** for a finished height of **71.5"/72"**. Standard with pre-mounted "J" bracket for wall mount applications.

- **NOTE:** Care should be taken to mount the units. Units should be mounted to wall studs using correct fasteners. Failure to do so may result in collapse of the unit and subsequent personal injury. **Mounting hardware not included.** Mounting hardware used should be based on wall material. Consult an installation professional for proper wall mounting.

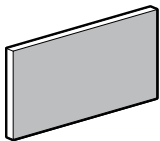

Wall Mounted Tackboard

ZWHT7825	1.25 x 78 x 24.5-25	85	21.70	1.80	1	\$706	
					2	\$814	
					3	\$933	
					4	\$1072	
					5	\$1233	

For use under **ZxxS160S/OSN** for a finished height of **71.5"/72"**. Standard with pre-mounted "J" bracket for wall mount applications.

- **NOTE:** Care should be taken to mount the units. Units should be mounted to wall studs using correct fasteners. Failure to do so may result in collapse of the unit and subsequent personal injury. **Mounting hardware not included.** Mounting hardware used should be based on wall material. Consult an installation professional for proper wall mounting.

Required Specifications

Fabric

25" WALL MOUNTED TACKBOARDS

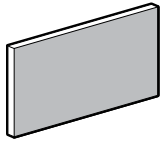

Wall Mounted Tackboard

MODEL#	DIMENSIONS	FREIGHT CLASS	WT/LBS.	CUBIC FT.	FABRIC GRADE	LIST PRICE
D x W x H						
ZWHT8425	1.25 x 84 x 24.5-25	85	23.30	1.80	1	\$767
					2	\$884
					3	\$1013
					4	\$1165
					5	\$1337

For use under **ZxxS160S/OSN** for a finished height of **71.5"/72"**. Standard with pre-mounted "J" bracket for wall mount applications.

- **NOTE:** Care should be taken to mount the units. Units should be mounted to wall studs using correct fasteners. Failure to do so may result in collapse of the unit and subsequent personal injury. **Mounting hardware not included.** Mounting hardware used should be based on wall material. Consult an installation professional for proper wall mounting.

Required Specifications

Fabric

BOOKCASES

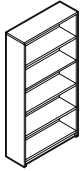

Bookcase - 72" High

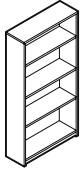

Bookcase - 65.5" High

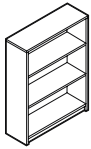

Bookcase - 48.5" High

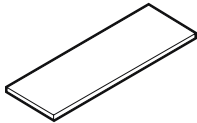

Bookcase Shelf

MODEL#	DIMENSIONS	FREIGHT CLASS	WT/LBS.	CUBIC FT.	1" TOP	1.5" TOP	GLAZE ADD	HP ADD
--------	------------	---------------	---------	-----------	--------	----------	-----------	--------

D x W x H

ZHBC72	12 x 36 x 71.9-72.4	125	176	23	\$1064	\$1126	N/A	N/A
--------	---------------------	-----	-----	----	---------------	---------------	-----	-----

One fixed shelf.

ZHBC65	12 x 36 x 65.5-66	125	156	21	\$1030	\$1091	N/A	N/A
--------	-------------------	-----	-----	----	---------------	---------------	-----	-----

One fixed shelf and two adjustable shelves.

ZHBC48	12 x 36 x 48.5-49	125	122	15.75	\$780	\$841	N/A	N/A
--------	-------------------	-----	-----	-------	--------------	--------------	-----	-----

Two adjustable shelves.

ZHSHELF	11 x 34 x 5-1	100	13	1.50	\$273	N/A	N/A	N/A
---------	---------------	-----	----	------	--------------	-----	-----	-----

Extra shelf for bookcases. 1" thick.

TABLE TOP BOOKCASES

NOTE: UNITS UNDER 30"W MUST BE SECURELY FASTENED TO THE WALL OR GANGED TO AN ADJACENT UNIT 30"W OR WIDER

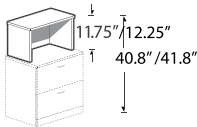

Table Top Bookcase 11.75"/12.25" High

Z36S12TN	16 x 36 x 11.25-11.75	100	44.91	5.25	\$311	\$373	N/A	N/A
----------	-----------------------	-----	-------	------	--------------	--------------	-----	-----

Z30S12TN	16 x 30 x 11.25-11.75	100	39.33	4.30	\$285	\$338	N/A	N/A
----------	-----------------------	-----	-------	------	--------------	--------------	-----	-----

To be placed **on top of 29"/29.5" high units to achieve 40.8"/41.8" final height** or placed on top of **40.8"/41.3" high units to achieve 52.5"/53.5" final height.**

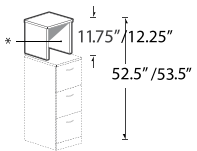

Table Top Bookcase 11.75"/12.25" High

Z21S12TN	16 x 21 x 11.25-11.75	100	28.87	3.10	\$238	\$280	N/A	N/A
----------	-----------------------	-----	-------	------	--------------	--------------	-----	-----

Z18S12TN	16 x 18 x 11.25-11.75	92.5	27.13	2.70	\$228	\$266	N/A	N/A
----------	-----------------------	------	-------	------	--------------	--------------	-----	-----

Z16S12TN	16 x 16 x 11.25-11.75	92.5	24.57	2.40	\$217	\$252	N/A	N/A
----------	-----------------------	------	-------	------	--------------	--------------	-----	-----

Z15S12TN	16 x 15 x 11.25-11.75	92.5	24.34	2.30	\$208	\$238	N/A	N/A
----------	-----------------------	------	-------	------	--------------	--------------	-----	-----

Z12S12TN	16 x 12 x 11.25-11.75	92.5	21.55	1.90	\$197	\$223	N/A	N/A
----------	-----------------------	------	-------	------	--------------	--------------	-----	-----

* Accepts collator 11" high

To be placed **on top of 29"/29.5" high units to achieve 40.8"/41.8" final height** or placed on top of **40.8"/41.3" high units to achieve 52.5"/53.5" final height.**

Required Specifications

Top finish
Base finish
Top/Edge Detail

Optional Specifications

Collator (Open Shelf)

TABLE TOP BOOKCASES

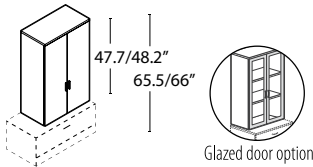

**Closed Table Top Bookcase
47.7" High**

MODEL#	DIMENSIONS D x W x H	FREIGHT CLASS	WT/LBS.	CUBIC FT.	1" TOP	1.5" TOP	GLAZE ADD	HP ADD
Z36S48T	36 x 16 x 47.7	125	149	20.25	\$1268	\$1330	\$1336	N/A
Z30S48T	30 x 16 x 47.7	125	130	17	\$1158	\$1211	\$1153	N/A

Designed to be placed **on top of 17.87"/18.37" high units to achieve 65.5"/66" final height.**
Laminate doors are standard. **Includes one adjustable shelf.** Standard with lock.

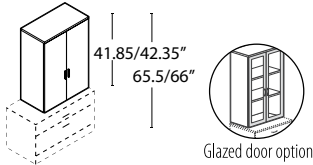

**Closed Table Top Bookcase
41" High**

Z36S41T	36 x 16 x 41.85	125	128	17.75	\$1042	\$1104	\$1159	N/A
Z30S41T	30 x 16 x 41.85	125	111	15	\$1091	\$1144	\$1010	N/A

Designed to be placed **on top of 23.75"/24.25" high units to achieve 65.5"/66" final height.**
Laminate doors are standard. **Includes one adjustable shelf.** Standard with lock.

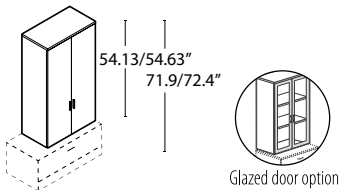

**Closed Table Top Bookcase
54" High**

Z36S54T	36 x 16 x 54.13	125	163	22.75	\$1497	\$1559	\$1336	N/A
Z30S54T	30 x 16 x 54.13	125	142	19	\$1158	\$1211	\$1153	N/A

Designed to be placed **on top of 17.87"/18.37" high units to achieve 71.9"/72.4" final height.**
Laminate doors are standard. **Includes one adjustable shelf.** Standard with lock.

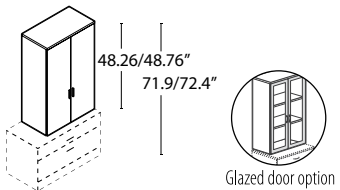

**Closed Table Top Bookcase
48" High**

Z36S49T	36 x 16 x 48.26	125	141	20.25	\$1330	\$1392	\$881	N/A
Z30S49T	30 x 16 x 48.26	125	123	17.25	\$1193	\$1245	\$787	N/A

Designed to be placed **on top of 23.75"/24.25" high units to achieve 71.9"/72.4" final height.**
Laminate doors are standard. **Includes one adjustable shelf.** Standard with lock.

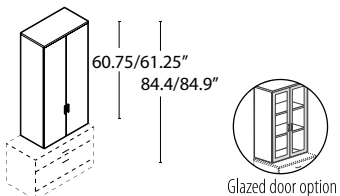

**Closed Table Top Bookcase
61" High**

Z36S61T	36 x 16 x 60.75	125	176	25.25	\$1571	\$1633	\$1048	N/A
Z30S61T	30 x 16 x 60.75	125	153	21.25	\$1404	\$1456	\$935	N/A

Designed to be placed **on top of 23.75"/24.25" high units to achieve 84.4"/84.9" final height.**
Laminate doors are standard. **Includes one adjustable shelf.** Standard with lock.

Required Specifications

- Top finish
- Base finish
- Top/Edge Detail

Optional Specifications

- Glazing - Doors

TABLE TOP BOOKCASES

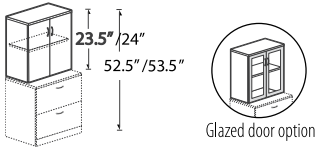

Table Top Bookcase 23.5\"/>

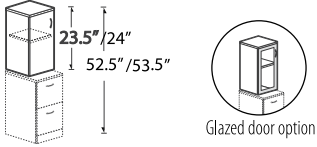

Table Top Bookcase with Door - LEFT 23.5\"/>

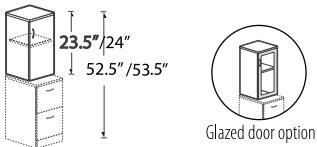

Table Top Bookcase with Door - RIGHT 23.5\"/>

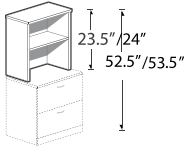

Table Top Bookcase 23.5\"/>

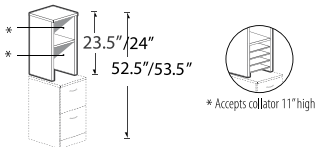

Table Top Bookcase 23.5\"/>

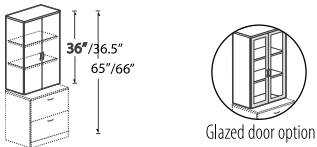

Table Top Bookcase with Doors 36\"/>

MODEL#	DIMENSIONS	FREIGHT CLASS	WT./LBS.	CUBIC FT.	1\"/>			
Z36S23T	16 x 36 x 23-23.5	100	87.45	9.50	\$744	\$806	\$733	N/A
Z30S23T	16 x 30 x 23-23.5	100	75.78	8	\$677	\$730	\$647	N/A

Designed to be placed on top of 29\"/>

MODEL#	DIMENSIONS	FREIGHT CLASS	WT./LBS.	CUBIC FT.	1\"/>			
Z21S23TL	16 x 21 x 23-23.5	92.5	58.83	5.75	\$530	\$571	\$400	N/A
Z18S23TL	16 x 18 x 23-23.5	92.5	54.65	5	\$511	\$546	\$365	N/A
Z16S23TL	16 x 16 x 23-23.5	92.5	46.71	4.50	\$453	\$488	\$357	N/A
Z15S23TL	16 x 15 x 23-23.5	92.5	46.06	4.20	\$430	\$460	\$322	N/A
Z12S23TL	16 x 12 x 23-23.5	92.5	40.77	3.50	\$401	\$427	\$290	N/A

Designed to be placed on top of 29\"/>

Z21S23TR	16 x 21 x 23-23.5	92.5	58.83	5.75	\$530	\$571	\$400	N/A
Z18S23TR	16 x 18 x 23-23.5	92.5	54.65	5	\$511	\$546	\$365	N/A
Z16S23TR	16 x 16 x 23-23.5	92.5	46.71	4.50	\$453	\$488	\$357	N/A
Z15S23TR	16 x 15 x 23-23.5	92.5	46.06	4.20	\$430	\$460	\$322	N/A
Z12S23TR	16 x 12 x 23-23.5	92.5	40.77	3.50	\$401	\$427	\$290	N/A

Designed to be placed on top of 29\"/>

Z36S23TN	16 x 36 x 23-23.5	125	69.06	9.50	\$487	\$549	N/A	N/A
Z30S23TN	16 x 30 x 23-23.5	125	60.33	8	\$447	\$499	N/A	N/A

Designed to be placed on top of 29\"/>

Z21S23TN	16 x 21 x 23-23.5	100	47.77	5.75	\$380	\$421	N/A	N/A
Z18S23TN	16 x 18 x 23-23.5	100	44.98	5	\$374	\$409	N/A	N/A
Z16S23TN	16 x 16 x 23-23.5	100	38.22	4.50	\$317	\$352	N/A	N/A
Z15S23TN	16 x 15 x 23-23.5	100	37	4.20	\$304	\$333	N/A	N/A
Z12S23TN	16 x 12 x 23-23.5	100	34.15	3.50	\$284	\$311	N/A	N/A

Designed to be placed on top of 29\"/>

Z36S36T	16 x 36 x 35.5-36	100	124.30	14.25	\$956	\$1018	\$945	N/A
Z30S36T	16 x 30 x 35.5-36	100	106.67	12	\$827	\$879	\$826	N/A

Designed to be placed on top of 29\"/>

Required Specifications

Top finish
Base finish
Top/Edge Detail

Optional Specifications

Collator (Open Shelves)
Glazing - Doors

TABLE TOP BOOKCASES

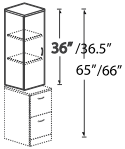

**Table Top Bookcase with Doors
36"/36.5" High - LEFT**

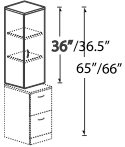

**Table Top Bookcase with Doors
36"/36.5" High - RIGHT**

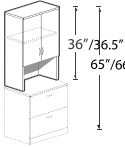

**Table Top Bookcase with Doors and
Cavity - 36"/36.5" High**

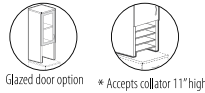
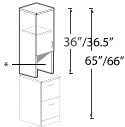

**Table Top Bookcase with Doors and
Cavity - 36"/36.5" High - LEFT**

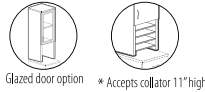
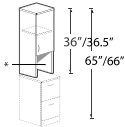

**Table Top Bookcase with Doors and
Cavity - 36"/36.5" High - RIGHT**

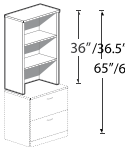

Table Top Bookcase 36"/36.5" High

MODEL#	DIMENSIONS D x W x H	FREIGHT CLASS	WT/LBS.	CUBIC FT.	1" TOP	1.5" TOP	GLAZE ADD	HP ADD
Z21S36TL	16 x 21 x 35.5-36	100	82.99	8.75	\$677	\$719	\$519	N/A
Z18S36TL	16 x 18 x 35.5-36	100	74.72	7.50	\$648	\$683	\$469	N/A
Z16S36TL	16 x 16 x 35.5-36	92.5	67.82	6.75	\$592	\$627	\$462	N/A
Z15S36TL	16 x 15 x 35.5-36	92.5	66.46	6.50	\$563	\$593	\$411	N/A
Z12S36TL	16 x 12 x 35.5-36	92.5	59.30	5.25	\$523	\$549	\$370	N/A

Designed to be placed **on top of 29"/29.5" high units to achieve 65"/66" final height.** Laminate door is standard.
Includes two adjustable shelves. Standard with lock.

Z21S36TR	16 x 21 x 35.5-36	100	82.99	8.75	\$677	\$719	\$519	N/A
Z18S36TR	16 x 18 x 35.5-36	100	74.72	7.50	\$648	\$683	\$469	N/A
Z16S36TR	16 x 16 x 35.5-36	92.5	67.82	6.75	\$592	\$627	\$462	N/A
Z15S36TR	16 x 15 x 35.5-36	92.5	66.46	6.50	\$563	\$593	\$411	N/A
Z12S36TR	16 x 12 x 35.5-36	92.5	59.30	5.25	\$523	\$549	\$370	N/A

Designed to be placed **on top of 29"/29.5" high units to achieve 65"/66" final height.** Laminate door is standard.
Includes two adjustable shelves. Standard with lock.

Z36S36TC	16 x 36 x 35.5-36	100	116.98	14.25	\$903	\$965	\$835	N/A
Z30S36TC	16 x 30 x 35.5-36	100	100.58	12	\$782	\$835	\$727	N/A

Designed to be placed **on top of 29"/29.5" high units to achieve 65"/66" final height.** Laminate doors are standard.
Includes one adjustable shelf. Standard with lock.

Z21S36TCL	16 x 21 x 35.5-36	100	78.72	8.75	\$645	\$687	\$463	N/A
Z18S36TCL	16 x 18 x 35.5-36	100	71.07	7.50	\$622	\$660	\$417	N/A
Z16S36TCL	16 x 16 x 35.5-36	100	64.57	6.75	\$564	\$599	\$411	N/A
Z15S36TCL	16 x 15 x 35.5-36	100	63.42	6.50	\$542	\$571	\$364	N/A
Z12S36TCL	16 x 12 x 35.5-36	92.5	56.87	5.25	\$504	\$531	\$326	N/A

Designed to be placed **on top of 29"/29.5" high units to achieve 65"/66" final height.** Laminate door is standard.
Includes one adjustable shelf. Standard with lock.

Z21S36TCR	16 x 21 x 35.5-36	100	78.72	8.75	\$645	\$687	\$463	N/A
Z18S36TCR	16 x 18 x 35.5-36	100	71.07	7.50	\$622	\$660	\$417	N/A
Z16S36TCR	16 x 16 x 35.5-36	100	64.57	6.75	\$564	\$599	\$411	N/A
Z15S36TCR	16 x 15 x 35.5-36	100	63.42	6.50	\$542	\$571	\$364	N/A
Z12S36TCR	16 x 12 x 35.5-36	92.5	56.87	5.25	\$504	\$531	\$326	N/A

Designed to be placed **on top of 29"/29.5" high units to achieve 65"/66" final height.** Laminate door is standard.
Includes one adjustable shelf. Standard with lock.

Z36S36TN	16 x 36 x 35.5-36	125	95.31	14.25	\$642	\$705	N/A	N/A
Z30S36TN	16 x 30 x 35.5-36	125	82.38	12	\$547	\$600	N/A	N/A

Designed to be placed **on top of 29"/29.5" high units to achieve 65"/66" final height.** **Includes two adjustable shelves.**

Required Specifications

Top finish
Base finish
Top/Edge Detail

Optional Specifications

Collator (Open Shelves)
Glazing - Doors

TABLE TOP BOOKCASES

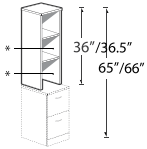

* Accepts collator 11\"/>

Table Top Bookcase 36\"/>

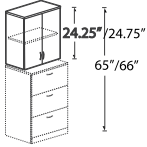

Glazed door option

Table Top Bookcase with Doors
24.25\"/>

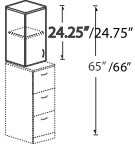

Glazed door option

Table Top Bookcase with Door - LEFT
24.25\"/>

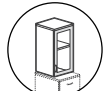
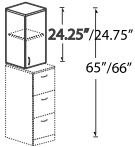

Glazed door option

Table Top Bookcase with Door - RIGHT
24.25\"/>

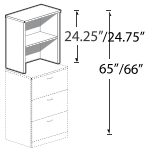
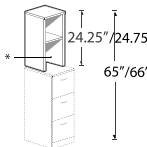

Table Top Bookcase
24.25\"/>



* Accepts collator 11\"/>

Table Top Bookcase
24.25\"/>

MODEL#	DIMENSIONS	FREIGHT CLASS	WT/LBS.	CUBIC FT.	1\"/>			
Z21S36TN	16 x 21 x 35.5-36	125	65.62	8.75	\$497	\$539	N/A	N/A
Z18S36TN	16 x 18 x 35.5-36	125	59.68	7.50	\$484	\$522	N/A	N/A
Z16S36TN	16 x 16 x 35.5-36	100	56	6.75	\$428	\$463	N/A	N/A
Z15S36TN	16 x 15 x 35.5-36	100	53.74	6.50	\$414	\$444	N/A	N/A
Z12S36TN	16 x 12 x 35.5-36	125	48.85	6.25	\$387	\$413	N/A	N/A

Designed to be placed on top of 29\"/>

Z36S24T	16 x 36 x 23.75-24.25	100	89.26	10	\$746	\$808	\$835	N/A
Z30S24T	16 x 30 x 23.75-24.25	100	77.47	8.25	\$681	\$733	\$727	N/A

Designed to be placed on top of 40.8\"/>

Z21S24TL	16 x 21 x 23.75-24.25	100	59.24	6	\$530	\$572	\$463	N/A
Z18S24TL	16 x 18 x 23.75-24.25	92.5	56.11	5.25	\$512	\$547	\$417	N/A
Z16S24TL	16 x 16 x 23.75-24.25	92.5	48.13	4.60	\$454	\$489	\$411	N/A
Z15S24TL	16 x 15 x 23.75-24.25	92.5	46.35	4.30	\$431	\$461	\$364	N/A
Z12S24TL	16 x 12 x 23.75-24.25	85	44.32	3.60	\$402	\$428	\$326	N/A

Designed to be placed on top of 40.8\"/>

Z21S24TR	16 x 21 x 23.75-24.25	100	59.24	6	\$530	\$572	\$463	N/A
Z18S24TR	16 x 18 x 23.75-24.25	92.5	56.11	5.25	\$512	\$547	\$417	N/A
Z16S24TR	16 x 16 x 23.75-24.25	92.5	48.13	4.60	\$454	\$489	\$411	N/A
Z15S24TR	16 x 15 x 23.75-24.25	92.5	46.35	4.30	\$431	\$461	\$364	N/A
Z12S24TR	16 x 12 x 23.75-24.25	85	44.32	3.60	\$402	\$428	\$326	N/A

Designed to be placed on top of 40.8\"/>

Z36S24TN	16 x 36 x 23.75-24.25	125	70.11	10	\$487	\$550	N/A	N/A
Z30S24TN	16 x 30 x 23.75-24.25	125	61.38	8.25	\$447	\$500	N/A	N/A

Designed to be placed on top of 40.8\"/>

Z21S24TN	16 x 21 x 23.75-24.25	125	47.77	6	\$380	\$422	N/A	N/A
Z18S24TN	16 x 18 x 23.75-24.25	100	46.03	5.25	\$374	\$412	N/A	N/A
Z16S24TN	16 x 16 x 23.75-24.25	100	39.27	4.60	\$318	\$353	N/A	N/A
Z15S24TN	16 x 15 x 23.75-24.25	100	37.99	4.30	\$304	\$334	N/A	N/A
Z12S24TN	16 x 12 x 23.75-24.25	92.5	37.30	3.60	\$285	\$311	N/A	N/A

Designed to be placed on top of 40.8\"/>

Required Specifications

Top finish
Base finish
Top/Edge Detail

Optional Specifications

Collator (Open Shelves)
Glazing - Doors

TABLE TOP BOOKCASES

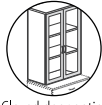
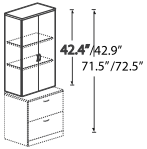

Glazed door option

Table Top Bookcase with Doors
42.4"/42.9" High

MODEL#	DIMENSIONS D x W x H	FREIGHT CLASS	WT/LBS.	CUBIC FT.	1" TOP	1.5" TOP	GLAZE ADD	HP ADD
Z36S42T	16 x 36 x 41.9-42.4	100	137.40	16.75	\$1042	\$1104	\$1159	N/A
Z30S42T	16 x 30 x 41.9-42.4	100	119.06	14	\$910	\$963	\$1010	N/A

Designed to be placed on top of 29"/29.5" high units to achieve 71.5"/72.5" final height. DO NOT USE ON TOP OF 40.8"/41.3" HIGH UNITS. Laminate doors are standard. Includes two adjustable shelves. Standard with lock.

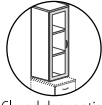
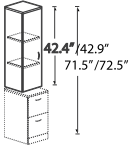

Glazed door option

Table Top Bookcase with Door - LEFT
42.4"/42.9" High

Z21S42TL	16 x 21 x 41.9-42.4	300	119	70	\$738	\$780	\$641	N/A
Z18S42TL	16 x 18 x 41.9-42.4	85	117	8.75	\$709	\$744	\$576	N/A
Z16S42TL	16 x 16 x 41.9-42.4	300	112	62	\$639	\$674	\$571	N/A
Z15S42TL	16 x 15 x 41.9-42.4	250	109	54	\$606	\$635	\$501	N/A
Z12S42TL	16 x 12 x 41.9-42.4	250	105	49	\$563	\$590	\$452	N/A

Designed to be placed on top of 29"/29.5" high units to achieve 71.5"/72.5" final height. DO NOT USE ON TOP OF 40.8"/41.3" HIGH UNITS. Laminate door is standard. Includes two adjustable shelves. Standard with lock.

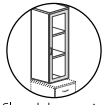
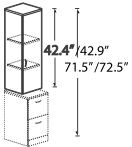

Glazed door option

Table Top Bookcase with Door - RIGHT
42.4"/42.9" High

Z21S42TR	16 x 21 x 41.9-42.4	300	119	70	\$738	\$780	\$641	N/A
Z18S42TR	16 x 18 x 41.9-42.4	85	117	8.75	\$709	\$744	\$576	N/A
Z16S42TR	16 x 16 x 41.9-42.4	300	112	62	\$639	\$674	\$571	N/A
Z15S42TR	16 x 15 x 41.9-42.4	250	109	54	\$606	\$635	\$501	N/A
Z12S42TR	16 x 12 x 41.9-42.4	250	105	49	\$563	\$590	\$452	N/A

Designed to be placed on top of 29"/29.5" high units to achieve 71.5"/72.5" final height. DO NOT USE ON TOP OF 40.8"/41.3" HIGH UNITS. Laminate door is standard. Includes two adjustable shelves. Standard with lock.

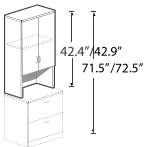

Glazed door option

Table Top Bookcase with Doors and
Cavity 42.4"/42.9" High

Z36S42TC	16 x 36 x 41.9-42.4	125	130.09	16.75	\$1010	\$1072	\$912	N/A
Z30S42TC	16 x 30 x 41.9-42.4	100	112.97	14	\$882	\$935	\$793	N/A

Designed to be placed on top of 29"/29.5" high units to achieve 71.5"/72.5" final height. DO NOT USE ON TOP OF 40.8"/41.3" HIGH UNITS. Laminate doors are standard. Includes one adjustable shelf. Standard with lock.

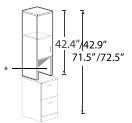

* Accepts collator 11" high

Table Top Bookcase with Door and
Cavity 42.4"/42.9" High - LEFT

Z21S42TCL	16 x 21 x 41.9-42.4	100	87.84	10	\$722	\$763	\$506	N/A
Z18S42TCL	16 x 18 x 41.9-42.4	100	79.83	8.75	\$693	\$728	\$455	N/A
Z16S42TCL	16 x 16 x 41.9-42.4	100	73.75	8	\$622	\$657	\$451	N/A
Z15S42TCL	16 x 15 x 41.9-42.4	100	70.71	7.50	\$592	\$621	\$397	N/A
Z12S42TCL	16 x 12 x 41.9-42.4	92.5	62.70	6	\$549	\$576	\$357	N/A

Designed to be placed on top of 29"/29.5" high units to achieve 71.5"/72.5" final height. DO NOT USE ON TOP OF 40.8"/41.3" HIGH UNITS. Laminate door is standard. Includes one adjustable shelf. Standard with lock.

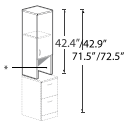

* Accepts collator 11" high

Table Top Bookcase with Door and
Cavity 42.4"/42.9" High - RIGHT

Z21S42TCR	16 x 21 x 41.9-42.4	100	87.84	10	\$722	\$763	\$506	N/A
Z18S42TCR	16 x 18 x 41.9-42.4	100	79.83	8.75	\$693	\$728	\$455	N/A
Z16S42TCR	16 x 16 x 41.9-42.4	100	73.75	8	\$622	\$657	\$451	N/A
Z15S42TCR	16 x 15 x 41.9-42.4	100	70.71	7.50	\$592	\$621	\$397	N/A
Z12S42TCR	16 x 12 x 41.9-42.4	92.5	62.70	6	\$549	\$576	\$357	N/A

Designed to be placed on top of 29"/29.5" high units to achieve 71.5"/72.5" final height. DO NOT USE ON TOP OF 40.8"/41.3" HIGH UNITS. Laminate door is standard. Includes one adjustable shelf. Standard with lock.

Required Specifications

Top finish
Base finish
Top/Edge Detail

Optional Specifications

Collator (Open Shelves)
Glazing - Doors

TABLE TOP BOOKCASES

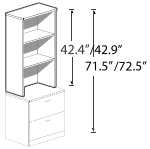
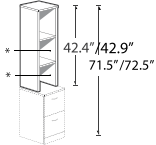
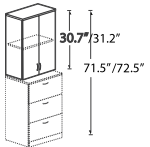

Table Top Bookcase
42.4\"/>



* Accepts collator 11\"/>

Table Top Bookcase
42.4\"/>



Glazed door option

Table Top Bookcase with Doors
30.7\"/>

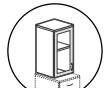
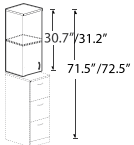

Glazed door option

Table Top Bookcase with Door
30.7\"/>

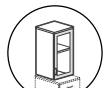
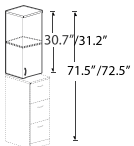

Glazed door option

Table Top Bookcase with Door
30.7\"/>

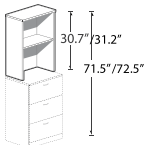

Table Top Bookcase
30.7\"/>

MODEL#	DIMENSIONS	FREIGHT CLASS	WT/LBS.	CUBIC FT.	1\"/>			
Z36S42TN	16 x 36 x 41.9-42.4	125	103.71	16.75	\$700	\$762	N/A	N/A
Z30S42TN	16 x 30 x 41.9-42.4	125	90.78	14	\$609	\$662	N/A	N/A

Designed to be placed **on top of 29\"/>**

MODEL#	D x W x H	FREIGHT CLASS	WT/LBS.	CUBIC FT.	1\"/>			
Z21S42TN	16 x 21 x 41.9-42.4	125	71.92	10	\$542	\$584	N/A	N/A
Z18S42TN	16 x 18 x 41.9-42.4	125	65.98	8.75	\$530	\$565	N/A	N/A
Z16S42TN	16 x 16 x 41.9-42.4	125	61.32	8	\$458	\$493	N/A	N/A
Z15S42TN	16 x 15 x 41.9-42.4	125	58.99	7.50	\$447	\$477	N/A	N/A
Z12S42TN	16 x 12 x 41.9-42.4	100	53.05	6	\$416	\$442	N/A	N/A

Designed to be placed **on top of 29\"/>**

Z36S31T	16 x 36 x 30.2-30.7	100	104.19	12.25	\$820	\$882	\$912	N/A
Z30S31T	16 x 30 x 30.2-30.7	100	89.36	10.50	\$734	\$787	\$793	N/A

Designed to be placed **on top of 40.8\"/>**

Z21S31TL	16 x 21 x 30.2-30.7	100	69.88	7.50	\$587	\$629	\$506	N/A
Z18S31TL	16 x 18 x 30.2-30.7	92.5	65.22	6.50	\$537	\$572	\$455	N/A
Z16S31TL	16 x 16 x 30.2-30.7	92.5	59.18	5.75	\$512	\$547	\$451	N/A
Z15S31TL	16 x 15 x 30.2-30.7	92.5	56.15	5.50	\$488	\$517	\$397	N/A
Z12S31TL	16 x 12 x 30.2-30.7	92.5	50.39	4.40	\$455	\$482	\$357	N/A

Designed to be placed **on top of 40.8\"/>**

Z21S31TR	16 x 21 x 30.2-30.7	100	69.88	7.50	\$587	\$629	\$506	N/A
Z18S31TR	16 x 18 x 30.2-30.7	92.5	65.22	6.50	\$537	\$572	\$455	N/A
Z16S31TR	16 x 16 x 30.2-30.7	92.5	59.18	5.75	\$512	\$547	\$451	N/A
Z15S31TR	16 x 15 x 30.2-30.7	92.5	56.15	5.50	\$488	\$517	\$397	N/A
Z12S31TR	16 x 12 x 30.2-30.7	92.5	50.39	4.40	\$455	\$482	\$357	N/A

Designed to be placed **on top of 40.8\"/>**

Z36S31TN	16 x 36 x 30.2-30.7	125	79.56	12.25	\$534	\$596	N/A	N/A
Z30S31TN	16 x 30 x 30.2-30.7	125	68.73	10.50	\$481	\$533	N/A	N/A

Designed to be placed **on top of 40.8\"/>**

Required Specifications

- Top finish
- Base finish
- Top/Edge Detail

Optional Specifications

- Collator (Open Shelves)
- Glazing - Doors

TABLE TOP BOOKCASES

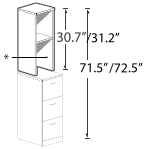

* Accepts collator 11" high

Table Top Bookcase
30.7"/31.2" High

MODEL#	DIMENSIONS D x W x H	FREIGHT CLASS	WT./LBS.	CUBIC FT.	1" TOP	1.5" TOP	GLAZE ADD	HP ADD
Z21S31TN	16 x 21 x 30.2-30.7	125	55.12	7.50	\$420	\$461	N/A	N/A
Z18S31TN	16 x 18 x 30.2-30.7	100	52.33	6.50	\$385	\$420	N/A	N/A
Z16S31TN	16 x 16 x 30.2-30.7	100	47.67	5.75	\$364	\$399	N/A	N/A
Z15S31TN	16 x 15 x 30.2-30.7	100	45.34	5.50	\$352	\$381	N/A	N/A
Z12S31TN	16 x 12 x 30.2-30.7	100	41.50	4.40	\$327	\$353	N/A	N/A

Designed to be placed on top of 40.8"/41.8" high units to achieve 71.5"/72.5" final height. Includes one adjustable shelf.

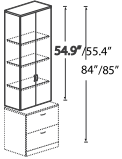

Glazed door option

Table Top Bookcase with Doors
54.9"/55.4" High

Z36S55T	16 x 36 x 54.4-54.9	100	174.25	21.50	\$1268	\$1330	\$1336	N/A
Z30S55T	16 x 30 x 54.4-54.9	100	152.16	18	\$1158	\$1211	\$1153	N/A

Designed to be placed on top of 29"/29.5" high units to achieve 84"/85" final height. Includes three adjustable shelves. Standard with lock.

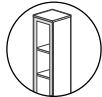
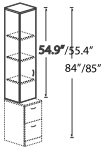

Glazed door option

Table Top Bookcase with Door - LEFT
54.9"/55.4" High

Z21S55TL	16 x 21 x 54.4-54.9	100	116.26	13	\$900	\$942	\$744	N/A
Z18S55TL	16 x 18 x 54.4-54.9	100	104.66	11.25	\$845	\$883	\$665	N/A
Z16S55TL	16 x 16 x 54.4-54.9	100	97.67	10	\$805	\$840	\$659	N/A
Z15S55TL	16 x 15 x 54.4-54.9	100	94.17	9.50	\$768	\$797	\$574	N/A
Z12S55TL	16 x 12 x 54.4-54.9	92.5	83.67	7.75	\$712	\$738	\$512	N/A

Designed to be placed on top of 29"/29.5" high units to achieve 84"/85" final height. Laminate door is standard. Includes three adjustable shelves. Standard with lock.

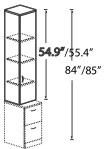

Glazed door option

Table Top Bookcase with Door - RIGHT
54.9"/55.4" High

Z21S55TR	16 x 21 x 54.4-54.9	100	116.26	13	\$900	\$942	\$744	N/A
Z18S55TR	16 x 18 x 54.4-54.9	100	104.66	11.25	\$845	\$883	\$665	N/A
Z16S55TR	16 x 16 x 54.4-54.9	100	97.67	10	\$805	\$840	\$659	N/A
Z15S55TR	16 x 15 x 54.4-54.9	100	94.17	9.50	\$768	\$797	\$574	N/A
Z12S55TR	16 x 12 x 54.4-54.9	92.5	83.67	7.75	\$712	\$738	\$512	N/A

Designed to be placed on top of 29"/29.5" high units to achieve 84"/85" final height. Laminate door is standard. Includes three adjustable shelves. Standard with lock.

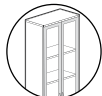
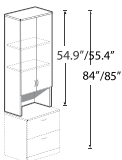

Glazed door option

Table Top Bookcase with Doors
and Cavity 54.9"/55.4" High

Z36S55TC	16 x 36 x 54.4-54.9	125	166.94	21.50	\$1235	\$1297	\$1163	N/A
Z30S55TC	16 x 30 x 54.4-54.9	100	146.06	18	\$1128	\$1181	\$1013	N/A

Designed to be placed on top of 29"/29.5" high units to achieve 84"/85" final height. Laminate doors are standard. Includes two adjustable shelves. Standard with lock.

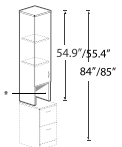

* Accepts collator 11" high

Table Top Bookcase with Door - LEFT
and Cavity 54.9"/55.4" High

Z21S55TCL	16 x 21 x 54.4-54.9	100	112	13	\$869	\$910	\$644	N/A
Z18S55TCL	16 x 18 x 54.4-54.9	100	101.01	11.25	\$819	\$854	\$578	N/A
Z16S55TCL	16 x 16 x 54.4-54.9	100	94.42	10	\$775	\$813	\$572	N/A
Z15S55TCL	16 x 15 x 54.4-54.9	100	91.12	9.50	\$739	\$769	\$504	N/A
Z12S55TCL	16 x 12 x 54.4-54.9	92.5	81.24	7.75	\$687	\$713	\$454	N/A

Designed to be placed on top of 29"/29.5" high units to achieve 84"/85" final height. Laminate door is standard. Includes two adjustable shelves. Standard with lock.

Required Specifications

Top finish
Base finish
Top/Edge Detail

Optional Specifications

Collator (Open Shelves)
Glazing - Doors

TABLE TOP BOOKCASES

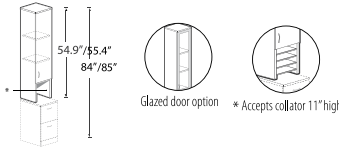

Table Top Bookcase with Door - RIGHT and Cavity - 54.9\"/>

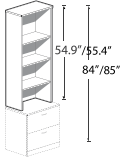

Table Top Bookcase 54.9\"/>

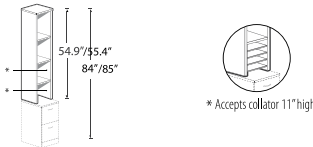

Table Top Bookcase 54.9\"/>

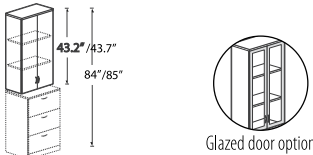

Table Top Bookcase with Doors 43.2\"/>

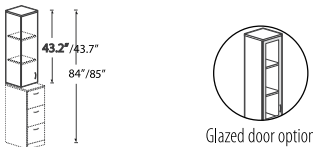

Table Top Bookcase with Door 43.2\"/>



Table Top Bookcase with Door 43.2\"/>

MODEL#	DIMENSIONS	FREIGHT CLASS	WT/LBS.	CUBIC FT.	1\"/>				
D x W x H									
Z21S55TCR	16 x 21 x 54.4-54.9	100	112	13	\$869	\$910	\$644	N/A	
Z18S55TCR	16 x 18 x 54.4-54.9	100	101.01	11.25	\$819	\$854	\$578	N/A	
Z16S55TCR	16 x 16 x 54.4-54.9	100	94.42	10	\$775	\$813	\$572	N/A	
Z15S55TCR	16 x 15 x 54.4-54.9	100	91.12	9.50	\$739	\$769	\$504	N/A	
Z12S55TCR	16 x 12 x 54.4-54.9	92.5	81.24	7.75	\$687	\$713	\$454	N/A	

Designed to be placed **on top of 29\"/>**

Z36S55TN	16 x 36 x 54.4-54.9	125	129.96	21.50	\$844	\$906	N/A	N/A
Z30S55TN	16 x 30 x 54.4-54.9	125	114.93	18	\$786	\$838	N/A	N/A

Designed to be placed **on top of 29\"/>**

Z21S55TN	16 x 21 x 54.4-54.9	125	89.77	13	\$658	\$699	N/A	N/A
Z18S55TN	16 x 18 x 54.4-54.9	125	81.73	11.25	\$626	\$661	N/A	N/A
Z16S55TN	16 x 16 x 54.4-54.9	125	77.07	10	\$586	\$621	N/A	N/A
Z15S55TN	16 x 15 x 54.4-54.9	125	74.74	9.50	\$572	\$602	N/A	N/A
Z12S55TN	16 x 12 x 54.4-54.9	100	67.75	7.75	\$534	\$560	N/A	N/A

Designed to be placed **on top of 29\"/>**

Z36S43T	16 x 36 x 42.7-43.2	100	139.22	17	\$1065	\$1127	\$1163	N/A
Z30S43T	16 x 30 x 42.7-43.2	100	120.76	14.50	\$910	\$963	\$1013	N/A

Designed to be placed **on top of 40.8\"/>**

Z21S43TL	16 x 21 x 42.7-43.2	100	93.62	10.25	\$754	\$795	\$644	N/A
Z18S43TL	16 x 18 x 42.7-43.2	100	84.94	9	\$722	\$757	\$578	N/A
Z16S43TL	16 x 16 x 42.7-43.2	100	78.42	8	\$647	\$682	\$572	N/A
Z15S43TL	16 x 15 x 42.7-43.2	92.5	75.16	7.50	\$609	\$638	\$504	N/A
Z12S43TL	16 x 12 x 42.7-43.2	92.5	66.48	6.25	\$564	\$591	\$454	N/A

Designed to be placed **on top of 40.8\"/>**

Z21S43TR	16 x 21 x 42.7-43.2	100	93.62	10.25	\$754	\$795	\$644	N/A
Z18S43TR	16 x 18 x 42.7-43.2	100	84.94	9	\$722	\$757	\$578	N/A
Z16S43TR	16 x 16 x 42.7-43.2	100	78.42	8	\$647	\$682	\$572	N/A
Z15S43TR	16 x 15 x 42.7-43.2	92.5	75.16	7.50	\$609	\$638	\$504	N/A
Z12S43TR	16 x 12 x 42.7-43.2	92.5	66.48	6.25	\$564	\$591	\$454	N/A

Designed to be placed **on top of 40.8\"/>**

Required Specifications

- Top finish
- Base finish
- Top/Edge Detail

Optional Specifications

- Collator (Open Shelves)
- Glazing - Doors

TABLE TOP BOOKCASES

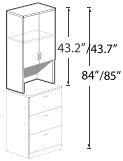

Glazed door option

Table Top Bookcase with Doors and Cavity - 43.2\"/>

MODEL#	DIMENSIONS D x W x H	FREIGHT CLASS	WT/LBS.	CUBIC FT.	1\"/>			
Z36S43TC	16 x 36 x 42.7-43.2	125	131.91	17	\$1030	\$1092	\$915	N/A
Z30S43TC	16 x 30 x 42.7-43.2	125	114.67	14.50	\$901	\$953	\$780	N/A

Designed to be placed **on top of 40.8\"/>**

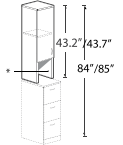

Glazed door option



* Accepts collator 11\"/>

Table Top Bookcase with Door and Cavity - 43.2\"/>

Z21S43TCL	16 x 21 x 42.7-43.2	100	89.36	10.25	\$734	\$776	\$505	N/A
Z18S43TCL	16 x 18 x 42.7-43.2	100	81.29	9	\$704	\$739	\$454	N/A
Z16S43TCL	16 x 16 x 42.7-43.2	100	75.17	8	\$630	\$665	\$450	N/A
Z15S43TCL	16 x 15 x 42.7-43.2	100	72.11	7.50	\$594	\$623	\$396	N/A
Z12S43TCL	16 x 12 x 42.7-43.2	92.5	64.05	6.25	\$551	\$578	\$357	N/A

Designed to be placed **on top of 40.8\"/>**

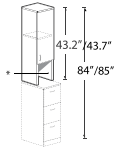

Glazed door option



* Accepts collator 11\"/>

Table Top Bookcase with Door and Cavity - 43.2\"/>

Z21S43TCR	16 x 21 x 42.7-43.2	100	89.36	10.25	\$734	\$776	\$505	N/A
Z18S43TCR	16 x 18 x 42.7-43.2	100	81.29	9	\$704	\$739	\$454	N/A
Z16S43TCR	16 x 16 x 42.7-43.2	100	75.17	8	\$630	\$665	\$450	N/A
Z15S43TCR	16 x 15 x 42.7-43.2	100	72.11	7.50	\$594	\$623	\$396	N/A
Z12S43TCR	16 x 12 x 42.7-43.2	92.5	64.05	6.25	\$551	\$578	\$357	N/A

Designed to be placed **on top of 40.8\"/>**

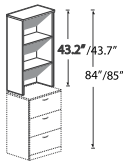
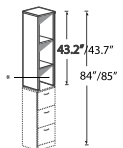

Table Top Bookcase 43.2\"/>

Z36S43TN	16 x 36 x 42.7-43.2	125	104.76	17	\$721	\$783	N/A	N/A
Z30S43TN	16 x 30 x 42.7-43.2	125	91.83	14.50	\$625	\$678	N/A	N/A

Designed to be placed **on top of 40.8\"/>**



* Accepts collator 11\"/>

Table Top Bookcase* 43.2\"/>

Z21S43TN	16 x 21 x 42.7-43.2	125	72.97	10.25	\$556	\$598	N/A	N/A
Z18S43TN	16 x 18 x 42.7-43.2	125	67.03	9	\$541	\$576	N/A	N/A
Z16S43TN	16 x 16 x 42.7-43.2	125	62.37	8	\$465	\$500	N/A	N/A
Z15S43TN	16 x 15 x 42.7-43.2	100	60.04	7.50	\$448	\$478	N/A	N/A
Z12S43TN	16 x 12 x 42.7-43.2	100	54.10	6.25	\$417	\$443	N/A	N/A

Designed to be placed **on top of 40.8\"/>**

Required Specifications

Top finish
Base finish
Top/edge detail

Optional Specifications

Collator**
Glazed doors*

END SHELVES

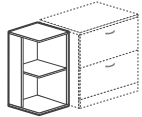

End Shelf - LEFT 29"/29.5" High*

MODEL#	DIMENSIONS D x W x H	FREIGHT CLASS	WT/LBS.	CUBIC FT.	1" TOP	1.5" TOP	GLAZE ADD	HP ADD
Z24L2ESHL	24 x 24 x 29.5-30	70	99.75	4.75	\$617	\$669	N/A	\$121
Z20M2ESHL	20 x 20 x 29.5-30	70	76.65	3.75	\$512	\$551	N/A	\$77
Z16S2ESHL	16 x 16 x 29.5-30	65	53.55	2.25	\$435	\$470	N/A	\$77

For use at **LEFT end of 29"/29.5"H units. One adjustable shelf.** Shipped RTA (ready to assemble).

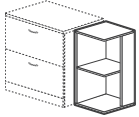

End Shelf - RIGHT 29"/29.5" High*

Z24L2ESHR	24 x 24 x 29.5-30	70	99.75	4.75	\$617	\$669	N/A	\$121
Z20M2ESHR	20 x 20 x 29.5-30	70	76.65	3.75	\$512	\$551	N/A	\$77
Z16S2ESHR	16 x 16 x 29.5-30	65	53.55	2.25	\$435	\$470	N/A	\$77

For use at **RIGHT end of 29"/29.5"H units. One adjustable shelf.** Shipped RTA (ready to assemble).

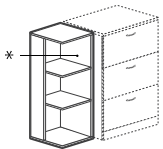

* Accepts collator 11" high

End Shelf - LEFT 40.8"/41.3" High**

Z24L4ESHL	24 x 24 x 41.3-41.8	65	130.20	4.75	\$792	\$845	N/A	N/A
Z20M4ESHL	20 x 20 x 41.3-41.8	60	101	3.25	\$665	\$704	N/A	N/A
Z16S4ESHL	16 x 16 x 41.3-41.8	65	73.87	2.50	\$565	\$600	N/A	N/A

For use at **LEFT end of 40.8"/41.3"H units. Two adjustable shelves.** Shipped RTA (ready to assemble).

- Collator only available on **Z16S4ESHL**

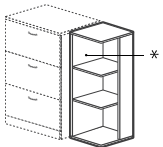

* Accepts collator 11" high

End Shelf - RIGHT 40.8"/41.3" High**

Z24L4ESHR	24 x 24 x 41.3-41.8	65	130.20	4.75	\$792	\$845	N/A	N/A
Z20M4ESHR	20 x 20 x 41.3-41.8	60	101	3.25	\$665	\$704	N/A	N/A
Z16S4ESHR	16 x 16 x 41.3-41.8	65	73.87	2.50	\$565	\$600	N/A	N/A

For use at **RIGHT end of 40.8"/41.3"H units. Two adjustable shelves.** Shipped RTA (ready to assemble).

- Collator only available on **Z16S4ESHR**

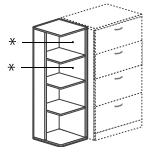

* Accepts collator 11" high

End Shelf - LEFT 52.5"/53" High**

Z24L5ESHL	24 x 24 x 53-53.5	60	162.75	4.75	\$982	\$1034	N/A	N/A
Z20M5ESHL	20 x 20 x 53-53.5	60	125.69	4	\$810	\$849	N/A	N/A
Z16S5ESHL	16 x 16 x 53-53.5	65	91.35	3.25	\$683	\$721	N/A	N/A

For use at **LEFT end of 52.5"/53"H units. Three adjustable shelves.** Shipped RTA (ready to assemble).

- Collator only available on **Z16S5ESHL**

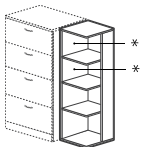

* Accepts collator 11" high

End Shelf - RIGHT 52.5"/53" High**

Z24L5ESHR	24 x 24 x 53-53.5	60	162.75	4.75	\$982	\$1034	N/A	N/A
Z20M5ESHR	20 x 20 x 53-53.5	60	125.69	4	\$810	\$849	N/A	N/A
Z16S5ESHR	16 x 16 x 53-53.5	65	91.35	3.25	\$683	\$721	N/A	N/A

For use at **RIGHT end of 52.5"/53"H units. Three adjustable shelves.** Shipped RTA (ready to assemble).

- Collator only available on **Z16S5ESHR**

Required Specifications

Top finish
Base finish
Top/edge detail

Optional Specifications

Collator**
HP laminate*

END SHELVES

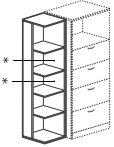

* Accepts collator 11" high

End Shelf - LEFT 65"/65.5" High

MODEL#	DIMENSIONS D x W x H	FREIGHT CLASS	WT/LBS.	CUBIC FT.	1" TOP	1.5" TOP	GLAZE ADD	HP ADD
Z24L6ESHL	24 x 24 x 65.5-66	60	196	6	\$1148	\$1201	N/A	N/A
Z20M6ESHL	20 x 20 x 65.5-66	60	152	5	\$954	\$993	N/A	N/A
Z16S6ESHL	16 x 16 x 65.5-66	65	111.30	4.25	\$814	\$849	N/A	N/A

For use at **LEFT end of 65"/65.5"H units. Four adjustable shelves.** Shipped RTA (ready to assemble).
 • Collator only available on **Z16S6ESHL**

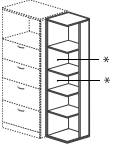

* Accepts collator 11" high

End Shelf - RIGHT 65"/65.5" High

Z24L6ESHR	24 x 24 x 65.5-66	60	196	6	\$1148	\$1201	N/A	N/A
Z20M6ESHR	20 x 20 x 65.5-66	60	152	5	\$954	\$993	N/A	N/A
Z16S6ESHR	16 x 16 x 65.5-66	65	111.30	4.25	\$814	\$849	N/A	N/A

For use at **RIGHT end of 65"/65.5"H units. Four adjustable shelves.** Shipped RTA (ready to assemble).
 • Collator only available on **Z16S6ESHR**

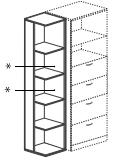

* Accepts collator 11" high

End Shelf - LEFT 71.5"/72" High

Z24L7ESHL	24 x 24 x 71.9-72.4	60	206.85	6.50	\$1205	\$1257	N/A	N/A
Z20M7ESHL	20 x 20 x 71.9-72.4	65	160.65	5.75	\$1006	\$1045	N/A	N/A
Z16S7ESHL	16 x 16 x 71.9-72.4	65	117.60	4.75	\$856	\$891	N/A	N/A

For use at **LEFT end of 71.5"/72"H units. Four adjustable shelves.** Shipped RTA (ready to assemble).
 • Collator only available on **Z16S7ESHL**

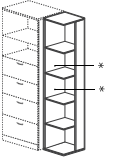

* Accepts collator 11" high

End Shelf - RIGHT 71.5"/72" High

Z24L7ESHR	24 x 24 x 71.9-72.4	60	206.85	6.50	\$1205	\$1257	N/A	N/A
Z20M7ESHR	20 x 20 x 71.9-72.4	65	160.65	5.75	\$1006	\$1045	N/A	N/A
Z16S7ESHR	16 x 16 x 71.9-72.4	65	117.60	4.75	\$856	\$891	N/A	N/A

For use at **RIGHT end of 71.5"/72"H units. Four adjustable shelves.** Shipped RTA (ready to assemble).
 • Collator only available on **Z16S7ESHR**

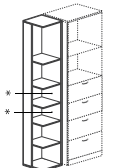

* Accepts collator 11" high

End Shelf - LEFT 84"/84.5" High

Z24L8ESHL	24 x 24 x 84.4-84.9	60	241.50	7.75	\$1383	\$1435	N/A	N/A
Z20M8ESHL	20 x 20 x 84.4-84.9	65	185.85	6.50	\$1153	\$1192	N/A	N/A
Z16S8ESHL	16 x 16 x 84.4-84.9	65	136.50	5.50	\$979	\$1014	N/A	N/A

For use at **LEFT end of 84"/84.5"H units. Five adjustable shelves.** Shipped RTA (ready to assemble).
 • Collator only available on **Z16S8ESHL**

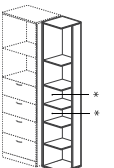

* Accepts collator 11" high

End Shelf - RIGHT 84"/84.5" High

Z24L8ESHR	24 x 24 x 84.4-84.9	60	241.50	7.75	\$1383	\$1435	N/A	N/A
Z20M8ESHR	20 x 20 x 84.4-84.9	65	185.85	6.50	\$1153	\$1192	N/A	N/A
Z16S8ESHR	16 x 16 x 84.4-84.9	65	136.50	5.50	\$979	\$1014	N/A	N/A

For use at **RIGHT end of 84"/84.5"H units. Five adjustable shelves.** Shipped RTA (ready to assemble).
 • Collator only available on **Z16S8ESHR**

Required Specifications

Top finish
 Base finish
 Top/edge detail

Optional Specifications

Collator

TABLE TOP END SHELVES

MODEL# DIMENSIONS FREIGHT CLASS WT/LBS. CUBIC FT. 1" TOP 1.5" TOP GLAZE ADD HP ADD

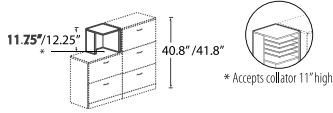

Table Top End Shelf - LEFT
11.75\"/>

D x W x H									
Z16S12DL	16 x 16 x 11.25-11.75	70	26	1.60	\$221	\$256	N/A	N/A	

To be placed **on top of 29\"/>**

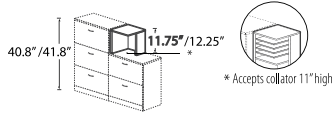

Table Top End Shelf - RIGHT
11.75\"/>

Z16S12DR	16 x 16 x 11.25-11.75	70	26	1.60	\$221	\$256	N/A	N/A	
----------	-----------------------	----	----	------	-------	-------	-----	-----	--

To be placed **on top of 29\"/>**

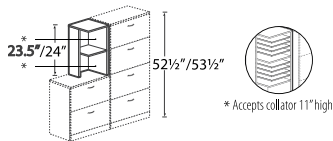

Table Top End Shelf - LEFT
23.5\"/>

Z16S23DL	16 x 16 x 23-23.5	65	42	1.60	\$339	\$377	N/A	N/A	
----------	-------------------	----	----	------	-------	-------	-----	-----	--

To be placed **on top of 29\"/>**

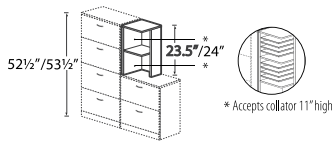

Table Top End Shelf - RIGHT
23.5\"/>

Z16S23DR	16 x 16 x 23-23.5	65	42	1.60	\$339	\$377	N/A	N/A	
----------	-------------------	----	----	------	-------	-------	-----	-----	--

To be placed **on top of 29\"/>**

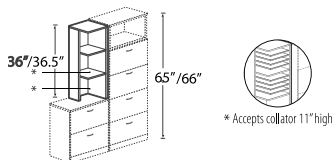

Table Top End Shelf - LEFT
36\"/>

Z16S36DL	16 x 16 x 35.5-36	70	62.84	2.80	\$473	\$508	N/A	N/A	
----------	-------------------	----	-------	------	-------	-------	-----	-----	--

To be placed **on top of 29\"/>**

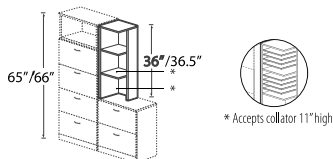

Table Top End Shelf - RIGHT
36\"/>

Z16S36DR	16 x 16 x 35.5-36	70	62.84	2.80	\$473	\$508	N/A	N/A	
----------	-------------------	----	-------	------	-------	-------	-----	-----	--

To be placed **on top of 29\"/>**

Required Specifications

Top finish
Base finish
Top/edge detail

Optional Specifications

Collator

TABLE TOP END SHELVES

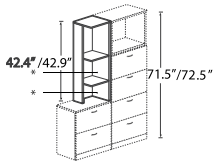

Table Top End Shelf - LEFT*
42.4\"/>



* Accepts collator 11\"/>

MODEL#	DIMENSIONS	FREIGHT CLASS	WT/LBS.	CUBIC FT.	1\"/>			
Z16S42DL	16-36 x 16 x 41.9-42.4	65	70	2.80	\$511	\$546	N/A	N/A

To be placed **on top of 29\"/>**

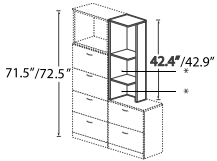

Table Top End Shelf - RIGHT*
42.4\"/>



* Accepts collator 11\"/>

Z16S42DR	16-36 x 16 x 41.9-42.4	65	70	2.80	\$511	\$546	N/A	N/A
----------	------------------------	----	----	------	-------	-------	-----	-----

To be placed **on top of 29\"/>**

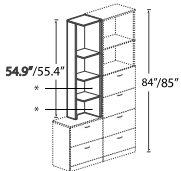

Table Top End Shelf - LEFT*
54.9\"/>



* Accepts collator 11\"/>

Z16S55DL	16-36 x 16 x 54.4-54.9	60	89	2.80	\$630	\$668	N/A	N/A
----------	------------------------	----	----	------	-------	-------	-----	-----

To be placed **on top of 29\"/>**

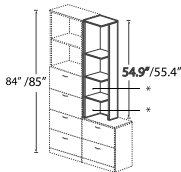

Table Top End Shelf - RIGHT*
54.9\"/>



* Accepts collator 11\"/>

Z16S55DR	16-36 x 16 x 54.4-54.9	60	89	2.80	\$630	\$668	N/A	N/A
----------	------------------------	----	----	------	-------	-------	-----	-----

To be placed **on top of 29\"/>**

ACCESSORIES

LIST PRICE

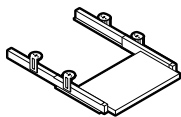

Pull-Out Keyboard

APOKL28	17 x 28 x 3.5	85	13	.90	\$312
APOKL22	17 x 22 x 3.5	85	12	.90	\$282

APOKL28 will accommodate keyboard and mousepad. **APOKL28** will only fit on a single pedestal desk, freestanding table, or **Z42205C**.

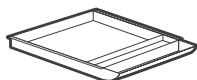

Pencil Drawer

W1518PDR	18 x 15 x 2.25	92.5	4	0.4	\$253
----------	----------------	------	---	-----	-------

Black ABS plastic. Provides space for writing instruments and small items at the workspace. Attaches to underside of any 24\"/>

Required Specifications

Finishes
Top/edge detail*

Optional Specifications

Collator*

ACCESSORIES



L Bracket

MODEL#	DIMENSIONS	FREIGHT CLASS	WT/LBS.	CUBIC FT.	LIST PRICE
MLB90	D x W x H --	70	1	.01	\$55

Used to attach worksurfaces to end panels.



LEFT Skateboard

RIGHT

Z1425SKL (left)	13.9-36 x 25 x 3.2-3.7	100	13	1.50	\$126
---------------------------	------------------------	-----	----	------	--------------

Z1425SKR (right)	13.9-36 x 25 x 3.2-3.7	100	13	1.50	\$126
----------------------------	------------------------	-----	----	------	--------------

Mobile CPU holder designed to fit inside 'faux' pedestals of a single pedestal desk.

CENTER DRAWERS

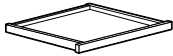

Center Drawer

MODEL#	DIMENSIONS	FREIGHT CLASS	WT/LBS.	CUBIC FT.	LIST PRICE
CD20	18 x 20 x 3	100	8	1	\$198

Laminate drawer front is attached to a 4-sided frame. Recommended for use on small L-shaped units, and on 30" x 60" and 66" desks.

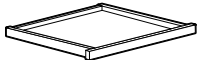

Center Drawer

CD28	18 x 28 x 3	150	5	1	\$260
------	-------------	-----	---	---	--------------

Laminate drawer front is attached to a 4-sided frame. Recommended for use on 36" x 72" desks.

Required Specifications

Finishes

Z ZIRA™ BOARDROOM - NOTES

TOP AND BASE FINISHES

ACJ	Absolute Acajou	NGL	Noce Grigio
ASN	Asian Night	NEL	Noce Leggero
AWC	Avant Cherry	NML	Noce Medio
AWH	Avant Honey	QTM	Quartered Mahogany
BLK	Black	SOG	Storm Grey
BRC	Brushed Cobalt	TFW	Tiger Fruitwood
CMB	Clear Maple	TWL	Tiger Walnut
DES	Dark Espresso	WHE	Walnut Heights
DWT	Designer White	WHC	White Chocolate
HGT	Hayden Grey	WGY	Willow Grey
NBL	Noce Biondo	WCR	Winter Cherry

BASE TRIM FINISHES

BRC	Brushed Cobalt
BLK	Black

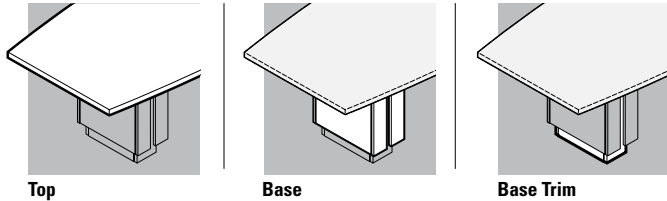

TOP THICKNESS/EDGE DETAIL



BASES

- 2 doors on base for wire management access from both sides

TOPS

- 96" tops are standard in one piece. All tops 120", 144" and 168" tops are standard in two equal size pieces. Woodgrain laminate finishes may NOT align where the two tops join. Tops 192" and larger are standard in 3 equal pieces.
- 96" tops are standard with **two bases**
- Tops 120", 144" and 168" are standard with **three bases**
- Tops 192" and larger are standard with **four bases**
- Four top shapes: **Boat shaped, Bow End, Rectangular** and **Racetrack**

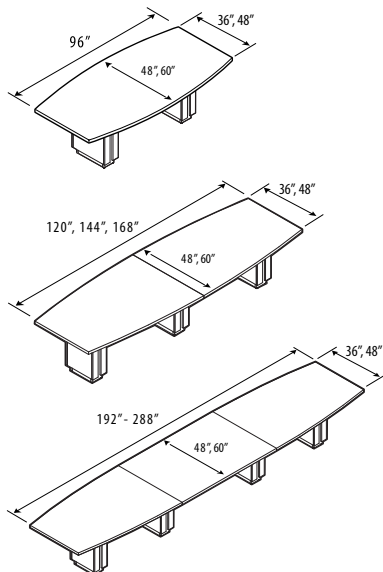

POWER & TECHNOLOGY SOLUTIONS

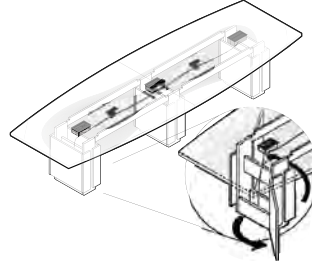

PRODUCT CODE DIAGRAM

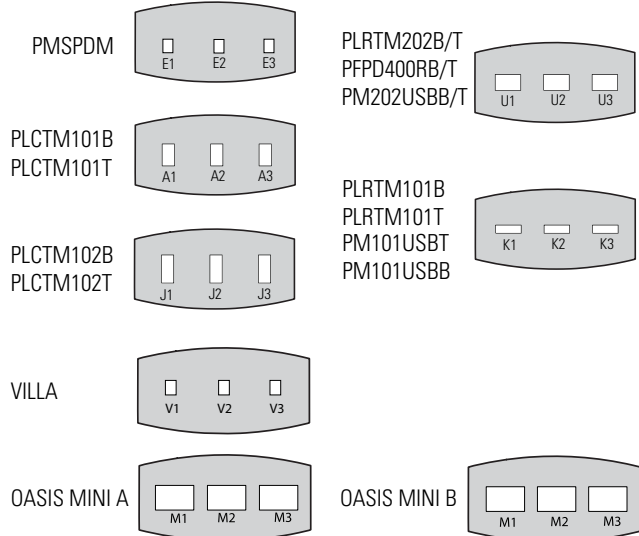

CUT-OUTS

- Optional cut-out available in standard worksurface locations (left, center or right) for all table shapes. **Add \$88 for each cut-out.**
- Select power block option from **Productivity Solutions** section
- Optional custom sized cut-out available in standard locations (left, center or right) for all table shapes. Submit appropriate form beginning on page 739 with order. **Add \$272** for each cut-out.
- Cut-outs may be placed at non-standard locations. Please contact customer care.
- Match power block desired with cut-out code and location from above grid.
Note: J1, J2 and J3 cut-outs not available on Zira collaborative tables.

AUDIOVISUAL

Three components:
Multimedia Cart

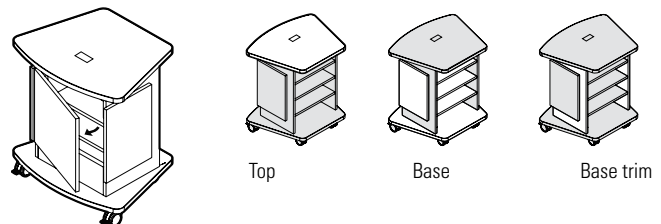

Lectern

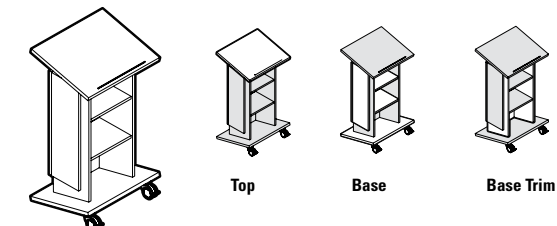

Visual Board

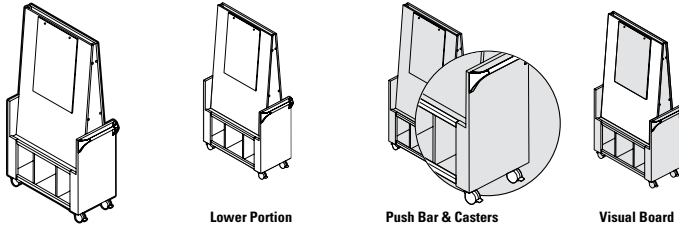

Multimedia Cart and Lectern:

- Available in all laminates listed above
- Color of casters will match base trim
- Offered in the following **top thickness and edge details:**

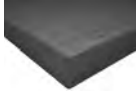

A3 1" top, standard



AR 1" top, bicut edge



C3 1.5" top, standard



CR 1.5" top, bicut edge



CF 1.5" top, fluted edge

Visual Board:

- Available in all laminates listed above
- Push Bar available in Black (BLK) or Tungsten (TUN)
- Color of casters and aluminum trim will match push bar
- Visual Board comes standard in white color

BUFFET

Three components: **Buffet Carts, Buffets** and **Serving Carts**

- Top and/or base available in all laminates
- Push Bar on Buffet Carts and Serving Carts and Aluminum Trim on Open and Mixed Buffets available in Black (BLK) or Tungsten (TUN)
- Optional glazing available on Serving Carts with doors and Buffets with doors

Buffet Carts

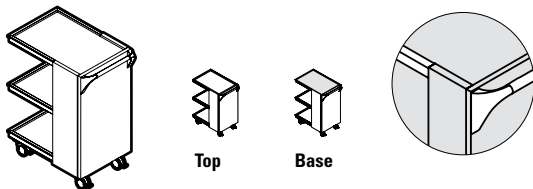

Serving Cart with Doors

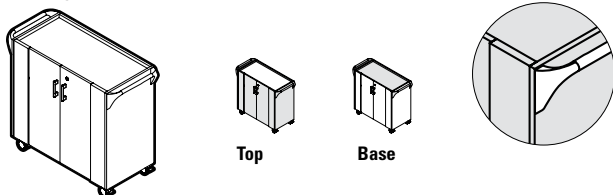

Serving Cart - Open

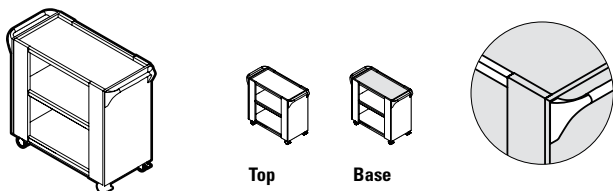

Buffet - Open

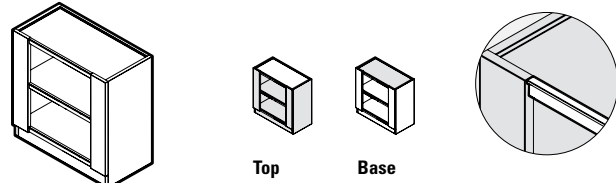

Buffet with Doors

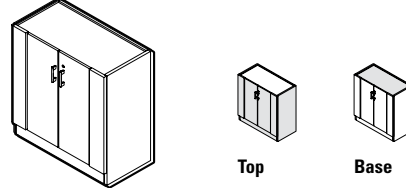

Buffet - Mixed

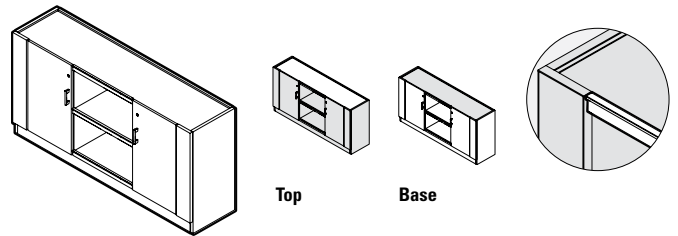

Glazing (Doors - Serving Cart and Buffets)



Z1 frosted glazing, Tungsten (TUN) frame



Z2 frosted glazing, Black (BLK) frame



Z3 ribbed glazing, Tungsten (TUN) frame



Z4 ribbed glazing, Black (BLK) frame

Handles

- Handles are standard on models with doors. Each handle is identified by the letters "HU", "HV", "HW", "HX", "HS", "HZ", "HO", "HQ", and "HR". To specify a handle, please specify the code after the model number.



HS Flared Silver



HV Square Edge Silver



HO Crescent Black



HW Flared Brass



HU Square Edge Black



HZ Dimpled Nickel



HX Flared Black



HQ Bar Silver



HR Bar Black

Z ZIRA™ BOARDROOM

TABLE NOTES - ESTIMATED CAPACITY

- Use the following for determining the size of a table and the number of chairs needed for a conference area. All estimates are based on an average chair width of 23" with a 4" clearance between chairs. Adjust accordingly for a different chair size.

Top Size	Rectangular	Bow End	Boat	Racetrack
48x96	6-8	6-8	6-8	6-8
48x120	8-10	8-10	8-10	8-10
48x144	10-12	10-12	10-12	10-12
48x168	12-14	12-14	12-14	12-14
48x192	14-16	14-16	14-16	14-16
48x216	16-18	16-18	16-18	16-18
48x240	18-20	18-20	18-20	18-20
48x264	20-22	20-22	20-22	20-22
48x288	22-24	22-24	22-24	22-24

BOARDROOM TABLES

MODEL#	DIMENSIONS	FREIGHT CLASS	WT/LBS.	CUBIC FT.	1"TOP	1.5" TOP	GLAZE ADD	HP ADD
--------	------------	---------------	---------	-----------	-------	----------	-----------	--------

D x W x H (1.5" TOP)

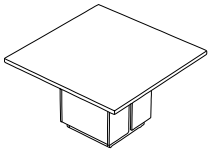

Boardroom Table - Square

Z3636SQ	36 x 36 x 30	85	129	10	N/A	\$2226	N/A	\$329
Z4242SQ	42 x 42 x 30	85	165.50	13.50	N/A	\$2535	N/A	\$451
Z4848SQ	48 x 48 x 30	85	190	14.24	N/A	\$2746	N/A	\$583
Z5454SQ	54 x 54 x 30	85	262	21.24	N/A	\$3072	N/A	\$739
Z6060SQ	60 x 60 x 30	85	300	22.74	N/A	\$3283	N/A	\$909

Square Table includes ONE BASE with wire access doors on each side of base. Shipped in 2 cartons.

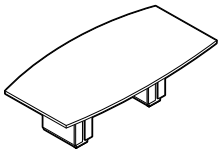

Boardroom Table - Boat Shaped

Z4896BE	48 x 96 x 30	70	342	21.95	N/A	\$3629	N/A	\$895
---------	--------------	----	-----	-------	-----	---------------	-----	--------------

Boat Shaped Table includes TWO BASES with wire access doors on each side of base and wire concealment runners between bases. Shipped in 3 cartons.

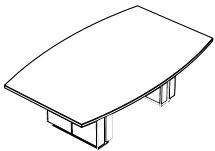

Boardroom Table - Boat Shaped

Z6096BE	60 x 96 x 30	85	432	35.39	N/A	\$5889	N/A	\$1454
---------	--------------	----	-----	-------	-----	---------------	-----	---------------

Boat Shaped Table includes TWO BASES with wire access doors on each side of base and wire concealment runners between bases. Shipped in 3 cartons.

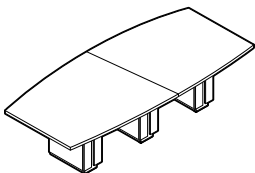

Boardroom Table - Boat Shaped

Z48120BE	48 x 120 x 30	70	452	23.48	N/A	\$5217	N/A	\$1118
Z48144BE	48 x 144 x 30	70	502	25.72	N/A	\$5268	N/A	\$1340
Z48168BE	48 x 168 x 30	85	557	37.25	N/A	\$7030	N/A	\$1695

Boat Shaped Table includes THREE BASES with wire access doors on each side of base and wire concealment runners between bases. Z48144BE and Z48120BE shipped in 4 cartons. Z48168BE shipped in 5 cartons.

Required Specifications

Top finish
Top/edge detail
Base finish
Base trim finish

Optional Specifications

HP laminate
Additional grommet

Accessories

Power block

BOARDROOM TABLES

MODEL# DIMENSIONS FREIGHT CLASS WT/LBS. CUBIC FT. 1"TOP 1.5" TOP GLAZE ADD HP ADD

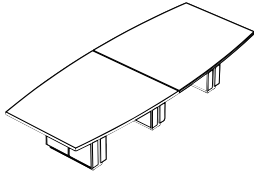

Boardroom Table - Boat Shaped

	D x W x H (1.5" TOP)								
Z60120BE	60 x 120 x 30	85	599	48.50	N/A	\$8928	N/A	\$1815	
Z60144BE	60 x 144 x 30	85	664.65	53.25	N/A	\$9556	N/A	\$2179	
Z60168BE	60 x 168 x 30	85	741.30	58	N/A	\$10304	N/A	\$2541	

Boat Shaped Table includes THREE BASES with wire access doors on each side of base and wire concealment runners between bases. Shipped in 5 cartons.

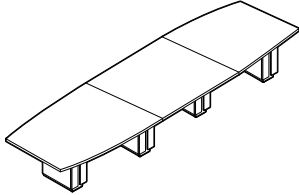

Boardroom Table - Boat Shaped

Z48192BE	48 x 192 x 30	70	688	45.66	N/A	\$8780	N/A	\$1936	
Z48216BE	48 x 216 x 30	70	746	48.67	N/A	\$9193	N/A	\$2179	
Z48240BE	48 x 240 x 30	70	803	51.68	N/A	\$9774	N/A	\$2420	
Z48264BE	48 x 264 x 30	70	855	54.69	N/A	\$10352	N/A	\$2662	
Z48288BE	48 x 288 x 30	70	906	57.69	N/A	\$10352	N/A	\$2903	

Boat Shaped Table includes FOUR BASES with wire access doors on each side of base and wire concealment runners between bases. Shipped in 7 cartons.

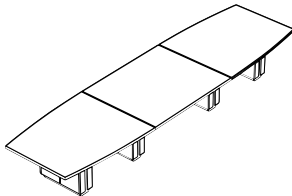

Boardroom Table - Boat Shaped

Z60192BE	60 x 192 x 30	85	912.45	71.19	N/A	\$12962	N/A	\$2903	
Z60216BE	60 x 216 x 30	85	980.70	75.94	N/A	\$13688	N/A	\$3264	
Z60240BE	60 x 240 x 30	85	1062.60	80.98	N/A	\$14276	N/A	\$3629	
Z60264BE	60 x 264 x 30	85	1129.80	85.73	N/A	\$14843	N/A	\$3991	
Z60288BE	60 x 288 x 30	85	1198.05	90.49	N/A	\$15747	N/A	\$4355	

Boat Shaped Table includes FOUR BASES with wire access doors on each side of base and wire concealment runners between bases. Shipped in 7 cartons.

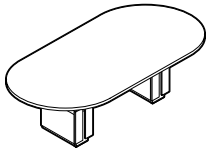

Boardroom Table - Racetrack

Z4896RTE	48 x 96 x 30	70	336	21.95	N/A	\$3528	N/A	\$895	
----------	--------------	----	-----	-------	-----	---------------	-----	--------------	--

Racetrack Shaped Table includes TWO BASES with wire access doors on each side of base and wire concealment runners between bases. Shipped in 3 cartons.

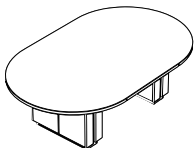

Boardroom Table - Racetrack

Z6096RTE	60 x 96 x 30	92.5	417	35.39	N/A	\$5889	N/A	\$1454	
----------	--------------	------	-----	-------	-----	---------------	-----	---------------	--

Racetrack Shaped Table includes TWO BASES with wire access doors on each side of base and wire concealment runners between bases. Shipped in 3 cartons.

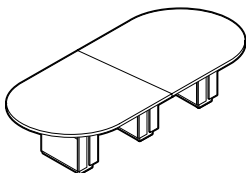

Boardroom Table - Racetrack

Z48120RTE	48 x 120 x 30	70	453	28.28	N/A	\$4906	N/A	\$1118	
Z48144RTE	48 x 144 x 30	70	506	25.72	N/A	\$5229	N/A	\$1340	
Z48168RTE	48 x 168 x 30	70	563	37.25	N/A	\$7073	N/A	\$1297	

Racetrack Shaped Table includes THREE BASES with wire access doors on each side of base and wire concealment runners between bases. Z48144RTE and Z48120RTE shipped in 4 cartons. Z48168RTE shipped in 5 cartons.

Required Specifications

Top finish
Top/edge detail
Base finish
Base trim finish

Optional Specifications

HP laminate
Additional grommet

Accessories

Power block

BOARDROOM TABLES

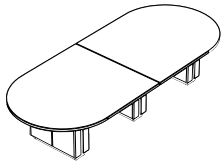

Boardroom Table - Racetrack

MODEL#	DIMENSIONS D x W x H (1.5" TOP)	FREIGHT CLASS	WT/LBS.	CUBIC FT.	1" TOP	1.5" TOP	GLAZE ADD	HP ADD
Z6012ORTE	60 x 120 x 30	85	585.90	48.50	N/A	\$8928	N/A	\$1815
Z60144ORTE	60 x 144 x 30	85	656.25	53.25	N/A	\$9556	N/A	\$2179
Z60168ORTE	60 x 168 x 30	85	737.10	58	N/A	\$10304	N/A	\$2541

Racetrack Shaped Table includes THREE BASES with wire access doors on each side of base and wire concealment runners between bases. Shipped in 5 cartons.

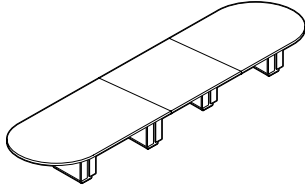

Boardroom Table - Racetrack

Z48192RTE	48 x 192 x 30	70	689	45.45	N/A	\$8824	N/A	\$1936
Z48216RTE	48 x 216 x 30	70	749	48.95	N/A	\$9235	N/A	\$2179
Z48240RTE	48 x 240 x 30	70	809	51.75	N/A	\$9815	N/A	\$2420
Z48264RTE	48 x 264 x 30	70	862	54.55	N/A	\$10395	N/A	\$2662
Z48288RTE	48 x 288 x 30	70	917	58.04	N/A	\$10395	N/A	\$2903

Racetrack Shaped Table includes FOUR BASES with wire access doors on each side of base and wire concealment runners between bases. Shipped in 7 cartons.

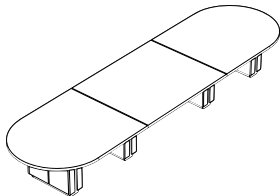

Boardroom Table - Racetrack

Z60192RTE	60 x 192 x 30	85	901.95	71.19	N/A	\$12962	N/A	\$2903
Z60216RTE	60 x 216 x 30	85	972.30	75.94	N/A	\$13688	N/A	\$3264
Z60240RTE	60 x 240 x 30	85	1057.35	80.98	N/A	\$14276	N/A	\$3629
Z60264RTE	60 x 264 x 30	85	1127.70	85.73	N/A	\$14843	N/A	\$3991
Z60288RTE	60 x 288 x 30	85	1198.05	90.49	N/A	\$15747	N/A	\$4355

Racetrack Shaped Table includes FOUR BASES with wire access doors on each side of base and wire concealment runners between bases. Shipped in 7 cartons.

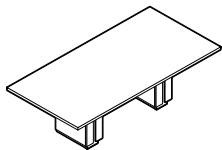

Boardroom Table - Rectangular

Z4896REE	48 x 96 x 30	70	356	21.95	N/A	\$3611	N/A	\$895
----------	--------------	----	-----	-------	-----	---------------	-----	--------------

Rectangular Shaped Table includes TWO BASES with wire access doors on each side of base and wire concealment runners between bases. Shipped in 3 cartons.

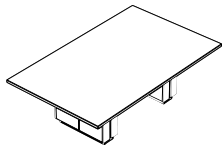

Boardroom Table - Rectangular

Z6096REE	60 x 96 x 30	85	448	35.39	N/A	\$5399	N/A	\$1454
----------	--------------	----	-----	-------	-----	---------------	-----	---------------

Rectangular Shaped Table includes TWO BASES with wire access doors on each side of base and wire concealment runners between bases. Shipped in 3 cartons.

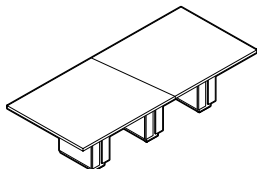

Boardroom Table - Rectangular

Z48120REE	48 x 120 x 30	70	472	23.48	N/A	\$4889	N/A	\$1118
Z48144REE	48 x 144 x 30	70	525	25.72	N/A	\$5234	N/A	\$1340
Z48168REE	48 x 168 x 30	70	583	37.25	N/A	\$6969	N/A	\$1695

Rectangular Shaped Table includes THREE BASES with wire access doors on each side of base and wire concealment runners between bases. Z48144REE and Z48120REE shipped in 4 cartons. Z48168REE shipped in 5 cartons.

Required Specifications

Top finish
Top/edge detail
Base finish
Base trim finish

Optional Specifications

HP laminate
Additional grommet

Accessories

Power block

BOARDROOM TABLES

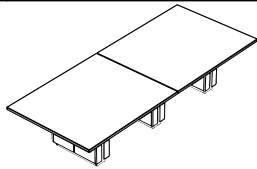

Boardroom Table - Rectangular

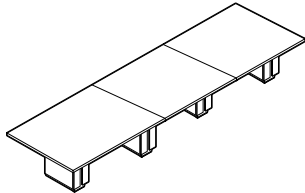

Boardroom Table - Rectangular

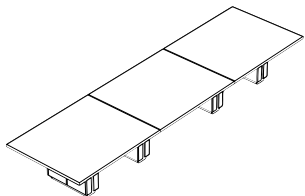

Boardroom Table - Rectangular

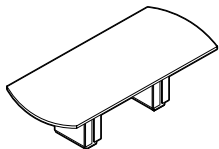

Boardroom Table - Bow End

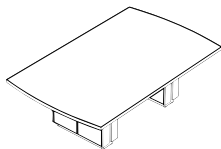

Boardroom Table - Bow End

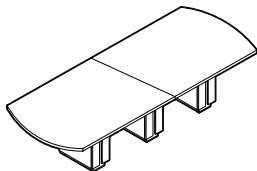

Boardroom Table - Bow End

MODEL#	DIMENSIONS D x W x H (1.5" TOP)	FREIGHT CLASS	WT/LBS.	CUBIC FT.	1" TOP	1.5" TOP	GLAZE ADD	HP ADD
Z60120REE	60 x 120 x 30	85	618	48.50	N/A	\$8184	N/A	\$1815
Z60144REE	60 x 144 x 30	85	688	53.25	N/A	\$8759	N/A	\$2179
Z60168REE	60 x 168 x 30	85	769	58	N/A	\$9433	N/A	\$2541

Rectangular Shaped Table includes THREE BASES with wire access doors on each side of base and wire concealment runners between bases. Shipped in 5 cartons.

Z48192REE	48 x 192 x 30	70	708	45.45	N/A	\$8721	N/A	\$1936
Z48216REE	48 x 216 x 30	70	768	48.95	N/A	\$9133	N/A	\$2179
Z48240REE	48 x 240 x 30	70	828	51.75	N/A	\$9712	N/A	\$2420
Z48264REE	48 x 264 x 30	70	882	54.55	N/A	\$10293	N/A	\$2662
Z48288REE	48 x 288 x 30	70	936	58.04	N/A	\$10293	N/A	\$2903

Rectangular Shaped Table includes FOUR BASES with wire access doors on each side of base and wire concealment runners between bases. Shipped in 7 cartons.

Z60192REE	60 x 192 x 30	85	941.85	71.12	N/A	\$11882	N/A	\$2903
Z60216REE	60 x 216 x 30	85	1003.80	75.94	N/A	\$12540	N/A	\$3264
Z60240REE	60 x 240 x 30	85	1088.85	80.98	N/A	\$13078	N/A	\$3629
Z60264REE	60 x 264 x 30	85	1159.20	85.73	N/A	\$13592	N/A	\$3991
Z60288REE	60 x 288 x 30	85	1229.55	90.49	N/A	\$14414	N/A	\$4355

Rectangular Shaped Table includes FOUR BASES with wire access doors on each side of base and wire concealment runners between bases. Shipped in 7 cartons.

Z4896BW	48 x 96 x 30	85	329	21.95	N/A	\$3739	N/A	\$895
---------	--------------	----	-----	-------	-----	---------------	-----	--------------

Bow End Table includes TWO BASES with wire access doors on each side of base and wire concealment runners between bases. Shipped in 3 cartons.

Z6096BW	60 x 96 x 30	85	436	35.39	N/A	\$5889	N/A	\$1454
---------	--------------	----	-----	-------	-----	---------------	-----	---------------

Bow End Table includes TWO BASES with wire access doors on each side of base and wire concealment runners between bases. Shipped in 3 cartons.

Z48120BW	48 x 120 x 30	70	476	29.35	N/A	\$4979	N/A	\$1118
Z48144BW	48 x 144 x 30	70	513	25.72	N/A	\$5332	N/A	\$1340
Z48168BW	48 x 168 x 30	70	573	37.25	N/A	\$7000	N/A	\$1695

Bow End Table includes THREE BASES with wire access doors on each side of base and wire concealment runners between bases. Z48144BW and Z48120BW shipped in 4 cartons. Z48168BW shipped in 5 cartons.

Required Specifications

Top finish
Top/edge detail
Base finish
Base trim finish

Optional Specifications

HP laminate
Additional grommet

Accessories

Power block

BOARDROOM TABLES

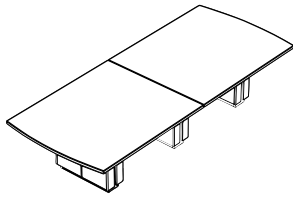

Boardroom Table - Bow End

MODEL#	DIMENSIONS D x W x H (1.5" TOP)	FREIGHT CLASS	WT./LBS.	CUBIC FT.	1" TOP	1.5" TOP	GLAZE ADD	HP ADD
Z60120BW	60 x 120 x 30	85	602	48.50	N/A	\$8928	N/A	\$1815
Z60144BW	60 x 144 x 30	85	673	53.25	N/A	\$9556	N/A	\$2179
Z60168BW	60 x 168 x 30	85	753	58	N/A	\$10304	N/A	\$2541

Bow End Table includes THREE BASES with wire access doors on each side of base and wire concealment runners between bases. Shipped in 5 cartons.

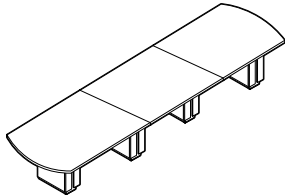

Boardroom Table - Bow End

Z48192BW	48 x 192 x 30	70	698	45.45	N/A	\$8753	N/A	\$1936
Z48216BW	48 x 216 x 30	70	758	48.95	N/A	\$9162	N/A	\$2179
Z48240BW	48 x 240 x 30	70	818	51.75	N/A	\$9742	N/A	\$2420
Z48264BW	48 x 264 x 30	70	872	54.55	N/A	\$10324	N/A	\$2662
Z48288BW	48 x 288 x 30	70	926	58.04	N/A	\$10324	N/A	\$2903

Bow End Table includes FOUR BASES with wire access doors on each side of base and wire concealment runners between bases. Shipped in 7 cartons.

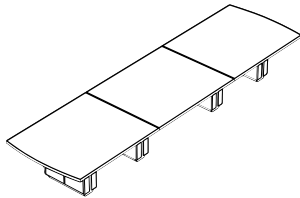

Boardroom Table - Bow End

Z60192BW	60 x 192 x 30	85	917.70	71.19	N/A	\$12962	N/A	\$2903
Z60216BW	60 x 216 x 30	85	988.05	75.94	N/A	\$13688	N/A	\$3264
Z60240BW	60 x 240 x 30	85	1073.10	80.98	N/A	\$14276	N/A	\$3629
Z60264BW	60 x 264 x 30	85	1143.45	85.73	N/A	\$14843	N/A	\$3991
Z60288BW	60 x 288 x 30	85	1213.80	90.49	N/A	\$15747	N/A	\$4355

Bow End Table includes FOUR BASES with wire access doors on each side of base and wire concealment runners between bases. Shipped in 7 cartons.

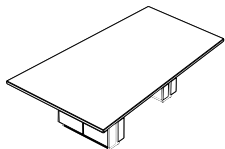

Boardroom Table - Wedge

Z6096WE	60 x 96 x 30	70	398	26.17	N/A	\$5889	N/A	\$1454
---------	--------------	----	-----	-------	-----	---------------	-----	---------------

Wedge Table includes TWO BASES with wire access doors on each side of base. Wedge tapers from 60" w to 48" w. Shipped in 3 cartons.

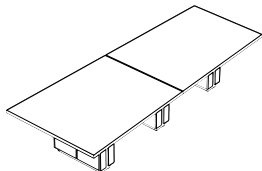

Boardroom Table - Wedge

Z60120WE	60 x 120 x 30	85	544.95	36.50	N/A	\$8928	N/A	\$1815
Z60144WE	60 x 144 x 30	70	603.75	39.50	N/A	\$9556	N/A	\$2179
Z60168WE	60 x 168 x 30	70	673.05	42.50	N/A	\$10304	N/A	\$2541

Wedge Table includes THREE BASES with wire access doors on each side of base. Wedge tapers from 60" w to 48" w. Shipped in 5 cartons.

Required Specifications

Top finish
Top/edge detail
Base finish
Base trim finish

Optional Specifications

HP laminate
Additional grommet

Accessories

Power block

MEDIA TABLES

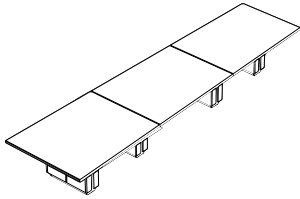

Boardroom Table - Wedge

MODEL#	DIMENSIONS D x W x H (1.5" TOP)	FREIGHT CLASS	WT/LBS.	CUBIC FT.	1" TOP	1.5" TOP	GLAZE ADD	HP ADD
Z60192WE	60 x 192 x 30	85	824.25	63.71	N/A	\$12962	N/A	\$2903
Z60216WE	60 x 216 x 30	85	884.10	68.25	N/A	\$13688	N/A	\$3264
Z60240WE	60 x 240 x 30	85	948.15	72.94	N/A	\$14276	N/A	\$3629
Z60264WE	60 x 264 x 30	85	1006.95	77.48	N/A	\$14843	N/A	\$3991
Z60288WE	60 x 288 x 30	85	1065.75	81.96	N/A	\$15747	N/A	\$4355

Wedge Table includes FOUR BASES with wire access doors on each side of base. Wedge tapers from 60" w to 48" w. Shipped in 7 cartons.

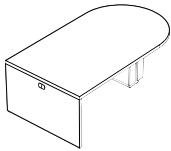

Media Table - D Island

Z4860DMIL	48 x 60 x 30	70	267	17.69	N/A	\$3671	N/A	\$729
Z4872DMIL	48 x 72 x 30	70	298.20	19.67	N/A	\$3936	N/A	\$873
Z4884DMIL	48 x 84 x 30	70	326.55	21.44	N/A	\$4192	N/A	\$1019
Z4896DMIL	48 x 96 x 30	85	347.55	23.41	N/A	\$4439	N/A	\$1162

D Media Island includes ONE BASE with wire access doors on each side of base and wire concealment runners between the base and the end panel. Grommet centered at the top of the end panel for wire pass through. Shipped in 3 cartons.

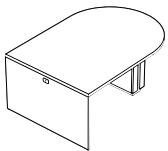

Media Table - D Island

Z6060DMIL	60 x 60 x 30	85	323.93	23.17	N/A	\$4403	N/A	\$909
Z6072DMIL	60 x 72 x 30	85	359.10	25.66	N/A	\$4716	N/A	\$1091
Z6084DMIL	60 x 84 x 30	85	397.95	27.90	N/A	\$5030	N/A	\$1274
Z6096DMIL	60 x 96 x 30	85	433.65	30.39	N/A	\$5327	N/A	\$1454

D Media Island includes ONE BASE with wire access doors on each side of base and wire concealment runners between the base and the end panel. Grommet centered at the top of the end panel for wire pass through. Shipped in 3 cartons.

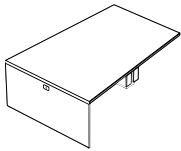

Media Table - D Wedge

Z6060WMIL	60 x 60 x 30	85	306.60	20.69	N/A	\$4403	N/A	\$909
Z6072WMIL	60 x 72 x 30	85	338.10	22.90	N/A	\$4716	N/A	\$1091
Z6084WMIL	60 x 84 x 30	85	374.85	25.42	N/A	\$5030	N/A	\$1274
Z6096WMIL	60 x 96 x 30	85	407.40	27.90	N/A	\$5327	N/A	\$1454

Wedge Media Island includes ONE BASE with wire access doors on each side of base and wire concealment runners between the base and the end panel. Grommet centered at the top of the end panel for wire pass through. Wedge tapers from 60" w to 48" w. Shipped in 3 cartons.

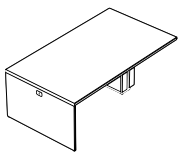

Media Table - Rectangular Island

Z4860RMIL	48 x 60 x 30	70	279.30	17.69	N/A	\$3380	N/A	\$729
Z4872RMIL	48 x 72 x 30	70	307.65	19.67	N/A	\$3623	N/A	\$873
Z4884RMIL	48 x 84 x 30	70	337.05	21.44	N/A	\$3854	N/A	\$1019
Z4896RMIL	48 x 96 x 30	70	357	23.41	N/A	\$4076	N/A	\$1162

Rectangular Media Island includes ONE BASE with wire access doors on each side of base and wire concealment runners between the base and the end panel. Grommet centered at the top of the end panel for wire pass through. Shipped in 3 cartons.

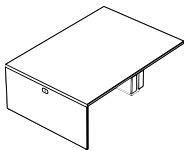

Media Table - Rectangular Island

Z6060RMIL	60 x 60 x 30	70	339.15	22.22	N/A	\$4044	N/A	\$909
Z6072RMIL	60 x 72 x 30	85	373.80	25.66	N/A	\$4330	N/A	\$1091
Z6084RMIL	60 x 84 x 30	85	414.75	27.90	N/A	\$4614	N/A	\$1274
Z6096RMIL	60 x 96 x 30	85	449.40	30.39	N/A	\$4885	N/A	\$1454

Rectangular Media Island includes ONE BASE with wire access doors on each side of base and wire concealment runners between the base and the end panel. Grommet centered at the top of the end panel for wire pass through. Shipped in 3 cartons.

Required Specifications

Top finish
Top/edge detail
Base finish
Base trim finish

Optional Specifications

HP laminate
Additional grommet

Accessories

Power block

MEDIA TABLES

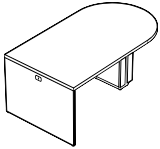

Media Table - D Island, 36" H

MODEL#	DIMENSIONS D x W x H (1.5" TOP)	FREIGHT CLASS	WT/LBS.	CUBIC FT.	1" TOP	1.5" TOP	GLAZE ADD	HP ADD
Z4860DMIM	48 x 60 x 36.5	70	291.90	19.19	N/A	\$4017	N/A	\$729
Z4872DMIM	48 x 72 x 36.5	70	321.30	21.17	N/A	\$4282	N/A	\$873
Z4884DMIM	48 x 84 x 36.5	70	349.65	22.90	N/A	\$4530	N/A	\$1019
Z4896DMIM	48 x 96 x 36.5	85	370.65	24.91	N/A	\$4783	N/A	\$1162

D Media Island includes ONE BASE with wire access doors on each side of base and wire concealment runners between the base and the end panel. Grommet centered at the top of the end panel for wire pass through. Shipped in 3 cartons.

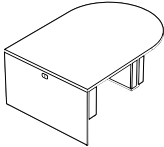

Media Table - D Island, 36" H

Z6060DMIM	60 x 60 x 36.5	85	352.28	25.42	N/A	\$4748	N/A	\$909
Z6072DMIM	60 x 72 x 36.5	85	386.40	27.66	N/A	\$5055	N/A	\$1091
Z6084DMIM	60 x 84 x 36.5	85	426.30	30.15	N/A	\$5370	N/A	\$1274
Z6096DMIM	60 x 96 x 36.5	85	462	32.63	N/A	\$5665	N/A	\$1454

D Media Island includes ONE BASE with wire access doors on each side of base and wire concealment runners between the base and the end panel. Grommet centered at the top of the end panel for wire pass through. Shipped in 3 cartons.

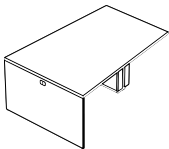

Media Table - D Wedge, 36" H

Z6060WMIM	60 x 60 x 36.5	85	331.80	22.16	N/A	\$4748	N/A	\$909
Z6072WMIM	60 x 72 x 36.5	85	364.35	24.67	N/A	\$5055	N/A	\$1091
Z6084WMIM	60 x 84 x 36.5	70	424.20	26.92	N/A	\$5370	N/A	\$1274
Z6096WMIM	60 x 96 x 36.5	85	424.20	29.40	N/A	\$5665	N/A	\$1454

Wedge Media Island includes ONE BASE with wire access doors on each side of base and wire concealment runners between the base and the end panel. Grommet centered at the top of the end panel for wire pass through. Wedge tapers from 60" w to 48" w. Shipped in 3 cartons.

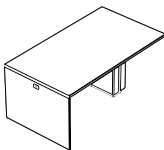

Media Table - Rectangular Island, 36" H

Z4860RMIM	48 x 60 x 36.5	70	301.35	19.19	N/A	\$3689	N/A	\$729
Z4872RMIM	48 x 72 x 36.5	70	330.75	21.17	N/A	\$3932	N/A	\$873
Z4884RMIM	48 x 84 x 36.5	70	360.15	22.90	N/A	\$4160	N/A	\$1019
Z4896RMIM	48 x 96 x 36.5	70	380.10	24.91	N/A	\$4390	N/A	\$1162

Rectangular Media Island includes ONE BASE with wire access doors on each side of base and wire concealment runners between the base and the end panel. Grommet centered at the top of the end panel for wire pass through. Shipped in 3 cartons.

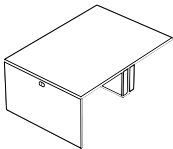

Media Table - Rectangular Island, 36" H

Z6060RMIM	60 x 60 x 36.5	85	367.50	25.42	N/A	\$4355	N/A	\$909
Z6072RMIM	60 x 72 x 36.5	85	402.15	27.66	N/A	\$4633	N/A	\$1091
Z6084RMIM	60 x 84 x 36.5	85	442.05	30.15	N/A	\$4921	N/A	\$1274
Z6096RMIM	60 x 96 x 36.5	85	477.75	32.63	N/A	\$5193	N/A	\$1454

Rectangular Media Island includes ONE BASE with wire access doors on each side of base and wire concealment runners between the base and the end panel. Grommet centered at the top of the end panel for wire pass through. Shipped in 3 cartons.

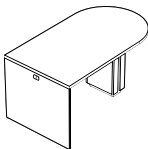

Media Table - D Island, 42" H

Z4860DMIH	48 x 60 x 42.5	70	312.90	20.69	N/A	\$4270	N/A	\$729
Z4872DMIH	48 x 72 x 42.5	70	342.30	22.66	N/A	\$4535	N/A	\$873
Z4884DMIH	48 x 84 x 42.5	70	371.70	24.40	N/A	\$4790	N/A	\$1019
Z4896DMIH	48 x 96 x 42.5	85	391.65	26.41	N/A	\$5037	N/A	\$1162

D Media Island includes ONE BASE with wire access doors on each side of base and wire concealment runners between the base and the end panel. Grommet centered at the top of the end panel for wire pass through. Shipped in 3 cartons.

Required Specifications

Top finish
Top/edge detail
Base finish
Base trim finish

Optional Specifications

HP laminate
Additional grommet

Accessories

Power block

MEDIA TABLES

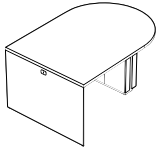

Media Table - D Island, 42”H

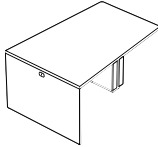

Media Table - Wedge, 42”H

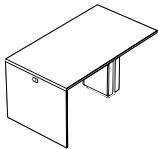

Media Table - Rectangular Island, 42”H

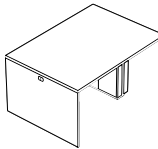

Media Table - Rectangular Island, 42”H

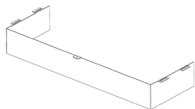

Media Table - Base Cover

MODEL#	DIMENSIONS D x W x H (1.5" TOP)	FREIGHT CLASS	WT/LBS.	CUBIC FT.	1" TOP	1.5" TOP	GLAZE ADD	HP ADD
Z6060DMIH	60 x 60 x 42.5	85	378	27.40	N/A	\$4999	N/A	\$909
Z6072DMIH	60 x 72 x 42.5	85	413.70	29.91	N/A	\$5308	N/A	\$1091
Z6084DMIH	60 x 84 x 42.5	85	453.60	32.40	N/A	\$5629	N/A	\$1274
Z6096DMIH	60 x 96 x 42.5	85	488.25	34.88	N/A	\$5918	N/A	\$1454

D Media Island includes ONE BASE with wire access doors on each side of base and wire concealment runners between the base and the end panel. Grommet centered at the top of the end panel for wire pass through. Shipped in 3 cartons.

Z6060WMIH	60 x 60 x 42.5	85	355	23.92	N/A	\$4999	N/A	\$909
Z6072WMIH	60 x 72 x 42.5	85	387	26.17	N/A	\$5308	N/A	\$1091
Z6084WMIH	60 x 84 x 42.5	85	424	28.65	N/A	\$5629	N/A	\$1274
Z6096WMIH	60 x 96 x 42.5	85	457	31.14	N/A	\$5918	N/A	\$1454

Wedge Media Island includes ONE BASE with wire access doors on each side of base and wire concealment runners between the base and the end panel. Grommet centered at the top of the end panel for wire pass through. Wedge tapers from 60”w to 48”w. Shipped in 3 cartons.

Z4860RMIH	48 x 60 x 42.5	70	324	20.69	N/A	\$3925	N/A	\$729
Z4872RMIH	48 x 72 x 42.5	70	353	22.66	N/A	\$4166	N/A	\$873
Z4884RMIH	48 x 84 x 42.5	70	382	24.40	N/A	\$4395	N/A	\$1019
Z4896RMIH	48 x 96 x 42.5	70	402	26.41	N/A	\$4621	N/A	\$1162

Rectangular Media Island includes ONE BASE with wire access doors on each side of base and wire concealment runners between the base and the end panel. Grommet centered at the top of the end panel for wire pass through. Shipped in 3 cartons.

Z6060RMIH	60 x 60 x 42.5	85	394	27.40	N/A	\$4589	N/A	\$909
Z6072RMIH	60 x 72 x 42.5	85	429	29.91	N/A	\$4867	N/A	\$1091
Z6084RMIH	60 x 84 x 42.5	85	469	32.40	N/A	\$5158	N/A	\$1274
Z6096RMIH	60 x 96 x 42.5	85	504	34.88	N/A	\$5422	N/A	\$1454

Rectangular Media Island includes ONE BASE with wire access doors on each side of base and wire concealment runners between the base and the end panel. Grommet centered at the top of the end panel for wire pass through. Shipped in 3 cartons.

Z60BEC	12.2 x 34.5 x 4.3	250	5	1.50	\$510
Z48BEC	12.2 x 22.5 x 4.3	250	5	1.50	\$467

For use on Zira Media Tables, but can be used on any Zira Boardroom table of corresponding width. Acts as a “cap” at the upper part of a base to hide any wire or power block that may be visible to users. Available in Black or Tungsten finish.

Required Specifications

Top finish
Top/edge detail
Base finish
Base trim finish

Optional Specifications

HP laminate
Additional grommet

Accessories

Power block

COLLABORATIVE TABLES

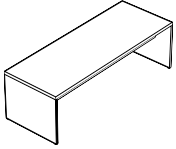

Collaborative Table - 29" H

MODEL#	DIMENSIONS D x W x H (1.5" TOP)	FREIGHT CLASS	WT/LBS.	CUBIC FT.	1" TOP	1.5" TOP	GLAZE ADD	HP ADD
Z367229BT	36 x 72 x 30	70	237	12.93	N/A	\$1815	N/A	\$656
Z368429BT	36 x 84 x 30	70	237	14.70	N/A	\$2111	N/A	\$766
Z369629BT	36 x 96 x 30	70	289	16.44	N/A	\$2288	N/A	\$873

Collaborative table with full end panels. Wire management runners span the length of the table between end panels. Shipped in 3 cartons.

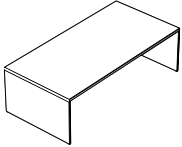

Collaborative Table - 29" H

Z487229BT	48 x 72 x 30	70	302	13.95	N/A	\$2281	N/A	\$873
Z488429BT	48 x 84 x 30	70	335	15.69	N/A	\$2457	N/A	\$1019
Z489629BT	48 x 96 x 30	70	360	17.43	N/A	\$2655	N/A	\$1162

Collaborative table with full end panels. Wire management runners span the length of the table between end panels. Shipped in 3 cartons.

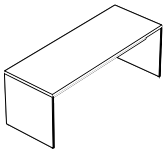

Collaborative Table - 36" H

Z367236BT	36 x 72 x 36.5	70	249	13.20	N/A	\$1883	N/A	\$656
Z368436BT	36 x 84 x 36.5	70	275	14.94	N/A	\$2185	N/A	\$766
Z369636BT	36 x 96 x 36.5	70	301	16.68	N/A	\$2360	N/A	\$873

Collaborative table with full end panels. Wire management runners span the length of the table between end panels. Shipped in 3 cartons.

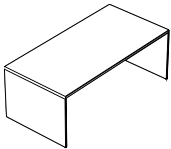

Collaborative Table - 36" H

Z487236BT	48 x 72 x 36.5	70	319	14.43	N/A	\$2365	N/A	\$873
Z488436BT	48 x 84 x 36.5	70	351	16.20	N/A	\$2548	N/A	\$1019
Z489636BT	48 x 96 x 36.5	70	376	17.93	N/A	\$2746	N/A	\$1162

Collaborative table with full end panels. Wire management runners span the length of the table between end panels. Shipped in 3 cartons.

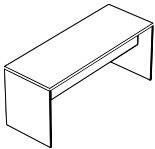

Collaborative Table - 42" H

Z367242BT	36 x 72 x 42.5	70	283	14.19	N/A	\$2107	N/A	\$656
Z368442BT	36 x 84 x 42.5	70	312	15.93	N/A	\$2432	N/A	\$766
Z369642BT	36 x 96 x 42.5	70	342	17.93	N/A	\$2631	N/A	\$873

Collaborative table with full end panels. Wire management runners span the length of the table between end panels. Shipped in 3 cartons.

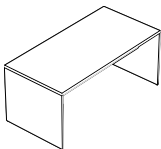

Collaborative Table - 42" H

Z487242BT	48 x 72 x 42.5	65	356	15.45	N/A	\$2607	N/A	\$873
Z488442BT	48 x 84 x 42.5	70	392	17.43	N/A	\$2807	N/A	\$1019
Z489642BT	48 x 96 x 42.5	70	421	19.19	N/A	\$3036	N/A	\$1162

Collaborative table with full end panels. Wire management runners span the length of the table between end panels. Shipped in 3 cartons.

Required Specifications

Top finish
Top/edge detail
Base finish
Base trim finish

Optional Specifications

HP laminate
Additional grommet

Accessories

Power block

ACCESSORIES

MODEL# DIMENSIONS FREIGHT CLASS WT/LBS. CUBIC FT. 1"TOP 1.5" TOP GLAZE ADD HP ADD

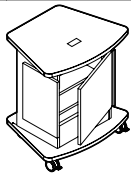

Multimedia Cart*

MODEL#	D x W x H (1.5" TOP)	FREIGHT CLASS	WT/LBS.	CUBIC FT.	1"TOP	1.5" TOP	GLAZE ADD	HP ADD
Z2822MCE	22.25 x 28 x 29.5	125	86	13.50	\$859	\$926	N/A	\$170

Multimedia cart features one non-locking hinged door on the back. Includes 3 fixed shelves, 1 grommet on top and 1 grommet in bottom panel for wire pass thru. 4 locking casters included.

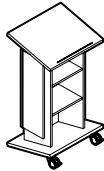

Lectern*

Z2444LEC	18 x 24 x 44.3	150	100	17	\$835	\$890	N/A	\$170
----------	----------------	-----	-----	----	-------	-------	-----	-------

Features angled stand and storage with 2 fixed shelves. 2 locking casters included.

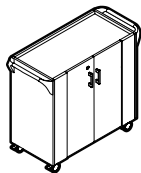

Serving Cart with Doors**

Z361836KD	18 x 36 x 36	125	150	20	\$1745	N/A	\$419	N/A
Z361829KD	18 x 36 x 29	125	113	16	\$1476	N/A	\$353	N/A

Cart features 2 doors with lock and 1 fixed height adjustable shelf. Top is recessed within side and end panels to act as a tray. Unique push handles are standard on both sides of the cart. 4 locking casters included.

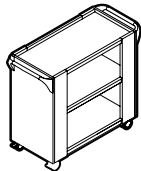

Serving Cart*

Z361836KO	18 x 36 x 36	125	121	20	\$1893	N/A	N/A	N/A
Z361829KO	18 x 36 x 29	125	108	16	\$1583	N/A	N/A	N/A

Cart features 1 fixed height adjustable shelf. Top is recessed within side and end panels to act as a tray. Decorative aluminum trim is standard on the lip of each shelf. Unique push handles are standard on both sides of the cart. 4 locking casters included.

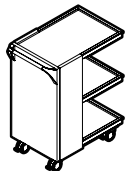

Buffet Cart*

Z261836BK	18 x 26 x 36	150	79	15	\$1800	N/A	N/A	\$170
-----------	--------------	-----	----	----	--------	-----	-----	-------

Cart features 1 fixed shelf. Top is recessed within side and end panels to act as a tray. Unique push handles are standard. Decorative aluminum trim is standard on the lip of each shelf. Locking casters included. Height aligns with 36" buffets.

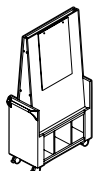

Visual Board*

Z361872VB	18 x 36 x 72.4	100	187	19.25	\$2735	N/A	N/A	N/A
-----------	----------------	-----	-----	-------	--------	-----	-----	-----

Angled visual board with paper pad on one side and dry erase board on the opposite side. Unique push handles are standard. Locking casters included. Decorative aluminum trim is standard on the lip of each shelf. Height aligns with 36" buffets. Shipped RTA (ready to assemble).

- *Wallmounted Visual Boards are available in Desk Accessories section.*

Required Specifications

Top finish Push bar finish**
 Base finish Handles
 Top/edge detail*
 Base trim finish (not Z3618xxKD)

Optional Specifications

HP laminate
 Glazed door (only Z3618xxKD)

BOARDROOM TABLES

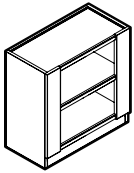

Buffet

MODEL#	DIMENSIONS D x W x H (1.5" TOP)	FREIGHT CLASS	WT/LBS.	CUBIC FT.	1" TOP	1.5" TOP	GLAZE ADD	HP ADD
Z481836BO	18 x 48 x 36	125	152.50	22.50	\$1665	N/A	N/A	\$227
Z481829BO	18 x 48 x 29	125	135	18	\$1536	N/A	N/A	\$227
Z361836BO	18 x 36 x 36	125	126	18	\$1373	N/A	N/A	\$170
Z361829BO	18 x 36 x 29	100	112	14	\$1263	N/A	N/A	\$170

Buffet features 1 fixed height adjustable shelf. Top is recessed within side and end panels to act as a tray. Decorative aluminum trim is standard on the lip of each shelf.

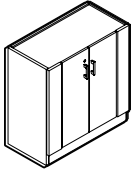

Buffet with Doors**

Z481836BD	18 x 48 x 36	125	171	22.50	\$1733	N/A	\$368	\$227
Z481829BD	18 x 48 x 29	100	148	18	\$1548	N/A	\$420	\$227
Z361836BD	18 x 36 x 36	125	138.50	18	\$1540	N/A	\$419	\$170
Z361829BD	18 x 36 x 29	100	119	14	\$1295	N/A	\$353	\$170

Buffet features 2 doors with lock and 1 fixed height adjustable shelf. Top is recessed within side and end panels to act as a tray.

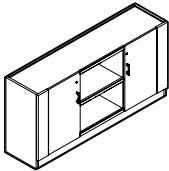

Buffet with Doors**

Z721836BU	18 x 72 x 36	125	242	33.50	\$2563	N/A	\$507	\$338
Z721829BU	18 x 72 x 29	125	211	27	\$2317	N/A	\$419	\$419
Z601836BU	18 x 60 x 36	125	188	28	\$2302	N/A	\$419	\$282
Z601829BU	18 x 60 x 29	125	163	22.50	\$2109	N/A	\$353	\$282

Buffet features 3 separate compartments. The two outer compartments come standard with locking doors and each features 1 fixed height adjustable shelf. The center compartment is open with 1 fixed height adjustable shelf. Decorative aluminum trim is standard on the lip of the open shelf. Top is recessed within side and end panels to act as a tray.

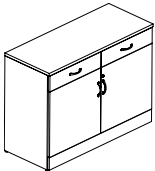

Buffet Credenza**

Z482036BD	20 x 48 x 36	100	199	24.70	\$2045	\$2164	\$882	\$384
-----------	--------------	-----	-----	-------	---------------	---------------	--------------	--------------

Buffet credenza with one locking storage compartment with two doors. Hinged doors cover one three-position height adjustable shelf. Two 6" drawers above storage compartment are non-locking.

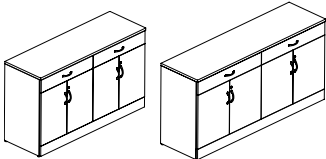

Buffet Credenza**

Z722036BD	20 x 72 x 36	125	265	36.50	\$2965	\$3110	\$1761	\$618
Z602036BD	20 x 60 x 36	125	228	30.75	\$2571	\$2703	\$1617	\$501

Buffet credenza with two locking storage compartments side by side. Hinged doors cover 1 three-position height adjustable shelf. Two 6" drawers above storage compartment are non-locking.

Required Specifications

Top finish Top/edge detail*
Base finish
Handles
Aluminum trim finish (only ZxxxxBO/BU)

Optional Specifications

HP laminate
Glazed door**

BOARDROOM TABLES MODEL# DIMENSIONS FREIGHT CLASS WT/LBS. CUBIC FT. 1" TOP 1.5" TOP GLAZE ADD HP ADD

D x W x H (1.5" TOP)

Interconnecting Cables - Common Cable Lengths (in inches)

Female/Female	42FF-86 \$188	42FM-41 \$139
42FF-27 \$116	42FF-97 \$216	42FM-50 \$151
42FF-38 \$129	42FF-98 \$216	42FM-63 \$167
42FF-41 \$133	42FF-100 \$205	42FM-75 \$181
42FF-50 \$145	42FF-110 \$219	42FM-82 \$190
42FF-53 \$149		42FM-86 \$195
42FF-63 \$159	Female/Male	42FM-97 \$216
42FF-75 \$175	42FM-12 \$104	42FM-98 \$216
42FF-76 \$176	42FM-27 \$121	42FM-100 \$230
42FF-82 \$184	42FM-38 \$134	42FM-110 \$230

VILLA DAISYLINK OR OASIS MINI CABLE LENGTHS NEEDED FOR DAISY-CHAINING

Model #	Villa DaisyLink, Oasis Mini USB Oasis Mini A Oasis Mini B	Villa DaisyLink, Oasis Mini USB Oasis Mini A Oasis Mini B	Oasis Mini USB Oasis Mini A	Oasis Mini USB Oasis Mini A	Villa DaisyLink or Oasis Mini B	Villa DaisyLink or Oasis Mini B
Cutout Positions	V1, V3, M1, M3	V1, V3, M1, M3	M1, M2 & M3	M1, M2 & M3	V1, V2, V3, M1, M2, M3	V1, V2, V3, M1, M2, M3
Infeed Position	Left or Right	Center	Left or Right	Center	Left or Right	Center
Reference	Drawing 1A/1B	Drawing 2A/2B	Drawing 3	Drawing 4	Drawing 5	Drawing 6
Z4896BE Z4896RTE Z4896REE Z4896BW	(1) 42FF-53 SPECIFY INFEED	(1) 42FF-27 (1) 42FM-27 (1) DAISY-T SPECIFY INFEED	N/A	N/A	N/A	N/A
Z48120BE Z48120RTE Z48120REE Z48120BW	(1) 42FF-76 SPECIFY INFEED	(1) 42FF-38 (1) 42FM-38 (1) DAISY-T SPECIFY INFEED	(3) 42FF-41 SPECIFY INFEED	(3) 42FF-41 SPECIFY INFEED	(2) 42FF-41 SPECIFY INFEED	(2) 42FF-41 (1) 42FM-12 (1) DAISY-T SPECIFY INFEED
Z48144BE Z48144RTE Z48144REE Z48144BW	(1) 42FF-100 SPECIFY INFEED	(1) 42FF-50 (1) 42FM-50 (1) DAISY-T SPECIFY INFEED	(3) 42FF-53 SPECIFY INFEED	(3) 42FF-53 SPECIFY INFEED	(2) 42FF-53 SPECIFY INFEED	(2) 42FF-53 (1) 42FM-12 (1) DAISY-T SPECIFY INFEED
Z48168BE Z48168RTE Z48168REE Z48168BW	(1) 42FF-63 (1) 42FM-63 SPECIFY INFEED	1) 42FF-63 (1) 42FM-63 (1) DAISY-T SPECIFY INFEED	(3) 42FF-65 SPECIFY INFEED	(3) 42FF-65 SPECIFY INFEED	(2) 42FF-65 SPECIFY INFEED	(2) 42FF-65 (1) 42FM-12 (1) DAISY-T SPECIFY INFEED
Z48192BE Z48192RTE Z48192REE Z48192BW	(1) 42FF-75 (1) 42FM-75 SPECIFY INFEED	1) 42FF-75 (1) 42FM-75 (1) DAISY-T SPECIFY INFEED	(3) 42FF-77 SPECIFY INFEED	(3) 42FF-77 SPECIFY INFEED	(2) 42FF-77 SPECIFY INFEED	(2) 42FF-77 (1) 42FM-12 (1) DAISY-T SPECIFY INFEED
Z48216BE Z48216RTE Z48216REE Z48216BW	(1) 42FF-86 (1) 42FM-86 SPECIFY INFEED	1) 42FF-85 (1) 42FM-85 (1) DAISY-T SPECIFY INFEED	(3) 42FF-89 SPECIFY INFEED	(3) 42FF-89 SPECIFY INFEED	(2) 42FF-89 SPECIFY INFEED	(2) 42FF-89 (1) 42FM-12 (1) DAISY-T SPECIFY INFEED
Z48240BE Z48240RTE Z48240REE Z48240BW	(1) 42FF-98 (1) 42FM-98 SPECIFY INFEED	1) 42FF-97 (1) 42FM-97 (1) DAISY-T SPECIFY INFEED	(3) 42FF-101 SPECIFY INFEED	(3) 42FF-101 SPECIFY INFEED	(2) 42FF-101 SPECIFY INFEED	(2) 42FF-101 (1) 42FM-12 (1) DAISY-T SPECIFY INFEED

Model #	Villa DaisyLink, Oasis Mini USB Oasis Mini A Oasis Mini B	Villa DaisyLink, Oasis Mini USB Oasis Mini A Oasis Mini B	Oasis Mini USB Oasis Mini A	Oasis Mini USB Oasis Mini A	Villa DaisyLink or Oasis Mini B	Villa DaisyLink or Oasis Mini B
Z48264BE Z48264RTE Z48264REE Z48264BW	(1) 42FF-110 (1) 42FM-110 SPECIFY INFEED	(1) 42FF-110 (1) 42FM-110 (1) DAISY-T SPECIFY INFEED	(3) 42FF-113 SPECIFY INFEED	(3) 42FF-113 SPECIFY INFEED	(2) 42FF-113 SPECIFY INFEED	(2) 42FF-113 (1) 42FM-12 (1) DAISY-T SPECIFY INFEED
Z48288BE Z48288RTE Z48288REE Z48288BW	(1) 42FF-82 (2) 42FM-82 SPECIFY INFEED	(2) 42FF-41 (2) 42FM-41 (1) DAISY-T SPECIFY INFEED	(3) 42FF-63 (3) 42FM-63 SPECIFY INFEED	(3) 42FF-63 (3) 42FM-63 SPECIFY INFEED	(2) 42FF-63 (2) 42FM-63 SPECIFY INFEED	(2) 42FF-63 (2) 42FM-63 (1) DAISY-T SPECIFY INFEED

RECEPTION DESKS AND RETURNS

- Offered with **Straight** and **Bow** front
- Transactional tops available in 1" or 1 1/2" thick top with a variety of edge details
- Worksurface available in 1" thickness with A3 edge only

TOP AND BASE FINISHES

ACJ Absolute Acajou	NGL Noce Grigio
ASN Asian Night	NEL Noce Leggero
AWC Avant Cherry	NML Noce Medio
AWH Avant Honey	QTM Quartered Mahogany
BLK Black	SOG Storm Grey
BRC Brushed Cobalt	TFW Tiger Fruitwood
CMB Clear Maple	TWL Tiger Walnut
DES Dark Espresso	WHE Walnut Heights
DWT Designer White	WHC White Chocolate
HGT Hayden Grey	WGY Willow Grey
NBL Noce Biondo	WCR Winter Cherry

Reception Desks:

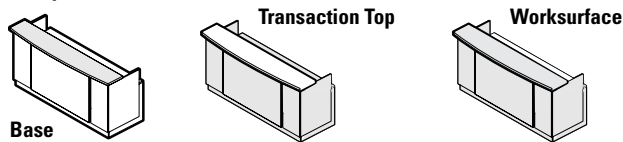

Reception Returns:

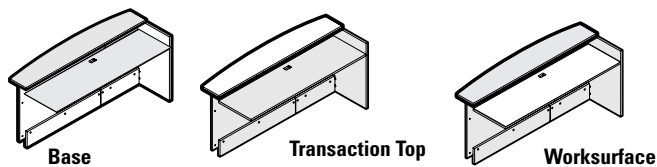

TRANSACTION TOP THICKNESS/EDGE DETAIL

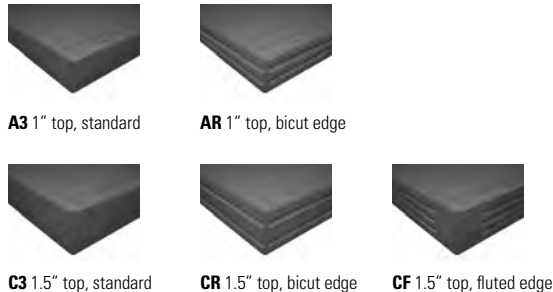

GLAZING (Center Panels)

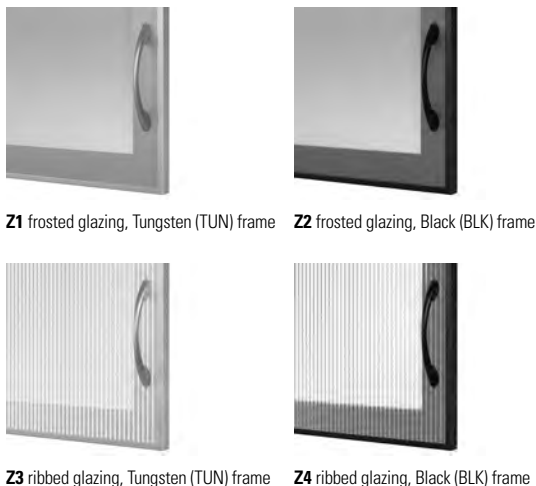

GROMMETS - RECEPTION DESKS ONLY

- Two grommets are standard in position **AG1** and **AG3**
- Standard grommets can be removed at an upcharge
- Optional grommets available in **AG2**

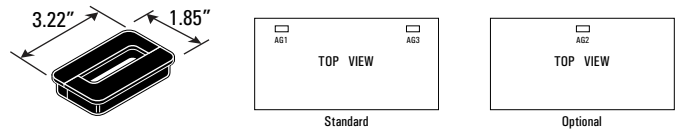

- Grommet hole dimensions are 3 1/4" wide x 1 7/8" deep.

POWER BLOCK

- A Power Block (model **PMSPDM**) may be ordered on transaction tops.
- A Power Block is a rectangular worksurface power/data module with one electrical duplex receptacle and two data (RJ45) receptacles. 9 foot black cord included. Power Block dimensions are 3 1/2" deep x 6 1/2" wide x 2 3/4" high.
- To purchase a Power Block, you must specify both the Power Block cut-out location and the Power Block model #. Order Power Block as **PMSPDM**, Add **\$330**. Power Blocks are available in standard worksurface locations (left, center or right). Order as **E1**, **E2** or **E3**. Add **\$88**.

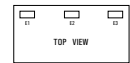

Power Block **PMSPDM** Add **\$330**

Specify location **E1**, **E2** or **E3** Add **\$88**

TASK LIGHT

- Illuminates worksurface and optional glazed center panel
- Specify LED task light separately. Use PLED50 for 60", 66" and 72" wide reception units. Use PLED50 or PLED100 for 84" and 96" wide units. See page 522 for details.

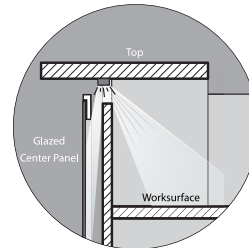

RECEPTION RETURNS - PIGEON

- Available in all laminates
- Worksurface available in 1" thickness with A3 edge only
- Collator shelves offered in Black (BLK) or Brushed Cobalt (BRC)
- One grommet is standard in position **AG3**
- Standard grommet can be removed at an upcharge
- Optional grommet available in position **AG2**, see upcharges above
- Power blocks are available in positions **E2** and **E3**

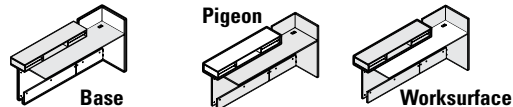

RECEPTION RETURNS - BOOKCASE

- Available in all laminates listed above
- Worksurface available in 1" thickness with A3 edge only
- One grommet is standard in position **AG2**
- Standard grommet can be removed at an upcharge
- Optional grommet available in position **AG3** for **54"**, **60"** and **72"** wide units only
- Power blocks are available in positions **E2** and **E3** for **54"**, **60"** and **72"** wide units only

RECEPTION DESKS

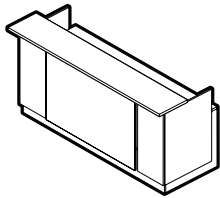

Reception Desk

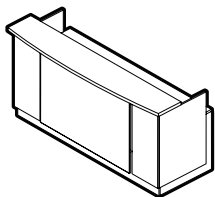

Reception Desk - Bow Front

MODEL#	DIMENSIONS	FREIGHT CLASS	WT/LBS.	CUBIC FT.	1" TOP	1.5" TOP	GLAZE ADD	HP ADD
D x W x H (1.5" TOP)								
Z3096RDS	35.5 x 96 x 43.3	70	385	23.23	\$3315	\$3501	\$693	\$784
Z3084RDS	35.5 x 89.4 x 43.3	70	351	20.48	\$2946	\$3113	\$598	\$686
Z3072RDS	35.5 x 77.4 x 43.3	70	315	17.99	\$2717	\$2861	\$501	\$589
Z3066RDS	35.5 x 71.4 x 43.3	70	298	16.98	\$2581	\$2720	\$453	\$541
Z3060RDS	35.5 x 65.4 x 43.3	70	280	15.48	\$2460	\$2587	\$405	\$490
Z2496RDS	30 x 96 x 43.3	70	353	21.98	\$3125	\$3311	\$693	\$671
Z2484RDS	30 x 89.4 x 43.3	70	320	19.49	\$2785	\$2952	\$598	\$589
Z2472RDS	30 x 77.4 x 43.3	70	287	16.98	\$2564	\$2712	\$501	\$505
Z2466RDS	30 x 71.4 x 43.3	70	272	15.99	\$2430	\$2569	\$453	\$463
Z2460RDS	30 x 65.4 x 43.3	70	256	15	\$2316	\$2443	\$405	\$420

Z24xxRDS units are not freestanding; they must be connected to a return. Z30xxRDS units can be specified as freestanding. Standard with two grommets. Accommodates shells of all depths. Shipped RTA (ready to assemble) in 3 cartons.

- **Zxx96RDS** units feature a 90" w worksurface

Z3096RDB	35.5 x 96 x 43.3	70	382	23.23	\$3315	\$3501	\$693	\$784
Z3084RDB	35.5 x 89.4 x 43.3	70	348	20.48	\$2946	\$3113	\$598	\$686
Z3072RDB	35.5 x 77.4 x 43.3	70	312	17.99	\$2717	\$2861	\$501	\$589
Z3066RDB	35.5 x 71.4 x 43.3	70	295	16.98	\$2581	\$2720	\$453	\$541
Z3060RDB	35.5 x 65.4 x 43.3	70	277	15.99	\$2460	\$2587	\$405	\$490
Z2496RDB	30 x 96 x 43.3	70	350	21.98	\$3125	\$3292	\$693	\$671
Z2484RDB	30 x 89.4 x 43.3	70	317	19.49	\$2785	\$2952	\$598	\$589
Z2472RDB	30 x 77.4 x 43.3	70	284	16.98	\$2564	\$2712	\$501	\$505
Z2466RDB	30 x 71.4 x 43.3	70	269	15.99	\$2430	\$2569	\$453	\$463
Z2460RDB	30 x 65.4 x 43.3	70	253	15	\$2316	\$2443	\$405	\$420

Z24xxRDB units are not freestanding; they must be connected to a return. Z30xxRDB units can be specified as freestanding. Standard with two grommets. Accommodates shells of all depths. Shipped RTA (ready to assemble) in 3 cartons.

- **Zxx96RDB** units feature a 90" w worksurface

Required Specifications

Top finish
Top/edge detail
Base/surround finish
Transaction top finish

Optional Specifications

HP laminate
Additional grommet

Accessories

Power block

HIGH RECEPTION RETURNS

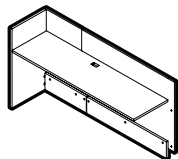

High Reception Return - LEFT

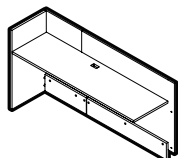

High Reception Return - LEFT

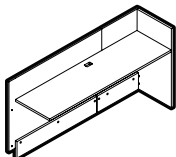

High Reception Return - RIGHT

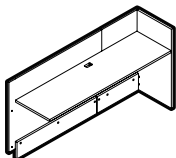

High Reception Return - RIGHT

MODEL#	DIMENSIONS	FREIGHT CLASS	WT/LBS.	CUBIC FT.	1" TOP	1.5" TOP	GLAZE ADD	HP ADD
D x W x H								
Z2472HRRL	25 x 75.7 x 40.3	70	151	8.20	\$1240	N/A	N/A	\$338
Z2460HRRL	25 x 63.7 x 40.3	70	131.20	7	\$1084	N/A	N/A	\$282
Z2454HRRL	25 x 57.7 x 40.3	70	120.90	5.75	\$984	N/A	N/A	\$254
Z2448HRRL	25 x 51.7 x 40.3	70	110.90	5.25	\$913	N/A	N/A	\$227
Z2442HRRL	25 x 45.7 x 40.3	70	100.80	4.80	\$842	N/A	N/A	\$198
Z2436HRRL	25 x 39.7 x 40.3	70	90.70	4.30	\$770	N/A	N/A	\$170

Not freestanding. Grommet in worksurface. Shipped RTA (ready to assemble). Accommodates shells of all depths. Connecting hardware included. Widths and depths listed are outside dimensions including outside surrounds. Model numbers reflect the primary worksurface dimensions.

Z2072HRRL	20.9 x 75.7 x 40.3	70	139	8.20	\$1093	N/A	N/A	\$282
Z2060HRRL	20.9 x 63.7 x 40.3	70	121	7	\$953	N/A	N/A	\$237
Z2054HRRL	20.9 x 57.7 x 40.3	70	111	5.75	\$860	N/A	N/A	\$212
Z2048HRRL	20.9 x 51.7 x 40.3	70	102	5.25	\$799	N/A	N/A	\$190
Z2042HRRL	20.9 x 45.7 x 40.3	70	92	4.80	\$733	N/A	N/A	\$166
Z2036HRRL	20.9 x 39.7 x 40.3	70	83	4.30	\$668	N/A	N/A	\$144

Not freestanding. Grommet in worksurface. Shipped RTA (ready to assemble). Accommodates shells of **20" depths**. Connecting hardware included. Widths and depths listed are outside dimensions including outside surrounds. Model numbers reflect the primary worksurface dimensions.

Z2472HRRR	25 x 75.7 x 40.3	70	151	8.20	\$1240	N/A	N/A	\$338
Z2460HRRR	25 x 63.7 x 40.3	70	131.20	7	\$1084	N/A	N/A	\$282
Z2454HRRR	25 x 57.7 x 40.3	70	120.90	5.75	\$984	N/A	N/A	\$254
Z2448HRRR	25 x 51.7 x 40.3	70	110.90	5.25	\$913	N/A	N/A	\$227
Z2442HRRR	25 x 45.7 x 40.3	70	100.80	4.80	\$842	N/A	N/A	\$198
Z2436HRRR	25 x 39.7 x 40.3	70	90.70	4.30	\$770	N/A	N/A	\$170

Not freestanding. Grommet in worksurface. Shipped RTA (ready to assemble). Accommodates shells of all depths. Connecting hardware included. Widths and depths listed are outside dimensions including outside surrounds. Model numbers reflect the primary worksurface dimensions.

Z2072HRRR	20.9 x 75.7 x 40.3	70	139	8.20	\$1093	N/A	N/A	\$282
Z2060HRRR	20.9 x 63.7 x 40.3	70	121	7	\$953	N/A	N/A	\$237
Z2054HRRR	20.9 x 57.7 x 40.3	70	111	5.75	\$860	N/A	N/A	\$212
Z2048HRRR	20.9 x 51.7 x 40.3	70	102	5.25	\$799	N/A	N/A	\$190
Z2042HRRR	20.9 x 45.7 x 40.3	70	92	4.80	\$733	N/A	N/A	\$166
Z2036HRRR	20.9 x 39.7 x 40.3	70	83	4.30	\$668	N/A	N/A	\$144

Not freestanding. Grommet in worksurface. Shipped RTA (ready to assemble). Accommodates shells of **20" depths**. Connecting hardware included. Widths and depths listed are outside dimensions including outside surrounds. Model numbers reflect the primary worksurface dimensions.

Required Specifications

Top finish
Top/edge detail
Base/surround finish

Optional Specifications

HP laminate
Additional grommet

Accessories

Power block

LOW RECEPTION RETURNS

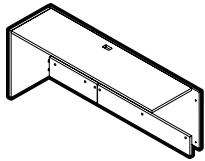

Low Reception Return - LEFT

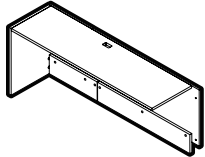

Low Reception Return - LEFT

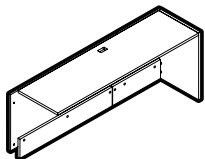

Low Reception Return - RIGHT

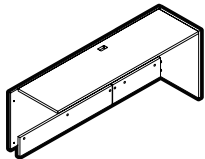

Low Reception Return - RIGHT

MODEL#	DIMENSIONS D x W x H	FREIGHT CLASS	WT/LBS.	CUBIC FT.	1" TOP	1.5" TOP	GLAZE ADD	HP ADD
Z2472LRRL	25 x 75.7 x 29.6	70	141	6.75	\$1205	N/A	N/A	\$338
Z2460LRRL	25 x 63.7 x 29.6	70	122	5.75	\$1040	N/A	N/A	\$282
Z2454LRRL	25 x 57.7 x 29.6	70	112.90	5.50	\$952	N/A	N/A	\$254
Z2448LRRL	25 x 51.7 x 29.6	70	103.40	5	\$883	N/A	N/A	\$227
Z2442LRRL	25 x 45.7 x 29.6	70	94	4.50	\$812	N/A	N/A	\$198
Z2436LRRL	25 x 39.7 x 29.6	70	84.30	4	\$739	N/A	N/A	\$170

Not freestanding. Grommet in worksurface. Shipped RTA (ready to assemble). Accommodates shells of all depths. Connecting hardware included. Widths and depths listed are outside dimensions including outside surrounds. Model numbers reflect the primary worksurface dimensions.

Z2072LRRL	20.9 x 75.7 x 29.6	70	128.80	6.75	\$1060	N/A	N/A	\$282
Z2060LRRL	20.9 x 63.7 x 29.6	70	111.30	5.75	\$910	N/A	N/A	\$237
Z2054LRRL	20.9 x 57.7 x 29.6	70	102.80	5.50	\$833	N/A	N/A	\$212
Z2048LRRL	20.9 x 51.7 x 29.6	70	94.10	5	\$770	N/A	N/A	\$190
Z2042LRRL	20.9 x 45.7 x 29.6	70	85.30	4.50	\$706	N/A	N/A	\$166
Z2036LRRL	20.9 x 39.7 x 29.6	70	76.30	4	\$642	N/A	N/A	\$144

Not freestanding. Grommet in worksurface. Shipped RTA (ready to assemble). Accommodates shells of **20" depths**. Connecting hardware included. Widths and depths listed are outside dimensions including outside surrounds. Model numbers reflect the primary worksurface dimensions.

Z2472LRRR	25 x 75.7 x 29.6	70	141	6.75	\$1205	N/A	N/A	\$338
Z2460LRRR	25 x 63.7 x 29.6	70	122	5.75	\$1040	N/A	N/A	\$282
Z2454LRRR	25 x 57.7 x 29.6	70	112.90	5.50	\$952	N/A	N/A	\$254
Z2448LRRR	25 x 51.7 x 29.6	70	103.40	5	\$883	N/A	N/A	\$227
Z2442LRRR	25 x 45.7 x 29.6	70	94	4.50	\$812	N/A	N/A	\$198
Z2436LRRR	25 x 39.7 x 29.6	70	84.30	4	\$739	N/A	N/A	\$170

Not freestanding. Grommet in worksurface. Shipped RTA (ready to assemble). Accommodates shells of all depths. Connecting hardware included. Widths and depths listed are outside dimensions including outside surrounds. Model numbers reflect the primary worksurface dimensions.

Z2072LRRR	20.9 x 75.7 x 29.6	70	128.80	6.75	\$1060	N/A	N/A	\$282
Z2060LRRR	20.9 x 63.7 x 29.6	70	111.30	5.75	\$910	N/A	N/A	\$237
Z2054LRRR	20.9 x 57.7 x 29.6	70	102.80	5.50	\$833	N/A	N/A	\$212
Z2048LRRR	20.9 x 51.7 x 29.6	70	94.10	5	\$770	N/A	N/A	\$190
Z2042LRRR	20.9 x 45.7 x 29.6	70	85.30	4.50	\$706	N/A	N/A	\$166
Z2036LRRR	20.9 x 39.7 x 29.6	70	76.30	4	\$642	N/A	N/A	\$144

Not freestanding. Grommet in worksurface. Shipped RTA (ready to assemble). Accommodates shells of **20" depths**. Connecting hardware included. Widths and depths listed are outside dimensions including outside surrounds. Model numbers reflect the primary worksurface dimensions.

Required Specifications

Top finish
Top/edge detail
Base/surround finish

Optional Specifications

HP laminate
Additional grommet

Accessories

Power block

TRANSACTIONAL RETURNS

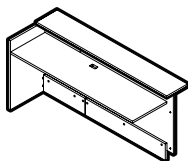

Transactional Return - LEFT

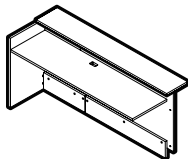

Transactional Return - LEFT

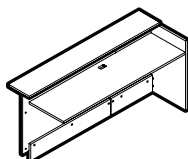

Transactional Return - RIGHT

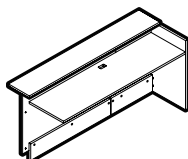

Transactional Return - RIGHT

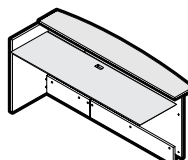

Transactional Return, Bow Front - LEFT

MODEL#	DIMENSIONS D x W x H (1.5" TOP)	FREIGHT CLASS	WT/LBS.	CUBIC FT.	1" TOP	1.5" TOP	GLAZE ADD	HP ADD
Z2472TSRL	29.7 x 75.7 x 37.5	70	166	9.75	\$1475	\$1591	N/A	\$338
Z2460TSRL	29.7 x 63.7 x 37.5	70	144	8.75	\$1274	\$1374	N/A	\$282
Z2454TSRL	29.7 x 57.7 x 37.5	70	132	7.50	\$1157	\$1250	N/A	\$254
Z2448TSRL	29.7 x 51.7 x 37.5	70	121	7	\$1064	\$1145	N/A	\$227
Z2442TSRL	29.7 x 45.7 x 37.5	70	109	6.25	\$976	\$1051	N/A	\$198
Z2436TSRL	29.7 x 39.7 x 37.5	70	96	5.50	\$885	\$950	N/A	\$170

Not freestanding. Grommet in worksurface. Shipped RTA (ready to assemble). Accommodates shells of all depths. Connecting hardware included. Widths and depths listed are outside dimensions including transaction top overhang on the front and sides. Model numbers reflect the primary worksurface dimensions.

Z2072TSRL	25.6 x 75.7 x 37.5	70	153	8.25	\$1327	\$1443	N/A	\$282
Z2060TSRL	25.6 x 63.7 x 37.5	70	132	7.25	\$1139	\$1239	N/A	\$237
Z2054TSRL	25.6 x 57.7 x 37.5	70	120	6.25	\$1032	\$1125	N/A	\$212
Z2048TSRL	25.6 x 51.7 x 37.5	70	110	5.50	\$947	\$1028	N/A	\$190
Z2042TSRL	25.6 x 45.7 x 37.5	70	100	5	\$862	\$937	N/A	\$166
Z2036TSRL	25.6 x 39.7 x 37.5	70	89	4.40	\$782	\$847	N/A	\$144

Not freestanding. Grommet in worksurface. Shipped RTA (ready to assemble). Accommodates shells of 20" depths. Connecting hardware included. Widths and depths listed are outside dimensions including transaction top overhang on the front and sides. Model numbers reflect the primary worksurface dimensions.

Z2472TSRR	29.7 x 75.7 x 37.5	70	166	9.75	\$1475	\$1591	N/A	\$338
Z2460TSRR	29.7 x 63.7 x 37.5	70	144	8.75	\$1274	\$1374	N/A	\$282
Z2454TSRR	29.7 x 57.7 x 37.5	70	132	7.50	\$1157	\$1250	N/A	\$254
Z2448TSRR	29.7 x 51.7 x 37.5	70	121	7	\$1064	\$1145	N/A	\$227
Z2442TSRR	29.7 x 45.7 x 37.5	70	109	6.25	\$976	\$1051	N/A	\$198
Z2436TSRR	29.7 x 39.7 x 37.5	70	96	5.50	\$885	\$950	N/A	\$170

Not freestanding. Grommet in worksurface. Shipped RTA (ready to assemble). Accommodates shells of all depths. Connecting hardware included. Widths and depths listed are outside dimensions including transaction top overhang on the front and sides. Model numbers reflect the primary worksurface dimensions.

Z2072TSRR	25.6 x 75.7 x 37.5	70	153	8.25	\$1327	\$1443	N/A	\$282
Z2060TSRR	25.6 x 63.7 x 37.5	70	132	7.25	\$1139	\$1239	N/A	\$237
Z2054TSRR	25.6 x 57.7 x 37.5	70	120	6.25	\$1032	\$1125	N/A	\$212
Z2048TSRR	25.6 x 51.7 x 37.5	70	110	5.50	\$947	\$1028	N/A	\$190
Z2042TSRR	25.6 x 45.7 x 37.5	70	100	5	\$862	\$937	N/A	\$166
Z2036TSRR	25.6 x 39.7 x 37.5	70	89	4.40	\$782	\$847	N/A	\$144

Not freestanding. Grommet in worksurface. Shipped RTA (ready to assemble). Accommodates shells of 20" depths. Connecting hardware included. Widths and depths listed are outside dimensions including transaction top overhang on the front and sides. Model numbers reflect the primary worksurface dimensions.

Z2472TBRL	32.7 x 75.7 x 37.5	70	168.20	9.75	\$1475	\$1591	N/A	\$338
Z2460TBRL	32.7 x 63.7 x 37.5	70	145.30	8.50	\$1274	\$1374	N/A	\$282
Z2454TBRL	32.7 x 57.7 x 37.5	70	134.40	7.50	\$1157	\$1250	N/A	\$254
Z2448TBRL	32.7 x 51.7 x 37.5	70	122.20	7	\$1064	\$1145	N/A	\$227
Z2442TBRL	32.7 x 45.7 x 37.5	70	110.90	6.25	\$976	\$1051	N/A	\$198
Z2436TBRL	32.7 x 39.7 x 37.5	70	98.40	5.50	\$885	\$950	N/A	\$170

Not freestanding. Grommet in worksurface. Shipped RTA (ready to assemble). Accommodates shells of all depths. Connecting hardware included. Widths and depths listed are outside dimensions including transaction top overhang on the front and sides. Model numbers reflect the primary worksurface dimensions.

Required Specifications

Top finish
Base/surround finish
Transaction top finish

Optional Specifications

HP laminate
Additional grommet

Accessories

Power block

TRANSACTIONAL RETURNS

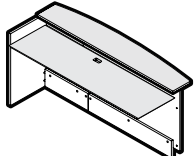

Transactional Return, Bow Front - LEFT

MODEL#	DIMENSIONS D x W x H (1.5" TOP)	FREIGHT CLASS	WT/LBS.	CUBIC FT.	1" TOP	1.5" TOP	GLAZE ADD	HP ADD
Z2072TBRL	28.6 x 75.7 x 37.5	70	155.60	8.25	\$1327	\$1443	N/A	\$282
Z2060TBRL	28.6 x 63.7 x 37.5	70	134.20	7.50	\$1139	\$1239	N/A	\$237
Z2054TBRL	28.6 x 57.7 x 37.5	70	124	6.50	\$1032	\$1125	N/A	\$212
Z2048TBRL	28.6 x 51.7 x 37.5	70	112.60	6	\$947	\$1028	N/A	\$190
Z2042TBRL	28.6 x 45.7 x 37.5	70	101.90	5.25	\$862	\$937	N/A	\$166
Z2036TBRL	28.6 x 39.7 x 37.5	70	90.10	4.70	\$782	\$847	N/A	\$144

Not freestanding. Grommet in worksurface. Shipped RTA (ready to assemble). Accommodates shells of **20" depths**. Connecting hardware included. Widths and depths listed are outside dimensions including transaction top overhang on the front and sides. Model numbers reflect the primary worksurface dimensions.

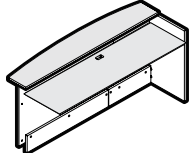

Transactional Return, Bow Front - RIGHT

Z2472TBRR	32.7 x 75.7 x 37.5	70	168.20	9.75	\$1475	\$1591	N/A	\$338
Z2460TBRR	32.7 x 63.7 x 37.5	70	145.30	8.50	\$1274	\$1374	N/A	\$282
Z2454TBRR	32.7 x 57.7 x 37.5	70	134.40	7.50	\$1157	\$1250	N/A	\$254
Z2448TBRR	32.7 x 51.7 x 37.5	70	122.20	7	\$1064	\$1145	N/A	\$227
Z2442TBRR	32.7 x 45.7 x 37.5	70	110.90	6.25	\$976	\$1051	N/A	\$198
Z2436TBRR	32.7 x 39.7 x 37.5	70	98.40	5.50	\$885	\$950	N/A	\$170

Not freestanding. Grommet in worksurface. Shipped RTA (ready to assemble). Accommodates shells of all depths. Connecting hardware included. Widths and depths listed are outside dimensions including transaction top overhang on the front and sides. Model numbers reflect the primary worksurface dimensions.

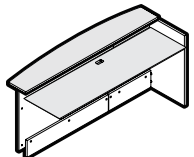

Transactional Return, Bow Front - RIGHT

Z2072TBRR	28.6 x 75.7 x 37.5	70	155.60	8.25	\$1327	\$1443	N/A	\$282
Z2060TBRR	28.6 x 63.7 x 37.5	70	134.20	7.50	\$1139	\$1239	N/A	\$237
Z2054TBRR	28.6 x 57.7 x 37.5	70	124	6.50	\$1032	\$1125	N/A	\$212
Z2048TBRR	28.6 x 51.7 x 37.5	70	112.60	6	\$947	\$1028	N/A	\$190
Z2042TBRR	28.6 x 45.7 x 37.5	70	101.90	5.25	\$862	\$937	N/A	\$166
Z2036TBRR	28.6 x 39.7 x 37.5	70	90.10	4.70	\$782	\$847	N/A	\$144

Not freestanding. Grommet in worksurface. Shipped RTA (ready to assemble). Accommodates shells of **20" depths**. Connecting hardware included. Widths and depths listed are outside dimensions including transaction top overhang on the front and sides. Model numbers reflect the primary worksurface dimensions.

Required Specifications

Top finish
Transaction top finish
Base/surround finish

Optional Specifications

HP laminate
Additional grommet

Accessories

Power block

PIGEON RECEPTION RETURNS

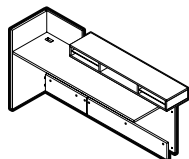

Pigeon Reception Return - LEFT*

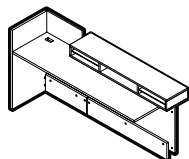

Pigeon Reception Return - LEFT*

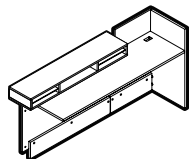

Pigeon Reception Return - RIGHT*

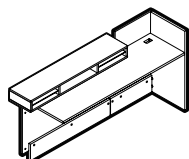

Pigeon Reception Return - RIGHT*

MODEL#	DIMENSIONS D x W x H	FREIGHT CLASS	WT/LBS.	CUBIC FT.	1" TOP	1.5" TOP	GLAZE ADD	HP ADD
Z2472PRRL	31 x 75.7 x 40.3	70	171.30	9.75	\$1671	N/A	N/A	\$338
Z2460PRRL	31 x 63.7 x 40.3	70	149	8.25	\$1468	N/A	N/A	\$282
Z2454PRRL	31 x 57.7 x 40.3	70	136.40	7.50	\$1365	N/A	N/A	\$254

Not freestanding. Grommet in worksurface. Shipped RTA (ready to assemble). Accommodates shells of all depths. Connecting hardware included. Widths and depths listed are outside dimensions including transaction top overhang on the front and sides. Model numbers reflect the primary worksurface dimensions.

Z2072PRRL	26.9 x 75.7 x 40.3	70	159	9.75	\$1527	N/A	N/A	\$282
Z2060PRRL	26.9 x 63.7 x 40.3	70	138.20	8.25	\$1337	N/A	N/A	\$237
Z2054PRRL	26.9 x 57.7 x 40.3	70	126.20	7.50	\$1242	N/A	N/A	\$212

Not freestanding. Grommet in worksurface. Shipped RTA (ready to assemble). Accommodates shells of 20" depths. Connecting hardware included. Widths and depths listed are outside dimensions including transaction top overhang on the front and sides. Model numbers reflect the primary worksurface dimensions.

Z2472PRRR	31 x 75.7 x 40.3	70	171.30	9.75	\$1671	N/A	N/A	\$338
Z2460PRRR	31 x 63.7 x 40.3	70	149	8.25	\$1468	N/A	N/A	\$282
Z2454PRRR	31 x 57.7 x 40.3	70	136.40	7.50	\$1365	N/A	N/A	\$254

Not freestanding. Grommet in worksurface. Shipped RTA (ready to assemble). Accommodates shells of all depths. Connecting hardware included. Widths and depths listed are outside dimensions including transaction top overhang on the front and sides. Model numbers reflect the primary worksurface dimensions.

Z2072PRRR	26.9 x 75.7 x 40.3	70	159	9.75	\$1527	N/A	N/A	\$282
Z2060PRRR	26.9 x 63.7 x 40.3	70	138.20	8.25	\$1337	N/A	N/A	\$237
Z2054PRRR	26.9 x 57.7 x 40.3	70	126.20	7.50	\$1242	N/A	N/A	\$212

Not freestanding. Grommet in worksurface. Shipped RTA (ready to assemble). Accommodates shells of 20" depths. Connecting hardware included. Widths and depths listed are outside dimensions including transaction top overhang on the front and sides. Model numbers reflect the primary worksurface dimensions.

Required Specifications

Top finish
Base/surround finish
Pigeon hole finish
Collator finish

Optional Specifications

HP laminate
Additional grommet

Accessories

Power block

BOOKCASE RETURNS

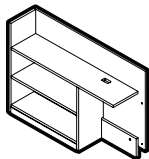

Bookcase Reception Return - LEFT

MODEL#	DIMENSIONS D x W x H	FREIGHT CLASS	WT/LBS.	CUBIC FT.	1" TOP	1.5" TOP	GLAZE ADD	HP ADD
Z1272BRRL	13.7 x 75.7 x 40.3	70	158	7.50	\$1336	N/A	N/A	\$170
Z1260BRRL	13.7 x 63.7 x 40.3	70	139	6.25	\$1181	N/A	N/A	\$144

Not freestanding. Grommet in worksurface. Shipped RTA (ready to assemble). Accommodates shells of all depths. Connecting hardware included. Widths and depths listed are outside dimensions including outside surrounds. Model numbers reflect the primary worksurface dimensions.

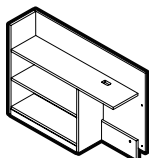

Bookcase Reception Return - LEFT

Z1254BRRL	13.7 x 57.7 x 40.3	65	131	5.75	\$1093	N/A	N/A	\$128
Z1248BRRL	13.7 x 51.7 x 40.3	70	114	5.25	\$973	N/A	N/A	\$115
Z1242BRRL	13.7 x 45.7 x 40.3	65	106	4.60	\$914	N/A	N/A	\$101
Z1236BRRL	13.7 x 39.7 x 40.3	65	98	4.10	\$857	N/A	N/A	\$87

Not freestanding. Grommet in worksurface. Shipped RTA (ready to assemble). Accommodates shells of all depths. Connecting hardware included. Widths and depths listed are outside dimensions including outside surrounds. Model numbers reflect the primary worksurface dimensions.

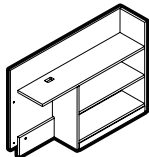

Bookcase Reception Return - RIGHT

Z1272BRRR	13.7 x 75.7 x 40.3	70	158	7.50	\$1336	N/A	N/A	\$170
Z1260BRRR	13.7 x 63.7 x 40.3	70	139	6.25	\$1181	N/A	N/A	\$144

Not freestanding. Grommet in worksurface. Shipped RTA (ready to assemble). Accommodates shells of all depths. Connecting hardware included. Widths and depths listed are outside dimensions including outside surrounds. Model numbers reflect the primary worksurface dimensions.

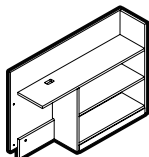

Bookcase Reception Return - RIGHT

Z1254BRRR	13.7 x 57.7 x 40.3	65	131	5.75	\$1093	N/A	N/A	\$128
Z1248BRRR	13.7 x 51.7 x 40.3	70	114	5.25	\$973	N/A	N/A	\$115
Z1242BRRR	13.7 x 45.7 x 40.3	65	106	4.60	\$914	N/A	N/A	\$101
Z1236BRRR	13.7 x 39.7 x 40.3	65	98	4.10	\$857	N/A	N/A	\$87

Not freestanding. Grommet in worksurface. Shipped RTA (ready to assemble). Accommodates shells of all depths. Connecting hardware included. Widths and depths listed are outside dimensions including outside surrounds. Model numbers reflect the primary worksurface dimensions.

RECEPTION DESK VERTICAL STORAGE

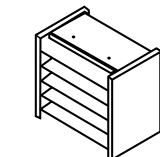

Reception Desk - Vertical Storage*

MODEL#	DIMENSIONS	FREIGHT CLASS	WT/LBS.	CUBIC FT.	1" TOP	1.5" TOP	GLAZE ADD	HP ADD
ZRDVS13	8.6 x 13.4 x 12.2	70	12.50	.80	\$219	N/A	N/A	N/A

Collator shelves.

Required Specifications

Top finish
Base/surround finish
Pigeon hole finish*
Collator finish*

Optional Specifications

HP laminate
Additional grommet

Accessories

Power block

GENERAL INFORMATION

- Comprehensive range of personal storage in a variety of sizes and configurations starting at 27.5"/28"H single column widths up to 66.5"/67"H triple column widths.
- Configurations include units with 1, 2, 3, 4, 6, 8 or 9 compartments depending on size.
- Lockers adapt to any space plan; in personal or shared work spaces, individually tailored to suit storage needs. Ideal for flex spaces or used to define space and used as barriers between work areas and to help guide workplace foot traffic flow.
- Available in two depths with door front in thermally fused laminate to add warmth and complement desking products or millwork.
- Multiple door pull options to match Global Desking series
- Units have internal drill points for optional ganging.
- Ships fully assembled.

CONSTRUCTION

- Tops are available in 1" or 1.5" thick thermally fused laminate tops with a variety of edge details
- Side panels utilize 1" thick material
- Shelves and backs utilize 11/16" thick material.
- Tops are sealed with Global's preferred edge in matching color. Woodgrain surfaces feature edging with matching printed woodgrain
- Constructed of 45 lb. density particleboard with high performance thermally fused laminate
- Virtually no loose hardware
- Leveling glides are standard

LOCKS

- Locks are standard on all lockers. Finish will coordinate with handles and/or aluminum doors.
- Please note that Flared Brass (HW) handle defaults to Black locks

SHIPPING

- Shipped assembled, 1 per carton, unless otherwise noted.

PRODUCT CODE BREAKDOWN:

- ZL**- indicates Zira locker
- ##** - 3rd & 4th position indicates height
- ##** - 5th & 6th position indicates width
- F** - indicates 18"D overall / **L** - indicates 24"D overall
- #** - 8th position indicates the number of columns side to side
- #** - 9th position indicates the number of rows top to bottom
- L** or **R** - indicates doors installed for left or right hand hinge

FINISH OPTIONS

- Must specify finish for top, case and doors separately

Thermally fused laminate finish options:

ACJ Absolute Acajou	NGL Noce Grigio
ASN Asian Night	NEL Noce Leggero
AWC Avant Cherry	NML Noce Medio
AWH Avant Honey	QTM Quartered Mahogany
BLK Black	SOG Storm Grey
BRC Brushed Cobalt	TFW Tiger Fruitwood
CMB Clear Maple	TWL Tiger Walnut
DES Dark Espresso	WHE Walnut Heights
DWT Designer White	WHC White Chocolate
HGT Hayden Grey	WGY Willow Grey
NBL Noce Biondo	WCR Winter Cherry

Top Thickness/Edge Detail

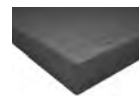

A3 1" top, standard flat edge



AR 1" top, bicut edge



C3 1.5" top, standard flat edge



CR 1.5" top, bicut edge



CF 1.5" top, fluted edge

HANDLES

- To order handles, please specify corresponding code to image as below (**HS, HO, HW, HX, HV, HU, HQ, HZ, or HR**):



HS Flared Silver



HV Square Edge Silver



HO Crescent Black



HW Flared Brass



HU Square Edge Black



HZ Dimpled Nickel



HX Flared Black



HQ Bar Silver



HR Bar Black

INTERIOR SHELF AND HANGING OPTIONS

- Hooks and hat shelves are standard in certain units. See individual product description for details
- When standard, hat shelf is 11/16" thick and includes 9" of clearance.
- A chrome coat hook is affixed to the left or right side wall of the opening (based on left and right handed units) on single row lockers 40.5" and up, and on double row lockers 53.5"h and up.
- When standard, a chrome coat hook is affixed to the door.

GANGING

- **All units 12", 15" or 18" wide must be ganged to another locker or anchored to a fixed wall or adjacent cabinet for compliance with applicable ANSI/BIFMA X5.6 Storage standards.**
- Units ship factory ready for ganging and include pre-drills on cabinet interiors as well as the necessary hardware to connect unit to unit.

SINGLE COLUMN LOCKERS

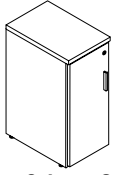

Left shown

One Column, One Row - 27.5/28" H

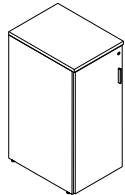

Left shown

One Column, One Row - 40.5/41" H

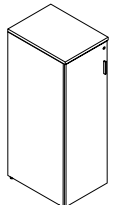

Left shown

One Column, One Row - 53.5/54" H

MODEL#	DIMENSIONS D x W x H	FREIGHT CLASS	WT/LBS.	CUBIC FT.	1" TOP	1.5" TOP
ZL2712F11L	18 x 12 x 27.5-28	92.5	52	5	\$650	\$666
ZL2712F11R	18 x 12 x 27.5-28	92.5	52	5	\$650	\$666

- Select suffix **(L)** for **left** hand / **(R)** for **right** hand opening.
- 12" wide lockers to be ganged or anchored for compliance with ANSI/BIFMA X5.6 storage standards.

ZL4012F11L	18 x 12 x 40.5-41	92.5	71	7.09	\$839	\$871
ZL4015F11L	18 x 15 x 40.5-41	100	74	8.75	\$907	\$939
ZL4018F11L	18 x 18 x 40.5-41	100	86	10.25	\$991	\$1023
ZL4012L11L	24 x 12 x 40.5-41	100	89	9.35	\$923	\$954
ZL4015L11L	24 x 15 x 40.5-41	100	97	11.25	\$1007	\$1023
ZL4018L11L	24 x 18 x 40.5-41	125	105	13.25	\$1091	\$1127

ZL4012F11R	18 x 12 x 40.5-41	92.5	71	7.09	\$839	\$871
ZL4015F11R	18 x 15 x 40.5-41	100	74	8.75	\$907	\$939
ZL4018F11R	18 x 18 x 40.5-41	100	86	10.25	\$991	\$1023
ZL4012L11R	24 x 12 x 40.5-41	100	89	9.35	\$923	\$954
ZL4015L11R	24 x 15 x 40.5-41	100	97	11.25	\$1007	\$1023
ZL4018L11R	24 x 18 x 40.5-41	125	105	13.25	\$1091	\$1127

- Select suffix **(L)** for **left** hand / **(R)** for **right** hand opening. Includes hat shelf and coat hook.
- 12", 15" or 18" wide lockers to be ganged or anchored for compliance with ANSI/BIFMA X5.6 storage standards.

ZL5312F11L	18 x 12 x 53.5-54	100	92	9.25	\$1075	\$1091
ZL5315F11L	18 x 15 x 53.5-54	100	101	11.25	\$1180	\$1211
ZL5318F11L	18 x 18 x 53.5-54	100	111	13	\$1295	\$1347
ZL5312L11L	24 x 12 x 53.5-54	100	115	12	\$1180	\$1211
ZL5315L11L	24 x 15 x 53.5-54	100	126	14.5	\$1264	\$1295
ZL5318L11L	24 x 18 x 53.5-54	100	136	17	\$1384	\$1431

ZL5312F11R	18 x 12 x 53.5-54	100	92	9.25	\$1075	\$1091
ZL5315F11R	18 x 15 x 53.5-54	100	101	11.25	\$1180	\$1211
ZL5318F11R	18 x 18 x 53.5-54	100	111	13	\$1295	\$1347
ZL5312L11R	24 x 12 x 53.5-54	100	115	12	\$1180	\$1211
ZL5315L11R	24 x 15 x 53.5-54	100	126	14.5	\$1264	\$1295
ZL5318L11R	24 x 18 x 53.5-54	100	136	17	\$1384	\$1431

- Select suffix **(L)** for **left** hand / **(R)** for **right** hand opening. Includes hat shelf and coat hook.
- 12", 15" or 18" wide lockers to be ganged or anchored for compliance with ANSI/BIFMA X5.6 storage standards.

Required Specifications

Top Finish
 Door Finish
 Top/Edge Detail
 Handles
 Base Finish

Optional Specifications

Key #

Accessories

SINGLE COLUMN LOCKERS

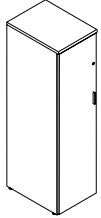

Left shown

One Column, One Row - 66.5/67" H

MODEL#	DIMENSIONS	FREIGHT CLASS	WT/LBS.	CUBIC FT.	1" TOP	1.5" TOP
D x W x H						
ZL6612F11L	18 x 12 x 66.5-67	100	111	11.5	\$1227	\$1247
ZL6615F11L	18 x 15 x 66.5-67	100	122	13.75	\$1316	\$1347
ZL6618F11L	18 x 18 x 66.5-67	125	127	16.25	\$1468	\$1499
ZL6612L11L	24 x 12 x 66.5-67	100	139	15	\$1363	\$1400
ZL6615L11L	24 x 15 x 66.5-67	100	151	18	\$1452	\$1499
ZL6618L11L	24 x 18 x 66.5-67	125	163	22	\$1589	\$1636
ZL6612F11R	18 x 12 x 66.5-67	100	111	11.5	\$1227	\$1247
ZL6615F11R	18 x 15 x 66.5-67	100	122	13.75	\$1316	\$1347
ZL6618F11R	18 x 18 x 66.5-67	125	127	16.25	\$1468	\$1499
ZL6612L11R	24 x 12 x 66.5-67	100	139	15	\$1363	\$1400
ZL6615L11R	24 x 15 x 66.5-67	100	151	18	\$1452	\$1499
ZL6618L11R	24 x 18 x 66.5-67	125	163	22	\$1589	\$1636

- Select suffix **(L)** for left hand / **(R)** for right hand opening. Includes hat shelf and coat hook.
- 12", 15" or 18" wide lockers to be ganged or anchored for compliance with ANSI/BIFMA X5.6 storage standards.

ONE COLUMN LOCKERS, TWO ROWS

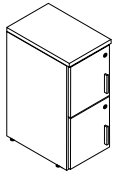

Left shown

One Column, Two Rows - 27.5/28" H

MODEL#	DIMENSIONS	FREIGHT CLASS	WT/LBS.	CUBIC FT.	1" TOP	1.5" TOP
ZL2712F12L	18 x 12 x 27.5-28	92.5	55	5	\$771	\$797
ZL2712F12R	18 x 12 x 27.5-28	92.5	55	5	\$771	\$797

- Select suffix **(L)** for left hand / **(R)** for right hand opening.
- 12" wide lockers to be ganged or anchored for compliance with ANSI/BIFMA X5.6 storage standards.

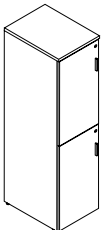

Left shown

One Column, Two Rows - 66.5/67" H

ZL6612F12L	18 x 12 x 66.5-67	100	112	11.5	\$1368	\$1395
ZL6618F12L	18 x 18 x 66.5-67	100	135	16.25	\$1599	\$1641
ZL6612L12L	24 x 12 x 66.5-67	100	140	15	\$1499	\$1531
ZL6618L12L	24 x 18 x 66.5-67	125	165	21.25	\$1741	\$1788
ZL6612F12R	18 x 12 x 66.5-67	100	112	11.5	\$1368	\$1395
ZL6618F12R	18 x 18 x 66.5-67	100	135	16.25	\$1599	\$1641
ZL6612L12R	24 x 12 x 66.5-67	100	140	15	\$1499	\$1531
ZL6618L12R	24 x 18 x 66.5-67	125	165	21.25	\$1741	\$1788

- Select suffix **(L)** for left hand / **(R)** for right hand opening. Includes coat hook in each opening
- 12" or 18" wide lockers to be ganged or anchored for compliance with ANSI/BIFMA X5.6 storage standards.

Required Specifications

Top Finish Base Finish
 Door Finish
 Top/Edge Detail
 Handles

Optional Specifications

Key #

Accessories

ONE COLUMN LOCKERS, THREE ROWS

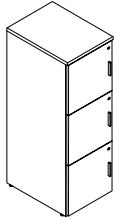

Left shown

One Column, Three Rows - 53.5/54" H

MODEL#	DIMENSIONS D x W x H	FREIGHT CLASS	WT/LBS.	CUBIC FT.	1" TOP	1.5" TOP
ZL5312F13L	18 x 12 x 53.5-54	92.5	96	9.25	\$1211	\$1237
ZL5318F13L	18 x 18 x 53.5-54	100	118	13.25	\$1447	\$1484
ZL5312L13L	24 x 12 x 53.5-54	100	121	12.25	\$1321	\$1353
ZL5318L13L	24 x 18 x 53.5-54	100	145	17.25	\$1568	\$1667
ZL5312F13R	18 x 12 x 53.5-54	92.5	96	9.25	\$1211	\$1237
ZL5318F13R	18 x 18 x 53.5-54	100	118	13.25	\$1447	\$1484
ZL5312L13R	24 x 12 x 53.5-54	100	121	12.25	\$1321	\$1353
ZL5318L13R	24 x 18 x 53.5-54	100	145	17.25	\$1568	\$1667

- Select suffix **(L)** for **left** hand / **(R)** for **right** hand.
- 12" or 18" wide lockers to be ganged or anchored for compliance with ANSI/BIFMA X5.6 storage standards.

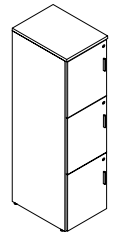

Left shown

One Column, Three Rows - 66.5/67" H

ZL6612F13L	18 x 12 x 66.5-67	92.5	115	11.5	\$1368	\$1395
ZL6618F13L	18 x 18 x 66.5-67	100	140	16.25	\$1620	\$1672
ZL6612L13L	24 x 12 x 66.5-67	100	144	15	\$1494	\$1526
ZL6618L13L	24 x 18 x 66.5-67	100	171	21.25	\$1767	\$1814
ZL6612F13R	18 x 12 x 66.5-67	92.5	115	11.5	\$1368	\$1395
ZL6618F13R	18 x 18 x 66.5-67	100	140	16.25	\$1620	\$1672
ZL6612L13R	24 x 12 x 66.5-67	100	144	15	\$1494	\$1526
ZL6618L13R	24 x 18 x 66.5-67	100	171	21.25	\$1767	\$1814

- Select suffix **(L)** for **left** hand / **(R)** for **right** hand opening.
- 12" or 18" wide lockers to be ganged or anchored for compliance with ANSI/BIFMA X5.6 storage standards.

ONE COLUMN LOCKERS, FOUR ROWS

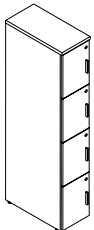

Left shown

One Column, Four Rows - 66.5/67" H

MODEL#	DIMENSIONS	FREIGHT CLASS	WT/LBS.	CUBIC FT.	1" TOP	1.5" TOP
ZL6612F14L	18 x 12 x 66.5-67	92.5	119	11.5	\$1520	\$1547
ZL6612L14L	24 x 12 x 66.5-67	100	149	15	\$1651	\$1683
ZL6612F14R	18 x 12 x 66.5-67	92.5	119	11.5	\$1520	\$1547
ZL6612L14R	24 x 12 x 66.5-67	100	149	15	\$1651	\$1683

- Select suffix **(L)** for **left** hand / **(R)** for **right** hand opening.
- 12" wide lockers to be ganged or anchored for compliance with ANSI/BIFMA X5.6 storage standards.

Required Specifications

Top Finish _____ Base Finish _____
 Door Finish _____
 Top/Edge Detail _____
 Handles _____

Optional Specifications

Key # _____

Accessories

TWO COLUMN LOCKERS, ONE ROW

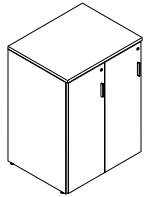

Left shown

Two Columns, One Row - 40.5/41" H

MODEL#	DIMENSIONS	FREIGHT CLASS	WT/LBS.	CUBIC FT.	1" TOP	1.5" TOP
D x W x H						
ZL4024F21L	18 x 24 x 40.5-41	100	118	13.25	\$1421	\$1473
ZL4030F21L	18 x 30 x 40.5-41	100	133	16.5	\$1536	\$1599
ZL4024L21L	24 x 24 x 40.5-41	100	149	17.25	\$1562	\$1620
ZL4030L21L	24 x 30 x 40.5-41	125	166	21.25	\$1683	\$1756
ZL4024F21R	18 x 24 x 40.5-41	100	118	13.25	\$1421	\$1473
ZL4030F21R	18 x 30 x 40.5-41	100	133	16.5	\$1536	\$1599
ZL4024L21R	24 x 24 x 40.5-41	100	149	17.25	\$1562	\$1620
ZL4030L21R	24 x 30 x 40.5-41	125	166	21.25	\$1683	\$1756

- Select suffix **(L)** for left hand / **(R)** for right hand opening. Includes coat hook in each opening

TWO COLUMN LOCKERS, TWO ROWS

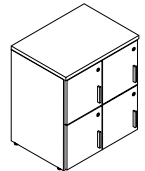

Left shown

Two Columns, Two Rows - 27.5/28" H

MODEL#	DIMENSIONS	FREIGHT CLASS	WT/LBS.	CUBIC FT.	1" TOP	1.5" TOP
ZL2724F22L	18 x 24 x 27.5-28	100	94	9.5	\$1321	\$1368
ZL2724F22R	18 x 24 x 27.5-28	100	94	9.5	\$1321	\$1368

- Select suffix **(L)** for left hand / **(R)** for right hand opening.

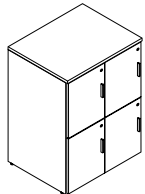

Left shown

Two Columns, Two Rows - 40.5/41" H

ZL4024F22L	18 x 24 x 40.5-41	100	125	13.25	\$1552	\$1599
ZL4030F22L	18 x 30 x 40.5-41	100	142	16.25	\$1683	\$1741
ZL4024L22L	24 x 24 x 40.5-41	100	158	17.25	\$1704	\$1762
ZL4030L22L	24 x 30 x 40.5-41	100	178	21.25	\$1845	\$1919
ZL4024F22R	18 x 24 x 40.5-41	100	125	13.25	\$1552	\$1599
ZL4030F22R	18 x 30 x 40.5-41	100	142	16.25	\$1683	\$1741
ZL4024L22R	24 x 24 x 40.5-41	100	158	17.25	\$1704	\$1762
ZL4030L22R	24 x 30 x 40.5-41	100	178	21.25	\$1845	\$1919

- Select suffix **(L)** for left hand / **(R)** for right hand opening.

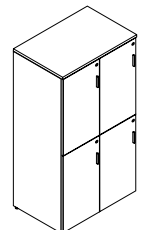

Left shown

Two Columns, Two Rows - 66.5/67" H

ZL6624F22L	18 x 24 x 66.5-67	100	187	21.25	\$2317	\$2364
ZL6636F22L	18 x 36 x 66.5-67	125	235	31	\$2721	\$2789
ZL6636L22L	24 x 36 x 66.5-67	125	283	40	\$2925	\$3009
ZL6624F22R	18 x 24 x 66.5-67	100	187	21.25	\$2317	\$2364
ZL6636F22R	18 x 36 x 66.5-67	125	235	31	\$2721	\$2789
ZL6636L22R	24 x 36 x 66.5-67	125	283	40	\$2925	\$3009

- Select suffix **(L)** for left hand / **(R)** for right hand opening. Includes coat hook in each opening and on each door.

Required Specifications

Top Finish _____ Base Finish _____
 Door Finish _____
 Top/Edge Detail _____
 Handles _____

Optional Specifications

Key # _____

Accessories

TWO COLUMN LOCKERS, THREE ROWS

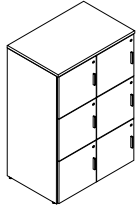

Left shown

Two Columns, Three Rows - 53.5/54" H

MODEL#	DIMENSIONS	FREIGHT CLASS	WT/LBS.	CUBIC FT.	1" TOP	1.5" TOP
D x W x H						
ZL5324F23L	18 x 24 x 53.5-54	100	163	17.25	\$2071	\$2123
ZL5330F23L	18 x 30 x 53.5-54	100	185	21.25	\$2249	\$2307
ZL5336F23L	18 x 36 x 53.5-54	100	207	25.25	\$2464	\$2537
ZL5324L23L	24 x 24 x 53.5-54	100	205	22.5	\$2265	\$2322
ZL5330L23L	24 x 30 x 53.5-54	100	230	27.5	\$2453	\$2527
ZL5336L23L	24 x 36 x 53.5-54	125	252	32.75	\$2673	\$2757
ZL5324F23R	18 x 24 x 53.5-54	100	163	17.25	\$2071	\$2123
ZL5330F23R	18 x 30 x 53.5-54	100	185	21.25	\$2249	\$2307
ZL5336F23R	18 x 36 x 53.5-54	100	207	25.25	\$2464	\$2537
ZL5324L23R	24 x 24 x 53.5-54	100	205	22.5	\$2265	\$2322
ZL5330L23R	24 x 30 x 53.5-54	100	230	27.5	\$2453	\$2527
ZL5336L23R	24 x 36 x 53.5-54	125	252	32.75	\$2673	\$2757

- Select suffix **(L)** for **left** hand / **(R)** for **right** hand.
- 12" or 18" wide lockers to be ganged or anchored for compliance with ANSI/BIFMA X5.6 storage standards.

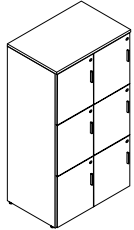

Left shown

Two Columns, Three Rows - 66.5/67" H

ZL6624F23L	18 x 24 x 66.5-67	100	194	21.25	\$2312	\$2359
ZL6630F23L	18 x 30 x 66.5-67	100	219	26	\$2511	\$2569
ZL6636F23L	18 x 36 x 66.5-67	125	246	31	\$2763	\$2836
ZL6624L23L	24 x 24 x 66.5-67	100	243	27.5	\$2527	\$2584
ZL6630L23L	24 x 30 x 66.5-67	100	271	33.75	\$2742	\$2810
ZL6636L23L	24 x 36 x 66.5-67	125	297	40	\$2988	\$3072
ZL6624F23R	18 x 24 x 66.5-67	100	194	21.25	\$2312	\$2359
ZL6630F23R	18 x 30 x 66.5-67	100	219	26	\$2511	\$2569
ZL6636F23R	18 x 36 x 66.5-67	125	246	31	\$2763	\$2836
ZL6624L23R	24 x 24 x 66.5-67	100	243	27.5	\$2527	\$2584
ZL6630L23R	24 x 30 x 66.5-67	100	271	33.75	\$2742	\$2810
ZL6636L23R	24 x 36 x 66.5-67	125	297	40	\$2988	\$3072

- Select suffix **(L)** for **left** hand / **(R)** for **right** hand.
- 12" or 18" wide lockers to be ganged or anchored for compliance with ANSI/BIFMA X5.6 storage standards.

TWO COLUMN LOCKERS, FOUR ROWS

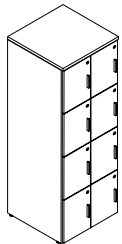

Left shown

Two Columns, Four Rows - 66.5/67" H

MODEL#	DIMENSIONS	FREIGHT CLASS	WT/LBS.	CUBIC FT.	1" TOP	1.5" TOP
ZL6624F24L	18 x 24 x 66.5-67	100	201	21.25	\$2616	\$2663
ZL6624L24L	24 x 24 x 66.5-67	100	252	27.5	\$2841	\$2904
ZL6624F24R	18 x 24 x 66.5-67	100	201	21.25	\$2616	\$2663
ZL6624L24R	24 x 24 x 66.5-67	100	252	27.5	\$2841	\$2904

- Select suffix **(L)** for **left** hand / **(R)** for **right** hand opening.

Required Specifications

Top Finish
 Door Finish
 Top/Edge Detail
 Handles

Optional Specifications

Key #

Accessories

THREE COLUMN LOCKERS, ONE ROW

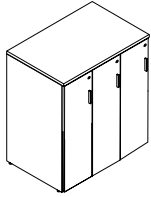

Left shown

Three Columns, One Row - 40.5/41" H

MODEL#	DIMENSIONS D x W x H	FREIGHT CLASS	WT/LBS.	CUBIC FT.	1" TOP	1.5" TOP
ZL4036F31L	18 x 36 x 40.5-41	100	165	19.5	\$1971	\$2045
ZL4036L31L	24 x 36 x 40.5-41	100	203	25.25	\$2134	\$2217
ZL4036F31R	18 x 36 x 40.5-41	100	165	19.5	\$1971	\$2045
ZL4036L31R	24 x 36 x 40.5-41	100	203	25.25	\$2134	\$2217

- Select suffix **(L)** for left hand / **(R)** for right hand opening. Includes coat hook in each opening

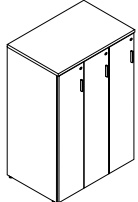

Left shown

Three Columns, One Row - 53.5/54" H

ZL5336F31L	18 x 36 x 53.5-54	100	215	25.25	\$2432	\$2506
ZL5336L31L	24 x 36 x 53.5-54	100	265	32.75	\$2668	\$2752
ZL5336F31R	18 x 36 x 53.5-54	100	215	25.25	\$2432	\$2506
ZL5336L31R	24 x 36 x 53.5-54	100	265	32.75	\$2668	\$2752

- Select suffix **(L)** for left hand / **(R)** for right hand opening. Includes hat shelf and coat hook in each opening.

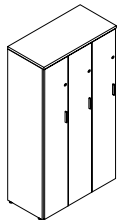

Left shown

Three Columns, One Row - 66.5/67" H

ZL6636F31L	18 x 36 x 66.5-67	100	258	31	\$2763	\$2831
ZL6636L31L	24 x 36 x 66.5-67	125	317	40	\$3025	\$3108
ZL6636F31R	18 x 36 x 66.5-67	100	258	31	\$2763	\$2831
ZL6636L31R	24 x 36 x 66.5-67	125	317	40	\$3025	\$3108

- Select suffix **(L)** for left hand / **(R)** for right hand opening. Includes hat shelf and coat hook in each opening.

THREE COLUMN LOCKERS, TWO ROWS

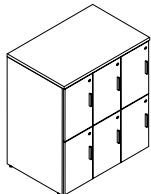

Left shown

Three Columns, Two Rows - 40.5/41" H

MODEL#	DIMENSIONS	FREIGHT CLASS	WT/LBS.	CUBIC FT.	1" TOP	1.5" TOP
ZL4036F32L	18 x 36 x 40.5-41	100	176	19.5	\$2165	\$2233
ZL4036L32L	24 x 36 x 40.5-41	100	218	25.25	\$2349	\$2432
ZL4036F32R	18 x 36 x 40.5-41	100	176	19.5	\$2165	\$2233
ZL4036L32R	24 x 36 x 40.5-41	100	218	25.25	\$2349	\$2432

- Select suffix **(L)** for left hand / **(R)** for right hand opening.

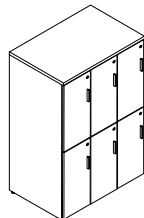

Left shown

Three Columns, Two Rows - 53.5/54" H

ZL5336F32L	18 x 36 x 53.5-54	100	219	25.25	\$2925	\$2993
ZL5336L32L	24 x 36 x 53.5-54	100	269	32.75	\$3140	\$3224
ZL5336F32R	18 x 36 x 53.5-54	100	219	25.25	\$2925	\$2993
ZL5336L32R	24 x 36 x 53.5-54	100	269	32.75	\$3140	\$3224

- Select suffix **(L)** for left hand / **(R)** for right hand opening. Includes coat hook in each opening and on each door.

Required Specifications

Top Finish _____ Base Finish _____
 Door Finish _____
 Top/Edge Detail _____
 Handles _____

Optional Specifications

Key # _____

Accessories

THREE COLUMN LOCKERS, TWO ROWS

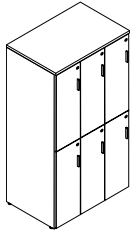

Left shown

Three Columns, Two Rows - 66.5/67" H

MODEL#	DIMENSIONS D x W x H	FREIGHT CLASS	WT/LBS.	CUBIC FT.	1" TOP	1.5" TOP
ZL6636F32L	18 x 36 x 66.5-67	100	262	31	\$3292	\$3360
ZL6636L32L	24 x 36 x 66.5-67	100	322	40	\$3549	\$3633
ZL6636F32R	18 x 36 x 66.5-67	100	262	31	\$3292	\$3360
ZL6636L32R	24 x 36 x 66.5-67	100	322	40	\$3549	\$3633

- Select suffix **(L)** for **left** hand / **(R)** for **right** hand opening. Includes coat hook in each opening and on each door.

THREE COLUMN LOCKERS, THREE ROWS

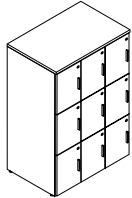

Left shown

Three Columns, Three Rows - 53.5/54" H

MODEL#	DIMENSIONS	FREIGHT CLASS	WT/LBS.	CUBIC FT.	1" TOP	1.5" TOP
ZL5336F33L	18 x 36 x 53.5-54	100	229	25.25	\$2920	\$2988
ZL5336L33L	24 x 36 x 53.5-54	100	283	32.75	\$3150	\$3234
ZL5336F33R	18 x 36 x 53.5-54	100	229	25.25	\$2920	\$2988
ZL5336L33R	24 x 36 x 53.5-54	100	283	32.75	\$3150	\$3234

- Select suffix **(L)** for **left** hand / **(R)** for **right** hand opening.

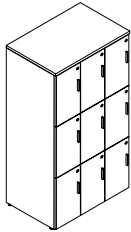

Left shown

Three Columns, Three Rows - 66.5/67" H

ZL6636F33L	18 x 36 x 66.5-67	100	272	31	\$3287	\$3355
ZL6636L33L	24 x 36 x 66.5-67	100	336	40	\$3564	\$3648
ZL6636F33R	18 x 36 x 66.5-67	100	272	31	\$3287	\$3355
ZL6636L33R	24 x 36 x 66.5-67	100	336	40	\$3564	\$3648

- Select suffix **(L)** for **left** hand / **(R)** for **right** hand opening.

Required Specifications

Top Finish _____ Base Finish _____
 Door Finish _____
 Top/Edge Detail _____
 Handles _____

Optional Specifications

Key # _____

Accessories

desking – metal



StreamLINE II

308



Global's **StreamLINE** series incorporates a rich laminate top with a sturdy steel body. This unique combination is great for heavy duty environments such as offices, schools, warehouses and factories.

Full-to-Floor Pedestals were designed to utilize all available space. Choose from Box/Box/File and File/File combinations as well as hanging pedestals. File drawers have high drawer sides for hanging folders and eliminate the need for file bars.

Models include Desks, Returns, Bridges, Credenzas, Hutches and Accessories such as a center drawer and optional keys for keying alike. This wide range of models, pedestal options and finish selections are sure to fit a variety of office and organizational needs.

Features and Benefits

- Tops are 1" thick with 3mm plastic edge banding
- Full to floor or hanging pedestals available
- Pencil tray is standard on box-box-file pedestals
- High wall drawer sides accommodate front-to-back hanging file folders and eliminate the need for costly hanging file frames
- 1" adjustable leveling glides standard on all units. Double pedestal desks have eight, Single pedestal desks use six
- Steel chassis are finished with an Earth friendly electrostatically applied powder paint process that protects the environment and provides a durable finish
- Available in a range of colors and finishes - see Notes for details



Tops are 1" thick with 3mm plastic edge banding



Full to floor pedestals



High drawer sides accommodate hanging folders

GENERAL INFORMATION

- Tops are constructed of 45 lb. density particleboard with high performance thermally fused laminate
- All tops have Global's preferred edging in matching color (i.e. wood grain surfaces feature edging with matching wood grain)
- Chassis incorporates an earth friendly electrostatically applied powder paint process that protects the environment and provides a durable finish
- For environmental certifications, please visit globalfurnituregroup.com.

CONSTRUCTION

- Tops are constructed of 45 lb. density particleboard with high performance thermally fused laminate. Tops are flush with end panels.
- Chassis is prime cold rolled commercial quality steel
- 1" adjustable leveling glides standard on all units. Double pedestal desks have eight, single pedestal desks use six.
- High Pressure Tops are available in all laminate finishes at an extended lead time. Please see model # for pricing and availability
- Products specified with the high pressure laminate option are finished on the underside of the surface with a kraft paper backing.

MODESTY PANELS

- Standard modesty panel heights are 18" (¾) and 26" (full)
- Hanging pedestal models are standard with a 20" modesty panel

LOCKS

- Locks have removable cores for keying alike

STORAGE

- Full extension ball-bearing suspension on file drawers, ¾ extension ball-bearing suspension on box drawers for smooth and durable drawer movement
- High wall drawer sides accommodate front-to-back hanging file folders and eliminate the need for costly hanging file frames

GROMMETS

- Grommets are available in standard worksurface locations (left, center or right).
Order as: **AG1, AG2 or AG3 - Add \$88**
- Grommet hole dimensions are 3 ¼" wide x 1 7/8" deep.

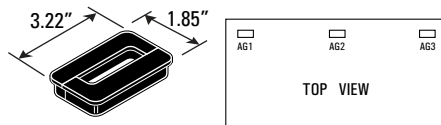

- Actual grommet locations on the worksurface are depicted in the example drawings shown below. Dimensions shown are actual measurements (in inches).

- Grommets are standard in corners, islands and extended corners only. Desks, returns and bridges have no standard grommet.

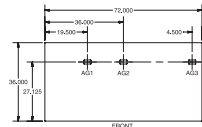

36 x 72 single pedestal left desks

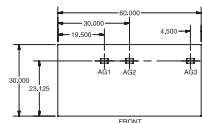

30 x 60 single pedestal left desks

- Grommets may be placed at non-standard locations. Order as: **AGS - Add \$88** A drawing must be supplied with vertical and horizontal dimensions to the center of the cut-out (as in drawing above). Please refer to CUSTOM GROMMET LOCATION FORM in the back reference section.

TOP FINISHES - LAMINATE

- ACJ** Absolute Acajou
- ASN** Asian Night
- AWC** Avant Cherry
- AWH** Avant Honey
- BLK** Black
- BRC** Brushed Cobalt
- CMB** Clear Maple
- DES** Dark Espresso
- DWT** Designer White
- HGT** Hayden Grey
- NBL** Noce Biondo
- NGL** Noce Grigio
- NEL** Noce Leggero
- NML** Noce Medio
- QTM** Quartered Mahogany
- SOG** Storm Grey
- TFW** Tiger Fruitwood
- TWL** Tiger Walnut
- WHE** Walnut Heights
- WHC** White Chocolate
- WGY** Willow Grey
- WCR** Winter Cherry

BODY FINISHES (INCLUDING PEDESTALS) - METAL

- BGR** Business Grey
- BKC** Black Coffee Textured
- BLK** Black
- BNE** Bone
- BZD** Blizzard Textured
- CHR** Charcoal
- CLT** Claret
- DCH** Dark Chocolate Textured
- DPT** Desert Putty
- DWT** Designer White
- FOG** Fog
- GRY** Grey
- LGR** Light Grey
- ICE** Ice
- IVR** Ivory
- MCH** Mocha Textured
- MET** Metro
- MOS** Moss
- NEV** Nevada
- NVY** Navy
- OYS** Oyster
- SDT** Stonedust Textured
- SGR** Storm Grey
- SIL** Silver
- SKY** Sky
- STN** Stone
- TPE** Taupe
- TSA** Tahiti Sand
- TUN** Tungsten (add 10% upcharge)
- WIL** Willow

CUSTOM PAINT FINISHES

- All special colors must use ONE uniform color per series (example: Steel Desks). Quantities of 1 to 10 add 10%; 11 or more are NO UPCHARGE.
- Mica and Metallic: 10% upcharge will apply.
- White special finishes can be applied at 10% upcharge.
- ALL NONSTANDARD FINISHES MUST BE APPROVED BY GLOBAL BEFORE ANY ORDER WILL BE ACCEPTED. LONGER LEAD TIMES WILL APPLY.

DOUBLE PEDESTAL DESKS

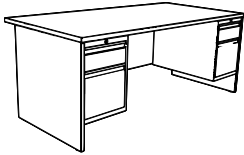

20" modesty

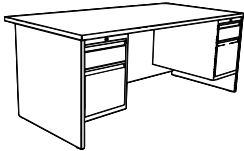

26" modesty

Double Pedestal Desk

MODEL#	DIMENSIONS D x W x H	FREIGHT CLASS	WT/LBS.	CUBIC FT.	LIST PRICE	HP ADD
SDM2448HH20	24 x 48 x 29	100	188	22.28	\$1991	
SDM2454HH20	24 x 54 x 29	100	201.50	24.98	\$2031	
SDM2460HH20	24 x 60 x 29	125	207	27.68	\$2071	
SDM2466HH20	24 x 66 x 29	125	211.50	30.38	\$2096	
SDM2472HH20	24 x 72 x 29	125	226	33.08	\$2116	
SDM2448HH26	24 x 48 x 29	100	192	22.28	\$2004	
SDM2454HH26	24 x 54 x 29	100	206	24.98	\$2047	
SDM2460HH26	24 x 60 x 29	125	212	27.68	\$2088	
SDM2466HH26	24 x 66 x 29	125	217	30.38	\$2116	
SDM2472HH26	24 x 72 x 29	125	232	33.08	\$2137	
SDM3048HH20	30 x 48 x 29	100	222.50	27.52	\$2450	
SDM3054HH20	30 x 54 x 29	125	237	30.86	\$2498	
SDM3060HH20	30 x 60 x 29	125	244	34.19	\$2531	
SDM3066HH20	30 x 66 x 29	125	254.50	37.53	\$2605	
SDM3072HH20	30 x 72 x 29	125	265	40.87	\$2659	
SDM3048HH26	30 x 48 x 29	100	226.50	27.52	\$2464	
SDM3054HH26	30 x 54 x 29	125	241.50	30.86	\$2512	
SDM3060HH26	30 x 60 x 29	125	248.50	34.19	\$2546	
SDM3066HH26	30 x 66 x 29	125	259.50	37.53	\$2623	
SDM3072HH26	30 x 72 x 29	125	271	40.87	\$2680	
SDM3660HH20	36 x 60 x 29	125	262.50	34.19	\$2683	
SDM3666HH20	36 x 66 x 29	125	270	44.68	\$2700	
SDM3672HH20	36 x 72 x 29	150	278	48.65	\$2714	
SDM3660HH26	36 x 60 x 29	125	267.50	34.19	\$2694	
SDM3666HH26	36 x 66 x 29	125	275.50	44.68	\$2721	
SDM3672HH26	36 x 72 x 29	150	283.50	48.65	\$2734	

Standard with **box/file** pedestals on both sides. Pedestal locks. One pencil tray.

- SDMxxxxHH20 has a 20" modesty panel
- SDM24xxBB26 has a 26" modesty panel
- 6.125" overhang on 36"D desks

Required Specifications

Top Finish
Body Finish

Optional Specifications

Grommet
HP laminate

DOUBLE PEDESTAL DESKS

MODEL# DIMENSIONS FREIGHT CLASS WT/LBS. CUBIC FT. LIST PRICE HP ADD

D x W x H

SDM2448BB18	24 x 48 x 29	100	184	22.28	\$1824
SDM2454BB18	24 x 54 x 29	125	197.50	24.98	\$1865
SDM2460BB18	24 x 60 x 29	125	203	27.68	\$1904
SDM2466BB18	24 x 66 x 29	125	208	30.38	\$1932
SDM2472BB18	24 x 72 x 29	125	222	33.08	\$1949
SDM2448BB26	24 x 48 x 29	100	188	22.28	\$1839
SDM2454BB26	24 x 54 x 29	100	202	24.98	\$1881
SDM2460BB26	24 x 60 x 29	125	208	27.68	\$1921
SDM2466BB26	24 x 66 x 29	125	213	30.38	\$1949
SDM2472BB26	24 x 72 x 29	125	228	33.08	\$1971
SDM3048BB18	30 x 48 x 29	125	202.50	27.52	\$2325
SDM3054BB18	30 x 54 x 29	125	217	30.86	\$2371
SDM3060BB18	30 x 60 x 29	125	224	34.19	\$2405
SDM3066BB18	30 x 66 x 29	125	234.50	37.53	\$2479
SDM3072BB18	30 x 72 x 29	125	270	40	\$2535
SDM3048BB26	30 x 48 x 29	125	206.50	27.52	\$2340
SDM3054BB26	30 x 54 x 29	125	221.50	30.86	\$2389
SDM3060BB26	30 x 60 x 29	125	228.50	34.19	\$2421
SDM3066BB26	30 x 66 x 29	125	240	37.53	\$2499
SDM3072BB26	30 x 72 x 29	125	251	40.87	\$2553
SDM3660BB18	36 x 60 x 29	125	242.50	34.19	\$2558
SDM3666BB18	36 x 66 x 29	150	250	44.68	\$2576
SDM3672BB18	36 x 72 x 29	150	258	48.65	\$2589
SDM3660BB26	36 x 60 x 29	125	247.50	34.19	\$2567
SDM3666BB26	36 x 66 x 29	150	255.50	44.68	\$2597
SDM3672BB26	36 x 72 x 29	150	263.50	48.65	\$2609



18" modesty



26" modesty

Double Pedestal Desk

Standard with full to floor **box/box/file** pedestals on both sides. Pedestal locks. One pencil tray.

- SDMxxxxBB18 has an 18" modesty panel
- SDM24xxBB26 has a 26" modesty panel
- 6.125" overhang on 36"D desks

Required Specifications

Top Finish
Body Finish

Optional Specifications

Grommet
HP laminate

DOUBLE PEDESTAL DESKS

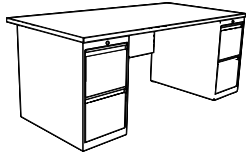

18" modesty

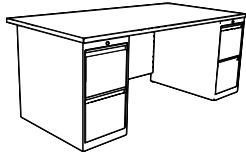

26" modesty

Double Pedestal Desk

MODEL#	DIMENSIONS D x W x H	FREIGHT CLASS	WT/LBS.	CUBIC FT.	LIST PRICE	HP ADD
SDM2448FF18	24 x 48 x 29	100	184	22.28	\$1824	
SDM2454FF18	24 x 54 x 29	125	197.50	24.98	\$1865	
SDM2460FF18	24 x 60 x 29	125	203	27.68	\$1904	
SDM2466FF18	24 x 66 x 29	125	208	30.38	\$1932	
SDM2472FF18	24 x 72 x 29	125	222	33.08	\$1949	
SDM2448FF26	24 x 48 x 29	100	188	22.28	\$1839	
SDM2454FF26	24 x 54 x 29	100	202	24.98	\$1881	
SDM2460FF26	24 x 60 x 29	125	208	27.68	\$1921	
SDM2466FF26	24 x 66 x 29	125	213	30.38	\$1949	
SDM2472FF26	24 x 72 x 29	125	228	33.08	\$1971	
SDM3048FF18	30 x 48 x 29	125	202.50	27.52	\$2325	
SDM3054FF18	30 x 54 x 29	125	217	30.86	\$2371	
SDM3060FF18	30 x 60 x 29	125	224	34.19	\$2405	
SDM3066FF18	30 x 66 x 29	125	234.50	37.53	\$2479	
SDM3072FF18	30 x 72 x 29	125	270	40	\$2535	
SDM3048FF26	30 x 48 x 29	125	206.50	27.52	\$2340	
SDM3054FF26	30 x 54 x 29	125	221.50	30.86	\$2389	
SDM3060FF26	30 x 60 x 29	125	228.50	34.19	\$2421	
SDM3066FF26	30 x 66 x 29	125	240	37.53	\$2499	
SDM3072FF26	30 x 72 x 29	150	240	40.87	\$2553	
SDM3660FF18	36 x 60 x 29	125	242.50	34.19	\$2558	
SDM3666FF18	36 x 66 x 29	150	250	44.68	\$2576	
SDM3672FF18	36 x 72 x 29	150	258	48.65	\$2589	
SDM3660FF26	36 x 60 x 29	125	247.50	34.19	\$2567	
SDM3666FF26	36 x 66 x 29	150	255.50	44.68	\$2597	
SDM3672FF26	36 x 72 x 29	150	263.50	48.65	\$2609	

Standard with full to floor **file/file** pedestals on both sides. Pedestal locks.

- SDMxxxxFF18 has an 18" modesty panel
- SDM24xxFF26 has a 26" modesty panel
- 6.125" overhang on 36"D desks

Required Specifications

Top Finish
Body Finish

Optional Specifications

Grommet
HP laminate

DOUBLE PEDESTAL DESKS

MODEL# DIMENSIONS FREIGHT CLASS WT/LBS. CUBIC FT. LIST PRICE HP ADD

D x W x H

SDM2448FB18	24 x 48 x 29	100	184	22.28	\$1824
SDM2454FB18	24 x 54 x 29	125	197.50	24.98	\$1865
SDM2460FB18	24 x 60 x 29	125	203	27.68	\$1904
SDM2466FB18	24 x 66 x 29	125	208	30.38	\$1932
SDM2472FB18	24 x 72 x 29	125	222	33.08	\$1949
SDM2448FB26	24 x 48 x 29	100	188	22.28	\$1839
SDM2454FB26	24 x 54 x 29	100	202	24.98	\$1881
SDM2460FB26	24 x 60 x 29	125	208	27.68	\$1921
SDM2466FB26	24 x 66 x 29	125	213	30.38	\$1949
SDM2472FB26	24 x 72 x 29	125	228	33.08	\$1971
SDM3048FB18	30 x 48 x 29	125	202.50	27.52	\$2325
SDM3054FB18	30 x 54 x 29	125	217	30.86	\$2371
SDM3060FB18	30 x 60 x 29	125	224	34.19	\$2405
SDM3066FB18	30 x 66 x 29	125	234.50	37.53	\$2479
SDM3072FB18	30 x 72 x 29	150	245	40.87	\$2535
SDM3048FB26	30 x 48 x 29	125	206.50	27.52	\$2340
SDM3054FB26	30 x 54 x 29	125	221.50	30.86	\$2389
SDM3060FB26	30 x 60 x 29	125	228.50	34.19	\$2421
SDM3066FB26	30 x 66 x 29	125	240	37.53	\$2499
SDM3072FB26	30 x 72 x 29	125	251	40.87	\$2553
SDM3660FB18	36 x 60 x 29	125	242.50	34.19	\$2558
SDM3666FB18	36 x 66 x 29	150	250	44.68	\$2576
SDM3672FB18	36 x 72 x 29	150	258	48.65	\$2589
SDM3660FB26	36 x 60 x 29	125	247.50	34.19	\$2567
SDM3666FB26	36 x 66 x 29	150	255.50	44.68	\$2597
SDM3672FB26	36 x 72 x 29	150	263.50	48.65	\$2609



18" modesty

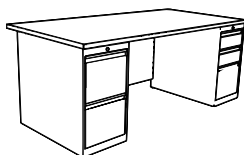

26" modesty

Double Pedestal Desk

Standard with full to floor **file/file** pedestal on **left** and **box/box/file** pedestal on **right**. Pedestal locks. One pencil tray.

- SDMxxxxFB18 has an 18" modesty panel
- SDMxxxxFB26 has a 26" modesty panel
- 6.125" overhang on 36"D desks

Required Specifications

Top Finish
Body Finish

Optional Specifications

Grommet
HP laminate

DOUBLE PEDESTAL DESKS

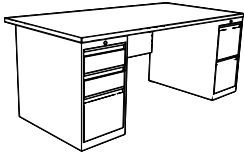

18" modesty



26" modesty

Double Pedestal Desk

MODEL#	DIMENSIONS D x W x H	FREIGHT CLASS	WT/LBS.	CUBIC FT.	LIST PRICE	HP ADD
SDM2448BF18	24 x 48 x 29	100	184	22.28	\$1824	
SDM2454BF18	24 x 54 x 29	125	197.50	24.98	\$1865	
SDM2460BF18	24 x 60 x 29	125	203	27.68	\$1904	
SDM2466BF18	24 x 66 x 29	125	208	30.38	\$1932	
SDM2472BF18	24 x 72 x 29	125	222	33.08	\$1949	
SDM2448BF26	24 x 48 x 29	100	188	22.28	\$1839	
SDM2454BF26	24 x 54 x 29	100	202	24.98	\$1881	
SDM2460BF26	24 x 60 x 29	125	208	27.68	\$1921	
SDM2466BF26	24 x 66 x 29	125	213	30.38	\$1949	
SDM2472BF26	24 x 72 x 29	125	228	33.08	\$1971	
SDM3048BF18	30 x 48 x 29	125	202.50	27.52	\$2325	
SDM3054BF18	30 x 54 x 29	125	217	30.86	\$2371	
SDM3060BF18	30 x 60 x 29	125	224	34.19	\$2405	
SDM3066BF18	30 x 66 x 29	125	234.50	37.53	\$2479	
SDM3072BF18	30 x 72 x 29	150	245	40.87	\$2535	
SDM3048BF26	30 x 48 x 29	125	206.50	27.52	\$2340	
SDM3054BF26	30 x 54 x 29	125	221.50	30.86	\$2389	
SDM3060BF26	30 x 60 x 29	125	228.50	34.19	\$2421	
SDM3066BF26	30 x 66 x 29	125	240	37.53	\$2499	
SDM3072BF26	30 x 72 x 29	125	251	40.87	\$2553	
SDM3660BF18	36 x 60 x 29	125	242.50	34.19	\$2558	
SDM3666BF18	36 x 66 x 29	150	250	44.68	\$2576	
SDM3672BF18	36 x 72 x 29	150	258	48.65	\$2589	
SDM3660BF26	36 x 60 x 29	125	247.50	34.19	\$2567	
SDM3666BF26	36 x 66 x 29	150	255.50	44.68	\$2597	
SDM3672BF26	36 x 72 x 29	150	263.50	48.65	\$2609	

Standard with full to floor **file/file** pedestal on **right** and **box/box/file** pedestal on **left**. Pedestal locks. One pencil tray.

- SDMxxxxBF18 has an 18" modesty panel
- SDMxxxxBF26 has a 26" modesty panel
- 6.125" overhang on 36"D desks

Required Specifications

Top Finish
Body Finish

Optional Specifications

Grommet
HP laminate

SINGLE PEDESTAL DESKS

MODEL# DIMENSIONS FREIGHT CLASS WT/LBS. CUBIC FT. LIST PRICE HP ADD

D x W x H

SDM2442BG18	24 x 42 x 29	125	140.50	19.58	\$1429
SDM2448BG18	24 x 48 x 29	125	146	22.28	\$1469
SDM2454BG18	24 x 54 x 29	125	160	24.98	\$1510
SDM2460BG18	24 x 60 x 29	150	165	27.68	\$1549
SDM2466BG18	24 x 66 x 29	150	170	30.38	\$1574
SDM2472BG18	24 x 72 x 29	150	184	33.08	\$1593

SDM2442BG26	24 x 42 x 29	125	144	19.58	\$1441
SDM2448BG26	24 x 48 x 29	125	150	22.28	\$1485
SDM2454BG26	24 x 54 x 29	125	164	24.98	\$1525
SDM2460BG26	24 x 60 x 29	125	170	27.68	\$1568
SDM2466BG26	24 x 66 x 29	150	175	30.38	\$1593
SDM2472BG26	24 x 72 x 29	150	190	33.08	\$1614

SDM3042BG18	30 x 42 x 29	125	159	24.19	\$1825
SDM3048BG18	30 x 48 x 29	125	165.50	27.52	\$1868
SDM3054BG18	30 x 54 x 29	150	180	30.86	\$1913
SDM3060BG18	30 x 60 x 29	150	187	34.19	\$1945
SDM3066BG18	30 x 66 x 29	150	197.50	37.53	\$2022
SDM3072BG18	30 x 72 x 29	150	208	40.87	\$2074

SDM3042BG26	30 x 42 x 29	125	162.50	24.19	\$1839
SDM3048BG26	30 x 48 x 29	125	169.50	27.52	\$1881
SDM3054BG26	30 x 54 x 29	150	184.50	30.86	\$1929
SDM3060BG26	30 x 60 x 29	150	191.50	34.19	\$1964
SDM3066BG26	30 x 66 x 29	150	203	37.53	\$2040
SDM3072BG26	30 x 72 x 29	150	214	40.87	\$2095

SDM3660BG18	36 x 60 x 29	125	210.50	34.19	\$2098
SDM3666BG18	36 x 66 x 29	150	218	44.68	\$2119
SDM3672BG18	36 x 72 x 29	150	226	48.65	\$2129

SDM3660BG26	36 x 60 x 29	125	215.50	34.19	\$2111
SDM3666BG26	36 x 66 x 29	150	223.50	44.68	\$2137
SDM3672BG26	36 x 72 x 29	150	231.50	48.65	\$2152



18" modesty



26" modesty

Single Pedestal Desk - Left

Standard with full to floor **box/box/file** pedestal on **left**. Pedestal lock. One pencil tray.

- SDMxxxBG18 has an 18" modesty panel
- SDMxxxBG26 has a 26" modesty panel
- 6.125" overhang on 36"D desks

Required Specifications

Top Finish
Body Finish

Optional Specifications

Grommet
HP laminate

SINGLE PEDESTAL DESKS

MODEL# DIMENSIONS FREIGHT CLASS WT/LBS. CUBIC FT. LIST PRICE HP ADD

D x W x H

SDM2442GB18	24 x 42 x 29	125	140.50	19.58	\$1429
SDM2448GB18	24 x 48 x 29	125	146	22.28	\$1469
SDM2454GB18	24 x 54 x 29	125	160	24.98	\$1510
SDM2460GB18	24 x 60 x 29	150	165	27.68	\$1549
SDM2466GB18	24 x 66 x 29	150	170	30.38	\$1574
SDM2472GB18	24 x 72 x 29	150	184	33.08	\$1593
SDM2442GB26	24 x 42 x 29	125	144	19.58	\$1441
SDM2448GB26	24 x 48 x 29	125	150	22.28	\$1485
SDM2454GB26	24 x 54 x 29	125	164	24.98	\$1525
SDM2460GB26	24 x 60 x 29	125	170	27.68	\$1568
SDM2466GB26	24 x 66 x 29	150	175	30.38	\$1593
SDM2472GB26	24 x 72 x 29	150	190	33.08	\$1614
SDM3042GB18	30 x 42 x 29	125	159	24.19	\$1825
SDM3048GB18	30 x 48 x 29	125	165.50	27.52	\$1868
SDM3054GB18	30 x 54 x 29	150	180	30.86	\$1913
SDM3060GB18	30 x 60 x 29	150	187	34.19	\$1945
SDM3066GB18	30 x 66 x 29	150	197.50	37.53	\$2022
SDM3072GB18	30 x 72 x 29	150	270	40	\$2074
SDM3042GB26	30 x 42 x 29	125	162.50	24.19	\$1839
SDM3048GB26	30 x 48 x 29	125	169.50	27.52	\$1881
SDM3054GB26	30 x 54 x 29	150	184.50	30.86	\$1929
SDM3060GB26	30 x 60 x 29	150	191.50	34.19	\$1964
SDM3066GB26	30 x 66 x 29	150	203	37.53	\$2040
SDM3072GB26	30 x 72 x 29	150	203	40.87	\$2095
SDM3660GB18	36 x 60 x 29	125	210.50	34.19	\$2098
SDM3666GB18	36 x 66 x 29	150	218	44.68	\$2119
SDM3672GB18	36 x 72 x 29	150	226	48.65	\$2129
SDM3660GB26	36 x 60 x 29	125	215.50	34.19	\$2111
SDM3666GB26	36 x 66 x 29	150	223.50	44.68	\$2137
SDM3672GB26	36 x 72 x 29	150	231.50	48.65	\$2152

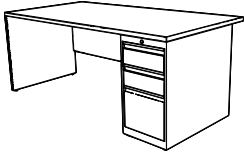

18" modesty

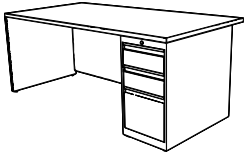

26" modesty

Single Pedestal Desk - Right

Standard with full to floor **box/box/file** pedestal on **right**. Pedestal lock.

- SDMxxxxGB18 has an 18" modesty panel
- SDM24xxGB26 has a 26" modesty panel
- 6.125" overhang on 36"D desks

Required Specifications

Top Finish
Body Finish

Optional Specifications

Grommet
HP laminate

SINGLE PEDESTAL DESKS

MODEL# DIMENSIONS FREIGHT CLASS WT/LBS. CUBIC FT. LIST PRICE HP ADD

D x W x H

SDM2442FG18	24 x 42 x 29	125	140.50	19.58	\$1429
SDM2448FG18	24 x 48 x 29	125	146	22.28	\$1469
SDM2454FG18	24 x 54 x 29	125	160	24.98	\$1510
SDM2460FG18	24 x 60 x 29	150	165	27.68	\$1549
SDM2466FG18	24 x 66 x 29	150	170	30.38	\$1574
SDM2472FG18	24 x 72 x 29	150	184	33.08	\$1593

SDM2442FG26	24 x 42 x 29	125	144	19.58	\$1441
SDM2448FG26	24 x 48 x 29	125	150	22.28	\$1485
SDM2454FG26	24 x 54 x 29	125	164	24.98	\$1525
SDM2460FG26	24 x 60 x 29	125	170	27.68	\$1568
SDM2466FG26	24 x 66 x 29	150	165.50	30.38	\$1593
SDM2472FG26	24 x 72 x 29	150	190	33.08	\$1614

SDM3042FG18	30 x 42 x 29	125	159	24.19	\$1825
SDM3048FG18	30 x 48 x 29	125	165.50	27.52	\$1868
SDM3054FG18	30 x 54 x 29	150	180	30.86	\$1913
SDM3060FG18	30 x 60 x 29	150	187	34.19	\$1945
SDM3066FG18	30 x 66 x 29	150	197.50	37.53	\$2022
SDM3072FG18	30 x 72 x 29	150	208	40.87	\$2074

SDM3042FG26	30 x 42 x 29	125	162.50	24.19	\$1839
SDM3048FG26	30 x 48 x 29	125	169.50	27.52	\$1881
SDM3054FG26	30 x 54 x 29	150	184.50	30.86	\$1929
SDM3060FG26	30 x 60 x 29	150	191.50	34.19	\$1964
SDM3066FG26	30 x 66 x 29	150	203	37.53	\$2040
SDM3072FG26	30 x 72 x 29	150	214	40.87	\$2095

SDM3660FG18	36 x 60 x 29	125	210.50	34.19	\$2098
SDM3666FG18	36 x 66 x 29	150	218	44.68	\$2119
SDM3672FG18	36 x 72 x 29	150	226	48.65	\$2129

SDM3660FG26	36 x 60 x 29	125	215.50	34.19	\$2111
SDM3666FG26	36 x 66 x 29	150	223.50	44.68	\$2137
SDM3672FG26	36 x 72 x 29	150	231.50	48.65	\$2152

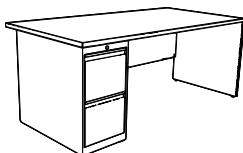

18" modesty

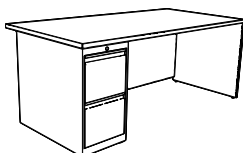

26" modesty

Single Pedestal Desk - Left

Standard with full to floor **file/file** pedestal on **left**. Pedestal lock.

- SDMxxxxFG18 has an 18" modesty panel
- SDMxxxxFG26 has a 26" modesty panel
- 6.125" overhang on 36"D desks

Required Specifications

Top Finish
Body Finish

Optional Specifications

Grommet
HP laminate

SINGLE PEDESTAL DESKS

MODEL#	DIMENSIONS	FREIGHT CLASS	WT/LBS.	CUBIC FT.	LIST PRICE	HP ADD
--------	------------	---------------	---------	-----------	------------	--------

D x W x H

SDM2442GF18	24 x 42 x 29	125	140.50	19.58	\$1429	
SDM2448GF18	24 x 48 x 29	125	146	22.28	\$1469	
SDM2454GF18	24 x 54 x 29	125	160	24.98	\$1510	
SDM2460GF18	24 x 60 x 29	150	165	27.68	\$1549	
SDM2466GF18	24 x 66 x 29	150	170	30.38	\$1574	
SDM2472GF18	24 x 72 x 29	150	184	33.08	\$1593	
SDM2442GF26	24 x 42 x 29	125	144	19.58	\$1441	
SDM2448GF26	24 x 48 x 29	125	150	22.28	\$1485	
SDM2454GF26	24 x 54 x 29	125	164	24.98	\$1525	
SDM2460GF26	24 x 60 x 29	125	170	27.68	\$1568	
SDM2466GF26	24 x 66 x 29	150	175	30.38	\$1593	
SDM2472GF26	24 x 72 x 29	150	190	33.08	\$1614	
SDM3042GF18	30 x 42 x 29	125	159	24.19	\$1825	
SDM3048GF18	30 x 48 x 29	125	165.50	27.52	\$1868	
SDM3054GF18	30 x 54 x 29	150	180	30.86	\$1913	
SDM3060GF18	30 x 60 x 29	150	187	34.19	\$1945	
SDM3066GF18	30 x 66 x 29	150	197.50	37.53	\$2022	
SDM3072GF18	30 x 72 x 29	150	208	40.87	\$2074	
SDM3042GF26	30 x 42 x 29	125	162.50	24.19	\$1839	
SDM3048GF26	30 x 48 x 29	125	169.50	27.52	\$1881	
SDM3054GF26	30 x 54 x 29	150	184.50	30.86	\$1929	
SDM3060GF26	30 x 60 x 29	150	191.50	34.19	\$1964	
SDM3066GF26	30 x 66 x 29	150	203	37.53	\$2040	
SDM3072GF26	30 x 72 x 29	150	214	40.87	\$2095	
SDM3660GF18	36 x 60 x 29	125	210.50	34.19	\$2098	
SDM3666GF18	36 x 66 x 29	150	218	44.68	\$2119	
SDM3672GF18	36 x 72 x 29	150	226	48.65	\$2129	
SDM3660GF26	36 x 60 x 29	125	215.50	34.19	\$2111	
SDM3666GF26	36 x 66 x 29	150	223.50	44.68	\$2137	
SDM3672GF26	36 x 72 x 29	150	231.50	48.65	\$2152	

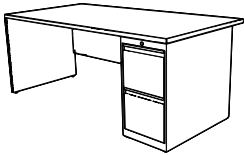

18" modesty

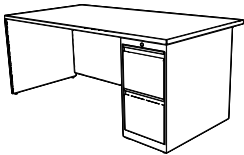

26" modesty

Single Pedestal Desk - Right

Standard with full to floor **file/file** pedestal on **right**. Pedestal lock.

- SDMxxxxGF18 has an 18" modesty panel
- SDMxxxxGF26 has a 26" modesty panel
- 6.125" overhang on 36"D desks

Required Specifications

Top Finish
Body Finish

Optional Specifications

Grommet
HP laminate

SINGLE PEDESTAL DESKS

MODEL# DIMENSIONS FREIGHT CLASS WT/LBS. CUBIC FT. LIST PRICE HP ADD

D x W x H

SDM2442HG20	24 x 42 x 29	125	143	19.58	\$1513
SDM2448HG20	24 x 48 x 29	125	148	22.28	\$1553
SDM2454HG20	24 x 54 x 29	125	161.50	24.98	\$1592
SDM2460HG20	24 x 60 x 29	125	167	27.68	\$1634
SDM2466HG20	24 x 66 x 29	150	172	30.38	\$1659
SDM2472HG20	24 x 72 x 29	150	186	33.08	\$1679

SDM2442HG26	24 x 42 x 29	125	146	19.58	\$1525
SDM2448HG26	24 x 48 x 29	125	152	22.28	\$1568
SDM2454HG26	24 x 54 x 29	125	166	24.98	\$1608
SDM2460HG26	24 x 60 x 29	125	172	27.68	\$1650
SDM2466HG26	24 x 66 x 29	150	177	30.38	\$1679
SDM2472HG26	24 x 72 x 29	150	192	33.08	\$1700

SDM3042HG20	30 x 42 x 29	125	169	24.19	\$1889
SDM3048HG20	30 x 48 x 29	125	175.50	27.52	\$1929
SDM3054HG20	30 x 54 x 29	125	190	30.86	\$1976
SDM3060HG20	30 x 60 x 29	150	197	34.19	\$2008
SDM3066HG20	30 x 66 x 29	150	207.50	37.53	\$2083
SDM3072HG20	30 x 72 x 29	150	218	40.87	\$2137

SDM3042HG26	30 x 42 x 29	125	172.50	24.19	\$1902
SDM3048HG26	30 x 48 x 29	125	180	27.52	\$1942
SDM3054HG26	30 x 54 x 29	125	194.50	30.86	\$1991
SDM3060HG26	30 x 60 x 29	150	201.50	34.19	\$2026
SDM3066HG26	30 x 66 x 29	150	213	37.53	\$2102
SDM3072HG26	30 x 72 x 29	150	224	40.87	\$2158

SDM3660HG20	36 x 60 x 29	125	220.50	34.19	\$2162
SDM3666HG20	36 x 66 x 29	150	228	44.68	\$2181
SDM3672HG20	36 x 72 x 29	150	238	48.65	\$2191

SDM3660HG26	36 x 60 x 29	125	225.50	34.19	\$2172
SDM3666HG26	36 x 66 x 29	150	233.50	44.68	\$2202
SDM3672HG26	36 x 72 x 29	150	241.50	48.65	\$2214

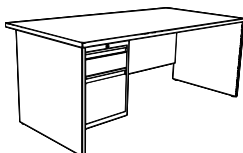

20" modesty



26" modesty

Single Pedestal Desk - Left

Standard with **box/file** pedestal on **left**. Pedestal lock. One pencil tray.

- SDMxxxHG20 has a 20" modesty panel
- SDMxxxHG26 has a 26" modesty panel
- 6.125" overhang on 36"D desks

Required Specifications

Top Finish
Body Finish

Optional Specifications

Grommet
HP laminate

SINGLE PEDESTAL DESKS

MODEL# DIMENSIONS FREIGHT CLASS WT/LBS. CUBIC FT. LIST PRICE HP ADD

D x W x H

SDM2442GH20	24 x 42 x 29	125	143	19.58	\$1513
SDM2448GH20	24 x 48 x 29	125	148	22.28	\$1553
SDM2454GH20	24 x 54 x 29	125	161.50	24.98	\$1592
SDM2460GH20	24 x 60 x 29	125	167	27.68	\$1634
SDM2466GH20	24 x 66 x 29	150	172	30.38	\$1659
SDM2472GH20	24 x 72 x 29	150	186	33.08	\$1679
SDM2442GH26	24 x 42 x 29	125	146	19.58	\$1525
SDM2448GH26	24 x 48 x 29	125	152	22.28	\$1568
SDM2454GH26	24 x 54 x 29	125	166	24.98	\$1608
SDM2460GH26	24 x 60 x 29	125	172	27.68	\$1650
SDM2466GH26	24 x 66 x 29	150	177	30.38	\$1679
SDM2472GH26	24 x 72 x 29	150	192	33.08	\$1700
SDM3042GH20	30 x 42 x 29	125	169	24.19	\$1889
SDM3048GH20	30 x 48 x 29	125	175.50	27.52	\$1929
SDM3054GH20	30 x 54 x 29	125	190	30.86	\$1976
SDM3060GH20	30 x 60 x 29	150	197	34.19	\$2008
SDM3066GH20	30 x 66 x 29	150	207.50	37.53	\$2083
SDM3072GH20	30 x 72 x 29	150	218	40.87	\$2137
SDM3042GH26	30 x 42 x 29	125	172.50	24.19	\$1902
SDM3048GH26	30 x 48 x 29	125	180	27.52	\$1942
SDM3054GH26	30 x 54 x 29	125	194.50	30.86	\$1991
SDM3060GH26	30 x 60 x 29	150	201.50	34.19	\$2026
SDM3066GH26	30 x 66 x 29	150	213	37.53	\$2102
SDM3072GH26	30 x 72 x 29	150	224	40.87	\$2158
SDM3660GH20	36 x 60 x 29	125	220.50	34.19	\$2162
SDM3666GH20	36 x 66 x 29	150	228	44.68	\$2181
SDM3672GH20	36 x 72 x 29	150	241.50	48.65	\$2191
SDM3660GH26	36 x 60 x 29	125	225.50	34.19	\$2172
SDM3666GH26	36 x 66 x 29	150	233.50	44.68	\$2202
SDM3672GH26	36 x 72 x 29	150	236	48.65	\$2214

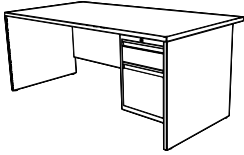

20" modesty

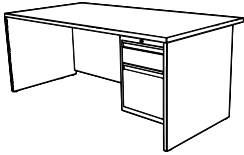

26" modesty

Single Pedestal Desk - Right

Standard with **box/file** pedestal on **right**. Pedestal lock. One pencil tray.

- SDMxxxxGH20 has a 20" modesty panel
- SDMxxxxGH26 has a 26" modesty panel
- 6.125" overhang on 36"D desks

Required Specifications

Paint Finish
Body Finish

Optional Specifications

Grommet
HP laminate

DESK SHELLS

MODEL# DIMENSIONS FREIGHT CLASS WT/LBS. CUBIC FT. LIST PRICE HP ADD

D x W x H

SDM2442GG18	24 x 42 x 29	150	103	19.58	\$1075
SDM2448GG18	24 x 48 x 29	150	108	22.28	\$1117
SDM2454GG18	24 x 54 x 29	150	122	24.98	\$1155
SDM2460GG18	24 x 60 x 29	150	127.50	27.68	\$1196
SDM2466GG18	24 x 66 x 29	150	170	30.38	\$1220
SDM2472GG18	24 x 72 x 29	150	146.50	33.08	\$1240

SDM2442GG26	24 x 42 x 29	150	106	19.58	\$1087
SDM2448GG26	24 x 48 x 29	150	112	22.28	\$1128
SDM2454GG26	24 x 54 x 29	150	126	24.98	\$1170
SDM2460GG26	24 x 60 x 29	150	132	27.68	\$1214
SDM2466GG26	24 x 66 x 29	150	175	30.38	\$1240
SDM2472GG26	24 x 72 x 29	150	152	33.08	\$1261

SDM3042GG18	30 x 42 x 29	150	122	24.19	\$1368
SDM3048GG18	30 x 48 x 29	150	128.50	27.52	\$1407
SDM3054GG18	30 x 54 x 29	150	143	30.86	\$1453
SDM3060GG18	30 x 60 x 29	150	150	34.19	\$1488
SDM3066GG18	30 x 66 x 29	150	160.50	37.53	\$1561
SDM3072GG18	30 x 72 x 29	150	171	40.87	\$1614

SDM3042GG26	30 x 42 x 29	150	125.50	24.19	\$1379
SDM3048GG26	30 x 48 x 29	150	132.50	27.52	\$1469
SDM3054GG26	30 x 54 x 29	150	147.50	30.86	\$1469
SDM3060GG26	30 x 60 x 29	150	146	34.19	\$1503
SDM3066GG26	30 x 66 x 29	150	166	37.53	\$1582
SDM3072GG26	30 x 72 x 29	150	177	40.87	\$1637

SDM3660GG18	36 x 60 x 29	150	178.50	34.19	\$1640
SDM3666GG18	36 x 66 x 29	150	222	44.68	\$1659
SDM3672GG18	36 x 72 x 29	150	205	48.65	\$1672

SDM3660GG26	36 x 60 x 29	150	183.50	34.19	\$1654
SDM3666GG26	36 x 66 x 29	150	227.50	44.68	\$1679
SDM3672GG26	36 x 72 x 29	150	220	48.65	\$1693

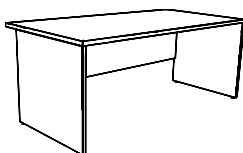

18" modesty

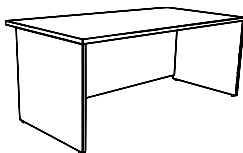

26" modesty

Desk Shell

- SDMxxxxGG18 has an 18" modesty panel
- SDMxxxxGG26 has a 26" modesty panel
- 6.125" overhang on 36"D desks

Required Specifications

Paint Finish
Body Finish

Optional Specifications

HP laminate

CORNERS

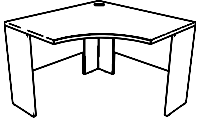

Curved Corner, 20" Throat

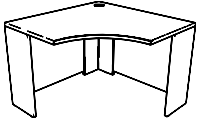

Curved Corner, 24" Throat

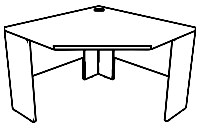

5-Sided Corner, 20" Throat

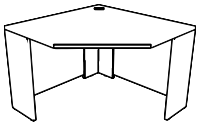

5-Sided Corner, 24" Throat

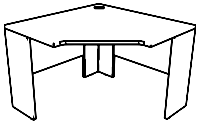

Keyboard Corner, 20" Throat

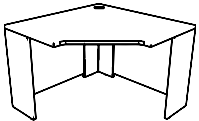

Keyboard Corner, 24" Throat

MODEL#	DIMENSIONS	FREIGHT CLASS	WT/LBS.	CUBIC FT.	LIST PRICE	HP ADD
--------	------------	---------------	---------	-----------	------------	--------

D x W x H

SCM2036RND18	36 x 36 x 29	150	116.80	24.82	\$1702	
SCM2042RND18	42 x 42 x 29	250	127.80	33.40	\$1755	
SCM2036RND26	36 x 36 x 29	150	121.10	24.82	\$1728	
SCM2042RND26	42 x 42 x 29	250	133.30	33.40	\$1780	

- SCM20xxRND18 has an 18" modesty panel
- SCM20xxRND26 has a 26" modesty panel

SCM2436RND18	36 x 36 x 29	150	116.80	24.82	\$1702	
SCM2442RND18	42 x 42 x 29	150	142.10	33.40	\$1755	
SCM2436RND26	36 x 36 x 29	150	121.10	24.82	\$1728	
SCM2442RND26	42 x 42 x 29	150	147.60	33.40	\$1780	

- SCM24xxRND18 has an 18" modesty panel
- SCM24xxRND26 has a 26" modesty panel

SCM2036STR18	36 x 36 x 29	150	118.90	24.82	\$1690	
SCM2042STR18	42 x 42 x 29	250	131.80	33.40	\$1741	
SCM2036STR26	36 x 36 x 29	150	123.30	24.82	\$1712	
SCM2042STR26	42 x 42 x 29	150	137.30	33.40	\$1765	

- SCM20xxSTR18 has an 18" modesty panel
- SCM20xxSTR26 has a 26" modesty panel

SCM2436STR18	36 x 36 x 29	150	118.90	24.82	\$1690	
SCM2442STR18	42 x 42 x 29	250	131.80	33.40	\$1741	
SCM2436STR26	36 x 36 x 29	150	123.30	24.82	\$1712	
SCM2442STR26	42 x 42 x 29	150	137.30	33.40	\$1765	

- SCM24xxSTR18 has an 18" modesty panel
- SCM24xxSTR26 has a 26" modesty panel

SCM2036SVR18	36 x 36 x 29	150	117.60	24.82	\$1724	
SCM2042SVR18	42 x 42 x 29	250	130	33.40	\$1778	
SCM2036SVR26	36 x 36 x 29	150	122	24.82	\$1749	
SCM2042SVR26	42 x 42 x 29	150	135.50	33.40	\$1800	

- SCM20xxSVR18 has an 18" modesty panel
- SCM20xxSVR26 has a 26" modesty panel

SCM2436SVR18	36 x 36 x 29	150	117.60	24.82	\$1724	
SCM2442SVR18	42 x 42 x 29	250	130	33.40	\$1778	
SCM2436SVR26	36 x 36 x 29	150	122	24.82	\$1749	
SCM2442SVR26	42 x 42 x 29	250	132.30	33.40	\$1800	

- SCM24xxSVR18 has an 18" modesty panel
- SCM24xxSVR26 has a 26" modesty panel

Required Specifications

Top Finish
Body Finish

Optional Specifications

Grommet
HP laminate

LEFT EXTENDED CORNERS

MODEL# DIMENSIONS FREIGHT CLASS WT./LBS. CUBIC FT. LIST PRICE HP ADD

D x W x H

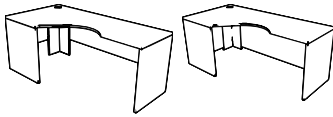

SDM2066FFL18	36 x 66 x 29	250	154.50	44.68	\$1589
SDM2072FFL18	36 x 72 x 29	250	169	48.65	\$1589
SDM2066FFL26	36 x 66 x 29	250	159	44.68	\$1614
SDM2072FFL26	36 x 72 x 29	250	173.50	48.65	\$1614

Left Extended Corner, 20" Throat

Extended worksurface on **right**. **Full end panels on left and right**. Connects to **24"D** space saver returns and **20"D** returns.

- SDM20xxFFL18 has an 18" modesty panel • SDM20xxFFL26 has a 26" modesty panel
- GWPSS pedestals **will not fit** properly under the extended end of **66" w** extended corners; available space measures 13.8"

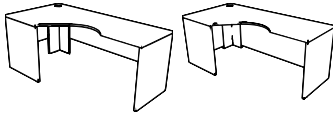

SDM2466FFL18	36 x 66 x 29	250	158.50	44.68	\$1672
SDM2472FFL18	36 x 72 x 29	250	173	48.65	\$1790
SDM2466FFL26	36 x 66 x 29	250	163	44.68	\$1700
SDM2472FFL26	36 x 72 x 29	250	177.50	48.65	\$1811

Left Extended Corner, 24" Throat

Extended worksurface on **right**. **Full end panels on left and right**. Connects to **30"D** space saver returns and **24"D** returns.

- SDM24xxFFL18 has an 18" modesty panel • SDM24xxFFL26 has a 26" modesty panel
- GWPSS pedestals **will not fit** properly under the extended end of **66" w** extended corners; available space measures 13.8"

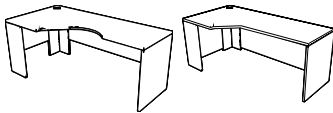

SDM2066NFL18	36 x 66 x 29	250	142.50	44.68	\$1547
SDM2072NFL18	36 x 72 x 29	250	157	48.65	\$1547
SDM2066NFL26	36 x 66 x 29	250	147	44.68	\$1572
SDM2072NFL26	36 x 72 x 29	250	161.50	48.65	\$1572

Left Extended Corner, 20" Throat

Extended worksurface on **right**. **Narrow end panel on left. Full end panel on right**. Connects to **24"D** space saver return or **20"D** returns. Corner has one grommet.

- SDM20xxNFL18 has an 18" modesty panel • SDM20xxNFL26 has a 26" modesty panel
- GWPSS pedestals **will not fit** properly under the extended end of **66" w** extended corners; available space measures 13.8"

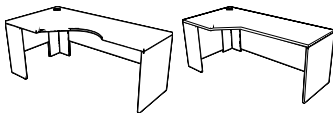

SDM2466NFL18	36 x 66 x 29	250	146.50	44.68	\$1630
SDM2472NFL18	36 x 72 x 29	250	161	48.65	\$1672
SDM2466NFL26	36 x 66 x 29	250	151	44.68	\$1658
SDM2472NFL26	36 x 72 x 29	250	165.50	48.65	\$1700

Left Extended Corner, 24" Throat

Extended worksurface on **right**. **Narrow end panel on left. Full end panel on right**. Connects to **30"D** space saver return or **24"D** returns. Corner has one grommet.

- SDM24xxNFL18 has an 18" modesty panel. • SDM24xxNFL26 has a 26" modesty panel
- GWPSS pedestals **will not fit** properly under the extended end of **66" w** extended corners; available space measures 13.8"

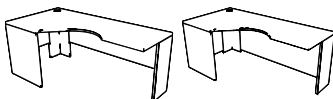

SDM2066FNL18	36 x 66 x 29	250	142.50	44.68	\$1547
SDM2072FNL18	36 x 72 x 29	250	157	48.65	\$1547
SDM2066FNL26	36 x 66 x 29	250	147	44.68	\$1572
SDM2072FNL26	36 x 72 x 29	250	161.50	48.65	\$1572

Left Extended Corner, 20" Throat

Extended worksurface on **right**. **Narrow end panel on right. Full end panel on left**. Connects to **24"D** space saver returns or **20"D** returns. Corner has one grommet.

- SDM20xxFNL18 has an 18" modesty panel • SDM20xxFNL26 has a 26" modesty panel
- GWPSS pedestals **will not fit** properly under the extended end of **66" w** extended corners; available space measures 13.8"

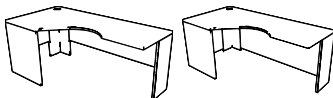

SDM2466FNL18	36 x 66 x 29	250	146.50	44.68	\$1630
SDM2472FNL18	36 x 72 x 29	250	161	48.65	\$1672
SDM2466FNL26	36 x 66 x 29	250	151	44.68	\$1658
SDM2472FNL26	36 x 72 x 29	250	165.50	48.65	\$1700

Left Extended Corner, 24" Throat

Extended worksurface on **right**. **Narrow end panel on right. Full end panel on left**. Connects to **30"D** space saver returns or **24"D** returns. Corner has one grommet.

- SDM24xxFNL18 has an 18" modesty panel • SDM24xxFNL26 has a 26" modesty panel
- GWPSS pedestals **will not fit** properly under the extended end of **66" w** extended corners; available space measures 13.8"

Required Specifications

Top Finish
Body Finish

Optional Specifications

Grommet
HP laminate

RIGHT EXTENDED CORNERS

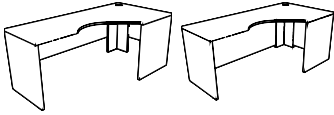

Right Extended Corner, 20" Throat

MODEL#	DIMENSIONS D x W x H	FREIGHT CLASS	WT./LBS.	CUBIC FT.	LIST PRICE	HP ADD
SDM2066FFR18	36 x 66 x 29	250	154.50	44.68	\$1589	
SDM2072FFR18	36 x 72 x 29	250	169	48.65	\$1589	
SDM2066FFR26	36 x 66 x 29	250	159	44.68	\$1614	
SDM2072FFR26	36 x 72 x 29	250	173.50	48.65	\$1614	

Extended worksurface on **left. Full end panels on left and right.** Connects to **24"D** space saver return and **20"D** returns.

- SDM20xxFFR18 has an 18" modesty panel • SDM20xxFFR26 has a 26" modesty panel
- GWPSS pedestals **will not fit** properly under the extended end of **66" w** extended corners; available space measures 13.8"

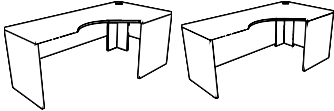

Right Extended Corner, 24" Throat

SDM2466FFR18	36 x 66 x 29	250	158.50	44.68	\$1672	
SDM2472FFR18	36 x 72 x 29	250	173	48.65	\$1790	
SDM2466FFR26	36 x 66 x 29	250	163	44.68	\$1700	
SDM2472FFR26	36 x 72 x 29	250	177.50	48.65	\$1811	

Extended worksurface on **left. Full end panels on left and right.** Connects to **30"D** space saver return and **24"D** returns.

- SDM24xxFFR18 has an 18" modesty panel • SDM24xxFFR26 has a 26" modesty panel
- GWPSS pedestals **will not fit** properly under the extended end of **66" w** extended corners; available space measures 13.8"

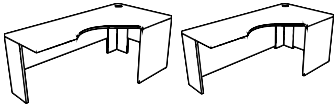

Right Extended Corner, 20" Throat

SDM2066NFR18	36 x 66 x 29	250	142.50	44.68	\$1547	
SDM2072NFR18	36 x 72 x 29	250	157	48.65	\$1547	
SDM2066NFR26	36 x 66 x 29	250	147	44.68	\$1572	
SDM2072NFR26	36 x 72 x 29	250	161.50	48.65	\$1572	

Extended worksurface on **left. Narrow end panel on left. Full end panel on right.** Connects to **24"D** space saver return or **20"D** returns. Corner has one grommet.

- SDM20xxNFR18 has an 18" modesty panel • SDM20xxNFR26 has a 26" modesty panel
- GWPSS pedestals **will not fit** properly under the extended end of **66" w** extended corners; available space measures 13.8"

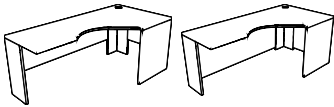

Right Extended Corner, 24" Throat

SDM2466NFR18	36 x 66 x 29	250	146.50	44.68	\$1630	
SDM2472NFR18	36 x 72 x 29	250	161	48.65	\$1672	
SDM2466NFR26	36 x 66 x 29	250	151	44.68	\$1658	
SDM2472NFR26	36 x 72 x 29	250	165.50	48.65	\$1700	

Extended worksurface on **left. Narrow end panel on left. Full end panel on right.** Connects to **30"D** space saver return or **24"D** returns. Corner has one grommet.

- SDM24xxNFR18 has an 18" modesty panel • SDM24xxNFR26 has a 26" modesty panel
- GWPSS pedestals **will not fit** properly under the extended end of **66" w** extended corners; available space measures 13.8"

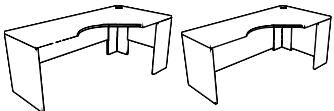

Right Extended Corner, 20" Throat

SDM2066FNR18	36 x 66 x 29	250	142.50	44.68	\$1547	
SDM2072FNR18	36 x 72 x 29	250	157	48.65	\$1547	
SDM2066FNR26	36 x 66 x 29	250	147	44.68	\$1572	
SDM2072FNR26	36 x 72 x 29	250	161.50	48.65	\$1572	

Extended worksurface on **left. Narrow end panel on right. Full end panel on left.** Connects to **24"D** space saver returns or **20"D** returns. Corner has one grommet.

- SDM20xxFNR18 has an 18" modesty panel • SDM20xxFNR26 has a 26" modesty panel
- GWPSS pedestals **will not fit** properly under the extended end of **66" w** extended corners; available space measures 13.8"

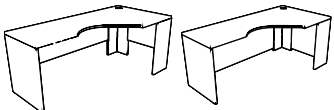

Right Extended Corner, 24" Throat

SDM2466FNR18	36 x 66 x 29	250	146.50	44.68	\$1630	
SDM2472FNR18	36 x 72 x 29	250	161	48.65	\$1672	
SDM2466FNR26	36 x 66 x 29	250	151	44.68	\$1658	
SDM2472FNR26	36 x 72 x 29	250	165.50	48.65	\$1700	

Extended worksurface on **left. Narrow end panel on right. Full end panel on left.** Connects to **30"D** space saver returns or **24"D** returns. Corner has one grommet.

- SDM24xxFNR18 has an 18" modesty panel • SDM24xxFNR26 has a 26" modesty panel.
- GWPSS pedestals **will not fit** properly under the extended end of **66" w** extended corners; available space measures 13.8"

Required Specifications

Top Finish
Body Finish

Optional Specifications

Grommet
HP laminate

ISLANDS

MODEL# DIMENSIONS FREIGHT CLASS WT/LBS. CUBIC FT. LIST PRICE HP ADD

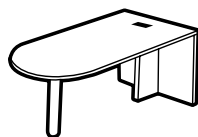

"D" Island - Full End Panel & Post (T-Base)

D x W x H						
SDIM3060	30 x 60 x 29	150	150	34.19	\$1261	
SDIM3066	30 x 66 x 29	150	205	37.53	\$1351	
SDIM3072	30 x 72 x 29	150	220	40.87	\$1439	
SDIM3660	36 x 60 x 29	250	157	40.70	\$1248	
SDIM3666	36 x 66 x 29	150	212	44.67	\$1330	
SDIM3672	36 x 72 x 29	150	227	48.20	\$1415	

Connects to narrow end panel. Attaching hardware included. **Not freestanding.**

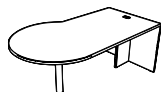

"P" Island LEFT - Full End Panel & Post (T-Base)

SPIM3060L	30 x 60 x 29	150	160	34.19	\$1248	
SPIM3066L	30 x 66 x 29	150	215	37.53	\$1330	
SPIM3072L	30 x 72 x 29	150	230	40.87	\$1415	
SPIM3660L	36 x 60 x 29	250	113	52	\$1491	
SPIM3666L	36 x 66 x 29	250	113	52	\$1614	
SPIM3672L	36 x 72 x 29	150	237	48.20	\$1741	

Connects to left side of worksurface. Attaching hardware included. **Not freestanding.** Grommet in worksurface.

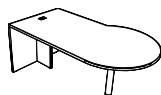

"P" Island RIGHT - Full End Panel & Post (T-Base)

SPIM3060R	30 x 60 x 29	150	160	34.19	\$1248	
SPIM3066R	30 x 66 x 29	150	215	37.53	\$1330	
SPIM3072R	30 x 72 x 29	150	230	40.87	\$1415	
SPIM3660R	36 x 60 x 29	250	113	52	\$1491	
SPIM3666R	36 x 66 x 29	250	113	52	\$1614	
SPIM3672R	36 x 72 x 29	150	237	48.20	\$1741	

Connects to right side of worksurface. Attaching hardware included. **Not freestanding.** Grommet in worksurface.

BRIDGES

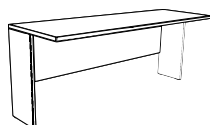

18" modesty

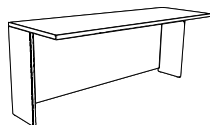

26" modesty

Bridge

SBM243018	24 x 36 x 29	250	56	14.18	\$910	
SBM243618	24 x 36 x 29	250	67.50	16.88	\$950	
SBM244218	24 x 42 x 29	150	79	19.58	\$992	
SBM244818	24 x 48 x 29	250	84.50	22.28	\$1032	
SBM245418	24 x 54 x 29	250	98	24.98	\$1073	
SBM246018	24 x 60 x 29	250	103.50	27.68	\$1110	
SBM246618	24 x 66 x 29	250	108	30.38	\$1138	
SBM247218	24 x 72 x 29	250	122.50	33.08	\$1157	
SBM243026	24 x 36 x 29	150	58	14.18	\$922	
SBM243626	24 x 36 x 29	150	70	16.88	\$963	
SBM244226	24 x 42 x 29	150	82	19.58	\$1006	
SBM244826	24 x 48 x 29	250	88	22.28	\$1045	
SBM245426	24 x 54 x 29	150	102	24.98	\$1087	
SBM246026	24 x 60 x 29	250	108	27.68	\$1128	
SBM246626	24 x 66 x 29	250	113.50	30.38	\$1157	
SBM247226	24 x 72 x 29	250	128	33.08	\$1177	

- SBM24xx18 has an 18" modesty panel
- SBM24xx26 has a 26" modesty panel

Required Specifications

Top Finish
Body Finish

Optional Specifications

Grommet
HP laminate

RETURNS

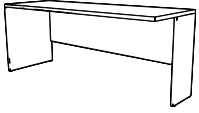

18" modesty

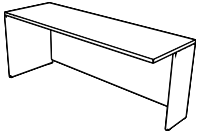

26" modesty

Return Shell - Left

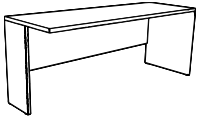

18" modesty

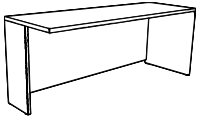

26" modesty

Return Shell - Right

MODEL#	DIMENSIONS D x W x H	FREIGHT CLASS	WT/LBS.	CUBIC FT.	LIST PRICE	HP ADD
SRM2430LG18	24 x 30 x 29	150	80	14.18	\$953	
SRM2436LG18	24 x 36 x 29	125	120	20	\$993	
SRM2442LG18	24 x 42 x 29	150	91	19.58	\$1033	
SRM2448LG18	24 x 48 x 29	150	96.50	22.28	\$1074	
SRM2454LG18	24 x 54 x 29	150	110	24.98	\$1114	
SRM2460LG18	24 x 60 x 29	150	115.50	27.68	\$1154	
SRM2466LG18	24 x 66 x 29	250	120	30.38	\$1179	
SRM2472LG18	24 x 72 x 29	150	134.50	33.08	\$1198	
SRM2430LG26	24 x 30 x 29	150	82	14.18	\$963	
SRM2436LG26	24 x 36 x 29	150	83	16.88	\$1006	
SRM2442LG26	24 x 42 x 29	150	94	19.58	\$1045	
SRM2448LG26	24 x 48 x 29	150	100	22.28	\$1087	
SRM2454LG26	24 x 54 x 29	150	114	24.98	\$1128	
SRM2460LG26	24 x 60 x 29	150	120	27.68	\$1170	
SRM2466LG26	24 x 66 x 29	150	125.50	30.38	\$1198	
SRM2472LG26	24 x 72 x 29	150	140	33.08	\$1219	

- SRM24xxLG18 has an 18" modesty panel
- SRM24xxLG26 has a 26" modesty panel

SRM2430RG18	24 x 30 x 29	150	80	14.18	\$953	
SRM2436RG18	24 x 36 x 29	125	120	20	\$993	
SRM2442RG18	24 x 42 x 29	150	91	19.58	\$1033	
SRM2448RG18	24 x 48 x 29	150	96.50	22.28	\$1074	
SRM2454RG18	24 x 54 x 29	150	110	24.98	\$1114	
SRM2460RG18	24 x 60 x 29	150	115.50	27.68	\$1154	
SRM2466RG18	24 x 66 x 29	250	120	30.38	\$1179	
SRM2472RG18	24 x 72 x 29	150	134.50	33.08	\$1198	
SRM2430RG26	24 x 30 x 29	150	82	14.18	\$963	
SRM2436RG26	24 x 36 x 29	150	83	16.88	\$1006	
SRM2442RG26	24 x 42 x 29	150	94	19.58	\$1045	
SRM2448RG26	24 x 48 x 29	150	100	22.28	\$1087	
SRM2454RG26	24 x 54 x 29	150	114	24.98	\$1128	
SRM2460RG26	24 x 60 x 29	150	120	27.68	\$1170	
SRM2466RG26	24 x 66 x 29	150	125.50	30.38	\$1198	
SRM2472RG26	24 x 72 x 29	150	140	33.08	\$1219	

- SRM24xxRG18 has an 18" modesty panel
- SRM24xxRG26 has a 26" modesty panel

Required Specifications

Top Finish
Body Finish

Optional Specifications

Grommet
HP laminate

RETURNS

MODEL# DIMENSIONS FREIGHT CLASS WT/LBS. CUBIC FT. LIST PRICE HP ADD

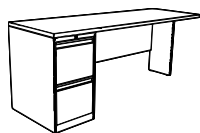

18" modesty

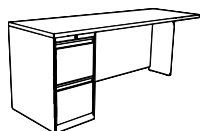

26" modesty

Return - Left

D x W x H						
SRM2430LF18	24 x 30 x 29	100	117.50	14.18	\$1280	
SRM2436LF18	24 x 36 x 29	125	123	16.88	\$1319	
SRM2442LF18	24 x 42 x 29	125	128.50	19.58	\$1360	
SRM2448LF18	24 x 48 x 29	150	135	24	\$1401	
SRM2454LF18	24 x 54 x 29	150	147.50	24.98	\$1440	
SRM2460LF18	24 x 60 x 29	150	153	27.68	\$1481	
SRM2466LF18	24 x 66 x 29	150	158	30.38	\$1507	
SRM2472LF18	24 x 72 x 29	150	172	33.08	\$1525	
SRM2430LF26	24 x 30 x 29	100	120	14.18	\$1287	
SRM2436LF26	24 x 36 x 29	125	126	16.88	\$1330	
SRM2442LF26	24 x 42 x 29	125	132	19.58	\$1372	
SRM2448LF26	24 x 48 x 29	125	138	22.28	\$1415	
SRM2454LF26	24 x 54 x 29	125	152	24.98	\$1456	
SRM2460LF26	24 x 60 x 29	150	157.90	27.68	\$1497	
SRM2466LF26	24 x 66 x 29	150	163	30.38	\$1525	
SRM2472LF26	24 x 72 x 29	150	178	33.08	\$1547	

Standard with full to floor **file/file** pedestal on **left**. Pedestal lock.

- SRM24xxLF18 has an 18" modesty panel
- SRM24xxLF26 has a 26" modesty panel

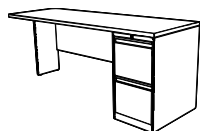

18" modesty

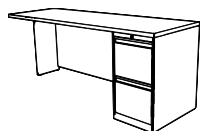

26" modesty

Return - Right

SRM2430RF18	24 x 30 x 29	100	117.50	14.18	\$1280	
SRM2436RF18	24 x 36 x 29	125	123	16.88	\$1319	
SRM2442RF18	24 x 42 x 29	125	128.50	19.58	\$1360	
SRM2448RF18	24 x 48 x 29	150	135	24	\$1401	
SRM2454RF18	24 x 54 x 29	150	147.50	24.98	\$1440	
SRM2460RF18	24 x 60 x 29	150	153	27.68	\$1481	
SRM2466RF18	24 x 66 x 29	150	158	30.38	\$1507	
SRM2472RF18	24 x 72 x 29	150	172	33.08	\$1525	
SRM2430RF26	24 x 30 x 29	100	120	14.18	\$1287	
SRM2436RF26	24 x 36 x 29	125	126	16.88	\$1330	
SRM2442RF26	24 x 42 x 29	125	132	19.58	\$1372	
SRM2448RF26	24 x 48 x 29	125	138	22.28	\$1415	
SRM2454RF26	24 x 54 x 29	125	152	24.98	\$1456	
SRM2460RF26	24 x 60 x 29	150	157.90	27.68	\$1497	
SRM2466RF26	24 x 66 x 29	150	163	30.38	\$1525	
SRM2472RF26	24 x 72 x 29	150	178	33.08	\$1547	

Standard with full to floor **file/file** pedestal on **right**. Pedestal lock.

- SRM24xxRF18 has an 18" modesty panel
- SRM24xxRF26 has a 26" modesty panel.

Required Specifications

Top Finish
Body Finish

Optional Specifications

Grommet
HP laminate

RETURNS

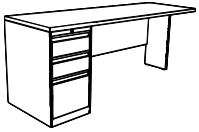

18" modesty



26" modesty

Return - Left

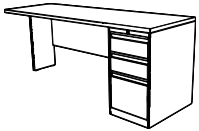

18" modesty



26" modesty

Return - Right

MODEL#	DIMENSIONS	FREIGHT CLASS	WT/LBS.	CUBIC FT.	LIST PRICE	HP ADD
--------	------------	---------------	---------	-----------	------------	--------

D x W x H

SRM2430LB18	24 x 30 x 29	100	117.50	14.18	\$1280	
SRM2436LB18	24 x 36 x 29	125	123	16.88	\$1319	
SRM2442LB18	24 x 42 x 29	125	128.50	19.58	\$1360	
SRM2448LB18	24 x 48 x 29	150	135	24	\$1401	
SRM2454LB18	24 x 54 x 29	150	147.50	24.98	\$1440	
SRM2460LB18	24 x 60 x 29	150	153	27.68	\$1481	
SRM2466LB18	24 x 66 x 29	150	158	30.38	\$1507	
SRM2472LB18	24 x 72 x 29	150	172	33.08	\$1525	
SRM2430LB26	24 x 30 x 29	100	120	14.18	\$1287	
SRM2436LB26	24 x 36 x 29	125	126	16.88	\$1330	
SRM2442LB26	24 x 42 x 29	125	132	19.58	\$1372	
SRM2448LB26	24 x 48 x 29	125	138	22.28	\$1415	
SRM2454LB26	24 x 54 x 29	125	152	24.98	\$1456	
SRM2460LB26	24 x 60 x 29	150	157.90	27.68	\$1497	
SRM2466LB26	24 x 66 x 29	150	163	30.38	\$1525	
SRM2472LB26	24 x 72 x 29	150	178	33.08	\$1547	

Standard with full to floor **box/box/file** pedestal on **left**. Pedestal lock. One pencil tray.

- SRM24xxLB18 has an 18" modesty panel
- SRM24xxLB26 has a 26" modesty panel.

SRM2430RB18	24 x 30 x 29	100	117.50	14.18	\$1280	
SRM2436RB18	24 x 36 x 29	125	123	16.88	\$1319	
SRM2442RB18	24 x 42 x 29	125	128.50	19.58	\$1360	
SRM2448RB18	24 x 48 x 29	150	135	24	\$1401	
SRM2454RB18	24 x 54 x 29	150	147.50	24.98	\$1440	
SRM2460RB18	24 x 60 x 29	150	153	27.68	\$1481	
SRM2466RB18	24 x 66 x 29	150	158	30.38	\$1507	
SRM2472RB18	24 x 72 x 29	150	172	33.08	\$1525	
SRM2430RB26	24 x 30 x 29	100	120	14.18	\$1287	
SRM2436RB26	24 x 36 x 29	125	126	16.88	\$1330	
SRM2442RB26	24 x 42 x 29	125	132	19.58	\$1372	
SRM2448RB26	24 x 48 x 29	125	138	22.28	\$1415	
SRM2454RB26	24 x 54 x 29	125	152	24.98	\$1456	
SRM2460RB26	24 x 60 x 29	150	157.90	27.68	\$1497	
SRM2466RB26	24 x 66 x 29	150	163	30.38	\$1525	
SRM2472RB26	24 x 72 x 29	150	178	33.08	\$1547	

Standard with full to floor **box/box/file** pedestal on **right**. Pedestal lock. One pencil tray.

- SRM24xxRB18 has an 18" modesty panel
- SRM24xxRB26 has a 26" modesty panel

Required Specifications

Top Finish
Body Finish

Optional Specifications

Grommet
HP laminate

RETURNS

MODEL# DIMENSIONS FREIGHT CLASS WT/LBS. CUBIC FT. LIST PRICE HP ADD

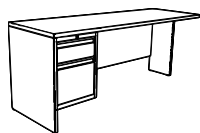

20" modesty

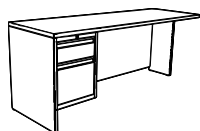

26" modesty

Return - Left

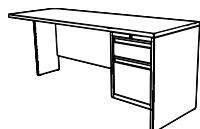

20" modesty

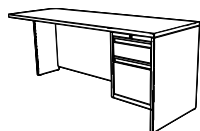

26" modesty

Return - Right

D x W x H

SRM2430LH20	24 x 30 x 29	100	119.50	14.18	\$1254
SRM2436LH20	24 x 36 x 29	125	125	16.88	\$1293
SRM2442LH20	24 x 42 x 29	125	130.50	19.58	\$1331
SRM2448LH20	24 x 48 x 29	125	136	22.28	\$1372
SRM2454LH20	24 x 54 x 29	150	149.50	24.98	\$1411
SRM2460LH20	24 x 60 x 29	150	155	27.68	\$1452
SRM2466LH20	24 x 66 x 29	150	160	30.38	\$1479
SRM2472LH20	24 x 72 x 29	150	174	33.08	\$1497

SRM2430LH26	24 x 30 x 29	100	122	14.18	\$1261
SRM2436LH26	24 x 36 x 29	125	128	16.88	\$1305
SRM2442LH26	24 x 42 x 29	125	134	19.58	\$1346
SRM2448LH26	24 x 48 x 29	125	140	22.28	\$1387
SRM2454LH26	24 x 54 x 29	125	154	24.98	\$1428
SRM2460LH26	24 x 60 x 29	150	160	27.68	\$1469
SRM2466LH26	24 x 66 x 29	150	165	30.38	\$1497
SRM2472LH26	24 x 72 x 29	150	180	33.08	\$1518

Standard with **box/file** pedestal on **left**. Pedestal lock. One pencil tray.

- SRM24xxLH20 has a 20" modesty panel
- SRM24xxLH26 has a 26" modesty panel

SRM2430RH20	24 x 30 x 29	100	119.50	14.18	\$1254
SRM2436RH20	24 x 36 x 29	125	125	16.88	\$1293
SRM2442RH20	24 x 42 x 29	125	130.50	19.58	\$1331
SRM2448RH20	24 x 48 x 29	125	136	22.28	\$1372
SRM2454RH20	24 x 54 x 29	150	149.50	24.98	\$1411
SRM2460RH20	24 x 60 x 29	150	155	27.68	\$1452
SRM2466RH20	24 x 66 x 29	150	160	30.38	\$1479
SRM2472RH20	24 x 72 x 29	150	174	33.08	\$1497

SRM2430RH26	24 x 30 x 29	100	122	14.18	\$1261
SRM2436RH26	24 x 36 x 29	125	128	16.88	\$1305
SRM2442RH26	24 x 42 x 29	125	134	19.58	\$1346
SRM2448RH26	24 x 48 x 29	125	140	22.28	\$1387
SRM2454RH26	24 x 54 x 29	125	154	24.98	\$1428
SRM2460RH26	24 x 60 x 29	150	160	27.68	\$1469
SRM2466RH26	24 x 66 x 29	150	165	30.38	\$1497
SRM2472RH26	24 x 72 x 29	150	180	33.08	\$1518

Standard with **box/file** pedestal on **right**. Pedestal lock. One pencil tray.

- SRM24xxRH20 has a 20" modesty panel
- SRM24xxRH26 has a 26" modesty panel

Required Specifications

Top Finish
Body Finish

Optional Specifications

Grommet
HP laminate

SPACE SAVER RETURNS

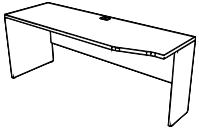

18" modesty

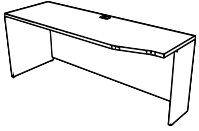

26" modesty

24" D Space Saver Return, Left

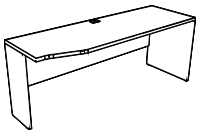

18" modesty

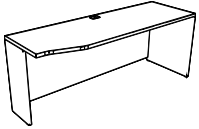

26" modesty

24" D Space Saver Return, Right

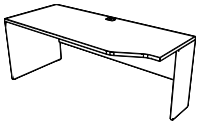

18" modesty

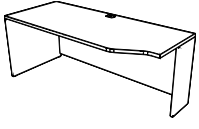

26" modesty

30" D Space Saver Return, Left

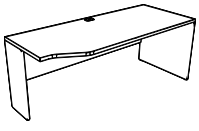

18" modesty

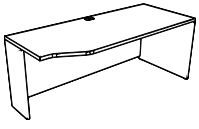

26" modesty

30" D Space Saver Return, Right

MODEL#	DIMENSIONS	FREIGHT CLASS	WT./LBS.	CUBIC FT.	LIST PRICE HP ADD
--------	------------	---------------	----------	-----------	-------------------

D x W x H

SDM244820LK18	24 x 48 x 29	150	94.50	22.28	\$1319
SDM245420LK18	24 x 54 x 29	150	108	24.98	\$1341
SDM246020LK18	24 x 60 x 29	150	113.50	27.68	\$1362
SDM246620LK18	24 x 66 x 29	250	118	30.38	\$1402
SDM247220LK18	24 x 72 x 29	150	132.50	33.08	\$1450
SDM244820LK26	24 x 48 x 29	150	98	22.28	\$1338
SDM245420LK26	24 x 54 x 29	150	112	24.98	\$1359
SDM246020LK26	24 x 60 x 29	150	118	27.68	\$1379
SDM246620LK26	24 x 66 x 29	150	123.50	30.38	\$1421
SDM247220LK26	24 x 72 x 29	150	138	33.08	\$1469

Connects to **20" D 5-sided** corner unit. Grommet in worksurface.

- SDM24xx20LK18 has an 18" modesty panel
- SDM24xx20LK26 has a 26" modesty panel

SDM244820RK18	24 x 48 x 29	150	94.50	22.28	\$1319
SDM245420RK18	24 x 54 x 29	150	108	24.98	\$1341
SDM246020RK18	24 x 60 x 29	150	113.50	27.68	\$1362
SDM246620RK18	24 x 66 x 29	250	118	30.38	\$1402
SDM247220RK18	24 x 72 x 29	150	132.50	33.08	\$1450

SDM244820RK26	24 x 48 x 29	150	98	22.28	\$1338
SDM245420RK26	24 x 54 x 29	150	112	24.98	\$1359
SDM246020RK26	24 x 60 x 29	150	118	27.68	\$1379
SDM246620RK26	24 x 66 x 29	150	123.50	30.38	\$1421
SDM247220RK26	24 x 72 x 29	150	138	33.08	\$1469

Connects to **20" D 5-sided** corner unit. Grommet in worksurface.

- SDM24xx20RK18 has an 18" modesty panel
- SDM24xx20RK26 has a 26" modesty panel

SDM306024LK18	24 x 60 x 29	150	142	34.19	\$1418
SDM306624LK18	24 x 66 x 29	150	151.50	37.53	\$1456
SDM307224LK18	24 x 72 x 29	250	163	40.87	\$1560

SDM306024LK26	24 x 60 x 29	150	146.50	34.19	\$1436
SDM306624LK26	24 x 66 x 29	150	158	37.53	\$1476
SDM307224LK26	24 x 72 x 29	150	169	40.87	\$1582

Connects to **24" D 5-sided** corner unit. Grommet in worksurface.

- SDM30xx24LK18 has an 18" modesty panel
- SDM30xx24LK26 has a 26" modesty panel

SDM306024RK18	24 x 60 x 29	150	142	34.19	\$1418
SDM306624RK18	24 x 66 x 29	150	151.50	37.53	\$1456
SDM307224RK18	24 x 72 x 29	250	163	40.87	\$1560

SDM306024RK26	24 x 60 x 29	150	146.50	34.19	\$1436
SDM306624RK26	24 x 66 x 29	150	158	37.53	\$1476
SDM307224RK26	24 x 72 x 29	150	169	40.87	\$1582

Connects to **24" D 5-sided** corner unit. Grommet in worksurface.

- SDM30xx24RK18 has an 18" modesty panel
- SDM30xx24RK26 has a 26" modesty panel

Required Specifications

Top Finish
Body Finish

Optional Specifications

Grommet
HP laminate

SPACE SAVER RETURNS

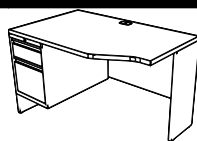

20" modesty

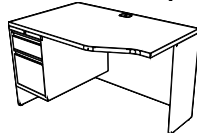

26" modesty

30" D Space Saver Return, Left

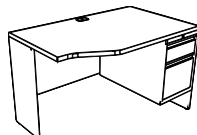

20" modesty

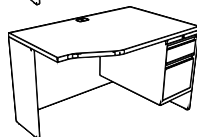

26" modesty

30" D Space Saver Return, Right

MODEL# DIMENSIONS FREIGHT CLASS WT/LBS. CUBIC FT. LIST PRICE HP ADD

D x W x H

SDM304824HLK20	24 x 48 x 29	150	147.50	27.50	\$1859
SDM304824HLK26	24 x 48 x 29	150	151.50	27.50	\$1873

Standard with **box/file** pedestal on **left**. Pedestal lock. One pencil tray.

- SDM304824HLK20 has a 20" modesty panel
- SDM304824HLK26 has a 26" modesty panel

SDM304824HRK20	24 x 48 x 29	150	147.50	27.50	\$1859
SDM304824HRK26	24 x 48 x 29	150	151.50	27.50	\$1873

Standard with **box/file** pedestal on **right**. Pedestal lock. One pencil tray.

- SDM304824HRK20 has a 20" modesty panel
- SDM304824HRK26 has a 26" modesty panel

DOUBLE PEDESTAL CRENZAS

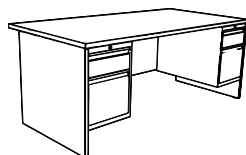

20" modesty

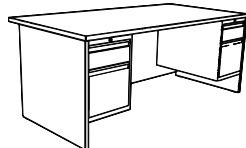

26" modesty

Double Pedestal Credenza



18" modesty



26" modesty

Double Pedestal Credenza

SDM2448HH20	24 x 48 x 29	100	188	22.28	\$1991
SDM2454HH20	24 x 54 x 29	100	201.50	24.98	\$2031
SDM2460HH20	24 x 60 x 29	125	207	27.68	\$2071
SDM2466HH20	24 x 66 x 29	125	211.50	30.38	\$2096
SDM2472HH20	24 x 72 x 29	125	226	33.08	\$2116

SDM2448HH26	24 x 48 x 29	100	192	22.28	\$2004
SDM2454HH26	24 x 54 x 29	100	206	24.98	\$2047
SDM2460HH26	24 x 60 x 29	125	212	27.68	\$2088
SDM2466HH26	24 x 66 x 29	125	217	30.38	\$2116
SDM2472HH26	24 x 72 x 29	125	232	33.08	\$2137

Standard with **box/file** pedestals on both sides. Pedestal locks. One pencil tray.

- SDM24xxHH20 has a 20" modesty panel
- SDM24xxHH26 has a 26" modesty panel

SDM2448BB18	24 x 48 x 29	100	184	22.28	\$1824
SDM2454BB18	24 x 54 x 29	125	197.50	24.98	\$1865
SDM2460BB18	24 x 60 x 29	125	203	27.68	\$1904
SDM2466BB18	24 x 66 x 29	125	208	30.38	\$1932
SDM2472BB18	24 x 72 x 29	125	222	33.08	\$1949

SDM2448BB26	24 x 48 x 29	100	188	22.28	\$1839
SDM2454BB26	24 x 54 x 29	100	202	24.98	\$1881
SDM2460BB26	24 x 60 x 29	125	208	27.68	\$1921
SDM2466BB26	24 x 66 x 29	125	213	30.38	\$1949
SDM2472BB26	24 x 72 x 29	125	228	33.08	\$1971

Standard with full to floor **box/box/file** pedestals on both sides. Pedestal locks. One pencil tray.

- SDM24xxBB18 has an 18" modesty panel
- SDM24xxBB26 has a 26" modesty panel

Required Specifications

Top Finish
Body Finish

Optional Specifications

Grommet
HP laminate

DOUBLE PEDESTAL DESKS

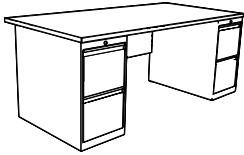

18" modesty

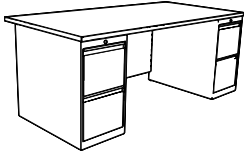

26" modesty

Double Pedestal Credenza

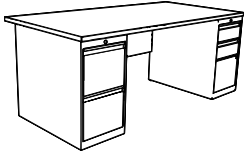

18" modesty

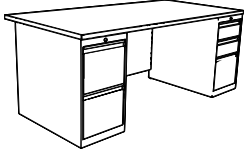

26" modesty

Double Pedestal Credenza

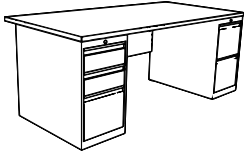

18" modesty

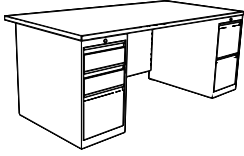

26" modesty

Double Pedestal Credenza

MODEL#	DIMENSIONS	FREIGHT CLASS	WT/LBS.	CUBIC FT.	LIST PRICE	HP ADD
--------	------------	---------------	---------	-----------	------------	--------

D x W x H

SDM2448FF18	24 x 48 x 29	100	184	22.28	\$1824	
SDM2454FF18	24 x 54 x 29	125	197.50	24.98	\$1865	
SDM2460FF18	24 x 60 x 29	125	203	27.68	\$1904	
SDM2466FF18	24 x 66 x 29	125	208	30.38	\$1932	
SDM2472FF18	24 x 72 x 29	125	222	33.08	\$1949	
SDM2448FF26	24 x 48 x 29	100	188	22.28	\$1839	
SDM2454FF26	24 x 54 x 29	100	202	24.98	\$1881	
SDM2460FF26	24 x 60 x 29	125	208	27.68	\$1921	
SDM2466FF26	24 x 66 x 29	125	213	30.38	\$1949	
SDM2472FF26	24 x 72 x 29	125	228	33.08	\$1971	

Standard with full to floor **file/file** pedestals on both sides. Pedestal locks.

- SDM24xxFF18 has an 18" modesty panel
- SDM24xxFF26 has a 26" modesty panel

SDM2448FB18	24 x 48 x 29	100	184	22.28	\$1824	
SDM2454FB18	24 x 54 x 29	125	197.50	24.98	\$1865	
SDM2460FB18	24 x 60 x 29	125	203	27.68	\$1904	
SDM2466FB18	24 x 66 x 29	125	208	30.38	\$1932	
SDM2472FB18	24 x 72 x 29	125	222	33.08	\$1949	

SDM2448FB26	24 x 48 x 29	100	188	22.28	\$1839	
SDM2454FB26	24 x 54 x 29	100	202	24.98	\$1881	
SDM2460FB26	24 x 60 x 29	125	208	27.68	\$1921	
SDM2466FB26	24 x 66 x 29	125	213	30.38	\$1949	
SDM2472FB26	24 x 72 x 29	125	228	33.08	\$1971	

Standard with full to floor **file/file** pedestal on **left** and **box/box/file** pedestal on **right**. Pedestal locks. One pencil tray.

- SDM24xxFB18 has an 18" modesty panel
- SDM24xxFB26 has a 26" modesty panel.

SDM2448BF18	24 x 48 x 29	100	184	22.28	\$1824	
SDM2454BF18	24 x 54 x 29	125	197.50	24.98	\$1865	
SDM2460BF18	24 x 60 x 29	125	203	27.68	\$1904	
SDM2466BF18	24 x 66 x 29	125	208	30.38	\$1932	
SDM2472BF18	24 x 72 x 29	125	222	33.08	\$1949	

SDM2448BF26	24 x 48 x 29	100	188	22.28	\$1839	
SDM2454BF26	24 x 54 x 29	100	202	24.98	\$1881	
SDM2460BF26	24 x 60 x 29	125	208	27.68	\$1921	
SDM2466BF26	24 x 66 x 29	125	213	30.38	\$1949	
SDM2472BF26	24 x 72 x 29	125	228	33.08	\$1971	

Standard with full to floor **file/file** pedestal on **right** and **box/box/file** pedestal on **left**. Pedestal locks. One pencil tray.

- SDM24xxBF18 has an 18" modesty panel
- SDM24xxBF26 has a 26" modesty panel

Required Specifications

Top Finish
Body Finish

Optional Specifications

Grommet
HP laminate

SINGLE PEDESTAL CREDENZAS



18" modesty



26" modesty

Single Pedestal Credenza - Left

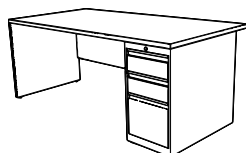

18" modesty



26" modesty

Single Pedestal Credenza - Right

MODEL# DIMENSIONS FREIGHT CLASS WT/LBS. CUBIC FT. LIST PRICE HP ADD

D x W x H

SDM2442BG18	24 x 42 x 29	125	140.50	19.58	\$1429
SDM2448BG18	24 x 48 x 29	125	146	22.28	\$1469
SDM2454BG18	24 x 54 x 29	125	160	24.98	\$1510
SDM2460BG18	24 x 60 x 29	150	165	27.68	\$1549
SDM2466BG18	24 x 66 x 29	150	170	30.38	\$1574
SDM2472BG18	24 x 72 x 29	150	184	33.08	\$1593

SDM2442BG26	24 x 42 x 29	125	144	19.58	\$1441
SDM2448BG26	24 x 48 x 29	125	150	22.28	\$1485
SDM2454BG26	24 x 54 x 29	125	164	24.98	\$1525
SDM2460BG26	24 x 60 x 29	125	170	27.68	\$1568
SDM2466BG26	24 x 66 x 29	150	175	30.38	\$1593
SDM2472BG26	24 x 72 x 29	150	190	33.08	\$1614

Standard with full to floor **box/box/file** pedestal on **left**. Pedestal lock. One pencil tray.

- SDM24xxBG18 has an 18" modesty panel
- SDM24xxBG26 has a 26" modesty panel

SDM2442GB18	24 x 42 x 29	125	140.50	19.58	\$1429
SDM2448GB18	24 x 48 x 29	125	146	22.28	\$1469
SDM2454GB18	24 x 54 x 29	125	160	24.98	\$1510
SDM2460GB18	24 x 60 x 29	150	165	27.68	\$1549
SDM2466GB18	24 x 66 x 29	150	170	30.38	\$1574
SDM2472GB18	24 x 72 x 29	150	184	33.08	\$1593

SDM2442GB26	24 x 42 x 29	125	144	19.58	\$1441
SDM2448GB26	24 x 48 x 29	125	150	22.28	\$1485
SDM2454GB26	24 x 54 x 29	125	164	24.98	\$1525
SDM2460GB26	24 x 60 x 29	125	170	27.68	\$1568
SDM2466GB26	24 x 66 x 29	150	175	30.38	\$1593
SDM2472GB26	24 x 72 x 29	150	190	33.08	\$1614

Standard with full to floor **box/box/file** pedestal on **right**. Pedestal lock. One pencil tray.

- SDM24xxGB18 has an 18" modesty panel
- SDM24xxGB26 has a 26" modesty panel

Required Specifications

Top Finish
Body Finish

Optional Specifications

Grommet
HP laminate

SINGLE PEDESTAL CREDENZAS

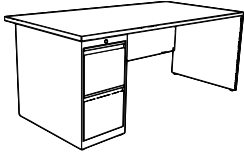

18" modesty

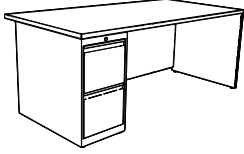

26" modesty

Single Pedestal Credenza - Left

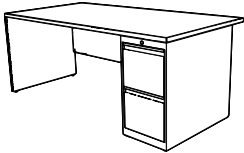

18" modesty

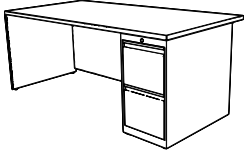

26" modesty

Single Pedestal Credenza - Right

MODEL#	DIMENSIONS	FREIGHT CLASS	WT/LBS.	CUBIC FT.	LIST PRICE	HP ADD
--------	------------	---------------	---------	-----------	------------	--------

D x W x H

SDM2442FG18	24 x 42 x 29	125	140.50	19.58	\$1429	
SDM2448FG18	24 x 48 x 29	125	146	22.28	\$1469	
SDM2454FG18	24 x 54 x 29	125	160	24.98	\$1510	
SDM2460FG18	24 x 60 x 29	150	165	27.68	\$1549	
SDM2466FG18	24 x 66 x 29	150	170	30.38	\$1574	
SDM2472FG18	24 x 72 x 29	150	184	33.08	\$1593	
SDM2442FG26	24 x 42 x 29	125	144	19.58	\$1441	
SDM2448FG26	24 x 48 x 29	125	150	22.28	\$1485	
SDM2454FG26	24 x 54 x 29	125	164	24.98	\$1525	
SDM2460FG26	24 x 60 x 29	125	170	27.68	\$1568	
SDM2466FG26	24 x 66 x 29	150	165.50	30.38	\$1593	
SDM2472FG26	24 x 72 x 29	150	190	33.08	\$1614	

Standard with full to floor **file/file** pedestal on **left**. Pedestal lock. One pencil tray.

- SDM24xxFG18 has an 18" modesty panel
- SDM24xxFG26 has a 26" modesty panel

SDM2442GF18	24 x 42 x 29	125	140.50	19.58	\$1429	
SDM2448GF18	24 x 48 x 29	125	146	22.28	\$1469	
SDM2454GF18	24 x 54 x 29	125	160	24.98	\$1510	
SDM2460GF18	24 x 60 x 29	150	165	27.68	\$1549	
SDM2466GF18	24 x 66 x 29	150	170	30.38	\$1574	
SDM2472GF18	24 x 72 x 29	150	184	33.08	\$1593	
SDM2442GF26	24 x 42 x 29	125	144	19.58	\$1441	
SDM2448GF26	24 x 48 x 29	125	150	22.28	\$1485	
SDM2454GF26	24 x 54 x 29	125	164	24.98	\$1525	
SDM2460GF26	24 x 60 x 29	125	170	27.68	\$1568	
SDM2466GF26	24 x 66 x 29	150	175	30.38	\$1593	
SDM2472GF26	24 x 72 x 29	150	190	33.08	\$1614	

Standard with full to floor **file/file** pedestal on **right**. Pedestal lock. One pencil tray.

- SDM24xxGF18 has an 18" modesty panel
- SDM24xxGF26 has a 26" modesty panel

Required Specifications

Top Finish
Body Finish

Optional Specifications

Grommet
HP laminate

SINGLE PEDESTAL CREDENZAS

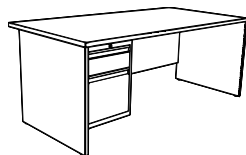

20" modesty



26" modesty

Single Pedestal Credenza - Left

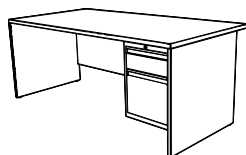

20" modesty

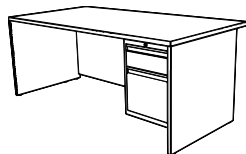

26" modesty

Single Pedestal Credenza - Right

MODEL#	DIMENSIONS	FREIGHT CLASS	WT/LBS.	CUBIC FT.	LIST PRICE	HP ADD
D x W x H						
SDM2442HG20	24 x 42 x 29	125	143	19.58	\$1513	
SDM2448HG20	24 x 48 x 29	125	148	22.28	\$1553	
SDM2454HG20	24 x 54 x 29	125	161.50	24.98	\$1592	
SDM2460HG20	24 x 60 x 29	125	167	27.68	\$1634	
SDM2466HG20	24 x 66 x 29	150	172	30.38	\$1659	
SDM2472HG20	24 x 72 x 29	150	186	33.08	\$1679	
SDM2442HG26	24 x 42 x 29	125	146	19.58	\$1525	
SDM2448HG26	24 x 48 x 29	125	152	22.28	\$1568	
SDM2454HG26	24 x 54 x 29	125	166	24.98	\$1608	
SDM2460HG26	24 x 60 x 29	125	172	27.68	\$1650	
SDM2466HG26	24 x 66 x 29	150	177	30.38	\$1679	
SDM2472HG26	24 x 72 x 29	150	192	33.08	\$1700	

Standard with **box/file** pedestal on **left**. Pedestal lock. One pencil tray.

- SDM24xxHG20 has a 20" modesty panel
- SDM24xxHG26 has a 26" modesty panel

SDM2442GH20	24 x 42 x 29	125	143	19.58	\$1513	
SDM2448GH20	24 x 48 x 29	125	148	22.28	\$1553	
SDM2454GH20	24 x 54 x 29	125	161.50	24.98	\$1592	
SDM2460GH20	24 x 60 x 29	125	167	27.68	\$1634	
SDM2466GH20	24 x 66 x 29	150	172	30.38	\$1659	
SDM2472GH20	24 x 72 x 29	150	186	33.08	\$1679	
SDM2442GH26	24 x 42 x 29	125	146	19.58	\$1525	
SDM2448GH26	24 x 48 x 29	125	152	22.28	\$1568	
SDM2454GH26	24 x 54 x 29	125	166	24.98	\$1608	
SDM2460GH26	24 x 60 x 29	125	172	27.68	\$1650	
SDM2466GH26	24 x 66 x 29	150	177	30.38	\$1679	
SDM2472GH26	24 x 72 x 29	150	192	33.08	\$1700	

Standard with **box/file** pedestal on **right**. Pedestal lock. One pencil tray.

- SDM24xxGH20 has a 20" modesty panel
- SDM24xxGH26 has a 26" modesty panel

Required Specifications

Top Finish
Body Finish

Optional Specifications

Grommet
HP laminate

S STREAMLINE II™

CREDENZAS

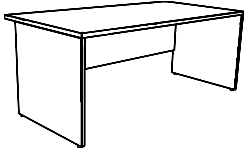

18" modesty

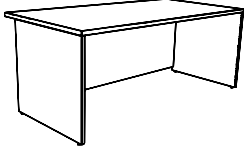

26" modesty

Credenza Shell*

MODEL#	DIMENSIONS D x W x H	FREIGHT CLASS	WT./LBS.	CUBIC FT.	LIST PRICE	HP ADD
SDM2442GG18	24 x 42 x 29	150	103	19.58	\$1075	
SDM2448GG18	24 x 48 x 29	150	108	22.28	\$1117	
SDM2454GG18	24 x 54 x 29	150	122	24.98	\$1155	
SDM2460GG18	24 x 60 x 29	150	127.50	27.68	\$1196	
SDM2466GG18	24 x 66 x 29	150	170	30.38	\$1220	
SDM2472GG18	24 x 72 x 29	150	146.50	33.08	\$1240	
SDM2442GG26	24 x 42 x 29	150	106	19.58	\$1087	
SDM2448GG26	24 x 48 x 29	150	112	22.28	\$1128	
SDM2454GG26	24 x 54 x 29	150	126	24.98	\$1170	
SDM2460GG26	24 x 60 x 29	150	132	27.68	\$1214	
SDM2466GG26	24 x 66 x 29	150	175	30.38	\$1240	
SDM2472GG26	24 x 72 x 29	150	152	33.08	\$1261	

- SDM24xxGG18 has an 18" modesty panel
- SDM24xxGG26 has a 26" modesty panel

HUTCHES

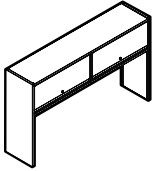

Closed Hutch with Open Back

SH1572	15 x 72 x 39	125	115	14.50	\$1297
SH1566	15 x 66 x 39	100	110	13	\$1258
SH1560	15 x 60 x 39	100	105	12	\$1214
SH1548	15 x 48 x 39	100	95	10	\$1174
SH1542	15 x 42 x 39	100	85	9	\$1124
SH1536	15 x 36 x 39	92.5	75	7.50	\$1095

Hutch with two receding doors and one fixed shelf divider. **ALL METAL.** Doors lock. Not slotted for plate dividers. Shipped RTA (ready to assemble). Clearance from worksurface to shelf is 24".

- Models SH1542/SH1536 use a single receding door and no shelf divider.

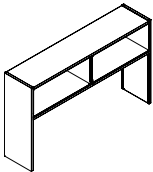

Open Hutch with Open Back

SH1572ND	15 x 72 x 39.62	125	115	14.50	\$1097
SH1566ND	15 x 66 x 39.62	100	115	13	\$1065
SH1560ND	15 x 60 x 39.62	100	115	12	\$1029
SH1548ND	15 x 48 x 39.62	92.5	115	10	\$1006
SH1542ND	15 x 42 x 39.62	85	115	9	\$953
SH1536ND	15 x 36 x 39.62	70	115	7.50	\$930

One fixed shelf and one fixed shelf divider. **ALL METAL.** Not slotted for plate dividers. Shipped RTA (ready to assemble). Clearance from worksurface to shelf is 24".

BACK PANELS

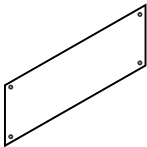

Back Panel

SHM72	.75 x 72 x 24	65	33	1.30	\$625
SHM66	.75 x 66 x 24	65	31	1.20	\$597
SHM60	.75 x 60 x 24	65	28	1	\$568
SHM48	.75 x 48 x 24	60	24	.80	\$517
SHM42	.75 x 42 x 24	65	21	.75	\$494
SHM36	.75 x 36 x 24	60	19	.60	\$472

For StreamLINE Series Hutches Only. **ALL METAL.**

Required Specifications

Top Finish
Body Finish

Optional Specifications

Grommet*
HP laminate*

TACKBOARDS FOR HUTCHES MODEL# DIMENSIONS FREIGHT CLASS WT./LBS. CUBIC FT. FABRIC GRADE LIST PRICE

D x W x H

BACK PANEL Notes: Tackboards can be upholstered in all of the following fabrics:

Grade 1: Hudson, Jenny, Quilt, Terrace, Urban, Waterfall

Grade 2: Imprint, Lola, Silhouette

Grade 3: Anchorage, Merge

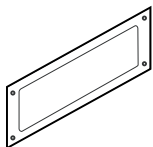

Back Panel

SHMTB72	.75 x 72 x 24	65	33	1.30	1	\$756
					2	\$835
					3	\$911
					4	\$999
					5	\$1106

For StreamLINE Series Hutches Only. **ALL METAL** with tackboard.

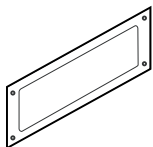

Back Panel

SHMTB66	.75 x 66 x 24	65	31	1.20	1	\$716
					2	\$788
					3	\$857
					4	\$935
					5	\$1034

For StreamLINE Series Hutches Only. **ALL METAL** with tackboard.

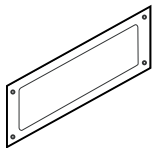

Back Panel

SHMTB60	.75 x 60 x 24	65	28	1	1	\$679
					2	\$742
					3	\$802
					4	\$877
					5	\$963

For StreamLINE Series Hutches Only. **ALL METAL** with tackboard.

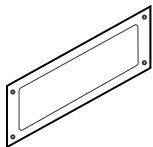

Back Panel

SHMTB48	.75 x 48 x 24	60	24	.80	1	\$611
					2	\$659
					3	\$706
					4	\$762
					5	\$813

For StreamLINE Series Hutches Only. **ALL METAL** with tackboard.

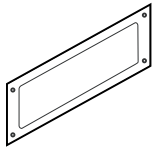

Back Panel

SHMTB42	.75 x 42 x 24	65	21	.75	1	\$579
					2	\$620
					3	\$664
					4	\$717
					5	\$778

For StreamLINE Series Hutches Only. **ALL METAL** with tackboard.

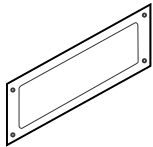

Back Panel

SHMTB36	.75 x 36 x 24	60	19	.60	1	\$546
					2	\$585
					3	\$623
					4	\$671
					5	\$727

For StreamLINE Series Hutches Only. **ALL METAL** with tackboard.

Required Specifications

- Paint finish
- Fabric

S STREAMLINE II™

PEDESTALS

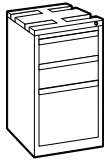

Box/Box/File Pedestal

MODEL#	DIMENSIONS D x W x H	FREIGHT CLASS	WT./LBS.	CUBIC FT.	LIST PRICE
GW PSS18BBF	18 x 15 x 27.75	70	76	4.8	\$698
GW PSS24BBF	24 x 15 x 27.75	85	84	5.8	\$710
GW PSS30BBF	30 x 15 x 27.75	85	94	7.3	\$726

Two box and 1 file drawer pedestal.

- **Cannot be used with 66" w Streamline Extended Corners**

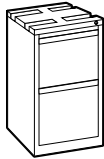

File/File Pedestal

GW PSS18FF	18 x 15 x 27.75	70	76	4.8	\$698
GW PSS24FF	24 x 15 x 27.75	85	84	5.8	\$710
GW PSS30FF	30 x 15 x 27.75	85	97	7.3	\$726

Two file drawer pedestal.

- **Cannot be used with 66" w Streamline Extended Corners**

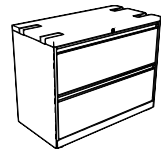

2 Drawer Lateral File - Fixed Front Worksurface supporting

1230P2FFDAO	18 x 30 x 27.75	125	69.29	10	\$1074
1236P2FFDAO	18 x 36 x 27.75	125	86	12.38	\$1095
1242P2FFDAO	18 x 42 x 27.75	125	105	14.36	\$1128

Two fixed front drawers. Side-to-side hanging file bars included.

ACCESSORIES

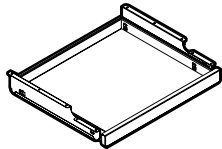

Center Drawer

SDMCD	16.75 x 20 x 1.75	100	8	1	\$196
-------	-------------------	-----	---	---	--------------

Metal drawer front is attached to a 4-sided frame. All Metal.

Required Specifications

Top Finish
Body Finish

Optional Specifications

Grommet

benching



Bridges II

340



Intelli Beam

424



bridges II

connect
share
achieve

Our desire was to develop an environment for collaborative teamwork which would facilitate connection, or bridging of people and ideas. A set of components which would even serve as a catalyst, inviting team members out of their cocooned comfort zones and encouraging them to engage, co-create. With Bridges II you can develop an environment of collaborative teamwork through workspace configuration that enhances line communication and bridges people with a spectrum of ideas and interfaces. Bridges II features a set of components that facilitate communication and streamline interaction through product that efficiently adapts and creatively configures. The product focuses on advancing engagement and collaborative creation through quick adaptations necessary to meet the needs of a fast paced and ever changing work environment. With flexible building components, Bridges II fits numerous applications, from boardrooms to multi-person workstations. It is easy to customize and reconfigure to fit specific requirements.

Features and Benefits

- High performance thermally fused laminate tops are 1" thick
- High pressure laminate tops are 1-1/16" thick
- Flat 3mm edge profile on all sides
- Worksurfaces provided with pilot holes for alignment
- Numerous Power/Data accessories
- Interconnected storage units can form a spine to create space division, storage, cable management and worksurface support
- Leg Options:
 - Height adjustable round legs
 - Fixed height rectangular legs



Rectangular Leg



Power Trough



Round Leg

GENERAL INFORMATION**Flexible Building components**

- Single leg tables (freestanding or mobile)
- Training Rooms
- Boardrooms
- Libraries
- 1 person general and private office
- 2 person workstation
- 3 person workstation
- 6+ person workstation
- Storage spine-based workstation

Easy to customize and reconfigure to fit specific requirements. From the facility manager's perspective, all workstations can be standardized to form a linear worksurface and power/data services, and their respective function or purpose can be governed by the type, quantity and placement of adjacent components like dividers, storage cabinets, shelves and accessories. These adjacent components can be easily reconfigured with minimal down time - without having to invite electrical and IT crews.

Compatible with various environments

- Clean, simple, elegant design language, with finishes suggesting comfortable, even domestic flavor. Understated to designer combinations, like anodized aluminum and white, give a hint of subtle sophistication.

Choice of **two functionally and visually different leg** supports

- Casters or levelers
- Height adjustable round legs
- Fixed height rectangular legs
- Optional anodized aluminum finish (Rectangular legs only). Refer to individual models for upcharge.

Various **power/data delivery** levels to choose from

- Wire basket to organize cable access under worksurfaces and storage units
- Vertical cable manager integrated into rectangular leg
- Worksurface edge-mounted power/data units (easy to reconfigure, plug into wall/floor outlets), or power troughs
- Single-sided and double-sided below worksurface power/data trough (desktop/floor standing computers and office equipment)
- Worksurface access door (access to below worksurface power outlets and data terminals)
- Above worksurface power/data trough provides immediate access for laptops, tablets and phones
- Storage integrated power/data unit
- Horizontal cable management under storage units with optional wire basket

Interconnected storage units can form a spine to create space division, storage, cable management and worksurface support. Storage leg can be configured to act as a ganging bracket.

- For environmental certifications, please visit globalfurnituregroup.com.

B BRIDGES II™ - NOTES

WORKSURFACES

- Standard in high performance thermally fused laminate. Optional high pressure (HP) laminate available.
- High performance thermally fused laminate tops are 1" thick particle board and have a flat 3mm edge profile on all sides
- High pressure (HP) laminate tops are 1-1/16" thick laminate particle board and have a flat 3mm edge profile on all sides
- Laminate surfaces offer a selection of matching + coordinating edgeband. Specify separately from the surface finish.



- Products specified with the high pressure laminate option are finished on the underside of the surface with a kraft paper backing.
- Doors and Drawer Fronts feature a matching 3mm edge. All other surfaces feature a matching self edge.

TABLES

- All multiple linear workstations are standard with levelers
- Tops square for flush surface-to-surface abutment and to accept desk mounted accessories
- Worksurfaces provided with pilot holes for alignment purposes

CODES

- This price list uses a numbering system with meaningful alphanumeric characters to create a simple-to-understand product number. This makes specifying the product much easier and more accurate.

Example of a worksurface:

Product code: BRTWS2472AWC + HP

BRT = Bridges II

WS = Type of Worksurface

2472 = Size: Depth x Width

AWC = High Pressure Laminate

HP = Finish

RECTANGULAR LEG

- For single and shared worksurface support
- Bridges II Rectangular legs are available with:
Locking Casters (**BRTLCS**) or Levelers (**BRTLVS**)

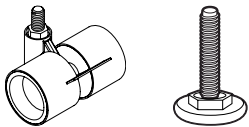

- Casters and Levelers **CANNOT** be retrofitted
- Levelers have a 2" height range, with 5/16" thread
- Levelers are available in Black only
- Casters are 45mm high with 8mm thread, available in White body / Grey tire combination only
- Leg frame is offered in 8 standard paint finishes and anodized aluminum finish
- Paint finish is a durable, environmentally friendly epoxy powder coating
- When anodized finish is selected, crossbeam is always White

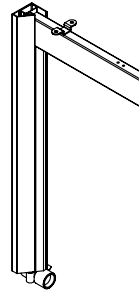

ROUND LEG

- For single and shared worksurface support
- Tubular steel legs are adjustable in 1" increments
- Height adjustment allows the user to easily set the height of a table
- Legs have a height adjustment of 24" - 32" in 1" increments with levelers and 27" - 35" with casters
- Bridges II Round legs are available with:
Locking Casters (**BRTLCR**) or Levelers (**BRTLVR**)

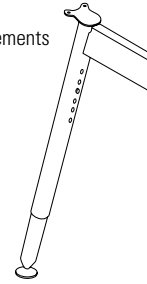
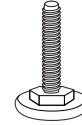

- Casters and Levelers CAN be retrofitted
- Levelers have a 1" height range, with 3/8-16" thread
- Levelers are available in Chrome only
- Casters available in Tungsten/Black combination only
- Casters are 3" diameter with an overall height of 3 3/4" with 3/8-16" thread
- Inner legs are available in Chrome only
- Leg frame is offered in 8 standard paint finishes
- Paint finish is a durable, environmentally friendly epoxy powder coating

FINISHES

Metal Frame Finishes:

BLK	Black
CHR	Charcoal
DWT	Designer White
FOG	Fog
NEV	Nevada
SIL	Silver
TPE	Taupe
TUN	Tungsten
ANO*	Anodized Aluminum - Upcharge applies. Refer to models for upcharge.

*ANO is a process, not a paint finish.

Laminate Top Finishes:

ACJ	Absolute Acajou
ASN	Asian Night
AWC	Avant Cherry
AWH	Avant Honey
BLK	Black - Coordinates with BLK Metal Frame Finish
BRC	Brushed Cobalt - Coordinates with TUN Metal Frame Finish
CMB	Clear Maple
CGY	Custom Grey - Coordinates with SIL Metal Frame Finish
DES	Dark Espresso
DWT	Designer White - Coordinates with DWT Metal Frame Finish
HGT	Hayden Grey
NBL	Noce Biondo
NGL	Noce Grigio
NEL	Noce Leggero
NML	Noce Medio
QTM	Quartered Mahogany
SOG	Storm Grey - Coordinates with CHR Metal Frame Finish
STG	String - Coordinates with NEV Metal Frame Finish
TFW	Tiger Fruitwood
TWL	Tiger Walnut
WHE	Walnut Heights
WHC	White Chocolate
WCR	Winter Cherry
WGY	Willow Grey

Edgeband Finishes:

AAE	Absolute Acajou
ASE	Asian Night
ACE	Avant Cherry
AHE	Avant Honey
BLK	Black
BRC	Brushed Cobalt
CHR	Charcoal (<i>use w/SOG</i>)
CME	Clear Maple
DEE	Dark Espresso
DWE	Designer White
NEV	Nevada (<i>use w/STG</i>)
QTM	Quartered Mahogany
SIL	Silver (<i>use w/WGY</i>)
TPE	Taupe (<i>use w/HGT</i>)
TFE	Tiger Fruitwood
TWE	Tiger Walnut
WHE	Walnut Heights
CBE	White Chocolate
WCE	Winter Cherry

Chassis/Accent Finishes:

ACJ	Absolute Acajou
ASN	Asian Night
AWC	Avant Cherry
AWH	Avant Honey
BLK	Black - Coordinates with BLK Metal Frame Finish
BRC	Brushed Cobalt - Coordinates with TUN Metal Frame Finish
CGY	Custom Grey - Coordinates with SIL Metal Frame Finish
CMB	Clear Maple
DES	Dark Espresso
DWT	Designer White - Coordinates with DWT Metal Frame Finish
HGT	Hayden Grey - Coordinates with TPE Metal Frame Finish
NBL	Noce Biondo
NGL	Noce Grigio
NEL	Noce Leggero
NML	Noce Medio
QTM	Quartered Mahogany
SOG	Storm Grey - Coordinates with CHR Metal Frame Finish
STG	String - Coordinates with NEV Metal Frame Finish
TFW	Tiger Fruitwood
TWL	Tiger Walnut
WHC	White Chocolate
WHE	Walnut Heights
WCR	Winter Cherry

FABRIC TABLE DIVIDERS / SEAT PRIVACY PARTITIONS

Bridges II Fabric Table Dividers are available in:

- Global: **Anchorage, Lola, Merge**

COLLABORATIVE SEATING

- All standard seating fabrics and grades apply.

30"W UNITS STORAGE CAPACITY CHART

Side to Side

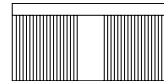

LETTER LETTER

Side to Side Letter/Front to Back Legal

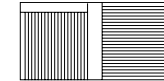

LETTER LEGAL

36"W UNITS STORAGE CAPACITY CHART

Side to Side Letter

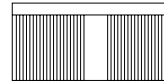

LETTER LETTER

Side to Side Legal

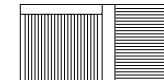

LETTER LEGAL

Side to Side Letter/Front to Back Legal



LEGAL LEGAL

RECTANGULAR LEG PACKAGES

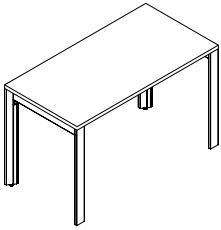

Single Line 1 Person Pod with Levelers

MODEL#	DIMENSIONS	FREIGHT CLASS	WT./LBS.	CUBIC FT.	LIST PRICE	HP ADD
D x W x H						
BRTS1P2484L	24 x 84 x 29	70	75	4.92	\$1440	\$140
BRTS1P2478L	24 x 78 x 29	85	72	4.82	\$1398	\$134
BRTS1P2472L	24 x 72 x 29	85	69	4.73	\$1349	\$139
BRTS1P2466L	24 x 66 x 29	85	66	4.65	\$1334	\$123
BRTS1P2463L	24 x 62.5 x 29	85	63	4.57	\$1324	\$120
BRTS1P2460L	24 x 60 x 29	85	60	4.48	\$1310	\$119
BRTS1P2454L	24 x 54 x 29	85	57	4.4	\$1264	\$103
BRTS1P2451L	24 x 50.5 x 29	85	54	4.3	\$1230	\$99
BRTS1P2448L	24 x 48 x 29	85	51	4.2	\$1197	\$94
BRTS1P2442L	24 x 42 x 29	92.5	48	4.1	\$1145	\$77
BRTS1P2436L	24 x 36 x 29	92.5	45	4	\$1073	\$66
BRTS1P3084L	30 x 84 x 29	70	84	5.2	\$1510	\$150
BRTS1P3078L	30 x 78 x 29	70	81	5.1	\$1451	\$139
BRTS1P3072L	30 x 72 x 29	70	78	5.01	\$1417	\$137
BRTS1P3066L	30 x 66 x 29	70	75	4.9	\$1383	\$131
BRTS1P3063L	30 x 62.5 x 29	70	72	4.8	\$1372	\$127
BRTS1P3060L	30 x 60 x 29	85	69	4.73	\$1359	\$123
BRTS1P3054L	30 x 54 x 29	85	66	4.6	\$1328	\$102
BRTS1P3051L	30 x 50.5 x 29	85	63	4.5	\$1303	\$108
BRTS1P3048L	30 x 48 x 29	85	60	4.41	\$1281	\$103
BRTS1P3042L	30 x 42 x 29	85	57	4.3	\$1253	\$101
BRTS1P3036L	30 x 36 x 29	85	54	4.2	\$1158	\$70

Single Line Table Assemblies consist of one worksurface, two leg assemblies, and one supporting structural beam.

- Anodized Aluminum Leg - Add **\$140.** list upcharge

Required Specifications

Top finish
Edge finish
Metal finish (legs)

Optional Specifications

Anodized Aluminum Leg
HP laminate

RECTANGULAR LEG PACKAGES

MODEL#	DIMENSIONS	FREIGHT CLASS	WT/LBS.	CUBIC FT.	LIST PRICE	HP ADD
	D x W x H					
BRTS1P2484C	24 x 84 x 29	70	75	4.92	\$1510	\$140
BRTS1P2478C	24 x 78 x 29	85	72	4.82	\$1468	\$134
BRTS1P2472C	24 x 72 x 29	85	69	4.73	\$1428	\$131
BRTS1P2466C	24 x 66 x 29	85	66	4.65	\$1405	\$123
BRTS1P2463C	24 x 62.5 x 29	85	63	4.57	\$1393	\$120
BRTS1P2460C	24 x 60 x 29	85	60	4.48	\$1381	\$119
BRTS1P2454C	24 x 54 x 29	85	57	4.4	\$1334	\$103
BRTS1P2451C	24 x 50.5 x 29	85	54	4.3	\$1301	\$99
BRTS1P2448C	24 x 48 x 29	85	51	4.2	\$1267	\$94
BRTS1P2442C	24 x 42 x 29	92.5	48	4.1	\$1213	\$77
BRTS1P2436C	24 x 36 x 29	92.5	45	4	\$1146	\$66
BRTS1P3084C	30 x 84 x 29	70	84	5.2	\$1593	\$139
BRTS1P3078C	30 x 78 x 29	70	81	5.1	\$1521	\$139
BRTS1P3072C	30 x 72 x 29	70	78	5.01	\$1487	\$117
BRTS1P3066C	30 x 66 x 29	70	75	4.9	\$1454	\$131
BRTS1P3063C	30 x 62.5 x 29	70	72	4.8	\$1443	\$127
BRTS1P3060C	30 x 60 x 29	85	69	4.73	\$1429	\$123
BRTS1P3054C	30 x 54 x 29	85	66	4.6	\$1399	\$102
BRTS1P3051C	30 x 50.5 x 29	85	63	4.5	\$1374	\$108
BRTS1P3048C	30 x 48 x 29	85	60	4.41	\$1351	\$103
BRTS1P3042C	30 x 42 x 29	85	57	4.3	\$1325	\$101
BRTS1P3036C	30 x 36 x 29	85	54	4.2	\$1229	\$70

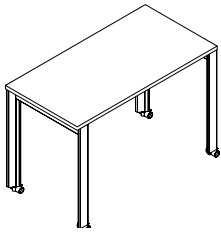

Single Line 1 Person Pod with Casters

Single Line Table Assemblies consist of one worksurface, two leg assemblies, and one supporting structural beam. 40mm white locking casters with grey tires; steel horizontal beams, aluminum legs.

- Anodized Aluminum Leg - Add **\$140**. list upcharge

Required Specifications

Top finish
Edge finish
Metal finish (legs)

Optional Specifications

Anodized Aluminum Leg
HP laminate

RECTANGULAR LEG PACKAGES

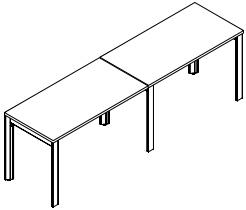

Single Line 2 Person Pod with Levelers

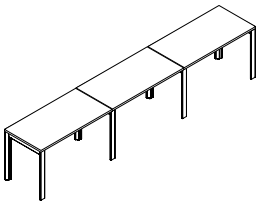

Single Line 3 Person Pod with Levelers

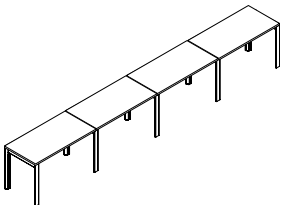

Single Line 4 Person Pod with Levelers

MODEL#	DIMENSIONS D x W x H	FREIGHT CLASS	WT/LBS.	CUBIC FT.	LIST PRICE	HP ADD
BRTS2P2484L	24 x 168 x 29	70	149	7.41	\$2522	\$278
BRTS2P2478L	24 x 156 x 29	70	140	7.27	\$2437	\$264
BRTS2P2472L	24 x 144 x 29	70	131	7.13	\$2361	\$257
BRTS2P2466L	24 x 132 x 29	70	122	6.95	\$2311	\$242
BRTS2P2460L	24 x 120 x 29	70	113	6.71	\$2261	\$236
BRTS2P2454L	24 x 108 x 29	70	104	6.45	\$2169	\$205
BRTS2P2448L	24 x 96 x 29	70	95	6.21	\$2036	\$184
BRTS2P3084L	30 x 168 x 29	70	173	8.25	\$2646	\$299
BRTS2P3078L	30 x 156 x 29	70	164	7.97	\$2530	\$275
BRTS2P3072L	30 x 144 x 29	70	155	7.69	\$2477	\$267
BRTS2P3066L	30 x 132 x 29	70	140	7.41	\$2393	\$257
BRTS2P3060L	30 x 120 x 29	70	131	7.13	\$2346	\$242
BRTS2P3054L	30 x 108 x 29	70	122	6.85	\$2279	\$205
BRTS2P3048L	30 x 96 x 29	70	113	6.57	\$2187	\$205
BRTS3P2484L	24 x 252 x 29	70	219	9.74	\$3608	\$415
BRTS3P2478L	24 x 234 x 29	70	206	9.53	\$3480	\$394
BRTS3P2472L	24 x 216 x 29	70	192	9.32	\$3364	\$384
BRTS3P2466L	24 x 198 x 29	70	179	9.11	\$3288	\$364
BRTS3P2460L	24 x 180 x 29	70	165	8.89	\$3217	\$334
BRTS3P2454L	24 x 162 x 29	70	152	8.68	\$3078	\$304
BRTS3P2448L	24 x 144 x 29	70	138	8.47	\$2877	\$273
BRTS3P3084L	30 x 252 x 29	65	263	11.59	\$3784	\$447
BRTS3P3078L	30 x 234 x 29	70	246	11.16	\$3609	\$412
BRTS3P3072L	30 x 216 x 29	70	229	10.72	\$3503	\$401
BRTS3P3066L	30 x 198 x 29	70	212	10.3	\$3402	\$384
BRTS3P3060L	30 x 180 x 29	70	195	9.87	\$3332	\$364
BRTS3P3054L	30 x 162 x 29	70	178	9.44	\$3233	\$304
BRTS3P3048L	30 x 144 x 29	70	161	9.01	\$3096	\$304
BRTS4P2484L	24 x 336 x 29	70	291	13.67	\$4688	\$554
BRTS4P2478L	24 x 312 x 29	70	273	13.18	\$4520	\$525
BRTS4P2472L	24 x 288 x 29	70	254	12.69	\$4392	\$519
BRTS4P2466L	24 x 264 x 29	70	236	12.2	\$4266	\$483
BRTS4P2460L	24 x 240 x 29	70	217	11.71	\$4168	\$469
BRTS4P2454L	24 x 216 x 29	70	199	11.22	\$3985	\$405
BRTS4P2448L	24 x 192 x 29	70	180	10.73	\$3717	\$364
BRTS4P3084L	30 x 336 x 29	65	345	14.87	\$4918	\$595
BRTS4P3078L	30 x 312 x 29	65	323	14.3	\$4686	\$545
BRTS4P3072L	30 x 288 x 29	70	301	13.73	\$4546	\$532
BRTS4P3066L	30 x 264 x 29	70	279	13.16	\$4412	\$510
BRTS4P3060L	30 x 240 x 29	70	257	12.59	\$4321	\$483
BRTS4P3054L	30 x 216 x 29	70	235	12.02	\$4186	\$405
BRTS4P3048L	30 x 192 x 29	70	213	11.45	\$4003	\$405

Single Line 2 Person workstation consists of two worksurfaces, three leg assemblies, and two supporting structural beams. One leg can be shared by 2 adjoining worksurfaces.

- Anodized Aluminum Leg - Add **\$207.** list upcharge

Single Line 3 Person workstation consists of three worksurfaces, four leg assemblies, and three supporting structural beams. One leg can be shared by 2 adjoining worksurfaces.

- Anodized Aluminum Leg - Add **\$277.** list upcharge

Single Line 4 Person workstation consists of four worksurfaces, five leg assemblies, and four supporting structural beams. One leg can be shared by 2 adjoining worksurfaces.

- Anodized Aluminum Leg - Add **\$347.** list upcharge

Required Specifications

Top finish
Edge finish
Metal finish (legs)

Optional Specifications

Anodized Aluminum Leg
HP laminate

RECTANGULAR LEG PACKAGES

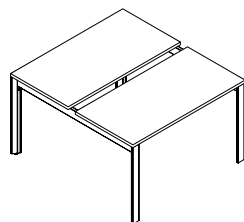

Back-to-Back 2 Person Pod with Levelers

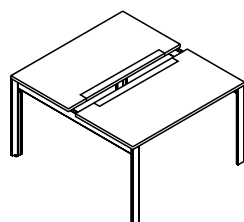

Back-to-Back 2 Person Pod with Access Door and Levelers

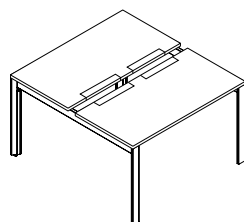

Back-to-Back 2 Person Pod with Access Doors and Levelers

MODEL#	DIMENSIONS D x W x H	FREIGHT CLASS	WT/LBS.	CUBIC FT.	LIST PRICE	HP ADD
BRTBAR2P2484L	50.5 x 84 x 29	70	146	9.4	\$2382	\$278
BRTBAR2P2478L	50.5 x 78 x 29	85	137	9.2	\$2296	\$264
BRTBAR2P2472L	50.5 x 72 x 29	85	128	9.02	\$2220	\$257
BRTBAR2P2466L	50.5 x 66 x 29	85	119	8.76	\$2169	\$242
BRTBAR2P2460L	50.5 x 60 x 29	85	110	8.56	\$2122	\$236
BRTBAR2P3084L	62.5 x 84 x 29	70	174	10.4	\$2453	\$299
BRTBAR2P3078L	62.5 x 78 x 29	70	163	9.8	\$2344	\$264
BRTBAR2P3072L	62.5 x 72 x 29	70	152	9.54	\$2269	\$264
BRTBAR2P3066L	62.5 x 66 x 29	70	141	9.25	\$2200	\$257
BRTBAR2P3060L	62.5 x 60 x 29	85	130	9	\$2152	\$242

Back-to-back 2 Person workstation consists of two worksurfaces, two back-to-back leg assemblies, and two supporting structural beams.

- Anodized Aluminum Leg - Add **\$140**. list upcharge

BRTBAR2PA2484L	50.5 x 84 x 29	70	146	9.4	\$2504	\$497
BRTBAR2PA2478L	50.5 x 78 x 29	85	137	9.2	\$2434	\$444
BRTBAR2PA2472L	50.5 x 72 x 29	85	128	9.02	\$2382	\$426
BRTBAR2PA2466L	50.5 x 66 x 29	85	119	8.76	\$2294	\$373
BRTBAR2PA2460L	50.5 x 60 x 29	85	110	8.56	\$2206	\$338
BRTBAR2PA3084L	62.5 x 84 x 29	70	174	10.4	\$2734	\$603
BRTBAR2PA3078L	62.5 x 78 x 29	70	163	9.8	\$2646	\$568
BRTBAR2PA3072L	62.5 x 72 x 29	70	152	9.54	\$2593	\$516
BRTBAR2PA3066L	62.5 x 66 x 29	70	141	9.25	\$2504	\$461
BRTBAR2PA3060L	62.5 x 60 x 29	85	130	9	\$2382	\$426

Back-to-back 2 Person workstation consists of two worksurfaces, two back-to-back leg assemblies, and two supporting structural beams. Anodized aluminum worksurface door provides access to power/data trough below worksurface. Worksurface with access doors CANNOT be combined with above worksurface power trough.

- Anodized Aluminum Leg - Add **\$140**. list upcharge

BRTBAR2PDA2484L	50.5 x 84 x 29	70	146	9.4	\$2702	\$532
BRTBAR2PDA2478L	50.5 x 78 x 29	85	137	9.2	\$2627	\$477
BRTBAR2PDA2472L	50.5 x 72 x 29	85	128	9.02	\$2570	\$458
BRTBAR2PDA2466L	50.5 x 66 x 29	85	119	8.76	\$2476	\$401
BRTBAR2PDA2460L	50.5 x 60 x 29	85	110	8.56	\$2381	\$362
BRTBAR2PDA3084L	62.5 x 84 x 29	70	174	10.4	\$2949	\$647
BRTBAR2PDA3078L	62.5 x 78 x 29	70	163	9.8	\$2854	\$609
BRTBAR2PDA3072L	62.5 x 72 x 29	70	152	9.54	\$2799	\$551
BRTBAR2PDA3066L	62.5 x 66 x 29	70	141	9.25	\$2702	\$492
BRTBAR2PDA3060L	62.5 x 60 x 29	85	130	9	\$2570	\$458

Back-to-back 2 Person workstation consists of two worksurfaces, two back-to-back leg assemblies, and two supporting structural beams. These tables feature dual access doors providing a central connection point for monitor lifts. Anodized aluminum worksurface door provides access to power/data trough below worksurface. Worksurface with access doors CANNOT be combined with above worksurface power trough.

- Anodized Aluminum Leg - Add **\$140**. list upcharge

Required Specifications

Top finish
Edge finish
Metal finish (legs)

Optional Specifications

Anodized Aluminum Leg
HP laminate

RECTANGULAR LEG PACKAGES

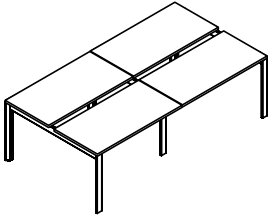

Back-to-Back 4 Person Pod with Levelers

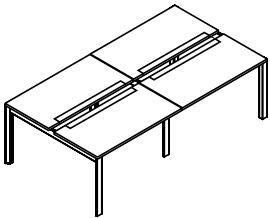

Back-to-Back 4 Person Pod with Access Door and Levelers

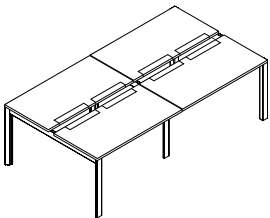

Back-to-Back 4 Person Pod with Access Door and Levelers

MODEL#	DIMENSIONS D x W x H	FREIGHT CLASS	WT/LBS.	CUBIC FT.	LIST PRICE	HP ADD
BRTBAR4P2484L	50.5 x 168 x 29	70	272	15.66	\$4266	\$554
BRTBAR4P2478L	50.5 x 156 x 29	70	256	15.2	\$4097	\$525
BRTBAR4P2472L	50.5 x 144 x 29	70	240	14.74	\$3944	\$510
BRTBAR4P2466L	50.5 x 132 x 29	70	224	14.28	\$3844	\$483
BRTBAR4P2460L	50.5 x 120 x 29	70	208	13.82	\$3745	\$469
BRTBAR4P3084L	62.5 x 168 x 29	70	333	16.86	\$4443	\$595
BRTBAR4P3078L	62.5 x 156 x 29	70	313	16.32	\$4210	\$545
BRTBAR4P3072L	62.5 x 144 x 29	70	293	15.78	\$4069	\$532
BRTBAR4P3066L	62.5 x 132 x 29	70	273	15.24	\$3936	\$510
BRTBAR4P3060L	62.5 x 120 x 29	70	253	14.7	\$3844	\$483

Back-to-back 4 Person workstation consists of four worksurfaces, two back-to-back outer leg assemblies, 1 back-to-back narrow leg assembly, and four supporting structural beams.

- Anodized Aluminum Leg - Add **\$207.** list upcharge

BRTBAR4PA2484L	50.5 x 168 x 29	70	272	15.66	\$4513	\$991
BRTBAR4PA2478L	50.5 x 156 x 29	70	256	15.2	\$4372	\$883
BRTBAR4PA2472L	50.5 x 144 x 29	70	240	14.74	\$4266	\$848
BRTBAR4PA2466L	50.5 x 132 x 29	70	224	14.28	\$4090	\$744
BRTBAR4PA2460L	50.5 x 120 x 29	70	208	13.82	\$3913	\$674
BRTBAR4PA3084L	62.5 x 168 x 29	70	333	16.86	\$4936	\$1200
BRTBAR4PA3078L	62.5 x 156 x 29	70	313	16.32	\$4760	\$1130
BRTBAR4PA3072L	62.5 x 144 x 29	70	293	15.78	\$4656	\$1026
BRTBAR4PA3066L	62.5 x 132 x 29	70	273	15.24	\$4478	\$920
BRTBAR4PA3060L	62.5 x 120 x 29	70	253	14.7	\$4232	\$848

Back-to-back 4 Person workstation consists of four worksurfaces, two back-to-back outer leg assemblies, 1 back-to-back narrow leg assembly, and four supporting structural beams. Anodized aluminum worksurface door provides access to power/data trough below worksurface. Worksurface with access doors CANNOT be combined with above worksurface power trough.

- Anodized Aluminum Leg - Add **\$207.** list upcharge

BRTBAR4PDA2484L	50.5 x 168 x 29	70	272	15.66	\$4870	\$1064
BRTBAR4PDA2478L	50.5 x 156 x 29	70	256	15.2	\$4717	\$949
BRTBAR4PDA2472L	50.5 x 144 x 29	70	240	14.74	\$4602	\$913
BRTBAR4PDA2466L	50.5 x 132 x 29	70	224	14.28	\$4415	\$795
BRTBAR4PDA2460L	50.5 x 120 x 29	70	208	13.82	\$4221	\$721
BRTBAR4PDA3084L	62.5 x 168 x 29	70	333	16.86	\$5327	\$1289
BRTBAR4PDA3078L	62.5 x 156 x 29	70	313	16.32	\$5135	\$1215
BRTBAR4PDA3072L	62.5 x 144 x 29	70	293	15.78	\$5022	\$1100
BRTBAR4PDA3066L	62.5 x 132 x 29	70	273	15.24	\$4831	\$988
BRTBAR4PDA3060L	62.5 x 120 x 29	70	253	14.7	\$4567	\$910

Back-to-back 4 Person workstation consists of four worksurfaces, two back-to-back outer leg assemblies, 1 back-to-back narrow leg assembly, and four supporting structural beams. These tables feature dual access doors providing a central connection point for monitor lifts. Anodized aluminum worksurface door provides access to power/data trough below worksurface. Worksurface with access doors CANNOT be combined with above worksurface power trough.

- Anodized Aluminum Leg - Add **\$207.** list upcharge

Required Specifications

Top finish
Edge finish
Metal finish (legs)

Optional Specifications

Anodized Aluminum Leg
HP laminate

RECTANGULAR LEG PACKAGES

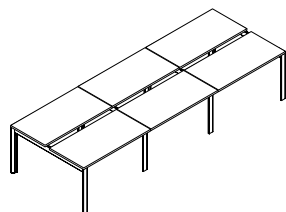

Back-to-Back 6 Person Pod with Levelers

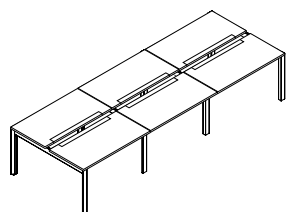

Back-to-Back 6 Person Pod with Access Door and Levelers

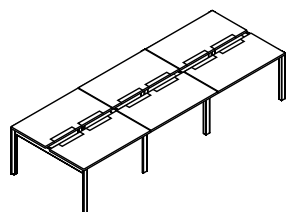

Back-to-Back 6 Person Pod with Access Door and Levelers

MODEL#	DIMENSIONS	FREIGHT CLASS	WT/LBS.	CUBIC FT.	LIST PRICE	HP ADD
D x W x H						
BRTBAR6P2484L	50.5 x 252 x 29	70	434	22.88	\$6152	\$827
BRTBAR6P2478L	50.5 x 234 x 29	70	409	22.1	\$5897	\$786
BRTBAR6P2472L	50.5 x 216 x 29	70	359	21.32	\$5666	\$766
BRTBAR6P2466L	50.5 x 198 x 29	70	329	20.54	\$5518	\$722
BRTBAR6P2460L	50.5 x 180 x 29	70	308	19.76	\$5335	\$700
BRTBAR6P3084L	62.5 x 252 x 29	70	493	24.53	\$6400	\$892
BRTBAR6P3078L	62.5 x 234 x 29	70	462	23.75	\$6050	\$817
BRTBAR6P3072L	62.5 x 216 x 29	70	431	22.86	\$5840	\$797
BRTBAR6P3066L	62.5 x 198 x 29	70	400	21.97	\$5637	\$766
BRTBAR6P3060L	62.5 x 180 x 29	70	369	21.08	\$5465	\$722

Back-to-back 6 Person workstation consists of six worksurfaces, two back-to-back outer leg assemblies, two back-to-back narrow leg assemblies, and six supporting structural beams.

- Anodized Aluminum Leg - Add **\$277**. list upcharge

BRTBAR6PA2484L	50.5 x 252 x 29	70	434	22.88	\$6523	\$1484
BRTBAR6PA2478L	50.5 x 234 x 29	70	409	22.1	\$6312	\$1325
BRTBAR6PA2472L	50.5 x 216 x 29	70	359	21.32	\$6152	\$1271
BRTBAR6PA2466L	50.5 x 198 x 29	70	329	20.54	\$5888	\$1113
BRTBAR6PA2460L	50.5 x 180 x 29	70	308	19.76	\$5589	\$1006
BRTBAR6PA3084L	62.5 x 252 x 29	70	493	24.53	\$7140	\$1800
BRTBAR6PA3078L	62.5 x 234 x 29	70	462	23.75	\$6875	\$1695
BRTBAR6PA3072L	62.5 x 216 x 29	70	431	22.86	\$6716	\$1536
BRTBAR6PA3066L	62.5 x 198 x 29	70	400	21.97	\$6452	\$1378
BRTBAR6PA3060L	62.5 x 180 x 29	70	369	21.08	\$6047	\$1271

Back-to-back 6 Person workstation consists of six worksurfaces, two back-to-back outer leg assemblies, two back-to-back narrow leg assemblies, and six supporting structural beams. Anodized aluminum worksurface door provides access to power/data trough below worksurface. Worksurface with access doors CANNOT be combined with above worksurface power trough.

- Anodized Aluminum Leg - Add **\$277**. list upcharge

BRTBAR6PDA2484L	50.5 x 252 x 29	70	434	22.88	\$7038	\$1590
BRTBAR6PDA2478L	50.5 x 234 x 29	70	409	22.1	\$6810	\$1423
BRTBAR6PDA2472L	50.5 x 216 x 29	70	359	21.32	\$6639	\$1368
BRTBAR6PDA2466L	50.5 x 198 x 29	70	329	20.54	\$6352	\$1141
BRTBAR6PDA2460L	50.5 x 180 x 29	70	308	19.76	\$6029	\$1082
BRTBAR6PDA3084L	62.5 x 252 x 29	70	493	24.53	\$7704	\$1934
BRTBAR6PDA3078L	62.5 x 234 x 29	70	462	23.75	\$7416	\$1819
BRTBAR6PDA3072L	62.5 x 216 x 29	70	431	22.86	\$7246	\$1648
BRTBAR6PDA3066L	62.5 x 198 x 29	70	400	21.97	\$6960	\$1477
BRTBAR6PDA3060L	62.5 x 180 x 29	70	369	21.08	\$6525	\$1365

Back-to-back 6 Person workstation consists of six worksurfaces, two back-to-back outer leg assemblies, two back-to-back narrow leg assemblies, and six supporting structural beams. These tables feature dual access doors providing a central connection point for monitor lifts. Anodized aluminum worksurface door provides access to power/data trough below worksurface. Worksurface with access doors CANNOT be combined with above worksurface power trough.

- Anodized Aluminum Leg - Add **\$277**. list upcharge

Required Specifications

Top finish
Edge finish
Metal finish (legs)

Optional Specifications

Anodized Aluminum Leg
HP laminate

RECTANGULAR LEG PACKAGES

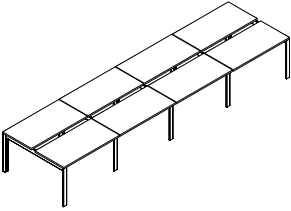

Back-to-Back 8 Person Pod with Levelers

MODEL#	DIMENSIONS D x W x H	FREIGHT CLASS	WT./LBS.	CUBIC FT.	LIST PRICE	HP ADD
BRTBAR8P2484L	50.5 x 336 x 29	70	556	28.30	\$8038	\$1104
BRTBAR8P2478L	50.5 x 312 x 29	70	520	27.30	\$7700	\$1046
BRTBAR8P2472L	50.5 x 288 x 29	70	484	26.30	\$7389	\$1018
BRTBAR8P2466L	50.5 x 264 x 29	70	448	25.30	\$7192	\$961
BRTBAR8P2460L	50.5 x 240 x 29	70	412	24.42	\$7029	\$933
BRTBAR8P3084L	62.5 x 336 x 29	70	669	30.58	\$8354	\$1189
BRTBAR8P3078L	62.5 x 312 x 29	70	625	29.48	\$7889	\$1088
BRTBAR8P3072L	62.5 x 288 x 29	70	581	28.38	\$7609	\$1060
BRTBAR8P3066L	62.5 x 264 x 29	70	536	27.28	\$7340	\$1018
BRTBAR8P3060L	62.5 x 240 x 29	70	492	26.18	\$7155	\$961

Back-to-back 8 Person workstation consists of eight worksurfaces, two back-to-back outer leg assemblies, three back-to-back narrow leg assemblies, and eight supporting structural beams.

- Anodized Aluminum Leg - Add **\$347.** list upcharge

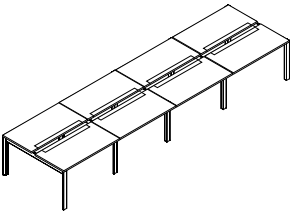

Back-to-Back 8 Person Pod with Access Door and Levelers

BRTBAR8PA2484L	50.5 x 336 x 29	70	556	28.30	\$8530	\$1976
BRTBAR8PA2478L	50.5 x 312 x 29	70	520	27.30	\$8248	\$1764
BRTBAR8PA2472L	50.5 x 288 x 29	70	484	26.30	\$8038	\$1695
BRTBAR8PA2466L	50.5 x 264 x 29	70	448	25.30	\$7684	\$1484
BRTBAR8PA2460L	50.5 x 240 x 29	70	412	24.42	\$7369	\$1341
BRTBAR8PA3084L	62.5 x 336 x 29	70	669	30.58	\$9342	\$2399
BRTBAR8PA3078L	62.5 x 312 x 29	70	625	29.48	\$8987	\$2258
BRTBAR8PA3072L	62.5 x 288 x 29	70	581	28.38	\$8777	\$2047
BRTBAR8PA3066L	62.5 x 264 x 29	70	536	27.28	\$8425	\$1836
BRTBAR8PA3060L	62.5 x 240 x 29	70	492	26.18	\$7931	\$1695

Back-to-back 8 Person workstation consists of eight worksurfaces, two back-to-back outer leg assemblies, three back-to-back narrow leg assemblies, and eight supporting structural beams. Anodized aluminum worksurface door provides access to power/data trough below worksurface. Worksurface with access doors CANNOT be combined with above worksurface power trough.

- Anodized Aluminum Leg - Add **\$347.** list upcharge

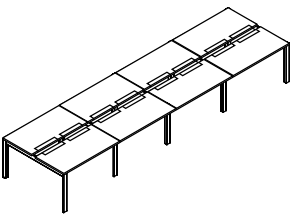

Back-to-Back 8 Person Pod with Access Door and Levelers

BRTBAR8PDA2484L	50.5 x 336 x 29	70	556	28.30	\$9204	\$2123
BRTBAR8PDA2478L	50.5 x 312 x 29	70	520	27.30	\$8897	\$1896
BRTBAR8PDA2472L	50.5 x 288 x 29	70	484	26.30	\$8671	\$1822
BRTBAR8PDA2466L	50.5 x 264 x 29	70	448	25.30	\$8291	\$1594
BRTBAR8PDA2460L	50.5 x 240 x 29	70	412	24.42	\$7949	\$1442
BRTBAR8PDA3084L	62.5 x 336 x 29	70	669	30.58	\$10079	\$2396
BRTBAR8PDA3078L	62.5 x 312 x 29	70	625	29.48	\$9696	\$2428
BRTBAR8PDA3072L	62.5 x 288 x 29	70	581	28.38	\$9468	\$2201
BRTBAR8PDA3066L	62.5 x 264 x 29	70	536	27.28	\$9091	\$1969
BRTBAR8PDA3060L	62.5 x 240 x 29	70	492	26.18	\$8557	\$1822

Back-to-back 8 Person workstation consists of eight worksurfaces, two back-to-back outer leg assemblies, three back-to-back narrow leg assemblies, and eight supporting structural beams. These tables feature dual access doors providing a central connection point for monitor lifts. Anodized aluminum worksurface door provides access to power/data trough below worksurface. Worksurface with access doors CANNOT be combined with above worksurface power trough.

- Anodized Aluminum Leg - Add **\$347.** list upcharge

Required Specifications

Top finish
Edge finish
Metal finish (legs)

Optional Specifications

Anodized Aluminum Leg
HP laminate

RECTANGULAR LEG PACKAGES

MODEL# DIMENSIONS FREIGHT CLASS WT./LBS. CUBIC FT. LIST PRICE HP ADD

D x W x H

BRT36P2484C	24 x 84 x 36	70	120.68	6.42	\$3023	\$167
BRT36P2478C	24 x 78 x 36	70	114.16	6.13	\$2948	\$155
BRT36P2472C	24 x 72 x 36	70	107.64	5.83	\$2872	\$149
BRT36P2466C	24 x 66 x 36	70	101.12	5.62	\$2816	\$145
BRT36P2460C	24 x 60 x 36	70	94.60	5.41	\$2755	\$138
BRT36P2454C	24 x 54 x 36	70	88.08	5.19	\$2669	\$120
BRT36P2448C	24 x 48 x 36	70	81.56	4.98	\$2534	\$109
BRT36P2442C	24 x 42 x 36	70	76.04	4.76	\$2445	\$92
BRT36P2436C	24 x 36 x 36	70	68.52	4.55	\$2370	\$74

BRT36P3084C	30 x 84 x 36	70	148.11	7.32	\$3455	\$179
BRT36P3078C	30 x 78 x 36	70	139.96	6.95	\$3358	\$161
BRT36P3072C	30 x 72 x 36	70	131.81	6.59	\$3274	\$155
BRT36P3066C	30 x 66 x 36	70	123.66	6.32	\$3194	\$155
BRT36P3060C	30 x 60 x 36	70	115.51	6.06	\$3129	\$145
BRT36P3054C	30 x 54 x 36	70	107.36	5.79	\$3046	\$120
BRT36P3048C	30 x 48 x 36	70	99.21	5.53	\$2914	\$120
BRT36P3042C	30 x 42 x 36	70	91.06	5.26	\$2849	\$114
BRT36P3036C	30 x 36 x 36	70	83.91	5	\$2728	\$84

BRT36P3684C	36 x 84 x 36	70	161.97	8.91	\$3869	\$202
BRT36P3678C	36 x 78 x 36	70	152.82	8.50	\$3771	\$191
BRT36P3672C	36 x 72 x 36	70	144.67	8.10	\$3662	\$179
BRT36P3666C	36 x 66 x 36	70	135.52	7.79	\$3562	\$167
BRT36P3660C	36 x 60 x 36	70	126.37	7.48	\$3452	\$149
BRT36P3654C	36 x 54 x 36	70	118.22	7.18	\$3342	\$138
BRT36P3648C	36 x 48 x 36	70	109.07	6.87	\$3192	\$120
BRT36P3642C	36 x 42 x 36	70	99.92	6.56	\$3090	\$109

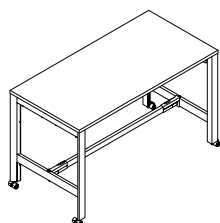

36"H Single Table with Casters

Single table assembly consists of one worksurface, two H leg assemblies, horizontal structural beams, and one bottom table beam. 40mm dia. locking casters with 8mm thread, white body and grey tires.

- 24"D tables include 3 horizontal structural beams. 30"/36"D tables include 4 horizontal structural beams.
- Anodized Aluminum Leg - Add **\$140.** list upcharge

BRT36P2484L	24 x 84 x 36	70	120.20	6.42	\$2923	\$167
BRT36P2478L	24 x 78 x 36	70	113.68	6.13	\$2851	\$155
BRT36P2472L	24 x 72 x 36	70	107.16	5.83	\$2772	\$149
BRT36P2466L	24 x 66 x 36	70	100.64	5.62	\$2719	\$145
BRT36P2460L	24 x 60 x 36	70	94.12	5.41	\$2655	\$138
BRT36P2454L	24 x 54 x 36	70	87.60	5.19	\$2569	\$120
BRT36P2448L	24 x 48 x 36	70	81.08	4.98	\$2434	\$109
BRT36P2442L	24 x 42 x 36	70	75.56	4.76	\$2346	\$92
BRT36P2436L	24 x 36 x 36	85	68.04	4.55	\$2270	\$74

BRT36P3084L	30 x 84 x 36	70	147.63	7.32	\$3355	\$179
BRT36P3078L	30 x 78 x 36	70	139.48	6.96	\$3260	\$161
BRT36P3072L	30 x 72 x 36	70	131.33	6.59	\$3175	\$155
BRT36P3066L	30 x 66 x 36	70	123.18	6.32	\$3097	\$155
BRT36P3060L	30 x 60 x 36	70	115.03	6.06	\$3029	\$145
BRT36P3054L	30 x 54 x 36	70	106.88	5.79	\$2945	\$120
BRT36P3048L	30 x 48 x 36	70	98.73	5.53	\$2816	\$120
BRT36P3042L	30 x 42 x 36	70	90.58	5.26	\$2749	\$114
BRT36P3036L	30 x 36 x 36	70	83.43	5	\$2630	\$84

BRT36P3684L	36 x 84 x 36	70	161.49	8.91	\$3772	\$202
BRT36P3678L	36 x 78 x 36	70	152.34	8.50	\$3671	\$191
BRT36P3672L	36 x 72 x 36	70	144.19	8.10	\$3565	\$179
BRT36P3666L	36 x 66 x 36	70	135.04	7.79	\$3461	\$167
BRT36P3660L	36 x 60 x 36	70	125.89	7.48	\$3354	\$149
BRT36P3654L	36 x 54 x 36	70	117.74	7.18	\$3241	\$138
BRT36P3648L	36 x 48 x 36	70	108.59	6.87	\$3096	\$120
BRT36P3642L	36 x 42 x 36	70	99.44	6.56	\$2991	\$109

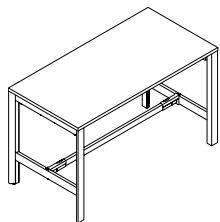

36"H Single Table with Levelers

Single table assembly consists of one worksurface, two H leg assemblies, horizontal structural beams, and one bottom table beam.

- 24"D tables include 3 horizontal structural beams. 30"/36"D tables include 4 horizontal structural beams.
- Anodized Aluminum Leg - Add **\$140.** list upcharge

Required Specifications

Top finish
Edge finish
Metal finish (legs)

Optional Specifications

Anodized Aluminum Leg
HP laminate

RECTANGULAR LEG PACKAGES

MODEL# DIMENSIONS FREIGHT CLASS WT./LBS. CUBIC FT. LIST PRICE HP ADD

D x W x H

BRT36A2484L	24 x 84 x 36	70	106.36	4.74	\$2363	\$167
BRT36A2478L	24 x 78 x 36	70	99.84	4.45	\$2293	\$155
BRT36A2472L	24 x 72 x 36	70	93.32	4.15	\$2215	\$149
BRT36A2466L	24 x 66 x 36	70	86.80	3.94	\$2161	\$145
BRT36A2460L	24 x 60 x 36	70	80.28	3.73	\$2097	\$138
BRT36A2454L	24 x 54 x 36	70	73.76	3.51	\$2010	\$120
BRT36A2448L	24 x 48 x 36	70	67.24	3.30	\$1877	\$109
BRT36A2442L	24 x 42 x 36	70	61.72	3.08	\$1789	\$92
BRT36A2436L	24 x 36 x 36	70	54.20	2.87	\$1712	\$74
BRT36A3084L	30 x 84 x 36	65	131.77	5.56	\$2763	\$179
BRT36A3078L	30 x 78 x 36	65	123.62	5.19	\$2666	\$161
BRT36A3072L	30 x 72 x 36	65	115.47	4.83	\$2582	\$155
BRT36A3066L	30 x 66 x 36	65	107.32	4.56	\$2503	\$155
BRT36A3060L	30 x 60 x 36	65	99.17	4.30	\$2434	\$145
BRT36A3054L	30 x 54 x 36	65	91.02	4.03	\$2352	\$120
BRT36A3048L	30 x 48 x 36	70	82.87	3.77	\$2222	\$120
BRT36A3042L	30 x 42 x 36	70	74.72	3.50	\$2154	\$114
BRT36A3036L	30 x 36 x 36	70	67.57	3.24	\$2036	\$84
BRT36A3684L	36 x 84 x 36	70	143.70	6.65	\$3095	\$202
BRT36A3678L	36 x 78 x 36	70	134.55	6.24	\$2993	\$191
BRT36A3672L	36 x 72 x 36	70	126.40	5.84	\$2886	\$179
BRT36A3666L	36 x 66 x 36	70	117.25	5.53	\$2784	\$167
BRT36A3660L	36 x 60 x 36	70	108.10	5.22	\$2676	\$149
BRT36A3654L	36 x 54 x 36	70	99.95	4.92	\$2564	\$138
BRT36A3648L	36 x 48 x 36	70	90.80	4.61	\$2416	\$120
BRT36A3642L	36 x 42 x 36	70	81.65	4.30	\$2313	\$109

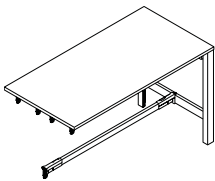

36" H Add-On with Levelers

Single table assembly consists of one worksurface, one H leg assembly, horizontal structural beams, and one bottom table beam.

- 24"D tables include 3 horizontal structural beams. 30"/36" D tables include 4 horizontal structural beams.
- Anodized Aluminum Leg - Add \$70. list upcharge

BRT42P2484C	24 x 84 x 42	70	122.58	6.98	\$3076	\$167
BRT42P2478C	24 x 78 x 42	70	116.06	6.69	\$3005	\$155
BRT42P2472C	24 x 72 x 42	70	109.54	6.39	\$2927	\$149
BRT42P2466C	24 x 66 x 42	70	103.02	6.18	\$2872	\$145
BRT42P2460C	24 x 60 x 42	70	96.50	5.97	\$2809	\$138
BRT42P2454C	24 x 54 x 42	70	89.98	5.75	\$2723	\$120
BRT42P2448C	24 x 48 x 42	70	83.46	5.54	\$2589	\$109
BRT42P2442C	24 x 42 x 42	85	77.94	5.32	\$2501	\$92
BRT42P2436C	24 x 36 x 42	85	70.42	5.11	\$2425	\$74
BRT42P3084C	30 x 84 x 42	70	150.01	7.92	\$3510	\$179
BRT42P3078C	30 x 78 x 42	70	141.86	7.55	\$3413	\$161
BRT42P3072C	30 x 72 x 42	70	133.71	7.19	\$3329	\$155
BRT42P3066C	30 x 66 x 42	70	125.56	6.92	\$3250	\$155
BRT42P3060C	30 x 60 x 42	70	117.41	6.66	\$3184	\$145
BRT42P3054C	30 x 54 x 42	70	109.26	6.39	\$3099	\$120
BRT42P3048C	30 x 48 x 42	70	101.11	6.13	\$2971	\$120
BRT42P3042C	30 x 42 x 42	70	92.96	5.86	\$2903	\$114
BRT42P3036C	30 x 36 x 42	70	85.81	5.60	\$2784	\$84
BRT42P3684C	36 x 84 x 42	70	163.87	9.69	\$3925	\$202
BRT42P3678C	36 x 78 x 42	70	154.72	9.28	\$3825	\$191
BRT42P3672C	36 x 72 x 42	70	146.57	8.88	\$3718	\$179
BRT42P3666C	36 x 66 x 42	70	137.42	8.57	\$3615	\$167
BRT42P3660C	36 x 60 x 42	70	128.27	8.26	\$3508	\$149
BRT42P3654C	36 x 54 x 42	70	120.12	7.96	\$3397	\$138
BRT42P3648C	36 x 48 x 42	85	110.97	7.65	\$3248	\$120
BRT42P3642C	36 x 42 x 42	85	101.82	7.34	\$3144	\$109

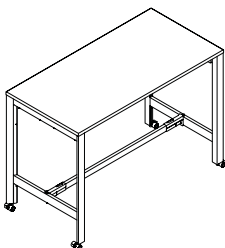

42" H Pod with Casters

Single table assembly consists of one worksurface, two H leg assemblies, horizontal structural beams and one bottom table beam. 40mm dia. locking casters with 8mm thread, white body and grey tires.

- 24"D tables include 3 horizontal structural beams. 30"/36" D tables include 4 horizontal structural beams.
- Anodized Aluminum Leg - Add \$140. list upcharge

Required Specifications

Top finish
Edge finish
Metal finish (legs)

Optional Specifications

Anodized Aluminum Leg
HP laminate

RECTANGULAR LEG PACKAGES

MODEL# DIMENSIONS FREIGHT CLASS WT./LBS. CUBIC FT. LIST PRICE HP ADD

D x W x H

BRT42P2484L	24 x 84 x 42	70	122.10	6.98	\$2979	\$167
BRT42P2478L	24 x 78 x 42	70	115.58	6.69	\$2906	\$155
BRT42P2472L	24 x 72 x 42	70	109.06	6.39	\$2829	\$149
BRT42P2466L	24 x 66 x 42	70	102.54	6.18	\$2772	\$145
BRT42P2460L	24 x 60 x 42	70	96.02	5.97	\$2712	\$138
BRT42P2454L	24 x 54 x 42	70	89.50	5.75	\$2624	\$120
BRT42P2448L	24 x 48 x 42	85	82.98	5.54	\$2490	\$109
BRT42P2442L	24 x 42 x 42	85	77.46	5.32	\$2401	\$92
BRT42P2436L	24 x 36 x 42	85	69.94	5.11	\$2326	\$74

BRT42P3084L	30 x 84 x 42	70	149.53	7.92	\$3414	\$179
BRT42P3078L	30 x 78 x 42	70	141.38	7.55	\$3317	\$161
BRT42P3072L	30 x 72 x 42	70	133.23	7.19	\$3233	\$155
BRT42P3066L	30 x 66 x 42	70	125.08	6.92	\$3154	\$155
BRT42P3060L	30 x 60 x 42	70	116.93	6.66	\$3087	\$145
BRT42P3054L	30 x 54 x 42	70	108.78	6.39	\$3003	\$120
BRT42P3048L	30 x 48 x 42	70	100.63	6.13	\$2875	\$120
BRT42P3042L	30 x 42 x 42	70	92.48	5.86	\$2807	\$114
BRT42P3036L	30 x 36 x 42	70	85.33	5.60	\$2689	\$84

BRT42P3684L	36 x 84 x 42	70	163.39	9.69	\$3828	\$202
BRT42P3678L	36 x 78 x 42	70	154.24	9.28	\$3727	\$191
BRT42P3672L	36 x 72 x 42	70	146.09	8.88	\$3619	\$179
BRT42P3666L	36 x 66 x 42	70	136.94	8.57	\$3519	\$167
BRT42P3660L	36 x 60 x 42	70	127.79	8.26	\$3409	\$149
BRT42P3654L	36 x 54 x 42	70	119.64	7.96	\$3298	\$138
BRT42P3648L	36 x 48 x 42	85	110.49	7.65	\$3149	\$120
BRT42P3642L	36 x 42 x 42	85	101.34	7.34	\$3048	\$109

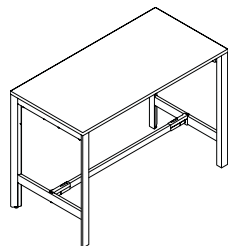

42" H Pod with Levelers

Single table assembly consists of one worksurface, two H leg assemblies, horizontal structural beams and one bottom table beam.

- 24"D tables include 3 horizontal structural beams. 30"/36"D tables include 4 horizontal structural beams.
- Anodized Aluminum Leg - Add **\$140.** list upcharge

BRT42A2484L	24 x 84 x 42	70	107.31	5.02	\$2391	\$167
BRT42A2478L	24 x 78 x 42	70	100.79	4.73	\$2319	\$155
BRT42A2472L	24 x 72 x 42	70	94.27	4.43	\$2245	\$149
BRT42A2466L	24 x 66 x 42	70	87.75	4.22	\$2187	\$145
BRT42A2460L	24 x 60 x 42	70	81.23	4.01	\$2126	\$138
BRT42A2454L	24 x 54 x 42	70	74.71	3.79	\$2039	\$120
BRT42A2448L	24 x 48 x 42	70	68.19	3.58	\$1906	\$109
BRT42A2442L	24 x 42 x 42	70	62.67	3.36	\$1736	\$92
BRT42A2436L	24 x 36 x 42	70	55.15	3.15	\$1665	\$74

BRT42A3084L	30 x 84 x 42	65	132.72	5.86	\$2791	\$179
BRT42A3078L	30 x 78 x 42	65	124.57	5.49	\$2694	\$161
BRT42A3072L	30 x 72 x 42	65	116.42	5.13	\$2609	\$155
BRT42A3066L	30 x 66 x 42	70	108.27	4.86	\$2531	\$155
BRT42A3060L	30 x 60 x 42	70	100.12	4.60	\$2465	\$145
BRT42A3054L	30 x 54 x 42	70	91.97	4.33	\$2381	\$120
BRT42A3048L	30 x 48 x 42	70	83.82	4.07	\$2251	\$120
BRT42A3042L	30 x 42 x 42	70	75.67	3.80	\$2184	\$114
BRT42A3036L	30 x 36 x 42	70	68.52	3.54	\$2064	\$84

BRT42A3684L	36 x 84 x 42	70	114.65	7.04	\$3120	\$202
BRT42A3678L	36 x 78 x 42	70	135.50	6.63	\$3023	\$191
BRT42A3672L	36 x 72 x 42	70	127.35	6.23	\$2913	\$179
BRT42A3666L	36 x 66 x 42	70	118.20	5.92	\$2813	\$167
BRT42A3660L	36 x 60 x 42	70	109.05	5.61	\$2702	\$149
BRT42A3654L	36 x 54 x 42	70	100.90	5.31	\$2592	\$138
BRT42A3648L	36 x 48 x 42	70	91.75	5	\$2444	\$120
BRT42A3642L	36 x 42 x 42	70	82.60	4.69	\$2340	\$109

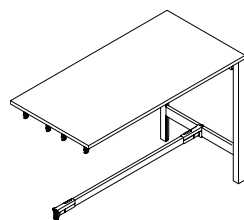

42" H Add-On with Levelers

Single table assembly consists of one worksurface, one H leg assembly, horizontal structural beams, and one bottom table beam.

- 24"D tables include 3 horizontal structural beams. 30"/36"D tables include 4 horizontal structural beams.
- Anodized Aluminum Leg - Add **\$70.** list upcharge

Required Specifications

Top finish
Edge finish
Metal finish (legs)

Optional Specifications

Anodized Aluminum Leg
HP laminate

ROUND LEG PACKAGES

MODEL#	DIMENSIONS D x W x H	FREIGHT CLASS	WT./LBS.	CUBIC FT.	LIST PRICE	HP ADD
BRTS1P2484LR	24 x 84 x 29	70	75	4.92	\$1483	\$140
BRTS1P2478LR	24 x 78 x 29	85	72	4.82	\$1440	\$134
BRTS1P2472LR	24 x 72 x 29	85	69	4.73	\$1402	\$131
BRTS1P2466LR	24 x 66 x 29	85	66	4.65	\$1376	\$123
BRTS1P2463LR	24 x 62.5 x 29	85	63	4.57	\$1365	\$120
BRTS1P2460LR	24 x 60 x 29	85	60	4.48	\$1351	\$119
BRTS1P2454LR	24 x 54 x 29	85	57	4.40	\$1324	\$85
BRTS1P2451LR	24 x 50.5 x 29	85	54	4.30	\$1271	\$80
BRTS1P2448LR	24 x 48 x 29	85	51	4.20	\$1240	\$94
BRTS1P2442LR	24 x 42 x 29	92.5	48	4.10	\$1188	\$59
BRTS1P2436LR	24 x 36 x 29	92.5	45	4	\$1148	\$41

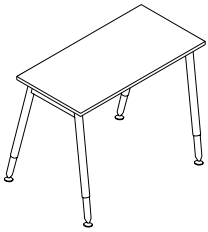

**Single Line 1 Person Pod with Levelers
Round Leg**

BRTS1P3084LR	30 x 84 x 29	70	75	4.92	\$1516	\$150
BRTS1P3078LR	30 x 78 x 29	85	72	4.82	\$1460	\$139
BRTS1P3072LR	30 x 72 x 29	85	69	4.73	\$1423	\$117
BRTS1P3066LR	30 x 66 x 29	85	66	4.65	\$1391	\$131
BRTS1P3063LR	30 x 62.5 x 29	85	63	4.57	\$1381	\$127
BRTS1P3060LR	30 x 60 x 29	85	60	4.48	\$1368	\$104
BRTS1P3054LR	30 x 54 x 29	85	57	4.40	\$1334	\$103
BRTS1P3051LR	30 x 50.5 x 29	85	54	4.30	\$1311	\$108
BRTS1P3048LR	30 x 48 x 29	85	51	4.20	\$1270	\$103
BRTS1P3042LR	30 x 42 x 29	92.5	48	4.10	\$1244	\$101
BRTS1P3036LR	30 x 36 x 29	92.5	45	4	\$1113	\$73

Single Line Table Assemblies consist of one worksurface, two leg assemblies, and one supporting structural beam.

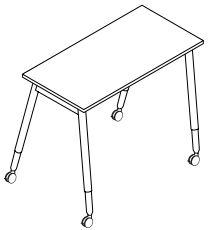

**Single Line 1 Person Pod with Casters
Round Leg**

BRTS1P2484CR	24 x 84 x 29	70	75	4.92	\$1566	\$140
BRTS1P2478CR	24 x 78 x 29	85	72	4.82	\$1525	\$134
BRTS1P2472CR	24 x 72 x 29	85	69	4.73	\$1486	\$131
BRTS1P2466CR	24 x 66 x 29	85	66	4.65	\$1462	\$123
BRTS1P2463CR	24 x 62.5 x 29	85	63	4.57	\$1451	\$120
BRTS1P2460CR	24 x 60 x 29	85	60	4.48	\$1437	\$119
BRTS1P2454CR	24 x 54 x 29	85	57	4.40	\$1407	\$85
BRTS1P2451CR	24 x 50.5 x 29	85	54	4.30	\$1357	\$80
BRTS1P2448CR	24 x 48 x 29	85	51	4.20	\$1324	\$94
BRTS1P2442CR	24 x 42 x 29	92.5	48	4.10	\$1270	\$59
BRTS1P2436CR	24 x 36 x 29	92.5	45	4	\$1233	\$41

BRTS1P3084CR	30 x 84 x 29	70	75	4.92	\$1601	\$150
BRTS1P3078CR	30 x 78 x 29	85	72	4.82	\$1543	\$139
BRTS1P3072CR	30 x 72 x 29	85	69	4.73	\$1511	\$115
BRTS1P3066CR	30 x 66 x 29	85	66	4.65	\$1474	\$131
BRTS1P3063CR	30 x 62.5 x 29	85	63	4.57	\$1464	\$127
BRTS1P3060CR	30 x 60 x 29	85	60	4.48	\$1451	\$104
BRTS1P3054CR	30 x 54 x 29	85	57	4.40	\$1419	\$103
BRTS1P3051CR	30 x 50.5 x 29	85	54	4.30	\$1394	\$108
BRTS1P3048CR	30 x 48 x 29	85	51	4.20	\$1356	\$103
BRTS1P3042CR	30 x 42 x 29	92.5	48	4.10	\$1328	\$101
BRTS1P3036CR	30 x 36 x 29	92.5	45	4	\$1198	\$73

Single Line Table Assemblies consist of one worksurface, two leg assemblies, and one supporting structural beam. 40mm locking casters with grey tires; steel horizontal beams, aluminum legs.

Required Specifications

Top finish
Edge finish
Metal finish (legs)

Optional Specifications

Anodized Aluminum Leg
HP laminate

ROUND LEG PACKAGES

MODEL#	DIMENSIONS	FREIGHT CLASS	WT./LBS.	CUBIC FT.	LIST PRICE	HP ADD
--------	------------	---------------	----------	-----------	------------	--------

D x W x H

BRTS2P2484LR	24 x 168 x 29	70	149	7.41	\$2601	\$264
BRTS2P2478LR	24 x 156 x 29	70	140	7.27	\$2501	\$264
BRTS2P2472LR	24 x 144 x 29	70	131	7.13	\$2424	\$257
BRTS2P2466LR	24 x 132 x 29	70	122	6.95	\$2382	\$236
BRTS2P2460LR	24 x 120 x 29	70	113	6.71	\$2326	\$236
BRTS2P2454LR	24 x 108 x 29	70	104	6.45	\$2233	\$205
BRTS2P2448LR	24 x 96 x 29	70	95	6.21	\$2099	\$184

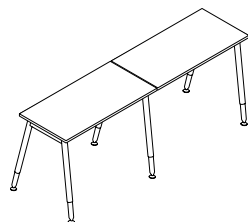

**Single Line 2 Person Pod with Levelers
Round Leg**

BRTS2P3084LR	30 x 168 x 29	70	173	8.25	\$2656	\$299
BRTS2P3078LR	30 x 156 x 29	70	164	7.97	\$2540	\$275
BRTS2P3072LR	30 x 144 x 29	70	155	7.69	\$2469	\$267
BRTS2P3066LR	30 x 132 x 29	70	140	7.41	\$2402	\$257
BRTS2P3060LR	30 x 120 x 29	70	131	7.13	\$2358	\$242
BRTS2P3054LR	30 x 108 x 29	70	122	6.85	\$2291	\$205
BRTS2P3048LR	30 x 96 x 29	70	113	6.57	\$2200	\$205

Single Line 2 Person workstation consists of two worksurfaces, three leg assemblies, and two supporting structural beams. One leg can be shared by 2 adjoining worksurfaces.

BRTS3P2484LR	24 x 252 x 29	70	219	9.74	\$3691	\$415
BRTS3P2478LR	24 x 234 x 29	70	206	9.53	\$3564	\$394
BRTS3P2472LR	24 x 216 x 29	70	192	9.32	\$3448	\$384
BRTS3P2466LR	24 x 198 x 29	70	179	9.11	\$3374	\$364
BRTS3P2460LR	24 x 180 x 29	70	165	8.89	\$3300	\$352
BRTS3P2454LR	24 x 162 x 29	70	152	8.68	\$3162	\$304
BRTS3P2448LR	24 x 144 x 29	70	138	8.47	\$2962	\$273

BRTS3P3084LR	30 x 263 x 29	65	263	11.59	\$3796	\$447
BRTS3P3078LR	30 x 234 x 29	70	246	11.16	\$3621	\$412
BRTS3P3072LR	30 x 216 x 29	70	229	10.72	\$3517	\$401
BRTS3P3066LR	30 x 198 x 29	70	212	10.30	\$3416	\$384
BRTS3P3060LR	30 x 180 x 29	70	195	9.87	\$3347	\$364
BRTS3P3054LR	30 x 162 x 29	70	178	9.44	\$3247	\$304
BRTS3P3048LR	30 x 144 x 29	70	161	9.01	\$3109	\$304

Single Line 3 Person workstation consists of three worksurfaces, four leg assemblies, and three supporting structural beams. One leg can be shared by 2 adjoining worksurfaces.

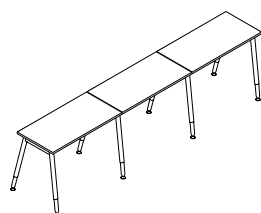

**Single Line 3 Person Pod with Levelers
Round Leg**

BRTS4P2484LR	24 x 336 x 29	70	291	13.67	\$4796	\$554
BRTS4P2478LR	24 x 312 x 29	70	273	13.18	\$4626	\$525
BRTS4P2472LR	24 x 288 x 29	70	254	12.69	\$4472	\$510
BRTS4P2466LR	24 x 264 x 29	70	236	12.20	\$4372	\$483
BRTS4P2460LR	24 x 240 x 29	70	217	11.71	\$4260	\$483
BRTS4P2454LR	24 x 216 x 29	70	199	11.22	\$4090	\$405
BRTS4P2448LR	24 x 192 x 29	70	180	10.73	\$3780	\$405

BRTS4P3084LR	30 x 336 x 29	65	345	14.87	\$4936	\$595
BRTS4P3078LR	30 x 312 x 29	65	323	14.30	\$4705	\$545
BRTS4P3072LR	30 x 288 x 29	70	301	13.73	\$4563	\$532
BRTS4P3066LR	30 x 264 x 29	70	279	13.16	\$4428	\$510
BRTS4P3060LR	30 x 240 x 29	70	257	12.59	\$4336	\$483
BRTS4P3054LR	30 x 216 x 29	70	235	12.02	\$4203	\$405
BRTS4P3048LR	30 x 192 x 29	70	213	11.45	\$4020	\$405

Single Line 4 Person workstation consists of four worksurfaces, five leg assemblies, and four supporting structural beams. One leg can be shared by 2 adjoining worksurfaces.

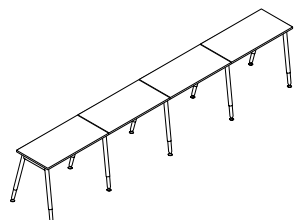

**Single Line 4 Person Pod with Levelers
Round Leg**

Required Specifications

Top finish
Edge finish
Metal finish (legs)

Optional Specifications

Anodized Aluminum Leg
HP laminate

ROUND LEG PACKAGES

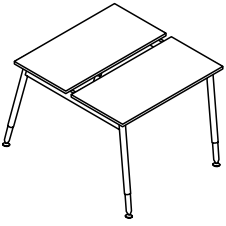

Back-to-Back 2 Person Pod with Levelers Round Leg

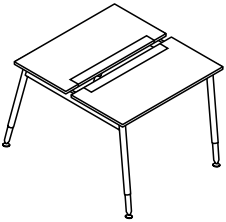

Back-to-Back 2 Person Pod with Access Door and Levelers, Round Leg

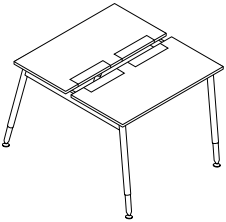

Back-to-Back 2 Person Pod with Access Door and Levelers, Round Leg

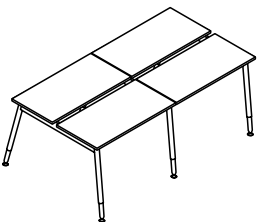

Back-to-Back 4 Person Pod with Levelers Round Leg

MODEL#	DIMENSIONS D x W x H	FREIGHT CLASS	WT./LBS.	CUBIC FT.	LIST PRICE	HP ADD
BRTBAR2P2484LR	50.5 x 84 x 29	70	146	9.40	\$2420	\$278
BRTBAR2P2478LR	50.5 x 78 x 29	85	137	9.20	\$2354	\$264
BRTBAR2P2472LR	50.5 x 72 x 29	85	128	9.02	\$2276	\$257
BRTBAR2P2466LR	50.5 x 66 x 29	85	119	8.76	\$2225	\$242
BRTBAR2P2460LR	50.5 x 60 x 29	85	110	8.56	\$2178	\$236
BRTBAR2P3084LR	62.5 x 84 x 29	70	174	10.40	\$2510	\$299
BRTBAR2P3078LR	62.5 x 78 x 29	70	163	9.80	\$2393	\$275
BRTBAR2P3072LR	62.5 x 72 x 29	70	152	9.54	\$2321	\$257
BRTBAR2P3066LR	62.5 x 66 x 29	70	141	9.25	\$2255	\$257
BRTBAR2P3060LR	62.5 x 60 x 29	85	130	9	\$2025	\$426

Back-to-back 2 Person workstation consists of two worksurfaces, two back-to-back leg assemblies, and two supporting structural beams.

BRTBAR2PA2484LR	50.5 x 84 x 29	70	146	9.40	\$2544	\$497
BRTBAR2PA2478LR	50.5 x 78 x 29	85	137	9.20	\$2490	\$444
BRTBAR2PA2472LR	50.5 x 72 x 29	85	128	9.02	\$2437	\$426
BRTBAR2PA2466LR	50.5 x 66 x 29	85	119	8.76	\$2349	\$373
BRTBAR2PA2460LR	50.5 x 60 x 29	85	110	8.56	\$2261	\$338
BRTBAR2PA3084LR	62.5 x 84 x 29	70	174	10.40	\$2756	\$603
BRTBAR2PA3078LR	62.5 x 78 x 29	70	163	9.80	\$2669	\$568
BRTBAR2PA3072LR	62.5 x 72 x 29	70	152	9.54	\$2612	\$516
BRTBAR2PA3066LR	62.5 x 66 x 29	70	141	9.25	\$2525	\$461
BRTBAR2PA3060LR	62.5 x 60 x 29	85	130	9	\$2402	\$426

Back-to-back 2 Person workstation consists of two worksurfaces, two back-to-back leg assemblies, and two supporting structural beams. Anodized aluminum worksurface door provides access to power/data trough below worksurface. Worksurface with access doors CANNOT be combined with above worksurface power trough.

BRTBAR2PDA2484LR	50.5 x 84 x 29	70	146	9.40	\$2744	\$534
BRTBAR2PDA2478LR	50.5 x 78 x 29	85	137	9.20	\$2689	\$476
BRTBAR2PDA2472LR	50.5 x 72 x 29	85	128	9.02	\$2629	\$458
BRTBAR2PDA2466LR	50.5 x 66 x 29	85	119	8.76	\$2536	\$400
BRTBAR2PDA2460LR	50.5 x 60 x 29	85	110	8.56	\$2442	\$365
BRTBAR2PDA3084LR	62.5 x 84 x 29	70	174	10.40	\$2972	\$647
BRTBAR2PDA3078LR	62.5 x 78 x 29	70	163	9.80	\$2878	\$609
BRTBAR2PDA3072LR	62.5 x 72 x 29	70	152	9.54	\$2818	\$555
BRTBAR2PDA3066LR	62.5 x 66 x 29	70	141	9.25	\$2725	\$496
BRTBAR2PDA3060LR	62.5 x 60 x 29	85	130	9	\$2591	\$459

Back-to-back 2 Person workstation consists of two worksurfaces, two back-to-back leg assemblies, and two supporting structural beams. These tables feature dual access doors providing a central connection point for monitor lifts. Anodized aluminum worksurface door provides access to power/data trough below worksurface. Worksurface with access doors CANNOT be combined with above worksurface power trough.

BRTBAR4P2484LR	50.5 x 168 x 29	70	272	15.66	\$4387	\$554
BRTBAR4P2478LR	50.5 x 156 x 29	70	256	15.20	\$4217	\$525
BRTBAR4P2472LR	50.5 x 144 x 29	70	240	14.74	\$4062	\$510
BRTBAR4P2466LR	50.5 x 132 x 29	70	224	14.28	\$3964	\$483
BRTBAR4P2460LR	50.5 x 120 x 29	70	208	13.82	\$3865	\$469
BRTBAR4P3084LR	62.5 x 168 x 29	70	333	16.86	\$4529	\$595
BRTBAR4P3078LR	62.5 x 156 x 29	70	313	16.32	\$4295	\$545
BRTBAR4P3072LR	62.5 x 144 x 29	70	293	15.78	\$4155	\$532
BRTBAR4P3066LR	62.5 x 132 x 29	70	273	15.24	\$3985	\$510
BRTBAR4P3060LR	62.5 x 120 x 29	70	253	14.70	\$3964	\$483

Back-to-back 4 Person workstation consists of four worksurfaces, three back-to-back outer leg assemblies, and four supporting structural beams.

Required Specifications

Top finish
Edge finish
Metal finish (legs)

Optional Specifications

Anodized Aluminum Leg
HP laminate

ROUND LEG PACKAGES

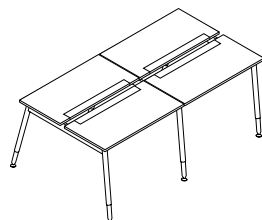

Back-to-Back 4 Person Pod with Access Door and Levelers, Round Leg

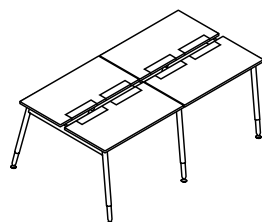

Back-to-Back 4 Person Pod with Access Door and Levelers, Round Leg

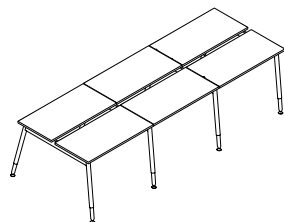

Back-to-Back 6 Person Pod with Levelers Round Leg

MODEL#	DIMENSIONS D x W x H	FREIGHT CLASS	WT/LBS.	CUBIC FT.	LIST PRICE	HP ADD
BRTBAR4PA2484LR	50.5 x 168 x 29	70	272	15.66	\$4513	\$991
BRTBAR4PA2478LR	50.5 x 156 x 29	70	256	15.20	\$4372	\$883
BRTBAR4PA2472LR	50.5 x 144 x 29	70	240	14.74	\$4266	\$848
BRTBAR4PA2466LR	50.5 x 132 x 29	70	224	14.28	\$4090	\$744
BRTBAR4PA2460LR	50.5 x 120 x 29	70	208	13.82	\$3913	\$674
BRTBAR4PA3084LR	62.5 x 168 x 29	70	333	16.86	\$4936	\$1200
BRTBAR4PA3078LR	62.5 x 156 x 29	70	313	16.32	\$4760	\$1130
BRTBAR4PA3072LR	62.5 x 144 x 29	70	293	15.78	\$4656	\$1026
BRTBAR4PA3066LR	62.5 x 132 x 29	70	273	15.24	\$4478	\$920
BRTBAR4PA3060LR	62.5 x 120 x 29	70	253	14.70	\$4232	\$848

Back-to-back 4 Person workstation consists of four worksurfaces, three back-to-back outer leg assemblies, and four supporting structural beams. Anodized aluminum worksurface door provides access to power/data trough below worksurface. Worksurface with access doors CANNOT be combined with above worksurface power trough.

BRTBAR4PDA2484LR	50.5 x 168 x 29	70	272	15.66	\$4998	\$1064
BRTBAR4PDA2478LR	50.5 x 156 x 29	70	256	15.20	\$4846	\$950
BRTBAR4PDA2472LR	50.5 x 144 x 29	70	240	14.74	\$4731	\$912
BRTBAR4PDA2466LR	50.5 x 132 x 29	70	224	14.28	\$4626	\$799
BRTBAR4PDA2460LR	50.5 x 120 x 29	70	208	13.82	\$4352	\$722
BRTBAR4PDA3084LR	62.5 x 168 x 29	70	333	16.86	\$5416	\$1291
BRTBAR4PDA3078LR	62.5 x 156 x 29	70	313	16.32	\$5226	\$1215
BRTBAR4PDA3072LR	62.5 x 144 x 29	70	293	15.78	\$5111	\$1100
BRTBAR4PDA3066LR	62.5 x 132 x 29	70	273	15.24	\$4998	\$910
BRTBAR4PDA3060LR	62.5 x 120 x 29	70	253	14.70	\$4694	\$912

Back-to-back 4 Person workstation consists of four worksurfaces, three back-to-back outer leg assemblies, and four supporting structural beams. These tables feature dual access doors providing a central connection point for monitor lifts. Anodized aluminum worksurface door provides access to power/data trough below worksurface. Worksurface with access doors CANNOT be combined with above worksurface power trough.

BRTBAR6P2484LR	50.5 x 252 x 29	70	434	22.88	\$6335	\$827
BRTBAR6P2478LR	50.5 x 234 x 29	70	409	22.10	\$6081	\$786
BRTBAR6P2472LR	50.5 x 216 x 29	70	359	21.32	\$5850	\$766
BRTBAR6P2466LR	50.5 x 198 x 29	70	329	20.54	\$5700	\$722
BRTBAR6P2460LR	50.5 x 180 x 29	70	308	19.76	\$5554	\$711
BRTBAR6P3084LR	62.5 x 252 x 29	70	493	24.53	\$6559	\$880
BRTBAR6P3078LR	62.5 x 234 x 29	70	462	23.75	\$6198	\$817
BRTBAR6P3072LR	62.5 x 216 x 29	70	431	22.86	\$5986	\$797
BRTBAR6P3066LR	62.5 x 198 x 29	70	400	21.97	\$5784	\$766
BRTBAR6P3060LR	62.5 x 180 x 29	70	369	21.08	\$5648	\$722

Back-to-back 6 Person workstation consists of six worksurfaces, four back-to-back outer leg assemblies, and six supporting structural beams.

Required Specifications

Top finish
Edge finish
Metal finish (legs)

Optional Specifications

Anodized Aluminum Leg
HP laminate

ROUND LEG PACKAGES

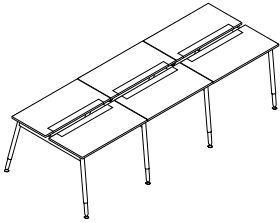

Back-to-Back 6 Person Pod with Access Door and Levelers, Round Leg

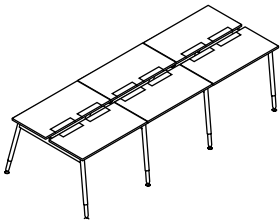

Back-to-Back 6 Person Pod with Access Door and Levelers, Round Leg

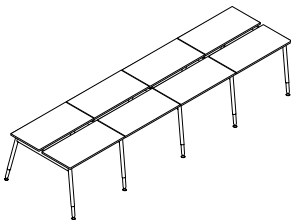

Back-to-Back 8 Person Pod with Levelers Round Leg

MODEL#	DIMENSIONS D x W x H	FREIGHT CLASS	WT/LBS.	CUBIC FT.	LIST PRICE	HP ADD
BRTBAR6PA2484LR	50.5 x 252 x 29	70	434	22.88	\$6705	\$1484
BRTBAR6PA2478LR	50.5 x 234 x 29	70	409	22.10	\$6493	\$1325
BRTBAR6PA2472LR	50.5 x 216 x 29	70	359	21.32	\$6335	\$1271
BRTBAR6PA2466LR	50.5 x 198 x 29	70	329	20.54	\$6070	\$1113
BRTBAR6PA2460LR	50.5 x 180 x 29	70	308	19.76	\$5806	\$1006
BRTBAR6PA3084LR	62.5 x 252 x 29	70	493	24.53	\$7287	\$1800
BRTBAR6PA3078LR	62.5 x 234 x 29	70	462	23.75	\$7023	\$1695
BRTBAR6PA3072LR	62.5 x 216 x 29	70	431	22.86	\$6864	\$1536
BRTBAR6PA3066LR	62.5 x 198 x 29	70	400	21.97	\$6600	\$1378
BRTBAR6PA3060LR	62.5 x 180 x 29	70	369	21.08	\$6230	\$1271

Back-to-back 6 Person workstation consists of six worksurfaces, four back-to-back leg assemblies, and six supporting structural beams. Anodized aluminum worksurface door provides access to power/data trough below worksurface. Worksurface with access doors CANNOT be combined with above worksurface power trough.

BRTBAR6PDA2484LR	50.5 x 252 x 29	70	434	22.88	\$7235	\$1592
BRTBAR6PDA2478LR	50.5 x 234 x 29	70	409	22.10	\$7005	\$1422
BRTBAR6PDA2472LR	50.5 x 216 x 29	70	359	21.32	\$6835	\$1365
BRTBAR6PDA2466LR	50.5 x 198 x 29	70	329	20.54	\$6547	\$1198
BRTBAR6PDA2460LR	50.5 x 180 x 29	70	308	19.76	\$6267	\$1081
BRTBAR6PDA3084LR	62.5 x 252 x 29	70	493	24.53	\$7861	\$1934
BRTBAR6PDA3078LR	62.5 x 234 x 29	70	462	23.75	\$7576	\$1817
BRTBAR6PDA3072LR	62.5 x 216 x 29	70	431	22.86	\$7407	\$1648
BRTBAR6PDA3066LR	62.5 x 198 x 29	70	400	21.97	\$7118	\$1481
BRTBAR6PDA3060LR	62.5 x 180 x 29	70	369	21.08	\$6722	\$1364

Back-to-back 6 Person workstation consists of six worksurfaces, four back-to-back leg assemblies, and six supporting structural beams. These tables feature dual access doors providing a central connection point for monitor lifts. Anodized aluminum worksurface door provides access to power/data trough below worksurface. Worksurface with access doors CANNOT be combined with above worksurface power trough.

BRTBAR8P2484LR	50.5 x 336 x 29	70	556	28.30	\$8297	\$1088
BRTBAR8P2478LR	50.5 x 312 x 29	70	520	27.30	\$7946	\$1046
BRTBAR8P2472LR	50.5 x 288 x 29	70	484	26.30	\$7635	\$1018
BRTBAR8P2466LR	50.5 x 264 x 29	70	448	25.30	\$7437	\$961
BRTBAR8P2460LR	50.5 x 240 x 29	70	412	24.42	\$7240	\$933
BRTBAR8P3084LR	62.5 x 336 x 29	70	669	30.58	\$8565	\$1189
BRTBAR8P3078LR	62.5 x 312 x 29	70	625	29.48	\$8100	\$1088
BRTBAR8P3072LR	62.5 x 288 x 29	70	581	28.38	\$7819	\$1060
BRTBAR8P3066LR	62.5 x 264 x 29	70	536	27.28	\$7551	\$1018
BRTBAR8P3060LR	62.5 x 240 x 29	70	492	26.18	\$7369	\$961

Back-to-back 8 Person workstation consists of eight worksurfaces, five back-to-back leg assemblies, and eight supporting structural beams.

Required Specifications

Top finish
Edge finish
Metal finish (legs)

Optional Specifications

Anodized Aluminum Leg
HP laminate

ROUND LEG PACKAGES

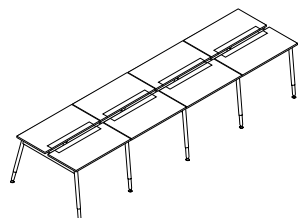

Back-to-Back 8 Person Pod with Access Door and Levelers, Round Leg

MODEL#	DIMENSIONS D x W x H	FREIGHT CLASS	WT/LBS.	CUBIC FT.	LIST PRICE	HP ADD
BRTBAR8PA2484LR	50.5 x 336 x 29	70	556	28.30	\$8777	\$1976
BRTBAR8PA2478LR	50.5 x 312 x 29	70	520	27.30	\$8495	\$1764
BRTBAR8PA2472LR	50.5 x 288 x 29	70	484	26.30	\$8284	\$1695
BRTBAR8PA2466LR	50.5 x 264 x 29	70	448	25.30	\$7931	\$1484
BRTBAR8PA2460LR	50.5 x 240 x 29	70	412	24.42	\$7578	\$1341
BRTBAR8PA3084LR	62.5 x 336 x 29	70	669	30.58	\$9553	\$2399
BRTBAR8PA3078LR	62.5 x 312 x 29	70	625	29.48	\$9199	\$2258
BRTBAR8PA3072LR	62.5 x 288 x 29	70	581	28.38	\$8987	\$2047
BRTBAR8PA3066LR	62.5 x 264 x 29	70	536	27.28	\$8636	\$1836
BRTBAR8PA3060LR	62.5 x 240 x 29	70	492	26.18	\$8142	\$1695

Back-to-back 8 Person workstation consists of eight worksurfaces, five back-to-back leg assemblies, and eight supporting structural beams. Anodized aluminum worksurface door provides access to power/data trough below worksurface. Worksurface with access doors CANNOT be combined with above worksurface power trough.

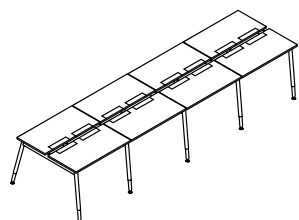

Back-to-Back 8 Person Pod with Access Door and Levelers, Round Leg

BRTBAR8PDA2484LR	50.5 x 336 x 29	70	556	28.30	\$9468	\$2123
BRTBAR8PDA2478LR	50.5 x 312 x 29	70	520	27.30	\$9164	\$1895
BRTBAR8PDA2472LR	50.5 x 288 x 29	70	484	26.30	\$8938	\$1817
BRTBAR8PDA2466LR	50.5 x 264 x 29	70	448	25.30	\$8557	\$1594
BRTBAR8PDA2460LR	50.5 x 240 x 29	70	412	24.42	\$8177	\$1442
BRTBAR8PDA3084LR	62.5 x 336 x 29	70	669	30.58	\$10305	\$2577
BRTBAR8PDA3078LR	62.5 x 312 x 29	70	625	29.48	\$9923	\$2428
BRTBAR8PDA3072LR	62.5 x 288 x 29	70	581	28.38	\$9696	\$2201
BRTBAR8PDA3066LR	62.5 x 264 x 29	70	536	27.28	\$9319	\$1971
BRTBAR8PDA3060LR	62.5 x 240 x 29	70	492	26.18	\$8785	\$1819

Back-to-back 8 Person workstation consists of eight worksurfaces, five back-to-back leg assemblies, and eight supporting structural beams. These tables feature dual access doors providing a central connection point for monitor lifts. Anodized aluminum worksurface door provides access to power/data trough below worksurface. Worksurface with access doors CANNOT be combined with above worksurface power trough.

RETURNS

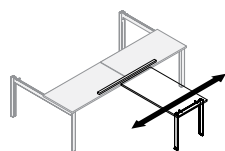

Rail Sliding Table Kit - Rectangular Legs

BRTSLDT72C	72 x 48 x 29	92.5	28.50	2.40	\$708	N/A
------------	--------------	------	-------	------	--------------	-----

Includes leg, leg support, sliding bracket hardware, 72" rail and hardware to secure table. **Worksurface not included.** Legs are for 24" d worksurfaces. 40mm dia. locking casters with 8mm thread, white body and grey tires. Maximum length of sliding table surface is 48". **Cannot be used on single line pods with rectangular legs.**

- Anodized Aluminum Leg - Add **\$56.** list upcharge

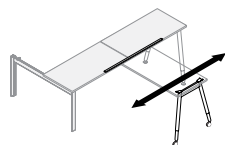

Rail Sliding Table Kit - Round Legs

BRTSLDT72CR	72 x 48 x 29	92.5	28.50	2.40	\$708	N/A
-------------	--------------	------	-------	------	--------------	-----

Includes leg, leg support, sliding bracket hardware, 72" rail and hardware to secure table. **Worksurface not included.** Legs are for 24" d worksurfaces. 3" dia. locking casters are standard. Maximum length of sliding table surface is 48".

Required Specifications

Top finish
Edge finish
Metal finish (legs)

Optional Specifications

Anodized Aluminum Leg
HP laminate

MEETING TABLES

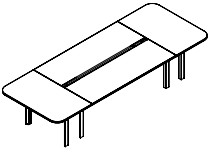

Boardroom Table with Rectangular Leg and Levelers

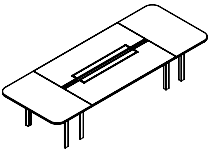

Boardroom Table with Rectangular Leg, Access Door and Levelers

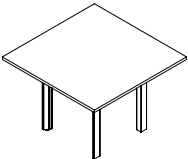

Square Meeting Table with Rectangular Legs

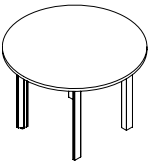

Round Meeting Table with Rectangular Legs

MODEL#	DIMENSIONS D x W x H	FREIGHT CLASS	WT./LBS.	CUBIC FT.	LIST PRICE	HP ADD
BRTBRDP276L	52.5 x 276 x 29	70	474	23.42	\$7710	\$965
BRTBRDP240L	52.5 x 240 x 29	70	408	22.64	\$7414	\$903
BRTBRDP204L	52.5 x 204 x 29	70	340	20.74	\$6009	\$711
BRTBRDP180L	52.5 x 180 x 29	70	308	19.82	\$5810	\$669
BRTBRDP132L	52.5 x 132 x 29	70	228	15.02	\$4321	\$458
BRTBRDP120L	52.5 x 120 x 29	85	210	14.56	\$4220	\$437

Boardroom Table assemblies consist of 2 or more back-to-back tables with end tables on either side. Inset support legs, levelers. Worksurfaces, supporting structure and connecting hardware included.

- Anodized Aluminum Leg - Add **\$277** list upcharge
- BRTBRDP276L consists of (6) 24" x 72" back-to-back tables and (2) 30" x 50.5" end tables
- BRTBRDP240L consists of (6) 24" x 60" back-to-back tables and (2) 30" x 50.5" end tables
- BRTBRDP204L consists of (4) 24" x 72" back-to-back tables and (2) 30" x 50.5" end tables
- BRTBRDP180L consists of (4) 24" x 60" back-to-back tables and (2) 30" x 50.5" end tables
- BRTBRDP132L consists of (2) 24" x 72" back-to-back tables and (2) 30" x 50.5" end tables
- BRTBRDP120L consists of (2) 24" x 60" back-to-back tables and (2) 30" x 50.5" end tables

BRTBRDPA276L	52.5 x 276 x 29	70	474	23.42	\$8196	\$1473
BRTBRDPA240L	52.5 x 240 x 29	70	408	22.64	\$7914	\$932
BRTBRDPA204L	52.5 x 204 x 29	70	340	20.74	\$6330	\$768
BRTBRDPA180L	52.5 x 180 x 29	70	308	19.82	\$5979	\$873
BRTBRDPA132L	52.5 x 132 x 29	70	228	15.02	\$4447	\$626
BRTBRDPA120L	52.5 x 120 x 29	85	210	14.56	\$4270	\$537

Boardroom Table assemblies consist of 2 or more back-to-back tables with end tables on either side. Inset support legs, levelers. Worksurfaces, supporting structure and connecting hardware included.

- Anodized Aluminum Leg - Add **\$277** list upcharge
- BRTBRDPA276L consists of (6) 24" x 72" back-to-back tables and (2) 30" x 50.5" end tables
- BRTBRDPA240L consists of (6) 24" x 60" back-to-back tables and (2) 30" x 50.5" end tables
- BRTBRDPA204L consists of (4) 24" x 72" back-to-back tables and (2) 30" x 50.5" end tables
- BRTBRDPA180L consists of (4) 24" x 60" back-to-back tables and (2) 30" x 50.5" end tables
- BRTBRDPA132L consists of (2) 24" x 72" back-to-back tables and (2) 30" x 50.5" end tables
- BRTBRDPA120L consists of (2) 24" x 60" back-to-back tables and (2) 30" x 50.5" end tables

BRTSQ42L	42 x 42 x 29	70	85	4.20	\$1334	\$145
BRTSQ42C	42 x 42 x 29	70	85	4.20	\$1405	\$145

3mm edging. Select BRTSQ42L for levelers or BRTSQ42C for casters.

- Anodized Aluminum Leg - Add **\$140** list upcharge

BRTR42L	42 x 42 x 29	70	65	3.90	\$1334	\$145
BRTR42C	42 x 42 x 29	70	65	3.90	\$1405	\$145

3mm edging. Select BRTR42L for levelers or BRTR42C for casters.

- Anodized Aluminum Leg - Add **\$140** list upcharge

Required Specifications

Top finish
Edge finish
Metal finish (legs)

Optional Specifications

HP laminate
Anodized aluminum leg
Table-edge mounted power module (Meeting Tables)

Below worksurface power trough with power distribution module (Meeting Tables)

LEG ASSEMBLIES

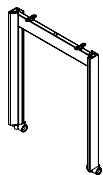

Single Rectangular Leg Assembly with Casters

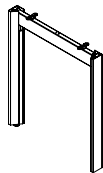

Single Rectangular Leg Assembly with Levelers

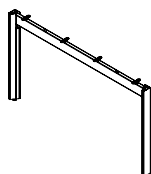

Back-to-Back Rectangular Leg Assembly with Levelers

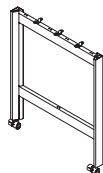

Single H Leg Assembly with Casters

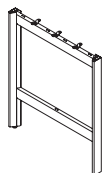

Single H Leg Assembly with Levelers

MODEL#	DIMENSIONS	FREIGHT CLASS	WT./LBS.	CUBIC FT.	LIST PRICE	HP ADD
--------	------------	---------------	----------	-----------	------------	--------

D x W x H

BRTSL24C	24 x 2.5 x 28	150	8	1.34	\$475	N/A
BRTSL30C	30 x 2.5 x 28	150	8	1.41	\$479	N/A
BRTSL36C	36 x 2.5 x 28	150	8	1.81	\$583	N/A

Two single leg assemblies combined with support beams form the structure of the Bridges II series Single Table. One leg can be shared by two adjoining worksurfaces. 40mm white locking casters with grey tires; steel horizontal beams, aluminum legs.

- Anodized Aluminum Leg - Add **\$70** list upcharge

BRTSL24L	24 x 2.5 x 28	150	8	1.34	\$430	N/A
BRTSL30L	30 x 2.5 x 28	150	8	1.34	\$448	N/A
BRTSL36L	36 x 2.5 x 28	125	9	1.50	\$394	N/A

Two single leg assemblies combined with support beams form the structure of the Bridges II series Single Table or Single Line tables. One leg can be shared by two adjoining worksurfaces. Leveling glides; steel horizontal beams, aluminum legs.

- Anodized Aluminum Leg - Add **\$70** list upcharge
- Please specify two beams when using BRTSL36L.

BRTBA34L	34 x 2.5 x 28	150	10	2.47	\$426	N/A
BRTBA51L	50.5 x 2.5 x 28	150	12	2.96	\$461	N/A
BRTBA63L	62.5 x 2.5 x 28	150	13	3.21	\$481	N/A

Two double leg assemblies combined with support beams form the structure of the Bridges II series Back-to-Back Table. One double leg can be shared by four adjoining worksurfaces. Leveling glides; steel horizontal beams, aluminum legs.

- Anodized Aluminum Leg - Add **\$70** list upcharge

BRTHL3624C	24 x 2.5 x 35	100	14	1.68	\$611	N/A
BRTHL3630C	30 x 2.5 x 35	100	16	1.76	\$646	N/A
BRTHL3636C	36 x 2.5 x 35	125	18	2.26	\$731	N/A

BRTHL4224C	24 x 2.5 x 41	125	15	1.96	\$639	N/A
BRTHL4230C	30 x 2.5 x 41	100	17	2.06	\$674	N/A
BRTHL4236C	36 x 2.5 x 41	125	19	2.65	\$757	N/A

Two single leg assemblies combined with support beams form the structure of the Bridges II series Single Line Tables. One leg can be shared by two adjoining worksurfaces. 40mm white locking casters with grey tires; steel horizontal beams, aluminum legs. For proper installation, the following beams are required:

- 24"D legs - 4 beams (3 under the surface and one at the bottom)
- 30"D/36"D legs - 5 beams (4 under the surface and one at the bottom)
- Anodized Aluminum Leg - Add **\$70** list upcharge

BRTHL3624L	24 x 2.5 x 35	100	14	1.68	\$562	N/A
BRTHL3630L	30 x 2.5 x 35	100	16	1.76	\$597	N/A
BRTHL3636L	36 x 2.5 x 35	125	18	2.26	\$682	N/A

BRTHL4224L	24 x 2.5 x 41	125	15	1.96	\$589	N/A
BRTHL4230L	30 x 2.5 x 41	100	17	2.06	\$625	N/A
BRTHL4236L	36 x 2.5 x 41	125	19	2.65	\$709	N/A

Two single leg assemblies combined with support beams form the structure of the Bridges II series Single Line Tables. One leg can be shared by two adjoining worksurfaces. For proper installation, the following beams are required:

- 24"D legs - 4 beams (3 under the surface and one at the bottom)
- 30"D/36"D legs - 5 beams (4 under the surface and one at the bottom)
- Anodized Aluminum Leg - Add **\$70** list upcharge

Required Specifications

Metal finish (legs)

Optional Specifications

Anodized aluminum leg

LEG ASSEMBLIES

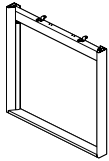

Single Loop Leg

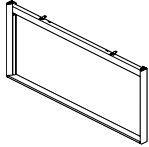

Back-to-Back Loop Leg



120° Rectangular Corner Leg Kit

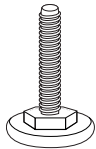

Leveler for Rectangular Leg Table

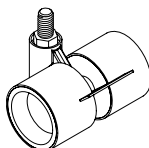

Caster for Rectangular Leg Table



Single Table Round Leg Assembly

MODEL#	DIMENSIONS	FREIGHT CLASS	WT./LBS.	CUBIC FT.	LIST PRICE	HP ADD
--------	------------	---------------	----------	-----------	------------	--------

D x W x H

BRTSLL24L	24 x 2.5 x 28	92.5	11	1.01	\$405	N/A
BRTSLL30L	30 x 2.5 x 28	92.5	13.75	1.26	\$434	N/A
BRTSLL36L	36 x 2.5 x 28	92.5	16.50	1.51	\$465	N/A

Two single leg assemblies combined with support beams form the structure of the Bridges II series Single Line tables. One leg can be shared by two adjoining worksurfaces. Leveling glides; steel horizontal beams, aluminum legs.

- Anodized Aluminum Leg - Add **\$70** list upcharge

BRTBALL51L	50.5 x 2.5 x 28	92.5	23.14	2.12	\$562	N/A
BRTBALL63L	62.5 x 2.5 x 28	92.5	28.64	2.62	\$588	N/A

Two back-to-back leg assemblies form the structure of the Bridges II series Single Line Back-to-Back Table. One double leg can be shared by four adjoining worksurfaces. Leveling glides; steel horizontal beams, aluminum legs.

- Anodized Aluminum Leg - Add **\$70** list upcharge

BRT120L42	34 x 2.5 x 28	250	6.60	2.80	\$814	N/A
-----------	---------------	-----	------	------	--------------	-----

One 120° corner leg kit combined with two single or double leg assemblies and support beams form the structure of the Bridges II 120° Tables. 120° corner leg kit includes one corner leg and adjacent, telescopic beams to support BRTWAC120xxxx or BRTWAC120xxxxA 120° worksurfaces. Telescopic horizontal beams allow single or double leg assemblies to be positioned either under the worksurface (end of a run) or to be shared by adjoining worksurfaces. Levelers, steel horizontal beams, aluminum legs.

- Anodized Aluminum Leg - Add **\$41** list upcharge

BRTLVS	1 x 1 x 2.5	70	.03	.01	\$10	N/A
--------	-------------	----	-----	-----	-------------	-----

5/16" thread with black base. Leveler has 2" adjustment range. Casters and levelers on Rectangular legs cannot be interchanged on site.

BRTLCS	2.6 x 2.7 x 2.5	70	.06	.01	\$31	N/A
--------	-----------------	----	-----	-----	-------------	-----

Locking. 40mm diameter with 8mm thread, white body, light grey tires. Casters and levelers on Rectangular legs cannot be interchanged on site.

BRTSL	24 x 3 x 28	125	8	1.25	\$377	N/A
-------	-------------	-----	---	------	--------------	-----

Two single table leg assemblies combined with a single beam form the supporting structure of the Bridges II series Single Line Table. One leg can be shared by two adjoining worksurfaces. Leveling Glides are standard. Locking casters are available on single tables. Specify BRTLCCR

Required Specifications

Top finish
Edge finish
Metal finish (legs)

Optional Specifications

Anodized Aluminum Leg
HP laminate

LEG ASSEMBLIES

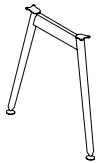

**Single Table Round Leg Assembly,
Fixed Height**

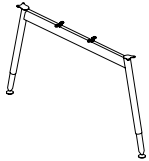

Double Table Round Leg Assembly

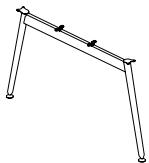

**Double Table Round Leg Assembly,
Fixed Height**

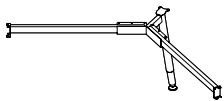

120° Round Corner Leg Assembly

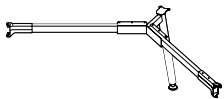

120° Fixed Height Corner Leg Assembly

MODEL#	DIMENSIONS	FREIGHT CLASS	WT/LBS.	CUBIC FT.	LIST PRICE	HP ADD
--------	------------	---------------	---------	-----------	------------	--------

D x W x H

BRTFSL	24 x 2.5 x 28	150	5	.97	\$322	N/A
--------	---------------	-----	---	-----	--------------	-----

Two single table leg assemblies combined with a single beam form the supporting structure of the Bridges II series Single Line Table. One leg can be shared by two adjoining worksurfaces. Leveling glides are standard.

BRTDL	50 x 3 x 28	150	12	2.81	\$489	N/A
-------	-------------	-----	----	------	--------------	-----

Two double table leg assemblies combined with two single beams form the supporting structure of the Bridges II series Back-to-Back Tables. One leg can be shared by two adjoining worksurfaces. Leveling glides are standard.

BRTFDL	50 x 2.5 x 28	250	8	2.03	\$439	N/A
--------	---------------	-----	---	------	--------------	-----

Two double table leg assemblies combined with two single beams form the supporting structure of the Bridges II series Back-to-Back Tables. One leg can be shared by two adjoining worksurfaces. Leveling glides are standard.

BRTCRL42	16 x 18 x 28	92.5	15	1.50	\$753	N/A
----------	--------------	------	----	------	--------------	-----

Provides support for worksurfaces connected at 120°. Single leg and beam assembly for 120° worksurface planning. Works with BRTWAC120xxxx or BRTWAC120xxxxA 120° worksurfaces. For a single application, two BRTSL (single legs) must be added. To join a back-to-back table application, leg assembly will join to existing pod.

- When joining to an existing table, the beam extends to reach the shared leg.

BRTFCRL42	16 x 18 x 28	92.5	13	1.50	\$700	N/A
-----------	--------------	------	----	------	--------------	-----

Provides support for worksurfaces connected at 120°, supported by fixed height legs. Single leg and beam assembly for 120° worksurface planning. Works with BRTWAC120xxxx or BRTWAC120xxxxA 120° worksurfaces. For a single application, two BRTFSL (single legs) must be added. To join a back-to-back table application, leg assembly will join to existing pod.

- When joining to an existing table, the beam extends to reach the shared leg.

Required Specifications

Metal finish (legs)

LEG ASSEMBLIES

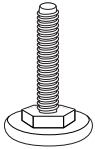

Leveler for Round Leg Table

MODEL#	DIMENSIONS D x W x H	FREIGHT CLASS	WT./LBS.	CUBIC FT.	LIST PRICE	HP ADD
BRTLVR	2.13 x 2.13 x 2	70	.20	.01	\$10	N/A

3/8" thread with black base. Leveler has 1" height adjustment range. Field retrofittable on round leg.

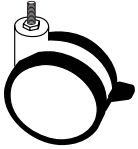

Caster for Round Leg Table

BRTLCR	1.5 x 3 x 3.75	70	.30	.01	\$31	N/A
--------	----------------	----	-----	-----	-------------	-----

Locking. 3" diameter with 3/8" -16 threaded stem. Field retrofittable on round leg.

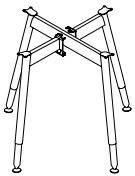

Round Table Leg Assembly

BRTRL	24 x 24 x 28	125	16	2.33	\$775	N/A
-------	--------------	-----	----	------	--------------	-----

Four leg assembly. Leveling Glides are standard. Locking casters are available. Specify (4) BRTLCR. Maximum table diameter is 42". Includes all connecting hardware.

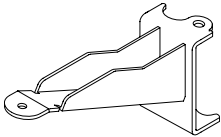

Leg Support Cantilever

BRTLSC	2 x 9 x 5	70	.50	.01	\$134	N/A
--------	-----------	----	-----	-----	--------------	-----

Provides stability for leg supports.

Required Specifications
Metal Finish (legs)

Optional Specifications
Casters (BRTRL)

BEAM APPLICATIONS

D x W x H

Table supporting structures - BEAMS

Legs are connected with supporting beams. There is one beam for a single line of tables while two beams connect back-to-back table structures. Adjustable clamps at either end of the beam can be adjusted to accommodate the following applications in both single table as well as back-to-back table configurations.

STANDARD TABLE BEAM**Single table beam application (1)**

Designed to bridge two legs to form support for a single table, or for two back-to-back worksurfaces. Adjustable clamps at either end of the beam are pushed all the way in to allow both table legs to be tucked under the worksurface.

**End of run table beam application (2)**

Supports one table leg assembly tucked under the worksurface (one adjustable clamp pushed all the way in), while the other table leg assembly can be shared between two adjacent worksurfaces (adjustable clamp pulled out to extend the beam).

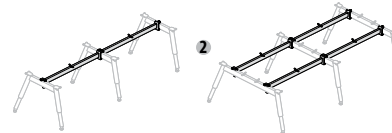
**Interconnecting table beam application (3)**

Supports both table leg assemblies extended to support adjacent worksurfaces on either side. Adjustable clamps at either end of the beam are pushed all the way in to allow both table legs to be tucked under the worksurface. Single table beam application supports single table leg assemblies with legs on both sides tucked under the worksurface.

**TELESCOPIC TABLE BEAM (4)**

Supports a return connected perpendicularly to a 24" or 30" deep primary worksurface. The Telescopic beam is connected to a single or back-to-back leg on one side and to any-worksurface supporting beam on the opposite side. Telescopic beam clamp allows the table leg to be tucked under the worksurface or shared between two adjacent worksurfaces.

**STORAGE TABLE BEAM (5)**

The Storage beam is connected to a single or back-to-back leg on one side and to the worksurface on the opposite side - thus saving one leg assembly. Assembly worksurface is connected to storage units with included storage brackets. Storage table beam's flexibility allows for a single table application (with the table leg tucked in under the worksurface) as well as for a double table installation (two adjacent tables supported by a shared leg in the middle and two storage cabinets at the opposite ends).

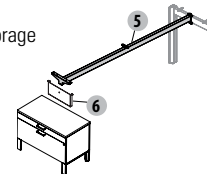
**STORAGE TABLE BEAM ADAPTER (6)**

Connects to a storage table beam. This assembly allows a worksurface to be supported by a leg on one side and a spine (formed by interconnected storage cabinets) on the opposite side.

BEAMS	MODEL#	DIMENSIONS	FREIGHT CLASS	WT./LBS.	CUBIC FT.	LIST PRICE
	BRTSB84C	1 x 79 x 2	60	8.02	.15	\$289
	BRTSB78C	1 x 73 x 2	60	7.38	.12	\$282
	BRTSB72C	1 x 67 x 2	60	6.74	.09	\$274
	BRTSB66C	1 x 61 x 2	60	6.09	.08	\$263
	BRTSB63C	1 x 57.5 x 2	60	5.72	.08	\$260
	BRTSB60C	1 x 55 x 2	60	5.45	.07	\$254
	BRTSB54C	1 x 49 x 2	60	4.86	.06	\$244
	BRTSB51C	1 x 45.5 x 2	60	4.81	.05	\$238
	BRTSB48C	1 x 43 x 2	60	4.60	.05	\$228
	BRTSB42C	1 x 37 x 2	60	3.59	.04	\$219
	BRTSB36C	1 x 31 x 2	60	3.31	.03	\$216
	BRTSB30C	1 x 25 x 2	60	2.70	.02	\$215
	BRTSB24C	1 x 19 x 2	60	2.03	.01	\$209
	BRTSB15C	1 x 10 x 2	70	1.28	.01	\$167

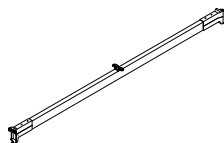
**Standard Table Beam**

Standard Table Beam bridges two legs to form support for a single table, or two back-to-back worksurfaces. Adjustable clamps at either end of the beam accommodate **standard table beam, end of run and interconnecting table beam applications**. Adjustable brackets ship attached to the beam. Specify Standard Table Beam size corresponding nominally to the worksurface length. Includes all hardware necessary to connect to legs. Powder coated steel beam and aluminum cast clamps.

Required Specifications

Metal Finish

BEAMS

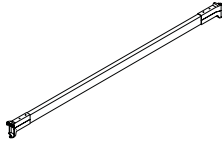

Bottom Table Beam

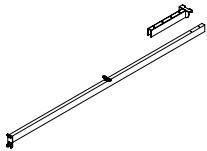

Telescopic Table Beam

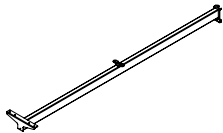

Storage Table Beam

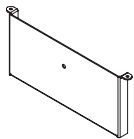

Storage Table Beam Adapter

MODEL#	DIMENSIONS D x W x H	FREIGHT CLASS	WT./LBS.	CUBIC FT.	LIST PRICE
BRTBB84C	1 x 79 x 2	60	10.32	.15	\$325
BRTBB78C	1 x 73 x 2	60	9.68	.12	\$317
BRTBB72C	1 x 67 x 2	60	9.04	.09	\$307
BRTBB66C	1 x 61 x 2	60	8.40	.09	\$296
BRTBB60C	1 x 55 x 2	60	7.75	.08	\$286
BRTBB54C	1 x 49 x 2	60	7.11	.07	\$275
BRTBB48C	1 x 43 x 2	60	6.74	.07	\$255
BRTBB42C	1 x 37 x 2	60	5.83	.06	\$244
BRTBB36C	1 x 31 x 2	60	5.19	.05	\$241

Bottom table beam connects to the lower cross beam on the 36" and 42" high "H" leg to create the footrest. One beam required for each table. Cannot be used as a substitute for the standard table beam. Specify bottom table beam that corresponds to the worksurface length. Includes all hardware necessary to connect to "H" leg. Powder coated steel beam and aluminum cast clamps.

BRTTB84C	1 x 96.5 x 2	60	10.32	.15	\$443
BRTTB78C	1 x 90.5 x 2	60	9.68	.12	\$435
BRTTB72C	1 x 84.5 x 2	60	9.04	.09	\$426
BRTTB66C	1 x 78.5 x 2	60	8.40	.09	\$416
BRTTB60C	1 x 72.5 x 2	60	7.75	.08	\$406
BRTTB54C	1 x 66.5 x 2	60	7.11	.07	\$391
BRTTB48C	1 x 60.5 x 2	60	6.74	.07	\$370
BRTTB42C	1 x 54.5 x 2	60	5.83	.06	\$355
BRTTB36C	1 x 48.5 x 2	60	5.19	.05	\$333

Provides support for a worksurface connected perpendicularly to a run of primary tables. Can be adjusted to accommodate 24" and 30" primary worksurfaces. One end of the beam is attached to a Leg Assembly while the other end is secured, off module to the perpendicular Standard Table Beam, End of Run or Interconnecting Beam. Specify Telescopic Table Beam size corresponding nominally to the return worksurface length.

BRTSTB84C	1 x 80.75 x 2	60	8.64	.09	\$318
BRTSTB78C	1 x 74.75 x 2	60	7.99	.08	\$310
BRTSTB72C	1 x 68.75 x 2	60	7.35	.08	\$299
BRTSTB66C	1 x 62.75 x 2	60	6.74	.07	\$289
BRTSTB60C	1 x 54.75 x 2	60	5.85	.06	\$274
BRTSTB54C	1 x 50.75 x 2	60	5.43	.05	\$254
BRTSTB48C	1 x 44.75 x 2	60	4.78	.05	\$241
BRTSTB42C	1 x 38.75 x 2	60	4.16	.04	\$238
BRTSTB36C	1 x 32.75 x 2	60	3.50	.03	\$228

Allows a worksurface to be supported by a leg on one side and storage tower(s) or spine of 21" and 25" interconnected storage units on the opposite side. Specify Storage Table Beam size corresponding nominally to the worksurface length. Includes all hardware necessary to connect the storage beam to the legs and worksurface.

BRTSA21	1 x 15.2 x 6.5	60	2.15	.05	\$109
BRTSA25	1 x 15.2 x 2.75	60	4.30	.02	\$93

Allows a worksurface to be supported by a leg on one side and storage spine on the opposite side. A typical storage spine is formed by series of Interconnected 21" or 25" storage cabinets of corresponding depth. The 21" or 25" adaptors provide structural support, acting as supports between the top of the storage cabinet spine and the bottom of the perpendicular worksurfaces. The flexible leg/beam/adaptor assembly arrangement allows the leg to be tucked in under the worksurface or to be shared by two adjacent worksurfaces. Specify Storage Beam nominally 18" shorter than worksurfaces for storage spine support application. Specify BRTSA21 or BRTSA25 depending on height of storage units forming the spine. Includes all hardware necessary to connect the adapter to the beam, worksurface and storage spine.

Required Specifications

Metal Finish

WORKSURFACES

MODEL# DIMENSIONS FREIGHT CLASS WT/LBS. CUBIC FT. LIST PRICE HP ADD

D x W x H

BRTWS2484	24 x 84 x 1	60	55	1.80	\$453	\$140
BRTWS2478	24 x 78 x 1	60	51	1.70	\$418	\$134
BRTWS2472	24 x 72 x 1	60	47	1.54	\$391	\$131
BRTWS2466	24 x 66 x 1	60	43	1.41	\$373	\$123
BRTWS2463	24 x 62.5 x 1	65	39	1.41	\$367	\$125
BRTWS2460	24 x 60 x 1	60	39	1.30	\$358	\$119
BRTWS2454	24 x 54 x 1	65	35	1.20	\$322	\$104
BRTWS2451	24 x 50.5 x 1	65	31	1.06	\$326	\$104
BRTWS2448	24 x 48 x 1	65	31	1.06	\$272	\$94
BRTWS2442	24 x 42 x 1	60	28	.90	\$228	\$77
BRTWS2436	24 x 36 x 1	60	23	.71	\$174	\$59
BRTWS3084	30 x 84 x 1	60	69	2.24	\$488	\$150
BRTWS3078	30 x 78 x 1	60	64	2.10	\$439	\$139
BRTWS3072	30 x 72 x 1	65	59	2	\$413	\$137
BRTWS3066	30 x 66 x 1	60	54	1.80	\$388	\$131
BRTWS3063	30 x 62.5 x 1	65	49	1.77	\$379	\$127
BRTWS3060	30 x 60 x 1	65	49	1.77	\$373	\$123
BRTWS3054	30 x 54 x 1	60	44	1.44	\$348	\$104
BRTWS3051	30 x 50.5 x 1	65	39	1.41	\$342	\$109
BRTWS3048	30 x 48 x 1	65	39	1.41	\$322	\$104
BRTWS3042	30 x 42 x 1	60	34	1.12	\$303	\$101
BRTWS3036	30 x 36 x 1	65	30	1.06	\$216	\$73
BRTWS3663	36 x 62.5 x 1	65	53	1.94	\$568	\$147
BRTWS3651	36 x 50.5 x 1	65	43	1.71	\$505	\$84

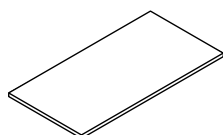

Rectangular Worksurface

Flat 3 mm edge profile on all sides.

BRTWSAA2484	24 x 84 x 1	60	51	1.70	\$540	\$262
BRTWSAA2478	24 x 78 x 1	60	47	1.54	\$511	\$234
BRTWSA2472	24 x 72 x 1	60	47	1.54	\$470	\$216
BRTWSA2466	24 x 66 x 1	60	43	1.41	\$436	\$187
BRTWSA2460	24 x 60 x 1	60	39	1.30	\$401	\$170
BRTWSA2454	24 x 54 x 1	65	35	1.20	\$356	\$162
BRTWSA2448	24 x 48 x 1	65	31	1.06	\$322	\$145
BRTWSA2442	24 x 42 x 1	60	28	.90	\$286	\$127
BRTWSAA3084	30 x 84 x 1	60	64	2.10	\$641	\$317
BRTWSAA3078	30 x 78 x 1	65	59	2	\$604	\$297
BRTWSA3072	30 x 72 x 1	65	59	2	\$559	\$259
BRTWSA3066	30 x 66 x 1	60	54	1.80	\$524	\$232
BRTWSA3060	30 x 60 x 1	65	49	1.77	\$470	\$216
BRTWSA3054	30 x 54 x 1	60	44	1.44	\$426	\$196
BRTWSA3048	30 x 48 x 1	65	39	1.41	\$381	\$170
BRTWSA3042	30 x 42 x 1	60	34	1.12	\$338	\$152

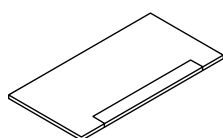

Rectangular Worksurface with Access Door

Flat 3 mm edge profile on all sides. Worksurfaces 42" to 72" w have one access door. 78" w and 84" w worksurfaces have two access doors. Access door is offset 13.5" from either side of work surface. Anodized aluminum work surface door provides access to power/data trough below work surface. Work surface with access doors CANNOT be combined with above work surface power trough.

BRTWBE2451R	24 x 50.5 x 1	65	31	1.06	\$322	\$104
BRTWBE2463R	24 x 62.5 x 1	65	39	1.41	\$373	\$123
BRTWBE3051R	30 x 50.5 x 1	65	39	1.41	\$348	\$104
BRTWBE3063R	30 x 62.5 x 1	65	49	1.77	\$388	\$131

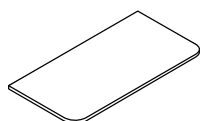

Rectangular Boardroom Table Top Extension, Round Corners

Flat 3 mm edge profile on all sides. Boardroom table extensions convert existing 24" or 30" deep back-to-back Bridges table assembly into a boardroom table. 24" and 30" d rectangular top with round corner can only be supported by 34" double leg and extension beams. *No freestanding and mobile application.*

Required Specifications

Top finish
Edge finish

Optional Specifications

HP laminate

WORKSURFACES

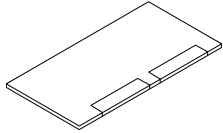

Rectangular Worksurface with 2 Access Doors

MODEL#	DIMENSIONS D x W x H	FREIGHT CLASS	WT/LBS.	CUBIC FT.	LIST PRICE	HP ADD
BRTWSAA2484	24 x 84 x 1	60	51	1.70	\$540	\$262
BRTWSAA2478	24 x 78 x 1	60	47	1.54	\$511	\$234
BRTWSAA2472	24 x 72 x 1	60	43	1.41	\$505	\$233
BRTWSAA2466	24 x 66 x 1	60	39	1.30	\$470	\$205
BRTWSAA2460	24 x 60 x 1	65	35	1.20	\$432	\$184
BRTWSAA3084	30 x 84 x 1	60	64	2.10	\$641	\$317
BRTWSAA3078	30 x 78 x 1	65	59	2	\$604	\$297
BRTWSAA3072	30 x 72 x 1	60	54	1.80	\$599	\$280
BRTWSAA3066	30 x 66 x 1	65	49	1.77	\$565	\$247
BRTWSAA3060	30 x 60 x 1	60	44	1.44	\$505	\$233

Flat 3 mm edge profile on all sides. Access doors are offset 10" (60" worksurfaces) and 13.5" (worksurfaces 66" and wider) from either side of worksurface. Anodized aluminum worksurface doors provide access to power/data trough below worksurface. Worksurfaces with access doors CANNOT be combined with above worksurface power troughs. Dimension between doors is 8" for 60" and 66" surfaces, 20" for 78", and 26" for 84".

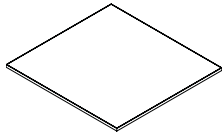

Meeting Table Top

BRTWS2451	24 x 50.5 x 1	65	31	1.06	\$326	\$104
BRTWS3051	30 x 50.5 x 1	65	39	1.41	\$342	\$109
BRTWS3651	36 x 50.5 x 1	65	43	1.71	\$505	\$84
BRTWS4251	42 x 50.5 x 1	65	48	1.93	\$559	\$150
BRTWS4851	48 x 50.5 x 1	65	52	2.07	\$635	\$166
BRTWS5151	50.5 x 50.5 x 1	65	55	2.12	\$680	\$157
BRTWS5451	54 x 50.5 x 1	65	59	2.19	\$734	\$205
BRTWS6051	60 x 50.5 x 1	65	63	2.26	\$835	\$210
BRTWS2463	24 x 62.5 x 1	65	39	1.41	\$367	\$125
BRTWS3063	30 x 62.5 x 1	65	49	1.77	\$379	\$127
BRTWS3663	36 x 62.5 x 1	65	53	1.94	\$568	\$147
BRTWS4263	42 x 62.5 x 1	65	57	2.07	\$680	\$178
BRTWS4863	48 x 62.5 x 1	65	61	2.13	\$816	\$206
BRTWS5463	54 x 62.5 x 1	65	63	2.21	\$917	\$231
BRTWS6063	60 x 62.5 x 1	65	67	2.34	\$1021	\$253

Can create convenient, flexible extension of the back-to-back Bridges table assembly. Worksurfaces provided with pilot holes for alignment purposes.

- Meeting table top 50.5" long side matches 24" deep back-to-back Bridges table assembly
- Meeting table top 62.5" long side matches 30" deep back-to-back Bridges table assembly



120° Worksurface

BRTWAC120424224	24 x 42 x 1	65	31	1.06	\$805	\$264
BRTWAC120424230	30 x 42 x 1	65	39	1.41	\$877	\$268

5-sided worksurface can be used for a single, freestanding table, can form a pod of two or three tables, or can be combined with rectangular worksurfaces to create a larger workstation.

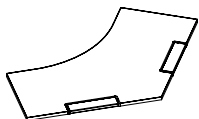

120° Worksurface with Access Door

BRTWAC120A424224	24 x 42 x 1	65	31	1.06	\$857	\$287
BRTWAC120A424230	30 x 42 x 1	65	39	1.41	\$926	\$360

5-sided worksurface can be used for a single, freestanding table, can form a pod of two or three tables, or can be combined with rectangular worksurfaces to create a larger workstation. Access door is offset 13.5" from either side of worksurface. Anodized aluminum worksurface door provides access to power/data trough below worksurface. Worksurface with access doors CANNOT be combined with above worksurface power trough.

Required Specifications

Top finish
Edge finish

Optional Specifications

HP laminate

WORKSURFACES

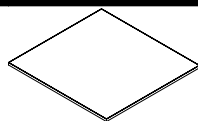

Rectangular Meeting Table Top*

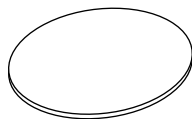

Round Meeting Table Top*

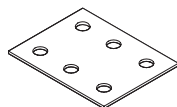

Flat Bracket

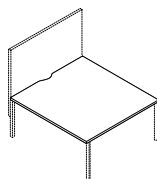

Display Wall Table Top w/Scoop*

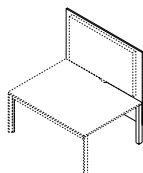

Monitor Facing Double Workstation**

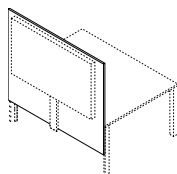

Monitor Facing Back of Double Workstation**

MODEL#	DIMENSIONS	FREIGHT CLASS	WT./LBS.	CUBIC FT.	LIST PRICE	HP ADD
--------	------------	---------------	----------	-----------	------------	--------

D x W x H

BRTMT5151	50.5 x 50.5 x 1	65	55	2.12	\$639	\$356
-----------	-----------------	----	----	------	-------	-------

50.5" long side matches 24" d back-to-back table assembly.

BRTMTR42	42 x 42 x 1	65	40	1.76	\$426	\$108
----------	-------------	----	----	------	-------	-------

BHBF01	4 x 3	70	.50	.01	\$20	
--------	-------	----	-----	-----	------	--

Constructed of cold rolled steel. May be used to ensure alignment of neighboring worksurfaces.

BRTWS6051SCP	60 x 50.5 x 1	60	75	1.75	\$817	\$207
BRTWS5451SCP	54 x 50.5 x 1	60	68	1.58	\$721	\$201
BRTWS4863SCP	48 x 62.5 x 1	60	75	1.74	\$800	\$202

BRTWS6063SCP	60 x 62.5 x 1	60	93	2.17	\$1000	\$247
BRTWS5463SCP	54 x 62.5 x 1	60	84	1.95	\$901	\$226
BRTWS4863SCP	48 x 62.5 x 1	60	75	1.74	\$800	\$202

Display wall mounts to the end of back-to-back table assembly supported by rectangular legs. As opposed to two separate back-to-back worksurfaces, the display wall table top provides one continuous, uninterrupted surface with a scoop cutout next to the display wall (the scoop facilitates cable passage from below the table). Table top 50.5" w side matches 24" d back-to-back table assemblies. Meeting table tops 62.5" w side matches 30" d back-to-back table assemblies.

BRTTVF63	4 x 62.5 x 52	100	74	7.52	\$1597	
BRTTVF51	4 x 50.5 x 52	92.5	62	6.08	\$1511	

Display wall faces the double workstation; facilitates seated presentation area. Includes laminate board, TV/display brackets (black), mounting hardware, vertical cable manager (black). Slim (22mm) bracket capable of supporting displays/TVs up to 50" (resp. 62") wide, up to 80lbs. When installed, top of the 52" x 50.5" (resp. 62.5") wide board reaches 65.5"h. 1" LP laminate board with 3mm edging. Specify **WHB** to add HP white, dry-erase marker board laminate on non-display board surface and standard HP laminate on the opposite side. Display wall mounts to the end of back-to-back table assembly supported by rectangular legs or back-to-back table structure with BRTWSxxxxSCP Display Wall Table Top with Scoop.

- Included vertical cable manager passes through the gap between 2 back-to-back worksurfaces. Should you need one continuous, uninterrupted surface specify BRTWSxxxxSCP Display Wall Table Top with Scoop.
- Add **\$1036** for white, dry erase on 51" w model, and **\$1383** for 63" w

BRTTVBK63	4 x 62.5 x 52	100	74	7.52	\$1597	
BRTTVBK51	4 x 50.5 x 52	92.5	62	6.08	\$1511	

Display wall support board mounts to end of back-to-back table assembly supported by rectangular legs. Display faces back of the double workstation (combine with collaborative seating). Includes laminate board, TV/display brackets (black), mounting hardware, vertical cable manager (black). Slim (22mm) bracket capable of supporting displays/TVs up to 50" (resp. 62") wide, up to 80lbs. When installed, top of the 52" x 50.5" (resp. 62.5") wide board reaches 65.5"h. 1" LP laminate board with 3mm edging. Specify **WHB** to add HP white, dry-erase marker board laminate on non-display board surface and standard HP laminate on the opposite side. Display wall mounts to the end of back-to-back table assembly supported by rectangular legs or back-to-back table structure with BRTWSxxxxSCP Display Wall Table Top with Scoop.

- Add **\$1036** for white, dry erase on 51" w model, and **\$1383** for 63" w

Required Specifications

Top finish
Edge finish

Optional Specifications

HP laminate

POWER DELIVERY / CABLE MANAGEMENT

D x W x H

At the basic level, table and floor based office equipment is serviced by a wall or floor power supply. As the operation grows, there might be a need to organize excessive cable clutter.

Wire Basket (1) connects to the underside of worksurfaces with sprig brackets, and cables are simply dropped and coiled into them. *Wire Basket is not to be used with power troughs.*

Cable Snake (2) Installed in proximity of floor monument to manage vertical cable clutter..

Table clamped, single circuit **Desk Top Power Data Modules (3)** deliver services to desk height, while tapping into wall or floor power supply. Again, the excessive cables can be managed with Cable Trays.

Ceiling pole **BRTCPP (4)** manages power and data cables between ceiling and above or below worksurface power troughs.

Above and Below Worksurface Power/Data Troughs (5) can be installed between back-to-back tables for extended below and above desk height power/data distribution. 8 wire, 4-circuit system. (2 + 2 circuit configuration)

NOTE: Specify **BRTHH58 (8)** to distribute power from double-sided, back-to-back below worksurface power trough to a single-sided, below worksurface power trough at the end of a table run.

Leg shroud (9) attaches to 34" w legs and manages power floor feed, as well as data cables from floor monument.

Single Sided Power/Data Troughs (6) can be installed to the underside of a single table.

Storage power/data box BRTVCM (7) attaches to storage units and provides access to one duplex/data terminal on top storage surface. Integrated single circuit module can be plugged to floor monument under the storage or to a wall outlet

4-2-2 Wiring Schematic

8-Wire Shared Neutral

"2 + 2" - 2 Utility Circuits, 2 Dedicated

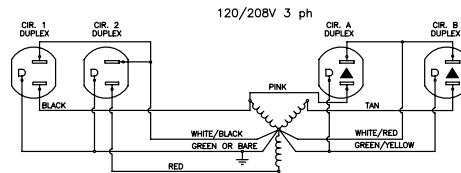
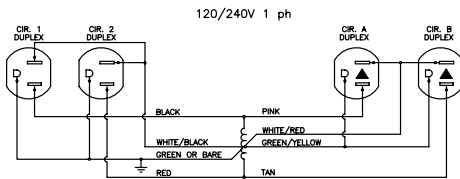

8 Wires

4 Lines (12 ga.)
2 Neutrals (10 ga.)
2 Grounds (12 ga.)

4 Circuits

2 Utility circuits
2 Dedicated Circuits

Receptacles

Duplex - Up to 12 duplex receptacles per circuit
(Up to 48 per infeed)

Specifications

System rated for connection to a grounded 120/240 V single phase, 20A, 60Hz or 120/208 V, 3 phase, 20A, 60Hz branch circuit for U.S. and 15A if product is marked with a C-UL Mark. Outlets rated 15A max.

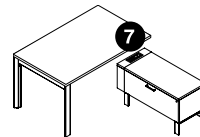
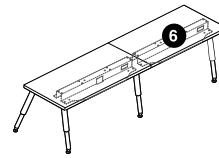
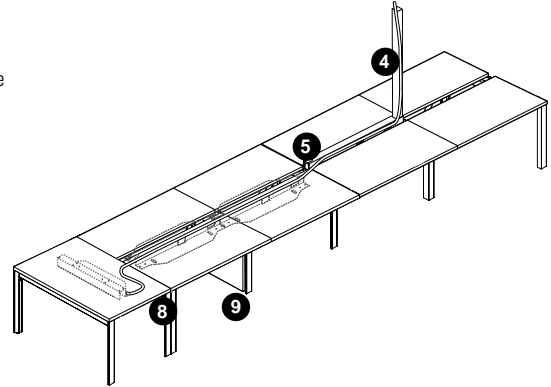
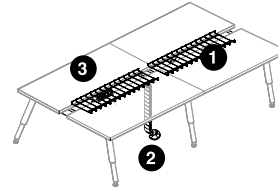

POWER DELIVERY / CABLE MANAGEMENT

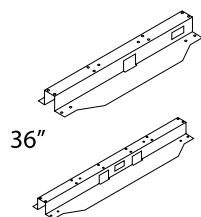

42" - 72"

Below Worksurface Single Power/Data Trough

MODEL# DIMENSIONS FREIGHT CLASS WT/LBS. CUBIC FT. LIST PRICE

D x W x H

MODEL#	DIMENSIONS	FREIGHT CLASS	WT/LBS.	CUBIC FT.	LIST PRICE
BRTEETB84SKIT	11.6 x 78.34 x 2.5	100	12	1.31	\$1026
BRTEETB78SKIT	11.6 x 72.34 x 2.5	100	11	1.21	\$982
BRTEETB72SKIT	11.6 x 66.34 x 2.5	100	9.80	1.11	\$639
BRTEETB66SKIT	11.6 x 60.34 x 2.5	100	8.90	1.01	\$618
BRTEETB60SKIT	11.6 x 54.34 x 2.5	100	8	.91	\$595
BRTEETB54SKIT	11.6 x 48.34 x 2.5	100	7.10	.81	\$583
BRTEETB48SKIT	11.6 x 42.34 x 2.5	100	6.20	.71	\$559
BRTEETB42SKIT	11.6 x 36.34 x 2.5	100	5.30	.61	\$516
BRTEETB36SKIT	11.6 x 30.34 x 2.5	125	4.50	.59	\$470

Formed steel trough is secured below a single table worksurface; outlets are facing the rear worksurface edge. Cannot be used on back-to-back tables. Specify Duplex receptacles separately. *Covers for duplex openings are not supplied.* 36" trough can house one duplex and 42-72" trough can house two duplexes. Specify jumpers between tables separately. Base feed entry at either end and not suitable for ceiling feed. Each trough provides one opening at 1.37" x 2.68" for terminal plate (not supplied). One terminal plate can accommodate up to 4 data/communication terminals (jacks). Data/comm plate spacer BRTPDS available to accommodate larger cable-to-terminal bending radius.

- BRTEETB36SKIT through BRTEETB72SKIT consist of one single sided steel trough, Power Distribution housing, mounting brackets and one charcoal grey extruded Data/Communication cable manager.
- BRTEETB78SKIT and BRTEETB84SKIT consist of two single-sided steel troughs, two Power Distribution Housings, mounting brackets and two charcoal grey extruded Data/Communication cable managers.
- BRTEETB78SKIT includes (1) BRTEETB36SKIT, (1) BRTEETB42SKIT and (1) JUMPER
- BRTEETB84SKIT includes (2) BRTEETB42SKIT and (1) JUMPER
- For 120° table applications, please specify BRTEETB36SKIT single trough kit for tables with BRTWAC120xx and BRTWAC120Axx worksurfaces. BRTEHH28 may be used as usual.
- Specify duplex receptacles separately
- Each trough includes one black BRTPDS Data/Comm spacer, extending the depth behind the Data/Comm opening by 0.6". White (BRTPDSW) and Silver (BRTPDSS). Data/Comm spacers are available as a special order for **\$53** list, see BRTPDS.

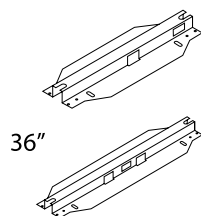

36"

42" - 72"

Below Worksurface Double Power/Data Trough

BRTEETB84DKIT	8.5 x 78.3 x 2.5	92.5	9.80	.96	\$1325
BRTEETB78DKIT	8.5 x 72.3 x 2.5	92.5	9	.88	\$1306
BRTEETB72DKIT	8.5 x 66.3 x 2.5	92.5	8.30	.81	\$770
BRTEETB66DKIT	8.5 x 60.3 x 2.5	92.5	7.50	.74	\$753
BRTEETB60DKIT	8.5 x 54.3 x 2.5	92.5	6.80	.66	\$727
BRTEETB54DKIT	8.5 x 48.3 x 2.5	92.5	6	.59	\$708
BRTEETB48DKIT	8.5 x 42.3 x 2.5	92.5	5.30	.52	\$691
BRTEETB42DKIT	8.5 x 36.3 x 2.5	92.5	4.50	.44	\$663
BRTEETB36DKIT	8.5 x 30.3 x 2.5	92.5	3.80	.37	\$647

Formed steel trough is secured below worksurface; outlets between back-to-back stations supported by double table legs. Cannot be used on single table assemblies. Specify Duplex receptacles separately. *Covers for duplex openings are not supplied.* 36" trough can house one duplex per side and 42-72" trough can house two duplexes per side. Specify jumpers between tables separately. Ceiling feed entry through slots at either end; base feed entry at either end. Each trough provides one opening at 1.37" x 2.68" (one per side) for data/communication terminal plates. A single terminal plate (not supplied) can accommodate up to 4 data/communication plates. Data/comm plate spacer BRTPDS available to accommodate larger cable-to-terminal bending radius.

- BRTEETB36DKIT through BRTEETB72DKIT consist of one double-sided steel trough, Power Distribution housing, mounting brackets and one charcoal grey extruded Data/Communication cable manager.
- BRTEETB78DKIT and BRTEETB84DKIT consist of two double-sided steel troughs, two Power Distribution Housings, mounting brackets and two charcoal grey extruded Data/Communication cable managers.
- BRTEETB78DKIT includes (1) BRTEETB36DKIT, (1) BRTEETB42DKIT and (1) JUMPER
- BRTEETB84DKIT includes (2) BRTEETD42SKIT and (1) JUMPER
- Each trough includes one black BRTPDS Data/Comm spacer, extending the depth behind the Data/Comm opening by 0.6". White (BRTPDSW) and Silver (BRTPDSS). Data/Comm spacers are available as a special order for **\$53** list, see BRTPDS.

Required Specifications

Metal Finish (Power/Data Troughs)

ELECTRICAL COMPONENTS

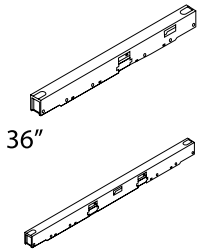

42" - 72"

Above Worksurface Power Trough

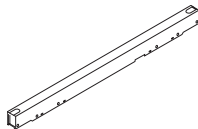

**Back-to-Back Storage Tower
Gap Filler Kit**

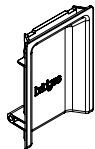

Above Worksurface Power Trough

MODEL#	DIMENSIONS D x W x H	FREIGHT CLASS	WT./LBS.	CUBIC FT.	LIST PRICE
BRTEETA84KIT	2.5 x 84 x 3.5	65	9.49	.42	\$1150
BRTEETA78KIT	2.5 x 78 x 3.5	65	8.81	.39	\$1106
BRTEETA72KIT	2.5 x 71.9 x 3.5	65	8.12	.36	\$727
BRTEETA66KIT	2.5 x 65.9 x 3.5	65	7.45	.33	\$718
BRTEETA60KIT	2.5 x 59.9 x 3.5	65	6.77	.30	\$663
BRTEETA54KIT	2.5 x 53.9 x 3.5	65	6.09	.27	\$647
BRTEETA48KIT	2.5 x 47.9 x 3.5	65	5.41	.24	\$612
BRTEETA42KIT	2.5 x 41.9 x 3.5	65	4.73	.21	\$576
BRTEETA36KIT	2.5 x 35.9 x 3.5	65	4.06	.18	\$532

Formed steel trough is secured between back-to-back stations. Cannot be used on single table assemblies. Specify Duplex receptacles separately. *Covers for duplex openings are not supplied.* 36" trough side. Specify jumpers between tables separately. Ceiling feed entry through can house one duplex per side and 42-72" trough can house two duplexes per slots at either end; base feed entry at either end. Each trough provides two openings at 1.37" x 2.68" (one per side) for data/communication terminal plates. A single terminal plate (not supplied) can accommodate up to 4 data/comm plates. Data/comm plate spacer BRTPDS available to accommodate larger cable-to-terminal bending radius.

- BRTEETA36KIT through BRTEETA72KIT consist of one double-sided steel trough, Power Distribution Housing, mounting brackets and one charcoal grey extruded Data/Communication cable manager.
- BRTEETA78KIT and BRTEETA84KIT consist of two double-sided steel troughs, two Power Distribution Housings, mounting brackets and two charcoal grey extruded Data/Communication cable managers.
- BRTEETA78KIT includes (1) BRTEETA36KIT, (1) BRTEETA42KIT and (1) JUMPER
- BRTEETA84KIT includes (2) BRTEETA42KIT and (1) JUMPER
- Specify above worksurface power trough end cap BRTEETEC to finish open ends of the power trough
- Each trough includes one black BRTPDS Data/Comm spacer, extending the depth behind the Data/Comm opening by 0.6". White (BRTPDSW) and Silver (BRTPDSS). Data/Comm spacers are available as a special order for **\$53** list, see BRTPDS.

BRTEST15KIT	15.5 x 2.5 x 3.5	65	2	.08	\$479
BRTEST24KIT	24 x 2.5 x 3.5	70	2.50	.12	\$520
BRTEST30KIT	31 x 2.5 x 3.5	70	3.50	.16	\$554
BRTEST48KIT	48 x 2.5 x 3.5	70	4	.24	\$611

Consists of a formed sheet metal cover and four brackets which allow the cover to be mounted at either above worksurface power trough level or below worksurface power trough level. Versatile brackets secure the cover trough at corners, to the bottom of back-to-back worksurface supported by either shared 51" or 63" legs or storage beam and storage towers.

- Note: the back-to-back storage tower gap filler is not compatible with single, freestanding tables.
- The BRTEST15kit and BRTEST24kit cover the gap between two back-to-back BRTT5024x or BRTT5030x storage towers
- The BRTEST30kit and BRTEST48kit cover the gap between two pairs of back-to-back BRTT5024x or BRTT5030x storage towers

BRTEETEC	.5 x 2.25 x 3	70	.10	.01	\$10
----------	---------------	----	-----	-----	-------------

Covers the end of the worksurface power trough. Specify two per linear trough assembly. White finish only.

Required Specifications

Metal Finish (Power/Data Troughs)

ELECTRICAL COMPONENTS

MODEL# DIMENSIONS FREIGHT CLASS WT./LBS. CUBIC FT. LIST PRICE

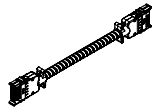

Housing to Housing Harness

D x W x H

BRTEHH28	.5 x 28 x 2	70	1	1.17	\$162
BRTEHH40	.5 x 40.5 x 2	70	1.10	1.25	\$173
BRTEHH44	.5 x 44.5 x 2	70	1.5	1.17	\$187
BRTEHH52	.5 x 52.5 x 2	300	2.0	1.17	\$197
BRTEHH58	.5 x 58.5 x 2	300	2.2	1.17	\$205
BRTEHH76	.5 x 76.5 x 2	250	2.8	1.17	\$229

Distributes power between Power Distribution Housings.

- BRTEHH28 distributes power between back-to-back troughs in a straight run.
- BRTEHH40 distributes power from back-to-back and single sided power troughs
- BRTEHH44 distributes power between back-to-back power troughs separated by (1) pair of storage cabinets without wardrobes. Specify BRTEST15KIT separately.
- BRTEHH52 distributes power from back-to-back power troughs separated by (1) pair of storage cabinets without wardrobes. Specify BRTEST24KIT separately.
- BRTEHH58 distributes power from back-to-back power troughs separated by (2) pairs of storage cabinets without wardrobes. Specify BRTEST30KIT separately.
- BRTEHH58 also distributes power from double-sided, back-to-back below worksurface power troughs to a single sided, below worksurface power trough at the end of a table run.
- BRTEHH76 distributes power from back-to-back power troughs separated by (2) pairs of storage cabinets without wardrobes. Specify BRTEST48KIT separately.

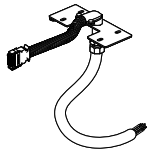

Base Feed

BRTEBF	6 x 4 x 72	250	4	2	\$492
BRTEBF120	6 x 4 x 120	250	6	2	\$686
BRTEBF144	6 x 4 x 144	150	8	2	\$738

Provides single power entry from floor or wall located building power supply. Connects to Power Distribution Housing. Must be hard wired to the building power supply by a licensed electrician.

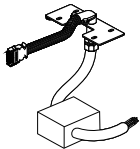

Base Feed - New York Electrical

BRTEBFK	6 x 4 x 100	250	4	2	\$773
---------	-------------	-----	---	---	--------------

Provides single power entry from floor or wall located building power supply. Connects to Power Distribution Housing. Must be hard wired to the building power supply by a licensed electrician.



Ceiling Pole

BRTCPP	1.5 x 4.75 x 99	65	13	.48	\$267
--------	-----------------	----	----	-----	--------------

Brings ceiling feed conduit and data cables from the ceiling down to Power Troughs at desk height. Accommodates 10' ceiling heights. Two part construction allows power/data conduit lay-in. Attaches to a junction between two adjacent Power Troughs in back-to-back applications only. Not for use on single sided Bridges II troughs. Includes mounting hardware and ceiling bezel. Painted Finish.

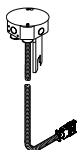

Ceiling Feed

BRTECF120	6 x 6 x 120	250	5	2	\$432
BRTECF144	6 x 6 x 144	250	5	2	\$481

Provides single power entry from ceiling, through ceiling pole into Power Trough, into Power Distribution Module. An 8 wire (4 circuit) metal conduit harness with included metal junction box for hard wiring to the building power supply above ceiling tile. Must be hard wired to the building power supply by a licensed electrician. Ceiling Pole not included.

Required Specifications

Metal Finish (BRTCPP)

ELECTRICAL COMPONENTS

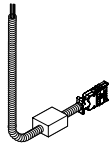

Ceiling Feed - New York Electrical

MODEL#	DIMENSIONS D x W x H	FREIGHT CLASS	WT./LBS.	CUBIC FT.	LIST PRICE
BRTECFK120	6 x 6 x 120	250	5	2	\$647
BRTECFK144	6 x 6 x 144	250	5	2	\$718

Provides single power entry from ceiling, through ceiling pole into Power Trough, into Power Distribution Module. An 8 wire (4 circuit) metal conduit harness with included metal junction box for hard wiring to the building power supply above ceiling tile. Must be hard wired to the building power supply by a licensed electrician. Ceiling Pole not included.

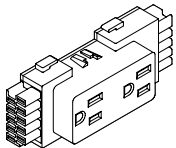

Duplex Receptacles

BRTE8D1	1.25 x 4.63 x 2	70	.10	.01	\$38
BRTE8D2	1.25 x 4.63 x 2	70	.10	.01	\$38
BRTE8DA	1.25 x 4.63 x 2	70	.10	.01	\$38
BRTE8DB	1.25 x 4.63 x 2	70	.10	.01	\$38
BRTE8DXW1	1.25 x 4.63 x 2	70	.10	.01	\$53
BRTE8DXW2	1.25 x 4.63 x 2	70	.10	.01	\$53
BRTE8DXWA	1.25 x 4.63 x 2	70	.10	.01	\$53
BRTE8DXWB	1.25 x 4.63 x 2	70	.10	.01	\$53

Snaps into Power Distribution Housing. Up to 13 duplex receptacles per circuit XW identifies white color plastic, all others standard in black.

- BRTE8D1 / BRTE8DXW1 - Circuit #1 (utility circuit)
- BRTE8D2 / BRTE8DXW2 - Circuit #2 (utility circuit)
- BRTE8DA / BRTE8DXWA - Circuit A (dedicated circuit)
- BRTE8DB / BRTE8DXWB - Circuit B (dedicated circuit)

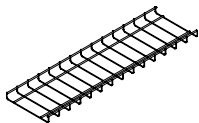

Power/Data Cable Basket

BRTCB76KIT	8 x 34 x 1	70	1.56	.15	\$239
BRTCB70	8 x 70 x 1	100	3.22	.34	\$173
BRTCB64	8 x 64 x 1	92.5	2.94	.29	\$161
BRTCB58	8 x 58 x 1	92.5	2.66	.26	\$156
BRTCB52	8 x 52 x 1	100	2.39	.24	\$147
BRTCB46	8 x 46 x 1	92.5	2.16	.21	\$139
BRTCB40	8 x 40 x 1	70	1.80	.18	\$131
BRTCB34	8 x 34 x 1	70	1.56	.15	\$126
BRTCB28	8 x 28 x 1	70	1.20	.13	\$111
BRTCB22	8 x 22 x 1	70	1.01	.10	\$104
BRTCB16	8 x 16 x 1	70	.73	.07	\$98
BRTCB8	8 x 8 x 1	70	.36	.03	\$88

Shallow, 8" wide basket manages cable excess and serves to manage cords and cables. It can be easily unclipped from spring steel brackets (included) to rearrange cable connections from below worksurface. Spring steel brackets can suspend the Cable Basket below storage cabinet's bottom where it keeps the cords and cables off the floor and manages them under storage cabinets along the horizontal plane - between floor monuments and Storage Vertical Cable Manager, for example. Tall storage cabinet's legs provide easy access to the Cable Basket where it can easily be unclipped from spring steel brackets to rearrange cable connections. Steel wire construction, chrome finish baskets; black spring steel hanging brackets, fasteners.

- Wide Cable Baskets can span under several storage cabinets. Specify Cable Basket a min. 8" shorter than the storage cabinet spine assembly.

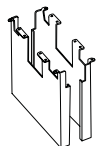

34" Leg Shroud

BRTDLSHS34	5 x 30 x 29	92.5	62	5.25	\$490
------------	-------------	------	----	------	--------------

A two part steel enclosure creates 5" deep and 30" wide cable management cavity between 34" rectangular table legs. Hides floor power feeds as well as data/communication cables rising from floor monuments to the underside of Bridges II tables. Secures to BRTBA34L rectangular leg and to underside of worksurfaces. Specify powder coat finish.

Required Specifications
Metal Finish (BRTDLSHS34)

ELECTRICAL COMPONENTS

**Cable Snake**

MODEL#	DIMENSIONS	FREIGHT CLASS	WT/LBS.	CUBIC FT.	LIST PRICE
	D x W x H				
BRTCS	2 x 8 x 30	70	3	.19	\$138

Flexible cable management trough. Two pathways within the snake, one for data/communication and one for routing power cables. Translucent White finish only.

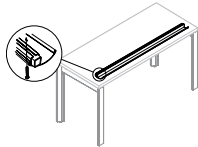
**Wire Manager**

BRTCM43	46 x 5 x 3	92.5	8	.67	\$56
BRTCM55	58 x 5 x 3	92.5	9	.85	\$65

Replacement wire manager can be added. Wire Manager neatly organizes and stores electrical and communication cables. Two lengths: 46" for tops 60" and under; 58" for tops 72". Black Plastic only.

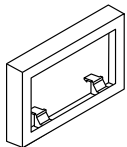
**Data/Comm Spacer**

BRTPDS	.6 x 4.75 x 2.04	70	.10	.01	\$53
BRTPDSW	.6 x 4.75 x 2.04	70	.10	.01	\$53
BRTPDSS	.6 x 4.75 x 2.04	70	.10	.01	\$53

Data/Comm plate spacer extends the depth behind data/comm jacks by 0.6" in order to accommodate larger data/comm cable bending radius. BRTPDS is Black, BRTPDSW is White and BRTPDSS is Silver.

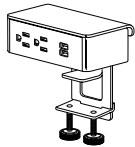
**Duo Module**

BRED50	3.2 x 5.5 x 1.8	70	2.50	.14	\$386
--------	-----------------	----	------	-----	--------------

The duo power module is completely integrated with a mounting clamp to attach to the edge of a worksurface. Provides two outlets and two 2.1 amp USB ports. White face plate, outlets and bracket; 72" long three-prong black cord, silver body.

**Duo Under Module**

BREDU51	2.8 x 5.5 x 1.8	70	2.50	.14	\$335
---------	-----------------	----	------	-----	--------------

The duo under power module comes with a thin flush mounting bracket to attach to the underside of a worksurface or above worksurface shelves. Provides two outlets and two 2.1 amp USB ports. White face plate, outlets and brackets; 72" long three-prong black cord, silver body.

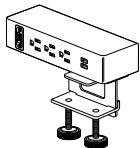
**Trio Plus Module**

BRETP53	3.2 x 8 x 1.8	70	2.50	.14	\$436
---------	---------------	----	------	-----	--------------

The trio plus power module is completely integrated with a mounting clamp to attach to the edge of a worksurface or above worksurface shelves. Provides three outlets and two 2.1 amp USB ports and an adapter kit containing blank cover, HDMI, RJ45 or VGA adapter brackets. Note: HDMI, RJ45 and VGA connectors are not included. White face plate, outlets, adapters and brackets; 72" long three-prong black cord.

ELECTRICAL COMPONENTS

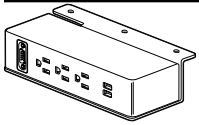

Trio Plus Under Module

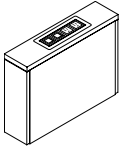

Vertical Cable Manager*

MODEL#	DIMENSIONS	FREIGHT CLASS	WT./LBS.	CUBIC FT.	LIST PRICE
--------	------------	---------------	----------	-----------	------------

	D x W x H				
BRETPU54	2.8 x 8 x 1.8	70	2.50	.14	\$406

The trio plus under power module comes with a thin flush mounting bracket to attach to the underside of a worksurface. Provides three outlets and two 2.1 amp USB ports and an adapter kit containing blank cover, HDMI, RJ45 or VGA adapter brackets. Note: HDMI, RJ45 and VGA connectors are not included. White face plate, outlets, adapters and brackets; 72" long three-prong black cord.

BRTVCM2118	18 x 6 x 21	92.5	14	1.31	\$971
BRTVCM2518	18 x 6 x 25	92.5	17	1.56	\$991
BRTVCM2124	24 x 6 x 21	100	17	1.75	\$1026
BRTVCM2524	24 x 6 x 25	92.5	22	2.08	\$1042

Facilitates power/data transfer from a floor monument under storage cabinets. The units can join other 18" or 24" deep storage units to form a storage spine. Removable top with a Below worksurface Power/Data Module provides easy access. Optional cable basket suspends off storage unit's bottom and manages cables along the horizontal plane. 1" top, unfinished cut-out edges. Universal connecting hardware included. Below Worksurface Power/Data Module included. Provides power - two outlets; 72"L 3-prong power cord. White face plate, outlets and coupler & jack adapters; anodized aluminum bracket supports; thumb screws, black cord. Provides data - two coupler/jack ports; includes Voice/Data Adapter Kit to accept various couplers & jacks (Not Included).

Required Specifications

- Top finish*
- Edge finish*
- Chassis finish*

ACCESSORIES / TABLE DIVIDERS MODEL# DIMENSIONS FREIGHT CLASS WT./LBS. CUBIC FT. LIST PRICE

- 9mm thick panels offered in 9 finishes
- Made from 100% PET (polyester) fiber with a high content (50%) of post-recycled material, free of added chemicals, binders and adhesives
- Lightweight panels are tackable, impact and tear resistant, bacteria resistant, moisture resistant, and installation friendly
- Variation in fiber mix and color are inherent to the character of the product

BRACKET/EXTRUSION FINISH

BLK	Black
CHR	Charcoal
DWT	Designer White
FOG	Fog
NEV	Nevada
SIL	Silver
TPE	Taupe
TUN	Tungsten
ANO	Anodized Aluminum - upcharge applies. Available on select models only. Refer to model for availability and upcharge.

FELT COLORS

BLK	Black	MTS	Mist
BRI	Brick	PWT	Pewter
DEN	Denim	SHR	Shamrock
GPH	Graphite	WHT	White
HVT	Harvest		

FELT DIVIDERS MODEL# DIMENSIONS FREIGHT CLASS WT./LBS. CUBIC FT. LIST PRICE

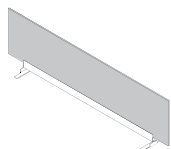

Back-to-Back Parallel Felt Divider

BRTAFDD84	7.5 x 81 x 16.88	125	6.30	1	\$645
BRTAFDD78	7.5 x 75 x 16.88	125	5.90	.92	\$615
BRTAFDD72	7.5 x 69 x 16.88	125	5.40	.85	\$586
BRTAFDD66	7.5 x 63 x 16.88	125	5	.77	\$555
BRTAFDD60	7.5 x 57 x 16.88	125	4.60	.70	\$524
BRTAFDD54	7.5 x 51 x 16.88	125	4.10	.63	\$496
BRTAFDD48	7.5 x 45 x 16.88	125	3.70	.55	\$349
BRTAFDD42	7.5 x 39 x 16.88	125	3.20	.48	\$309
BRTAFDD36	7.5 x 33 x 16.88	125	2.80	.41	\$277

Secures between two back-to-back tables; provides privacy, divides space. 9mm felt material is tackable. Installed divider measures 15.7" from the top of the worksurface. Available in 9 PET felt colors. Please specify. Brackets and extrusion available in all standard Bridges II paint finishes. 36"- 72" wide dividers include 2 support brackets. 78" and 84" wide dividers include 3.

- Anodized Aluminum extrusion - Add **\$149** list upcharge

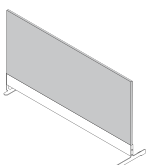

Perpendicular Side to Side Off Module Felt Divider

BRTAFPPD30M	6.5 x 30.24 x 16.85	100	2.60	.27	\$262
BRTAFPPD24M	6.5 x 24.24 x 16.85	100	2.10	.22	\$232

Secures off module to front and back edges of a table; provides privacy, divides space. 9mm felt material is tackable. 24M and 30M kits are designed to be installed on tables with **recessed** legs (round legs, 34" rectangular legs). Cannot be installed at the end of a run. Installed divider measures 15.7" from the top of the worksurface. Available in 9 PET felt colors. Please specify. Brackets and extrusion available in all standard Bridges II paint finishes.

- Anodized Aluminum extrusion - Add **\$149** list upcharge

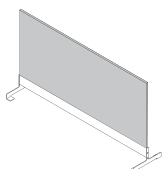

Perpendicular Side to Side Felt Divider

BRTAFPPD63S	6.5 x 62.81 x 16.85	100	4.20	.46	\$545
BRTAFPPD51S	6.5 x 50.81 x 16.85	100	4.20	.46	\$486
BRTAFPPD30S	6.5 x 30.24 x 16.85	92.5	2.70	.27	\$269
BRTAFPPD24S	6.5 x 24.24 x 16.85	92.5	2.30	.22	\$239

Secures to the front edge of both worksurfaces, regardless of type of leg support - supporting brackets can straddle over shared leg; provides privacy, divides space. 9mm felt material is tackable. Cannot be installed at the end of a run. Installed divider measures 15.7" from the top of the worksurface. Available in 9 PET felt colors. Please specify. Brackets and extrusion available in all standard Bridges II paint finishes.

- Anodized Aluminum extrusion - Add **\$149** list upcharge

Required Specifications

- Felt color
- Bracket/extrusion finish

Optional Specifications

- Anodized extrusion

FELT DIVIDERS

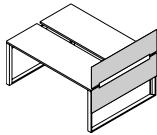
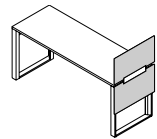

End of Run Felt Divider & Modesty Kit*

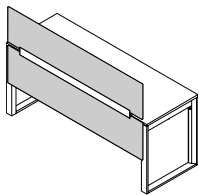

Felt Divider & Modesty Panel Kit*

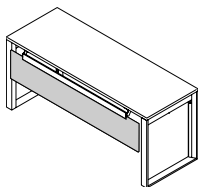

Felt Modesty Panel

MODEL#	DIMENSIONS D x W x H	FREIGHT CLASS	WT/LBS.	CUBIC FT.	LIST PRICE
BRTAFEDN24	4.05 x 25.46 x 30.68	250	3.3	1.12	\$402
BRTAFEDN30	4.05 x 31.46 x 30.68	250	3.98	1.29	\$451
BRTAFEDN51	4.05 x 50.56 x 30.68	150	6.22	1.46	\$829
BRTAFEDN63	4.05 x 62.56 x 30.68	150	7.57	1.63	\$944

Secures to the side bottom of a single or back-to-back table; provides privacy above and below the worksurface. 9mm felt material is tackable. Installed divider measures 15.7" from the top of the worksurface and 15" below the worksurface. Kit includes two felt dividers, support extrusion and left and right brackets. Available in 9 PET felt colors. Please specify. Brackets and extrusion available in all standard Bridges II paint finishes.

BRTAFDSN84	4.05 x 78 x 30.68	125	9.24	1.2	\$1128
BRTAFDSN78	4.05 x 72 x 30.68	125	8.57	1.11	\$1074
BRTAFDSN72	4.05 x 69 x 30.68	125	7.89	1.02	\$1021
BRTAFDSN66	4.05 x 63 x 30.68	125	7.21	0.93	\$890
BRTAFDSN60	4.05 x 57 x 30.68	125	6.54	0.84	\$850
BRTAFDSN54	4.05 x 51 x 30.68	125	5.87	0.74	\$798
BRTAFDSN48	4.05 x 45 x 30.68	125	5.19	0.65	\$660

Secures to the rear bottom of a single table; provides privacy above and below the worksurface. 9mm felt material is tackable. Installed divider measures 15.7" from the top of the worksurface and 15" below the worksurface. Kit includes two felt dividers, support extrusion and left and right brackets. Available in 9 PET felt colors. Please specify. Brackets and extrusion available in all standard Bridges II paint finishes.

- 66" - 84" dividers require 3 support brackets and cannot be used with worksurfaces that have a single access door.

BRTAFMPSN84	4.17 x 77.75 x 13.82	65	31.12	1.2	\$481
BRTAFMPSN78	4.17 x 71.75 x 13.82	65	28.72	1.11	\$456
BRTAFMPSN72	4.17 x 65.75 x 13.82	65	26.32	1.02	\$432
BRTAFMPSN66	4.17 x 59.75 x 13.82	65	23.92	0.93	\$408
BRTAFMPSN60	4.17 x 53.75 x 13.82	65	21.51	0.84	\$384
BRTAFMPSN54	4.17 x 47.75 x 13.82	65	19.11	0.74	\$368
BRTAFMPSN48	4.17 x 41.75 x 13.82	65	16.71	0.65	\$270

Secures to the rear bottom of a single table; provides privacy below the worksurface. 9mm felt material is tackable. Installed divider measures 15" below the worksurface. Kit includes felt modesty, support extrusion and left and right brackets. Available in 9 PET felt colors. Please specify. Brackets and extrusion available in all standard Bridges II paint finishes.

- 66" - 84" dividers require 3 support brackets and cannot be used with worksurfaces that have a single access door.

Required Specifications

Felt color
Bracket/extrusion finish

TABLE DIVIDERS

MODEL# DIMENSIONS FREIGHT CLASS WT./LBS. CUBIC FT. LIST PRICE

D x W x H

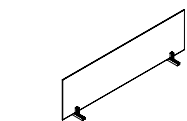

36" - 72"

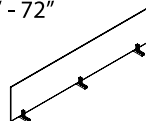

78" - 84"

Table Divider - Glass

BRTAGDD84	.25 x 81 x 16	60	29	.18	\$789
BRTAGDD78	.25 x 75 x 16	60	27	.17	\$744
BRTAGDD72	.25 x 69 x 16	60	25	.16	\$639
BRTAGDD66	.25 x 63 x 16	60	23	.14	\$595
BRTAGDD60	.25 x 57 x 16	60	21	.13	\$549
BRTAGDD54	.25 x 51 x 16	60	18	.11	\$524
BRTAGDD48	.25 x 45 x 16	60	16	.10	\$481
BRTAGDD42	.25 x 39 x 16	60	14	.09	\$444
BRTAGDD36	.25 x 33 x 16	60	12	.07	\$401

Secures between two back-to-back tables; provides privacy, divides space. Installed divider measures 15.7" from the top of the worksurface. 36" - 72" wide dividers include 2 support brackets. 78" and 84" wide dividers include 3. Frosted tempered glass. Satin chrome lower bracket, upper is available in all standard Bridges II paint finishes.

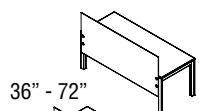

36" - 72"

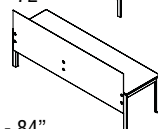

78" - 84"

Parallel Table Divider - Glass

BRTAGDS84	.25 x 81 x 32	60	55	.35	\$1504
BRTAGDS78	.25 x 75 x 32	60	51	.33	\$1430
BRTAGDS72	.25 x 69 x 32	60	47	.30	\$1197
BRTAGDS66	.25 x 63 x 32	60	43	.28	\$1125
BRTAGDS60	.25 x 57 x 32	60	39	.25	\$1052
BRTAGDS54	.25 x 51 x 32	60	35	.23	\$982
BRTAGDS48	.25 x 45 x 32	60	31	.20	\$909
BRTAGDS42	.25 x 39 x 32	60	27	.18	\$837
BRTAGDS36	.25 x 33 x 32	60	23	.15	\$767

Secures to the rear edge of a single table; provides privacy, divides space while not obstructing available light. 36" - 72" wide dividers include 2 support brackets. 78" and 84" wide dividers include 3. Frosted tempered glass. Satin chrome lower bracket, upper is available in all standard Bridges II paint finishes.

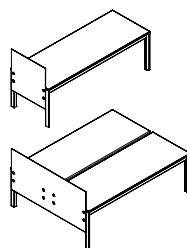

Perpendicular End of Run Divider - Glass

BRTAGED63	.25 x 62.5 x 32	60	35	.23	\$1577
BRTAGED51	.25 x 50.5 x 32	60	31	.20	\$1430
BRTAGED30	.25 x 30 x 32	60	27	.18	\$801
BRTAGED24	.25 x 24 x 32	60	23	.15	\$731

Secures to the rear edge of a single or double back-to-back table; provides privacy, divides space while not obstructing available light. Installed divider reaches 15.7" from the top of the worksurface and 15" below the worksurface. Rounded front top corner of 24" and 30" deep glass dividers. 51" and 63" glass dividers for back-to-back tables have both top corners rounded. 24" and 30" wide dividers include 2 support brackets; 51" and 63" wide dividers include 3. Frosted tempered glass. Satin chrome lower bracket, upper is available in all standard Bridges II paint finishes.

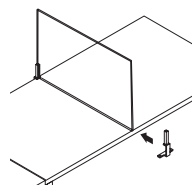

Shared Perpendicular Side to Side Divider, Middle - Glass, Rounded Corners

BRTAGPPD24M	.25 x 24 x 16	60	9	.06	\$459
BRTAGPPD30M	.25 x 30 x 16	60	11.25	.07	\$482

Provides privacy, divides space while not obstructing available light. 24M and 30M kits are designed to be installed on tables with **recessed** legs (round legs, 34" rectangular legs). 24" and 30" kits consist of a wide rear bracket, narrow front bracket (white powder coated steel), tempered glass with **rounded** top corners (acid etched on one side), bracket-fitting gaskets and mounting screws securing the brackets to the underside of the worksurface. Satin chrome lower bracket, upper is available in all standard Bridges II paint finishes.

Required Specifications

Bracket finish

TABLE DIVIDERS

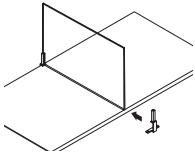

Shared Perpendicular Side to Side Divider, Middle - Glass, Square Corners

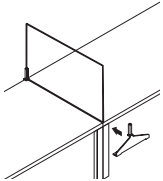

Shared Perpendicular Side to Side Divider, Seam - Glass, Rounded Corners

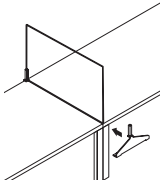

Shared Perpendicular Side to Side Divider, Seam - Glass, Square Corners

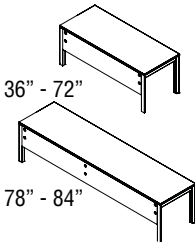

Modesty Panel - Glass

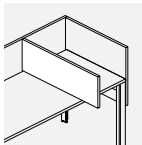

Perpendicular Laminate Side to Side Divider - Extended*

MODEL#	DIMENSIONS D x W x H	FREIGHT CLASS	WT/LBS.	CUBIC FT.	LIST PRICE
BRTAGPPD24MQ	.25 x 24 x 16	60	9	.06	\$459
BRTAGPPD30MQ	.25 x 30 x 16	60	11.25	.07	\$482

Provides privacy, divides space while not obstructing available light. 24M and 30M kits are designed to be installed on tables with **recessed** legs (round legs, 34" rectangular legs). 24" and 30" kits consist of a wide rear bracket, narrow front bracket (white powder coated steel), tempered glass with **square** top corners (acid etched on one side), bracket-fitting gaskets and mounting screws securing the brackets to the underside of the worksurface. Brackets are available in all standard Bridges II paint finishes.

BRTAGPPD24S	.25 x 24 x 16	60	9	.05	\$459
BRTAGPPD30S	.25 x 30 x 16	60	11.25	.07	\$482

Provides privacy, divides space while not obstructing available light. 24S and 30S kits are designed to be installed in the middle or over a seam of two adjacent worksurfaces supported by a shared, full depth **rectangular** leg. 24S and 30S kits consist of two wide rear brackets, wide front bracket, tempered glass with **rounded** top corners (acid etched on one side), bracket-fitting gaskets and mounting screws securing the brackets to the underside of the worksurface. Brackets are available in all standard Bridges II paint finishes.

BRTAGPPD24SQ	.25 x 24 x 16	60	9	.05	\$459
BRTAGPPD30SQ	.25 x 30 x 16	60	11.25	.07	\$482

Provides privacy, divides space while not obstructing available light. 24S and 30S kits are designed to be installed in the middle or over a seam of two adjacent worksurfaces supported by a shared, full depth **rectangular** leg. 24S and 30S kits consist of two wide rear brackets, wide front bracket, tempered glass with **square** top corners (acid etched on one side), bracket-fitting gaskets and mounting screws securing the brackets to the underside of the worksurface. Brackets are available in all standard Bridges II paint finishes.

BRTAGMPS84	.25 x 77.75 x 13.25	60	24	.14	\$982
BRTAGMPS78	.25 x 71.75 x 13.25	60	22	.13	\$947
BRTAGMPS72	.25 x 65.75 x 13.25	60	20	.12	\$749
BRTAGMPS66	.25 x 59.75 x 13.25	60	19	.11	\$712
BRTAGMPS60	.25 x 53.75 x 13.25	60	17	.10	\$676
BRTAGMPS54	.25 x 47.75 x 13.25	60	15	.09	\$641
BRTAGMPS48	.25 x 41.75 x 13.25	60	11	.06	\$606
BRTAGMPS42	.25 x 35.75 x 13.25	60	11	.06	\$568
BRTAGMPS36	.25 x 29.75 x 13.25	60	9	.05	\$533

Secures to the rear edge of a single table, between table legs; provides privacy. Installed divider reaches 15" below the worksurface. 36" - 72" wide modesty panels include 2 mounting brackets. 78" and 84" wide modesty panels include 3 mounting brackets. Tempered glass, acid etched on one side (similar to frosted), and satin chrome disc fasteners. Brackets are available in all standard Bridges II paint finishes.

BRTLPE36	.75 x 36 x 16	60	11	.25	\$273
BRTLPE30	.75 x 30 x 16	60	9	.21	\$238

Protrudes by 6" beyond the front worksurface edge for added privacy. Secures off-module or on-module to the front and back edge of worksurface, regardless of type of leg support - supporting brackets can straddle over shared leg. 3/4" LP PVC edge boards. Brackets are available in all standard Bridges II paint finishes.

- Specify BRTLPE30 for 24" d worksurfaces and BRTLPE36 for 30" d worksurfaces

Required Specifications

Chassis/Accent Finish (Laminate Dividers)
Bracket finish
Edge finish*

TABLE DIVIDERS



Perpendicular Laminate Side to Side Double Divider - Extended

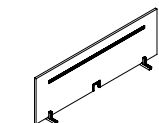

36" - 72"

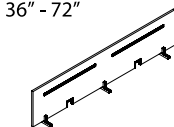

78" - 84"

Table Divider - Laminate

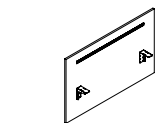

36" - 72"

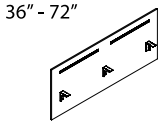

78" - 84"

High Table Divider - Laminate

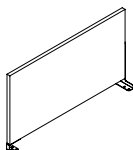

High Perpendicular Side-to-Side Divider - Laminate

MODEL#	DIMENSIONS	FREIGHT CLASS	WT/LBS.	CUBIC FT.	LIST PRICE
--------	------------	---------------	---------	-----------	------------

D x W x H

BRTLPDSE75	.75 x 75 x 16	60	22	.52	\$489
BRTLPDSE63	.75 x 63 x 16	60	18	.44	\$439

Protrudes by 6" beyond the front worksurface edge for added privacy. Installs on-module, between two BRTLPDD dividers. It is secured to the front edge of both worksurfaces, regardless of type of leg support - supporting brackets can straddle over shared leg. Brackets are available in all standard Bridges II paint finishes. 3/4" LP PVC edge boards.

- Can ONLY be installed on-module between two BRTLPDD dividers.
- Specify BRTLPDSE63 for 24"d back-to-back worksurfaces and BRTLPDSE75 for 30"d back-to-back worksurfaces

BRTLPDD84	.75 x 81 x 16	60	24	.56	\$594
BRTLPDD78	.75 x 75 x 16	60	23	.52	\$574
BRTLPDD72	.75 x 69 x 16	60	21	.47	\$458
BRTLPDD66	.75 x 63 x 16	60	19	.43	\$429
BRTLPDD60	.75 x 57 x 16	60	17	.39	\$409
BRTLPDD54	.75 x 51 x 16	60	15	.35	\$391
BRTLPDD48	.75 x 45 x 16	60	14	.31	\$370
BRTLPDD42	.75 x 39 x 16	60	12	.27	\$344
BRTLPDD36	.75 x 33 x 16	60	10	.22	\$312

Secures between two back-to-back tables; provides privacy, divides space. Installed divider measures 15.7" from the top of the worksurface. 36" - 72" wide dividers include 2 support brackets and one pass-through grommet. 78" and 84" wide dividers include 3 support brackets and 2 pass-through grommets. 3/4" PVC edged boards. Integrated anodized aluminum accessory rail, white cut out and rail trims. Brackets are available in all standard Bridges II paint finishes.

- Please refer to the **Compatibility Guide** on page 416 to determine available accessories

BRTLPDS84	.75 x 81 x 32	60	50	1.16	\$930
BRTLPDS78	.75 x 75 x 32	60	47	1.08	\$892
BRTLPDS72	.75 x 69 x 32	60	43	1	\$730
BRTLPDS66	.75 x 63 x 32	60	40	.91	\$691
BRTLPDS60	.75 x 57 x 32	60	36	.83	\$652
BRTLPDS54	.75 x 51 x 32	60	32	.75	\$603
BRTLPDS48	.75 x 45 x 32	60	29	.66	\$574
BRTLPDS42	.75 x 39 x 32	60	25	.56	\$535
BRTLPDS36	.75 x 33 x 32	60	22	.50	\$438

Installed on one side only. Secures to the back of a single table; provides privacy, divides space. Installed divider measures 15.7" from the top of the worksurface and 15" below the worksurface. 36" - 72" wide dividers include 2 support brackets. 78" and 84" wide dividers include 4 support brackets. 3/4" self edged boards. Integrated anodized aluminum accessory rail, white cut out and rail trims. Brackets are available in all standard Bridges II paint finishes. Integrated modesty panel.

- Please refer to the **Compatibility Guide** on page 416 to determine available accessories

BRTLPPD24	.75 x 24 x 16	60	7	.16	\$217
BRTLPPD30	.75 x 30 x 16	60	9	.20	\$236

Secures off-module to front and back edges of a table; provides privacy, divides space. Can be installed anywhere along worksurface or over the seam of two adjacent worksurfaces. Cannot be installed at the end of a run. Installed divider measures 15.7" from the top of the worksurface. 3/4" self edged boards. Brackets are available in all standard Bridges II paint finishes.

Required Specifications

Chassis/Accent finish
Bracket finish
Edge finish

TABLE DIVIDERS

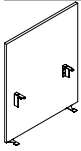

Perpendicular End of Run Divider, Laminate*

MODEL#	DIMENSIONS D x W x H	FREIGHT CLASS	WT/LBS.	CUBIC FT.	LIST PRICE
BRTLPE24	.75 x 24 x 32	60	7	.16	\$345
BRTLPE30	.75 x 30 x 32	60	9	.20	\$370
BRTLPE51	.75 x 50.5 x 32	60	15	.35	\$583
BRTLPE63	.75 x 62.5 x 32	60	19	.43	\$661

Secures to the side edge of a table; provides privacy, divides space. Installed divider measures 15.7" from the top of the worksurface and 15" below the worksurface. Integrated modesty panel. 3/4" self edged boards. Brackets are available in all standard Bridges II paint finishes. For Rectangular leg only.

- BRTLPE51 divider matches 24" deep back-to-back assemblies
- BRTLPE63 divider matches 30" deep back-to-back assemblies

TABLE DIVIDERS - FABRIC

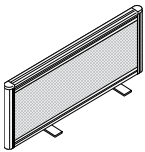

Table Divider - Fabric**

MODEL#	DIMENSIONS	YARDAGE	FREIGHT CLASS	WT/LBS.	CUBIC FT.	LIST PRICE
BR2AFD84	1.30 x 84 x 16	1	70	32	1.95	\$572
BR2AFD78	1.30 x 78 x 16	1	70	28	1.81	\$540
BR2AFD72	1.30 x 72 x 16	1	70	24	1.57	\$505
BR2AFD66	1.30 x 66 x 16	1	85	20	1.53	\$485
BR2AFD60	1.30 x 60 x 16	.50	92.5	15	1.39	\$485
BR2AFD54	1.30 x 54 x 16	.50	92.5	13	1.25	\$453
BR2AFD48	1.30 x 48 x 16	.50	85	11	.75	\$420
BR2AFD42	1.30 x 42 x 16	.50	100	9	.97	\$408
BR2AFD36	1.30 x 36 x 16	.50	100	8	.83	\$391

Attaches between Back-to-Back Tables for space division and privacy. Includes accessory rail along the top to hang accessories on both sides. Installed dividers measure 16" from the top of the worksurface. 36", 42" and 48" wide dividers include 2 brackets, all others include 3. To be used on corresponding table lengths. Extended third, central bracket can pass under worksurface access door. Dividers over 60" must have fabric railroaded. Brackets are available in all standard Bridges II paint finishes.

- Please refer to the **Compatibility Guide** on page 416 to determine available accessories

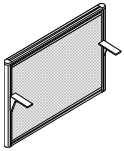

Table Divider - Fabric, Table Hung**

BR2AHD72	1.30 x 72 x 32	1	70	50	3	\$641
BR2AHD66	1.30 x 66 x 32	1	70	42	2.75	\$638
BR2AHD60	1.30 x 60 x 32	.60	85	36	2.50	\$648
BR2AHD54	1.30 x 54 x 32	.60	85	31	2.25	\$616
BR2AHD48	1.30 x 48 x 32	.50	85	28	2	\$590
BR2AHD42	1.30 x 42 x 32	.50	85	24	1.75	\$564
BR2AHD36	1.30 x 36 x 32	.40	85	19	1.50	\$529

Attaches to the rear edge of a table and serves as a privacy/modesty panel. Includes accessory rail along the top to hang accessories on both sides. Installed dividers measure 16" from the top of the worksurface and 15" below the worksurface. For round leg table assemblies only. To be used on corresponding table lengths. Dividers over 60" must have fabric railroaded. Brackets are available in all standard Bridges II paint finishes.

- Please refer to the **Compatibility Guide** on page 416 to determine available accessories

MODESTY PANEL

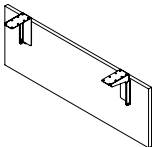

Laminate Modesty Panel*

MODEL#	DIMENSIONS	FREIGHT CLASS	WT/LBS.	CUBIC FT.	LIST PRICE
BRTMPS84	.75 x 78.5 x 14	60	22	.51	\$524
BRTMPS78	.75 x 72.5 x 14	60	20	.47	\$505
BRTMPS72	.75 x 66.5 x 14	60	19	.43	\$488
BRTMPS66	.75 x 60.5 x 14	60	17	.40	\$470
BRTMPS60	.75 x 54.5 x 14	60	16	.36	\$453
BRTMPS54	.75 x 48.5 x 14	60	14	.32	\$436
BRTMPS48	.75 x 42.5 x 14	60	13	.29	\$417
BRTMPS42	.75 x 36.5 x 14	60	11	.25	\$401
BRTMPS36	.75 x 30.5 x 14	60	9	.21	\$381

Secures to the back edge of a table; provides privacy, divides space. Installed divider measures 15" below the worksurface. 3/4" self edged boards. Flips down for easy access to underside of worksurface. Brackets are available in all standard Bridges II paint finishes.

Required Specifications

- Chassis/Accent finish*
- Edge finish*
- Panel fabric**
- Bracket finish

ACCESSORIES

MODEL# DIMENSIONS FREIGHT CLASS WT./LBS. CUBIC FT. LIST PRICE

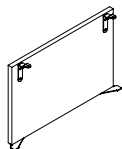

Laminate End of Run Gable*

	D x W x H				
BRTPEG24	.75 x 24 x 14	60	6	.14	\$224
BRTPEG24H21	.75 x 24 x 20.5	60	9	.21	\$260
BRTPEG24H27	.75 x 24 x 26.5	60	12	.26	\$303
BRTPEG30	.75 x 30 x 14	60	8	.18	\$241
BRTPEG30H21	.75 x 30 x 20.5	60	12	.26	\$276
BRTPEG30H27	.75 x 30 x 26.5	60	15	.33	\$321
BRTPEG51	.75 x 50.5 x 14	60	13	.30	\$391
BRTPEG51H21	.75 x 50.5 x 20.5	60	20	.43	\$474
BRTPEG51H27	.75 x 50.5 x 26.5	60	26	.56	\$549
BRTPEG63	.75 x 62.5 x 14	60	16	.38	\$426
BRTPEG63H21	.75 x 62.5 x 20.5	60	25	.53	\$507
BRTPEG63H27	.75 x 62.5 x 26.5	60	32	.69	\$583

Perpendicular end of a run gable. Secures to the side edge of a table/tables and legs; provides privacy, divides space. ¾" self edged boards. Brackets are available in all standard Bridges II paint finishes. **For Rectangular leg only.**

- BRTPEG24, 30, 51 and 63 measure 15" below worksurface
- BRTPEGxxH21 lines up with the bottom of storage cabinets
- BRTPEGxxH27 reaches down 1" from the floor (creates full panel look)

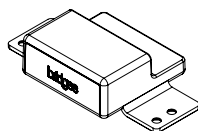
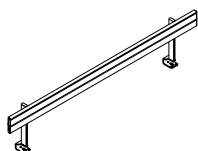

Table End Gap Filler

BRTTEGF	4.5 x 2.5 x 1	70	.03	.01	\$14
---------	---------------	----	-----	-----	------

Injection molded block fills the gap finishing the end of back-to-back table assemblies. Secures to the bottom of two back-to-back worksurfaces. Injection molded resin, white.



Single Table Accessory Rail

BRLBST84	2.95 x 81 x 13.5	70	10.24	.61	\$498
BRLBST78	2.95 x 75 x 13.5	70	9.69	.56	\$483
BRLBST72	2.95 x 69 x 13.5	70	9.15	.52	\$469
BRLBST66	2.95 x 63 x 13.5	70	8.61	.48	\$453
BRLBST60	2.95 x 57 x 13.5	70	8.07	.43	\$438
BRLBST54	2.95 x 51 x 13.5	70	7.52	.39	\$429
BRLBST48	2.95 x 45 x 13.5	70	6.98	.35	\$413
BRLBST42	2.95 x 39 x 13.5	70	6.44	.30	\$399
BRLBST36	2.95 x 33 x 13.5	65	5.90	.26	\$379

Table mounted accessory rail. Compatible with standard accessories. Includes end caps and mounting hardware.

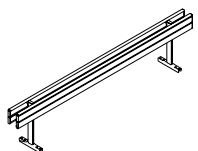

Back-To-Back Accessory Rail

BRLBB2B84	7.50 x 81 x 13.5	65	17.69	.74	\$821
BRLBB2B78	7.50 x 75 x 13.5	65	16.61	.69	\$791
BRLBB2B72	7.50 x 69 x 13.5	65	15.52	.63	\$762
BRLBB2B66	7.50 x 63 x 13.5	65	14.44	.58	\$733
BRLBB2B60	7.50 x 57 x 13.5	65	13.36	.53	\$704
BRLBB2B54	7.50 x 51 x 13.5	65	12.27	.48	\$683
BRLBB2B48	7.50 x 45 x 13.5	65	11.19	.42	\$652
BRLBB2B42	7.50 x 39 x 13.5	65	10.10	.37	\$623
BRLBB2B36	7.50 x 33 x 13.5	65	9.02	.32	\$587

Table mounted accessory rail. Compatible with standard accessories. Includes end caps and mounting hardware.

Required Specifications

Chassis/Accent finish*

Edge finish*

Bracket finish*

FRAMED DIVIDERS

D x W x H

Single Table Or Single Table Row Application; 16" and 30" high dividers

Table Mounted Framed Divider for single table or single table row; recessed 1.5" at both ends, mounted to the table with 0.6" gap at the back.
 BRTMFD/BRTMLD 36" (33" actual) - 66" (63" actual) dividers have 2 mounting brackets.
 BRTMFD/BRTMLD 72" (69" actual) - 84" (81" actual) dividers have 3 mounting brackets.

Perpendicular Single Table End of Run Framed Divider;
 BREFD/BRELD 24" (21" actual for 24" deep worksurfaces),
 BREFD/BRELD 30" (27" actual for 30" deep worksurfaces),
 BREFD/BRELD 36" (33" actual for 36" deep worksurfaces),

Two brackets secure the divider to the side edge of work surface. Flush with rear edge, 3" recessed from front work surface edge.

Perpendicular Shared Framed Divider;
 BRSEFD/BRSLD 24" (21" actual for 24" deep worksurfaces),
 BRSEFD/BRSLD 30" (27" actual for 30" deep worksurfaces),
 BRSEFD/BRSLD 36" (33" actual for 36" deep worksurfaces),

Single bracket secures the divider to the rear edge of worksurface; Can be mounted off-module or over the seam of two adjacent worksurfaces. Flush with the rear edge, 3" recessed from front worksurface edge.

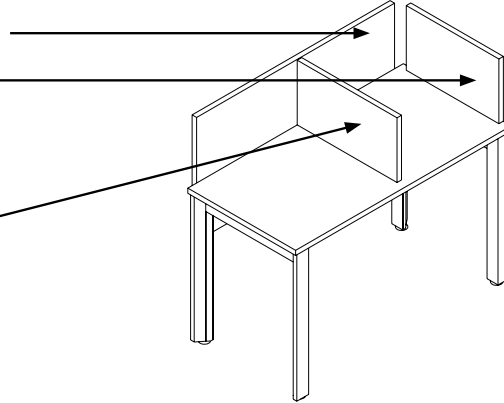

Back-To-Back Table Application; 16" dividers

Perpendicular Back 2 Back Parallel Framed Divider secured between two back-to-back tables; recessed 1.5" at both ends; 0.6" gap between the divider and work surfaces.
 BRPFD/BRPLD 36" (33" actual) - 66" (63" actual) dividers have 2 mounting brackets.
 BRPFD/BRPLD 72" (69" actual) - 84" (81" actual) dividers have 3 mounting brackets.

Perpendicular Shared Frame Back 2 Back Framed Divider;
 BRSEFD/BRSDLD 51" (45" actual for 24" deep back-to-back work surfaces)
 BRSEFD/BRSDLD 63" (57" actual for 30" deep back-to-back work surfaces).
 One bracket secures the divider through the gap between work surfaces; two brackets locate top of the divider between two adjacent Parallel dividers.
 NOTE: cannot be used on its own without the two Parallel dividers.
 3" recessed from front worksurface edges.

Perpendicular Back-To-Back End of Run Framed Divider;
 BREDFD/BRELDL 51" (45" actual for 24" deep back-to-back worksurfaces)
 BREDFD/BRELDL 63" (57" actual for 30" deep back-to-back worksurfaces).
 Three brackets secure the divider to both side edges of worksurfaces.
 3" recessed from front worksurface edges.

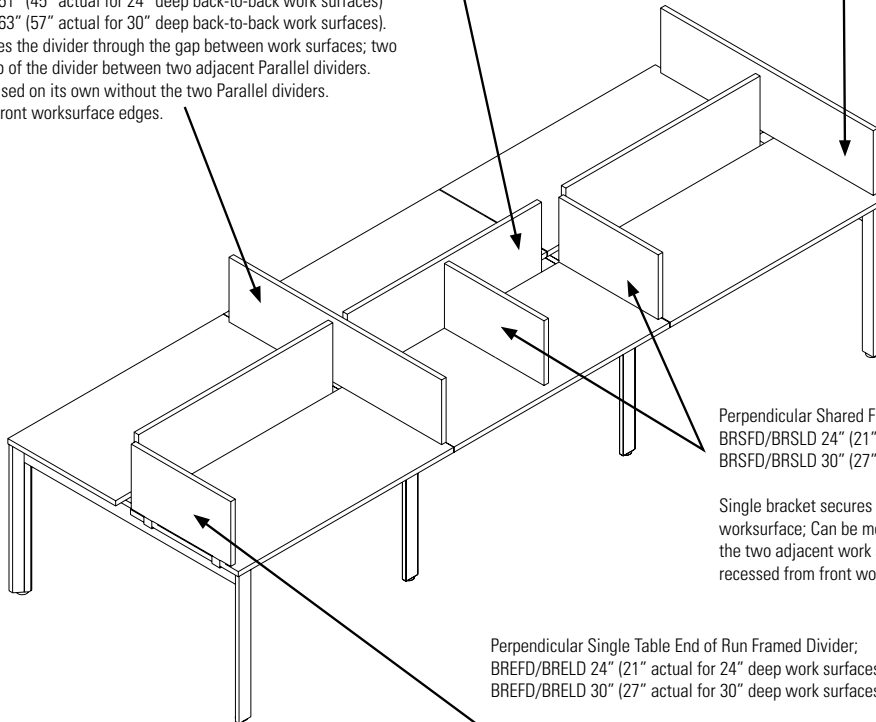

Perpendicular Shared Framed Divider;
 BRSEFD/BRSLD 24" (21" actual for 24" deep work surfaces).
 BRSEFD/BRSLD 30" (27" actual for 30" deep work surfaces).

Single bracket secures the divider to the rear edge of worksurface; Can be mounted off-module or over the seam of the two adjacent work surfaces. Flush with the rear edge, 3" recessed from front work surfaces edge.

Perpendicular Single Table End of Run Framed Divider;
 BREFD/BRELD 24" (21" actual for 24" deep work surfaces).
 BREFD/BRELD 30" (27" actual for 30" deep work surfaces).

Two brackets secure the divider to the side edge of work surface. Flush with the rear edge, 3" recessed from front work surface edge.

Required Specifications

Top finish
 Edge finish
 Metal finish (legs)

Optional Specifications

Anodized Aluminum Leg
 HP laminate

FRAMED DIVIDERS

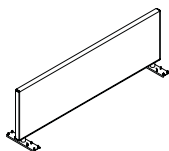

**Back-to-Back Parallel Framed Divider
Fabric**

MODEL#	DIMENSIONS D x W x H	FREIGHT CLASS	WT/LBS.	CUBIC FT.	LIST PRICE
BRPFD84	1.25 x 81 x 16	70	32	1.95	\$824
BRPFD78	1.25 x 75 x 16	70	28	1.81	\$782
BRPFD72	1.25 x 69 x 16	70	24	1.57	\$772
BRPFD66	1.25 x 63 x 16	85	20	1.53	\$742
BRPFD60	1.25 x 57 x 16	92.5	15	1.39	\$700
BRPFD54	1.25 x 51 x 16	92.5	13	1.25	\$590
BRPFD48	1.25 x 45 x 16	85	11	.75	\$559
BRPFD42	1.25 x 39 x 16	100	9	.97	\$485
BRPFD36	1.25 x 33 x 16	100	8	.83	\$474

Secures to the underside of the worksurface. Fabric divider is tackable and always railroaded. Installed divider measures 15.7" from top of worksurface. 36" to 54" dividers include 2 support brackets. 60" to 84" dividers include 3 support brackets. Brackets are available in all standard Bridges II paint finishes.

- 60" - 84" dividers require 3 support brackets and cannot be used with worksurfaces that have a single access door

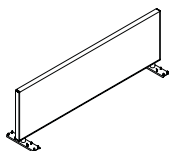

Back-to-Back Parallel Framed Divider

					LIST PRICE	HP ADD	DE ADD	DM ADD
BRPLD84	1.25 x 81 x 16	70	32	2.25	\$579	\$291	\$659	\$1678
BRPLD78	1.25 x 75 x 16	70	28	2.08	\$569	\$263	\$660	\$1672
BRPLD72	1.25 x 69 x 16	70	24	1.92	\$562	\$236	\$659	\$1660
BRPLD66	1.25 x 63 x 16	85	20	1.75	\$543	\$245	\$552	\$1509
BRPLD60	1.25 x 57 x 16	92.5	15	1.58	\$524	\$202	\$560	\$1410
BRPLD54	1.25 x 51 x 16	92.5	13	1.42	\$438	\$178	\$585	\$1434
BRPLD48	1.25 x 45 x 16	85	11	1.25	\$376	\$135	\$261	\$687
BRPLD42	1.25 x 39 x 16	100	9	1.08	\$333	\$108	\$222	\$592
BRPLD36	1.25 x 33 x 16	100	8	.92	\$317	\$99	\$199	\$522

Secures to the underside of the worksurface. Divider infill can be specified in low pressure laminate (**LP**), high pressure laminate (**HP**), dry erase whiteboard (**DE**) or dry erase magnetic whiteboard (**DM**). Installed divider measures 15.7" from top of worksurface. 36" to 54" dividers include 2 support brackets. 60" to 84" dividers include 3 support brackets. Brackets are available in all standard Bridges II paint finishes.

- 60" - 84" dividers require 3 support brackets and cannot be used with worksurfaces that have a single access door

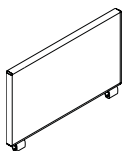

**Perpendicular Single Table End of Run
Framed Divider, Fabric**

					LIST PRICE
BREFD36	1.25 x 33 x 16	85	12	.92	\$418
BREFD30	1.25 x 27 x 16	85	11	.75	\$378
BREFD24	1.25 x 21 x 16	70	9	.58	\$367

Connects to the perpendicular end of a single or back-to-back table. Fabric divider is tackable and always railroaded. Installed divider measures 15.7" from top of worksurface. Divider comes with 2 support brackets. Two brackets secure the divider to the side edge of worksurface. Flush with the rear edge, 3" recessed from front worksurface edge. Brackets are available in all standard Bridges II paint finishes.

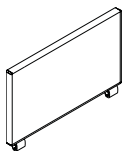

**Perpendicular Single Table End of Run
Framed Divider, Laminate**

					LIST PRICE	HP ADD	DE ADD	DM ADD
BRELD36	1.25 x 33 x 16	70	20	.92	\$273	\$100	\$199	\$310
BRELD30	1.25 x 27 x 16	65	17	.75	\$264	\$88	\$151	\$238
BRELD24	1.25 x 21 x 16	65	14	.58	\$237	\$73	\$137	\$208

Connects to the perpendicular end of a single or back-to-back table. Divider infill can be specified in low pressure laminate (**LP**), high pressure laminate (**HP**), dry erase whiteboard (**DE**) or dry erase magnetic whiteboard (**DM**). Installed divider measures 15.7" from top of worksurface. Divider comes with 2 support brackets. Two brackets secure the divider to the side edge of worksurface. Flush with the rear edge, 3" recessed from front worksurface edge. When dry erase magnetic whiteboard (**DM**) is specified it is applied user side ONLY and dry erase whiteboard (**DE**) is applied on the opposite side. Brackets are available in all standard Bridges II paint finishes.

Required Specifications

Fabric
Finish
Bracket finish

SHARED FRAMED DIVIDERS

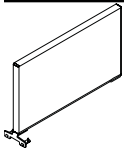

Perpendicular Shared Framed Divider, Fabric

MODEL#	DIMENSIONS D x W x H	FREIGHT CLASS	WT/LBS.	CUBIC FT.	LIST PRICE
BRSFD36	1.25 x 33 x 16	85	12	.92	\$408
BRSFD30	1.25 x 27 x 16	85	11	.75	\$367
BRSFD24	1.25 x 21 x 16	70	9	.58	\$356

Connects anywhere along and between worksurfaces to divide space and create privacy. Divider is fastened under the worksurface flush to the back of the table and recessed 3" from the front edge on the user side. Fabric divider is tackable and always railroaded. Installed divider measures 15.7" from top of worksurface. Divider comes with a support bracket at the back and a spacer plate with double sided adhesive at the front. Brackets are available in all standard Bridges II paint finishes.

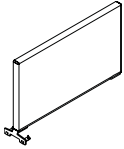

Perpendicular Shared Framed Divider, Laminate

					LIST PRICE	HP ADD	DE ADD	DM ADD
BRSLD36	1.25 x 33 x 16	70	20	.92	\$273	\$100	\$178	\$567
BRSLD30	1.25 x 27 x 16	65	17	.75	\$255	\$88	\$135	\$504
BRSLD24	1.25 x 21 x 16	65	14	.58	\$237	\$65	\$114	\$377

Connects anywhere along and between worksurfaces to divide space and create privacy. Divider is fastened under the worksurface flush to the back of the table and recessed 3" from the front edge on the user side. Divider infill can be specified in low pressure laminate (**LP**), high pressure laminate (**HP**), dry erase whiteboard (**DE**) or dry erase magnetic whiteboard (**DM**). Installed divider measures 15.7" from top of worksurface. Divider comes with a support bracket at the back and a spacer plate with double sided adhesive at the front. Brackets are available in all standard Bridges II paint finishes.

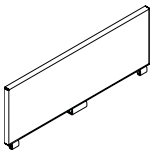

Perpendicular Back-to-Back End of Run Framed Divider, Fabric

					LIST PRICE
BREDFD63	1.25 x 57 x 16	85	21	1.58	\$646
BREDFD51	1.25 x 45 x 16	85	18	1.25	\$570

Connects to the end of run on a back-to-back tables to create privacy. Divider is fastened under the worksurface and recessed 3" from the user edge on either side. Fabric divider is tackable and always railroaded. Installed divider measures 15.7" from top of worksurface. Divider comes with 1 large and 2 small support brackets. Brackets are available in all standard Bridges II paint finishes.

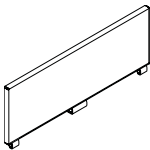

Perpendicular Back-to-Back End of Run Framed Divider, Laminate

					LIST PRICE	HP ADD	DE ADD	DM ADD
BREDLD63	1.25 x 57 x 16	70	32	1.58	\$474	\$202	\$510	\$844
BREDLD51	1.25 x 45 x 16	70	26	1.25	\$385	\$133	\$243	\$403

Connects to the end of run on a back-to-back tables to create privacy. Divider is fastened under the worksurface and recessed 3" from the user edge on either side. Divider infill can be specified in low pressure laminate (**LP**), high pressure laminate (**HP**), dry erase whiteboard (**DE**) or dry erase magnetic whiteboard (**DM**). Installed divider measures 15.7" from top of worksurface. Divider comes with 1 large and 2 small support brackets. When dry erase magnetic whiteboard (DM) is specified it is applied user side ONLY and dry erase whiteboard (DE) is applied on the opposite side. Brackets are available in all standard Bridges II paint finishes.

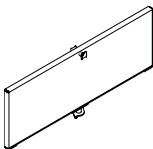

Perpendicular Back-to-Back Shared Framed Divider, Fabric

					LIST PRICE
BRSDFD63	1.25 x 57 x 16	85	20	1.58	\$613
BRSDFD51	1.25 x 45 x 16	85	17	1.25	\$536

Connects between parallel framed dividers for back-to-back tables to divide space and create privacy. Divider is fastened under the worksurface and recessed 3" from the user edge on either side. Fabric divider is tackable and always railroaded. Installed divider measures 15.7" from top of worksurface. Divider comes with 1 center support bracket, 2 spacer plates with adhesive and 2 top spacer clamps. Brackets are available in all standard Bridges II paint finishes.

- Cannot be used on its own without the two parallel dividers

Required Specifications

Fabric
Finish
Bracket finish

SHARED FRAMED DIVIDERS

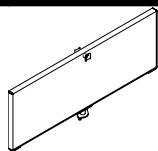

Perpendicular Back-to-Back Shared Framed Divider, Laminate*

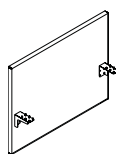

Table Mounted Framed Divider, Fabric*

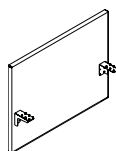

Table Mounted Framed Divider, Laminate*



Ceiling Pole for Wellness Screens

MODEL#	DIMENSIONS D x W x H	FREIGHT CLASS	WT/LBS.	CUBIC FT.	LIST PRICE			
					LIST PRICE	HP ADD	DE ADD	DM ADD
BRSDLD63	1.25 x 57 x 16	70	32	1.58	\$454	\$194	\$502	\$1551
BRSDLD51	1.25 x 45 x 16	70	26	1.25	\$368	\$133	\$233	\$754

Connects between parallel framed dividers for back-to-back tables to divide space and create privacy. Divider is fastened under the worksurface and recessed 3" from the user edge on either side. Divider infill can be specified in low pressure laminate (**LP**), high pressure laminate (**HP**), dry erase whiteboard (**DE**) or dry erase magnetic whiteboard (**DM**). Installed divider measures 15.7" from top of worksurface. Divider comes with 1 center support bracket, 2 spacer plates with adhesive and 2 top spacer clamps. Brackets are available in all standard Bridges II paint finishes.

- Cannot be used on its own without the two parallel dividers

					LIST PRICE			
BRTMFD84	1.25 x 81 x 30	70	43	4.22	\$935			
BRTMFD78	1.25 x 75 x 30	70	40	3.91	\$870			
BRTMFD72	1.25 x 69 x 30	70	37	3.59	\$837			
BRTMFD66	1.25 x 63 x 30	85	33	3.28	\$809			
BRTMFD60	1.25 x 57 x 30	92.5	30	2.97	\$711			
BRTMFD54	1.25 x 51 x 30	92.5	27	2.66	\$634			
BRTMFD48	1.25 x 45 x 30	85	25	2.34	\$570			
BRTMFD42	1.25 x 39 x 30	100	22	2.03	\$506			
BRTMFD36	1.25 x 33 x 30	100	20	1.90	\$430			

Parallel divider for single tables. Fabric divider is tackable and always railroaded. Fastens to the underside of the worksurface. 0.6" gap between worksurface and divider allows for cable pass thru. Installed divider reaches 15.7" up and 15" down from top of worksurface. 36" to 66" dividers include 2 support brackets. 72" to 84" dividers include 3 support brackets. Brackets are available in all standard Bridges II paint finishes.

- 72" - 84" dividers require 3 support brackets and cannot be used with worksurfaces that have a single access door

					LIST PRICE	HP ADD	DE ADD	DM ADD
BRTMLD84	1.25 x 81 x 30	70	83	4.22	\$1183	\$388	\$1318	\$2589
BRTMLD78	1.25 x 75 x 30	70	77	3.91	\$1165	\$390	\$1318	\$2589
BRTMLD72	1.25 x 69 x 30	70	71	3.59	\$589	\$261	\$1772	\$3146
BRTMLD66	1.25 x 63 x 30	85	66	3.28	\$562	\$263	\$1779	\$3154
BRTMLD60	1.25 x 57 x 30	92.5	60	2.97	\$543	\$186	\$1787	\$3154
BRTMLD54	1.25 x 51 x 30	92.5	54	2.66	\$516	\$186	\$1685	\$2980
BRTMLD48	1.25 x 45 x 30	85	48	2.34	\$498	\$186	\$695	\$1415
BRTMLD42	1.25 x 39 x 30	100	42	2.03	\$479	\$186	\$704	\$1320
BRTMLD36	1.25 x 33 x 30	100	38	1.90	\$461	\$186	\$385	\$1023

Parallel divider for single tables. Divider infill can be specified in low pressure laminate (**LP**), high pressure laminate (**HP**), dry erase whiteboard (**DE**) or dry erase magnetic whiteboard (**DM**) user side only. Fastens to the underside of the worksurface. 0.6" gap between worksurface and divider allows for cable pass thru. Installed divider reaches 15.7" up and 15" down from top of worksurface. 36" to 66" dividers include 2 support brackets. 72" to 84" dividers include 3 support brackets. Brackets are available in all standard Bridges II paint finishes.

- 72" - 84" dividers require 3 support brackets and cannot be used with worksurfaces that have a single access door

BRTADPCPP	1.5 x 4.75 x 99	65	13	.48	\$567			
-----------	-----------------	----	----	-----	--------------	--	--	--

Brings ceiling feed conduit and data cables from the ceiling down to Power Troughs at desk height. Accommodates 10' ceiling heights. Two part construction allows power/data conduit lay-in. Attaches to a junction between two adjacent Power Troughs in back-to-back applications only. Not for use on single sided Bridges II troughs. Includes mounting hardware and ceiling bezel. Painted Finish.

- Screens must be specified 6" shorter than the nominal worksurface dimension in order to accommodate this ceiling feed.

Required Specifications

Fabric
Finish
Bracket finish*

BACK-TO-BACK WELLNESS SCREENS

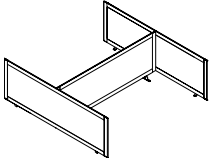

24" H Back-to-Back Wellness Screen

MODEL#	DIMENSIONS D x W x H	FREIGHT CLASS	WT./LBS.	CUBIC FT.	LIST PRICE
BRTADP5136H24	50.50 x 36 x 24.63	150	33	6.31	\$1483
BRTADP5142H24	50.50 x 42 x 24.63	150	34.50	7.36	\$1512
BRTADP5148H24	50.50 x 48 x 24.63	150	36	8.42	\$1544
BRTADP5154H24	50.50 x 54 x 24.63	250	37.50	9.47	\$1575
BRTADP5160H24	50.50 x 60 x 24.63	250	39	10.52	\$1605
BRTADP5166H24	50.50 x 66 x 24.63	250	40.50	11.57	\$1637
BRTADP5172H24	50.50 x 72 x 24.63	250	42	12.63	\$1666
BRTADP5178H24	50.50 x 78 x 24.63	250	43.50	13.68	\$1698
BRTADP5184H24	50.50 x 84 x 24.63	250	45	14.73	\$1729
BRTADP6336H24	62.50 x 36 x 24.63	150	46.50	7.81	\$1603
BRTADP6342H24	62.50 x 42 x 24.63	150	48	9.11	\$1632
BRTADP6348H24	62.50 x 48 x 24.63	150	49.50	10.42	\$1665
BRTADP6354H24	62.50 x 54 x 24.63	150	51	11.72	\$1695
BRTADP6360H24	62.50 x 60 x 24.63	150	52.50	13.02	\$1725
BRTADP6366H24	62.50 x 66 x 24.63	250	54	14.32	\$1757
BRTADP6372H24	62.50 x 72 x 24.63	250	55	15.63	\$1788
BRTADP6378H24	62.50 x 78 x 24.63	250	57.35	16.93	\$1819
BRTADP6384H24	62.50 x 84 x 24.63	250	58.50	18.23	\$1850

Powder coated aluminum frame, translucent ribbed polycarbonate. Includes all hardware to connect. Brackets are painted steel. Side dividers extend 6.25" from the front edge of each surface. Center divider sits over the gap between the worksurface allowing for cable pass-through to trough. Gap for each side is approximately 1". Width and depth are nominal sizes representing the sizes of the Bridges configuration. Allow for .25" overhang at the sides and 6.25" at the front. Frame and hardware available in all Bridges paint finishes. End trim cap is only available in Charcoal (CHR).

- **BRTADP51xxH24 are for configurations with 24" deep surfaces.**
- **BRTADP63xxH24 are for configurations with 30" deep surfaces.**

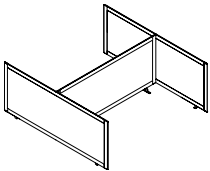

30" H Back-to-Back Wellness Screen

BRTADP5136H30	50.50 x 36 x 30.63	150	35.50	6.31	\$1643
BRTADP5142H30	50.50 x 42 x 30.63	150	37	7.36	\$1680
BRTADP5148H30	50.50 x 48 x 30.63	150	38.50	8.42	\$1713
BRTADP5154H30	50.50 x 54 x 30.63	150	40	9.47	\$1752
BRTADP5160H30	50.50 x 60 x 30.63	250	41.50	10.52	\$1787
BRTADP5166H30	50.50 x 66 x 30.63	250	43	11.57	\$1824
BRTADP5172H30	50.50 x 72 x 30.63	250	44.50	12.63	\$1858
BRTADP5178H30	50.50 x 78 x 30.63	250	46	13.68	\$1893
BRTADP5184H30	50.50 x 84 x 30.63	250	47.50	14.73	\$1930
BRTADP6336H30	62.50 x 36 x 30.63	125	49	7.81	\$1847
BRTADP6342H30	62.50 x 42 x 30.63	150	50.50	9.11	\$1882
BRTADP6348H30	62.50 x 48 x 30.63	150	52	10.42	\$1918
BRTADP6354H30	62.50 x 54 x 30.63	150	53.50	11.72	\$1953
BRTADP6360H30	62.50 x 60 x 30.63	150	55	13.02	\$1989
BRTADP6366H30	62.50 x 66 x 30.63	250	56.50	14.32	\$2025
BRTADP6372H30	62.50 x 72 x 30.63	250	58	15.63	\$2060
BRTADP6378H30	62.50 x 78 x 30.63	250	59.50	16.93	\$2096
BRTADP6384H30	62.50 x 84 x 30.63	250	61	18.23	\$2131

Powder coated aluminum frame, translucent ribbed polycarbonate. Includes all hardware to connect. Brackets are painted steel. Side dividers extend 6.25" from the front edge of each surface. Center divider sits over the gap between the worksurface allowing for cable pass-through to trough. Gap for each side is approximately 1". Width and depth are nominal sizes representing the sizes of the Bridges configuration. Allow for .25" overhang at the sides and 6.25" at the front. Frame and hardware available in all Bridges paint finishes. End trim cap is only available in Charcoal (CHR).

- **BRTADP51xxH30 are for configurations with 24" deep surfaces.**
- **BRTADP63xxH30 are for configurations with 30" deep surfaces.**

Required Specifications
Frame finish

BACK-TO-BACK WELLNESS SCREENS

MODEL# DIMENSIONS FREIGHT CLASS WT/LBS. CUBIC FT. LIST PRICE

D x W x H

BRTADPE5136H24	50.50 x 36 x 24.63	150	26.35	6.31	\$1005
BRTADPE5142H24	50.50 x 42 x 24.63	250	27.85	7.36	\$1035
BRTADPE5148H24	50.50 x 48 x 24.63	250	29.35	8.42	\$1066
BRTADPE5154H24	50.50 x 54 x 24.63	250	30.85	9.47	\$1095
BRTADPE5160H24	50.50 x 60 x 24.63	250	32.35	10.52	\$1128
BRTADPE5166H24	50.50 x 66 x 24.63	250	33.85	11.57	\$1159
BRTADPE5172H24	50.50 x 72 x 24.63	250	35.35	12.63	\$1192
BRTADPE5178H24	50.50 x 78 x 24.63	250	36.85	13.68	\$1221
BRTADPE5184H24	50.50 x 84 x 24.63	250	38.35	14.73	\$1251

BRTADPE6336H24	62.50 x 36 x 24.63	150	39.85	7.81	\$1065
BRTADPE6342H24	62.50 x 42 x 24.63	150	41.35	9.11	\$1094
BRTADPE6348H24	62.50 x 48 x 24.63	150	42.85	10.42	\$1126
BRTADPE6354H24	62.50 x 54 x 24.63	250	44.35	11.72	\$1158
BRTADPE6360H24	62.50 x 60 x 24.63	250	45.85	13.02	\$1189
BRTADPE6366H24	62.50 x 66 x 24.63	250	47.35	14.32	\$1221
BRTADPE6372H24	62.50 x 72 x 24.63	250	48.85	15.63	\$1250
BRTADPE6378H24	62.50 x 78 x 24.63	250	50.35	16.93	\$1281
BRTADPE6384H24	62.50 x 84 x 24.63	250	51.85	18.23	\$1313

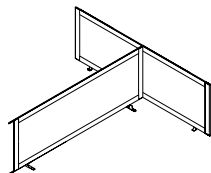

24" H Back-to-Back Wellness Screen Extension Kit

Intended to always connect to Back-to-Back Divider Screen Kit. Powder coated aluminum frame, translucent ribbed polycarbonate. Includes all hardware to connect. Brackets are painted steel. Side dividers extend 6.25" from the front edge of each surface. Center divider sits over the gap between the worksurface allowing for cable pass-through to trough. Gap for each side is approximately 1". Width and depth are nominal sizes representing the sizes of the Bridges configuration. Allow for .25" overhang at the sides and 6.25" at the front. Frame and hardware available in all Bridges paint finishes. End trim cap is only available in Charcoal (CHR).

- **BRTADPE51xxH24 are for configurations with 24" deep surfaces.**
- **BRTADPE63xxH24 are for configurations with 30" deep surfaces.**

BRTADPE5136H30	50.50 x 36 x 30.63	150	28.85	6.31	\$1104
BRTADPE5142H30	50.50 x 42 x 30.63	150	30.35	7.36	\$1140
BRTADPE5148H30	50.50 x 48 x 30.63	250	31.85	8.42	\$1176
BRTADPE5154H30	50.50 x 54 x 30.63	250	33.35	9.47	\$1213
BRTADPE5160H30	50.50 x 60 x 30.63	250	34.85	10.52	\$1247
BRTADPE5166H30	50.50 x 66 x 30.63	250	36.35	11.57	\$1283
BRTADPE5172H30	50.50 x 72 x 30.63	250	37.85	12.63	\$1320
BRTADPE5178H30	50.50 x 78 x 30.63	250	39.35	13.68	\$1353
BRTADPE5184H30	50.50 x 84 x 30.63	250	40.85	14.73	\$1390

BRTADPE6336H30	62.50 x 36 x 30.63	150	42.35	7.81	\$1174
BRTADPE6342H30	62.50 x 42 x 30.63	150	43.85	9.11	\$1211
BRTADPE6348H30	62.50 x 48 x 30.63	150	45.35	10.42	\$1246
BRTADPE6354H30	62.50 x 54 x 30.63	250	46.85	11.72	\$1281
BRTADPE6360H30	62.50 x 60 x 30.63	250	48.35	13.02	\$1317
BRTADPE6366H30	62.50 x 66 x 30.63	250	49.85	14.32	\$1352
BRTADPE6372H30	62.50 x 72 x 30.63	250	51.35	15.63	\$1390
BRTADPE6378H30	62.50 x 78 x 30.63	250	52.85	16.93	\$1423
BRTADPE6384H30	62.50 x 84 x 30.63	250	54.35	18.23	\$1460

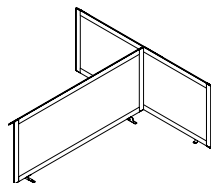

30" H Back-to-Back Wellness Screen Extension Kit

Intended to always connect to Back-to-Back Divider Screen Kit. Powder coated aluminum frame, translucent ribbed polycarbonate. Includes all hardware to connect. Brackets are painted steel. Side dividers extend 6.25" from the front edge of each surface. Center divider sits over the gap between the worksurface allowing for cable pass-through to trough. Gap for each side is approximately 1". Width and depth are nominal sizes representing the sizes of the Bridges configuration. Allow for .25" overhang at the sides and 6.25" at the front. Frame and hardware available in all Bridges paint finishes. End trim cap is only available in Charcoal (CHR).

- **BRTADPE51xxH30 are for configurations with 24" deep surfaces.**
- **BRTADPE63xxH30 are for configurations with 30" deep surfaces.**

Required Specifications

Frame finish

SINGLE TABLE WELLNESS SCREENS

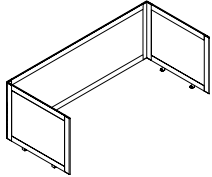

24" H Single Table Wellness Screen

MODEL#	DIMENSIONS D x W x H	FREIGHT CLASS	WT./LBS.	CUBIC FT.	LIST PRICE
BRTADP2436H24	31.75 x 36 x 24.63	125	26.55	3.97	\$1023
BRTADP2442H24	31.75 x 42 x 24.63	125	28.10	4.63	\$1056
BRTADP2448H24	31.75 x 48 x 24.63	150	29.65	5.29	\$1085
BRTADP2454H24	31.75 x 54 x 24.63	150	31.20	5.95	\$1117
BRTADP2460H24	31.75 x 60 x 24.63	150	32.75	6.61	\$1148
BRTADP2466H24	31.75 x 66 x 24.63	150	34.30	7.28	\$1177
BRTADP2472H24	31.75 x 72 x 24.63	150	35.85	7.94	\$1210
BRTADP2478H24	31.75 x 78 x 24.63	150	37.40	8.60	\$1241
BRTADP2484H24	31.75 x 84 x 24.63	150	38.95	9.26	\$1271
BRTADP3036H24	37.75 x 36 x 24.63	100	40.50	4.72	\$1095
BRTADP3042H24	37.75 x 42 x 24.63	125	42.05	5.51	\$1128
BRTADP3048H24	37.75 x 48 x 24.63	125	43.60	6.29	\$1159
BRTADP3054H24	37.75 x 54 x 24.63	150	42.15	7.08	\$1192
BRTADP3060H24	37.75 x 60 x 24.63	150	46.70	7.87	\$1221
BRTADP3066H24	37.75 x 66 x 24.63	150	48.25	8.65	\$1251
BRTADP3072H24	37.75 x 72 x 24.63	150	49.80	9.44	\$1283
BRTADP3078H24	37.75 x 78 x 24.63	150	51.35	10.22	\$1314
BRTADP3084H24	37.75 x 84 x 24.63	150	52.90	11.01	\$1346

Powder coated aluminum frame, translucent ribbed polycarbonate. Includes all hardware to connect. Brackets are painted steel. Side dividers extend 6.25" from the front edge of each surface. Back divider extends over the back edge of the worksurface by 1.5", allowing for cable pass-through to trough. Width and depth are nominal sizes representing the sizes of the Bridges configuration. Allow for .25" overhang at the sides, 1.5" at the back, and 6.25" at the front. Frame and hardware available in all Bridges paint finishes. End trim cap is only available in Charcoal (CHR).

- **BRTADP24xxH24 are for configurations with 24" deep surfaces.**
- **BRTADP30xxH24 are for configurations with 30" deep surfaces.**

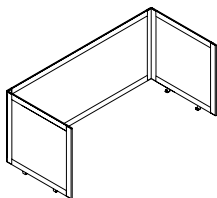

30" H Single Table Wellness Screen

BRTADP2436H30	31.75 x 36 x 30.63	125	28.85	3.97	\$1148
BRTADP2442H30	31.75 x 42 x 30.63	125	30.40	4.63	\$1185
BRTADP2448H30	31.75 x 48 x 30.63	125	31.95	5.29	\$1221
BRTADP2454H30	31.75 x 54 x 30.63	150	33.50	5.95	\$1256
BRTADP2460H30	31.75 x 60 x 30.63	150	35.05	6.61	\$1292
BRTADP2466H30	31.75 x 66 x 30.63	150	36.60	7.28	\$1327
BRTADP2472H30	31.75 x 72 x 30.63	150	38.15	7.94	\$1363
BRTADP2478H30	31.75 x 78 x 30.63	150	39.70	8.60	\$1398
BRTADP2484H30	31.75 x 84 x 30.63	150	41.25	9.26	\$1434
BRTADP3036H30	37.75 x 36 x 30.63	100	42.80	4.72	\$1218
BRTADP3042H30	37.75 x 42 x 30.63	100	44.35	5.51	\$1256
BRTADP3048H30	37.75 x 48 x 30.63	125	45.90	6.29	\$1291
BRTADP3054H30	37.75 x 54 x 30.63	125	47.45	7.08	\$1324
BRTADP3060H30	37.75 x 60 x 30.63	125	49	7.87	\$1360
BRTADP3066H30	37.75 x 66 x 30.63	150	50.55	8.65	\$1397
BRTADP3072H30	37.75 x 72 x 30.63	150	52.10	9.44	\$1430
BRTADP3078H30	37.75 x 78 x 30.63	150	53.65	10.22	\$1468
BRTADP3084H30	37.75 x 84 x 30.63	150	55.20	11.01	\$1504

Powder coated aluminum frame, translucent ribbed polycarbonate. Includes all hardware to connect. Brackets are painted steel. Side dividers extend 6.25" from the front edge of each surface. Back divider extends over the back edge of the worksurface by 1.5", allowing for cable pass-through to trough. Width and depth are nominal sizes representing the sizes of the Bridges configuration. Allow for .25" overhang at the sides, 1.5" at the back, and 6.25" at the front. Frame and hardware available in all Bridges paint finishes. End trim cap is only available in Charcoal (CHR).

- **BRTADP24xxH30 are for configurations with 24" deep surfaces.**
- **BRTADP30xxH30 are for configurations with 30" deep surfaces.**

Required Specifications

Frame finish

SINGLE TABLE WELLNESS SCREENS

MODEL# DIMENSIONS FREIGHT CLASS WT./LBS. CUBIC FT. LIST PRICE

D x W x H

BRTADPE2436H24	31.75 x 36 x 24.63	150	21.05	3.97	\$768
BRTADPE2442H24	31.75 x 42 x 24.63	150	22.60	4.63	\$843
BRTADPE2448H24	31.75 x 48 x 24.63	150	24.15	5.29	\$875
BRTADPE2454H24	31.75 x 54 x 24.63	150	25.70	5.95	\$905
BRTADPE2460H24	31.75 x 60 x 24.63	150	27.25	6.61	\$935
BRTADPE2466H24	31.75 x 66 x 24.63	250	28.80	7.28	\$967
BRTADPE2472H24	31.75 x 72 x 24.63	250	30.35	7.94	\$998
BRTADPE2478H24	31.75 x 78 x 24.63	250	31.90	8.60	\$1029
BRTADPE2484H24	31.75 x 84 x 24.63	250	33.45	9.26	\$1058

BRTADPE3036H24	37.75 x 36 x 24.63	125	35	4.72	\$799
BRTADPE3042H24	37.75 x 42 x 24.63	125	36.55	5.51	\$872
BRTADPE3048H24	37.75 x 48 x 24.63	125	38.10	6.29	\$905
BRTADPE3054H24	37.75 x 54 x 24.63	150	39.65	7.08	\$935
BRTADPE3060H24	37.75 x 60 x 24.63	150	41.20	7.87	\$967
BRTADPE3066H24	37.75 x 66 x 24.63	150	42.75	8.65	\$996
BRTADPE3072H24	37.75 x 72 x 24.63	150	44.30	9.44	\$1026
BRTADPE3078H24	37.75 x 78 x 24.63	150	45.85	10.01	\$1058
BRTADPE3084H24	37.75 x 84 x 24.63	150	47.40	10.01	\$1089

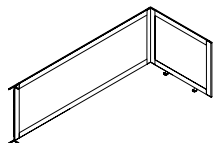

24" H Single Table Wellness Screen Extension Kit

Intended to always connect to Single Table Divider Screen Kit. Powder coated aluminum frame, translucent ribbed polycarbonate. Includes all hardware to connect. Brackets are painted steel. Side dividers extend 6.25" from the front edge of each surface. Back divider extends over the back edge of the worksurface by 1.5", allowing for cable pass-through to trough. Width and depth are nominal sizes representing the sizes of the Bridges configuration. Allow for .25" overhang at the sides, 1.5" at the back, and 6.25" at the front. Frame and hardware available in all Bridges paint finishes. End trim cap is only available in Charcoal (CHR).

- **BRTADPE24xxH24 are for configurations with 24" deep surfaces.**
- **BRTADPE30xxH24 are for configurations with 30" deep surfaces.**

BRTADPE2436H30	31.75 x 36 x 30.63	150	22.85	3.97	\$845
BRTADPE2442H30	31.75 x 42 x 30.63	150	24.40	4.63	\$925
BRTADPE2448H30	31.75 x 48 x 30.63	150	25.95	5.29	\$960
BRTADPE2454H30	31.75 x 54 x 30.63	150	27.50	5.95	\$995
BRTADPE2460H30	31.75 x 60 x 30.63	150	29.05	6.61	\$1032
BRTADPE2466H30	31.75 x 66 x 30.63	150	30.60	7.28	\$1066
BRTADPE2472H30	31.75 x 72 x 30.63	150	32.15	7.94	\$1101
BRTADPE2478H30	31.75 x 78 x 30.63	250	33.70	8.60	\$1137
BRTADPE2484H30	31.75 x 84 x 30.63	250	35.25	9.26	\$1173

BRTADPE3036H30	37.75 x 36 x 30.63	125	36.80	4.72	\$880
BRTADPE3042H30	37.75 x 42 x 30.63	125	38.35	5.51	\$960
BRTADPE3048H30	37.75 x 48 x 30.63	125	39.90	6.29	\$995
BRTADPE3054H30	37.75 x 54 x 30.63	150	41.45	7.08	\$1030
BRTADPE3060H30	37.75 x 60 x 30.63	150	43	7.87	\$1066
BRTADPE3066H30	37.75 x 66 x 30.63	150	44.55	8.65	\$1101
BRTADPE3072H30	37.75 x 72 x 30.63	150	46.10	9.44	\$1136
BRTADPE3078H30	37.75 x 78 x 30.63	150	47.65	10.22	\$1173
BRTADPE3084H30	37.75 x 84 x 30.63	150	49.20	11.01	\$1207

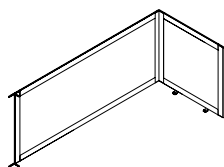

30" H Single Table Wellness Screen Extension Kit

Intended to always connect to Single Table Divider Screen Kit. Powder coated aluminum frame, translucent ribbed polycarbonate. Includes all hardware to connect. Brackets are painted steel. Side dividers extend 6.25" from the front edge of each surface. Back divider extends over the back edge of the worksurface by 1.5", allowing for cable pass-through to trough. Width and depth are nominal sizes representing the sizes of the Bridges configuration. Allow for .25" overhang at the sides, 1.5" at the back, and 6.25" at the front. Frame and hardware available in all Bridges paint finishes. End trim cap is only available in Charcoal (CHR).

- **BRTADPE24xxH30 are for configurations with 24" deep surfaces.**
- **BRTADPE30xxH30 are for configurations with 30" deep surfaces.**

Required Specifications

Frame finish

BACK-TO-BACK FELT DIVIDER SCREENS

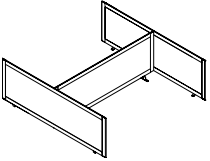

24" H Back-to-Back Felt Divider Screen

MODEL#	DIMENSIONS D x W x H	FREIGHT CLASS	WT/LBS.	CUBIC FT.	LIST PRICE
BRTADF5136H24	50.50 x 36 x 24.60	150	28	6.31	\$1170
BRTADF5142H24	50.50 x 42 x 24.60	150	29.50	7.36	\$1190
BRTADF5148H24	50.50 x 48 x 24.60	150	31	8.42	\$1213
BRTADF5154H24	50.50 x 54 x 24.60	250	32.50	9.47	\$1232
BRTADF5160H24	50.50 x 60 x 24.60	250	34	10.52	\$1259
BRTADF5166H24	50.50 x 66 x 24.60	250	35.50	11.57	\$1281
BRTADF5172H24	50.50 x 72 x 24.60	250	37	12.63	\$1304
BRTADF5178H24	50.50 x 78 x 24.60	250	38.50	13.68	\$1329
BRTADF5184H24	50.50 x 84 x 24.60	250	40	14.73	\$1371
BRTADF6336H24	62.50 x 36 x 24.60	150	41.50	7.81	\$1259
BRTADF6342H24	62.50 x 42 x 24.60	150	43	9.11	\$1281
BRTADF6348H24	62.50 x 48 x 24.60	150	44.50	10.42	\$1304
BRTADF6354H24	62.50 x 54 x 24.60	150	46	11.72	\$1327
BRTADF6360H24	62.50 x 60 x 24.60	150	47.50	13.02	\$1349
BRTADF6366H24	62.50 x 66 x 24.60	250	49	14.32	\$1371
BRTADF6372H24	62.50 x 72 x 24.60	250	50.50	15.63	\$1394
BRTADF6378H24	62.50 x 78 x 24.60	250	52	16.93	\$1417
BRTADF6384H24	62.50 x 84 x 24.60	250	53.50	18.23	\$1461

Provides privacy in an open plan environment. Powder coated aluminum frame with 9mm felt. Includes all hardware to connect. Brackets are painted steel. Side dividers extend 6.25" from the front edge of each surface. Center divider sits over the gap between the worksurface allowing for cable pass-through to trough. Gap for each side is approximately 1". Width and depth are nominal sizes representing the sizes of the Bridges configuration. Allow for .25" overhang at the sides and 6.25" at the front. Frame and hardware available in all Bridges paint finishes. End trim cap is only available in Charcoal (CHR). 9mm PET felt material is tackable and available in 9 colors.

- **BRTAPF51xxH24 are for configurations with 24" deep surfaces.**
- **BRTAPF63xxH24 are for configurations with 30" deep surfaces.**

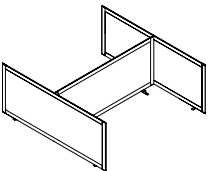

30" H Back-to-Back Felt Divider Screen

BRTADF5136H30	50.50 x 36 x 30.60	150	30.50	6.31	\$1165
BRTADF5142H30	50.50 x 42 x 30.60	150	32	7.36	\$1187
BRTADF5148H30	50.50 x 48 x 30.60	150	33.50	8.42	\$1208
BRTADF5154H30	50.50 x 54 x 30.60	150	35	9.47	\$1229
BRTADF5160H30	50.50 x 60 x 30.60	250	36.50	10.52	\$1250
BRTADF5166H30	50.50 x 66 x 30.60	250	38	11.57	\$1270
BRTADF5172H30	50.50 x 72 x 30.60	250	39.50	12.63	\$1292
BRTADF5178H30	50.50 x 78 x 30.60	250	41	13.68	\$1315
BRTADF5184H30	50.50 x 84 x 30.60	250	42.50	14.73	\$1363
BRTADF6336H30	62.50 x 36 x 30.60	125	44	7.81	\$1309
BRTADF6342H30	62.50 x 42 x 30.60	150	45.50	9.11	\$1329
BRTADF6348H30	62.50 x 48 x 30.60	150	47	10.42	\$1349
BRTADF6354H30	62.50 x 54 x 30.60	150	48.50	11.72	\$1370
BRTADF6360H30	62.50 x 60 x 30.60	150	50	13.02	\$1391
BRTADF6366H30	62.50 x 66 x 30.60	250	51.50	14.32	\$1413
BRTADF6372H30	62.50 x 72 x 30.60	250	53	15.63	\$1434
BRTADF6378H30	62.50 x 78 x 30.60	250	54.50	16.93	\$1455
BRTADF6384H30	62.50 x 84 x 30.60	250	56	18.23	\$1504

Provides privacy in an open plan environment. Powder coated aluminum frame with 9mm felt. Includes all hardware to connect. Brackets are painted steel. Side dividers extend 6.25" from the front edge of each surface. Center divider sits over the gap between the worksurface allowing for cable pass-through to trough. Gap for each side is approximately 1". Width and depth are nominal sizes representing the sizes of the Bridges configuration. Allow for .25" overhang at the sides and 6.25" at the front. Frame and hardware available in all Bridges paint finishes. End trim cap is only available in Charcoal (CHR). 9mm PET felt material is tackable and available in 9 colors.

- **BRTADF51xxH30 are for configurations with 24" deep surfaces.**
- **BRTADF63xxH30 are for configurations with 30" deep surfaces.**

Required Specifications

Frame finish
Felt finish

BACK-TO-BACK FELT DIVIDER SCREENS

MODEL# DIMENSIONS FREIGHT CLASS WT/LBS. CUBIC FT. LIST PRICE

D x W x H

BRTADFE5136H24	50.50 x 36 x 24.60	150	23.35	6.31	\$797
BRTADFE5142H24	50.50 x 42 x 24.60	250	24.85	7.36	\$820
BRTADFE5148H24	50.50 x 48 x 24.60	250	26.35	8.42	\$842
BRTADFE5154H24	50.50 x 54 x 24.60	250	27.85	9.47	\$865
BRTADFE5160H24	50.50 x 60 x 24.60	250	29.35	10.52	\$887
BRTADFE5166H24	50.50 x 66 x 24.60	250	30.85	11.57	\$910
BRTADFE5172H24	50.50 x 72 x 24.60	250	32.35	12.63	\$932
BRTADFE5178H24	50.50 x 78 x 24.60	250	33.85	13.68	\$956
BRTADFE5184H24	50.50 x 84 x 24.60	250	35.35	14.73	\$1001

BRTADFE6336H24	62.50 x 36 x 24.60	150	36.85	7.81	\$840
BRTADFE6342H24	62.50 x 42 x 24.60	150	38.35	9.11	\$862
BRTADFE6348H24	62.50 x 48 x 24.60	150	39.85	10.42	\$886
BRTADFE6354H24	62.50 x 54 x 24.60	250	41.35	11.72	\$908
BRTADFE6360H24	62.50 x 60 x 24.60	250	42.85	13.02	\$931
BRTADFE6366H24	62.50 x 66 x 24.60	250	44.35	14.32	\$953
BRTADFE6372H24	62.50 x 72 x 24.60	250	45.85	15.63	\$977
BRTADFE6378H24	62.50 x 78 x 24.60	250	47.35	16.93	\$999
BRTADFE6384H24	62.50 x 84 x 24.60	250	48.85	18.23	\$1044

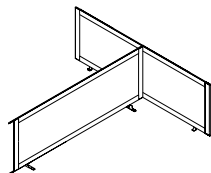

24" H Back-to-Back Felt Divider Screen Extension Kit

Provides an extension to privacy in an open plan environment. Intended to always connect to Back-to-Back Divider Screen Kit. Powder coated aluminum frame with 9mm felt. Includes all hardware to connect. Brackets are painted steel. Side dividers extend 6.25" from the front edge of each surface. Center divider sits over the gap between the worksurface allowing for cable pass-through to trough. Gap for each side is approximately 1". Width and depth are nominal sizes representing the sizes of the Bridges configuration. Allow for .25" overhang at the sides and 6.25" at the front. Frame and hardware available in all Bridges paint finishes. End trim cap is only available in Charcoal (CHR). 9mm PET felt material is tackable and available in 9 colors.

- **BRTADFE51xxH24 are for configurations with 24" deep surfaces.**
- **BRTADFE63xxH24 are for configurations with 30" deep surfaces.**

BRTADFE5136H30	50.50 x 36 x 30.60	150	25.85	6.31	\$795
BRTADFE5142H30	50.50 x 42 x 30.60	150	27.35	7.36	\$816
BRTADFE5148H30	50.50 x 48 x 30.60	250	28.85	8.42	\$838
BRTADFE5154H30	50.50 x 54 x 30.60	250	30.35	9.47	\$859
BRTADFE5160H30	50.50 x 60 x 30.60	250	31.85	10.52	\$880
BRTADFE5166H30	50.50 x 66 x 30.60	250	33.35	11.57	\$901
BRTADFE5172H30	50.50 x 72 x 30.60	250	34.85	12.63	\$922
BRTADFE5178H30	50.50 x 78 x 30.60	250	36.35	13.68	\$943
BRTADFE5184H30	50.50 x 84 x 30.60	250	37.85	14.73	\$992

BRTADFE6336H30	62.50 x 36 x 30.60	150	39.35	7.81	\$837
BRTADFE6342H30	62.50 x 42 x 30.60	150	40.85	9.11	\$858
BRTADFE6348H30	62.50 x 48 x 30.60	150	42.35	10.42	\$879
BRTADFE6354H30	62.50 x 54 x 30.60	250	43.85	11.72	\$900
BRTADFE6360H30	62.50 x 60 x 30.60	250	45.35	13.02	\$921
BRTADFE6366H30	62.50 x 66 x 30.60	250	46.85	14.32	\$942
BRTADFE6372H30	62.50 x 72 x 30.60	250	48.35	15.63	\$963
BRTADFE6378H30	62.50 x 78 x 30.60	250	49.85	16.93	\$984
BRTADFE6384H30	62.50 x 84 x 30.60	250	51.35	18.23	\$1032

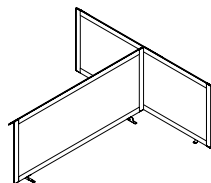

30" H Back-to-Back Felt Divider Screen Extension Kit

Provides an extension to privacy in an open plan environment. Intended to always connect to Back-to-Back Divider Screen Kit. Powder coated aluminum frame with 9mm felt. Includes all hardware to connect. Brackets are painted steel. Side dividers extend 6.25" from the front edge of each surface. Center divider sits over the gap between the worksurface allowing for cable pass-through to trough. Gap for each side is approximately 1". Width and depth are nominal sizes representing the sizes of the Bridges configuration. Allow for .25" overhang at the sides and 6.25" at the front. Frame and hardware available in all Bridges paint finishes. End trim cap is only available in Charcoal (CHR). 9mm PET felt material is tackable and available in 9 colors.

- **BRTADFE51xxH30 are for configurations with 24" deep surfaces.**
- **BRTADFE63xxH30 are for configurations with 30" deep surfaces.**

Required Specifications

Frame finish
Felt finish

SINGLE TABLE FELT DIVIDER SCREENS

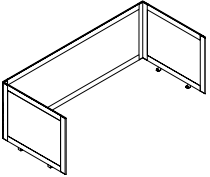

24" H Single Table Felt Divider Screen

MODEL#	DIMENSIONS D x W x H	FREIGHT CLASS	WT./LBS.	CUBIC FT.	LIST PRICE
BRTADF2436H24	31.50 x 36 x 24.60	125	22.55	3.94	\$851
BRTADF2442H24	31.50 x 42 x 24.60	125	24.10	4.59	\$873
BRTADF2448H24	31.50 x 48 x 24.60	150	25.65	5.25	\$896
BRTADF2454H24	31.50 x 54 x 24.60	150	27.20	5.91	\$918
BRTADF2460H24	31.50 x 60 x 24.60	150	28.75	6.56	\$942
BRTADF2466H24	31.50 x 66 x 24.60	150	30.30	7.22	\$964
BRTADF2472H24	31.50 x 72 x 24.60	150	31.85	7.88	\$987
BRTADF2478H24	31.50 x 78 x 24.60	150	33.40	8.53	\$1010
BRTADF2484H24	31.50 x 84 x 24.60	150	34.95	9.19	\$1054
BRTADF3036H24	37.75 x 36 x 24.60	100	36.50	4.72	\$880
BRTADF3042H24	37.75 x 42 x 24.60	125	38.05	5.51	\$904
BRTADF3048H24	37.75 x 48 x 24.60	125	39.60	6.29	\$926
BRTADF3054H24	37.75 x 54 x 24.60	150	41.15	7.08	\$949
BRTADF3060H24	37.75 x 60 x 24.60	150	41.70	7.87	\$971
BRTADF3066H24	37.75 x 66 x 24.60	150	44.25	8.65	\$995
BRTADF3072H24	37.75 x 72 x 24.60	150	45.80	9.44	\$1015
BRTADF3078H24	37.75 x 78 x 24.60	150	47.35	10.22	\$1038
BRTADF3084H24	37.75 x 84 x 24.60	150	48.90	11.01	\$1084

Provides privacy in an open plan environment. Powder coated aluminum frame with 9mm felt. Includes all hardware to connect. Brackets are painted steel. Side dividers extend 6.237" from the front edge of each surface. Back divider extends over the back edge of the worksurface by 1.5", allowing for cable pass-through to trough. Width and depth are nominal sizes representing the sizes of the Bridges configuration. Allow for .25" overhang at the sides, 1.5" at the back, and 6.237" at the front. Frame and hardware available in all Bridges paint finishes. End trim cap is only available in Charcoal (CHR). 9mm PET felt material is tackable and available in 9 colors.

- **BRTADF24xxH24 are for configurations with 24" deep surfaces.**
- **BRTADF30xxH24 are for configurations with 30" deep surfaces.**

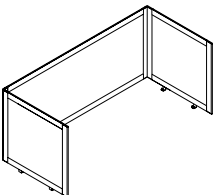

30" H Single Table Felt Divider Screen

BRTADF2436H30	31.50 x 36 x 30.60	125	24.85	3.97	\$845
BRTADF2442H30	31.50 x 42 x 30.60	125	26.40	4.59	\$867
BRTADF2448H30	31.50 x 48 x 30.60	125	27.95	5.25	\$887
BRTADF2454H30	31.50 x 54 x 30.60	150	29.50	5.91	\$908
BRTADF2460H30	31.50 x 60 x 30.60	150	31.05	6.56	\$929
BRTADF2466H30	31.50 x 66 x 30.60	150	32.60	7.22	\$950
BRTADF2472H30	31.50 x 72 x 30.60	150	34.14	7.88	\$971
BRTADF2478H30	31.50 x 78 x 30.60	150	34.70	8.53	\$992
BRTADF2484H30	31.50 x 84 x 30.60	150	37.25	9.19	\$1042
BRTADF3036H30	37.75 x 36 x 30.60	100	38.80	4.72	\$886
BRTADF3042H30	37.75 x 42 x 30.60	100	40.35	5.51	\$907
BRTADF3048H30	37.75 x 48 x 30.60	125	41.90	6.29	\$928
BRTADF3054H30	37.75 x 54 x 30.60	125	43.45	7.08	\$949
BRTADF3060H30	37.75 x 60 x 30.60	125	45	7.87	\$971
BRTADF3066H30	37.75 x 66 x 30.60	150	46.55	8.65	\$992
BRTADF3072H30	37.75 x 72 x 30.60	150	48.10	9.44	\$1012
BRTADF3078H30	37.75 x 78 x 30.60	150	49.65	10.22	\$1033
BRTADF3084H30	37.75 x 84 x 30.60	150	51.20	11.01	\$1082

Provides privacy in an open plan environment. Powder coated aluminum frame with 9mm felt. Includes all hardware to connect. Brackets are painted steel. Side dividers extend 6.237" from the front edge of each surface. Back divider extends over the back edge of the worksurface by 1.5", allowing for cable pass-through to trough. Width and depth are nominal sizes representing the sizes of the Bridges configuration. Allow for .25" overhang at the sides, 1.5" at the back, and 6.237" at the front. Frame and hardware available in all Bridges paint finishes. End trim cap is only available in Charcoal (CHR). 9mm PET felt material is tackable and available in 9 colors.

- **BRTADF24xxH30 are for configurations with 24" deep surfaces.**
- **BRTADF30xxH30 are for configurations with 30" deep surfaces.**

Required Specifications

Frame finish
Felt finish

SINGLE TABLE FELT DIVIDER SCREENS

MODEL# DIMENSIONS FREIGHT CLASS WT/LBS. CUBIC FT. LIST PRICE

D x W x H

BRTADFE2436H24	31.50 x 36 x 24.60	150	18.55	3.94	\$644
BRTADFE2442H24	31.50 x 42 x 24.60	150	20.10	4.59	\$705
BRTADFE2448H24	31.50 x 48 x 24.60	150	21.65	5.25	\$729
BRTADFE2454H24	31.50 x 54 x 24.60	150	23.20	5.91	\$751
BRTADFE2460H24	31.50 x 60 x 24.60	150	24.75	6.56	\$774
BRTADFE2466H24	31.50 x 66 x 24.60	250	26.30	7.22	\$797
BRTADFE2472H24	31.50 x 72 x 24.60	250	27.85	7.88	\$820
BRTADFE2478H24	31.50 x 78 x 24.60	250	29.40	8.53	\$842
BRTADFE2484H24	31.50 x 84 x 24.60	250	30.95	9.19	\$887

BRTADFE3036H24	37.75 x 36 x 24.60	125	32.50	4.72	\$668
BRTADFE3042H24	37.75 x 42 x 24.60	125	34.05	5.51	\$730
BRTADFE3048H24	37.75 x 48 x 24.60	125	35.60	6.29	\$753
BRTADFE3054H24	37.75 x 54 x 24.60	150	37.15	7.08	\$775
BRTADFE3060H24	37.75 x 60 x 24.60	150	38.70	7.87	\$799
BRTADFE3066H24	37.75 x 66 x 24.60	150	40.25	8.65	\$821
BRTADFE3072H24	37.75 x 72 x 24.60	150	41.80	9.44	\$844
BRTADFE3078H24	37.75 x 78 x 24.60	150	43.35	10.01	\$867
BRTADFE3084H24	37.75 x 84 x 24.60	150	44.90	10.01	\$912

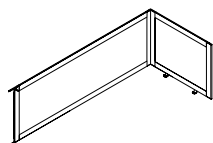

24" H Single Table Felt Divider Screen Extension Kit

Provides an extension for privacy in an open plan environment. Intended to always connect to Single Table Divider Screen Kit. Powder coated aluminum frame with 9mm felt. Includes all hardware to connect. Brackets are painted steel. Side dividers extend 6.237" from the front edge of each surface. Back divider extends over the back edge of the worksurface by 1.5", allowing for cable pass-through to trough. Width and depth are nominal sizes representing the sizes of the Bridges configuration. Allow for .25" overhang at the sides, 1.5" at the back, and 6.237" at the front. Frame and hardware available in all Bridges paint finishes. End trim cap is only available in Charcoal (CHR). 9mm PET felt material is tackable and available in 9 colors.

- **BRTADFE24xxH24 are for configurations with 24" deep surfaces.**
- **BRTADFE30xxH24 are for configurations with 30" deep surfaces.**

BRTADFE2436H30	31.50 x 36 x 30.60	150	20.35	3.94	\$675
BRTADFE2442H30	31.50 x 42 x 30.60	150	21.90	4.59	\$737
BRTADFE2448H30	31.50 x 48 x 30.60	150	23.45	5.25	\$757
BRTADFE2454H30	31.50 x 54 x 30.60	150	25	5.91	\$779
BRTADFE2460H30	31.50 x 60 x 30.60	150	26.55	6.56	\$800
BRTADFE2466H30	31.50 x 66 x 30.60	150	28.10	7.22	\$821
BRTADFE2472H30	31.50 x 72 x 30.60	150	29.65	7.88	\$842
BRTADFE2478H30	31.50 x 78 x 30.60	250	31.20	8.53	\$862
BRTADFE2484H30	31.50 x 84 x 30.60	250	32.75	9.19	\$912

BRTADFE3036H30	37.75 x 36 x 30.60	125	34.30	4.72	\$700
BRTADFE3042H30	37.75 x 42 x 30.60	125	35.85	5.51	\$765
BRTADFE3048H30	37.75 x 48 x 30.60	125	37.40	6.29	\$786
BRTADFE3054H30	37.75 x 54 x 30.60	150	38.95	7.08	\$809
BRTADFE3060H30	37.75 x 60 x 30.60	150	40.50	7.87	\$830
BRTADFE3066H30	37.75 x 66 x 30.60	150	42.05	8.65	\$851
BRTADFE3072H30	37.75 x 72 x 30.60	150	43.60	9.44	\$872
BRTADFE3078H30	37.75 x 78 x 30.60	150	45.15	10.22	\$893
BRTADFE3084H30	37.75 x 84 x 30.60	150	46.70	11.01	\$942

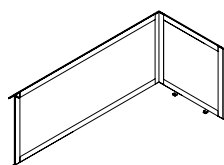

30" H Single Table Felt Divider Screen Extension Kit

Provides an extension for privacy in an open plan environment. Intended to always connect to Single Table Divider Screen Kit. Powder coated aluminum frame with 9mm felt. Includes all hardware to connect. Brackets are painted steel. Side dividers extend 6.237" from the front edge of each surface. Back divider extends over the back edge of the worksurface by 1.5", allowing for cable pass-through to trough. Width and depth are nominal sizes representing the sizes of the Bridges configuration. Allow for .25" overhang at the sides, 1.5" at the back, and 6.237" at the front. Frame and hardware available in all Bridges paint finishes. End trim cap is only available in Charcoal (CHR). 9mm PET felt material is tackable and available in 9 colors.

- **BRTADFE24xxH30 are for configurations with 24" deep surfaces.**
- **BRTADFE30xxH30 are for configurations with 30" deep surfaces.**

Required Specifications

Frame finish
Felt finish

BACK-TO-BACK GLASS DIVIDER SCREENS

MODEL#	DIMENSIONS D x W x H	FREIGHT CLASS	WT./LBS.	CUBIC FT.	LIST PRICE	FRST ADD
BRTADG5136H24	50.50 x 36 x 24.60	150	28	6.31	\$1314	\$401
BRTADG5142H24	50.50 x 42 x 24.60	150	29.50	7.36	\$2039	\$413
BRTADG5148H24	50.50 x 48 x 24.60	150	31	8.42	\$2086	\$419
BRTADG5154H24	50.50 x 54 x 24.60	250	32.50	9.47	\$2133	\$431
BRTADG5160H24	50.50 x 60 x 24.60	250	34	10.52	\$2180	\$437
BRTADG5166H24	50.50 x 66 x 24.60	250	35.50	11.57	\$2226	\$449
BRTADG5172H24	50.50 x 72 x 24.60	250	37	12.63	\$2274	\$461
BRTADG5178H24	50.50 x 78 x 24.60	250	38.50	13.68	\$2321	\$466
BRTADG5184H24	50.50 x 84 x 24.60	250	40	14.73	\$2369	\$477
BRTADG6336H24	62.50 x 36 x 24.60	150	41.50	7.81	\$2180	\$437
BRTADG6342H24	62.50 x 42 x 24.60	150	43	9.11	\$2221	\$449
BRTADG6348H24	62.50 x 48 x 24.60	150	44.50	10.42	\$2274	\$461
BRTADG6354H24	62.50 x 54 x 24.60	150	46	11.72	\$2316	\$466
BRTADG6360H24	62.50 x 60 x 24.60	150	47.50	13.02	\$2369	\$477
BRTADG6366H24	62.50 x 66 x 24.60	250	49	14.32	\$2415	\$484
BRTADG6372H24	62.50 x 72 x 24.60	250	50.50	15.63	\$2457	\$496
BRTADG6378H24	62.50 x 78 x 24.60	250	52	16.93	\$2510	\$507
BRTADG6384H24	62.50 x 84 x 24.60	250	53.50	18.23	\$2551	\$514

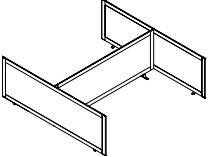

24" H Back-to-Back Glass Divider Screen

Provides privacy in an open plan environment. Easy to clean table mounted partitions. Powder coated aluminum frame with 4mm clear (CLR) glass. Includes all hardware to connect. Brackets are painted steel. Side dividers extend 6.25" from the front edge of each surface. Center divider sits over the gap between the worksurface allowing for cable pass-through to trough. Gap for each side is approximately 1". Width and depth are nominal sizes representing the sizes of the Bridges configuration. Allow for .25" overhang at the sides and 6.25" at the front. Frame and hardware available in all Bridges paint finishes. End trim cap is only available in Charcoal (CHR). **Add 20%** upcharge for frosted glass (FRST).

- **BRTADG51xxH24 are for configurations with 24" deep surfaces.**
- **BRTADG63xxH24 are for configurations with 30" deep surfaces.**

BRTADG5136H30	50.50 x 36 x 30.60	150	30.50	6.31	\$2104	\$424
BRTADG5142H30	50.50 x 42 x 30.60	150	32	7.36	\$2157	\$437
BRTADG5148H30	50.50 x 48 x 30.60	150	33.50	8.42	\$2198	\$443
BRTADG5154H30	50.50 x 54 x 30.60	150	35	9.47	\$2251	\$454
BRTADG5160H30	50.50 x 60 x 30.60	250	36.50	10.52	\$2298	\$461
BRTADG5166H30	50.50 x 66 x 30.60	250	38	11.57	\$2345	\$472
BRTADG5172H30	50.50 x 72 x 30.60	250	39.50	12.63	\$2374	\$477
BRTADG5178H30	50.50 x 78 x 30.60	250	41	13.68	\$2445	\$490
BRTADG5184H30	50.50 x 84 x 30.60	250	42.50	14.73	\$2491	\$502
BRTADG6336H30	62.50 x 36 x 30.60	125	44	7.81	\$2362	\$477
BRTADG6342H30	62.50 x 42 x 30.60	150	45.50	9.11	\$2410	\$484
BRTADG6348H30	62.50 x 48 x 30.60	150	47	10.42	\$2457	\$496
BRTADG6354H30	62.50 x 54 x 30.60	150	48.50	11.72	\$2510	\$507
BRTADG6360H30	62.50 x 60 x 30.60	150	50	13.02	\$2557	\$514
BRTADG6366H30	62.50 x 66 x 30.60	250	51.50	14.32	\$2597	\$525
BRTADG6372H30	62.50 x 72 x 30.60	250	53	15.63	\$2634	\$530
BRTADG6378H30	62.50 x 78 x 30.60	250	54.50	16.93	\$2698	\$543
BRTADG6384H30	62.50 x 84 x 30.60	250	56	18.23	\$2751	\$555

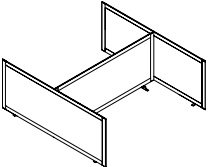

30" H Back-to-Back Glass Divider Screen

Provides privacy in an open plan environment. Easy to clean table mounted partitions. Powder coated aluminum frame with 4mm clear (CLR) glass. Includes all hardware to connect. Brackets are painted steel. Side dividers extend 6.25" from the front edge of each surface. Center divider sits over the gap between the worksurface allowing for cable pass-through to trough. Gap for each side is approximately 1". Width and depth are nominal sizes representing the sizes of the Bridges configuration. Allow for .25" overhang at the sides and 6.25" at the front. Frame and hardware available in all Bridges paint finishes. End trim cap is only available in Charcoal (CHR). **Add 20%** upcharge for frosted glass (FRST).

- **BRTADG51xxH30 are for configurations with 24" deep surfaces.**
- **BRTADG63xxH30 are for configurations with 30" deep surfaces.**

Required specifications
Frame finish

Optional specifications
Frosted glass (FRST)

BACK-TO-BACK GLASS DIVIDER SCREENS

MODEL# DIMENSIONS FREIGHT CLASS WT/LBS. CUBIC FT. LIST PRICE FRST ADD

D x W x H

BRTADGE5136H24	50.50 x 36 x 24.60	150	23.35	6.31	\$1314	\$265
BRTADGE5142H24	50.50 x 42 x 24.60	250	24.85	7.36	\$1362	\$278
BRTADGE5148H24	50.50 x 48 x 24.60	250	26.35	8.42	\$1408	\$284
BRTADGE5154H24	50.50 x 54 x 24.60	250	27.85	9.47	\$1456	\$295
BRTADGE5160H24	50.50 x 60 x 24.60	250	29.35	10.52	\$1503	\$302
BRTADGE5166H24	50.50 x 66 x 24.60	250	30.85	11.57	\$1550	\$313
BRTADGE5172H24	50.50 x 72 x 24.60	250	32.35	12.63	\$1597	\$325
BRTADGE5178H24	50.50 x 78 x 24.60	250	33.85	13.68	\$1643	\$331
BRTADGE5184H24	50.50 x 84 x 24.60	250	35.35	14.73	\$1691	\$343

BRTADGE6336H24	62.50 x 36 x 24.60	150	36.85	7.81	\$1408	\$284
BRTADGE6342H24	62.50 x 42 x 24.60	150	38.35	9.11	\$1456	\$295
BRTADGE6348H24	62.50 x 48 x 24.60	150	39.85	10.42	\$1503	\$302
BRTADGE6354H24	62.50 x 54 x 24.60	250	41.35	11.72	\$1550	\$313
BRTADGE6360H24	62.50 x 60 x 24.60	250	42.85	13.02	\$1590	\$318
BRTADGE6366H24	62.50 x 66 x 24.60	250	44.35	14.32	\$1643	\$331
BRTADGE6372H24	62.50 x 72 x 24.60	250	45.85	15.63	\$1691	\$343
BRTADGE6378H24	62.50 x 78 x 24.60	250	47.35	16.93	\$1733	\$348
BRTADGE6384H24	62.50 x 84 x 24.60	250	48.85	18.23	\$1786	\$360

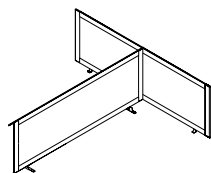

**24" H Back-to-Back Glass Divider
Screen Extension Kit**

Provides an extension to privacy in an open plan environment. Easy to clean table mounted partitions. Intended to always connect to Back-to-Back Divider Screen Kit. Powder coated aluminum frame with 4mm clear (CLR) glass. Includes all hardware to connect. Brackets are painted steel. Side dividers extend 6.25" from the front edge of each surface. Center divider sits over the gap between the worksurface allowing for cable pass-through to trough. Gap for each side is approximately 1". Width and depth are nominal sizes representing the sizes of the Bridges configuration. Allow for .25" overhang at the sides and 6.25" at the front. Frame and hardware available in all Bridges paint finishes. End trim cap is only available in Charcoal (CHR). **Add 20%** upcharge for frosted glass (FRST).

- **BRTADGE51xxH24 are for configurations with 24" deep surfaces.**
- **BRTADGE63xxH24 are for configurations with 30" deep surfaces.**

BRTADGE5136H30	50.50 x 36 x 30.60	150	25.85	6.31	\$1391	\$284
BRTADGE5142H30	50.50 x 42 x 30.60	150	27.35	7.36	\$1431	\$290
BRTADGE5148H30	50.50 x 48 x 30.60	250	28.85	8.42	\$1479	\$302
BRTADGE5154H30	50.50 x 54 x 30.60	250	30.35	9.47	\$1532	\$307
BRTADGE5160H30	50.50 x 60 x 30.60	250	31.85	10.52	\$1579	\$318
BRTADGE5166H30	50.50 x 66 x 30.60	250	33.35	11.57	\$1632	\$331
BRTADGE5172H30	50.50 x 72 x 30.60	250	34.85	12.63	\$1656	\$337
BRTADGE5178H30	50.50 x 78 x 30.60	250	36.35	13.68	\$1721	\$348
BRTADGE5184H30	50.50 x 84 x 30.60	250	37.85	14.73	\$1774	\$360

BRTADGE6336H30	62.50 x 36 x 30.60	150	39.35	7.81	\$1479	\$302
BRTADGE6342H30	62.50 x 42 x 30.60	150	40.85	9.11	\$1532	\$307
BRTADGE6348H30	62.50 x 48 x 30.60	150	42.35	10.42	\$1579	\$318
BRTADGE6354H30	62.50 x 54 x 30.60	250	43.85	11.72	\$1627	\$331
BRTADGE6360H30	62.50 x 60 x 30.60	250	45.35	13.02	\$1673	\$337
BRTADGE6366H30	62.50 x 66 x 30.60	250	46.85	14.32	\$1721	\$348
BRTADGE6372H30	62.50 x 72 x 30.60	250	48.35	15.63	\$1756	\$355
BRTADGE6378H30	62.50 x 78 x 30.60	250	49.85	16.93	\$1821	\$366
BRTADGE6384H30	62.50 x 84 x 30.60	250	51.35	18.23	\$1868	\$378

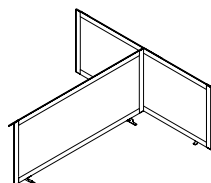

**30" H Back-to-Back Glass Divider
Screen Extension Kit**

Provides an extension to privacy in an open plan environment. Easy to clean table mounted partitions. Intended to always connect to Back-to-Back Divider Screen Kit. Powder coated aluminum frame with 4mm clear (CLR) glass. Includes all hardware to connect. Brackets are painted steel. Side dividers extend 6.25" from the front edge of each surface. Center divider sits over the gap between the worksurface allowing for cable pass-through to trough. Gap for each side is approximately 1". Width and depth are nominal sizes representing the sizes of the Bridges configuration. Allow for .25" overhang at the sides and 6.25" at the front. Frame and hardware available in all Bridges paint finishes. End trim cap is only available in Charcoal (CHR). **Add 20%** upcharge for frosted glass (FRST).

- **BRTADGE51xxH30 are for configurations with 24" deep surfaces.**
- **BRTADGE63xxH30 are for configurations with 30" deep surfaces.**

Required specifications

Frame finish

Optional specifications

Frosted glass (FRST)

SINGLE TABLE GLASS DIVIDER SCREENS

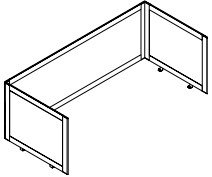

24" H Single Table Glass Divider Screen

MODEL#	DIMENSIONS D x W x H	FREIGHT CLASS	WT./LBS.	CUBIC FT.	LIST PRICE	FRST ADD
BRTADG2436H24	31.50 x 36 x 24.60	125	22.55	3.94	\$1438	\$290
BRTADG2442H24	31.50 x 42 x 24.60	125	24.10	4.59	\$1484	\$302
BRTADG2448H24	31.50 x 48 x 24.60	150	25.65	5.25	\$1532	\$307
BRTADG2454H24	31.50 x 54 x 24.60	150	27.20	5.91	\$1579	\$318
BRTADG2460H24	31.50 x 60 x 24.60	150	28.75	6.56	\$1627	\$331
BRTADG2466H24	31.50 x 66 x 24.60	150	30.30	7.22	\$1673	\$337
BRTADG2472H24	31.50 x 72 x 24.60	150	31.85	7.88	\$1721	\$348
BRTADG2478H24	31.50 x 78 x 24.60	150	33.40	8.53	\$1768	\$355
BRTADG2484H24	31.50 x 84 x 24.60	150	34.95	9.19	\$1815	\$366
BRTADG3036H24	37.75 x 36 x 24.60	100	36.50	4.72	\$1532	\$307
BRTADG3042H24	37.75 x 42 x 24.60	125	38.05	5.51	\$1574	\$318
BRTADG3048H24	37.75 x 48 x 24.60	125	39.60	6.29	\$1627	\$331
BRTADG3054H24	37.75 x 54 x 24.60	125	41.15	7.08	\$1668	\$337
BRTADG3060H24	37.75 x 60 x 24.60	150	41.70	7.87	\$1715	\$348
BRTADG3066H24	37.75 x 66 x 24.60	150	44.25	8.65	\$1762	\$355
BRTADG3072H24	37.75 x 72 x 24.60	150	45.80	9.44	\$1809	\$366
BRTADG3078H24	37.75 x 78 x 24.60	150	47.35	10.22	\$1855	\$371
BRTADG3084H24	37.75 x 84 x 24.60	150	48.90	11.01	\$1903	\$384

Provides privacy in an open plan environment. Easy to clean table mounted partitions. Powder coated aluminum frame with 4mm clear (CLR) glass. Includes all hardware to connect. Brackets are painted steel. Side dividers extend 6.237" from the front edge of each surface. Back divider extends over the back edge of the worksurface by 1.5", allowing for cable pass-through to trough. Width and depth are nominal sizes representing the sizes of the Bridges configuration. Allow for .25" overhang at the sides, 1.5" at the back, and 6.237" at the front. Frame and hardware available in all Bridges paint finishes. End trim cap is only available in Charcoal (CHR). 9mm PET felt material is tackable and available in 9 colors.

- **BRTADG24xxH24 are for configurations with 24" deep surfaces.**
- **BRTADG30xxH24 are for configurations with 30" deep surfaces.**

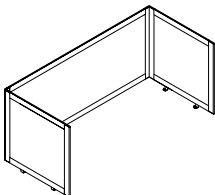

30" H Single Table Glass Divider Screen

BRTADG2436H30	31.50 x 36 x 30.60	125	24.85	3.97	\$1503	\$302
BRTADG2442H30	31.50 x 42 x 30.60	125	26.40	4.59	\$1544	\$313
BRTADG2448H30	31.50 x 48 x 30.60	125	27.95	5.25	\$1590	\$318
BRTADG2454H30	31.50 x 54 x 30.60	150	29.50	5.91	\$1643	\$331
BRTADG2460H30	31.50 x 60 x 30.60	150	31.05	6.56	\$1691	\$343
BRTADG2466H30	31.50 x 66 x 30.60	150	32.60	7.22	\$1744	\$355
BRTADG2472H30	31.50 x 72 x 30.60	150	34.14	7.88	\$1768	\$355
BRTADG2478H30	31.50 x 78 x 30.60	150	34.70	8.53	\$1832	\$371
BRTADG2484H30	31.50 x 84 x 30.60	150	37.25	9.19	\$1885	\$378
BRTADG3036H30	37.75 x 36 x 30.60	100	38.80	4.72	\$1590	\$318
BRTADG3042H30	37.75 x 42 x 30.60	100	40.35	5.51	\$1643	\$331
BRTADG3048H30	37.75 x 48 x 30.60	125	41.90	6.29	\$1691	\$343
BRTADG3054H30	37.75 x 54 x 30.60	125	43.45	7.08	\$1733	\$348
BRTADG3060H30	37.75 x 60 x 30.60	125	45	7.87	\$1786	\$360
BRTADG3066H30	37.75 x 66 x 30.60	150	46.55	8.65	\$1832	\$371
BRTADG3072H30	37.75 x 72 x 30.60	150	48.10	9.44	\$1868	\$378
BRTADG3078H30	37.75 x 78 x 30.60	150	49.65	10.22	\$1933	\$390
BRTADG3084H30	37.75 x 84 x 30.60	150	51.20	11.01	\$1974	\$396

Provides privacy in an open plan environment. Easy to clean table mounted partitions. Powder coated aluminum frame with 4mm clear (CLR) glass. Includes all hardware to connect. Brackets are painted steel. Side dividers extend 6.237" from the front edge of each surface. Back divider extends over the back edge of the worksurface by 1.5", allowing for cable pass-through to trough. Width and depth are nominal sizes representing the sizes of the Bridges configuration. Allow for .25" overhang at the sides, 1.5" at the back, and 6.237" at the front. Frame and hardware available in all Bridges paint finishes. End trim cap is only available in Charcoal (CHR). **Add 20% upcharge for frosted glass (FRST).**

- **BRTADG24xxH30 are for configurations with 24" deep surfaces.**
- **BRTADG30xxH30 are for configurations with 30" deep surfaces.**

Required specifications
Frame finish

Optional specifications
Frosted glass (FRST)

SINGLE TABLE GLASS DIVIDER SCREENS

MODEL# DIMENSIONS FREIGHT CLASS WT/LBS. CUBIC FT. LIST PRICE FRST ADD

D x W x H

BRTADGE2436H24	31.50 x 36 x 24.60	150	18.55	3.94	\$1032	\$207
BRTADGE2442H24	31.50 x 42 x 24.60	150	20.10	4.59	\$1126	\$231
BRTADGE2448H24	31.50 x 48 x 24.60	150	21.65	5.25	\$1166	\$237
BRTADGE2454H24	31.50 x 54 x 24.60	150	23.20	5.91	\$1214	\$249
BRTADGE2460H24	31.50 x 60 x 24.60	150	24.75	6.56	\$1261	\$254
BRTADGE2466H24	31.50 x 66 x 24.60	250	26.30	7.22	\$1309	\$265
BRTADGE2472H24	31.50 x 72 x 24.60	250	27.85	7.88	\$1355	\$272
BRTADGE2478H24	31.50 x 78 x 24.60	250	29.40	8.53	\$1403	\$284
BRTADGE2484H24	31.50 x 84 x 24.60	250	30.95	9.19	\$1450	\$295

BRTADGE3036H24	37.75 x 36 x 24.60	125	32.50	4.72	\$1079	\$219
BRTADGE3042H24	37.75 x 42 x 24.60	125	34.05	5.51	\$1173	\$237
BRTADGE3048H24	37.75 x 48 x 24.60	125	35.60	6.29	\$1219	\$249
BRTADGE3054H24	37.75 x 54 x 24.60	150	37.15	7.08	\$1267	\$254
BRTADGE3060H24	37.75 x 60 x 24.60	150	38.70	7.87	\$1314	\$265
BRTADGE3066H24	37.75 x 66 x 24.60	150	40.25	8.65	\$1362	\$278
BRTADGE3072H24	37.75 x 72 x 24.60	150	41.80	9.44	\$1408	\$284
BRTADGE3078H24	37.75 x 78 x 24.60	150	43.35	10.01	\$1456	\$295
BRTADGE3084H24	37.75 x 84 x 24.60	150	44.90	10.01	\$1503	\$302

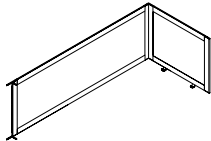
**24" H Single Table Glass Divider Screen Extension Kit**

Provides an extension for privacy in an open plan environment. Intended to always connect to Single Table Divider Screen Kit. Easy to clean table mounted partitions. Powder coated aluminum frame with 4mm clear (CLR) glass. Includes all hardware to connect. Brackets are painted steel. Side dividers extend 6.237" from the front edge of each surface. Back divider extends over the back edge of the worksurface by 1.5", allowing for cable pass-through to trough. Width and depth are nominal sizes representing the sizes of the Bridges configuration. Allow for .25" overhang at the sides, 1.5" at the back, and 6.237" at the front. Frame and hardware available in all Bridges paint finishes. End trim cap is only available in Charcoal (CHR). **Add 20%** upcharge for frosted glass (FRST).

- **BRTADGE24xxH24 are for configurations with 24" deep surfaces.**
- **BRTADGE30xxH24 are for configurations with 30" deep surfaces.**

BRTADGE2436H30	31.50 x 36 x 30.60	150	20.35	3.94	\$1079	\$219
BRTADGE2442H30	31.50 x 42 x 30.60	150	21.90	4.59	\$1173	\$237
BRTADGE2448H30	31.50 x 48 x 30.60	150	23.45	5.25	\$1219	\$249
BRTADGE2454H30	31.50 x 54 x 30.60	150	25	5.91	\$1272	\$260
BRTADGE2460H30	31.50 x 60 x 30.60	150	26.55	6.56	\$1320	\$265
BRTADGE2466H30	31.50 x 66 x 30.60	150	28.10	7.22	\$1373	\$278
BRTADGE2472H30	31.50 x 72 x 30.60	150	29.65	7.88	\$1397	\$284
BRTADGE2478H30	31.50 x 78 x 30.60	250	31.20	8.53	\$1461	\$295
BRTADGE2484H30	31.50 x 84 x 30.60	250	32.75	9.19	\$1514	\$307

BRTADGE3036H30	37.75 x 36 x 30.60	125	34.30	4.72	\$1132	\$231
BRTADGE3042H30	37.75 x 42 x 30.60	125	35.85	5.51	\$1219	\$249
BRTADGE3048H30	37.75 x 48 x 30.60	125	37.40	6.29	\$1272	\$260
BRTADGE3054H30	37.75 x 54 x 30.60	150	38.95	7.08	\$1320	\$265
BRTADGE3060H30	37.75 x 60 x 30.60	150	40.50	7.87	\$1373	\$278
BRTADGE3066H30	37.75 x 66 x 30.60	150	42.05	8.65	\$1415	\$284
BRTADGE3072H30	37.75 x 72 x 30.60	150	43.60	9.44	\$1444	\$290
BRTADGE3078H30	37.75 x 78 x 30.60	150	45.15	10.22	\$1514	\$307
BRTADGE3084H30	37.75 x 84 x 30.60	150	46.70	11.01	\$1562	\$313

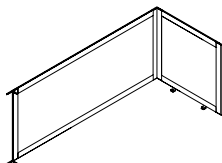
**30" H Single Table Glass Divider Screen Extension Kit**

Provides an extension for privacy in an open plan environment. Intended to always connect to Single Table Divider Screen Kit. Easy to clean table mounted partitions. Powder coated aluminum frame with 4mm clear (CLR) glass. Includes all hardware to connect. Brackets are painted steel. Side dividers extend 6.237" from the front edge of each surface. Back divider extends over the back edge of the worksurface by 1.5", allowing for cable pass-through to trough. Width and depth are nominal sizes representing the sizes of the Bridges configuration. Allow for .25" overhang at the sides, 1.5" at the back, and 6.237" at the front. Frame and hardware available in all Bridges paint finishes. End trim cap is only available in Charcoal (CHR). **Add 20%** upcharge for frosted glass (FRST).

- **BRTADGE24xxH30 are for configurations with 24" deep surfaces.**
- **BRTADGE30xxH30 are for configurations with 30" deep surfaces.**

Required specifications

Frame finish

Optional specifications

Frosted glass (FRST)

STORAGE

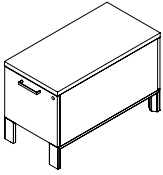

File Pedestal

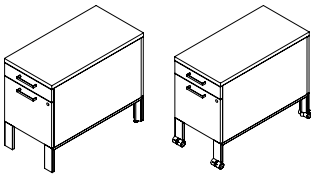

Box/File Pedestal

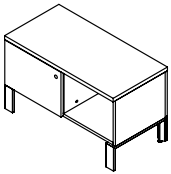

Sliding Door Storage

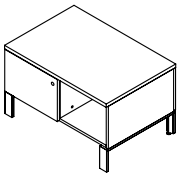

Shared Sliding Door Storage

MODEL#	DIMENSIONS D x W x H	FREIGHT CLASS	WT/LBS.	CUBIC FT.	LIST PRICE	HP ADD
BRT21BF18L	18 x 15.5 x 21	70	58	3.39	\$777	\$57
BRT21BF24L	24 x 15.5 x 21	85	64	4.52	\$903	\$57
BRT21BF30L	30 x 15.5 x 21	85	72	5.65	\$991	\$74
BRT21BF18C	18 x 15.5 x 21	70	58	3.39	\$777	\$57
BRT21BF24C	24 x 15.5 x 21	85	64	4.52	\$971	\$57
BRT21BF30C	30 x 15.5 x 21	85	72	5.65	\$1060	\$74

Can join with other 21" h storage units of corresponding depth to form a spine or slide out on casters to serve as an additional worksurface. One file drawer. Fits under table beams even with optional seat cushion. Optional cable basket suspends off storage unit's bottom and manages cables and data cables under storage spine. (Leveler models only.) 1" top; metal handles; powder coated aluminum or anodized aluminum legs. Specify "L" models for levelers or "C" models for 40mm white/grey locking casters.

- Anodized Aluminum Leg - Add **\$77** list upcharge
- 18" deep storage components will not accept legal size paper

BRT25BF18L	18 x 15.5 x 25	70	69	3.89	\$883	\$57
BRT25BF24L	24 x 15.5 x 25	85	74	5.02	\$1026	\$57
BRT25BF30L	30 x 15.5 x 25	85	82	6.15	\$1113	\$74
BRT25BF18C	18 x 15.5 x 25	70	69	3.89	\$954	\$57
BRT25BF24C	24 x 15.5 x 25	85	74	5.02	\$1094	\$57
BRT25BF30C	30 x 15.5 x 25	85	82	6.15	\$1183	\$74

Can join with other 25" h storage units of corresponding depth to form a spine or slide out on casters to serve as an additional worksurface. One box drawer, one file drawer. Optional cable basket suspends off storage unit's bottom and manages cables and data cables under storage spine. (Leveler models only.) 1" top; metal handles; powder coated aluminum or anodized aluminum legs. Specify "L" models for levelers or "C" models for 40mm white/grey locking casters. Black pencil tray included.

- Anodized Aluminum Leg - Add **\$77** list upcharge
- 18" deep storage components will not accept legal size paper

BRT21LS30L	18 x 30 x 21	100	53	6.56	\$848	\$74
BRT21LS36L	18 x 36 x 21	125	60	7.87	\$938	\$74
BRT21LS42L	18 x 42 x 21	125	67	9.18	\$1026	\$74

Can join with other 21" h storage units of corresponding depth to form a spine. Optional 15.5" x 18" cushion. Storage compartment internal height: 12.36" Sliding door locks on left side. Optional cable basket suspends off storage unit's bottom and manages cables along the horizontal plane. 1" top; metal handles; powder coated aluminum or anodized aluminum legs.

- Anodized Aluminum Leg - Add **\$77** list upcharge
- 18" deep storage components will not accept legal size paper

BRT21LSS30L	24 x 30 x 21	125	69	8.75	\$1183	\$74
BRT21LSS36L	24 x 36 x 21	125	78	10.50	\$1289	\$93
BRT21LSS42L	24 x 42 x 21	125	87	12.25	\$1394	\$109

Offers two 11" deep storage compartments on either side. For use beside a table assembly, between two adjacent workstations. Can join with other 21" h, 24" d storage units to form a spine. Optional 15.5" x 18" cushion. Storage compartment internal height: 12.36" Sliding door locks on left side. Optional cable basket suspends off storage unit's bottom and manages cables along the horizontal plane. 1" top; metal handles; powder coated aluminum or anodized aluminum legs.

- Anodized Aluminum Leg - Add **\$77** list upcharge

Required Specifications

Metal finish
 Top finish Edge finish
 Chassis finish
 Drawer/door front finish

Optional Specifications

Anodized Aluminum Leg
 HP laminate (tops only)
 Cable Basket

STORAGE

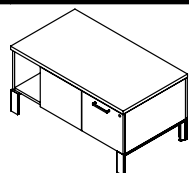

Shared File/Open Storage*

MODEL#	DIMENSIONS	FREIGHT CLASS	WT./LBS.	CUBIC FT.	LIST PRICE	HP ADD
--------	------------	---------------	----------	-----------	------------	--------

	D x W x H					
BRT21LSO42L	24 x 42 x 21	100	124	14	\$1588	\$127

Offers storage compartments on either side. For use between two adjacent workstations. Can join with other 21"h, 24"d storage units to form a spine or serve as an additional return worksurface or ad-hoc guest seating with optional 15.5" x 18" cushion. One locking file drawer, One open compartment per side. Storage compartment internal height without shelf: 12.36". Optional cable basket suspends off storage unit's bottom and manages cables along the horizontal plane. 1" top; metal handles; powder coated aluminum or anodized aluminum legs.

- Anodized Aluminum Leg - Add \$77 list upcharge

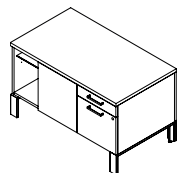

Shared Storage Unit*

BRT25LBF042L	24 x 42 x 25	100	154	16.66	\$1994	\$109
--------------	--------------	-----	-----	-------	--------	-------

Offers storage compartments on either side. For use between two adjacent workstations. Can join with other 25"h, 24"d storage units to form a spine or serve as an additional return worksurface or ad-hoc guest seating with optional 15.5" x 18" cushion. One locking file drawer, One open compartment per side. Storage compartment internal height without shelf: 12.36". Optional cable basket suspends off storage unit's bottom and manages cables along the horizontal plane. 1" top; metal handles; powder coated aluminum or anodized aluminum legs. Black pencil tray included.

- Anodized Aluminum Leg - Add \$77 list upcharge
- 25" high Bridges storage should not be used under back-to-back Bridges table applications using Below Worksurface Trough. Storage will not fit under the trough.

MODULAR STORAGE

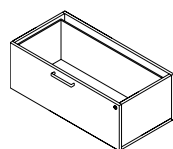

21"H Lateral File Drawer, No Top

MODEL#	DIMENSIONS	FREIGHT CLASS	WT./LBS.	CUBIC FT.	LIST PRICE	HP ADD
--------	------------	---------------	----------	-----------	------------	--------

BRT21F3018U	18 x 30 x 13	92.5	47	4.06	\$917	n/a
BRT21F3618U	18 x 36 x 13	92.5	51	4.88	\$1013	n/a
BRT21F4218U	18 x 42 x 13	100	56	5.69	\$1176	n/a
BRT21F3024U	24 x 30 x 13	100	51	5.42	\$939	n/a
BRT21F3624U	24 x 36 x 13	100	55	6.5	\$1046	n/a
BRT21F4224U	24 x 42 x 13	125	60	7.58	\$1230	n/a

Fits below Bridges II tables. Can join with other 21"h storage units of corresponding depth to form a spine. Floor clearance allows for installation of optional cable basket to manage cords and data cables under storage spine. One file drawer. **Top and legs to be ordered separately.** Metal handles.

- 18" deep storage components will not accept legal size paper

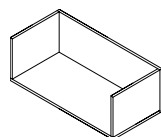

21"H Open Storage, No Top

BRT21LO3018U	18 x 30 x 13	125	25	4.06	\$289	n/a
BRT21LO3618U	18 x 36 x 13	150	29	4.88	\$430	n/a
BRT21LO4218U	18 x 42 x 13	150	32	5.69	\$467	n/a
BRT21LO3024U	24 x 30 x 13	150	29	5.42	\$300	n/a
BRT21LO3624U	24 x 36 x 13	150	33	6.5	\$447	n/a
BRT21LO4224U	24 x 42 x 13	150	36	7.58	\$485	n/a

Open storage unit with no top. Positioned beside a Bridges II table assembly or between two adjacent workstations. Can join with other 21"h storage units to form a spine. Floor clearance allows for installation of optional cable basket to manage cords and data cables under storage spine. One box opening. **Top and legs to be ordered separately.**

Required Specifications

Metal finish*	
Top finish*	Edge finish*
Chassis finish	
Drawer/door front finish	

Optional Specifications

Anodized Aluminum Leg*
HP laminate* (tops only)
Cable Basket
Cushion (BRT21LSO42L)

MODULAR STORAGE

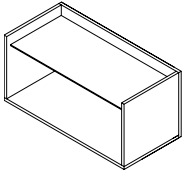

25" H Open Storage, Glass Shelf, No Top

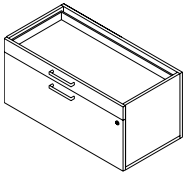

Lateral Box/File Storage, No Top*

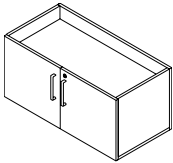

25" H Storage Cabinet, No Top*

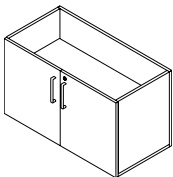

29" H Storage Cabinet, No Top*

MODEL#	DIMENSIONS D x W x H	FREIGHT CLASS	WT./LBS.	CUBIC FT.	LIST PRICE	HP ADD
BRT25L03018U	18 x 30 x 17	125	40	5.31	\$427	n/a
BRT25L03618U	18 x 36 x 17	125	46	6.38	\$586	n/a
BRT25L04218U	18 x 42 x 17	125	52	7.44	\$605	n/a
BRT25L03024U	24 x 30 x 17	125	44	7.08	\$455	n/a
BRT25L03624U	24 x 36 x 17	150	50	8.5	\$609	n/a
BRT25L04224U	24 x 42 x 17	150	56	9.92	\$635	n/a

Positioned usually beside a table assembly or between two adjacent workstations. Can join with other 25" h storage units to form a storage spine. Floor clearance allows for installation of optional cable basket to manage cords and data cables under storage spine. One box opening with glass shelf. **Top and legs to be ordered separately.**

- 25" high Bridges storage should not be used under back-to-back Bridges table applications using Below Worksurface Trough. Storage will not fit under the trough.

BRT25LBF3018U	18 x 30 x 17	92.5	58	5.31	\$1100	n/a
BRT25LBF3618U	18 x 36 x 17	85	78	6.38	\$1277	n/a
BRT25LBF4218U	18 x 42 x 17	100	68	7.44	\$1360	n/a
BRT25LBF3024U	24 x 30 x 17	100	62	7.08	\$1143	n/a
BRT25LBF3624U	24 x 36 x 17	100	82	8.5	\$1328	n/a
BRT25LBF4224U	24 x 42 x 17	125	72	9.92	\$1415	n/a

Positioned usually beside a table assembly or between two adjacent workstations. Can join with other 25" h storage units to form a storage spine. Floor clearance allows for installation of optional cable basket to manage cords and data cables under storage spine. One locking file drawer, one box drawer. **Top and legs to be ordered separately.** Metal handles. Black pencil tray included.

- 18" deep storage components will not accept legal size paper
- 25" high Bridges storage should not be used under back-to-back Bridges table applications using Below Worksurface Trough. Storage will not fit under the trough.

BRT25L2D3018U	18 x 30 x 17	125	39	5.31	\$814	n/a
BRT25L2D3618U	18 x 36 x 17	125	45	6.38	\$874	n/a
BRT25L2D4218U	18 x 42 x 17	125	54	7.44	\$910	n/a
BRT25L2D3024U	24 x 30 x 17	125	43	7.08	\$947	n/a
BRT25L2D3624U	24 x 36 x 17	150	49	8.5	\$1032	n/a
BRT25L2D4224U	24 x 42 x 17	150	58	9.92	\$1075	n/a

Positioned usually beside a table assembly or between two adjacent workstations. Can join with other 25" h storage units to form a storage spine. Floor clearance allows for installation of optional cable basket to manage cords and data cables under storage spine. Two lockable doors, glass shelf included. **Top and legs to be ordered separately.** Storage compartment internal height is 16.5". Metal handles.

- 25" high Bridges storage should not be used under back-to-back Bridges table applications using Below Worksurface Trough. Storage will not fit under the trough.

BRT29L2D3018U	18 x 30 x 21	125	49	6.56	\$929	n/a
BRT29L2D3618U	18 x 36 x 21	125	55	7.88	\$970	n/a
BRT29L2D4218U	18 x 42 x 21	125	64	9.19	\$1012	n/a
BRT29L2D3024U	24 x 30 x 21	125	53	8.75	\$1090	n/a
BRT29L2D3624U	24 x 36 x 21	150	59	10.5	\$1139	n/a
BRT29L2D4224U	24 x 42 x 21	150	68	12.25	\$1164	n/a

Positioned usually beside a table assembly or between two adjacent workstations. Units are level with Bridges tops and can join other 29" h storage units to form a credenza or serve as an additional return worksurface. Floor clearance allows for installation of optional cable basket to manage cords and data cables under storage spine. Two lockable doors, glass shelf included. **Top and legs to be ordered separately.** Storage compartment internal height is 20.5". Metal handles.

- 25" high Bridges storage should not be used under back-to-back Bridges table applications using Below Worksurface Trough. Storage will not fit under the trough.

Required Specifications

Chassis finish
Drawer/door front finish*

Optional Specifications

Cable Basket

MODULAR STORAGE

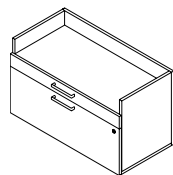

29" H Box/File/Open Storage, No Top

MODEL#	DIMENSIONS D x W x H	FREIGHT CLASS	WT/LBS.	CUBIC FT.	LIST PRICE	HP ADD
BRT29LOBF3018U	18 x 30 x 21	92.5	70	6.56	\$1294	n/a
BRT29LOBF3618U	18 x 36 x 21	100	78	7.88	\$1460	n/a
BRT29LOBF4218U	18 x 42 x 21	100	86	9.19	\$1604	n/a
BRT29LOBF3024U	24 x 30 x 21	100	74	8.75	\$1347	n/a
BRT29LOBF3624U	24 x 36 x 21	125	82	10.52	\$1519	n/a
BRT29LOBF4224U	24 x 42 x 21	125	90	12.25	\$1668	n/a

Positioned beside a table assembly or between two adjacent workstations. Units are level with Bridges tops and can join other 29" h storage units to form a credenza or serve as an additional return worksurface. Floor clearance allows for installation of optional cable basket to manage cords and data cables under storage spine. One locking file drawer, one box drawer and one open compartment. **Top and legs to be ordered separately.** Storage compartment internal height: 3.9". Metal handles. Black pencil tray included.

- 18" deep storage components will not accept legal size paper

BRTWU1830	18 x 30 x 1	60	15	0.5	\$162	\$57
BRTWU1836	18 x 36 x 1	60	18	0.59	\$185	\$62
BRTWU1842	18 x 42 x 1	60	21	0.68	\$243	\$82
BRTWU1860	18 x 60 x 1	65	29	0.97	\$384	\$112
BRTWU1866	18 x 66 x 1	65	32	1.1	\$403	\$127
BRTWU1872	18 x 72 x 1	65	35	1.2	\$420	\$138
BRTWU1878	18 x 78 x 1	65	38	1.3	\$444	\$145
BRTWU1884	18 x 84 x 1	65	41	1.4	\$487	\$152
BRTWU1890	18 x 90 x 1	65	44	1.5	\$506	\$157
BRTWU1896	18 x 96 x 1	65	47	1.6	\$527	\$164

BRTWU2430	24 x 30 x 1	60	20	0.65	\$170	\$51
BRTWU2436	24 x 36 x 1	60	24	0.78	\$189	\$64
BRTWU2442	24 x 42 x 1	60	28	0.9	\$249	\$81
BRTWU2460	24 x 60 x 1	60	39	1.3	\$392	\$129
BRTWU2466	24 x 66 x 1	60	43	1.41	\$409	\$133
BRTWU2472	24 x 72 x 1	60	47	1.54	\$427	\$34
BRTWU2478	24 x 78 x 1	60	51	1.7	\$458	\$146
BRTWU2484	24 x 84 x 1	60	55	1.8	\$496	\$154
BRTWU2490	24 x 90 x 1	60	59	1.9	\$516	\$159
BRTWU2496	24 x 96 x 1	60	63	2	\$536	\$167

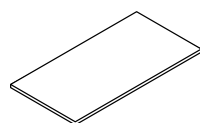

Worksurface for Modular Storage*

Flat 3mm profile on all sides. Worksurface provided with pilot holes for alignment purposes. Worksurfaces can be used for each modular unit or can span two to three units.

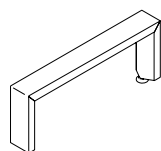

Modular Storage Leg**

BRT18LEGL	18 x 2.5 x 8	150	8	1.34	\$61	n/a
BRT24LEGL	24 x 2.5 x 8	150	8	1.34	\$68	n/a

Two single legs form the structure of the Bridges II series modular storage. A single leg can be used at the end of each modular storage unit or can be used to support where two modular units meet. Leveling glides, steel frame, aluminum legs.

- Anodized Aluminum leg - Add **\$32** list upcharge

Required Specifications

Top finish*
Edge finish
Chassis finish
Metal finish**

Optional Specifications

HP laminate* (tops only)
Anodized Aluminum Leg**
Cable Basket (storage unit)

STORAGE

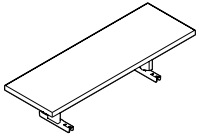

Center Mount Shelf*

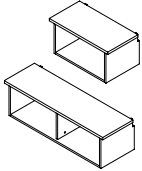
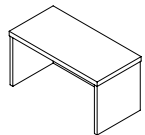
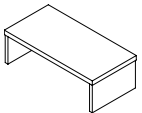

Table Mounted End Shelf*



Single Sided Elevated Table Shelf*

MODEL#	DIMENSIONS	FREIGHT CLASS	WT/LBS.	CUBIC FT.	LIST PRICE	HP ADD
--------	------------	---------------	---------	-----------	------------	--------

	D x W x H					
BRTCMS36	12 x 36 x 6.75	100	15.20	1.69	\$338	n/a
BRTCMS30	12 x 30 x 6.75	100	12.60	1.41	\$238	n/a

Open, shared center mount shelf “floats” 6.75” above the gap formed by two back-to-back worksurfaces. Accepts BRTESSBIN Elevated Shelf Binder Bin - The 30”w shelf accommodates two; 36”w shelf accommodates up to three. Shelves overhang the support structure by 6” on either side. Aluminum/die cast structure attaches to the underside of both worksurfaces.

- Not compatible with BRTEETA Above Worksurface Power Trough and Worksurfaces with Access Doors
- Anodized Aluminum support structure - Add **\$77** list upcharge

BRTTES24	15.5 x 24 x 15	100	29	3.22	\$656	\$57
BRTTES30	15.5 x 30 x 15	100	34	4.03	\$718	\$64
BRTTES51	15.5 x 50.5 x 15	100	57	6.79	\$1183	\$117
BRTTES63	15.5 x 62.5 x 15	100	68	8.40	\$1300	\$151

Single or double open shelf/extended worksurface. Secured to the end of single or back-to-back Bridges table. All mounting hardware included. Storage compartment internal height: 13.25”. 1” top.

BRTSTS0824	12 x 24 x 8	92.5	14	1.33	\$232	\$74
BRTSTS0830	12 x 30 x 8	100	16	1.66	\$267	\$74
BRTSTS0851	12 x 50.5 x 8	100	25	2.80	\$426	\$109
BRTSTS0863	12 x 62.5 x 8	100	28	3.47	\$481	\$162

BRTSTS1324	12 x 24 x 13	100	18	2.16	\$251	\$74
BRTSTS1330	12 x 30 x 13	125	21	2.70	\$286	\$74
BRTSTS1351	12 x 50.5 x 13	125	32	4.55	\$426	\$109
BRTSTS1363	12 x 62.5 x 13	125	38	5.64	\$497	\$145

BRTSTS1624	12 x 24 x 16	125	19	2.66	\$286	\$74
BRTSTS1630	12 x 30 x 16	100	29	3.33	\$338	\$74
BRTSTS1651	12 x 50.5 x 16	150	33	5.61	\$497	\$127
BRTSTS1663	12 x 62.5 x 16	150	39	6.94	\$568	\$162

Secured perpendicularly to the single or back-to-back Bridges table. Integrated anodized aluminum accessory rail. White cut out and accessory rail trims. Optional Elevated Shelf Binder Bin (BRTESSBIN) rests on top surface for enhanced privacy. 8”h provides additional storage space without obstructing view and reaches 16” module height when combined w/8”h Binder shelf. Internal height: 6.6”. 16”h lines up with top of 16” table dividers (15.8”). Specify 12” narrower shared elevated shelf immediately adjacent to the perpendicular elevated shelf. Internal height: 14.6”.

- Please refer to the **Compatibility Guide** on page 416 to determine available accessories

Required Specifications

Top finish
Edge finish
Chassis/Accent Finish

Optional Specifications

HP laminate (tops only)
Elevated Shelf Binder Bin

STORAGE

MODEL#	DIMENSIONS	FREIGHT CLASS	WT/LBS.	CUBIC FT.	LIST PRICE	HP ADD
--------	------------	---------------	---------	-----------	------------	--------

D x W x H

BRTBTS0836	12 x 36 x 8	100	16	2	\$356	\$74
BRTBTS0842	12 x 42 x 8	100	19	2.33	\$391	\$74
BRTBTS0848	12 x 48 x 8	125	21	2.66	\$426	\$109
BRTBTS0854	12 x 54 x 8	125	23	3	\$444	\$127
BRTBTS0860	12 x 60 x 8	125	26	3.33	\$497	\$145
BRTBTS0866	12 x 66 x 8	125	28	3.66	\$532	\$162
BRTBTS0872	12 x 72 x 8	125	30	4	\$568	\$162
BRTBTS0878	12 x 78 x 8	125	32	4.33	\$603	\$180
BRTBTS0884	12 x 84 x 8	125	35	4.66	\$639	\$196

BRTBTS1336	12 x 36 x 13	125	22	3.25	\$426	\$93
BRTBTS1342	12 x 42 x 13	125	25	3.79	\$481	\$93
BRTBTS1348	12 x 48 x 13	125	28	4.33	\$516	\$127
BRTBTS1354	12 x 54 x 13	125	30	4.87	\$568	\$127
BRTBTS1360	12 x 60 x 13	150	33	5.86	\$603	\$127
BRTBTS1366	12 x 66 x 13	150	36	6.45	\$618	\$216
BRTBTS1372	12 x 72 x 13	125	39	6.50	\$708	\$180
BRTBTS1378	12 x 78 x 13	150	42	7.04	\$761	\$180
BRTBTS1384	12 x 84 x 13	150	44	7.58	\$814	\$196

BRTBTS1636	12 x 36 x 16	125	25	4	\$444	\$74
BRTBTS1642	12 x 42 x 16	125	28	4.66	\$497	\$109
BRTBTS1648	12 x 48 x 16	150	31	5.33	\$549	\$109
BRTBTS1654	12 x 54 x 16	150	34	6	\$583	\$145
BRTBTS1660	12 x 60 x 16	150	38	6.66	\$639	\$145
BRTBTS1666	12 x 66 x 16	150	41	7.33	\$691	\$145
BRTBTS1672	12 x 72 x 16	150	44	8	\$744	\$162
BRTBTS1678	12 x 78 x 16	150	47	8.66	\$777	\$180
BRTBTS1684	12 x 84 x 16	150	50	9.33	\$833	\$196

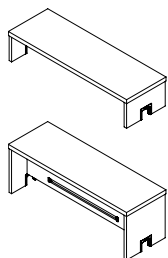

Shared Elevated Table Shelf

Rests on back-to-back Bridges tables. Cut outs in both supporting side gables allow placement over above worksurface power/data troughs. Integrated anodized aluminum accessory rail. White cut out and accessory rail trims. Three heights available. 8" h provides additional storage space without obstructing view; reaches 16" module height when combined w/8" h Binder shelf. Internal height: 6.6". 16" h lines up with top of 16" table dividers (15.8"). Specify 12" narrower shared elevated shelf immediately adjacent to the perpendicular elevated shelf. Internal height: 14.6". Optional Elevated Shelf Binder Bin (BRTESBBIN) rests on top surface for enhanced privacy. 1" top.

- Please refer to the **Compatibility Guide** on page 416 to determine available accessories

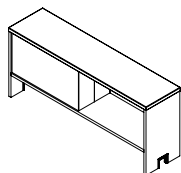

Table Supported Shared Overhead

BRTBAS048	12 x 48 x 21	125	54	7	\$708	\$109
-----------	--------------	-----	----	---	-------	-------

One compartment per side. White magnetic back wall. Lines up with 50" h floor standing storage. Fits over the gap between two parallel back-to-back Bridges tables. Fits over worksurface power/data trough. Storage compartment internal height: 12.8". Optional Elevated Shelf Binder Bin (BRTESBBIN) rests on top surface for enhanced privacy. 1" top.

- Please refer to the **Compatibility Guide** on page 416 to determine available accessories

Required Specifications

Top finish
Edge finish
Chassis/accent finish

Optional Specifications

HP laminate (tops only)
Elevated Shelf Binder Bin

STORAGE

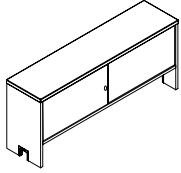

Shared Elevated Overhead*

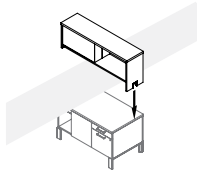

45" High Shared Storage Divider**

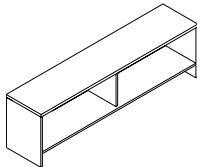

Open Single Sided Storage

MODEL#	DIMENSIONS D x W x H	FREIGHT CLASS	WT./LBS.	CUBIC FT.	LIST PRICE	HP ADD
BRTBASL36	16 x 36 x 21	250	23.50	6.56	\$2045	\$137
BRTBASL42	16 x 42 x 21	250	27.50	7.65	\$2188	\$167
BRTBASL48	16 x 48 x 21	250	31.40	8.75	\$2302	\$197
BRTBASL54	16 x 54 x 21	250	35.30	9.84	\$2477	\$207
BRTBASL60	16 x 60 x 21	250	35.30	9.84	\$2611	\$217
BRTBASL66	16 x 66 x 21	250	43.20	12.03	\$2947	\$250
BRTBASL72	16 x 72 x 21	250	47.10	13.12	\$3102	\$279
BRTBASL78	16 x 78 x 21	250	51	14.21	\$3265	\$300
BRTBASL84	16 x 84 x 21	250	55	15.31	\$3308	\$413

Two compartments facing in opposite direction with locking, sliding laminate doors. Storage compartment internal height: 12.25". Shared elevated overhead fits over the gap between two parallel Bridges back-to-back tables. Integrated anodized aluminum accessory rail below the storage compartments. Fits over Above Worksurface Power/Data Troughs. Elevated Shelf Binder Bins DO NOT work with this overhead. 1" top.

- Note: In order to prevent duplex outlet and worksurface access door interference, please specify Overhead of the same width as the supporting worksurface.
- To prevent interference with Ceiling feed pole, please specify Overhead 6" shorter in width corresponding with the length of the supporting worksurface.
- Please refer to the **Compatibility Guide** on page 416 to determine available accessories

BRTSDS48	12 x 48 x 16	92.5	54	5.33	\$568	\$109
----------	--------------	------	----	------	--------------	--------------

Divides side-to-side workstations. Two shared, open shelves. One compartment per side. White magnetic back wall. Rests on top of shared 25" box/file/open and back-to-back worksurface. Top of unit is 15.7" from the top of the worksurface. Storage compartment internal height: 12.8". Optional Elevated Shelf Binder Bin (BRTEBBIN) rests on top surface for enhanced privacy. 1" top, white powder-coated steel central partition and backs.

BRT21HO3616	16 x 36 x 21	100	81	9	\$1019	\$137
BRT21HO4216	16 x 42 x 21	100	81	9	\$1093	\$157
BRT21HO4816	16 x 48 x 21	250	31.40	8.75	\$1166	\$179
BRT21HO5416	16 x 54 x 21	250	35.30	9.84	\$1239	\$201
BRT21HO6016	16 x 60 x 21	250	35.30	9.84	\$1320	\$224
BRT21HO6616	16 x 66 x 21	250	43.20	12.03	\$1404	\$245
BRT21HO7216	16 x 72 x 21	250	47.10	13.12	\$1456	\$278
BRT21HO7816	16 x 78 x 21	250	51	14.21	\$1566	\$289
BRT21HO8416	16 x 84 x 21	250	55	15.31	\$1629	\$311

Table supported single sided open storage. Storage compartment internal height: 14". 1" top.

- Cannot be used in conjunction with above worksurface power trough.
- To prevent duplex outlet and worksurface access door interference, please specify Overhead of the same width of the supporting worksurface.
- To prevent interference with ceiling feed pole, please specify Overhead 6" shorter in width corresponding with the length of the supporting worksurface.
- Please refer to the **Compatibility Guide** on page 416 to determine available accessories

Required Specifications

Top finish
Edge finish
Chassis finish*
Drawer/door front finish*

Optional Specifications

HP laminate (tops only)
Elevated Shelf Binder Bin**

STORAGE

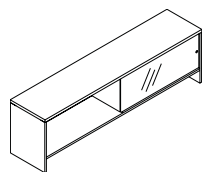

**Open Single Sided Storage,
1 Glass Door**

MODEL#	DIMENSIONS D x W x H	FREIGHT CLASS	WT/LBS.	CUBIC FT.	LIST PRICE	HP ADD
BRT21GS3616	16 x 36 x 21	100	87	9	\$1602	\$135
BRT21GS4216	16 x 42 x 21	100	103	10.50	\$1684	\$156
BRT21GS4816	16 x 48 x 21	100	108	12	\$1756	\$179
BRT21GS5416	16 x 54 x 21	100	133	13.50	\$2094	\$201
BRT21GS6016	16 x 60 x 21	100	144	15	\$2176	\$224
BRT21GS6616	16 x 66 x 21	100	155	16.50	\$2279	\$245
BRT21GS7216	16 x 72 x 21	100	164	18	\$2356	\$267
BRT21GS7816	16 x 78 x 21	100	174	19.50	\$2481	\$288
BRT21GS8416	16 x 84 x 21	100	181	21	\$2554	\$312

Table supported single sided open storage with single sliding glass door with recessed pull. Storage compartment internal height: 14". 1" top.

- Cannot be used in conjunction with above worksurface power trough.
- To prevent duplex outlet and worksurface access door interference, please specify Overhead of the same width of the supporting worksurface.
- To prevent interference with ceiling feed pole, please specify Overhead 6" shorter in width corresponding with the length of the supporting worksurface.
- Please refer to the **Compatibility Guide** on page 416 to determine available accessories

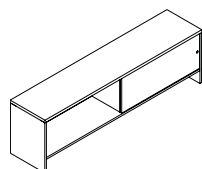

**Open Single Sided Storage,
1 Laminate Door****

BRT21LS3616	16 x 36 x 21	92.5	94	9	\$1556	\$192
BRT21LS4216	16 x 42 x 21	92.5	111	10.50	\$1631	\$221
BRT21LS4816	16 x 48 x 21	100	117	12	\$1703	\$253
BRT21LS5416	16 x 54 x 21	92.5	143	13.50	\$1775	\$286
BRT21LS6016	16 x 60 x 21	92.5	155	15	\$2055	\$313
BRT21LS6616	16 x 66 x 21	92.5	167	16.50	\$2140	\$345
BRT21LS7216	16 x 72 x 21	100	177	18	\$2200	\$378
BRT21LS7816	16 x 78 x 21	100	188	19.50	\$2300	\$409
BRT21LS8416	16 x 84 x 21	100	198	21	\$2362	\$439

Table supported single sided open storage with single sliding laminate door with recessed pull. Storage compartment internal height: 14". 1" top.

- Cannot be used in conjunction with above worksurface power trough.
- To prevent duplex outlet and worksurface access door interference, please specify Overhead of the same width of the supporting worksurface.
- To prevent interference with ceiling feed pole, please specify Overhead 6" shorter in width corresponding with the length of the supporting worksurface.
- Please refer to the **Compatibility Guide** on page 416 to determine available accessories

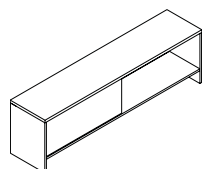

Open Double Sided Storage*

BRT21HDO3616	16 x 36 x 21	100	81	9	\$1056	\$135
BRT21HDO4216	16 x 42 x 21	100	96	10.50	\$1116	\$157
BRT21HDO4816	16 x 48 x 21	100	100	12	\$1169	\$182
BRT21HDO5416	16 x 54 x 21	100	124	13.50	\$1258	\$202
BRT21HDO6016	16 x 60 x 21	100	134	15	\$1324	\$222
BRT21HDO6616	16 x 66 x 21	100	144	16.50	\$1423	\$244
BRT21HDO7216	16 x 72 x 21	100	152	18	\$1469	\$267
BRT21HDO7816	16 x 78 x 21	100	161	19.50	\$1585	\$289
BRT21HDO8416	16 x 84 x 21	100	168	21	\$1630	\$312

Table supported double sided open storage. Fits over the gap between two parallel Bridges II back-to-back tables. Storage compartment internal height: 14". 1" top.

- Cannot be used in conjunction with above worksurface power trough.
- To prevent duplex outlet and worksurface access door interference, please specify Overhead of the same width of the supporting worksurface.
- To prevent interference with ceiling feed pole, please specify Overhead 6" shorter in width corresponding with the length of the supporting worksurface.
- Please refer to the **Compatibility Guide** on page 416 to determine available accessories

Required Specifications

Top finish
Edge finish
Chassis finish*
Drawer/door front finish**

Optional Specifications

HP laminate (tops only)
Elevated Shelf Binder Bin

STORAGE

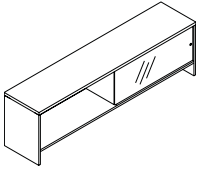

Double Sided Storage, Glass Door

MODEL#	DIMENSIONS D x W x H	FREIGHT CLASS	WT/LBS.	CUBIC FT.	LIST PRICE	HP ADD
BRT21GDS3616	16 x 36 x 21	92.5	94	9	\$2080	\$131
BRT21GDS4216	16 x 42 x 21	92.5	111	10.50	\$2178	\$157
BRT21GDS4816	16 x 48 x 21	100	117	12	\$2225	\$180
BRT21GDS5416	16 x 54 x 21	92.5	143	13.50	\$2879	\$201
BRT21GDS6016	16 x 60 x 21	92.5	155	15	\$2930	\$224
BRT21GDS6616	16 x 66 x 21	92.5	167	16.50	\$3124	\$244
BRT21GDS7216	16 x 72 x 21	100	177	18	\$3193	\$267
BRT21GDS7816	16 x 78 x 21	100	188	19.50	\$3326	\$288
BRT21GDS8416	16 x 84 x 21	100	196	21	\$3540	\$311

Table supported double sided open storage with sliding glass doors and recessed pull. Fits over the gap between two parallel Bridges II back-to-back tables. Storage compartment internal height: 14". 1" top.

- Cannot be used in conjunction with above worksurface power trough.
- To prevent duplex outlet and worksurface access door interference, please specify Overhead of the same width of the supporting worksurface.
- To prevent interference with ceiling feed pole, please specify Overhead 6" shorter in width corresponding with the length of the supporting worksurface.
- Please refer to the **Compatibility Guide** on page 416 to determine available accessories

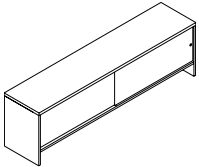

Double Sided Storage, Laminate Door*

BRT21LDS3616	16 x 36 x 21	92.5	106	9	\$2044	\$135
BRT21LDS4216	16 x 42 x 21	85	126	10.50	\$2173	\$157
BRT21LDS4816	16 x 48 x 21	92.5	134	12	\$2219	\$179
BRT21LDS5416	16 x 54 x 21	85	162	13.50	\$2770	\$201
BRT21LDS6016	16 x 60 x 21	92.5	176	15	\$2818	\$224
BRT21LDS6616	16 x 66 x 21	92.5	190	16.50	\$3008	\$245
BRT21LDS7216	16 x 72 x 21	92.5	203	18	\$3053	\$267
BRT21LDS7816	16 x 78 x 21	92.5	216	19.50	\$3167	\$288
BRT21LDS8416	16 x 84 x 21	92.5	227	21	\$3358	\$311

Table supported double sided open storage with sliding laminate doors and recessed pull. Fits over the gap between two parallel Bridges II back-to-back tables. Storage compartment internal height: 14". 1" top.

- Cannot be used in conjunction with above worksurface power trough.
- To prevent duplex outlet and worksurface access door interference, please specify Overhead of the same width of the supporting worksurface.
- To prevent interference with ceiling feed pole, please specify Overhead 6" shorter in width corresponding with the length of the supporting worksurface.
- Please refer to the **Compatibility Guide** on page 416 to determine available accessories

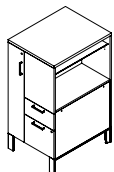

50" H Storage Tower w/Coat Storage*

BRTTW5024L	24 x 24 x 50	100	142	16.66	\$1923	\$127
BRTTW5024R	24 x 24 x 50	100	142	16.66	\$1923	\$127
BRTTW5030L	30 x 24 x 50	125	163	20.83	\$2134	\$127
BRTTW5030R	30 x 24 x 50	125	163	20.83	\$2134	\$127

Provides storage and privacy at the end of a table. Box/File drawers, open compartment with adjustable shelf (50"h); coat storage with hinged door. Specify Left or Right handed. Capable of supporting worksurface on one side. Built-in threaded inserts to secure dedicated worksurface supporting beam. Open side storage compartment internal height: 19.6". Optional cable basket suspends off storage unit's bottom and manages cables along the horizontal plane. 1" top; metal handles; powder-coated aluminum or anodized aluminum legs. Black pencil tray included.

- Anodized Aluminum Leg - Add **\$77** list upcharge

Required Specifications

Top finish
Chassis finish
Drawer/door front finish
Metal finish (legs)

Edge finish

Optional Specifications

Anodized aluminum leg*
HP laminate
E-Lock*

STORAGE

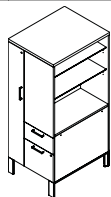
**66" H Storage Tower with Coat Storage**

MODEL#	DIMENSIONS	FREIGHT CLASS	WT/LBS.	CUBIC FT.	LIST PRICE	HP ADD
--------	------------	---------------	---------	-----------	------------	--------

D x W x H

BRTTW6624L	24 x 24 x 66	125	170	22	\$2550	\$164
BRTTW6624R	24 x 24 x 66	125	170	22	\$2550	\$164
BRTTW6630L	30 x 24 x 66	125	195	27.50	\$2829	\$166
BRTTW6630R	30 x 24 x 66	125	195	27.50	\$2829	\$199

Provides storage and privacy at the end of a table. Box/File drawers, open compartment with 2 adjustable shelves (66" h); coat storage with hinged door and 2 shelves. Specify Left or Right handed. Capable of supporting worksurface on one side. Built-in threaded inserts to secure dedicated worksurface supporting beam. Open side storage compartment internal height: 35.6". Optional cable basket suspends off storage unit's bottom and manages cables along the horizontal plane. 1" top; metal handles; powder-coated aluminum or anodized aluminum legs. Black pencil tray included.

- Anodized Aluminum Leg - Add **\$77** list upcharge

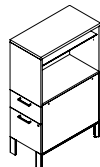
**50" H Storage Tower**

BRTT5024L	24 x 15.5 x 50	100	88	10.76	\$1429	\$93
BRTT5024R	24 x 15.5 x 50	100	88	10.76	\$1429	\$93
BRTT5030L	30 x 15.5 x 50	125	101	13.45	\$1572	\$109
BRTT5030R	30 x 15.5 x 50	125	101	13.45	\$1572	\$109

Provides storage and privacy at the end of a table. Box/File drawers, open compartment with adjustable shelf (50" h). Specify Left or Right handed. Capable of supporting worksurface on one side. Built-in threaded inserts to secure dedicated worksurface supporting beam. Open side storage compartment internal height: 19.6". Optional cable basket suspends off storage unit's bottom and manages cables along the horizontal plane. 1" top; metal handles; powder-coated aluminum or anodized aluminum legs. Black pencil tray included.

- Anodized Aluminum Leg - Add **\$77** list upcharge

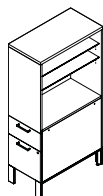
**66" H Storage Tower**

BRTT6624L	24 x 15.5 x 66	100	106	12.91	\$1895	\$119
BRTT6624R	24 x 15.5 x 66	100	106	12.91	\$1895	\$119
BRTT6630L	30 x 15.5 x 66	125	121	16.14	\$2083	\$144
BRTT6630R	30 x 15.5 x 66	125	121	16.14	\$2083	\$144

Provides storage and privacy at the end of a table. Box/File drawers, open compartment with 2 adjustable glass shelves (66" h). Specify Left or Right handed. Capable of supporting worksurface on one side. Built-in threaded inserts to secure dedicated worksurface supporting beam. Open side storage compartment internal height: 35.6". Optional cable basket suspends off storage unit's bottom and manages cables along the horizontal plane. 1" top; metal handles; powder-coated aluminum or anodized aluminum legs. Black pencil tray included.

- Anodized Aluminum Leg - Add **\$77** list upcharge

**Cantilever Storage***

BRTCS45BBFFL	18 x 36 x 45	92.5	256	24	\$2599	\$135
BRTCS45BBFFR	18 x 36 x 45	92.5	256	24	\$2599	\$135

Provides storage and privacy anywhere along the length of the bench. The middle opening of the cabinet allows the upper portion to cantilever above the worksurface. 2 locking file drawers. 2 pencil drawers (not locking). Open compartment with adjustable glass shelf, internal dimension of 15.9". Three fixed open compartments; two above worksurfaces (6.7" interior dimension), one below (3.7" interior dimension). Specify Left or Right handed. Optional cable basket suspends off storage unit's bottom and manages cables along the horizontal plane. 1" top; metal handles; powder-coated aluminum or anodized aluminum legs.

- Anodized Aluminum Leg - Add **\$77** list upcharge

Required Specifications

Top finish
Edge finish
Chassis finish
Drawer/door front finish

Optional Specifications

Anodized aluminum leg
E-Lock*
HP laminate

STORAGE

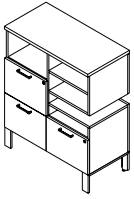

Cantilever Storage*

MODEL#	DIMENSIONS	FREIGHT CLASS	WT/LBS.	CUBIC FT.	LIST PRICE	HP ADD
--------	------------	---------------	---------	-----------	------------	--------

D x W x H

BRTCS45FFFOL	18 x 36 x 45	92.5	256	24	\$2662	\$135
BRTCS45FFFOR	18 x 36 x 45	92.5	256	24	\$2662	\$135

Provides storage and privacy anywhere along the length of the bench. The middle opening of the cabinet allows the upper portion to cantilever above the worksurface. 3 locking file drawers with 2 locks. Open compartment (10.3" interior dimension). Three fixed open compartments; two above worksurfaces (6.7" interior dimension), one below (3.7" interior dimension). Specify Left or Right handed. Optional cable basket suspends off storage unit's bottom and manages cables along the horizontal plane. 1" top; metal handles; powder-coated aluminum or anodized aluminum legs.

- Anodized Aluminum Leg - Add **\$77** list upcharge

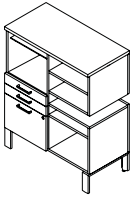

Cantilever Storage*

BRTCS45BBFOOL	18 x 36 x 45	92.5	256	24	\$2542	\$135
BRTCS45BBFOR	18 x 36 x 45	92.5	256	24	\$2542	\$135

Provides storage and privacy anywhere along the length of the bench. The middle opening of the cabinet allows the upper portion to cantilever above the worksurface. Locking file drawer. 2 pencil drawers (not locking). Open compartment (10.3" interior dimension) with adjustable glass shelf. 4 fixed open compartments; two above worksurfaces (6.7" interior dimension), two below (lower 12.2" interior dimension; upper 3.3" interior dimension). Specify Left or Right handed. Optional cable basket suspends off storage unit's bottom and manages cables along the horizontal plane. 1" top; metal handles; powder-coated aluminum or anodized aluminum legs.

- Anodized Aluminum Leg - Add **\$77** list upcharge

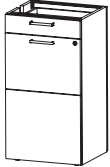

Pier Storage, Box/File

BRTDS2B2F	16 x 18 x 36	125	85	14	\$1592	n/a
-----------	--------------	-----	----	----	---------------	-----

Supports side-by-side divider with Box/File on opposite sides for side-by-side application. Two lockable file drawers, two box drawers. Black pencil tray included.

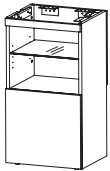

Pier Storage, Open w/Glass Shelves

BRTDSOP	16 x 18 x 36	150	75	14	\$1059	n/a
---------	--------------	-----	----	----	---------------	-----

Supports side-by-side divider with Box/File on opposite sides for side-by-side application. Storage compartment internal height without adjustable shelf: 15"

Required Specifications

Top finish*
Edge finish*
Chassis finish
Drawer/door front finish

Optional Specifications

Anodized aluminum leg*

ACCESSORIES

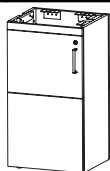
**Pier Storage, Door w/Glass Shelves**

MODEL#	DIMENSIONS	FREIGHT CLASS	WT/LBS.	CUBIC FT.	GRADE	LIST	GRADE	LIST
--------	------------	---------------	---------	-----------	-------	------	-------	------

D x W x H

BRTDS2D	16 x 18 x 36	150	79	14		\$1422	n/a	
---------	--------------	-----	----	----	--	---------------	-----	--

Supports side-by-side divider with hinged, lockable door on opposite sides for side-by-side application. Storage compartment internal height without adjustable shelf: 15"

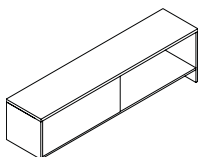
**Side-by-Side Storage, Open***

BRT21PHDO4216	16 x 42 x 21	100	96	10.50		\$921	\$157	
BRT21PHDO4816	16 x 48 x 21	100	100	12		\$979	\$182	
BRT21PHDO5416	16 x 54 x 21	100	124	13.50		\$1073	\$201	
BRT21PHDO6016	16 x 60 x 21	100	134	15		\$1134	\$224	
BRT21PHDO6616	16 x 66 x 21	100	144	16.50		\$1230	\$243	
BRT21PHDO7216	16 x 72 x 21	100	152	18		\$1295	\$267	

Pier and table supported side-by-side double-sided open storage. Divides space and provides storage anywhere along bench or table. Storage compartment internal height: 14". 1" top.

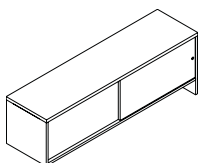
**Side-by-Side Storage, Laminate Doors***

BRT21PLDS4216	16 x 42 x 21	92.5	126	11		\$2133	\$157	
BRT21PLDS4816	16 x 48 x 21	92.5	134	12		\$2179	\$180	
BRT21PLDS5416	16 x 54 x 21	92.5	162	14		\$2733	\$201	
BRT21PLDS6016	16 x 60 x 21	92.5	176	15		\$2781	\$224	
BRT21PLDS6616	16 x 66 x 21	92.5	190	17		\$2970	\$245	
BRT21PLDS7216	16 x 72 x 21	92.5	203	18		\$3015	\$267	

Pier and table supported side-by-side double-sided storage with sliding laminate doors and recessed pull. Divides space and provides storage anywhere along bench or table. Storage compartment internal height: 14". 1" top.

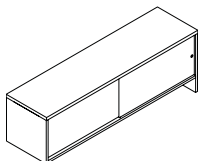
**Side-by-Side Storage, Glass Doors**

BRT21PGDS4216	16 x 42 x 21	92.5	110	10.50		\$2154	\$155	
BRT21PGDS4816	16 x 48 x 21	100	116	12		\$2202	\$179	
BRT21PGDS5416	16 x 54 x 21	92.5	141	13.50		\$2856	\$201	
BRT21PGDS6016	16 x 60 x 21	92.5	153	15		\$2907	\$222	
BRT21PGDS6616	16 x 66 x 21	92.5	165	16.50		\$3101	\$244	
BRT21PGDS7216	16 x 72 x 21	100	175	18		\$3171	\$268	

Pier and table supported side-by-side double-sided storage with sliding glass doors and recessed pull. Divides space and provides storage anywhere along bench or table. Storage compartment internal height: 14". 1" top.

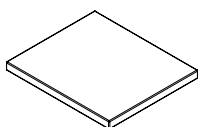
**Cushion***

BRTC	18 x 15.5 x 1.25	150	2	.41	1	\$231	7	\$411
					2	\$258	8	\$472
					3	\$277	9	\$520
					4	\$308	10	\$573
					5	\$351	11	\$682
					6	\$370	12	\$799

Optional seat cushion may be added to any storage component. Available in all Global seating fabrics.

- When added to 25"h storage units, unit will NOT fit under any table with a beam

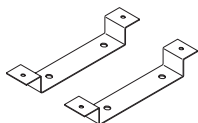
**Glide Tray Adapter**

GAGTA01	2 x 9 x 2.5	70	.50	.03		\$104		
---------	-------------	----	-----	-----	--	--------------	--	--

Accommodates the placement of sliding keyboard mechanisms and CPU holders below the cross beam of Bridges tables. Attaches to Glide Tracks of all Productivity Solutions Keyboard Mechanisms and Sliding CPU holders. Mounting hardware included. Available in black only.

- Cannot be used with GACPU01. See Productivity Solutions for compatible keyboard mechanisms and sliding CPU holder.

Required Specifications

Fabric*
Metal finish (hanging bracket)

ACCESSORIES

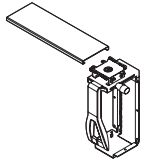

CPU Holder on Glide Track

MODEL#	DIMENSIONS D x W x H	FREIGHT CLASS	WT./LBS.	CUBIC FT.	LIST PRICE
GACPU02	9.2 x 11.7 x 18.5	92.5	12.60	1.15	\$229

Accepts tower CPUs with a width range of 12.5" to 22.5" and width range of 3.5" to 9.3". Soft touch knob for side clamp adjustment and bayonet lance for vertical height adjustment. 12" glide track mounted and 360° swivel for easy access to rear of CPU. Manufactured from steel and engineered resin, providing rugged durability and support. Available in black only.

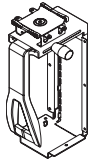

Fixed Mount CPU Holder

GACPU01	9.2 x 11.7 x 18.5	125	9	1.15	\$207
---------	-------------------	-----	---	------	--------------

Fully adjustable clamping mechanism to accept tower CPUs with a height range of 12.5" to 22.5" and width range of 3.5" to 9.3". Soft touch knob for side clamp adjustment and bayonet lance for vertical height adjustment. Mounts directly to underside of desk surface. CPU Holder can also be mounted directly to an upright desk leg surface or wall via side mounting holes. Manufactured from Steel and Engineered Resin, providing rugged durability and support. Available in black only.

- Not compatible with GAGTA01

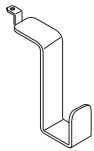

Hanging Bracket

BRTHB	3.3 x 1.5 x 3.5	70	.20	.01	\$29
-------	-----------------	----	-----	-----	-------------

A formed steel bracket hooks over Bridges II table leg. Can be secured either on the inner or outer side of the leg. Specify frame finish.

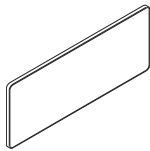

Whiteboard

BRTWB0924	0.5 x 24 x 8.5	70	1	.56	\$231
-----------	----------------	----	---	-----	--------------

White dry-erase marker board surface on white powder coated steel backer. Fits 16" tall Bridges II dividers and single-sided shelves. White dry-erase surface attaches magnetically to the steel backer. When removed, the steel backer can be used as a magnetic board. Please refer to the **Compatibility Guide** (page 416) to determine available accessories.

- Available in Tungsten (TUN) or Designer White (DWT) Only

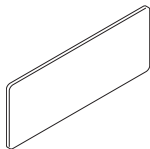

Tackboard*

BRTTB0924	0.5 x 24 x 8.5	70	1	.56	\$231
-----------	----------------	----	---	-----	--------------

Grey tackboard surface on white powder coated steel backer. Fits 16" tall Bridges II dividers and single-sided shelves. Please refer to the **Compatibility Guide** (page 416) to determine available accessories.

- Available in Tungsten (TUN) or Designer White (DWT) Only

Required Specifications

Metal finish
Fabric*

MONITOR ARMS

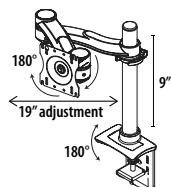
**Single Screen Double Extension Arm**

MODEL#	DIMENSIONS	FREIGHT CLASS	WT/LBS.	CUBIC FT.	LIST PRICE
	D x W x H				
GAMCSSDE	-- x -- x --	125	7.50	1.09	\$519

Double extension allows 19" of horizontal back and forth movement. Arm folds back to post for more desk space. Displays are able to tilt 180°, swing 180° side-to-side and rotate from landscape to portrait. Minor assembly required.

- Short clamp allows arm to be clamped on rear worksurface edge in conjunction with BRTEETxxxDKIT power troughs

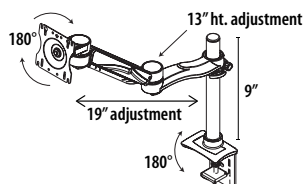
**Single Screen Double Extension Arm with Height Adjustment**

GAMCSSDEH	-- x -- x --	125	8.20	1.09	\$622
-----------	--------------	-----	------	------	--------------

Counterbalanced arm provides an additional 13" of height adjustment. Double extension allows 19" of horizontal back and forth movement. Easy to use Allen wrench allows user to adjust the counterbalance mechanism for easy movement of the monitor. Displays are able to tilt 180°, swing 180° side-to-side and rotate from landscape to portrait. Cable manager comes on extension arm and hides all cables. Minor assembly required.

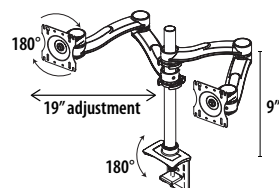
**Dual Screen Double Extension Arm**

GAMCDSDE	-- x -- x --	100	10.70	1.09	\$914
----------	--------------	-----	-------	------	--------------

For dual monitor applications. Double extension arms allow 19" of horizontal back and forth movement. Easy to use Allen wrench allows user to adjust the counterbalance mechanism for easy movement of the monitor. Displays are able to tilt 180°, swing 180° side-to-side and rotate from landscape to portrait. Minor assembly required.

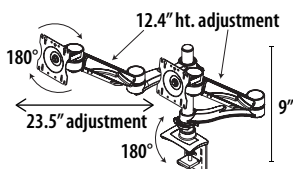
**Dual Screen Double Extension Arm with Height Adjustment**

GAMCDSDEH	-- x -- x --	92.5	12.2	1.09	\$1247
-----------	--------------	------	------	------	---------------

For dual monitor applications. Counterbalanced arms provide an additional 13" of height adjustment. Double extension arms allow 19" of horizontal back and forth movement. Easy to use Allen wrench allows user to adjust the counterbalance mechanism for easy movement of the monitor. Displays are able to tilt 180°, swing 180° side-to-side and rotate from landscape to portrait. Cable manager comes on extension arm and hides all cables. Minor assembly required.

ACCESSORIES

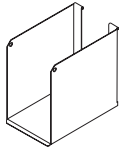

Binder Bin

MODEL#	DIMENSIONS D x W x H	FREIGHT CLASS	WT./LBS.	CUBIC FT.	LIST PRICE
BABB01	10.25 x 4 x 9	100	2	.21	\$63

Load bar/accessory rail mounted metal binder bin.
 • Please refer to the **Compatibility Guide** on page 416 to determine compatible storage components

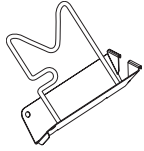

Flip Sorter

BAFS01	9.25 x 2.75 x 9.25	70	.06	.14	\$49
--------	--------------------	----	-----	-----	-------------

Load bar/accessory rail mounted metal flip sorter. Comes with chrome wire.
 • Please refer to the **Compatibility Guide** on page 416 to determine compatible storage components

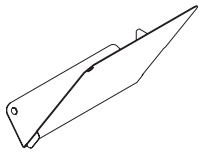

Slant Sorter

BASS01L (Left)	10.25 x 5 x 9.5	70	1	.28	\$40
BASS01R (Right)	10.25 x 5 x 9.5	70	1	.28	\$40

Load bar/accessory rail mounted metal slant sorter.
 • Please refer to the **Compatibility Guide** on page 416 to determine compatible storage components

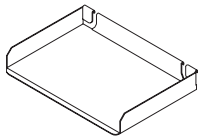

Letter/Legal Tray

BALTO1 (Letter)	9.25 x 13.5 x 2	70	.05	.15	\$52
BALTO1LGL (Legal)	9.25 x 15 x 2	70	.05	.15	\$64

Load bar/accessory rail mounted metal letter or legal tray.
 • Please refer to the **Compatibility Guide** on page 416 to determine compatible storage components

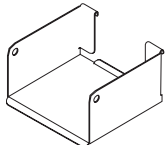

Media Bin

BAMB01	5.25 x 5.75 x 3	70	.08	.05	\$52
--------	-----------------	----	-----	-----	-------------

Load bar/accessory rail mounted metal media bin.
 • Please refer to the **Compatibility Guide** on page 416 to determine compatible storage components

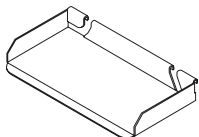

Utility Tray

BAUT01	3.75 x 5.75 x 3	70	.05	.02	\$34
--------	-----------------	----	-----	-----	-------------

Load bar/accessory rail mounted metal utility tray.
 • Please refer to the **Compatibility Guide** on page 416 to determine compatible storage components

Required Specifications

Fabric (Cushion)
 Metal Finish (hanging bracket, whiteboard, tackboard)

ACCESSORIES

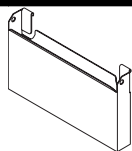
**Mail Box**

MODEL#	DIMENSIONS	FREIGHT CLASS	WT./LBS.	CUBIC FT.	LIST PRICE
--------	------------	---------------	----------	-----------	------------

	D x W x H				
BAPP01	2.75 x 16 x 9	100	2	.25	\$80

Load bar/accessory rail mounted metal mail box.

- Please refer to the **Compatibility Guide** on page 416 to determine compatible storage components

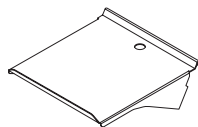
**Telephone Holder**

BATH01	10 x 9 x 2	125	2	.26	\$77
--------	------------	-----	---	-----	-------------

Load bar/accessory rail mounted metal telephone holder.

- Please refer to the **Compatibility Guide** on page 416 to determine compatible storage components

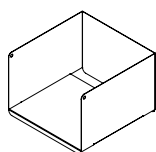
**Elevated Shelf Binder Bin**

BRTESBBIN	12 x 12 x 8	100	6	.66	\$164
-----------	-------------	-----	---	-----	--------------

Load bar/accessory rail mounted elevated shelf binder bin.

- Please refer to the **Compatibility Guide** on page 416 to determine compatible storage components

ACCESSORIES

D x W x H

ACCESSORIES COMPATIBILITY GUIDE

	DIVIDERS: BRTL PDD BRTL PDS BR2AFD BR2AHD	Elevated Shelves BRTSTS08 BRTBTS08 8" high	Elevated Shelves BRTSTS13 BRTBTS13 13" high	Elevated Shelves BRTSTS16 BRTBTS16 16" high	Shared Overhead BRTBAS048 12" deep	Shared Overhead with slid- ing doors BRTBASS 16" deep
Binder Bin BABB01	yes	no	no	yes	no	no
Flip Sorter BAFS01	yes	no	yes	no	no	no
Slant Sorter BASS01	yes	no	yes	no	no	no
Letter Tray BALT01	yes	yes	yes	yes	yes	yes
Media Bin BAMB01	yes	yes	yes	yes	yes	yes
Utility Tray BAUT01	yes	yes	yes	yes	yes	yes
Mail Box BAPP01	yes	no	no	yes	no	no
Phone Holder BVATH01	yes	yes	yes	yes	yes	yes
Elevated Shelf Binder Bin BRTEBBIN	no	no	no	no	yes	no
Tackboard BRTTB	yes	no	no	yes	no	no
Whiteboard BRTWB	yes	no	no	yes	no	no

COLLABORATIVE SEATING

D x W x H

Bridges collaborative seating collection consists of seating, privacy screens, tables, tablets and power. It is a versatile modular furniture series which can be configured into many space planning scenarios, including corner, in-line, open concept, traditional reception, as well as secluded seating with high privacy partitions.

Furniture pieces can be used as stand alone items or can be mechanically linked together to form a variety of seating configurations.

Seat and backrest can be integrated with Bridges tables.

Corner tables and in-line 6" table modules double as power delivery centers.

Dedicated seat backrests feature dual USB charging port.

Some inline 6" table modules are furnished with grommets to support tablets.

Legs are available in standard Bridges metal painted finishes and anodized aluminum finish.

Bridges Collaborative Seating upholstery features a single stitch, thick white thread around the edges. The white, wide stitch along with crisp corners are part of its distinctive personality. In order to achieve crisp edges and to minimize "pillow" effect caused by taut fabric, the upholstery material has been applied deliberately loose, which may over time, produce puckering of the upholstery surface material. This can be easily corrected by stretching the fabric by hand or during vacuuming.

In order to efficiently utilize fabric yield, all 60" seats and backs feature a seam in the middle. The double stitch seam is sewn with a thin thread, closely matching the upholstery material in color.

Some complicated fabric patterns prevent pattern matching and will be upholstered without the seam at the discretion of the factory.

Should you require no middle seam by cutting into the roll, please specify "NO SEAM" at time of your order.

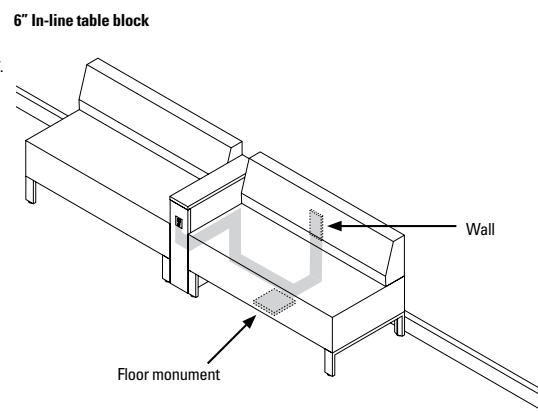
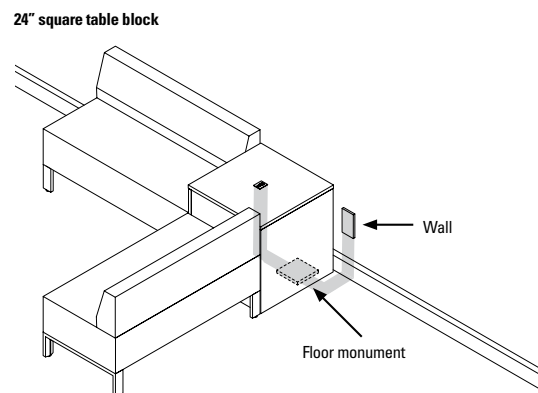
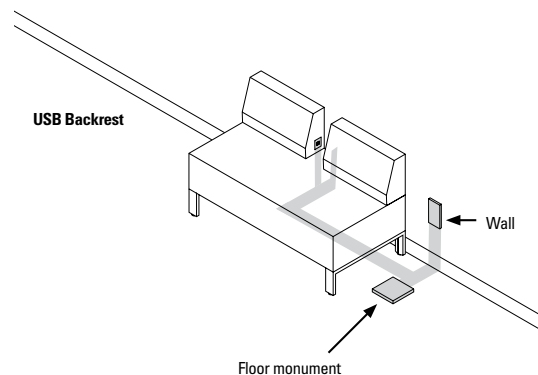

COLLABORATIVE SEATING

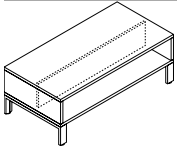

Low Table*

MODEL#	DIMENSIONS D x W x H	FREIGHT CLASS	WT/LBS.	CUBIC FT.	LIST PRICE	HP ADD
BRTST2460F	24 x 60 x 17	150	83.60	14.17	\$800	\$296
BRTST2448F	24 x 48 x 17	125	69	11.33	\$715	\$215
BRTST2424F	24 x 24 x 17	125	40.70	5.67	\$505	\$88

Freestanding 17”h table. Central partition divides space under top surface into two 11” deep compartments. All LP chassis w/ HP or LP top (3mm edging). Bridges storage aluminum leg.

- Anodized Aluminum Leg - Add **\$67**. list upcharge
- To convert to mobile - Add an **M** at the end of the product code. Add **\$35**. list upcharge.

COLLABORATIVE SEATING

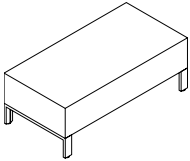

Lounge Seat

					GRADE	LIST	GRADE	LIST
BRTSE60NB	24 x 60 x 17	250	47	14.17	1	\$1508	7	\$2020
					2	\$1584	8	\$2199
					3	\$1641	9	\$2338
					4	\$1727	10	\$2490
					5	\$1852	11	\$2803
					6	\$1909	12	\$3139
BRTSE48NB	24 x 48 x 17	250	36.90	11.33	1	\$1302	7	\$1715
					2	\$1364	8	\$1857
					3	\$1411	9	\$1966
					4	\$1480	10	\$2090
					5	\$1578	11	\$2342
					6	\$1625	12	\$2608
BRTSE24NB	24 x 24 x 17	150	22.70	5.57	1	\$715	7	\$972
					2	\$755	8	\$1063
					3	\$784	9	\$1132
					4	\$827	10	\$1208
					5	\$888	11	\$1364
					6	\$917	12	\$1532

Fully upholstered armless lounge seat with metal base. Seats can be freestanding or linked with optional interlocking bracket kit.

- Anodized Aluminum Leg - Add **\$67** list upcharge

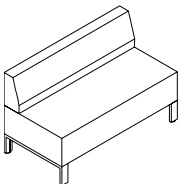

Lounge Seat, Full Backrest

BRTSE6060B	24 x 60 x 29	250	70	24.17	1	\$2408	7	\$3332
					2	\$2542	8	\$3652
					3	\$2647	9	\$3898
					4	\$2803	10	\$4172
					5	\$3024	11	\$4739
					6	\$3128	12	\$5343
BRTSE4848B	24 x 48 x 29	250	55.50	19.33	1	\$2078	7	\$2796
					2	\$2181	8	\$3044
					3	\$2263	9	\$3237
					4	\$2385	10	\$3450
					5	\$2559	11	\$3892
					6	\$2637	12	\$4360
BRTSE2424B	24 x 24 x 29	250	33	9.57	1	\$1126	7	\$1589
					2	\$1195	8	\$1749
					3	\$1247	9	\$1873
					4	\$1325	10	\$2011
					5	\$1435	11	\$2295
					6	\$1488	12	\$2595

Fully upholstered armless lounge seat with full backrest and metal base. Backrests are permanently secured to the seats and cannot be reconfigured on site. Seats can be freestanding or linked with optional interlocking bracket kit.

- Anodized Aluminum Leg - Add **\$67** list upcharge

Required Specifications

Top finish* Edge finish*
 Chassis finish*
 Fabric
 Metal Finish (legs)

Optional Specifications

Anodized Aluminum Leg
 HP laminate*

COLLABORATIVE SEATING

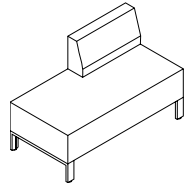

Lounge Seat, 24" Offset Backrest

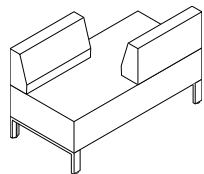

Lounge Seat, Two 24" Offset Backrests

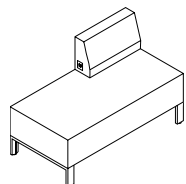

Lounge Seat, 21" USB Backrest

MODEL#	DIMENSIONS	FREIGHT CLASS	WT/LBS.	CUBIC FT.	GRADE	LIST	GRADE	LIST
D x W x H								
BRTSE2448BL	24 x 48 x 29	250	46.10	19.33	1	\$1712	7	\$2329
					2	\$1804	8	\$2544
					3	\$1874	9	\$2708
					4	\$1975	10	\$2889
					5	\$2125	11	\$3268
					6	\$2194	12	\$3669
BRTSE2448BR (shown)	24 x 48 x 29	250	46.10	19.33	1	\$1712	7	\$2329
					2	\$1804	8	\$2544
					3	\$1874	9	\$2708
					4	\$1975	10	\$2889
					5	\$2125	11	\$3268
					6	\$2194	12	\$3669
Fully upholstered armless lounge seat with one backrest and metal base. Specify backrest as either left or right side. Backrests are permanently secured to the bench and cannot be reconfigured on site. Seats can be freestanding or linked with optional interlocking bracket kit.								
• Anodized Aluminum Leg - Add \$67 list upcharge								
BRTSE2448BODL (shown)	24 x 48 x 29	250	46.10	19.33	1	\$2123	7	\$2944
					2	\$2243	8	\$3229
					3	\$2335	9	\$3447
					4	\$2473	10	\$3693
					5	\$2672	11	\$4196
					6	\$2764	12	\$4731
BRTSE2448BODR	24 x 48 x 29	250	46.10	19.33	1	\$2123	7	\$2944
					2	\$2243	8	\$3229
					3	\$2335	9	\$3447
					4	\$2473	10	\$3693
					5	\$2672	11	\$4196
					6	\$2764	12	\$4731
Fully upholstered armless lounge seat with two offset backrests and metal base. Specify either left or right backrest configuration. Backrests are permanently secured to the bench and cannot be reconfigured on site. Seats can be freestanding or linked with optional interlocking bracket kit.								
• Anodized Aluminum Leg - Add \$67 list upcharge								
BRTSE2148EBL	24 x 48 x 29	250	33	9.67	1	\$1985	7	\$2601
					2	\$2077	8	\$2815
					3	\$2146	9	\$2981
					4	\$2249	10	\$3162
					5	\$2398	11	\$3539
					6	\$2468	12	\$3942
BRTSE2148EBR (shown)	24 x 48 x 29	250	46.10	19.33	1	\$1985	7	\$2601
					2	\$2077	8	\$2815
					3	\$2146	9	\$2981
					4	\$2249	10	\$3162
					5	\$2398	11	\$3539
					6	\$2468	12	\$3942
Fully upholstered armless lounge seat with one backrest and metal base. 21" w backrest comes with embedded dual USB port in its side. Note: The side mounted power/USB outlets always point to the center of the seat. Each USB outlet offers 2 amps. AC/DC transformer plugs into the wall or floor monument (approx. 4' long cable available from the bottom of the seat). Transformer power consumption: 0.68 amps. Specify either left or right backrest configuration. Backrests are permanently secured to the bench and cannot be reconfigured on site. Seats can be freestanding or linked with optional interlocking bracket kit. White USB outlets.								
• Anodized Aluminum Leg - Add \$67 list upcharge								

Required SpecificationsFabric
Metal Finish (legs)**Optional Specifications**

Anodized Aluminum Leg

COLLABORATIVE SEATING

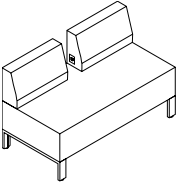

Lounge Seat, Two 21" USB Backrests

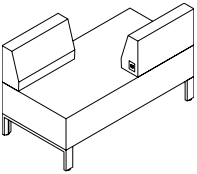

Lounge Seat, Two Offset USB Backrests

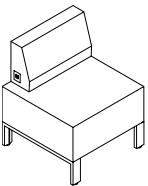

Lounge Seat, 21" USB Backrest

MODEL#	DIMENSIONS D x W x H	FREIGHT CLASS	WT/LBS.	CUBIC FT.	GRADE	LIST	GRADE	LIST
BRTSE2148E2B	24 x 48 x 29	250	57	19.33	1	\$2667	7	\$3487
					2	\$2786	8	\$3772
					3	\$2877	9	\$3991
					4	\$3016	10	\$4235
					5	\$3214	11	\$4738
					6	\$3308	12	\$5274

Fully upholstered armless lounge seat with two backrests and metal base. Both 21" w backrests come with embedded dual USB port in its side. Note: The side mounted power/USB outlets always point to the center of the seat. Each USB outlet offers 2 amps. AC/DC transformer plugs into the wall or floor monument (approx. 52" long cable available from the bottom of the seat). Transformer power consumption: 0.68 amps. Backrests are permanently secured to the bench and cannot be reconfigured on site. Seats can be freestanding or linked with optional interlocking bracket kit. White USB outlets.

- Anodized Aluminum Leg - Add \$67 list upcharge

BRTSE2148EBODL (shown)	24 x 48 x 29	250	57	19.33	1	\$2667	7	\$3487
					2	\$2786	8	\$3772
					3	\$2877	9	\$3991
					4	\$3016	10	\$4235
					5	\$3214	11	\$4738
					6	\$3308	12	\$5274

BRTSE2148EBODR	24 x 48 x 29	250	57	19.33	1	\$2667	7	\$3487
					2	\$2786	8	\$3772
					3	\$2877	9	\$3991
					4	\$3016	10	\$4235
					5	\$3214	11	\$4738
					6	\$3308	12	\$5274

Fully upholstered armless lounge seat with two offset backrests and metal base. Both 21" w backrests come with embedded dual USB port in its side. Note: The side mounted power/USB outlets always point to the center of the seat. Each USB outlet offers 2 amps. AC/DC transformer plugs into the wall or floor monument (approx. 52" long cable available from the bottom of the seat). Transformer power consumption: 0.68 amps. Specify either left or right backrest configuration. Backrests are permanently secured to the bench and cannot be reconfigured on site. Seats can be freestanding or linked with optional interlocking bracket kit. White USB outlets.

- Anodized Aluminum Leg - Add \$67 list upcharge

BRTSE2124EBL	24 x 24 x 29	250	46.10	19.33	1	\$1398	7	\$1861
					2	\$1465	8	\$2021
					3	\$1519	9	\$2144
					4	\$1596	10	\$2281
					5	\$1707	11	\$2564
					6	\$1760	12	\$2866

BRTSE2124EBR (shown)	24 x 24 x 29	250	46.10	19.33	1	\$1398	7	\$1861
					2	\$1465	8	\$2021
					3	\$1519	9	\$2144
					4	\$1596	10	\$2281
					5	\$1707	11	\$2564
					6	\$1760	12	\$2866

Fully upholstered armless lounge seat with one backrest and metal base. 21" w backrest comes with embedded dual USB port in its side. Note: Each USB outlet offers 2 amps. AC/DC transformer plugs into the wall or floor monument (approx. 52" long cable available from the bottom of the seat). Transformer power consumption: 0.68 amps. Specify either left or right. Backrests are permanently secured to the bench and cannot be reconfigured on site. Seats can be freestanding or linked with optional interlocking bracket kit. White USB outlets.

- Anodized Aluminum Leg - Add \$67 list upcharge

Required Specifications

Fabric
Metal Finish (legs)

Optional Specifications

Anodized Aluminum Leg

COLLABORATIVE SEATING

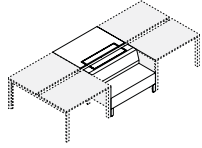

Integrated Lounge Seat, Single-Sided

MODEL#	DIMENSIONS	FREIGHT CLASS	WT./LBS.	CUBIC FT.	GRADE	LIST	GRADE	LIST		
BRTSINT60S	24 x 60 x 29	125	155	24.17						
						D x W x H				
					1	\$4812	7	\$5715		
					2	\$4928	8	\$6036		
					3	\$5030	9	\$6284		
					4	\$5189	10	\$6557		
5	\$5409	11	\$7124							
6	\$5515	12	\$7727							
BRTSINT48S	24 x 48 x 29	100	182	19.33	1	\$4604	7	\$5323		
					2	\$4709	8	\$5572		
					3	\$4790	9	\$5765		
					4	\$4913	10	\$5978		
					5	\$5085	11	\$6419		
					6	\$5166	12	\$6888		

Fully upholstered armless lounge seat with full width backrest and metal legs integrated into Bridges 62.5" d back-to-back linear table assembly. The single-sided kit consists of 24" x 48" or 24" x 60" seat, full width back, three-sided below worksurface enclosure, 6" d worksurface module with access door, 30" x 48" or 30" x 60" w worksurface with access door and supporting hardware. The seat module accommodates continuation of power and data distribution services below worksurfaces (specify Below Worksurface Power Trough and power components separately). The 6" d worksurface module with access door provides access to Below Worksurface Power Trough. Backrests are permanently secured to the bench and cannot be reconfigured on site. Tables not included.

• **Only compatible with back-to-back 30" d worksurfaces (62.5" total depth) supported by Bridges rectangular legs.** Not compatible with round legs, 24" d worksurfaces; not compatible with single line table assemblies 24" and 30" d. The kit cannot be used at the end of a table run, nor can it be used as a standalone, freestanding configuration. It must always be supported by back-to-back table assemblies on either side

- Anodized Aluminum Leg - Add **\$67** list upcharge
- High pressure laminate - Add **\$241** list upcharge

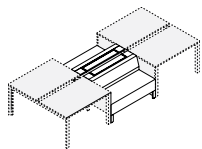

Integrated Lounge Seat, Double-Sided

BRTSINT60D	24 x 60 x 29	125	155	24.17	1	\$6248	7	\$7172
					2	\$6382	8	\$7492
					3	\$6487	9	\$7738
					4	\$6643	10	\$8012
					5	\$6864	11	\$8579
					6	\$6969	12	\$9184
BRTSINT48D	24 x 48 x 29	100	182	19.33	1	\$5589	7	\$6307
					2	\$5692	8	\$6556
					3	\$5774	9	\$6748
					4	\$5896	10	\$6961
					5	\$6070	11	\$7403
					6	\$6151	12	\$7871

Fully upholstered armless lounge bench with full backrests and metal legs integrated into Bridges 62.5" d back-to-back linear table assembly. The double-sided kit consists of two 24" x 48" or 24" x 60" seats, full width backs, three-sided below worksurface enclosures, 6" d worksurface modules with access doors and supporting hardware. The seat module accommodates continuation of power and data distribution services below worksurfaces (specify Below Worksurface Power Trough and power components separately). The 6" d worksurface module with access door provides access to Below Worksurface Power Trough. Backrests are permanently secured to the bench and cannot be reconfigured on site. Tables not included.

• **Only compatible with back-to-back 30" d worksurfaces (62.5" total depth) supported by Bridges rectangular legs.** Not compatible with round legs, 24" d worksurfaces; not compatible with single line table assemblies 24" and 30" d. The kit cannot be used at the end of a table run, nor can it be used as a standalone, freestanding configuration. It must always be supported by back-to-back table assemblies on either side.

- Anodized Aluminum Leg - Add **\$67** list upcharge
- High pressure laminate - Add **\$241** list upcharge

Required Specifications

Fabric
Laminate finish (enclosure)
Edge finish (enclosure)
Metal finish (legs)

Optional Specifications

Anodized Aluminum Leg
HP laminate (enclosure)

SEATING PARTITIONS

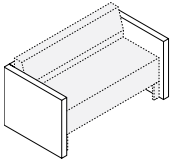

Seat Partitions

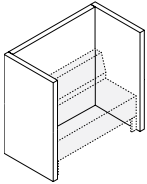

Seat Privacy Partitions

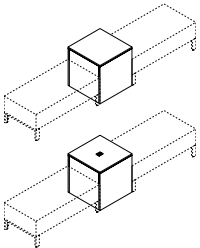

Square Table Block*

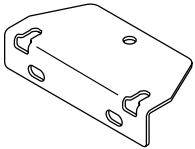

Square Table Block Ganging Bracket Kit

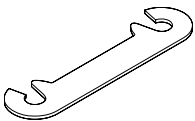

Ganging Bracket Kit

MODEL#	DIMENSIONS D x W x H	FREIGHT CLASS	WT./LBS.	CUBIC FT.	LIST PRICE
BRTPP2448L1	28.7 x 53 x 25	300	41	22.01	\$1764
BRTPP2424L1	28.7 x 29 x 25	250	32	12.04	\$1320

Fully upholstered 2.5" thick, 3-part, low level partition kit wraps around 24" or 48" bridges seat. The seat front is recessed by 2.5". The kit is secured to seats on-site (brackets connecting seat legs to the inner side of the partition are included). Upholstered kits consist of 2" hollow core boards, 1/4" foam, fabric, levelers and connecting hardware. Note: Seats and backrests are not included.

BRTPP2448L2	28.7 x 53 x 50	400	41	44.01	\$2557
BRTPP2424L2	28.7 x 29 x 50	300	32	24.08	\$1999

Fully upholstered 2.5" thick, 3-part, two tier partition kit wraps around 24" or 48" bridges seat. The 50"h assembly provides seated visual privacy. 2.5" thick upholstered partitions improve acoustic privacy for focused time away from the team or for a quiet phone call. Recessed seat extends the partition at the front by 2.5" for enhanced sense of privacy. The kit is secured to seats on-site (brackets connecting seat legs to the inner side of the partition are included). Upholstered kits consist of 2" hollow core boards, 1/4" foam, fabric, levelers and connecting hardware. Note: Seats and backrests are not included.

BRTS2424B	24 x 24 x 25	250	32	12.04	\$562	\$81
BRTS2424BP	24 x 24 x 25	125	59.30	8.33	\$1119	\$81

Freestanding 24" square table block serves as a visual anchor whenever a bridges seat needs to turn a corner or split into 2, 3 or 4 directions. BRTS2424BP can be positioned directly over a floor monument, which will supply power to the top-mounted power module. This option includes 24"x 24" block chassis and flush-mounted Duo power module (two outlets and two 2.1 amp USB ports, white face plate, outlets and bezel, 72" long three prong black cord). The square table block can function as a self-supporting, freestanding unit or it can be secured permanently to adjacent bridges seats with optional interconnecting brackets listed below. 2 Square Table Ganging Bracket Kits included.

BRTSTBG	2.4 x 5 x 1.1	70	.05	.01	\$42	n/a
---------	---------------	----	-----	-----	-------------	-----

Two square table block ganging brackets connect seat legs permanently to the side of the 24" square table block on site. The kit employs machine screws connecting legs to seats, and ships with wood screws which provide permanent connection to the square table block. Includes 2 brackets and screws. Black powdercoat finish.

BRTSTSB	1.3 x 6 x .1	70	.03	.01	\$19	n/a
---------	--------------	----	-----	-----	-------------	-----

Two ganging brackets connect seat temporarily to adjacent in-line seat or 24"d bridges storage. Black powdercoat finish.

Required Specifications

Fabric

COLLABORATIVE SEATING

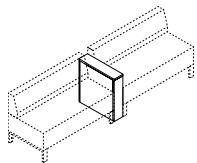
**Inline 6" Block**

BRTS2406B

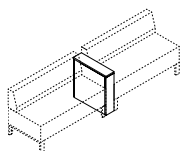

Inline table - no power module or swivel arm

MODEL#	DIMENSIONS D x W x H	FREIGHT CLASS	WT/LBS.	CUBIC FT.	LIST PRICE	HP ADD
BRTS2406B	24 x 6 x 25	92.5	21	2.08	\$482	\$42
BRTS2406BP	24 x 6 x 25	92.5	23.30	2.08	\$1040	\$42
BRTS2406B2P	24 x 6 x 25	92.5	24.30	2.08	\$1598	\$42
BRTS2406BT	24 x 6 x 25	85	25.60	2.08	\$921	\$42
BRTS2406BPT	24 x 6 x 25	92.5	24.30	2.08	\$1479	\$42

Multifunctional inline 6" table block divides seating areas, serves as a utility surface, can support tablet arms, lamps, and double as a power delivery center. It is permanently secured between two bridge seats and cannot be placed at the end of a run. Two Square Table Block Ganging Brackets (BRTSTBG) connect seat legs permanently to the side of the in-line table block on site. The included kit employs machine screws connecting legs to seats and ships with wood screws, which provide permanent connection to the in-line 6" block. Black powdercoat finish. The chassis is available without power module, with one power module or with two vertically embedded power modules. Vertical panel flush-mounted Duo module provides two outlets and two 2.1 amp USB ports; 72" cord exits through the bottom and plugs into a floor monument under seats, white face plate and bezel. 2 Square Table Ganging Bracket Kits included.

- BRTS2406BT and BRTS2406BPT include 9.5" x 14.5" swivel tablet. If top is specified in high pressure laminate, tablet will also be manufactured in high pressure laminate.

BRTS2406BP

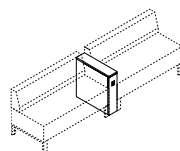

Inline table w/front power module

BRTS2406B2P

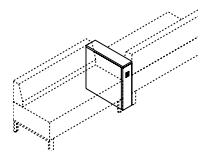

Inline table w/front and rear power module

BRTS2406BT

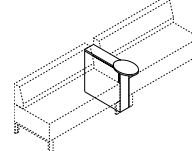

Inline table w/swivel tablet arm

BRTS2406BPT

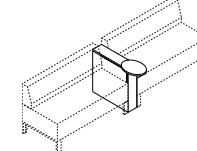

Inline table w/front power module and swivel tablet arm

Required Specifications

Top finish*
Edge finish*
Chassis/Accent finish*

Optional Specifications

HP laminate* (top only)



Intelli Beam™ brings forward a new era of open workspaces, combining the robust capabilities of panel systems with the flexibility and style demanded in today's office and education environments.

Integrate Intelli Beam with FreeFit and Foli height adjustable tables, Bungee, Junction or 2gether tables, or pair with Global metal or laminate storage to optimize your workspace while supporting both collaborative and individual needs. Extension kits offer privacy and height options for sitting and/or standing variations. Extension kits are available in tackable fabrics, laminate, and frosted or clear tempered glass. Laminate end-of-run panels add a finishing touch.

Intelli Beam's modular design make it easy to specify. Simply start the run and "add-on" with two leg choices - post or t-leg. Run power/data from a base feed kit up and into the Intelli Beam system. Punch outs on beam provide easy access for power and a center knockout for data.

Features and Benefits

- Delivers power at 3 heights - 24", 30", 36"
- Extension modules offered in fabric, laminate or glass
- Leg options: infeed with post leg, infeed with t-leg, or t-leg
- Integrates with FreeFit and Foli height adjustable tables, Bungee, Junction or 2gether tables
- Pair with Global metal or laminate storage
- Made from recycled materials and is 100% recyclable



Duplex receptacles snap into raceway.



Optional cable chain manages power from the raceway to any table.



Tackable fabric extension kits and optional privacy glass.

GENERAL INFORMATION

- Freestanding beam delivers power at 3 heights - 24", 30", 36"
- Extensions add fabric, laminate or glass division (available in 6", 12" and 18"H)
- Frameless privacy glass available at 6", 9" and 12"H
- For use with height adjustable or fixed tables
- For environmental certifications, please visit globalfurnituregroup.com.

INTELLI BEAM INFORMATION

- All metal components are painted with environmentally friendly epoxy powder
- Raceway interiors are coated with recycled epoxy powder
- The entire Intelli Beam product line and the processes used to manufacture it are designed to save and protect the environment. Intelli Beam is made from recycled materials and is 100% recyclable.
- Modules conform to CGSB and ANSI/BIFMA standards
- Modules have a steel frame and are 2.875" thick
- Leveling glides extend 1.25" long
- Foot on T-leg is 18" wide

INTELLI BEAM OPTIONS

- Powered raceway modules are available in the following heights: 24", 30", 36"
- All raceways come in (7) sizes: 36", 42", 48", 54", 60", 66" and 72"
- 66"w modules include (1) 30" and (1) 36" Intelli Beam raceway
- 72"w modules include (2) 36" Intelli Beam raceways

EXTENSION MODULES

- Attaches to the top of the beam
- Offered in 6", 12" and 18" heights
- Can be stacked up to 42" H above a finished floor (A.F.F.)

EXTENSION MODULE OPTIONS

- Tackable fabric
- Glazed - clear or frosted tempered glass
- Laminate

FRAMELESS PRIVACY GLASS

- Integrated into top trim
- Available in clear or frosted tempered glass
- 6", 9" and 12" high

RECONFIGURATION

- Extension modules can be modified on site by replacing fabric modules with Glazed or Laminate at any time after the initial installation
- Fabric can be replaced easily; using pre-cut segments of fabric, a drawstring (C-Jex) is sewn in around the edges. Then a rubber spline is used to 'screen' the fabric in place. Contact Customer Care for part #'s and pricing if required.

VOICE/DATA AND ELECTRICAL POWER

- NOTE: module and electric components are CSA/UL approved. Tools are not required to install electrical in the Evolve Panel System.

Voice and Data can be run at the following level:

- Power beam - 24", 30" or 36" H
- Dealer to provide data components

ADDITIONAL DATA AND ELECTRIC OPTIONS

- Desktop modules are available to install on the worksurface for electric, data and USB (via Productivity Solutions - see page 482)
- Vertical basefeed cover provides entry for the standard or NY infeed

ELECTRIC INFORMATION

- Electric can be run in the power beam module:
 - 8-Wire, 4-Circuit Capability
 - 2 Utility + 2 Dedicated Circuits
 - 10 Gauge (oversized) Neutrals.
- All circuits can support up to 20 amps (15 CSA). Controlled circuit duplexes and USB duplexes available.
- New York and Chicago electrical options available, see page 440

RACEWAY INFORMATION

- Raceway knockouts sizes conform to the ANSI/TIA/EIA Furniture Opening Standard of 1.38" x 2.71" at the base and Beltline.
- Power beam modules 36"-60" wide include raceway covers with three knockouts.
- Power beam modules 66" wide include raceway covers with five knockouts.
- Power beam modules 72" wide include raceway covers with six knockouts.
- Standard data face mount plates can be used without the need of adapter plates (supplied by others).
- Center knockouts in raceway covers are for data only.
- **Cabling Capacities**
(calculations below are based on CAT5 cables)
- **Power Beam Module**
 - Without Electric – 65 Cables
 - With Electric – 54 Cables

WORKSURFACES

- Foli height adjustable table (24" H beam)
- Bungee, Junction or 2gether tables (30" or 36" H beam)

STORAGE

- Global metal or laminate storage can be paired with Intelli Beam

LAMINATE FINISHES

ACJ	Absolute Acajou	NGL	Noce Grigio
ASN	Asian Night	NEL	Noce Leggero
AWC	Avant Cherry	NML	Noce Medio
AWH	Avant Honey	QTM	Quartered Mahogany
BLK	Black	SOG	Storm Grey
BRC	Brushed Cobalt	TFW	Tiger Fruitwood
CMB	Clear Maple	TWL	Tiger Walnut
DES	Dark Espresso	WHE	Walnut Heights
DWT	Designer White	WHC	White Chocolate
HGT	Hayden Grey	WGY	Willow Grey
NBL	Noce Biondo	WCR	Winter Cherry

METAL FINISHES:

BLK	Black
DWT	Designer White
TUN	Tungsten

FABRIC

Anchorage panel fabric only.

STARTER BEAM KITS

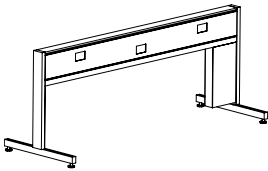

24" H Starter Beam Kits

MODEL#	DIMENSIONS D x W x H	FREIGHT CLASS	WT/LBS.	CUBIC FT.	LIST PRICE
IBBSU2436	2.87 x 36 x 24	85	32.50	2.57	\$1241
IBBSU2442	2.87 x 42 x 24	85	34.10	2.65	\$1268
IBBSU2448	2.87 x 48 x 24	85	50	4	\$1320
IBBSU2454	2.87 x 54 x 24	85	37.20	2.81	\$1357
IBBSU2460	2.87 x 60 x 24	85	38.80	2.89	\$1375
IBBSU2466	2.87 x 66 x 24	70	48	3	\$1989
IBBSU2472	2.87 x 72 x 24	70	49	3.09	\$2031

24"H starter beam kit with (2) T-legs - one T-leg is slotted for the vertical basefeed cover. Includes Intelli Beam raceway, vertical base feed cover, power distribution housing, 17" electrical jumper cable and (2) end of run trims. Each raceway includes (2) knockouts for duplexes and (1) center knockout for data. Can be used as a freestanding two pack or used as the start of a longer run. For add-on beam kits, see page 429.

- 66"W Intelli Beam starter kits include (1) 30"W and (1) 36"W raceway, (1) inline connector and (1) extra 17" electrical jumper cable.
- 72"W Intelli Beam kits include (2) 36"W raceways, (1) inline connector and (1) extra 17" electrical jumper cable.

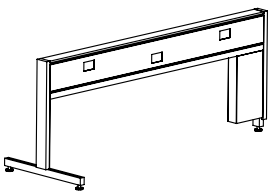

24" H Starter Beam Kits

IBBSP2436	2.87 x 36 x 24	85	32.50	2.57	\$1197
IBBSP2442	2.87 x 42 x 24	85	34.10	2.65	\$1225
IBBSP2448	2.87 x 48 x 24	85	35.60	2.73	\$1277
IBBSP2454	2.87 x 54 x 24	85	37.20	2.81	\$1315
IBBSP2460	2.87 x 60 x 24	85	38.80	2.89	\$1333
IBBSP2466	2.87 x 66 x 24	70	48	3	\$1948
IBBSP2472	2.87 x 72 x 24	70	49	3.09	\$1988

24"H starter beam kit with (1) T-leg and (1) post leg with slotting for vertical basefeed cover. Includes Intelli Beam raceway, vertical base feed cover, power distribution housing, 17" electrical jumper cable and (2) end of run trims. Each raceway includes (2) knockouts for duplexes and (1) center knockout for data. Can be used as a freestanding two pack or used as the start of a longer run. For add-on beam kits, see page 429.

- 66"W Intelli Beam starter kits include (1) 30"W and (1) 36"W raceway, (1) inline connector and (1) extra 17" electrical jumper cable.
- 72"W Intelli Beam kits include (2) 36"W raceways, (1) inline connector and (1) extra 17" electrical jumper cable.
- Vertical basefeed cover must be installed on post leg.

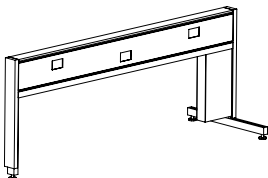

24" H Starter Beam Kits

IBBST2436	2.87 x 36 x 24	85	32.50	2.57	\$1241
IBBST2442	2.87 x 42 x 24	85	34.10	2.65	\$1268
IBBST2448	2.87 x 48 x 24	85	50	4	\$1320
IBBST2454	2.87 x 54 x 24	85	37.20	2.81	\$1357
IBBST2460	2.87 x 60 x 24	85	38.80	2.89	\$1375
IBBST2466	2.87 x 66 x 24	70	48	3	\$1989
IBBST2472	2.87 x 72 x 24	70	49	3.09	\$2031

24"H starter beam kit with (1) T-leg with slotting for vertical basefeed cover and (1) post leg. Includes Intelli Beam raceway, vertical base feed cover, power distribution housing, 17" electrical jumper cable and (2) end of run trims. Each raceway includes (2) knockouts for duplexes and (1) center knockout for data. Can be used as a freestanding two pack or used as the start of a longer run. For add-on beam kits, see page 429.

- 66"W Intelli Beam starter kits include (1) 30"W and (1) 36"W raceway, (1) inline connector and (1) extra 17" electrical jumper cable.
- 72"W Intelli Beam kits include (2) 36"W raceways, (1) inline connector and (1) extra 17" electrical jumper cable.
- Vertical basefeed cover must be installed on T-leg.

Required Specifications

Paint finish

STARTER BEAM KITS

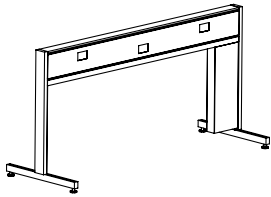

30" H Starter Beam Kits

MODEL# DIMENSIONS FREIGHT CLASS WT./LBS. CUBIC FT. LIST PRICE

D x W x H

IBBSU3036	2.87 x 36 x 30	92.5	33.90	3.04	\$1323
IBBSU3042	2.87 x 42 x 30	92.5	35.50	3.12	\$1352
IBBSU3048	2.87 x 48 x 30	92.5	37	3.20	\$1405
IBBSU3054	2.87 x 54 x 30	92.5	38.60	3.28	\$1440
IBBSU3060	2.87 x 60 x 30	85	50	4	\$1460
IBBSU3066	2.87 x 66 x 30	60	49.40	.38	\$2075
IBBSU3072	2.87 x 72 x 30	65	50.40	2.18	\$2116

30"H starter beam kit with (2) T-legs - one T-leg is slotted for the vertical basefeed cover. Includes Intelli Beam raceway, vertical base feed cover, power distribution housing, 17" electrical jumper cable and (2) end of run trims. Each raceway includes (2) knockouts for duplexes and (1) center knockout for data. Can be used as a freestanding two pack or used as the start of a longer run. For add-on beam kits, see page 429.

- 66"W Intelli Beam starter kits include (1) 30"W and (1) 36"W raceway, (1) inline connector and (1) extra 17" electrical jumper cable.
- 72"W Intelli Beam kits include (2) 36"W raceways, (1) inline connector and (1) extra 17" electrical jumper cable.

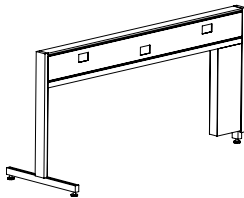

30" H Starter Beam Kits

IBBSP3036	2.87 x 36 x 30	92.5	33.90	3.04	\$1280
IBBSP3042	2.87 x 42 x 30	92.5	35.50	3.12	\$1307
IBBSP3048	2.87 x 48 x 30	92.5	37	3.20	\$1360
IBBSP3054	2.87 x 54 x 30	92.5	38.60	3.28	\$1398
IBBSP3060	2.87 x 60 x 30	92.5	40.20	3.36	\$1417
IBBSP3066	2.87 x 66 x 30	85	49.40	3.47	\$2031
IBBSP3072	2.87 x 72 x 30	85	50.40	3.56	\$2072

30"H starter beam kit with (1) T-leg and (1) post leg with slotting for vertical basefeed cover. Includes Intelli Beam raceway, vertical base feed cover, power distribution housing, 17" electrical jumper cable and (2) end of run trims. Each raceway includes (2) knockouts for duplexes and (1) center knockout for data. Can be used as a freestanding two pack or used as the start of a longer run. For add-on beam kits, see page 429.

- 66"W Intelli Beam starter kits include (1) 30"W and (1) 36"W raceway, (1) inline connector and (1) extra 17" electrical jumper cable.
- 72"W Intelli Beam kits include (2) 36"W raceways, (1) inline connector and (1) extra 17" electrical jumper cable.
- Vertical basefeed cover must be installed on post leg.

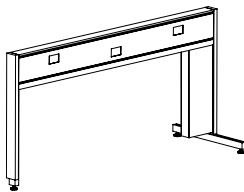

30" H Starter Beam Kits

IBBST3036	2.87 x 36 x 30	92.5	33.90	3.04	\$1323
IBBST3042	2.87 x 42 x 30	92.5	35.50	3.12	\$1352
IBBST3048	2.87 x 48 x 30	92.5	37	3.20	\$1405
IBBST3054	2.87 x 54 x 30	92.5	38.60	3.28	\$1440
IBBST3060	2.87 x 60 x 30	85	50	4	\$1460
IBBST3066	2.87 x 66 x 30	60	49.40	.38	\$2075
IBBST3072	2.87 x 72 x 30	65	50.40	2.18	\$2116

30"H starter beam kit with (1) T-leg with slotting for vertical basefeed cover and (1) post leg. Includes Intelli Beam raceway, vertical base feed cover, power distribution housing, 17" electrical jumper cable and (2) end of run trims. Each raceway includes (2) knockouts for duplexes and (1) center knockout for data. Can be used as a freestanding two pack or used as the start of a longer run. For add-on beam kits, see page 429.

- 66"W Intelli Beam starter kits include (1) 30"W and (1) 36"W raceway, (1) inline connector and (1) extra 17" electrical jumper cable.
- 72"W Intelli Beam kits include (2) 36"W raceways, (1) inline connector and (1) extra 17" electrical jumper cable.
- Vertical basefeed cover must be installed on T-leg.

Required Specifications

Paint finish

STARTER BEAM KITS

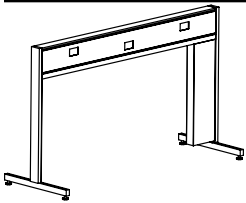

36" H Starter Beam Kits

MODEL#	DIMENSIONS D x W x H	FREIGHT CLASS	WT/LBS.	CUBIC FT.	LIST PRICE
IBBSU3636	2.87 x 36 x 36	92.5	36.30	3.55	\$1372
IBBSU3642	2.87 x 42 x 36	92.5	37.90	3.63	\$1403
IBBSU3648	2.87 x 48 x 36	92.5	39.40	3.71	\$1444
IBBSU3654	2.87 x 54 x 36	92.5	41	3.79	\$1479
IBBSU3660	2.87 x 60 x 36	60	42.60	.56	\$1499
IBBSU3666	2.87 x 66 x 36	60	51.80	.45	\$2114
IBBSU3672	2.87 x 72 x 36	70	52.80	2.62	\$2155

36"H starter beam kit with (2) T-legs-one T-leg is slotted for the vertical basefeed cover. Includes Intelli Beam raceway, vertical base feed cover, power distribution housing, 17" electrical jumper cable and (2) end of run trims. Each raceway includes (2) knockouts for duplexes and (1) center knockout for data. Can be used as a freestanding two pack or used as the start of a longer run. For add-on beam kits, see page 429.

- 66"W Intelli Beam starter kits include (1) 30"W and (1) 36"W raceway, (1) inline connector and (1) extra 17" electrical jumper cable.
- 72"W Intelli Beam kits include (2) 36"W raceways, (1) inline connector and (1) extra 17" electrical jumper cable.

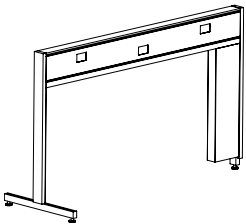

36" H Starter Beam Kits

IBBSP3636	2.87 x 36 x 36	92.5	36.30	3.55	\$1329
IBBSP3642	2.87 x 42 x 36	92.5	37.90	3.63	\$1359
IBBSP3648	2.87 x 48 x 36	92.5	39.40	3.71	\$1400
IBBSP3654	2.87 x 54 x 36	92.5	41	3.79	\$1436
IBBSP3660	2.87 x 60 x 36	92.5	42.60	3.87	\$1456
IBBSP3666	2.87 x 66 x 36	85	51.80	3.98	\$2071
IBBSP3672	2.87 x 72 x 36	85	52.80	4.07	\$2112

36"H starter beam kit with (1) T-leg and (1) post leg with slotting for vertical basefeed cover. Includes Intelli Beam raceway, vertical base feed cover, power distribution housing, 17" electrical jumper cable and (2) end of run trims. Each raceway includes (2) knockouts for duplexes and (1) center knockout for data. Can be used as a freestanding two pack or used as the start of a longer run. For add-on beam kits, see page 429.

- 66"W Intelli Beam starter kits include (1) 30"W and (1) 36"W raceway, (1) inline connector and (1) extra 17" electrical jumper cable.
- 72"W Intelli Beam kits include (2) 36"W raceways, (1) inline connector and (1) extra 17" electrical jumper cable.
- Vertical basefeed cover must be installed on post leg.

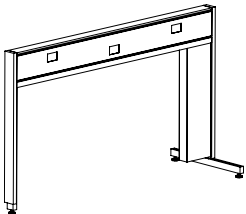

36" H Starter Beam Kits

IBBST3636	2.87 x 36 x 36	92.5	36.30	3.55	\$1372
IBBST3642	2.87 x 42 x 36	92.5	37.90	3.63	\$1403
IBBST3648	2.87 x 48 x 36	92.5	39.40	3.71	\$1444
IBBST3654	2.87 x 54 x 36	92.5	41	3.79	\$1479
IBBST3660	2.87 x 60 x 36	60	42.60	.56	\$1499
IBBST3666	2.87 x 66 x 36	60	51.80	.45	\$2114
IBBST3672	2.87 x 72 x 36	70	52.80	2.62	\$2155

36"H starter beam kit with (1) T-leg with slotting for vertical basefeed cover and (1) post leg. Includes Intelli Beam raceway, vertical base feed cover, power distribution housing, 17" electrical jumper cable and (2) end of run trims. Each raceway includes (2) knockouts for duplexes and (1) center knockout for data. Can be used as a freestanding two pack or used as the start of a longer run. For add-on beam kits, see page 429.

- 66"W Intelli Beam starter kits include (1) 30"W and (1) 36"W raceway, (1) inline connector and (1) extra 17" electrical jumper cable.
- 72"W Intelli Beam kits include (2) 36"W raceways, (1) inline connector and (1) extra 17" electrical jumper cable.
- Vertical basefeed cover must be installed on T-leg.

Required Specifications

Paint finish

ADD-ON BEAM KITS

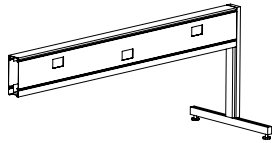

24" H Add-On Beam Kits - T Leg

MODEL#	DIMENSIONS	FREIGHT CLASS	WT/LBS.	CUBIC FT.	LIST PRICE
--------	------------	---------------	---------	-----------	------------

D x W x H

IBBAT2436	2.87 x 36 x 24	65	21.40	.78	\$834
IBBAT2442	2.87 x 42 x 24	65	23	.86	\$859
IBBAT2448	2.87 x 48 x 24	65	24.50	.94	\$909
IBBAT2454	2.87 x 54 x 24	65	26.10	1.02	\$946
IBBAT2460	2.87 x 60 x 24	65	27.70	1.10	\$963
IBBAT2466	2.87 x 66 x 24	60	36.90	1.21	\$1562
IBBAT2472	2.87 x 72 x 24	65	37.90	1.30	\$1602

24"H add-on beam kit with T-leg includes Intelli Beam raceway, power distribution housing and 17" electrical jumper cable. Each raceway includes (2) knockouts for duplexes and (1) center knockout for data. Must be used in conjunction with starter beam kits, beginning on page 426.

- 66"W Intelli Beam kits include (1) 30"W and (1) 36"W raceway, (1) inline connector and (1) extra 17" electrical jumper cable.
- 72"W Intelli Beam kits include (2) 36"W raceways, (1) inline connector and (1) extra 17" electrical jumper cable.

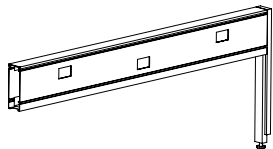

24" H Add-on Beam Kits - Post Leg

IBBAP2436	2.87 x 36 x 24	60	15.50	.48	\$790
IBBAP2442	2.87 x 42 x 24	60	17.10	.56	\$816
IBBAP2448	2.87 x 48 x 24	65	18.60	.64	\$864
IBBAP2454	2.87 x 54 x 24	65	20.20	.72	\$901
IBBAP2460	2.87 x 60 x 24	65	21.80	.80	\$917
IBBAP2466	2.87 x 66 x 24	60	31	.91	\$1517
IBBAP2472	2.87 x 72 x 24	60	32	1	\$1558

24"H add-on beam kit with (1) post leg includes Intelli Beam raceway, vertical base feed cover, power distribution housing, 17" electrical jumper cable and (2) end of run trims. Each raceway includes (2) knockouts for duplexes and (1) center knockout for data. Must be used in conjunction with starter beam kits, beginning on page 426.

- 66"W Intelli Beam kits include (1) 30"W and (1) 36"W raceway, (1) inline connector and (1) extra 17" electrical jumper cable.
- 72"W Intelli Beam kits include (2) 36"W raceways, (1) inline connector and (1) extra 17" electrical jumper cable.

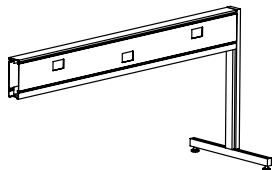

30" H Add-On Beam Kits - T Leg

IBBAT3036	2.87 x 36 x 30	65	22.70	.86	\$839
IBBAT3042	2.87 x 42 x 30	65	24.30	.94	\$864
IBBAT3048	2.87 x 48 x 30	65	25.80	1.02	\$916
IBBAT3054	2.87 x 54 x 30	65	27.40	1.10	\$952
IBBAT3060	2.87 x 60 x 30	65	29	1.18	\$969
IBBAT3066	2.87 x 66 x 30	65	38.20	1.29	\$1569
IBBAT3072	2.87 x 72 x 30	65	39.20	1.38	\$1609

30"H add-on beam kit with T-leg includes Intelli Beam raceway, power distribution housing and 17" electrical jumper cable. Each raceway includes (2) knockouts for duplexes and (1) center knockout for data. Must be used in conjunction with starter beam kits, beginning on page 426.

- 66"W Intelli Beam kits include (1) 30"W and (1) 36"W raceway, (1) inline connector and (1) extra 17" electrical jumper cable.
- 72"W Intelli Beam kits include (2) 36"W raceways, (1) inline connector and (1) extra 17" electrical jumper cable.

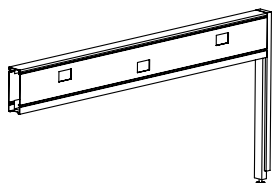

30" H Add-on Beam Kits - Post Leg

IBBAP3036	2.87 x 36 x 30	60	15.50	.48	\$798
IBBAP3042	2.87 x 42 x 30	60	17.10	.56	\$823
IBBAP3048	2.87 x 48 x 30	65	18.60	.64	\$875
IBBAP3054	2.87 x 54 x 30	65	20.20	.72	\$909
IBBAP3060	2.87 x 60 x 30	65	21.80	.80	\$927
IBBAP3066	2.87 x 66 x 30	60	31	.91	\$1525
IBBAP3072	2.87 x 72 x 30	60	32	1	\$1566

30"H add-on beam kit with (1) post leg includes Intelli Beam raceway, vertical base feed cover, power distribution housing, 17" electrical jumper cable and (2) end of run trims. Each raceway includes (2) knockouts for duplexes and (1) center knockout for data. Must be used in conjunction with starter beam kits, beginning on page 426.

- 66"W Intelli Beam kits include (1) 30"W and (1) 36"W raceway, (1) inline connector and (1) extra 17" electrical jumper cable.
- 72"W Intelli Beam kits include (2) 36"W raceways, (1) inline connector and (1) extra 17" electrical jumper cable.

Required Specifications

Paint finish

ADD-ON BEAM KITS

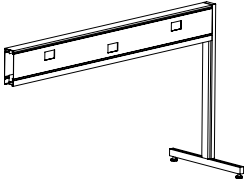

36" H Add-On Beam Kits - T Leg

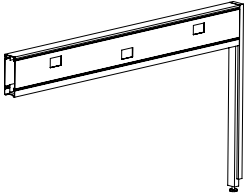

36" H Add-on Beam Kits - Post Leg

MODEL#	DIMENSIONS	FREIGHT CLASS	WT/LBS.	CUBIC FT.	LIST PRICE
--------	------------	---------------	---------	-----------	------------

D x W x H

IBBAT3636	2.87 x 36 x 36	65	24	.93	\$845
IBBAT3642	2.87 x 42 x 36	65	25.60	1.01	\$872
IBBAT3648	2.87 x 48 x 36	65	27.10	1.09	\$924
IBBAT3654	2.87 x 54 x 36	65	28.70	1.17	\$959
IBBAT3660	2.87 x 60 x 36	65	30.30	1.25	\$976
IBBAT3666	2.87 x 66 x 36	65	39.50	1.36	\$1576
IBBAT3672	2.87 x 72 x 36	65	40.50	1.45	\$1617

36"H add-on beam kit with T-leg includes Intelli Beam raceway, power distribution housing and 17" electrical jumper cable. Each raceway includes (2) knockouts for duplexes and (1) center knockout for data. Must be used in conjunction with starter beam kits, beginning on page 426.

- 66"W Intelli Beam kits include (1) 30"W and (1) 36"W raceway, (1) inline connector and (1) extra 17" electrical jumper cable.
- 72"W Intelli Beam kits include (2) 36"W raceways, (1) inline connector and (1) extra 17" electrical jumper cable.

IBBAP3636	2.87 x 36 x 36	60	15.50	.48	\$845
IBBAP3642	2.87 x 42 x 36	60	17.10	.56	\$872
IBBAP3648	2.87 x 48 x 36	65	18.60	.64	\$924
IBBAP3654	2.87 x 54 x 36	65	20.20	.72	\$959
IBBAP3660	2.87 x 60 x 36	65	21.80	.80	\$976
IBBAP3666	2.87 x 66 x 36	60	31	.91	\$1576
IBBAP3672	2.87 x 72 x 36	60	32	1	\$1617

36"H add-on beam kit with (1) post leg includes Intelli Beam raceway, vertical base feed cover, power distribution housing, 17" electrical jumper cable and (2) end of run trims. Each raceway includes (2) knockouts for duplexes and (1) center knockout for data. Must be used in conjunction with starter beam kits, beginning on page 426.

- 66"W Intelli Beam kits include (1) 30"W and (1) 36"W raceway, (1) inline connector and (1) extra 17" electrical jumper cable.
- 72"W Intelli Beam kits include (2) 36"W raceways, (1) inline connector and (1) extra 17" electrical jumper cable.

Required Specifications

Paint finish

STARTER EXTENSION KITS

6"



12"



18"

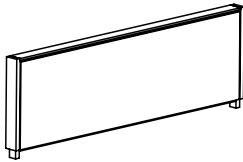

Starter Extension Kit - Fabric

MODEL# DIMENSIONS FREIGHT CLASS WT./LBS. CUBIC FT. LIST PRICE

D x W x H

MODEL#	DIMENSIONS	FREIGHT CLASS	WT./LBS.	CUBIC FT.	LIST PRICE
IBSFE0636	2.87 x 36 x 6	92.5	10.29	1.01	\$451
IBSFE0642	2.87 x 42 x 6	92.5	11.72	1.09	\$485
IBSFE0648	2.87 x 48 x 6	92.5	13.15	1.16	\$509
IBSFE0654	2.87 x 54 x 6	92.5	14.59	1.23	\$535
IBSFE0660	2.87 x 60 x 6	85	16.02	1.31	\$543
IBSFE0666	2.87 x 66 x 6	92.5	18.20	1.60	\$753
IBSFE0672	2.87 x 72 x 6	92.5	19.64	1.67	\$782
IBSFE1236	2.87 x 36 x 12	92.5	14.42	1.42	\$451
IBSFE1242	2.87 x 42 x 12	92.5	15.42	1.42	\$485
IBSFE1248	2.87 x 48 x 12	92.5	16.42	1.61	\$509
IBSFE1254	2.87 x 54 x 12	150	11.42	2.19	\$535
IBSFE1260	2.87 x 60 x 12	92.5	19.42	1.74	\$543
IBSFE1266	2.87 x 66 x 12	70	25.42	1.50	\$753
IBSFE1272	2.87 x 72 x 12	70	26.42	1.54	\$782
IBSFE1836	2.87 x 36 x 18	70	44.50	2.02	\$571
IBSFE1842	2.87 x 42 x 18	70	46.50	2.21	\$606
IBSFE1848	2.87 x 48 x 18	70	48	2.35	\$642
IBSFE1854	2.87 x 54 x 18	70	50	2.43	\$678
IBSFE1860	2.87 x 60 x 18	70	52.50	2.53	\$717
IBSFE1866	2.87 x 66 x 18	70	61	3.41	\$942
IBSFE1872	2.87 x 72 x 18	70	62	3.62	\$988

Fabric starter extension kit attaches on top of a starter beam kit of the same width. Includes fabric extension panel, (2) extension connectors and (2) extension trims. Must be used in conjunction with starter beam kits, beginning on page 426.

- 66"W fabric starter extension kits include (1) 30"W extension panel, (1) 36"W extension panel, and (1) extra extension connector.
- 72"W fabric starter extension kits include (2) 36"W extension panels and (1) extra extension connector.
- Full end of run trim can be specified separate to equal the total height (up to 42"H) of the beam
- **For stability, panels may be stacked no higher than 42" above the floor.**

Required Specifications

- Paint finish
- Fabric

STARTER EXTENSION KITS

6"



12"



18"

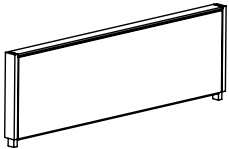

Starter Extension Kit - Laminate

MODEL#	DIMENSIONS D x W x H	FREIGHT CLASS	WT/LBS.	CUBIC FT.	LIST PRICE
IBSLE0636	2.87 x 36 x 6	92.5	10.29	1.01	\$686
IBSLE0642	2.87 x 42 x 6	92.5	11.72	1.09	\$754
IBSLE0648	2.87 x 48 x 6	85	13.15	1.06	\$819
IBSLE0654	2.87 x 54 x 6	92.5	14.59	1.23	\$922
IBSLE0660	2.87 x 60 x 6	85	16.02	1.31	\$940
IBSLE0666	2.87 x 66 x 6	92.5	18.20	1.60	\$1189
IBSLE0672	2.87 x 72 x 6	92.5	19.64	1.67	\$1253
IBSLE1236	2.87 x 36 x 12	70	28.42	1.42	\$686
IBSLE1242	2.87 x 42 x 12	70	32.42	1.47	\$754
IBSLE1248	2.87 x 48 x 12	65	40.42	1.53	\$819
IBSLE1254	2.87 x 54 x 12	65	48.42	1.67	\$922
IBSLE1260	2.87 x 60 x 12	60	54.42	1.74	\$940
IBSLE1266	2.87 x 66 x 12	70	50.42	2.36	\$1189
IBSLE1272	2.87 x 72 x 12	70	54.42	2.54	\$1253
IBSLE1836	2.87 x 36 x 18	70	45.40	2.14	\$982
IBSLE1842	2.87 x 42 x 18	70	46.70	2.14	\$1079
IBSLE1848	2.87 x 48 x 18	70	47.12	2.53	\$1193
IBSLE1854	2.87 x 54 x 18	70	48.75	2.57	\$1288
IBSLE1860	2.87 x 60 x 18	70	51.25	2.93	\$1371
IBSLE1866	2.87 x 66 x 18	70	60.90	3.62	\$1705
IBSLE1872	2.87 x 72 x 18	70	63.80	3.86	\$1810

Laminate starter extension kit attaches on top of a starter beam kit of the same width. Includes laminate extension panel, (2) extension connectors and (2) extension trims. Must be used in conjunction with starter beam kits, beginning on page 426.

- 66"W laminate starter extension kits include (1) 30"W extension panel, (1) 36"W extension panel, and (1) extra extension connector.
- 72"W laminate starter extension kits include (2) 36"W extension panels and (1) extra extension connector.
- Full end of run trim can be specified separate to equal the total height (up to 42"H) of the beam
- **For stability, panels may be stacked no higher than 42" above the floor.**

Required Specifications

Paint finish
Laminate finish

STARTER EXTENSION KITS

6"



12"

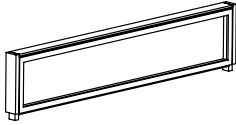

18"

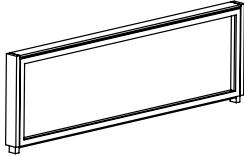

Starter Extension Kit - Glazed

MODEL#	DIMENSIONS D x W x H	FREIGHT CLASS	WT/LBS.	CUBIC FT.	LIST PRICE	FRST ADD
IBSGE0636	2.87 x 36 x 6	85	11.69	.95	\$758	\$216
IBSGE0642	2.87 x 42 x 6	85	12.69	1.01	\$885	\$261
IBSGE0648	2.87 x 48 x 6	92.5	12.69	1.08	\$970	\$292
IBSGE0654	2.87 x 54 x 6	85	13.69	1.14	\$1045	\$318
IBSGE0660	2.87 x 60 x 6	85	14.69	1.21	\$1110	\$343
IBSGE0666	2.87 x 66 x 6	85	21.44	1.49	\$1369	\$418
IBSGE0672	2.87 x 72 x 6	85	22.40	1.55	\$1398	\$427
IBSGE1236	2.87 x 36 x 12	85	14.42	1.11	\$758	\$216
IBSGE1242	2.87 x 42 x 12	85	15.42	1.22	\$885	\$261
IBSGE1248	2.87 x 48 x 12	92.5	16.42	1.42	\$970	\$292
IBSGE1254	2.87 x 54 x 12	92.5	22.78	2.19	\$1045	\$318
IBSGE1260	2.87 x 60 x 12	85	19.42	1.57	\$1110	\$343
IBSGE1266	2.87 x 66 x 12	85	25.42	1.80	\$1369	\$418
IBSGE1272	2.87 x 72 x 12	85	26.19	1.86	\$1398	\$427
IBSGE1836	2.87 x 36 x 18	65	50.16	1.74	\$994	\$284
IBSGE1842	2.87 x 42 x 18	65	52.83	1.90	\$1100	\$323
IBSGE1848	2.87 x 48 x 18	65	55.54	2.08	\$1205	\$360
IBSGE1854	2.87 x 54 x 18	65	58.10	2.26	\$1288	\$392
IBSGE1860	2.87 x 60 x 18	65	60.80	2.46	\$1367	\$419
IBSGE1866	2.87 x 66 x 18	65	70.66	2.84	\$1771	\$647
IBSGE1872	2.87 x 72 x 18	65	73.32	3.06	\$1836	\$564

Glazed starter extension kit attaches on top of a starter beam kit of the same width. Includes glass extension panel, (2) extension connectors and (2) extension trims. Must be used in conjunction with starter beam kits, beginning on page 426. Standard in Clear (CLR) glass. Frosted (FRST) glass is available at an upcharge.

- 66"W glass starter extension kits include (1) 30"W extension panel, (1) 36"W extension panel, and (1) extra extension connector.
- 72"W glass starter extension kits include (2) 36"W extension panels and (1) extra extension connector.
- Full end of run trim can be specified separate to equal the total height (up to 42"H) of the beam
- **For stability, panels may be stacked no higher than 42" above the floor.**

Required Specifications
Paint finish

Optional Specifications
Frosted glass

ADD-ON EXTENSION KITS

6"



12"



18"

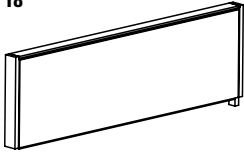

Add-On Extension Kit - Fabric

MODEL#	DIMENSIONS D x W x H	FREIGHT CLASS	WT./LBS.	CUBIC FT.	LIST PRICE
IBAFE0636	2.87 x 36 x 6	85	9.35	.66	\$334
IBAFE0642	2.87 x 42 x 6	85	10.78	.74	\$368
IBAFE0648	2.87 x 48 x 6	70	12.21	.81	\$393
IBAFE0654	2.87 x 54 x 6	70	13.65	.88	\$418
IBAFE0660	2.87 x 60 x 6	70	15.08	.96	\$428
IBAFE0666	2.87 x 66 x 6	85	17.26	1.25	\$635
IBAFE0672	2.87 x 72 x 6	85	18.70	1.32	\$667
IBAFE1236	2.87 x 36 x 12	92.5	12	1.12	\$334
IBAFE1242	2.87 x 42 x 12	92.5	13	1.12	\$368
IBAFE1248	2.87 x 48 x 12	92.5	16	1.50	\$393
IBAFE1254	2.87 x 54 x 12	150	9	1.89	\$418
IBAFE1260	2.87 x 60 x 12	92.5	17	1.44	\$428
IBAFE1266	2.87 x 66 x 12	70	23	1.50	\$635
IBAFE1272	2.87 x 72 x 12	92.5	14	1.24	\$667
IBAFE1836	2.87 x 36 x 18	92.5	17.60	1.60	\$419
IBAFE1842	2.87 x 42 x 18	92.5	19.50	1.79	\$454
IBAFE1848	2.87 x 48 x 18	92.5	21	1.93	\$491
IBAFE1854	2.87 x 54 x 18	92.5	23	2.01	\$524
IBAFE1860	2.87 x 60 x 18	92.5	25.50	2.14	\$564
IBAFE1866	2.87 x 66 x 18	92.5	34	2.99	\$790
IBAFE1872	2.87 x 72 x 18	100	35	3.62	\$837

Fabric add-on extension kit attaches on top of an add-on beam kit of the same width. Includes fabric extension panel and (1) extension connector. Must be used in conjunction with add-on beam kits - see page 429.

- 66"W fabric add-on extension kits include (1) 30"W extension panel, (1) 36"W extension panel, and (1) extra extension connector.
- 72"W fabric add-on extension kits include (2) 36"W extension panels and (1) extra extension connector.
- **For stability, panels may be stacked no higher than 42" above the floor.**

Required Specifications

Paint finish
Fabric

ADD-ON EXTENSION KITS

6"



12"



18"

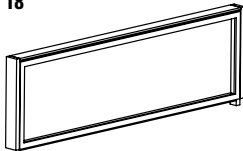

Add-On Extension Kit - Glass

MODEL#	DIMENSIONS D x W x H	FREIGHT CLASS	WT./LBS.	CUBIC FT.	LIST PRICE	FRST ADD
IBAGE0636	2.87 x 36 x 6	70	10.75	.60	\$642	\$216
IBAGE0642	2.87 x 42 x 6	70	11.75	.66	\$770	\$261
IBAGE0648	2.87 x 48 x 6	70	11.75	.73	\$855	\$292
IBAGE0654	2.87 x 54 x 6	70	12.75	.79	\$928	\$318
IBAGE0660	2.87 x 60 x 6	70	13.75	.86	\$993	\$343
IBAGE0666	2.87 x 66 x 6	70	20.50	1.14	\$1253	\$418
IBAGE0672	2.87 x 72 x 6	70	21.50	1.20	\$1281	\$427
IBAGE1236	2.87 x 36 x 12	85	12	.81	\$642	\$216
IBAGE1242	2.87 x 42 x 12	85	13	.92	\$770	\$261
IBAGE1248	2.87 x 48 x 12	85	14	1.12	\$855	\$292
IBAGE1254	2.87 x 54 x 12	92.5	20.36	1.89	\$928	\$318
IBAGE1260	2.87 x 60 x 12	85	17	1.27	\$993	\$343
IBAGE1266	2.87 x 66 x 12	70	23	1.50	\$1253	\$418
IBAGE1272	2.87 x 72 x 12	85	24	1.62	\$1281	\$427
IBAGE1836	2.87 x 36 x 18	70	23.16	1.32	\$843	\$284
IBAGE1842	2.87 x 42 x 18	70	25.83	1.48	\$947	\$323
IBAGE1848	2.87 x 48 x 18	70	28.54	1.66	\$1054	\$360
IBAGE1854	2.87 x 54 x 18	70	31.10	1.84	\$1138	\$392
IBAGE1860	2.87 x 60 x 18	70	33.80	2.04	\$1214	\$419
IBAGE1866	2.87 x 66 x 18	70	43.66	2.42	\$1618	\$647
IBAGE1872	2.87 x 72 x 18	70	46.32	2.64	\$1683	\$564

Glass add-on extension kit attaches on top of an add-on beam kit of the same width. Includes glass extension panel and (1) extension connector. Must be used in conjunction with add-on beam kits - see page 429. Standard in Clear (CLR) glass. Frosted (FRST) glass is available at an upcharge.

- 66"W glass add-on extension kits include (1) 30"W extension panel, (1) 36"W extension panel, and (1) extra extension connector.
- 72"W fabric add-on extension kits include (2) 36"W extension panels and (1) extra extension connector.
- **For stability, panels may be stacked no higher than 42" above the floor.**

Required Specifications
Paint finish

Optional Specifications
Frosted glass

I INTELLI BEAM™

ADD-ON EXTENSION KITS

6"



12"



18"

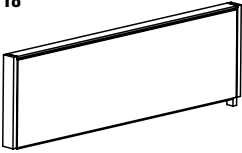

Add-On Extension Kit - Laminate

MODEL#	DIMENSIONS D x W x H	FREIGHT CLASS	WT/LBS.	CUBIC FT.	LIST PRICE
IBALE0636	2.87 x 36 x 6	85	9.35	.66	\$570
IBALE0642	2.87 x 42 x 6	85	10.78	.74	\$640
IBALE0648	2.87 x 48 x 6	70	12.21	.71	\$705
IBALE0654	2.87 x 54 x 6	70	13.65	.88	\$805
IBALE0660	2.87 x 60 x 6	70	15.08	.96	\$823
IBALE0666	2.87 x 66 x 6	85	17.26	1.25	\$1072
IBALE0672	2.87 x 72 x 6	85	18.70	1.32	\$1138
IBALE1236	2.87 x 36 x 12	65	26	1.12	\$570
IBALE1242	2.87 x 42 x 12	65	30	1.17	\$640
IBALE1248	2.87 x 48 x 12	60	38	1.23	\$705
IBALE1254	2.87 x 54 x 12	60	46	1.37	\$805
IBALE1260	2.87 x 60 x 12	60	52	1.44	\$823
IBALE1266	2.87 x 66 x 12	65	48	2.06	\$1072
IBALE1272	2.87 x 72 x 12	65	52	2.24	\$1138
IBALE1836	2.87 x 36 x 18	92.5	18.40	1.72	\$829
IBALE1842	2.87 x 42 x 18	92.5	19.70	1.72	\$928
IBALE1848	2.87 x 48 x 18	100	20.12	2.11	\$1040
IBALE1854	2.87 x 54 x 18	92.5	21.75	2.15	\$1138
IBALE1860	2.87 x 60 x 18	92.5	21.75	2.15	\$1218
IBALE1866	2.87 x 66 x 18	92.5	33.90	3.20	\$1552
IBALE1872	2.87 x 72 x 18	92.5	36.80	3.44	\$1656

Laminate add-on extension kit attaches on top of an add-on beam kit of the same width. Includes laminate extension panel and (1) extension connector. Must be used in conjunction with add-on beam kits - see page 429.

- 66"W laminate add-on extension kits include (1) 30"W extension panel, (1) 36"W extension panel, and (1) extra extension connector.
- 72"W laminate add-on extension kits include (2) 36"W extension panels and (1) extra extension connector.
- **For stability, panels may be stacked no higher than 42" above the floor.**

Required Specifications

Paint finish
Laminate finish

PRIVACY GLASS KITS

MODEL# DIMENSIONS FREIGHT CLASS WT./LBS. CUBIC FT. LIST PRICE FRST ADD

D x W x H

IBPGK0636	2.87 x 36 x 6	125	3.58	.50	\$380	\$53
IBPGK0642	2.87 x 42 x 6	125	3.72	.60	\$408	\$39
IBPGK0648	2.87 x 48 x 6	125	3.72	.60	\$423	\$63
IBPGK0654	2.87 x 54 x 6	125	3.75	.62	\$450	\$80
IBPGK0660	2.87 x 60 x 6	125	3.75	.62	\$465	\$105
IBPGK0666	2.87 x 66 x 6	92.5	7.30	.65	\$783	\$91
IBPGK0672	2.87 x 72 x 6	125	7.44	1.20	\$809	\$74



6" H Privacy Glass*

6"H privacy glass kit attaches on top of any module of the same width. Privacy glass is integrated into the aluminum top trim. Attaching hardware is included. Standard in Clear (CLR) glass. Frosted (FRST) glass is available at an upcharge.

- 66"W privacy glass kits include (1) 30"W privacy glass screen and trim and (1) 36"W privacy glass screen and trim.
- 72"W privacy glass kits include (2) 36"W privacy glass screens and trims.
- **May be placed on Intelli Beam configuration of any height.**

IBPGK0936	2.87 x 36 x 9	125	3.58	.50	\$380	\$53
IBPGK0942	2.87 x 42 x 9	125	3.72	.60	\$408	\$39
IBPGK0948	2.87 x 48 x 9	60	36.72	.60	\$423	\$63
IBPGK0954	2.87 x 54 x 9	125	3.75	.62	\$450	\$80
IBPGK0960	2.87 x 60 x 9	125	3.75	.62	\$465	\$105
IBPGK0966	2.87 x 66 x 9	92.5	7.30	.65	\$783	\$91
IBPGK0972	2.87 x 72 x 9	125	7.44	1.20	\$809	\$74



9" H Privacy Glass*

9"H privacy glass kit attaches on top of any module of the same width. Privacy glass is integrated into the aluminum top trim. Attaching hardware is included. Standard in Clear (CLR) glass. Frosted (FRST) glass is available at an upcharge.

- 66"W privacy glass kits include (1) 30"W privacy glass screen and trim and (1) 36"W privacy glass screen and trim.
- 72"W privacy glass kits include (2) 36"W privacy glass screens and trims.
- **May be placed on Intelli Beam configuration of any height.**

IBPGK1236	2.87 x 36 x 12	125	3.58	.50	\$380	\$53
IBPGK1242	2.87 x 42 x 12	125	3.72	.60	\$408	\$39
IBPGK1248	2.87 x 48 x 12	125	3.72	.60	\$423	\$63
IBPGK1254	2.87 x 54 x 12	125	3.75	.62	\$450	\$80
IBPGK1260	2.87 x 60 x 12	125	3.75	.62	\$465	\$105
IBPGK1266	2.87 x 66 x 12	92.5	7.30	.65	\$783	\$91
IBPGK1272	2.87 x 72 x 12	125	7.44	1.20	\$809	\$74



12" H Privacy Glass*

12"H privacy glass kit attaches on top of any module of the same width. Privacy glass is integrated into the aluminum top trim. Attaching hardware is included. Standard in Clear (CLR) glass. Frosted (FRST) glass is available at an upcharge.

- 66"W privacy glass kits include (1) 30"W privacy glass screen and trim and (1) 36"W privacy glass screen and trim.
- 72"W privacy glass kits include (2) 36"W privacy glass screens and trims.
- **May be placed on Intelli Beam configuration of any height.**

IPBLERT24	-- x 24 x 2.87	70	1	.05	\$64	
IPBLERT30	-- x 30 x 2.87	70	1.20	.05	\$87	
IPBLERT36	-- x 36 x 2.87	70	1.50	.08	\$94	
IPBLERT42	-- x 42 x 2.87	70	2	.10	\$99	



End of Run Trim

End of run trim can be used to replace the trim included with Intelli Beam kits for a cleaner, finished look. Specify model # that corresponds with the overall height of the Intelli Beam + Extension Kits (if applicable).

Optional Specifications

Frosted glass*

LAMINATE END PANELS

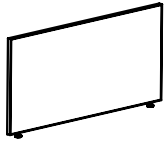

24" H Laminate End Panel

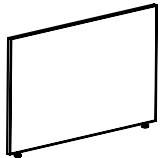

30" H Laminate End Panel

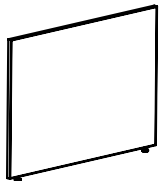

36" H Laminate End Panel

MODEL#	DIMENSIONS D x W x H	FREIGHT CLASS	WT./LBS.	CUBIC FT.	LIST PRICE
IBLEP2451	1 x 51 x 24	60	33.20	.95	\$338
IBLEP2463	1 x 63 x 24	60	33.20	.95	\$413

24" H laminate end panels attach to T-Legs and end trim at the end of any run of 24" H Intelli Beam stations.

- **Laminate end panel must be used with T-legs at the end of a run**
- Use 51" w panels for applications with 24" d surfaces on either side of Intelli Beam
- Use 63" w panels for applications with 30" d surfaces on either side of Intelli Beam

IBLEP3051	1 x 51 x 30	60	33.20	.95	\$421
IBLEP3063	1 x 63 x 30	60	33.20	.95	\$515

30" H laminate end panels attach to T-Legs and end trim at the end of any run of 30" H Intelli Beam stations.

- **Laminate end panel must be used with T-legs at the end of a run**
- Use 51" w panels for applications with 24" d surfaces on either side of Intelli Beam
- Use 63" w panels for applications with 30" d surfaces on either side of Intelli Beam

IBLEP3651	1 x 51 x 36	60	33.20	.95	\$511
IBLEP3663	1 x 63 x 36	60	33.20	.95	\$611

36" H laminate end panels attach to T-Legs and end trim at the end of any run of 36" H Intelli Beam stations.

- **Laminate end panel must be used with T-legs at the end of a run**
- Use 51" w panels for applications with 24" d surfaces on either side of Intelli Beam
- Use 63" w panels for applications with 30" d surfaces on either side of Intelli Beam

Required Specifications

Laminate finish

4-2-2 Wiring Schematic

8-Wire Shared Neutral

"2 + 2" - 2 Utility Circuits, 2 Dedicated

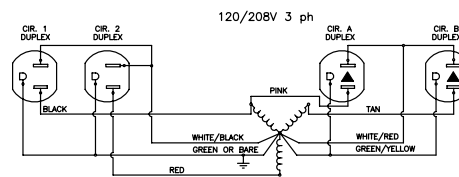
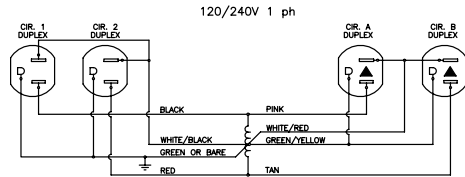

8 Wires

4 Lines (12 ga.)
2 Neutrals (10 ga.)
2 Grounds (12 ga.)

4 Circuits

2 Utility circuits
2 Dedicated Circuits

Receptacles

Duplex - Up to 12 duplex receptacles per circuit
(Up to 48 per infeed)

Specifications

System rated for connection to a grounded 120/240 V single phase, 20A, 60Hz or 120/208 V, 3 phase, 20A, 60Hz branch circuit for U.S. and 15A if product is marked with a C-UL Mark. Outlets rated 15A max.

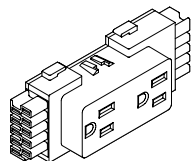

Duplex Receptacle

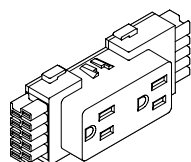

Controlled Circuit Duplex Receptacle

Black

IBE8RD1	1 x 1.5 x 2	70	.01	.01	\$42
IBE8RD2	1 x 1.5 x 2	70	.01	.01	\$42
IBE8RDA	1 x 1.5 x 2	70	.01	.01	\$42
IBE8RDB	1 x 1.5 x 2	70	.01	.01	\$42

White

IBE8RD1WT	1 x 1.5 x 2	70	.01	.01	\$60
IBE8RD2WT	1 x 1.5 x 2	70	.01	.01	\$60
IBE8DAWT	1 x 1.5 x 2	70	.01	.01	\$60
IBE8RDBWT	1 x 1.5 x 2	70	.01	.01	\$60

Snaps into the power distribution housing located within the Intelli Beam raceway. White duplexes end in WT; all others are standard in Black. For 30"-60" Intelli Beam, specify (2) duplexes per side. For 66" and 72" Intelli Beam, you may specify up to (4) duplexes per side.

- IBE8RD1 / IBE8RD1WT - Circuit #1 (utility circuit)
- IBE8RD2 / IBE8RD2WT - Circuit #2 (utility circuit)
- IBE8RDA / IBE8DAWT - Circuit A (dedicated circuit)
- IBE8RDB / IBE8RDBWT - Circuit B (dedicated circuit)

Black

IBE8RD1CA	1 x 1.5 x 2	70	.01	.01	\$48
IBE8RD2CA	1 x 1.5 x 2	70	.01	.01	\$48
IBE8RDACA	1 x 1.5 x 2	70	.01	.01	\$48
IBE8RDBCA	1 x 1.5 x 2	70	.01	.01	\$48

Snaps into power distribution housing located within the Intelli Beam raceway. To be used when California Title 24 energy savings standards are required. For 36"-60" Intelli Beam, specify (2) duplexes per side. For 66" and 72" Intelli Beam, you may specify up to (4) duplexes per side.

- IBE8RD1CA - Circuit #1 (utility circuit)
- IBE8RD2CA - Circuit #2 (utility circuit)
- IBE8RDACA - Circuit A (dedicated circuit)
- IBE8RDBCA - Circuit B (dedicated circuit)

INTELLI BEAM ELECTRICAL

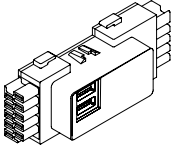

USB Duplex Module

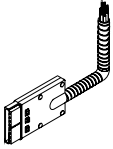

Base Feed

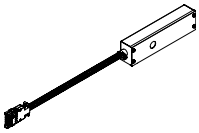

Base Feed - New York

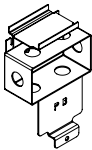

Hardwire Junction Box - Chicago

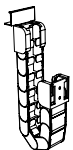

Cable Chain with Bracket

MODEL#	DIMENSIONS D x W x H	FREIGHT CLASS	WT/LBS.	CUBIC FT.	LIST PRICE
IBEUSB01W	-- x -- x --	70	.01	.01	\$247
IBEUSB01B	-- x -- x --	70	.01	.01	\$247

Snaps into the power distribution housing located within the Intelli Beam raceway. Can be used in lieu of a standard duplex receptacle. Specify model # ending in "W" for White and "B" for Black.

IBE8FR3PB	-- x 84 x --	60	4.90	.01	\$535
-----------	--------------	----	------	-----	--------------

Provides single power entry from floor or wall located building power supply. Connects to end of power distribution housing through any Intelli Beam Starter Kit. 84" length. Must be hardwired to the building power supply by a licensed electrician.

IBEENY2PB	-- x 32 x --	60	4.90	.01	\$518
-----------	--------------	----	------	-----	--------------

Provides single power entry from floor or wall located building power supply. Connects to end of power distribution housing through any Intelli Beam Starter Kit. Includes junction box for hardwire connection per NYC code. 32" length. Must be hardwired by a licensed electrician.

- Junction box is mounted within the vertical raceway on any Intelli Beam Starter Kit, in middle between Intelli Beam raceways.

IBEJBC1PB	-- x -- x --	60	4.90	.01	\$117
-----------	--------------	----	------	-----	--------------

To be retrofitted into open receptacle location. Gives access to one side at each location only. Customer supplies conduit, wiring, receptacle and face plate. Must be hardwired by a licensed electrician.

IBPBECH34	2 x 41 x 1	70	.60	.04	\$459
-----------	------------	----	-----	-----	--------------

Cable chain provides cables management from Intelli Beam to height adjustable table. Includes bracket to attach to bottom trim of Intelli Beam. Cables fit easily. Cable chain is 34 links long and includes mounting brackets. Includes two metal screws and two wood screws. Available in black only.

panels and components



Divide

page 442



Divide is a modular desk-mounted panel system that can be retro installed on many Global Desks. The panels can be vertically stacked to provide varying degrees of privacy. The panels are available in laminate or fabric tackboards as well as glazed panels that allow light to pass through. Divide's off-desk accessories help to organize paperwork and free up the workspace. Divide is offered in many laminate and fabric color options to complement any office environment.



Features and Benefits

- Available as fabric, glazed or laminate partitioning panels in an array of heights and widths
- Easy to specify: choose the desired panel height and width and its corresponding height divide post(s)
- A built-in paper management rail (on fabric and glazed panels) is designed to accommodate off-desk accessories for workspace organization.
- Laminate panels offer an optional wire access cutout at the bottom of each panel (order as SCP2)
- Laminate transaction tops are offered in various shapes and sizes, and are standard as either 1" thick or 1.5" thick to match
- All Adaptabilities, Genoa, and Zira laminate colors are offered as well as a wide variety of fabrics

GENERAL INFORMATION

- Divide is a desk mounted panel system that can be field installed at any time on many Global desks
- Vertical stacking of varying heights provides semi-private to private work areas
- Designed for use on the Adaptabilities, Genoa, and Zira laminate desk series', and may be retrofitted onto non-Global square edged product if necessary.
- Panels are available in 12", 18", 24" and 36" heights and can be stacked to produce heights of 24", 30", 36" and 42" for a virtually limitless variety of configurations
- Progressive, desk mounted partition system consisting of three major categories:
 - Divide posts - to support the partitions
 - Partitioning screens - a variety of widths and heights to create personalized privacy; offered in laminate, glaze or select fabrics
 - Transaction tops - laminate tops ideal for creating reception stations
- For environmental certifications, please visit globalfurnituregroup.com
- Model numbers reflect total width of panel and posts

DIVIDE POSTS

- Available in 6 standard heights:
 - 12" high - to create **semi-private** spaces and to support Transaction Tops
 - 18" high - to create **semi-private** spaces and to support Transaction Tops
 - 24" high - to create **semi-private** spaces
 - 30" high - to create **semi-private** spaces
 - 36" high - to create **private** spaces and to match the height of 36" high hutches and/or 65" high Adaptabilities, Genoa and Zira cabinets
 - 42" high - to create **private** spaces and to match the height of 42" high hutches and/or 72" high Zira cabinets
- Posts are field installed. Each plate divider includes: 1 post mounting plate, 1 threaded rod, 3 cover strips and 1 top cap plus mounting hardware (contains 8 screws, 1 washer, 1 locking nut). 2 divide posts are required per partitioning panel.
- Available in Black (**BLK**) or Tungsten (**TUN**) finish, please specify.

PARTITIONING SCREENS

- Available in 4 standard heights: 12", 18", 24" and 36" and can be used in combinations to create systems consisting of 12", 18", 24", 30", 36" and 42" heights.
- Available in 3 materials:
 - **Laminate** - available in all laminate colors used on Adaptabilities, Genoa, Halton and Zira (see right). Accent edging at top and bottom is Black (**BLK**) only. Optional wire access scoop cut-out is offered, centered at the bottom of the panel - order as **SCP2** after model #. Woodgrain direction is horizontal for all sizes.
 - **Glazed** - choice of **clear**, **ribbed** or **frosted** glazing. Top and bottom rail optional in Black (**BLK**) or Tungsten (**TUN**) finish, please specify. Top rail is designed to accommodate off-desk accessories. Glazed panels with document pass-through feature a 4" gap at the bottom.
 - **Fabric** - available in all Grade 1, 2, 3 and 4 panel fabrics and select Grade 1, 2, 3 and 4 seating fabrics (see right). Top and bottom rail optional in Black (**BLK**) or Tungsten (**TUN**), finish please specify. Top rail is designed to accommodate off-desk accessories.
- Filler panels are included with each Divide panel. To be used between two posts in a straight run from worksurface to worksurface.
- Special width panels are available in Laminate or Glazed material options only. To price, take the list price of the next larger standard size up and add 10%.

TRANSACTION TOPS

- Tops are available in 1" or 1.5" thick thermally fused laminate
- Tops are sealed with Global's preferred edging in matching color
- Woodgrain surfaces feature edging in matching printed woodgrain
- Transaction tops are available with optional edges at no upcharge. Please specify (see right column).



A3 1" top, standard



AR 1" top, bicut edge



C3 1.5" top, standard



CR 1.5" top, bicut edge



CF 1.5" top, fluted edge

- Includes all necessary flat mounting plates and joining plates.
- Features pre-drilled locating holes to allow for quick alignment with the divide post
- Available with a radius cut on one or both ends (each radius adds a 6" overhang).
- Woodgrain surfaces feature edging with matching printed woodgrain
- Products specified with the high pressure laminate option are finished on the underside of the surface with a kraft paper backing.

LAMINATE AND EDGE FINISHES (laminate panels and transaction tops)

ACJ	Absolute Acajou	NGL	Noce Grigio
ASN	Asian Night	NEL	Noce Leggero
AWC	Avant Cherry	NML	Noce Medio
AWH	Avant Honey	QTM	Quartered Mahogany
BLK	Black	SOG	Storm Grey
BRC	Brushed Cobalt	TFW	Tiger Fruitwood
CMB	Clear Maple	TWL	Tiger Walnut
DES	Dark Espresso	WHE	Walnut Heights
DWT	Designer White	WHC	White Chocolate
HGT	Hayden Grey	WGY	Willow Grey
NBL	Noce Biondo	WCR	Winter Cherry

FABRICS (fabric screens)

Fabric screens can be upholstered in the following fabrics:

- Anchorage
- Couture
- Imprint
- Lola
- Match
- Merge
- Replay
- Silhouette

D DIVIDE™ - NOTES

PLEASE NOTE:

- Divide screens cannot be centered between two back to back worksurfaces.
- Screens must be installed on one worksurface or the other.
- Divide cannot be used with Adaptabilities reception units.
- When panels are mounted on a 30" deep worksurface from Adaptabilities, Genoa or Zira, please specify 29" wide panel

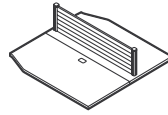

Correct Installation

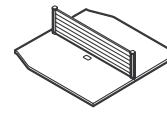

Incorrect Installation

HOW TO ORDER DIVIDE SCREENS

example: DTB 1236 GN31

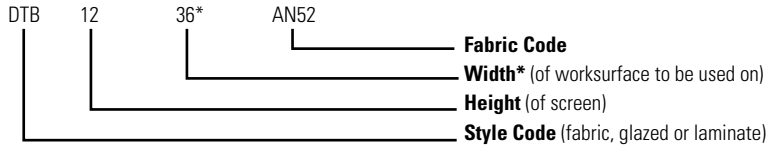

*NOTE: Number denotes width of worksurface to use - please see dimensions in price book for actual dimensions of the screen.

PARTS AND COMPONENTS

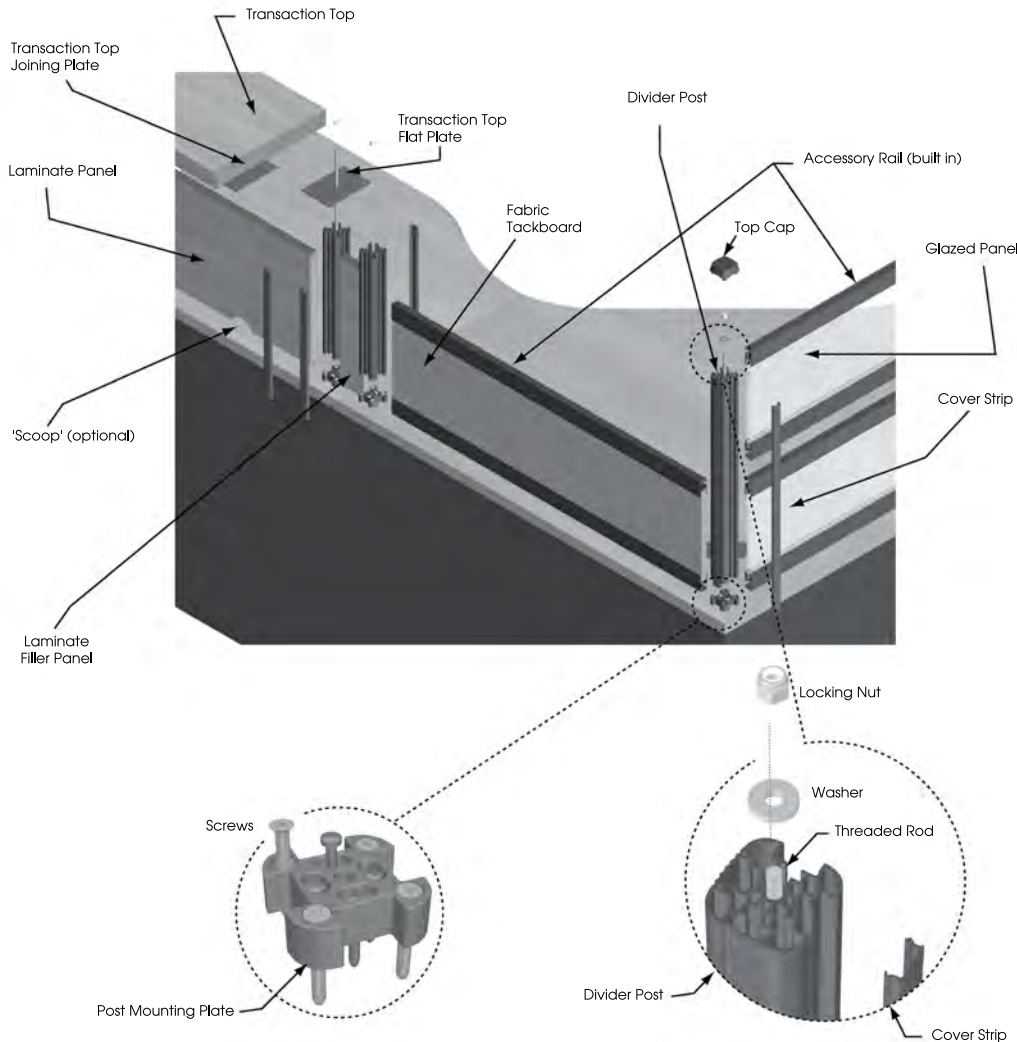

INSTALLATION IS AS SIMPLE AS 1...2...3

- 1) Attach the threaded **Post Mounting Plate** with enclosed screws to the top side of the worksurface.
- 2) **Divider Post** is bolted to the Mounting Plate.
- 3) **Top Cap** is attached to the top of the Divide Post.

12”H System



12” panel



12” raised panel

18”H System



18” panel

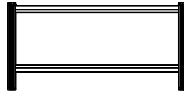

18” raised panel

24”H System



24” panel

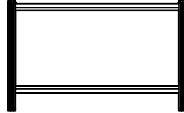

24” raised panel

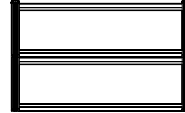

(2) 12” panels

30”H System



12” panel + 18” panel

36”H System

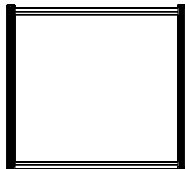

36” panel

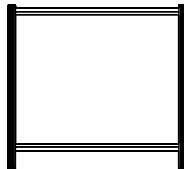

36” raised panel

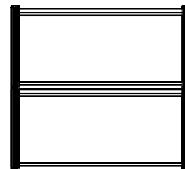

(2) 18” panels

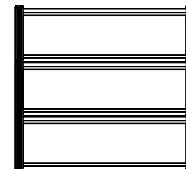

(3) 12” panels

42”H System

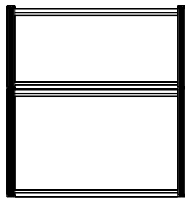

18” panel + 24” panel

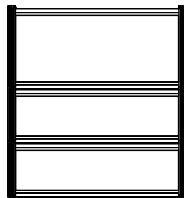

(1) 18” panel
(2) 12” panels

FABRIC PANELS

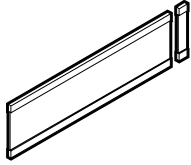

Fabric Panel - 12" High

MODEL#	DIMENSIONS D x W x H	FREIGHT CLASS	WT/LBS.	CUBIC FT.	GR. 1	GR. 2	GR. 3	GR. 4	GR. 5
DTB1220	.68 x 14.8 x 12	92.5	3	.30	\$250	\$280	\$303	\$338	\$388
DTB1224	.68 x 18.9 x 12	85	4	.30	\$261	\$290	\$313	\$346	\$395
DTB1229	.68 x 24.5 x 12	92.5	4	.40	\$276	\$308	\$328	\$364	\$411
DTB1230	.68 x 24.8 x 12	85	5	.40	\$276	\$308	\$328	\$364	\$411
DTB1236	.68 x 30.8 x 12	85	5	.40	\$307	\$337	\$359	\$393	\$441
DTB1242	.68 x 36.8 x 12	85	6	.50	\$357	\$387	\$408	\$442	\$491
DTB1248	.68 x 42.8 x 12	92.5	7	.60	\$387	\$415	\$438	\$471	\$520
DTB1260	.68 x 54.8 x 12	85	9	.70	\$413	\$444	\$465	\$500	\$548
DTB1266	.68 x 60.8 x 12	85	10	.80	\$437	\$466	\$490	\$523	\$572
DTB1272	.68 x 66.8 x 12	85	11	.80	\$464	\$495	\$517	\$550	\$599

Features built-in accessory rail. Includes matching filler panel. Ships 1 set per carton. **Specify DTB1229 for panels placed along the depth side of a 30" deep worksurface.**

- Top and bottom rail optional in Black (**BLK**) or Tungsten (**TUN**) finish, please specify.
- *Model # depicts size of worksurface to be used on - see NOTES on page 444 for additional ordering information.*
- When specifying a Grade 1, 2, 3, 4 or 5 seating fabric, please note fabric pattern will run horizontally
- Divide Post **MUST** be ordered separately. Two posts are required per panel.

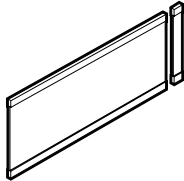

Fabric Panel - 18" High

DTB1820	.68 x 14.8 x 18	85	4	.30	\$276	\$308	\$328	\$364	\$411
DTB1824	.68 x 18.9 x 18	85	5	.40	\$290	\$319	\$342	\$374	\$423
DTB1829	.68 x 24.5 x 18	85	6	.50	\$307	\$337	\$359	\$393	\$441
DTB1830	.68 x 24.8 x 18	85	6	.50	\$307	\$337	\$359	\$393	\$441
DTB1836	.68 x 30.8 x 18	92.5	7	.60	\$357	\$387	\$408	\$442	\$491
DTB1842	.68 x 36.8 x 18	92.5	8	.70	\$390	\$419	\$440	\$474	\$522
DTB1848	.68 x 42.8 x 18	85	10	.80	\$413	\$444	\$465	\$500	\$548
DTB1860	.68 x 54.8 x 18	85	12	.90	\$437	\$466	\$490	\$523	\$572
DTB1866	.68 x 60.8 x 18	85	14	1	\$464	\$495	\$517	\$550	\$599
DTB1872	.68 x 66.8 x 18	85	14	1.10	\$520	\$550	\$573	\$607	\$655

Features built-in accessory rail. Includes matching filler panel. Ships 1 set per carton. **Specify DTB1829 for panels placed along the depth side of a 30" deep worksurface.**

- Top and bottom rail optional in Black (**BLK**) or Tungsten (**TUN**) finish, please specify.
- *Model # depicts size of worksurface to be used on - see NOTES on page 444 for additional ordering information.*
- When specifying a Grade 1, 2, 3, 4 or 5 seating fabric, please note fabric pattern will run horizontally
- Divide Post **MUST** be ordered separately. Two posts are required per panel.

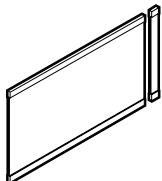

Fabric Panel - 24" High

DTB2420	.68 x 14.8 x 24	92.5	4	.40	\$307	\$337	\$359	\$393	\$441
DTB2424	.68 x 18.9 x 24	100	4	.50	\$307	\$337	\$359	\$393	\$441
DTB2429	.68 x 24.5 x 24	92.5	6	.60	\$357	\$387	\$408	\$442	\$491
DTB2430	.68 x 24.8 x 24	92.5	6	.60	\$357	\$387	\$408	\$442	\$491
DTB2436	.68 x 30.8 x 24	92.5	7	.70	\$387	\$415	\$438	\$471	\$520
DTB2442	.68 x 36.8 x 24	92.5	8	.80	\$413	\$444	\$465	\$500	\$548
DTB2448	.68 x 42.8 x 24	92.5	9	.90	\$437	\$466	\$490	\$523	\$572
DTB2460	.68 x 54.8 x 24	92.5	11	1.10	\$464	\$495	\$517	\$550	\$599
DTB2466	.68 x 60.8 x 24	92.5	12	1.20	\$520	\$550	\$573	\$607	\$655
DTB2472	.68 x 66.8 x 24	92.5	14	1.40	\$565	\$596	\$620	\$651	\$702

Features built-in accessory rail. Includes matching filler panel. Ships 1 set per carton. **Specify DTB2429 for panels placed along the depth side of a 30" deep worksurface.**

- Top and bottom rail optional in Black (**BLK**) or Tungsten (**TUN**) finish, please specify.
- *Model # depicts size of worksurface to be used on - see NOTES on page 444 for additional ordering information.*
- When specifying a Grade 1, 2, 3, 4 or 5 seating fabric, please note fabric pattern will run horizontally
- Divide Post **MUST** be ordered separately. Two posts are required per panel.

Required Specifications

Fabric
Rail Finish

FABRIC PANELS

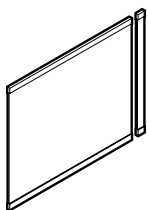

Fabric Panel - 36" High*

MODEL#	DIMENSIONS	FREIGHT CLASS	WT/LBS.	CUBIC FT.	GR. 1	GR. 2	GR. 3	GR. 4	GR. 5
D x W x H									
DTB3620	.68 x 14.8 x 36	92.5	6	.60	\$357	\$387	\$408	\$442	\$491
DTB3624	.68 x 18.9 x 36	92.5	7	.70	\$368	\$399	\$420	\$454	\$502
DTB3629	.68 x 24.5 x 36	92.5	9	.90	\$387	\$415	\$438	\$471	\$520
DTB3630	.68 x 24.8 x 36	92.5	9	.90	\$387	\$415	\$438	\$471	\$520
DTB3636	.68 x 30.8 x 36	92.5	10	1	\$413	\$444	\$465	\$500	\$548
DTB3642	.68 x 36.8 x 36	92.5	12	1.20	\$437	\$466	\$490	\$523	\$572
DTB3648	.68 x 42.8 x 36	92.5	14	1.30	\$464	\$495	\$517	\$550	\$599
DTB3660	.68 x 54.8 x 36	92.5	17	1.60	\$520	\$550	\$573	\$607	\$655
DTB3666	.68 x 60.8 x 36	92.5	19	1.80	\$565	\$596	\$620	\$651	\$702
DTB3672	.68 x 66.8 x 36	92.5	21	1.90	\$611	\$642	\$662	\$696	\$745

Features built-in accessory rail. Includes matching filler panel. Ships 1 set per carton. **Specify DTB3629 for panels placed along the depth side of a 30" deep worksurface.**

- Top and bottom rail optional in Black (BLK) or Tungsten (TUN) finish, please specify.
- Model # depicts size of worksurface to be used on - see NOTES on page 444 for additional ordering information.
- When specifying a Grade 1, 2, 3, 4 or 5 seating fabric, please note fabric pattern will run horizontally
- Divide Post **MUST** be ordered separately. Two posts are required per panel.

GLAZED PANELS

LIST PRICE

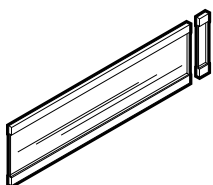

Glazed Panel - 12" High**

DGP1220	.68 x 14.8 x 12	125	2	.30	\$245
DGP1224	.68 x 18.9 x 12	92.5	3	.30	\$261
DGP1229	.68 x 24.5 x 12	125	3	.40	\$310
DGP1230	.68 x 24.8 x 12	92.5	4	.40	\$310
DGP1236	.68 x 30.8 x 12	92.5	4	.40	\$360
DGP1242	.68 x 36.8 x 12	92.5	5	.50	\$409
DGP1248	.68 x 42.8 x 12	100	5	.60	\$483
DGP1260	.68 x 54.8 x 12	92.5	7	.70	\$565
DGP1266	.68 x 60.8 x 12	100	7	.80	\$618
DGP1272	.68 x 66.8 x 12	92.5	8	.80	\$669

Features built-in accessory rail. Includes matching filler panel. Ships 1 set per carton. **Specify DGP1229 for panels placed along the depth side of a 30" deep worksurface.**

- Top and bottom rail optional in Black (BLK) or Tungsten (TUN) finish, please specify.
- Model # depicts size of worksurface to be used on - see NOTES on page 444 for additional ordering information.
- Divide Post **MUST** be ordered separately. Two posts are required per panel.
- Glazing is available in Frosted (GF), Clear (GC) or Ribbed (RG).

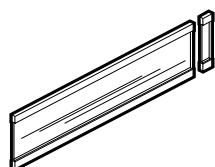

Glazed Panel - 12" High, Raised**

DRGP1220	.68 x 14.8 x 12	60	2	.02	\$218
DRGP1224	.68 x 18.9 x 12	60	3	.03	\$253
DRGP1229	.68 x 24.5 x 12	60	3	.03	\$298
DRGP1230	.68 x 24.8 x 12	60	4	.03	\$298
DRGP1236	.68 x 30.8 x 12	60	4	.04	\$349
DRGP1242	.68 x 36.8 x 12	60	5	.05	\$395
DRGP1248	.68 x 42.8 x 12	60	5	.05	\$469
DRGP1260	.68 x 54.8 x 12	60	7	.07	\$555
DRGP1266	.68 x 60.8 x 12	60	7	.07	\$606
DRGP1272	.68 x 66.8 x 12	60	8	.08	\$658

4" gap at bottom. Features built-in accessory rail. Includes matching filler panel. Ships 1 set per carton. Raised glazed panels to be offered on the lower level only. **Specify DRGP1229 for panels placed along the depth side of a 30" deep worksurface.**

- Top and bottom rail optional in Black (BLK) or Tungsten (TUN) finish, please specify.
- Model # depicts size of worksurface to be used on - see NOTES on page 444 for additional ordering information.
- Divide Post **MUST** be ordered separately. Two posts are required per panel.
- Glazing is available in Frosted (GF), Clear (GC) or Ribbed (RG).

Required Specifications

Fabric*
Glaze**
Rail Finish

GLAZED PANELS

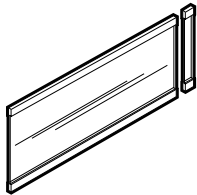

Glazed Panel - 18" High

MODEL#	DIMENSIONS D x W x H	FREIGHT CLASS	WT./LBS.	CUBIC FT.	LIST PRICE
DGP1820	.68 x 14.8 x 18	92.5	3	.30	\$274
DGP1824	.68 x 18.9 x 18	125	3	.40	\$296
DGP1829	.68 x 24.5 x 18	100	4	.50	\$346
DGP1830	.68 x 24.8 x 18	100	4	.50	\$346
DGP1836	.68 x 30.8 x 18	100	5	.60	\$400
DGP1842	.68 x 36.8 x 18	125	5	.70	\$446
DGP1848	.68 x 42.8 x 18	125	6	.80	\$535
DGP1860	.68 x 54.8 x 18	100	8	.90	\$639
DGP1866	.68 x 60.8 x 18	100	8	1	\$691
DGP1872	.68 x 66.8 x 18	100	9	1.10	\$747

Features built-in accessory rail. Includes matching filler panel. Ships 1 set per carton. **Specify DGP1829 for panels placed along the depth side of a 30" deep worksurface.**

- Top and bottom rail optional in Black (**BLK**) or Tungsten (**TUN**) finish, please specify.
- *Model # depicts size of worksurface to be used on - see NOTES on page 444 for additional ordering information.*
- Divide Post **MUST** be ordered separately. Two posts are required per panel.
- Glazing is available in Frosted (**GF**), Clear (**GC**) or Ribbed (**RG**).

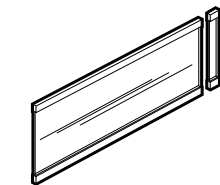

Glazed Panel - 18" High, Raised

DRGP1820	.68 x 14.8 x 18	60	3	.03	\$253
DRGP1824	.68 x 18.9 x 18	60	3	.04	\$287
DRGP1829	.68 x 24.5 x 18	60	4	.05	\$332
DRGP1830	.68 x 24.8 x 18	60	4	.05	\$332
DRGP1836	.68 x 30.8 x 18	60	5	.06	\$390
DRGP1842	.68 x 36.8 x 18	60	5	.06	\$435
DRGP1848	.68 x 42.8 x 18	60	6	.07	\$521
DRGP1860	.68 x 54.8 x 18	60	8	.09	\$623
DRGP1866	.68 x 60.8 x 18	100	8	1	\$675
DRGP1872	.68 x 66.8 x 18	100	9	1.10	\$731

4" gap at bottom. Features built-in accessory rail. Includes matching filler panel. Ships 1 set per carton. Raised glazed panels to be offered on the lower level only. **Specify DRGP1829 for panels placed along the depth side of a 30" deep worksurface.**

- Top and bottom rail optional in Black (**BLK**) or Tungsten (**TUN**) finish, please specify.
- *Model # depicts size of worksurface to be used on - see NOTES on page 444 for additional ordering information.*
- Divide Post **MUST** be ordered separately. Two posts are required per panel.
- Glazing is available in Frosted (**GF**), Clear (**GC**) or Ribbed (**RG**).

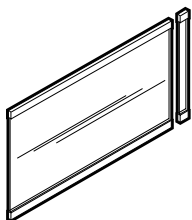

Glazed Panel - 24" High

DGP2420	.68 x 14.8 x 24	125	3	.40	\$296
DGP2424	.68 x 18.9 x 24	100	4	.50	\$331
DGP2429	.68 x 24.5 x 24	125	4	.60	\$397
DGP2430	.68 x 24.8 x 24	100	5	.60	\$397
DGP2436	.68 x 30.8 x 24	125	5	.70	\$458
DGP2442	.68 x 36.8 x 24	125	6	.80	\$520
DGP2448	.68 x 42.8 x 24	125	7	.90	\$611
DGP2460	.68 x 54.8 x 24	100	9	1.10	\$741
DGP2466	.68 x 60.8 x 24	100	10	1.20	\$809
DGP2472	.68 x 66.8 x 24	125	10	1.40	\$870

Features built-in accessory rail. Includes matching filler panel. Ships 1 set per carton. **Specify DGP2429 for panels placed along the depth side of a 30" deep worksurface.**

- Top and bottom rail optional in Black (**BLK**) or Tungsten (**TUN**) finish, please specify.
- *Model # depicts size of worksurface to be used on - see NOTES on page 444 for additional ordering information.*
- Divide Post **MUST** be ordered separately. Two posts are required per panel.
- Glazing is available in Frosted (**GF**), Clear (**GC**) or Ribbed (**RG**).

Required Specifications

Glaze
Rail finish

GLAZED PANELS

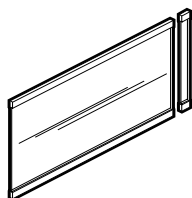

Glazed Panel - 24" High, Raised

MODEL#	DIMENSIONS D x W x H	FREIGHT CLASS	WT/LBS.	CUBIC FT.	LIST PRICE
DRGP2420	.68 x 14.8 x 24	60	3	.04	\$287
DRGP2424	.68 x 18.9 x 24	60	4	.05	\$322
DRGP2429	.68 x 24.5 x 24	60	4	.06	\$384
DRGP2430	.68 x 24.8 x 24	60	5	.06	\$384
DRGP2436	.68 x 30.8 x 24	60	5	.07	\$447
DRGP2442	.68 x 36.8 x 24	60	6	.08	\$509
DRGP2448	.68 x 42.8 x 24	60	7	.09	\$594
DRGP2460	.68 x 54.8 x 24	100	9	1.10	\$726
DRGP2466	.68 x 60.8 x 24	100	10	1.20	\$793
DRGP2472	.68 x 66.8 x 24	125	10	1.30	\$857

4" gap at bottom. Features built-in accessory rail. Includes matching filler panel. Ships 1 set per carton. Raised glazed panels to be offered on the lower level only. **Specify DRGP2429 for panels placed along the depth side of a 30" deep work surface.**

- Top and bottom rail optional in Black (BLK) or Tungsten (TUN) finish, please specify.
- Model # depicts size of work surface to be used on - see NOTES on page 444 for additional ordering information.
- Divide Post **MUST** be ordered separately. Two posts are required per panel.
- Glazing is available in Frosted (GF), Clear (GC) or Ribbed (RG).

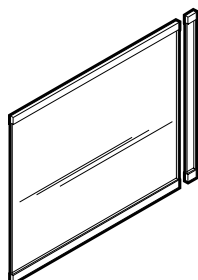

Glazed Panel - 36" High

DGP3620	.68 x 14.8 x 36	125	4	.60	\$360
DGP3624	.68 x 18.9 x 36	150	4	.70	\$397
DGP3629	.68 x 24.5 x 36	150	5	.90	\$474
DGP3630	.68 x 24.8 x 36	125	6	.90	\$474
DGP3636	.68 x 30.8 x 36	125	7	1	\$559
DGP3642	.68 x 36.8 x 36	125	8	1.20	\$639
DGP3648	.68 x 42.8 x 36	125	9	1.30	\$747
DGP3660	.68 x 54.8 x 36	125	11	1.60	\$901
DGP3666	.68 x 60.8 x 36	125	12	1.80	\$982
DGP3672	.68 x 66.8 x 36	125	13	1.90	\$1060

Features built-in accessory rail. Includes matching filler panel. Ships 1 set per carton. **Specify DGP3629 for panels placed along the depth side of a 30" deep work surface.**

- Top and bottom rail optional in Black (BLK) or Tungsten (TUN) finish, please specify.
- Model # depicts size of work surface to be used on - see NOTES on page 444 for additional ordering information.
- Divide Post **MUST** be ordered separately. Two posts are required per panel.
- Glazing is available in Frosted (GF), Clear (GC) or Ribbed (RG).

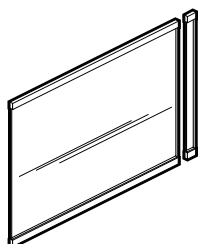

Glazed Panel - 36" High, Raised

DRGP3620	.68 x 14.8 x 36	60	4	.06	\$349
DRGP3624	.68 x 18.9 x 36	60	4	.07	\$384
DRGP3629	.68 x 24.5 x 36	60	5	.08	\$463
DRGP3630	.68 x 24.8 x 36	60	6	.08	\$463
DRGP3636	.68 x 30.8 x 36	125	7	1	\$549
DRGP3642	.68 x 36.8 x 36	125	8	1.10	\$623
DRGP3648	.68 x 42.8 x 36	125	9	1.30	\$731
DRGP3660	.68 x 54.8 x 36	125	11	1.60	\$879
DRGP3666	.68 x 60.8 x 36	125	12	1.70	\$959
DRGP3672	.68 x 66.8 x 36	125	13	1.90	\$1038

4" gap at bottom. Features built-in accessory rail. Includes matching filler panel. Ships 1 set per carton. Raised glazed panels to be offered on the lower level only. **Specify DRGP3629 for panels placed along the depth side of a 30" deep work surface.**

- Top and bottom rail optional in Black (BLK) or Tungsten (TUN) finish, please specify.
- Model # depicts size of work surface to be used on - see NOTES on page 444 for additional ordering information.
- Divide Post **MUST** be ordered separately. Two posts are required per panel.
- Glazing is available in Frosted (GF), Clear (GC) or Ribbed (RG).

Required Specifications

Glaze
Rail finish

LAMINATE PANELS

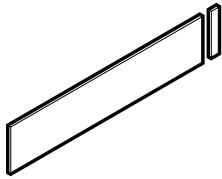

Laminate Panel - 12" High

MODEL#	DIMENSIONS D x W x H	FREIGHT CLASS	WT/LBS.	CUBIC FT.	LIST PRICE
DLP1220	.68 x 14.8 x 12	70	5	.30	\$81
DLP1224	.68 x 18.9 x 12	70	5	.30	\$96
DLP1229	.68 x 24.5 x 12	70	7	.40	\$121
DLP1230	.68 x 24.8 x 12	70	7	.40	\$121
DLP1236	.68 x 30.8 x 12	70	8	.40	\$133
DLP1242	.68 x 36.8 x 12	70	10	.50	\$151
DLP1248	.68 x 42.8 x 12	70	11	.60	\$170
DLP1260	.68 x 54.8 x 12	70	14	.70	\$184
DLP1266	.68 x 60.8 x 12	70	16	.80	\$202
DLP1272	.68 x 66.8 x 12	70	17	.80	\$228

Includes matching filler panel. Scoop option (**SCP2**) available, **Add \$42**. Ships 1 set per carton. **Specify DLP1229 for panels placed along the depth side of a 30" deep worksurface.**

- Model # depicts size of worksurface to be used on - see *NOTES* on page 444 for additional ordering information.
- Divide Post **MUST** be ordered separately. Two posts are required per panel.
- Accent edging at top and bottom Black (**BLK**) only.

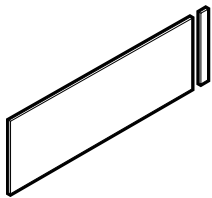

Laminate Panel - 18" High

DLP1820	.68 x 14.8 x 18	65	7	.30	\$98
DLP1824	.68 x 18.9 x 18	70	8	.40	\$111
DLP1829	.68 x 24.5 x 18	70	10	.50	\$131
DLP1830	.68 x 24.8 x 18	70	10	.50	\$131
DLP1836	.68 x 30.8 x 18	70	12	.60	\$149
DLP1842	.68 x 36.8 x 18	70	15	.70	\$170
DLP1848	.68 x 42.8 x 18	70	17	.80	\$197
DLP1860	.68 x 54.8 x 18	65	21	.90	\$215
DLP1866	.68 x 60.8 x 18	65	23	1	\$237
DLP1872	.68 x 66.8 x 18	65	25	1.10	\$261

Includes matching filler panel. Scoop option (**SCP2**) available, **Add \$42**. Ships 1 set per carton. **Specify DLP1829 for panels placed along the depth side of a 30" deep worksurface.**

- Model # depicts size of worksurface to be used on - see *NOTES* on page 444 for additional ordering information.
- Divide Post **MUST** be ordered separately. Two posts are required per panel.
- Accent edging at top and bottom Black (**BLK**) only.

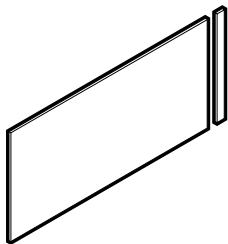

Laminate Panel - 24" High

DLP2420	.68 x 14.8 x 24	65	9	.40	\$111
DLP2424	.68 x 18.9 x 24	70	11	.50	\$120
DLP2429	.68 x 24.5 x 24	70	13	.60	\$149
DLP2430	.68 x 24.8 x 24	70	13	.60	\$149
DLP2436	.68 x 30.8 x 24	65	16	.70	\$164
DLP2442	.68 x 36.8 x 24	65	19	.80	\$191
DLP2448	.68 x 42.8 x 24	65	22	.90	\$218
DLP2460	.68 x 54.8 x 24	65	28	1.10	\$245
DLP2466	.68 x 60.8 x 24	65	30	1.20	\$273
DLP2472	.68 x 66.8 x 24	65	33	1.40	\$299

Includes matching filler panel. Scoop option (**SCP2**) available, **Add \$42**. Ships 1 set per carton. **Specify DLP2429 for panels placed along the depth side of a 30" deep worksurface.**

- Model # depicts size of worksurface to be used on - see *NOTES* on page 444 for additional ordering information.
- Divide Post **MUST** be ordered separately. Two posts are required per panel.
- Accent edging at top and bottom Black (**BLK**) only.

Required Specifications

Laminate finish. Note: woodgrain finishes are horizontal on all sizes.

LAMINATE PANELS

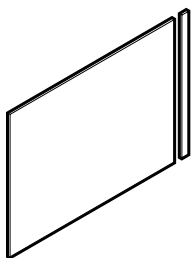

Laminate Panel - 36" High*

MODEL#	DIMENSIONS	FREIGHT CLASS	WT/LBS.	CUBIC FT.	LIST PRICE
--------	------------	---------------	---------	-----------	------------

D x W x H					
DLP3620	.68 x 14.8 x 36	70	13	.60	\$135
DLP3624	.68 x 18.9 x 36	65	16	.70	\$149
DLP3629	.68 x 24.5 x 36	70	20	.90	\$182
DLP3630	.68 x 24.8 x 36	70	20	.90	\$182
DLP3636	.68 x 30.8 x 36	65	24	1	\$210
DLP3642	.68 x 36.8 x 36	65	28	1.20	\$242
DLP3648	.68 x 42.8 x 36	65	33	1.30	\$273
DLP3660	.68 x 54.8 x 36	65	41	1.60	\$313
DLP3666	.68 x 60.8 x 36	65	45	1.80	\$346
DLP3672	.68 x 66.8 x 36	65	50	1.90	\$380

Includes matching filler panel. Scoop option (**SCP2**) available, **Add \$42**. Ships 1 set per carton. **Specify DLP3629 for panels placed along the depth side of a 30" deep worksurface.**

- Model # depicts size of worksurface to be used on - see *NOTES* on page 444 for additional ordering information.
- Divide Post **MUST** be ordered separately. Two posts are required per panel.
- Accent edging at top and bottom Black (**BLK**) only.

DIVIDE POSTS



Divide Post

MODEL#	DIMENSIONS	FREIGHT CLASS	WT/LBS.	CUBIC FT.	LIST PRICE
--------	------------	---------------	---------	-----------	------------

DPOST12	1.68 x 1.68 x 12	70	2	.10	\$112
DPOST18	1.68 x 1.68 x 18	70	2	.10	\$151
DPOST24	1.68 x 1.68 x 24	60	3	.10	\$198
DPOST30	1.68 x 1.68 x 30	60	4	.10	\$274
DPOST36	1.68 x 1.68 x 36	70	4	.20	\$313
DPOST42	1.68 x 1.68 x 42	65	5	.20	\$349

For supporting panels. Includes one post mounting plate, one top cap, three cover strips, threaded rod and all mounting hardware. Installation templates are supplied with each project. Available in Black (**BLK**) or Tungsten (**TUN**), please specify.

- Requires 2 divide posts per panel
- Divide post is mounted 1.063" from worksurface edge.



Post-to-Wall Filler Strip

DFS12	1.43 x .75 x 12	150	2	.50	\$62
DFS18	1.43 x .75 x 18	150	2	.50	\$62
DFS24	1.43 x .75 x 24	150	2	.50	\$62
DFS30	1.43 x .75 x 30	150	2	.50	\$65
DFS36	1.43 x .75 x 36	150	2	.50	\$65
DFS42	1.43 x .75 x 42	150	3	.60	\$65

Used to fill gap between divide post and an adjacent wall, wardrobe unit, or hutch. Ships 1 per carton. Black only.

Required Specifications

Laminate finish*. Note: woodgrain finishes are horizontal on all sizes.

TRANSACTION TOPS

D x W x H

- To order a radius end on one side of a transaction top, add the suffix "D" to the model number (ex. DATT30D). Add a **15% upcharge**.
- To order a radius end on both sides of a transaction top, add the suffix "DD" to the model number (ex. DATT30DD). Add a **20% upcharge**.
- Each radius end adds a 6" overhang per side (see illustrations below).

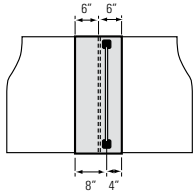

Transaction top is offset 6" from edge of worksurface in both directions.

Transaction top is offset 4" from the center of divider post towards the inside and 8" towards the outside.

Transaction Top Offset

- 4" from the center of the Divider Post to the inside of worksurface
- 8" from the center of the Divider Post to the outside of worksurface

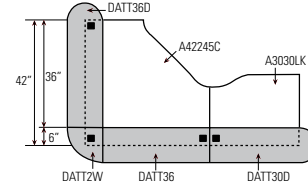

Two Way Connector Transaction Top (DATT2W/DCTT2W)

Use with a corner worksurface to link transaction tops together.

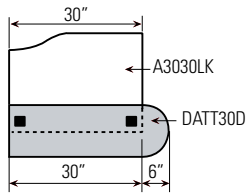

Radius End Transaction Top - one side

Add suffix "D" to model number for radius end on one side.

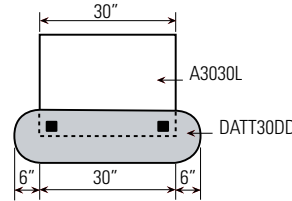

Radius End Transaction Top - two sides

Add suffix "DD" to model number for radius end on both sides.

STRAIGHT TRANSACTION TOPS

MODEL# DIMENSIONS FREIGHT CLASS WT./LBS. CUBIC FT. LIST PRICE

DATT14	12 x 14 x 1	65	7	.30	\$244
DATT18	12 x 18 x 1	70	8	.40	\$244
DATT20	12 x 20 x 1	70	9	.50	\$244
DATT23	12 x 23 x 1	70	10	.50	\$277
DATT24	12 x 24 x 1	70	10	.50	\$277
DATT29	12 x 29 x 1	70	12	.60	\$297
DATT30	12 x 30 x 1	70	12	.60	\$297
DATT36	12 x 36 x 1	70	14	.70	\$313
DATT42	12 x 42 x 1	70	16	.80	\$331
DATT48	12 x 48 x 1	70	18	.90	\$331
DATT54	12 x 54 x 1	70	21	1	\$374
DATT60	12 x 60 x 1	70	23	1.10	\$374
DATT66	12 x 66 x 1	70	25	1.20	\$417
DATT72	12 x 72 x 1	70	27	1.30	\$417



Straight Transaction Top - 1" thick

12" deep x 1" thick top. Includes all necessary Flat Plates, Joining Plates and screws. Thickness matches Adaptabilities, Genoa, Halton and Zira Series worksurfaces. Ships 1 set per carton.

- Add "D" to model number for radius end on one side, ADD **15% upcharge**.
- Add "DD" to model number for radius end on both sides, ADD **20% upcharge**.
- Each radius adds 6" overhang per side.

Required Specifications

Laminate Finish
Edge Detail

Optional Specifications

Radius End

TRANSACTION TOPS

MODEL# DIMENSIONS FREIGHT CLASS WT/LBS. CUBIC FT. LIST PRICE

D x W x H

DCTT14	12 x 14 x 1.5	60	9	.30	\$339
DCTT18	12 x 18 x 1.5	65	11	.40	\$339
DCTT20	12 x 14.8 x 1.5	65	12	.50	\$339
DCTT23	12 x 23 x 1.5	65	14	.50	\$394
DCTT24	12 x 18.9 x 1.5	65	14	.50	\$394
DCTT29	12 x 24.5 x 1.5	65	17	.60	\$419
DCTT30	12 x 30 x 1.5	65	17	.60	\$419
DCTT36	12 x 36 x 1.5	65	20	.70	\$439
DCTT42	12 x 42 x 1.5	65	23	.80	\$439
DCTT48	12 x 48 x 1.5	65	26	.90	\$439
DCTT54	12 x 54 x 1.5	65	29	1	\$500
DCTT60	12 x 60 x 1.5	65	32	1.10	\$500
DCTT66	12 x 66 x 1.5	65	35	1.20	\$547
DCTT72	12 x 72 x 1.5	65	38	1.30	\$547



Straight Transaction Top - 1½" thick

12" deep x 1½" thick top. Includes all necessary Flat Plates, Joining Plates and screws. Thickness matches Zira worksurfaces. Ships 1 set per carton.

- Add "D" to model number for radius end on one side, ADD **15% upcharge**.
- Add "DD" to model number for radius end on both sides, ADD **20% upcharge**.
- Each radius adds 6" overhang per side.

GALLERY CORNER TRANSACTION TOPS

MODEL# DIMENSIONS FREIGHT CLASS WT/LBS. CUBIC FT. LIST PRICE



Gallery Corner Transaction Top - 1" thick

DA1GC36	36 x 36 x 1	125	32	5	\$746
DA1GC42	42 x 42 x 1	150	38	6.50	\$746

One piece corner top to be used on 36" and 42" 5-sided corners. Cut-out maximizes use of worksurface space allowing for computer screen. Includes all necessary Flat Plates, Joining Plates and screws. Thickness matches Adaptabilities, Genoa, Halton and Zira Series worksurfaces. Ships 1 set per carton.

- Woodgrain runs in one direction.



Gallery Corner Transaction Top - 1½" thick

DC1GC36	36 x 36 x 1.5	100	43	5	\$928
DC1GC42	42 x 42 x 1.5	125	50	6.50	\$928

One piece corner top to be used on 36" and 42" 5-sided corners. Cut-out maximizes use of worksurface space allowing for computer screen. Includes all necessary Flat Plates, Joining Plates and screws. Thickness matches Zira worksurfaces. Ships 1 set per carton.

- Woodgrain runs in one direction.

2 PIECE GALLERY CORNER TRANSACTION TOPS

MODEL# DIMENSIONS FREIGHT CLASS WT/LBS. CUBIC FT. LIST PRICE



2 Piece Gallery Corner Transaction Top - 1" thick

DA2GC36	36 x 36 x 1	70	29	1.90	\$529
DA2GC42	42 x 42 x 1	70	33	1.90	\$529

Two piece corner top to be used on 36" and 42" 5-sided corners. Cut-out maximizes use of worksurface space allowing for computer screen. Includes all necessary Flat Plates, Joining Plates and screws. Thickness matches Adaptabilities, Genoa, Halton and Zira Series worksurfaces. Ships 1 set per carton.

- Woodgrain runs in two directions.

Required Specifications

Laminate Finish
Edge Detail

Optional Specifications

Radius End (DCTT models)

2 PIECE GALLERY CORNER TRANSACTION TOPS



**2 Piece Gallery Corner
Transaction Top - 1½" thick**

MODEL#	DIMENSIONS	FREIGHT CLASS	WT/LBS.	CUBIC FT.	LIST PRICE
D x W x H					
DC2GC36	36 x 36 x 1.5	70	39	1.90	\$711
DC2GC42	42 x 42 x 1.5	65	45	1.90	\$711

Two piece corner top to be used on 36" and 42" 5-sided corners. Cut-out maximizes use of worksurface space allowing for computer screen. Includes all necessary Flat Plates, Joining Plates and screws. Thickness matches Zira worksurfaces. Ships 1 set per carton.

- Woodgrain runs in two directions.

2-WAY CONNECTOR TRANSACTION TOPS

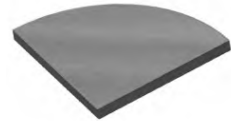

**2-Way Connector
Transaction Top - 1" thick**

MODEL#	DIMENSIONS	FREIGHT CLASS	WT/LBS.	CUBIC FT.	LIST PRICE
DATT2W	12 x 12 x 1	70	6	.30	\$334

Used as a corner piece to link two transaction tops. Deduct 6" from each side adjoining the corner piece. Includes all necessary Flat Plates, Joining Plates and screws. Thickness matches Adaptabilities, Genoa, Halton and Zira Series worksurfaces. Ships 1 set per carton.

- Woodgrain runs diagonally.

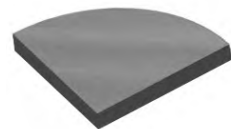

**2-Way Connector
Transaction Top - 1½" thick**

DCTT2W	12 x 12 x 1.5	65	7	.30	\$390
--------	---------------	----	---	-----	--------------

Used as a corner piece to link two transaction tops. Deduct 6" from each side adjoining the corner piece. Includes all necessary Flat Plates, Joining Plates and screws. Thickness matches Zira worksurfaces. Ships 1 set per carton.

- Woodgrain runs diagonally.

4-WAY CONNECTOR TRANSACTION TOPS

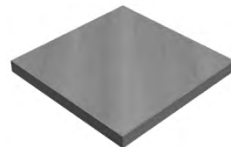

**4-Way Connector
Transaction Top - 1" thick**

DATT4W	12 x 12 x 1	65	8	.30	\$356
--------	-------------	----	---	-----	--------------

Used as a corner piece to link four transaction tops. Deduct 6" from each side adjoining the corner piece. Includes all necessary Flat Plates, Joining Plates and screws. Thickness matches Adaptabilities, Genoa, Halton and Zira Series worksurfaces. Ships 1 set per carton.

- Woodgrain runs diagonally.

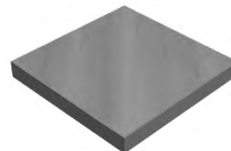

**4-Way Connector
Transaction Top - 1½" thick**

DCTT4W	12 x 12 x 1.5	60	10	.30	\$457
--------	---------------	----	----	-----	--------------

Used as a corner piece to link four transaction tops. Deduct 6" from each side adjoining the corner piece. Includes all necessary Flat Plates, Joining Plates and screws. Thickness matches Zira worksurfaces. Ships 1 set per carton.

- Woodgrain runs diagonally.

Required Specifications

- Laminate Finish
- Edge Detail

personal storage



Sidebar Storage

456

S SIDEBAR STORAGE - NOTES



Sidebar storage is well suited to the modern workplace. Fun, unique and functional storage items provide personal touches to the workspace all while maintaining a practical appeal.

Features and Benefits

- All surfaces are 1" thick, constructed of 45 lb. density particle board covered on both sides with high performance thermally fused laminate.
- Surfaces available in four detail options.
- Tapered feet feature adjustable glides and can be painted in Black (BLK) or Tungsten (TTU).
- Tiered storage enhances the visuals of any office setting



Foot options



Stack-on storage



Low credenza storage with cushion

GENERAL INFORMATION

- SideBar is a great complement to Bungee & Bungee SL training tables as well as Zira Desking.
- High pressure tops are available on all SideBar laminates at an extended lead time – please refer to model # for availability and pricing.
- For environmental certifications, please visit globalfurnituregroup.com

CONSTRUCTION

- Tops are 1" thick, available in a variety of edge details
- All finishes feature edging in matching color (i.e. wood grain surfaces feature edging with matching printed wood grain)
- High pressure tops are available in all SideBar laminate finishes at an extended lead time. Please see model # for availability and pricing
- Products specified with the high pressure laminate option are finished on the underside of the surface with a kraft paper backing.

STORAGE

- Tops of all storage units are 1" thick, available in a variety of edge details
- Drawer and open cavity heights are built on a common module of 13.5". In open cavities, this height accommodates standard size binders.
- All lateral files feature a foolproof interlock device
- 75 lb. box – 150 lb. file drawer weight capacity with full height sides. Pencil tray included in box drawer.
- All storage is standard with handles unless otherwise noted
- All drawers are locking unless otherwise noted
- All shelves are fixed

CONSTRUCTION

- Constructed of 45 lb. density particleboard covered on both sides with high performance thermally fused laminate
- Levelling glides are standard on all floor units
- Premium full extension progressive ball bearing slides on file drawers and box drawers
- All drawer fronts are edge banded on all four sides

FEET

- Levelers adjust up to 1".
- Storage unit feet will coordinate with handle finish (brass handles will default to Black [BLK] feet).
- If no handle selection is available, legs and feet are available in Tungsten (**TTU**) or Black (**TBL**)

LOCKS

- Locks are standard on all storage modules unless otherwise noted. Lock finish will coordinate with handle finish (brass handles will default to Black [BK] locks).

SHIPPING

- Most items are shipped assembled, 1 per carton, unless otherwise noted. Items are easy to assemble

S SIDEBAR STORAGE - NOTES

1. SPECIFY MODEL NUMBER

2. SPECIFY FINISH

Top/Base/Door, Drawer and Cabinet Finishes:

ACJ	Absolute Acajou	NGL	Noce Grigio
ASN	Asian Night	NEL	Noce Leggero
AWC	Avant Cherry	NML	Noce Medio
AWH	Avant Honey	QTM	Quartered Mahogany
BLK	Black	SOG	Storm Grey
BRC	Brushed Cobalt	TFW	Tiger Fruitwood
CMB	Clear Maple	TWL	Tiger Walnut
DES	Dark Espresso	WHE	Walnut Heights
DWT	Designer White	WHC	White Chocolate
HGT	Hayden Grey	WGY	Willow Grey
NBL	Noce Biondo	WCR	Winter Cherry

Edge:

AB	Split color edge with Black Trim
AS	Split color edge with Silver Trim
A3	Standard edge
AR	Bicut edge

Feet:

Storage Feet are available in Tungsten (**TTU**) or Black (**TBL**).

3. SPECIFY OPTIONS

EDGE OPTIONS



A3 - square corner, standard edge



AR - square corner, bicut edge



AS - square corner, Silver



AB - square corner, Black

HANDLES

- Handles are standard on most drawers/storage modules. All other drawers, including mobile and hanging pedestals, can be ordered with a choice of nine handle options to be **factory installed**. Each handle is identified by the letters "**HU**", "**HV**", "**HW**", "**HX**", "**HS**", "**HZ**", "**HO**", "**HQ**", and "**HR**". To specify a handle, please specify the code after the model number. To order a handle as an option, please specify the code when ordering. List Price is **\$47**.



HS Flared Silver



HV Square Edge Silver



HO Crescent Black



HW Flared Brass



HU Square Edge Black



HZ Dimpled Nickel



HX Flared Black



HQ Bar Silver



HR Bar Black

MOBILE PEDESTAL

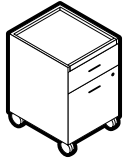

Mobile Pedestal*

MODEL#	DIMENSIONS D x W x H	FREIGHT CLASS	WT/LBS.	CUBIC FT.	LIST PRICE	HP ADD
S1619MP	19 x 16 x 25	85	76	6	\$915	n/a
S1623MP	23 x 16 x 25	92.5	82	7	\$951	n/a

Box/File drawers on fully progressive ball bearing slides, accommodate letter and legal size hanging files. Pedestal top is inset within side panels. Includes counterweight to prevent tipping. Drawers are locking. Handles are standard. Only front casters are locking.

- File drawer construction is for accommodating hanging files and NOT for stacking material on the drawer bottom.

MOBILE PEDESTAL

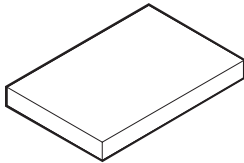

Cushion for Mobile Pedestals**

MODEL#	DIMENSIONS	FREIGHT CLASS	WT/LBS.	CUBIC FT.	GRADE	LIST	GRADE	LIST
CU1517	17 x 15 x 1.5	125	6	.90	1	\$134	7	\$381
					2	\$171	8	\$468
					3	\$198	9	\$534
					4	\$242	10	\$607
					5	\$299	11	\$758
					6	\$327	12	\$922
CU1520	20 x 15 x 1.5	70	1	1	1	\$144	7	\$390
					2	\$181	8	\$477
					3	\$207	9	\$543
					4	\$250	10	\$617
					5	\$310	11	\$768
					6	\$336	12	\$931

Cushion attaches with Velcro strips.

- CU1517 for use on S1619MP. CU1520 for use on S1623MP.

Required Specifications

- Top finish*
- Drawer front finish*
- Handles*
- Fabric**

S SIDEBAR STORAGE

STORAGE

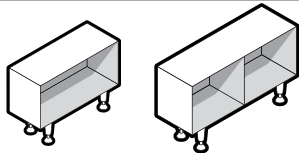

30" w 36" w

Low Bookcase

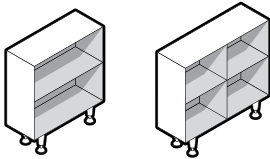

30" w 36" w

2 High Bookcase

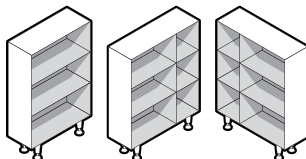

30" w 36" w - left 36" w - right

3 High Bookcase

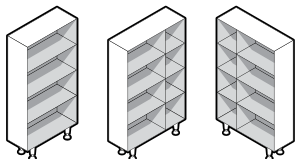

30" w 36" w - left 36" w - right

4 High Bookcase

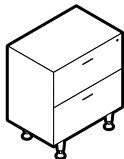

2 High Lateral File

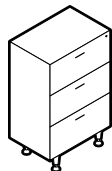

3 High Lateral File

MODEL#	DIMENSIONS	FREIGHT CLASS	WT/LBS.	CUBIC FT.	LIST PRICE	HP ADD
--------	------------	---------------	---------	-----------	------------	--------

D x W x H

S3012A0	12 x 30 x 22.85	125	49	7	\$572	n/a
S3612A0	12 x 36 x 22.85	125	61	8.25	\$662	n/a

Open bookcases accommodate binders in every cavity. One fixed shelf. 36" w units feature a fixed vertical divider.

S3012D0	12 x 30 x 36.35	125	77	10.50	\$789	n/a
S3612D0	12 x 36 x 36.35	125	94	12.50	\$915	n/a

Open bookcases accommodate binders in every cavity. Two fixed shelves. 36" w units feature a fixed vertical divider. Matches Tier 2.

S3012F0	12 x 30 x 49.85	125	102	14	\$951	n/a
S3612FOL	12 x 36 x 49.85	125	127	16.50	\$1127	n/a
S3612FOR	12 x 36 x 49.85	125	127	16.50	\$1127	n/a

Open bookcases accommodate binders in every cavity. Three fixed shelves. 36" w units feature a fixed vertical divider. Matches Tier 3.

S3012H0	12 x 30 x 63.35	125	129	17.50	\$1127	n/a
S3612HOL	12 x 36 x 63.35	125	161	20.75	\$1358	n/a
S3612HOR	12 x 36 x 63.35	125	161	20.75	\$1358	n/a

Open bookcases accommodate binders in every cavity. Four fixed shelves. 36" w units feature a fixed vertical divider. Matches Tier 4.

S3020DZ	20 x 30 x 36.35	100	142	16.50	\$1544	n/a
S3024DZ	24 x 30 x 36.35	125	149	19.50	\$1629	n/a
S3620DZ	20 x 36 x 36.35	125	153	19.50	\$1671	n/a
S3624DZ	24 x 36 x 36.35	125	168	23.35	\$1761	n/a

Two file drawers. Handles are standard. Lock secures all drawers. Front-to-back and side-to-side letter/legal filing capability. Matches Tier 2.

- Lateral file drawer construction is for accommodating hanging files and NOT for stacking material on the drawer bottom.

S3020FZ	20 x 30 x 49.85	100	191	22	\$1899	n/a
S3024FZ	24 x 30 x 49.85	125	198	26	\$1998	n/a
S3620FZ	20 x 36 x 49.85	125	203	26	\$2058	n/a
S3624FZ	24 x 36 x 49.85	125	221	31	\$2166	n/a

Three file drawers. Handles are standard. Lock secures all drawers. Front-to-back and side-to-side letter/legal filing capability. Matches Tier 3.

- Lateral file drawer construction is for accommodating hanging files and NOT for stacking material on the drawer bottom.

Required Specifications

Top finish
Top/edge detail
Base finish
Drawer Front Finish (Units w/doors)

Handles
Leg Finish (Bookcases only)
Shelf Finish (Open Units)

STORAGE

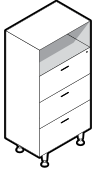

3 High Lateral File - Open

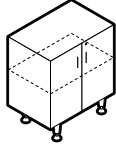

2 High Storage Cabinet

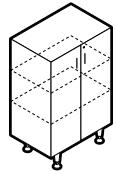

3 High Storage Cabinet

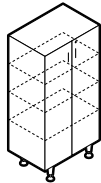

4 High Storage Cabinet

MODEL#	DIMENSIONS D x W x H	FREIGHT CLASS	WT/LBS.	CUBIC FT.	LIST PRICE	HP ADD
S3020HZ	20 x 30 x 63.35	100	239	27.50	\$2337	n/a
S3024HZ	24 x 30 x 63.35	125	246	32.50	\$2449	n/a
S3620HZ	20 x 36 x 63.35	125	253	32.75	\$2530	n/a
S3624HZ	24 x 36 x 63.35	125	275	38.75	\$2655	n/a

Three file drawers. Handles are standard. Lock secures all drawers. Front-to-back and side-to-side letter/legal filing capability. Matches Tier 4.

- Lateral file drawer construction is for accommodating hanging files and NOT for stacking material on the drawer bottom.

S3020DX	20 x 30 x 36.35	125	122	16.50	\$1199	n/a
S3024DX	24 x 30 x 36.35	125	139	19.50	\$1291	n/a
S3620DX	20 x 36 x 36.35	125	151	19.50	\$1406	n/a
S3624DX	24 x 36 x 36.35	125	173	23	\$1533	n/a

Laminate doors are standard. Handles are standard. Two fixed shelves. Standard with lock. Matches Tier 2.

S3020FX	20 x 30 x 49.85	125	167	22	\$1486	n/a
S3024FX	24 x 30 x 49.85	125	190	26	\$1603	n/a
S3620FX	20 x 36 x 49.85	100	209	23.75	\$1761	n/a
S3624FX	24 x 36 x 49.85	125	238	30.75	\$1927	n/a

Laminate doors are standard. Handles are standard. Three fixed shelves. Standard with lock. Matches Tier 3.

S3020HX	20 x 30 x 63.35	125	212	27.50	\$1780	n/a
S3024HX	24 x 30 x 63.35	125	241	32.50	\$1931	n/a
S3620HX	20 x 36 x 63.35	100	266	32.50	\$2166	n/a
S3624HX	24 x 36 x 63.35	125	303	38.50	\$2360	n/a

Laminate doors are standard. Handles are standard. Includes four fixed shelves. Standard with lock. Matches Tier 4.

Required Specifications

Top finish
 Top/edge detail
 Base finish
 Door / Drawer Front Finish

Handles

S SIDEBAR STORAGE

LOW CREDENZAS

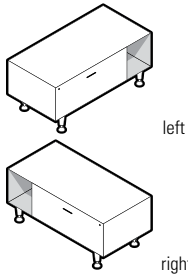

Low Credenza - Lateral Drawer

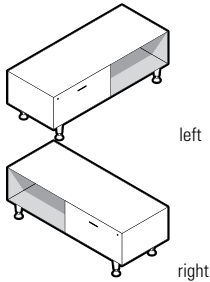

Low Credenza - Lateral Drawer

MODEL#	DIMENSIONS D x W x H	FREIGHT CLASS	WT./LBS.	CUBIC FT.	LIST PRICE	HP ADD
S4220ASL	20 x 42 x 22.85	125	110	15	\$1152	\$185
S4224ASL	24 x 42 x 22.85	125	123	17.50	\$1236	\$216
S4820ASL	20 x 48 x 22.85	125	121	17	\$1247	\$216
S4824ASL	24 x 48 x 22.85	125	136	20	\$1333	\$244
S4220ASR	20 x 42 x 22.85	125	110	15	\$1152	\$185
S4224ASR	24 x 42 x 22.85	125	123	17.50	\$1236	\$216
S4820ASR	20 x 48 x 22.85	125	121	17	\$1247	\$216
S4824ASR	24 x 48 x 22.85	125	136	20	\$1333	\$244

Lateral file drawer is standard on one side, open cavity on the other. Handles are standard. Specify left or right handed. Standard with lock. Front-to-back and side-to-side letter/legal filing capability.

- 42" w cabinet has a 30" w lateral drawer.
- 48" w cabinet has a 36" w lateral drawer.
- Lateral file drawer construction is for accommodating hanging files and NOT for stacking material on the drawer bottom.

S6020ASL	20 x 60 x 22.85	125	138	21	\$1374	\$276
S6024ASL	24 x 60 x 22.85	125	156	24.75	\$1470	\$306
S7220ASL	20 x 72 x 22.85	125	159	20.75	\$1533	\$306
S7224ASL	24 x 72 x 22.85	125	179	25	\$1633	\$366
S6020ASR	20 x 60 x 22.85	125	138	21	\$1374	\$276
S6024ASR	24 x 60 x 22.85	125	156	24.75	\$1470	\$306
S7220ASR	20 x 72 x 22.85	125	159	20.75	\$1533	\$306
S7224ASR	24 x 72 x 22.85	125	179	25	\$1633	\$366

Lateral file drawer is standard on one side, open cavity on the other. Specify left or right handed. Standard with lock. Front-to-back and side-to-side letter/legal filing capability.

- 60" w cabinet has a 30" w lateral drawer.
- 72" w cabinet has a 36" w lateral drawer.
- Lateral file drawer construction is for accommodating hanging files and NOT for stacking material on the drawer bottom.

MEDIUM CREDENZAS

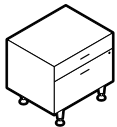

Medium Credenza - Box/File

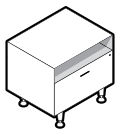

Medium Credenza w/Lateral File

MODEL#	DIMENSIONS	FREIGHT CLASS	WT./LBS.	CUBIC FT.	LIST PRICE	HP ADD
S3020BZ	20 x 30 x 29.6	100	113	13.75	\$1224	\$154
S3024BZ	24 x 30 x 29.6	125	126	16.25	\$1302	\$154
S3620BZ	20 x 36 x 29.6	125	128	16.25	\$1338	\$154
S3624BZ	24 x 36 x 29.6	100	142	16.75	\$1418	\$185

Wide box and lateral file. Handles are standard. Lock secures both drawers.

- Lateral file drawer construction is for accommodating hanging files and NOT for stacking material on the drawer bottom.

S3020BY	20 x 30 x 29.6	100	116	13.75	\$1162	\$154
S3024BY	24 x 30 x 29.6	100	131	16.25	\$1253	\$154
S3620BY	20 x 36 x 29.6	100	132	16.25	\$1279	\$154
S3624BY	24 x 36 x 29.6	100	149	16.75	\$1374	\$185

Open cavity and lateral file. Handles are standard. Standard with lock.

- Lateral file drawer construction is for accommodating hanging files and NOT for stacking material on the drawer bottom.

Required Specifications

Top finish
Top/edge detail
Base finish
Door/drawer front finish

Handles

Optional Specifications

HP laminate

MEDIUM CREDENZAS

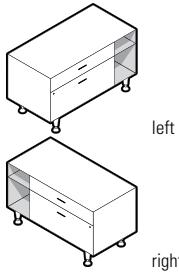

Medium Credenza - Box/Lateral File

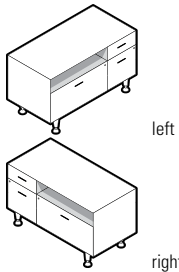

Medium Credenza - Mixed Drawers

MODEL#	DIMENSIONS D x W x H	FREIGHT CLASS	WT/LBS.	CUBIC FT.	LIST PRICE	HP ADD
S4220BSL	20 x 42 x 29.6	125	142	18.75	\$1448	\$185
S4224BSL	24 x 42 x 29.6	125	160	22	\$1544	\$216
S4820BSL	20 x 48 x 29.6	125	155	21.25	\$1569	\$216
S4824BSL	24 x 48 x 29.6	125	173	25	\$1671	\$244

S4220BSR	20 x 42 x 29.6	125	142	18.75	\$1448	\$185
S4224BSR	24 x 42 x 29.6	125	160	22	\$1544	\$216
S4820BSR	20 x 48 x 29.6	125	155	21.25	\$1569	\$216
S4824BSR	24 x 48 x 29.6	125	173	25	\$1671	\$244

Wide box and lateral file is standard on one side, open cavity with fixed shelf on the other. Handles are standard. Specify left or right handed. Standard with lock. Front-to-back and side-to-side letter/legal filing capability.

- 42" w credenza has a 30" w box/lateral file
- 48" w credenza has a 36" w box/lateral file
- Lateral file drawer construction is for accommodating hanging files and NOT for stacking material on the drawer bottom.

S4220BQL	20 x 42 x 29.6	100	165	18.75	\$1841	\$185
S4224BQL	24 x 42 x 29.6	100	184	22	\$1955	\$216
S4820BQL	20 x 48 x 29.6	100	179	21.25	\$1959	\$216
S4824BQL	24 x 48 x 29.6	100	184	22	\$1955	\$244

S4220BQR	20 x 42 x 29.6	100	165	18.75	\$1841	\$185
S4224BQR	24 x 42 x 29.6	100	184	22	\$1955	\$216
S4820BQR	20 x 48 x 29.6	100	179	21.25	\$1959	\$216
S4824BQR	24 x 48 x 29.6	100	184	22	\$1955	\$244

Box/file is standard on one side, open cavity and lateral file on the other side. Specify left or right handed. Handles are standard. Standard with locks. Front-to-back and side-to-side letter/legal filing capability.

- 42" w credenza has a 30" w lateral drawer
- 48" w credenza has a 36" w lateral drawer
- Lateral file drawer construction is for accommodating hanging files and NOT for stacking material on the drawer bottom.

Required Specifications

Top finish
Top/edge detail
Base finish
Door/drawer front finish

Handles

Optional Specifications

HP laminate

S SIDEBAR STORAGE

STACK-ON STORAGE

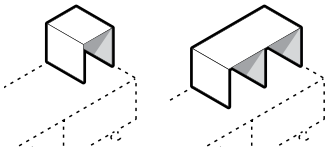

Stack-On Bookcases

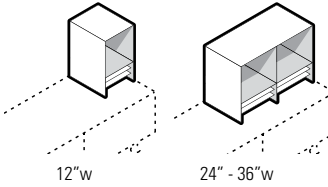

Stack-On Bookcase w/Collators**

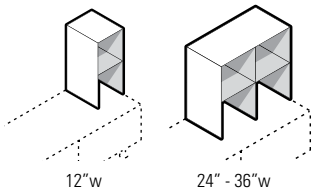

Stack-On Bookcases

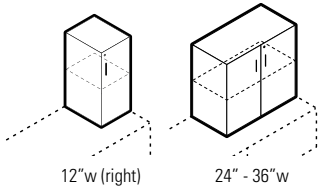

Stack-On Storage Cabinet*

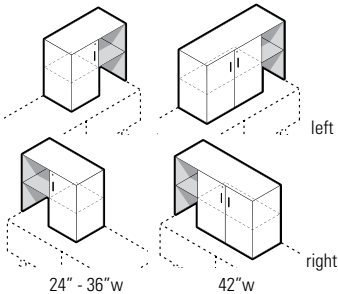

Stack-On Mixed Storage Cabinet*

MODEL#	DIMENSIONS D x W x H	FREIGHT CLASS	WT/LBS.	CUBIC FT.	LIST PRICE	HP ADD
S1214A0	14.3 x 12 x 13.5	92.5	23	2.20	\$228	n/a
S2414A0	14.3 x 24 x 13.5	100	37	4	\$347	n/a
S3014A0	14.3 x 30 x 13.5	100	41	5	\$384	n/a
S3614A0	14.3 x 36 x 13.5	125	46	5.90	\$419	n/a

Designed to be placed on top of credenzas. Open cavity. Unit rests directly on credenza top.
 • Sxx14A0 Stack-On bookcases add 1 tier when placed on any storage unit.

S1214B0	14.3 x 12 x 20.25	92.5	35	3.10	\$329	n/a
S2414B0	14.3 x 24 x 20.25	92.5	59	5.75	\$542	n/a
S3014B0	14.3 x 30 x 20.25	100	68	7	\$607	n/a
S3614B0	14.3 x 36 x 20.25	100	77	8.50	\$698	n/a

Designed to be placed on top credenzas. Open cavity with collator below. Unit rests directly on credenza top.
 • Sxx14B0 Stack-On bookcases add 1.5 tiers when placed on any storage unit.

S1214D0	14.3 x 12 x 27	92.5	41	4	\$371	n/a
S2414D0	14.3 x 24 x 27	100	68	7.50	\$583	n/a
S3014D0	14.3 x 30 x 27	100	76	9.25	\$639	n/a
S3614D0	14.3 x 36 x 27	125	85	11	\$710	n/a

Designed to be placed on top of credenzas. Open cavities with fixed shelf. Unit rests directly on credenza top.
 • Sxx14D0 Stack-On bookcases add 2 tiers when placed on any storage unit.

S1215DTL	15 x 12 x 27	92.5	47	4.20	\$487	n/a
S1215DTR	15 x 12 x 27	92.5	47	4.20	\$487	n/a
S2415DT	15 x 24 x 27	92.5	79	7.75	\$814	n/a
S3015DT	15 x 30 x 27	100	91	9.50	\$892	n/a
S3615DT	15 x 36 x 27	100	103	11.25	\$995	n/a

Designed to be placed on top of credenzas. Laminate doors are standard. Includes fixed shelf. For 12" w units specify left or right handed. Handles are standard. Standard with locks. Unit rests directly on credenza top.
 • Sxx15DT/DTL/DTR Stack-On storage cabinets add 2 tiers when placed on any storage unit.

S2415DNL	15 x 24 x 27	100	73	7.75	\$698	n/a
S3015DNL	15 x 30 x 27	100	83	9.50	\$766	n/a
S3615DNL	15 x 36 x 27	100	94	11.25	\$856	n/a
S4215DNL	15 x 42 x 27	100	117	13	\$1095	n/a
S2415DNR	15 x 24 x 27	100	73	7.75	\$698	n/a
S3015DNR	15 x 30 x 27	100	83	9.50	\$766	n/a
S3615DNR	15 x 36 x 27	100	94	11.25	\$856	n/a
S4215DNR	15 x 42 x 27	100	117	13	\$1095	n/a

Designed to be placed on top of credenzas. Laminate doors are standard on one side with one fixed shelf. Open cavity with one fixed shelf on the other side. Specify left or right handed. Handles are standard. Standard with locks. Unit rests directly on credenza top.
 • Sxx15DNL/DNR Stack-On mixed storage cabinets add 2 tiers when placed on any storage unit.

Required Specifications

Top finish
 Top/edge detail
 Base finish
 Door/drawer front finish*

Handles*
 Collator finish**

STACK-ON STORAGE

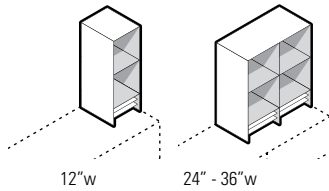

Stack-On Bookcase w/Collators

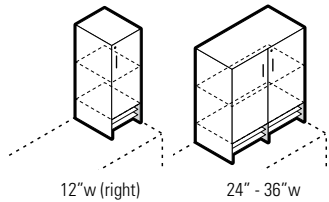

Stack-On Closed Storage* Cabinet w/Collators

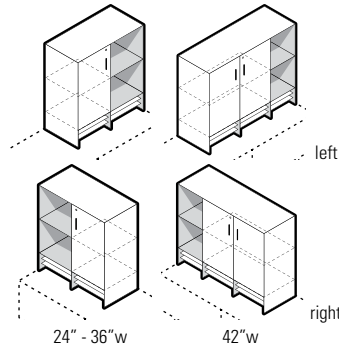

Stack-On Mixed Storage* Cabinet w/Collators

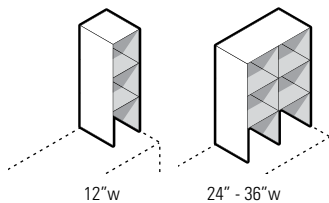

Stack-On Bookcases

MODEL#	DIMENSIONS	FREIGHT CLASS	WT/LBS.	CUBIC FT.	LIST PRICE	HP ADD
--------	------------	---------------	---------	-----------	------------	--------

D x W x H						
S1214EO	14.3 x 12 x 33.75	92.5	53	5	\$481	n/a
S2414EO	14.3 x 24 x 33.75	100	90	9.25	\$795	n/a
S3014EO	14.3 x 30 x 33.75	100	102	11.25	\$880	n/a
S3614EO	14.3 x 36 x 33.75	100	115	13.25	\$999	n/a

Designed to be placed on top of credenzas. Open cavities with one fixed shelf and collator below. Unit rests directly on credenza top.

- Sxx14EO Stack-On bookcases add 2.5 tiers when placed on any storage unit.

S1215ETL	15 x 12 x 33.75	92.5	59	5.25	\$595	n/a
S1215ETR	15 x 12 x 33.75	92.5	59	5.25	\$595	n/a
S2415ET	15 x 24 x 33.75	92.5	102	9.50	\$1019	n/a
S3015ET	15 x 30 x 33.75	100	117	11.75	\$1127	n/a
S3615ET	15 x 36 x 33.75	100	133	14	\$1279	n/a

Designed to be placed on top of credenzas. Laminate doors are standard with one fixed shelf and collator below. For 12\"/>

- Sxx15ET/ETL/ETR Stack-On storage cabinets add 2.5 tiers when placed on any storage unit.

S2415ENL	15 x 24 x 33.75	92.5	96	9.50	\$904	n/a
S3015ENL	15 x 30 x 33.75	100	110	11.75	\$1006	n/a
S3615ENL	15 x 36 x 33.75	100	124	14	\$1139	n/a
S4215ENL	15 x 42 x 33.75	100	154	16	\$1422	n/a

S2415ENR	15 x 24 x 33.75	92.5	96	9.50	\$904	n/a
S3015ENR	15 x 30 x 33.75	100	110	11.75	\$1006	n/a
S3615ENR	15 x 36 x 33.75	100	124	14	\$1139	n/a
S4215ENR	15 x 42 x 33.75	100	154	16	\$1422	n/a

Designed to be placed on top of credenzas. Laminate doors are standard on one side with one fixed shelf. Open cavities on the other side, with one fixed shelf and collator below. Specify left or right handed. Handles are standard. Standard with locks. Unit rests directly on credenza top.

- Sxx15ENL/ENR Stack-On mixed storage cabinets add 2.5 tiers when placed on any storage unit.

S1214FO	14.3 x 12 x 40.5	100	59	6	\$518	n/a
S2414FO	14.3 x 24 x 40.5	100	98	10.75	\$808	n/a
S3014FO	14.3 x 30 x 40.5	100	110	13.25	\$885	n/a
S3614FO	14.3 x 36 x 40.5	125	123	15.75	\$982	n/a

Designed to be placed on top of credenzas. Open cavities with two fixed shelves. Unit rests directly on credenza top.

- Sxx14FO Stack-On bookcases add 3 tiers when placed on any storage unit.

Required Specifications

Top finish
Top/edge detail
Base finish
Door/drawer front finish*

Handles*
Collator finish

S SIDEBAR STORAGE

STACK-ON STORAGE

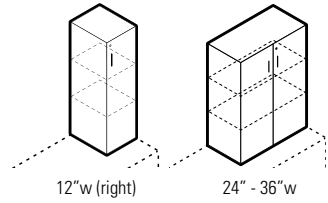

Stack-On Storage Cabinet

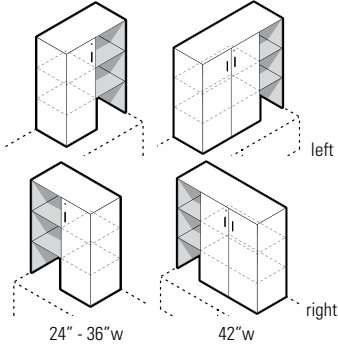

Stack-On Mixed Storage Cabinet

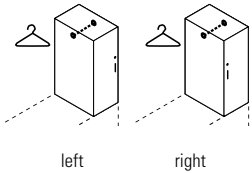

Stack-On Wardrobe Cabinet

MODEL#	DIMENSIONS D x W x H	FREIGHT CLASS	WT/LBS.	CUBIC FT.	LIST PRICE	HP ADD
S1215FTL	15 x 12 x 40.5	92.5	68	6.25	\$662	n/a
S1215FTR	15 x 12 x 40.5	92.5	68	6.25	\$662	n/a
S2415FT	15 x 24 x 40.5	92.5	116	11.25	\$1104	n/a
S3015FT	15 x 30 x 40.5	100	132	14	\$1211	n/a
S3615FT	15 x 36 x 40.5	100	150	16.50	\$1350	n/a

Designed to be placed on top of credenzas. Laminate doors are standard, with two fixed shelves. Handles are standard. Standard with locks. Unit rests directly on credenza top.

- Sxx15FT/FTL/FTR Stack-On storage cabinets add 3 tiers when placed on any storage unit.

S2415FNL	15 x 24 x 40.5	100	107	11.25	\$957	n/a
S3015FNL	15 x 30 x 40.5	100	121	14	\$1048	n/a
S3615FNL	15 x 36 x 40.5	100	137	16.50	\$1170	n/a
S4215FNL	15 x 42 x 40.5	100	171	19	\$1496	n/a

S2415FNR	15 x 24 x 40.5	100	107	11.25	\$957	n/a
S3015FNR	15 x 30 x 40.5	100	121	14	\$1048	n/a
S3615FNR	15 x 36 x 40.5	100	137	16.50	\$1170	n/a
S4215FNR	15 x 42 x 40.5	100	171	19	\$1496	n/a

Designed to be placed on top of credenzas. Laminate doors are standard on one side, with two fixed shelves. Open cavities on the other side, with two fixed shelves. Specify left or right handed. Handles are standard. Standard with locks. Unit rests directly on credenza top.

- Sxx15FNL/FNR Stack-On mixed storage cabinets add 3 tiers when placed on any storage unit.

S1224FTL	24 x 12 x 40.5	100	83	9.50	\$782	n/a
S1224FTR	24 x 12 x 40.5	100	83	9.50	\$782	n/a

Designed to be placed on top of credenzas. Laminate doors are standard. Includes hanging rod. Specify left or right handed. Handles are standard. Standard with locks. Unit rests directly on credenza top.

- S1224FTL/FTR Stack-On wardrobe cabinets add 3 tiers when placed on any storage unit.

Required Specifications

Top finish
Top/edge detail
Base finish
Door/drawer front finish

Handles

wellness solutions



Wellness Solutions 468



Acoustic Solutions 478

LAMINATE PANELS	MODEL#	DIMENSIONS	FREIGHT CLASS	WT/LBS.	CUBIC FT.	LIST PRICE	HP ADD
		D x W x H					
<ul style="list-style-type: none"> • Surface mounted wellness guard provides a physical divider • Acrylic glazing is clear and support rails are painted Designer White (DWT). • Kit includes all hardware to install on an existing surface • Aluminum extruded posts 							
			Laminate Finishes (for GCBMSGxxxxLP):				
			ACJ	Absolute Acajou	HGT	Hayden Grey	
			ASN	Asian Night	QTM	Quartered Mahogany	
			AWC	Avant Cherry	SOG	Storm Grey	
			AWH	Avant Honey	TFW	Tiger Fruitwood	
			BLK	Black	TWL	Tiger Walnut	
			BRC	Brushed Cobalt	WHE	Walnut Heights	
			CMB	Clear Maple	WHC	White Chocolate	
			DES	Dark Espresso	WCR	Winter Cherry	
			DWT	Designer White	WGY	Willow Grey	

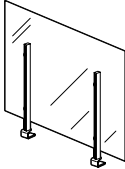
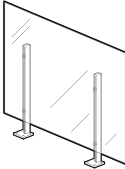
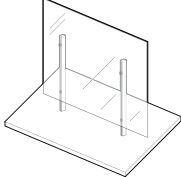
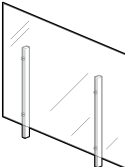
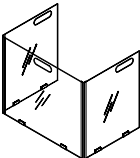
WELLNESS SCREENS	MODEL#	DIMENSIONS	FREIGHT CLASS	WT/LBS.	CUBIC FT.	LIST PRICE	
		D x W x H					
 <p>Wellness Screen - Clamp Mount</p>	GCTCSG3636LP	3 x 36 x 36	300	20.20	2.92	\$552	
	GCTCSG3648LP	3 x 48 x 36	300	22.80	3.98	\$687	
	GCTCSG3636W	3 x 36 x 36	300	20.20	2.92	\$567	
	GCTCSG3648W	3 x 48 x 36	300	22.80	3.98	\$702	
			Includes clamp mount brackets, for use with existing worksurface or transaction top. Select model ending in LP for tops up to 1-1/8" thick or W for tops up to 1 1/2" thick				
 <p>Wellness Screen - Surface Mount</p>	GCBRMSG3636LP	5 x 36 x 36	300	20.20	2.92	\$552	
	GCBRMSG3648LP	5 x 48 x 36	300	22.80	3.98	\$687	
			Includes flat face surface mounting brackets, for use with existing worksurface or transaction top.				
 <p>Wellness Screen - Freestanding*</p>	GCBMSG3636LP	12 x 36 x 36	250	28.45	2.92	\$612	
	GCBMSG3648LP	12 x 48 x 36	250	34.17	3.98	\$788	
			12"D, board mounted. Available in all standard Global laminate finishes.				
 <p>Wellness Screen - Under Mount</p>	GCAMSG3636LP	2 x 36 x 36	300	20.20	2.92	\$451	
	GCAMSG3648LP	2 x 48 x 36	300	22.80	3.98	\$587	
			No mounting hardware included; drilling required. For use with existing worksurface or transaction top.				
 <p>Wellness Screen - Tri-Fold</p>	Sold individually:						
	GCFSGS1618-1	15 x 18 x 15.75	150	5.15	0.97	\$448	
	GCFSGA1923-1	15.75 x 23 x 19	92.5	7.30	0.67	\$514	
	Sold in packs of 5:						
GCFSGS1618-5	15 x 18 x 15.75	150	25.75	4.86	\$2139		
GCFSGA1923-5	15.75 x 23 x 19	92.5	36.50	3.37	\$2479		
	Self-supported tri-fold wellness screens create a physical divider. Lightweight and foldable for easy transport or storage. Acrylic glazing is 3mm with clear finish. Includes non-marring base bumpers and integrated handles.						
	<ul style="list-style-type: none"> • Models ending in -1 are a single unit, individually packed • Models ending in -5 are a bundle of 5 units, bulk packed. 						

Required Specifications
Finish*

UNIVERSAL PRIVACY PANELS	MODEL#	DIMENSIONS	FREIGHT CLASS	WT/LBS.	CUBIC FT.	LIST PRICE
--------------------------	--------	------------	---------------	---------	-----------	------------

D x W x H

- Divide space with flexibility.
- Lightweight and easy to clean partitions
- Minimal footprint for storage
- Fluted solid white polypropylene screens are surrounded by a 0.5" x 2.5" powder coated aluminum frame in Designer White (**DWT**) or Tungsten (**TUN**)
- Charcoal soft touch radius end trim
- 7" panel opening at panel bottom for easy cleaning and cable pass-through
- Includes all connecting hardware and 1" leveling glide
- Stations are 60" wide by 42" deep by 66" high.

UNIVERSAL PRIVACY PANELS	MODEL#	DIMENSIONS	FREIGHT CLASS	WT/LBS.	CUBIC FT.	LIST PRICE
--------------------------	--------	------------	---------------	---------	-----------	------------

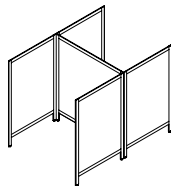

H-Configuration

GCPPH666085	85 x 60 x 66	150	90	18.74	\$2160
-------------	--------------	-----	----	-------	---------------

Pre-configured in a back-to-back "H", with ability to add stations with a "T" configuration. Includes four 42" w panels and one 60" w panel and all connecting hardware. Accepts "T-Configuration" to create longer runs of stations.

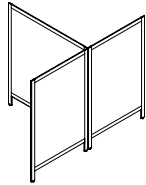

T-Configuration

GCPPT666085	85 x 60 x 66	125	73	11.82	\$1376
-------------	--------------	-----	----	-------	---------------

Includes two 42" w panels and one 60" w panel and all connecting hardware. Connects to "H-Configurations" to create longer runs of stations.

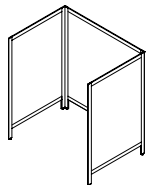

U-Configuration

GCPPU666043	43 x 60 x 66	125	73	11.82	\$1381
-------------	--------------	-----	----	-------	---------------

Pre-configured in a back-to-back "U", with ability to add stations with an "L" configuration. Includes two 42" w panels and one 60" w panel and all connecting hardware. Accepts "L-Configuration" to create longer runs of stations.

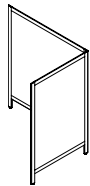

L-Configuration

GCPPL666043	43 x 60 x 66	125	58	8.36	\$984
-------------	--------------	-----	----	------	--------------

Includes two 42" w panels and one 60" w panel and all connecting hardware. Connects to "U-Configurations" to create longer runs of stations.

Required Specifications

Frame finish

FREESTANDING DIVIDERS - POLYCARBONATE

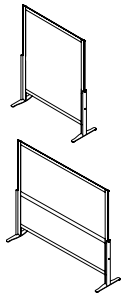

Polycarbonate Screen - Flat Feet

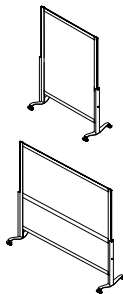

Polycarbonate Screen - Casters

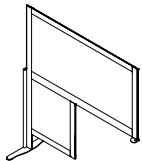

Shared Divider Polycarbonate Screen

MODEL#	DIMENSIONS D x W x H	FREIGHT CLASS	WT./LBS.	CUBIC FT.	LIST PRICE
GCUPFSP5442	20 x 42 x 51.75	400	21.95	25.16	\$903
GCUPFSP5448	20 x 48 x 51.75	400	20.96	28.75	\$914
GCUPFSP5460	20 x 60 x 51.75	400	22.96	35.94	\$1103
GCUPFSP6042	20 x 42 x 57.75	400	23.96	28.07	\$920
GCUPFSP6048	20 x 48 x 57.75	400	25.96	32.08	\$931
GCUPFSP6060	20 x 60 x 57.75	400	27.96	40.1	\$1120
GCUPFSP7242	20 x 42 x 69.75	400	25.96	33.91	\$1097
GCUPFSP7248	20 x 48 x 69.75	400	27.96	38.75	\$1108
GCUPFSP7260	20 x 60 x 69.75	400	29.96	48.44	\$1279

Provides privacy and room separation. Translucent fluted polycarbonate screen with steel flat feet. 60" wide divider has a crossbar in the middle.

GCUPMSP5442	20 x 42 x 52.05	400	23.13	25.3	\$1150
GCUPMSP5448	20 x 48 x 52.05	400	22.13	28.92	\$1161
GCUPMSP5460	20 x 60 x 52.05	400	24.13	36.15	\$1333
GCUPMSP6042	20 x 42 x 58.05	400	25.13	28.22	\$1161
GCUPMSP6048	20 x 48 x 58.05	400	27.13	32.25	\$1174
GCUPMSP6060	20 x 60 x 58.05	400	29.13	40.31	\$1350
GCUPMSP7242	20 x 42 x 70.05	400	27.13	34.05	\$1327
GCUPMSP7248	20 x 48 x 70.05	400	29.13	38.92	\$1338
GCUPMSP7260	20 x 60 x 70.05	400	31.13	48.65	\$1491

Provides privacy and room separation. Translucent fluted polycarbonate screen with steel feet with casters. 60" wide divider has a crossbar in the middle.

GCUPSHP5448	20 x 48 x 53.57	400	13.45	29.76	\$720
GCUPSHP5454	20 x 54 x 53.57	400	15.45	33.48	\$755
GCUPSHP6048	20 x 48 x 59.57	400	17.45	33.09	\$785
GCUPSHP6054	20 x 54 x 59.57	400	19.45	37.23	\$821

Provides privacy and divides space for workstations. Divider stands on the floor and sits on the worksurface. Has no mechanical connection to any surface. Lightweight and easy to clean and move. Translucent fluted polycarbonate screen with steel flat foot. 60" wide divider has a crossbar in the middle. Extends 24" from the worksurface. Sits 24" or 30" above worksurface.

Required Specifications

Frame/ foot finish

FREESTANDING DIVIDERS - FELT

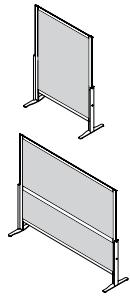

Felt Screen - Flat Feet

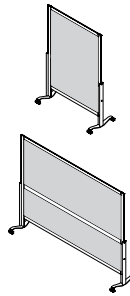

Felt Screen - Casters

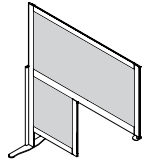

Shared Divider Felt Screen

MODEL#	DIMENSIONS D x W x H	FREIGHT CLASS	WT/LBS.	CUBIC FT.	LIST PRICE
GCUPFSF5442	20 x 42 x 51.75	400	21.8	25.16	\$715
GCUPFSF5448	20 x 48 x 51.75	400	22.54	28.75	\$727
GCUPFSF5460	20 x 60 x 51.75	400	24.03	35.94	\$891
GCUPFSF6042	20 x 42 x 57.75	400	22.57	28.07	\$732
GCUPFSF6048	20 x 48 x 57.75	400	23.3	32.08	\$738
GCUPFSF6060	20 x 60 x 57.75	400	24.87	40.1	\$903
GCUPFSF7242	20 x 42 x 69.75	400	24.06	33.91	\$896
GCUPFSF7248	20 x 48 x 69.75	400	24.88	38.75	\$908
GCUPFSF7260	20 x 60 x 69.75	400	29.79	48.44	\$1138

Provides privacy and room separation. PET felt screen with steel flat feet. 60" wide divider has a crossbar in the middle.

GCUPMSF5442	20 x 42 x 52.05	400	22.98	25.3	\$967
GCUPMSF5448	20 x 48 x 52.05	400	23.72	28.92	\$979
GCUPMSF5460	20 x 60 x 52.05	400	25.21	36.15	\$1132
GCUPMSF6042	20 x 42 x 58.05	400	23.75	28.22	\$985
GCUPMSF6048	20 x 48 x 58.05	400	24.51	32.25	\$997
GCUPMSF6060	20 x 60 x 58.05	400	26.05	40.31	\$1150
GCUPMSF7242	20 x 42 x 70.05	400	25.24	34.05	\$1143
GCUPMSF7248	20 x 48 x 70.05	400	26.06	38.92	\$1150
GCUPMSF7260	20 x 60 x 70.05	400	30.97	48.65	\$1362

Provides privacy and room separation. PET felt screen with steel feet with casters. 60" wide divider has a crossbar in the middle.

GCUPSHF5448	20 x 48 x 53.57	400	18.06	29.76	\$597
GCUPSHF5454	20 x 54 x 53.57	400	18.8	33.48	\$679
GCUPSHF6048	20 x 48 x 59.57	400	18.84	33.09	\$638
GCUPSHF6054	20 x 54 x 59.57	400	19.6	37.23	\$838

Provides privacy and divides space for workstations. Divider stands on the floor and sits on the worksurface. Has no mechanical connection to any surface. Lightweight and easy to clean and move. PET felt screen with steel flat foot. 60" wide divider has a crossbar in the middle. Extends 24" from the worksurface. Sits 24" or 30" above worksurface.

Required Specifications

Frame/ foot finish
PET felt

FREESTANDING DIVIDERS - GLASS

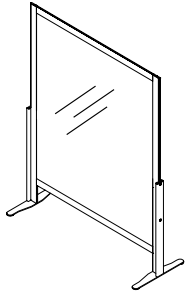

Glass Screen - Flat Feet

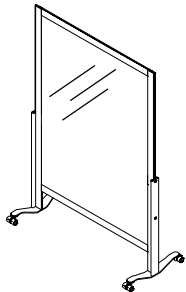

Glass Screen - Casters

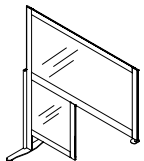

Shared Divider Glass Screen

MODEL#	DIMENSIONS D x W x H	FREIGHT CLASS	WT/LBS.	CUBIC FT.	LIST PRICE
GCUPFSG5424	20 x 24 x 51.75	250	30.83	14.38	\$814
GCUPFSG5430	20 x 30 x 51.75	300	34.95	17.97	\$885
GCUPFSG5436	20 x 36 x 51.75	300	39.07	21.56	\$954
GCUPFSG5442	20 x 42 x 51.75	300	43.19	25.16	\$1025
GCUPFSG5448	20 x 48 x 51.75	300	47.31	28.75	\$1096
GCUPFSG5460	20 x 60 x 51.75	300	55.56	35.94	\$1236
GCUPFSG6024	20 x 24 x 57.75	250	33.11	16.04	\$863
GCUPFSG6030	20 x 30 x 57.75	300	37.74	20.05	\$940
GCUPFSG6036	20 x 36 x 57.75	300	42.36	24.06	\$1017
GCUPFSG6042	20 x 42 x 57.75	300	46.99	28.07	\$1094
GCUPFSG6048	20 x 48 x 57.75	300	51.61	32.08	\$1172
GCUPFSG6060	20 x 60 x 57.75	300	60.86	40.1	\$1326

Provides privacy and room separation. Lightweight and easy to clean and move. Aluminum frame, clear glass screen with steel flat feet.

- For frosted glass (**FRST**), add 20%.

GCUPMSG5424	20 x 24 x 52.05	250	31.99	14.46	\$1167
GCUPMSG5430	20 x 30 x 52.05	300	36.11	18.07	\$1237
GCUPMSG5436	20 x 36 x 52.05	300	40.24	21.69	\$1307
GCUPMSG5442	20 x 42 x 52.05	300	44.36	25.3	\$1377
GCUPMSG5448	20 x 48 x 52.05	300	48.48	28.92	\$1447
GCUPMSG5460	20 x 60 x 52.05	300	56.72	36.15	\$1588
GCUPMSG6024	20 x 24 x 58.05	250	34.28	16.13	\$1215
GCUPMSG6030	20 x 30 x 58.05	300	38.9	20.16	\$1292
GCUPMSG6036	20 x 36 x 58.05	300	43.53	24.19	\$1369
GCUPMSG6042	20 x 42 x 58.05	300	48.15	28.22	\$1446
GCUPMSG6048	20 x 48 x 58.05	300	52.78	32.25	\$1523
GCUPMSG6060	20 x 60 x 58.05	300	62.03	40.31	\$1678

Provides privacy and room separation. Lightweight and easy to clean and move. Aluminum frame, clear glass screen with steel flat feet.

- For frosted glass (**FRST**), add 20%.

GCUPSHG5448	20 x 48 x 53.57	300	36.17	29.76	\$899
GCUPSHG5454	20 x 54 x 53.57	300	38.51	33.48	\$940
GCUPSHG6048	20 x 48 x 59.57	300	40.52	33.09	\$972
GCUPSHG6054	20 x 54 x 59.57	300	43.36	37.23	\$1020

Provides privacy and divides space for workstations. Divider stands on the floor and sits on the worksurface. Has no mechanical connection to any surface. Lightweight and easy to clean and move. Aluminum frame, clear glass screen with steel flat foot. Extends 24" from the worksurface. Sits 24" or 30" above worksurface.

- For frosted glass (**FRST**), add 20%.

Required Specifications

Frame/foot finish

Optional Specifications

Frosted glass (FRST)

LINKING PANELS	MODEL#	DIMENSIONS	FREIGHT CLASS	WT./LBS.	CUBIC FT.	LIST PRICE
----------------	--------	------------	---------------	----------	-----------	------------

D x W x H

- Segmented panels offer a thermally fused laminate lower and high pressure upper pressed on a lightweight core
- Minimal footprint for storage
- Easy to connect
- Easy to reconfigure
- Easy to clean
- Panels available in Designer White (**DWT**) or Absolute Acajou (**ACJ**) laminates
- Frames available in Designer White (**DWT**) or Tungsten (**TUN**)
- Width options: 36", 42", 48", 60" wide
- 66" high
- 1.3" thick.

LINKING PANELS - SEGMENTED	MODEL#	DIMENSIONS	FREIGHT CLASS	WT./LBS.	CUBIC FT.	LIST PRICE
----------------------------	--------	------------	---------------	----------	-----------	------------

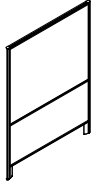

Segmented Linking Panel*

DLSP6636	1.3 x 36 x 66	92.5	35	3	\$768
DLSP6642	1.3 x 42 x 66	92.5	41	3.46	\$790
DLSP6648	1.3 x 48 x 66	92.5	47	3.93	\$805
DLSP6660	1.3 x 60 x 66	85	59	4.90	\$1236

Segmented panels offer a thermally fused laminate lower and high pressure upper pressed on a lightweight core. Minimal footprint for storage. Laminate core available in Designer White (**DWT**) or Absolute Acajou (**ACJ**). Aluminum extrusion comes in powder coated paint finish in Designer White (**DWT**) or Absolute Acajou (**ACJ**). Comes complete with hinge kits and levelers on both legs.

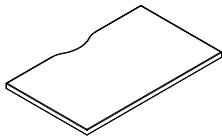

Worksurface, for Segmented Panel**

DLSPWS1830SCPLP	18 x 30 x 1	60	15	.50	\$179
-----------------	-------------	----	----	-----	--------------

Straight rectangular laminate worksurface, non handed, can be interchanged on site, and features a scoop for cable pass-through. Available in Designer White (**DWT**) or Absolute Acajou (**ACJ**). Edging available in Designer White (**DWE**) or Absolute Acajou (**ACJ**).

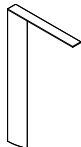

Worksurface Off-Module Cantilever*

DLSPHOMC	12 x 3 x 21	100	4	.42	\$140
----------	-------------	-----	---	-----	--------------

Installs on horizontal rails of panels to provide worksurface support. Frees up space under the worksurface. Powder coated paint finish in Designer White (**DWT**) or Tungsten (**TUN**).

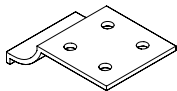

Worksurface Bracket*

DLSPHBRKT	3 x 2.25 x 0.75	70	.10	.05	\$12
-----------	-----------------	----	-----	-----	-------------

Extruded aluminum bracket that is bolted to the underside of the worksurface. Bracket supports worksurface at any location along the middle rail of the panel. Includes mounting hardware. Powder coated paint finish in Designer White (**DWT**) or Tungsten (**TUN**).

Required Specifications

- Frame finish*
- Laminate finish**

LAMINATE LINKING PANELS	MODEL#	DIMENSIONS	FREIGHT CLASS	WT/LBS.	CUBIC FT.	LIST PRICE
-------------------------	--------	------------	---------------	---------	-----------	------------

D x W x H

- Laminate linking panels provide privacy.
- Standard height of 54" or 66", width in 6" increments from 24" to 60".
- Aluminum extrusion comes in powder coated paint finish: Designer White (DWT) or Tungsten (TUN).
- Laminate core offered in Designer White (DWT) or Absolute Acajou (ACJ).
- Edge banded to match laminate finish.
- Panels come complete with hinge kits

Planning Diagrams

- When supported on one side (by 90° turn, supporting "T" legs or wall mounting), panels can run two long OR a maximum of 8'.
- When supported on both sides (by 90° turn, supporting "T" legs or wall mounting), panels can run three long OR a maximum of 13'.

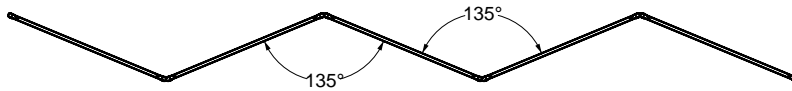
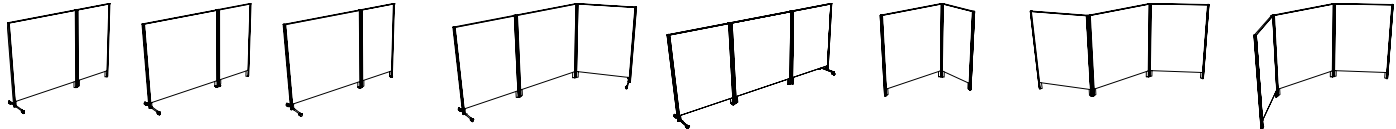

For longer, unsupported runs, panels must maintain a 135° angle (or less) to remain stable.

LAMINATE LINKING PANELS	MODEL#	DIMENSIONS	FREIGHT CLASS	WT/LBS.	CUBIC FT.	LIST PRICE
-------------------------	--------	------------	---------------	---------	-----------	------------

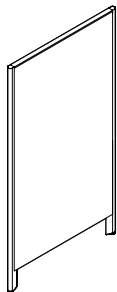

Laminate Panel - Leveler/Leveler

DPL5424	1.3 x 24 x 54	92.5	18	1.62	\$583	
DPL5430	1.3 x 30 x 54	92.5	23	2.08	\$647	
DPL5436	1.3 x 36 x 54	92.5	27	2.47	\$711	
DPL5442	1.3 x 42 x 54	92.5	32	2.85	\$775	
DPL5448	1.3 x 48 x 54	92.5	37	3.25	\$839	
DPL5454	1.3 x 54 x 54	92.5	42	3.63	\$904	
DPL5460	1.3 x 60 x 54	92.5	47	4.02	\$968	
DPL6624	1.3 x 24 x 66	92.5	23	2.04	\$662	
DPL6630	1.3 x 30 x 66	92.5	29	2.52	\$732	
DPL6636	1.3 x 36 x 66	92.5	35	3	\$802	
DPL6642	1.3 x 42 x 66	92.5	41	3.46	\$872	
DPL6648	1.3 x 48 x 66	92.5	47	3.93	\$944	
DPL6654	1.3 x 54 x 66	92.5	53	4.40	\$1015	
DPL6660	1.3 x 60 x 66	92.5	59	4.90	\$1084	

Levelers on both legs.

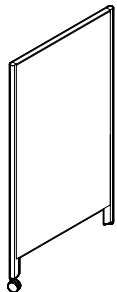

Laminate Panel - Caster/Leveler

DPLSCH5424	1.3 x 24 x 54	92.5	18	1.62	\$699	
DPLSCH5430	1.3 x 30 x 54	92.5	23	2.08	\$767	
DPLSCH5436	1.3 x 36 x 54	92.5	27	2.47	\$834	
DPLSCH5442	1.3 x 42 x 54	92.5	32	2.85	\$901	
DPLSCH5448	1.3 x 48 x 54	92.5	37	3.25	\$968	
DPLSCH5454	1.3 x 54 x 54	92.5	42	3.63	\$1035	
DPLSCH5460	1.3 x 60 x 54	92.5	47	4.02	\$1102	
DPLSCH6624	1.3 x 24 x 66	92.5	23	2.04	\$777	
DPLSCH6630	1.3 x 30 x 66	92.5	29	2.52	\$852	
DPLSCH6636	1.3 x 36 x 66	92.5	35	3	\$927	
DPLSCH6642	1.3 x 42 x 66	92.5	41	3.46	\$1000	
DPLSCH6648	1.3 x 48 x 66	92.5	47	3.93	\$1072	
DPLSCH6654	1.3 x 54 x 66	92.5	53	4.40	\$1174	
DPLSCH6660	1.3 x 60 x 66	92.5	59	4.90	\$1221	

Single locking caster on one leg, leveler on the other.

Required Specifications

- Frame finish
- Laminate finish

LAMINATE LINKING PANELS

MODEL#	DIMENSIONS	FREIGHT CLASS	WT./LBS.	CUBIC FT.	LIST PRICE
D x W x H					
DPLDF5424	1.3 x 24 x 54	65	40.2	1.62	\$688
DPLDF5430	1.3 x 30 x 54	65	47.6	2.08	\$737
DPLDF5436	1.3 x 36 x 54	70	54.9	2.47	\$784
DPLDF5442	1.3 x 42 x 54	70	62.3	2.85	\$833
DPLDF5448	1.3 x 48 x 54	70	69.6	3.25	\$880
DPLDF5454	1.3 x 54 x 54	70	77	3.63	\$929
DPLDF5460	1.3 x 60 x 54	70	84.3	4.02	\$977
DPLDF6624	1.3 x 24 x 66	65	48.6	2.04	\$746
DPLDF6630	1.3 x 30 x 66	65	57.9	2.52	\$798
DPLDF6636	1.3 x 36 x 66	70	67.3	3	\$851
DPLDF6642	1.3 x 42 x 66	70	76.6	3.46	\$903
DPLDF6648	1.3 x 48 x 66	70	85.9	3.93	\$956
DPLDF6654	1.3 x 54 x 66	70	95.2	4.40	\$1009
DPLDF6660	1.3 x 60 x 66	70	104.5	4.90	\$1062

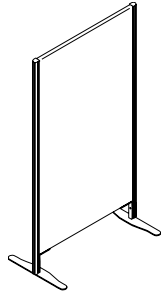

Laminate Panel - Flat Feet

Flat foot on both legs. Freestanding.

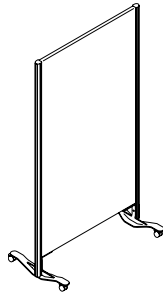

Laminate Panel - Double Casters

DPLMN5424	1.3 x 24 x 54	65	18	1.62	\$730
DPLMN5430	1.3 x 30 x 54	65	23	2.08	\$793
DPLMN5436	1.3 x 36 x 54	65	27	2.47	\$858
DPLMN5442	1.3 x 42 x 54	70	32	2.85	\$920
DPLMN5448	1.3 x 48 x 54	70	37	3.25	\$984
DPLMN5454	1.3 x 54 x 54	70	42	3.63	\$1048
DPLMN5460	1.3 x 60 x 54	70	47	4.02	\$1110

DPLMN6624	1.3 x 24 x 66	65	23	2.04	\$809
DPLMN6630	1.3 x 30 x 66	65	29	2.52	\$877
DPLMN6636	1.3 x 36 x 66	65	35	3	\$948
DPLMN6642	1.3 x 42 x 66	70	41	3.46	\$1019
DPLMN6648	1.3 x 48 x 66	70	47	3.93	\$1088
DPLMN6654	1.3 x 54 x 66	70	53	4.40	\$1157
DPLMN6660	1.3 x 60 x 66	70	59	4.90	\$1228

Double locking caster base on both legs. Freestanding.

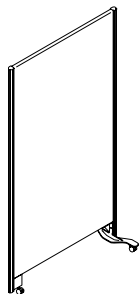

Laminate Panel - Single Caster/Double Casters

DPLDCMN5424	1.3 x 24 x 54	65	18	1.62	\$686
DPLDCMN5430	1.3 x 30 x 54	70	23	2.08	\$750
DPLDCMN5436	1.3 x 36 x 54	70	27	2.47	\$808
DPLDCMN5442	1.3 x 42 x 54	70	32	2.85	\$870
DPLDCMN5448	1.3 x 48 x 54	70	37	3.25	\$930
DPLDCMN5454	1.3 x 54 x 54	70	42	3.63	\$988
DPLDCMN5460	1.3 x 60 x 54	70	47	4.02	\$1052

DPLDCMN6624	1.3 x 24 x 66	65	23	2.04	\$758
DPLDCMN6630	1.3 x 30 x 66	70	29	2.52	\$826
DPLDCMN6636	1.3 x 36 x 66	70	35	3	\$892
DPLDCMN6642	1.3 x 42 x 66	70	41	3.46	\$959
DPLDCMN6648	1.3 x 48 x 66	70	47	3.93	\$1024
DPLDCMN6654	1.3 x 54 x 66	70	53	4.40	\$1091
DPLDCMN6660	1.3 x 60 x 66	70	59	4.90	\$1141

Single locking caster on one leg and double locking caster base on the other. Freestanding.

Required Specifications

- Frame finish
- Laminate finish

LAMINATE PANELS

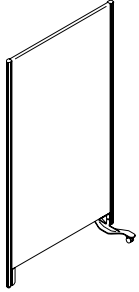

**Laminate Panel -
Leveler/Double Caster**

MODEL#	DIMENSIONS D x W x H	FREIGHT CLASS	WT./LBS.	CUBIC FT.	LIST PRICE
DPLDCHN5424	1.3 x 24 x 54	65	18	1.62	\$647
DPLDCHN5430	1.3 x 30 x 54	70	23	2.08	\$704
DPLDCHN5436	1.3 x 36 x 54	70	27	2.47	\$768
DPLDCHN5442	1.3 x 42 x 54	70	32	2.85	\$828
DPLDCHN5448	1.3 x 48 x 54	70	37	3.25	\$887
DPLDCHN5454	1.3 x 54 x 54	70	42	3.63	\$949
DPLDCHN5460	1.3 x 60 x 54	70	47	4.02	\$1010
DPLDCHN6624	1.3 x 24 x 66	65	23	2.04	\$718
DPLDCHN6630	1.3 x 30 x 66	70	29	2.52	\$786
DPLDCHN6636	1.3 x 36 x 66	70	35	3	\$851
DPLDCHN6642	1.3 x 42 x 66	70	41	3.46	\$916
DPLDCHN6648	1.3 x 48 x 66	70	47	3.93	\$984
DPLDCHN6654	1.3 x 54 x 66	70	53	4.40	\$1052
DPLDCHN6660	1.3 x 60 x 66	70	59	4.90	\$1118

Leveler on one leg and double locking caster base on the other. Freestanding.

LINKING PANEL ACCESSORIES



Wall Connection

MODEL#	DIMENSIONS	FREIGHT CLASS	WT./LBS.	CUBIC FT.	LIST PRICE
DPLWA54	2 x 2 x 54	70	2.3	0.13	\$151
DPLWA66	2 x 2 x 66	65	3.5	0.15	\$172

Connects linking panels to walls. Available in Designer White (**DWT**) or Tungsten (**TUN**) paint finish. Kit consists of vertical extrusion, charcoal PVC cover and hinge kits.

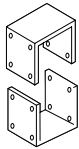

Expanding Kit

DPLEKIT	2 x 2 x 3	70	1	.05	\$264
---------	-----------	----	---	-----	--------------

Connects two linking panels in a straight line. This kit will accommodate any special width by overlapping the panels. Available in Designer White (**DWT**) or Tungsten (**TUN**) paint finish. Kit consists of a top and bottom bracket and all necessary hardware.

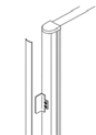

Door and Door Catch Kit

DPDC01	1.3 x 3 x 6	60	2	.05	\$166
--------	-------------	----	---	-----	--------------

Converts any linking panel into a door. Available in Designer White (**DWT**) or Tungsten (**TUN**) paint finish. Kit consists of striker plate, two hinge kits, single caster foot assembly and 1" caster.

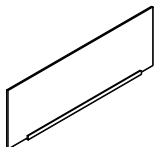

PET Felt Over Panel

DPLOP24	1.05 x 24 x 16.8	70	1.74	.39	\$137
DPLOP30	1.05 x 30 x 16.8	150	2.20	.49	\$162
DPLOP36	1.05 x 36 x 16.8	150	2.67	.59	\$190
DPLOP42	1.05 x 42 x 16.8	150	3.14	.70	\$210
DPLOP48	1.05 x 48 x 16.8	150	3.60	.80	\$313
DPLOP54	1.05 x 54 x 16.8	150	4.07	.90	\$339
DPLOP60	1.05 x 60 x 16.8	150	4.53	1.01	\$367

For laminate panels. Sits atop laminate panel and bridges the gap between the 66"H laminate linking panel and top of the consultation booth. Available in Designer White (**DWT**) or Tungsten (**TUN**) paint finish. Kit contains aluminum extrusion and felt insert.

Required Specifications

Finish

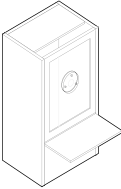
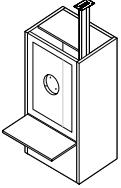
LINKING PANEL ACCESSORIES	MODEL#	DIMENSIONS	FREIGHT CLASS	WT/LBS.	CUBIC FT.	LIST PRICE
 <p>Booth to Panel Connector*</p>	DEBPA	D x W x H 1.3 x 3 x 66	65	3.5	.15	\$119
Facilitates the connection of a linking panel to the back gable edge of the consultation booth. Aluminum extrusion available in Designer White (DWT) or Tungsten (TUN) paint finish. Kit includes a vertical extrusion, charcoal PVC cover and all necessary hardware.						
 <p>Consultation Booth</p>	L2RSB	36 x 36 x 82	250	238.81	61.50	\$3556
Ideal for hospitals, clinics, reception areas, or anywhere a safe, self-contained environment is required. Consultation booth has a protected speaker hold, a paper space above the worksurface, an interior and exterior worksurface. Gap between the worksurface and glazed frame can be changed during assembly, from 1.5" to 4", based on the direction of the screen. Available in Designer White (DWT) only. Can be closed or connected with Linking Laminate Panels. Ships knocked down.						
 <p>Ceiling Feed Pole*</p>	L2SBCF	1.5 x 4.5 x 75	65	8.69	.29	\$202
Can be used to bring power and/or data from the ceiling to the booth. Aluminum extrusion available in Designer White (DWT) or Tungsten (TUN) paint finish. Kit includes aluminum extrusions, spacer, trim kit and double-sided adhesive tape.						

Required Specifications

Finish*



Priva acoustic pods provide a place for personal privacy, focus and online collaboration, away from the noise of the open office. Integrated ventilation and low-voltage LED lighting are motion-sensor activated to reduce energy consumption. The tempered glass entrance door, in combination with optional glass back panel, reduces the sense of confinement. Interior carpet flooring is comprised of eco-friendly nylon fiber, solution dyed with a polypropylene backing.

A laptop shelf, two AC outlets and two USB-A charging ports support the range of today's electronic and communication devices. The exterior is available in a variety of laminate finishes to coordinate with other furnishings. The interior can be finished in laminate or PET, for industry-leading sound absorption. Hinge and handle trim is available in Black or anodized Silver. Mechanical fasteners to affix the pod to the floor are available.



Features and Benefits

- Quiet and private
- Plug-and-play
- Internal frame is comprised of 14-gauge steel beams
- Easily clean high touch surfaces
- Slim, modern design
- Optional PET interior for greater acoustic properties
- Fixed touch-down shelf with power unit
- Special retractable casters enable Priva to be relocated easily



Two AC outlets and two USB-A charging ports, plus laminate touch-down shelf



Easy to clean

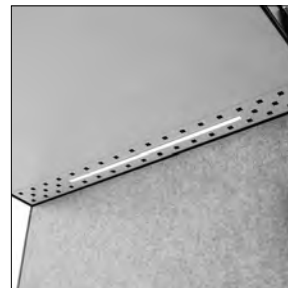

Ventilation fan and LED lights

GENERAL INFORMATION

- Priva is the culmination of 2 years of research and development of an acoustic phone booth that inhibits sound transmission between the interior and exterior creating a private room-in-room for workplace applications.
- Assembles in less than 90 minutes. Once complete, simply plug in and get to work!
- Priva has been tested and complies with all BIFMA mechanical tests.
- For environmental certification, please visit globalfurnituregroup.com.

CONSTRUCTION

- Exterior is clad in 3/4" thermally fused laminate with a 10mm tempered glass door and glass (POD1G) or laminate back panel (POD1L).
- Exterior corner details are made of extruded aluminum
- Internal frame is comprised of 14 gauge steel beams
- Interior is clad in PET (recommended for greater acoustic properties)
- Laminate interior is optional.
- Pod ceiling is Designer White laminate
- Interior carpet flooring is comprised of eco-friendly nylon fiber, solution dyed with a polypropylene backing.
- Laminate touch-down shelf is standard in Designer White (DWT) laminate.

DIMENSIONS

- Exterior: 44" w x 38" d x 88" h
- Interior: 36" w x 36" d x 80" h
- Door: 32" w x 88" h
- Shelf: 24" w x 8" d x 40" h

Exterior Dimensions

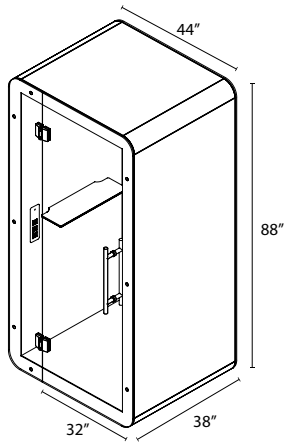

Interior Dimensions - Side View

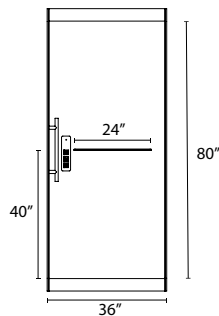

Interior Dimensions - Front View

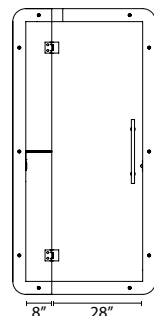

POWER + CONNECTIVITY

- Two AC outlets and two charging USB-A ports, coupled with an occupancy sensor controlling two 12V DC fans and an LED light circuit, ensure comfort in even the smallest of enclosed spaces, while keeping power consumption at a minimum.

ACOUSTIC RATINGS

- NIC-36, STI .24

AIRFLOW SPECIFICATIONS

- CFM 55

FINISHES

Exterior Finishes:

- ACJ Absolute Acajou
- ASN Asian Night
- BLK Black
- BRC Brushed Cobalt
- CMB Clear Maple
- DES Dark Espresso
- DWT Designer White
- NBL Noce Biondo
- NGL Noce Grigio
- NEL Noce Leggero
- NML Noce Medio
- SOG Storm Grey
- WHE Walnut Heights
- WHC White Chocolate
- WCR Winter Cherry

Exterior Frame Finishes

- BK Black
- CR Charcoal
- DW Designer White
- TU Tungsten

Interior Finishes - select Laminate or PET

- | | | | |
|--------------|--|--------------------|--|
| PET: | | Laminate: | |
| GPH Graphite | | BLK Black | |
| MTS Mist | | DWT Designer White | |
| PWT Pewter | | SOG Storm Grey | |

Hardware Finishes (Handle + Hinge)

- BK Black
- SI Silver

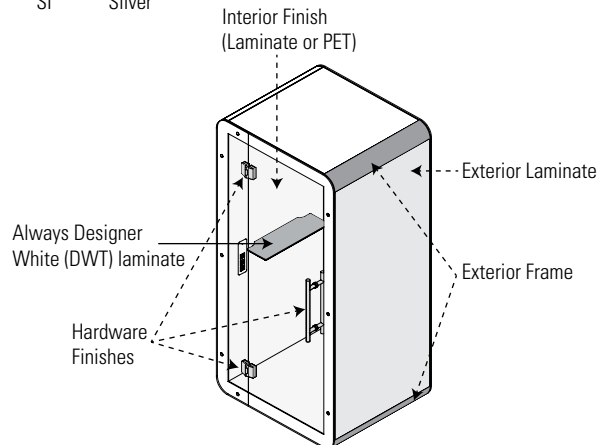

SINGLE USER POD

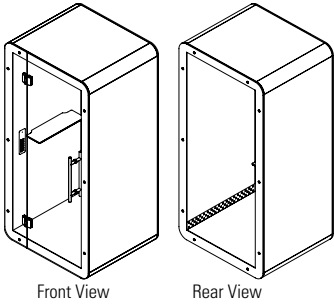

Front View

Rear View

Single User Pod - Glass Back Panel

MODEL#	DIMENSIONS D x W x H	FREIGHT CLASS	WT/LBS.	CUBIC FT.	LIST PRICE
POD1G	38 x 44 x 88	65	1323	44.80	\$22715

Acoustic pod includes laminate exterior with aluminum frame. PET interior provides acoustic privacy. Laminate interior optional for easy cleaning. Door is 10mm tempered glass with a **glass back panel**.

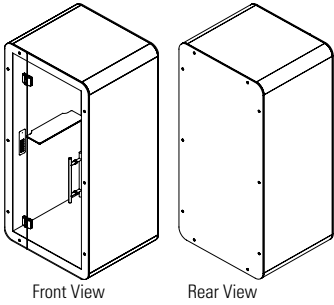

Front View

Rear View

Single User Pod - Laminate Back Panel

POD1L	38 x 44 x 88	65	1323	44.80	\$22715
-------	--------------	----	------	-------	----------------

Acoustic pod includes laminate exterior with aluminum frame. PET interior provides acoustic privacy. Laminate interior optional for easy cleaning. Door is 10mm tempered glass with a **laminate back panel**.

Required specifications

- Exterior laminate finish
- Exterior frame finish
- Hardware finish
- Interior finish

productivity solutions



Productivity Solutions 482



Productivity Solutions™ by Global is a comprehensive series of ergonomically sound products, naturally connecting people with technology to enhance comfort and productivity. Designed to Fit you and your technology and fully integrate with Global Furniture Group products to create complete office solutions that meet the needs of today's diverse workplaces.

Designed with human capabilities and comfort in mind, Productivity Solutions by Global provide a good Fit for today's workers and meet or exceed ergonomics standards, guidelines and ANSI/BIFMA standards for performance, durability and safety.

FIT = Move + Match + Support

Features and Benefits

- Foli Height Adjustable Table with 18.4" height range
- Manual Height Adjustable Table has counterbalanced spring mechanism
- 4 keyboard support mechanisms
- 5 keyboard trays
- New monitor arm options
- Wire management and power/data options
- Meets ANSI-BIFMA, Greenguard Indoor Air Quality, Greenguard Gold Certified
- Height Adjustable Tables are BIFMA level 2 certified



Monitor Arms



Power/Data Module



Lift n Lock Keyboard Tray



Foli Electric Height Adjustable Table



Manual Height Adjustable Desk

MANUAL HEIGHT ADJUSTABLE TABLES

- Manually operated height adjustable tables with counterbalanced spring mechanism
 - Exceptional ergonomic alternative to traditional desking
 - Sit-Stand design promotes increased circulation, improving performance and comfort
 - Can be used alone or in conjunction with Global desks.
- Please note:** Global desks are 1" or 1.5" thick.
- Meets ANSI/BIFMA requirements

TOP FINISHES

ACJ	Absolute Acajou	NGL	Noce Grigio
ASN	Asian Night	NEL	Noce Leggero
AWC	Avant Cherry	NML	Noce Medio
AWH	Avant Honey	QTM	Quartered Mahogany
BLK	Black	SOG	Storm Grey
BRC	Brushed Cobalt	TFW	Tiger Fruitwood
CMB	Clear Maple	TWL	Tiger Walnut
DES	Dark Espresso	WHE	Walnut Heights
DWT	Designer White	WHC	White Chocolate
HGT	Hayden Grey	WGY	Willow Grey
NBL	Noce Biondo	WCR	Winter Cherry

CONSTRUCTION

- 1" thick tops constructed of 45 lb. density particle board with high performance thermally fused laminate

DIMENSIONS

- When designing workstations, leave 1" clearance on either side to prevent finger pinch

EDGE

- Preferred matching edge

BASE

- Heavy duty steel formed legs with radius detail are available in Black only
- Easy to reach tension control supports loads up to 100 lbs.
- Environmentally friendly, recyclable epoxy powder coating provides a durable finish. Black only.
- Black plastic leveling glides offer 0.5" adjustability

GROMMETS

- Grommets available in standard worksurface locations (left, center or right)
- Order as: **AG1, AG2 or AG3. Add \$88.**

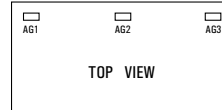

- Grommet hole dimensions are 3 1/4" wide x 1 7/8" deep

MECHANISM

- Counterbalanced height adjustable base supports weights up to 100 lbs.
- Height range from floor to underside of modesty shroud is 17" when surface height is 26"
- 7 year warranty

SHIPPING

- Shipped RTA (Ready to Assemble)
- Easy to assemble with Phillips or Robertson screwdriver

MODEL#	DIMENSIONS D x W x H	FREIGHT CLASS	WT/LBS.	CUBIC FT.	LIST PRICE
Rectangular Tops:					
HTM3058T	30 x 58 x 1	70	50	2.50	\$512
HTM3046T	30 x 46 x 1	70	40	2	\$428
HTM2458T	24 x 58 x 1	70	40	2	\$392
HTM2446T	24 x 46 x 1	70	32	1.50	\$364
Base:					
KEZLIFT	24 x 34.5 x 26-46	70	88	5.40	\$2741

Paddle activated height adjustable base. Height adjustable from 26" to 46". Keyboard tray and mechanism not necessary

- **Specify base separately from top**

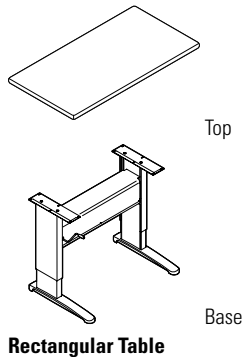

Required Specifications
Top Finish

FOLI ELECTRIC HEIGHT ADJUSTABLE TABLES

D x W x H

- Electric height adjustment allows for easy movement from sitting to standing and back throughout the day. Foli's work surface moves with you and your work without interruption.
- Foli offers a universal free-standing design and finish options to easily integrate with existing Global workstation configurations, becoming a natural part of your office space
- Whether in a private or general office, touch-down space, collaborative area or home office, Foli supports a more active and healthy work style
- Can be used alone or in conjunction with Global desks. Please note Global desks are 1" or 1.5" thick.

TOP FINISHES

ACJ	Absolute Acajou	NGL	Noce Grigio
ASN	Asian Night	NEL	Noce Leggero
AWC	Avant Cherry	NML	Noce Medio
AWH	Avant Honey	QTM	Quartered Mahogany
BLK	Black	SOG	Storm Grey
BRC	Brushed Cobalt	TFW	Tiger Fruitwood
CMB	Clear Maple	TWL	Tiger Walnut
DES	Dark Espresso	WHE	Walnut Heights
DWT	Designer White	WHC	White Chocolate
HGT	Hayden Grey	WGY	Willow Grey
NBL	Noce Biondo	WCR	Winter Cherry

EDGE

- Preferred matching edge

CONSTRUCTION

- Tops are 1" thick, constructed of 45 lb. density particle board covered on both sides with high performance thermally fused laminate. Optional high pressure laminate tops are 1-1/16" thick.
- Steel constructed leg tubing, feet and cross bar
- Table frame designed with 3.15" x 2.35" rectangular outer leg with large tubing facing down
- "T" leg, flat foot design with adjustable glides
- Expandable cross bars for table widths of 48", 54", 60", 66" and 72"
- Available table depths of 23" and 29"
- Products specified with the high pressure laminate option are finished on the underside of the surface with a kraft paper backing.

BASE

- 3-stage steel constructed leg tubing, feet and cross bar
- Dual motors are concealed within column.
- Provides height adjustment from 22.6" to 48.6" (26" adjustability with 1" top)
- Leveling glides offer 1" adjustability
- Operates at 1.3" per second
- Lifts 220 lbs.
- Shadow power draw 0.5 watts
- Base available in a Silver powder coated finish, will never mar during adjustment
- Open front cross bar to accommodate articulating keyboard platforms.
- Easy to use, push button controller with digital readout.
- Anti-collision feature standard

GROMMETS

- Grommets available in standard table top locations (left, center or right). Order as: **AG1, AG2 or AG3 - Add \$88**
- Grommet hole dimensions are 3 1/4" wide x 1 7/8" deep.
- Grommets may be placed at non-standard locations. Order as: **AGS - Add \$88**. A drawing must be supplied with vertical and horizontal dimensions to the center of the cut-out (as in drawing below). Please refer to CUSTOM GROMMET LOCATION FORM in the back reference section.

Grommet hole dimensions:

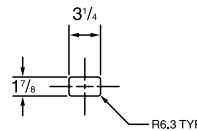

Grommet:

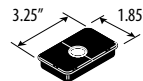

Grommet Locations:



POWER BLOCK

- A power block (model **PMSPPM**) may be installed on all Foli tables
- The power block module includes one electrical duplex receptacle and two data (RJ45) receptacles. 9' Black cord with NEMA plug. Power block dimensions are 6.5"W x 3.5"D x 2.75"H.
- Power block cutout dimensions are 2.75"D x 6"W.
- Specify the power block cut-out location when ordering the table. The power block is ordered separately. Order power block separately as **PMSPPM, Add \$330**. Power blocks are available in standard worksurface locations (left, center or right). Specify **E1, E2 or E3 cutout location. Add \$88**.

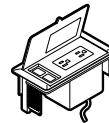

Power Block **PMSPPM. Add \$330**

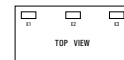

Specify location **E1, E2 or E3. Add \$88**

SHIPPING

- Shipped unassembled in 1 carton
- Easy to assemble.

FOLI ELECTRIC HEIGHT ADJUSTABLE TABLES

MODEL# DIMENSIONS FREIGHT CLASS WT/LBS. CUBIC FT. LIST PRICE HP ADD

D x W x H

Rectangular Tops:

PHAT2970T	29 x 70 x 1	65	70	2.50	\$543	\$271.5
PHAT2964T	29 x 64 x 1	65	64	2.26	\$518	\$259
PHAT2958T	29 x 58 x 1	65	59	2.10	\$496	\$248
PHAT2952T	29 x 52 x 1	65	52	1.90	\$486	\$243
PHAT2946T	29 x 46 x 1	65	44	1.70	\$474	\$237
PHAT2370T	23 x 70 x 1	65	57	2	\$539	\$269.5
PHAT2364T	23 x 64 x 1	65	52	1.82	\$498	\$249
PHAT2358T	23 x 58 x 1	65	47	1.67	\$475	\$237.5
PHAT2352T	23 x 52 x 1	65	42	1.52	\$427	\$213.5
PHAT2346T	23 x 46 x 1	65	35	1.40	\$399	\$199.5

Base:

PH3T6601	10 x -- x 26.8	70	59.5	2.83	\$1255	n/a
----------	----------------	----	------	------	---------------	-----

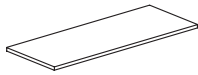

Top

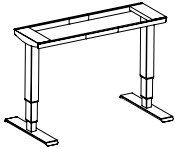

Base

Foli Rectangular Table

All table frames are easy to assemble with few parts. Lifts 220 lbs. Base manufactured so that leg paint will never mar during height adjustment. Leg assembly tubing, feet and upper structure assemblies constructed of steel. Table frame designed with 3.15" x 2.36" rectangular outer leg with the large tube facing down. Flat foot design with adjustable glides. I-profile crossbars that are expandable in fixed steps to create a variety of size table widths. Height range is 22.6" to 48.6" (26" adjustability with 1" top). Operates at 1.3" per second. Shadow power draw is 0.5 watts. Maximum power draw is 1.5A. Base finish in Silver powder coat only.

- **Specify base separately from top**
- **Recommended torque range for installing all fasteners is 3-5 foot pounds and should not be exceeded. In addition, no impact drivers or high-torque equipment are to be used for any fasteners included in the table assembly kits, as this creates a high risk for damage that is not covered under warranty. The use of hand tools is highly recommended.**

Return Tops:

PHAR2947T	29 x 47 x 1	60	104	2.30	\$474	\$237
PHAR2941T	29 x 41 x 1	65	40	1.70	\$469	\$234.5
PHAR2935T	29 x 35 x 1	65	34	1.50	\$469	\$234.5
PHAR2347T	23 x 47 x 1	60	94.5	2.10	\$399	\$199.5
PHAR2341T	23 x 41 x 1	65	40	1.60	\$380	\$190
PHAR2335T	23 x 35 x 1	65	34	1.40	\$344	\$172

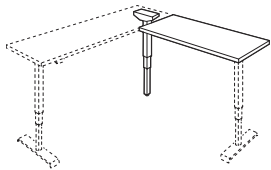

Return Kit

Third Leg Kit:

PH3TLK6601	10 x -- x 26.8	85	19	1.30	\$861	n/a
------------	----------------	----	----	------	--------------	-----

Third leg kit to be used with a Foli freestanding table to create an electric height adjustable L station. Post leg with return kit replaces one of the T-legs on freestanding table; the T-leg from the freestanding table is then moved to support one side of the return top. Cross bar is included to connect and support the return top to the freestanding table top. May be configured for left or right hand returns. All three legs plug into the freestanding table's controller and the three motors will electronically synchronize. The overall footprint with a return kit is not to exceed 72"W x 72"D. The 48"W return kit is only to be used with a 24"D primary table. 36" and 42"W return kits may be used with either 24"D or 30"D primary tables.

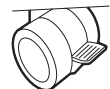

1.5" Dual Wheel Casters

P79100014	- x - x 1.5	60	2	0.4	\$77	N/A
-----------	-------------	----	---	-----	-------------	-----

Pack of four casters, two locking and two non-locking. Interchangeable on site with levelers on Foli electric height adjustable table PHATxxxx models only.

- **Cannot be used with Third Leg Kit**

Required Specifications

Top Finish

Optional Specifications

High Pressure Laminate
Grommet

P PRODUCTIVITY SOLUTIONS™ BY GLOBAL

PET FELT PANELS

- 9mm thick panels offered in 9 finishes
- Made from 100% PET (polyester) fiber with a high content (50%) of post-recycled material, free of added chemicals, binders and adhesives
- Lightweight panels are tackable, impact and tear resistant, bacteria resistant, moisture resistant, and installation friendly
- Variation in fiber mix and color are inherent to the character of the product
- Clamps are included. Available in satin anodized finish only.
- Privacy screen clamps for use on 1" surfaces only.

FELT COLORS

BLK	Black	MTS	Mist
BRI	Brick	PWT	Pewter
DEN	Denim	SHR	Shamrock
GPH	Graphite	WHT	White
HVT	Harvest		

PET FELT PRIVACY SCREENS

MODEL#	DIMENSIONS D x W x H	FREIGHT CLASS	WT./LBS.	CUBIC FT.	LIST PRICE
PT9PP3013-1	.36 x 30 x 12.5	250	2.12	.57	\$163
PT9PP3613-1	.36 x 36 x 12.5	250	2.38	.69	\$172
PT9PP4213-1	.36 x 42 x 12.5	250	2.63	.80	\$231
PT9PP4813-1	.36 x 48 x 12.5	250	3.31	.91	\$240
PT9PP5413-1	.36 x 54 x 12.5	250	3.57	1.03	\$300
PT9PP6013-1	.36 x 60 x 12.5	250	3.82	1.14	\$309
PT9PP6613-1	.36 x 66 x 12.5	250	4.50	1.25	\$368
PT9PP7213-1	.36 x 72 x 12.5	250	4.76	1.36	\$377
PT9PP7813-1	.36 x 78 x 12.5	250	5.01	1.48	\$385

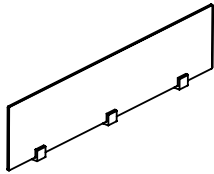

PET Felt Privacy Screen - 1 pk.

PET Felt Privacy Screen available in 9 finishes, please specify. 2, 3 or 4 clamps are included depending on screen size. Clamps available in satin anodized finish only. Privacy screen clamps for use on 1" surfaces only.

- Up to 42" w - 2 clamps per panel
- 48"-60" w - 3 clamps per panel
- 66"-78" w - 4 clamps per panel

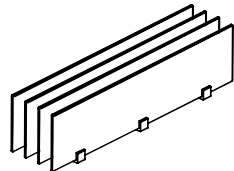

PET Felt Privacy Screen - 4 pk.

PT9PP3013-4	0.36 x 30 x 12.5	85	7.64	.60	\$617
PT9PP3613-4	0.36 x 36 x 12.5	85	8.56	.71	\$653
PT9PP4213-4	0.36 x 42 x 12.5	92.5	9.48	.83	\$882
PT9PP4813-4	0.36 x 48 x 12.5	85	11.90	.98	\$916
PT9PP5413-4	0.36 x 54 x 12.5	92.5	12.80	1.09	\$1148
PT9PP6013-4	0.36 x 60 x 12.5	92.5	13.80	1.20	\$1178
PT9PP6613-4	0.36 x 66 x 12.5	85	16.20	1.32	\$1407
PT9PP7213-4	0.36 x 72 x 12.5	92.5	17.10	1.43	\$1440
PT9PP7813-4	0.36 x 78 x 12.5	92.5	18	1.54	\$1469

PET Felt Privacy Screen available in 9 finishes, please specify. 2, 3 or 4 clamps are included depending on screen size. Clamps available in satin anodized finish only. Privacy screen clamps for use on 1" surfaces only.

- Up to 42" w - 2 clamps per panel
- 48"-60" w - 3 clamps per panel
- 66"-78" w - 4 clamps per panel

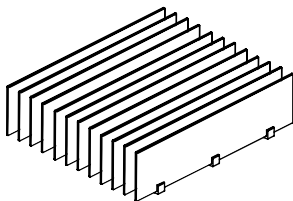

PET Felt Privacy Screen - 12 pk.

PT9PP3013-12	0.36 x 30 x 12.5	92.5	21.60	1.92	\$1812
PT9PP3613-12	0.36 x 36 x 12.5	92.5	24.30	2.26	\$1910
PT9PP4213-12	0.36 x 42 x 12.5	60	26.90	.80	\$2588
PT9PP4813-12	0.36 x 48 x 12.5	92.5	33.80	3.05	\$2682
PT9PP5413-12	0.36 x 54 x 12.5	92.5	36.40	3.39	\$3373
PT9PP6013-12	0.36 x 60 x 12.5	92.5	39	3.72	\$3457
PT9PP6613-12	0.36 x 66 x 12.5	92.5	45.90	4.18	\$4136
PT9PP7213-12	0.36 x 72 x 12.5	92.5	48.50	4.51	\$4220
PT9PP7813-12	0.36 x 78 x 12.5	92.5	51.10	4.85	\$4305

PET Felt Privacy Screen available in 9 finishes, please specify. 2, 3 or 4 clamps are included depending on screen size. Clamps available in satin anodized finish only. Privacy screen clamps for use on 1" surfaces only.

- Up to 42" w - 2 clamps per panel
- 48"-60" w - 3 clamps per panel
- 66"-78" w - 4 clamps per panel

Required Specifications

Finish

PET FELT MODESTY PANELS

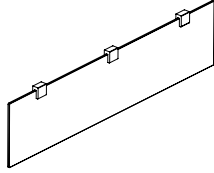

PET Felt Modesty Panel - 1 pk.

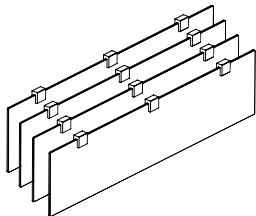

PET Felt Modesty Panel - 4 pk.

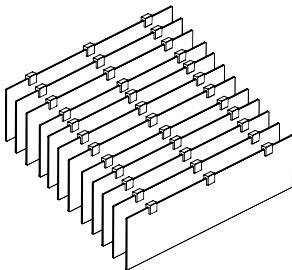

PET Felt Modesty Panel - 12 pk.

MODEL# DIMENSIONS FREIGHT CLASS WT/LBS. CUBIC FT. LIST PRICE

	D x W x H				
PT9MP3013-1	.36 x 30 x 12.5	250	2.12	.57	\$144
PT9MP3613-1	.36 x 36 x 12.5	250	2.38	.69	\$152
PT9MP4213-1	.36 x 42 x 12.5	250	2.63	.80	\$201
PT9MP4813-1	.36 x 48 x 12.5	250	3.31	.91	\$210
PT9MP5413-1	.36 x 54 x 12.5	250	3.57	1.03	\$272
PT9MP6013-1	.36 x 60 x 12.5	250	3.82	1.14	\$279
PT9MP6613-1	.36 x 66 x 12.5	250	4.50	1.25	\$327
PT9MP7213-1	.36 x 72 x 12.5	250	4.76	1.36	\$338
PT9MP7813-1	.36 x 78 x 12.5	250	5.01	1.48	\$346

PET Felt Modesty Panel available in 9 finishes, please specify. 2, 3 or 4 clamps are included depending on screen size. Clamps available in satin anodized finish only. **Specify a nominal size 6" shorter than worksurface size.**

- Up to 42"w - 2 clamps per panel
- 48"-60"w - 3 clamps per panel
- 66"-78"w - 4 clamps per panel

PT9MP3013-4	0.36 x 30 x 12.5	85	7.64	.60	\$540
PT9MP3613-4	0.36 x 36 x 12.5	85	8.56	.71	\$574
PT9MP4213-4	0.36 x 42 x 12.5	92.5	9.48	.83	\$764
PT9MP4813-4	0.36 x 48 x 12.5	85	11.90	.98	\$798
PT9MP5413-4	0.36 x 54 x 12.5	92.5	12.80	1.09	\$1030
PT9MP6013-4	0.36 x 60 x 12.5	92.5	13.80	1.20	\$1060
PT9MP6613-4	0.36 x 66 x 12.5	85	16.20	1.32	\$1248
PT9MP7213-4	0.36 x 72 x 12.5	92.5	17.10	1.43	\$1281
PT9MP7813-4	0.36 x 78 x 12.5	92.5	18	1.54	\$1311

PET Felt Modesty Panel available in 9 finishes, please specify. 2, 3 or 4 clamps are included depending on screen size. Clamps available in satin anodized finish only. **Specify a nominal size 6" shorter than worksurface size.**

- Up to 42"w - 2 clamps per panel
- 48"-60"w - 3 clamps per panel
- 66"-78"w - 4 clamps per panel

PT9MP3013-12	0.36 x 30 x 12.5	92.5	21.60	1.92	\$1574
PT9MP3613-12	0.36 x 36 x 12.5	92.5	24.30	2.26	\$1672
PT9MP4213-12	0.36 x 42 x 12.5	92.5	26.90	2.60	\$2232
PT9MP4813-12	0.36 x 48 x 12.5	92.5	33.80	3.05	\$2326
PT9MP5413-12	0.36 x 54 x 12.5	92.5	36.40	3.39	\$3016
PT9MP6013-12	0.36 x 60 x 12.5	92.5	39	3.72	\$3100
PT9MP6613-12	0.36 x 66 x 12.5	92.5	45.90	4.18	\$3660
PT9MP7213-12	0.36 x 72 x 12.5	92.5	48.50	4.51	\$3745
PT9MP7813-12	0.36 x 78 x 12.5	92.5	51.10	4.85	\$3829

PET Felt Modesty Panel available in 9 finishes, please specify. 2, 3 or 4 clamps are included depending on screen size. Clamps available in satin anodized finish only. **Specify a nominal size 6" shorter than worksurface size.**

- Up to 42"w - 2 clamps per panel
- 48"-60"w - 3 clamps per panel
- 66"-78"w - 4 clamps per panel

Required Specifications

Finish

PET TRI-FOLD SCREENS	MODEL#	DIMENSIONS	FREIGHT CLASS	WT/LBS.	CUBIC FT.	LIST PRICE
		D x W x H				
<ul style="list-style-type: none"> • 9mm thick panels offered in 9 finishes • Made from 100% PET (polyester) fiber with a high content (50%) of post-recycled material, free of added chemicals, binders and adhesives • Lightweight panels are tackable, impact and tear resistant, bacteria resistant, moisture resistant, and installation friendly • Variation in fiber mix and color are inherent to the character of the product. 	FELT COLORS					
		BLK	Black	MTS	Mist	
		BRI	Brick	PWT	Pewter	
		DEN	Denim	SHR	Shamrock	
		GPH	Graphite	WHT	White	
		HVT	Harvest			

PET TRI-FOLD SCREENS	MODEL#	DIMENSIONS	FREIGHT CLASS	WT/LBS.	CUBIC FT.	LIST PRICE
		D x W x H				

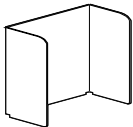

PET Felt Desktop Partition

PSDTP3224	15.5 x 31.5 x 15.5	85	7	0.5	\$278
-----------	--------------------	----	---	-----	--------------

Lightweight freestanding desktop partition. Move wherever you need to provide a focus space. 9mm thick PET Felt, no hardware connections. Folds flat for storage when not in use. Ships in two pieces with a puzzle-like joint. Easy to assemble.

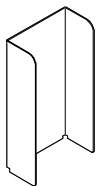

PET Felt Floor Partition

PSFSP3260	15.5 x 31.5 x 60	92.5	13	1.20	\$629
-----------	------------------	------	----	------	--------------

Lightweight freestanding floor partition. Move wherever you need to provide a focus space. 9mm thick PET Felt, no hardware connections. Folds flat for storage when not in use. Ships in two pieces with a puzzle-like joint. Easy to assemble.

Required Specifications

Finish

MONITOR ARMS	MODEL#	DIMENSIONS	FREIGHT CLASS	WT./LBS.	CUBIC FT.	LIST PRICE
		D x W x H				

- Free up valuable space on surfaces
- Attach to any standard surface with flush edge by a desk clamp or through a grommet. Grommets above support panels cannot be used for mounting. Mounting hardware included.
- Clamps on worksurfaces 1/2" to 2 5/8" thick
- 9" vertical height adjustment on 12" post
- For use in grommets up to 3.5" wide
- Built-in cable management
- Quick connect option is standard with hole patterns to meet Video Electronics Standards Association (VESA) standards (75mm x 75mm or 100mm x 100mm)
- Monitor arm components are 100% recycled aluminum die cast material, providing stability and durability
- Available finishes: Silver (**SIL**) standard; Black (**BLK**) and White (**WTE**)

MONITOR ARMS	MODEL#	DIMENSIONS	FREIGHT CLASS	WT./LBS.	CUBIC FT.	LIST PRICE
--------------	--------	------------	---------------	----------	-----------	------------

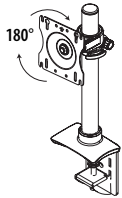

Single Screen Pole Position

MON1SPP	-- x -- x --	150	5.80	1.20	\$338
---------	--------------	-----	------	------	--------------

No extension arms. Minor assembly required. Supports 20 lb. load capacity. No maximum monitor width.

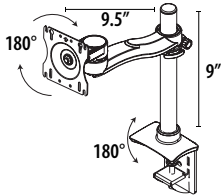

Single Screen Single Extension Arm

MON1SSE	-- x -- x --	150	6.20	1.20	\$456
---------	--------------	-----	------	------	--------------

9.5" horizontal reach from center of pole to front of monitor mounting plate. Displays are able to tilt 180°, swing 180° side-to-side and rotate from landscape to portrait. Minor assembly required. Supports 20 lb. load capacity. No maximum monitor width.

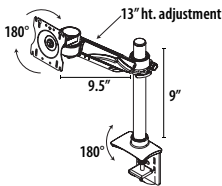

Single Screen Single Extension Arm with Height Adjustment

MON1SSEH	-- x -- x --	125	7.20	1.10	\$583
----------	--------------	-----	------	------	--------------

Counterbalanced arm provides an additional 13" of height adjustment. Easy to use Allen wrench allows user to adjust the counterbalance mechanism for easy movement of the monitor. 9.5" horizontal reach from center of pole to front of monitor mounting plate. Displays are able to tilt 180°, swing 180° side-to-side and rotate from landscape to portrait. Minor assembly required. Supports 20 lb. load capacity. No maximum monitor width.

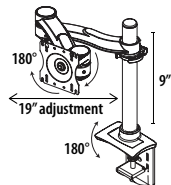

Single Screen Double Extension Arm

MON1SDE	-- x -- x --	125	7.50	1.20	\$569
---------	--------------	-----	------	------	--------------

Double extension allows 19" of horizontal back and forth movement. Arm folds back to post for more desk space. Displays are able to tilt 180°, swing 180° side-to-side and rotate from landscape to portrait. Minor assembly required. Supports 20 lb. load capacity. No maximum monitor width.

Required Specifications

Finish

MONITOR ARMS

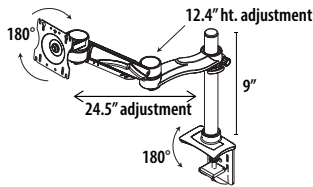

Single Screen Double Extension Arm w/Height Adjustment

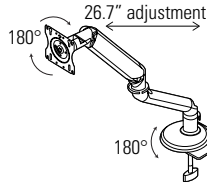

Single Screen Double Extension Arm - Light Duty

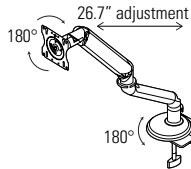

Single Screen Double Extension Arm - Medium Duty

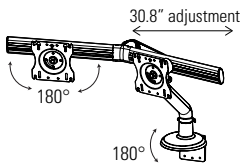

Dual Screen Double Extension Arm

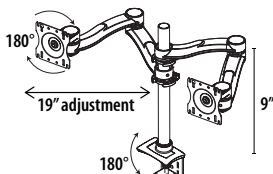

Dual Screen Double Extension Arm

MODEL#	DIMENSIONS D x W x H	FREIGHT CLASS	WT./LBS.	CUBIC FT.	LIST PRICE
MON1SDEH	29.3 x 9.5 x 12.5	125	8.20	1.10	\$684
Counterbalanced arm provides an additional 12.4" of height adjustment. Double extension allows 24.5" of horizontal back and forth movement. Easy to use Allen wrench allows user to adjust the counterbalance mechanism for easy movement of the monitor. Displays are able to tilt 180°, swing 180° side-to-side and rotate from landscape to portrait. Cable manager comes on extension arm and hides all cables. Minor assembly required. Supports 20 lb. load capacity. No maximum monitor width.					
M7750LD	5.5 x -- x --	100	10.34	1.12	\$782
For use with monitors weighing 5 to 20 lbs. Adjustable counterbalance provides free floating fingertip control. Maximum of 26.7" extension from rear of desk to back of monitor; folds to 4.5". Monitor can rotate 180° for portrait or landscape viewing with -90° to 45° tilt adjustment. Integral monitor weight adjustment gauge. Aluminum die cast construction. VESA plate edge clamp and grommet mount included. Silver finish. Some assembly required. Supports 20 lb. load capacity. No maximum monitor width. • Also available in Black finish #M7750LDB or White finish #M7750LDW.					
M7755MD	5.5 x -- x --	100	10.34	1.12	\$834
For use with monitors weighing 10 to 30 lbs. Adjustable counterbalance provides free floating fingertip control. Maximum of 26.7" extension from rear of desk to back of monitor; folds to 4.5". Monitor can rotate 180° for portrait or landscape viewing with -90° to 45° tilt adjustment. Integral monitor weight adjustment gauge. Aluminum die cast construction. VESA plate edge clamp and grommet mount included. Silver finish. Some assembly required. Supports 20 lb. load capacity. No maximum monitor width. • Also available in Black finish #M7755MDB or White finish #M7755MDW.					
M7760DSS	26 x 8.4-30.75 x 24.4	92.5	14.75	1.3	\$1081
For use with monitors weighing 6 to 28 lbs. total and maximum width of 24" diagonal. Adjustable counterbalance provides free floating fingertip control. Maximum of 30.8" extension from rear of desk to back of monitor; folds to 8.4". Monitor can rotate 180° for portrait or landscape viewing with -90° to 45° tilt adjustment. Integral monitor weight adjustment gauge. Aluminum die cast construction. VESA plate edge clamp and grommet mount included. Silver finish. Some assembly required. Supports 20 lb. load capacity. No maximum monitor width. • Also available in Black finish #M7760DSB or White finish #M7760DSW.					
MON2SDE	-- x -- x 12.5	100	10.70	1.20	\$1006
For dual monitor applications. 32" maximum monitor width. Supports a 20lb. load capacity per screen. Double extension arms reach out up to 19". Top of mounting pole is 12.5" from worksurface. Easy to use Allen wrench allows user to adjust the counterbalance mechanism for easy movement of the monitor. Displays are able to tilt 180°, swing 180° side-to-side and rotate from landscape to portrait. Minor assembly required.					

Required Specifications
Finish

MONITOR ARMS

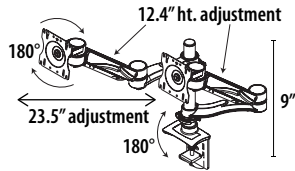

Dual Screen Double Extension Arm with Height Adjustment

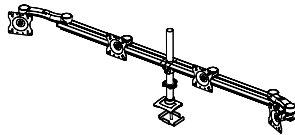

Parabolic Quad Screen Beam Mount*

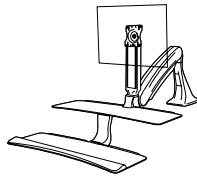

Single Screen Sit-Stand Workstation with Keyboard Tray and Shelf

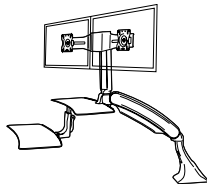

Dual Screen Sit-Stand Workstation with Keyboard Tray and Shelf

MODEL# DIMENSIONS FREIGHT CLASS WT./LBS. CUBIC FT. LIST PRICE

MODEL#	D x W x H	FREIGHT CLASS	WT./LBS.	CUBIC FT.	LIST PRICE
MON2SDEH	-- x -- x 12.5	150	6	1.20	\$1247

For dual monitor applications. 35" maximum monitor width. Supports a 20 lb. load capacity per screen. Counterbalanced arms provide an additional 12.4" of height adjustment. Double extension arms reach out up to 23.5". Easy to use Allen wrench allows user to adjust the counterbalance mechanism for easy movement of the monitor. Displays are able to tilt 180°, swing 180° side-to-side and rotate from landscape to portrait. Cable manager comes on extension arm and hides all cables. Minor assembly required. Supports 20 lb. load capacity.

MONQSBM	-- x -- x --	65	18.30	.70	\$1630
---------	--------------	----	-------	-----	---------------

Supports four monitors. Two outside single extension arms tilt 180° and swing 180° side-to-side. All displays can be rotated from landscape to portrait. Beam is 63.9"w. Minor assembly required. Supports 20 lb. load capacity. 21" maximum monitor width. Bracket for grommet mount only included.

M6011WS	28 x -- x --	125	36	4.8	\$3314
---------	--------------	-----	----	-----	---------------

Desktop edge (rear, side or corner) or grommet mount on 24" or 30" deep worksurfaces. Transition between seated and standing positions, HFES compliant. Over 22" of gas assisted height adjustment plus independent height adjustable mechanism for the keyboard tray. Additional 9.5" of independent counterbalance height adjustment for the monitor. 45° of tilt and 90° of portrait to landscape rotation. Monitor weight limit from 5 to 25 lbs. Silver/Grey (SG) finish. Assembly required.

- Also available in **Black/Black (B/B) finish** #M6011WSBB or **White/Grey (WG) finish** #M6011WSWG.

M6021WS	28 x -- x --	100	42	4.8	\$3670
---------	--------------	-----	----	-----	---------------

Desktop edge (rear, side or corner) or grommet mount on 24" or 30" deep worksurfaces. Transition between seated and standing positions, HFES compliant. Over 22" of gas assisted height adjustment plus independent height adjustable mechanism for the keyboard tray. Additional 9.5" of independent counterbalance height adjustment for the monitor. 45° of tilt and 90° of portrait to landscape rotation. Accommodates most 24" monitors weighing up to 8 lbs. each and offers independent screen adjustments. Silver/Grey (SG) finish. Assembly required.

- Also available in **Black/Black (B/B) finish** #M6021WSBB or **White/Grey (WG) finish** #M6021WSWG.

Required Specifications

Finish*

KEYBOARD TRAYS

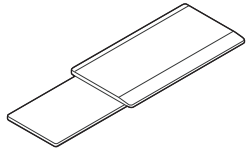

Tray with Sliding Mouse Support

MODEL#	DIMENSIONS D x W x H	FREIGHT CLASS	WT/LBS.	CUBIC FT.	LIST PRICE
KT01	10.5 x 21.3 x 2	70	7	.40	\$277

Mouse surface slides below support for left or right mouse positioning. Keyboard surface is 21" w x 11" d. Mouse surface extends 9" beyond the side of the tray. Compatible with all Global keyboard mechanisms. ABS plastic tray and sliding mouse tray.

- **Specify mechanism separately (see next page)**

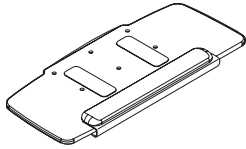

27" HDPE Tray

KT27M02	11.5 x 27.5 x .38	70	6	.40	\$357
---------	-------------------	----	---	-----	--------------

Allows mouse to be easily positioned at the same height as, and to the left or right of, the keyboard. Palm rest is easily removable. Includes anti-slip strips. High Density Polyethylene (HDPE) surface material. SSU palm rest. Compatible with all Global keyboard mechanisms.

- **Specify mechanism separately (see next page)**

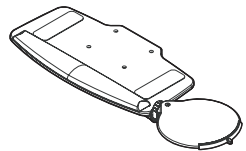

Tray with Height Adjustable Mouse Support - Black

KTMT03	11.5 x 23 x 2.8	100	5.80	.60	\$385
--------	-----------------	-----	------	-----	--------------

Low profile tray with highly adjustable Mouse Support that allows the user to position the mouse surface according to their needs and preferences. Mouse support features include: height adjustment, swivel and tilt. User can easily mount on left or right side of keyboard tray, easily swivel and adjust the height position to maintain neutral postures, and independently adjust the mouse surface tilt so mouse stays on the support when the keyboard tray is tilted. Compatible with all Global keyboard mechanisms. Palm rest is easily removable. Includes Mouse Fence with Cable Manager and anti-slip strips. Keyboard tray is 20.5" w x 11" d and mouse support is 11" in diameter. Tray support material is a compact phenolic panel; mouse tray in ABS plastic. Plug-in gel-feel foam palm rest.

- **Specify mechanism separately (see next page)**

KEYBOARD MECHANISMS

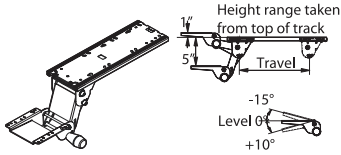

Soft Touch Keyboard Support Mechanism

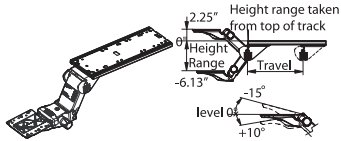

Lift-N-Lock Keyboard Support Mechanism

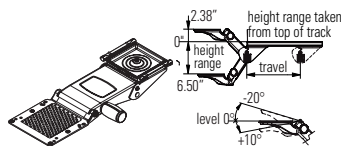

Slim Fit Keyboard Support Mechanism

MODEL# DIMENSIONS FREIGHT CLASS WT./LBS. CUBIC FT. LIST PRICE

	D x W x H				
KSM01-21	23.8 x 9 x 4.3	85	9.20	.70	\$275
KSM01-18	19.7 x 7.4 x 3.6	85	7.60	.60	\$275
KSM01-12	13 x 5 x 2.4	85	5.10	.40	\$275

Soft Touch knob for simultaneous height and tilt adjustment. Spring-assist mechanism. Compatible with all Global keyboard mechanisms. Good for single users who do not adjust their keyboard often.

- KSM01-21 requires 21.75" of depth clearance under the surface for installation.
- KSM01-18 requires 18" of depth clearance under the surface for installation.
- KSM01-12 requires 12" of depth clearance under the surface for installation.
- **Specify keyboard tray separately (see previous page)**

KSM02-21	23.8 x 9 x 9.7	85	9.70	.70	\$361
KSM02-18	19.7 x 7.4 x 8.2	85	8	.60	\$361
KSM02-12	13 x 5 x 5.4	85	5.40	.40	\$361

Knobless height adjustment and independent tilt adjustment. Locks automatically into position with release of tray. Compatible with all Global keyboard mechanisms. Good for single users who frequently change positions and for multiple users.

- KSM02-21 requires 21.75" of depth clearance under the surface for installation.
- KSM02-18 requires 18" of depth clearance under the surface for installation.
- KSM02-12 requires 12" of depth clearance under the surface for installation.
- **Specify keyboard tray separately (see previous page)**

Black:					
KSFK-21	17.5 x 7.5 x 4.75	70	9	.60	\$361
KSFK-18	17.5 x 7.5 x 4.75	70	8.30	.50	\$361
KSFK-12	17.5 x 7.5 x 4.75	85	7.30	.50	\$361

Warm White:					
KSFK-21-W	17.5 x 7.5 x 4.75	85	9	0.7	\$429

Super slim profile accommodates leg clearance requirements of more users. Knobless height adjustment and independent tilt adjustment. Height and depth indicators together in dashboard. Compatible with all Global keyboard mechanisms. Good for single users who frequently change positions and for multiple users. Swivels 360°.

- KSFK-21 requires 21.75" of depth clearance under the surface for installation.
- KSFK-18 requires 18" of depth clearance under the surface for installation.
- KSFK-12 requires 12" of depth clearance under the surface for installation.
- **Specify keyboard tray separately (see previous page)**

KEYBOARD MECHANISMS

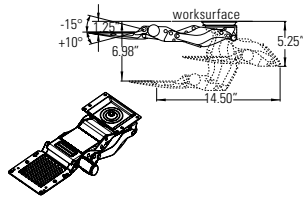

Trackless Keyboard Support Mechanism

MODEL# DIMENSIONS FREIGHT CLASS WT/LBS. CUBIC FT. LIST PRICE

D x W x H

Black:						
KSTRKLS-B	14.5 x 7.5 x 5.25	70	6	0.3	\$506	

Super slim profile trackless keyboard mechanism designed to fit worksurfaces such as height adjustable tables and benching systems, where space is limited and conventional track mounted keyboard mechanisms will not fit. Knobless height adjustment and independent tilt adjustment. Compatible with all Global keyboard trays.

- **Specify keyboard tray separately (see previous page)**

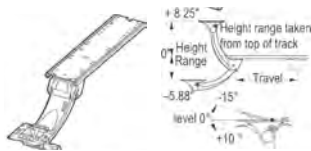

Lift-N-Lock Sit-Stand Mechanism

KSM03-21	23.8 x 9 x 9.7	85	11.80	.90	\$579
KSM03-18	19.7 x 7.4 x 8	85	9.70	.70	\$579
KSM03-12	13 x 5 x 5.3	85	6.50	.50	\$579

Ergonomic support for both seated and standing positions. Curved neck allows user closer access to the desk. Compatible with all Global keyboard mechanisms. Recommended for single users who alternate between sitting and standing.

- KSM03-21 requires 21.75" of depth clearance under the surface for installation.
- KSM03-18 requires 18" of depth clearance under the surface for installation.
- KSM03-12 requires 12" of depth clearance under the surface for installation.
- **Specify keyboard tray separately (see previous page)**

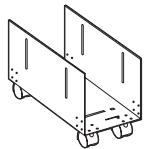

CPU Holder on Casters

PCPU-HC	15 x 5 x 10.37	70	8	.45	\$190
---------	----------------	----	---	-----	--------------

Adjusts 5" - 9" in width. Front locking casters. Assembly hardware included. Height without CPU is 10.4". Depth without CPU is 15". Black only.

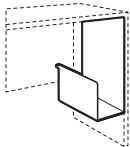

Power Park CPU Holder

PCPU-HO	15 x 5-11 x 18	92.5	11.50	1.06	\$166
---------	----------------	------	-------	------	--------------

Desk mounted CPU Holder. Adjusts 5" - 11" in width. Mounting hardware included. Height without CPU is 18". Depth without CPU is 15". Black only.



CPU Holder on Glide Track

PCPU-GT	-- x -- x --	100	12.60	1.40	\$412
---------	--------------	-----	-------	------	--------------

Accepts tower CPUs with widths from 3.5" to 9.3" and heights from 12.5" to 22.5". 17" glide track and 360° swivel for easy access to rear of CPU. Steel and engineered resin construction.

TASK LIGHTING

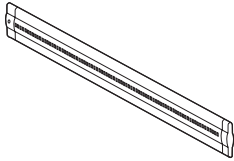

LED Task Light

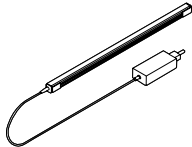

Starter LED Task Light

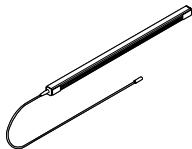

Add-On LED Task Light

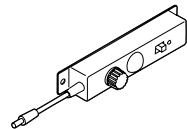

Occupancy Sensor

MODEL# DIMENSIONS FREIGHT CLASS WT/LBS. CUBIC FT. LIST PRICE

D x W x H

PLED30	1.5 x 15.5 x .5	150	2	.50	\$494
PLED50	1.5 x 23.5 x .5	150	2	.50	\$569
PLED100	1.5 x 43.5 x .5	125	3	.50	\$660

Energy efficient LED. Ultra slim design. Suitable for hanging under hutch or wallhung units. 6' power cord.

PLEDS240	0.94 x 22.9 x .79	70	2.5	0.13	\$243
PLEDS360	0.94 x 33.5 x .79	70	2.8	0.16	\$280
PLEDS480	0.94 x 45.5 x .79	70	3.2	0.21	\$311

Undercabinet slim profile LED linear light fixture with lens and On/Off switch. May be used as stand-alone or extended with add-on section below (PLEDAxxx). Plug-in power supply with 72" cord length plus 78" DC cable. Includes magnetic mounting brackets for both steel and laminate units; for laminate units, additional mounting plates are required and included. Light enclosure in clear anodizing finish. Color temperature cool white 4000K. Lifespan rated 30,000 hours.

	PLEDS240	PLEDS360	PLEDS480
Nominal size	24"W	36"W	48"W
Number of LEDs	36	54	72
Total light output (lumens)	580	780	1150
Power input per light (watts)	9	13.5	18

PLEDA240	0.94 x 22.9 x .79	70	2.5	0.13	\$199
PLEDA360	0.94 x 33.5 x .79	70	2.8	0.16	\$236
PLEDA480	0.94 x 45.5 x .79	70	3.2	0.21	\$267

Undercabinet slim profile LED linear add-on light fixture with lens. Daisy chain unit with 39" linking cable, no power supply. Add-on units can only be linked up to a total of 48 watts per power supply; this is equivalent to 10 feet of nominal length of light per power supply. Includes magnetic mounting brackets for both steel and laminate units; for laminate units, additional mounting plates are required and included. Light enclosure in clear anodizing finish. Color temperature cool white 4000K. Lifespan rated 30,000 hours.

	PLEDA240	PLEDA360	PLEDA480
Nominal size	24"W	36"W	48"W
Number of LEDs	36	54	72
Total light output (lumens)	580	780	1150
Power input per light (watts)	9	13.5	18

PLEDOS	0.93 x 4.4 x 1.3	70	0.40	0.01	\$98
--------	------------------	----	------	------	-------------

Inline add-on controller for dimming and occupancy sensor.

TASK LIGHTING	MODEL#	DIMENSIONS	FREIGHT CLASS	WT/LBS.	CUBIC FT.	LIST PRICE
		D x W x H				
	Mounting Options for Voyage and Revo Lights:					
	Freestanding Base (FS)					
	Freestanding Base with USB charge port (FSUSB) - Add \$104 .					
	Surface Mount (SM)					
	Clamp Mount (CM)					

REVO + VOYAGE	MODEL#	DIMENSIONS	FREIGHT CLASS	WT/LBS.	CUBIC FT.	LIST PRICE
---------------	--------	------------	---------------	---------	-----------	------------

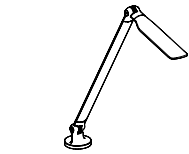

Voyage - Single Arm

LINLAMPS	6 x 6 x 14.1	60	2.66	.01	\$672
----------	--------------	----	------	-----	--------------

Fully articulating body with single arm. 6' power cord. Touch and hold dimming capability, with auto shut-off after 10 hours. Brightness adjustment from 100% to 15%. 18 fractional LEDs, 337 lumens, 3500K color temperature. 85 CRI. 94% post consumer recyclability by weight. Available in Black (BLK), White (WHT) and Silver (SLV). Mounting accessories sold separately (see above). Optional integrated USB port in base (**FSUSB**) allows for charging of mobile devices.

- Occupancy Sensor (**OS**) - Add **\$78**

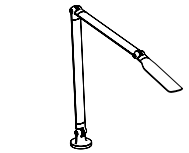

Voyage - Double Arm

LINLAMPD	6 x 6 x 21.6	60	2.66	.01	\$688
----------	--------------	----	------	-----	--------------

Fully articulating body with double arm. 6' power cord. Touch and hold dimming capability, with auto shut-off after 10 hours. Brightness adjustment from 100% to 15%. 18 fractional LEDs, 337 lumens, 3500K color temperature. 85 CRI. 94% post consumer recyclability by weight. Available in Black (BLK), White (WHT) and Silver (SLV). Mounting accessories sold separately (see above). Optional integrated USB port in base (**FSUSB**) allows for charging of mobile devices.

- Occupancy Sensor (**OS**) - Add **\$78**

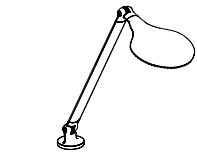

Revo - Single Arm

RNDLAMPS	6 x 6 x 14.1	60	2.66	.01	\$672
----------	--------------	----	------	-----	--------------

Fully articulating body with single arm. 6' power cord. Touch and hold dimming capability, with auto shut-off after 10 hours. Brightness adjustment from 100% to 15%. 18 fractional LEDs, 294 lumens, 3500K color temperature. 85 CRI. 94% post consumer recyclability by weight. Available in Black (BLK), White (WHT) and Silver (SLV). Mounting accessories sold separately (see above). Optional integrated USB port in base (**FSUSB**) allows for charging of mobile devices.

- Occupancy Sensor (**OS**) - Add **\$78**

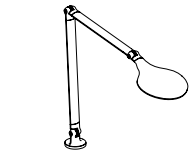

Revo - Double Arm

RNDLAMPD	6 x 6 x 21.6	60	2.66	.01	\$688
----------	--------------	----	------	-----	--------------

Fully articulating body with double arm. 6' power cord. Touch and hold dimming capability, with auto shut-off after 10 hours. Brightness adjustment from 100% to 15%. 18 fractional LEDs, 294 lumens, 3500K color temperature. 85 CRI. 94% post consumer recyclability by weight. Available in Black (BLK), White (WHT) and Silver (SLV). Mounting accessories sold separately (see above). Optional integrated USB port in base (**FSUSB**) allows for charging of mobile devices.

- Occupancy Sensor (**OS**) - Add **\$78**

Required Specifications

Finish
Mount

Optional Specifications

Occupancy Sensor

POWER/DATA

MODEL# DIMENSIONS FREIGHT CLASS WT/LBS. CUBIC FT. LIST PRICE HP ADD



Cable Snake

D x W x H	
PCSN01	2 x 3 x 31.25 92.5 2.10 .20 \$135

Flexible cable management. Provides access to power/data from floor to underside of worksurface where it attaches. Two pathways within Cable Snake. Silver (**SIL**) plastic only.

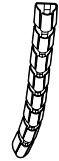

Cable Snake Extension

PCSN01E	- x - x - 92.5 2.1 0.2 \$108
---------	-------------------------------------

Extension kit to use with cable snake PCSN01. Additional 8 links extend cable snake up to 49" in length. Ideal for height adjustable tables. Silver plastic only.

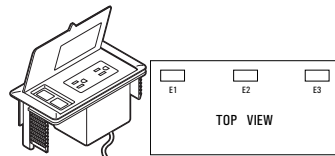

Power/Data Block

PMSPDM	3.5 x 6.5 x 2.75 70 2 .10 \$330
--------	--

Worksurface power and data module. Two power receptacles and two data receptacles. Specify position and add **\$88** for cut-out in worksurface. See diagram E1/E2/E3 for specification location. Black (**BLK**) only.



Mini Adapt Power Module

PEUTEM	3 x 3.8 x 2 70 1 .18 \$221
--------	-----------------------------------

Two power receptacles. Attaches to edge of table or desk through grommet hole. 6' black cord. Black (**BLK**) only.

POWER TOWERS

MODEL# DIMENSIONS FREIGHT CLASS WT/LBS. CUBIC FT. LIST PRICE

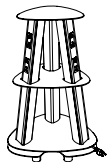

Isle Power Tower

PTISL96GB	18 x 18 x 25.5 92.5 68 6.50 \$2768
PTISL96GW	18 x 18 x 25.5 92.5 68 6.50 \$2768
PTISL96SP	18 x 18 x 25.5 92.5 68 6.50 \$2768

Includes twelve (12) 110V power outlets and six (6) rapid charge USB ports. 9' cord with molded plug. Available in Gloss Black (**GB**), Gloss White (**GW**) and Silver Pearl (**SP**) as indicated by last letter of model number.

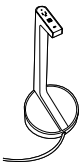

Vesta Portable Power Tower

PPVST1WF	12 x 12 x 28.25 250 10 4.30 \$2239
----------	---

Includes one 110V power outlet, two USB-A and one USB-C charging ports. 10' cord with plug. Matte White finish with Fog inserts.

Required Specifications

Finish

POWER / DATA

MODEL# DIMENSIONS FREIGHT CLASS WT./LBS. CUBIC FT. LIST PRICE

D x W x H

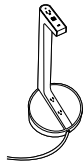

Vesta Portable Power Tower

PPVST3WF	12 x 12 x 28.25	250	10	4.30	\$2239
----------	-----------------	-----	----	------	---------------

Includes three 110V power outlets (one on top, two on base), two USB-A and one USB-C charging ports. 10' cord with plug. Matte White finish with Fog inserts.

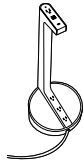

Vesta Portable Power Tower

PPVST4WF	12 x 12 x 28.25	250	10	4.30	\$2239
----------	-----------------	-----	----	------	---------------

Includes four 110V power outlets (one on top, three on base), two USB-A and one USB-C charging ports. 10' cord with plug. Matte White finish with Fog inserts.

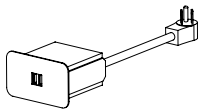

Cove Mini - Charging USB

COV-SM-U-_-108	--	70	1.5	.25	\$378
----------------	----	----	-----	-----	--------------

Retrofits into any AG or POG grommet cutout (grommet cover must be removed). Includes two 2.1 AMP USB charging ports. Requires 2" clearance below the worksurface. 9' black cord.

- This unit utilizes the entire grommet, eliminating available wire pass thru
- Replace _ with **B** for **Black**
- Replace _ with **S** for **Silver**

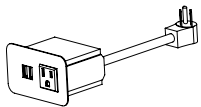

Cove Mini - Power & Charging USB

COV-SM-1U-_-108	--	70	1.5	.25	\$402
-----------------	----	----	-----	-----	--------------

Retrofits into any AG or POG grommet cutout (grommet cover must be removed). Includes one power outlet and two 2.1 AMP USB charging ports. Requires 2" clearance below the worksurface. 9' black cord.

- This unit utilizes the entire grommet, eliminating available wire pass thru
- Replace _ with **B** for **Black**
- Replace _ with **S** for **Silver**

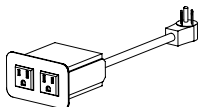

Cove Mini - Power

COV-SM-2-_-108	--	70	1.5	.25	\$249
----------------	----	----	-----	-----	--------------

Retrofits into any AG or POG grommet cutout (grommet cover must be removed). Includes two power outlets. Requires 2" clearance below the worksurface. 9' black cord.

- This unit utilizes the entire grommet, eliminating available wire pass thru
- Replace _ with **B** for **Black**
- Replace _ with **S** for **Silver**

Required Specifications

Finish

POWER / DATA

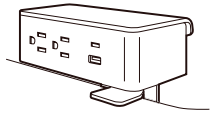

Clamp Mount 2 Power/USB-A&C



Under Mount 2 Power/USB-A&C

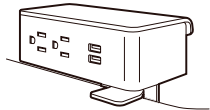

Clamp Mount 2 Power/2 USB-A



Under Mount 2 Power/2 USB-A

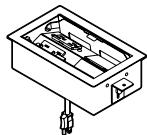

Voice/Data Block

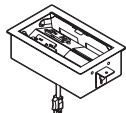

Power/USB Block

MODEL# DIMENSIONS FREIGHT CLASS WT./LBS. CUBIC FT. LIST PRICE

D x W x H

PS3525057	3.2 x 5.5 x 3	60	3.01	0.2	\$500
PS3525002	3.2 x 5.5 x 3	60	3.01	0.2	\$500

Ashley Duo clamp mount power module with two 15 amp 120 Volt AC receptacles; 2.4 amp USB-A port and 60 watt USB-C power delivery port, 10' power cord with molded plug, UL listed. Clamp accommodates worksurfaces 0.5" to 1.5" thick; fastened with thumb screws.

- PS3525057 - White module with Silver bracket.
- PS3525002 - Black module with Silver bracket

PS3526057	2.8 x 5.5 x 1.8	60	3.2	0.2	\$500
PS3526002	2.8 x 5.5 x 1.8	60	3.2	0.2	\$500

Ashley Duo under mount power module with two 15 amp 120 Volt AC receptacles; 2.4 amp USB-A port and 60 watt USB-C power delivery port, 10' power cord with molded plug, UL listed. Mountable under most worksurfaces. Installation template provided.

- PS3526057 - White module with Silver bracket
- PS3526002 - Black module with Silver bracket.

PS305057	3.2 x 5.5 x 3	60	3.01	0.05	\$386
PS305002	3.2 x 5.5 x 3	60	3.01	0.05	\$386

Ashley Duo clamp mount power module with two 15 amp 120 Volt AC receptacles and two 2.1 amp USB ports. Includes 10' power cord with NEMA plug. Edge clamp accommodates worksurfaces 0.5" to 1.5" thick; fastened with thumb screws.

- PS305057 - White module with Silver bracket.
- PS305002 - Black module with Silver bracket

PS305157	2.8 x 5.5 x 1.8	60	3.2	0.05	\$335
PS305102	2.8 x 5.5 x 1.8	60	3.2	0.05	\$335

Ashley Duo under mount power module with two 15 amp 120 Volt AC receptacles and two 2.1 amp USB ports. Includes 10' power cord with NEMA plug. Mountable under most worksurfaces. Installation template provided.

- PS305157 - White module with Silver bracket
- PS305102 - Black module with Silver bracket.

PLRTM202B	11 x 6.8 x 3.5	92.5	7	0.67	\$617
PLRTM202T	11 x 6.8 x 3.5	92.5	7	0.67	\$617

Power only included, specify telecom options separately. Includes four simplex outlets on top and one on bottom. 10' cord. Includes two telecom knockouts. Available in Black (**B**) and Tungsten (**T**) - indicated by last letter of model number. Surface access door. Cut-out option **U1**, **U2** or **U3** to be specified when ordering. Available on Zira Boardroom, Kadin and Zook tables only.

PM202USBB	11 x 6.8 x 3.5	92.5	7	0.67	\$863
PM202USBT	11 x 6.8 x 3.5	92.5	7	0.67	\$863

Power module with recessed doors. Includes: one duplex with two AC outlets and one duplex with two AC outlets and two USB-A charging ports), two telecom knockouts and one simplex convenience plug on the bottom. 10' power cord. Available in Black (**B**) and Tungsten (**T**) as indicated by the last character in the model number. Duplexes are white only. Corresponding cut out options are **U1**, **U2** or **U3**. Units are not approved for daisy chaining.

Required Specifications

Finish

POWER / DATA - COVE MINI

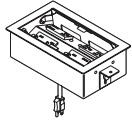

Power/USB Block

MODEL#	DIMENSIONS D x W x H	FREIGHT CLASS	WT/LBS.	CUBIC FT.	LIST PRICE
PFPD400RB	11 x 6.8 x --	92.5	7	0.67	\$882
PFPD400RT	11 x 6.8 x --	92.5	7	0.67	\$882

Power module with recessed doors. Includes four duplexes: two AC only duplexes and two AC with USB duplexes (each with two AC outlets and two USB-A charging ports) and one simplex on the bottom. In total eight AC outlets, four USB-A and one convenience plug on the bottom of the unit. 10' power cord. Available in Black (**B**) or Tungsten (**T**) as indicated by the last character of the model number. Duplexes are white only. Corresponding cut-out options are **U1**, **U2** or **U3**. Units are not approved for daisy chaining

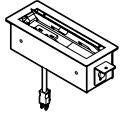

Voice/Data Block

PLRTM101B	11 x 4.3 x 3.5	125	4.65	0.67	\$531
PLRTM101T	11 x 4.3 x 3.5	125	4.65	0.67	\$531

Power only included, specify telecom options separately. Includes two simplex outlets on top and one on bottom. 10' cord. Includes one telecom knockout. Available in Black (**B**) and Tungsten (**T**) - indicated by last letter of model number. Surface access door. Cut-out option **K1**, **K2** or **K3** to be specified when ordering.

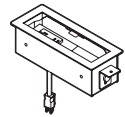

Power/USB Block

PM101USBB	11 x 4.3 x 3.5	70	6	0.3	\$653
PM101USBT	11 x 4.3 x 3.5	70	6	0.3	\$653

Power module with recessed door. Includes one duplex with two AC outlets and two USB-A charging ports, one telecom knockout and one simplex convenience plug on the bottom of the unit. 10' power cord. Available in Black (**B**) or Tungsten (**T**) as indicated by the last character in the model number. Duplex is white only. Corresponding cut out options are **K1**, **K2** or **K3**. Units are not approved for daisy chaining.

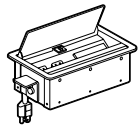

Power/Data Block

PLCTM101B	9 x 5.5 x -	70	6	0.3	\$279
PLCTM101T	9 x 5.5 x -	70	6	0.33	\$279

Power only included, specify telecom options separately, see above. Includes two simplex outlets on top and one on bottom. 10' cord. Includes one telecom knockout. Available in Black (**B**) and Tungsten (**T**) - indicated by last letter of model number. Surface access door. Cut-out option **A1**, **A2** or **A3** to be specified when ordering.

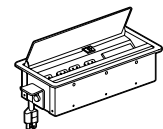

Power/Data Block

PLCTM102B	12 x 5.5 x -	125	5	0.67	\$402
PLCTM102T	12 x 5.5 x -	125	5	0.67	\$402

Power only included, specify telecom options separately, see above. Includes four simplex outlets on top and one on bottom. 10' cord. Includes one telecom knockout. Available in Black (**B**) and Tungsten (**T**) - indicated by last letter of model number. Surface access door. Cut-out option **J1**, **J2** or **J3** to be specified when ordering.

Required Specifications

Finish

POWER / DATA

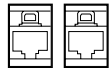

Telecom Plate - 2 x 6

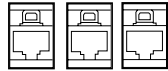

Telecom Plate - 3 x 6

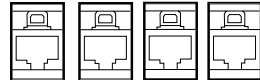

Telecom Plate - 4 x 6

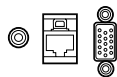

Telecom Plate - 3TSV

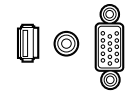

Telecom Plate - 3SVH

MODEL# DIMENSIONS FREIGHT CLASS WT/LBS. CUBIC FT. LIST PRICE

D x W x H

PTEL01	- x - x -	70	0.01	0.05	\$164
--------	-----------	----	------	------	--------------

Includes 2 x RJ45 cat 6 data. Black telecom plate. To be hardwired by data contractor.

PTEL02	- x - x -	70	0.01	0.05	\$222
--------	-----------	----	------	------	--------------

Includes 2 x RJ45 cat 6 data and 1 RJ11 cat phone. Black telecom plate. To be hardwired by data contractor.

PTEL03	- x - x -	70	0.01	0.05	\$340
--------	-----------	----	------	------	--------------

Includes 4 x RJ45 cat 6 data. Black telecom plate. To be hardwired by data contractor.

PTEL04	- x - x -	70	0.01	0.05	\$290
--------	-----------	----	------	------	--------------

Includes 1 x RJ45 cat 6 data, mini stereo and 15 pin HD VGA. Black telecom plate. To be hardwired by data contractor.

PTEL05	- x - x -	70	0.01	0.05	\$401
--------	-----------	----	------	------	--------------

Includes mini stereo, 15 pin HD VGA and HDMI. Black telecom plate.

WIRE MANAGEMENT

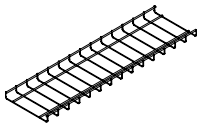

Power/Data Cable Basket

MODEL# DIMENSIONS FREIGHT CLASS WT/LBS. CUBIC FT. LIST PRICE

BRTCB76KIT	8 x 34 x 1	70	1.56	.15	\$239
BRTCB70	8 x 70 x 1	100	3.22	.34	\$173
BRTCB64	8 x 64 x 1	92.5	2.94	.29	\$161
BRTCB58	8 x 58 x 1	92.5	2.66	.26	\$156
BRTCB52	8 x 52 x 1	100	2.39	.24	\$147
BRTCB46	8 x 46 x 1	92.5	2.16	.21	\$139
BRTCB40	8 x 40 x 1	70	1.80	.18	\$131
BRTCB34	8 x 34 x 1	70	1.56	.15	\$126
BRTCB28	8 x 28 x 1	70	1.20	.13	\$111
BRTCB22	8 x 22 x 1	70	1.01	.10	\$104
BRTCB16	8 x 16 x 1	70	.73	.07	\$98
BRTCB8	8 x 8 x 1	70	.36	.03	\$88

Shallow, 8" wide basket manages cable excess and serves to manage cords and cables. It can be easily unclipped from spring steel brackets (included) to rearrange cable connections from below worksurface. Spring steel brackets can suspend the Cable Basket below the worksurface where it keeps the cords and cables off the floor and manages them along the horizontal plane - between floor monuments and Storage Vertical Cable Manager, for example. Tall storage cabinet's legs provide easy access to the Cable Basket where it can easily be unclipped from spring steel brackets to rearrange cable connections. Steel wire construction, chrome finish baskets; black spring steel hanging brackets, fasteners.

Required Specifications

Finish

POWER / DATA

MODEL# DIMENSIONS FREIGHT CLASS WT/LBS. CUBIC FT. LIST PRICE

D x W x H

PEWM5.5	2 x 66 x 2	70	.60	.10	\$198
PEWM5	2 x 60 x 2	70	.60	.10	\$166
PEWM4.5	2 x 54 x 2	70	.50	.10	\$148
PEWM4	2 x 48 x 2	70	.50	.10	\$135
PEWM3.5	2 x 42 x 2	70	.40	.10	\$116
PEWM3	2 x 36 x 2	70	.40	.10	\$104
PEWM2.5	2 x 30 x 2	70	.30	.10	\$85
PEWM2	2 x 24 x 2	70	.30	.10	\$70
PEWM1.5	2 x 18 x 2	70	.20	.10	\$55
PEWM1	2 x 12 x 2	70	.20	.10	\$40



Wire Manager

Plastic tray flexes to receive and hold electrical and data wires. Quickly attaches with two strips of double-sided tape. Black (**BLK**) only.

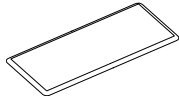

Anti-Fatigue Mat

Polyurethane anti-fatigue mat offers increased comfort and helps reduce strain while standing. Tapered, no-curl edges prevent tripping hazards. Anti-slip backing is suitable for low pile carpet or hard flooring. Black only.

PAFM3018	29.4 x 17.63 x .75	85	4.4	0.3	\$159
PAFM4820	48 x 20 x .75	85	7.7	0.59	\$255



Vertical Wire Manager

PEVWM	2 x 22 x 2	70	.30	.10	\$68
-------	------------	----	-----	-----	-------------

From underside of worksurface to bottom panel. Capable of holding electrical and data wires in a vertical position. Black (**BLK**) only. Attaches with two strips of double-sided tape.



Coat Tree

PCOS2	25 x 25 x 60	300	8	4.67	\$463
PCOS3	25 x 25 x 60	300	8	4.67	\$463

Square tube metal frame, complete with four Chrome double hooks. Adjustable glides. 60" high. Ships UPS.

- 3 per carton
- PCOS2 is finished in Black. PCOS3 is finished in Chrome.



Coat Tree*

PCT	25 x 25 x 65	250	6	3	\$594
-----	--------------	-----	---	---	--------------

Square tube. Complete with four satin brass double hooks. 65" high. Available in the following finishes: Absolute (AAM), Black (BKM), Cherry (ACM), Cherry Latte (CLM), Cocoa Vanilla (CVM), English Oak (EOM), Fruitwood (TFM), Honey (AHM), Gray (HGM), Mahogany (TMM), Maple (AVM), Medium Walnut (MWM), Night (ASM), Sandy Beach (SBM), Walnut (TWM), White (WHM) and Winter Cherry (WCM). Ships UPS.

- 1 per carton

Required Specifications

Finish*

DENVER BOOKCASES

MODEL#

DIMENSIONS

FREIGHT CLASS

WT/LBS.

CUBIC FT.

LIST PRICE

D x W x H

BOOKCASE NOTES

• Available in the following finishes to either match or coordinate with most Global laminate desk series:

- ACJ Absolute Acajou
- ASN Asian Night
- BRC Brushed Cobalt
- DWT Designer White
- HGT Hayden Grey
- SOG Storm Grey
- WHE Walnut Heights
- WHC White Chocolate
- WGY Willow Grey

- Sturdy 36" wide construction.
- All units include fixed and adjustable shelves.
- Standard with Black finish back panel.

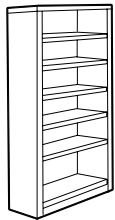

Denver Bookcase - 72" high

ZBC72	12 x 36 x 72	60	101	2.75	\$634
-------	--------------	----	-----	------	--------------

One fixed heavy duty shelf and four adjustable shelves. Shipped RTA (ready to assemble).

- All Denver bookcases are standard with Black finish back panel.

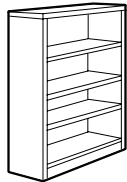

Denver Bookcase - 48" high

ZBC48	12 x 36 x 48	60	71	1.86	\$492
-------	--------------	----	----	------	--------------

Three adjustable shelves. Shipped RTA (ready to assemble).

- All Denver bookcases are standard with Black finish back panel.

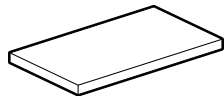

Bookcase Shelf

ZESH	12 x 34 x 1	60	10	.30	\$135
------	-------------	----	----	-----	--------------

Extra shelf for bookcases. 1" thick.

Required Specifications

Laminate finish

BOARDROOM ACCESSORIES	MODEL#	DIMENSIONS	FREIGHT CLASS	WT/LBS.	CUBIC FT.	LIST PRICE
		D x W x H				

CONFERENCE CABINET NOTES

- Visual boards feature a self edge all around.
- Available finishes:

ACJ	Absolute Acajou	ASN	Asian Night	AWC	Avant Cherry	AWH	Avant Honey
BLK	Black	BRC	Brushed Cobalt	DES	Dark Espresso	DWT	Designer White
HGT	Hayden Grey	QTM	Quartered Mahogany	SOG	Storm Grey	TFW	Tiger Fruitwood
TWL	Tiger Walnut	WHC	White Chocolate	WGY	Willow Grey	WCR	Winter Cherry

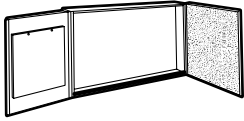

Visual Board*

GVB4848	4 x 48 x 48	85	122	9.25	\$1569
AVB4848	4 x 48 x 48	70	135	9	\$1527

Includes white board and two side opening doors containing cork board on right door and 50-sheet paper writing pad on left door. Marker board can be used for projection. Set of 4 dry markers and eraser included.

- **NOTE:** Care should be taken to mount the units. Units should be mounted to wall studs using correct fasteners. Failure to do so may result in collapse of the unit and subsequent personal injury. **Mounting hardware not included.** Mounting hardware used should be based on wall material. Consult an installation professional for proper wall mounting.

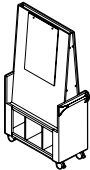

Visual Board*

Z361872VB	36 x 18 x 72	250	187	38.50	\$2735
-----------	--------------	-----	-----	-------	---------------

Angled visual board with paper pad on one side and dry erase board on the opposite side. Unique push handles are standard. Locking casters included. Decorative aluminum trim is standard on the lip of each shelf. Height aligns with 36" buffets. Shipped RTA (ready to assemble).

PENCIL DRAWERS	MODEL#	DIMENSIONS	FREIGHT CLASS	WT/LBS.	CUBIC FT.	LIST PRICE
----------------	--------	------------	---------------	---------	-----------	------------

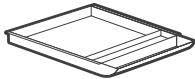

Pencil Drawer

W1624PDR	16 x 24 x 2.25	92.5	5	.50	\$335
W1518PDR	18 x 15 x 2.25	92.5	4	.40	\$253

Black ABS plastic. Provides space for writing instruments and small items at the workspace. Attaches to underside of any 24"D and 30"D worksurface with included roller slides. Shipped RTA (ready to assemble).

- May be used with all casegoods.

Required Specifications

Finish*

CENTER DRAWERS	MODEL#	DIMENSIONS	FREIGHT CLASS	WT/LBS.	CUBIC FT.	LIST PRICE
----------------	--------	------------	---------------	---------	-----------	------------

D x W x H

CENTER DRAWER NOTES

• Center drawers must be dealer or end user installed. Drawers do not fill entire center space opening. Approximate kneespace widths are:

30" x 60" DP	25½"	30" x 66" DP	31½"
30" x 72" DP	37½"	30" x 66"/20" x 40" L	22½"
30" x 66"/24" x 48" L	24½"	36" x 72"/24" x 48" L	30½"

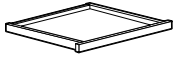

Center Drawer

CD20	18 x 20 x 3	100	8	1	\$198
------	-------------	-----	---	---	--------------

Laminate drawer front is attached to a 4-sided frame. Recommended for use on small L-shaped units, and on 30" x 60" and 30" x 66" desks. Specify finish from list available in each series. **Not available** on StreamLINE series.



Center Drawer

CD28	18 x 28 x 3	150	5	1	\$260
------	-------------	-----	---	---	--------------

Laminate drawer front is attached to a 4-sided frame. Recommended for use on 36" x 72" desks. Specify finish from list available in each series. **Not available** on StreamLINE series.

KEYBOARD DRAWERS	MODEL#	DIMENSIONS	FREIGHT CLASS	WT/LBS.	CUBIC FT.	LIST PRICE
------------------	--------	------------	---------------	---------	-----------	------------

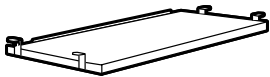

Keyboard Shelf

KS20	11 x 20 x 3.5	92.5	10	1	\$245
------	---------------	------	----	---	--------------

Pull-out laminate shelf. Specify finish from list available in each series.

- **Not available** on StreamLINE or Adaptabilities Series - see page 41 for comparable Adaptabilities option.

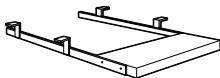

Keyboard Drawer

MPOKL	11 x 24 x 3.5	92.5	10	1	\$253
-------	---------------	------	----	---	--------------

Pull-out laminate drawer. Specify finish from list available in each series.

- **Not available** on StreamLINE or Adaptabilities Series - see page 41 for comparable Adaptabilities option.

ACCESSORIES	MODEL#	DIMENSIONS	FREIGHT CLASS	WT/LBS.	CUBIC FT.	LIST PRICE
-------------	--------	------------	---------------	---------	-----------	------------

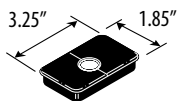

Wire Manager Grommet

AG1	1.875 d x 3.25 w	100	--	--	\$88
AG2					
AG3					

Rectangular **black** surface mount that can be factory installed in any worksurface. Indicate position - left (**AG1**), center (**AG2**) or right (**AG3**). **See individual Series Notes for further details.** To order a grommet cover only, please specify **GEN160-UN** - \$23 list each.



L Bracket

MLB90	4.5 x 1.5	70	1	.01	\$55
-------	-----------	----	---	-----	-------------

Used to attach worksurfaces to end panels. Black only.

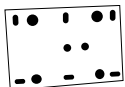

Flat Bracket

CST318	4.5 x 3	70	1	.01	\$51
--------	---------	----	---	-----	-------------

Used as a mending plate to give additional worksurface support. Black only.

Required Specifications

Finish (Drawers)

HANDLES	MODEL#	DIMENSIONS D x W x H	FREIGHT CLASS	WT/LBS.	CUBIC FT.	LIST PRICE
	GEN225-SIL	-- x 5 x --	70	1	.01	\$31
Silver Handle (HV)	<p>Silver finish, square edge handle style. For use on pedestals and all lateral files.</p> <ul style="list-style-type: none"> This handle has a measurement of 96mm center to center. Drawer handles on this page are for purchase. Installation is done by the customer. To purchase as a factory installed option on Zira desks, credenzas and returns, see series notes for option code and price. 					
	GEN225-BLK	-- x 5 x --	70	1	.01	\$31
Matte Black Handle (HU)	<p>Black matte finish, square edge handle style. For use on pedestals and all lateral files.</p> <ul style="list-style-type: none"> This handle has a measurement of 96mm center to center. Drawer handles on this page are for purchase. Installation is done by the customer. To purchase as a factory installed option on Zira desks, credenzas and returns, see series notes for option code and price. 					
	GEN217	-- x 5.25 x --	70	1	.01	\$31
Flared Brass Handle (HW)	<p>Satin brass finish, flared handle style. For use on pedestals and all lateral files.</p> <ul style="list-style-type: none"> This handle has a measurement of 96mm center to center. Drawer handles on this page are for purchase. Installation is done by the customer. To purchase as a factory installed option on Zira desks, credenzas and returns, see series notes for option code and price. 					
	GEN165	-- x 5.25 x --	70	1	.01	\$31
Flared Black Handle (HX)	<p>Black matte finish, flared handle style. For use on pedestals and all lateral files.</p> <ul style="list-style-type: none"> This handle has a measurement of 96mm center to center. Drawer handles on this page are for purchase. Installation is done by the customer. To purchase as a factory installed option on Zira desks, credenzas and returns, see series notes for option code and price. 					
	GEN189-HS	-- x 4.5 x --	70	1	.01	\$31
Flared Silver Handle (HS)	<p>Silver finish, flared handle style. For use on pedestals and all lateral files.</p> <ul style="list-style-type: none"> This handle has a measurement of 96mm center to center. Drawer handles on this page are for purchase. Installation is done by the customer. To purchase as a factory installed option on Zira desks, credenzas and returns, see series notes for option code and price. 					
	GEN190	-- x 4.9 x --	70	1	.01	\$31
Dimpled Nickel Handle (HZ)	<p>Nickel matte finish, dimpled handle style. For use on pedestals and all lateral files.</p> <ul style="list-style-type: none"> This handle has a measurement of 96mm center to center. Drawer handles on this page are for purchase. Installation is done by the customer. To purchase as a factory installed option on Zira desks, credenzas and returns, see series notes for option code and price. 					
	GEN256	-- x 4.75 x --	70	1	.01	\$31
Crescent Black Handle (H0)	<p>Black matte finish, crescent handle style. For use on pedestals and all lateral files.</p> <ul style="list-style-type: none"> This handle has a measurement of 96mm center to center. Drawer handles on this page are for purchase. Installation is done by the customer. To purchase as a factory installed option on Zira desks, credenzas and returns only, see series notes for option code and price. 					

HANDLES

MODEL# DIMENSIONS FREIGHT CLASS WT/LBS. CUBIC FT. LIST PRICE

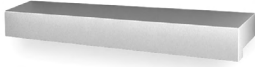

Bar Silver Handle (HQ)

	D x W x H				
CS0003-SIL	-- x 4.6 x --	70	1	.01	\$31

Silver finish, bar handle style **For use on pedestals and all lateral files.**

- This handle has a measurement of 96mm center to center.
- Drawer handles on this page are for purchase. Installation is done by the customer. To purchase as a factory installed option on **Zira desks, credenzas and returns only**, see series notes for option code and price.



Bar Black Handle (HR)

CS0003-BLK	-- x 4.6 x --	70	1	.01	\$31
------------	---------------	----	---	-----	------

Black finish, bar handle style **For use on pedestals and all lateral files.**

- This handle has a measurement of 96mm center to center.
- Drawer handles on this page are for purchase. Installation is done by the customer. To purchase as a factory installed option on **Zira desks, credenzas and returns only**, see series notes for option code and price.

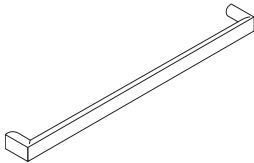

Bridges II Handle

BRH1	-- x 6.375 x --	70	1	.01	\$31
------	-----------------	----	---	-----	------

Silver Finish, square edged handle style. For use on all pedestals and storage cabinets with handles.

- This handle has a measurement of 128mm center to center.
- Drawer handles on this page are for purchase. Installation is done by the customer. To purchase as a factory installed option on **Bridges II pedestals and cabinets only**, see series notes for option code and price.

T TABLE POWER + TECHNOLOGY SOLUTIONS™ - NOTES

- Global is pleased to offer a range of sophisticated electrical and technology options for training and conference tables.
- Worksurface cut-outs for units must be specified separately, please see appropriate product note pages for details.
- Daisy chaining is generally defined as having multiple power units connect to one another from a single electrical infeed source.
- The daisy-chain units below utilize a 4-wire, 2 circuit system (when hardwired by a licensed electrician to a building power source) or can run a single circuit (when utilizing the 42AP1-72 plug and play infeed).
- The following maximums are to National Electric Code (NEC) – some local codes vary from NEC code – it is the customer's responsibility to follow all applicable local codes and guidelines.

Product	Max units per circuit
Villa I	8 units per circuit
Villa II	4 units per circuit
Villa USB	8 units per circuit
Oasis Mini A	3 units per circuit
Oasis Mini B	3 units per circuit

Electrical System

4-2 Wiring Schematic
 4-Wire Shared Neutral
 Complies with National Electric Code
 UL Listed
 All circuits rated for 20 AMP

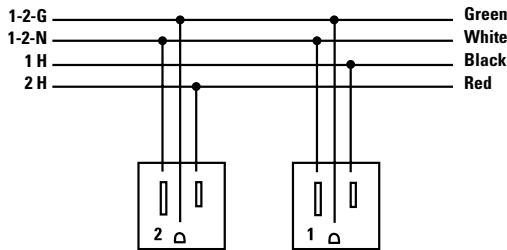

VILLA I, VILLA II AND VILLA USB DETAILS

- Each Villa unit is available two ways. Corded units includes three-prong plugs to connect directly into a standard outlet. DaisyLink kits can be specified separately to daisy-chain multiple units off of a single infeed. Infeeds are specified separately.
- Villa I units include two power outlets and either two knockouts or two data ports included, **all accessible at the surface**.
- Villa II units include two power outlets and either two knockouts for data or two data ports included accessible at the surface. Another two power outlets are **accessible below the surface**.
- Villa USB includes two power outlets, two 2.1 AMP charging USB ports and either two data knockouts or two data ports included, **all accessible at the surface**.

OASIS MINI DETAILS

- Each Oasis Mini (except for Chicago Mini Oasis) is available two ways. Corded units includes three-prong plugs to connect directly into a standard outlet. DaisyLink units must have interconnecting cords specified separately to daisy-chain multiple units off of a single infeed. Infeeds are specified separately.
- Oasis Mini A units includes six power outlets and two telecom plate knockouts
- Oasis Mini B units includes four power outlets and three telecom plate knockouts
- Oasis Mini USB units include six power outlets, two 2.1 AMP charging USB ports and one telecom plate knockouts

TELECOM PLATE DETAILS

- Telecom plates are for use on Oasis Mini units only, providing a means to provide different types of telephone, data and audio visual connections to the worksurface. For every telecom plate knockout on a Oasis Mini unit, please specify one telecom plate. If telecom plates are not required, it is recommended blank telecom plates are specified - see page 518 for details.

EXAMPLE LAYOUTS - TRAINING TABLES

- Single Power Block Kits Available on training tables 36" – 72" (**must specify V2 cut-out on table**):
- Each single block kit includes 1 Power Block and 1 Grommet Cover, 1 Female/Female Interconnecting Cable and 1 Female/Male Interconnecting Cable. Cable clamps for management of these cables are also included.

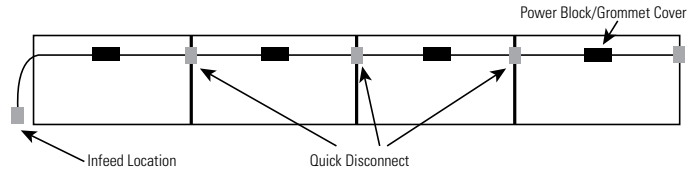

- Double Power Block Kits Available on 60", 66" and 72" (**must specify V1 and V3 cut-out on table**):
- Each double block kit includes 2 Power Blocks and 2 Grommet Covers, 2 Female/Female Interconnecting Cable and 1 Female/Male Interconnecting Cable. Cable clamps for management of these cables are also included.

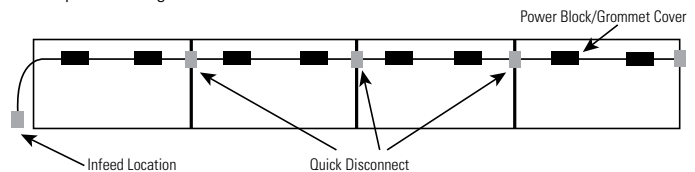

VILLA CUT-OUTS

- Optional Villa cut-out available in standard worksurface locations (left, center or right) **for Rectangular Tables**. Order as: **V1, V2 or V3**. **Add \$88 for each cut-out**.
- Villa cut-outs may be placed at non-standard locations. Please contact customer service.

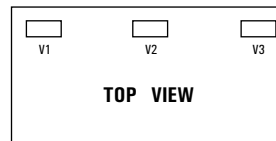

OASIS MINI CUT-OUTS

- Optional Oasis Mini cut-out available in standard worksurface locations (left, center or right) **for Rectangular Tables**. Order as: **M1, M2 or M3**. **Add \$88 for each cut-out**.
- Oasis Mini cut-outs may be placed at non-standard locations. Please contact customer care.
- Oasis Mini is only available on Zira Boardroom Tables**

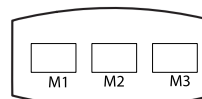

VILLA I, CENTER POSITION- DAISYLINK KITS

MODEL#	DIMENSIONS	FREIGHT CLASS	WT/LBS.	CUBIC FT.	LIST PRICE
--------	------------	---------------	---------	-----------	------------

D x W x H

VIF-41-DKO_72SK	--	70	9	.45	\$496
VIF-41-DKO_66SK	--	70	9	.45	\$496
VIF-41-DKO_60SK	--	70	9	.45	\$496
VIF-41-DKO_54K	--	70	9	.45	\$496
VIF-41-DKO_48K	--	70	9	.45	\$496
VIF-41-DKO_42K	--	70	9	.45	\$496
VIF-41-DKO_36K	--	70	9	.45	\$496

Villa Power Base

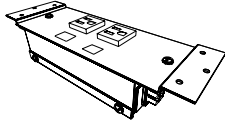

Villa Flush Lid



Data Knockouts, No Data Ports



42 FF Cable



42 FM Cable

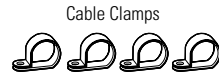

Cable Clamps

Includes **one power block** with **two power receptacles** and two knockouts for data, grommet cover, one female/female interconnecting cable, one female/male interconnecting cable and four cable clamps. **V2 cut-out must be specified on training table** (see product notes section for more details and cut-out upcharge). **Power Infeed required and sold separate** (see page 519). For multiple circuit configurations, please contact customer service. UL listed and CSA Certified.

- Replace _ with **B** for **Black**
- Replace _ with **S** for **Silver Pearl**
- Villa DaisyLink kits are not recommended for use on 2gether tables or Zira Boardroom Tables

VIF-41-D_-72SK	--	70	9	.45	\$648
VIF-41-D_-66SK	--	70	9	.45	\$648
VIF-41-D_-60SK	--	70	9	.45	\$648
VIF-41-D_-54K	--	70	9	.45	\$648
VIF-41-D_-48K	--	70	9	.45	\$648
VIF-41-D_-42K	--	70	9	.45	\$648
VIF-41-D_-36K	--	70	9	.45	\$648

Villa Power Base

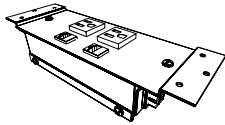

Villa Flush Lid



Data Knockouts, Data Ports Included



42 FF Cable



42 FM Cable

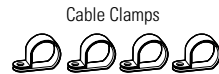

Cable Clamps

Includes **one power block** with **two power receptacles** and **two RJ45** Cat 6 Data, grommet cover, one female/female interconnecting cable, one female/male interconnecting cable and four cable clamps. **V2 cut-out must be specified on training table** (see product notes section for more details and cut-out upcharge). **Power Infeed required and sold separate** (see page 519). For multiple circuit configurations, please contact customer service. UL listed and CSA Certified.

- Replace _ with **B** for **Black**
- Replace _ with **S** for **Silver Pearl**
- Villa DaisyLink kits are not recommended for use on 2gether tables or Zira Boardroom Tables

Required Specifications

Finish
Power Infeed
Cut-out location

T TABLE POWER + TECHNOLOGY SOLUTIONS

VILLA I, CENTER POSITION- DAISYLINK KITS

MODEL# DIMENSIONS FREIGHT CLASS WT./LBS. CUBIC FT. LIST PRICE

D x W x H

MODEL#	DIMENSIONS	FREIGHT CLASS	WT./LBS.	CUBIC FT.	LIST PRICE
VIF-41-UDKO_-36K	--	70	10	.45	\$679
VIF-41-UDKO_-42K	--	70	10	.45	\$679
VIF-41-UDKO_-48K	--	70	10	.45	\$679
VIF-41-UDKO_-54K	--	70	10	.45	\$679
VIF-41-UDKO_60SK	--	70	10	.45	\$679
VIF-41-UDKO_66SK	--	70	10	.45	\$679
VIF-41-UDKO_72SK	--	70	10	.45	\$679

Villa Power Base

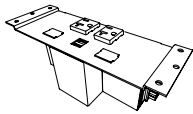

Villa Flush Lid



42 FF Cable



42 FM Cable



Cable Clamps

Villa I USB Data Knockouts, No Data Ports

Includes **one power block with two power receptacles, two 2.1 AMP USB charging ports** and two knockouts for data, grommet cover, one female/female interconnecting cable, one female/male interconnecting cable and four cable clamps. **V2 cut-out must be specified on training table** (see product notes section for more details and cut-out upcharge). **Power Infeed required and sold separate** (see page 519). For multiple circuit configurations, please contact customer service. UL listed and CSA Certified.

- Replace _ with **B** for **Black**
- Replace _ with **S** for **Silver Pearl**
- Villa DaisyLink kits are not recommended for use on 2gether tables or Zira Boardroom Tables
- Not compatible with Terina tables or Junction wire managers (JNECxx)

VIF-41-UD_-36K	--	70	10	.45	\$831
VIF-41-UD_-42K	--	70	10	.45	\$831
VIF-41-UD_-48K	--	70	10	.45	\$831
VIF-41-UD_-54K	--	70	10	.45	\$831
VIF-41-UD_60SK	--	70	10	.45	\$831
VIF-41-UD_66SK	--	70	10	.45	\$831
VIF-41-UD_72SK	--	70	10	.45	\$831

Villa Power Base

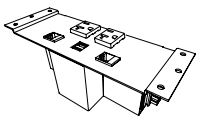

Villa Flush Lid



Villa I USB Data Knockouts, Data Ports Included

Includes **one power block with two power receptacles, two 2.1 AMP USB charging ports** and two RJ45 Cat 6 for data, grommet cover, one female/female interconnecting cable, one female/male interconnecting cable and four cable clamps. **V2 cut-out must be specified on training table** (see product notes section for more details and cut-out upcharge). **Power Infeed required and sold separate** (see page 519). For multiple circuit configurations, please contact customer service. UL listed and CSA Certified.

- Replace _ with **B** for **Black**
- Replace _ with **S** for **Silver Pearl**
- Villa DaisyLink kits are not recommended for use on 2gether tables or Zira Boardroom Tables
- Not compatible with Terina tables or Junction wire managers (JNECxx)

Required Specifications

Finish
Power Infeed
Cutout location

VILLA II, CENTER POSITION - DAISYLINK KITS

Villa II Power Base

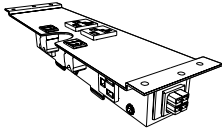

Villa II Flush Lid



Data Knockouts, No Data Ports

MODEL#	DIMENSIONS	FREIGHT CLASS	WT/LBS.	CUBIC FT.	LIST PRICE
--------	------------	---------------	---------	-----------	------------

D x W x H

VIF2-41-DKO_72SK	--	65	12	.45	\$585
VIF2-41-DKO_66SK	--	65	12	.45	\$585
VIF2-41-DKO_60SK	--	65	12	.45	\$585
VIF2-41-DKO_54K	--	65	12	.45	\$585
VIF2-41-DKO_48K	--	65	12	.45	\$585
VIF2-41-DKO_42K	--	65	12	.45	\$585
VIF2-41-DKO_36K	--	65	12	.45	\$585

42 FF Cable



42 FM Cable



Cable Clamps



Includes **one power block** with **four power receptacles** (two worksurface accessible, two below worksurface) and two knockouts for data, grommet cover, one female/female interconnecting cable, one female/male interconnecting cable and four cable clamps. **V2 cut-out must be specified on training table** (see product notes section for more details and cut-out upcharge). **Power Infeed required and sold separate** (see page 519). For multiple circuit configurations, please contact customer service. UL listed and CSA Certified.

- Replace _ with **B** for **Black**
- Replace _ with **S** for **Silver Pearl**
- Villa DaisyLink kits are not recommended for use on 2gether tables or Zira Boardroom Tables

Villa II Power Base

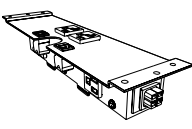

Villa II Flush Lid



Data Knockouts, Data Ports Included

VIF2-41-D_-72SK	--	65	12	.45	\$740
VIF2-41-D_-66SK	--	65	12	.45	\$740
VIF2-41-D_-60SK	--	65	12	.45	\$740
VIF2-41-D_-54K	--	65	12	.45	\$740
VIF2-41-D_-48K	--	65	12	.45	\$740
VIF2-41-D_-42K	--	65	12	.45	\$740
VIF2-41-D_-36K	--	65	12	.45	\$740

42 FF Cable



42 FM Cable



Cable Clamps



Includes **one power block** with **four power receptacles** (two worksurface accessible, two below worksurface) and **two RJ45 Cat 6 Data**, grommet cover, one female/female interconnecting cable, one female/male interconnecting cable and four cable clamps. **V2 cut-out must be specified on training table** (see product notes section for more details and cut-out upcharge). **Power Infeed required and sold separate** (see page 519). For multiple circuit configurations, please contact customer service. UL listed and CSA Certified.

- Replace _ with **B** for **Black**
- Replace _ with **S** for **Silver Pearl**
- Villa DaisyLink kits are not recommended for use on 2gether tables or Zira Boardroom Tables

Required Specifications

Finish
Power Infeed
Cutout location

T TABLE POWER + TECHNOLOGY SOLUTIONS

VILLA I, LEFT & RIGHT POSITION - DAISYLINK KITS MODEL# DIMENSIONS FREIGHT CLASS WT/LBS. CUBIC FT. LIST PRICE

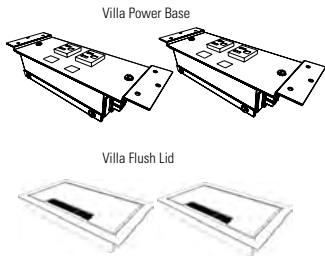

Data Knockouts, No Data Ports

MODEL#	D x W x H	FREIGHT CLASS	WT/LBS.	CUBIC FT.	LIST PRICE
GL-VIF41KO_72DK	--	60	18	.23	\$924
GL-VIF41KO_66DK	--	60	18	.23	\$924
GL-VIF41KO_60DK	--	60	18	.23	\$924

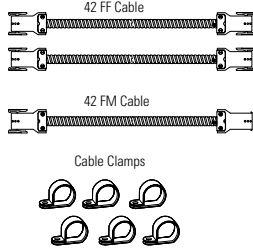

Includes **two power blocks** with **two power receptacles** and two knockouts for data in each block, two grommet covers, two female/female interconnecting cable, one female/male interconnecting cable and 6 cable clamps. **V1 & V3 cut-outs must be specified on training table** (see product notes section for more details and cut-out upcharge). **Power Infeed required and sold separate** (see page 519). For multiple circuit configurations, please contact customer service. UL listed and CSA Certified.

- Replace _ with **B** for **Black**
- Replace _ with **S** for **Silver Pearl**
- Villa DaisyLink kits are not recommended for use on 2gether tables or Zira Boardroom Tables

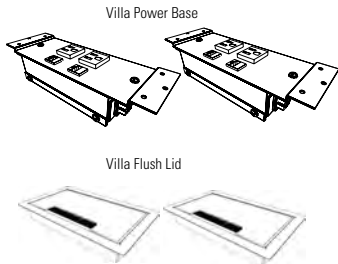

Data Knockouts, Data Ports Included

GL-VIF41D_72DK	--	60	18	.23	\$955
GL-VIF41D_66DK	--	60	18	.23	\$955
GL-VIF41D_60DK	--	60	18	.23	\$955

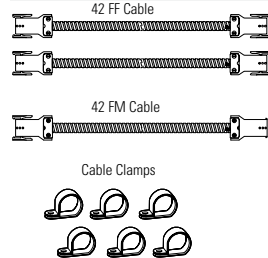

Includes **two power blocks** with **two power receptacles** and **two RJ45 Cat 6** data in each block, two grommet covers, two female/female interconnecting cable, one female/male interconnecting cable and 6 cable clamps. **V1 & V3 cut-outs must be specified on training table** (see product notes section for more details and cut-out upcharge). **Power Infeed required and sold separate** (see page 519). For multiple circuit configurations, please contact customer service. UL listed and CSA Certified.

- Replace _ with **B** for **Black**
- Replace _ with **S** for **Silver Pearl**
- Villa DaisyLink kits are not recommended for use on 2gether tables or Zira Boardroom tables

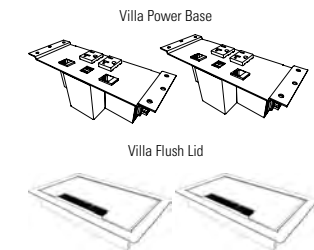

Villa I USB

GL-VIF41UKO_72DK	--	60	23	.23	\$1294
GL-VIF41UKO_66DK	--	60	23	.23	\$1294
GL-VIF41UKO_60DK	--	60	23	.23	\$1294

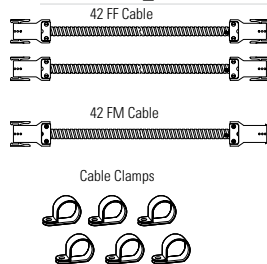

Includes **two power blocks** with **two power receptacles**, **two 2.1 AMP USB charging ports** and two knockouts for data, grommet cover, one female/female interconnecting cable, one female/male interconnecting cable and four cable clamps. **V1 & V3 cut-outs must be specified on training table** (see product notes section for more details and cut-out upcharge). **Power Infeed required and sold separate** (see page 519). For multiple circuit configurations, please contact customer service. UL listed and CSA Certified.

- Replace _ with **B** for **Black**
- Replace _ with **S** for **Silver Pearl**
- Villa DaisyLink kits are not recommended for use on 2gether tables or Zira Boardroom Tables
- Not compatible with Terina tables or Junction wire managers (JNECxx)

Required Specifications

Finish
Power infeed
Cut-out location

VILLA II, LEFT & RIGHT POSITION - DAISYLINK KITS **MODEL#** **DIMENSIONS** **FREIGHT CLASS** **WT/LBS.** **CUBIC FT.** **LIST PRICE**

D x W x H

GLVIF241KO_72DK	--	60	22	.23	\$986
GLVIF241KO_66DK	--	60	22	.23	\$986
GLVIF241KO_60DK	--	60	22	.23	\$986

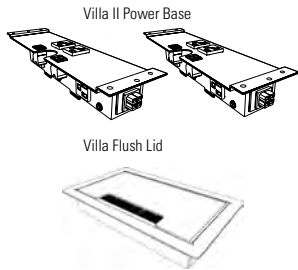

Data Knockouts, No Data Ports

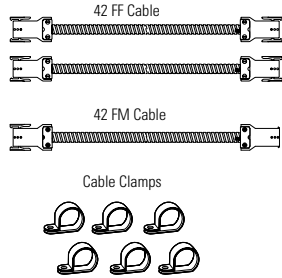

Includes **two power blocks** with **four power receptacles** (two worksurface accessible, two below worksurface) and two knockouts for data in each block, two grommet covers, two female/female interconnecting cable, one female/male interconnecting cable and 6 cable clamps. **V1 & V3 cut-outs must be specified on training table** (see product notes section for more details and cut-out upcharge). **Power Infeed required and sold separate** (see page 519). For multiple circuit configurations, please contact customer service. UL listed and CSA Certified.

- Replace _ with **B** for **Black**
- Replace _ with **S** for **Silver Pearl**
- Villa DaisyLink kits are not recommended for use on 2gether tables or Zira Boardroom Tables

GL-VIF241D_72DK	--	60	22	.23	\$1294
GL-VIF241D_66DK	--	60	22	.23	\$1294
GL-VIF241D_60DK	--	60	22	.23	\$1294

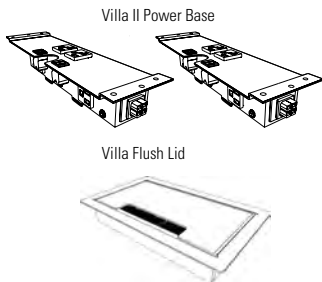

Data Knockouts, Data Ports Included

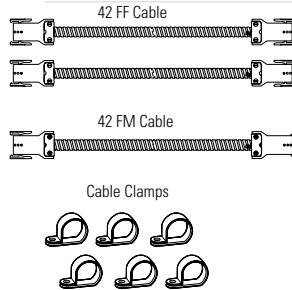

Includes **two power blocks** with **four power receptacles** (two worksurface accessible, two below worksurface) and **two RJ45 Cat 6** data in each block, two grommet covers, two female/female interconnecting cable, one female/male interconnecting cable and 6 cable clamps. **V1 & V3 cut-outs must be specified on training table** (see product notes section for more details and cut-out upcharge). **Power Infeed required and sold separate** (see page 519). For multiple circuit configurations, please contact customer service. UL listed and CSA Certified.

- Replace _ with **B** for **Black**
- Replace _ with **S** for **Silver Pearl**
- Villa DaisyLink kits are not recommended for use on 2gether tables or Zira Boardroom Tables

Required Specifications

- Finish
- Power Infeed
- Cut-out location

T TABLE POWER + TECHNOLOGY SOLUTIONS

VILLA I - CORDED UNITS

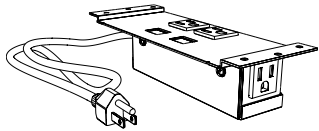

Data Knockouts, No Data Ports

MODEL#	DIMENSIONS D x W x H	FREIGHT CLASS	WT/LBS.	CUBIC FT.	LIST PRICE
VIL-C-DKO-_-108	3.25 x 8.75 x 2.25	100	4	.45	\$249
VIL-C-DKO-_-72	3.25 x 8.75 x 2.25	100	4	.45	\$249

Villa I with 3-prong plug. Includes **two power receptacles** and two knockouts for data. A third convenience receptacle is provided below the worksurface. **V1, V2 or V3 cut-out(s) must be specified on training table** (see product notes section for more details and cut-out upcharge). **Grommet cover is required and sold separate** (see page 515). UL/CUL listed.

- Replace _ with **B** for **Black**
- Replace _ with **S** for **Silver Pearl**
- -108 models include a 108" long cord. -72 models include a 72" long cord.

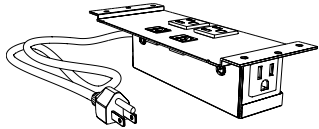

Data Knockouts, Data Ports Included

VIL-C-D-_-108	3.25 x 8.75 x 2.25	100	4	.45	\$402
VIL-C-D-_-72	3.25 x 8.75 x 2.25	100	4	.45	\$402

Villa I with 3-prong plug. Includes **two power receptacles** and **two RJ45 Cat 6** data. A third convenience receptacle is provided below the worksurface. **V1, V2 or V3 cut-out(s) must be specified on training table** (see product notes section for more details and cut-out upcharge). **Grommet cover is required and sold separate** (see page 515). UL/CUL listed.

- Replace _ with **B** for **Black**
- Replace _ with **S** for **Silver Pearl**

VILLA II - CORDED UNITS

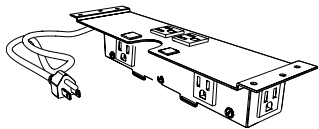

Data Knockouts, No Data Ports

MODEL#	DIMENSIONS	FREIGHT CLASS	WT/LBS.	CUBIC FT.	LIST PRICE
VIL2-C2-DKO_-108	3.25 x 11 x 2.25	85	6	.45	\$340
VIL2-C2-DKO_-72	3.25 x 11 x 2.25	85	6	.45	\$340

Villa II with 3-prong plug. Includes **four power receptacles** (two worksurface accessible, two below worksurface) and two knockouts for data. A fifth convenience receptacle is provided below the worksurface. **V1, V2 or V3 cut-out(s) must be specified on training table** (see product notes section for more details and cut-out upcharge). **Grommet cover is required and sold separate** (see below). UL/CUL listed.

- Replace _ with **B** for **Black**
- Replace _ with **S** for **Silver Pearl**

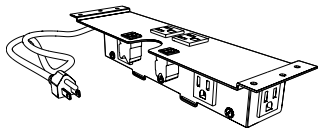

Data Knockouts, Data Ports Included

VIL2-C2-D-_-108	3.25 x 11 x 2.25	85	6	.45	\$496
VIL2-C2-D-_-72	3.25 x 11 x 2.25	85	6	.45	\$496

Villa II with 3-prong plug. Includes **four power receptacles** (two worksurface accessible, two below worksurface) and **two RJ45 Cat 6** data. A fifth convenience receptacle is provided below the worksurface. **V1, V2 or V3 cut-out(s) must be specified on training table** (see product notes section for more details and cut-out upcharge). **Grommet cover is required and sold separate** (see below). UL/CUL listed.

- Replace _ with **B** for **Black**
- Replace _ with **S** for **Silver Pearl**

Required Specifications

Finish
Power Infeed
Cutout location

VILLA DAISYLINK

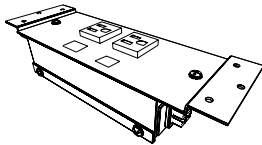

Villa I, DaisyLink

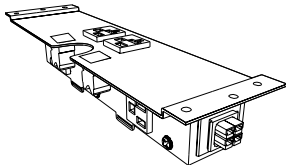

Villa II, DaisyLink

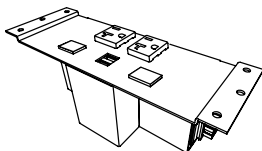

Villa USB, DaisyLink

MODEL#	DIMENSIONS	FREIGHT CLASS	WT/LBS.	CUBIC FT.	LIST PRICE
--------	------------	---------------	---------	-----------	------------

D x W x H

VIL-4-1-DKO-__	--	100	4	.45	\$218
----------------	----	-----	---	-----	--------------

Villa I for use in hardwire or DaisyLink applications. Includes **two power receptacles** and **two knockouts for data in each block**. **V1, V2 or V3 cut-out(s) must be specified on table** (see product notes section for more details and cut-out upcharge). **Power infeed required and sold separate** (see page 519). *Please see our **Daisy-Chain guide** on page 520 for appropriate cable lengths and important notes.* **Grommet cover is required and sold separate** (see page 515). UL Listed & CSA Certified.

- Replace __ with **B** for **Black**
- Replace __ with **S** for **Silver Pearl**
- Villa DaisyLink kits are not recommended for use on 2gether tables
- Intended for use on Zira Boardroom & Collaborative Tables, Kadin and Swap Tables

VIL2-4-1-DKO-__	--	85	6	.45	\$310
-----------------	----	----	---	-----	--------------

Villa II for use in hardwire or DaisyLink applications. Includes **four power receptacles (two worksurface accessible, two below worksurface)** and **two knockouts for data in each block**. **V1, V2 or V3 cut-out(s) must be specified on table** (see product notes section for more details and cut-out upcharge). **Power infeed and connecting cables sold separate** (see page 519). *Please see our **Daisy-Chain guide** on page 520 for appropriate cable lengths and important notes.* **Grommet cover is required and sold separate** (see page 515). UL Listed & CSA Certified.

- Replace __ with **B** for **Black**
- Replace __ with **S** for **Silver Pearl**
- Villa DaisyLink kits are not recommended for use on 2gether tables
- Intended for use on Zira Boardroom & Collaborative Tables, Kadin and Swap Tables

VIL-4-1-U-DKO-__	--	85	6	.45	\$402
------------------	----	----	---	-----	--------------

Villa USB for use in hardwire or DaisyLink applications. Includes **two power receptacles, two 2.1 AMB USB charging ports, and two knockouts for data in each block**. **V1, V2 or V3 cut-out(s) must be specified on table** (see product notes section for more details and cut-out upcharge). **Power infeed and connecting cables sold separate** (see page 519). *Please see our **Daisy-Chain guide** on page 520 for appropriate cable lengths and important notes.* **Grommet cover is required and sold separate** (see page 515). UL Listed & CSA Certified.

- Replace __ with **B** for **Black**
- Replace __ with **S** for **Silver Pearl**
- Villa DaisyLink kits are not recommended for use on 2gether tables
- Not compatible with Terina tables or Junction wire managers (JNECxx)
- Intended for use on Zira Boardroom & Collaborative Tables, Kadin and Swap Tables

VILLA GROMMET COVERS

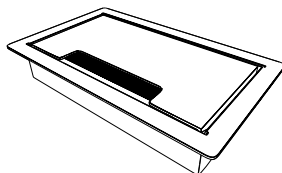

Villa Grommet Cover

MODEL#	DIMENSIONS	FREIGHT CLASS	WT/LBS.	CUBIC FT.	LIST PRICE
--------	------------	---------------	---------	-----------	------------

VIL-GROM-F-__	3.5 x 5.75 x .94	70	1	.08	\$126
---------------	------------------	----	---	-----	--------------

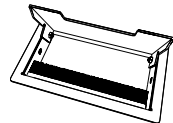

Powder coated flush metal grommet to be used with Villa I and Villa II **corded** series power blocks. Cut-outs in tables must be specified separately. **V1, V2 or V3 cut-out(s) must be specified on training table** (see product notes section for more details and cut-out upcharge). **Grommet cover remains open while in use.**

- **Cannot be used with PMSPDM.**
- Replace __ with **B** for **Black**
- Replace __ with **S** for **Silver Pearl**

Required Specifications

Finish
Power Infeed
Cutout location

T TABLE POWER + TECHNOLOGY SOLUTIONS

OASIS MINI

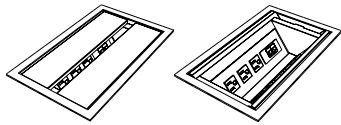

Oasis Mini A, Corded

MODEL#	DIMENSIONS D x W x H	FREIGHT CLASS	WT./LBS.	CUBIC FT.	LIST PRICE
OAM-A-PC-__	15 x 9 x 5.25	92.5	16	1.53	\$1826

Mini Oasis A unit. 15" Trough with six power receptacles, two telecom plate cut-outs (**telecom plates sold separate**, see page 518) and two 108" 3-prong plugs. **M1, M2 or M3 cut-out(s) must be specified on conference table** (see product notes section for more details and cut-out upcharge). UL Listed.

- **Cannot be daisy-chained.**
- Replace _ with **B** for **Black**
- Replace _ with **S** for **Silver Pearl**

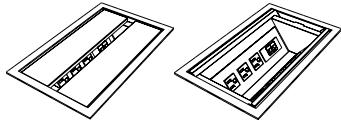

Oasis Mini A, DaisyLink Version

OAM-A-PC-4-1-__	15 x 9 x 5.25	92.5	16	1.53	\$2091
-----------------	---------------	------	----	------	---------------

For hardwire and daisy chain applications. Mini Oasis A unit. 15" Trough with six power receptacles, two telecom plate cut-outs (**telecom plates sold separate**, see page 518). **Power infeed sold separate** (see page 519). **M1, M2 or M3 cut-out(s) must be specified on conference table** (see product notes section for more details and cut-out upcharge). For multiple circuit configurations, please contact customer service. *Please see our **Daisy-Chain guide** on page 520 for appropriate cable lengths and important notes.* UL Listed.

- Replace _ with **B** for **Black**
- Replace _ with **S** for **Silver Pearl**

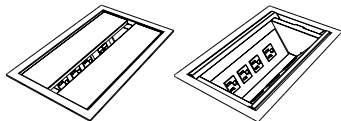

Oasis Mini B, Corded

OAM-B-PC-__	15 x 9 x 5.25	92.5	16	1.53	\$1826
-------------	---------------	------	----	------	---------------

Mini Oasis B unit. 15" Trough with four power receptacles, three telecom plate cut-outs (**telecom plates sold separate**, see page 518) and one 108" 3-prong plug. **M1, M2 or M3 cut-out(s) must be specified on conference table** (see product notes section for more details and cut-out upcharge). UL Listed.

- **Cannot be daisy-chained.**
- Replace _ with **B** for **Black**
- Replace _ with **S** for **Silver Pearl**

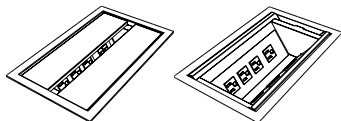

Oasis Mini B, DaisyLink Version

OAM-B-PC-4-1-__	15 x 9 x 5.25	92.5	16	1.53	\$2091
-----------------	---------------	------	----	------	---------------

For hardwire and daisy chain applications. Mini Oasis B unit. 15" Trough with four power receptacles, three telecom plate cut-outs (**telecom plates sold separate**, see page 518). **Power infeed sold separate** (see page 519). **M1, M2 or M3 cut-out(s) must be specified on conference table** (see product notes section for more details and cut-out upcharge). For multiple circuit configurations, please contact customer service. *Please see our **Daisy-Chain guide** on page 520 for appropriate cable lengths and important notes.* UL Listed.

- Replace _ with **B** for **Black**
- Replace _ with **S** for **Silver Pearl**

Required Specifications

Finish
Power Infeed
Cut-out location

OASIS MINI

MODEL#	DIMENSIONS	FREIGHT CLASS	WT/LBS.	CUBIC FT.	LIST PRICE
--------	------------	---------------	---------	-----------	------------

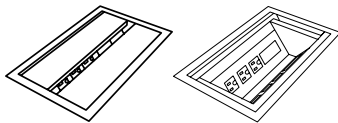

Oasis Mini USB, Corded

	D x W x H				
OAM-U-PC-__	15 x 9 x 5.25	92.5	16	1.53	\$2044

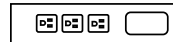

Mini Oasis USB unit. 15" trough with six power receptacles, two 2.1 AMP USB charging ports and one telecom plate cut-out (**telecom plates sold separate**, see page 518) and two 108" 3-prong plugs. **M1, M2 or M3 cut-out(s) must be specified on conference table** (see product notes section for more details and cut-out upcharge). UL Listed.

- **Cannot be daisy-chained.**
- Replace __ with **B** for **Black**
- Replace __ with **S** for **Silver Pearl**

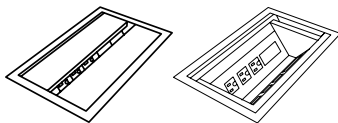

Oasis Mini USB, DaisyLink Version

OAM-U-PC-4-1-__	15 x 9 x 5.25	92.5	16	1.53	\$2307
-----------------	---------------	------	----	------	---------------

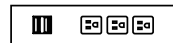

For hardwire and daisy chain applications. Mini Oasis USB unit. 15" trough with six power receptacles, two 2.1 AMP USB charging ports and one telecom plate cut-out (**telecom plates sold separate**, see page 518). **Power infeed sold separate** (see page 519). **M1, M2 or M3 cut-out(s) must be specified on conference table** (see product notes section for more details and cut-out upcharge). For multiple circuit configurations, please contact customer service. *Please see our **Daisy-Chain guide** on page 520 for appropriate cable lengths and important notes.* UL Listed.

- Replace __ with **B** for **Black**
- Replace __ with **S** for **Silver Pearl**

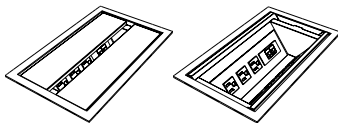

Oasis Mini, Chicago Code

GL-OAMPD_P72HW	15 x 9 x 5.25	92.5	16	1.53	\$2490
----------------	---------------	------	----	------	---------------

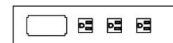

Mini Oasis for Chicago code includes electrical trough with (2) separate hardwire inserts. Each insert includes (3) simplex outlets and (1) telecom plate cut-out (**telecom plates sold separate**, see page 518). **M1, M2 or M3 cut-out(s) must be specified on conference table** (see product notes section for more details and cut-out upcharge). Each component is UL listed.

- **Cannot be daisy-chained.**
- Replace __ with **B** for **Black**
- Replace __ with **S** for **Silver Pearl**

Required Specifications

Finish
Power Infeed
Cut-out location

T TABLE POWER + TECHNOLOGY SOLUTIONS

TOP TELECOM PLATES

D x W x H





NOT COMPATIBLE WITH VILLA UNITS

TOP TELECOM PLATE	MODEL	CONFIGURATION	LIST PRICE
	A-__-A-B	Telecom plate with RJ11 Cat 3 Phone and RJ45 Cat 6 Data	\$108
	A-__-B-B	(2) RJ45 Cat 6 Connectors	\$141
	A-__-B-B-B	(3) RJ45 Cat 6 Connectors	\$206
	A-__-B-B-B-B	(4) RJ45 Cat 6 Connectors	\$274
	A-__-B-C51-L	RJ45 Cat 6 Data, Mini-Stereo Inline and 15 pin HD VGA Female/Female with 72" patch cord attached.	\$244
	A-__-B-B-C51	(2) RJ45 Cat 6 Data and (1) 15 pin HD VGA Female/Female with 72" patch cord attached.	\$254
	A-__-A-B-102	RJ11 Cat 3 phone, RJ45 Cat 6 Data and USB with 72" patch cord attached.	\$244
	A-__-B	RJ45 Cat 6 Data	\$76
	A-__-C51-L	Mini Stereo Inline and 15 pin HD VGA Female/Female with 72" patch cord attached.	\$191
	A-__-CRDMINDER	Cordminder Plate - 2 5/8" holes and 1 7/8" holes	\$43
	A-__-C45-C51-L	HDMI Female/Female with 36" patch cord attached. Mini Stereo Inline and 15 Pin HD VGA Female/Female with 72" patch cord attached.	\$333

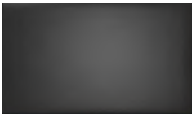

Required Specifications

- Finish
- Power Infeed
- Cut-out location

TOP TELECOM PLATES

		D x W x H				
TOP TELECOM PLATE	MODEL	CONFIGURATION				LIST PRICE
	A-__-C45	HDMI Female/Female with 36" patch cord attached.				\$164
	A-__-A-B-B	(1) RJ11 Cat 3 Phone and (2) RJ45 Cat 6 data.				\$178
	A-__	Blank telecom plate				\$10
	A-__-102	USB with 72" patch cord attached.				\$76
	A-__-C51	15 pin HD VGA Female/Female with 72" patch cord attached.				\$123
<ul style="list-style-type: none"> • Replace __ with BL for Black • Replace __ with GR for Grey 						

POWER INFEEDS

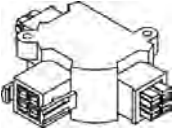
	42AP1-72	--	--	--	--	\$245
Plug and Play Infeed	Single Circuit 20 AMP Power Infeed with 72" 3-prong plug. Provides single power entry from floor or wall mounted standard power supply. Connects to Oasis Mini or Villa units that require a separate infeed. UL Listed.					
	42SB2-108	--	--	--	--	\$203
	42SB2-72	--	--	--	--	\$158
	42SB2-36	--	--	--	--	\$115
Multi-Circuit Hardwire Power Infeed	Multi-Circuit Hardwire Infeed (up to 20 AMPS per circuit), two circuits. Provides single power entry from floor or wall located building power supply. Connects to Oasis Mini or Villa units that require a power infeed. TO BE HARDWIRED BY A LICENSED ELECTRICIAN. UL Listed.					
	DAISY-T	--	70	1	1	\$187
3 Way Power Splitter	Daisy-T power manager includes two male and one female connection. For use in splitting a power source two ways.					

Required Specifications

Finish
Power Infeed
Cut-out location

T TABLE POWER + TECHNOLOGY SOLUTIONS

TOP TELECOM PLATES



Interconnecting Cables

D x W x H

42FF-__	Female/Female
42FM-__	Female/Male

UL Listed and CSA Certified. For appropriate quantity and sizes, please refer to the chart on the next page.

Interconnecting Cables - Common Cable Lengths (in inches)

Female/Female	Female/Male
42FF-27 \$116	42FM-12 \$104
42FF-38 \$129	42FM-27 \$121
42FF-41 \$133	42FM-38 \$134
42FF-50 \$145	42FM-41 \$139
42FF-53 \$149	42FM-50 \$151
42FF-63 \$159	42FM-63 \$167
42FF-75 \$175	42FM-75 \$181
42FF-76 \$176	42FM-82 \$190
42FF-82 \$184	42FM-86 \$195
42FF-86 \$188	42FM-97 \$216
42FF-97 \$216	42FM-98 \$216
42FF-98 \$216	42FM-100 \$230
42FF-100 \$205	42FM-110 \$230
42FF-110 \$219	

DRAWING 1A - OASIS MINI A & OASIS MINI USB

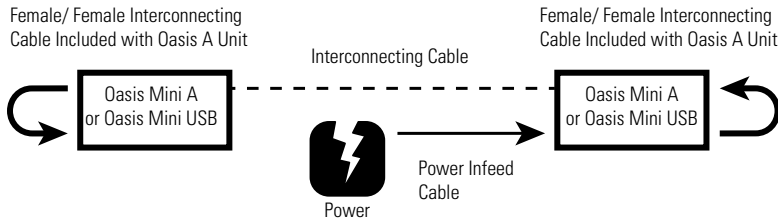

DRAWING 1B - OASIS MINI B

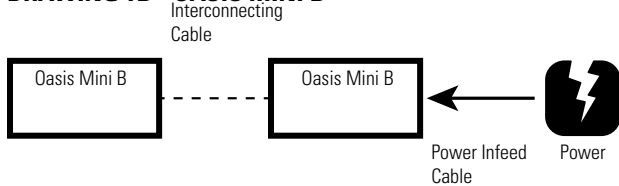

DRAWING 2A - OASIS MINI A & OASIS MINI USB

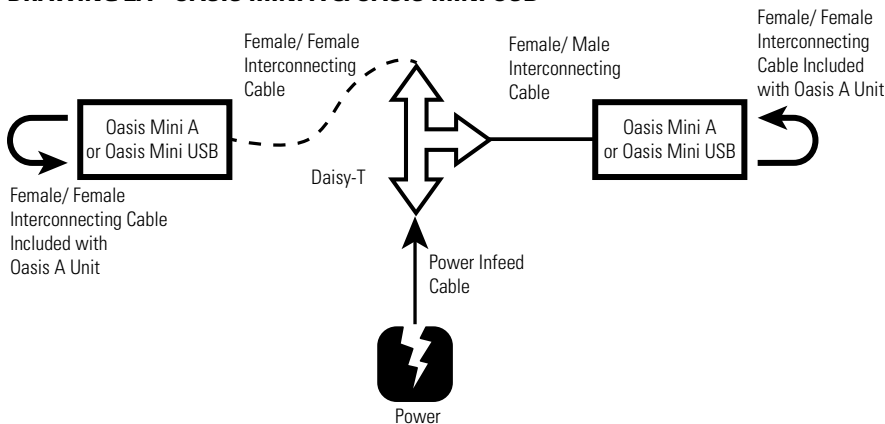

DRAWING 2B - OASIS MINI B

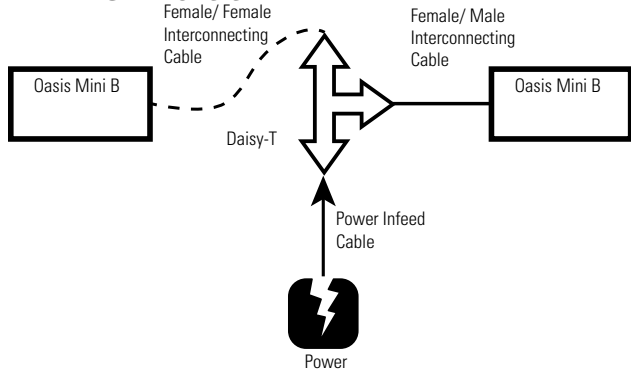

DRAWING 3 - OASIS MINI A & OASIS MINI USB

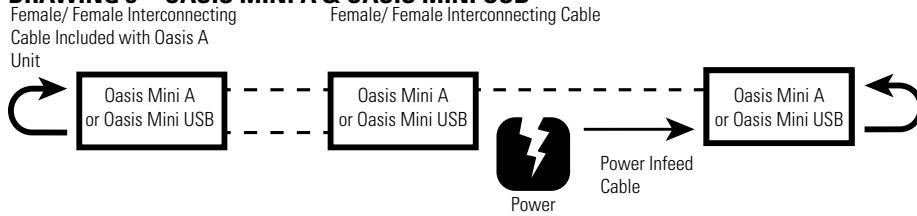

DRAWING 4 - OASIS MINI A & OASIS MINI USB

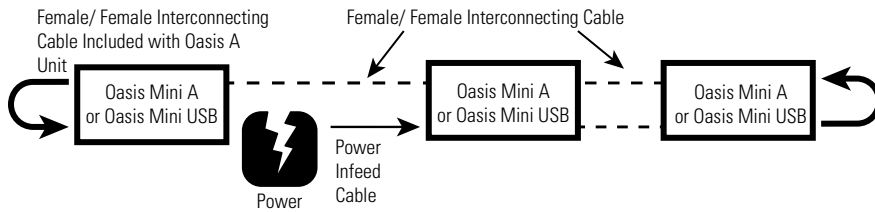

DRAWING 5 - OASIS MINI B

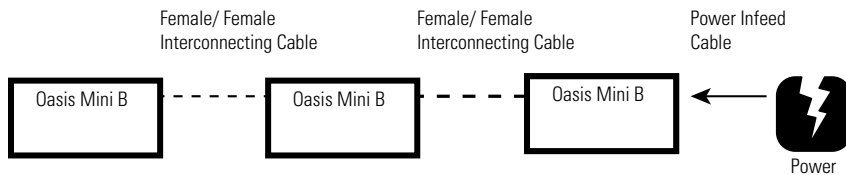

DRAWING 6 - OASIS MINI B

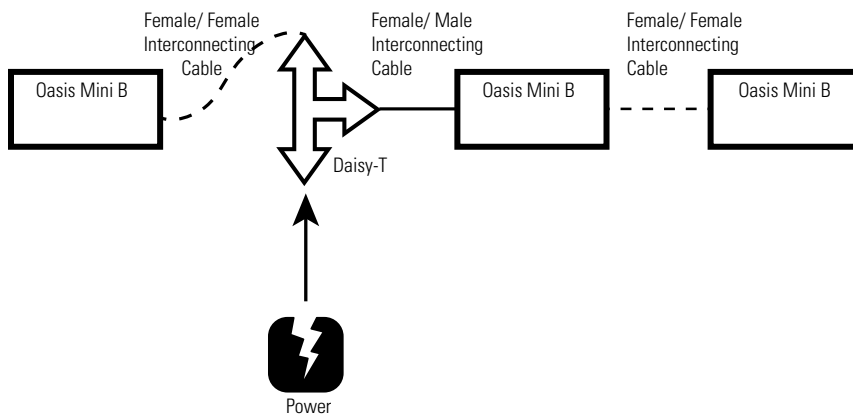

TABLE POWER + TECHNOLOGY SOLUTIONS - NOTES

OASIS MINI A, B & USB CABLE LENGTHS NEEDED FOR DAISY-CHAINING

Model #	Villa DaisyLink, Oasis Mini USB Oasis Mini A Oasis Mini B	Villa DaisyLink, Oasis Mini USB Oasis Mini A Oasis Mini B	Oasis Mini USB Oasis Mini A	Oasis Mini USB Oasis Mini A	Villa DaisyLink or Oasis Mini B	Villa DaisyLink or Oasis Mini B
Cut-out Positions	V1, V3, M1, M3	V1, V3, M1, M3	M1, M2 & M3	M1, M2 & M3	V1, V2, V3, M1, M2, M3	V1, V2, V3, M1, M2, M3
Infeed Position	Left or Right	Center	Left or Right	Center	Left or Right	Center
Reference	Drawing 1A/1B	Drawing 2A/2B	Drawing 3	Drawing 4	Drawing 5	Drawing 6
A3672RE A3672RT	N/A	N/A	N/A	N/A	N/A	N/A
A4896RE A4896B A4896RT	(1) 42FF-42 SPECIFY INFEED	(1) 42FF-21 (1) 42FM-21 (1) DAISY-T SPECIFY INFEED	N/A	N/A	N/A	N/A
A48120RE A48120RT	(1) 42FF-64 SPECIFY INFEED	(1) 42FF-32 (1) 42FM-32 (1) DAISY-T SPECIFY INFEED	(3) 42FF-29 SPECIFY INFEED	(3) 42FF-29 SPECIFY INFEED	(2) 42FF-29 SPECIFY INFEED	(2) 42FF-29 (1) 42FM-12 (1) DAISY-T SPECIFY INFEED
A48144B A48144RT	(1) 42FF-92 SPECIFY INFEED	(1) 42FF-46 (1) 42FM-46 (1) DAISY-T SPECIFY INFEED	(3) 42FF-41 SPECIFY INFEED	(3) 42FF-41 SPECIFY INFEED	(2) 41FF-42 SPECIFY INFEED	(2) 42FF-41 (1) 42FM-12 (1) DAISY-T SPECIFY INFEED
Z4896BE Z4896RTE Z4896REE Z4896BW	(1) 42FF-53 SPECIFY INFEED	(1) 42FF-27 (1) 42FM-27 (1) DAISY-T SPECIFY INFEED	N/A	N/A	N/A	N/A
Z48120BE Z48120RTE Z48120REE Z48120BW	(1) 42FF-76 SPECIFY INFEED	(1) 42FF-38 (1) 42FM-38 (1) DAISY-T SPECIFY INFEED	(3) 42FF-41 SPECIFY INFEED	(3) 42FF-41 SPECIFY INFEED	(2) 42FF-41 SPECIFY INFEED	(2) 42FF-41 (1) 42FM-12 (1) DAISY-T SPECIFY INFEED
Z48144BE Z48144RTE Z48144REE Z48144BW	(1) 42FF-100 SPECIFY INFEED	(1) 42FF-50 (1) 42FM-50 (1) DAISY-T SPECIFY INFEED	(3) 42FF-53 SPECIFY INFEED	(3) 42FF-53 SPECIFY INFEED	(2) 42FF-53 SPECIFY INFEED	(2) 42FF-53 (1) 42FM-12 (1) DAISY-T SPECIFY INFEED
Z48168BE Z48168RTE Z48168REE Z48168BW	(1) 42FF-63 (1) 42FM-63 SPECIFY INFEED	(1) 42FF-63 (1) 42FM-63 (1) DAISY-T SPECIFY INFEED	(3) 42FF-65 SPECIFY INFEED	(3) 42FF-65 SPECIFY INFEED	(2) 42FF-65 SPECIFY INFEED	(2) 42FF-65 (1) 42FM-12 (1) DAISY-T SPECIFY INFEED
Z48192BE Z48192RTE Z48192REE Z48192BW	(1) 42FF-75 (1) 42FM-75 SPECIFY INFEED	(1) 42FF-75 (1) 42FM-75 (1) DAISY-T SPECIFY INFEED	(3) 42FF-77 SPECIFY INFEED	(3) 42FF-77 SPECIFY INFEED	(2) 42FF-77 SPECIFY INFEED	(2) 42FF-77 (1) 42FM-12 (1) DAISY-T SPECIFY INFEED
Z48216BE Z48216RTE Z48216REE Z48216BW	(1) 42FF-86 (1) 42FM-86 SPECIFY INFEED	(1) 42FF-85 (1) 42FM-85 (1) DAISY-T SPECIFY INFEED	(3) 42FF-89 SPECIFY INFEED	(3) 42FF-89 SPECIFY INFEED	(2) 42FF-89 SPECIFY INFEED	(2) 42FF-89 (1) 42FM-12 (1) DAISY-T SPECIFY INFEED
Z48240BE Z48240RTE Z48240REE Z48240BW	(1) 42FF-98 (1) 42FM-98 SPECIFY INFEED	(1) 42FF-97 (1) 42FM-97 (1) DAISY-T SPECIFY INFEED	(3) 42FF-101 SPECIFY INFEED	(3) 42FF-101 SPECIFY INFEED	(2) 42FF-101 SPECIFY INFEED	(2) 42FF-101 (1) 42FM-12 (1) DAISY-T SPECIFY INFEED
Z48264BE Z48264RTE Z48264REE Z48264BW	(1) 42FF-110 (1) 42FM-110 SPECIFY INFEED	(1) 42FF-110 (1) 42FM-110 (1) DAISY-T SPECIFY INFEED	(3) 42FF-113 SPECIFY INFEED	(3) 42FF-113 SPECIFY INFEED	(2) 42FF-113 SPECIFY INFEED	(2) 42FF-113 (1) 42FM-12 (1) DAISY-T SPECIFY INFEED
Z48288BE Z48288RTE Z48288REE Z48288BW	(1) 42FF-82 (2) 42FM-82 SPECIFY INFEED	(2) 42FF-41 (2) 42FM-41 (1) DAISY-T SPECIFY INFEED	(3) 42FF-63 (3) 42FM-63 SPECIFY INFEED	(3) 42FF-63 (3) 42FM-63 SPECIFY INFEED	(2) 42FF-63 (2) 42FM-63 SPECIFY INFEED	(2) 42FF-63 (2) 42FM-63 (1) DAISY-T SPECIFY INFEED

tables and accessories

café, meeting and conference

Boardroom.....	526	Swap.....	659
Kadin.....	650		

training

2gether.....	524	Edventure.....	597
Bungee.....	547	FreeFit.....	607
Bungee SL.....	564	Junction.....	643
Connectables.....	578	Terina.....	704
Duet.....	594	Zook.....	708

reception and occasional

Citi.....	722	Sirena.....	727
Lite Lift II.....	726	Wind.....	728
Occasional tables.....	724	Work tables.....	730

GENERAL INFORMATION

- 2gether is a series of multi-purpose flip-top tables for collaboration, classroom, training and conference applications.
- “Easy Touch” mechanism allows you to flip the tables up or down with maximum ease
- Adjustable leveling casters provide smooth mobility
- Offset “Y” sculpted legs allow for parallel space-saving table nesting, to minimize footprint required for storage
- Optional modesty panels with integrated wire troughs are available
- Grommets are available on 24” deep worksurfaces
- Available sizes: 18”D x 60”W, 24”D x 60”W and 72”W
- Shipped easy to assemble. Each component is packaged individually; legs are shipped 1 per carton.
- For environmental certifications, please visit globalfurnituregroup.com

WORKSURFACES

- 1” thick tops are constructed of 45 lb. density particleboard with high performance thermally fused laminate

CONSTRUCTION

- “Easy touch” lever located at both sides of table for flip-top operation from either side
- Global’s preferred matching edge
- Tops are pre-drilled with threaded steel inserts
- Tops 60” and 72” wide feature a built-in support bar
- 14.25” high optional articulating modesty panel attaches to underside of flip-top
- Bumpers on legs and undercarriage prevent tables from being damaged while nested
- Grommets optional on 24” deep tops only
- Champagne base finish
- Products specified with the high pressure laminate option are finished on the underside of the surface with a kraft paper backing.

LAMINATE FINISHES

ACJ	Absolute Acajou	NGL	Noce Grigio
ASN	Asian Night	NEL	Noce Leggero
AWC	Avant Cherry	NML	Noce Medio
AWH	Avant Honey	QTM	Quartered Mahogany
BLK	Black	SOG	Storm Grey
BRC	Brushed Cobalt	TFW	Tiger Fruitwood
CMB	Clear Maple	TWL	Tiger Walnut
DES	Dark Espresso	WHE	Walnut Heights
DWT	Designer White	WHC	White Chocolate
HGT	Hayden Grey	WGY	Willow Grey
NBL	Noce Biondo	WCR	Winter Cherry

GANGING PLATES

- Ganging plates are available for ganging adjoining tables together.
- Ganging plates are black epoxy coated steel plates with two thumbscrews

GROMMETS

- Available only on 24” deep worksurfaces
- Additional grommets available in standard worksurface locations (left, center or right). Order as: **AG1, AG2 or AG3. Add \$88**
- Grommet hole dimensions are 3 ¼” wide x 1 7/8” deep.

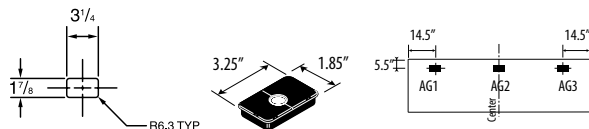

- Grommets may be placed at non-standard locations. Order as: **AGS - Add \$88** A drawing must be supplied with vertical and horizontal dimensions to the center of the cut-out (as in drawing above). Please refer to CUSTOM GROMMET LOCATION FORM in the back reference section.

POWER BLOCK

- Available only on 24” deep worksurfaces
- A Power Block is a rectangular worksurface power/data module with one electrical duplex receptacle and two data (RJ45) receptacles. 9’ black cord included. Power Block dimensions are 3 ½” deep x 6 ½” wide x 2 ¾” high.
- A Power Block (model **PMSPPDM**) may be ordered for **24” Deep Tables** in place of standard grommets.
- To purchase a Power Block, you must specify both the Power Block cut-out location and the Power Block model #. Order Power Block as **PMSPPDM, Add \$330**. Power Blocks are available in standard worksurface locations (left, center or right). Order as **E1, E2 or E3. Add \$88**.

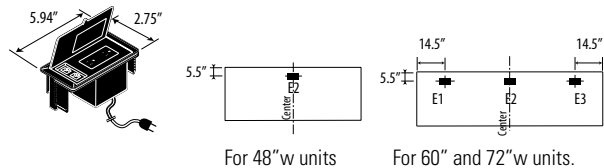

Power Block **PMSPPDM, Add \$330** Specify location **E1, E2 or E3, Add \$88**

VILLA CUTOUTS

- Available only on 24” deep worksurfaces
- A Villa Power Block is available in kits for daisy-chaining, or corded for use on individual tables (see page 509 for Villa details). Villa Power Block dimensions vary by model. Villa cutout dimensions are 3” deep x 5 ¼” wide
- A Villa cutout may be ordered for 24” Deep Tables. Order as **V1, V2 or V3, Add \$88 for each cutout**.
- Order Villa Power Block and Villa Grommet Cover separately, see page 509 for pricing and details

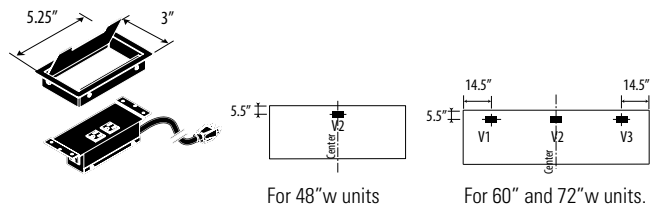

SHIPPING

- Items are shipped R.T.A. (Ready To Assemble)
- Easy to assemble with screwdriver
- Each top is packaged and shipped individually
- “Y” legs are packaged and shipped in one carton
- Table base is packaged and shipped in one carton

RECTANGULAR TOP **MODEL#** **DIMENSIONS** **FREIGHT CLASS** **WT/LBS.** **CUBIC FT.** **LIST PRICE** **HP ADD**

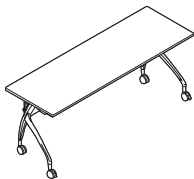

Rectangular Table - Flip-Top

	D x W x H						
IT2472RX	24 x 72 x 29	92.5	97.20	8.68	\$2071	\$253	
IT2460RX	24 x 60 x 29	92.5	86	7.68	\$1937	\$224	
IT1860RX	18 x 60 x 29	92.5	75	6.98	\$1864	\$198	

Easy touch flip-top table on 4 adjustable leveling casters, 2 locking. Easy touch lever located at both ends of the table allows for activation on either side of the table; offset Y leg accommodates in-line nesting for space-saving storage. Wire management channel included. Champagne finish leg, black casters. Optional articulating modesty panel available.

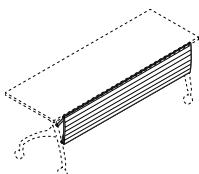

Modesty Panel

IT72MP	2.75 x 63 x 14.25	125	13.20	2	\$303		
IT60MP	2.75 x 51 x 14.25	125	11.40	1.60	\$279		

Articulating modesty for use with flip-top 2gether tables. Champagne finish.

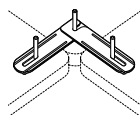
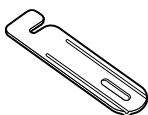

Ganging Connector

CNGFP	5 x 2.5 x 1.13	70	.20	.10	\$63		
-------	----------------	----	-----	-----	-------------	--	--

Black epoxy coated 13 gauge steel with 2 thumbscrews included. Used to connect tabletops together for additional stability or for connecting freestanding tops together. Holes with steel inserts are located in the corner of all tops to accommodate this plate. **Sold individually.**

Required Specifications
Top Finish

Accessories
Modesty Panel

B BOARDROOM TABLES



Sturdy and economically priced, Global boardroom tables are excellent choices. All tables are made from thermally fused, high performance laminate and are easy to maintain.

Choose from four attractive table edges: Bullnose, T-mold, Self-edge, or Built-up Self-edge. Available in a variety of colors, all edge options are durable and wear-resistant.

Table tops are offered in five shapes - rectangular, racetrack, boat-shaped, square and round - and a variety of bases including slab, drum and arch. Add to this an impressive variety of laminate finishes that may be mixed and matched and you'll find Global can satisfy any and every business need.

From small meeting rooms to large boardrooms, from traditional to contemporary, Global's incredible range of table components, shapes, sizes and colors will enhance any office decor.



Features and Benefits

- One-piece tops can be cut to 2 pieces for an upcharge
- Tables 96" to 144" in length special ordered with two piece tops must have a third base
- All tops are premarked as to base location
- All tops are 1 1/8" thick - a 1 3/4" built-up self edge is available on all models
- Tops and bases boxed as appropriate
- Custom finish laminate tables available as special order
- Bullnose edges available in Black or Grey
- T-Mold edge available in Black, Grey or coordinating laminate finish.
- Self-edge and built-up self edge available in same color as laminate finish.
- All edges available on all tables
- Metal legs and bases are standard in Chrome - also available in Black or Grey

GENERAL INFORMATION

- All tables are 29" high and constructed of 45 lb. density particle board
- Tables 144" or less are standard in one piece
- All tops over 144" are standard in two pieces
- Five top shapes: Rectangular, Racetrack, Boat-Shaped, Square and Round
- Four edge options: Bullnose, T-Mold, Self-edge or Built-Up Self Edge
- For environmental certifications, please visit globalfurnituregroup.com

CONSTRUCTION

- All Boardroom tables are 29" high and made of 45 lb. density particle board covered on both sides with high performance, thermally fused laminate. Table width is nominal.
- All tables with cross bases use Blum fasteners
- All tops are 1 1/8" thick with high performance, thermally fused laminate on both sides. A 1 3/4" built-up self edge is available on all models.
- Tops are crated and bases boxed or crated as appropriate
- Table tops of 144" or less in length are standard as one piece. 1 piece tops can be cut to 2 piece tops, **Add \$267**; however, an additional base will be required. Tables 96" to 144" in length special ordered with 2 piece tops **must** have a third base.
- All tops are **PREMARKED** as to base location, and the slot and hook assembly method (on selected tables) allows for easy installation.
- All racetrack, boat and rectangular tables 144" and under are standard with 2 drum, slab, arch, 2-legged, or tubular bases and are priced accordingly. For 3 bases, **Add \$468** list per table for a drum, and **Add \$308** list per table for the slab. The arch base tables will require a special 3" thick slab at a list price of **\$414** per table. **Add \$398** list per table for 2-legged base, and **Add \$414** list per table for tubular.
- Custom size tables are priced at next size table price, not to exceed width or length. Example: 44" x 108" would be priced at the 48" x 120" price. Contact Customer Service for pricing of tables over 48" in width. Custom tables **less** than the smallest size must be quoted.
- Products specified with the high pressure laminate option are finished on the underside of the surface with a kraft paper backing.

EDGE OPTIONS

- Self, built-up, bullnose, T-mold and slant edges are available on all models. Corners of rectangular, square and boat shaped tables ordered with T-mold or bullnose will be rounded.
- **Bullnose** edge is available in Black (**BK**) or Grey (**GR**) only.
- **T-mold** edge is available in Black (**BK**), Grey (**GR**) or coordinating laminate finish (**ME**)
- **Self edge and built-up** edges are same color as laminate finish.

METAL BASE FINISHES

Painted finishes

TBL	Black	TIN	Ink
TBZ	Buzz Blue	TKA	Kalua
TCC	Cactus	TLA	Latte
TCR	Carrot	TMO	Mocha
TIV	Cloud	TNE	Nevada
TDW	Designer White	TSN	Sand
TDJ	Dijon	TSR	Scarlet
TEG	Eggplant	TSH	Shadow
TFO	Fog	TOA	Toast
TFR	Frost	TTU	Tungsten

Plated finishes - upcharge applies

CHM	Polished Chrome
BCH*	Brushed Chrome
ACO*	Antique Copper
SBR*	Satin Brass

*Available for GCARxx, GTCRxx, GCRRx, GCASxx, GTCsxx, and GCRSxx tables

LAMINATE FINISHES

ACJ	Absolute Acajou	NGL	Noce Grigio
ASN	Asian Night	NEL	Noce Leggero
AWC	Avant Cherry	NML	Noce Medio
AWH	Avant Honey	QTM	Quartered Mahogany
BLK	Black	SOG	Storm Grey
BRC	Brushed Cobalt	TFW	Tiger Fruitwood
CMB	Clear Maple	TWL	Tiger Walnut
DES	Dark Espresso	WHE	Walnut Heights
DWT	Designer White	WHC	White Chocolate
HGT	Hayden Grey	WGY	Willow Grey
NBL	Noce Biondo	WCR	Winter Cherry

- White Chocolate (**WHC**) not available on 10 & 12 foot tables. Must be cut in two pieces and specify third base.
- The above laminate finishes are available in **High Pressure**. Upcharge varies by model.
- Tables in woodgrain finishes over 12' in length will not have a perfect match of grain at the center where the two halves meet.
- All tables with Drum Bases & Pedestal require approx. 125 lb. of sand in each base for adequate stability. Sand is not included with Drum Bases.
- If other than a Global standard laminate finish is preferred, contact your customer care Representative. Information needed includes the name of the laminate manufacturer, color name, number and model of table. You will then be given a quote for this special order.

BASE SIZE CHART (Table width is nominal)

Round or Square Tops:

Top	Slab	Drum	Arch	Cross	4 Leg	Trumpet	4 Tube
36"	n/a	n/a	n/a	n/a	32"	24"	30"
42"	n/a	18"	n/a	30"	32"	24"	30"
48"	n/a	24"	n/a	30"	32"	n/a	30"
60"	n/a	30"	n/a	36"	n/a	n/a	n/a

Rectangular, Boat or Racetrack Tops:

Top	Slab	Drum	Arch	Cross	2 Leg	Trumpet	2/3 Tube
36" x 72"	24"	18"	24"	n/a	32"	n/a	30"
48" x 96"	28"	18"	28"	n/a	32"	n/a	30"
48" x 120"	28"	24"	28"	n/a	32"	n/a	30"
48" x 144"	28"	24"	28"	n/a	32"	n/a	30"

GROMMETS

- Grommets available in standard table top locations (left, center or right). Order as: **AG1, AG2 or AG3. Add \$88.**
- Grommet hole dimensions are 3 1/4" wide x 1 7/8" deep.



- Actual grommet locations will vary according to base selection.

POWER BLOCK

- A Power Block (model **PMSpDM**) may be ordered on all worksurfaces.
- A Power Block is a rectangular worksurface power/data module with one electrical duplex receptacle and two data (RJ45) receptacles. 9' black cord included. Power Block dimensions are 3 1/2" deep x 6 1/2" wide x 2 3/4" high.
- Actual Power Block locations vary according to base selection. The locations will be left

B BOARDROOM TABLES

(AG1, E1), center (AG2, E2), and right (AG3, E3). **Example:** 8' table with drum base does not have a modesty panel, so the grommet (AG2) and power block (E2) can be perfectly centered in the table. An 8' table with a slab base has the modesty panel, so the grommet (AG2) and power block (E2) will be offset alongside the modesty panel.

- To purchase a Power Block, you must specify both the Power Block cut-out location and the Power Block model #. Order Power Block as **PMSPDM, Add \$330**. Power Blocks are available in standard worksurface locations (left, center or right). Order as **E1, E2 or E3. Add \$88**.

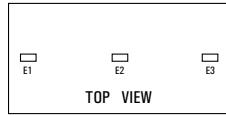
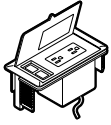

Power Block **PMSPDM - Add \$330** Specify location **E1, E2 or E3 - Add \$88**

TABLE NOTES - ESTIMATED CAPACITY

- Use the following for determining the size of a round table and the number of chairs needed for a conference area. All estimates are based on an average chair width of 23" with a 4" clearance between chairs. Adjust accordingly for a different chair size.

Top Size	Round	Square	Rectangular	Boat	Racetrack	Elliptical
30x30	3	3	N/A	N/A	N/A	N/A
36x36	4	4	N/A	N/A	N/A	N/A
42x42	4	4	N/A	N/A	N/A	N/A
48x48	4	4	N/A	N/A	N/A	N/A
60x60	5	6	N/A	N/A	N/A	N/A
30x60	N/A	N/A	4-6	4-6	4-6	4
36x72	N/A	N/A	4-6	4-6	4-6	4
44x84	N/A	N/A	6-8	6-8	6-8	6
48x96	N/A	N/A	6-8	6-8	6-8	6
48x120	N/A	N/A	8-10	8-10	8-10	8
48x144	N/A	N/A	10-12	10-12	10-12	10
48x168	N/A	N/A	12-14	12-14	12-14	12
48x192	N/A	N/A	14-16	14-16	14-16	14
48x216	N/A	N/A	16-18	16-18	16-18	16
48x240	N/A	N/A	18-20	18-20	18-20	18
48x264	N/A	N/A	20-22	20-22	20-22	20
48x288	N/A	N/A	22-24	22-24	22-24	22

BASE OPTIONS

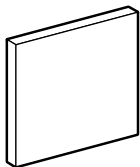

slab

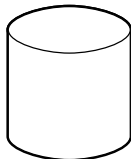

drum

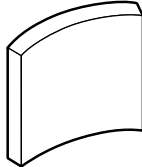

arch

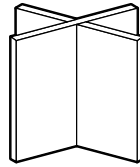

cross

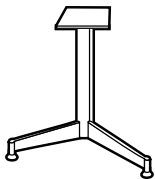

2-leg



4-leg

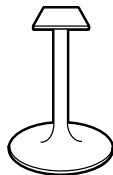

trumpet

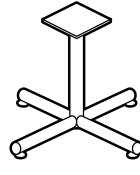

tube

EDGE OPTIONS

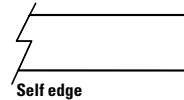

Self edge

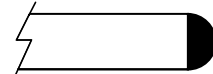

Bullnose

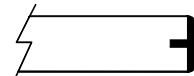

T-mold

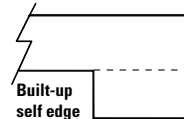

Built-up self edge

TABLE TOP STYLES

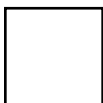

Square

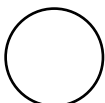

Round

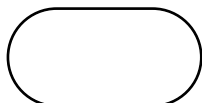

Racetrack



Boat

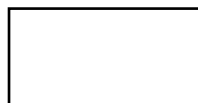

Rectangular

ROUND TOP - DRUM BASE

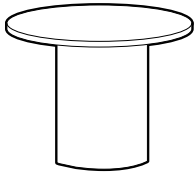

	MODEL#	DIMENSIONS D x W x H	FRT. CLASS	WT./LBS.	CUBIC FT.	LIST PRICE	HP ADD		
self edge	G42CZ	42 x 42 x 29	92.5	89	8.50	\$847	\$426		
bullnose edge	G42CZBN	42 x 42 x 29	92.5	86	8.50	\$847	\$426		
T-mold edge	G42CZTM	42 x 42 x 29	92.5	90	8.50	\$847	\$426		
built-up self edge	G42CZBU	42 x 42 x 29	92.5	96	9.40	\$940	\$470		
self edge	G48CZ	48 x 48 x 29	125	106	13.60	\$980	\$490		
bullnose edge	G48CZBN	48 x 48 x 29	100	117	13.60	\$980	\$490		
T-mold edge	G48CZTM	48 x 48 x 29	100	121	13.60	\$980	\$490		
built-up self edge	G48CZBU	48 x 48 x 29	100	133	14.90	\$1092	\$546		
self edge	G60CZ	60 x 60 x 29	100	171	21	\$1228	\$614		
bullnose edge	G60CZBN	60 x 60 x 29	100	171	21	\$1228	\$614		
T-mold edge	G60CZTM	60 x 60 x 29	100	171	21	\$1228	\$614		
built-up self edge	G60CZBU	60 x 60 x 29	125	174	23.20	\$1444	\$722		

• All Drum Bases require approx. 125 lb. of sand in each base for adequate stability. Sand is not included.

ROUND TOP - CROSS BASE

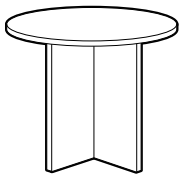

self edge	G42CH	42 x 42 x 29	70	97	5	\$788	\$395		
bullnose edge	G42CHBN	42 x 42 x 29	70	94	5	\$788	\$395		
T-mold edge	G42CHTM	42 x 42 x 29	70	98	5	\$788	\$395		
built-up self edge	G42CHBU	42 x 42 x 29	70	104	5.70	\$847	\$426		
self edge	G48CH	48 x 48 x 29	70	101	6	\$918	\$459		
bullnose edge	G48CHBN	48 x 48 x 29	70	112	6	\$918	\$459		
T-mold edge	G48CHTM	48 x 48 x 29	70	116	6	\$918	\$459		
built-up self edge	G48CHBU	48 x 48 x 29	70	128	6.60	\$1053	\$527		
self edge	G60CH	60 x 60 x 29	70	174	9	\$1176	\$589		
bullnose edge	G60CHBN	60 x 60 x 29	125	64	9	\$1176	\$589		
T-mold edge	G60CHTM	60 x 60 x 29	125	64	9	\$1176	\$589		
built-up self edge	G60CHBU	60 x 60 x 29	70	190	9.70	\$1386	\$694		

ROUND TOP - 4 LEG BASE



	MODEL#	DIMENSIONS	FRT. CLASS	WT./LBS.	CUBIC FT.	LIST PRICE	HP ADD	BCH	ACO/SBR
self edge	GCAR36	36 x 36 x 29	250	48	13	\$571	\$286	\$85	\$307
bullnose edge	GCAR36BN	36 x 36 x 29	150	55	13	\$571	\$286	\$85	\$307
T-mold edge	GCAR36TM	36 x 36 x 29	250	48	13	\$571	\$286	\$85	\$307
built-up self edge	GCAR36BU	36 x 36 x 29	150	68	13	\$635	\$318	\$85	\$307
self edge	GCAR42	42 x 42 x 29	150	59	14	\$681	\$341	\$85	\$307
bullnose edge	GCAR42BN	42 x 42 x 29	150	68	14	\$681	\$341	\$85	\$307
T-mold edge	GCAR42TM	42 x 42 x 29	150	61	14	\$681	\$341	\$85	\$307
built-up self edge	GCAR42BU	42 x 42 x 29	150	78	14	\$752	\$377	\$85	\$307
self edge	GCAR48	48 x 48 x 29	150	72	15	\$799	\$400	\$85	\$307
bullnose edge	GCAR48BN	48 x 48 x 29	150	83	15	\$799	\$400	\$85	\$307
T-mold edge	GCAR48TM	48 x 48 x 29	150	87	15	\$799	\$400	\$85	\$307
built-up self edge	GCAR48BU	48 x 48 x 29	125	99	15	\$887	\$444	\$85	\$307

Required Specifications

Finish
Base Finish
Edge Color, if applicable

B BOARDROOM TABLES

ROUND TOP - TRUMPET BASE

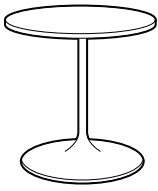

	MODEL#	DIMENSIONS	FRT. CLASS	WT./LBS.	CUBIC FT.	LIST PRICE	HP ADD	BCH	ACO/SBR
		D x W x H							
self edge	GTCR36	36 x 36 x 29	250	54	19	\$799	\$400	\$82	\$336
bullnose edge	GTCR36BN	36 x 36 x 29	250	61	18	\$799	\$400	\$82	\$336
T-mold edge	GTCR36TM	36 x 36 x 29	250	54	18	\$799	\$400	\$82	\$336
built-up self edge	GTCR36BU	36 x 36 x 29	150	74	18	\$887	\$444	\$82	\$336
self edge	GTCR42	42 x 42 x 29	150	77	19	\$896	\$449	\$82	\$336
bullnose edge	GTCR42BN	42 x 42 x 29	250	74	19	\$896	\$449	\$82	\$336
T-mold edge	GTCR42TM	42 x 42 x 29	150	78	19	\$896	\$449	\$82	\$336
built-up self edge	GTCR42BU	42 x 42 x 29	150	84	19	\$998	\$500	\$82	\$336

ROUND TOP - TUBULAR BASE



	MODEL#	DIMENSIONS	FRT. CLASS	WT./LBS.	CUBIC FT.	LIST PRICE	HP ADD	BCH	ACO/SBR
self edge	GCRR36	36 x 36 x 29	250	50	18	\$688	\$345	\$85	\$368
bullnose edge	GCRR36BN	36 x 36 x 29	250	57	19	\$688	\$345	\$85	\$368
T-mold edge	GCRR36TM	36 x 36 x 29	250	50	19	\$688	\$345	\$85	\$368
built-up self edge	GCRR36BU	36 x 36 x 29	250	70	19	\$768	\$384	\$85	\$368
self edge	GCRR42	42 x 42 x 29	250	61	19	\$799	\$400	\$85	\$368
bullnose edge	GCRR42BN	42 x 42 x 29	250	70	19	\$799	\$400	\$85	\$368
T-mold edge	GCRR42TM	42 x 42 x 29	250	63	19	\$799	\$400	\$85	\$368
built-up self edge	GCRR42BU	42 x 42 x 29	150	80	19	\$887	\$444	\$85	\$368
self edge	GCRR48	48 x 48 x 29	250	74	20	\$918	\$459	\$85	\$368
bullnose edge	GCRR48BN	48 x 48 x 29	150	85	20	\$918	\$459	\$85	\$368
T-mold edge	GCRR48TM	48 x 48 x 29	150	89	20	\$918	\$459	\$85	\$368
built-up self edge	GCRR48BU	48 x 48 x 29	150	101	20	\$1017	\$509	\$85	\$368

SQUARE TOP - DRUM BASE

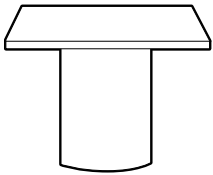

						LIST PRICE	HP ADD
self edge	G42SZ	42 x 42 x 29	100	89	9	\$847	\$426
bullnose edge	G42SZBN	42 x 42 x 29	100	89	9	\$847	\$426
T-mold edge	G42SZTM	42 x 42 x 29	100	89	9	\$847	\$426
built-up self edge	G42SZBU	42 x 42 x 29	92.5	106	9.40	\$940	\$470
self edge	G48SZ	48 x 48 x 29	100	121	13.40	\$980	\$490
bullnose edge	G48SZBN	48 x 48 x 29	100	121	13.40	\$980	\$490
T-mold edge	G48SZTM	48 x 48 x 29	100	121	13.60	\$980	\$490
built-up self edge	G48SZBU	48 x 48 x 29	100	133	14.90	\$1092	\$546
self edge	G60SZ	60 x 60 x 29	100	171	21	\$1228	\$614
bullnose edge	G60SZBN	60 x 60 x 29	100	171	21	\$1228	\$614
T-mold edge	G60SZTM	60 x 60 x 29	100	171	21	\$1228	\$614
built-up self edge	G60SZBU	60 x 60 x 29	125	174	23.20	\$1444	\$722

- All Drum Bases require approx. 125 lb. of sand in each base for adequate stability. Sand is not included.

SQUARE TOP - CROSS BASE

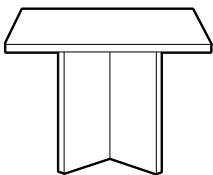

						LIST PRICE	HP ADD
self edge	G42SH	42 x 42 x 29	70	97	5	\$788	\$395
bullnose edge	G42SHBN	42 x 42 x 29	70	97	5	\$788	\$395
T-mold edge	G42SHTM	42 x 42 x 29	70	97	5	\$788	\$395
built-up self edge	G42SHBU	42 x 42 x 29	70	114	5.70	\$847	\$426
self edge	G48SH	48 x 48 x 29	70	116	6	\$918	\$459
bullnose edge	G48SHBN	48 x 48 x 29	70	116	6	\$918	\$459
T-mold edge	G48SHTM	48 x 48 x 29	70	116	6	\$918	\$459
built-up self edge	G48SHBU	48 x 48 x 29	70	122	6.40	\$1053	\$527
self edge	G60SH	60 x 60 x 29	125	64	9	\$1176	\$589
bullnose edge	G60SHBN	60 x 60 x 29	125	64	9	\$1176	\$589
T-mold edge	G60SHTM	60 x 60 x 29	125	64	9	\$1176	\$589
built-up self edge	G60SHBU	60 x 60 x 29	125	64	9.70	\$1386	\$694

Required Specifications

Finish
Base Finish
Edge Color, if applicable

Optional Specifications

HP laminate

SQUARE TOP - 4 LEG BASE



	MODEL#	DIMENSIONS	FRT. CLASS	WT/LBS.	CUBIC FT.	LIST PRICE	HP ADD	BCH	ACO/SBR
		D x W x H							
self edge	GCAS36	36 x 36 x 29	150	63	13	\$571	\$286	\$85	\$307
bullnose edge	GCAS36BN	36 x 36 x 29	150	63	13	\$571	\$286	\$85	\$307
T-mold edge	GCAS36TM	36 x 36 x 29	150	63	13	\$571	\$286	\$85	\$307
built-up self edge	GCAS36BU	36 x 36 x 29	150	67	13	\$635	\$318	\$85	\$307
self edge	GCAS42	42 x 42 x 29	150	71	14	\$681	\$341	\$85	\$307
bullnose edge	GCAS42BN	42 x 42 x 29	150	78	14	\$681	\$341	\$85	\$307
T-mold edge	GCAS42TM	42 x 42 x 29	150	78	14	\$681	\$341	\$85	\$307
built-up self edge	GCAS42BU	42 x 42 x 29	125	86	14	\$752	\$377	\$85	\$307
self edge	GCAS48	48 x 48 x 29	125	97	15	\$799	\$401	\$85	\$307
bullnose edge	GCAS48BN	48 x 48 x 29	125	97	15	\$799	\$401	\$85	\$307
T-mold edge	GCAS48TM	48 x 48 x 29	125	97	15	\$799	\$401	\$85	\$307
built-up self edge	GCAS48BU	48 x 48 x 29	125	108	15	\$887	\$444	\$85	\$307

SQUARE TOP - TRUMPET BASE



self edge	GTCS36	36 x 36 x 29	250	69	18	\$799	\$401	\$82	\$336
bullnose edge	GTCS36BN	36 x 36 x 29	250	69	18	\$799	\$401	\$82	\$336
T-mold edge	GTCS36TM	36 x 36 x 29	250	69	18	\$799	\$401	\$82	\$336
built-up self edge	GTCS36BU	36 x 36 x 29	150	76	18	\$887	\$444	\$82	\$336
self edge	GTCS42	42 x 42 x 29	150	77	19	\$896	\$449	\$82	\$336
bullnose edge	GTCS42BN	42 x 42 x 29	150	77	19	\$896	\$449	\$82	\$336
T-mold edge	GTCS42TM	42 x 42 x 29	150	77	19	\$896	\$449	\$82	\$336
built-up self edge	GTCS42BU	42 x 42 x 29	150	84	19	\$998	\$500	\$82	\$336

SQUARE TOP - TUBULAR BASE



self edge	GCRS36	36 x 36 x 29	250	65	18	\$688	\$345	\$85	\$368
bullnose edge	GCRS36BN	36 x 36 x 29	250	65	18	\$688	\$345	\$85	\$368
T-mold edge	GCRS36TM	36 x 36 x 29	250	65	18	\$688	\$345	\$85	\$368
built-up self edge	GCRS36BU	36 x 36 x 29	250	69	18	\$768	\$384	\$85	\$368
self edge	GCRS42	42 x 42 x 29	250	73	19	\$799	\$401	\$85	\$368
bullnose edge	GCRS42BN	42 x 42 x 29	150	80	19	\$799	\$401	\$85	\$368
T-mold edge	GCRS42TM	42 x 42 x 29	150	80	19	\$799	\$401	\$85	\$368
built-up self edge	GCRS42BU	42 x 42 x 29	150	88	19	\$887	\$444	\$85	\$368
self edge	GCRS48	48 x 48 x 29	150	101	20	\$918	\$459	\$85	\$368
bullnose edge	GCRS48BN	48 x 48 x 29	150	101	20	\$918	\$459	\$85	\$368
T-mold edge	GCRS48TM	48 x 48 x 29	150	101	20	\$918	\$459	\$85	\$368
built-up self edge	GCRS48BU	48 x 48 x 29	150	109	20	\$1017	\$510	\$85	\$368

Required Specifications

Finish
Base Finish
Edge Color, if applicable

Optional Specifications

HP laminate

B BOARDROOM TABLES

RECTANGULAR TOP - SLAB BASE

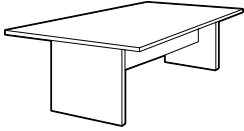

	MODEL#	DIMENSIONS	FREIGHT CLASS	WT./LBS.	CUBIC FT.	LIST PRICE	HP ADD
D x W x H							
5 foot	self edge	GCT5RX	30 x 60 x 29	70	131	6	\$994 \$498
	bullnose edge	GCT5RXBN	30 x 60 x 60	70	131	6	\$994 \$498
	T-mold edge	GCT5RXTM	30 x 60 x 29	70	131	6	\$994 \$498
	built-up self edge	GCT5RXBU	30 x 60 x 29	70	134	7	\$1099 \$550
6 foot	self edge	GCT6RX	36 x 72 x 29	70	174	11.38	\$1113 \$557
	bullnose edge	GCT6RXBN	36 x 72 x 29	70	174	11.38	\$1113 \$557
	T-mold edge	GCT6RXTM	36 x 72 x 29	70	174	11.38	\$1113 \$557
	built-up self edge	GCT6RXBU	36 x 72 x 29	85	177	13.32	\$1241 \$621
7 foot	self edge	GCT7RX	44 x 84 x 29	85	199	14.94	\$1434 \$717
	bullnose edge	GCT7RXBN	44 x 84 x 29	85	199	14.94	\$1434 \$717
	T-mold edge	GCT7RXTM	44 x 84 x 84	85	199	14.94	\$1434 \$717
	built-up self edge	GCT7RXBU	44 x 84 x 84	92.5	203	17.93	\$1618 \$809
8 foot	self edge	GCT8WRX	48 x 96 x 29	70	218	11.29	\$1434 \$717
	bullnose edge	GCT8WRXBN	48 x 96 x 29	70	218	11.29	\$1434 \$717
	T-mold edge	GCT8WRXTM	48 x 96 x 29	70	218	11.29	\$1434 \$717
	built-up self edge	GCT8WRXBU	48 x 96 x 29	70	249	13.53	\$1618 \$809
10 foot	self edge	GCT10WRX2	48 x 120 x 29	70	272	13.53	\$1662 \$833
	bullnose edge	GCT10WRX2BN	48 x 120 x 29	70	272	13.53	\$1662 \$833
	T-mold edge	GCT10WRX2TM	48 x 120 x 29	70	272	13.53	\$1662 \$833
	built-up self edge	GCT10WRX2BU	48 x 120 x 29	70	291	16.20	\$1966 \$983
12 foot	self edge	GCT12WRX2	48 x 144 x 29	70	309	15.54	\$1949 \$975
	bullnose edge	GCT12WRX2BN	48 x 144 x 29	70	309	15.54	\$1949 \$975
	T-mold edge	GCT12WRX2TM	48 x 144 x 29	70	309	15.54	\$1949 \$975
	built-up self edge	GCT12WRX2BU	48 x 144 x 29	70	348	18.77	\$2288 \$1144
14 foot	self edge	GCT14WRX2	48 x 168 x 29	70	419	22.50	\$2818 \$1409
	bullnose edge	GCT14WRX2BN	48 x 168 x 29	70	419	22.50	\$2818 \$1409
	T-mold edge	GCT14WRX2TM	48 x 168 x 29	65	419	18	\$2818 \$1409
	built-up self edge	GCT14WRX2BU	48 x 168 x 29	70	425	20	\$3146 \$1574
16 foot	self edge	GCT16WRX2	48 x 192 x 29	70	460	22.72	\$2937 \$1469
	bullnose edge	GCT16WRX2BN	48 x 192 x 29	70	460	22.72	\$2937 \$1469
	T-mold edge	GCT16WRX2TM	48 x 192 x 29	70	460	22.70	\$2937 \$1469
	built-up self edge	GCT16WRX2BU	48 x 192 x 29	70	466	27.20	\$3279 \$1640
18 foot	self edge	GCT18WRX2	48 x 216 x 29	70	521	24.60	\$3655 \$1828
	bullnose edge	GCT18WRX2BN	48 x 216 x 29	70	521	24.60	\$3655 \$1828
	T-mold edge	GCT18WRX2TM	48 x 216 x 29	70	521	24.60	\$3655 \$1828
	built-up self edge	GCT18WRX2BU	48 x 216 x 29	70	528	29.80	\$4097 \$2051
20 foot	self edge	GCT20WRX2	48 x 240 x 29	70	572	26.60	\$3713 \$1857
	bullnose edge	GCT20WRX2BN	48 x 240 x 29	70	572	26.60	\$3713 \$1857
	T-mold edge	GCT20WRX2TM	48 x 240 x 29	70	572	26.60	\$3713 \$1857
	built-up self edge	GCT20WRX2BU	48 x 240 x 29	70	580	32.50	\$4156 \$2078
22 foot	self edge	GCT22WRX2	48 x 264 x 29	70	612	28.90	\$4310 \$2155
	bullnose edge	GCT22WRX2BN	48 x 264 x 29	70	612	28.90	\$4310 \$2155
	T-mold edge	GCT22WRX2TM	48 x 264 x 29	70	612	28.90	\$4310 \$2155
	built-up self edge	GCT22WRX2BU	48 x 264 x 29	70	620	35.10	\$4760 \$2380
24 foot	self edge	GCT24WRX2	48 x 288 x 29	70	673	31.20	\$4431 \$2216
	bullnose edge	GCT24WRX2BN	48 x 288 x 29	70	673	31.20	\$4431 \$2216
	T-mold edge	GCT24WRX2TM	48 x 288 x 29	70	673	31.20	\$4431 \$2216
	built-up self edge	GCT24WRX2BU	48 x 288 x 29	70	682	37.70	\$4902 \$2451

- All tops over 144" are standard in two pieces. Woodgrain laminate finishes will NOT align where the two tops join.
- All tops 168", 192", 216" and 240" are SHIPPED WITH 3 SLAB BASES.
- All tops 264" and 288" are SHIPPED WITH 4 SLAB BASES.

Required Specifications

Finish
Base Finish
Edge Color, if applicable

Optional Specifications

Grommet
HP laminate

Accessories

Power Block

RECTANGULAR TOP - DRUM BASE

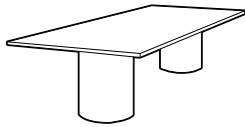

	MODEL#	DIMENSIONS	FREIGHT CLASS			CUBIC FT.	LIST PRICE	HP ADD		
			D	W	H					
6 foot	self edge	GCT6RZ	36	72	29	100	154	17.50	\$1505	\$753
	bullnose edge	GCT6RZBN	36	72	29	100	167	17.50	\$1505	\$753
	T-mold edge	GCT6RZTM	36	72	29	100	167	17.50	\$1505	\$753
	built-up self edge	GCT6RZBU	36	72	29	100	177	18.80	\$1684	\$842
7 foot	self edge	GCT7RZ	44	84	29	125	196	29.04	\$1743	\$872
	bullnose edge	GCT7RZBN	44	84	29	125	196	29.04	\$1743	\$872
	T-mold edge	GCT7RZTM	44	84	29	125	196	29.04	\$1743	\$872
	built-up self edge	GCT7RZBU	44	84	29	125	199	31.66	\$1921	\$961
8 foot	self edge	GCT8WRZ	48	96	29	125	219	31.82	\$1743	\$872
	bullnose edge	GCT8WRZBN	48	96	29	125	219	31.82	\$1743	\$872
	T-mold edge	GCT8WRZTM	48	96	29	125	219	31.82	\$1743	\$872
	built-up self edge	GCT8WRZBU	48	96	29	125	250	35.18	\$1921	\$961
10 foot	self edge	GCT10WRZ2	48	120	29	100	295	33	\$2042	\$1021
	bullnose edge	GCT10WRZ2BN	48	120	29	100	295	33	\$2042	\$1021
	T-mold edge	GCT10WRZ2TM	48	120	29	100	295	33.02	\$2042	\$1021
	built-up self edge	GCT10WRZ2BU	48	120	29	100	314	35.72	\$2251	\$1126
12 foot	self edge	GCT12WRZ2	48	144	29	100	328	35.10	\$2283	\$1142
	bullnose edge	GCT12WRZ2BN	48	144	29	100	328	35.10	\$2283	\$1142
	T-mold edge	GCT12WRZ2TM	48	144	29	250	97	35.10	\$2283	\$1142
	built-up self edge	GCT12WRZ2BU	48	144	29	250	367	96	\$2534	\$1267
14 foot	self edge	GCT14WRZ2	48	168	29	92.5	441	39	\$3059	\$1530
	bullnose edge	GCT14WRZ2BN	48	168	29	92.5	441	39	\$3059	\$1530
	T-mold edge	GCT14WRZ2TM	48	168	29	92.5	441	39	\$3059	\$1530
	built-up self edge	GCT14WRZ2BU	48	168	29	92.5	447	42	\$3392	\$1696
16 foot	self edge	GCT16WRZ2	48	192	29	92.5	482	42.50	\$3178	\$1589
	bullnose edge	GCT16WRZ2BN	48	192	29	92.5	482	42.50	\$3178	\$1589
	T-mold edge	GCT16WRZ2TM	48	192	29	92.5	482	42.50	\$3178	\$1589
	built-up self edge	GCT16WRZ2BU	48	192	29	92.5	488	47	\$3507	\$1754
18 foot	self edge	GCT18WRZ2	48	216	29	100	523	54.40	\$4133	\$2067
	bullnose edge	GCT18WRZ2BN	48	216	29	100	523	54.40	\$4133	\$2067
	T-mold edge	GCT18WRZ2TM	48	216	29	100	523	54.40	\$4133	\$2067
	built-up self edge	GCT18WRZ2BU	48	216	29	100	550	59	\$4646	\$2324
20 foot	self edge	GCT20WRZ2	48	240	29	100	564	66.20	\$4193	\$2097
	bullnose edge	GCT20WRZ2BN	48	240	29	100	564	66.20	\$4193	\$2097
	T-mold edge	GCT20WRZ2TM	48	240	29	100	564	66.20	\$4193	\$2097
	built-up self edge	GCT20WRZ2BU	48	240	29	100	572	70.60	\$4707	\$2354
22 foot	self edge	GCT22WRZ2	48	264	29	100	604	68.20	\$4670	\$2336
	bullnose edge	GCT22WRZ2BN	48	264	29	100	604	68.20	\$4670	\$2336
	T-mold edge	GCT22WRZ2TM	48	264	29	100	604	68.20	\$4670	\$2336
	built-up self edge	GCT22WRZ2BU	48	264	29	100	612	73.68	\$5217	\$2609
24 foot	self edge	GCT24WRZ2	48	288	29	100	646	70.20	\$4791	\$2396
	bullnose edge	GCT24WRZ2BN	48	288	29	100	646	70.20	\$4791	\$2396
	T-mold edge	GCT24WRZ2TM	48	288	29	100	646	70.20	\$4791	\$2396
	built-up self edge	GCT24WRZ2BU	48	288	29	100	655	76.80	\$5329	\$2665

- All Drum Bases require approx. 125 lb. of sand in each base for adequate stability. Sand is not included.
- All tops over 144" are standard in two pieces. Woodgrain laminate finishes will NOT align where the two tops join.
- All tops 168", 192" and 216" are SHIPPED WITH 3 DRUM BASES.
- All tops 240", 264" and 288" are SHIPPED WITH 4 DRUM BASES.

Required Specifications

Finish
Base Finish
Edge Color, if applicable

Optional Specifications

Grommet
HP laminate

Accessories

Power Block

B BOARDROOM TABLES

RECTANGULAR TOP - ARCH BASE

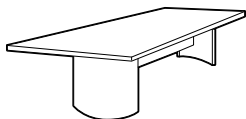

	MODEL#	DIMENSIONS	FREIGHT CLASS	WT./LBS.	CUBIC FT.	LIST PRICE	HP ADD
D x W x H							
5 foot	self edge	GCT5RA	30 x 60 x 29	85	131	9	\$1324 \$663
	bullnose edge	GCT5RABN	30 x 60 x 29	85	131	9	\$1324 \$663
	T-mold edge	GCT5RATM	30 x 60 x 29	85	131	9	\$1324 \$663
	built-up self edge	GCT5RABU	30 x 60 x 29	85	134	10	\$1504 \$752
6 foot	self edge	GCT6RA	36 x 72 x 29	125	157	24.64	\$1385 \$693
	bullnose edge	GCT6RABN	36 x 72 x 29	125	157	24.64	\$1385 \$693
	T-mold edge	GCT6RATM	36 x 72 x 29	70	157	8.24	\$1385 \$693
	built-up self edge	GCT6RABU	36 x 72 x 29	100	167	17.96	\$1645 \$823
7 foot	self edge	GCT7RA	44 x 84 x 29	92.5	203	19.43	\$1685 \$843
	bullnose edge	GCT7RABN	44 x 84 x 29	92.5	203	19.43	\$1685 \$843
	T-mold edge	GCT7RATM	44 x 84 x 29	92.5	203	19.43	\$1685 \$843
	built-up self edge	GCT7RABU	44 x 84 x 29	100	206	20.90	\$1907 \$954
8 foot	self edge	GCT8WRA	48 x 96 x 29	100	220	22.40	\$1685 \$843
	bullnose edge	GCT8WRABN	48 x 96 x 29	100	220	22.40	\$1685 \$843
	T-mold edge	GCT8WRATM	48 x 96 x 29	100	220	22.40	\$1685 \$843
	built-up self edge	GCT8WRABU	48 x 96 x 29	92.5	251	23.89	\$1907 \$954
10 foot	self edge	GCT10WRA	48 x 120 x 29	70	274	16.95	\$1922 \$962
	bullnose edge	GCT10WRABN	48 x 120 x 29	70	274	16.95	\$1922 \$962
	T-mold edge	GCT10WRATM	48 x 120 x 29	70	274	16.95	\$1922 \$962
	built-up self edge	GCT10WRABU	48 x 120 x 29	70	293	18.92	\$2266 \$1134
12 foot	self edge	GCT12WRA	48 x 144 x 29	70	311	19.94	\$2222 \$1111
	bullnose edge	GCT12WRABN	48 x 144 x 29	70	311	19.94	\$2222 \$1111
	T-mold edge	GCT12WRATM	48 x 144 x 29	70	311	19.94	\$2222 \$1111
	built-up self edge	GCT12WRABU	48 x 144 x 29	70	350	21.92	\$2593 \$1297
14 foot	self edge	GCT14WRA	48 x 168 x 29	70	423	26	\$3418 \$1709
	bullnose edge	GCT14WRABN	48 x 168 x 29	70	423	26	\$3418 \$1709
	T-mold edge	GCT14WRATM	48 x 168 x 29	70	423	26	\$3418 \$1709
	built-up self edge	GCT14WRABU	48 x 168 x 29	70	429	28	\$3809 \$1905
16 foot	self edge	GCT16WRA	48 x 192 x 29	70	474	30	\$3596 \$1798
	bullnose edge	GCT16WRABN	48 x 192 x 29	70	474	30	\$3596 \$1798
	T-mold edge	GCT16WRATM	48 x 192 x 29	70	474	30	\$3596 \$1798
	built-up self edge	GCT16WRABU	48 x 192 x 29	70	480	32	\$4020 \$2010
18 foot	self edge	GCT18WRA	48 x 216 x 29	70	525	31.92	\$4431 \$2216
	bullnose edge	GCT18WRABN	48 x 216 x 29	70	525	31.92	\$4431 \$2216
	T-mold edge	GCT18WRATM	48 x 216 x 29	70	525	31.92	\$4431 \$2216
	built-up self edge	GCT18WRABU	48 x 216 x 29	70	532	33.89	\$4952 \$2477
20 foot	self edge	GCT20WRA	48 x 240 x 29	70	576	33.89	\$4495 \$2248
	bullnose edge	GCT20WRABN	48 x 240 x 29	70	576	33.89	\$4495 \$2248
	T-mold edge	GCT20WRATM	48 x 240 x 29	70	576	33.89	\$4495 \$2248
	built-up self edge	GCT20WRABU	48 x 240 x 29	70	584	35.93	\$4999 \$2500
22 foot	self edge	GCT22WRA	48 x 264 x 29	70	626	36.89	\$5025 \$2513
	bullnose edge	GCT22WRABN	48 x 264 x 29	70	626	36.89	\$5025 \$2513
	T-mold edge	GCT22WRATM	48 x 264 x 29	70	626	36.89	\$5025 \$2513
	built-up self edge	GCT22WRABU	48 x 264 x 29	70	634	37.90	\$5618 \$2809
24 foot	self edge	GCT24WRA	48 x 288 x 29	70	678	40	\$5146 \$2573
	bullnose edge	GCT24WRABN	48 x 288 x 29	70	678	40	\$5146 \$2573
	T-mold edge	GCT24WRATM	48 x 288 x 29	70	678	40	\$5146 \$2573
	built-up self edge	GCT24WRABU	48 x 288 x 29	70	687	42	\$5734 \$2868

- All tops over 144" are standard in two pieces. Woodgrain laminate finishes will NOT align where the two tops join.
- All tops 168", 192", 216" and 240" are SHIPPED WITH 2 ARCH BASES AND 1 SLAB BASE.
- All tops 264" and 288" are SHIPPED WITH 2 ARCH BASES AND 2 SLAB BASES.

Required Specifications

Finish
Base Finish
Edge Color, if applicable

Optional Specifications

Grommet
HP laminate

Accessories

Power Block

RECTANGULAR TOP - 2 LEG BASE



	MODEL#	DIMENSIONS	FREIGHT CLASS			CUBIC FT.	LIST PRICE	HP ADD
			D	W	H			
5 foot	self edge	GCT5R	30 x 60 x 29	125	88	13	\$1169	\$585
	bullnose edge	GCT5RBN	30 x 60 x 29	125	88	13	\$1169	\$585
	T-mold edge	GCT5RTM	30 x 60 x 29	125	88	13	\$1169	\$585
	built-up self edge	GCT5RBU	30 x 60 x 29	125	91	14	\$1305	\$653
6 foot	self edge	GCT6R	36 x 72 x 29	125	115	15	\$1302	\$651
	bullnose edge	GCT6RBN	36 x 72 x 29	92.5	152	15	\$1302	\$651
	T-mold edge	GCT6RTM	36 x 72 x 29	92.5	152	15	\$1302	\$651
	built-up self edge	GCT6RBU	36 x 72 x 29	92.5	162	16	\$1446	\$723
7 foot	self edge	GCT7R	44 x 84 x 29	100	155	17	\$1505	\$753
	bullnose edge	GCT7RBN	44 x 84 x 29	100	155	17	\$1505	\$753
	T-mold edge	GCT7RTM	44 x 84 x 29	100	155	17	\$1505	\$753
	built-up self edge	GCT7RBU	44 x 84 x 29	100	158	19.02	\$1686	\$843
8 foot	self edge	GCT8WR	48 x 96 x 29	92.5	194	19.04	\$1505	\$753
	bullnose edge	GCT8WRBN	48 x 96 x 29	100	180	19.02	\$1505	\$753
	T-mold edge	GCT8WRTM	48 x 96 x 29	100	180	19.02	\$1505	\$753
	built-up self edge	GCT8WRBU	48 x 96 x 29	92.5	211	21	\$1686	\$843
10 foot	self edge	GCT10WR	48 x 120 x 29	92.5	214	20.93	\$2090	\$1046
	bullnose edge	GCT10WRBN	48 x 120 x 29	92.5	237	21	\$2090	\$1046
	T-mold edge	GCT10WRTM	48 x 120 x 29	92.5	237	21	\$2090	\$1046
	built-up self edge	GCT10WRBU	48 x 120 x 29	125	256	34.37	\$2338	\$1170
12 foot	self edge	GCT12WR	48 x 144 x 29	92.5	270	23	\$2352	\$1176
	bullnose edge	GCT12WRBN	48 x 144 x 29	85	270	21	\$2352	\$1176
	T-mold edge	GCT12WRTM	48 x 144 x 29	92.5	270	22.90	\$2352	\$1176
	built-up self edge	GCT12WRBU	48 x 144 x 29	85	309	24.91	\$2620	\$1311
14 foot	self edge	GCT14WR	48 x 168 x 29	100	326	34	\$2698	\$1350
	bullnose edge	GCT14WRBN	48 x 168 x 29	100	326	34	\$2698	\$1350
	T-mold edge	GCT14WRTM	48 x 168 x 29	100	326	34	\$2698	\$1350
	built-up self edge	GCT14WRBU	48 x 168 x 29	100	332	38	\$2981	\$1491
16 foot	self edge	GCT16WR	48 x 192 x 29	100	367	38	\$2818	\$1409
	bullnose edge	GCT16WRBN	48 x 192 x 29	100	367	38	\$2818	\$1409
	T-mold edge	GCT16WRTM	48 x 192 x 29	100	367	38	\$2818	\$1409
	built-up self edge	GCT16WRBU	48 x 192 x 29	100	373	40	\$3052	\$1527
18 foot	self edge	GCT18WR	48 x 216 x 29	92.5	408	40	\$3358	\$1680
	bullnose edge	GCT18WRBN	48 x 216 x 29	92.5	408	40	\$3358	\$1680
	T-mold edge	GCT18WRTM	48 x 216 x 29	92.5	408	40	\$3358	\$1680
	built-up self edge	GCT18WRBU	48 x 216 x 29	100	416	42	\$3744	\$1872
20 foot	self edge	GCT20WR	48 x 240 x 29	92.5	449	42	\$3477	\$1739
	bullnose edge	GCT20WRBN	48 x 240 x 29	92.5	449	42	\$3477	\$1739
	T-mold edge	GCT20WRTM	48 x 240 x 29	92.5	449	42	\$3477	\$1739
	built-up self edge	GCT20WRBU	48 x 240 x 29	92.5	457	44	\$3858	\$1930
22 foot	self edge	GCT22WR	48 x 264 x 29	92.5	489	44	\$3833	\$1917
	bullnose edge	GCT22WRBN	48 x 264 x 29	92.5	489	44	\$3833	\$1917
	T-mold edge	GCT22WRTM	48 x 264 x 29	92.5	489	44	\$3833	\$1917
	built-up self edge	GCT22WRBU	48 x 264 x 29	92.5	497	46	\$4316	\$2159
24 foot	self edge	GCT24WR	48 x 288 x 29	92.5	531	46	\$3951	\$1976
	bullnose edge	GCT24WRBN	48 x 288 x 29	92.5	531	46	\$3951	\$1976
	T-mold edge	GCT24WRTM	48 x 288 x 29	92.5	531	46	\$3951	\$1976
	built-up self edge	GCT24WRBU	48 x 288 x 29	92.5	540	48	\$4418	\$2210

- All tops over 144" are standard in two pieces. Woodgrain laminate finishes will NOT align where the two tops join.
- All tops 120", 144", and 168" are SHIPPED WITH 3 LEG BASES.
- All tops 192" are SHIPPED WITH 4 LEG BASES.
- All tops 216", 240", 264" and 288" are SHIPPED WITH 6 LEG BASES.

Required Specifications

Finish
Base Finish
Edge Color, if applicable

Optional Specifications

Grommet
HP laminate

Accessories

Power Block

B BOARDROOM TABLES

RECTANGULAR TOP - TUBULAR BASE

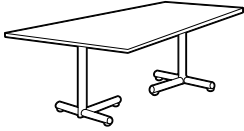

	MODEL#	DIMENSIONS	FREIGHT CLASS	WT/LBS.	CUBIC FT.	LIST PRICE	HP ADD
D x W x H							
5 foot	self edge	GCR5R	30 x 60 x 29	150	94	21	\$1206 \$604
	bullnose edge	GCR5RBN	30 x 60 x 29	150	94	21	\$1206 \$604
	T-mold edge	GCR5RTM	30 x 60 x 29	150	94	21	\$1206 \$604
	built-up self edge	GCR5RBU	30 x 60 x 29	150	97	23	\$1346 \$674
6 foot	self edge	GCR6R	36 x 72 x 29	150	107	23	\$1339 \$670
	bullnose edge	GCR6RBN	36 x 72 x 29	150	107	23	\$1339 \$670
	T-mold edge	GCR6RTM	36 x 72 x 29	150	107	23	\$1339 \$670
	built-up self edge	GCR6RBU	36 x 72 x 29	150	117	25	\$1490 \$746
7 foot	self edge	GCR7R	44 x 84 x 29	125	161	25	\$1543 \$772
	bullnose edge	GCR7RBN	44 x 84 x 29	125	161	25	\$1543 \$772
	T-mold edge	GCR7RTM	44 x 84 x 29	125	161	25	\$1543 \$772
	built-up self edge	GCR7RBU	44 x 84 x 29	125	164	27	\$1726 \$863
8 foot	self edge	GCR8WR	48 x 96 x 29	125	177	27	\$1543 \$772
	bullnose edge	GCR8WRBN	48 x 96 x 29	125	177	27	\$1543 \$772
	T-mold edge	GCR8WRM	48 x 96 x 29	125	177	27	\$1543 \$772
	built-up self edge	GCR8WRBU	48 x 96 x 29	125	208	29	\$1726 \$863
10 foot	self edge	GCR10WR	48 x 120 x 29	125	221	28.92	\$2112 \$1056
	bullnose edge	GCR10WRBN	48 x 120 x 29	125	221	28.92	\$2112 \$1056
	T-mold edge	GCR10WRM	48 x 120 x 29	125	221	29	\$2112 \$1056
	built-up self edge	GCR10WRBU	48 x 120 x 29	125	239	32	\$2370 \$1186
12 foot	self edge	GCR12WR	48 x 144 x 29	100	270	30.96	\$2379 \$1190
	bullnose edge	GCR12WRBN	48 x 144 x 29	100	270	30.96	\$2379 \$1190
	T-mold edge	GCR12WRM	48 x 144 x 29	100	270	30.96	\$2379 \$1190
	built-up self edge	GCR12WRBU	48 x 144 x 29	100	293	33.89	\$2656 \$1329
14 foot	self edge	GCR14WR	48 x 168 x 29	125	330	50	\$2733 \$1367
	bullnose edge	GCR14WRBN	48 x 168 x 29	125	330	50	\$2733 \$1367
	T-mold edge	GCR14WRM	48 x 168 x 29	125	330	50	\$2733 \$1367
	built-up self edge	GCR14WRBU	48 x 168 x 29	125	336	54	\$3018 \$1510
16 foot	self edge	GCR16WR	48 x 192 x 29	125	371	54	\$2853 \$1427
	bullnose edge	GCR16WRBN	48 x 192 x 29	125	371	54	\$2853 \$1427
	T-mold edge	GCR16WRM	48 x 192 x 29	125	371	54	\$2853 \$1427
	built-up self edge	GCR16WRBU	48 x 192 x 29	125	377	58	\$3133 \$1567
18 foot	self edge	GCR18WR	48 x 216 x 29	125	412	56	\$3380 \$1690
	bullnose edge	GCR18WRBN	48 x 216 x 29	125	412	56	\$3380 \$1690
	T-mold edge	GCR18WRM	48 x 216 x 29	125	412	56	\$3380 \$1690
	built-up self edge	GCR18WRBU	48 x 216 x 29	125	419	60	\$3775 \$1888
20 foot	self edge	GCR20WR	48 x 240 x 29	125	453	58	\$3500 \$1751
	bullnose edge	GCR20WRBN	48 x 240 x 29	125	453	58	\$3500 \$1751
	T-mold edge	GCR20WRM	48 x 240 x 29	125	453	58	\$3500 \$1751
	built-up self edge	GCR20WRBU	48 x 240 x 29	125	461	62	\$3901 \$1951
22 foot	self edge	GCR22WR	48 x 264 x 29	100	493	60	\$3894 \$1948
	bullnose edge	GCR22WRBN	48 x 264 x 29	100	493	60	\$3894 \$1948
	T-mold edge	GCR22WRM	48 x 264 x 29	100	493	60	\$3894 \$1948
	built-up self edge	GCR22WRBU	48 x 264 x 29	125	501	64	\$4349 \$2175
24 foot	self edge	GCR24WR	48 x 288 x 29	100	535	62	\$4016 \$2008
	bullnose edge	GCR24WRBN	48 x 288 x 29	100	535	62	\$4016 \$2008
	T-mold edge	GCR24WRM	48 x 288 x 29	100	535	62	\$4016 \$2008
	built-up self edge	GCR24WRBU	48 x 288 x 29	100	544	66	\$4463 \$2232

- All tops over 144" are standard in two pieces. Woodgrain laminate finishes will NOT align where the two tops join.
- All tops 120", 144", and 168" are SHIPPED WITH 3 TUBULAR BASES.
- All tops 192" are SHIPPED WITH 4 TUBULAR BASES.
- All tops 216", 240", 264" and 288" are SHIPPED WITH 6 TUBULAR BASES.

Required Specifications

Finish
Base Finish
Edge Color, if applicable

Optional Specifications

Grommet
HP laminate

Accessories

Power Block

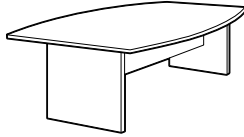
BOAT TOP - SLAB BASE

	MODEL#	DIMENSIONS	FREIGHT CLASS			CUBIC FT.	LIST PRICE	HP ADD
			WT/LBS.	D x W x H				
5 foot	self edge	GCT5BX	30 x 60 x 29	70	131	6	\$994	\$498
	bullnose edge	GCT5BXBN	30 x 60 x 29	70	131	6	\$994	\$498
	T-mold edge	GCT5BXTM	30 x 60 x 29	70	131	7	\$994	\$498
	built-up self edge	GCT5BXBU	30 x 60 x 29	125	114	17	\$1099	\$550
6 foot	self edge	GCT6BX	36 x 72 x 29	70	138	7.60	\$1113	\$557
	bullnose edge	GCT6BXBN	36 x 72 x 29	70	138	7.60	\$1113	\$557
	T-mold edge	GCT6BXTM	36 x 72 x 29	70	147	7.60	\$1113	\$557
	built-up self edge	GCT6BXBU	36 x 72 x 29	70	157	8.90	\$1241	\$621
7 foot	self edge	GCT7BX	44 x 84 x 29	70	199	9.94	\$1434	\$717
	bullnose edge	GCT7BXBN	44 x 84 x 29	70	199	9.94	\$1434	\$717
	T-mold edge	GCT7BXTM	44 x 84 x 29	70	199	9.94	\$1434	\$717
	built-up self edge	GCT7BXBU	44 x 84 x 29	70	203	11.95	\$1618	\$809
8 foot	self edge	GCT8WBX	48 x 96 x 29	70	218	11.29	\$1434	\$717
	bullnose edge	GCT8WBXBN	48 x 96 x 29	70	218	11.29	\$1434	\$717
	T-mold edge	GCT8WBXTM	48 x 96 x 29	70	218	11.29	\$1434	\$717
	built-up self edge	GCT8WBXBU	48 x 96 x 29	70	218	13.53	\$1618	\$809
10 foot	self edge	GCT10WBX2	48 x 120 x 29	70	249	13.53	\$1662	\$832
	bullnose edge	GCT10WBX2BN	48 x 120 x 29	70	249	13.53	\$1662	\$832
	T-mold edge	GCT10WBX2TM	48 x 120 x 29	70	249	13.53	\$1662	\$832
	built-up self edge	GCT10WBX2BU	48 x 120 x 29	70	294	16.20	\$1966	\$983
12 foot	self edge	GCT12WBX2	48 x 144 x 29	70	308	15.54	\$1949	\$975
	bullnose edge	GCT12WBX2BN	48 x 144 x 29	70	308	15.54	\$1949	\$975
	T-mold edge	GCT12WBX2TM	48 x 144 x 29	70	308	15.54	\$1949	\$975
	built-up self edge	GCT12WBX2BU	48 x 144 x 29	70	338	18.83	\$2288	\$1144
14 foot	self edge	GCT14WBX2	48 x 168 x 29	65	419	18	\$2818	\$1409
	bullnose edge	GCT14WBX2BN	48 x 168 x 29	65	419	18	\$2818	\$1409
	T-mold edge	GCT14WBX2TM	48 x 168 x 29	65	419	18	\$2818	\$1409
	built-up self edge	GCT14WBX2BU	48 x 168 x 29	65	425	16	\$3146	\$1574
16 foot	self edge	GCT16WBX2	48 x 192 x 29	70	460	22.70	\$2937	\$1469
	bullnose edge	GCT16WBX2BN	48 x 192 x 29	70	460	22.70	\$2937	\$1469
	T-mold edge	GCT16WBX2TM	48 x 192 x 29	70	460	22.70	\$2937	\$1469
	built-up self edge	GCT16WBX2BU	48 x 192 x 29	70	466	27.20	\$3279	\$1640
18 foot	self edge	GCT18WBX2	48 x 216 x 29	70	521	24.60	\$3655	\$1828
	bullnose edge	GCT18WBX2BN	48 x 216 x 29	70	521	24.60	\$3655	\$1828
	T-mold edge	GCT18WBX2TM	48 x 216 x 29	70	521	24.60	\$3655	\$1828
	built-up self edge	GCT18WBX2BU	48 x 216 x 29	70	528	29.80	\$4097	\$2049
20 foot	self edge	GCT20WBX2	48 x 240 x 29	70	572	26.60	\$3713	\$1857
	bullnose edge	GCT20WBX2BN	48 x 240 x 29	70	572	26.60	\$3713	\$1857
	T-mold edge	GCT20WBX2TM	48 x 240 x 29	70	572	26.60	\$3713	\$1857
	built-up self edge	GCT20WBX2BU	48 x 240 x 29	70	580	32.50	\$4156	\$2078
22 foot	self edge	GCT22WBX2	48 x 264 x 29	70	612	28.90	\$4310	\$2155
	bullnose edge	GCT22WBX2BN	48 x 264 x 29	70	612	28.90	\$4310	\$2155
	T-mold edge	GCT22WBX2TM	48 x 264 x 29	70	612	28.90	\$4310	\$2155
	built-up self edge	GCT22WBX2BU	48 x 264 x 29	70	620	35.10	\$4760	\$2380
24 foot	self edge	GCT24WBX2	48 x 288 x 29	70	673	31.20	\$4431	\$2216
	bullnose edge	GCT24WBX2BN	48 x 288 x 29	70	673	31.20	\$4431	\$2216
	T-mold edge	GCT24WBX2TM	48 x 288 x 29	70	673	31.20	\$4431	\$2216
	built-up self edge	GCT24WBX2BU	48 x 288 x 29	70	682	37.70	\$4902	\$2451

- All tops over 144" are standard in two pieces. Woodgrain laminate finishes will NOT align where the two tops join.
- All tops 168", 192", 216" and 240" are SHIPPED WITH 3 SLAB BASES.
- All tops 264" and 288" are SHIPPED WITH 4 SLAB BASES.

Required Specifications

Finish
Base Finish
Edge Color, if applicable

Optional Specifications

Grommet
HP laminate

Accessories

Power Block

B BOARDROOM TABLES

BOAT TOP - DRUM BASE

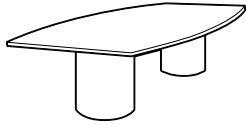

	MODEL#	DIMENSIONS	FREIGHT CLASS	WT./LBS.	CUBIC FT.	LIST PRICE	HP ADD
D x W x H							
6 foot	self edge	GCT6BZ	36 x 72 x 29	100	162	17.50	\$1505 \$753
	bullnose edge	GCT6BZBN	36 x 72 x 29	100	153	17.50	\$1505 \$753
	T-mold edge	GCT6BZTM	36 x 72 x 29	100	162	17.50	\$1505 \$753
	built-up self edge	GCT6BZBU	36 x 72 x 29	100	172	18.90	\$1684 \$842
7 foot	self edge	GCT7BZ	44 x 84 x 29	92.5	196	19.40	\$1709 \$855
	bullnose edge	GCT7BZBN	44 x 84 x 29	92.5	196	19.40	\$1709 \$855
	T-mold edge	GCT7BZTM	44 x 84 x 29	92.5	196	19.40	\$1709 \$855
	built-up self edge	GCT7BZBU	44 x 84 x 29	100	199	21.20	\$1921 \$961
8 foot	self edge	GCT8WBZ	48 x 96 x 29	92.5	219	21.20	\$1743 \$872
	bullnose edge	GCT8WBZBN	48 x 96 x 29	92.5	219	21.20	\$1743 \$872
	T-mold edge	GCT8WBZTM	48 x 96 x 29	92.5	219	21.20	\$1743 \$872
	built-up self edge	GCT8WBZBU	48 x 96 x 29	92.5	250	23.50	\$1921 \$961
10 foot	self edge	GCT10WBZ2	48 x 120 x 29	100	272	33.30	\$2042 \$1021
	bullnose edge	GCT10WBZ2BN	48 x 120 x 29	100	272	33.30	\$2042 \$1021
	T-mold edge	GCT10WBZ2TM	48 x 120 x 29	100	272	33.22	\$2042 \$1021
	built-up self edge	GCT10WBZ2BU	48 x 120 x 29	100	317	35.70	\$2251 \$1126
12 foot	self edge	GCT12WBZ2	48 x 144 x 29	100	327	35.30	\$2283 \$1142
	bullnose edge	GCT12WBZ2BN	48 x 144 x 29	100	327	35.30	\$2283 \$1142
	T-mold edge	GCT12WBZ2TM	48 x 144 x 29	100	327	35.30	\$2283 \$1142
	built-up self edge	GCT12WBZ2BU	48 x 144 x 29	100	357	38.40	\$2534 \$1267
14 foot	self edge	GCT14WBZ2	48 x 168 x 29	92.5	441	39	\$3059 \$1530
	bullnose edge	GCT14WBZ2BN	48 x 168 x 29	92.5	441	39	\$3059 \$1530
	T-mold edge	GCT14WBZ2TM	48 x 168 x 29	92.5	441	39	\$3059 \$1530
	built-up self edge	GCT14WBZ2BU	48 x 168 x 29	92.5	447	42	\$3392 \$1696
16 foot	self edge	GCT16WBZ2	48 x 192 x 29	92.5	482	42.52	\$3178 \$1589
	bullnose edge	GCT16WBZ2BN	48 x 192 x 29	92.5	482	42.52	\$3178 \$1589
	T-mold edge	GCT16WBZ2TM	48 x 192 x 29	92.5	482	42.52	\$3178 \$1589
	built-up self edge	GCT16WBZ2BU	48 x 192 x 29	92.5	488	47	\$3507 \$1754
18 foot	self edge	GCT18WBZ2	48 x 216 x 29	100	523	54.40	\$4133 \$2067
	bullnose edge	GCT18WBZ2BN	48 x 216 x 29	100	523	54.40	\$4133 \$2067
	T-mold edge	GCT18WBZ2TM	48 x 216 x 29	100	523	54.40	\$4133 \$2067
	built-up self edge	GCT18WBZ2BU	48 x 216 x 29	100	550	59	\$4646 \$2324
20 foot	self edge	GCT20WBZ2	48 x 240 x 29	100	564	66.20	\$4193 \$2097
	bullnose edge	GCT20WBZ2BN	48 x 240 x 29	100	564	66.20	\$4193 \$2097
	T-mold edge	GCT20WBZ2TM	48 x 240 x 29	100	564	66.20	\$4193 \$2097
	built-up self edge	GCT20WBZ2BU	48 x 240 x 29	100	572	70.60	\$4707 \$2354
22 foot	self edge	GCT22WBZ2	48 x 264 x 29	100	604	68.20	\$4670 \$2336
	bullnose edge	GCT22WBZ2BN	48 x 264 x 29	100	604	68.20	\$4670 \$2336
	T-mold edge	GCT22WBZ2TM	48 x 264 x 29	100	604	68.20	\$4670 \$2336
	built-up self edge	GCT22WBZ2BU	48 x 264 x 29	100	612	73.68	\$5217 \$2609
24 foot	self edge	GCT24WBZ2	48 x 288 x 29	100	646	70.20	\$4791 \$2396
	bullnose edge	GCT24WBZ2BN	48 x 288 x 29	100	646	70.20	\$4791 \$2396
	T-mold edge	GCT24WBZ2TM	48 x 288 x 29	100	646	70.20	\$4791 \$2396
	built-up self edge	GCT24WBZ2BU	48 x 288 x 29	100	655	76.80	\$5329 \$2665

- All Drum Bases require approx. 125 lb. of sand in each base for adequate stability. Sand is not included.
- All tops over 144" are standard in two pieces. Woodgrain laminate finishes will NOT align where the two tops join.
- All tops 168", 192" and 216" are SHIPPED WITH 3 DRUM BASES.
- All tops 240", 264" and 288" are SHIPPED WITH 4 DRUM BASES.

Required Specifications

Finish
Base Finish
Edge Color, if applicable

Optional Specifications

Grommet
HP laminate

Accessories

Power Block

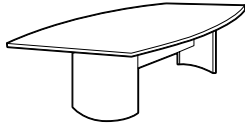
BOAT TOP - ARCH BASE

5 foot

MODEL#	DIMENSIONS	FREIGHT CLASS	WT/LBS.	CUBIC FT.	LIST PRICE	HP ADD
	D x W x H					
self edge	GCT5BA	30 x 60 x 29	85	131	9	\$1324 \$663
bullnose edge	GCT5BABN	30 x 60 x 29	85	131	9	\$1324 \$663
T-mold edge	GCT5BATM	30 x 60 x 29	85	131	9	\$1324 \$663
built-up self edge	GCT5BABU	30 x 60 x 29	85	134	10	\$1504 \$752

6 foot

self edge	GCT6BA	36 x 72 x 29	85	152	11	\$1385 \$693
bullnose edge	GCT6BABN	36 x 72 x 29	85	152	11	\$1385 \$693
T-mold edge	GCT6BATM	36 x 72 x 29	85	152	11	\$1385 \$693
built-up self edge	GCT6BABU	36 x 72 x 29	85	162	12	\$1645 \$823

7 foot

self edge	GCT7BA	44 x 84 x 29	70	203	12.96	\$1685 \$843
bullnose edge	GCT7BABN	44 x 84 x 29	70	203	12.96	\$1685 \$843
T-mold edge	GCT7BATM	44 x 84 x 29	70	203	12.96	\$1685 \$843
built-up self edge	GCT7BABU	44 x 84 x 29	85	206	13.98	\$1907 \$956

8 foot

self edge	GCT8WBA	48 x 96 x 29	70	228	14.97	\$1685 \$843
bullnose edge	GCT8WBABN	48 x 96 x 29	85	220	14.97	\$1685 \$843
T-mold edge	GCT8WBATM	48 x 96 x 29	85	220	14.97	\$1685 \$843
built-up self edge	GCT8WBABU	48 x 96 x 29	85	220	15.96	\$1907 \$956

10 foot

self edge	GCT10WBA	48 x 120 x 29	85	251	16.96	\$1922 \$962
bullnose edge	GCT10WBABN	48 x 120 x 29	85	251	16.95	\$1922 \$962
T-mold edge	GCT10WBATM	48 x 120 x 29	85	251	16.95	\$1922 \$962
built-up self edge	GCT10WBABU	48 x 120 x 29	70	296	18.92	\$2266 \$1134

12 foot

self edge	GCT12WBA	48 x 144 x 29	70	306	20	\$2222 \$1111
bullnose edge	GCT12WBABN	48 x 144 x 29	70	310	19.94	\$2222 \$1111
T-mold edge	GCT12WBATM	48 x 144 x 29	70	310	19.94	\$2222 \$1111
built-up self edge	GCT12WBABU	48 x 144 x 29	70	340	21.89	\$2593 \$1297

14 foot

self edge	GCT14WBA	48 x 168 x 29	70	423	25.93	\$3418 \$1709
bullnose edge	GCT14WBABN	48 x 168 x 29	70	423	25.93	\$3418 \$1709
T-mold edge	GCT14WBATM	48 x 168 x 29	70	423	25.93	\$3418 \$1709
built-up self edge	GCT14WBABU	48 x 168 x 29	70	429	27.90	\$3809 \$1905

16 foot

self edge	GCT16WBA	48 x 192 x 29	70	474	29.94	\$3596 \$1798
bullnose edge	GCT16WBABN	48 x 192 x 29	70	474	29.94	\$3596 \$1798
T-mold edge	GCT16WBATM	48 x 192 x 29	70	474	29.94	\$3596 \$1798
built-up self edge	GCT16WBABU	48 x 192 x 29	70	480	31.92	\$4020 \$2010

18 foot

self edge	GCT18WBA	48 x 216 x 29	70	525	31.92	\$4431 \$2216
bullnose edge	GCT18WBABN	48 x 216 x 29	70	525	31.92	\$4431 \$2216
T-mold edge	GCT18WBATM	48 x 216 x 29	70	525	31.92	\$4431 \$2216
built-up self edge	GCT18WBABU	48 x 216 x 29	70	532	33.89	\$4952 \$2477

20 foot

self edge	GCT20WBA	48 x 240 x 29	70	576	33.89	\$4495 \$2248
bullnose edge	GCT20WBABN	48 x 240 x 29	70	576	33.89	\$4495 \$2248
T-mold edge	GCT20WBATM	48 x 240 x 29	70	576	33.89	\$4495 \$2248
built-up self edge	GCT20WBABU	48 x 240 x 29	70	584	35.93	\$4999 \$2500

22 foot

self edge	GCT22WBA	48 x 264 x 29	70	626	36.89	\$5025 \$2513
bullnose edge	GCT22WBABN	48 x 264 x 29	70	626	36.89	\$5025 \$2513
T-mold edge	GCT22WBATM	48 x 264 x 29	70	626	36.89	\$5025 \$2513
built-up self edge	GCT22WBABU	48 x 264 x 29	70	634	37.90	\$5618 \$2809

24 foot

self edge	GCT24WBA	48 x 288 x 29	70	678	40	\$5146 \$2573
bullnose edge	GCT24WBABN	48 x 288 x 29	70	678	40	\$5146 \$2573
T-mold edge	GCT24WBATM	48 x 288 x 29	70	678	40	\$5146 \$2573
built-up self edge	GCT24WBABU	48 x 288 x 29	65	687	25.10	\$5734 \$2868

- All tops over 144" are standard in two pieces. Woodgrain laminate finishes will NOT align where the two tops join.
- All tops 168", 192", 216" and 240" are SHIPPED WITH 2 ARCH BASES AND 1 SLAB BASE.
- All tops 264" and 288" are SHIPPED WITH 2 ARCH BASES AND 2 SLAB BASES.

Required Specifications

Finish
Base Finish
Edge Color, if applicable

Optional Specifications

Grommet
HP laminate

Accessories

Power Block

B BOARDROOM TABLES

BOAT TOP - 2 LEG BASE



	MODEL#	DIMENSIONS	FREIGHT CLASS	WT/LBS.	CUBIC FT.	LIST PRICE	HP ADD
D x W x H							
5 foot	self edge	GCT5B	30 x 60 x 29	125	88	13	\$1169 \$585
	bullnose edge	GCT5BBN	30 x 60 x 29	125	88	13	\$1169 \$585
	T-mold edge	GCT5BTM	30 x 60 x 29	125	88	13	\$1169 \$585
	built-up self edge	GCT5BBU	30 x 60 x 29	125	91	14	\$1305 \$653
6 foot	self edge	GCT6B	36 x 72 x 29	100	123	15	\$1302 \$651
	bullnose edge	GCT6BBN	36 x 72 x 29	125	114	15	\$1302 \$651
	T-mold edge	GCT6BTM	36 x 72 x 29	100	123	15	\$1302 \$651
	built-up self edge	GCT6BBU	36 x 72 x 29	100	133	16	\$1446 \$723
7 foot	self edge	GCT7B	44 x 84 x 29	100	155	16.98	\$1505 \$753
	bullnose edge	GCT7BBN	44 x 84 x 29	100	155	16.98	\$1505 \$753
	T-mold edge	GCT7BTM	44 x 84 x 29	100	155	16.98	\$1505 \$753
	built-up self edge	GCT7BBU	44 x 84 x 29	100	158	18.98	\$1686 \$843
8 foot	self edge	GCT8WB	48 x 96 x 29	100	188	19	\$1505 \$753
	bullnose edge	GCT8WBBN	48 x 96 x 29	100	180	19	\$1505 \$753
	T-mold edge	GCT8WBTM	48 x 96 x 29	100	180	18.98	\$1505 \$753
	built-up self edge	GCT8WBBU	48 x 96 x 29	100	180	21	\$1686 \$843
10 foot	self edge	GCT10WB	48 x 120 x 29	92.5	214	21	\$2090 \$1046
	bullnose edge	GCT10WBBN	48 x 120 x 29	92.5	214	20.98	\$2090 \$1046
	T-mold edge	GCT10WBTM	48 x 120 x 29	92.5	214	20.93	\$2090 \$1046
	built-up self edge	GCT10WBBU	48 x 120 x 29	92.5	259	22.93	\$2338 \$1170
12 foot	self edge	GCT12WB	48 x 144 x 29	92.5	265	22.80	\$2352 \$1176
	bullnose edge	GCT12WBBN	48 x 144 x 29	92.5	269	22.69	\$2352 \$1176
	T-mold edge	GCT12WBTM	48 x 144 x 29	92.5	269	22.69	\$2352 \$1176
	built-up self edge	GCT12WBBU	48 x 144 x 29	92.5	299	25.69	\$2622 \$1312
14 foot	self edge	GCT14WB	48 x 168 x 29	100	326	34	\$2698 \$1350
	bullnose edge	GCT14WBBN	48 x 168 x 29	100	326	34	\$2698 \$1350
	T-mold edge	GCT14WBTM	48 x 168 x 29	100	326	34	\$2698 \$1350
	built-up self edge	GCT14WBBU	48 x 168 x 29	100	332	38	\$2981 \$1491
16 foot	self edge	GCT16WB	48 x 192 x 29	100	367	38	\$2818 \$1409
	bullnose edge	GCT16WBBN	48 x 192 x 29	100	367	38	\$2818 \$1409
	T-mold edge	GCT16WBTM	48 x 192 x 29	100	367	38	\$2818 \$1409
	built-up self edge	GCT16WBBU	48 x 192 x 29	100	373	40	\$3052 \$1527
18 foot	self edge	GCT18WB	48 x 216 x 29	92.5	408	40	\$3358 \$1680
	bullnose edge	GCT18WBBN	48 x 216 x 29	92.5	408	40	\$3358 \$1680
	T-mold edge	GCT18WBTM	48 x 216 x 29	92.5	408	40	\$3358 \$1680
	built-up self edge	GCT18WBBU	48 x 216 x 29	100	416	42	\$3744 \$1872
20 foot	self edge	GCT20WB	48 x 240 x 29	92.5	449	42	\$3477 \$1739
	bullnose edge	GCT20WBBN	48 x 240 x 29	92.5	449	42	\$3477 \$1739
	T-mold edge	GCT20WBTM	48 x 240 x 29	92.5	449	42	\$3477 \$1739
	built-up self edge	GCT20WBBU	48 x 240 x 29	92.5	457	44	\$3858 \$1930
22 foot	self edge	GCT22WB	48 x 264 x 29	92.5	489	44	\$3833 \$1917
	bullnose edge	GCT22WBBN	48 x 264 x 29	92.5	489	44	\$3833 \$1917
	T-mold edge	GCT22WBTM	48 x 264 x 29	92.5	489	44	\$3833 \$1917
	built-up self edge	GCT22WBBU	48 x 264 x 29	92.5	497	46	\$4316 \$2159
24 foot	self edge	GCT24WB	48 x 288 x 29	92.5	531	46	\$3951 \$1976
	bullnose edge	GCT24WBBN	48 x 288 x 29	92.5	531	46	\$3951 \$1976
	T-mold edge	GCT24WBTM	48 x 288 x 29	92.5	531	46	\$3951 \$1976
	built-up self edge	GCT24WBBU	48 x 288 x 29	92.5	540	48	\$4418 \$2210

- All tops over 144" are standard in two pieces. Woodgrain laminate finishes will NOT align where the two tops join.
- All tops 120", 144", and 168" are SHIPPED WITH 3 LEG BASES.
- All tops 192" are SHIPPED WITH 4 LEG BASES.
- All tops 216", 240", 264" and 288" are SHIPPED WITH 6 LEG BASES.

Required Specifications

Finish
Base Finish
Edge Color, if applicable

Optional Specifications

Grommet
HP laminate

Accessories

Power Block

BOAT TOP - TUBULAR BASE



	MODEL#	DIMENSIONS	FREIGHT CLASS			CUBIC FT.	LIST PRICE	HP ADD
			D	W	H			
5 foot	self edge	GCR5B	30 x 60 x 29	150	94	21	\$1206	\$604
	bullnose edge	GCR5BBN	30 x 60 x 29	150	94	21	\$1206	\$604
	T-mold edge	GCR5BTM	30 x 60 x 29	150	94	21	\$1206	\$604
	built-up self edge	GCR5BBU	30 x 60 x 29	150	97	23	\$1346	\$674
6 foot	self edge	GCR6B	36 x 72 x 29	150	107	23	\$1339	\$670
	bullnose edge	GCR6BBN	36 x 72 x 29	150	107	23	\$1339	\$670
	T-mold edge	GCR6BTM	36 x 72 x 29	150	107	23	\$1339	\$670
	built-up self edge	GCR6BBU	36 x 72 x 29	150	117	25	\$1490	\$746
7 foot	self edge	GCR7B	44 x 84 x 29	125	161	25	\$1543	\$772
	bullnose edge	GCR7BBN	44 x 84 x 29	125	161	25	\$1543	\$772
	T-mold edge	GCR7BTM	44 x 84 x 29	125	161	25	\$1543	\$772
	built-up self edge	GCR7BBU	44 x 84 x 29	150	164	29	\$1726	\$863
8 foot	self edge	GCR8WB	48 x 96 x 29	125	184	27	\$1543	\$772
	bullnose edge	GCR8WBBN	48 x 96 x 29	125	177	27	\$1543	\$772
	T-mold edge	GCR8WBTM	48 x 96 x 29	125	177	27	\$1543	\$772
	built-up self edge	GCR8WBBU	48 x 96 x 29	125	208	29	\$1726	\$863
10 foot	self edge	GCR10WB	48 x 120 x 29	125	221	29	\$2112	\$1056
	bullnose edge	GCR10WBBN	48 x 120 x 29	125	221	29	\$2112	\$1056
	T-mold edge	GCR10WBTM	48 x 120 x 29	125	221	29	\$2112	\$1056
	built-up self edge	GCR10WBBU	48 x 120 x 29	125	239	32	\$2370	\$1329
12 foot	self edge	GCR12WB	48 x 144 x 29	100	270	31	\$2379	\$1190
	bullnose edge	GCR12WBBN	48 x 144 x 29	100	270	31	\$2379	\$1190
	T-mold edge	GCR12WBTM	48 x 144 x 29	100	270	30.78	\$2379	\$1190
	built-up self edge	GCR12WBBU	48 x 144 x 29	100	293	34	\$2656	\$1329
14 foot	self edge	GCR14WB	48 x 168 x 29	125	330	50	\$2733	\$1367
	bullnose edge	GCR14WBBN	48 x 168 x 29	125	330	50	\$2733	\$1367
	T-mold edge	GCR14WBTM	48 x 168 x 29	125	330	50	\$2733	\$1367
	built-up self edge	GCR14WBBU	48 x 168 x 29	125	336	54	\$3018	\$1510
16 foot	self edge	GCR16WB	48 x 192 x 29	125	371	54	\$2853	\$1427
	bullnose edge	GCR16WBBN	48 x 192 x 29	125	371	54	\$2853	\$1427
	T-mold edge	GCR16WBTM	48 x 192 x 29	125	371	54	\$2853	\$1427
	built-up self edge	GCR16WBBU	48 x 192 x 29	125	377	58	\$3133	\$1567
18 foot	self edge	GCR18WB	48 x 216 x 29	125	412	56	\$3380	\$1690
	bullnose edge	GCR18WBBN	48 x 216 x 29	125	412	56	\$3380	\$1690
	T-mold edge	GCR18WBTM	48 x 216 x 29	125	412	56	\$3380	\$1690
	built-up self edge	GCR18WBBU	48 x 216 x 29	125	419	60	\$3775	\$1888
20 foot	self edge	GCR20WB	48 x 240 x 29	125	453	58	\$3500	\$1751
	bullnose edge	GCR20WBBN	48 x 240 x 29	125	453	58	\$3500	\$1751
	T-mold edge	GCR20WBTM	48 x 240 x 29	125	453	58	\$3500	\$1751
	built-up self edge	GCR20WBBU	48 x 240 x 29	125	461	62	\$3901	\$1951
22 foot	self edge	GCR22WB	48 x 264 x 29	100	493	60	\$3894	\$1948
	bullnose edge	GCR22WBBN	48 x 264 x 29	100	493	60	\$3894	\$1948
	T-mold edge	GCR22WBTM	48 x 264 x 29	100	493	60	\$3894	\$1948
	built-up self edge	GCR22WBBU	48 x 264 x 29	125	501	64	\$4349	\$2175
24 foot	self edge	GCR24WB	48 x 288 x 29	100	535	62	\$4016	\$2008
	bullnose edge	GCR24WBBN	48 x 288 x 29	100	535	62	\$4016	\$2008
	T-mold edge	GCR24WBTM	48 x 288 x 29	100	535	62	\$4016	\$2008
	built-up self edge	GCR24WBBU	48 x 288 x 29	100	544	66	\$4463	\$2232

- All tops over 144" are standard in two pieces. Woodgrain laminate finishes will NOT align where the two tops join.
- All tops 120", 144", and 168" are SHIPPED WITH 3 TUBULAR BASES.
- All tops 192" are SHIPPED WITH 4 TUBULAR BASES.
- All tops 216", 240", 264" and 288" are SHIPPED WITH 6 TUBULAR BASES.

Required Specifications

Finish
Base Finish
Edge Color, if applicable

Optional Specifications

Grommet
HP laminate

Accessories

Power Block

B BOARDROOM TABLES

RACETRACK TOP - SLAB BASE

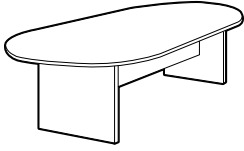

	MODEL#	DIMENSIONS	FREIGHT CLASS	WT./LBS.	CUBIC FT.	LIST PRICE	HP ADD
D x W x H							
5 foot	self edge	GRT5X	30 x 60 x 29	70	131	6	\$994 \$498
	bullnose edge	GRT5XBN	30 x 60 x 29	70	131	6	\$994 \$498
	T-mold edge	GRT5XTM	30 x 60 x 29	70	131	6	\$994 \$498
	built-up self edge	GRT5XBU	30 x 60 x 29	70	134	7	\$1099 \$550
6 foot	self edge	GRT6X	36 x 72 x 29	70	135	7.60	\$1113 \$557
	bullnose edge	GRT6XBN	36 x 72 x 29	70	143	7.60	\$1113 \$557
	T-mold edge	GRT6XTM	36 x 72 x 29	70	143	7.60	\$1113 \$557
	built-up self edge	GRT6XBU	36 x 72 x 29	70	160	8.90	\$1241 \$621
7 foot	self edge	GRT7X	44 x 84 x 29	70	199	9.94	\$1434 \$717
	bullnose edge	GRT7XBN	44 x 84 x 29	70	199	9.97	\$1434 \$717
	T-mold edge	GRT7XTM	44 x 84 x 29	70	199	9.94	\$1434 \$717
	built-up self edge	GRT7XBU	44 x 84 x 29	70	203	11.95	\$1618 \$809
8 foot	self edge	GRT8WX	48 x 96 x 29	70	216	11.29	\$1434 \$717
	bullnose edge	GRT8WXBN	48 x 96 x 29	70	218	11.29	\$1434 \$717
	T-mold edge	GRT8WXTM	48 x 96 x 29	70	216	11.29	\$1434 \$717
	built-up self edge	GRT8WXBU	48 x 96 x 29	70	242	13.53	\$1618 \$809
10 foot	self edge	GRT10WX2	48 x 120 x 29	70	280	13.53	\$1662 \$832
	bullnose edge	GRT10WX2BN	48 x 120 x 29	70	266	13.53	\$1662 \$832
	T-mold edge	GRT10WX2TM	48 x 120 x 29	70	256	13.53	\$1662 \$832
	built-up self edge	GRT10WX2BU	48 x 120 x 29	70	289	16.20	\$1966 \$983
12 foot	self edge	GRT12WX2	48 x 144 x 29	70	210	12.54	\$1949 \$975
	bullnose edge	GRT12WX2BN	48 x 144 x 29	65	307	12.54	\$1949 \$975
	T-mold edge	GRT12WX2TM	48 x 144 x 29	65	307	12.54	\$1949 \$975
	built-up self edge	GRT12WX2BU	48 x 144 x 29	70	340	18.83	\$2288 \$1144
14 foot	self edge	GRT14WX2	48 x 168 x 29	65	419	18	\$2818 \$1409
	bullnose edge	GRT14WX2BN	48 x 168 x 29	65	419	18	\$2818 \$1409
	T-mold edge	GRT14WX2TM	48 x 168 x 29	65	419	18	\$2818 \$1409
	built-up self edge	GRT14WX2BU	48 x 168 x 29	70	425	20	\$3146 \$1574
16 foot	self edge	GRT16WX2	48 x 192 x 29	70	460	22.70	\$2937 \$1469
	bullnose edge	GRT16WX2BN	48 x 192 x 29	70	460	22.70	\$2937 \$1469
	T-mold edge	GRT16WX2TM	48 x 192 x 29	70	460	22.70	\$2937 \$1469
	built-up self edge	GRT16WX2BU	48 x 192 x 29	70	466	27.20	\$3279 \$1640
18 foot	self edge	GRT18WX2	48 x 216 x 29	70	521	24.60	\$3655 \$1828
	bullnose edge	GRT18WX2BN	48 x 216 x 29	70	521	24.60	\$3655 \$1828
	T-mold edge	GRT18WX2TM	48 x 216 x 29	70	521	24.60	\$3655 \$1828
	built-up self edge	GRT18WX2BU	48 x 216 x 29	70	528	29.80	\$4097 \$2049
20 foot	self edge	GRT20WX2	48 x 240 x 29	70	572	26.60	\$3713 \$1857
	bullnose edge	GRT20WX2BN	48 x 240 x 29	70	572	26.60	\$3713 \$1857
	T-mold edge	GRT20WX2TM	48 x 240 x 29	70	572	26.60	\$3713 \$1857
	built-up self edge	GRT20WX2BU	48 x 240 x 29	70	580	32.50	\$4156 \$2078
22 foot	self edge	GRT22WX2	48 x 264 x 29	70	612	28.90	\$4310 \$2155
	bullnose edge	GRT22WX2BN	48 x 264 x 29	70	612	28.90	\$4310 \$2155
	T-mold edge	GRT22WX2TM	48 x 264 x 29	70	612	28.90	\$4310 \$2155
	built-up self edge	GRT22WX2BU	48 x 264 x 29	70	620	35.10	\$4760 \$2380
24 foot	self edge	GRT24WX2	48 x 288 x 29	70	673	31.20	\$4431 \$2216
	bullnose edge	GRT24WX2BN	48 x 288 x 29	70	673	31.20	\$4431 \$2216
	T-mold edge	GRT24WX2TM	48 x 288 x 29	70	673	31.20	\$4431 \$2216
	built-up self edge	GRT24WX2BU	48 x 288 x 29	70	682	37.70	\$4902 \$2451

- All tops over 144" are standard in two pieces. Woodgrain laminate finishes will NOT align where the two tops join.
- All tops 168", 192", 216" and 240" are SHIPPED WITH 3 SLAB BASES.
- All tops 264" and 288" are SHIPPED WITH 4 SLAB BASES.

Required Specifications

Finish
Base Finish
Edge Color, if applicable

Optional Specifications

Grommet
HP laminate

Accessories

Power Block

RACETRACK TOP - DRUM BASE

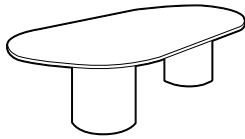

	MODEL#	DIMENSIONS	FREIGHT CLASS			CUBIC FT.	LIST PRICE	HP ADD
			WT/LBS.	D x W x H				
6 foot	self edge	GRT6Z	36 x 72 x 29	100	150	17.50	\$1505	\$753
	bullnose edge	GRT6ZBN	36 x 72 x 29	100	158	17.50	\$1505	\$753
	T-mold edge	GRT6ZTM	36 x 72 x 29	100	158	17.50	\$1505	\$753
	built-up self edge	GRT6ZBU	36 x 72 x 29	100	175	18.80	\$1684	\$842
7 foot	self edge	GRT7Z	44 x 84 x 29	92.5	196	19.40	\$1743	\$872
	bullnose edge	GRT7ZBN	44 x 84 x 29	92.5	196	19.40	\$1743	\$872
	T-mold edge	GRT7ZTM	44 x 84 x 29	92.5	196	19.40	\$1743	\$872
	built-up self edge	GRT7ZBU	44 x 84 x 29	100	199	21.20	\$1921	\$961
8 foot	self edge	GRT8WZ	48 x 96 x 29	92.5	217	21.26	\$1743	\$872
	bullnose edge	GRT8WZBN	48 x 96 x 29	92.5	219	21.26	\$1743	\$872
	T-mold edge	GRT8WZTM	48 x 96 x 29	92.5	217	21.26	\$1743	\$872
	built-up self edge	GRT8WZBU	48 x 96 x 29	92.5	243	23.50	\$1921	\$872
10 foot	self edge	GRT10WZ2	48 x 120 x 29	100	313	33.14	\$2042	\$1021
	bullnose edge	GRT10WZ2BN	48 x 120 x 29	100	289	33.14	\$2042	\$1021
	T-mold edge	GRT10WZ2TM	48 x 120 x 29	100	279	33.14	\$2042	\$1021
	built-up self edge	GRT10WZ2BU	48 x 120 x 29	100	312	35.70	\$2251	\$1126
12 foot	self edge	GRT12WZ2	48 x 144 x 29	100	329	35.14	\$2283	\$1142
	bullnose edge	GRT12WZ2BN	48 x 144 x 29	150	326	58.70	\$2283	\$1142
	T-mold edge	GRT12WZ2TM	48 x 144 x 29	100	326	35.14	\$2283	\$1142
	built-up self edge	GRT12WZ2BU	48 x 144 x 29	100	359	38.32	\$2534	\$1142
14 foot	self edge	GRT14WZ2	48 x 168 x 29	92.5	478	44.44	\$3059	\$1530
	bullnose edge	GRT14WZ2BN	48 x 168 x 29	92.5	441	39	\$3059	\$1530
	T-mold edge	GRT14WZ2TM	48 x 168 x 29	92.5	441	39	\$3059	\$1530
	built-up self edge	GRT14WZ2BU	48 x 168 x 29	92.5	447	42	\$3392	\$1696
16 foot	self edge	GRT16WZ2	48 x 192 x 29	92.5	478	42.50	\$3178	\$1589
	bullnose edge	GRT16WZ2BN	48 x 192 x 29	92.5	482	42.50	\$3178	\$1589
	T-mold edge	GRT16WZ2TM	48 x 192 x 29	92.5	482	42.50	\$3178	\$1589
	built-up self edge	GRT16WZ2BU	48 x 192 x 29	92.5	488	47	\$3507	\$1754
18 foot	self edge	GRT18WZ2	48 x 216 x 29	100	523	54.40	\$4133	\$2067
	bullnose edge	GRT18WZ2BN	48 x 216 x 29	100	523	54	\$4133	\$2067
	T-mold edge	GRT18WZ2TM	48 x 216 x 29	100	523	54.40	\$4133	\$2067
	built-up self edge	GRT18WZ2BU	48 x 216 x 29	100	550	59	\$4646	\$2324
20 foot	self edge	GRT20WZ2	48 x 240 x 29	100	564	66.20	\$4193	\$2097
	bullnose edge	GRT20WZ2BN	48 x 240 x 29	100	564	66.20	\$4193	\$2097
	T-mold edge	GRT20WZ2TM	48 x 240 x 29	100	564	66.20	\$4193	\$2097
	built-up self edge	GRT20WZ2BU	48 x 240 x 29	100	572	70.60	\$4707	\$2354
22 foot	self edge	GRT22WZ2	48 x 264 x 29	100	604	68.20	\$4670	\$2336
	bullnose edge	GRT22WZ2BN	48 x 264 x 29	100	604	68.20	\$4670	\$2336
	T-mold edge	GRT22WZ2TM	48 x 264 x 29	100	604	68.20	\$4670	\$2336
	built-up self edge	GRT22WZ2BU	48 x 264 x 29	100	612	73.70	\$5217	\$2609
24 foot	self edge	GRT24WZ2	48 x 288 x 29	100	646	70.20	\$4791	\$2396
	bullnose edge	GRT24WZ2BN	48 x 288 x 29	100	646	70.20	\$4791	\$2396
	T-mold edge	GRT24WZ2TM	48 x 288 x 29	100	646	70.20	\$4791	\$2396
	built-up self edge	GRT24WZ2BU	48 x 288 x 29	100	655	76.80	\$5329	\$2665

- All Drum Bases require approx. 125 lb. of sand in each base for adequate stability. Sand is not included.
- All tops over 144" are standard in two pieces. Woodgrain laminate finishes will NOT align where the two tops join.
- All tops 168", 192" and 216" are SHIPPED WITH 3 DRUM BASES.
- All tops 240", 264" and 288" are SHIPPED WITH 4 DRUM BASES.

Required Specifications

Finish
Base Finish
Edge Color, if applicable

Optional Specifications

Grommet
HP laminate

Accessories

Power Block

B BOARDROOM TABLES

RACETRACK TOP - ARCH BASE

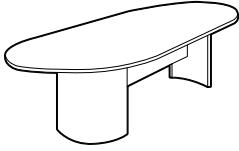

	MODEL#	DIMENSIONS	FREIGHT CLASS	WT./LBS.	CUBIC FT.	LIST PRICE	HP ADD
D x W x H							
5 foot	self edge	GRT5A	30 x 60 x 29	85	131	9	\$1324 \$663
	bullnose edge	GRT5ABN	30 x 60 x 29	85	131	9	\$1324 \$663
	T-mold edge	GRT5ATM	30 x 60 x 29	85	131	9	\$1324 \$663
	built-up self edge	GRT5ABU	30 x 60 x 29	85	134	10	\$1504 \$752
6 foot	self edge	GRT6A	36 x 72 x 29	85	140	11	\$1385 \$693
	bullnose edge	GRT6ABN	36 x 72 x 29	85	148	11	\$1385 \$693
	T-mold edge	GRT6ATM	36 x 72 x 29	85	148	11	\$1385 \$693
	built-up self edge	GRT6ABU	36 x 72 x 29	85	165	12	\$1645 \$823
7 foot	self edge	GRT7A	44 x 84 x 29	70	203	12.93	\$1685 \$843
	bullnose edge	GRT7ABN	44 x 84 x 29	70	203	12.93	\$1685 \$843
	T-mold edge	GRT7ATM	44 x 84 x 29	70	203	12.93	\$1685 \$843
	built-up self edge	GRT7ABU	44 x 84 x 29	85	206	13.95	\$1907 \$956
8 foot	self edge	GRT8WA	48 x 96 x 29	85	218	14.94	\$1685 \$843
	bullnose edge	GRT8WABN	48 x 96 x 29	92.5	236	22.40	\$1685 \$843
	T-mold edge	GRT8WATM	48 x 96 x 29	85	218	14.94	\$1685 \$843
	built-up self edge	GRT8WABU	48 x 96 x 29	70	244	15.93	\$1907 \$956
10 foot	self edge	GRT10WA	48 x 120 x 29	70	268	16.95	\$1922 \$962
	bullnose edge	GRT10WABN	48 x 120 x 29	70	268	16.95	\$1922 \$962
	T-mold edge	GRT10WATM	48 x 120 x 29	70	268	16.95	\$1922 \$962
	built-up self edge	GRT10WABU	48 x 120 x 29	70	291	18.92	\$2266 \$1134
12 foot	self edge	GRT12WA	48 x 144 x 29	85	309	24.94	\$2222 \$1111
	bullnose edge	GRT12WABN	48 x 144 x 29	65	309	11.98	\$2222 \$1111
	T-mold edge	GRT12WATM	48 x 144 x 29	100	309	33.29	\$2222 \$1111
	built-up self edge	GRT12WABU	48 x 144 x 29	70	342	21.95	\$2593 \$1297
14 foot	self edge	GRT14WA	48 x 168 x 29	70	423	26	\$3418 \$1709
	bullnose edge	GRT14WABN	48 x 168 x 29	70	423	26	\$3418 \$1709
	T-mold edge	GRT14WATM	48 x 168 x 29	70	423	26	\$3418 \$1709
	built-up self edge	GRT14WABU	48 x 168 x 29	70	429	28	\$3809 \$1905
16 foot	self edge	GRT16WA	48 x 192 x 29	70	474	30	\$3596 \$1798
	bullnose edge	GRT16WABN	48 x 192 x 29	70	474	29.94	\$3596 \$1798
	T-mold edge	GRT16WATM	48 x 192 x 29	70	474	29.94	\$3596 \$1798
	built-up self edge	GRT16WABU	48 x 192 x 29	70	480	31.92	\$4020 \$2010
18 foot	self edge	GRT18WA	48 x 216 x 29	70	525	31.92	\$4431 \$2216
	bullnose edge	GRT18WABN	48 x 216 x 29	70	525	31.92	\$4431 \$2216
	T-mold edge	GRT18WATM	48 x 216 x 29	70	525	31.92	\$4431 \$2216
	built-up self edge	GRT18WABU	48 x 216 x 29	70	532	33.89	\$4952 \$2477
20 foot	self edge	GRT20WA	48 x 240 x 29	70	576	33.89	\$4495 \$2248
	bullnose edge	GRT20WABN	48 x 240 x 29	70	576	33.89	\$4495 \$2248
	T-mold edge	GRT20WATM	48 x 240 x 29	70	576	33.89	\$4495 \$2248
	built-up self edge	GRT20WABU	48 x 240 x 29	70	584	35.93	\$4999 \$2500
22 foot	self edge	GRT22WA	48 x 264 x 29	70	626	36.89	\$5025 \$2513
	bullnose edge	GRT22WABN	48 x 264 x 29	70	626	36.89	\$5025 \$2513
	T-mold edge	GRT22WATM	48 x 264 x 29	70	626	36.89	\$5025 \$2513
	built-up self edge	GRT22WABU	48 x 264 x 29	70	634	37.90	\$5618 \$2809
24 foot	self edge	GRT24WA	48 x 288 x 29	70	678	39.88	\$5146 \$2573
	bullnose edge	GRT24WABN	48 x 288 x 29	70	678	39.88	\$5146 \$2573
	T-mold edge	GRT24WATM	48 x 288 x 29	70	678	39.88	\$5146 \$2573
	built-up self edge	GRT24WABU	48 x 288 x 29	70	687	41.92	\$5734 \$2868

- All tops over 144" are standard in two pieces. Woodgrain laminate finishes will NOT align where the two tops join.
- All tops 168", 192", 216" and 240" are SHIPPED WITH 2 ARCH BASES AND 1 SLAB BASE.
- All tops 264" and 288" are SHIPPED WITH 2 ARCH BASES AND 2 SLAB BASES.

Required Specifications

Finish
Base Finish
Edge Color, if applicable

Optional Specifications

Grommet
HP laminate

Accessories

Power Block

RACETRACK TOP - 2 LEG BASE



	MODEL#	DIMENSIONS	FREIGHT CLASS			CUBIC FT.	LIST PRICE	HP ADD
			WT/LBS.	D x W x H				
5 foot	self edge	GRT5	30 x 60 x 29	125	88	13	\$1169	\$585
	bullnose edge	GRT5BN	30 x 60 x 29	125	88	13	\$1169	\$585
	T-mold edge	GRT5TM	30 x 60 x 29	125	88	13	\$1169	\$585
	built-up self edge	GRT5BU	30 x 60 x 29	125	91	14	\$1305	\$653
6 foot	self edge	GRT6	36 x 72 x 29	125	111	15	\$1302	\$651
	bullnose edge	GRT6BN	36 x 72 x 29	125	119	15	\$1302	\$651
	T-mold edge	GRT6TM	36 x 72 x 29	125	119	15	\$1302	\$651
	built-up self edge	GRT6BU	36 x 72 x 29	100	136	16	\$1446	\$723
7 foot	self edge	GRT7	44 x 84 x 29	100	155	17	\$1505	\$753
	bullnose edge	GRT7BN	44 x 84 x 29	100	155	17	\$1505	\$753
	T-mold edge	GRT7TM	44 x 84 x 29	100	155	17	\$1505	\$753
	built-up self edge	GRT7BU	44 x 84 x 29	100	158	19	\$1686	\$843
8 foot	self edge	GRT8W	48 x 96 x 29	100	178	19	\$1505	\$753
	bullnose edge	GRT8WBN	48 x 96 x 29	100	180	19	\$1505	\$753
	T-mold edge	GRT8WTM	48 x 96 x 29	100	178	19	\$1505	\$753
	built-up self edge	GRT8WBU	48 x 96 x 29	100	204	21	\$1686	\$843
10 foot	self edge	GRT10W	48 x 120 x 29	300	39	21	\$2090	\$1046
	bullnose edge	GRT10WBN	48 x 120 x 29	92.5	231	21	\$2090	\$1046
	T-mold edge	GRT10WTM	48 x 120 x 29	92.5	221	21	\$2090	\$1046
	built-up self edge	GRT10WBU	48 x 120 x 29	92.5	254	23	\$2338	\$1170
12 foot	self edge	GRT12W	48 x 144 x 29	92.5	271	23	\$2352	\$1176
	bullnose edge	GRT12WBN	48 x 144 x 29	92.5	268	23	\$2352	\$1176
	T-mold edge	GRT12WTM	48 x 144 x 29	92.5	268	23	\$2352	\$1176
	built-up self edge	GRT12WBU	48 x 144 x 29	92.5	301	25.90	\$2622	\$1312
14 foot	self edge	GRT14W	48 x 168 x 29	100	326	34	\$2698	\$1350
	bullnose edge	GRT14WBN	48 x 168 x 29	100	326	34	\$2698	\$1350
	T-mold edge	GRT14WTM	48 x 168 x 29	100	326	34	\$2698	\$1350
	built-up self edge	GRT14WBU	48 x 168 x 29	100	332	38	\$2981	\$1491
16 foot	self edge	GRT16W	48 x 192 x 29	100	367	38	\$2818	\$1409
	bullnose edge	GRT16WBN	48 x 192 x 29	100	367	38	\$2818	\$1409
	T-mold edge	GRT16WTM	48 x 192 x 29	100	367	38	\$2818	\$1409
	built-up self edge	GRT16WBU	48 x 192 x 29	100	368	40	\$3052	\$1527
18 foot	self edge	GRT18W	48 x 216 x 29	92.5	408	40	\$3358	\$1680
	bullnose edge	GRT18WBN	48 x 216 x 29	92.5	408	40	\$3358	\$1680
	T-mold edge	GRT18WTM	48 x 216 x 29	92.5	408	40	\$3358	\$1680
	built-up self edge	GRT18WBU	48 x 216 x 29	100	416	42	\$3744	\$1872
20 foot	self edge	GRT20W	48 x 240 x 29	92.5	449	42	\$3477	\$1739
	bullnose edge	GRT20WBN	48 x 240 x 29	92.5	449	42	\$3477	\$1739
	T-mold edge	GRT20WTM	48 x 240 x 29	92.5	449	42	\$3477	\$1739
	built-up self edge	GRT20WBU	48 x 240 x 29	92.5	457	44	\$3858	\$1930
22 foot	self edge	GRT22W	48 x 264 x 29	92.5	489	44	\$3833	\$1917
	bullnose edge	GRT22WBN	48 x 264 x 29	92.5	489	44	\$3833	\$1917
	T-mold edge	GRT22WTM	48 x 264 x 29	92.5	489	44	\$3833	\$1917
	built-up self edge	GRT22WBU	48 x 264 x 29	92.5	497	46	\$4316	\$2159
24 foot	self edge	GRT24W	48 x 288 x 29	92.5	531	46	\$3951	\$1976
	bullnose edge	GRT24WBN	48 x 288 x 29	92.5	531	46	\$3951	\$1976
	T-mold edge	GRT24WTM	48 x 288 x 29	92.5	531	46	\$3951	\$1976
	built-up self edge	GRT24WBU	48 x 288 x 29	92.5	540	48	\$4418	\$2210

- All tops over 144" are standard in two pieces. Woodgrain laminate finishes will NOT align where the two tops join.
- All tops 120", 144", and 168" are SHIPPED WITH 3 LEG BASES.
- All tops 192" are SHIPPED WITH 4 LEG BASES.
- All tops 216", 240", 264" and 288" are SHIPPED WITH 6 LEG BASES.

Required Specifications

Finish
Base Finish
Edge Color, if applicable

Optional Specifications

Grommet
HP laminate

Accessories

Power Block

B BOARDROOM TABLES

RACETRACK TOP - TUBULAR BASE

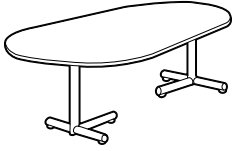

	MODEL#	DIMENSIONS	FREIGHT CLASS	WT./LBS.	CUBIC FT.	LIST PRICE	HP ADD
D x W x H							
5 foot	self edge	GRT5R	30 x 60 x 29	150	94	21	\$1206 \$604
	bullnose edge	GRT5RBN	30 x 60 x 29	150	94	21	\$1206 \$604
	T-mold edge	GRT5RTM	30 x 60 x 29	150	94	21	\$1206 \$604
	built-up self edge	GRT5RBU	30 x 60 x 29	150	97	23	\$1346 \$674
6 foot	self edge	GRT6R	36 x 72 x 29	150	107	23	\$1339 \$670
	bullnose edge	GRT6RBN	36 x 72 x 29	150	107	23	\$1339 \$670
	T-mold edge	GRT6RTM	36 x 72 x 29	150	107	23	\$1339 \$670
	built-up self edge	GRT6RBU	36 x 72 x 29	150	117	25	\$1490 \$746
7 foot	self edge	GRT7R	44 x 84 x 29	125	161	25	\$1543 \$772
	bullnose edge	GRT7RBN	44 x 84 x 29	125	161	25	\$1543 \$772
	T-mold edge	GRT7RTM	44 x 84 x 29	125	161	25	\$1543 \$772
	built-up self edge	GRT7RBU	44 x 84 x 29	125	164	27	\$1726 \$863
8 foot	self edge	GRT8WR	48 x 96 x 29	125	175	27	\$1543 \$772
	bullnose edge	GRT8WRBN	48 x 96 x 29	125	177	27	\$1543 \$772
	T-mold edge	GRT8WRM	48 x 96 x 29	125	175	27	\$1543 \$772
	built-up self edge	GRT8WRBU	48 x 96 x 29	125	176	29	\$1726 \$863
10 foot	self edge	GRT10WR	48 x 120 x 29	125	221	29	\$2112 \$1056
	bullnose edge	GRT10WRBN	48 x 120 x 29	125	221	29	\$2112 \$1056
	T-mold edge	GRT10WRM	48 x 120 x 29	125	221	29	\$2112 \$1056
	built-up self edge	GRT10WRBU	48 x 120 x 29	125	239	32	\$2370 \$1186
12 foot	self edge	GRT12WR	48 x 144 x 29	100	270	31	\$2379 \$1190
	bullnose edge	GRT12WRBN	48 x 144 x 29	100	270	31	\$2379 \$1190
	T-mold edge	GRT12WRM	48 x 144 x 29	100	270	30.90	\$2379 \$1190
	built-up self edge	GRT12WRBU	48 x 144 x 29	100	301	34	\$2656 \$1329
14 foot	self edge	GRT14WR	48 x 168 x 29	125	330	50	\$2733 \$1367
	bullnose edge	GRT14WRBN	48 x 168 x 29	125	330	50	\$2733 \$1367
	T-mold edge	GRT14WRM	48 x 168 x 29	125	330	50	\$2733 \$1367
	built-up self edge	GRT14WRBU	48 x 168 x 29	125	326	54	\$3018 \$1510
16 foot	self edge	GRT16WR	48 x 192 x 29	125	371	54	\$2853 \$1427
	bullnose edge	GRT16WRBN	48 x 192 x 29	125	371	54	\$2853 \$1427
	T-mold edge	GRT16WRM	48 x 192 x 29	125	371	54	\$2853 \$1427
	built-up self edge	GRT16WRBU	48 x 192 x 29	125	377	58	\$3133 \$1567
18 foot	self edge	GRT18WR	48 x 216 x 29	125	412	56	\$3380 \$1690
	bullnose edge	GRT18WRBN	48 x 216 x 29	125	412	56	\$3380 \$1690
	T-mold edge	GRT18WRM	48 x 216 x 29	125	412	56	\$3380 \$1690
	built-up self edge	GRT18WRBU	48 x 216 x 29	125	419	60	\$3775 \$1888
20 foot	self edge	GRT20WR	48 x 240 x 29	125	453	58	\$3500 \$1751
	bullnose edge	GRT20WRBN	48 x 240 x 29	125	453	58	\$3500 \$1751
	T-mold edge	GRT20WRM	48 x 240 x 29	125	453	58	\$3500 \$1751
	built-up self edge	GRT20WRBU	48 x 240 x 29	125	461	62	\$3901 \$1951
22 foot	self edge	GRT22WR	48 x 264 x 29	100	493	60	\$3894 \$1948
	bullnose edge	GRT22WRBN	48 x 264 x 29	100	493	60	\$3894 \$1948
	T-mold edge	GRT22WRM	48 x 264 x 29	100	493	60	\$3894 \$1948
	built-up self edge	GRT22WRBU	48 x 264 x 29	125	501	64	\$4349 \$2175
24 foot	self edge	GRT24WR	48 x 288 x 29	100	535	62	\$4016 \$2008
	bullnose edge	GRT24WRBN	48 x 288 x 29	100	535	62	\$4016 \$2008
	T-mold edge	GRT24WRM	48 x 288 x 29	100	535	62	\$4016 \$2008
	built-up self edge	GRT24WRBU	48 x 288 x 29	100	544	66	\$4463 \$2232

- All tops over 144" are standard in two pieces. Woodgrain laminate finishes will NOT align where the two tops join.
- All tops 120", 144", and 168" are SHIPPED WITH 3 TUBULAR BASES.
- All tops 192" are SHIPPED WITH 4 TUBULAR BASES.
- All tops 216", 240", 264" and 288" are SHIPPED WITH 6 TUBULAR BASES.

Required Specifications

Finish
Base Finish
Edge Color, if applicable

Optional Specifications

Grommet
HP laminate

Accessories

Power Block

BUNGEE™ TABLES



Bungee is a series of freestanding tables and accessories designed for classrooms, training rooms, boardrooms and any other multi-functional space that may require frequent configurations. Tables are sold complete with legs and Bungee cords so they may quickly and easily be connected together without searching for tools or worrying about loose parts.

Bungee tables feature rounded corners with a unique “bubble molding” that is engineered to compress under the tension of the Bungee cords. The compressed molding creates a seal that serves to locate and align interconnected tables while also providing a soft and forgiving edge.

Choose from a variety of top shapes and laminate finishes to create your individual style. In addition, most tables offer a choice of tapered legs or spider legs in a Tungsten or Black finish with adjustable levelers or optional casters. Optional modesty panels, grommets, wire management and power blocks further enhance your workspace.

Features and Benefits

- Bungee tables are complete with Top, Legs and Bungee cords
- Bungee cords provide a fast and easy method of reconfiguring tables without requiring a tool
- Tops are 1” thick and are offered in a variety of shapes and sizes
- Legs are offered in tapered or spider design in a Tungsten or Black finish.
- Levelers on legs are standard.
- Laminate modesty panels and filler modesty inserts help conceal wires and enhance visual appeal
- Wire management tracks neatly contain wires, using two separate channels for data and voice wires
- Optional grommets or power blocks offer technological flexibility
- Models with handles feature a bow handle in Silver or Black Nickel finish
- Metal feet are height adjustable and offered in Black or Tungsten finish
- Boardrooms were never easier to specify - table “sets” and accessories such as AV Cabinets and Credenza Buffets are specified with one model number

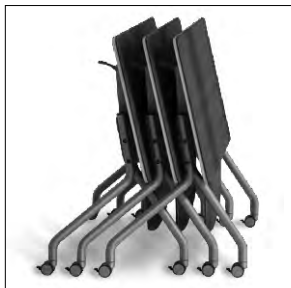

Flip-Top tables can be nested and easily stored by activating the single hand release mechanism from the left or right side.

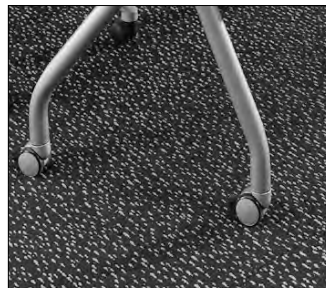

Optional locking casters are available in Tungsten or Black (standard on Flip-Top models).

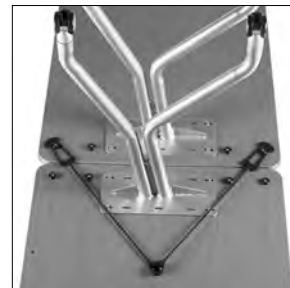

Bungee cords are utilized to quickly and easily reconfigure tables

B BUNGEE™ TABLES - NOTES

GENERAL INFORMATION

- Bungee is a series of freestanding tables and accessories designed for classrooms, training rooms, boardrooms and any other multifunctional space that requires frequent reconfigurations.
- Bungee tables come complete with a work top, a set of legs and built-in Bungee cord connectors
- Bungee cords allow the movement and reconfiguration of tables without a risk of damage or losing loose parts
- High pressure tops are available in all Bungee laminate finishes at an extended lead time - please see model # for pricing.
- Unique “bubble molding” edging is specially engineered to create a secure seal to align interconnected tables.
- Bungee products have been tested and comply with all mechanical tests.
- For environmental certifications, please visit globalfurnituregroup.com

CONSTRUCTION

- Tops are 1" thick. Modesty panels are 11/16" thick.
- All components are made of 45 lb. commercial density particle board, covered on both sides with high performance, thermally fused laminate.
- Tops 54" and over feature a built-in support bar.
- Products specified with the high pressure laminate option are finished on the underside of the surface with a kraft paper backing.

BUNGEE CORDS

- Bungee cords are patented elastic devices designed to provide a rapid, no-tool method of attaching tables of the same depth.
- The elastic nature of cords allows two connected tables to be moved around without risk of damage to the table top or connecting hardware.
- Bungee cords are included with all freestanding tables and carry a lifetime warranty.

EDGE DETAIL

- Bungee comes with a choice of four edge styles (check model for edge availability):



A3 - square corner, standard edge



AR - square corner, bicut edge



AS - square corner, Silver



AB - square corner, Black



BS - rounded corner, Silver



BB - rounded corner, Black

- **BB/BS** - Bungee Bubble Edge: unique “bubble” molding is engineered to compress under the tension of the Bungee cords, creating a seal that serves to locate and align interconnected tables.
- **AB/AS** - Split color PVC edge: edge matches split color aesthetic of the bubble edge, but allows for 90 degree corners and a cleaner look.
- **A3** - Global's preferred edge. Coordinates well with Adaptabilities and Zira 1" tops.
- **AR** - Bicut edge. Coordinates well with Zira 1" tops.
- **NOTE:** Trapezoid tables can only be specified with Bubble Edge (Rounded Corners).
- **NOTE:** Boardroom Table sets allow for all edge types but ONLY with rounded corners (when AS/AB/A3/AR are selected, the table will be produced with rounded corners).

LEGS

- Tables feature two styles of legs - Tapered leg or Spider leg. Legs on fixed tables offer glides or casters. Adjusts 3mm-10mm in height.
- For legs and glides in Tungsten, specify (**TTU**).
- For legs and glides in Black, specify (**TBL**).
- For legs and casters in Tungsten, specify (**TTC**).
- For legs and casters in Black, specify (**TBC**).



Tapered Leg



Spider Leg

HANDLES

- Metal handles are standard on all drawers and doors. Handles are offered in two finishes: Silver (**HS**) or Black Nickel (**HT**), please specify
- Handle finish will match leg finish.



bow handle, Silver finish (**HS**)



bow handle, Black Nickel finish (**HT**)

FEET

- Metal feet are standard on all cabinets. Feet adjust 3/4" in height.
- Feet are available in Tungsten Finish (**TTU**) or Black Finish (**BLK**).



TTU - Tungsten



BLK - Black Nickel

MODESTY PANELS

- Panels are 9.5" high, recessed 3/4" from the back and inset 7" from the sides.
- Available in all Bungee laminate finishes.
- Edge available in Silver finish (**SI**) or Black finish (**BK**). Please specify.

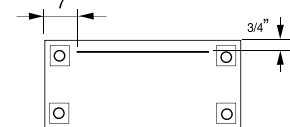
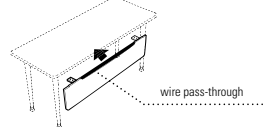

FILLER MODESTY PANELS

- Used to fill the space between two modesty panels when two tables are linked together. Helps conceal wires and enhance visual appeal.
- Reversible - Black on one side, Silver on the other.

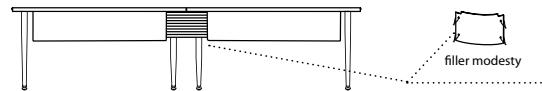

WIRE MANAGEMENT

- Wire management tracks are mounted to the underside of the worksurface. Available in 5" and 22" track lengths.
- 5" track includes one wire clamp; 22" track includes two wire clamps.
- Data and voice wires can be routed separately using two separate channels on each clamp.
- Available in Black only.

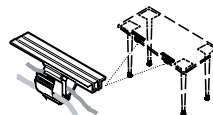

5" Wire Management Track

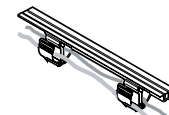

22" Wire Management Track

1. SPECIFY MODEL NUMBER

2. SPECIFY FINISH

LAMINATE FINISHES

ACJ Absolute Acajou	NGL Noce Grigio
ASN Asian Night	NEL Noce Leggero
AWC Avant Cherry	NML Noce Medio
AWH Avant Honey	QTM Quartered Mahogany
BLK Black	SOG Storm Grey
BRC Brushed Cobalt	TFW Tiger Fruitwood
CMB Clear Maple	TWL Tiger Walnut
DES Dark Espresso	WHE Walnut Heights
DWT Designer White	WHC White Chocolate
HGT Hayden Grey	WGY Willow Grey
NBL Noce Biondo	WCR Winter Cherry

Edge:

BB	Bungee bubble edge with Black trim
BS	Bungee bubble edge with Silver trim
AB	Split color edge with Black trim
AS	Split color edge with Silver trim
A3	Matching edge
AR	Matching bicut edge

Legs with Glides:

TBL	Black
TTU	Tungsten

Legs with Casters:

TBC	Black
TTC	Tungsten

Handles:

HS	Silver
HT	Black Nickel

Modesty Panel Edge:

SI	Silver
BK	Black Nickel

Feet:

BLK	Black Nickel
TTU	Tungsten

3. SPECIFY OPTIONS

GROMMETS

- Optional Grommets available in standard worksurface locations (left, center or right) for **Rectangular Tops 48" and up**. Order as: **AG1, AG2 or AG3 - Add \$88**
- Additional grommets are available in **center position only** for **Rectangular Tops (36", 42" and 48") and Trapezoid Tables**. Order as **AG2 - Add \$88**.
- Grommet hole dimensions are 3 1/4" wide x 1 7/8" deep.
- Grommets may be placed at non-standard locations. Order as: **AGS - Add \$88**. A drawing must be supplied with vertical and horizontal dimensions to the center of the cut-out (as in drawing above). Please refer to CUSTOM GROMMET LOCATION FORM in the back reference section.

Grommet hole dimensions

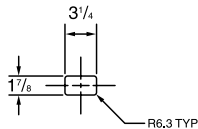

Grommet

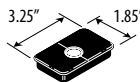

Rectangular Tops

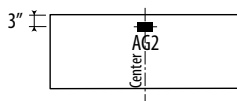

For **36"** and **42"** wide units



For **48"**, **60"** and **72"** wide units



Trapezoid Tables

Grommet Location - **AG2...Add \$88**

POWER BLOCK

- A Power Block is a rectangular worksurface power/data module with one electrical duplex receptacle and two data (RJ45) receptacles. 9' black cord included. Power Block dimensions are 3 1/2" deep x 6 1/2" wide x 2 3/4" high.
- A Power Block (model **PMSPDM**) may be ordered for **Rectangular Tables 60" and up** in place of standard grommets. Order as **E1, E2 or E3 - Add \$88**.
- Additional Power Blocks are available in **center position only** for **Rectangular Tops (36", 42" and 48") and Trapezoid Tables**. Order as **E2 - Add \$88**.

- To purchase a Power Block, you must specify both the Power Block cut-out location and the Power Block model #. Order Power Block as **PMSPDM, Add \$330**.
- Power Blocks are available in standard worksurface locations (left, center or right). Order as **E1, E2 or E3. Add \$88**.
- See above for examples of placement.



Power Block **PMSPDM Add \$330**

Rectangular Tops

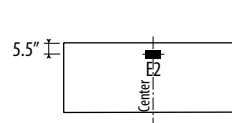

For **36"**, **42"** and **48"** wide units

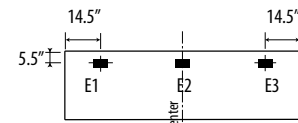

For **60"** and **72"** wide units

VILLA CUTOUTS

- Optional Villa cutout available in standard worksurface locations (left, center or right) for **Rectangular Tables 60" and up**. Order as: **V1, V2 or V3 - Add \$88 for each cutout**.
- Additional power block cutouts are available in **center position only** for **Rectangular Tops (36", 42" and 48") and Trapezoid Tables**. Order as **V2 - Add \$88**.
- Villa cutouts may be placed at non-standard locations. Please contact customer care.
- To purchase a Villa Power Block, you must specify both the Villa Power Block cutout location and the Power Block model #. Please see page 509 for Villa models.

Rectangular Tops

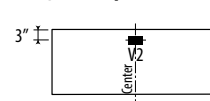

For **36"**, **42"** and **48"** wide units

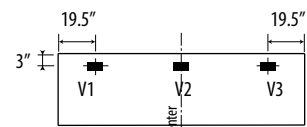

For **60"** and **72"** wide units

B BUNGEE™ TABLES

CONNECTING CONDITIONS

- Bungee cords allow for fast and easy reconfiguring of tables whenever needed. Due to the elastic nature of the Bungee cord, two tables connected with Bungee cords can be moved around without risk of damage to the table top or the connecting hardware.
- Connecting tables is simple and intuitive. Tools are not required and there are no loose parts that may be misplaced.
- Bungee cords connect tables of the same depth in all directions.
- Rectangular Tables 48" and longer connect in both Straight and "L" configurations. Rectangular Tables 36" and 42" connect in Straight configurations only.

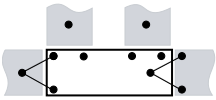
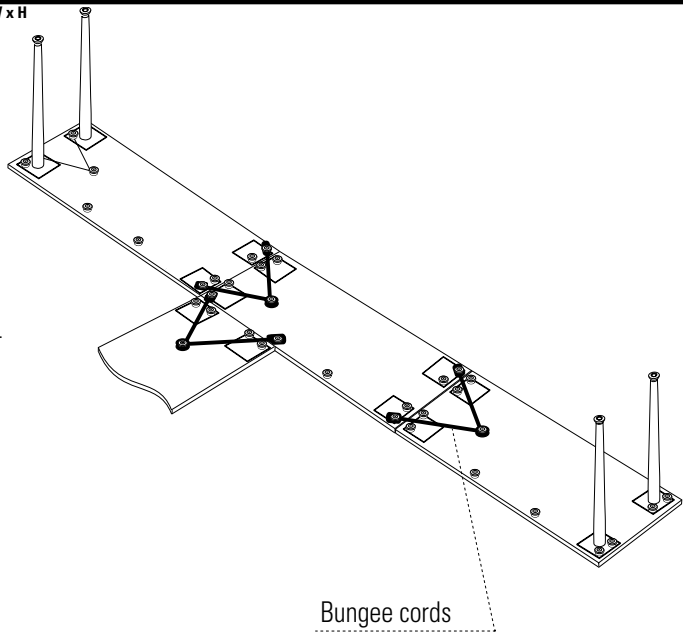

Rectangular Tables

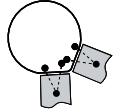

Round Wedge Tables

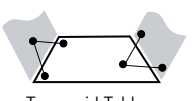

Trapezoid Tables

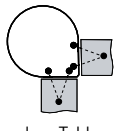

Teardrop Tables

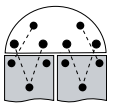

Half Moon Tables

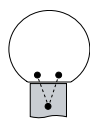

Flat Round Tables

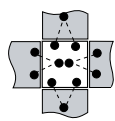

Square Tables

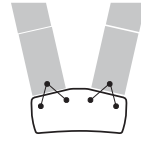

Keystone Tables

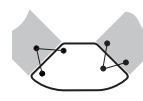

Wedge Tables

SAMPLE TABLE CONFIGURATIONS

- The following table configurations can be created using Bungee Boardroom Table Sets only.

Meeting/Boardroom Table

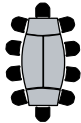

Meeting/Boardroom Table



Training

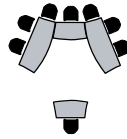

Lecture / AV Presentations

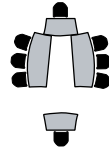

Small Teaming Stations



Large Teaming Stations



Meeting/Boardroom Table

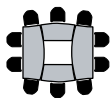

Training

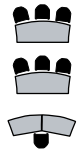

FLIP TOP TABLE NESTING DIAGRAM

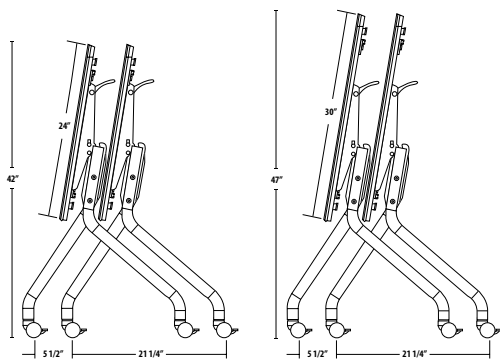

RECTANGULAR TABLES

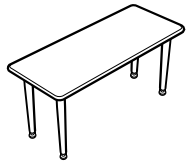
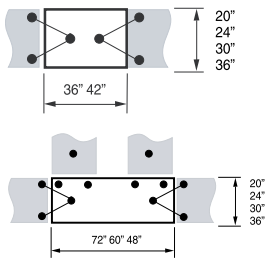

Rectangular Table - Tapered Legs

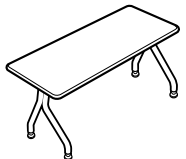
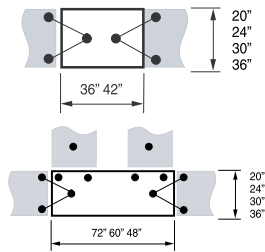

Rectangular Table - Spider Legs

MODEL#	DIMENSIONS D x W x H	FREIGHT CLASS	WT/LBS.	CUBIC FT.	LIST PRICE	HP ADD
B2036REF	20 x 36 x 29	92.5	59	5.26	\$809	\$164
B2042REF	20 x 42 x 29	92.5	62	5.76	\$838	\$218
B2048REF	20 x 48 x 29	92.5	67	6	\$870	\$218
B2060REF	20 x 60 x 29	92.5	74	7	\$985	\$300
B2072REF	20 x 72 x 29	92.5	81	7.26	\$1080	\$339
B2436REF	24 x 36 x 29	92.5	65	5.76	\$856	\$164
B2442REF	24 x 42 x 29	92.5	69	6	\$885	\$218
B2448REF	24 x 48 x 29	92.5	72	6.50	\$914	\$218
B2460REF	24 x 60 x 29	92.5	82	7.26	\$1056	\$326
B2472REF	24 x 72 x 29	92.5	91	8	\$1140	\$507
B3036REF	30 x 36 x 29	100	70	7.26	\$845	\$307
B3042REF	30 x 42 x 29	92.5	78	7.50	\$885	\$339
B3048REF	30 x 48 x 29	92.5	81	7.50	\$909	\$326
B3060REF	30 x 60 x 29	92.5	92	8.26	\$1056	\$408
B3072REF	30 x 72 x 29	92.5	102	9	\$1157	\$507
B3642REF	36 x 42 x 29	150	83	15	\$970	\$326
B3648REF	36 x 48 x 29	92.5	91	8	\$1064	\$309
B3660REF	36 x 60 x 29	92.5	103	9	\$1157	\$384
B3672REF	36 x 72 x 29	92.5	116	10	\$1293	\$487

Freestanding table includes four tapered legs with levellers and Bungee cords. Each table can be "Bungee-tied" to other tables of the same depth. Shipped RTA (ready to assemble). Modesty panels available, see page 555.

- **Tables 48" and longer connect in both Straight and "L" configurations**
- **Tables 36" and 42" connect in Straight configurations only.**
- Available with optional locking casters, specify option "TBC" or "TTC".

B2036RES	20 x 36 x 29	100	57	6.76	\$909	\$164
B2042RES	20 x 42 x 29	100	60	7.26	\$939	\$218
B2048RES	20 x 48 x 29	100	65	7.50	\$970	\$218
B2060RES	20 x 60 x 29	100	72	8.50	\$1093	\$300
B2072RES	20 x 72 x 29	100	79	8.76	\$1194	\$339
B2436RES	24 x 36 x 29	100	62	7.26	\$962	\$164
B2442RES	24 x 42 x 29	150	64	15	\$985	\$218
B2448RES	24 x 48 x 29	125	71	10	\$1023	\$218
B2460RES	24 x 60 x 29	125	80	10.76	\$1157	\$326
B2472RES	24 x 72 x 29	125	89	11.26	\$1253	\$507
B3036RES	30 x 36 x 29	125	72	10.26	\$985	\$307
B3042RES	30 x 42 x 29	125	80	10.50	\$1015	\$339
B3048RES	30 x 48 x 29	125	83	10.50	\$1048	\$374
B3060RES	30 x 60 x 29	100	94	11.26	\$1194	\$374
B3072RES	30 x 72 x 29	100	104	12	\$1280	\$508

Freestanding table includes two spider legs with levellers and Bungee cords. Each table can be "Bungee-tied" to other tables of the same depth. Shipped RTA (ready to assemble). Modesty panels available, see page 555.

- **Tables 48" and longer connect in both Straight and "L" configurations**
- **Tables 36" and 42" connect in Straight configurations only.**
- Available with optional locking casters, specify option "TBC" or "TTC".

Required Specifications

Top finish
Edge
Leg finish

Optional Specifications

Casters
Grommet
Modesty Panel
High Pressure Laminate

Accessories

Power Block

B BUNGEE™ TABLES

TRAPEZOID TABLES

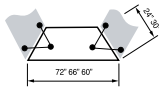

Trapezoid Table - Tapered Legs

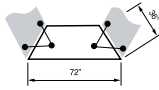
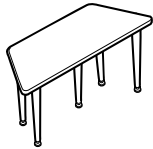

Trapezoid Table - Tapered Legs

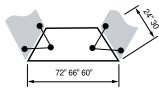
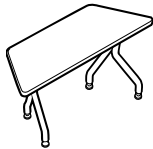

Trapezoid Table - Spider Legs

MODEL#	DIMENSIONS	FREIGHT CLASS	WT/LBS.	CUBIC FT.	LIST PRICE	HP ADD
--------	------------	---------------	---------	-----------	------------	--------

D x W x H

B2460TRF	24 x 60 x 29	100	71	7.50	\$970	\$326
B2466TRF	24 x 66 x 29	100	74	8	\$995	\$507
B2472TRF	24 x 72 x 29	100	78	8.26	\$1069	\$507
B3060TRF	30 x 60 x 29	100	78	8.50	\$1037	\$374
B3066TRF	30 x 66 x 29	100	81	9.50	\$1080	\$507
B3072TRF	30 x 72 x 29	100	85	9.50	\$1148	\$507

Freestanding table includes four tapered legs with levelers and Bungee cords. Each table can be "Bungee-tied" to other tables of the same depth. Shipped RTA (ready to assemble). Modesty panels available, see page 555.

• Available with bubble edge (BB or BS) only.

B3672TRF	36 x 72 x 29	100	91	10.50	\$1325	\$487
----------	--------------	-----	----	-------	---------------	--------------

Freestanding table includes five tapered legs with levelers and Bungee cords. Each table can be "Bungee-tied" to other tables of the same depth. Shipped RTA (ready to assemble). Modesty panels available, see page 555.

• Available with bubble edge (BB or BS) only.

• Available with optional locking casters, specify option "TBC" or "TTC".

B2060TRS	20 x 60 x 29	125	67	8.76	\$1048	\$300
B2066TRS	20 x 66 x 29	125	68	9	\$1080	\$339
B2072TRS	20 x 72 x 29	125	74	9.26	\$1123	\$339

B2460TRS	24 x 60 x 29	125	69	9.26	\$1080	\$326
B2466TRS	24 x 66 x 29	125	72	9.76	\$1123	\$507
B2472TRS	24 x 72 x 29	125	76	10	\$1170	\$507

B3060TRS	30 x 60 x 29	125	79	11.50	\$1161	\$374
B3066TRS	30 x 66 x 29	125	83	12.50	\$1204	\$507
B3072TRS	30 x 72 x 29	125	87	12.50	\$1270	\$507

Freestanding table includes two spider legs with levelers and Bungee cords. Each table can be "Bungee-tied" to other tables of the same depth. Shipped RTA (ready to assemble). Modesty panels available, see page 555.

• Available with bubble edge (BB or BS) only.

• Available with optional locking casters, specify option "TBC" or "TTC".

KEYSTONE TABLES

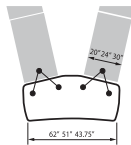
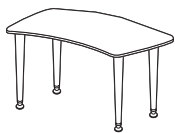

Keystone Table - Tapered Legs

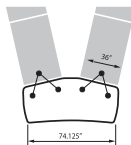

Keystone Table - Tapered Legs

B30KSF	30 x 62 x 29	150	69	15.20	\$1029	\$408
B24KSF	24 x 51 x 29	150	60	13	\$952	\$274
B20KSF	20 x 43.75 x 29	150	58	13	\$940	\$218

Freestanding table includes four tapered legs with levelers and Bungee cords. Each table can be "Bungee-tied" to other tables of 24" and 30" depth. Shipped RTA (ready to assemble). Modesty panels or Filler Modestys are NOT available.

B36KSF	36 x 74.13 x 29	150	84	16.80	\$1271	\$575
--------	-----------------	-----	----	-------	---------------	--------------

Freestanding table includes five tapered legs with levelers and Bungee cords. Each table can be "Bungee-tied" to other tables of 24" and 30" depth. Shipped RTA (ready to assemble). Modesty panels or Filler Modestys are NOT available.

Required Specifications

Top finish
Edge
Leg finish

Optional Specifications

Grommet
Casters
Modesty panel (Trapezoid Tables only)
HP laminate

Accessories

Power block

KEYSTONE TABLES

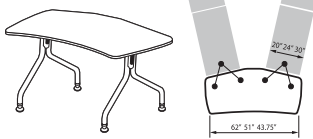

Keystone Table - Spider Legs

MODEL#	DIMENSIONS	FREIGHT CLASS	WT./LBS.	CUBIC FT.	LIST PRICE	HP ADD
D x W x H						
B30KSS	30 x 62 x 29	150	77	15.20	\$1201	\$406
B24KSS	24 x 51 x 29	150	66	13	\$1118	\$253
B20KSS	20 x 43.75 x 29	150	64	13	\$1099	\$218

Freestanding table includes two spider legs with levelers and Bungee cords. Each table can be "Bungee-tied" to other tables of 24" and 30" depth. Shipped RTA (ready to assemble). Modesty panels or Filler Modestys are NOT available.

- Available with optional locking casters, specify option "TBC" or "TTC".

WEDGE TABLES

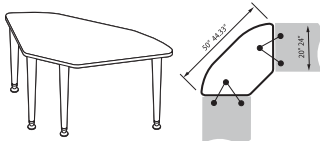

Wedge Table - Tapered Legs

B24WEF	24 x 63 x 29	150	54	13.20	\$996	\$273
B20WEF	20 x 57 x 29	150	46	10.20	\$912	\$218

Freestanding table includes four tapered legs with levelers and Bungee cords. Each table can be "Bungee-tied" to other tables of the same depth. Shipped RTA (ready to assemble). Modesty panels are NOT available.

- Available with optional locking casters, specify option "TBC" or "TTC".

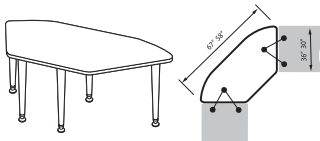

Wedge Table - Tapered Legs

B36WEF	36 x 80 x 29	150	84	18.80	\$1356	\$487
B30WEF	30 x 70 x 29	150	70	14.40	\$1201	\$339

Freestanding table includes five tapered legs with levelers and Bungee cords. Each table can be "Bungee-tied" to other tables of the same depth. Shipped RTA (ready to assemble). Modesty panels are NOT available.

- Available with optional locking casters, specify option "TBC" or "TTC".

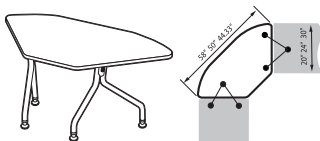

Wedge Table - Spider Legs

B30WES	30 x 70 x 29	150	73	14.40	\$1190	\$342
B24WES	24 x 63 x 29	150	62	13.20	\$1112	\$273
B20WES	20 x 57 x 29	150	52	10.20	\$1029	\$218

Freestanding table includes two spider legs with levelers and Bungee cords. Each table can be "Bungee-tied" to other tables of the same depth. Shipped RTA (ready to assemble). Modesty panels are NOT available.

- Available with optional locking casters, specify option "TBC" or "TTC".

HALF MOON TABLES

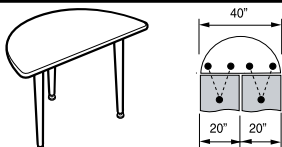

Half Moon Table - Tapered Legs

B2040HMF	20 x 40 x 29	100	49	6	\$640	\$218
----------	--------------	-----	----	---	--------------	--------------

Freestanding table includes three tapered legs with levelers and Bungee cords. Each table can be "Bungee-tied" to other tables of the same depth. Shipped RTA (ready to assemble). Modesty panels or Filler Modestys are NOT available.

- Available with optional locking casters, specify option "TBC" or "TTC".

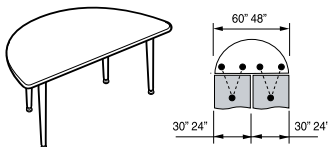

Half Moon Table - Tapered Legs

B2448HMF	24 x 48 x 29	100	69	7.76	\$833	\$218
B3060HMF	30 x 60 x 29	100	81	8.50	\$885	\$374

Freestanding table includes four tapered legs with levelers and Bungee cords. Each table can be "Bungee-tied" to other tables of the same depth. Shipped RTA (ready to assemble). Modesty panels or Filler Modestys are NOT available.

- Available with optional locking casters, specify option "TBC" or "TTC".

Required Specifications

Top finish
Edge
Leg finish

Optional Specifications

Casters
HP laminate

Accessories

Power Block (position 2 only)

B BUNGEE™ TABLES

HALF MOON TABLES

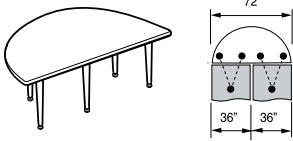

Half Moon Table - Tapered Legs

MODEL#	DIMENSIONS D x W x H	FREIGHT CLASS	WT./LBS.	CUBIC FT.	LIST PRICE	HP ADD
B3672HMF	36 x 72 x 29	100	110	11.50	\$1246	\$487

Freestanding table includes five tapered legs with levellers and Bungee cords. Each table can be "Bungee-tied" to other tables of the same depth. Shipped RTA (ready to assemble). Modesty panels or Filler Modestys are NOT available.

- Available with optional locking casters, specify option "TBC" or "TTC".

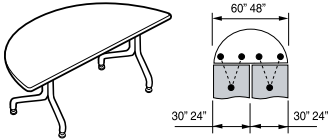

Half Moon Table - Spider Legs

B2448HMS	24 x 48 x 29	125	67	9.26	\$947	\$218
B3060HMS	30 x 60 x 29	125	83	11.50	\$1015	\$374

Freestanding table includes two spider legs with levellers and Bungee cords. Each table can be "Bungee-tied" to other tables of the same depth. Shipped RTA (ready to assemble). Modesty panels or Filler Modestys are NOT available.

- Available with optional locking casters, specify option "TBC" or "TTC".

SQUARE TABLES

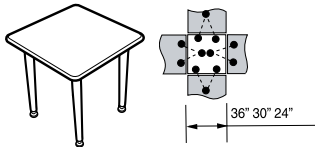

Square Table - Tapered Legs

B2424SQF	24 x 24 x 29	92.5	55	4.60	\$792	\$139
B3030SQF	30 x 30 x 29	100	65	7.50	\$809	\$206
B3636SQF	36 x 36 x 29	100	78	8	\$925	\$245

Freestanding table includes four tapered legs with levellers and Bungee cords. Each table can be "Bungee-tied" to other tables of the same depth. Shipped RTA (ready to assemble). Modesty panels available, see page 555.

- Available with optional locking casters, specify option "TBC" or "TTC".

ROUND WEDGE TABLES

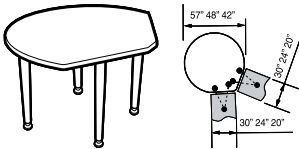

Round Wedge 120° Table

B2042RWF	20 x 42 x 29	100	76	8.26	\$885	\$475
B2448RWF	24 x 48 x 29	125	85	10.76	\$909	\$475
B3057RWF	30 x 57 x 29	100	102	12	\$1080	\$676

Freestanding table includes four tapered legs with levellers and Bungee cords. Each table can be "Bungee-tied" to other tables of the same depth. Shipped RTA (ready to assemble). Modesty panels or Filler Modestys are NOT available.

- Available with bubble edge (BB or BS) only.
- Available with optional locking casters, specify option "TBC" or "TTC".

TEARDROP TABLES

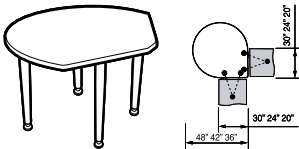

Teardrop 90° Table

B2036TDF	20 x 36 x 29	100	71	8	\$833	\$307
B2442TDF	24 x 42 x 29	100	81	8.50	\$909	\$475
B3048TDF	30 x 48 x 29	100	91	11	\$999	\$441

Freestanding table includes four tapered legs with levellers and Bungee cords. Each table can be "Bungee-tied" to other tables of the same depth. Shipped RTA (ready to assemble). Modesty panels or Filler Modestys are NOT available.

- Available with bubble edge (BB or BS) only.
- Available with optional locking casters, specify option "TBC" or "TTC".

Required Specifications

Top finish
Edge
Leg finish

Optional Specifications

Casters
High Pressure Laminate

FLAT ROUND TABLES

MODEL# DIMENSIONS FREIGHT CLASS WT/LBS. CUBIC FT. LIST PRICE HP ADD

D x W x H

B2030FRF	20 x 30 x 29	100	56	6	\$809	\$274
B2036FRF	20 x 36 x 29	100	66	7.26	\$809	\$307
B2436FRF	24 x 36 x 29	100	64	7.26	\$809	\$307
B2442FRF	24 x 42 x 29	100	76	8.26	\$962	\$475
B3042FRF	30 x 42 x 29	100	74	8	\$962	\$475
B3048FRF	30 x 48 x 29	100	88	11	\$962	\$434
B3648FRF	36 x 48 x 29	125	85	11	\$1064	\$676
B3652FRF	36 x 52 x 29	100	93	11	\$1064	\$676

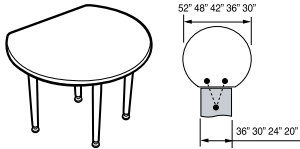

Flat Round Table*

Freestanding table includes four tapered legs with levellers and Bungee cords. Each table can be "Bungee-tied" to other tables of the same depth. Shipped RTA (ready to assemble). Modesty panels or Filler Modestys are NOT available.

- Available with bubble edge (BB or BS) only.
- Available with optional locking casters, specify option "TBC" or "TTC".

MODESTY PANELS

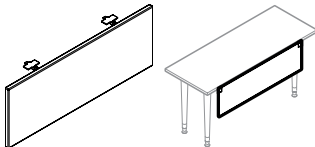

Modesty Panel

BX36QMP	9.5 x 21 x .69	60	3	1.20	\$105	N/A
BX42QMP	9.5 x 27 x .69	60	4	1.35	\$111	N/A
BX48QMP	9.5 x 33 x .69	60	4	1.60	\$117	N/A
BX60QMP	9.5 x 45 x .69	60	5	2.10	\$127	N/A
BX66QMP	9.5 x 51 x .69	60	6	2.60	\$133	N/A
BX72QMP	9.5 x 57 x .69	60	7	2.60	\$139	N/A

For use on **Rectangular** and **Square** Tables. Includes hinged mounting bracket. Available in all Bungee laminate finishes. Edge available in Silver finish (SI) or Black finish (BK).

- Modesty panel model number indicates the width of table to be used on.

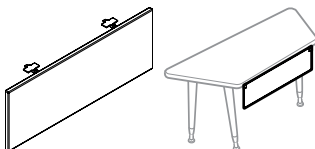

Modesty Panel

BXM60QMP	9.5 x 21 x .69	60	4	1.20	\$111	N/A
BXM66QMP	9.5 x 27 x .69	60	4	1.35	\$117	N/A
BXM72QMP	9.5 x 33 x .69	60	5	1.60	\$122	N/A
BXL60QMP	9.5 x 21 x .69	60	3	1.20	\$109	N/A
BXL66QMP	9.5 x 27 x .69	60	4	1.35	\$111	N/A
BXL72QMP	9.5 x 33 x .69	60	4	1.60	\$117	N/A

For use on **Trapezoid** Tables. Includes hinged mounting bracket. Intended for use on the short side of the table; may be used on long side but leaves a larger gap. Available in all Bungee laminate finishes.

- Edge available in Silver finish (SI) or Black finish (BK).
- Modesty panel model number indicates the width of table to be used on.
 - Specify **BXM** models for 24" D tables and **BXL** models for 30" D tables.

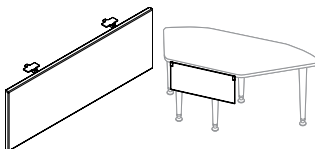

Modesty Panel

BXWQMP	9.5 x 27 x .69	60	4	.40	\$111	N/A
--------	----------------	----	---	-----	--------------	-----

For use on **Wedge** Tables. Includes hinged mounting bracket. Intended for use on the short side of the table. Available in all Bungee laminate finishes.

Edge available in Silver finish (SI) or Black finish (BK).

Required Specifications

Top finish
Edge
Leg finish*

Optional Specifications

Casters*
HP laminate*

B BUNGEE™ TABLES

FILLER MODESTY PANELS



Filler Modesty Panel - Straight

MODEL#	DIMENSIONS D x W x H	FREIGHT CLASS	WT/LBS.	CUBIC FT.	LIST PRICE	HP ADD
BSFMS	.06 x 21 x 9	70	1	.30	\$115	N/A

Used to fill the space between two **square** modesty panels where tables are linked in a straight configuration. Available in Silver (**SI**) or Black (**BK**). Please specify.



Filler Modesty Panel - Straight to Wedge

BSWFM	.06 x 21 x 9	100	1	1.5	\$125	N/A
-------	--------------	-----	---	-----	--------------	-----

Used to fill the space between a straight modesty panel and a wedge table. Use for regular wedge table - tapered legs and flip-top wedge - spider legs. Available in Silver (**SI**) or Black (**BK**). Please specify.

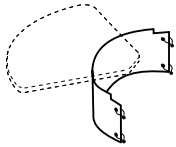

Filler Modesty Panel - Inside Curve

B23IFMS	.06 x 23 x 9	250	3	1.50	\$138	N/A
B29IFMS	.06 x 29 x 9	250	3	1.50	\$138	N/A
B30IFMS	.06 x 30 x 9	250	3	1.50	\$138	N/A

Used to fill the space (inside curve) between two modesty panels where tables are linked at an angle or curve. Use for the inside curve of Round Wedge Tables, Teardrop Tables, or Trapezoid Tables. Available in Silver (**SI**) or Black (**BK**). Please specify.

- Use model **B23IFMS** for Trapezoid Tables inside curve only.
- Use model **B29IFMS** for Teardrop Tables inside curve only.
- Use model **B30IFMS** for Round Wedge Tables inside curve only.

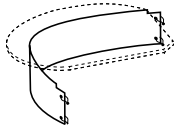

Filler Modesty Panel - Outside Curve

B56S	.06 x 56 x 9	250	4	1.50	\$199	N/A
B62S	.06 x 62 x 9	250	4	1.50	\$215	N/A
B71S	.06 x 71 x 9	250	4	1.50	\$260	N/A

Used to fill the space (outside curve) between two modesty panels where tables are linked at an angle or curve. Use for Teardrop Tables only (**B2036TDF**, **B2442TDF** and **B3048TDF**). Available in Silver (**SI**) or Black (**BK**). Please specify.

- Use model **B56S** for **B2036TDF** Teardrop Tables outside curve only.
- Use model **B62S** for **B2442TDF** Teardrop Tables outside curve only.
- Use model **B71S** for **B3048TDF** Teardrop Tables outside curve only.

Required Specifications

Finish

WIRE MANAGEMENT

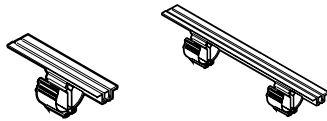

Wire Management - 5" /22" Track

MODEL#	DIMENSIONS D x W x H	FREIGHT CLASS	WT/LBS.	CUBIC FT.	LIST PRICE	HP ADD
BWMS5	2 x 5 x 3.5	70	1	.10	\$15	N/A
BWMD22	2 x 22 x 3.5	70	1	.10	\$22	N/A

Retrofittable track mounts to the underside of worksurface. Includes wire clamp that can route data and voice wires separately. Black only.

- For a 5" track, order model **BWMS5** - includes one wire clamp.
- For a 22" track, order model **BWMD22** - includes two wire clamps.

BOARDROOM TABLE SETS

11 Foot Configurations

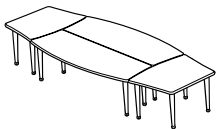

Boardroom Table Set - 11 foot



Boardroom Table Set - 11 foot

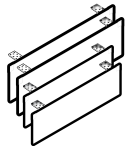

Modesty Panel Set for Boardroom Table

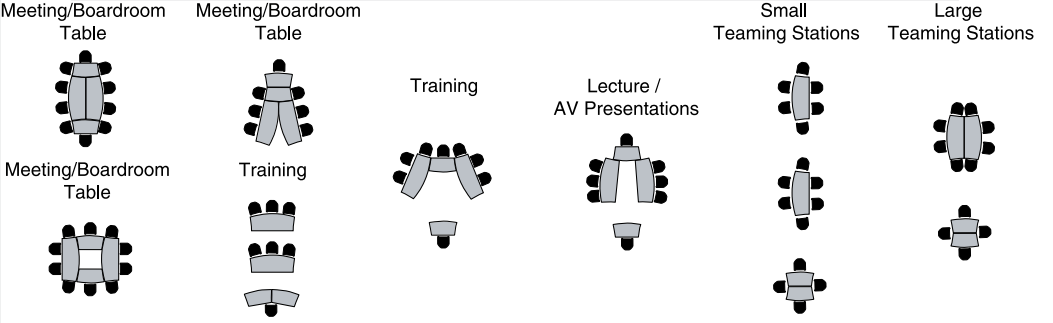

MODEL#	DIMENSIONS D x W x H	FREIGHT CLASS	WT/LBS.	CUBIC FT.	LIST PRICE	HP ADD
BK132F	60 x 132 x 29	85	290	19.25	\$3907	\$1487

Set includes four freestanding tables with **tapered legs** and Bungee cords for tool free ganging. Leg finish or legs with casters optional, see page 548 . Shipped easy to assemble in 6 cartons. Modesty panel set available, order **BXK132QMP**.

- **Due to the unique geometry of the tables, all edge types will feature rounded corners.**

BK132S	60 x 132 x 29	85	290	22.25	\$4384	\$1487
--------	---------------	----	-----	-------	---------------	---------------

Set includes four freestanding tables with **spider legs** and Bungee cords for tool free ganging. Leg finish or legs with casters optional, see page 548 . Shipped easy to assemble in 6 cartons. Modesty panel set available, order **BXK132QMP**.

- **Due to the unique geometry of the tables, all edge types will feature rounded corners.**

BXK132QMP	.69 x 34 x 9	92.5	13	1.10	\$429	N/A
-----------	--------------	------	----	------	--------------	-----

For use on **11 foot Boardroom Table Set**. Includes mounting bracket and wire access sweep. Available in all Bungee laminate finishes.

Required Specifications	Optional Specifications
Top finish	Casters
Edge	Grommet
Leg finish	Modesty panel
	HP laminate

B BUNGEE™ TABLES

BOARDROOM TABLE SETS

13/15 Foot Configurations

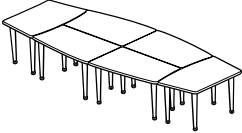

Boardroom Table Set - 13 and 15 foot

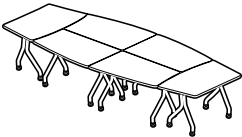

Boardroom Table Set - 13 and 15 foot

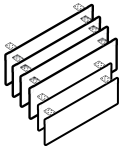

Modesty Panel Set for Boardroom Table

MODEL#	DIMENSIONS D x W x H	FREIGHT CLASS	WT/LBS.	CUBIC FT.	LIST PRICE	HP ADD
Meeting/Boardroom Table	Lecture / AV Presentations	Training			Small Teaming Stations	Large Teaming Stations
Meeting/Boardroom Table	Lecture / AV Presentations	Meeting/Boardroom Table	Training		Small Teaming Stations	
BK156F	60 x 156 x 29	85	374	26.25	\$5751	\$1886
BK180F	60 x 180 x 29	100	420	29.75	\$6267	\$2154

Set includes six freestanding tables with **tapered legs** and Bungee cords for tool free ganging. Leg finish or legs with casters optional, see page 548 . Shipped easy to assemble in 9 cartons. Modesty panel set available, order **BK156QMP/ BK180QMP**.

- Due to the unique geometry of the tables, all edge types will feature rounded corners.

BK156S	60 x 156 x 29	85	374	28.75	\$5934	\$1886
BK180S	60 x 180 x 29	70	420	32.50	\$6434	\$2154

Set includes six freestanding tables with **spider legs** and Bungee cords for tool free ganging. Leg finish or legs with casters optional, see page 548 . Shipped easy to assemble in 9 cartons. Modesty panel set available, order **BK156QMP/ BK180QMP**.

- Due to the unique geometry of the tables, all edge types will feature rounded corners.

BXK156QMP	.69 x 34 x 9	70	20	1	\$726	N/A
BXK180QMP	.69 x 46 x 9	65	25	1.10	\$696	N/A

For use on **13 & 15 foot Boardroom Table Set**. Includes mounting bracket and wire access sweep. Available in all Bungee laminate finishes. Edge available in Silver finish (**SI**) or Black finish (**BK**).

- Use model **BXK156QMP** for **BK156F/S** Boardroom Table Set.
- Use model **BXK180QMP** for **BK180F/S** Boardroom Table Set.

Required Specifications

Top finish
Edge
Leg + caster finish

Optional Specifications

Grommet
Modesty panel
HP laminate

Accessories

Power block

RECTANGULAR TABLE - FLIP TOP

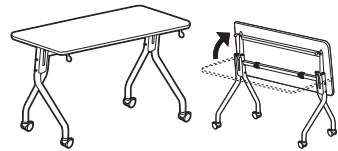
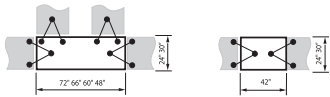

Flip-Top Rectangular Table - Spider Legs

MODEL#	DIMENSIONS D x W x H	FREIGHT CLASS	WT/LBS.	CUBIC FT.	LIST PRICE	HP ADD
BX2442RES	24 x 42 x 29	250	66	20.75	\$1438	\$215
BX2448RES	24 x 48 x 29	250	72	23.50	\$1458	\$215
BX2460RES	24 x 60 x 29	250	84	29	\$1492	\$268
BX2466RES	24 x 66 x 29	250	97	31.75	\$1505	\$321
BX2472RES	24 x 72 x 29	250	102	34.75	\$1533	\$321
BX3042RES	30 x 42 x 29	250	73	25.50	\$1438	\$268
BX3048RES	30 x 48 x 29	250	73	28.75	\$1458	\$268
BX3060RES	30 x 60 x 29	250	94	35.75	\$1498	\$333
BX3066RES	30 x 66 x 29	250	106	39.25	\$1513	\$400
BX3072RES	30 x 72 x 29	250	112	42.50	\$1547	\$400

Table features a flip-top worksurface for ease of storage. Single hand release mechanism can be activated from left or right side of the table. Tables can be nested when folded. Each table can be "Bungee-tied" to other tables of the same depth. Folding modesty panels available, see next page.

- **Tables 48" and longer connect in both Straight and "L" configurations**
- **Standard with locking casters**
- **Due to hardware placement, tables placed in back-to-back configurations will not be able to be "Bungee-tied" together.**

TRAPEZOID TABLES - FLIP TOP

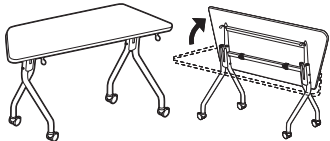
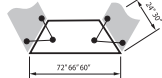

Flip-Top Trapezoid Table - Spider Legs

BX2460TRS	24 x 60 x 29	150	112	28	\$1349	\$268
BX2466TRS	24 x 66 x 29	250	112	31	\$1371	\$321
BX2472TRS	24 x 72 x 29	250	112	33	\$1390	\$321
BX3060TRS	30 x 60 x 29	250	112	35.50	\$1378	\$333
BX3066TRS	30 x 66 x 29	250	112	39	\$1398	\$400
BX3072TRS	30 x 72 x 29	250	112	42.50	\$1418	\$400

Table features a flip-top worksurface for ease of storage. Single hand release mechanism can be activated from left or right side of the table. Tables can be nested when folded. Each table can be "Bungee-tied" to other tables of the same depth. Folding modesty panels available, see next page.

- **Available with bubble edge (BB or BS) only.**
- **Standard with locking casters**

KEYSTONE TABLES - FLIP TOP

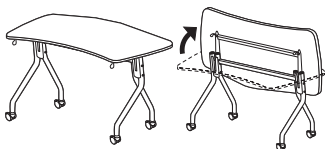

Flip-Top Keystone Table - Spider Legs

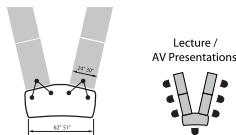

BX24KSS	24 x 51 x 29	125	112	16.50	\$1341	\$268
BX30KSS	30 x 62 x 29	125	112	16.50	\$1398	\$400

Table features a flip-top worksurface for ease of storage. Single hand release mechanism can be activated from left or right side of the table. Tables can be nested when folded. Each table can be "Bungee-tied" to other tables of the same depth.

- **Modesty panels or Filler Modestys are NOT available.**
- **Standard with locking casters**

Required Specifications

Top finish
Edge
Leg + caster finish

Optional Specifications

Grommet
Modesty panel
HP laminate

Accessories

Power block

B BUNGEE™ TABLES

WEDGE TABLES - FLIP TOP

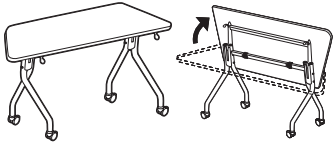

Flip-Top Wedge Table - Spider Legs

MODEL#	DIMENSIONS D x W x H	FREIGHT CLASS	WT/LBS.	CUBIC FT.	LIST PRICE	HP ADD
BX24WES	24 x 63 x 29	60	76	33	\$1689	\$384
BX30WES	30 x 70 x 29	60	84	33	\$1717	\$384

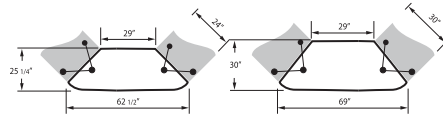
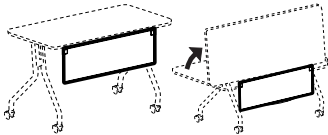

Table features a flip-top worksurface for ease of storage. Single hand release mechanism can be activated from left or right side of the table. Tables can be nested when folded. Each table can be “Bungee-tied” to other tables of the same depth. Folding modesty panels available, see below.

- Standard with locking casters

MODESTY PANELS - FLIP TOP



Modesty Panel

BX36QMP	9.5 x 21 x .69	60	3	1.20	\$105	N/A
BX42QMP	9.5 x 27 x .69	60	4	1.35	\$111	N/A
BX48QMP	9.5 x 33 x .69	60	4	1.60	\$117	N/A
BX60QMP	9.5 x 45 x .69	60	5	2.10	\$127	N/A
BX66QMP	9.5 x 51 x .69	60	6	2.60	\$133	N/A
BX72QMP	9.5 x 57 x .69	60	7	2.60	\$139	N/A

For use on **Flip Top Rectangular Tables**. Includes hinged mounting bracket. Available in all Bungee laminate finishes. Edge available in Silver finish (**SI**) or Black finish (**BK**).

- Modesty panel model number indicates the width of table to be used on.

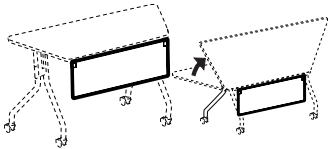

Modesty Panel

BXM60QMP	9.5 x 21 x .69	60	4	1.20	\$111	N/A
BXM66QMP	9.5 x 27 x .69	60	4	1.35	\$117	N/A
BXM72QMP	9.5 x 33 x .69	60	5	1.60	\$122	N/A
BXL60QMP	9.5 x 21 x .69	60	3	1.20	\$109	N/A
BXL66QMP	9.5 x 27 x .69	60	4	1.35	\$111	N/A
BXL72QMP	9.5 x 33 x .69	60	4	1.60	\$117	N/A

For use on **Flip Top Trapezoid Tables**. Includes hinged mounting bracket. Intended for use on the short side of the table; may be used on long side but leaves a larger gap. Available in all Bungee laminate finishes. Edge available in Silver finish (**SI**) or Black finish (**BK**).

- Modesty panel model number indicates the width of table to be used on.
- Specify **BXM** models for 24”D tables and **BXL** models for 30”D tables.

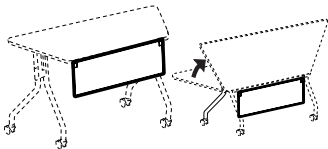

Modesty Panel

BXWQMP	9.5 x 27 x .69	60	4	.40	\$111	N/A
--------	----------------	----	---	-----	--------------	-----

For use on **Flip Top Wedge Tables**. Includes hinged mounting bracket. Intended for use on the short side of the table. Available in all Bungee laminate finishes. Edge available in Silver finish (**SI**) or Black finish (**BK**).

- Modesty panel model number indicates the width of table to be used on.

Required Specifications

Top finish
Edge
Leg + caster finish

Optional Specifications

Grommet
Modesty panel
HP laminate

Accessories

Power block

BOARDROOM TABLE SET - FLIP TOP

MODEL#

DIMENSIONS

FREIGHT CLASS

WT/LBS.

CUBIC FT.

LIST PRICE

HP ADD

D x W x H

4 pc. Configurations

Meeting/Boardroom Table



Meeting/Boardroom Table



Training



Lecture / AV Presentations

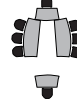

Small Teaming Stations



Large Teaming Stations



Meeting/Boardroom Table



Training



BXK132S

60 x 132 x 29

250

352

151.25

\$5520

\$1519



Boardroom Table Set - 4pc. Flip Top

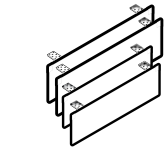
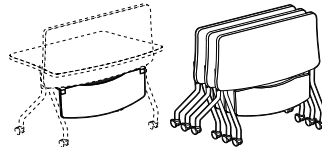

Square Modesty Panel Set for 4pc. Flip Top Table

BXK132QMP

.69 x 34 x 9

92.5

13

1.10

\$429

N/A

For use on 4 pc. flip top table kits. Modesty panels flip down for storage. Features black wire access sweep. Available in all Bungee laminate finishes. Edge available in Silver finish (SI) or Black finish (BK).

Required Specifications

- Top finish
- Edge
- Leg + caster finish

Optional Specifications

- HP laminate

B BUNGEE™ TABLES

MODESTY PANEL SETS

6 pc. Configurations

MODEL#	DIMENSIONS D x W x H	FREIGHT CLASS	WT/LBS.	CUBIC FT.	LIST PRICE	HP ADD

BXK156S	60 x 156 x 29	250	452	181.75	\$8172	\$1753
BXK180S	60 x 180 x 29	250	507	209.50	\$8370	\$2017



Boardroom Table Set - 6pc. Flip Top

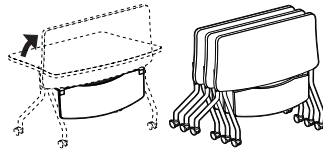

Set includes six freestanding tables with **spider legs** and Bungee cords for tool free ganging. Only legs with casters available, see page 548 for finish choices. All tables feature a flip top worksurface for ease of storage. Single hand release mechanism can be activated from left or right side of table. Tables can be nested when folded. Shipped in 6 cartons. Modesty panel set available, order **BXK156QMP/ BXK180QMP**.

• **Due to the unique geometry of the tables, all edge types will feature rounded corners.**

BXK156QMP	.69 x 34 x 9	70	20	1	\$726	N/A
BXK180QMP	.69 x 46 x 9	65	25	1.10	\$696	N/A

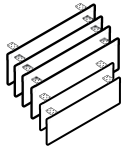

Square Modesty Panel Set for 6 pc. Flip Top Table

For use on **6 pc. flip top table kits**. Modesty panels flip down for storage. Features black wire access sweep. Available in all Bungee laminate finishes. Edge available in Silver finish (**SI**) or Black finish (**BK**).

Required Specifications

Top finish
Edge
Leg + caster finish

Optional Specifications

Grommet

Accessories

Power block

ACCESSORIES

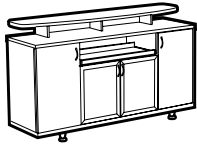

Credenza Buffet

MODEL#	DIMENSIONS D x W x H	FREIGHT CLASS	WT./LBS.	CUBIC FT.	LIST PRICE	HP ADD
B2072BUF	20 x 72 x 42	100	305	37.50	\$3408	\$502

Pull-out shelf. Top transaction shelf is edged with bubble molding. Side storage compartments feature a laminate door and one adjustable shelf each. Center storage features frosted aluminum doors with one adjustable shelf. Leveler feet are standard.

- Some assembly required.

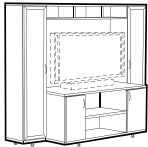

Audio/Visual Cabinet

B249072AV	24 x 90 x 72	92.5	530	52.52	\$5618	\$507
-----------	--------------	------	-----	-------	---------------	--------------

Top pigeon holes and center adjustable shelf accommodate electronic equipment, CDs and other media. Bottom storage compartments feature laminate doors and one adjustable shelf. Side storage towers feature frosted aluminum doors with three adjustable shelves each. Accommodates TVs up to 58" w x 34" h x 24" d.

- Some assembly required.



Lectern

B44LEC	17 x 22 x 44	250	36	12.50	\$856	\$164
--------	--------------	-----	----	-------	--------------	--------------

Features angled stand with pencil ledge. Locking casters. **Specify CS or CK.**

Required Specifications

Top finish
Edge
Leg finish

Optional Specifications

Grommet

Accessories

Power block

B BUNGEE SL™ - NOTES



BUNGEE SL - a completely new product line to complement and coordinate with the Bungee Training Tables series. Bungee SL takes the popular aesthetic of the Bungee series and allows tables to be specified in shared leg and permanent applications - great for training, teaming and academic areas. Bungee SL tops and legs are sold separately, increasing the flexibility of the product in the future and allows for space saving in areas where real estate is a premium.

For greater flexibility, specify **Power and Data Management Troughs** for the BUNGEE SL table series. Add Global's proprietary 4-wire power kits and create inexpensive and versatile training, benching, academic and meeting areas. Front panels are available in Laminate or Aluminum. A center spine version allows for inexpensive double-sided applications.

Features and Benefits

- Tops are 1" thick with a choice of four edges: BB/BS - Bungee bubble edge, AB/AS - split color edge, A3 - matching edge and AR - Bicut edge.
- Legs are offered in Tapered or Spider design in a Tungsten or Black finish. Levelers are standard
- Power and data management troughs are sold separately and are meant to be used on BUNGEE SL only.



Tapered leg with levelers, offered in Tungsten or Black finish.



Optional power and data management troughs for Bungee SL. Center spine shown.



Shared leg, back-to-back tables with center spine trough.

GENERAL INFORMATION

- Introducing **BUNGEE SL** - a completely new product line to complement and coordinate with the top selling Bungee Training Tables series.
- Bungee SL takes the popular aesthetic of the Bungee series and allows tables to be specified in shared leg and permanent applications - great for benching, training, teaming and academic areas.
- Bungee SL tops and legs are sold separately, increasing the flexibility of the product in the future and allows for space saving in areas where real estate is a premium.
- High pressure tops are available in all BUNGEE SL laminates at an extended lead time - please refer to model # for pricing.
- For environmental certifications, please visit globalfurnituregroup.com

CONSTRUCTION

- Tops are 1" thick
- All laminate components are made of 45 lb. density particleboard with high performance thermally fused laminate.
- Tops 60" and over feature a built-in support bar. The support bar is 10" from the **approach** side, and clearance to the bottom of the support bar is 27" from the floor.
- **BUNGEE CORDS ARE NOT INCLUDED AND ARE NOT COMPATIBLE WITH BUNGEE SL TOPS**
- Products specified with the high pressure laminate option are finished on the underside of the surface with a kraft paper backing.

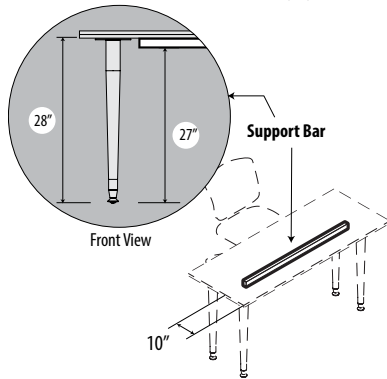

EDGE DETAIL

- Bungee SL comes with a choice of four edge styles:



A3 - square corner, standard edge



AR - square corner, bicut edge



AS - square corner, Silver



AB - square corner, Black



BS - rounded corner, Silver



BB - rounded corner, Black

- **BB/BS** - Bungee Bubble Edge: unique "bubble" molding found on original Bungee
- **AB/AS** - Split color PVC edge: edge matches split color aesthetic of the bubble edge, but allows for 90 degree corners and a cleaner look.
- **A3** - Global's preferred edge. Coordinates well with Adaptabilities and Zira 1" tops.
- **AR** - Bicut edge. Coordinates well with Zira 1" tops.

LEGS

- Two leg styles are available - Tapered and Spider leg. Available in Black (**TBL**) or Tungsten (**TTU**) finish. Levelers are standard; casters are not available for Bungee SL legs. Levelers adjust 3mm - 10mm in height.

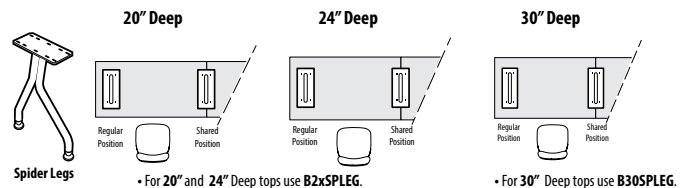

MODESTY PANELS

- See **POWER AND DATA MANAGEMENT TROUGHS** - page 571
- For modesty panels without power and data management, please see **Bungee modesty panels**, found on page 547

WIRE MANAGEMENT / POWER OPTIONS

- **TO UTILIZE BUNGEE SL TO THE FULLEST EXTENT, SPECIFY POWER AND DATA MANAGEMENT TROUGH (SEE PAGE 571).**
- For basic wire management, see details on page 547.

B BUNGEE SL™ - NOTES

1. SPECIFY MODEL NUMBER

2. SPECIFY FINISH

Laminate Finishes:

ACJ	Absolute Acajou	NGL	Noce Grigio
ASN	Asian Night	NEL	Noce Leggero
AWC	Avant Cherry	NML	Noce Medio
AWH	Avant Honey	QTM	Quartered Mahogany
BLK	Black	SOG	Storm Grey
BRC	Brushed Cobalt	TFW	Tiger Fruitwood
CMB	Clear Maple	TWL	Tiger Walnut
DES	Dark Espresso	WHE	Walnut Heights
DWT	Designer White	WHC	White Chocolate
HGT	Hayden Grey	WGY	Willow Grey
NBL	Noce Biondo	WCR	Winter Cherry

Edge:

BB	Bungee bubble edge with Black trim
BS	Bungee bubble edge with Silver trim
AB	Split color edge with Black trim
AS	Split color edge with Silver trim
A3	Matching edge
AR	Matching bicut edge

Legs:

TBL	Black
TTU	Tungsten

3. SPECIFY OPTIONS

GROMMETS

- Optional Grommets available in standard worksurface locations (left, center or right) **for rectangular tops 48" and up**. Order as: **AG1, AG2 or AG3 - Add \$88**
- Optional grommets are available in **center position only for rectangular tops** (36" and 42"), **keystone, half moon and wedge tops**. Order as **AG2 - Add \$88**.
- Grommet hole dimensions are 3.25" wide x 1.875" deep.
- Grommets may be placed at non-standard locations. Order as: **AGS - Add \$88**. A drawing must be supplied with vertical and horizontal dimensions to the center of the cut-out (as in drawing below). Please refer to CUSTOM GROMMET LOCATION FORM in the back reference section.

Grommet hole dimensions

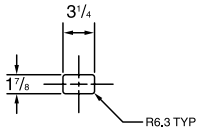

Grommet

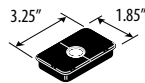

Keystone

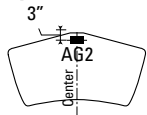

Half Moon

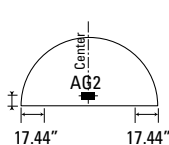

Wedge

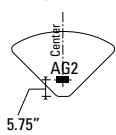

Rectangular Tops

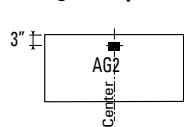

For 36" and 42" wide units

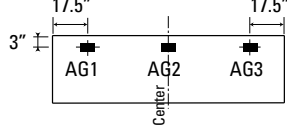

For 48", 60" and 72" wide units

POWER BLOCK

- A Power Block is a rectangular worksurface power/data module with one electrical duplex receptacle and two data (RJ45) receptacles. 9' black cord included. Power block dimensions are 3.5"D x 6.5"W x 2.75"H. Power block cutout dimensions are 2.75"D x 6"W.
- A power block cutout (model **PMSPDM**) may be ordered for **rectangular tops** (48" and up) in place of standard grommets. Order as **E1, E2 or E3. Add \$88**.
- A power block cutout (model **PMSPDM**) may be ordered in the **center position only for rectangular tops** (36" and 42"), **keystone and half moon tops**. Order as **E2. Add \$88**.

- To purchase a power block, you must specify both the power block cut-out location and the power block model #. Order power block separately as **PMSPDM, Add \$330**.

Keystone

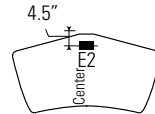

Half Moon

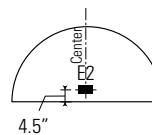

Power Block

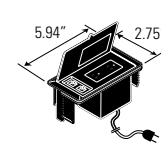

Rectangular Tops

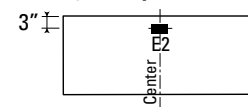

For 36", 42" and 48" wide units

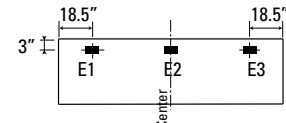

For 60" and 72" wide units

VILLA POWER BLOCK (CORDED VERSION ONLY)

- A Villa power block (corded) is available in four options (see page 577 for Villa Corded details). Villa power block (corded) dimensions vary by model. Villa cutout dimensions are 3"D x 5.25"W.
- A Villa cutout may be ordered for **rectangular tops 48" and up**. Order as: **V1, V2 or V3 - Add \$88 for each cutout**.
- A Villa cutout may be ordered in the **center position only for rectangular tops** (36" and 42"), **keystone and half moon tops**. Order as: **V2 - Add \$88**.
- Order Villa Power Block and Villa Grommet Cover separately, see page 577 for pricing and details.

Keystone

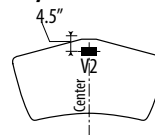

Half Moon

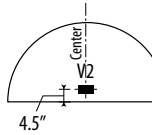

Villa Power Block

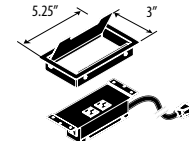

Rectangular Tops

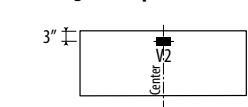

For 36", 42" and 48" wide units

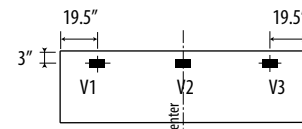

For 60" and 72" wide units

TOPS WITH SQUARE CORNERS (A3, AR OR AB/AS EDGE) MODEL# DIMENSIONS FREIGHT CLASS WT/LBS. CUBIC FT. LIST PRICE HP ADD

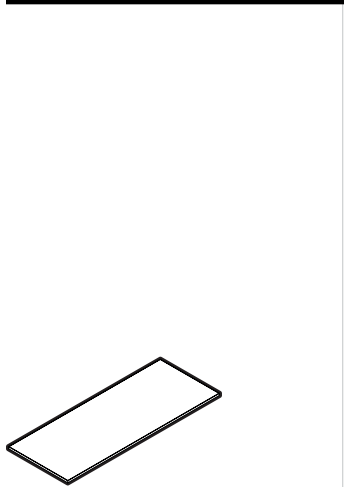

Rectangular Top - Square Corners

	D x W x H						
BS3072REC	30 x 72 x 1	70	60	4	\$532	\$457	
BS3060REC	30 x 60 x 1	70	53	3.40	\$444	\$380	
BS3048REC	30 x 48 x 1	70	46	2.70	\$273	\$306	
BS3042REC	30 x 42 x 1	70	42	2.40	\$265	\$268	
BS3036REC	30 x 36 x 1	70	38	2.10	\$212	\$231	
BS2472REC	24 x 72 x 1	70	51	3.30	\$465	\$366	
BS2460REC	24 x 60 x 1	70	44	2.80	\$406	\$306	
BS2448REC	24 x 48 x 1	70	37	2.30	\$232	\$244	
BS2442REC	24 x 42 x 1	70	33	2	\$219	\$216	
BS2436REC	24 x 36 x 1	70	29	1.80	\$207	\$185	
BS2072REC	20 x 72 x 1	85	43	2.90	\$432	\$306	
BS2060REC	20 x 60 x 1	70	37	2.40	\$366	\$257	
BS2048REC	20 x 48 x 1	70	30	2	\$218	\$216	
BS2042REC	20 x 42 x 1	70	27	1.80	\$201	\$185	
BS2036REC	20 x 36 x 1	70	24	1.50	\$189	\$185	

Rectangular 1" thick worksurface with **Square Corners**. Can accept Tapered (B29TPLEG) or Spider Legs (B2XSPLEG / B30SPLEG) in "end of run" or shared leg positions. Tops 60" and up include a built-in support bar. Shipped RTA (ready to assemble). Compatible with **power and data management troughs** (see page 571) or standard modesty panels (see page 573).

- For worksurfaces to be used as a return, please see Return Tops.
- Legs sold separately.

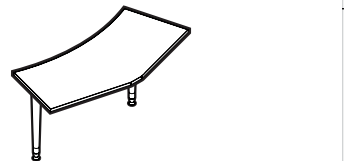

Keystone Top - Square Corners

BS30KSF	30.50 x 62.75 x 29	92.5	37	3.60	\$1029	\$457	
BS24KSF	28.75 x 52 x 29	92.5	29	2.80	\$952	\$334	
BS20KSF	27.75 x 44 x 29	92.5	25	2.40	\$940	\$276	

1" thick worksurface with **Square Corners**. Includes (2) Tapered legs. *Not available with Spider Legs*. Connects to other tops of 20", 24" or 30" depths. Shipped RTA (ready to assemble). Modesty panels or filler panels are NOT available.

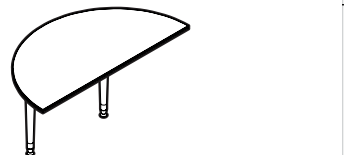

Half Moon Top - Square Corners

BS3060HMF	29.75 x 59.4 x 29	92.5	36	3.30	\$885	\$380	
BS2448HMF	24 x 48.2 x 29	92.5	24	2.30	\$833	\$244	

1" thick worksurface with **Square Corners**. Includes (2) Tapered legs. *Not available with Spider Legs*. Connects to other tables equaling the same length. Shipped RTA (ready to assemble). Modesty panels or filler panels are NOT available.

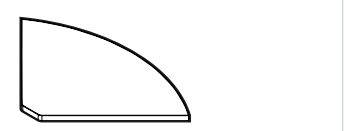

90° Wedge Top - Square Corners

BS24WE	26.8 x 26.8 x 1	92.5	15	1.50	\$257	\$216	
BS20WE	22.8 x 22.8 x 1	100	10	1.20	\$189	\$185	

1" thick worksurface with **Square Corners**. Can accept Tapered (B29TPLEG) or Spider Legs (B2XSPLEG / B30SPLEG) in shared positions only. Shipped RTA (ready to assemble). Accepts filler modesty panels.

- Legs sold separately.

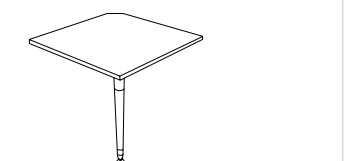

90° Corner - Square Corners

BS30CN	33.17 x 33.17 x 29	125	36	2.50	\$577	\$179	
--------	--------------------	-----	----	------	-------	-------	--

Connects to 30" Deep Rectangular Tables. Includes (1) Tapered leg. *Not available with Spider Legs*.

Required Specifications	Optional Specifications	HP Laminate
Top Finish	Grommet	
Top / Edge Detail	Power/Data Management Troughs - (Rectangular tops only)	Accessories
	Modesty Panel (Rectangular tops only)	Power Block
		Villa Power Block (Corded)

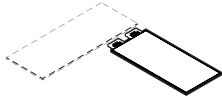

Rectangular Return Tops - Square Corners

MODEL#	DIMENSIONS D x W x H	FREIGHT CLASS	WT./LBS.	CUBIC FT.	LIST PRICE	HP ADD
BS3054RRE	30 x 54 x 1	70	50	3.10	\$290	\$344
BS3048RRE	30 x 48 x 1	70	46	2.70	\$273	\$306
BS3042RRE	30 x 42 x 1	70	42	2.40	\$265	\$268
BS3036RRE	30 x 36 x 1	70	38	2.10	\$212	\$231
BS2454RRE	24 x 54 x 1	70	40	2.50	\$251	\$276
BS2448RRE	24 x 48 x 1	70	37	2.30	\$232	\$244
BS2442RRE	24 x 42 x 1	70	33	2	\$219	\$216
BS2436RRE	24 x 36 x 1	70	29	1.80	\$207	\$185
BS2054RRE	20 x 54 x 1	70	33	2.20	\$238	\$231
BS2048RRE	20 x 48 x 1	70	30	2	\$218	\$206
BS2042RRE	20 x 42 x 1	70	27	1.80	\$201	\$185
BS2036RRE	20 x 36 x 1	70	24	1.50	\$189	\$154

Rectangular 1" thick worksurface with **Square Corners**. Includes two flat brackets to attach to another worksurface on one end. Can accept Tapered (B29TPLEG) or Spider Legs (B2XSPLEG / B30SPLEG) on the other end. 54" tops include a built-in support bar. Shipped RTA (ready to assemble). Compatible with standard modesty panels (see page 555).

- For worksurfaces to be used as a main surface, please see Rectangular Tops.
- Legs sold separately.

TOPS WITH ROUNDED CORNERS (BB/BS EDGES ONLY)



Rectangular Top - Rounded Corners

BB3072REC	30 x 72 x 1	85	59	4	\$682	\$457
BB3060REC	30 x 60 x 1	70	52	3.40	\$570	\$380
BB3048REC	30 x 48 x 1	70	45	2.70	\$347	\$306
BB3042REC	30 x 42 x 1	70	41	2.40	\$339	\$268
BB3036REC	30 x 36 x 1	70	37	2.10	\$274	\$231
BB2472REC	24 x 72 x 1	70	50	3.30	\$598	\$366
BB2460REC	24 x 60 x 1	70	43	2.80	\$520	\$306
BB2448REC	24 x 48 x 1	70	36	2.30	\$295	\$244
BB2442REC	24 x 42 x 1	70	32	2	\$282	\$216
BB2436REC	24 x 36 x 1	70	28	1.80	\$265	\$185
BB2072REC	20 x 72 x 1	85	42	2.90	\$554	\$306
BB2060REC	20 x 60 x 1	70	36	2.40	\$469	\$257
BB2048REC	20 x 48 x 1	85	29	2	\$279	\$216
BB2042REC	20 x 42 x 1	85	26	1.80	\$257	\$185
BB2036REC	20 x 36 x 1	70	23	1.50	\$240	\$185

Rectangular 1" thick worksurface with **Rounded Corners**. Can accept Tapered (B29TPLEG) or Spider Legs (B2XSPLEG / B30SPLEG) in "end of run" or shared leg positions. Tops 60" and up include a built-in support bar. Shipped RTA (ready to assemble). Compatible with **power and data management troughs** (see page 571) or standard modesty panels (see page 555).

- For worksurfaces to be used as a return, please see Return Tops
- Legs sold separately.

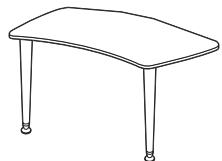

Keystone Top - Rounded Corners

BB30KSF	30.50 x 62.75 x 29	92.5	36	3.60	\$1029	\$457
BB24KSF	28.75 x 52 x 29	92.5	28	2.80	\$952	\$334
BB20KSF	27.75 x 44 x 29	92.5	24	2.40	\$940	\$276

1" thick worksurface with **Rounded Corners**. Includes (2) Tapered legs. *Not available with Spider Legs*. Connects to other tops of 20", 24" or 30" depths. Shipped RTA (ready to assemble). Modesty panels or filler panels are NOT available.

Required Specifications

Top Finish
Top / Edge Detail

Optional Specifications

Grommet
Power/Data Management Troughs -
(Rectangular tops only)
Modesty Panel

HP Laminare

Accessories

Power Block
Villa Power Block (Corded)

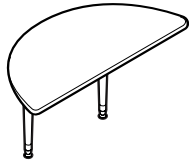

Half Moon Top - Rounded Corners

MODEL#	DIMENSIONS	FREIGHT CLASS	WT/LBS.	CUBIC FT.	LIST PRICE	HP ADD
D x W x H						
BB3060HMF	29.75 x 59.4 x 29	92.5	35	3.30	\$885	\$380
BB2448HMF	24 x 48.2 x 29	92.5	23	2.30	\$833	\$244

1" thick worksurface with **Rounded Corners**. Includes (2) Tapered legs. *Not available with Spider Legs*. Connects to other tables equaling the same length. Shipped RTA (ready to assemble). Modesty panels or filler panels are NOT available.



90° Wedge Top - Rounded Corners

BB24WE	26.8 x 26.8 x 1	100	14	1.50	\$329	\$216
BB20WE	22.8 x 22.8 x 1	125	9	1.20	\$240	\$185

1" thick worksurface with **Rounded Corners**. Can accept Tapered (B29TPLEG) or Spider Legs (B2XSPLEG / B30SPLEG) in shared positions only. Shipped RTA (ready to assemble). Accepts filler modesty panels.

- Legs sold separately.

BB3054RRE	30 x 54 x 1	70	50	3.06	\$373	\$344
BB3048RRE	30 x 48 x 1	70	46	2.75	\$347	\$306
BB3042RRE	30 x 42 x 1	70	42	2.44	\$339	\$268
BB3036RRE	30 x 36 x 1	70	38	2.13	\$274	\$231

BB2454RRE	24 x 54 x 1	70	40	2.54	\$321	\$276
BB2448RRE	24 x 48 x 1	70	37	2.28	\$295	\$244
BB2442RRE	24 x 42 x 1	70	33	2.03	\$282	\$216
BB2436RRE	24 x 36 x 1	70	29	1.77	\$265	\$185

BB2054RRE	20 x 54 x 1	70	33	2.20	\$304	\$231
BB2048RRE	20 x 48 x 1	70	30	1.97	\$279	\$206
BB2042RRE	20 x 42 x 1	70	27	1.75	\$257	\$185
BB2036RRE	20 x 36 x 1	70	24	1.53	\$240	\$154

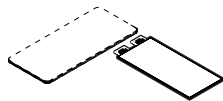

Rectangular Return Tops - Rounded Corners

Rectangular 1" thick worksurface with **Rounded Corners**. Includes two flat brackets to attach to another worksurface on one end. Can accept Tapered (B29TPLEG) or Spider Legs (B2XSPLEG / B30SPLEG) on the other end. 54" tops include a built-in support bar. Shipped RTA (ready to assemble). Compatible with standard modesty panels (see page 573).

- For worksurfaces to be used as a main surface, please see Rectangular Tops
- Legs sold separately.

BB30CN	33.17 x 33.17 x 29	125	36	2.50	\$621	\$179
--------	--------------------	-----	----	------	--------------	--------------

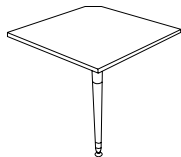

90° Corner - Rounded Corners

Connects to 30" Deep Rectangular Tables. Includes (1) Tapered leg. *Not available with Spider Legs*.

B30SPLEG	25 x 6 x 28	150	16	2.90	\$373	
----------	-------------	-----	----	------	--------------	--



Spider Legs for 30" D Tables

Spider leg with levellers. Shipped/sold one per carton. **Tops sold separately.**

- Available in Tungsten (**TTU**) or Black (**TBL**). Please specify.
- **To be used with 30" D tops only**

Required Specifications

Top Finish
Top / Edge Detail

Optional Specifications

Grommet
Filler Modesty Panel (Wedge Tops only)
Modesty Panel (Rectangular Return Tops)
HP Laminate

Accessories

Power Block
Villa Power Block (Corded)

B BUNGEE SL™

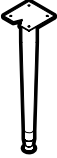
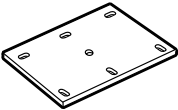
	MODEL#	DIMENSIONS	FREIGHT CLASS	WT/LBS.	CUBIC FT.	LIST PRICE
 <p>Spider Legs for 20" & 24" D Tables</p>	B2XSPLEG	D x W x H 20 x 6 x 28	125	14	2.20	\$322
	<p>Spider leg with levellers. Shipped/sold one per carton. Tops sold separately.</p> <ul style="list-style-type: none"> • Available in Tungsten (TTU) or Black (TBL). Please specify. • To be used with 24" & 24" deep tops only 					
 <p>Tapered Leg</p>	B29TPLEG	6 x 6 x 28	85	11	.80	\$152
	<p>Tapered leg with levellers for tables of all depths. Shipped/sold one per carton. Tops sold separately.</p> <ul style="list-style-type: none"> • Available in Tungsten (TTU) or Black (TBL). Please specify. 					
 <p>Flat Bracket</p>	B6PLT	4.5 x 3 x .125	70	2	.10	\$52
	<p>To be used as a mending plate for Bungee SL. Black only. Shipped/sold one per pack.</p>					

Required Specifications

Leg Finish

GENERAL INFORMATION

- Power and Data Management Troughs for the **BUNGEE SL** table series. Add Global's proprietary 4-wire power kits and create inexpensive and versatile training, benching, academic and meeting areas.
- Front panels are available in Laminate or Aluminum. A center spine version allows for inexpensive double-sided applications.
- **POWER AND DATA MANAGEMENT TROUGHS** are sold separately and are meant to be used on **BUNGEE SL only**.
- **POWER AND DATA MANAGEMENT TROUGHS** accept Global's 4-wire power kit in addition to numerous data, phone and other multimedia wires.
- Filler modesty panels conceal wiring in spaces not covered by troughs.
- For environmental certifications, please visit globalfurnituregroup.com

FINISHES

LAMINATE:

ACJ	Absolute Acajou	NGL	Noce Grigio
ASN	Asian Night	NEL	Noce Leggero
AWC	Avant Cherry	NML	Noce Medio
AWH	Avant Honey	QTM	Quartered Mahogany
BLK	Black	SOG	Storm Grey
BRC	Brushed Cobalt	TFW	Tiger Fruitwood
CMB	Clear Maple	TWL	Tiger Walnut
DES	Dark Espresso	WHE	Walnut Heights
DWT	Designer White	WHC	White Chocolate
HGT	Hayden Grey	WGY	Willow Grey
NBL	Noce Biondo	WCR	Winter Cherry

Aluminum Face Panel, Trough, Filler Panels and End Caps:

Black (BLK) Tungsten (TUN)

LAMINATE FACE PANEL (LFP)

- Laminate face panel (LFP) on the approach side is 11/16" thick. LFP height is 13".
- Rear access panel is 1/4" thick laminate. Rear panel height is 7.25".
- LFP and rear panel swing up to allow wire access and feature a flexible sweep at the top.
- All laminate components are made of 45 lb. commercial density particle board, covered on both sides with high performance, thermally fused laminate.
- The trough portion of the unit is made of a heavy duty aluminum extrusion to allow wire systems (including Global's 4-Wire System) to lie within the bottom.
- LFP is available in all standard laminates, aluminum trough available in Tungsten (TUN) or Black (BLK) finish, please specify (rear access panel is finished in Brushed Cobalt (BRC) laminate when TUN is specified, or Black (BLK) laminate when BLK is specified).
- End Caps (JBEC) sold separately

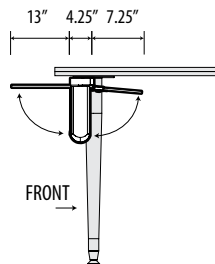

Tops, legs and end caps not included

ALUMINUM FACE PANEL (AFP)

- Aluminum face panel (AFP) is an aluminum extrusion. AFP height is 8.25".
- AFP swings down to allow wire access and features a flexible sweep at the top.
- Rear access panel is 1/4" thick laminate. Rear panel height is 7.25".
- Rear panel swings up to allow wire access and features a flexible sweep at the top.
- The trough portion of the unit is made of a heavy duty aluminum extrusion to allow wire systems (including Global's 4-Wire System) to lie within the bottom.
- AFP and aluminum trough available in Tungsten (TUN) or Black (BLK) finish, please specify (rear access panel is finished in Brushed Cobalt (BRC) laminate when TUN is specified, or Black (BLK) laminate when BLK is specified).
- End Caps (JBEC) sold separately.

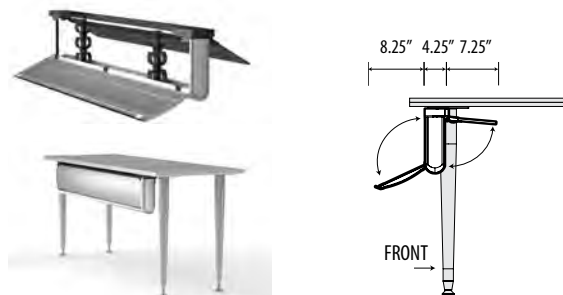

Tops, legs and end caps not included

CENTER SPINE (CS)

- 1/4" thick laminate panels on both sides of the unit. Panel height is 7.25".
- Both panels swing up to allow wire access and feature a flexible sweep at the top.
- All laminate components are made of 45 lb. commercial density particle board, covered on both sides with high performance, thermally fused laminate.
- The trough portion of the unit is made of a heavy duty aluminum extrusion to allow wire systems (like Global's 4-Wire System) to lie within the bottom.
- Aluminum trough available in Tungsten (TUN) or Black (BLK) finish, please specify (rear access panel is finished in Brushed Cobalt (BRC) laminate when TUN is specified, or both access panels are finished in Black (BLK) laminate when BLK is specified).
- End Caps (JBEC) sold separately.



Tops, legs and end caps not included

B BUNGEE SL™ POWER/DATA MANAGEMENT TROUGHS - NOTES

FILLER MODESTY PANELS

- Used to fill the space between two power and data management troughs and conceal wiring from the approach side
- Straight Filler allows for use in straight configurations between two rectangular tables with power and data management troughs
- Curved Filler allows for use at curve with 90° wedge tables between two rectangular tables with power and data management troughs
- Available in Silver (SI) or Black (BK) finish. Please specify.

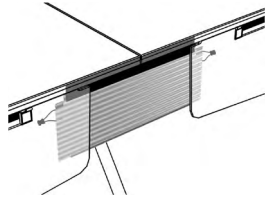

Straight Filler Modesty Panel

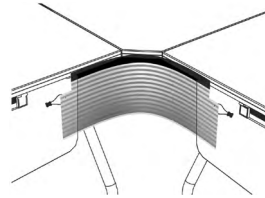

Curved Filler Modesty Panel

END CAPS

- Plastic end caps with decorative insert. Required for beginning and end of runs.
- Cap can be notched in field to allow wire infeed pass through.
- Charcoal finish only.



WIRE MANAGEMENT

- Two wire manager clamps are included within all power and data management troughs.
- Attached to the unit, they can slide from side to side to accommodate wiring systems
- Data, voice, multi-media and power can be routed separately using channels on each wire manager.
- Additional wire manager clamps are available to retrofit.
- Available in black only.

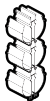

GLOBAL 4-WIRE POWER SYSTEM

- Global's proprietary power system comes with everything you need to power your **BUNGEE SL** layouts. Kits coordinate to the size of the table being used and fit snugly into the bottom of the power and data management trough.
- Single duplex kits come with one duplex – centered on the wiring harness. Duplexes are 6" wide.
- Double duplex kits come with two duplexes – 11" of wiring on each side of the harness allows for flexibility between connections. Duplexes are 6" wide.
- One end of the harness kit features a female connection, while the opposite end features a male connection for a quick and easy connect/disconnect
- Actual kit length is 1" longer than nominal
- Must be hardwired using infeeds (specified separately) by a licensed electrician
- All conduits are enclosed in a black nylon sleeve to reduce visibility
- All duplexes and connectors are plastic. Black only.
- **8 DUPLEXES PER CIRCUIT MAXIMUM** – maximums are to National Electric Code (NEC) – some local codes vary from NEC code – it is the customer's responsibility to follow all applicable local codes and guidelines.

ELECTRICAL SYSTEM

- 4-2 Wiring Schematic
- 4-Wire Shared Neutral
- Complies with National Electric Code
- UL Listed
- All circuits rated for 20 AMP

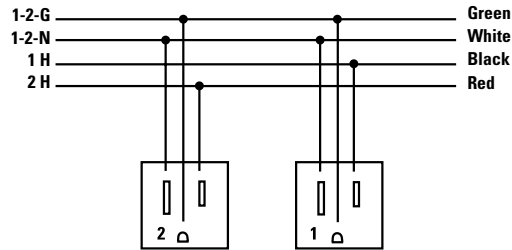

PRODUCT

MAX UNITS PER CIRCUIT

P42S	8 units per circuit
P42D	4 units per circuit

POWER/DATA MANAGEMENT TROUGH PLACEMENT

Single Table - AFP or LFP

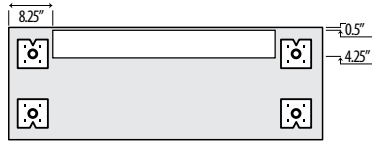

Shared Leg Tables - AFP or LFP

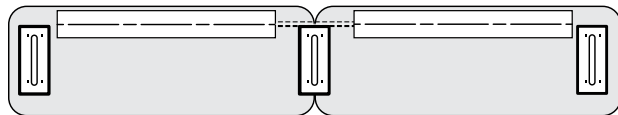
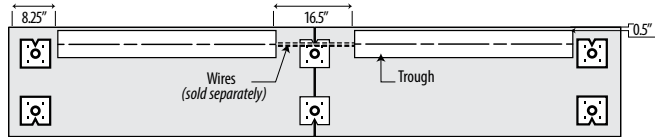

CS

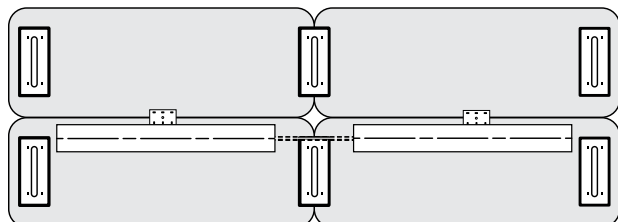
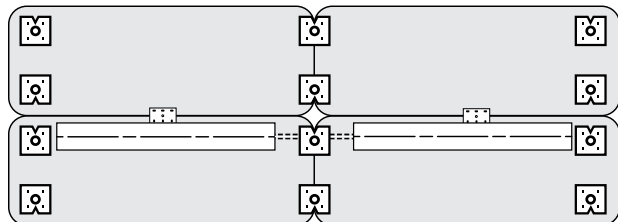
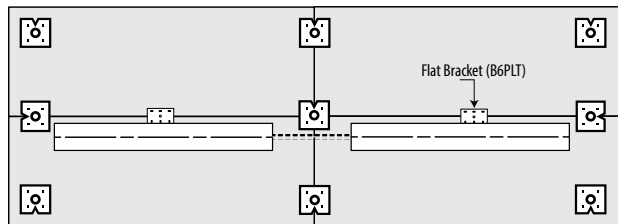

GLOBAL 4-WIRE POWER TO POWER/DATA MANAGEMENT TROUGH:

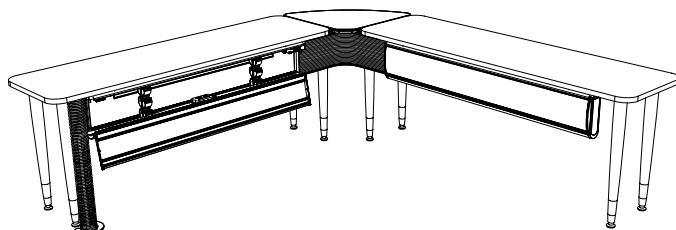

Bungee SL with AFP Power/Data Management Trough - 90° Corner Application

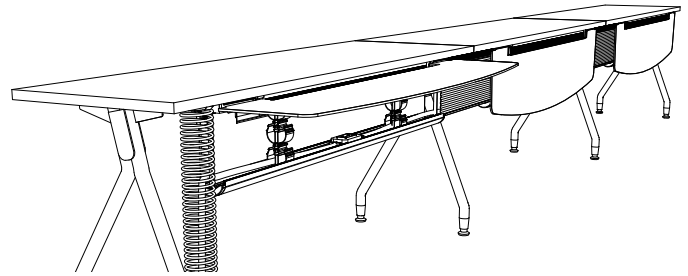

Bungee SL with LFP Power/Data Management Trough - Single Sided Straight Run

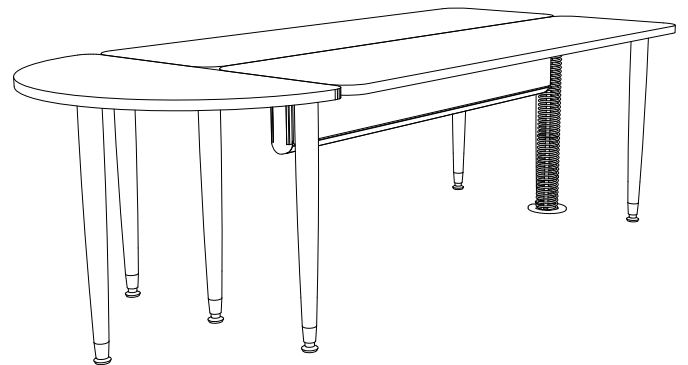

Bungee SL with CS Power/Data Management Trough - Back to Back Application (shown with power snake)

UTILIZING POWER BLOCKS AND GROMMETS WITH POWER/DATA MANAGEMENT TROUGH

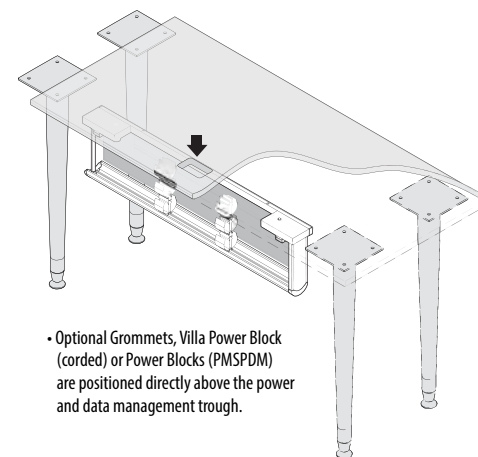

• Optional Grommets, Villa Power Block (corded) or Power Blocks (PMSPDM) are positioned directly above the power and data management trough.



Grommet



Power Block



Villa Corded

B BUNGEE SL™ POWER/DATA MANAGEMENT TROUGHS

MODEL#	DIMENSIONS D x W x H	FREIGHT CLASS	WT/LBS.	CUBIC FT.	LIST PRICE
JB72L	4.25 x 55.75 x 10	125	23	2.90	\$793
JB60L	4.25 x 43.75 x 10	125	18	2.30	\$710
JB48L	4.25 x 31.75 x 10	100	14	1.70	\$617
JB42L	4.25 x 25.75 x 10	100	12	1.50	\$572
JB36L	4.25 x 19.75 x 10	100	10	1.20	\$524

Trough w/Laminate Face Panel (LFP)

For use on rectangular Bungee SL surfaces only. Out-facing laminate panel swings up to allow wire access and features flexible sweep at the top. In-facing laminate panel swings up to allow wire access and features flexible sweep at the top. Black wire management clamps included.

- To fill the gap between two power/data management trough (LFP) modules in a straight run, a single filler modesty panel (JBFSFM) is recommended.
- To fill the gap between two power/data management trough (LFP) modules at 90°, a corner filler modesty panel (JBCFM) is recommended.
- Model # corresponds to the size table power/data management trough will fit on (i.e. JB72L will fit a 72" wide table).



JB72A	4.25 x 55.75 x 10	100	21	2.20	\$824
JB60A	4.25 x 43.75 x 10	100	17	1.80	\$753
JB48A	4.25 x 31.75 x 10	92.5	13	1.30	\$661
JB42A	4.25 x 25.75 x 10	92.5	11	1.10	\$615
JB36A	4.25 x 19.75 x 10	60	9	.08	\$568

Trough w/Aluminum Face Panel (AFP)

For use on rectangular Bungee SL surfaces only. Out-facing aluminum panel swings down to allow wire access and features flexible sweep at the top. In-facing laminate panel swings up to allow wire access and features flexible sweep at the top. Black wire management clamps included.

- To fill the gap between two power/data management trough (AFP) modules in a straight run, a single filler modesty panel (JBFSFM) is recommended.
- To fill the gap between two power/data management trough (AFP) modules at 90°, a corner filler modesty panel (JBCFM) is recommended.
- Model # corresponds to the size table power/data management trough will fit on (i.e. JB72A will fit a 72" wide table).



JB72C	4.25 x 55.75 x 10	100	19	2.20	\$716
JB60C	4.25 x 43.75 x 10	100	15	1.80	\$675
JB48C	4.25 x 31.75 x 10	100	12	1.30	\$571
JB42C	4.25 x 25.75 x 10	100	10	1.10	\$532
JB36C	4.25 x 19.75 x 10	60	8	.08	\$492

Trough w/Center Spine (CS)

For use on rectangular Bungee SL surfaces only in back-to-back applications only. Two laminate panels swing up to allow wire access and feature flexible sweep at the top. Black wire management clamps included.

- To fill the gap between two power/data management trough (CS) modules in a straight run, two filler modesty panels (JBFSFM) are recommended to conceal wiring from both sides.
- Model # corresponds to the size table power/data management trough will fit on (i.e. JB72C will fit a 72" wide table).
- Laminate panels are Black - no finish options available.

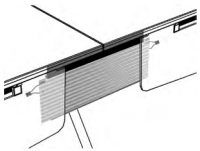

JBFSFM	0.25 x 22.5 x 9	70	1.60	.04	\$173
--------	-----------------	----	------	-----	--------------

Straight Filler Modesty Panel

Straight filler modesty is used to fill the space between two power/data management trough modules where tables are linked in a straight configuration.

- In center spine applications, two straight filler modesty panels should be specified to cover cabling and wires from both sides.
- Filler modesty panels are reversible with Black (BK) finish on one side and Silver (SI) finish on the opposite side.

Required Specifications

Laminate face panel finish (LFP)
Aluminum face panel finish (AFP)
Power/Data Trough finish
Filler Modesty Panel finish.

Optional Specifications

4-Wire Power System

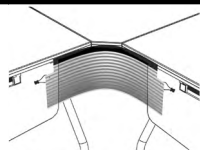

Curved Filler Modesty Panel

MODEL#	DIMENSIONS	FREIGHT CLASS	WT./LBS.	CUBIC FT.	LIST PRICE
--------	------------	---------------	----------	-----------	------------

D x W x H

JBCFM	0.25 x 22.5 x 9	70	1.80	.05	\$206
-------	-----------------	----	------	-----	--------------

Curved filler modesty is used to fill the space between two power/data management troughs where tables are linked at a 90° curve.

- For interior curves only.
- Filler modesty panels are reversible with Black (BK) finish on one side and Silver (SI) finish on the opposite side.



End Cap

JBEC	3 x 8 x 1	70	1	.15	\$42
------	-----------	----	---	-----	-------------

Plastic end cap to be snapped into place at the end of power/data management troughs. To be specified for the beginning and end of runs for a finished look. Charcoal finish only.

- Plastic cap can be notched in the field to allow infeed or data cable pass-through.

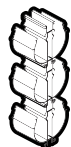

Wire Management Clamp

JBWM2	2.5 x 6 x 1.75	70	1	.01	\$155
-------	----------------	----	---	-----	--------------

Wire management track with double wire clamp - triple height. Can be affixed to the underside of worksurface using double-sided tape (supplied) or retrofit into power/data management trough modules. Black finish only.

- Recommended for use at 90° corners.
- Retrofitting requires disassembly of power/data management trough modules.

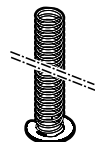

Power Snake

JBPS	4 x 4 x 34	100	2	.25	\$97
------	------------	-----	---	-----	-------------

Attaches to the underside of worksurface with supplied wood screws. Used to organize and channel wires from the power/data management trough down to the floor infeed. Black finish only.

4-WIRE POWER SYSTEM

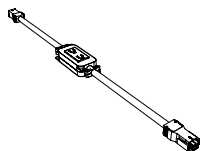

Single Duplex Kit

P42S-72	73 x 2 x 2	60	3.19	.10	\$195
P42S-60	61 x 2 x 2	60	2.82	.09	\$178
P42S-48	49 x 2 x 2	60	2.44	.08	\$164
P42S-42	43 x 2 x 2	60	2.26	.07	\$156
P42S-36	37 x 2 x 2	60	2.07	.06	\$149

Single Duplex Kit includes one black plastic duplex connected to harnesses. Male connection (IN) on one side with female connection (OUT) on the opposite for easy connect and disconnect. Conduit is wrapped in black nylon sleeve. Actual length is 1" longer than nominal.

- Specify Circuit 1 or Circuit 2
- Model # corresponds to the size table power/data management trough will fit on (i.e. P42S-48 will fit a JB48A, JB48L or JB48C module).
- Infeed required for connection to building power. Sold separately (next page)

Required Specifications

Circuit 1 or Circuit 2 (duplex kits)

B BUNGEE SL™ POWER/DATA MANAGEMENT TROUGHS

4-WIRE POWER SYSTEM

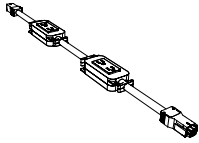

Double Duplex Kit



Power Harness Jumper

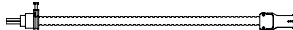

72" Multi-circuit Hardwire Infeed

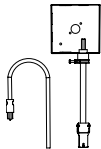

Single-circuit 3-Prong Infeed

MODEL#	DIMENSIONS	FREIGHT CLASS	WT/LBS.	CUBIC FT.	LIST PRICE
--------	------------	---------------	---------	-----------	------------

D x W x H

P42D-72	2 x 73 x 2	60	3.01	.10	\$226
P42D-60	2 x 61 x 2	65	2.63	.09	\$208
P42D-48	2 x 49 x 2	65	2.26	.08	\$194
P42D-42	2 x 43 x 2	65	2.07	.07	\$187
P42D-36	2 x 37 x 2	70	1.88	.06	\$178

Double Duplex Kit includes two black plastic duplexes connected to harnesses. Male connection (IN) on one side with female connection (OUT) on the opposite for easy connect and disconnect. Conduit is wrapped in black nylon sleeve. Actual length is 1" longer than nominal.

- Specify Circuit 1 or Circuit 2. Both duplexes on the kit will be assigned to the same circuit.
- Model # corresponds to the size table power/data management trough will fit on (i.e. P42D-48 will fit a JB48A, JB48L or JB48C module).
- Infeed required for connection to building power. Sold separately (below).

P42J-72	2 x 73 x 2	60	3	.10	\$176
P42J-60	2 x 61 x 2	60	2.73	.09	\$157
P42J-48	2 x 49 x 2	65	2.35	.08	\$139
P42J-42	2 x 43 x 2	60	2.16	.07	\$129
P42J-36	2 x 37 x 2	70	1.98	.06	\$120
P42J-18	2 x 19 x 2	70	1.41	.04	\$93

Male connection (IN) on one side with female connection (OUT) on the opposite for easy connect and disconnect. Conduit is wrapped in black nylon sleeve. Actual length is 1" longer than nominal.

- Use P42J-18 between two power/data management troughs separated by Bungee SL wedge, keystone or half moon tables
- Use all other sizes to jump between power kits on power/data management troughs that are NOT powered (i.e. use a P42J-60 as a pass-through on a 60" wide non-powered table between POWERED power/data management trough modules.

P42HW-72	1 x 72 x 1	70	6.50	.30	\$193
----------	------------	----	------	-----	--------------

72" Multi-circuit Hardwire Infeed (up to 20 AMPS per circuit), two circuits. Provides single power entry from floor or wall located building power supply. Conduit is wrapped in black nylon sleeve.

- Connects P42S or P42D kits
- **TO BE HARDWIRED BY LICENSED ELECTRICIAN.** UL listed.
- Where Liquid Tight conduit is required, specify P42HW-72L

P42TP-120	8 x 4 x 2	70	6.10	.30	\$239
P42TP-72	8 x 4 x 4	60	4.50	.15	\$218

Hardwire junction box included (to be mounted on underside of table). Provides single power entry from floor or wall located building power supply. Conduit is wrapped in black nylon sleeve. Allows for quick and easy disconnection from the wall. Available in 72" or 120" overall lengths.

- Connects P42S or P42D kits. **Power circuit 1 only.**
- **TO BE HARDWIRED BY LICENSED ELECTRICIAN.** UL listed.

Required Specifications

Face panel and box finish - BLK or TUN

POWER BLOCK

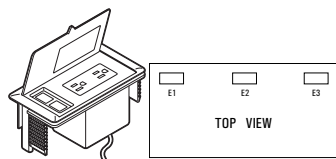

Power/Data Block

MODEL#	DIMENSIONS	FREIGHT CLASS	WT/LBS.	CUBIC FT.	LIST PRICE
	D x W x H				
PMSPDM	3.5 x 6.5 x 2.75	70	2	.10	\$330

Worksurface power and data module. Two power receptacles and two data receptacles. 9' cord. Specify position and **add \$65** for cutout in worksurface. See diagram E1/E2/E3 for specification location. Black (**BLK**) only.

VILLA I SERIES CORDED UNITS

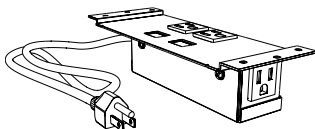

Data Knockouts, No Data Ports

VIL-C-DKO-_-108	3.25 x 8.75 x 2.25	100	4	.45	\$249
VIL-C-DKO-_-72	3.25 x 8.75 x 2.25	100	4	.45	\$249

Villa I with 3-prong plug. Includes **two power receptacles** and two knockouts for data. A third convenience receptacle is provided below the worksurface. **V1, V2 or V3 cutout(s) must be specified on training table** (see product notes section for more details and cutout upcharge). **Grommet cover is required and sold separate** (see below). UL/CUL listed.

- Replace _ with **B** for **Black**
- Replace _ with **S** for **Silver Pearl**

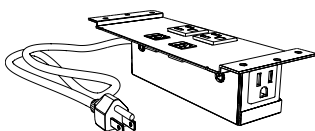

Data Knockouts, Data Ports Included

VIL-C-D-_-108	3.25 x 8.75 x 2.25	100	4	.45	\$402
VIL-C-D-_-72	3.25 x 8.75 x 2.25	100	4	.45	\$402

Villa I with 3-prong plug. Includes **two power receptacles** and **two RJ45 Cat 6** data. A third convenience receptacle is provided below the worksurface. **V1, V2 or V3 cutout(s) must be specified on training table** (see product notes section for more details and cutout upcharge). **Grommet cover is required and sold separate** (see below). UL/CUL listed.

- Replace _ with **B** for **Black**
- Replace _ with **S** for **Silver Pearl**

VILLA GROMMET COVERS

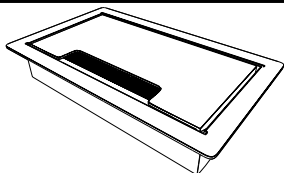

Villa Grommet Cover

VIL-GROM-F-_-	3.5 x 5.75 x .94	70	1	.08	\$126
---------------	------------------	----	---	-----	--------------

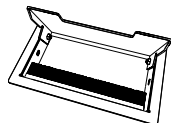

Powder coated flush metal grommet to be used with Villa I **corded** series power blocks. Cutouts in tables must be specified separately. **V1, V2 or V3 cutout(s) must be specified on training table** (see product notes section for more details and cutout upcharge). **Grommet cover remains open while in use.**

- **Cannot be used with PMSPDM.**
- Replace _ with **B** for **Black**
- Replace _ with **S** for **Silver Pearl**

Required Specifications

Face panel and box finish



ConnectTABLES® provides solutions for a variety of day-to-day work environments. Designed as easy-to-use linking or freestanding tables, ConnectTABLES is limited only by your imagination.

Open Conference

Many ConnectTABLES® tops can be assembled to be freestanding. When combined with locking casters and the flip top “T” leg, the result is easy storage and complete portability.

Meeting Rooms

ConnectTABLES® modular units will provide quick and affordable answers for all sizes and shapes of rooms and applications.

Educational and Training Rooms

ConnectTABLES® table tops configure easily into temporary or permanent educational applications.



Features and Benefits

- Optional, easy-to-use thumbscrews allow installation without tools.
- Optional zinc-plated steel ganging hardware connects free standing tops without moving “T” Leg position.
- Optional modesty panel wire management unit available.
- Casters will not affect table height when used in conjunction with or in place of glides.
- Optional Black grommets for convenient wire management can be ordered “factory installed”.
- Tops are 1” thick and constructed of 45 lb. density particleboard.
- Optional casters available with or without manual locks provide mobility.
- ConnectTABLES® tops are available in all Global laminate finishes with three leg and two edge color options.



T Leg with leveling glides



Modesty Panel

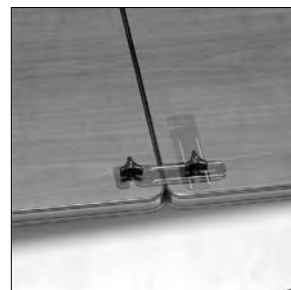

Optional ganging connector

GENERAL INFORMATION

- ConnecTABLES® is an affordable and highly flexible system of modular tables. Designed as easy-to-use linking or freestanding tables, ConnecTABLES adapts to most every requirement: seminar or training room, meeting room, personal workstations, educational, conferencing and team cluster workgroups.
- ConnecTABLES have nine basic top shapes available in various sizes.
- ConnecTABLES edges **do not match** any other Global product in either color or style.
- For environmental certifications, please visit globalfurnituregroup.com.

WORKSURFACES

- Tops are 1" thick, made of 45 lb. density particle board covered on both sides with high performance thermally fused laminate. Optional high pressure laminate tops are 1-1/16" thick.
- Laminate finishes are available in High Pressure. Contact Customer Care for a quote.
- If other than a Global standard laminate finish is preferred, contact Customer Care. Information needed includes the name of the laminate manufacturer, color name, number and model of table. You will then be given a quote for this special order.
- **ConnecTABLES® edges do not match any other Global product in either color or style.**
- Products specified with the high pressure laminate option are finished on the underside of the surface with a kraft paper backing.

CONSTRUCTION

- Some components can stand alone when the "T" base is set in the freestanding position. When the "T" base is in the linking position, all the components can be used in grouping configurations (clusters).
- Optional wire grommets not available on 45° wedge and the 60° triangle.
- Rectangular tops 54" in length and longer are supplied with a 16" gauge steel support channel. Top is pre-drilled for placement.
- Shipped RTA (ready to assemble). Quick and easy to assemble.
- Special width tops are available. Use next size up.
- Tables adjust from 28 3/4" to 29 3/4" high.
- Elliptical column cover, glides, casters, thumbscrews and endcaps available in Black only.
- Must specify top, edge, and "T" base color with each order.

LEGS

- "T" leg is coated with environmentally friendly, recyclable paint electrostatically applied epoxy powder coating for a very durable finish in three colors as specified below. Only the bottom horizontal portion of the painted leg is visible.
- Black plastic leveling glides offer 1" adjustability.
- Two black plastic elliptical column caps cover each leg column.
- Casters will not affect table height when used in conjunction with or in place of glides.
- Casters can facilitate mobility in installations which need to be moved frequently.

LAMINATE FINISHES

ACJ	Absolute Acajou	NGL	Noce Grigio
ASN	Asian Night	NEL	Noce Leggero
AWC	Avant Cherry	NML	Noce Medio
AWH	Avant Honey	QTM	Quartered Mahogany
BLK	Black	SOG	Storm Grey
BRC	Brushed Cobalt	TFW	Tiger Fruitwood
CMB	Clear Maple	TWL	Tiger Walnut
DES	Dark Espresso	WHE	Walnut Heights
DWT	Designer White	WHC	White Chocolate
HGT	Hayden Grey	WGY	Willow Grey
NBL	Noce Biondo	WCR	Winter Cherry

EDGE COLORS

Black (BK) Grey (GR)

LEG COLORS

Black (TBL) Shadow (TSH)
Tungsten (TTU) Chrome (CHM) - optional on foot only, upcharge applies

GROMMETS

- Optional Grommets available in standard worksurface locations (left, center or right) for Rectangular Tables. Order as: **AG1, AG2 or AG3. Add \$88**
- Grommet hole dimensions are 3 1/4" wide x 1 7/8" deep.



- Grommets may be placed at non-standard locations. Order as: **AGS - Add \$88**. A drawing must be supplied with vertical and horizontal dimensions to the center of the cut-out (as in drawing above). Please refer to CUSTOM GROMMET LOCATION FORM in the back reference section.

POWER BLOCK

- A Power Block (model **PMSPDM**) may be ordered on all worksurfaces.
- A Power Block is a rectangular worksurface power/data module with one electrical duplex receptacle and two data (RJ45) receptacles. 9' black cord included. Power Block dimensions are 3 1/2" deep x 6 1/2" wide x 2 3/4" high.
- To purchase a Power Block, you must specify both the Power Block cut-out location and the Power Block model #. Order Power Block as **PMSPDM. Add \$330**. Power Blocks are available in standard worksurface locations (left, center or right). Order as **E1, E2 or E3. Add \$88**.



Power Block **PMSPDM, Add \$330** Specify location **E1, E2 or E3, Add \$88**.

EXAMPLES OF GROMMET AND POWER BLOCK POSITIONS

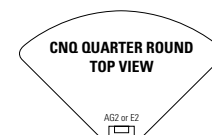
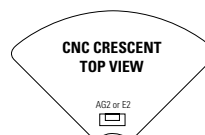
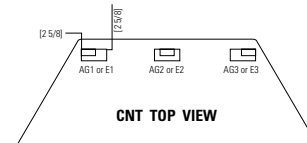
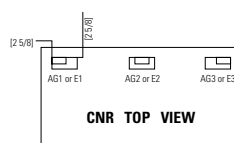

C CONNECTABLES® - NOTES

VILLA CUTOUTS

- Optional Villa cutout available in standard worksurface locations (left, center or right) for **Rectangular Tables**. Order as: **V1, V2 or V3** - Add \$88 for each cutout.
- Villa cutouts may be placed at non-standard locations. Please contact customer care.

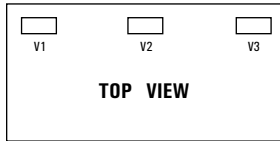

TOP & EDGE OPTIONS

- ConnectTABLES® have nine basic top shapes available in various sizes. All top shapes have a variety of straight or curved edges which are referred to as **Working (W)**, **Connecting (C) or End (E) edges**. Edges can also have a combination of edge types as shown.

*cannot freestand

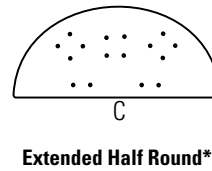
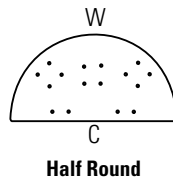
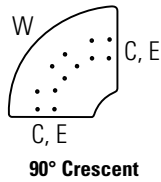
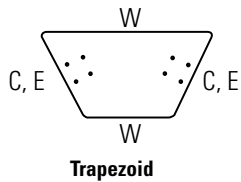
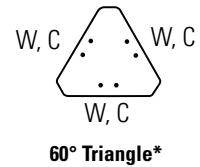
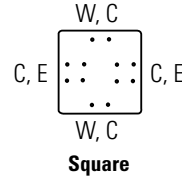
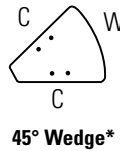
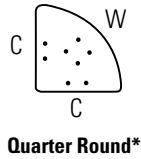
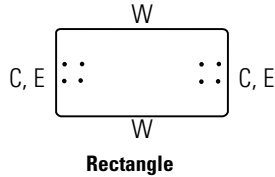

Working Edge (1) - Edges designated with the letter "W" indicate that this is a **working** or sitting edge. These edges can be connected with optional ganging hardware in free-standing applications.

Connecting Edge (2) - Edges designated with the letter "C" indicate that this is a **connecting** edge. These edges can be connected to any other connecting edge of equal width, regardless of the top shape or size.

End Edge (3) - Edges designated with the letter "E" indicate that this is an **end** edge or an edge that can finish a run of tops. If a top has two end edges it can be freestanding. 90° crescent tops can be freestanding if the optional center leg is added.

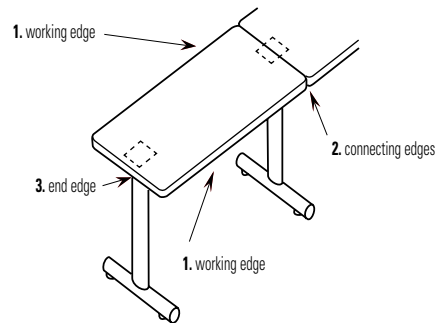

FREESTANDING AND CONNECTING CONDITIONS

Freestanding tables are defined as any one worksurface supported by two or more legs;

connecting tables are defined as more than one work surface supported by a single leg at each point of connection. The rule for determining the quantity of legs of an open configuration is the number of worksurfaces plus one (**See Figure 1**).

On closed configurations, the number of legs is equal to the number of worksurfaces (**See Figure 2**). There are some exceptions, such as when optional third legs are used on quarter round or 90° crescent shapes.

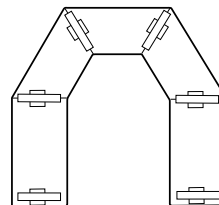

Figure 1. Open Configuration
Number of Surfaces = 5
Number of Legs = 6

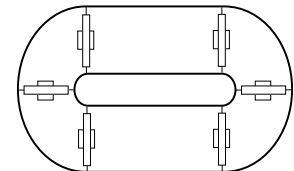

Figure 2. Closed Configuration
Number of Surfaces = 6
Number of Legs = 6

FREESTANDING CONDITIONS

- All square, rectangle and trapezoid shapes are able to act as freestanding tables (**Figure 3**).
- When Trapezoid tops are freestanding, legs must be on the outer left and right sides (**Figure 4**).
- 90° crescent work surfaces have provision for an optional third center leg for additional stability when heavy loads are applied to the outside edge. They can also be used as freestanding tables when a third leg is added (**Figure 5**).
- All freestanding tables can be connected with optional ganging hardware.
- Freestanding tables can be ganged with connected tables in some cases, providing that the number and size of connected tables is easily movable (**Figure 6**).
- **DO NOT DRAG TABLES WHEN RE-CONFIGURING.**

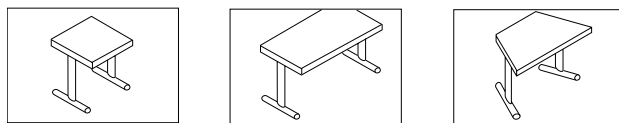
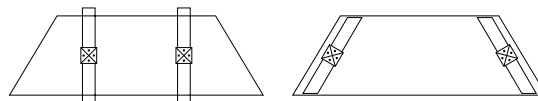

Figure 3 - Freestanding Tables



Incorrect

Correct

Figure 4 - Trapezoid Tops

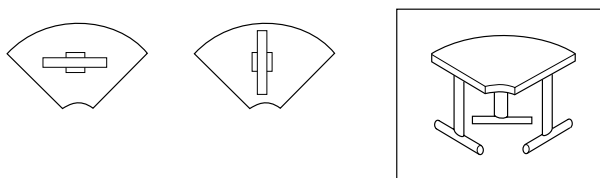

Figure 5 - Adding a Third Leg

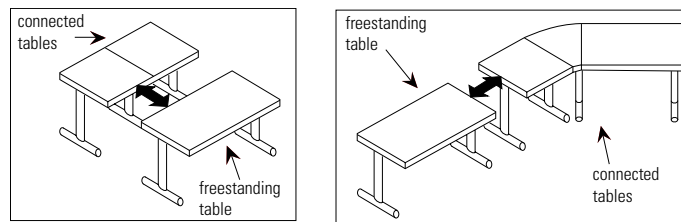

Figure 6 - Ganging with Connected Tables

CONNECTING CONDITIONS

- Any two worksurfaces of equal depth (24"D, 30"D or 36"D) can be connected with one leg, at the connecting or end edges (**Figure 8**).
- Half round work surfaces can be used in the following ways: They must be of equal width when connected to each other (**Figure 7**) or the connecting shapes must be equal to half the width of the connecting half round (**Figure 8**).
- ConnectABLES® is designed with the leg to be fastened parallel to connecting edges, but in some cases you may wish to fasten legs at 90° to connecting edges. This could allow for increased leg or knee clearance, depending on the intended use (**Figure 9**).
- Quarter round and 90° crescent work surfaces have provision for an optional third leg for additional stability when heavy loads are applied to the outside edge. For quarter round work surfaces, it is recommended that configuration "A" be used since the outside end of the center leg in configuration "B" is almost flush with the outside edge of the worksurface. If configuration "B" is installed against a wall or where there will be no traffic flow, then configuration "B" can be used.

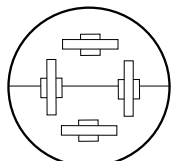

Figure 7

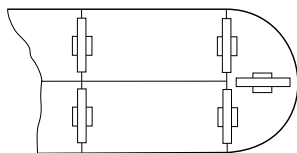

Figure 8

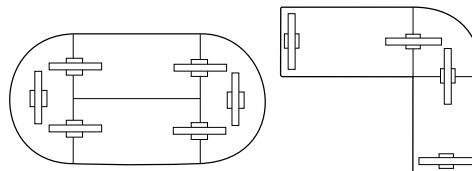
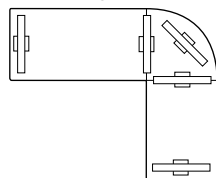
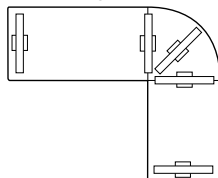

Figure 9 - 90° Leg Connections



Configuration A



Configuration B

C CONNECTABLES® - PUTTING IT ALL TOGETHER

Legs are fastened to work surfaces utilizing a steel-to-steel connection. Each leg comes equipped with four ¼" x 7/8" machine screws. Screws are inserted through the four oval shaped holes only. Do not use wood screws! When fastening legs to work surfaces, hand thread screws into position to prevent any cross threading. When all screws have been hand threaded, tighten firmly with screwdriver to secure. Optional thumbscrews can be used in place of machine screws. Thumbscrews eliminate the need for a screwdriver, whether assembling or disassembling tables. **Do not use power tools for assembly of legs.**

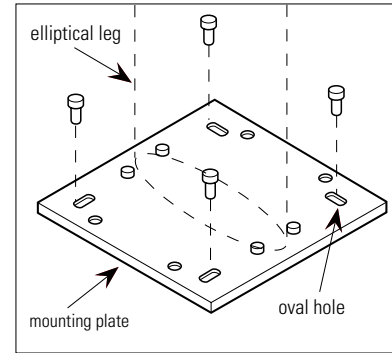

FREESTANDING TABLES

1. Turn work surface upside-down on clean floor. (You may want to use carton from packaging as a protective assembly surface to protect the top from scratching.)
2. Position leg mounting plate holes over threaded steel inserts in top.
3. Fasten each leg to top with four ¼" x 7/8" screws.
4. Turn table right-side up.
5. Level table by adjusting glides.

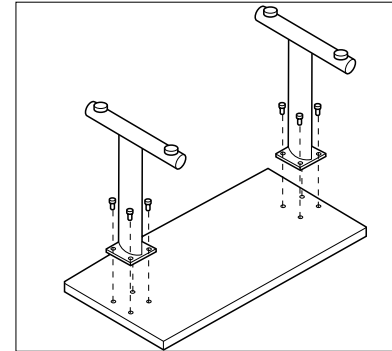

CONNECTING TABLES

1. Determine approximate location of desired configuration in room and turn work surfaces upside-down on floor. (Remember you are working in reverse.)
2. Position leg mounting plate so it is centered over the connecting edge of the first work surface. Fasten leg with two ¼" x 7/8" screws.
3. Repeat step 2 and 3 on the opposite edge of the first work surface.
4. Turn table right-side up.
5. Turn table right-side up and fasten to the previous top from the underside.
6. To add additional work surfaces repeat step 6.
7. When all the tops have been connected, level complete configuration by adjusting glides.

Note: Use the same procedures as above when using optional thumb screws.

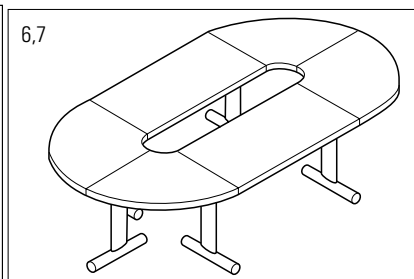
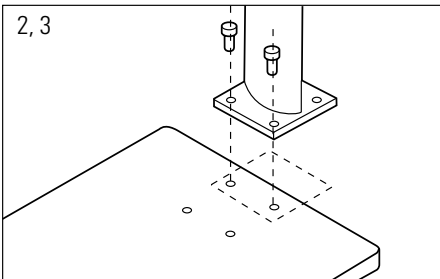
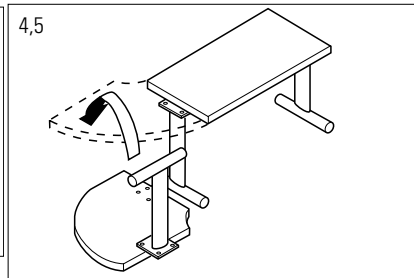
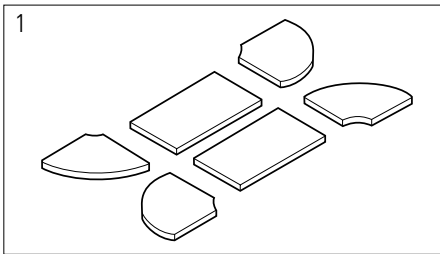

OPTIONAL CASTERS

1. Turn work surface upside-down on floor.
2. Remove existing glide if previously installed.
3. Fasten caster to T-leg by threading caster stem into base of T-leg and secure by tightening lock nut.
4. If casters are used in combination with gliders, level table by adjusting glides.

Note: Casters are available in locking or non-locking styles.

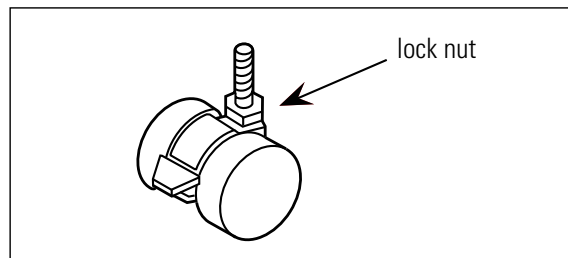
**OPTIONAL GANGING HARDWARE**

1. Optional ganging hardware should be used when quick and frequent reconfigurations are required.
2. Turn work surfaces to be ganged upside-down on floor.
3. Remove ganging hardware from package. Holes with steel inserts are located in the corner of tops.
4. Fasten ganging hardware to each work surface with supplied thumb screws.
5. Projected arm from ganging hardware can pivot out of the way when not in use.

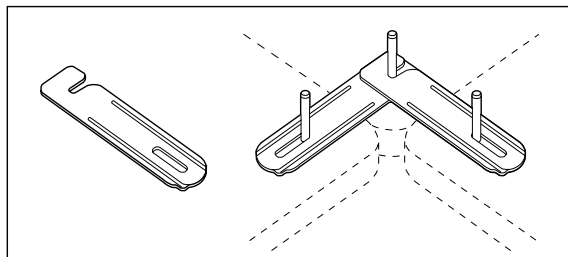

SQUARE TOPS

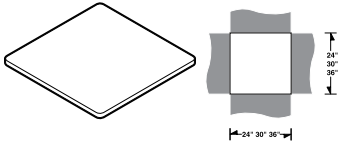

Square Top

MODEL#	DIMENSIONS D x W x H	FREIGHT CLASS	WT./LBS.	CUBIC FT.	LIST PRICE	HP ADD
CNS2424	24 x 24 x 1.12	70	18	1	\$399	\$200
CNS3030	30 x 30 x 1.12	70	27	1.56	\$486	\$243
CNS3636	36 x 36 x 1.12	70	39	2	\$521	\$262

T-mold edging. Predrilled with threaded steel inserts for freestanding and linking installations.

RECTANGULAR TOPS

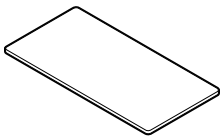
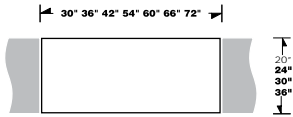

Rectangle Top

MODEL #	DIMENSIONS	FREIGHT CLASS	WT./LB.	CUBIC FT.	LIST PRICE	HP ADD
CNR2030	20 x 30 x 1.13	70	22	1.25	\$288	\$145
CNR2036	20 x 36 x 1.13	60	22.50	.46	\$320	\$161
CNR2042	20 x 42 x 1.13	70	31	1.75	\$344	\$172
CNR2048	20 x 48 x 1.13	70	35	2	\$383	\$192
CNRU2054	20 x 54 x 1.13	60	33.75	.69	\$475	\$238
CNRU2060	20 x 60 x 1.13	70	37.50	1.40	\$511	\$256
CNRU2066	20 x 66 x 1.13	70	41.25	.84	\$552	\$276
CNRU2072	20 x 72 x 1.13	70	45	1	\$589	\$295
CNR2430	24 x 30 x 1.12	70	22	1.25	\$288	\$145
CNR2436	24 x 36 x 1.12	70	26	1.50	\$320	\$161
CNR2442	24 x 42 x 1.12	70	31	1.75	\$344	\$172
CNR2448	24 x 48 x 1.12	70	35	2	\$383	\$192
CNRU2454	24 x 54 x 1.12	70	42	2.34	\$475	\$238
CNRU2460	24 x 60 x 1.12	70	47	2.50	\$511	\$256
CNRU2466	24 x 66 x 1.12	70	52	2.80	\$552	\$276
CNRU2472	24 x 72 x 1.12	70	57	3	\$589	\$295
CNR3036	30 x 36 x 1.12	70	33	1.88	\$383	\$192
CNR3042	30 x 42 x 1.12	70	38	2.19	\$417	\$209
CNR3048	30 x 48 x 1.13	70	44	2.50	\$441	\$221
CNRU3054	30 x 54 x 1.12	70	52	2.80	\$546	\$274
CNRU3060	30 x 60 x 1.12	70	59	3.13	\$587	\$294
CNRU3066	30 x 66 x 1.12	70	64	3.44	\$626	\$313
CNRU3072	30 x 72 x 1.12	70	70	3.75	\$667	\$334
CNR3642	36 x 42 x 1.12	60	52.50	1.60	\$552	\$276
CNR3648	36 x 48 x 1.12	60	60	1.80	\$604	\$303
CNRU3654	36 x 54 x 1.12	60	70	2	\$730	\$365
CNRU3660	36 x 60 x 1.12	60	78	2.20	\$810	\$405
CNRU3666	36 x 66 x 1.12	60	87	2.40	\$887	\$444
CNRU3672	36 x 72 x 1.12	60	94	2.60	\$965	\$483

T-mold edging. Predrilled with threaded steel inserts for freestanding and linking installations. **Tops 54" and longer are standard with a 16 gauge steel support channel.**

TRAPEZOID TOPS

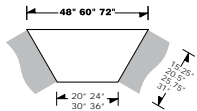

Trapezoid Top

MODEL #	DIMENSIONS	FREIGHT CLASS	WT./LB.	CUBIC FT.	LIST PRICE	HP ADD
CNT2048	15.25 x 48 x 1.13	65	26.25	.55	\$402	\$202
CNT2060	15.25 x 60 x 1.13	65	44	1.85	\$483	\$242
CNT2448	20.5 x 48 x 1.12	92.5	21	2	\$402	\$202
CNT2460	20.5 x 60 x 1.12	65	44	1.85	\$483	\$242
CNT3060	25.75 x 60 x 1.12	92.5	35	3.13	\$528	\$264
CNT3072	25.75 x 72 x 1.12	60	66	2.20	\$589	\$295
CNT3660	31 x 60 x 1.12	60	66	2.20	\$753	\$377
CNT3672	31 x 72 x 1.12	65	79.20	3.50	\$899	\$450

T-mold edging. Predrilled with threaded steel inserts for freestanding and linking installations.

Required Specifications

Top Finish
Edge Finish

Optional Specifications

Grommet

Accessories

Power Block

90° CRESCENT TOPS

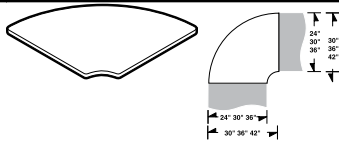

90° Crescent Top

MODEL #	DIMENSIONS	FREIGHT CLASS	WT/LBS.	CUBIC FT.	LIST PRICE	HP ADD
	D x W x H					
CNC2430	30 x 30 x 1.12	85	20	1.56	\$421	\$211
CNC3036	36 x 36 x 1.12	85	30	2.25	\$597	\$299
CNC3642	42 x 42 x 1.12	70	50	3.15	\$819	\$410

T-mold edging. Predrilled with threaded steel inserts for freestanding and linking installations.

- **CNC2430** for use with 24" deep tops
- **CNC3036** for use with 30" deep tops
- **CNC3642** for use with 36" deep tops
- **CNC2430** does not require a center leg

QUARTER ROUND TOPS

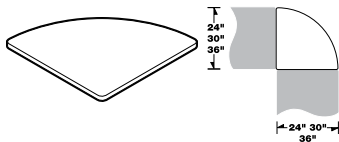

Quarter Round Top

MODEL #	DIMENSIONS	FREIGHT CLASS	WT/LB.	CUBIC FT.	LIST PRICE	HP ADD
CNQ2424	24 x 24 x 1.12	85	14	1	\$265	\$133
CNQ3030	30 x 30 x 1.12	85	21	1.56	\$321	\$161
CNQ3636	36 x 36 x 1.12	60	45	1.30	\$455	\$228

T-mold edging. Predrilled with threaded steel inserts for **linking installations ONLY**.

45° WEDGE TOPS

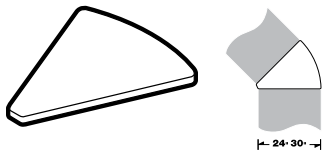

45° Wedge Top

MODEL #	DIMENSIONS	FREIGHT CLASS	WT/LB.	CUBIC FT.	LIST PRICE	HP ADD
CNW2424	24 x 24 x 1.12	92.5	10	1	\$284	\$143
CNW3030	30 x 30 x 1.12	100	14	1.56	\$345	\$173

T-mold edging. Predrilled with threaded steel inserts for **linking installations ONLY**.

THREE WAY CONNECTOR TOPS

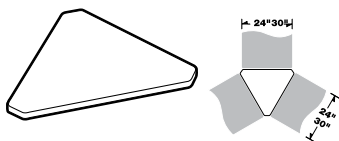

Three Way Connector Top

MODEL #	DIMENSIONS	FREIGHT CLASS	WT/LB.	CUBIC FT.	LIST PRICE	HP ADD
CNY2424	24 x 24 x 1.12	85	13	1	\$265	\$133
CNY3030	30 x 30 x 1.12	92.5	18	1.56	\$321	\$161

T-mold edging. Predrilled with threaded steel inserts for **linking installations ONLY**.

HALF ROUND TOPS

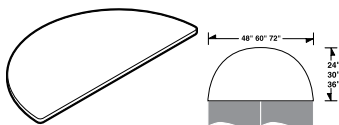

Half Round Top

MODEL #	DIMENSIONS	FREIGHT CLASS	WT/LB.	CUBIC FT.	LIST PRICE	HP ADD
CNHFS2448	24 x 48 x 1.12	70	36	2	\$405	\$203
CNHFS3060	30 x 60 x 1.12	70	56	3.13	\$525	\$263
CNHFS3672	36 x 72 x 1.12	65	81	3.30	\$899	\$450

T-mold edging. Predrilled with threaded steel inserts for freestanding and linking installations.

- *Requires three legs for freestanding*

EXTENDED HALF ROUND TOPS

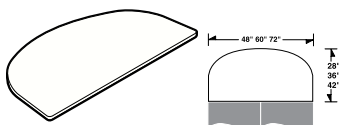

Extended Half Round Top

MODEL #	DIMENSIONS	FREIGHT CLASS	WT/LB.	CUBIC FT.	LIST PRICE	HP ADD
CNHE24	28 x 48 x 1.13	65	50	1.88	\$496	\$249
CNHE30	36 x 60 x 1.13	65	75	2.87	\$689	\$345
CNHE36	42 x 72 x 1.13	65	102	3.88	\$1097	\$549

T-mold edging. Predrilled with threaded steel inserts for **linking installations ONLY**.

Required Specifications

Top Finish
Edge Finish

Optional Specifications

Grommet

Accessories

Power Block

MODESTY PANELS



Modesty Panel



Modesty Panel

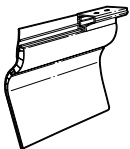

Modesty Panel

MODEL#	DIMENSIONS D x W x H	FREIGHT CLASS	WT./LBS.	CUBIC FT.	LIST PRICE
CNCA2430	2.75 x 35 x 11.75	150	2.80	.50	\$236
CNCA3036	2.75 x 43 x 11.75	150	3.30	.60	\$275
CNCA3642	2.75 x 53 x 11.75	150	3.90	.70	\$360

For use with **CNC crescent tops**. 11 3/4" high, Black plastic, attractive ribbed design. Includes two fold-away installation clips and flexible privacy strips. Connects to predrilled holes in table top.

- *Can not be used when worksurface tops are attached to flip top legs.*

CNOA2424	2.75 x 27 x 11.75	150	2.20	.40	\$201
CNOA3030	2.75 x 35 x 11.75	150	2.80	.50	\$236
CNOA3636	2.75 x 44 x 11.75	150	3.30	.60	\$275

For use with **CNQ quarter round tops**. 11 3/4" high, Black plastic, attractive ribbed design. Includes two fold-away installation clips and flexible privacy strips. Connects to predrilled holes in table top.

- *Can not be used when worksurface tops are attached to flip top legs.*

CNRA2030	2.75 x 29 x 11.75	150	2.80	.50	\$201
CNRA2036	2.75 x 35 x 11.75	150	3.30	.60	\$236
CNRA2042	2.75 x 41 x 11.75	150	3.90	.70	\$275
CNRA2048	2.75 x 47 x 11.75	150	4.40	.80	\$312
CNRA2054	2.75 x 53 x 11.75	150	5	.90	\$360
CNRA2060	2.75 x 59 x 11.75	150	5.50	1	\$390
CNRA2066	2.75 x 65 x 11.75	150	6.10	1.10	\$428
CNRA2072	2.75 x 71 x 11.75	150	6.60	1.20	\$467

CNRA2430	2.75 x 29 x 11.75	150	2.80	.50	\$201
CNRA2436	2.75 x 35 x 11.75	150	3.30	.60	\$236
CNRA2442	2.75 x 41 x 11.75	150	3.90	.70	\$275
CNRA2448	2.75 x 47 x 11.75	150	4.40	.80	\$312
CNRA2454	2.75 x 53 x 11.75	150	5	.90	\$360
CNRA2460	2.75 x 59 x 11.75	150	5.50	1	\$390
CNRA2466	2.75 x 65 x 11.75	150	6.10	1.10	\$428
CNRA2472	2.75 x 71 x 11.75	150	6.60	1.20	\$467

CNRA3036	2.75 x 35 x 11.75	150	3.30	.60	\$236
CNRA3042	2.75 x 41 x 11.75	150	3.90	.70	\$275
CNRA3048	2.75 x 47 x 11.75	150	4.40	.80	\$312
CNRA3054	2.75 x 53 x 11.75	150	5	.90	\$360
CNRA3060	2.75 x 59 x 11.75	150	5.50	1	\$390
CNRA3066	2.75 x 65 x 11.75	150	6.10	1.10	\$428
CNRA3072	2.75 x 71 x 11.75	150	6.60	1.20	\$467

CNRA3642	2.75 x 41 x 11.75	150	3.90	.70	\$275
CNRA3648	2.75 x 47 x 11.75	150	4.40	.80	\$312
CNRA3654	2.75 x 53 x 11.75	150	5	.90	\$360
CNRA3660	2.75 x 59 x 11.75	150	5.50	1	\$390
CNRA3666	2.75 x 65 x 11.75	150	6.10	1.10	\$428
CNRA3672	2.75 x 71 x 11.75	150	6.60	1.20	\$467

For use with **CNR/CNRU rectangular tops**. 11 3/4" high, Black plastic, attractive ribbed design. Includes two fold-away installation clips and flexible privacy strips. Connects to predrilled holes in table top.

- *Can not be used when worksurface tops are attached to flip top legs.*

Required Specifications

Top Finish
Edge Finish

Optional Specifications

Grommet

Accessories

Power Block

MODESTY PANELS

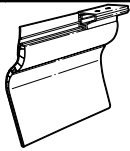

Modesty Panel

MODEL# DIMENSIONS FREIGHT CLASS WT/LBS. CUBIC FT. LIST PRICE

D x W x H

CNSA2424	2.75 x 23 x 11.75	150	2.20	.40	\$161
CNSA3030	2.75 x 29 x 11.75	150	2.80	.50	\$201
CNSA3636	2.75 x 35 x 11.75	150	3.30	.60	\$236

For use with **long side of CNS square tops**. 11 3/4" high, Black plastic, attractive ribbed design. Includes two fold-away installation clips and flexible privacy strips. Connects to predrilled holes in table top.

- Can not be used when worksurface tops are attached to flip top legs.

CNTA2048L	2.75 x 43 x 11.75	150	4.40	.80	\$275
CNTA2060L	2.75 x 55 x 11.75	150	5.50	1.20	\$360

CNTA2448L	2.75 x 43 x 11.75	150	4.40	.80	\$275
CNTA2460L	2.75 x 55 x 11.75	150	5.50	1.20	\$360

CNTA3060L	2.75 x 55 x 11.75	150	5.50	1.20	\$360
CNTA3072L	2.75 x 67 x 11.75	150	6.60	1.40	\$428

CNTA3660L	2.75 x 55 x 11.75	150	5.50	1.20	\$360
CNTA3672L	2.75 x 67 x 11.75	150	6.60	1.40	\$428

For use with **long side of CNT trapezoid tops**. 11 3/4" high, Black plastic, attractive ribbed design. Includes two fold-away installation clips and flexible privacy strips. Connects to predrilled holes in table top.

- Can not be used when worksurface tops are attached to flip top legs.

CNTA2048S	2.75 x 24 x 11.75	150	2.20	.40	\$161
CNTA2060S	2.75 x 36 x 11.75	150	2.80	.50	\$236

CNTA2448S	2.75 x 23 x 11.75	150	2.20	.40	\$161
CNTA2460S	2.75 x 35 x 11.75	150	2.20	.40	\$236

CNTA3060S	2.75 x 29 x 11.75	150	2.80	.50	\$201
CNTA3072S	2.75 x 41 x 11.75	150	2.80	.50	\$275

CNTA3660S	2.75 x 23 x 11.75	150	3.30	.60	\$161
CNTA3672S	2.75 x 35 x 11.75	150	3.30	.60	\$236

For use with **short side of CNT trapezoid tops**. 11 3/4" high, Black plastic, attractive ribbed design. Includes two fold-away installation clips and flexible privacy strips. Connects to predrilled holes in table top.

- Can not be used when worksurface tops are attached to flip top legs.

CNWA2424	2.75 x 17 x 11.75	150	2.20	.40	\$125
CNWA3030	2.75 x 22 x 11.75	150	2.80	.50	\$161

For use with **CNW wedge tops**. 11 3/4" high, Black plastic, attractive ribbed design. Includes two fold-away installation clips and flexible privacy strips. Connects to predrilled holes in table top.

- Can not be used when worksurface tops are attached to flip top legs.

CNYA2424	2.75 x 22 x 11.75	150	2.20	.40	\$151
CNYA3030	2.75 x 27 x 11.75	150	2.80	.50	\$184

For use with **CNY triangle tops**. 11 3/4" high, Black plastic, attractive ribbed design. Includes two fold-away installation clips and flexible privacy strips. Connects to predrilled holes in table top.

- Can not be used when worksurface tops are attached to flip top legs.

Modesty Panel

Modesty Panel

Modesty Panel

Required Specifications

Top Finish
Edge Finish

Optional Specifications

Grommet

Accessories

Power Block

WIRE MANAGEMENT UNITS

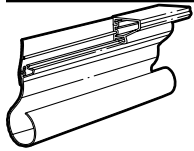

Wire Management Unit

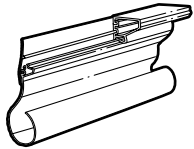

Wire Management Unit

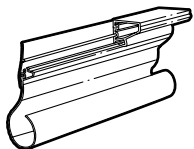

Wire Management Unit

MODEL#	DIMENSIONS D x W x H	FREIGHT CLASS	WT./LBS.	CUBIC FT.	LIST PRICE
CNCB2430	2.75 x 35 x 6	70	1.50	.50	\$178
CNCB3036	2.75 x 43 x 6	70	1.80	.60	\$199
CNCB3642	2.75 x 53 x 6	250	2.10	.70	\$258

For use with **CNC crescent tops**. 6" high, Black plastic, attractive ribbed design. Includes two fold-away installation clips and flexible privacy strips. Connects to predrilled holes in table top. Can be used with or without wire management grommet.

- *Can not be used when worksurface tops are attached to flip top legs.*

CNQB2424	2.75 x 27 x 6	70	1.20	.40	\$150
CNQB3030	2.75 x 35 x 6	70	1.50	.50	\$178
CNQB3636	2.75 x 44 x 6	70	1.80	.60	\$229

For use with **CNQ quarter round tops**. 6" high, Black plastic, attractive ribbed design. Includes two fold-away installation clips and flexible privacy strips. Connects to predrilled holes in table top. Can be used with or without wire management grommet.

- *Can not be used when worksurface tops are attached to flip top legs.*

CNRB2030	2.75 x 29 x 6	70	1.50	.50	\$150
CNRB2036	2.75 x 35 x 6	70	1.80	.60	\$178
CNRB2042	2.75 x 41 x 6	250	2.10	.70	\$199
CNRB2048	2.75 x 47 x 6	250	2.40	.80	\$275
CNRB2054	2.75 x 53 x 6	250	2.70	.90	\$288
CNRB2060	2.75 x 59 x 6	250	3	1	\$288
CNRB2066	2.75 x 65 x 6	250	3.30	1.10	\$288
CNRB2072	2.75 x 71 x 6	250	3.60	1.20	\$390

CNRB2430	2.75 x 29 x 6	70	1.50	.50	\$150
CNRB2436	2.75 x 35 x 6	70	1.80	.60	\$178
CNRB2442	2.75 x 41 x 6	250	2.10	.70	\$199
CNRB2448	2.75 x 47 x 6	250	2.40	.80	\$275
CNRB2454	2.75 x 53 x 6	250	2.70	.90	\$288
CNRB2460	2.75 x 59 x 6	250	3	1	\$288
CNRB2466	2.75 x 65 x 6	250	3.30	1.10	\$288
CNRB2472	2.75 x 71 x 6	250	3.60	1.20	\$390

CNRB3036	2.75 x 35 x 6	70	1.80	.60	\$178
CNRB3042	2.75 x 41 x 6	250	2.10	.70	\$199
CNRB3048	2.75 x 47 x 6	250	2.40	.80	\$229
CNRB3054	2.75 x 53 x 6	250	2.70	.90	\$258
CNRB3060	2.75 x 59 x 6	250	3	1	\$288
CNRB3066	2.75 x 65 x 6	250	3.30	1.10	\$340
CNRB3072	2.75 x 71 x 6	250	3.60	1.20	\$390

CNRB3642	2.75 x 41 x 6	250	2.10	.70	\$199
CNRB3648	2.75 x 47 x 6	250	2.40	.80	\$258
CNRB3654	2.75 x 53 x 6	250	2.70	.90	\$258
CNRB3660	2.75 x 59 x 6	250	3	1	\$288
CNRB3666	2.75 x 65 x 6	250	3.30	1.10	\$288
CNRB3672	2.75 x 71 x 6	250	3.60	1.20	\$390

For use with **CNR/CNRU rectangular tops**. 6" high, Black plastic, attractive ribbed design. Includes two fold-away installation clips and flexible privacy strips. Connects to predrilled holes in table top. Can be used with or without wire management grommet.

- *Can not be used when worksurface tops are attached to flip top legs.*

Required Specifications

Top Finish
Edge Finish

Optional Specifications

Grommet

Accessories

Power Block

WIRE MANAGEMENT UNITS

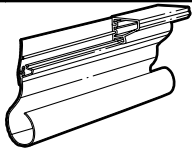

Wire Management Unit

MODEL# DIMENSIONS FREIGHT CLASS WT/LBS. CUBIC FT. LIST PRICE

D x W x H

CNSB2424	2.75 x 23 x 6	70	1.80	.40	\$119
CNSB3030	2.75 x 29 x 6	70	1.50	.50	\$150
CNSB3636	2.75 x 35 x 6	70	1.80	.60	\$178

For use with **CNS square tops**. 6" high, Black plastic, attractive ribbed design. Includes two fold-away installation clips and flexible privacy strips. Connects to predrilled holes in table top. Can be used with or without wire management grommet.

- *Can not be used when worksurface tops are attached to flip top legs.*

CNTB2048L	2.75 x 43 x 6	250	2.40	.80	\$199
CNTB2060L	2.75 x 55 x 6	250	3	1	\$258

CNTB2448L	2.75 x 43 x 6	250	2.40	.80	\$199
CNTB2460L	2.75 x 55 x 6	250	3	1	\$258

CNTB3060L	2.75 x 55 x 6	250	3	1	\$258
CNTB3072L	2.75 x 67 x 6	250	3.60	1.20	\$360

CNTB3660L	2.75 x 55 x 6	250	3	1	\$258
CNTB3672L	2.75 x 67 x 6	250	3.60	1.20	\$360

For use with **long side of CNT trapezoid tops**. 6" high, Black plastic, attractive ribbed design. Includes two fold-away installation clips and flexible privacy strips. Connects to predrilled holes in table top. Can be used with or without wire management grommet.

- *Can not be used when worksurface tops are attached to flip top legs.*

CNTB2048S	2.75 x 23 x 6	70	1.20	.40	\$119
CNTB2060S	2.75 x 35 x 6	70	1.50	.50	\$178

CNTB2448S	2.75 x 23 x 6	70	1.20	.40	\$119
CNTB2460S	2.75 x 35 x 6	70	1.20	.40	\$178

CNTB3060S	2.75 x 29 x 6	70	1.50	.50	\$150
CNTB3072S	2.75 x 41 x 6	70	1.50	.50	\$199

CNTB3660S	2.75 x 23 x 6	70	1.80	.60	\$119
CNTB3672S	2.75 x 35 x 6	70	1.80	.60	\$178

For use with **short side of CNT trapezoid tops**. 6" high, Black plastic, attractive ribbed design. Includes two fold-away installation clips and flexible privacy strips. Connects to predrilled holes in table top. Can be used with or without wire management grommet.

- *Can not be used when worksurface tops are attached to flip top legs.*

CNWB2424	2.75 x 17 x 6	70	1.20	.40	\$98
CNWB3030	2.75 x 22 x 6	70	1.50	.50	\$119

For use with **CNW wedge tops**. 6" high, Black plastic, attractive ribbed design. Includes two fold-away installation clips and flexible privacy strips. Connects to predrilled holes in table top. Can be used with or without wire management grommet.

- *Can not be used when worksurface tops are attached to flip top legs.*

CNYB2424	2.75 x 22 x 6	70	1.20	.40	\$119
CNYB3030	2.75 x 27 x 6	70	1.50	.50	\$150

For use with **CNY triangle tops**. 6" high, Black plastic, attractive ribbed design. Includes two fold-away installation clips and flexible privacy strips. Connects to predrilled holes in table top. Can be used with or without wire management grommet.

- *Can not be used when worksurface tops are attached to flip top legs.*

Required Specifications

Top Finish
Edge Finish

Optional Specifications

Grommet

Accessories

Power Block

MODESTY PANEL WITH WIRE MANAGEMENT

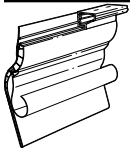

Modesty Panel with Wire Management

MODEL#	DIMENSIONS D x W x H	FREIGHT CLASS	WT./LBS.	CUBIC FT.	LIST PRICE
CNCC2430	2.75 x 35 x 11.75	100	4.30	.50	\$258
CNCC3036	2.75 x 43 x 11.75	100	5.10	.60	\$293
CNCC3642	2.75 x 53 x 11.75	100	6	.70	\$380

For use with **CNC crescent tops**. 11 3/4" high, Black plastic, attractive ribbed design. Includes two fold-away installation clips and flexible privacy strips. Connects to predrilled holes in table top. Can be used with or without wire management grommet.

- *Can not be used when worksurface tops are attached to flip top legs.*

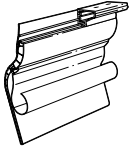

Modesty Panel with Wire Management

CNQC2424	2.75 x 27 x 11.75	100	3.40	.40	\$215
CNQC3030	2.75 x 35 x 11.75	100	4.30	.50	\$258
CNQC3636	2.75 x 44 x 11.75	100	5.10	.60	\$293

For use with **CNC quarter round tops**. 11 3/4" high, Black plastic, attractive ribbed design. Includes two fold-away installation clips and flexible privacy strips. Connects to predrilled holes in table top. Can be used with or without wire management grommet.

- *Can not be used when worksurface tops are attached to flip top legs.*

CNRC2030	2.75 x 29 x 11.75	100	4.30	.50	\$215
CNRC2036	2.75 x 35 x 11.75	100	5.10	.60	\$258
CNRC2042	2.75 x 41 x 11.75	100	6	.70	\$293
CNRC2048	2.75 x 47 x 11.75	100	6.80	.80	\$341
CNRC2054	2.75 x 53 x 11.75	100	7.70	.90	\$380
CNRC2060	2.75 x 59 x 11.75	100	8.50	1	\$422
CNRC2066	2.75 x 65 x 11.75	100	9.40	1.10	\$456
CNRC2072	2.75 x 71 x 11.75	100	10.20	1.20	\$483

CNRC2430	2.75 x 29 x 11.75	100	4.30	.50	\$215
CNRC2436	2.75 x 35 x 11.75	100	5.10	.60	\$258
CNRC2442	2.75 x 41 x 11.75	100	6	.70	\$293
CNRC2448	2.75 x 47 x 11.75	100	6.80	.80	\$341
CNRC2454	2.75 x 53 x 11.75	100	7.70	.90	\$380
CNRC2460	2.75 x 59 x 11.75	100	8.50	1	\$422
CNRC2466	2.75 x 65 x 11.75	100	9.40	1.10	\$456
CNRC2472	2.75 x 71 x 11.75	100	10.20	1.20	\$483

CNRC3036	2.75 x 35 x 11.75	100	5.10	.60	\$258
CNRC3042	2.75 x 41 x 11.75	100	6	.70	\$293
CNRC3048	2.75 x 47 x 11.75	100	6.80	.80	\$341
CNRC3054	2.75 x 53 x 11.75	100	7.70	.90	\$380
CNRC3060	2.75 x 59 x 11.75	100	8.50	1	\$422
CNRC3066	2.75 x 65 x 11.75	100	9.40	1.10	\$456
CNRC3072	2.75 x 71 x 11.75	100	10.20	1.20	\$483

CNRC3642	2.75 x 41 x 11.75	100	6	.70	\$293
CNRC3648	2.75 x 47 x 11.75	100	6.80	.80	\$341
CNRC3654	2.75 x 53 x 11.75	100	7.70	.90	\$380
CNRC3660	2.75 x 59 x 11.75	100	8.50	1	\$422
CNRC3666	2.75 x 65 x 11.75	100	9.40	1.10	\$456
CNRC3672	2.75 x 71 x 11.75	100	10.20	1.20	\$483

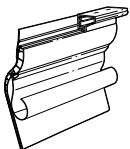

Modesty Panel with Wire Management

For use with **CNR/CNRU rectangular tops**. 11 3/4" high, Black plastic, attractive ribbed design. Includes two fold-away installation clips and flexible privacy strips. Connects to predrilled holes in table top. Can be used with or without wire management grommet.

- *Can not be used when worksurface tops are attached to flip top legs.*

Required Specifications

Top Finish
Leg Finish
Edge Finish

Optional Specifications

Grommet

Accessories

Power Block

MODESTY PANEL WITH WIRE MANAGEMENT

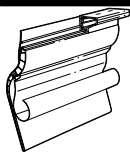

Modesty Panel with Wire Management

MODEL# DIMENSIONS FREIGHT CLASS WT./LBS. CUBIC FT. LIST PRICE

D x W x H

CNSC2424	2.75 x 23 x 11.75	100	3.50	.40	\$178
CNSC3030	2.75 x 29 x 11.75	100	4.30	.50	\$215
CNSC3636	2.75 x 35 x 11.75	100	5.10	.60	\$258

For use with **CNC square tops**. 11 3/4" high, Black plastic, attractive ribbed design. Includes two fold-away installation clips and flexible privacy strips. Connects to predrilled holes in table top. Can be used with or without wire management grommet.

- *Can not be used when worksurface tops are attached to flip top legs.*

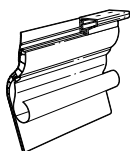

Modesty Panel with Wire Management

CNTC2048L	2.75 x 43 x 11.75	100	6.80	.80	\$293
CNTC2060L	2.75 x 55 x 11.75	100	8.50	1	\$380
CNTC2448L	2.75 x 43 x 11.75	100	6.80	.80	\$293
CNTC2460L	2.75 x 55 x 11.75	100	8.50	1	\$380
CNTC3060L	2.75 x 55 x 11.75	100	8.50	1	\$380
CNTC3072L	2.75 x 67 x 11.75	100	10.20	1.20	\$456
CNTC3660L	2.75 x 55 x 11.75	100	8.50	1	\$380
CNTC3672L	2.75 x 67 x 11.75	100	10.20	1.20	\$456

For use with **long side of CNT trapezoid tops**. 11 3/4" high, Black plastic, attractive ribbed design. Includes two fold-away installation clips and flexible privacy strips. Connects to predrilled holes in table top. Can be used with or without wire management grommet.

- *Can not be used when worksurface tops are attached to flip top legs.*

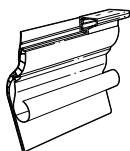

Modesty Panel with Wire Management

CNTC2048S	2.75 x 24 x 11.75	100	3.40	.40	\$178
CNTC2060S	2.75 x 36 x 11.75	100	3.50	.50	\$258
CNTC2448S	2.75 x 23 x 11.75	100	3.40	.40	\$178
CNTC2460S	2.75 x 35 x 11.75	100	3.40	.40	\$258
CNTC3060S	2.75 x 29 x 11.75	100	4.30	.50	\$215
CNTC3072S	2.75 x 41 x 11.75	100	4.30	.50	\$293
CNTC3660S	2.75 x 23 x 11.75	100	5.10	.60	\$178
CNTC3672S	2.75 x 35 x 11.75	100	5.10	.60	\$258

For use with **short side of CNT trapezoid tops**. 11 3/4" high, Black plastic, attractive ribbed design. Includes two fold-away installation clips and flexible privacy strips. Connects to predrilled holes in table top. Can be used with or without wire management grommet.

- *Can not be used when worksurface tops are attached to flip top legs.*

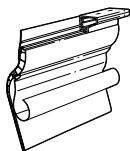

Modesty Panel with Wire Management

CNWC2424	2.75 x 17 x 11.75	100	3.40	.40	\$146
CNWC3030	2.75 x 22 x 11.75	100	4.30	.50	\$178

For use with **CNW wedge tops**. 11 3/4" high, Black plastic, attractive ribbed design. Includes two fold-away installation clips and flexible privacy strips. Connects to predrilled holes in table top. Can be used with or without wire management grommet.

- *Can not be used when worksurface tops are attached to flip top legs.*

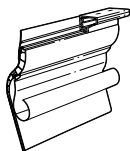

Modesty Panel with Wire Management

CNYC2424	2.75 x 22 x 11.75	100	3.40	.40	\$178
CNYC3030	2.75 x 27 x 11.75	100	4.30	.50	\$215

For use with **CNY triangle tops**. 11 3/4" high, Black plastic, attractive ribbed design. Includes two fold-away installation clips and flexible privacy strips. Connects to predrilled holes in table top. Can be used with or without wire management grommet.

- *Can not be used when worksurface tops are attached to flip top legs.*

Required Specifications

Top Finish
Leg Finish
Edge Finish

Optional Specifications

Grommet

Accessories

Power Block

T LEGS

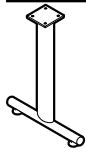

"T" Leg

MODEL#	DIMENSIONS D x W x H	FREIGHT CLASS	WT/LBS.	CUBIC FT.	LIST PRICE
GCNTLEG18	5.25 x 18 x 27.63	125	15	2.10	\$272
GCNTLG18P	5.25 x 18 x 27.63	125	17	2.10	\$535

18" long with plastic elliptical column cover, leveling glides and end caps. **For assembly with 20" tops.**

- For a single leg, order **GCNTLEG18**.
- For a pair of legs (set of 2), order **GCNTLG18P**.
- Chrome (CHM) is available (on foot only). **Add \$88** list for model GCNTLEG18 and **\$172** list for model GCNTLG18P.

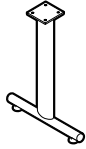

"T" Leg

GCNTLEG24	5.25 x 20 x 27.63	150	9	2.10	\$272
GCNTLG24P	5.25 x 20 x 27.63	100	17	2.10	\$535

20" long with plastic elliptical column cover, leveling glides and end caps. **For assembly with 24" tops.**

- For a single leg, order **GCNTLEG24**.
- For a pair of legs (set of 2), order **GCNTLG24P**.
- Chrome (CHM) is available (on foot only). **Add \$88** list for model GCNTLEG24 and **\$172** list for model GCNTLG24P.

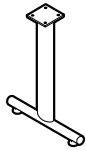

"T" Leg

GCNTLEG30	5.25 x 26 x 27.63	250	10	2.60	\$293
GCNTLG30P	5.25 x 26 x 27.63	125	19	2.60	\$583

26" long with plastic elliptical column cover, leveling glides and end caps. **For assembly with 30" tops.**

- For a single leg, order **GCNTLEG30**.
- For a pair of legs (set of 2), order **GCNTLG30P**.
- Chrome (CHM) is available (on foot only). **Add \$88** list for model GCNTLEG30 and **\$172** list for model GCNTLG30P.

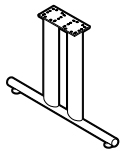

"T" Leg

GCNTLEG36	5.75 x 32 x 27.63	150	14	3.30	\$589
GCNTLG36P	5.25 x 32 x 27.63	100	27	3.30	\$1168

32" long with double post plastic elliptical column cover, leveling glides and end caps. **For assembly with 36" tops.**

- For a single leg, order **GCNTLEG36**.
- For a pair of legs (set of 2), order **GCNTLG36P**.
- Chrome (CHM) is available (on foot only). **Add \$88** list for model GCNTLEG36 and **\$172** list for model GCNTLG36P.

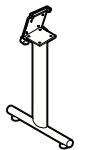

Flip Top "T" Leg

CNTFLEG24	6.5 x 20 x 27.62	150	10	2.40	\$506
-----------	------------------	-----	----	------	--------------

20" long with plastic elliptical column cover, leveling glides and end caps. **For assembly with 24" deep rectangular and square tops only.** Hinged plate with locking mechanism to lock in open or closed position. Cannot be installed with thumbscrews.

- *Can not be used when modesty panels and wire management are attached to worksurface tops.*
- List Price is per **each leg**.
- Chrome (CHM) is available (on foot only). **Add \$88** list.

Required Specifications
Leg Finish

T LEGS

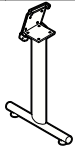

Flip Top "T" Leg

MODEL#	DIMENSIONS	FREIGHT CLASS	WT./LBS.	CUBIC FT.	LIST PRICE
	D x W x H				
CNTFLEG30	6.5 x 26 x 27.62	150	14	3	\$535

26" long with plastic elliptical column cover, leveling glides and end caps. **For assembly with 30" deep rectangular and square tops only.** Hinged plate with locking mechanism to lock in open or closed position. Cannot be installed with thumbscrews.

- *Can not be used when modesty panels and wire management are attached to worksurface tops.*
- *List Price is per **each leg**.*
- *Chrome (CHM) is available (on foot only). **Add \$88 list***

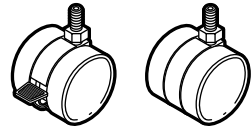

Casters

CNCP	- x - x 1.5	70	1	.15	\$58
------	-------------	----	---	-----	-------------

Set of (2) 1½" dual wheel casters, one locking. Suggested for hard floor surfaces and industrial carpeting. Casters are fully interchangeable with glides. Black only.

- *For use with **ConnecTABLES** units only.*
- *Casters **DO NOT** affect table height.*



Thumbscrews

CNTS	1.25 x 1.25 x 1.5	70	1	.15	\$37
------	-------------------	----	---	-----	-------------

Triangular thumbscrew with ¾" steel thread. Set of 4. Can be used in place of factory supplied screws to allow installation of "T" legs to tops without tools. Black only.

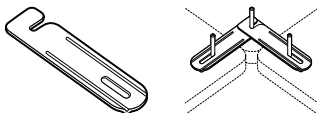

Ganging Connector

CNGFP	5 x 2.5 x 1.13	70	.20	.10	\$63
-------	----------------	----	-----	-----	-------------

Black epoxy coated 13 gauge steel with 2 thumbscrews included. Used to connect tabletops together for additional stability or for connecting freestanding tops together. Holes with steel inserts are located in the corner of all tops to accommodate this plate. **Sold individually.**

Required Specifications

Leg Finish



Duet tables are multi-purpose stacking tables that offer optimum space utilization and flexibility. Their personality and simple design make them ideal for use in any learning or training environment at post-secondary and adult levels. Temporarily and easily convert auditoriums and other spaces into examination and seminar spaces. They can be partnered with stacking chairs such as Duet or Popcorn in matching or complementary colors (stacking chairs can be found in the Multi-Purpose section of the Seating price list).

The one-piece molded top and modesty are gently contoured providing an eased edge with an elegant waterfall transition from top to modesty.

Tops are available in a wide array of colors in 0.5" thick polypropylene. Polypropylene material offers strength and ease of cleaning with a slightly textured surface to offer scratch resistance.



Features and Benefits

- One-piece molded top and modesty are 0.5" thick polypropylene.
- Tables are rated 250 lbs. capacity.
- Surface includes factory installed metal inserts for solid and secure connection to the sled frame.
- 0.5" diameter solid steel rod sled frame.
- Bumpers on the underside for protection when stacking.
- Model with ADA width compliant frame is available.
- Shipped fully assembled.



One-piece top and modesty.



Stacks 5 high on floor or 20 high on dolly.

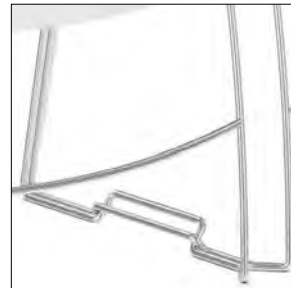

Ganging frame to keep tables evenly aligned.

GENERAL INFORMATION

- Duet tables are multi-purpose stacking tables ideal for auditoriums, seminars or any learning or training environment.
- Lightweight and easy to handle whether stacking for storage or setting up a room.
- Made of durable materials to withstand more demanding environments.
- Shipped fully assembled. Packaged 4 per carton.
- Global products are in compliance with stringent emission guidelines set out by the Greenguard Environmental Institute under the standards for low emitting products and materials. www.greenguard.org.
- Covered by Global's Lifetime Warranty.
- **Level 2 Certified.**

WORKSURFACES

- Top and modesty are a one-piece injection molded design in 0.5" thick polypropylene.
- Available in a wide array of colors (see right column "FINISHES") to complement any space or to define sections by color.
- One-piece molded top and modesty are contoured providing an eased user edge, with an elegant waterfall transition from top to modesty.

26"W x 18"D x 9.75"H

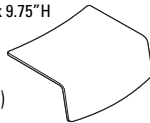

CONSTRUCTION

- Surface includes molded in threaded inserts to provide a secure metal-to-metal connection to the sled frame.
- Bumpers are included on the underside of top and inside modesty to protect surfaces when stacking.

FRAME

- 0.5" diameter solid steel rod sled frame.
- Available in a durable Chrome finish.
- Model with ganging frame keeps tables evenly positioned and aligned. No tools or fasteners required for ganging; the frames simply interlock.
- Model with ADA compliant frame is also available. The frame is 33" wide and the polypropylene top/modesty remain a constant size.
- Tables are standard without glides and are suitable for carpet, rubber or cork flooring.
- Glide options are available (see right column "GLIDES"). Glides must be chosen to best suit flooring type and site conditions. Upcharges apply.

DOLLY

- For space saving storage and transport.
- Constructed from 1.5" x 0.5" steel tubing with heavy duty casters (two locking) and a removable handle.
- Dolly can stack up to 20 tables.
- Stacking height on dolly is up to 68".

FINISHES

BZB	Buzz Blue	FRO	Frost
CCT	Cactus	INK	Ink
CRO	Carrot	LAB	Latte
IVC	Cloud	BLK	Night
DJN	Dijon	SND	Sand
EGP	Eggplant	SAR	Scarlet
FOG	Fog	SHW	Shadow

GLIDES

- CG** Clear polycarbonate (for carpet, rubber or concrete flooring). Height added to table: 0.18". **Add \$16/set.**
- SG** Glides with stainless steel pads (for carpet or rubber flooring). Height added to table: 0.17". **Add \$31/set.**
- FG** Glides with felt pads (for vinyl, cork or laminate flooring). Height added to table: 0.24". **Add \$31/set.**
- RG** Glides with rubber pads (for vinyl, hardwood, laminate, stone or ceramic flooring). Height added to table: 0.16". **Add \$31/set.**

SPECIFICATIONS

- Specifications marked with an * are applicable to only those products which have the * symbol beside the product name.

EXAMPLE DUET TABLE ORDER CODE:

Duet stacking table, polypropylene surface in Latte, clear polycarbonate glides

DTS1828P	-LAB	-CG
Model #	Surface finish	Glides

D DUET™ TABLES

STACKING TABLES

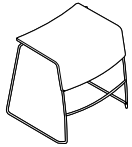

Stacking Table*

MODEL#	DIMENSIONS D x W x H	FREIGHT CLASS	WT./LBS.	CUBIC FT.	LIST PRICE
DTS1828P	25 x 29 x 28	150	26	17.75	\$477

One-piece polypropylene top and modesty with Chrome frame. Shipped fully assembled, 4 per carton.

- Price shown is per table. It is recommended to order in multiples of 4.
- Please be sure to select the appropriate glide (see previous page) for the flooring surface, as scratches could occur.
- Worksurface is 18" D x 28" W

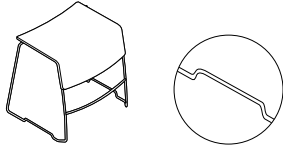

Stacking Table, Ganging Frame*

DTS1828PG	25 x 30.75 x 28	150	26	17.75	\$509
-----------	-----------------	-----	----	-------	--------------

One-piece polypropylene top and modesty with Chrome ganging frame.

Shipped fully assembled, 4 per carton.

- Price shown is per table. It is recommended to order in multiples of 4.
- Please be sure to select the appropriate glide (see previous page) for the flooring surface, as scratches could occur.
- Worksurface is 18" D x 28" W

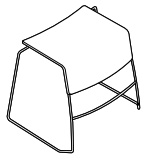

Stacking Table, 32" Wide*

DTA1832P	25 x 33 x 28	150	26	17.75	\$539
----------	--------------	-----	----	-------	--------------

ADA (American with Disabilities Act) compliant. 33" wide. One-piece polypropylene top and modesty with Chrome frame. Underside clearance is 27.1"H (extra height if glides are selected). Stacks up to 5 high on floor only; dolly does not accommodate. Shipped fully assembled, 4 per carton.

- Price shown is per table. It is recommended to order in multiples of 4.
- Please be sure to select the appropriate glide (see previous page) for the flooring surface, as scratches could occur.
- Worksurface is 18" D x 32" W

DOLLY

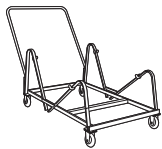

Dolly

MODEL #	DIMENSIONS	FREIGHT CLASS	WT./LB.	CUBIC FT.	LIST PRICE
DTD20	29.5 x 63 x 38.5	250	50	21	\$693

For use with tables DTS1828P and DTS1828PG. Can stack up to 20 tables. Black only. Removable handle for storage. Shipped fully assembled in 1 carton.

Required Specifications
Finish

Optional Specifications
Grommet

Accessories
Power Block



Edventure is a value series collection that offers a range of teacher desks, student desks, study carrels and lecterns for more traditional learning environments. Designed to withstand daily rigorous use, traditional style meets modern performance.

Tops are available in a wide array of finishes in 1" thick thermally fused laminate or 1 1/16" high pressure laminate with matching or complementary 2mm PVC edgebanding. Edventure's color palette also includes nine new bold finishes available on select components in high pressure laminate only.

Mobile lecterns and teacher desks offer versatility with storage options for educators on the move.

Single and connecting study carrels create quiet work areas with optional power and data to stay connected.

Features and Benefits

- Tops are 1" thick thermally fused laminate or 1 1/16" high pressure laminate.
- Tops are constructed of 45 lb. density particle board.
- Matching or complementary 2mm PVC edgebanding.
- Surfaces include factory installed metal inserts for solid and secure leg connections.
- H-leg design on teacher and student desks.
- Teacher's desk includes modesty panel and is available with or without casters.
- Teacher's desk with left or right hand box/box/file pedestal available on casters only.
- Study carrel features curved side panels for seated privacy with a 29"H worksurface.
- Easy to assemble.



H-legs with cross bar.



Mobile teacher desk with modesty panel.



Freestanding and add-on study carrels.

GENERAL INFORMATION

- Edventure series is an affordable collection of teacher desks, student desks, study carrels and lecterns with personal storage options, that bring a traditional element to the classroom.
- Simple and elegant design respects space requirements to accommodate various teaching styles.
- Edventure series is a high achiever, built to withstand the most demanding environments.
- Shipped easy to assemble.
- For environmental certifications, please visit globalfurnituregroup.com

WORKSURFACES

- Tops are available in 1" thick thermally fused laminate or 1 1/16" thick high pressure laminate.
- Available in an array of finishes in both thermally fused laminate or high pressure laminate.
- Products specified with the high pressure laminate option are finished on the underside of the surface with a kraft paper backing.

CONSTRUCTION

- Top core is made of 45 lb. density particle board.
- Surfaces include factory installed metal inserts for solid and secure leg connections.

EDGE DETAIL

- Global's preferred 2mm PVC edgebanding is standard.
- Edgebanding may be specified in a matching or a complementary finish for tops in standard Global laminates.

LEGS

- H-legs are 28" high and constructed from 2" x 2" square tubing with a 1" x 2" rectangular cross bar and adjustable leveling glides.
- Available in Black (**TBL**), Buzz Blue (**TBZ**), Cactus (**TCC**), Carrot (**TCR**), Cloud (**TIV**), Designer White (**TDW**), Dijon (**TDJ**), Eggplant (**TEG**), Fog (**TFO**), Frost (**TFR**), Ink (**TIN**), Kalua (**TKA**), Latte (**TLA**), Mocha (**TMO**), Nevada (**TNE**), Sand (**TSN**), Scarlet (**TSR**), Shadow (**TSH**), Toast (**TOA**) or Tungsten (**TTU**) painted finishes, Sandtex finish applied.

CASTERS

- Teacher desks and lecterns are available with locking casters. See models ending in C.
- Casters are 3.5" high overall.

MODESTY PANELS

- 12"H modesty panel is included with teacher desks.
- Available in an array of finishes (see page 600) in thermally fused laminate with matching edges only.

STORAGE LECTERNS

- The steel storage lectern features integrated full pulls and a full welded seamless top for added strength and crisp appearance.
- Drawer and door fronts have welded reinforcements for additional strength.
- Available in three configurations, offering multiple storage options for storing personal items or keeping active files and resource materials close at hand.
- Removable cam locks are standard.
- Storage lecterns are supported by 2" x 2" x 3.5"H square tube legs on leveling glides or 3.5"H industrial size casters. Feet will match case finish.
- Finished laminate tops to complement deskings are available. See model ENMST1824.
- An optional lectern shelf offers a perfect platform for keeping presentation materials organized and at the presenter's fingertips. See model ENLS182.

STUDY CARRELS

- The study carrel features a 29" high worksurface and curved side panels for privacy.
- Freestanding (starter) and add-on models are available. Legs and privacy panels are shared between adjoining add-on carrels.
- The back panel is inset to hide connecting fasteners from user's view. The inset back also creates a wire drop for the optional LED task light cord.
- Carrels with an optional shelf are available. See models ending in **S**.
- Optional LED task light is available for carrel with shelf, see page page 604
- Optional Cove Daisylink system is available to bring power, USB charging or data to the carrel surface for desktop access, see page 606

GROMMETS

- Optional grommets are available in standard worksurface locations (left, center or right). Order as: **AG1, AG2** or **AG3**. **Add \$88.**
- Grommet hole dimensions are 3.25"W x 1.875"D
 - ENSTxxxx, ENAC2924/3524, ENFC3024/3624 models - **AG2** option only
 - ENFC6024/7224, ENFC5924/7124 models - **AG1 and AG3** option only

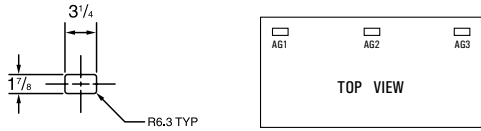

POWER BLOCK

- A power block is a rectangular worksurface power/data module with one electrical duplex receptacle and two data (RJ45) receptacles. 9' Black cord included. Power block dimensions are 6.5"W x 3.5"D x 2.75"H.
 - ENSTxxxx, ENAC2924/3524, ENFC3024/3624 models - **E2** option only
 - ENFC6024/7224, ENFC5924/7124 models - **E1 and E3** option only

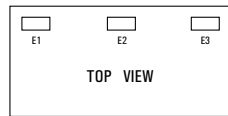
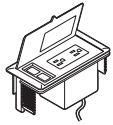

Power block **PMSPPM**. **Add \$330.** Specify location **E1, E2** or **E3**. **Add \$88.**

VILLA CUTOUTS

- Optional Villa cutout available in standard worksurface locations (left, center or right) for Rectangular tables. Order as: **V1, V2** or **V3** - **Add \$88 for each cutout.**
 - ENSTxxxx, ENAC2924/3524, ENFC3024/3624 models - **V2** option only
 - ENFC6024/7224, ENFC5924/7124 models - **V1 and V3** option only

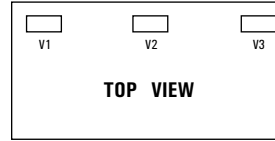

COVE DAISYLINK COMPONENTS

- A daisy-chain power solution with a unique "no particular order" feature, making installation or reconfiguration easy.
- Cove Daisylink modules must be ordered separately and are available for study carrels only.
- Specify the cut-out for Cove Daisylink modules when ordering the study carrels; order the Cove kits (modules and jumpers) and infeed separately.
- When **CV** cut-out is specified on 29", 30", 35" and 36" study carrels, **one** cut-out in the center position is included. **Add \$88.**
- When **CV** cut-out is specified on 59", 60", 71" and 72" study carrels, **two** cut-outs in the left and right positions are included. **Add \$176.**
- For Cove Daisylink components, see page 606
- Maximum of 9 Cove modules per each infeed.

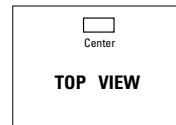

29", 30", 35" and 36" study carrels

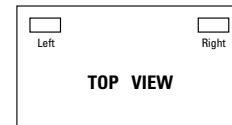

59", 60", 71" and 72" study carrels

SPECIFICATIONS

- Specifications marked with an * are applicable to only those products which have the* symbol beside the product name.

FINISHES

Thermally Fused or High Pressure Laminate Tops and 2mm Thick Edgebanding

ACJ Absolute Acajou	LAB Latte*
ASN Asian Night	NBL Noce Biondo
AWC Avant Cherry	NGL Noce Grigio
AWH Avant Honey	NEL Noce Leggero
BLK Black	NML Noce Medio
BRC Brushed Cobalt	QTM Quartered Mahogany
BZB Buzz Blue*	SAR Scarlet*
CCT Cactus*	SHW Shadow*
CRO Carrot*	SOG Storm Grey
CMB Clear Maple	TFW Tiger Fruitwood
DES Dark Espresso	TWL Tiger Walnut
DWT Designer White	WHE Walnut Heights
DJN Dijon*	WHC White Chocolate
FOG Fog*	WGY Willow Grey
HGT Hayden Grey	WCR Winter Cherry

*Only available as an edgeband finish.

Note: Modesty panel and lectern shelf are available in thermally fused laminate finishes only. Modesty panel and pedestal edging will match thermally fused laminate finish specified.

High Pressure Laminate Finishes - Tops only

BTT Blue Titanium	KKW Kool Kiwi
BBY Blueberry	LBR Liberty Red
CBB Caribbean Blue	MYL Morning Yellow
FJT Fiji Teal	RPL Royal Purple
FPY Fresh Papaya	

Legs and Storage Lectern Metal Trim Finishes

TBL Black	TIN Ink
TBZ Buzz Blue	TKA Kalua
TCC Cactus	TLA Latte
TCR Carrot	TMO Mocha
TIV Cloud	TNE Nevada
TDW Designer White	TSN Sand
TDJ Dijon	TSR Scarlet
TEG Eggplant	TSH Shadow
TFO Fog	TOA Toast
TFR Frost	TTU Tungsten

Painted Finishes for Metal Storage Lecterns

BGR Business Grey	MCH Mocha Textured*
BKC Black Coffee Textured*	MET Metro
BLK Black	MOS Moss
BNE Bone	NEV Nevada
BZD Blizzard Textured*	NVY Navy
CHR Charcoal	OYS Oyster
CLT Claret	SDT Stonedust Textured*
DCH Dark Chocolate Textured*	SGR Storm Grey
DPT Desert Putty	SIL Silver
DWT Designer White	SKY Sky
FOG Fog	STN Stone
GRY Grey	TPE Taupe
LGR Light Grey	TSA Tahiti Sand
ICE Ice	TUN Tungsten (add 10% upcharge)
IVR Ivory	WIL Willow

*textured finishes

TO SPECIFY:

1. SPECIFY MODEL NUMBER

2. SPECIFY THE FOLLOWING:

FOR TEACHER AND STUDENT DESKS:

- Top finish
- Optional HP laminate
- Edge finish (top only)
- Modesty finish if applicable
- Pedestal finish if applicable
- Leg finish
- Optional AG grommet or cut-out for PMSDPM, if applicable
- Optional key alike or select number (#100-120) applicable with teacher's desks with pedestals

FOR STORAGE LECTERNS:

- Case painted finish
- Optional key alike

FOR STUDY CARRELS:

- Top surface finish (shelf, if applicable, will be in the same finish)
- Optional HP laminate
- Edge finish
- Leg finish
- Surround finish (side and back panels)
- Optional cut-out(s) for Cove Daisylink components

EXAMPLE ADVENTURE ORDER CODES:

Teacher desk

ENTD7230	-ACJ	-HPL	-ACJ	-TTU	-ACJ
Model #	Top finish	High pressure laminate	Edge finish	Leg finish	Modesty panel finish

Storage lectern

EL18LPBF	-DWT	-KA
Model #	Case finish	Key alike

Study carrel

ENFC3024	-ACJ	-HPL	-ACJ	-TTU	-ACJ	-CV
Model #	Top finish	High pressure laminate	Top edge finish	Leg finish	Surround finish	Cut-out for Cove

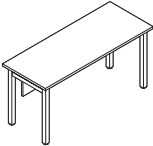
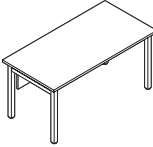
STORAGE LECTERNS	MODEL#	DIMENSIONS	FREIGHT CLASS	WT/LBS.	CUBIC FT.	LIST PRICE	HP ADD
	D x W x H						
	ENTD4824	24 x 48 x 29	70	74	4.6	\$991	\$156
	ENTD5424	24 x 54 x 29	70	80	4.7	\$1003	\$179
	ENTD6024	24 x 60 x 29	70	86	4.9	\$1018	\$191
12"H modesty panel included. Shipped easy to assemble in 2 cartons.							
	ENTD6030	30 x 60 x 29	70	96	6.4	\$1083	\$207
	ENTD6630	30 x 66 x 29	70	103	6.6	\$1120	\$252
	ENTD7230	30 x 72 x 29	70	110	6.8	\$1157	\$270
12"H modesty panel included. Shipped easy to assemble in 2 cartons.							

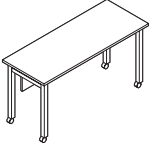
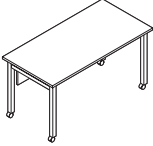
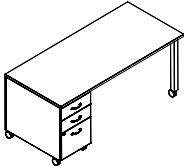
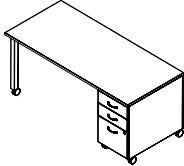
MOBILE TEACHER DESKS	MODEL #	DIMENSIONS	FREIGHT CLASS	WT/LB.	CUBIC FT.	LIST PRICE	HP ADD
	ENTD4824C	24 x 48 x 29	70	75	4.6	\$1150	\$156
	ENTD5424C	24 x 54 x 29	70	81	4.7	\$1163	\$168
	ENTD6024C	24 x 60 x 29	70	87	4.9	\$1178	\$181
12"H modesty panel included. Shipped easy to assemble in 2 cartons.							
	ENTD6030C	30 x 60 x 29	70	98	5.4	\$1243	\$193
12"H modesty panel included. Shipped easy to assemble in 2 cartons.							
	ET6024BBFLC	24 x 60 x 29	85	155	12.37	\$2208	\$180
	ET6624BBFLC	24 x 66 x 29	85	161	12.57	\$2248	\$193
	ET7224BBFLC	24 x 72 x 29	85	167	12.75	\$2290	\$206
	ET6030BBFLC	30 x 60 x 29	85	193	14.67	\$2334	\$193
	ET6630BBFLC	30 x 66 x 29	85	201	14.85	\$2375	\$236
	ET7230BBFLC	30 x 72 x 29	85	210	15.06	\$2416	\$253
Inset 12"H modesty panel and flush left hand locking box/box/file pedestal included. Top box drawer is non-locking. Top is pre-drilled above the pedestal on the underside for the addition of lectern shelf ENLS182. Shipped easy to assemble (BBF pedestal is fully assembled) in 3 cartons.							
	ET6024BBFRC	24 x 60 x 29	85	155	12.37	\$2208	\$180
	ET6624BBFRC	24 x 66 x 29	85	161	12.57	\$2248	\$193
	ET7224BBFRC	24 x 72 x 29	85	167	12.75	\$2290	\$206
	ET6030BBFRC	30 x 60 x 29	85	193	14.67	\$2334	\$193
	ET6630BBFRC	30 x 66 x 29	85	201	14.85	\$2375	\$236
	ET7230BBFRC	30 x 72 x 29	85	210	15.06	\$2416	\$253
Inset 12"H modesty panel and flush right hand locking box/box/file pedestal included. Top box drawer is non-locking. Top is pre-drilled above the pedestal on the underside for the addition of lectern shelf ENLS182. Shipped easy to assemble (BBF pedestal is fully assembled) in 3 cartons.							

Required specifications

Top finish
 Edge finish
 Leg finish
 Modesty finish
 Pedestal finish*

Optional specifications

HP laminate
 AG grommet or cut-out for PMSDPM*
 Key alike/select key*

Accessories

Lectern shelf*

STUDENT DESK

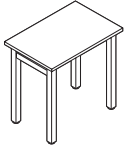

Student Desk**

MODEL#	DIMENSIONS	FREIGHT CLASS	WT./LBS.	CUBIC FT.	LIST PRICE	HP ADD
--------	------------	---------------	----------	-----------	------------	--------

D x W x H						
ENST3020	20 x 30 x 29	85	49	3.9	\$502	\$106

Shipped easy to assemble in 2 cartons.

STORAGE LECTERNS

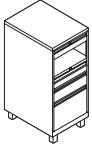

Storage Lectern w/Laptop Drawer*

MODEL #	DIMENSIONS	FREIGHT CLASS	WT./LB.	CUBIC FT.	LIST PRICE
---------	------------	---------------	---------	-----------	------------

EL18LPBF	24 x 18 x 38	85	148	11.7	\$3433
----------	--------------	----	-----	------	--------

Locking laptop drawer, open shelf, locking personal drawer, box drawer and file drawer. Cord escape on backside for laptop charging. 3.5" high metal legs with leveling glides. Shipped assembled in 1 carton.

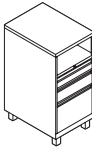

Storage Lectern - Box/File*

EL18PBF	24 x 18 x 38	85	145	11.7	\$2902
---------	--------------	----	-----	------	--------

Open shelf, locking personal drawer, box drawer and file drawer. 3.5" high metal legs with leveling glides. Shipped assembled in 1 carton.

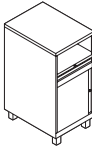

Storage Lectern*

EL18PHDL	24 x 18 x 38	92.5	128	11.7	\$2902
----------	--------------	------	-----	------	--------

Open shelf, locking personal drawer and **left** side hinged locking door with shelf inside. 3.5" high metal legs with leveling glides. Shipped assembled in 1 carton.

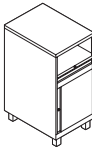

Storage Lectern*

EL18PHDR	24 x 18 x 38	92.5	128	11.7	\$2902
----------	--------------	------	-----	------	--------

Open shelf, locking personal drawer and **right** side hinged locking door with shelf inside. 3.5" high metal legs with leveling glides. Shipped assembled in 1 carton.

Required specifications



Top finish**
Edge finish**
Painted finish*

Optional specifications

HP laminate**
Key alike*

Accessories

Laminate top*
Lectern shelf*
Book box**

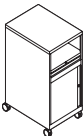
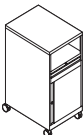
MOBILE STORAGE LECTERNS	MODEL #	DIMENSIONS	FREIGHT CLASS	WT/LB.	CUBIC FT.	LIST PRICE	HP ADD
 <p>Mobile Storage Lectern w/Laptop Drawer</p>		D x W x H					
	EL18LPBFC	24 x 18 x 38	85	148	11.7	\$3577	
	<p>Mobile, locking laptop drawer, open shelf, locking personal drawer, box drawer, file drawer, on four locking casters. Cord escape on back side for laptop charging. Shipped assembled in 1 carton.</p>						
	<hr/>						
 <p>Mobile Storage Lectern - Box/File</p>	EL18PBFC	24 x 18 x 38	85	145	11.7	\$3047	
	<p>Mobile, open shelf, locking personal drawer, box drawer, file drawer, on four locking casters. Shipped assembled in 1 carton.</p>						
 <p>Mobile Storage Lectern*</p>	EL18PHDLC	24 x 18 x 38	92.5	128	11.7	\$3047	N/A
	<p>Mobile, open shelf, locking personal drawer, left side hinged locking door with shelf inside, on four locking casters. Shipped assembled in 1 carton.</p>						
 <p>Mobile Storage Lectern*</p>	EL18PHDRC	24 x 18 x 38	92.5	128	11.7	\$3047	N/A
	<p>Mobile, open shelf, locking personal drawer, right side hinged locking door with shelf inside, on four locking casters. Shipped assembled in 1 carton.</p>						

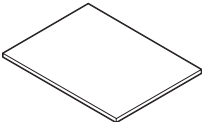
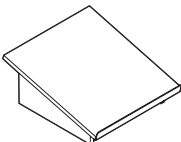
ACCESSORIES	MODEL #	DIMENSIONS	FREIGHT CLASS	WT/LB.	CUBIC FT.	LIST PRICE	HP ADD
 <p>Top for Storage Lectern**</p>	ENMST1824	24 x 18 x 1	60	10.5	0.27	\$200	\$88
	<p>Finished laminate top for storage lecterns. Available in an array of thermally fused laminate or high pressure laminate finishes to complement desking. Shipped in 1 carton.</p>						
 <p>Lectern Shelf**</p>	ENLS182	21 x 18 x 3.25-8.25	125	19	2.55	\$384	N/A
	<p>Offers the perfect platform for keeping lectern materials at the facilitator's fingertips. May be secured to finished top or left unattached to use elsewhere. Screws provided to secure to finished top from the underside. Shipped assembled in 1 carton.</p>						

Required specifications

Paint finish, case*
 Laminate finish**
 Edge finish (ENMST1824 only)
 Trim finish (ENLS182 only)

Optional specifications

Key alike*
 HP laminate (ENMST1824 only)

FREESTANDING OR STARTER STUDY CARRELS

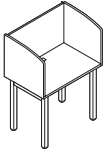

Freestanding/Starter Study Carrel*

MODEL #	DIMENSIONS D x W x H	FREIGHT CLASS	WT/LB.	CUBIC FT.	LIST PRICE	HP ADD	CUT-OUT ADD
ENFC3024	24 x 30 x 50	70	89	4.44	\$967	\$110	\$88
ENFC3624	24 x 36 x 50	70	97.5	4.72	\$1010	\$128	\$88
ENFC6024	24 x 60 x 50	70	115	5.8	\$1177	\$191	\$88
ENFC7224	24 x 72 x 50	70	123.5	6.34	\$1258	\$220	\$88

Features a 29" high work surface with curved side privacy panels. Shown with optional cut-out. Bring power and USB charging to the user with Cove Daisylink components, see page 606. Shipped easy to assemble in 2 cartons.

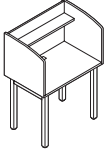

Freestanding/Starter Study Carrel w/Shelf*

ENFC3024S	24 x 30 x 50	70	93	4.44	\$1016	\$127	\$88
ENFC3624S	24 x 36 x 50	70	102.5	4.72	\$1064	\$148	\$88
ENFC6024S	24 x 60 x 50	70	122	5.8	\$1262	\$227	\$88
ENFC7224S	24 x 72 x 50	70	131.5	6.34	\$1356	\$260	\$88

Features a 29" high work surface with curved side privacy panels. Shown with optional cut-out. Shelf is 6" deep and accepts optional LED task light. Bring power and USB charging to the user with Cove Daisylink components, see page 606. Shipped easy to assemble in 2 cartons.

ADD-ON STUDY CARRELS

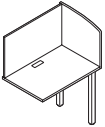

Add-On Study Carrel*

MODEL #	DIMENSIONS	FREIGHT CLASS	WT/LB.	CUBIC FT.	LIST PRICE	HP ADD	CUT-OUT ADD
ENAC2924	24 x 29 x 50	85	63	4.4	\$726	\$110	\$88
ENAC3524	24 x 35 x 50	70	71.5	4.67	\$768	\$128	\$88
ENAC5924	24 x 59 x 50	70	89	5.75	\$940	\$191	\$88
ENAC7124	24 x 71 x 50	70	97.5	6.3	\$1022	\$220	\$88

Features a 29" high work surface with curved side privacy panels. Shown with optional cut-out. Bring power and USB charging to the user with Cove Daisylink components, see page 606. Shipped easy to assemble in 2 cartons.

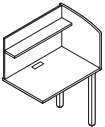

Add-On Study Carrel w/Shelf*

ENAC2924S	24 x 29 x 50	70	67	4.4	\$773	\$127	\$88
ENAC3524S	24 x 35 x 50	70	76.5	4.67	\$822	\$148	\$88
ENAC5924S	24 x 59 x 50	70	96	5.75	\$1027	\$227	\$88
ENAC7124S	24 x 59 x 50	70	105.5	6.3	\$1120	\$260	\$88

Features a 29" high work surface with curved side privacy panels. Shown with optional cut-out. Shelf is 6" deep and accepts optional LED task light. Bring power and USB charging to the user with Cove Daisylink components, see page 606. Shipped easy to assemble in 2 cartons.

LED TASK LIGHTS

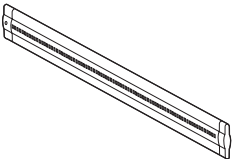

LED Task Light

MODEL #	DIMENSIONS	FREIGHT CLASS	WT/LB.	CUBIC FT.	LIST PRICE
PLED30	1.5 x 15.5 x .5	150	2	.50	\$494
PLED50	1.5 x 23.5 x .5	150	2	.50	\$569
PLED100	1.5 x 43.5 x .5	125	3	.50	\$660

Energy efficient LED. Ultra slim design. Suitable for mounting on the underside of the shelf of a study carrel. 6' power cord.

Required specifications

Top finish*
Edge finish*
Leg finish*
Surround finish*

Optional specifications

HP laminate*
Cut-out for Cove Daisylink modules*

Accessories

Cove Daisylink modules*
LED task lights*

COVE DAISYLINK COMPONENTS

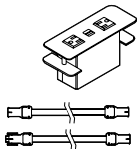

Single Power/USB for 29"/30" Carrels

MODEL#	DIMENSIONS D x W x H	FREIGHT CLASS	WT/LBS.	CUBIC FT.	LIST PRICE
ECV2PU30B	2 x 30 x -	60	4.5	0.5	\$640
ECV2PU30S	2 x 30 x -	60	4.5	0.5	\$640

Cove single desktop module with two power outlets and two 2.1A USB charging ports. Includes four cable clamps, one 14" female/male connecting cable and one 14" female/female connecting cable. Connecting cables will daisy-chain modules between two 30" wide starter carrels, one 30" wide starter carrel and one 29" wide add-on carrel, or two 29" wide add-on carrels. Available in Black **(B)** or Silver **(S)** - indicated by last letter of the model number. Infeed to be ordered separately.

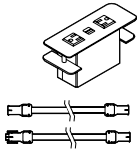

Single Power/USB for 35"/36" Carrels

ECV2PU36B	2 x 36 x -	60	4.6	0.5	\$644
ECV2PU36S	2 x 36 x -	60	4.6	0.5	\$644

Cove single desktop module includes two power outlets and two 2.1A USB charging ports. Includes four cable clamps, one 17" female/male connecting cable and one 17" female/female connecting cable. Connecting cables will daisy-chain modules between two 36" wide starter carrels, one 36" wide starter carrel and one 35" wide add-on carrel, or two 35" wide add-on carrels. Available in Black **(B)** or Silver **(S)** - indicated by last letter of the model number. Infeed to be ordered separately.

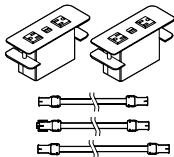

Double Power/USB for 59"/60" Carrels

ECV2PU60B	2 x 60 x -	60	4.6	0.5	\$1182
ECV2PU60S	2 x 60 x -	60	4.6	0.5	\$1182

Cove double desktop modules - each module includes two power outlets and two 2.1A USB charging ports. Includes four cable clamps, one 12" female/male connecting cable, one 12" female/female connecting cable and one 26" female/female interconnecting cable. Connecting cables will daisy-chain modules between two 60" wide starter carrels, one 60" wide starter carrel and one 59" wide add-on carrel, or two 59" wide add-on carrels. Available in Black **(B)** or Silver **(S)** - indicated by last letter of the model number.

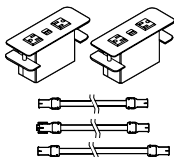

Double Power/USB for 71"/72" Carrels

ECV2PU72B	2 x 72 x -	60	4.6	0.5	\$1202
ECV2PU72S	2 x 72 x -	60	4.6	0.5	\$1202

Cove double desktop modules - each module includes two power outlets and two 2.1A USB charging ports. Includes four cable clamps, one 15" female/male connecting cable, one 15" female/female connecting cable and one 31" female/female interconnecting cable. Connecting cables will daisy-chain modules between two 72" wide starter carrels, one 72" wide starter carrel and one 71" wide add-on carrel, or two 71" wide add-on carrels. Available in Black **(B)** or Silver **(S)** - indicated by last letter of the model number.

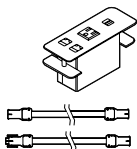

Single Power/Data/USB for 29"/30" Carrels

ECVPUD30B	2 x 30 x -	60	4.6	0.5	\$602
ECVPUD30S	2 x 30 x -	60	4.6	0.5	\$602

Cove single desktop module includes one power outlet, two data knockouts and two 2.1A USB charging ports. Includes four cable clamps, one 14" female/male connecting cable and one 14" female/female connecting cable. Data/telecom options to be ordered separately. Connecting cables will daisy-chain modules between two 30" wide starter carrels, one 30" wide starter carrel and one 29" wide add-on carrel, or two 29" wide add-on carrels. Available in Black **(B)** or Silver **(S)** - indicated by last letter of the model number. Infeed to be ordered separately.

COVE DAISYLINK COMPONENTS

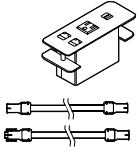

Single Power/Data/USB for 35"/36" Carrels

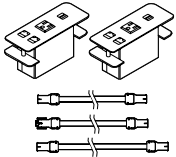

Double Power/Data/USB for 59"/60" Carrels

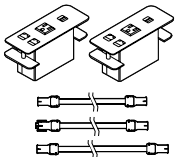

Double Power/Data/USB for 71"/72" Carrels

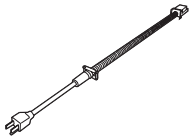

Single-Circuit Corded Infeed, 72"



Multi-Circuit Power Hardwire Infeed, 72"

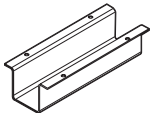

Jumper Guards - Set of 4

MODEL#	DIMENSIONS D x W x H	FREIGHT CLASS	WT/LBS.	CUBIC FT.	LIST PRICE
ECVPUD36B	2 x 36 x -	60	4.60	0.5	\$609
ECVPUD36S	2 x 36 x -	60	4.60	0.5	\$609

Cove single desktop module includes one power outlet, two data knockouts and two 2.1A USB charging ports. Includes four cable clamps, one 17" female/male connecting cable and one 17" female/female connecting cable. Data/telecom options to be ordered separately. Connecting cables will daisy-chain modules between two 36" wide starter carrels, one 36" wide starter carrel and one 35" wide add-on carrel, or two 35" wide add-on carrels. Available in Black (**B**) or Silver (**S**) - indicated by last letter of the model number. Infeed to be ordered separately.

ECVPUD60B	2 x 60 x -	60	4.6	0.5	\$1112
ECVPUD60S	2 x 60 x -	60	4.6	0.5	\$1112

Cove double desktop modules - each module includes one power outlet, two data knockouts and two 2.1A USB charging ports. Includes four cable clamps, one 12" female/male connecting cable, one 12" female/female connecting cable and one 26" female/female interconnecting cable. Data/telecom options to be ordered separately. Connecting cables will daisy-chain modules between two 60" wide starter carrels, one 60" wide starter carrel and one 59" wide add-on carrel, or two 59" wide add-on carrels. Available in Black (**B**) or Silver (**S**) - indicated by last letter of the model number. Infeed to be ordered separately.

ECVPUD72B	2 x 72 x -	60	4.6	0.5	\$1123
ECVPUD72S	2 x 72 x -	60	4.6	0.5	\$1123

Cove double desktop modules - each module includes one power outlet, two data knockouts and two 2.1A USB charging ports. Includes four cable clamps, one 15" female/male connecting cable, one 15" female/female connecting cable and one 31" female/female interconnecting cable. Data/telecom options to be ordered separately. Connecting cables will daisy-chain modules between two 72" wide starter carrels, one 72" wide starter carrel and one 71" wide add-on carrel, or two 71" wide add-on carrels. Available in Black (**B**) or Silver (**S**) - indicated by last letter of the model number. Infeed to be ordered separately.

42AP1-72	72"W	70	1	1.80	\$245
----------	------	----	---	------	--------------

72" corded infeed to start a run of Cove Daisylink modules. Maximum of 9 Cove modules per each infeed (Cove double counts as two modules).

42SB2-72	72"W	70	1	1.80	\$158
----------	------	----	---	------	--------------

Hardwire infeed to start a run of Cove Daisylink modules. Maximum of 9 Cove modules per each infeed (Cove double counts as two modules). Certified electrician required for installation.

ENCVG12	5 x 12 x 3.1	85	14	1.1	\$130
---------	--------------	----	----	-----	--------------

Metal channel to protect jumper connection to Cove Daisylink module. Black only. Mounts directly to the underside of surface.



FreeFit offers a universal freestanding design with finish options on bases and surfaces that allow you to easily integrate with existing Global workstation configurations, becoming a part of your workspace. With two concealed motors on each base, FreeFit adjusts at 1.5" per second while emitting just 44db. Select from two table ranges – standard range accommodates most users, while extended range meets BIFMA ergonomics guidelines accommodating an extensive array of user needs.



Features and Benefits

- Tops are 1" thick thermally fused laminate or 1 1/16" high pressure laminate
- Tops are constructed of 45 lb. density particle board
- Worksurfaces are sold separate from the base
- Steel constructed leg tubing, feet and cross bar
- Table frames include expandable width upper cross bars
- Standard up/down handset. Optional digital readout handset.



Add a 3rd leg kit to create an electric height adjustable L station.

GENERAL INFORMATION

- FreeFit Height Adjustable Tables allow for easy movement from sitting to standing and back throughout the day.
- FreeFit offers a universal freestanding design with finish options on the bases and surfaces that allow you to easily integrate with existing Global workstation configurations, becoming a part of your office space.
- Can be used alone or in conjunction with Global desks. Please note Global desks are 1" or 1.5" thick
- Global laminate products are in compliance with stringent emission guidelines set out by the Greenguard Environmental Institute under the standards for low emitting products and materials. www.greenguard.org.
- **Level 3 Certified.**

ORDERING GUIDELINES

CODES

The price list uses a numbering system with meaningful alphanumeric characters to create a simple to understand product number. This makes specifying the product much easier and more accurate.

SPECIFICATION EXAMPLE OF A HEIGHT ADJUSTABLE TABLE:

Ordered as components, please order:

1. BASE

PRODUCT CODE: **FT** - FreeFit
5 - Standard Range Legs
2 - Leg Quantity
SF - Small Frame
24 - Depth

OPTIONS:

Frame Style: **5** - Standard Range Frame 27.5" to 47"
6 - Extended Range Frame 22.5" to 48.5"

Leg Quantity: **1** - 1 leg for return kit
2 - 2 leg table kit
4 - 4 leg table kit

Frame Size: **BF** - Base Frame, for 30" to 42" wide tables
SF - Small Frame, for 48" to 60" wide tables
LF - Large Frame, for 66" to 84" wide tables

Worksurface Depth: **24** - For 23" deep worksurfaces
30 - For 29" and 35" deep worksurfaces

Leg Style: **CL** - C-shaped table leg
TL - T-shaped table leg

Controller Style: **S** - Standard controller
D - Display controller, add \$47 list (\$94 list for back-to-back benching and media tables).

Base Finish: BLK Black
DWT Designer White
TUN Tungsten

2. TOP

PRODUCT CODE: **FTWR2436**

Top: **LP** - Low Pressure laminate, 1" thick
HP - High Pressure laminate, 1-1/16" thick

Top Finish Laminate: Select Color

Top PVC Edge Finish: Select Color

3. ACCESSORIES

PRODUCT CODE: **FTAEC12**

Base Finish: BLK Black
DWT Designer White
TUN Tungsten

CONSTRUCTION

- Table frames feature 3.15" x 1.97" rectangular outer leg with larger tube attached to the foot.
- Open base design with ample room for chair and user's legs
- Flat foot design includes ½" adjustable glides
- Table frames include expandable width upper cross bars.
- Open base design has no lower crossbars.
- All table frames are easy to assemble with few parts.
- Tables are designed so that the paint will never mar on the leg during operation.
- Steel construction of the leg assembly tubing, feet and upper structure assemblies.
- Powder coat finishes for bases is standard in Designer White (**DWT**), Black (**BLK**) or Tungsten (**TUN**).
- All standard Global laminate finishes are available.
- Sizes of tops are "nominal". Unless otherwise stated, actual depth is 1" less and actual width is 2" less than "nominal" size.
- All bases lift 350 lbs on two leg tables.
- Operates at 1.5" per second.
- Standard Range Frame adjusts from 27.5" to 47" including the worksurface.
- Extended Range Frame adjusts from 22.5" to 48.5" including the worksurface.
- Worksurfaces and troughs are sold separate from the base.
- 1" thick tops constructed of 45 lb. density particle board with high performance thermally fused laminate.
- Laminate surfaces offer a selection of matching + coordinating edgeband. Specify separately from the surface finish.
- Products specified with the high pressure laminate option are 1-1/16" thick and finished on the underside of the surface with a kraft paper backing.
- Worksurface sizes are "nominal". Main worksurface sizes are 1" less in depth and 2" less in width.
- Steel constructed leg tubing, feet and cross bar.
- Back-to-back benching kits feature a pad foot with ½" adjustable glides
- Foot on single sided benching is 3.55"W x 1"H (with glides fully recessed).
- All products meet or exceed ANSI-BIFMA X5.5-2014 and 7.1 VOC. and CSA-C22.2 No. 6809, CAN/CGSB-44.228-2008.
- **All components** are UL 962 listed.

STANDARD RANGE COLUMNS

The 2-part lifting column is a perfect choice for a wide range of different desk applications in the office.

- Compact design where guide and actuator functions are an integrated unit
- Reinforced column and optimized motor housing design for extra strength and stability
- Max. load 800 N per column
- Max. speed 1.5"/second unloaded
- Standard installation dimension 25.4"
- Standard stroke length 19.7"
- Weight: Approximately 14.3 lbs. per column
- Column dimensions: 1.97" x 3.15" (outer profile) and 1.71" x 2.89" (inner profile)
- Motor housing dimensions: 6.97" x 3.82" x 1.81"
- Low noise level
- No visible gliding pads
- Standard Range Tables have 2-stages and feature an adjustment range of 27.5" – 45.5" (18" travel).

EXTENDED RANGE COLUMNS

The 3-part construction ensures a short installation dimension combined with a long stroke length making the Extended Range Column the optimum choice no matter the height of the person using it. The middle profile of the column moves synchronously so the profiles are always in the same height optimizing the desk design and the stability.

- Compact design where guide and actuator functions are an integrated unit
- Reinforced column and optimized motor housing design for extra strength and stability

- Max. thrust 1200 N per column (12 mm spindle pitch)
- Max. speed 1.5"/second unloaded
- Installation dimension: 22" / 20.4" (BIFMA)
- Stroke length: 25.6" / 26.2" (BIFMA)
- Weight: 17.2 lbs. per column
- Column dimensions: 1.97" x 3.15" (outer profile), 1.71" x 2.89" (middle profile), 1.46" x 2.64" (inner profile)
- Low noise level
- No visible gliding pads

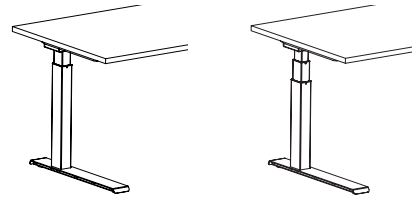

Standard range (2 stage)

Extended range (3-stage)

FOOT TYPE

- FreeFit offers two foot styles, either a "T" or "C".
- Feet offered in two lengths: 22.75" and 28".
- Foot offers a recessed connection for the column and connects from the bottom with 4 bolts.
- Adjustable glides are standard

DESK MOUNT FRAME

- Can be specified in three lengths:
Base Frame (**BF**) for tables 30" - 42" long (nominal dimensions)
Short Frame (**SF**) for tables 48" - 60" long (nominal dimensions)
Long Frame (**LF**) for tables 66" - 84" long (nominal dimensions)
- All metal parts are Black
- Cantilever length: 21.7"
- Central or off-center placement of columns (T-desk or C-desk)
- Includes all connecting hardware

CONTROL BOX

- Two leg tables come standard with a 200 W Control Box
 - Mains voltage 230 VAC, 50 Hz, or 120 VAC, 60 Hz
 - Ultra-compact; 8.25" long
 - Lightweight control box; weight is approximately 1 lb.
- Three Leg Tables come standard with a 300 W Control Box
 - can be connected up to 4 columns
 - Mains voltage 100-240 VAC, 50-60 Hz (universal)
 - Ultra-compact; 10.5" long
 - Lightweight control box; weight is approximately 1.1 lbs.
- Common features for the (200 W and 300 W):
 - Ultra-low; only 1.5" high
 - Environment: Operation Storage
 - Ambient temperature: 5 to 40 °C -10 to +50 °C
 - Relative humidity: 20 to 80 % at 30 °C 20 to 80 % at 30 °C
 - Atmospheric pressure: 700 to 1060 hPa 700 to 1060 hPa
 - Compact high-power SMPS (Switch Mode Power Supply)
 - Color: Black
 - Protection against overload (EOP), by individual current limitation
 - The control box is designed with a soft start/stop function
 - Autodetection of the number and type of columns connected
 - Cable grooves at the bottom to optimise cable management
 - White plugs for easy recognition when mounting/dismounting
 - PVC-Free™
 - Low standby power consumption – only 0.1 W.
 - Exchangeable standard mains cable

STANDARD HANDSET

- Features Bluetooth® connection, two favorite positions and an LED reminder to prompt users to change position.
- Controller is activated by tilting the desk panel in the same direction as the desk is intended to drive.
- Pulsating orange and green LED lights remind users to change positions.
- Using the integrated Bluetooth® and downloading the Desk Control App, users can also be reminded via notifications on their computer or smart devices.
- Black only. Black cable with RJ45 modular plug. 63" long.
- PVC-Free™, featuring ZERO™. Very low power consumption in standby mode.
- Approved according to EN 60335-1 and UL962

DISPLAY HANDSET

- Features Bluetooth® connection, four favorite positions, a display to guide users, and a light strip to prompt users to change position.
- Controller is activated by tilting the desk panel in the same direction as the desk is intended to drive.
- Display controller features a modern, discreet design with a glossy surface and integrated display to ensure a clean and minimalist design.
- The display provides guidance to users when operating the desk.
- Via pulsating orange and green lights, the light strip reminds users to change positions.
- Using the integrated Bluetooth® and downloading the Desk Control App, users can also be reminded via notifications on their computer or smart devices.
- Black only. Black cable with RJ45 modular plug. 63" long.
- PVC-Free™, featuring ZERO™. Very low power consumption in standby mode.
- Approved according to EN 60335-1 and UL962
- Specify **(D)**, add **\$59** list (**\$117** list for back-to-back benching and media tables).

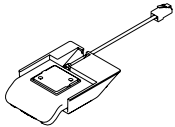

Standard handset **(S)**

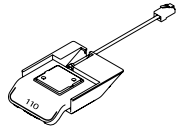

Display handset **(D)**

ANTI COLLISION SENSOR

- Features enhanced Anti-Collision protection which can limit material damage to a desk or an object if a collision occurs during driving of the desk.
- The sensor is a compact plug-in adapter based on gyroscope-technology, and it detects even slight tilting of the desk when the desk is driving up or down.
- Upon detected tilting, the system stops and drives in the opposite direction to avoid collision and damage to the desk or the object.
- The sensor can detect both hard and soft obstacles.
- The Anti-Collision Sensor is standard on all desks.
- Reacts to angle changes bigger than 0.7° per second
- Just plug it in – no mounting required
- ZERO™ power capable
- PVC-Free™

BATTERY BOX

- A high-performance lithium-Ion battery with a capacity of 2.15 Ah.
- On a full charge the table can cycle from 35 to 45 stroke lengths based upon the range of column selected and load on the table.
- Compact unit for easy handling and installation
- Battery alarm (audio) when charging is needed
- Battery charging indicator (LED light bars) indicating the capacity level
- Thermal switch protection, overcurrent protection
- Color: black
- Battery capacity: 2.15 Ah / 52 Wh
- Nominal voltage: 24 V DC
- Discharge current: 9 A (max)
- Maximum charging voltage: 40 V DC
- Charging current: 0.5 A
- Weight: 1.32 lbs.

USAGE

- Ambient temperature: 41 to 104 °C
- Storage temperature: 32 to 113 °C

Approved according to:

- EN 62133 (Battery safety testing)
- UL 1642 (Lithium cells, standard test)
- UN 38.3 (transportation of Lithium batteries)
- UL 2054 (Household and commercial batteries)
- EN 60335-1 with CBH Advanced

GROMMET WITH ACCESS DOOR OPTIONS FOR FREEFIT BENCHING

- Access door option is specified by first selecting a grommet position left or right of center, use code GL or GR, add \$83 list (see diagram on next page for specific position).
- Access doors are specified separately, using the code + list pricing below.
- Available in Black (**BLK**), Designer White (**DWT**) or Tungsten (**TUN**) paint finishes
- Device holder is only available in white plastic.
- CSA certified power bar includes (3) outlets and (2) charging USB ports (2.1 amp).

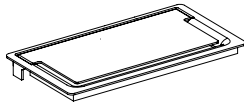

Standard Access Door (**GAADG**). Add **\$81**.

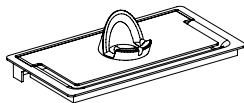

Access Door with Device Holder (**GAADGDH**). Add **\$88**.

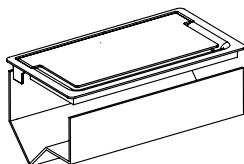

Access Door with Cable Tray (**GAADCT**). Add **\$131**.

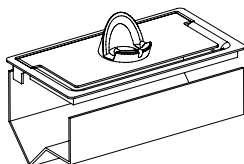

Access Door with Cable Tray & Device Holder (**GAADCTDH**). Add **\$139**.

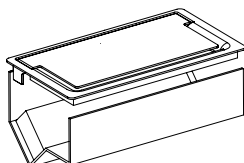

Access Door with Cable Tray & Power Bar (**GAADCTPD**). Add **\$279**.

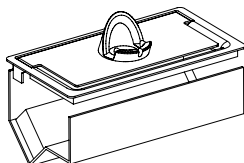

Access Door with Cable Tray, Power Bar & Device Holder (**GAADCTPDDH**). Add **\$287**.

ACCESS DOOR CUT-OUT DIMENSIONS

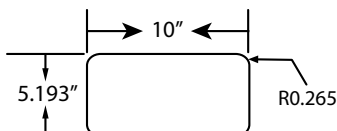

FINISHES

Laminate Top Finishes:

ACJ	Absolute Acajou
ASN	Asian Night
AWC	Avant Cherry
AWH	Avant Honey
BLK	Black - Coordinates with BLK Metal Frame Finish
BRC	Brushed Cobalt - Coordinates with TUN Metal Frame Finish
CMB	Clear Maple
CGY	Custom Grey
DES	Dark Espresso
DWT	Designer White - Coordinates with DWT Metal Frame Finish
HGT	Hayden Grey
NBL	Noce Biondo
NGL	Noce Grigio
NEL	Noce Leggero
NML	Noce Medio
QTM	Quartered Mahogany
SOG	Storm Grey
STG	String
TFW	Tiger Fruitwood
TWL	Tiger Walnut
WHE	Walnut Heights
WHC	White Chocolate
WCR	Winter Cherry
WGY	Willow Grey

Base Finishes

BLK	Black
DWT	Designer White
TUN	Tungsten

Edgeband Finishes:

AAE	Absolute Acajou
ASE	Asian Night
ACE	Avant Cherry
AHE	Avant Honey
BLK	Black
BRC	Brushed Cobalt
CHR	Charcoal (use w/SOG)
CME	Clear Maple
DEE	Dark Espresso
DWE	Designer White
NEV	Nevada (use w/STG)
QTM	Quartered Mahogany
SIL	Silver (use w/WGY)
TPE	Taupe (use w/HGT)
TFE	Tiger Fruitwood
TWE	Tiger Walnut
WHE	Walnut Heights
CBE	White Chocolate
WCE	Winter Cherry

CUT-OUT LOCATIONS

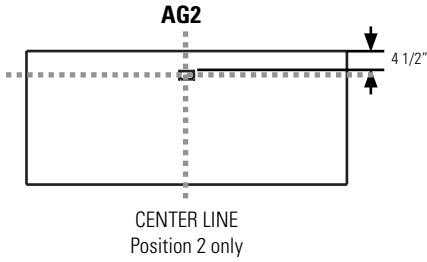

Rectangular Worksurfaces: 46", 52" & 58"
End of Run Table Top: 51"
Rectangular Return/Extension Return Worksurface: All sizes

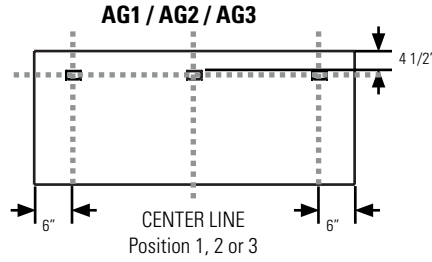

Rectangular Worksurfaces: 64", 70", 76", & 82"
End of Run Table Top: 63"

Access Door grommet in left position (GL)

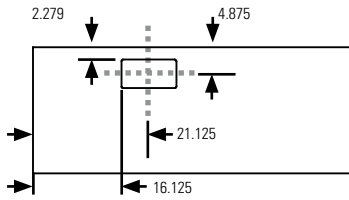

Access Door grommet in right position (GR)

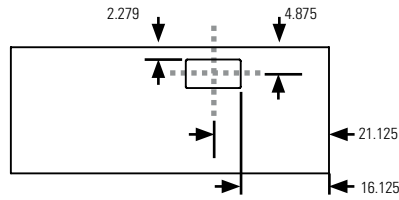

Select one or the other; both options are not available in one surface.
Rectangular Worksurfaces: 46" - 82"
End of Run Table Top: 51" & 63"

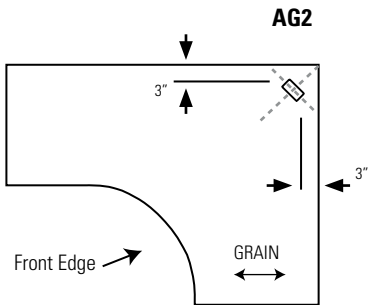

90° Corner Table Tops
Extended 90° Corner Table Tops

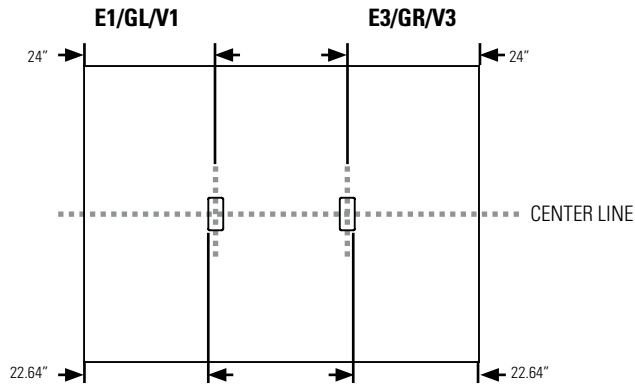

Media Table Tops

WORKSURFACES	MODEL#	DIMENSIONS	FREIGHT CLASS	WT/LBS.	CUBIC FT.	LIST PRICE	HP ADD
		D x W x H					
	FTWR2328	23 x 28 x 1	70	20	1.16	\$204	\$61
	FTWR2334	23 x 34 x 1	70	24	1.40	\$226	\$69
	FTWR2340	23 x 40 x 1	70	28	1.64	\$290	\$94
	FTWR2346	23 x 46 x 1	70	31	1.84	\$388	\$116
	FTWR2352	23 x 52 x 1	70	36	2.08	\$415	\$131
	FTWR2358	23 x 58 x 1	70	40	2.32	\$463	\$147
	FTWR2364	23 x 64 x 1	70	44	2.56	\$485	\$152
	FTWR2370	23 x 70 x 1	85	48	3.80	\$524	\$162
	FTWR2376	23 x 76 x 1	70	52	3.03	\$529	\$168
	FTWR2382	23 x 82 x 1	70	56	3.27	\$571	\$175
	FTWR2928	29 x 28 x 1	70	25	1.46	\$237	\$75
	FTWR2934	29 x 34 x 1	70	30	1.76	\$277	\$87
	FTWR2940	29 x 40 x 1	70	35	2.06	\$388	\$120
	FTWR2946	29 x 46 x 1	70	40	2.32	\$462	\$131
	FTWR2952	29 x 52 x 1	70	45	2.62	\$473	\$131
	FTWR2958	29 x 58 x 1	70	50	2.92	\$483	\$152
	FTWR2964	29 x 64 x 1	70	55	3.22	\$504	\$164
	FTWR2970	29 x 70 x 1	70	60	3.52	\$529	\$169
	FTWR2976	29 x 76 x 1	70	65	3.83	\$553	\$174
	FTWR2982	29 x 82 x 1	70	71	4.13	\$615	\$191
	FTWR3528	35 x 28 x 1	70	30	1.76	\$245	\$78
	FTWR3534	35 x 34 x 1	70	35	2	\$288	\$90
	FTWR3540	35 x 40 x 1	70	40	2.50	\$403	\$125
	FTWR3546	35 x 46 x 1	70	48	2.80	\$525	\$131
	FTWR3552	35 x 52 x 1	70	54	3.16	\$581	\$149
	FTWR3558	35 x 58 x 1	70	60	3.52	\$647	\$162
	FTWR3564	35 x 64 x 1	70	67	3.89	\$705	\$180
	FTWR3570	35 x 70 x 1	70	73	4.25	\$767	\$193
	FTWR3576	35 x 76 x 1	70	79	4.62	\$823	\$209
	FTWR3582	35 x 82 x 1	70	85	4.98	\$887	\$222
	FTWMR5460	54 x 60 x 1	70	96	5.63	\$772	\$298
	FTWMR5466	54 x 66 x 1	70	106	6.19	\$842	\$327
	FTWMR5472	54 x 72 x 1	70	115	6.75	\$912	\$358
	FTWMR5478	54 x 78 x 1	70	125	7.31	\$980	\$388
	FTWMR5484	54 x 84 x 1	70	135	7.88	\$1050	\$417
	FTWMR5490	54 x 90 x 1	70	144	8.44	\$1122	\$447
	FTWMR5496	54 x 96 x 1	70	154	9	\$1192	\$476
	FTWMR6060	60 x 60 x 1	70	107	6.25	\$846	\$332
	FTWMR6066	60 x 66 x 1	70	118	6.88	\$925	\$366
	FTWMR6072	60 x 72 x 1	70	128	7.50	\$1001	\$399
	FTWMR6078	60 x 78 x 1	70	139	8.13	\$1079	\$430
	FTWMR6084	60 x 84 x 1	70	150	8.75	\$1155	\$463
	FTWMR6090	60 x 90 x 1	70	160	9.38	\$1233	\$497
	FTWMR6096	60 x 96 x 1	70	171	10	\$1309	\$530



Rectangular Worksurfaces

Rectangular worksurfaces are non-handed and can be interchanged on site. For 23" deep worksurfaces, use FT52xx24 or FT62xx24. For 29" deep worksurfaces, use FT52xx30 or FT62xx30. For 35" deep worksurfaces, use FT52xx30 or FT62xx30.

• **35" deep worksurfaces cannot be used with Back-to-Back bases.**

• For back-to-back bases, please use the following chart:

FTWR(23/29)46, FT54BSF/FT64BSF	FTWR(23/29)64, FT54BLF/FT64BLF
FTWR(23/29)52, FT54BSF/FT64BSF	FTWR(23/29)72, FT54BLF/FT64BLF
FTWR(23/29)58, FT54BSF/FT64BSF	FTWR(23/29)76, FT54BLF/FT64BLF
	FTWR(23/29)82, FT54BLF/FT64BLF



Media Table Top

For tables FTWMR5460 and 6060, use FTM5B2BSF standard range or FTM6B2BSF extended range base. For all other tables, use FTM5B2BLF standard range or FTM6B2BLF extended range base

Required specifications

Top finish
Edge finish

Optional specifications

HP laminate
Grommet

WORKSURFACES

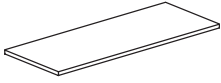

Rectangular Return Worksurfaces

MODEL#	DIMENSIONS D x W x H	FREIGHT CLASS	WT/LBS.	CUBIC FT.	LIST PRICE	HP ADD
FTWRR2329	23 x 29 x 1	70	20	1.16	\$247	\$61
FTWRR2335	23 x 35 x 1	70	24	1.40	\$334	\$73
FTWRR2341	23 x 41 x 1	70	28	1.64	\$369	\$97
FTWRR2347	23 x 47 x 1	70	32	1.88	\$388	\$116
FTWRR2353	23 x 53 x 1	70	36	2.12	\$415	\$131
FTWRR2359	23 x 59 x 1	70	40	2.36	\$457	\$147
FTWRR2929	29 x 29 x 1	70	25	1.46	\$309	\$76
FTWRR2935	29 x 35 x 1	70	30	1.76	\$457	\$88
FTWRR2941	29 x 41 x 1	70	35	2.06	\$457	\$123
FTWRR2947	29 x 47 x 1	70	40	2.36	\$462	\$131
FTWRR2953	29 x 53 x 1	70	46	2.67	\$473	\$131
FTWRR2959	29 x 59 x 1	70	51	2.97	\$551	\$152

Rectangular return worksurfaces are non-handed and can be interchanged on site. Includes two flat brackets for connection. For use with FT51SR/LR or FT61SR/LR. To determine the appropriate return base, use the following chart:

Main Surface	Return Surface	Return Base
FTWR23xx	FTWRR(23/29)29	FT51/61SR
FTWR23xx	FTWRR(23/29)35	FT51/61SR
FTWR23xx	FTWRR(23/29)41	FT51/61SR
FTWR23xx	FTWRR(23/29)47	FT51/61LR
FTWR23xx	FTWRR(23/29)53	FT51/61LR
FTWR23xx	FTWRR(23/29)59	FT51/61LR
FTWR29xx	FTWRR(23/29)29	FT51/61SR
FTWR29xx	FTWRR(23/29)35	FT51/61SR
FTWR29xx	FTWRR(23/29)41	FT51/61LR
FTWR29xx	FTWRR(23/29)47	FT51/61LR
FTWR29xx	FTWRR(23/29)53	FT51/61LR
FTWR29xx	FTWRR(23/29)59	FT51/61LR

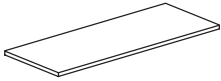

Rectangular End of Run Worksurfaces

FTWR2351	23 x 51 x 1	70	40	2.02	\$452	\$147
FTWR2362	23 x 62 x 1	70	44	2.50	\$475	\$152
FTWR2951	29 x 51 x 1	70	50	2.54	\$475	\$152
FTWR2962	29 x 62 x 1	70	55	3.15	\$486	\$245

Rectangular return worksurfaces are non-handed and can be interchanged on site.

- For 23" deep worksurfaces, use with FT52xx24 or FT62xx24.
- For 29" deep worksurfaces, use with FT52xx30 or FT62xx30.
- For back-to-back bases, please use the following chart:
 FTWR(23/29)51, FT52BSF24/30 or FT62BSF24/30
 FTWR(23/29)62, FT52BLF24/30 or FT62BLF24/30

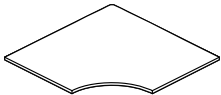

90° Corner Worksurface

FTWCC234023	40 x 40 x 1	60	80	1.5	\$751	\$75
FTWCC234623	46 x 46 x 1	60	95	2	\$773	\$77
FTWCC235223	52 x 52 x 1	70	80	4.69	\$897	\$93
FTWCC235823	58 x 58 x 1	70	100	5.84	\$1148	\$116
FTWCC294029	40 x 40 x 1	60	80	1.5	\$751	\$75
FTWCC294629	46 x 46 x 1	70	63	3.67	\$761	\$78
FTWCC295229	52 x 52 x 1	70	80	4.69	\$897	\$93
FTWCC295829	58 x 58 x 1	70	100	5.84	\$1148	\$116

For tables that connect with 23" deep worksurfaces, use with FT539FS24CL or FT639FS24CL. For tables that connect with 29" deep worksurfaces, use with FT539FS30CL or FT639FS30CL.

Required specifications

Top finish
Edge finish

Optional specifications

HP laminate
Grommet

EXTENDED CORNER WORKSURFACES

MODEL# DIMENSIONS FREIGHT CLASS WT/LBS. CUBIC FT. LIST PRICE HP ADD

D x W x H

FTWEC23584023	58 x 40 x 1	60	115	2.6	\$1012	\$255
FTWEC23644023	64 x 40 x 1	60	127	2.8	\$1125	\$282
FTWEC23704023	70 x 40 x 1	60	138	3.1	\$1230	\$311
FTWEC23764023	76 x 40 x 1	60	150	3.3	\$1313	\$326
FTWEC23824023	82 x 40 x 1	60	162	3.6	\$1393	\$349
FTWEC23584623	58 x 46 x 1	60	115	2.55	\$1058	\$265
FTWEC23644623	64 x 46 x 1	60	127	2.81	\$1176	\$296
FTWEC23704623	70 x 46 x 1	60	138	3.07	\$1286	\$325
FTWEC23764623	76 x 46 x 1	60	150	3.34	\$1372	\$343
FTWEC23824623	82 x 46 x 1	60	162	3.6	\$1456	\$366
FTWEC23585223	58 x 52 x 1	60	130	2.88	\$1089	\$276
FTWEC23645223	64 x 52 x 1	60	143	3.18	\$1211	\$306
FTWEC23705223	70 x 52 x 1	60	156	3.48	\$1324	\$334
FTWEC23765223	76 x 52 x 1	60	170	3.77	\$1413	\$353
FTWEC23825223	82 x 52 x 1	60	183	4.07	\$1498	\$377
FTWEC23645823	64 x 58 x 1	60	160	3.54	\$1247	\$313
FTWEC23705823	70 x 58 x 1	60	174	3.88	\$1364	\$344
FTWEC23765823	76 x 58 x 1	60	189	4.21	\$1456	\$365
FTWEC23825823	82 x 58 x 1	60	204	4.54	\$1543	\$391

FTWEC29584029	58 x 40 x 1	60	115	2.2	\$1053	\$264
FTWEC29644029	64 x 40 x 1	60	127	2.4	\$1172	\$292
FTWEC29704029	70 x 40 x 1	60	138	2.7	\$1279	\$323
FTWEC29764029	76 x 40 x 1	60	150	2.9	\$1365	\$339
FTWEC29824029	82 x 40 x 1	60	162	3.1	\$1448	\$364
FTWEC29584629	58 x 46 x 1	60	115	2.55	\$1101	\$277
FTWEC29644629	64 x 46 x 1	60	127	2.81	\$1223	\$307
FTWEC29704629	70 x 46 x 1	60	138	3.07	\$1337	\$339
FTWEC29764629	76 x 46 x 1	60	150	3.34	\$1427	\$355
FTWEC29824629	82 x 46 x 1	60	152	3.6	\$1513	\$380
FTWEC29585229	58 x 52 x 1	60	130	2.88	\$1134	\$287
FTWEC29645229	64 x 52 x 1	60	143	3.18	\$1259	\$318
FTWEC29705229	70 x 52 x 1	60	156	3.48	\$1378	\$347
FTWEC29765229	76 x 52 x 1	60	170	3.77	\$1469	\$366
FTWEC29825229	82 x 52 x 1	60	183	4.07	\$1560	\$392
FTWEC29645829	64 x 58 x 1	60	160	3.54	\$1297	\$327
FTWEC29705829	70 x 58 x 1	60	174	3.88	\$1420	\$357
FTWEC29765829	76 x 58 x 1	60	189	4.21	\$1513	\$379
FTWEC29825829	82 x 58 x 1	60	204	4.54	\$1605	\$403

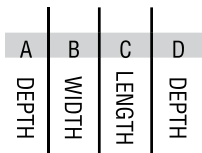
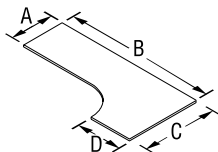

Ext. 90° Corner Worksurface, Left

For tables that connect with 23" deep (**A** and **D**) worksurfaces, use with FT539F(S/L)24CL or FT539F(S/L)24CL bases. For tables that connect with 29" deep (**A** and **D**) worksurfaces, use with FT539F(S/L)30CL or FT639F(S/L)30CL bases. Must use with FTWRExxx return surfaces only.

Required specifications

Top finish
Edge finish

Optional specifications

HP laminate
Grommet

MODEL# DIMENSIONS FREIGHT CLASS WT/LBS. CUBIC FT. LIST PRICE HP ADD

D x W x H

FTWEC23405823	58 x 40 x 1	60	115	2.6	\$1012	\$255
FTWEC23406423	64 x 40 x 1	60	127	2.8	\$1125	\$282
FTWEC23407023	70 x 40 x 1	60	138	3.1	\$1230	\$311
FTWEC23407623	76 x 40 x 1	60	150	3.3	\$1313	\$326
FTWEC23408223	82 x 40 x 1	60	162	3.6	\$1393	\$349
FTWEC23465823	58 x 46 x 1	60	115	2.55	\$1058	\$265
FTWEC23466423	64 x 46 x 1	60	127	2.81	\$1176	\$296
FTWEC23467023	70 x 46 x 1	60	138	3.07	\$1286	\$325
FTWEC23467623	76 x 46 x 1	60	150	3.34	\$1372	\$343
FTWEC23468223	82 x 46 x 1	60	162	3.6	\$1456	\$366
FTWEC23525823	58 x 52 x 1	60	130	2.88	\$1089	\$276
FTWEC23526423	64 x 52 x 1	60	143	3.18	\$1211	\$306
FTWEC23527023	70 x 52 x 1	60	156	3.48	\$1324	\$334
FTWEC23527623	76 x 52 x 1	60	170	3.77	\$1413	\$353
FTWEC23528223	82 x 52 x 1	60	183	4.07	\$1498	\$377
FTWEC23586423	64 x 58 x 1	60	160	3.54	\$1247	\$313
FTWEC23587023	70 x 58 x 1	60	174	3.88	\$1364	\$344
FTWEC23587623	76 x 58 x 1	60	189	4.21	\$1456	\$365
FTWEC23588223	82 x 58 x 1	60	204	4.54	\$1543	\$391

FTWEC29405829	58 x 40 x 1	60	115	2.2	\$1053	\$264
FTWEC29406429	64 x 40 x 1	60	127	2.4	\$1172	\$292
FTWEC29407029	70 x 40 x 1	60	138	2.7	\$1279	\$323
FTWEC29407629	76 x 40 x 1	60	127	2.4	\$1365	\$339
FTWEC29408229	82 x 40 x 1	60	162	3.1	\$1448	\$364
FTWEC29465829	58 x 46 x 1	60	115	2.55	\$1101	\$277
FTWEC29466429	64 x 46 x 1	60	127	2.81	\$1223	\$307
FTWEC29467029	70 x 46 x 1	60	138	3.07	\$1337	\$339
FTWEC29467629	76 x 46 x 1	60	150	3.34	\$1427	\$355
FTWEC29468229	82 x 46 x 1	60	162	3.6	\$1513	\$380
FTWEC29525829	58 x 52 x 1	60	130	2.88	\$1134	\$287
FTWEC29526429	64 x 52 x 1	60	143	3.18	\$1259	\$318
FTWEC29527029	70 x 52 x 1	60	156	3.48	\$1378	\$347
FTWEC29527629	76 x 52 x 1	60	170	3.77	\$1469	\$366
FTWEC29528229	82 x 52 x 1	60	183	4.07	\$1560	\$392
FTWEC29586429	64 x 58 x 1	60	160	3.54	\$1297	\$327
FTWEC29587029	70 x 58 x 1	60	174	3.88	\$1420	\$357
FTWEC29587629	76 x 58 x 1	60	189	4.21	\$1513	\$379
FTWEC29588229	82 x 58 x 1	60	204	4.54	\$1605	\$403

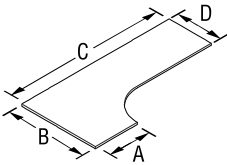

Ext. 90° Corner Worksurface, Right

For tables that connect with 23" deep (A and D) worksurfaces, use with FT539F(S/L)24CL or FT539F(S/L)24CL bases. For tables that connect with 29" deep (A and D) worksurfaces, use with FT539F(S/L)30CL or FT639F(S/L)30CL bases. Must use with FTWRExxxx return surfaces only.

FTWRE2324	23 x 24 x 1	70	16	0.96	\$191	\$63
FTWRE2330	23 x 30 x 1	70	20	1.2	\$208	\$61
FTWRE2336	23 x 36 x 1	70	25	1.44	\$231	\$73
FTWRE2924	29 x 24 x 1	70	21	1.21	\$227	\$67
FTWRE2930	29 x 30 x 1	70	26	1.51	\$241	\$76
FTWRE2936	29 x 36 x 1	70	31	1.81	\$280	\$88

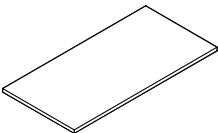

Rectangular Extension**
Return Worksurface

Worksurfaces to be used only with Extended 90° Corner Worksurfaces.

- FTWRE23 to be used with FTWEC23xxxx23
- FTWRE29 to be used with FTWEC29xxxx29

Required specifications

Top finish
Edge finish

Optional specifications

HP laminate
Grommet

BASES

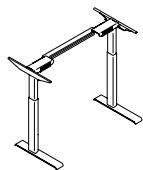

Standard Range Base*

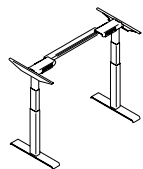

Extended Range Base*

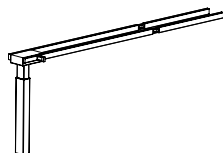

Standard Range Return Kit

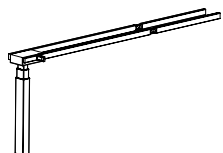

Extended Range Return Kit

MODEL# DIMENSIONS FREIGHT CLASS WT/LBS. CUBIC FT. LIST PRICE

D x W x H

FT52BF24	24 x 30-42 x 27.5-47	60	67	1.47	\$1255
FT52SF24		60	67	1.47	\$1382
FT52LF24		60	67	1.47	\$1388
FT52BF30	30-36 x 30-42 x 27.5-47	60	67	1.47	\$1265
FT52SF30		60	67	1.47	\$1392
FT52LF30		60	67	1.47	\$1398

Kit includes one beam, two cantilevers, two standard range columns, and two C or T styled feet. **BF** indicates base frame for 30" to 42" tables. **SF** indicates small frame for 48" to 60" tables. **LF** indicates large frame: 66" to 84" tables. For 23" deep worksurfaces, use 24" leg. For 29" and 35" deep worksurface, use 30" leg. For enhanced collision detection, an Anti Collision Desk Sensor is included with every base. Standard up/down controller with 2 memory positions, reminder settings + Bluetooth capability is standard - specify **(S)**. For a Display controller with height readout, 4 memory positions, reminder settings + Bluetooth capabilities, specify **(D)**, add **\$59** list. Specify paint finish: Black **(BLK)**, Designer White **(DWT)**, Tungsten **(TUN)**.

FT62BF24	24 x 30-42 x 22.5-48.5	60	67	1.47	\$1341
FT62SF24	24 x 48-60 x 22.5-48.5	60	67	1.47	\$1473
FT62LF24	24 x 66-84 x 22.5-48.5	60	67	1.47	\$1480
FT62BF30	30-36 x 30-42 x 22.5-48.5	60	67	1.47	\$1351
FT62SF30	30-36 x 48-60 x 22.5-48.5	60	67	1.47	\$1485
FT62LF30	30-36 x 66-84 x 22.5-48.5	60	67	1.47	\$1489

Kit includes one beam, two cantilevers, two extended range columns, and two C or T styled feet. **BF** indicates base frame for 30" to 42" tables. **SF** indicates small frame for 48" to 60" tables. **LF** indicates large frame: 66" to 84" tables. For 23" deep worksurfaces, use 24" leg. For 29" and 35" deep worksurface, use 30" leg. For enhanced collision detection, an Anti Collision Desk Sensor is included with every base. Standard up/down controller with 2 memory positions, reminder settings + Bluetooth capability is standard - specify **(S)**. For a Display controller with height readout, 4 memory positions, reminder settings + Bluetooth capabilities, specify **(D)**, add **\$59** list. Specify paint finish: Black **(BLK)**, Designer White **(DWT)**, Tungsten **(TUN)**.

FT51SRNL	-- x 24-48 x 27.5-47	60	61	1.47	\$846
FT51LRNL	-- x 54-72 x 27.5-47	60	61	1.47	\$863

Kit includes one beam, one cantilever, one standard range columns, and one pad foot. See chart on previous page to determine whether SR or LR kit is required. For 23" deep worksurfaces, use 24" return. For 29" and 35" deep worksurface, use 30" return. Specify paint finish: Black **(BLK)**, Designer White **(DWT)**, Tungsten **(TUN)**.

- When using the return kit for a 23"d return and a 29"/35" deep desk, a new foot must be ordered separately. See FTFOOT24TL/CL (page 627) for specification information.

FT61SRNL	-- x 24-48 x 22.5-48.5	60	61	1.47	\$890
FT61LRNL	-- x 54-72 x 22.5-48.5	60	61	1.47	\$908

Kit includes one beam, one cantilever, one standard range columns, and one pad foot. See chart on previous page to determine whether SR or LR kit is required. For 23" deep worksurfaces, use 24" return. For 29" and 35" deep worksurface, use 30" return. Specify paint finish: Black **(BLK)**, Designer White **(DWT)**, Tungsten **(TUN)**.

- When using the return kit for a 23"d return and a 29"/35" deep desk, a new foot must be ordered separately. See FTFOOT24TL/CL (page 627) for specification information.

Required specifications

Base finish
Leg style*

Optional specifications

Digital handset

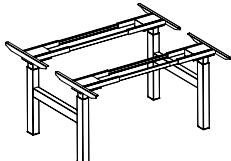
BASES	MODEL#	DIMENSIONS D x W x H	FREIGHT CLASS	WT/LBS.	CUBIC FT.	LIST PRICE
	FT54BSFNL	24 x 24-48 x 27.5-47	60	123	2.94	\$3080
	FT54BLFNL	24 x 54-72 x 27.5-47	60	123	2.94	\$3089

Back-to-Back Standard Range Base

Back-to-back height adjustable bases includes four height adjustable columns with pad feet, two sets of cross rails for surface support and two short beams to attach the columns back-to-back. Combine with surfaces & trough kits (sold separately) to create a complete workstation. For 50.5" depth, use two x 23" deep worksurfaces. For 62.5" depth, use two x 29" deep worksurfaces. **30" or larger depth worksurfaces cannot be used with Back to Back bases.** Duplex receptacles are not included, please specify separately. For enhanced collision detection, an Anti Collision Desk Sensor is included with every base. Standard up/down controller with 2 memory positions, reminder settings + Bluetooth capability is standard - specify **(S)**. For a Display controller with height readout, 4 memory positions, reminder settings + Bluetooth capabilities, specify **(D)**, add **\$117** list. Specify paint finish: Black **(BLK)**, Designer White **(DWT)**, Tungsten **(TUN)**.

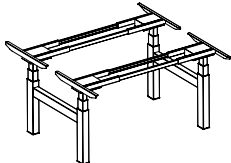

Back-to-Back Extended Range Base

FT64BSFNL	10 x -- x 22.5-48.5	60	123	2.94	\$3253
FT64BLFNL	10 x -- x 22.5-48.5	60	123	2.94	\$3264

Back-to-back height adjustable bases includes four height adjustable columns with pad feet, two sets of cross rails for surface support and two short beams to attach the columns back-to-back. Combine with surfaces & trough kits (sold separately) to create a complete workstation. For 50.5" depth, use two x 23" deep worksurfaces. For 62.5" depth, use two x 29" deep worksurfaces. **30" or larger depth worksurfaces cannot be used with Back to Back bases.** Duplex receptacles are not included, please specify separately. For enhanced collision detection, an Anti Collision Desk Sensor is included with every base. Standard up/down controller with 2 memory positions, reminder settings + Bluetooth capability is standard - specify **(S)**. For a Display controller with height readout, 4 memory positions, reminder settings + Bluetooth capabilities, specify **(D)**, add **\$117** list. Specify paint finish: Black **(BLK)**, Designer White **(DWT)**, Tungsten **(TUN)**.

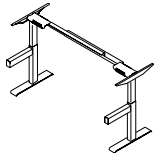

Standard Range Single Frame

FT52BSF24	24 x -- x 27.5-47	60	72	1.47	\$1741
FT52BLF24	24 x -- x 27.5-47	60	72	1.47	\$1751
FT52BSF30	30 x -- x 27.5-47	60	72	1.47	\$1806
FT52BLF30	30 x -- x 27.5-47	60	72	1.47	\$1816

Single sided height adjustable bases includes two height adjustable columns with "T" feet, one set of cross rails for surface support and two short beams to attach the columns to a trough kit. Combine with single surfaces & trough kits (sold separately) to create a complete workstation. Use 23" deep worksurfaces with FT52BSF24 + FT52BLF24. Use 29" deep worksurfaces with FT52BSF30 + FT52BLF30. **30" or larger depth worksurfaces cannot be used with benching bases.** Duplex receptacles are not included, please specify separately. For enhanced collision detection, an Anti Collision Desk Sensor is included with every base. Standard up/down controller with 2 memory positions, reminder settings + Bluetooth capability is standard - specify **(S)**. For a Display controller with height readout, 4 memory positions, reminder settings + Bluetooth capabilities, specify **(D)**, add **\$117** list. Specify paint finish: Black **(BLK)**, Designer White **(DWT)**, Tungsten **(TUN)**.

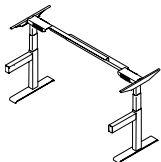

Extended Range Single Frame

FT62BSF24	24 x -- x 22.5-48.5	60	72	1.47	\$1887
FT62BLF24	24 x -- x 22.5-48.5	60	72	1.47	\$1892
FT62BSF30	30 x -- x 22.5-48.5	60	72	1.47	\$1897
FT62BLF30	30 x -- x 22.5-48.5	60	72	1.47	\$1903

Single sided height adjustable bases includes two height adjustable columns with "T" feet, one set of cross rails for surface support and two short beams to attach the columns to a trough kit. Combine with single surfaces & trough kits (sold separately) to create a complete workstation. Use 23" deep worksurfaces with FT62BSF24 + FT62BLF24. Use 29" deep worksurfaces with FT62BSF30 + FT62BLF30. **30" or larger depth worksurfaces cannot be used with benching bases.** Duplex receptacles are not included, please specify separately. For enhanced collision detection, an Anti Collision Desk Sensor is included with every base. Standard up/down controller with 2 memory positions, reminder settings + Bluetooth capability is standard - specify **(S)**. For a Display controller with height readout, 4 memory positions, reminder settings + Bluetooth capabilities, specify **(D)**, add **\$117** list. Specify paint finish: Black **(BLK)**, Designer White **(DWT)**, Tungsten **(TUN)**.

Required specifications

Base finish
Leg style*

Optional specifications

Digital handset

BASES

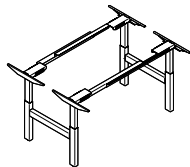

Standard Range Media Table Base

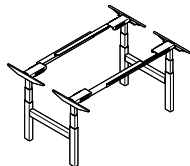

Extended Range Media Table Base

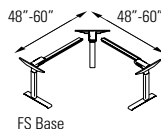

FS Base

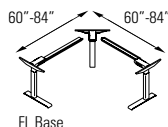

FL Base

Standard Range 90° Base, Equal Sides

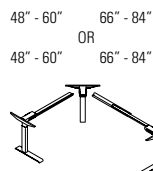

Standard Range 90° Base, Unequal Sides

MODEL# DIMENSIONS FREIGHT CLASS WT/LBS. CUBIC FT. LIST PRICE

D x W x H

FTM5B2BSF	54-60 x 60 x 27.5-47	60	123	2.94	\$3080
FTM5B2BLF	54-60 x 60 x 27.5-47	60	123	2.94	\$3089

Kit includes two beams, four cantilevers, four standard range columns and two controllers. SF indicates small base for 60" sided tables. LF indicates large base for 66" to 84" sided tables. For enhanced collision detection, an Anti Collision Desk Sensor is included with every base. Standard up/down controller with 2 memory positions, reminder settings + Bluetooth capability is standard - specify **(S)**. For a Display controller with height readout, 4 memory positions, reminder settings + Bluetooth capabilities, specify **(D)**, add **\$117** list. Specify paint finish: Black **(BLK)**, Designer White **(DWT)**, Tungsten **(TUN)**.

FTM6B2BSF	54-60 x 60 x 22.5-48.5	60	123	2.94	\$3253
FTM6B2BLF	54-60 x 60 x 22.5-48.5	60	123	2.94	\$3264

Kit includes two beams, four cantilevers, four extended range columns and two controllers. SF indicates small base for 60" sided tables. LF indicates large base for 66" to 84" sided tables. For enhanced collision detection, an Anti Collision Desk Sensor is included with every base. Standard up/down controller with 2 memory positions, reminder settings + Bluetooth capability is standard - specify **(S)**. For a Display controller with height readout, 4 memory positions, reminder settings + Bluetooth capabilities, specify **(D)**, add **\$117** list. Specify paint finish: Black **(BLK)**, Designer White **(DWT)**, Tungsten **(TUN)**.

FT539FS24CL	54-60 x 42-60 x 27.5-47	60	101	1.47	\$2011
FT539FS30CL	54-60 x 42-60 x 27.5-47	60	101	1.47	\$2023
FT539FL24CL	66-84 x 66-84 x 27.5-47	60	101	1.47	\$2047
FT539FL30CL	66-84 x 66-84 x 27.5-47	60	101	1.47	\$2030

Kit includes two equal length beams, three cantilevers, one standard range corner column, two standard range columns, and two C styled feet. **FS** indicates small base for 54" to 60" sided tables. **FL** indicates large base: 66" to 84" sided tables. For 23" deep worksurfaces, use 24" CL leg. For 29" and 35" deep worksurface, use 30" CL leg. For enhanced collision detection, an Anti Collision Desk Sensor is included with every base.

Standard up/down controller with 2 memory positions, reminder settings + Bluetooth capability is standard - specify **(S)**. For a Display controller with height readout, 4 memory positions, reminder settings + Bluetooth capabilities, specify **(D)**, add **\$59** list. Specify paint finish: Black **(BLK)**, Designer White **(DWT)**, Tungsten **(TUN)**.

- When using a 23"d return with the FT539FS30CL/LF30CL a 24" foot must be ordered separately. See FTFOOT24TL/CL (page 627) for specification information.

FT539FSL24CL	66-84 x 42-60 x 27.5-47	60	101	1.47	\$2030
FT539FSL30CL	66-84 x 42-60 x 27.5-47	60	101	1.47	\$2040

Kit includes two beams (one small, one large), three cantilevers, one standard range corner column, two standard range columns, and two C styled feet. For 23" deep worksurfaces, use 24" CL leg. For 29" and 35" deep worksurface, use 30" CL leg. For enhanced collision detection, an Anti Collision Desk Sensor is included with every base.

Standard up/down controller with 2 memory positions, reminder settings + Bluetooth capability is standard - specify **(S)**. For a Display controller with height readout, 4 memory positions, reminder settings + Bluetooth capabilities, specify **(D)**, add **\$59** list. Specify paint finish: Black **(BLK)**, Designer White **(DWT)**, Tungsten **(TUN)**.

- When using a 23"d return with the FT539FSL30CL a 24" foot must be ordered separately. See FTFOOT24TL/CL (page 627) for specification information.

Required specifications

Base finish

Optional specifications

Digital handset

BASES

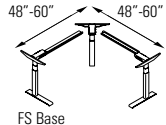

FS Base

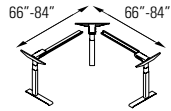

FL Base

Extended Range 90° Base, Equal Sides*

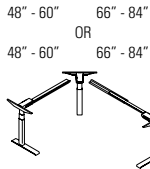

Extended Range 90° Base, Unequal Sides*

MODEL#	DIMENSIONS D x W x H	FREIGHT CLASS	WT/LBS.	CUBIC FT.	LIST PRICE
FT639FS24CL	48-60 x 42-60 x 22.5-48.5	60	101	1.47	\$2148
FT639FS30CL	48-60 x 42-60 x 22.5-48.5	60	101	1.47	\$2159
FT639FL24CL	66-84 x 66-84 x 22.5-48.5	60	101	1.47	\$2184
FT639FL30CL	66-84 x 66-84 x 22.5-48.5	60	101	1.47	\$2195

Kit includes two equal length beams, three cantilevers, one extended range corner column, two extended range columns, and two C styled feet. **FS** indicates small base for 54" to 60" sided tables. **FL** indicates large base: 66" to 84" sided tables. For 23" deep worksurfaces, use 24" CL leg. For 29" and 35" deep worksurface, use 30" CL leg. For enhanced collision detection, an Anti Collision Desk Sensor is included with every base.

Standard up/down controller with 2 memory positions, reminder settings + Bluetooth capability is standard - specify **(S)**. For a Display controller with height readout, 4 memory positions, reminder settings + Bluetooth capabilities, specify **(D)**, add **\$59** list. Specify paint finish: Black (**BLK**), Designer White (**DWT**), Tungsten (**TUN**).

- When using a 23"d return with the FT639FS30CL/LF30CL a 24" foot must be ordered separately. See FTFOOT24TL/CL (page 627) for specification information.

FT639FSL24CL	48-84 x 48-60 x 22.5-48.5	60	101	1.47	\$2166
FT639FSL30CL	48-84 x 48-60 x 22.5-48.5	60	101	1.47	\$2177

Kit includes two beams (one small, one large), three cantilevers, one extended range corner column, two extended range columns, and two C styled feet. For 23" deep worksurfaces, use 24" CL leg. For 29" and 35" deep worksurface, use 30" CL leg. For enhanced collision detection, an Anti Collision Desk Sensor is included with every base.

Standard up/down controller with 2 memory positions, reminder settings + Bluetooth capability is standard - specify **(S)**. For a Display controller with height readout, 4 memory positions, reminder settings + Bluetooth capabilities, specify **(D)**, add **\$59** list. Specify paint finish: Black (**BLK**), Designer White (**DWT**), Tungsten (**TUN**).

- When using a 23"d return with the FT639FSL30CL a 24" foot must be ordered separately. See FTFOOT24TL/CL (page 627) for specification information.

Required specifications

Top finish
Base finish
Foot style
Foot configuration

Optional specifications

HP laminate
Digital handset
Grommet
Insulation type

Accessories

Keyboard tray
Power block

LAMINATE LEG SHROUDS

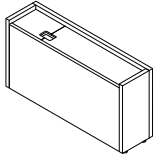

Laminate Leg Shroud, for C-Leg - Left**

MODEL# DIMENSIONS FREIGHT CLASS WT/LBS. CUBIC FT. LIST PRICE

D x W x H

FTB23L	9 x 23 x 18	65	47	2	\$519
FTB29L	9 x 29 x 18	70	55	3	\$537
FTB35L	9 x 35 x 18	70	67	3	\$560

Laminate housing to cover a FreeFit C-leg on the left side. Includes a felt liner at the top. Short side panel is removable to access interior. Specify laminate finish, PVC edge finish and felt finish.

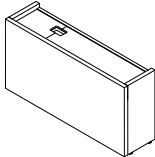

Laminate Leg Shroud, for C-Leg - Right**

FTB23R	9 x 23 x 18	65	47	2	\$519
FTB29R	9 x 29 x 18	70	55	3	\$537
FTB35R	9 x 35 x 18	70	67	3	\$560

Laminate housing to cover a FreeFit C-leg on the right side. Includes a felt liner at the top. Short side panel is removable to access interior. Specify laminate finish, PVC edge finish and felt finish.

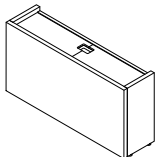

Laminate Housing for T-Leg**

FTB23	9 x 23 x 18	65	47	2	\$519
FTB29	9 x 29 x 18	70	55	3	\$537
FTB35	9 x 35 x 18	70	67	3	\$560

Laminate housing to cover a FreeFit T-leg. Includes a felt liner at the top. Short side panel is removable to access interior. Specify laminate finish, PVC edge finish and felt finish.

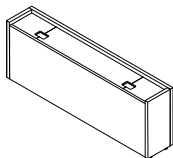

Laminate Leg Shroud, for Back to Back and Media Bases

FTB51	9 x 50.5 x 18	60	404	5	\$1152
FTB63	9 x 62.5 x 18	60	440	6	\$1339

Laminate shroud for either a FreeFit back-to-back or media table base. Includes a felt liner at the top. Side panel is removable to access interior. Specify laminate finish, PVC edge finish and felt finish.

Required specifications

- Laminate finish
- Edge finish
- Felt finish

4-2-2 Wiring Schematic
8-Wire Shared Neutral
"2 + 2" - 2 Utility Circuits, 2 Dedicated

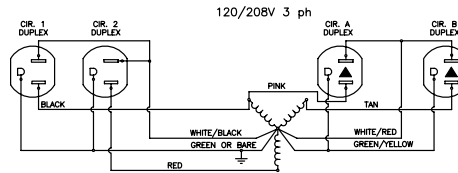
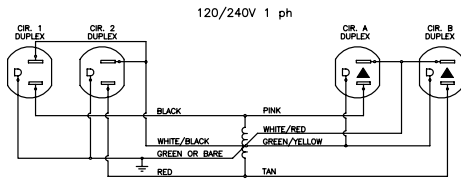

8 Wires	4 Circuits	Receptacles	Specifications
4 Lines (12 ga.) 2 Neutrals (10 ga.) 2 Grounds (12 ga.)	2 Utility circuits 2 Dedicated Circuits	Duplex - Up to 12 duplex receptacles per circuit (Up to 48 per infeed)	System rated for connection to a grounded 120/240 V single phase, 20A, 60Hz or 120/208 V, 3 phase, 20A, 60Hz branch circuit for U.S. and 15A if product is marked with a C-UL Mark. Outlets rated 15A max.

TROUGH KITS

MODEL#

DIMENSIONS

FREIGHT CLASS

WT/LBS.

CUBIC FT.

LIST PRICE



Back-to-Back Trough Kit

FTB2B48KITNB	--	92.5	3.50	.30	\$2201
FTB2B54KITNB	--	92.5	3.50	.30	\$2269
FTB2B60KITNB	--	92.5	3.50	.30	\$2383
FTB2B66KITNB	--	92.5	3.50	.30	\$2429
FTB2B72KITNB	--	92.5	3.50	.30	\$2457

For back-to-back benching applications. Trough kits contain all items needed for a standard back-to-back workstation when combined with the back-to-back height adjustable base and worksurfaces (both sold separately). Kits include two cable chains and one back-to-back power trough with distribution housing included. Specify duplexes separately.

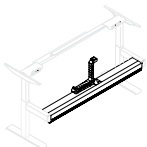

Single Sided Trough Kit

FTSGL48KITNB	--	92.5	3.50	.30	\$1438
FTSGL54KITNB	--	92.5	3.50	.30	\$1507
FTSGL60KITNB	--	92.5	3.50	.30	\$1592
FTSGL66KITNB	--	92.5	3.50	.30	\$1637
FTSGL72KITNB	--	92.5	3.50	.30	\$1683

For single-sided benching applications. Trough kits contain all items needed for a single sided workstation when combined with the back-to-back height adjustable base and worksurfaces (both sold separately). Kits include two cable chains and one back-to-back power trough with distribution housing included. Specify duplexes separately.

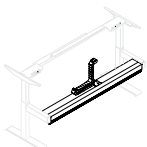

End of Run Trough Kit

FTSGL51T24KITNB	--	92.5	3.50	.30	\$1507
-----------------	----	------	------	-----	---------------

For perpendicular end of run benching applications. Trough kits contain all items needed for a standard back-to-back workstation when combined with the back-to-back height adjustable base and worksurfaces (both sold separately). Kits include two cable chains and one back-to-back power trough with distribution housing included. Specify duplexes separately.

ACCESS DOORS

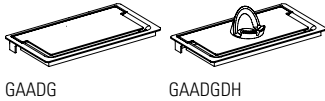

Access Door Module

MODEL# DIMENSIONS FREIGHT CLASS WT/LBS. CUBIC FT. LIST PRICE

D x W x H

GAADG	5.54 x 10.09 x 1.08	--	2	0.04	\$81
GAADGDH	5.54 x 10.09 x 1.08	--	2	0.04	\$88

Soft close door is set back from edge to allow for cable pass thru when closed. Available in all standard base finishes. GAADGDH includes device holder for most mobile phones or tablets. Holder is only available in White. FreeFit can only accommodate one grommet per worksurface.

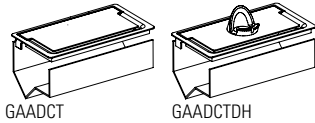

Access Door Module w/Cable Tray

GAADCT	5.54 x 10.09 x 5.07	--	4	0.19	\$131
GAADCTDH	5.54 x 10.09 x 5.07	--	4	0.19	\$139

Soft close door is set back from edge to allow for cable pass thru when closed. Cable tray comes standard with one telecom knockout and platform to mount a power bar. Sides are open for easy access. Available in all standard base finishes. GAADCTDH includes device holder for most mobile phones or tablets. Holder is only available in White. FreeFit can only accommodate one grommet per worksurface.

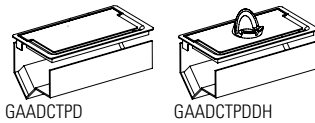

Access Door Module w/Cable Tray and Power Bar

GAADCTPD	5.54 x 10.09 x 6.96	--	4	0.20	\$279
GAADCTPDDH	5.54 x 10.09 x 6.96	--	4	0.20	\$287

Soft close door is set back from edge to allow for cable pass thru when closed. Cable tray comes standard with one telecom knockout and platform to mount a powerbar. Power bar with 3 simplex and 2 USB, CSA Certified. Sides are open for easy access. Available in all standard base finishes. GAADCTPDDH includes device holder for most mobile phones or tablets. Holder is only available in White. FreeFit can only accommodate one grommet per worksurface.

ELECTRICAL COMPONENTS

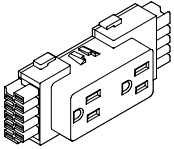

Duplex Receptacles

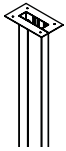

Ceiling Feed Post*



Ceiling Feed Harness

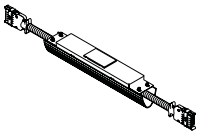

Table to Table Connector*

MODEL#	DIMENSIONS D x W x H	FREIGHT CLASS	WT/LBS.	CUBIC FT.	LIST PRICE
BRTE8D1	1.25 x 4.63 x 2	70	.10	.01	\$38
BRTE8D2	1.25 x 4.63 x 2	70	.10	.01	\$38
BRTE8DA	1.25 x 4.63 x 2	70	.10	.01	\$38
BRTE8DB	1.25 x 4.63 x 2	70	.10	.01	\$38
BRTE8DXW1	1.25 x 4.63 x 2	70	.10	.01	\$53
BRTE8DXW2	1.25 x 4.63 x 2	70	.10	.01	\$53
BRTE8DXWA	1.25 x 4.63 x 2	70	.10	.01	\$53
BRTE8DXWB	1.25 x 4.63 x 2	70	.10	.01	\$53

Snaps into Power Distribution Housing. Up to 13 duplex receptacles per circuit. XW identifies white color plastic, all others standard in black.

- BRTE8D1 / BRTE8DXW1 - Circuit #1 (utility circuit)
- BRTE8D2 / BRTE8DXW2 - Circuit #2 (utility circuit)
- BRTE8DA / BRTE8DXWA - Circuit A (dedicated circuit)
- BRTE8DB / BRTE8DXWB - Circuit B (dedicated circuit)

BWAECF	2.5 x 4.74 x 99.32	92.5	3.50	.30	\$390
--------	--------------------	------	------	-----	--------------

Ceiling pole brings ceiling feed conduit and data cables from the ceiling down to Power troughs height. Accommodates 10' ceiling heights. A two part construction allows power/data conduit lay-in. Includes mounting hardware and ceiling bezel. Ceiling feed harness sold separately.

BWAEECFH120	6 x 6 x 120	250	5	2	\$481
BWAEECFH144	6 x 6 x 144	250	6	3	\$534

Ceiling feed provides a single power entry from ceiling, through Ceiling pole into Power Trough, into Power Distribution Housing. An 8-wire (4-circuit) metal conduit harness with included metal junction box for hard wiring to the building power supply above ceiling tile. Must be hard wired to the building power supply by a licensed electrician. Ceiling feed post sold separately.

FTAETTC12	2.3 x 16 x 3	60	6	.12	\$371
FTAETTC18	2.3 x 22 x 3	60	8	.15	\$401
FTAETTC24	2.3 x 28 x 3	60	9	.18	\$423
FTAETTC30	2.3 x 34 x 3	60	10.60	.22	\$447
FTAETTC36	2.3 x 40 x 3	60	12	.24	\$469
FTAETTC42	2.3 x 46 x 3	60	11.60	.28	\$504
FTAETTC48	2.3 x 52 x 3	60	14	.30	\$537

Connects Freefit legs and trough provide to power data/communication pass thru. Connector kit consists of formed steel housing, mounting brackets, housing to housing harness (jumper) and one charcoal grey extruded data/communication cable manager. Knock out on top cover allows for ceiling post connection. Cover included. Specify paint finish.

- FTAETTC12 is used between two single sided or back to back stations that are 70"w (72" nominal) or less.
- FTAETTC18 is used between two single sided or back to back stations that are 76"w (78" nominal).
- FTAETTC24 is used between two single sided or back to back stations that are 82"w (84" nominal), or when separating two stations (up to 70"w) with a 12"w storage piece.
- FTAETTC30 is used to separate 2 workstations 70"w (72" nominal) or less with an 18"w storage unit in between the surfaces.
- FTAETTC36 is used between two single sided or back to back stations that are 70"w (72" nominal) or less with (2) 12"w storage units or (1) 24"w storage unit.
- FTAETTC42 is used between two single sided or back to back stations that are 70"w (72" nominal) or less with (2) 15"w storage units or (1) 30"w storage unit
- FTAETTC48 is used between two single sided or back to back stations that are 70"w (72" nominal) or less with (2) 18"w storage units or (1) 36"w storage unit.

Required specifications

Base finish*

ELECTRICAL COMPONENTS

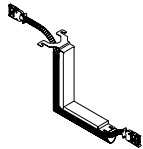
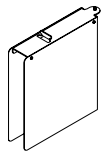

Table to Bridges Connector*



Leg Wire Manager*



Base Feed*

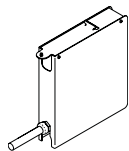

Base Feed* - New York Electrical

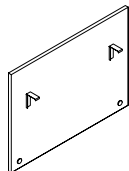

Back-to-Back End Gable*

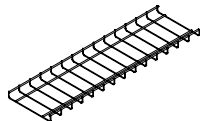

Under Worksurface Cable Basket

MODEL# DIMENSIONS FREIGHT CLASS WT./LBS. CUBIC FT. LIST PRICE

D x W x H

FTTABRC	14 x 2.3 x 15	100	2.40	.28	\$315
---------	---------------	-----	------	-----	--------------

Connects Freefit back-to-back benching to Bridges 29"H table with below worksurface power trough. Please specify paint finish on bracket. Wire manager is always Charcoal.

FTACCL	3.2 x 2 x 16	70	.06	.06	\$482
--------	--------------	----	-----	-----	--------------

Provides wire management from under FreeFit worksurface, down the leg and to the floor. Can only be used on FreeFit regular and media tables. Not for use on back-to-back tables. Kit includes wire manager housing, magnets, screws and cable chain. Magnetically fastens to the FreeFit leg and cable chain is screwed to worksurfaces. Please specify housing paint finish.

FTAEFF	8.75 x 2 x 10.8	92.5	3.50	.30	\$800
--------	-----------------	------	------	-----	--------------

Floor feed housing for FreeFit benching applications only. Includes liquitite whip , 72"L. Must be hard wired to the building power supply by a licensed electrician.

FTAEFF-NYC	14 x 2.55 x 13.41	92.5	3.50	.30	\$675
------------	-------------------	------	------	-----	--------------

Floor feed housing for FreeFit benching applications only. Includes liquitite whip , 72"L. Must be hard wired to the building power supply by a licensed electrician.

FTAEG18H	30.65 x .75 x 18	60	10	.24	\$435
FTAEG22H	30.65 x .75 x 22	60	13	.30	\$469

Optional back-to-back FreeFit Benching end gable is intended to be installed at the end of a FreeFit back-to-back table run. Made of 3/4" thermally fused laminate, it reduces the number of visible elements below the worksurface. Two heights are available. Specify FTAEG18H for extended range bases and FTAEG22H for standard range bases.

FFTCB36	8 x 8 x 1	70	.36	.03	\$110
FFTCB48	8 x 16 x 1	70	.73	.07	\$122
FFTCB54	8 x 22 x 1	70	1.01	.10	\$127
FFTCB60	8 x 28 x 1	70	1.20	.13	\$133
FFTCB66	8 x 34 x 1	70	1.56	.15	\$155
FFTCB72	8 x 40 x 1	70	1.80	.18	\$162
FFTCB78	8 x 46 x 1	92.5	2.16	.21	\$172
FFTCB84	8 x 52 x 1	100	2.39	.24	\$179

Shallow, 8" wide basket manages cable excess. It can be easily unclipped from steel brackets (included). Specify cable basket 30" shorter than worksurface. Steel wire construction, chrome finish baskets; black steel hanging brackets, fasteners.

Required specifications

Base finish*

ELECTRICAL COMPONENTS/ACCESSORIES

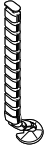

Cable Snake

MODEL#	DIMENSIONS D x W x H	FREIGHT CLASS	WT/LBS.	CUBIC FT.	LIST PRICE
BRACS	2 x 8 x 30	70	3	.19	\$139
BRACSH	2 x 8 x 49	70	3	.19	\$263

Flexible cable management trough. Two pathways within the snake, one for data/communication and one for routing power cables. Translucent White finish only.

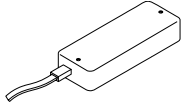

Battery and Charger

FTBATT	8 x 3 x 1.5	70	1.54	.02	\$466
--------	-------------	----	------	-----	--------------

Battery Pak with charging cable mounts to the underside of the worksurface. Features LED bars indicating capacity level and audio alarm when it needs to be charged. On a full charge, the table can cycle from 35 to 45 stroke lengths depending upon the range of column selected and load on the table.

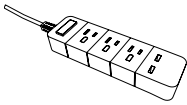

Power Bar with USB

BWAEGC00158GC	1 x 2.3 x 1.3	70	1	.50	\$132
---------------	---------------	----	---	-----	--------------

Power Bar with 3 receptacles + 2 USB and power switch. Standard with 6' cord. Rating 15A, 125V, AC 60Hz, 1875W. USB output 5V, 2.6A (max.) White case, white cord. Available to retrofit CTL/CTR or CTDHL/CTDHR.

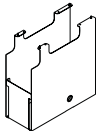

PC Holder

FTACPU	21 x 8 x 21	300	3.57	2.04	\$406
--------	-------------	-----	------	------	--------------

Accepts tower CPU's with a width range from 7.6" to 2.25" - and a maximum height of 18". Durable sheet metal construction. Please specify paint finish.

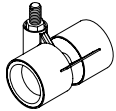

Dual Wheel Casters

BRTLCS	2.7 x 2.5 x 2.6	70	0.06	.01	\$31
--------	-----------------	----	------	-----	-------------

Locking caster for rectangular table. 40mm dia. caster with 8mm thread. White body, light grey tires.

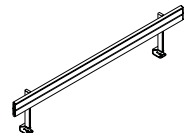

Single Table Accessory Rail*

BRLBST36	2.95 x 33 x 16	65	5.90	.26	\$379
BRLBST42	2.95 x 39 x 16	70	6.44	.30	\$399
BRLBST48	2.95 x 45 x 16	70	6.98	.35	\$413
BRLBST54	2.95 x 51 x 16	70	7.52	.39	\$429
BRLBST60	2.95 x 57 x 16	70	8.07	.43	\$438
BRLBST66	2.95 x 63 x 16	70	8.61	.48	\$453
BRLBST72	2.95 x 69 x 16	70	9.15	.52	\$469
BRLBST78	2.95 x 75 x 16	70	9.69	.56	\$483
BRLBST84	2.95 x 81 x 16	70	10.24	.61	\$498

Table mounted accessory rail. Compatible with standard Bins, Trays and Sorters. Includes end caps and mounting hardware. Please specify paint finish. To ensure proper connection and clearance on tables 46" wide and up, choose accessory rail 13" smaller than the actual table width (70" wide table gets 57" wide rail). Tables 40" wide and smaller use 33" wide accessory rail.

Required specifications

Base finish*

ACCESSORIES

MODEL# DIMENSIONS FREIGHT CLASS WT./LBS. CUBIC FT. LIST PRICE

D x W x H

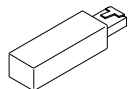

Anti-Collision Desk Sensor USB Plug

FTACDS	8 x 3 x 1.5	60	1.54	.01	\$49
--------	-------------	----	------	-----	-------------

Provides enhanced anti-collision detection. Plugs directly into leg column. Only one USB plug required for table assembly. This is a replacement part. One sensor ships standard with every table.

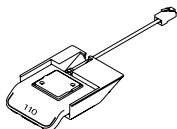

Reminder Controller - LED Display + Bluetooth

FTDPG1C	3 x 4.3 x 1	70	0.4	.01	\$108
---------	-------------	----	-----	-----	--------------

Up/down drive with 4 memory positions. LED light strip reminder, table height display. Bluetooth enabled, connects to Desk Control App. This is a replacement part. Every base comes standard with a controller.

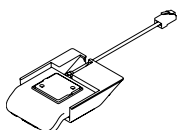

Diode Reminder Controller - Memory + Bluetooth

FTDPG1M	3 x 4.3 x 1	70	0.4	.01	\$44
---------	-------------	----	-----	-----	-------------

Up/down drive with 2 memory positions. Bluetooth enabled, connects to Desk Control App. This is a replacement part. Every base comes standard with a controller.

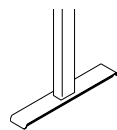

T-Foot*

FTFOOT24TL	23 x 3 x 1.16	60	4.4	.10	\$121
FTFOOT30TL	29 x 3 x 1.16	60	4.85	.10	\$131

Replacement single "T" foot or as an optional addition to a 3 leg table.

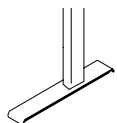

C-Foot*

FTFOOT24CL	23 x 3 x 1.16	60	4.4	.10	\$133
FTFOOT30CL	29 x 3 x 1.16	60	4.85	.10	\$144

Replacement single "C" foot or as an optional addition to a 3 leg table.

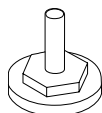

Replacement Glides

FTSETGLIDE	- x - x 1.5	70	.06	.10	\$9
------------	-------------	----	-----	-----	------------

Set of two with 1/2" adjustment.

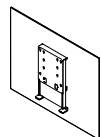

TV Mount

FTMT5145	4 x 51 x 40.5	250	16.82	4.8	\$915
----------	---------------	-----	-------	-----	--------------

TV mount for FreeFit media tables. Includes the TV/Display bracket and mounting hardware. Maximum TV size is 50".

Required specifications

Base finish*

PANTRY STORAGE - 42"H

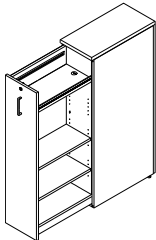

Left (NL) shown

Pantry Storage

MODEL#	DIMENSIONS D x W x H	FREIGHT CLASS	WT/LBS.	CUBIC FT.	LIST PRICE	HP ADD
FFPO1224H42NL	24 x 12 x 42	70	128	7	\$2107	\$26
FFPO1230H42NL	30 x 12 x 42	70	143	9	\$2213	\$31
FFPO1236H42NL	36 x 12 x 42	85	157	11	\$2319	\$36
FFPO1224H42NR	24 x 12 x 42	70	128	7	\$2107	\$26
FFPO1230H42NR	30 x 12 x 42	70	143	9	\$2213	\$31
FFPO1236H42NR	36 x 12 x 42	85	157	11	\$2319	\$36
FFPO1824H42NL	24 x 18 x 42	85	156	11	\$2425	\$36
FFPO1830H42NL	30 x 18 x 42	85	172	13	\$2541	\$46
FFPO1836H42NL	36 x 18 x 42	92.5	187	16	\$2657	\$56
FFPO1824H42NR	24 x 18 x 42	85	156	11	\$2425	\$36
FFPO1830H42NR	30 x 18 x 42	85	172	13	\$2541	\$46
FFPO1836H42NR	36 x 18 x 42	92.5	187	16	\$2657	\$56

The pull out cabinet serves as a multifunctional, customizable storage unit that both defines space and enhances privacy in an open plan environment. Internal organization consists of two fixed shelves on the top and bottom. The two middle shelves are adjustable. Two accessory rails (each 18.25" long) are standard and will accept metal accessories (sold separately - see previous page). Interior cabinet shelves and back are standard in Designer White. Cabinet shell, drawer and top can be specified in any standard laminate. FFPOxxxx will not allow binders.

- For Dry-erase marker board, specify **DE** and **add \$356**. If specified, the dry-erase marker laminate will be applied to the external surface of the pull-out drawer side wall.

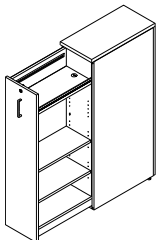

Left (NL) shown

Pantry Storage - w/USB

FFPO1224H42NLUSB	24 x 12 x 42	70	128	7	\$2624	\$26
FFPO1230H42NLUSB	30 x 12 x 42	70	143	9	\$2730	\$31
FFPO1236H42NLUSB	36 x 12 x 42	85	157	11	\$2836	\$36
FFPO1224H42NRUSB	24 x 12 x 42	70	128	7	\$2624	\$26
FFPO1230H42NRUSB	30 x 12 x 42	70	143	9	\$2730	\$31
FFPO1236H42NRUSB	36 x 12 x 42	85	157	11	\$2836	\$36
FFPO1824H42NLUSB	24 x 18 x 42	85	156	11	\$2942	\$36
FFPO1830H42NLUSB	30 x 18 x 42	85	172	13	\$3058	\$46
FFPO1836H42NLUSB	36 x 18 x 42	92.5	187	16	\$3174	\$56
FFPO1824H42NRUSB	24 x 18 x 42	85	156	11	\$2942	\$36
FFPO1830H42NRUSB	30 x 18 x 42	85	172	13	\$3058	\$46
FFPO1836H42NRUSB	36 x 18 x 42	92.5	187	16	\$3174	\$56

The pull out cabinet serves as a multifunctional, customizable storage unit that both defines space and enhances privacy in an open plan environment. Internal organization consists of two fixed shelves on the top and bottom. Top shelf comes with grey felt surface and grommet which allows for cable passage from the USB outlet (located below the top shelf). A 2-prong power cord exits the cabinet through the floor at the back. The two middle shelves are adjustable. Two accessory rails (each 18.25" long) are standard and will accept metal accessories (sold separately - see previous page). Interior cabinet shelves and back are standard in Designer White. Cabinet shell, drawer and top can be specified in any standard laminate. FFPOxxxx will not allow binders.

- For Dry-erase marker board, specify **DE** and **add \$356**. If specified, the dry-erase marker laminate will be applied to the external surface of the pull-out drawer side wall.

Required specifications

Laminate finish

Optional specifications

HP laminate
Dry-erase board

PANTRY STORAGE - 49.5"H

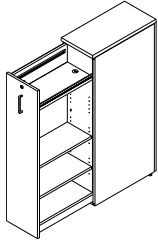

Left (NL) shown

Pantry Storage

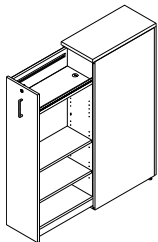

Left (NL) shown

Pantry Storage - w/USB

MODEL#	DIMENSIONS	FREIGHT CLASS	WT/LBS.	CUBIC FT.	LIST PRICE	HP ADD
D x W x H						
FFPO1224NL	24 x 12 x 49.5	70	133	8	\$2247	\$70
FFPO1230NL	30 x 12 x 49.5	85	148	10	\$2355	\$87
FFPO1236NL	36 x 12 x 49.5	92.5	162	15	\$2461	\$99
FFPO1224NR	24 x 12 x 49.5	70	133	8	\$2247	\$70
FFPO1230NR	30 x 12 x 49.5	85	148	10	\$2355	\$87
FFPO1236NR	36 x 12 x 49.5	92.5	162	15	\$2461	\$99
FFPO1824NL	24 x 18 x 49.5	85	161	12	\$2610	\$94
FFPO1830NL	30 x 18 x 49.5	92.5	177	15	\$2724	\$116
FFPO1836NL	36 x 18 x 49.5	92.5	192	18	\$2844	\$133
FFPO1824NR	24 x 18 x 49.5	85	161	12	\$2610	\$94
FFPO1830NR	30 x 18 x 49.5	92.5	177	15	\$2724	\$116
FFPO1836NR	36 x 18 x 49.5	92.5	192	18	\$2844	\$133

The pull out cabinet serves as a multifunctional, customizable storage unit that both defines space and enhances privacy in an open plan environment. Internal organization consists of two fixed shelves on the top and bottom. The two middle shelves are adjustable. Two accessory rails (each 18.25" long) are standard and will accept metal accessories (sold separately - see previous page). Interior cabinet shelves and back are standard in Designer White. Cabinet shell, drawer and top can be specified in any standard laminate. FFPOxxxx will not allow binders.

- For Dry-erase marker board, specify **DE** and **add \$356**. If specified, the dry-erase marker laminate will be applied to the external surface of the pull-out drawer side wall.

FFPO1224NLUSB	24 x 12 x 49.5	70	133	8	\$2769	\$70
FFPO1230NLUSB	30 x 12 x 49.5	85	148	10	\$2877	\$87
FFPO1236NLUSB	36 x 12 x 49.5	92.5	162	15	\$2985	\$99
FFPO1224NRUSB	24 x 12 x 49.5	70	133	8	\$2769	\$70
FFPO1230NRUSB	30 x 12 x 49.5	85	148	10	\$2877	\$87
FFPO1236NRUSB	36 x 12 x 49.5	92.5	162	15	\$2985	\$99
FFPO1824NLUSB	24 x 18 x 49.5	85	161	12	\$3129	\$94
FFPO1830NLUSB	30 x 18 x 49.5	92.5	177	15	\$3248	\$116
FFPO1836NLUSB	36 x 18 x 49.5	92.5	192	18	\$3368	\$133
FFPO1824NRUSB	24 x 18 x 49.5	85	161	12	\$3129	\$94
FFPO1830NRUSB	30 x 18 x 49.5	92.5	177	15	\$3248	\$116
FFPO1836NRUSB	36 x 18 x 49.5	92.5	192	18	\$3368	\$133

The pull out cabinet serves as a multifunctional, customizable storage unit that both defines space and enhances privacy in an open plan environment. Internal organization consists of two fixed shelves on the top and bottom. Top shelf comes with grey felt surface and grommet which allows for cable passage from the USB outlet (located below the top shelf). A 2-prong power cord exits the cabinet through the floor at the back. The two middle shelves are adjustable. Two accessory rails (each 18.25" long) are standard and will accept metal accessories (sold separately - see previous page). Interior cabinet shelves and back are standard in Designer White. Cabinet shell, drawer and top can be specified in any standard laminate. FFPOxxxx will not allow binders.

- For Dry-erase marker board, specify **DE** and **add \$356**. If specified, the dry-erase marker laminate will be applied to the external surface of the pull-out drawer side wall.

Required specifications

Laminate finish

Optional specifications

HP laminate
Dry-erase board

PANTRY STORAGE - 54"H

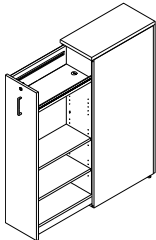

Left (NL) shown

Pantry Storage

MODEL#	DIMENSIONS D x W x H	FREIGHT CLASS	WT/LBS.	CUBIC FT.	LIST PRICE	HP ADD
FFPO1224H54NL	24 x 12 x 54	70	138	9	\$2319	\$26
FFPO1230H54NL	30 x 12 x 54	85	153	11	\$2430	\$26
FFPO1236H54NL	36 x 12 x 54	92.5	167	14	\$2541	\$36
FFPO1224H54NR	24 x 12 x 54	70	138	9	\$2319	\$26
FFPO1230H54NR	30 x 12 x 54	85	153	11	\$2430	\$26
FFPO1236H54NR	36 x 12 x 54	92.5	167	14	\$2541	\$36
FFPO1824H54NL	24 x 18 x 54	92.5	166	14	\$2687	\$36
FFPO1830H54NL	30 x 18 x 54	92.5	182	17	\$2809	\$46
FFPO1836H54NL	36 x 18 x 54	100	197	20	\$2930	\$51
FFPO1824H54NR	24 x 18 x 54	92.5	166	14	\$2687	\$36
FFPO1830H54NR	30 x 18 x 54	92.5	182	17	\$2809	\$46
FFPO1836H54NR	36 x 18 x 54	100	197	20	\$2930	\$51

The pull out cabinet serves as a multifunctional, customizable storage unit that both defines space and enhances privacy in an open plan environment. Internal organization consists of two fixed shelves on the top and bottom. The two middle shelves are adjustable. Two accessory rails (each 18.25" long) are standard and will accept metal accessories (sold separately - see previous page). Interior cabinet shelves and back are standard in Designer White. Cabinet shell, drawer and top can be specified in any standard laminate. FFPOxxxx will not allow binders.

- For Dry-erase marker board, specify **DE** and **add \$356**. If specified, the dry-erase marker laminate will be applied to the external surface of the pull-out drawer side wall.

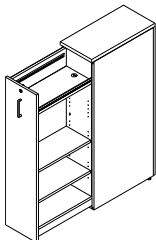

Left (NL) shown

Pantry Storage - w/USB

FFPO1224H54NLUSB	24 x 12 x 54	70	138	9	\$2836	\$26
FFPO1230H54NLUSB	30 x 12 x 54	85	153	11	\$2947	\$26
FFPO1236H54NLUSB	36 x 12 x 54	92.5	167	14	\$3058	\$36
FFPO1224H54NRUSB	24 x 12 x 54	70	138	9	\$2836	\$26
FFPO1230H54NRUSB	30 x 12 x 54	85	153	11	\$2947	\$26
FFPO1236H54NRUSB	36 x 12 x 54	92.5	167	14	\$3058	\$36
FFPO1824H54NLUSB	24 x 18 x 54	92.5	166	14	\$3204	\$36
FFPO1830H54NLUSB	30 x 18 x 54	92.5	182	17	\$3326	\$46
FFPO1836H54NLUSB	36 x 18 x 54	100	197	20	\$3447	\$51
FFPO1824H54NRUSB	24 x 18 x 54	92.5	166	14	\$3204	\$36
FFPO1830H54NRUSB	30 x 18 x 54	92.5	182	17	\$3326	\$46
FFPO1836H54NRUSB	36 x 18 x 54	100	197	20	\$3447	\$51

The pull out cabinet serves as a multifunctional, customizable storage unit that both defines space and enhances privacy in an open plan environment. Internal organization consists of two fixed shelves on the top and bottom. Top shelf comes with grey felt surface and grommet which allows for cable passage from the USB outlet (located below the top shelf). A 2-prong power cord exits the cabinet through the floor at the back. The two middle shelves are adjustable. Two accessory rails (each 18.25" long) are standard and will accept metal accessories (sold separately - see previous page). Interior cabinet shelves and back are standard in Designer White. Cabinet shell, drawer and top can be specified in any standard laminate. FFPOxxxx will not allow binders.

- For Dry-erase marker board, specify **DE** and **add \$356**. If specified, the dry-erase marker laminate will be applied to the external surface of the pull-out drawer side wall.

Required specifications

Laminate finish

Optional specifications

HP laminate
Dry-erase board

CUBE PEDESTALS

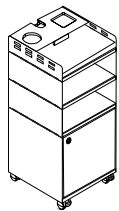

Left (BBFMKL) shown

Mobile Pedestal - BBF

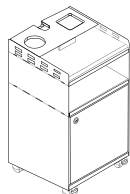

Left (BFMKL) shown

Mobile Pedestal - BF

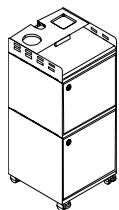

Left (SFMKL) shown

Mobile Pedestal - FF

MODEL#	DIMENSIONS	FREIGHT CLASS	WT/LBS.	CUBIC FT.	LIST PRICE
--------	------------	---------------	---------	-----------	------------

D x W x H

Without lock:

FTSSP12BBFML	12 x 12 x 28	70	35	2.33	\$793
FTSSP12BBFMR	12 x 12 x 28	70	35	2.33	\$793

With Lock:

FTSSP12BBFMKL	12 x 12 x 28	70	35	2.33	\$864
FTSSP12BBFMKR	12 x 12 x 28	70	35	2.33	\$864

Mobile pedestal with two open boxes in the middle, one file box at the bottom and a top accessory tray. File box interior dimensions: 11-7/8"H x 11-13/16"W x 10-7/16"D. Includes four locking casters, metal wire divider and optional lock (must specify "K" before the left or right option). Metal wire divider is chrome and sits 3-7/16" from either side and is interchangeable. File door lock, if specified, is located on the top right corner for the right pedestal and top left corner for the left pedestal. Bottom, middle and top shelves, front door and back are made of 3/4" LP laminate. Sides are made of powder coated metal. Accessory tray is PET felt. Ships knocked-down.

Without lock:

FTSSP12BFML	12 x 12 x 22	70	28	1.83	\$622
FTSSP12BFMR	12 x 12 x 22	70	28	1.83	\$622

With Lock:

FTSSP12BFMKL	12 x 12 x 22	70	28	1.83	\$692
FTSSP12BFMKR	12 x 12 x 22	70	28	1.83	\$692

Mobile pedestal with one open box in the middle, one file box at the bottom and a top accessory tray. File box interior dimensions: 11-7/8"H x 11-13/16"W x 10-7/16"D. Includes four locking casters, metal wire divider and optional lock (must specify "K" before the left or right option). Metal wire divider is chrome and sits 3-7/16" from either side and is interchangeable. File door lock, if specified, is located on the top right corner for the right pedestal and top left corner for the left pedestal. Bottom, middle and top shelves, front door and back are made of 3/4" LP laminate. Sides are made of powder coated metal. Accessory tray is PET felt. Ships knocked-down.

Without lock:

FTSSP12SFML	12 x 12 x 28	70	35	2.33	\$723
FTSSP12SFMR	12 x 12 x 28	70	35	2.33	\$723

With Lock:

FTSSP12SFMKL	12 x 12 x 28	70	35	2.33	\$905
FTSSP12SFMKR	12 x 12 x 28	70	35	2.33	\$905

Mobile pedestal with one closed storage box at the top, one file box at the bottom and a top accessory tray. File box interior dimensions: 11-7/8"H x 11-13/16"W x 10-7/16"D. Closed storage box interior dimensions: 10-1/2"H x 11-13/16"W x 10-7/16"D. Includes four locking casters, metal wire divider and optional lock (must specify "K" before the left or right option). Metal wire divider is chrome and sits 3-7/16" from either side and is interchangeable. Door locks, if specified are located on the top right corner for the right pedestal and top left corner for the left pedestal of each box. Bottom, middle and top shelves, front door and back are made of 3/4" LP laminate. Sides are made of powder coated metal. Accessory tray is PET felt. Ships knocked-down.

Required specifications

- Metal finish
- Laminate finish

HANGING PEDESTALS

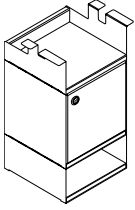

Left (BFBKL) shown

Hanging Pedestal - BFB

MODEL#	DIMENSIONS	FREIGHT CLASS	WT/LBS.	CUBIC FT.	LIST PRICE
--------	------------	---------------	---------	-----------	------------

D x W x H

Without lock:

FTSSPH12BFBKL	12 x 12 x 24	92.5	26	2.33	\$617
FTSSPH12BFBKR	12 x 12 x 24	92.5	26	2.33	\$617

With Lock:

FTSSPH12BFBKL	12 x 12 x 24	92.5	26	2.33	\$686
FTSSPH12BFBKR	12 x 12 x 24	92.5	26	2.33	\$686

Hanging pedestal with one file box in the middle and two open boxes, one at the top and one at the bottom. Attaches to the underside of a worksurface with supplied screws. File box interior dimensions: 11-7/8"H x 11-13/16"W x 10-7/16"D. Includes metal wire divider and optional lock (must specify "K" before the left or right option). Metal wire divider is chrome and sits 3-7/16" from either side and is interchangeable. File door lock, if specified, is located on the top right corner for the right pedestal and top left corner for the left pedestal. Bottom, middle and top shelves, front door and back are made of 3/4" LP laminate. Sides are made of powder coated metal. Ships knocked down.

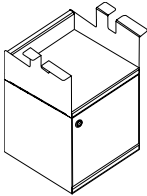

Left (BFKL) shown

Hanging Pedestal - FB

Without lock:

FTSSPH12BFL	12 x 12 x 18.5	92.5	20	1.83	\$445
FTSSPH12BFR	12 x 12 x 18.5	92.5	20	1.83	\$445

With Lock:

FTSSPH12BFL	12 x 12 x 18.5	92.5	20	1.83	\$516
FTSSPH12BFR	12 x 12 x 18.5	92.5	20	1.83	\$516

Hanging pedestal with one file box at the bottom and one open box at the top. Attaches to the underside of a worksurface with supplied screws. File box interior dimensions: 11-7/8"H x 11-13/16"W x 10-7/16"D. Includes metal wire divider and optional lock (must specify "K" before the left or right option). Metal wire divider is chrome and sits 3-7/16" from either side and is interchangeable. File door lock, if specified, is located on the top right corner for the right pedestal and top left corner for the left pedestal. Bottom, middle and top shelves, front door and back are made of 3/4" LP laminate. Sides are made of powder coated metal. Ships knocked down.

Required specifications

Metal finish
Laminate finish

HANGING PEDESTALS **MODEL#** **DIMENSIONS** **FREIGHT CLASS** **WT./LBS.** **CUBIC FT.** **LIST PRICE**

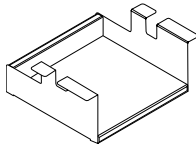

Hanging Pedestal Box*

D x W x H						
FTSSPH12B	12 x 12 x 6	125	6	0.96		\$172

Hanging pedestal open box. Attaches to the underside of a worksurface with supplied screws to create an open box. Bottom, middle and top shelves, front door and back are made of 3/4" LP laminate. Sides are made of powder coated metal. Ships knocked down.

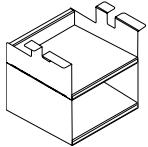

Hanging Pedestal - Two Open Boxes*

FTSSPH12BB	12 x 12 x 6	100	12	1.42		\$344
------------	-------------	-----	----	------	--	--------------

Hanging pedestal with two open boxes. Attaches to the underside of a worksurface with supplied screws. Bottom, middle and top shelves, front door and back are made of 3/4" LP laminate. Sides are made of powder coated metal. Ships knocked down.

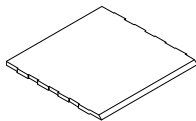

Felt Shelf Liner

FTFELT03BC	12 x 12 x 6	70	0.01	0.03		\$36
------------	-------------	----	------	------	--	-------------

Felt shelf liner can be added to any closed back shelf. Front edge is cut at 45°.

Required specifications

- Metal finish*
- Laminate finish*

BACK-TO-BACK TABLE - 21"H DIVIDERS

D x W x H

- FreeFit table mounted dividers for single table or single table row; recessed 6.5" at both ends (for example - 72" (70" actual) FreeFit table mounted divider measures 57").
- The center of all dividers is always mounted 2.250" from worksurface's rear edge. Please note the gap between the divider and the worksurface therefore varies, depending on the divider thickness (1.250" framed dividers, 0.750" frameless LP and 0.250" frameless glass).
- 48" (33" actual) - 66" (51" actual) dividers have 2 mounting brackets.
- 72" (57" actual) dividers have 3 mounting brackets.

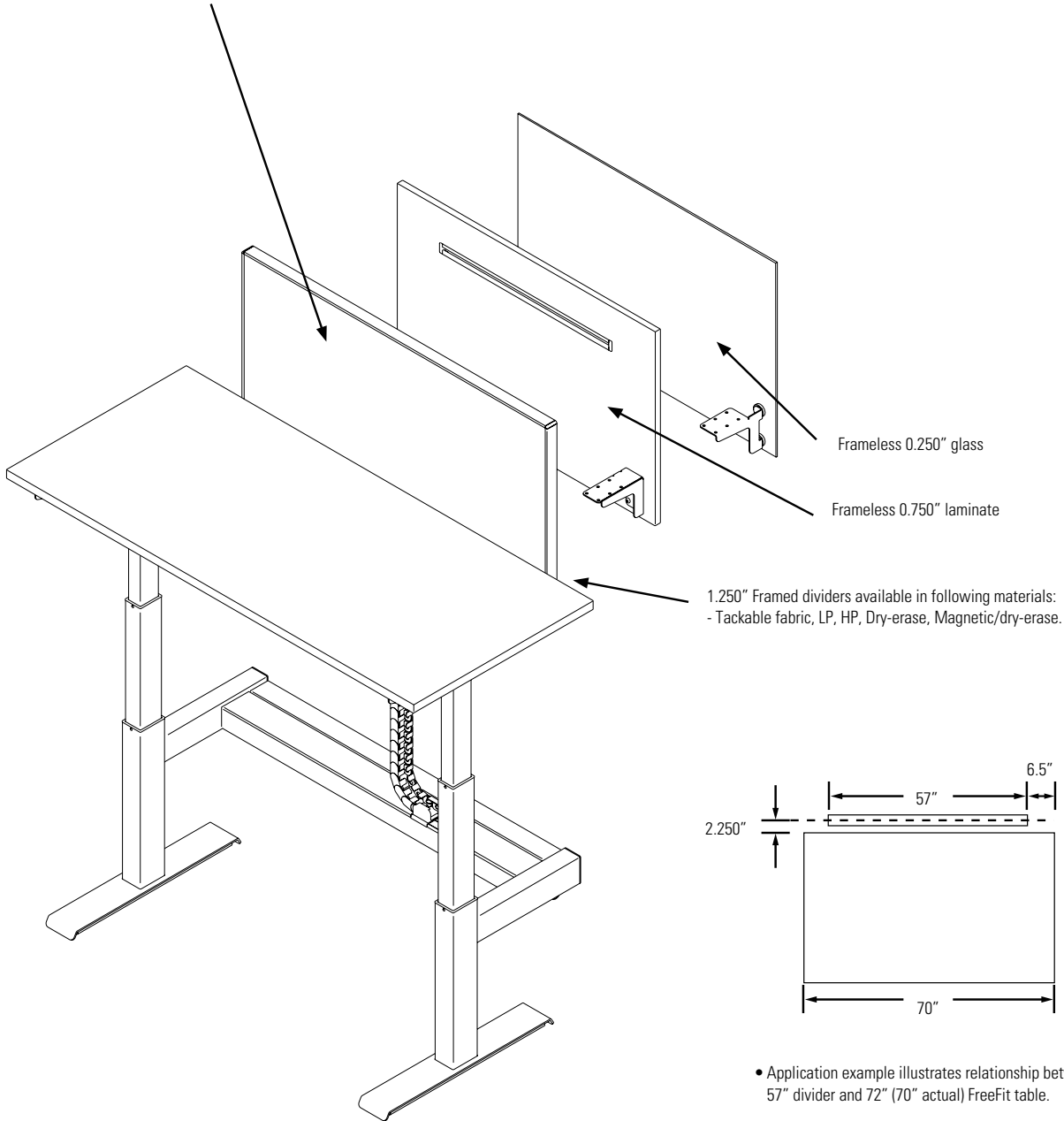

- Application example illustrates relationship between 57" divider and 72" (70" actual) FreeFit table.

- Example Order:
 BWATMFD72
 (actual dimension of 57") for
 BWA2D3072A8
 (actual dimension of 70").

BACK-TO-BACK TABLE - 37"H DIVIDERS

FreeFit Back-to-Back stationary dividers; stationary, shared, secured to table structure; recessed 6.5" at both ends (for example - 72" (70" actual) FreeFit table mounted divider measures 57").

The center of all dividers is always mounted 2.250" from worksurface's rear edge. Please note the gap between the divider and the worksurface therefore varies, depending on the divider thickness (1.250" Framed dividers, 0.750" frameless LP and 0.250" frameless glass).

- 48" (33" actual) divider for 48" (46" actual) table
- 54" (39" actual) divider for 54" (52" actual) table
- 60" (45" actual) divider for 60" (58" actual) table
- 66" (51" actual) divider for 66" (64" actual) table
- 72" (57" actual) divider for 72" (70" actual) table

- Framed dividers (Tackable fabric, LP, HP, Dryerase, Magnetic/dry-erase)
- Frameless LP
- Frameless glass

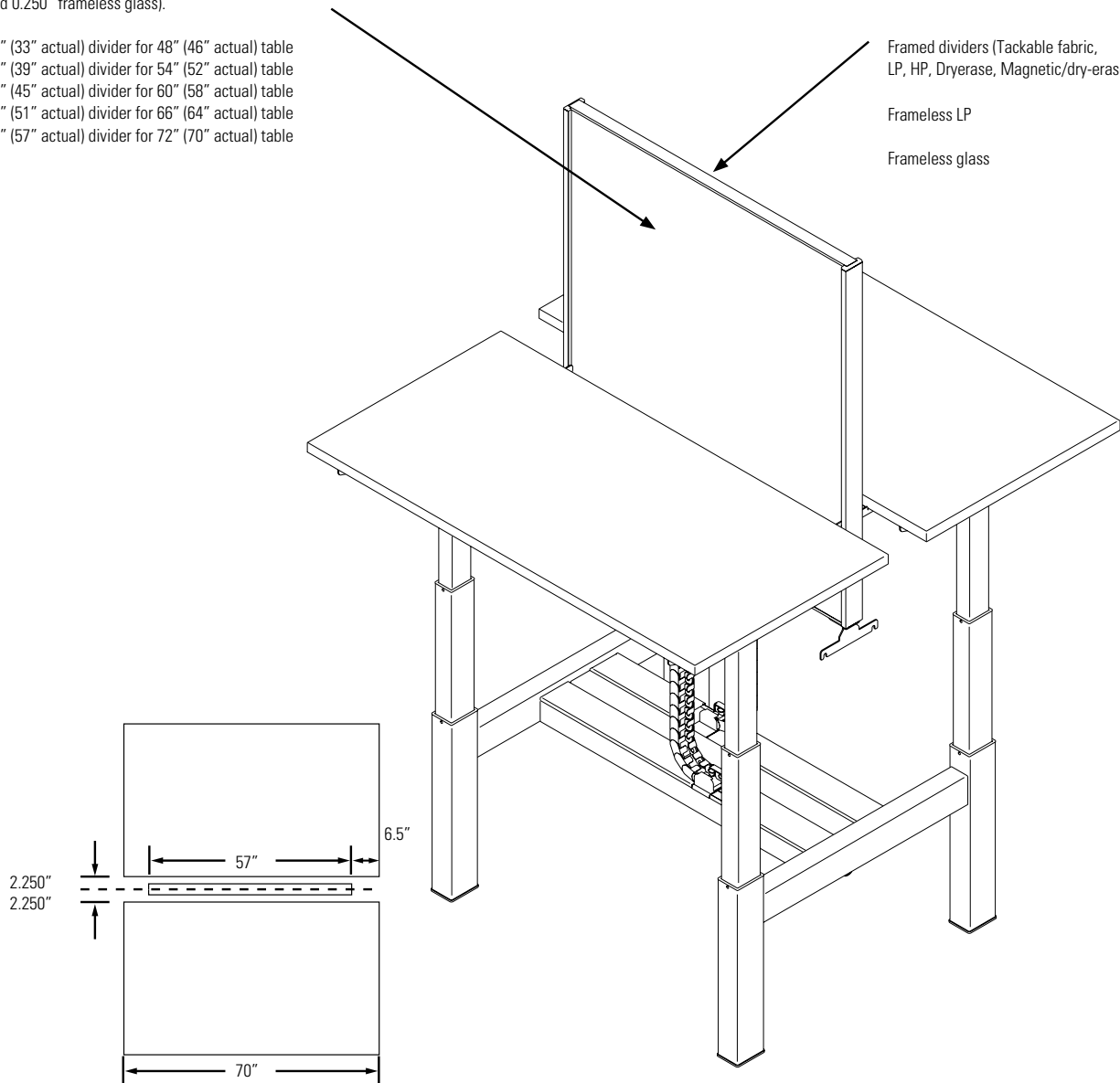

Application example illustrates relationship between 57" shared divider and 72" (70" actual) FreeFit Back-to-Back table.

- Example Order:
 BWASFD72
 (actual dimension of 57") for
 BWA2D6072A8
 (actual dimension of 70").

FELT DIVIDERS

- 9mm thick panels offered in 9 finishes
- Made from 100% PET (polyester) fiber with a high content (50%) of post-recycled material, free of added chemicals, binders and adhesives
- Lightweight panels are tackable, impact and tear resistant, bacteria resistant, moisture resistant, and installation friendly
- Variation in fiber mix and color are inherent to the character of the product

FELT COLORS

FELT COLOR	DESCRIPTION	MTS	MIST
BLK	Black	MTS	Mist
BRI	Brick	PWT	Pewter
DEN	Denim	SHR	Shamrock
GPH	Graphite	WHT	White
HVT	Harvest		

BRACKET FINISH

BLK	Black
DWT	Designer White
TUN	Tungsten

FELT DIVIDERS

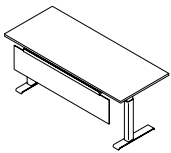

Modesty Felt Divider

FELT DIVIDERS

MODEL#	DIMENSIONS	FREIGHT CLASS	WT/LBS.	CUBIC FT.	LIST PRICE
BWAFMPSN48	4.17 x 33 x 13.94	250	2.44	0.65	\$258
BWAFMPSN54	4.17 x 39 x 13.94	250	2.86	0.74	\$290
BWAFMPSN60	4.17 x 45 x 13.94	250	3.27	0.84	\$327
BWAFMPSN66	4.17 x 51 x 13.94	250	3.68	0.93	\$461
BWAFMPSN72	4.17 x 57 x 13.94	150	4.09	1.02	\$491

9mm thick PET felt divider is tackable. Fastens to the underside of the worksurface. Installed divider measures 15" below top of the worksurface. 34" to 58" dividers include 2 brackets. 64" to 70" dividers include 3 brackets. Available in 9 PET felt colors. Please specify.

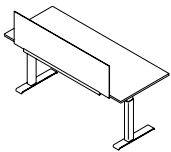

Parallel Felt Divider

BWAFPN48	5.86 x 33 x 18.24	150	2.82	0.65	\$276
BWAFPN54	5.86 x 39 x 18.24	150	3.29	0.74	\$309
BWAFPN60	5.86 x 45 x 18.24	150	3.75	0.84	\$351
BWAFPN66	5.86 x 51 x 18.24	150	4.22	0.93	\$493
BWAFPN72	5.86 x 57 x 18.24	150	4.69	1.02	\$526

Connects parallel on Freefit tables. 9mm thick PET felt divider is tackable. Installed divider measures 15.7" high from the top of the worksurface. Kit includes felt divider, support extrusion and left and right brackets. Available in 9 PET felt colors. Please specify.

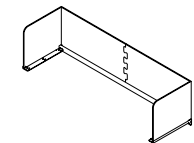

Single

BWAFWR2346	18.46 x 46.84 x 18.24	65	26.58	1.07	\$532
BWAFWR2352	18.46 x 52.84 x 18.24	65	28.4	1.21	\$563
BWAFWR2358	18.46 x 58.84 x 18.24	65	30.22	1.34	\$593
BWAFWR2364	18.46 x 64.84 x 18.24	60	32.02	0.74	\$784
BWAFWR2370	18.46 x 70.84 x 18.24	60	33.84	0.81	\$836
BWAFWR2946	24.46 x 46.84 x 18.24	65	30.74	1.07	\$602
BWAFWR2952	24.46 x 52.84 x 18.24	60	32.55	0.6	\$792
BWAFWR2958	24.46 x 58.84 x 18.24	60	34.37	0.67	\$845
BWAFWR2964	24.46 x 64.84 x 18.24	60	36.19	0.74	\$897
BWAFWR2970	24.46 x 70.84 x 18.24	60	38	0.81	\$950

End of Run:

BWAFWR2351	18.46 x 51.34 x 18.24	65	27.94	1.05	\$537
BWAFWR2951	24.46 x 51.34 x 18.24	60	32.09	0.62	\$791
BWAFWR2363	18.46 x 63.34 x 18.24	70	31.57	1.5	\$781
BWAFWR2963	24.46 x 63.34 x 18.24	60	35.73	0.87	\$894

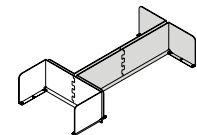

End of Run

Felt Wrap Around Divider*

Wraps around Freefit tables to provide privacy. 9mm thick PET felt divider is tackable. Fastens to the underside of the worksurface. Installed divider measures 15.7" from the top of the worksurface. Divider extends 1.5" past the back of the worksurface. Please choose standard base finish for the extrusion and brackets. PET is available in 9 felt colors. Please specify.

- Anodized Aluminum extrusion - Add **\$141** list upcharge

Required Specifications

Felt color
Bracket finish

Optional Specifications

Anodized extrusion

FELT DIVIDERS

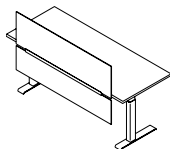

Felt Parallel Divider

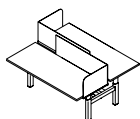
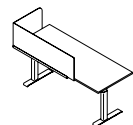

Corner Wrap Felt Divider

MODEL# DIMENSIONS FREIGHT CLASS WT/LBS. CUBIC FT. LIST PRICE

D x W x H

BWAFPDN48	5.86 x 33 x 30.68	150	3.82	0.94	\$414
BWAFPDN54	5.86 x 39 x 30.68	150	4.5	1.12	\$459
BWAFPDN60	5.86 x 45 x 30.68	150	5.17	1.29	\$535
BWAFPDN66	5.86 x 51 x 30.68	150	5.85	1.46	\$820
BWAFPDN72	5.86 x 57 x 30.68	150	6.53	1.63	\$870

Felt divider and modesty panel kit secures to the rear bottom of a regular FreeFit table and provides privacy above and below the worksurface. 9mm thick PET felt divider is tackable. Installed divider measures 15.7" from the top of the worksurface and 15" below the top of the worksurface. Kit includes two felt dividers, support extrusion and left and right brackets. Available in 9 PET felt colors. Please specify.

BW AFC2432L	18.52 x 32.46 x 18.24	150	3.82	0.94	\$376
BW AFC2432R	18.52 x 32.46 x 18.24	150	3.82	0.94	\$376
BW AFC2438L	18.52 x 38.46 x 18.24	250	5.46	1.62	\$429
BW AFC2438R	18.52 x 38.46 x 18.24	250	5.46	1.62	\$429
BW AFC2448L	18.52 x 47.46 x 18.24	250	6.16	1.87	\$461
BW AFC2448R	18.52 x 47.46 x 18.24	250	6.16	1.87	\$461

BW AFC3032L	24.52 x 32.46 x 18.24	250	5.72	1.62	\$424
BW AFC3032R	24.52 x 32.46 x 18.24	250	5.72	1.62	\$424
BW AFC3038L	24.52 x 38.46 x 18.24	250	6.19	1.87	\$455
BW AFC3038R	24.52 x 38.46 x 18.24	250	6.19	1.87	\$455
BW AFC3048L	24.52 x 47.46 x 18.24	250	6.89	1.9	\$489
BW AFC3048R	24.52 x 47.46 x 18.24	250	6.89	1.9	\$489

Felt Corner Wrap secures to the side and rear bottom of a FreeFit table, wraps around one side and provides limited privacy. 9mm thick PET felt divider is tackable. Installed divider measures 15.7" from the top of the worksurface. Kit includes felt dividers, support extrusion and large and small brackets. Available in 9 PET felt colors. Please specify.

Required Specifications

- Felt color
- Bracket finish

TABLE MOUNTED DIVIDERS

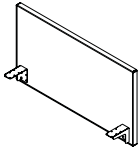

Table Mounted Framed Divider, Fabric*

MODEL#	DIMENSIONS D x W x H	FREIGHT CLASS	WT/LBS.	CUBIC FT.	LIST PRICE
BWATMFD48	1.25 x 33 x 21.5	85	16	1.23	\$391
BWATMFD54	1.25 x 39 x 21.5	85	18	1.46	\$483
BWATMFD60	1.25 x 45 x 21.5	85	20	1.68	\$528
BWATMFD66	1.25 x 51 x 21.5	85	22	1.90	\$592
BWATMFD72	1.25 x 57 x 21.5	85	26	2.13	\$647

Connects parallel on Freefit single and back-to-back tables. Fabric divider is tackable. Fastens to the underside of the worksurface. 1.625" gap between worksurface and divider allows for cable pass-through. Installed divider measures 15.7" from top of worksurface and 5.75" below the worksurface. 48" to 66" dividers include 2 support brackets. 72" divider includes 3 support brackets. Available in the following textiles:

- Global: **Anchorage, Lola, and Merge.**

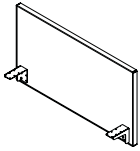

Table Mounted Framed Divider, Laminate**

MODEL#	DIMENSIONS D x W x H	FREIGHT CLASS	WT/LBS.	CUBIC FT.	LIST PRICE	HP ADD	DE ADD	DM ADD
BWATMLD48	1.25 x 33 x 21.5	85	35	1.23	\$257	\$150	\$309	\$471
BWATMLD54	1.25 x 39 x 21.5	85	39	1.46	\$290	\$193	\$385	\$595
BWATMLD60	1.25 x 45 x 21.5	85	44	1.68	\$344	\$204	\$405	\$633
BWATMLD66	1.25 x 51 x 21.5	85	48	1.90	\$396	\$280	\$847	\$1256
BWATMLD72	1.25 x 57 x 21.5	85	52	2.13	\$431	\$282	\$841	\$1248

Connects parallel on Freefit single and back-to-back tables. Divider infill can be specified in low pressure laminate (**LP**), high pressure laminate (**HP**), dry erase whiteboard (**DE**) or dry erase magnetic whiteboard (**DM**) user side only. Fastens to the underside of the worksurface. 1.625" gap between worksurface and divider allows for cable pass-through. Installed divider measures 15.7" from top of worksurface and 5.75" below the worksurface. 48" to 66" dividers include 2 support brackets. 72" divider includes 3 support brackets. When dry erase magnetic whiteboard (DM) is specified it is applied user side ONLY and dry erase whiteboard (DE) is applied on the opposite side.

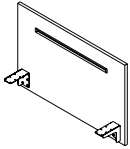

Table Mounted Laminate Divider**

BWATMLLD48	.75 x 33 x 21.5	125	16	1.23	\$308
BWATMLLD54	.75 x 39 x 21.5	125	18	1.46	\$326
BWATMLLD60	.75 x 45 x 21.5	125	20	1.68	\$345
BWATMLLD66	.75 x 51 x 21.5	125	22	1.90	\$510
BWATMLLD72	.75 x 57 x 21.5	125	26	2.13	\$527

Connects parallel on Freefit single and back-to-back tables. Laminate divider with integrated accessory rail, installed on one side only. Integrated anodized aluminum accessory rail, white cut out and rail trims; white power coat brackets. 3/4" LP PVC edged boards. Specify laminate and PVC edge. Fastens to the underside of the worksurface. 1.88" gap between worksurface and divider allows for cable pass-through. Installed divider measures 15.7" from top of worksurface and 5.75" below the worksurface. 48" to 66" dividers include 2 support brackets. 72" divider includes 3 support brackets.

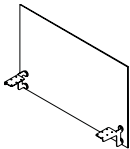

Table Mounted Glass Divider

BWATMGD48	.25 x 33 x 21.5	125	16	1.23	\$658
BWATMGD54	.25 x 39 x 21.5	125	19	1.46	\$708
BWATMGD60	.25 x 45 x 21.5	125	22	1.68	\$758
BWATMGD66	.25 x 51 x 21.5	125	24	1.90	\$803
BWATMGD72	.25 x 57 x 21.5	125	28	2.13	\$856

Frameless glass divider connects parallel on Freefit single and back-to-back tables. Tempered glass, acid etched on one side (similar to frosted), satin chrome disc fasteners and white powder coated steel support brackets. Fastens to the underside of the worksurface. 2.13" gap between worksurface and divider allows for cable pass-through. Installed divider measures 15.7" from top of worksurface and 4.75" below the worksurface. 48" to 66" dividers include 2 support brackets. 72" divider includes 3 support brackets. 1/2" radius on all four corners.

Required specifications

- Fabric*
- Laminate finish**
- Metal frame finish

STATIONARY DIVIDERS

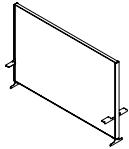

Stationary Framed Divider, Fabric*

MODEL#	DIMENSIONS D x W x H	FREIGHT CLASS	WT/LBS.	CUBIC FT.	LIST PRICE
BWASFD48	1.25 x 33 x 37.2	92.5	25	2.13	\$855
BWASFD54	1.25 x 39 x 37.2	92.5	28	2.52	\$871
BWASFD60	1.25 x 45 x 37.2	92.5	31	2.91	\$900
BWASFD66	1.25 x 51 x 37.2	92.5	34	3.29	\$956
BWASFD72	1.25 x 57 x 37.2	92.5	37	3.68	\$1221

Provides a stationary framed divider between back-to-back height adjustable tables. Fabric divider is tackable. Divider is anchored to the base and captured between two aluminum upright tracks. The uprights have sliding brackets that connect the worksurfaces to the divider providing continuous support as it travels up and down. 1.625" gap between worksurface and divider allows for cable pass-through. Installed divider measures 54" from floor. Available in the following textiles:

- Global: **Anchorage, Lola, and Merge**

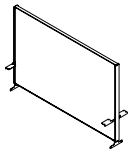

Stationary Framed Divider, Laminate**

MODEL#	DIMENSIONS D x W x H	FREIGHT CLASS	WT/LBS.	CUBIC FT.	LIST PRICE	HP ADD	DE ADD	DM ADD
BWASLD48	2 x 33 x 37.2	65	58	2.13	\$1085	\$368	\$771	\$2021
BWASLD54	2 x 39 x 37.2	65	66	2.52	\$1170	\$394	\$811	\$2125
BWASLD60	2 x 45 x 37.2	65	73	2.91	\$1189	\$395	\$811	\$2126
BWASLD66	2 x 51 x 37.2	65	81	3.29	\$1279	\$441	\$1773	\$4267
BWASLD72	2 x 57 x 37.2	65	88	3.68	\$1748	\$658	\$1704	\$4548

Provides a stationary framed divider between back-to-back height adjustable tables. Divider infill can be specified in low pressure laminate (**LP**), high pressure laminate (**HP**), dry erase whiteboard (**DE**) or dry erase magnetic whiteboard (**DM**) user side only. Divider is anchored to the base and captured between two aluminum upright tracks. The uprights have sliding brackets that connect the worksurfaces to the divider providing continuous support as it travels up and down. 1.625" gap between worksurface and divider allows for cable pass-through. Installed divider measures 54" from floor.

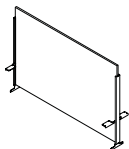

Stationary Laminate Divider**

BWASLLD48	2 x 33 x 37.2	85	28	2.13	\$622
BWASLLD54	2 x 39 x 37.2	85	33	2.52	\$641
BWASLLD60	2 x 45 x 37.2	85	37	2.91	\$659
BWASLLD66	2 x 51 x 37.2	85	41	3.29	\$998
BWASLLD72	2 x 57 x 37.2	85	46	3.68	\$1018

Provides a stationary laminate divider between back-to-back height adjustable tables. Divider is anchored to the base and captured between two aluminum upright tracks. The uprights have sliding brackets that connect the worksurfaces to the divider providing continuous support as it travels up and down. 1.88" gap between worksurface and divider allows for cable pass-through. Installed divider measures 54" from floor.

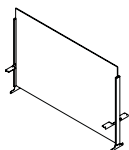

Stationary Glass Divider

BWASGD48	2 x 33 x 37.2	85	30	2.13	\$583
BWASGD54	2 x 39 x 37.2	85	34	2.52	\$663
BWASGD60	2 x 45 x 37.2	85	39	2.91	\$752
BWASGD66	2 x 51 x 37.2	85	43	3.29	\$834
BWASGD72	2 x 57 x 37.2	85	48	3.68	\$914

Provides a stationary glass divider between back-to-back height adjustable tables. Tempered glass, acid etched on one side (similar to frosted), satin chrome disc fasteners and white powder coated steel support brackets. Divider is anchored to the base and captured between two aluminum upright tracks. The uprights have sliding brackets that connect the worksurfaces to the divider providing continuous support as it travels up and down. 2.13" gap between worksurface and divider allows for cable pass-through. 1/2" radius on top two corners.

Required specifications

- Fabric*
- Laminate finish**
- Metal frame finish

WELLNESS SCREENS- POLYCARBONATE

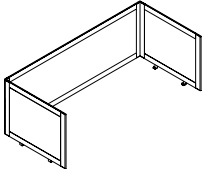

24" H Polycarbonate Divider Screen

MODEL#	DIMENSIONS D x W x H	FREIGHT CLASS	WT./LBS.	CUBIC FT.	LIST PRICE
FFTDP2436H24	31.75 x 34 x 24.6	125	26.55	3.94	\$1023
FFTDP2442H24	31.75 x 40 x 24.6	125	28.10	4.59	\$1056
FFTDP2448H24	31.75 x 46 x 24.6	150	29.65	5.25	\$1085
FFTDP2454H24	31.75 x 52 x 24.6	150	31.20	5.94	\$1117
FFTDP2460H24	31.75 x 58 x 24.6	150	32.75	6.56	\$1148
FFTDP2466H24	31.75 x 64 x 24.6	150	34.30	7.22	\$1177
FFTDP2472H24	31.75 x 70 x 24.6	150	35.85	7.88	\$1210
FFTDP2478H24	31.75 x 76 x 24.6	150	37.40	8.53	\$1241
FFTDP2484H24	31.75 x 82 x 24.6	150	38.95	9.19	\$1271
FFTDP3036H24	37.75 x 34 x 24.6	100	40.50	4.72	\$1095
FFTDP3042H24	37.75 x 40 x 24.6	125	42.05	5.51	\$1128
FFTDP3048H24	37.75 x 46 x 24.6	125	43.60	6.29	\$1159
FFTDP3054H24	37.75 x 52 x 24.6	125	45.15	7.08	\$1192
FFTDP3060H24	37.75 x 58 x 24.6	150	46.70	7.85	\$1221
FFTDP3066H24	37.75 x 64 x 24.6	150	48.25	8.65	\$1251
FFTDP3072H24	37.75 x 70 x 24.6	150	49.80	9.44	\$1283
FFTDP3078H24	37.75 x 76 x 24.6	150	51.35	10.22	\$1314
FFTDP3084H24	37.75 x 82 x 24.6	150	52.90	11.01	\$1346

Powder coated aluminum frame, translucent ribbed polycarbonate. Includes all hardware to connect. Brackets are painted steel. Side dividers extend 7.25" from the front edge of each surface. Back divider extends over the back edge of the worksurface by 1.5", allowing for cable pass-through to trough. Width and depth are nominal sizes representing the sizes of the FreeFit table. Allow for .25" overhang at the sides, 1.5" at the back, and 7.25" at the front. Frame and hardware available in Black (BLK), Designer White (DWT) and Tungsten (TUN).

- **FFTDP24xxH24 are for configurations with 23" deep surfaces.**
- **FFTDP30xxH24 are for configurations with 29" deep surfaces.**

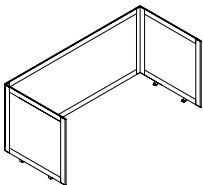

30" H Polycarbonate Divider Screen

FFTDP2436H30	31.75 x 34 x 30.6	125	26.55	3.94	\$1148
FFTDP2442H30	31.75 x 40 x 30.6	125	28.10	4.59	\$1185
FFTDP2448H30	31.75 x 46 x 30.6	150	29.65	5.25	\$1221
FFTDP2454H30	31.75 x 52 x 30.6	150	31.20	5.91	\$1256
FFTDP2460H30	31.75 x 58 x 30.6	150	32.75	6.56	\$1292
FFTDP2466H30	31.75 x 64 x 30.6	150	34.30	7.22	\$1327
FFTDP2472H30	31.75 x 70 x 30.6	150	35.85	7.88	\$1363
FFTDP2478H30	31.75 x 76 x 30.6	150	37.40	8.53	\$1398
FFTDP2484H30	31.75 x 82 x 30.6	150	38.95	9.19	\$1434
FFTDP3036H30	37.75 x 34 x 30.6	100	40.50	4.72	\$1218
FFTDP3042H30	37.75 x 40 x 30.6	125	42.05	5.51	\$1256
FFTDP3048H30	37.75 x 46 x 30.6	125	43.60	6.29	\$1291
FFTDP3054H30	37.75 x 52 x 30.6	125	45.15	7.08	\$1324
FFTDP3060H30	37.75 x 58 x 30.6	150	46.70	7.87	\$1360
FFTDP3066H30	37.75 x 64 x 30.6	150	48.25	8.65	\$1397
FFTDP3072H30	37.75 x 70 x 30.6	150	49.80	9.44	\$1430
FFTDP3078H30	37.75 x 76 x 30.6	150	51.35	10.22	\$1468
FFTDP3084H30	37.75 x 82 x 30.6	150	52.90	11.01	\$1504

Powder coated aluminum frame, translucent ribbed polycarbonate. Includes all hardware to connect. Brackets are painted steel. Side dividers extend 7.25" from the front edge of each surface. Back divider extends over the back edge of the worksurface by 1.5", allowing for cable pass-through to trough. Width and depth are nominal sizes representing the sizes of the FreeFit table. Allow for .25" overhang at the sides, 1.5" at the back, and 7.25" at the front. Frame and hardware available in Black (BLK), Designer White (DWT) and Tungsten (TUN).

- **FFTDP24xxH30 are for configurations with 23" deep surfaces.**
- **FFTDP30xxH30 are for configurations with 29" deep surfaces.**

Required specifications
Frame finish

WELLNESS SCREENS - GLASS

MODEL# DIMENSIONS FREIGHT CLASS WT/LBS. CUBIC FT. LIST PRICE FRST ADD

D x W x H

FFTDG2436H24	31.50 x 36 x 24.60	125	26.55	3.94	\$1426	\$289
FFTDG2442H24	31.50 x 42 x 24.60	125	28.10	4.59	\$1473	\$295
FFTDG2448H24	31.50 x 48 x 24.60	150	29.65	5.25	\$1521	\$307
FFTDG2454H24	31.50 x 54 x 24.60	150	31.20	5.91	\$1567	\$318
FFTDG2460H24	31.50 x 60 x 24.60	150	32.75	6.56	\$1620	\$325
FFTDG2466H24	31.50 x 66 x 24.60	150	34.30	7.22	\$1662	\$337
FFTDG2472H24	31.50 x 72 x 24.60	150	35.85	7.88	\$1721	\$348
FFTDG2478H24	31.50 x 78 x 24.60	150	37.40	8.53	\$1756	\$355
FFTDG2484H24	31.50 x 84 x 24.60	150	38.95	9.19	\$1802	\$366
FFTDG3036H24	37.75 x 36 x 24.60	100	40.50	4.72	\$1521	\$307
FFTDG3042H24	37.75 x 42 x 24.60	125	42.05	5.51	\$1562	\$313
FFTDG3048H24	37.75 x 48 x 24.60	125	43.60	6.29	\$1609	\$325
FFTDG3054H24	37.75 x 54 x 24.60	150	45.15	7.08	\$1656	\$337
FFTDG3060H24	37.75 x 60 x 24.60	150	46.70	7.87	\$1703	\$343
FFTDG3066H24	37.75 x 66 x 24.60	150	48.25	8.65	\$1756	\$355
FFTDG3072H24	37.75 x 72 x 24.60	150	49.80	9.44	\$1797	\$360
FFTDG3078H24	37.75 x 78 x 24.60	150	51.35	10.22	\$1844	\$371
FFTDG3084H24	37.75 x 84 x 24.60	150	52.90	11.01	\$1892	\$384

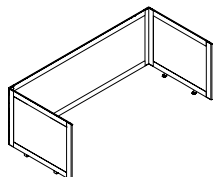

24" H Single Table Glass Divider Screen

Provides privacy in an open plan environment. Easy to clean table mounted partitions. Powder coated aluminum frame with 4mm clear (CLR) glass. Includes all hardware to connect. Brackets are painted steel. Side dividers extend 6.237" from the front edge of each surface. Back divider extends over the back edge of the worksurface by 1.5", allowing for cable pass-through to trough. Width and depth are nominal sizes representing the sizes of the FreeFit table. Allow for .25" overhang at the sides, 1.5" at the back, and 6.237" at the front. Frame and hardware available in Black (BLK), Designer White (DWT) and Tungsten (TUN). End trim cap is only available in Charcoal (CHR). **Add 20% upcharge for frosted glass (FRST).**

- **FFTDG24xxH24 are for configurations with 24" deep surfaces.**
- **FFTDG30xxH24 are for configurations with 30" deep surfaces.**

FFTDG2436H30	31.50 x 36 x 30.60	125	28.85	3.97	\$1497	\$302
FFTDG2442H30	31.50 x 42 x 30.60	125	30.40	4.59	\$1544	\$313
FFTDG2448H30	31.50 x 48 x 30.60	125	31.95	5.25	\$1590	\$318
FFTDG2454H30	31.50 x 54 x 30.60	150	33.50	5.91	\$1643	\$331
FFTDG2460H30	31.50 x 60 x 30.60	150	35.05	6.56	\$1691	\$343
FFTDG2466H30	31.50 x 66 x 30.60	150	36.60	7.22	\$1733	\$348
FFTDG2472H30	31.50 x 72 x 30.60	150	38.15	7.88	\$1768	\$355
FFTDG2478H30	31.50 x 78 x 30.60	150	39.70	8.53	\$1832	\$371
FFTDG2484H30	31.50 x 84 x 30.60	150	41.25	9.19	\$1885	\$378
FFTDG3036H30	37.75 x 36 x 30.60	100	42.80	4.72	\$1590	\$318
FFTDG3042H30	37.75 x 42 x 30.60	100	44.35	5.51	\$1643	\$331
FFTDG3048H30	37.75 x 48 x 30.60	125	45.90	6.29	\$1685	\$343
FFTDG3054H30	37.75 x 54 x 30.60	125	47.45	7.08	\$1733	\$348
FFTDG3060H30	37.75 x 60 x 30.60	125	49	7.87	\$1786	\$360
FFTDG3066H30	37.75 x 66 x 30.60	150	50.55	8.65	\$1832	\$371
FFTDG3072H30	37.75 x 72 x 30.60	150	52.10	9.44	\$1855	\$371
FFTDG3078H30	37.75 x 78 x 30.60	150	53.65	10.22	\$1927	\$390
FFTDG3084H30	37.75 x 84 x 30.60	150	55.20	11.01	\$1974	\$396

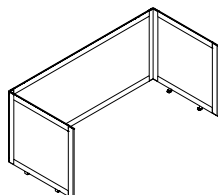

30" H Single Table Glass Divider Screen

Provides privacy in an open plan environment. Easy to clean table mounted partitions. Powder coated aluminum frame with 4mm clear (CLR) glass. Includes all hardware to connect. Brackets are painted steel. Side dividers extend 6.237" from the front edge of each surface. Back divider extends over the back edge of the worksurface by 1.5", allowing for cable pass-through to trough. Width and depth are nominal sizes representing the sizes of the Bridges configuration. Allow for .25" overhang at the sides, 1.5" at the back, and 6.237" at the front. Frame and hardware available in Black (BLK), Designer White (DWT) and Tungsten (TUN). End trim cap is only available in Charcoal (CHR). **Add 20% upcharge for frosted glass (FRST).**

- **FFTDG24xxH30 are for configurations with 24" deep surfaces.**
- **FFTDG30xxH30 are for configurations with 30" deep surfaces.**

Required specifications
Frame finish

Optional specifications
Frosted glass (FRST)

FELT DIVIDER SCREENS

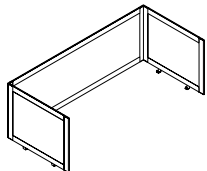

24" H Single Table Felt Divider Screen

MODEL#	DIMENSIONS D x W x H	FREIGHT CLASS	WT./LBS.	CUBIC FT.	LIST PRICE
FFTDF2436H24	31.50 x 36 x 24.60	125	22.55	3.94	\$851
FFTDF2442H24	31.50 x 42 x 24.60	125	24.10	4.59	\$873
FFTDF2448H24	31.50 x 48 x 24.60	150	25.65	5.25	\$896
FFTDF2454H24	31.50 x 54 x 24.60	150	27.20	5.91	\$918
FFTDF2460H24	31.50 x 60 x 24.60	150	28.75	6.56	\$942
FFTDF2466H24	31.50 x 66 x 24.60	150	30.30	7.22	\$966
FFTDF2472H24	31.50 x 72 x 24.60	150	31.85	7.88	\$987
FFTDF2478H24	31.50 x 78 x 24.60	150	33.40	8.53	\$1010
FFTDF2484H24	31.50 x 84 x 24.60	150	34.95	9.19	\$1054
FFTDF3036H24	37.75 x 36 x 24.60	100	36.50	4.72	\$880
FFTDF3042H24	37.75 x 42 x 24.60	125	38.05	5.51	\$960
FFTDF3048H24	37.75 x 48 x 24.60	125	39.60	6.29	\$926
FFTDF3054H24	37.75 x 54 x 24.60	150	41.15	7.08	\$949
FFTDF3060H24	37.75 x 60 x 24.60	150	41.70	7.87	\$971
FFTDF3066H24	37.75 x 66 x 24.60	150	44.25	8.65	\$995
FFTDF3072H24	37.75 x 72 x 24.60	150	45.80	9.44	\$1015
FFTDF3078H24	37.75 x 78 x 24.60	150	47.35	10.22	\$1038
FFTDF3084H24	37.75 x 84 x 24.60	150	48.90	11.01	\$1084

Provides privacy in an open plan environment. Powder coated aluminum frame with 9mm felt. Includes all hardware to connect. Brackets are painted steel. Side dividers extend 6.237" from the front edge of each surface. Back divider extends over the back edge of the worksurface by 1.5", allowing for cable pass-through to trough. Width and depth are nominal sizes representing the sizes of the FreeFit table. Allow for .25" overhang at the sides, 1.5" at the back, and 6.237" at the front. Frame and hardware available in Black (**BLK**), Designer White (**DWT**) and Tungsten (**TUN**). End trim cap is only available in Charcoal (CHR). 9mm PET felt material is tackable and available in 9 colors.

- **FFTDF24xxH24 are for configurations with 24" deep surfaces.**
- **FFTDF30xxH24 are for configurations with 30" deep surfaces.**

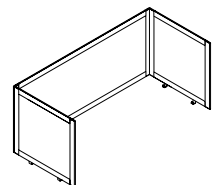

30" H Single Table Felt Divider Screen

FFTDF2436H30	31.50 x 36 x 30.60	125	24.85	3.97	\$845
FFTDF2442H30	31.50 x 42 x 30.60	125	26.40	4.59	\$867
FFTDF2448H30	31.50 x 48 x 30.60	125	27.95	5.25	\$887
FFTDF2454H30	31.50 x 54 x 30.60	150	29.50	5.91	\$908
FFTDF2460H30	31.50 x 60 x 30.60	150	31.05	6.56	\$929
FFTDF2466H30	31.50 x 66 x 30.60	150	32.60	7.22	\$950
FFTDF2472H30	31.50 x 72 x 30.60	150	34.14	7.88	\$971
FFTDF2478H30	31.50 x 78 x 30.60	150	34.70	8.53	\$992
FFTDF2484H30	31.50 x 84 x 30.60	150	37.25	9.19	\$1042
FFTDF3036H30	37.75 x 36 x 30.60	100	38.80	4.72	\$886
FFTDF3042H30	37.75 x 42 x 30.60	100	40.35	5.51	\$907
FFTDF3048H30	37.75 x 48 x 30.60	125	41.90	6.29	\$928
FFTDF3054H30	37.75 x 54 x 30.60	125	43.45	7.08	\$949
FFTDF3060H30	37.75 x 60 x 30.60	125	45	7.87	\$971
FFTDF3066H30	37.75 x 66 x 30.60	150	46.55	8.65	\$992
FFTDF3072H30	37.75 x 72 x 30.60	150	48.10	9.44	\$1012
FFTDF3078H30	37.75 x 78 x 30.60	150	49.65	10.22	\$1033
FFTDF3084H30	37.75 x 84 x 30.60	150	51.20	11.01	\$1082

Provides privacy in an open plan environment. Powder coated aluminum frame with 9mm felt. Includes all hardware to connect. Brackets are painted steel. Side dividers extend 6.237" from the front edge of each surface. Back divider extends over the back edge of the worksurface by 1.5", allowing for cable pass-through to trough. Width and depth are nominal sizes representing the sizes of the Bridges configuration. Allow for .25" overhang at the sides, 1.5" at the back, and 6.237" at the front. Frame and hardware available in Black (**BLK**), Designer White (**DWT**) and Tungsten (**TUN**). End trim cap is only available in Charcoal (CHR). 9mm PET felt material is tackable and available in 9 colors.

- **FFTDF24xxH30 are for configurations with 24" deep surfaces.**
- **FFTDF30xxH30 are for configurations with 30" deep surfaces.**

Required Specifications

Frame finish
Felt finish



Designed by Zoey Chu, **JUNCTION™** provides an affordable solution for boardroom, classroom and presentation room applications. Offered in 20", 24" and 30" depths and a variety of table top shapes to create unique configurations.

A freestanding or shared leg configuration with the unique "Y" leg allows you to either create a permanent table or one that can be reconfigured quickly and easily. A straight leg is available for use with half round and keystone tops.

Shared leg configurations allow more legroom and can also decrease cost because they use fewer components. Freestanding configurations provide more flexibility for changing environments.



Y Leg Design



Modesty Panel



Shared leg configuration provides more legroom and decreases the overall costs



Features and Benefits

- Tops are 1" thick and constructed of 45 lb. density particleboard.
- Optional Radius Corners (RM) available at no upcharge.
- Optional modesty panel with integrated wire trough available.
- Casters available with or without manual locks provide mobility.
- Black grommets for convenient wire management can be ordered factory installed.
- Optional, easy-to-use thumbscrews allow installation without tools.
- JUNCTION™ tops are available in Global laminate finishes with 2 leg options.

GENERAL INFORMATION

- Junction is a series of multi-purpose tables for classroom, training room and boardroom applications
- Ability for tables to be set up as freestanding or shared leg configuration
- Unique design by Zooney Chu
- Half round, trapezoid and Keystone tops are available to create a variety of package configurations
- Rectangular tops are available in 20", 24" and 30" depths
- Optional modesty panels with integrated wire troughs are available
- Optional large electrical manager provides a safe environment for equipment wires
- Special width tops are available. Use next size up.
- Shipped R.T.A. (Ready to Assemble). Each component is packaged individually; Legs are shipped one per carton.
- Global laminate and seating products are in compliance with stringent emission guidelines set out by the Greenguard Environmental Institute under the standards for low emitting products and materials. www.greenguard.org
- **Level 2 Certified**

WORKSURFACES

- Tops are 1" thick, made of 45 lb. density particle board covered on both sides with high performance thermally fused laminate.
- Laminate finishes are available in High Pressure. Contact your Customer Service Representative for a quote.
- If other than a Global standard laminate finish is preferred, contact your Customer Service Representative. Information needed includes the name of the laminate manufacturer, color name, number and model of table. You will then be given a quote for this special order.
- Products specified with the high pressure laminate option are finished on the underside of the surface with a kraft paper backing.

CONSTRUCTION

- Rectangular tops 54" in length and longer include a steel support channel for structural rigidity
- Tops are pre-drilled with threaded steel inserts
- Special width tops are available. Use next size up.
- Tables adjust from 28 ¾" to 29 ¾" high.

EDGE DETAIL

- Tops are sealed with Global's preferred edge in matching color.
- Optional Radius Corners (**RM**) are available on rectangular tops at no upcharge.

LEGS

- Unique Y design
- Straight leg available for assembly with Half Round tops and Keystone tops
- Heavy duty steel construction
- Coated with environmentally friendly recycled paint that provides a durable finish
- Black plastic leveling glides offer 1" adjustability
- Available in Black (**TBL**), Cloud (**TIV**), Designer White (**TDW**), Fog (**TFO**), Frost (**TFR**), Kalua (**TKA**), Latte (**TLA**), Mocha (**TMO**), Nevada (**TNE**), Sand (**TSN**), Shadow (**TSH**), Toast (**TOA**) or Tungsten (**TTU**) finish.
- Y Legs: 17.5" leg span - 20"D top, 21.5" leg span - 24"D top, 24.5" leg span - 30"D top.

CASTERS

- Optional casters are available
- 1½" Dual wheel casters with or without manual lock. Full 360° swivel.
- Can be used in any combination with or without standard glides
- Suggested for carpeted surfaces
- Available in Black only
- Sold in packages of two

GANGING

- Ganging plates are available for ganging workstations together
- Ganging plates are black epoxy coated steel plates with two thumbscrews
- Provides maximum stability and torque reduction

FLUSH PLATE

- Suggested for top clusters (fixed configurations for additional stability)
- Sold individually and shipped with two thumbscrews for mounting
- No tools required
- Flush plate allows for ganging together of two or more tops

WIRE MANAGEMENT

- Available for managing additional larger wires and power connectors
- 3½" high x 4¼" deep Black PVC channel attaches to the underside of top

1. SPECIFY MODEL NUMBER

2. SPECIFY FINISH

Laminate Finishes:

ACJ	Absolute Acajou	NML	Noce Medio
ASN	Asian Night	QTM	Quartered Mahogany
AWC	Avant Cherry	SOG	Storm Grey
AWH	Avant Honey	TFW	Tiger Fruitwood
BLK	Black	TWL	Tiger Walnut
BRC	Brushed Cobalt	WHE	Walnut Heights
CMB	Clear Maple	WHC	White Chocolate
DES	Dark Espresso	WGY	Willow Grey
DWT	Designer White	WCR	Winter Cherry
HGT	Hayden Grey		
NBL	Noce Biondo		
NGL	Noce Grigio		
NEL	Noce Leggero		

Legs:

TBL	Black
TIV	Cloud
TDW	Designer White
TFO	Fog
TFR	Frost
TKA	Kalua
TLA	Latte
TMO	Mocha
TNE	Nevada
TSN	Sand
TSH	Shadow
TOA	Toast
TTU	Tungsten

3. SPECIFY OPTIONS

Modesty Panels

- 11¼" high panel attaches to the underside of worksurface top
- Standard with integrated wire trough
- Available in black PVC

Grommets

- Grommets are available in **Rectangular and Trapezoid** Tops (left, center or right). See below for available locations. Order as: **AG1, AG2 or AG3. Add \$88.** For **Keystone** worksurface locations, order as **AG2. Add \$88.**
- Grommet hole dimensions are 3 ¼" wide x 1 7/8" deep.

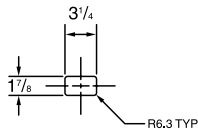

- Grommets may be placed at non-standard locations. Order as: **AGS - Add \$88.** A drawing must be supplied with vertical and horizontal dimensions to the center of the cut-out (as in drawing above). Please refer to CUSTOM GROMMET LOCATION FORM in the back reference section.

Power Block

- A Power Block (model **PMSADM**) may be ordered on all worksurfaces.
- A Power Block is a rectangular worksurface power/data module with one electrical duplex receptacle and two data (RJ45) receptacles. 9' black cord included. Power Block dimensions are 3 ½" deep x 6 ½" wide x 2 ¾" high.
- To purchase a Power Block, you must specify both the Power Block cut-out location and the Power Block model #. Order Power Block as **PMSADM, ADD \$330.** Power Blocks are available in standard worksurface locations (left, center or right). Order as **E1, E2 or E3. Add \$88.**



Power Block **PMSADM, Add \$330**

EXAMPLES OF GROMMET AND POWER BLOCK POSITIONS

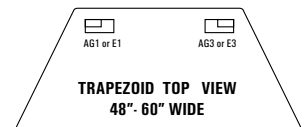
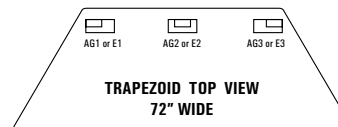
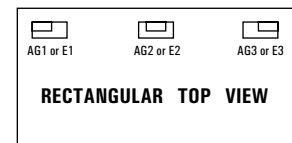
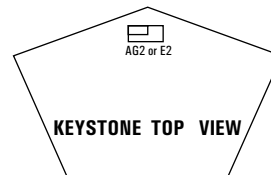

VILLA CUTOUTS

- Optional Villa cutout available in standard worksurface locations (left, center or right) for **Rectangular Tables.** Order as: **V1, V2 or V3. Add \$88 for each cutout.**
- Villa cutouts may be placed at non-standard locations. Please contact customer service.

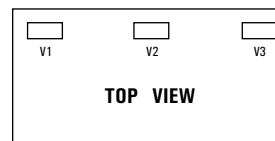

RECTANGULAR TOPS

MODEL# DIMENSIONS FREIGHT CLASS WT/LBS. CUBIC FT. LIST PRICE

D x W x H

JNR2042	20 x 42 x 1	65	26	1.10	\$343
JNR2048	20 x 48 x 1	65	29	1.15	\$383
JNRU2054	20 x 54 x 1	65	33	1.30	\$475
JNRU2060	20 x 60 x 1	65	37	1.40	\$511
JNRU2066	20 x 66 x 1	65	41	1.55	\$551
JNRU2072	20 x 72 x 1	65	45	1.66	\$588
JNR2442	24 x 42 x 1	65	31	1.25	\$343
JNR2448	24 x 48 x 1	65	35	1.40	\$383
JNRU2454	24 x 54 x 1	65	42	1.52	\$475
JNRU2460	24 x 60 x 1	65	47	1.67	\$511
JNRU2466	24 x 66 x 1	65	52	1.82	\$551
JNRU2472	24 x 72 x 1	65	57	2	\$588
JNR3042	30 x 42 x 1	65	38	1.51	\$417
JNR3048	30 x 48 x 1	65	44	1.70	\$439
JNRU3054	30 x 54 x 1	65	52	1.90	\$546
JNRU3060	30 x 60 x 1	65	59	2.10	\$586
JNRU3066	30 x 66 x 1	65	64	2.26	\$626
JNRU3072	30 x 72 x 1	65	70	2.50	\$667

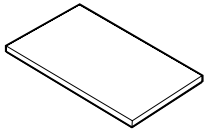

Rectangular Top

Pre-drilled with threaded steel inserts for freestanding and linking installations. **Tops 54" and longer are standard with a 16 gauge steel support channel.**

HALF ROUND TOPS

MODEL # DIMENSIONS FREIGHT CLASS WT/LB. CUBIC FT. LIST PRICE

JNHFS2040	20 x 40 x 1	70	23	1.05	\$363
JNHFS2048	20 x 48 x 1	65	27.50	1.15	\$376
JNHFS2448	24 x 48 x 1	65	34	1.40	\$404
JNHFS2454	27 x 54 x 1	65	38.25	1.52	\$477
JNHFS3060	30 x 60 x 1	60	53	1.67	\$524
JNHFS3066	33 x 66 x 1	60	58.30	1.82	\$655

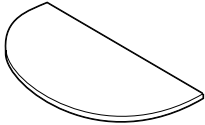

Half Round Top

Pre-drilled with threaded steel inserts for freestanding and linking installations. Four legs are required for freestanding configurations.

- **JNHFS2040/JNHFS2048** for use with 20" deep joining edge
- **JNHFS2448/JNHFS2454** for use with 24" deep joining edge
- **JNHFS3060/JNHFS3066** for use with 30" deep joining edge

TRAPEZOID TOPS

MODEL # DIMENSIONS FREIGHT CLASS WT/LB. CUBIC FT. LIST PRICE

JNTT2048	15.25 x 48 x 1	65	27.50	1.15	\$355
JNTT2060	15.25 x 60 x 1	65	34	1.40	\$422
JNTT2448	20.5 x 48 x 1	65	33	1.40	\$401
JNTT2460	20.5 x 60 x 1	65	41.25	1.67	\$483
JNTT3060	25.75 x 60 x 1	65	50.50	2.10	\$527
JNTT3072	25.75 x 72 x 1	65	61	2.50	\$588

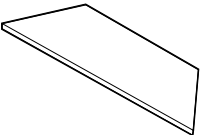

Trapezoid Top

Pre-drilled with threaded steel inserts for linking installations. **Not freestanding.**

- **JNTT2040/JNTT2048** for use with 20" deep joining edge
- **JNTT2448/JNTT2454** for use with 24" deep joining edge
- **JNTT3060/JNTT3066** for use with 30" deep joining edge

Required Specifications
Finish

Optional Specifications
Grommet

Accessories
Power Block

KEYSTONE TOPS

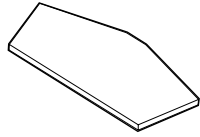

Keystone Top

MODEL#	DIMENSIONS	FREIGHT CLASS	WT/LB.	CUBIC FT.	LIST PRICE
--------	------------	---------------	--------	-----------	------------

D x W x H					
JN5S2424	24 x 42 x 1	65	35	1.40	\$410
JN5S3030	30 x 54 x 1	65	53	2.10	\$524

Pre-drilled with threaded steel inserts for linking installations. **Not freestanding**

- **JN5S2424** for use with 20" deep joining edge
- **JN5S3030** for use with 24" deep joining edge

MODESTY PANELS



Modesty Panel

MODEL#	DIMENSIONS	FREIGHT CLASS	WT/LB.	CUBIC FT.	LIST PRICE
--------	------------	---------------	--------	-----------	------------

JNMP42	6.92 x 29.19 x 11.25	250	3.70	1.50	\$284
JNMP48	6.92 x 35.19 x 11.25	250	4.50	1.75	\$318
JNMP54	6.92 x 41.19 x 11.25	250	5	2	\$356
JNMP60	6.92 x 47.19 x 11.25	250	5.90	2.25	\$391
JNMP66	6.92 x 53.19 x 11.25	250	6.60	2.50	\$419
JNMP72	6.92 x 59.19 x 11.25	250	7.40	2.75	\$455

For use with **JNR rectangular tops**. 11 ¼" high, Black plastic, attractive ribbed design. Includes integrated wire trough. Connects to predrilled holes in table top.



Modesty Panel

JNMTT2048	6.92 x 22.75 x 11.25	250	2.80	1.17	\$251
JNMTT2060	6.92 x 34.75 x 11.25	250	4.30	1.70	\$282
JNMTT2448	6.92 x 19 x 11.25	250	2.50	1	\$251
JNMTT2460	6.92 x 31 x 11.25	250	3.90	1.55	\$282
JNMTT3060	6.92 x 26 x 11.25	250	3.30	1.30	\$251
JNMTT3072	6.92 x 38 x 11.35	250	4.70	1.90	\$282

For use with **JNTT trapezoid tops**. 11 ¼" high, Black plastic, attractive ribbed design. Includes integrated wire trough. Connects to predrilled holes in table top.

WIRE MANAGEMENT



Wire Manager

MODEL #	DIMENSIONS	FREIGHT CLASS	WT/LB.	CUBIC FT.	LIST PRICE
---------	------------	---------------	--------	-----------	------------

JNEC5S	4.14 x 12.5 x 3.63	70	1	.10	\$76
--------	--------------------	----	---	-----	-------------

For use with **JN5S Keystone Tops**. For managing additional wires and power connectors. 3/8"H Black PVC channel connects to predrilled holes in table top.



Wire Manager

JNEC42	4.14 x 41.75 x 3.63	125	2.52	.33	\$180
JNEC48	4.14 x 47.75 x 3.63	125	2.88	.38	\$209
JNEC54	4.14 x 53.75 x 3.63	125	3.24	.43	\$237
JNEC60	4.14 x 59.75 x 3.63	125	3.60	.48	\$262
JNEC66	4.14 x 65.75 x 3.63	125	3.96	.53	\$274
JNEC72	4.14 x 71.75 x 3.63	125	4.32	.58	\$356

For use with **JNR Rectangular Tops**. For managing additional wires and power connectors. 3/8"H Black PVC channel connects to predrilled holes in the table top.

Required Specifications

Finish

Optional Specifications

Grommet

Accessories

Power Block

WIRE MANAGER



Wire Manager

MODEL#	DIMENSIONS D x W x H	FREIGHT CLASS	WT./LBS.	CUBIC FT.	LIST PRICE
JNECT2048	4.14 x 28.75 x 3.63	70	1.74	.23	\$180
JNECT2060	4.14 x 40.75 x 3.63	125	2.46	.33	\$251
JNECT2448	4.14 x 24.75 x 3.63	70	1.50	.20	\$180
JNECT2460	4.14 x 36.75 x 3.63	125	2.22	.30	\$251
JNECT3060	4.14 x 31.75 x 3.63	70	1.92	.25	\$180
JNECT3072	4.14 x 43.75 x 3.63	125	2.64	.35	\$251

For use with **JNTT Trapezoid Tops**. For managing additional wires and power connectors. 3/4" high Black PVC channel connects to predrilled holes in the table top.

LEGS

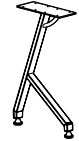

"Y" Leg

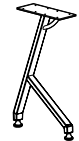

"Y" Leg

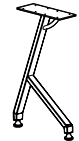

"Y" Leg

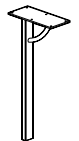

Straight Leg

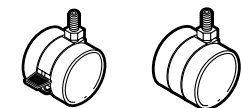

Casters

MODEL #	DIMENSIONS	FREIGHT CLASS	WT./LB.	CUBIC FT.	LIST PRICE
GJNLEG20	17.25 x 2 x 27.5	150	8.50	2	\$272
GJNLEG24	21.5 x 2 x 27.5	150	10	2.50	\$272
GJNLEG30	24.5 x 2 x 27.5	250	11	2.85	\$293
JNLEG	1 x 2 x 27.5	150	6	1.30	\$240
JNCP	--	--	--	--	\$58

Leg span is 17½". Leveling glides are standard. **For assembly with 20" deep tops**

- List price is per each leg.
- See page 645 for available finishes.

Leg span is 21½". Leveling glides are standard. **For assembly with 24" deep tops**

- List Price is per each leg.
- See page 645 for available finishes.

Leg span is 24½". Leveling glides are standard. **For assembly with 30" deep tops**

- List Price is per each leg.
- See page 645 for available finishes.

Leveling glides are standard. **For assembly with half round and keystone tops**. Mounting plate is 11" deep by 5" wide.

- List Price is per each leg.
- See page 645 for available finishes.

Set of (2) 1½" dual wheel casters, one locking. Suggested for carpeted surfaces. Casters are fully interchangeable with glides. Black only.

- For use with Junction units only
- Casters DO NOT affect table height

Required Specifications

Finish

Optional Specifications

Grommet (Keystone)

Accessories

Power Block (Keystone)

ACCESSORIES



Thumbscrews

MODEL#	DIMENSIONS	FREIGHT CLASS	WT/LBS.	CUBIC FT.	LIST PRICE
--------	------------	---------------	---------	-----------	------------

D x W x H

JNTS	--	--	--	--	\$33
------	----	----	----	----	-------------

Triangular thumbscrew with 3/4" steel thread. Set of 4. Can be used in place of factory supplied screws to allow installation of "Y" legs to tops without tools. Black only.

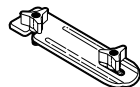

Ganging Flush Plate

JNGFP	--	--	--	--	\$61
-------	----	----	----	----	-------------

Black epoxy coated steel plates with 2 thumbscrews included. Used to connect table tops together for additional stability or for connecting freestanding tops together. Holes with steel inserts are located in the corner of the tops to accommodate this plate. Sold individually.

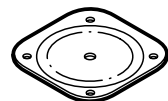

Flush Plate

JNFP1	5.25 d x 5.25 w	--	--	--	\$33
-------	-----------------	----	----	----	-------------

JNFP4	5.25 d x 5.25 w	--	--	--	\$123
-------	-----------------	----	----	----	--------------

Assures alignment on adjoining worksurfaces of the same height. Bolts included. Available in Black only.

JNFP1 - 1 per carton.

JNFP4 - 4 per carton.

Required Specifications

Finish



Kadin adds modern flair to your meeting space. From formal conference rooms to intimate meeting spaces or open forums, Kadin fits wherever people meet. Choose from round, square or rectangular tops in a variety of sizes with multiple edge options. Table depths start at 36", available widths are almost limitless. Surfaces are offered in architectural grade veneer and high-pressure laminate. The beautifully sculpted leg support maximizes leg clearance to keep guests comfortable. Extending from the leg support, the beam structure and connectors create visual interest as people come together. Pre-configured base assemblies make it easy to specify.



Features and Benefits

- Constructed of 45lb. density particleboard with high pressure laminate or grade A veneers
- 3 top shapes
- Solid die-cast aluminum leg with adjustable glide
- 5 edge options
- Metal bases available in 8 finishes
- Beam available in 7 finishes to match leg



90° connector



60° connector (for three leg tables only)



Beam construction

GENERAL INFORMATION

- Laminate or veneer tops with multiple edge options
- Three top shapes - round, square, rectangular
- Pre-configured assemblies make specifying easy
- Kadin pairs perfectly with storage from a number of Global desking series
- For environmental certifications, please visit globalfurnituregroup.com

**TABLES WITH LAMINATE TOPS:
CONSTRUCTION**

- Constructed of 45 lb. density particleboard with high pressure laminate
- Tables are pre-drilled with factory installed inserts for easy metal-to-metal base connection
- Solid die-cast aluminum leg with adjustable glide

WORKSURFACES

- Available in 1-1/16" or 1-7/16" high pressure laminate tops with a 3mm PVC edge trim or 1-3/16" high pressure laminate top with a 3mm PVC edge trim
- Laminate surfaces offer a selection of matching + coordinating edge band, specify separately from the surface finish
- Tables up to and including 96" long are manufactured in one piece, 108" to 180" long are manufactured in two pieces, and over 192" are manufactured in three pieces. If woodgrain laminate is chosen, the woodgrain pattern may not line up.
- Tables in two or three pieces will have the joining edge finished; hardware will be shipped for assembly
- Products specified with the high pressure laminate option are finished on the underside of the surface with a kraft paper backing.

EDGES

- Tables with **B** Edge are 1-1/16" thick and have a 3mm PVC edge
- Tables with a **W** Edge are 1-7/16" thick and have a 3mm PVC edge
- Tables with a **KL** edge are 1-3/16" thick with a 3mm PVC edge and a 2" undercut knife profile
- Square and Rectangular Tables with a **B** or **W** edge have a 1" radius at each corner. For 90° corners, please add **NR** at the end of the product code. No upcharge.
- Square and Rectangular tables with a **KL** edge have 90° corners. There is no radius corner option for the KL edge.

**TABLES WITH VENEER TOPS:
CONSTRUCTION**

- Constructed of 45 lb. density particleboard with grade A veneers
- Tables are pre-drilled with factory installed inserts for easy metal-to-metal base connection
- Solid die-cast aluminum leg with adjustable glide

WORKSURFACES

- 1-3/16" thick veneer tops with choice of edge.
- Tables up to and including 96" long are manufactured in one piece, 108" to 180" long are manufactured in two pieces, and over 192" are manufactured in three pieces.
- Veneer wood grain will run with the **length** of the table and align at the seam up to 180"
- Veneer wood grain will run with the **depth** of the table (i.e. cross grain) on tables 192" and up.
- Tables in two or three pieces will have the joining edge finished; hardware will be shipped for assembly

EDGES

- Tables with a **KF** edge are 1-3/16" thick with a flat 3mm hardwood edge, stained to match to veneer.
- Tables with a **KV** edge are 1-3/16" thick with a flat 3mm hardwood edge and 2" undercut knife edge profile.
- Square and Rectangular Tables with the **KF** and **KV** edge have 90° corners. There is no radius corner option.

GROMMETS

- Grommets available in standard table top locations (left, center or right). Order as: **AG1, AG2 or AG3. Add \$88**
- Grommet hole dimensions are 3 1/4" wide x 1 7/8" deep.

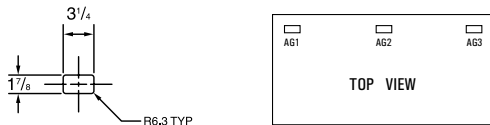

- Actual grommet locations will vary according to base selection.

WIRE MANAGEMENT

- For vertical and horizontal wire management, please refer to wire management section below, or Productivity Solutions on page 474.

CUT-OUTS FOR POWER BLOCKS

- Optional cut-out available in standard worksurface locations (left, center or right) for all table shapes. **Add \$88 for each cut-out.**
- Cut-outs may be placed at non-standard locations. Please contact customer care.
- Match power block desired with cut-out code and location from above grid
- Power module cut-out locations are not available on all models – please see diagrams to the right for restrictions.

*Oasis Mini is not available on 36"D models due to space restrictions caused by beam placement. **Only available on 60" square and 60" round 4-leg tables.**

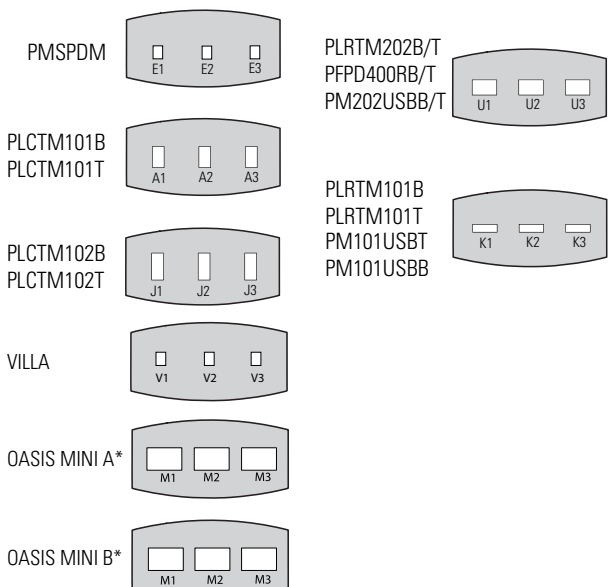

1. SPECIFY MODEL NUMBER

2. SPECIFY FINISH

LAMINATE FINISHES

ACJ	Absolute Acajou	NGL	Noce Grigio
ASN	Asian Night	NEL	Noce Leggero
AWC	Avant Cherry	NML	Noce Medio
AWH	Avant Honey	QTM	Quartered Mahogany
BLK	Black	SOG	Storm Grey
BRC	Brushed Cobalt	TFW	Tiger Fruitwood
CMB	Clear Maple	TWL	Tiger Walnut
DES	Dark Espresso	WHE	Walnut Heights
DWT	Designer White	WHC	White Chocolate
HGT	Hayden Grey	WGY	Willow Grey
NBL	Noce Biondo	WCR	Winter Cherry

BEAM FINISHES

BLK	Black	CHR	Charcoal
DWT	Designer White	NEV	Nevada
SIL	Silver	TPE	Taupe
TUN	Tungsten		

VENEER FINISHES:

Code	Finish	Veneer Type	Cut
AMW	Almond Cherry	Cherry	Flat Sliced
CAW	Cocoa Walnut	Walnut	Flat Sliced
CRW	Coral	White Oak	Rift
DCW	Dark Cherry	Cherry	Flat Sliced
EWV	Espresso Walnut	Walnut	Flat Sliced
EVV	Evening Oak	White Oak	Rift
GRW	Grey on Oak	White Oak	Rift
HAW	Hazelnut	Maple	Flat Sliced
SMW	Honey Maple	Maple	Flat Sliced
JAW	Java	White Oak	Rift
LTW	Latte Walnut	Walnut	Flat Sliced
MTW	Milestone	White Oak	Rift
MCW	Mocha	White Oak	Rift
MPW	Natural Maple	Maple	Flat Sliced
RCW	Red Cherry	Cherry	Flat Sliced
VNW	Vintage Cherry	Cherry	Flat Sliced
WLW	Walnut	Walnut	Flat Sliced
WCW	Warm Cherry	Cherry	Flat Sliced
WMW	White Maple	Maple	Flat Sliced

EDGE FINISHES (Laminate Surfaces Only)

AAE	Absolute Acajou	DWE	Designer White
ASE	Asian Night	QTM	Quartered Mahogany
ACE	Avant Cherry	TPE	Taupe (use w/HGT)
AHE	Avant Honey	TFE	Tiger Fruitwood
BLK	Black	TWE	Tiger Walnut
BRC	Brushed Cobalt	WHE	Walnut Heights
CHR	Charcoal (use w/SOG)	CBE	White Chocolate
CME	Clear Maple	WCE	Winter Cherry
DEE	Dark Espresso		

LEG FINISHES

CHM	Chrome	BLK	Black
CHR	Charcoal	DWT	Designer White
NEV	Nevada	SIL	Silver
TPE	Taupe	TUN	Tungsten

3. SPECIFY OPTIONS

Edge Options:

"B" Edges

Laminate surface with PVC edge

HP (B) 1-1/16" Thickness



"W" Edges

Laminate surface with PVC edge

HP (W) 1-7/16" Thickness



"KL" Edges

Laminate surface with PVC edge

HP (KL) 1-3/16" Thickness

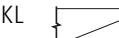

"KF" Edges

Veneer surface with Hardwood edge

(KF) 1-3/16" Thickness



"KV" Edges

Veneer surface with Hardwood edge

(KV) 1-3/16" Thickness

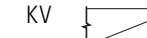

CUT-OUT LOCATIONS:

Square Table - position 2 only

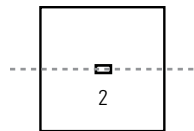

Round Table - position 2 only

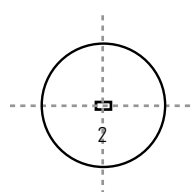

Rectangular Table

- Cut-out only in position 2: LKD3648, LKD3654, LKD4248, LKD4254, LKD4854
- One cut-out choice only (position 1, 2 or 3): LKD3660, LKD3666, LKD3672, LKD4260, LKD4266, LKD4272
- Up to 3 cut-outs in position 1, 2 and/or 3: LKD3678, LKD3684, LKD3696, LKD4278, LKD4284, LKD4296, LKD4878, LKD4884, LKD4896

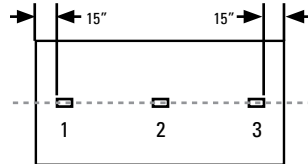

Rectangular Table - 2 piece top

- Up to 2 cut-outs in position 1 and/or 3 - all sizes

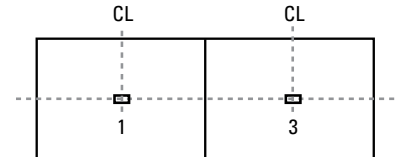

Rectangular Table - 3 piece top

- Up to 3 cut-outs in position 1, 2 and/or 3 - all sizes

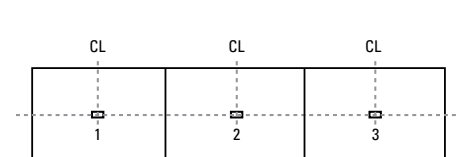

Note: Grommet orientation follows the length of table.

SQUARE TABLES - LAMINATE **MODEL#** **DIMENSIONS** **FREIGHT CLASS** **WT/LBS.** **CUBIC FT.** **B-EDGE** **W-EDGE** **KL-EDGE**

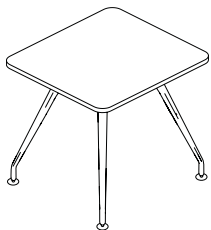

Square Table - Laminate Top*

	D x W x H							
LKD3636	36 x 36 x 29-29.5	100	73	4	\$1658	\$1862	\$1930	
LKD4242	42 x 42 x 29-29.5	100	86	4	\$1982	\$2176	\$2340	
LKD4848	48 x 48 x 29-29.5	92.5	107	5	\$2327	\$2564	\$2723	
LKD5454	54 x 54 x 29-29.5	85	120	5	\$2562	\$2850	\$3261	
LKD6060	60 x 60 x 29-29.5	92.5	135	6	\$2824	\$3168	\$3732	

Tops feature 3mm pvc edge and metal inserts for ease of assembly to base. Also includes four legs, four 90-degree connectors and four leg beams.

SQUARE TABLES - VENEER **KF EDGE** **KV EDGE**

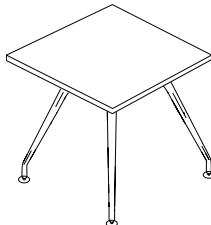

Square Table - Veneer Top

LKD3636K	36 x 36 x 29-29.5	100	73	4	\$2299	\$2380	
LKD4242K	42 x 42 x 29-29.5	92.5	86	4	\$2738	\$2848	
LKD4848K	48 x 48 x 29-29.5	92.5	107	5	\$3243	\$3386	
LKD5454K	54 x 54 x 29-29.5	85	120	5	\$3928	\$4107	
LKD6060K	60 x 60 x 29-29.5	92.5	135	6	\$4559	\$4779	

Tops feature hardwood edge and metal inserts for ease of assembly to base. Also includes four legs, four 90-degree connectors and four leg beams.

ROUND TABLES - LAMINATE **B-EDGE** **W-EDGE** **KL-EDGE**

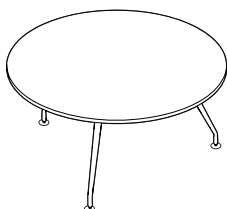

Round Table - 3 Legs*

LKD36DIA	36 x 36 x 29-29.5	92.5	66	3	\$1336	\$1546	\$1800
LKD42DIA	42 x 42 x 29-29.5	85	78	3	\$1648	\$1844	\$2301
LKD48DIA	48 x 48 x 29-29.5	85	99	4	\$1956	\$2200	\$2794
LKD54DIA	54 x 54 x 29-29.5	85	111	4	\$2192	\$2487	\$3415
LKD60DIA	60 x 60 x 29-29.5	85	126	5	\$2449	\$2802	\$4026

Tops feature 3mm pvc edge and metal inserts for ease of assembly to base. Also includes three legs, three 60-degree connectors and three leg beams.



Round Table - 4 Legs*

LKD436DIA	36 x 36 x 29-29.5	100	66	3	\$1737	\$1941	\$2092
LKD442DIA	42 x 42 x 29-29.5	92.5	78	3	\$1982	\$2176	\$2537
LKD448DIA	48 x 48 x 29-29.5	92.5	99	4	\$2327	\$2564	\$3077
LKD454DIA	54 x 54 x 29-29.5	85	111	4	\$2562	\$2850	\$3638
LKD460DIA	60 x 60 x 29-29.5	92.5	126	5	\$2824	\$3167	\$4272

Tops feature 3mm pvc edge and metal inserts for ease of assembly to base. Also includes four legs, four 90-degree connectors and four leg beams.

Required Specifications

Top Finish
Leg Finish
Edge Finish*
Edge Style

Optional Specifications

Grommet

Accessories

Power Block

ROUND TABLES - VENEER

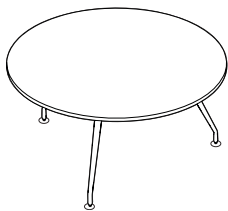

Round Table - 3 Legs

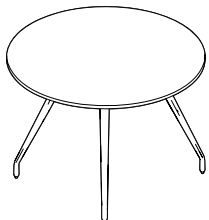

Round Table - 4 Legs

MODEL# DIMENSIONS FREIGHT CLASS WT./LBS. CUBIC FT. KF EDGE KV EDGE

D x W x H

LKD36DIAK	36 x 36 x 29-29.5	92.5	66	3	\$2189	\$2292
LKD42DIAK	42 x 42 x 29-29.5	85	78	3	\$2757	\$2894
LKD48DIAK	48 x 48 x 29-29.5	85	99	4	\$3395	\$3584
LKD54DIAK	54 x 54 x 29-29.5	85	111	4	\$4201	\$4432
LKD60DIAK	60 x 60 x 29-29.5	85	126	5	\$5021	\$5303

Tops feature hardwood edge and metal inserts for ease of assembly to base. Also includes three legs, three 60-degree connectors and three leg beams.

LKD436DIAK	36 x 36 x 29-29.5	100	66	3	\$2394	\$2497
LKD442DIAK	42 x 42 x 29-29.5	92.5	78	3	\$2973	\$3110
LKD448DIAK	48 x 48 x 29-29.5	92.5	99	4	\$3656	\$3845
LKD454DIAK	54 x 54 x 29-29.5	85	111	4	\$4401	\$4632
LKD460DIAK	60 x 60 x 29-29.5	92.5	126	5	\$5244	\$5526

Tops feature hardwood edge and metal inserts for ease of assembly to base. Also includes four legs, four 90-degree connectors and four leg beams.

RECTANGULAR TABLES - LAMINATE

B-EDGE W-EDGE KL-EDGE

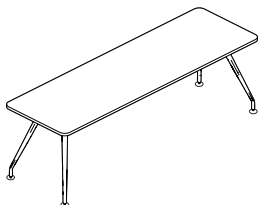

Rectangular Table*

LKD3648	36 x 48 x 29-29.5	100	75	4	\$2052	\$2261	\$2320
LKD3654	36 x 54 x 29-29.5	92.5	81	4	\$2142	\$2375	\$2533
LKD3660	36 x 60 x 29-29.5	100	88	5	\$2234	\$2488	\$2686
LKD3666	36 x 66 x 29-29.5	100	95	5	\$2327	\$2604	\$2838
LKD3672	36 x 72 x 29-29.5	92.5	101	5	\$2416	\$2713	\$2991
LKD3678	36 x 78 x 29-29.5	92.5	105	5	\$2507	\$2827	\$3145
LKD3684	36 x 84 x 29-29.5	92.5	108	5	\$2599	\$2942	\$3297
LKD3696	36 x 96 x 29-29.5	100	115	6	\$2782	\$3169	\$3603
LKD4248	42 x 48 x 29-29.5	92.5	87	4	\$2198	\$2404	\$2521
LKD4254	42 x 54 x 29-29.5	100	90	5	\$2307	\$2535	\$2757
LKD4260	42 x 60 x 29-29.5	100	94	5	\$2415	\$2659	\$2935
LKD4266	42 x 66 x 29-29.5	92.5	101	5	\$2521	\$2789	\$3110
LKD4272	42 x 72 x 29-29.5	92.5	106	5	\$2631	\$2917	\$3290
LKD4278	42 x 78 x 29-29.5	100	110	6	\$2736	\$3045	\$3465
LKD4284	42 x 84 x 29-29.5	100	113	6	\$2845	\$3174	\$3642
LKD4296	42 x 96 x 29-29.5	92.5	129	6	\$3061	\$3430	\$3997
LKD4854	48 x 54 x 29-29.5	100	94	5	\$2502	\$2753	\$2983
LKD4860	48 x 60 x 29-29.5	100	99	5	\$2622	\$2898	\$3184
LKD4866	48 x 66 x 29-29.5	100	107	6	\$2743	\$3038	\$3384
LKD4872	48 x 72 x 29-29.5	100	114	6	\$2864	\$3182	\$3586
LKD4878	48 x 78 x 29-29.5	92.5	120	6	\$2983	\$3328	\$3786
LKD4884	48 x 84 x 29-29.5	92.5	125	6	\$3105	\$3470	\$3987
LKD4896	48 x 96 x 29-29.5	92.5	149	7	\$3343	\$3754	\$4388

Tops feature 3mm pvc edge and metal inserts for ease of assembly to base. Also includes four legs, four 90-degree connectors and four leg beams.

Required Specifications

- Top Finish
- Leg Finish
- Edge Finish*
- Edge Style

Optional Specifications

- Grommet

Accessories

- Power Block

RECTANGULAR TABLES - LAMINATE

MODEL# DIMENSIONS FREIGHT CLASS WT/LBS. CUBIC FT. B-EDGE W-EDGE KL-EDGE

D x W x H

LKD36108	36 x 108 x 29-29.5	92.5	154	7	\$3827	\$4114	\$4553
LKD36120	36 x 120 x 29-29.5	125	164	8	\$4022	\$4342	\$4857
LKD42108	42 x 108 x 29-29.5	150	124	8	\$4082	\$4408	\$4991
LKD42120	42 x 120 x 29-29.5	150	141	9	\$4298	\$4654	\$5345
LKD48108	48 x 108 x 29-29.5	150	127	9	\$4391	\$4744	\$5437
LKD48120	48 x 120 x 29-29.5	150	151	9	\$4637	\$5031	\$5836
LKD48132	48 x 132 x 29-29.5	150	164	10	\$4877	\$5308	\$6239
LKD48144	48 x 144 x 29-29.5	125	181	10	\$4939	\$5377	\$6632
LKD48156	48 x 156 x 29-29.5	150	191	11	\$5357	\$5858	\$7042
LKD48168	48 x 168 x 29-29.5	125	206	11	\$5596	\$6128	\$7443
LKD48180	48 x 180 x 29-29.5	125	220	12	\$6013	\$6608	\$7850
LKD54144	54 x 144 x 29-29.5	150	193	11	\$5517	\$6023	\$7282
LKD54168	54 x 168 x 29-29.5	150	214	12	\$6048	\$6627	\$8181
LKD60144	60 x 144 x 29-29.5	150	206	12	\$5844	\$6393	\$7868
LKD60168	60 x 168 x 29-29.5	150	227	13	\$6421	\$7053	\$8857

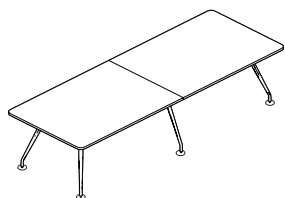

Rectangular Table - 2 piece top

Tops feature 3mm pvc edge and metal inserts for ease of assembly to base. Also includes six legs, four 90-degree connectors, two 3-way connectors and four leg beams.

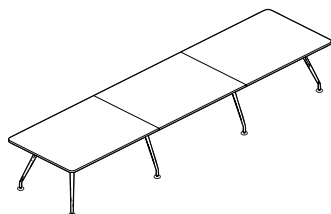

Rectangular Table - 3 piece top

LKD48192	48 x 192 x 29-29.5	150	279	14	\$6765	\$7367	\$8883
LKD54192	54 x 192 x 29-29.5	150	288	15	\$7272	\$7930	\$9723
LKD54216	54 x 216 x 29-29.5	150	270	16	\$7798	\$8533	\$10618
LKD54240	54 x 240 x 29-29.5	150	298	17	\$8328	\$9142	\$11517
LKD60192	60 x 192 x 29-29.5	150	257	16	\$7702	\$8414	\$10500
LKD60216	60 x 216 x 29-29.5	150	283	17	\$8281	\$9078	\$11492
LKD60240	60 x 240 x 29-29.5	150	311	18	\$8858	\$9737	\$12481

Tops feature 3mm pvc edge and metal inserts for ease of assembly to base. Also includes eight legs, four 90-degree connectors, four 3-way connectors and eight leg beams.

Required Specifications

Top Finish
Leg Finish
Edge Finish
Edge Style

Optional Specifications

Grommet

Accessories

Power Block

RECTANGULAR TABLES - VENEER

MODEL# DIMENSIONS FREIGHT CLASS WT/LBS. CUBIC FT. KF EDGE KV EDGE

D x W x H

LKD3648K	36 x 48 x 29-29.5	100	75	4	\$2708	\$2813
LKD3654K	36 x 54 x 29-29.5	92.5	81	4	\$2971	\$3091
LKD3660K	36 x 60 x 29-29.5	100	88	5	\$3174	\$3307
LKD3666K	36 x 66 x 29-29.5	100	95	5	\$3377	\$3524
LKD3672K	36 x 72 x 29-29.5	92.5	101	5	\$3580	\$3737
LKD3678K	36 x 78 x 29-29.5	92.5	105	5	\$3783	\$3956
LKD3684K	36 x 84 x 29-29.5	92.5	108	5	\$3988	\$4174
LKD3696K	36 x 96 x 29-29.5	100	115	6	\$4394	\$4606
LKD4248K	42 x 48 x 29-29.5	92.5	87	4	\$2974	\$3097
LKD4254K	42 x 54 x 29-29.5	100	90	5	\$3269	\$3409
LKD4260K	42 x 60 x 29-29.5	100	94	5	\$3505	\$3659
LKD4266K	42 x 66 x 29-29.5	92.5	101	5	\$3740	\$3910
LKD4272K	42 x 72 x 29-29.5	92.5	106	5	\$3975	\$4161
LKD4278K	42 x 78 x 29-29.5	100	110	6	\$4211	\$4410
LKD4284K	42 x 84 x 29-29.5	100	113	6	\$4445	\$4662
LKD4296K	42 x 96 x 29-29.5	92.5	129	6	\$4917	\$5161
LKD4854K	48 x 54 x 29-29.5	100	94	5	\$3569	\$3730
LKD4860K	48 x 60 x 29-29.5	100	99	5	\$3834	\$4012
LKD4866K	48 x 66 x 29-29.5	100	107	6	\$4102	\$4296
LKD4872K	48 x 72 x 29-29.5	100	114	6	\$4369	\$4581
LKD4878K	48 x 78 x 29-29.5	92.5	120	6	\$4636	\$4867
LKD4884K	48 x 84 x 29-29.5	92.5	125	6	\$4904	\$5149
LKD4896K	48 x 96 x 29-29.5	92.5	149	7	\$5438	\$5720

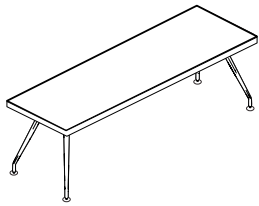

Rectangular Table

Tops feature hardwood edge and metal inserts for ease of assembly to base. Also includes four legs, four 90-degree connectors and four leg beams.

LKD36108K	36 x 108 x 29-29.5	125	154	7	\$5428	\$5666
LKD36120K	36 x 120 x 29-29.5	125	164	8	\$5835	\$6098
LKD42108K	42 x 108 x 29-29.5	150	124	8	\$6022	\$6299
LKD42120K	42 x 120 x 29-29.5	150	141	9	\$6491	\$6799
LKD48108K	48 x 108 x 29-29.5	150	127	9	\$6613	\$6928
LKD48120K	48 x 120 x 29-29.5	150	151	9	\$7148	\$7498
LKD48132K	48 x 132 x 29-29.5	150	164	10	\$7681	\$8068
LKD48144K	48 x 144 x 29-29.5	125	181	10	\$8216	\$8635
LKD48156K	48 x 156 x 29-29.5	150	191	11	\$8751	\$9206
LKD48168K	48 x 168 x 29-29.5	125	206	11	\$9285	\$9774
LKD48180K	48 x 180 x 29-29.5	125	220	12	\$9820	\$10345
LKD54144K	54 x 144 x 29-29.5	150	193	11	\$9059	\$9532
LKD54168K	54 x 168 x 29-29.5	150	214	12	\$10255	\$10808
LKD60144K	60 x 144 x 29-29.5	150	206	12	\$9844	\$10369
LKD60168K	60 x 168 x 29-29.5	150	227	13	\$11167	\$11780

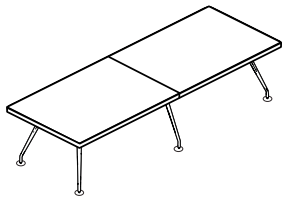

Rectangular Table - 2 piece top

Tops feature hardwood edge and metal inserts for ease of assembly to base. Also includes six legs, four 90-degree connectors, two 3-way connectors and four leg beams.

Required Specifications

Top Finish
Leg Finish
Edge Style

Optional Specifications

Grommet

Accessories

Power Block

RECTANGULAR TABLES - VENEER

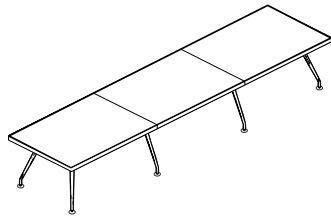

Rectangular Table - 3 piece top

MODEL# DIMENSIONS FREIGHT CLASS WT/LBS. CUBIC FT. KF EDGE KV EDGE

	D x W x H					
LKD48192K	48 x 192 x 29-29.5	150	279	14	\$10992	\$11551
LKD54192K	54 x 192 x 29-29.5	150	288	15	\$12095	\$12725
LKD54216K	54 x 216 x 29-29.5	150	270	16	\$13292	\$14000
LKD54240K	54 x 240 x 29-29.5	150	298	17	\$14488	\$15274
LKD60192K	60 x 192 x 29-29.5	150	257	16	\$13141	\$13841
LKD60216K	60 x 216 x 29-29.5	150	283	17	\$14464	\$15250
LKD60240K	60 x 240 x 29-29.5	150	311	18	\$15788	\$16660

Tops feature hardwood edge and metal inserts for ease of assembly to base. Also includes eight legs, four 90-degree connectors, four 3-way connectors and eight leg beams.

Required Specifications

Top Finish
Leg Finish
Edge Style

Optional Specifications

Grommet

Accessories

Power Block

WIRE MANAGEMENT



Cable Snake

MODEL #	DIMENSIONS D x W x H	FREIGHT CLASS	WT/LB.	CUBIC FT.	LIST PRICE
PCSN01	-- x -- x --	92.5	2.10	.20	\$135

Flexible cable management. Provides access to power/data from floor to underside of worksurface where it attaches. Two pathways within Cable Snake. Length under desk is 31.25". Silver (**SIL**) plastic only.



Cable Snake

BRTCS	2 x 8 x 30	70	3	.19	\$138
-------	------------	----	---	-----	--------------

Flexible cable management trough. Two pathways within the snake, one for data/communication and one for routing power cables. Translucent White finish only.

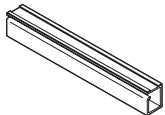

Wire Manager

PEWM5.5	2 x 66 x 2	70	.60	.10	\$198
PEWM5	2 x 60 x 2	70	.60	.10	\$166
PEWM4.5	2 x 54 x 2	70	.50	.10	\$148
PEWM4	2 x 48 x 2	70	.50	.10	\$135
PEWM3.5	2 x 42 x 2	70	.40	.10	\$116
PEWM3	2 x 36 x 2	70	.40	.10	\$104
PEWM2.5	2 x 30 x 2	70	.30	.10	\$85
PEWM2	2 x 24 x 2	70	.30	.10	\$70
PEWM1.5	2 x 18 x 2	70	.20	.10	\$55
PEWM1	2 x 12 x 2	70	.20	.10	\$40

Plastic tray flexes to receive and hold electrical and data wires. Quickly attaches with two strips of double-sided tape. Black (**BLK**) only.

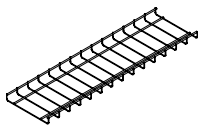

Power/Data Cable Basket

BRTCB76KIT	8 x 34 x 1	70	1.56	.15	\$239
BRTCB70	8 x 70 x 1	100	3.22	.34	\$173
BRTCB64	8 x 64 x 1	92.5	2.94	.29	\$161
BRTCB58	8 x 58 x 1	92.5	2.66	.26	\$156
BRTCB52	8 x 52 x 1	100	2.39	.24	\$147
BRTCB46	8 x 46 x 1	92.5	2.16	.21	\$139
BRTCB40	8 x 40 x 1	70	1.80	.18	\$131
BRTCB34	8 x 34 x 1	70	1.56	.15	\$126
BRTCB28	8 x 28 x 1	70	1.20	.13	\$111
BRTCB22	8 x 22 x 1	70	1.01	.10	\$104
BRTCB16	8 x 16 x 1	70	.73	.07	\$98
BRTCB8	8 x 8 x 1	70	.36	.03	\$88

Shallow, 8" wide basket manages cable excess and serves to manage cords and cables. It can be easily unclipped from spring steel brackets (included) to rearrange cable connections from below worksurface. Spring steel brackets can suspend the Cable Basket below the worksurface where it keeps the cords and cables off the floor and manages them along the horizontal plane - between floor monuments and Storage Vertical Cable Manager, for example. Tall storage cabinet's legs provide easy access to the Cable Basket where it can easily be unclipped from spring steel brackets to rearrange cable connections. Steel wire construction, chrome finish baskets; black spring steel hanging brackets, fasteners.

SWAP TABLES

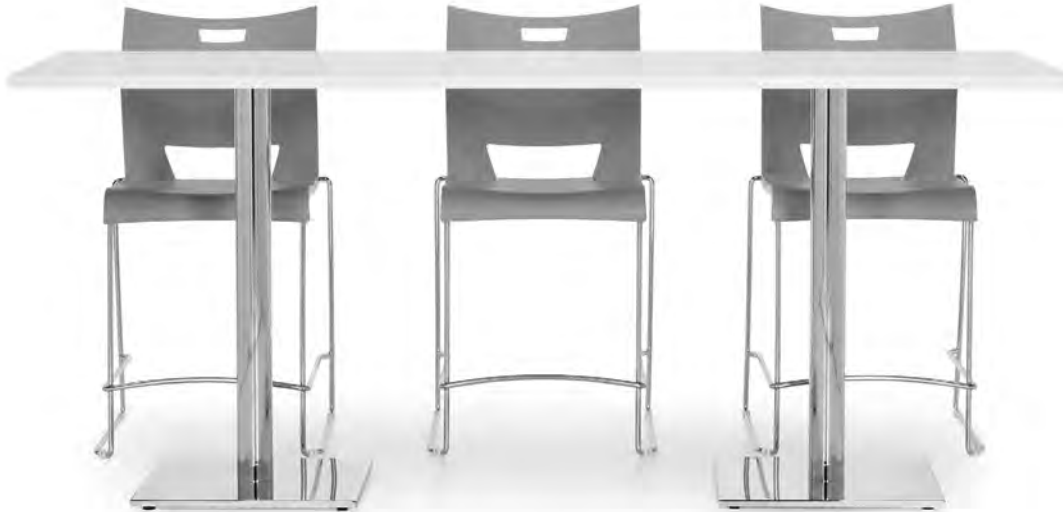

Global's Swap collection is a comprehensive offering including laptop tables, casual meeting tables, café tables, huddle tables and more. Suitable for a variety of applications: break rooms, dedicated/enclosed meeting rooms, casual/open area meeting spaces (lounges, seated, counter and bar height options), and private office (accommodate smaller 3-4 person discussions). Tops and bases are sold separately for ease of specification. Mix and match capabilities to create spaces for multi-purpose use. Choose your top, choose your base. Create the combination you desire for the way you want to work.

Features and Benefits

- All worksurfaces are 1" thick, constructed of 45 lb. density particle board covered on both sides with high performance, thermally fused laminate.
- Worksurfaces feature Global's preferred edge on all sides
- Bases are constructed of a solid steel metal plate and cover - round or square.
- Wire grommets and power block cutouts are available on most tables
- 6 heights:
 - Coffee table height at 16"H overall
 - End table height at 22"H
 - Lounge height at 25.5"H
 - Seated height at 29"H
 - Counter height at 36"H
 - Bar height at 41.5"H



½" thick steel square and round metal bases



Power management in select columns



Factory installed metal inserts for easy metal-to-metal base connection

GENERAL INFORMATION

- SWAP is a series of tables for use primarily in casual meeting spaces, lounges and café areas.
- A new way of specifying the exact worksurface requirements for today's shared spaces or to meet the needs of growing companies. What you choose today can be moved around or added to as the company changes and grows.
- Finish palette coordinates with most Global laminate casegoods series – tables can stand alone or blend with other solutions.
- Each component is packed individually. Bases are shipped assembled, one per carton. Easy to assemble.
- Global's counter and bar height stools are a perfect compliment to swap tables with counter and bar height bases.
- For environmental certifications, please visit globalfurnituregroup.com

TOPS

- All worksurfaces are 1" thick, constructed of 45 lb. density particleboard covered on both sides with high performance, thermally fused laminate
- Worksurfaces feature Global's preferred matching edge on all sides
- High pressure tops are available in all Swap laminate finishes at an extended lead time. Please see model # for pricing and availability
- High pressure tops are recommended for counter applications and other high use areas
- Products specified with the high pressure laminate option are finished on the underside of the surface with a kraft paper backing.
- Worksurfaces of 96" or less in length are standard in one piece (one carton)
- Worksurfaces 120" to 144" in length are standard in two pieces (two cartons)
- Worksurfaces 96", 120" and 144" x 48" include support channels

LAPTOP TABLES

- Round, square and rectangular tops are available with center or 3" off-centered mounting options.
- Tops are available in TFL and HP laminate options with matching edge band and include factory installed metal inserts for ease of assembly.
- Two base styles available: 14" diameter round base plate with centered column or 12.5" square base plate with centered or off-set column. 1.5" diameter column.
- Weighted base for balance includes cover plate, 0.5" adjustable leveling glides and machine screws for attaching the bases to Swap tops.

BASES

- **Caution:** to meet BIFMA standards for performance and stability, appropriate base size must be specified with corresponding top sizes identified. **Top plates and base plates vary by base size and will only work with table shape sizes as referenced on the following pages.**
- Bases are constructed of a round or square solid steel metal plate for counter balance, covered with a finished steel shroud, affixed with four bolts to a 3" diameter cold rolled steel tube.
- GRB14H25 attach to tops with a 6" x 6" steel plate, welded to a 1.5" diameter steel tube, bolted to a 0.5" thick solid steel counter balance. Not to be used on tops greater than 22" x 22" in size.
- GSB13H25 and GSOB13H25 attach to tops with a 6" x 6" steel plate, welded to a 1.5" diameter steel tube, bolted to a 0.5" thick solid steel counter balance. Not to be used on tops greater than 22" x 22" in size.
- GRB22H15, GRB22H21, GRB22H26, GRB22, GRB22H35, GRB22H41, GSB19H15, GSB19H21, GSB19H26, GSB19, GSB19H35 and GSB19H41 attach to tops with a 6" x 6" steel plate, welded to a 3" diameter steel tube, bolted to a 0.5" thick solid steel counter balance.
- **Top plate and base plate of GRB22 and GSB19 models in all heights, have pass-through cut-outs to accommodate a single port simplex or dual USB module to deliver power or USB charging to the surface.** This allows the module to be mounted directly above the base and to pass the unit's cord through the base column resulting in the cord and plug head exiting from the bottom of the base for plugging into a floor or wall mount power source.
- GRB28, GRB34, GSB23 and GSB28 attach to tops with an 11" x 11" steel plate, welded to a 4" diameter steel tube, bolted to a 0.375" thick solid steel counter balance.
- Bases are available PAINTED in a "Sandtex" finish for extra durability. Also available in plated finishes at an upcharge and with an extended lead time. Please see model # for pricing.
- All bases come with six 0.5" height adjustable glides for leveling on uneven floors
- Coffee table height bases with 14"H column and 0.375"H levelers
- End table height bases with 20"H column and 0.375"H levelers
- Lounge height bases with 26"H column and 0.375"H levelers
- Seated height bases with 27"H column and 0.375"H levelers.
- Counter height bases with 34"H column and 0.375"H levelers.
- Bar height bases with 39.5"H column and 0.375"H levelers.
- Round bases available in 22", 28" and 34" dia.
- Square bases available in 18.5", 22.5" and 28.5".

1. SPECIFY MODEL NUMBER

2. SPECIFY FINISH

Laminate Worksurface + Base Finishes:

ACJ Absolute Acajou	NGL Noce Grigio
ASN Asian Night	NEL Noce Leggero
AWC Avant Cherry	NML Noce Medio
AWH Avant Honey	QTM Quartered Mahogany
BLK Black	SOG Storm Grey
BRC Brushed Cobalt	TFW Tiger Fruitwood
CMB Clear Maple	TWL Tiger Walnut
DES Dark Espresso	WHE Walnut Heights
DWT Designer White	WHC White Chocolate
HGT Hayden Grey	WGY Willow Grey
NBL Noce Biondo	WCR Winter Cherry

Bases (painted):

TBL Black	TIN Ink
TBZ Buzz Blue	TKA Kalua
TCC Cactus	TLA Latte
TCR Carrot	TMO Mocha
TIV Cloud	TNE Nevada
TDW Designer White	TSN Sand
TDJ Dijon	TSR Scarlet
TEG Eggplant	TSH Shadow
TFO Fog	TOA Toast
TFR Frost	TTU Tungsten

Bases (plated): (upcharge applies)

ACO Antique Copper	BCH Brushed Chrome
CHM Polished Chrome	SBR Satin Brass

3. SPECIFY OPTIONS

POWER BLOCKS AND CUT-OUT LOCATIONS

- A power block delivers power/data to the table surface
- Power block modules are ordered separately
- Not all power block locations are available on all table sizes. Please refer to top/base chart on the following pages for more information.
- To purchase a power block, you must specify both the power block cut-out location when ordering the top. Order the power block separately.
- Optional cut-out available in standard worksurface locations (left, center or right) for all table shapes.
Order as **E1, U1, A1, J1, K1, M1, V1**, etc. **Add \$88** for each cut-out.
- Cut-outs may be placed in non-standard locations.
Order as **ES, US, AS, JS, KS, MS, VS** - **Add \$88**.
A drawing must be supplied with vertical and horizontal dimensions to the center of the cutout. Please refer to the CUSTOM GROMMET LOCATION FORM in the back reference section. Cutouts may NOT be placed directly over the bases.
- Select power block from Productivity Solutions, page 498.

SINGLE PORT MODULES

- Single port module with one simplex or dual USB charging port centered over base available for tops supported with single GRB22xx or GSB19xx base in any height
- Modules are listed on product pages with applicable tops and bases. Modules are ordered separately.
- Specify optional cut-out **Q2** to accommodate. **Add \$88**

PRODUCT CODE DIAGRAM

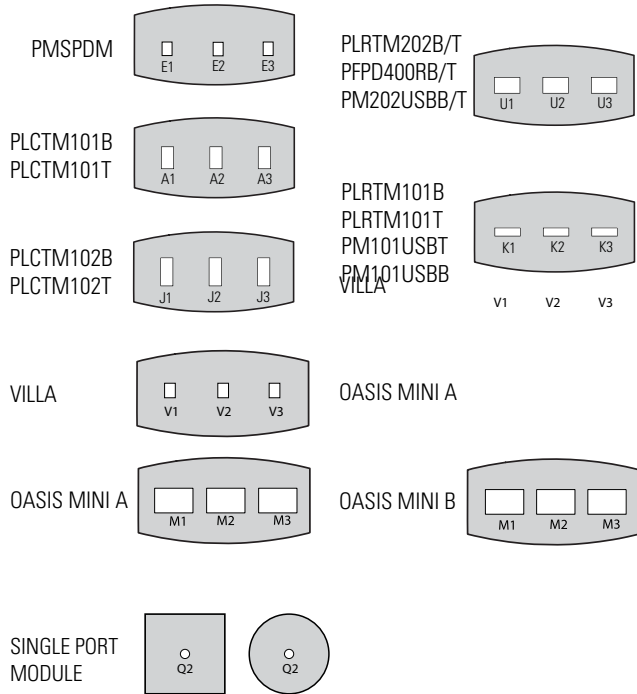



S SWAP TABLES - NOTES

APPLICABLE BASE OPTIONS FOR CORRESPONDING TOP											POWER MGMT OPTIONS	
Table Shape/Size	Model # for Top	Lounge Height 27"H		Seated Height 29"H		Counter Height 36"H		Bar Height 41.5"H		Base Qty.	# top pieces	Optional Cutouts in Tops applicable for power modules ordered separately
		Round base 22"	Square base 19"	Round base 22", 28", 34"	Square base 18.5", 22.5", 28.5"	Round base 22"	Square base 18.5"	Round base 22"	Square base 18.5"			
Round <input type="radio"/> Nominal base plate dimension indicated by 4th and 5th characters in base model numbers.												
24" diameter	GRBTP24	GRB22H26	GSB19H26	GRB22	GSB19	GRB22H35	GSB19H35	GRB22H41	GSB19H41	1	1	O2 only
30" diameter	GRBTP30	GRB22H26	GSB19H26	GRB22	GSB19	GRB22H35	GSB19H35	GRB22H41	GSB19H41	1	1	O2 only
36" diameter	GRBTP36	GRB22H26	GSB19H26	GRB22	GSB19	GRB22H35	GSB19H35	GRB22H41	GSB19H41	1	1	O2 only
42" diameter	GRBTP42	N/A	N/A	GRB28	GSB23	N/A	N/A	N/A	N/A	1	1	None
48" diameter	GRBTP48	N/A	N/A	GRB28	GSB23	N/A	N/A	N/A	N/A	1	1	None
54" diameter	GRBTP54	N/A	N/A	GRB34	GSB28	N/A	N/A	N/A	N/A	1	1	None
60" diameter	GRBTP60	N/A	N/A	GRB34	GSB28	N/A	N/A	N/A	N/A	1	1	None
Square <input type="checkbox"/>												
24" square	GSBTP24	GRB22H26	GSB19H26	GRB22	GSB19	GRB22H35	GSB19H35	GRB22H41	GSB19H41	1	1	O2 only
30" square	GSBTP30	GRB22H26	GSB19H26	GRB22	GSB19	GRB22H35	GSB19H35	GRB22H41	GSB19H41	1	1	O2 only
36" square	GSBTP36	GRB22H26	GSB19H26	GRB22	GSB19	GRB22H35	GSB19H35	GRB22H41	GSB19H41	1	1	O2 only
42" square	GSBTP42	N/A	N/A	GRB28	GSB23	N/A	N/A	N/A	N/A	1	1	None
54" square	GSBTP54	N/A	N/A	N/A	N/A	N/A	N/A	N/A	N/A	1	1	None
60" square	GSBTP60	N/A	N/A	N/A	N/A	N/A	N/A	N/A	N/A	1	1	None
Rectangular <input type="checkbox"/>												
30x24 Rectangular	GSBTP2430	GRB22H26	GSB19H26	GRB22	GSB19	GRB22H35	GSB19H35	GRB22H41	GSB19H41	1	1	O2 only
36x24 Rectangular	GSBTP2436	GRB22H26	GSB19H26	GRB22	GSB19	GRB22H35	GSB19H35	GRB22H41	GSB19H41	1	1	O2 only
36x30 Rectangular	GSBTP3036	GRB22H26	GSB19H26	GRB22	GSB19	GRB22H35	GSB19H35	GRB22H41	GSB19H41	1	1	O2 only
42x30 Rectangular	GSBTP3042	N/A	N/A	GRB28	GSB23	N/A	N/A	N/A	N/A	1	1	None
42x36 Rectangular	GSBTP3642	N/A	N/A	GRB28	GSB23	N/A	N/A	N/A	N/A	1	1	None
60x24 Rectangular	GRT5STP	GRB22H26	GSB19H26	N/A	N/A	GRB22H35	GSB19H35	GRB22H41	GSB19H41	2	1	Center: A2, E2, J2, K2, M2, U2, V2
66x24 Rectangular	GRT5HSTP	GRB22H26	GSB19H26	N/A	N/A	GRB22H35	GSB19H35	GRB22H41	GSB19H41	2	1	
72x24 Rectangular	GRT6STP	GRB22H26	GSB19H26	N/A	N/A	GRB22H35	GSB19H35	GRB22H41	GSB19H41	2	1	
84x24 Rectangular	GRT7STP	GRB22H26	GSB19H26	N/A	N/A	GRB22H35	GSB19H35	GRB22H41	GSB19H41	2	1	3 positions - Left/ Center/Right
96x24 Rectangular	GRT8STP	GRB22H26	GSB19H26	N/A	N/A	GRB22H35	GSB19H35	GRB22H41	GSB19H41	2	1	
60x30 Rectangular	GRT5NTP	GRB22H26	GSB19H26	GRB22	GSB19	GRB22H35	GSB19H35	GRB22H41	GSB19H41	2	1	Center: A2, E2, J2, K2, M2, U2, V2
60x36 Rectangular	GRT5TP	GRB22H26	GSB19H26	GRB22	GSB19	GRB22H35	GSB19H35	GRB22H41	GSB19H41	2	1	
66x30 Rectangular	GRT5NHTP	GRB22H26	GSB19H26	GRB22	GSB19	GRB22H35	GSB19H35	GRB22H41	GSB19H41	2	1	
66x36 Rectangular	GRT5HTP	GRB22H26	GSB19H26	GRB22	GSB19	GRB22H35	GSB19H35	GRB22H41	GSB19H41	2	1	
72x30 Rectangular	GRT6NTP	GRB22H26	GSB19H26	GRB22	GSB19	GRB22H35	GSB19H35	GRB22H41	GSB19H41	2	1	
72x36 Rectangular	GRT6TP	GRB22H26	GSB19H26	GRB22	GSB19	GRB22H35	GSB19H35	GRB22H41	GSB19H41	2	1	
84x30 Rectangular	GRT7NTP	GRB22H26	GSB19H26	GRB22	GSB19	GRB22H35	GSB19H35	GRB22H41	GSB19H41	2	1	3 positions - Left/ Center/Right A1/2/3, E1/2/3, J1/2/3, K1/2/3, M1/2/3, U1/2/3, V1/2/3
84x36 Rectangular	GRT7TP	GRB22H26	GSB19H26	GRB22	GSB19	GRB22H35	GSB19H35	GRB22H41	GSB19H41	2	1	
96x30 Rectangular	GRT8NTP	GRB22H26	GSB19H26	GRB22	GSB19	GRB22H35	GSB19H35	GRB22H41	GSB19H41	2	1	
96x36 Rectangular	GRT8TP	GRB22H26	GSB19H26	GRB22	GSB19	GRB22H35	GSB19H35	GRB22H41	GSB19H41	2	1	
96x42 Rectangular	GRT8MTP	N/A	N/A	GRB28	GSB23	N/A	N/A	N/A	N/A	2	1	
96x48 Rectangular	GRT8WTP	N/A	N/A	GRB28	GSB23	N/A	N/A	N/A	N/A	2	1	
120x48 Rectangular	GRT10WTP	N/A	N/A	GRB28	GSB23	N/A	N/A	N/A	N/A	3	2	Both ends: A1/3, E1/3, J1/3, K1/3, M1/3, U1/3, V1/3
144x48 Rectangular	GRT12WTP	N/A	N/A	GRB28	GSB23	N/A	N/A	N/A	N/A	3	2	

APPLICABLE BASE OPTIONS FOR CORRESPONDING TOP

**POWER MGMT
OPTIONS**

Table Shape/Size	Model # for Top	Lounge Height 27"H		Seated Height 29"H		Counter Height 36"H		Bar Height 41.5"h		Base Qty.	# top pieces	Optional Cutouts in Tops applicable for power modules ordered separately
		Round base 22"	Square base 19"	Round base 22", 28", 34"	Square base 18.5", 22.5", 28.5"	Round base 22"	Square base 18.5"	Round base 22"	Square base 18.5"			
<p>Racetrack  Nominal base plate dimension indicated by 4th and 5th characters in base model numbers.</p>												
60X24 Racetrack	GRC5STP	GRB22H26	GSB19H26	N/A	N/A	GRB22H35	GSB19H35	GRB22H41	GSB19H41	2	1	Center: A2 E2 J2 K2 U2 M2 V2
66X24 Racetrack	GRC5HSTP	GRB22H26	GSB19H26	N/A	N/A	GRB22H35	GSB19H35	GRB22H41	GSB19H41	2	1	
72X24 Racetrack	GRC6STP	GRB22H26	GSB19H26	N/A	N/A	GRB22H35	GSB19H35	GRB22H41	GSB19H41	2	1	
84X24 Racetrack	GRC7STP	GRB22H26	GSB19H26	N/A	N/A	GRB22H35	GSB19H35	GRB22H41	GSB19H41	2	1	3 positions - Left/ Center/Right
96X24 Racetrack	GRC8STP	GRB22H26	GSB19H26	N/A	N/A	GRB22H35	GSB19H35	GRB22H41	GSB19H41	2	1	
60x30 Racetrack	GRC5NTP	GRB22H26	GSB19H26	GRB22	GSB19	GRB22H35	GSB19H35	GRB22H41	GSB19H41	2	1	Center: A2 E2 J2 K2 M2 U2 V2
60X36 Racetrack	GRC5TP	GRB22H26	GSB19H26	GRB22	GSB19	GRB22H35	GSB19H35	GRB22H41	GSB19H41	2	1	
66x30 Racetrack	GRC5NHTP	GRB22H26	GSB19H26	GRB22	GSB19	GRB22H35	GSB19H35	GRB22H41	GSB19H41	2	1	
66X36 Racetrack	GRC5HTP	GRB22H26	GSB19H26	GRB22	GSB19	GRB22H35	GSB19H35	GRB22H41	GSB19H41	2	1	
72x30 Racetrack	GRC6NTP	GRB22H26	GSB19H26	GRB22	GSB19	GRB22H35	GSB19H35	GRB22H41	GSB19H41	2	1	
72x36 Racetrack	GRC6TP	GRB22H26	GSB19H26	GRB22	GSB19	GRB22H35	GSB19H35	GRB22H41	GSB19H41	2	1	
84x30 Racetrack	GRC7NTP	GRB22H26	GSB19H26	GRB22	GSB19	GRB22H35	GSB19H35	GRB22H41	GSB19H41	2	1	
84x36 Racetrack	GRC7TP	GRB22H26	GSB19H26	GRB22	GSB19	GRB22H35	GSB19H35	GRB22H41	GSB19H41	2	1	3 positions - Left/ Centered/Right (E1, E2, E3; V1/2/3, M1/2/3, A1/2/3, J1/2/3, K1/2/3, U1/2/3)
96x30 Racetrack	GRC8NTP	GRB22H26	GSB19H26	GRB22	GSB19	GRB22H35	GSB19H35	GRB22H41	GSB19H41	2	1	
96x36 Racetrack	GRC8TP	GRB22H26	GSB19H26	GRB22	GSB19	GRB22H35	GSB19H35	GRB22H41	GSB19H41	2	1	
96x42 Racetrack	GRC8MTP	N/A	N/A	GRB28	GSB23	N/A	N/A	N/A	N/A	2	1	Both ends: A1/3, E1/3, J1/3, K1/3, M1/3, U1/3
96x48 Racetrack	GRC8WTP	N/A	N/A	GRB28	GSB23	N/A	N/A	N/A	N/A	2	1	
120x48 Racetrack	GRC10WTP	N/A	N/A	GRB28	GSB23	N/A	N/A	N/A	N/A	3	2	
144x48 Racetrack	GRC12WTP	N/A	N/A	GRB28	GSB23	N/A	N/A	N/A	N/A	3	2	
<p>Boat Shape </p>												
60x30 Boat shape	GBT5NTP	GRB22H26	GSB19H26	GRB22	GSB19	GRB22H35	GSB19H35	GRB22H41	GSB19H41	2	1	Center: A2 E2 J2 K2 M2 U2 V2
60X36 Boat shape	GBT5TP	GRB22H26	GSB19H26	GRB22	GSB19	GRB22H35	GSB19H35	GRB22H41	GSB19H41	2	1	
66x30 Boat shape	GBT5NHTP	GRB22H26	GSB19H26	GRB22	GSB19	GRB22H35	GSB19H35	GRB22H41	GSB19H41	2	1	
66X36 Boat shape	GBT5HTP	GRB22H26	GSB19H26	GRB22	GSB19	GRB22H35	GSB19H35	GRB22H41	GSB19H41	2	1	
72x30 Boat shape	GBT6NTP	GRB22H26	GSB19H26	GRB22	GSB19	GRB22H35	GSB19H35	GRB22H41	GSB19H41	2	1	
72x36 Boat shape	GBT6TP	GRB22H26	GSB19H26	GRB22	GSB19	GRB22H35	GSB19H35	GRB22H41	GSB19H41	2	1	
84x30 Boat shape	GBT7NTP	GRB22H26	GSB19H26	GRB22	GSB19	GRB22H35	GSB19H35	GRB22H41	GSB19H41	2	1	3 positions - Left/ Center/Right A1/2/3, E1/2/3, J1/2/3, K1/2/3, M1/2/3, U1/2/3, V1/2/3
84x36 Boat shape	GBT7TP	GRB22H26	GSB19H26	GRB22	GSB19	GRB22H35	GSB19H35	GRB22H41	GSB19H41	2	1	
96x30 Boat shape	GBT8NTP	GRB22H26	GSB19H26	GRB22	GSB19	GRB22H35	GSB19H35	GRB22H41	GSB19H41	2	1	
96x36 Boat shape	GBT8TP	GRB22H26	GSB19H26	GRB22	GSB19	GRB22H35	GSB19H35	GRB22H41	GSB19H41	2	1	
96X42 Boat shape	GBT8MTP	N/A	N/A	GRB28	GSB23	N/A	N/A	N/A	N/A	2	1	
96x48 Boat shape	GBT8WTP	N/A	N/A	GRB28	GSB23	N/A	N/A	N/A	N/A	2	1	
120x48 Boat shape	GBT10WTP	N/A	N/A	GRB28	GSB23	N/A	N/A	N/A	N/A	3	2	
144x48 Boat shape	GBT12WTP	N/A	N/A	GRB28	GSB23	N/A	N/A	N/A	N/A	3	2	

S SWAP TABLES - NOTES





APPLICABLE BASE OPTIONS FOR CORRESPONDING TOP						POWER MGMT OPTIONS		
Table Shape/Size	Model # for Top	Centered Column 25.5"H		Offset Column 25.5"H		Base Qty.	# top pieces	Optional Cutouts in Tops applicable for power modules ordered separately
		Round base 14" 	Square base 12.5" 	Round base N/A	Square base 12.5" 			
Round Laptop Tables ○ <i>Nominal base plate dimension indicated by 4th and 5th characters in base model numbers.</i>								
16" dia centered base	GRBTP16	GRB14H25	GSB13H25	N/A	N/A	1	1	None
20" dia centered base	GRBTP20	GRB14H25	GSB13H25	N/A	N/A	1	1	None
22" dia centered base	GRBTP22	GRB14H25	GSB13H25	N/A	N/A	1	1	None
16" dia offset base	GRBOTP16	N/A	N/A	N/A	GSOB13H25	1	1	None
20" dia offset base	GRBOTP20	N/A	N/A	N/A	GSOB13H25	1	1	None
22" dia offset base	GRBOTP22	N/A	N/A	N/A	GSOB13H25	1	1	None
Square Laptop Tables □								
16"x16" centered base	GSBTP16	GRB14H25	GSB13H25	N/A	N/A	1	1	None
20"x20" centered base	GSBTP20	GRB14H25	GSB13H25	N/A	N/A	1	1	None
22"x22" centered base	GSBTP22	GRB14H25	GSB13H25	N/A	N/A	1	1	None
16"x16" offset base	GSBOTP16	N/A	N/A	N/A	GSOB13H25	1	1	None
20"x20" offset base	GSBOTP20	N/A	N/A	N/A	GSOB13H25	1	1	None
22"x22" offset base	GSBOTP22	N/A	N/A	N/A	GSOB13H25	1	1	None
Rectangular Laptop Tables ▭								
16"x20" centered base	GSBTP1620	GRB14H25	GSB13H25	N/A	N/A	1	1	None
16"x22" centered base	GSBTP1622	GRB14H25	GSB13H25	N/A	N/A	1	1	None
16"x20" offset base	GSBOT1620	N/A	N/A	N/A	GSOB13H25	1	1	None
16"x22" offset base	GSBOT1622	N/A	N/A	N/A	GSOB13H25	1	1	None
APPLICABLE BASE OPTIONS FOR CORRESPONDING TOP						POWER MGMT OPTIONS		
Table Shape/Size	Model # for Top	Coffee Table 16"H		End Table 22"H		Base Qty.	# top pieces	Optional Cutouts in Tops applicable for power modules ordered separately
		Round base 22" 	Square base 18.5" 	Round base 22" 	Square base 18.5" 			
Round Coffee/End Tables ○ <i>*Nominal base plate dimension indicated by 4th and 5th characters in base model numbers.</i>								
24" dia	GRBTP24	GRB22H15	GSB19H15	GRB22H21	GSB19H21	1	1	Q2 only
30" dia	GRBTP30	GRB22H15	GSB19H15	GRB22H21	GSB19H21	1	1	Q2 only
36" dia	GRBTP36	GRB22H15	GSB19H15	GRB22H21	GSB19H21	1	1	Q2 only
Square Coffee/End Tables □								
24" square	GSBTP24	GRB22H15	GSB19H15	GRB22H21	GSB19H21	1	1	Q2 only
30" square	GSBTP30	GRB22H15	GSB19H15	GRB22H21	GSB19H21	1	1	Q2 only
36" square	GSBTP36	GRB22H15	GSB19H15	GRB22H21	GSB19H21	1	1	Q2 only

TABLE NOTES - ESTIMATED CAPACITY

- Use the following to determine the size of a table and the number of chairs needed for a conference area.
- All estimates are based on an average chair width of 23" with a 4" clearance between chairs. Adjust accordingly for a different chair size.

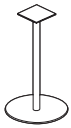
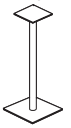
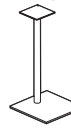
Top Size	NUMBER OF CHAIRS				
	Round	Square	Rectangular	Boat	Racetrack
24 x 24	2	2	N/A	N/A	N/A
24 x 30	N/A	N/A	2-3	N/A	N/A
24 x 36	N/A	N/A	3-4	N/A	N/A
30 x 30	3	4	N/A	N/A	N/A
30 x 36	N/A	N/A	4	N/A	N/A
30 x 42	N/A	N/A	4	N/A	N/A
36 x 36	4	4	N/A	N/A	N/A
36 x 42	N/A	N/A	4	N/A	N/A
42 x 42	4	4	N/A	N/A	N/A
48 x 48	4	4	N/A	N/A	N/A
54 x 54	5	6	N/A	N/A	N/A
60 x 60	5	6	N/A	N/A	N/A
24 x 60	N/A	N/A	4-6	N/A	N/A
24 x 66	N/A	N/A	4-6	N/A	N/A
24 x 72	N/A	N/A	4-6	N/A	N/A
24 x 84	N/A	N/A	4-6	N/A	N/A
24 x 96	N/A	N/A	6-8	N/A	N/A
30 x 60	N/A	N/A	4-6	4-6	4-6
30 x 66	N/A	N/A	4-6	4-6	4-6
30 x 72	N/A	N/A	4-6	4-6	4-6
30 x 84	N/A	N/A	4-6	4-6	4-6
30 x 96	N/A	N/A	6-8	6-8	6-8
36 x 60	N/A	N/A	4-6	4-6	4-6
36 x 66	N/A	N/A	4-6	4-6	4-6
36 x 72	N/A	N/A	4-6	4-6	4-6
36 x 84	N/A	N/A	4-6	4-6	4-6
36 x 96	N/A	N/A	6-8	6-8	6-8
48 x 84	N/A	N/A	6-8	6-8	6-8
48 x 96	N/A	N/A	6-8	6-8	6-8
48 x 120	N/A	N/A	8-10	8-10	8-10
48 x 144	N/A	N/A	10-12	10-12	10-12

S SWAP TABLES

LAPTOP TABLES FOR CENTER BASE

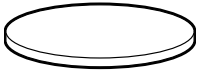

Round Tops, for Center Base

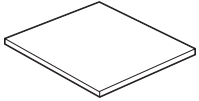

Square Tops, for Center Base

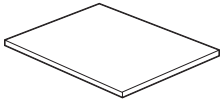

Rectangular Tops, for Center Base

MODEL#	DIMENSIONS	FREIGHT CLASS	WT./LBS.	CUBIC FT.	LIST PRICE	HP ADD	CHROME ADD
--------	------------	---------------	----------	-----------	------------	--------	------------

D x W x H

GRBTP16	16 x 16 x 1	70	6	.30	\$198	\$92	n/a
GRBTP20	20 x 20 x 1	70	9	.50	\$226	\$106	n/a
GRBTP22	22 x 22 x 1	70	9	.50	\$256	\$117	n/a

GSBTP16	16 x 16 x 1	65	7	.30	\$198	\$92	n/a
GSBTP20	20 x 20 x 1	70	11	.50	\$226	\$106	n/a
GSBTP22	22 x 22 x 1	65	13	.50	\$256	\$117	n/a

GSBTP1620	16 x 20 x 1	65	9	.40	\$206	\$101	n/a
GSBTP1622	16 x 22 x 1	70	11	.50	\$236	\$106	n/a

Tops feature metal inserts for ease of assembly to base. One base required. Use with round or square centered base only.

LAPTOP TABLES FOR OFFSET BASE

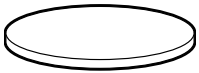

Round Tops, for Offset Base

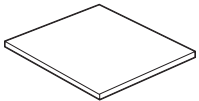

Square Tops, for Offset Base

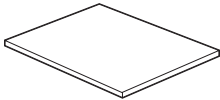

Rectangular Tops, for Offset Base

GRBOTP16	16 x 16 x 1	70	6	.30	\$198	\$92	n/a
GRBOTP20	20 x 20 x 1	70	9	.50	\$226	\$106	n/a
GRBOTP22	22 x 22 x 1	70	11	.70	\$256	\$117	n/a

GSBOTP16	16 x 16 x 1	65	7	.30	\$198	\$92	n/a
GSBOTP20	20 x 20 x 1	70	11	.50	\$226	\$106	n/a
GSBOTP22	22 x 22 x 1	70	13	.70	\$256	\$117	n/a

GSBOT1620	16 x 20 x 1	65	9	.40	\$206	\$101	n/a
GSBOT1622	16 x 22 x 1	70	11	.50	\$236	\$106	n/a

Tops feature metal inserts for ease of assembly to base. One base required. Tops are drilled to offset mount on either long or short side. Use tops for offset base with square offset base only.

LAPTOP TABLE BASES

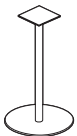

14" Round Centered Base

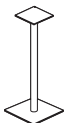

12.5" Square Centered Base

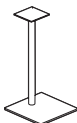

12.5" Square Offset Base

BASE SIZE AND STYLE OPTIONS VALID FOR TOPS ABOVE:

Order the quantity of bases as indicated by each top size

GRB14H25	14 x 14 x 24.5	150	17.54	3.50	\$693	n/a	\$134
----------	----------------	-----	-------	------	--------------	-----	--------------

GSB13H25	12.5 x 12.5 x 24.5	150	17.11	3.50	\$717	n/a	\$123
----------	--------------------	-----	-------	------	--------------	-----	--------------

GSOB13H25	12.5 x 12.5 x 24.5	150	17.11	3.50	\$717	n/a	\$123
-----------	--------------------	-----	-------	------	--------------	-----	--------------

1.5" diameter column. Weighted base for balance includes cover plate, 0.5" adjustable glides to level on uneven surfaces. Screws included with base for attaching to appropriate top(s). Available in painted and plated finishes as listed on page 661. Upcharge on plated finishes.

Required Specifications

Finish

Optional Specifications

HP laminate (tops)

Plated base

TOPS 24" - 36" WIDE AND BASES



Round Tops*

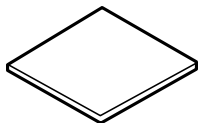

Square Tops*

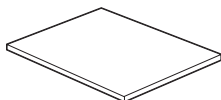

Rectangular Tops*

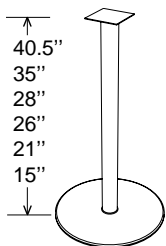

22" Dia Round Bases

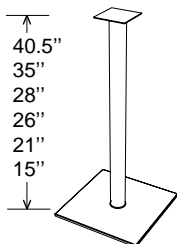

18.5" Square Bases



Single Port Module w/dual port USB-A



Single Port Module w/one Simplex

MODEL#	DIMENSIONS D x W x H	FREIGHT CLASS	WT/LBS.	CUBIC FT.	LIST PRICE	HP ADD	CHROME ADD
GRBTP24	24 x 24 x 1	70	20	1	\$226	\$114	n/a
GRBTP30	30 x 30 x 1	70	29	1.50	\$262	\$132	n/a
GRBTP36	36 x 36 x 1	70	40	2	\$334	\$169	n/a

GSBTP24	24 x 24 x 1	70	48	2.50	\$233	\$117	n/a
GSBTP30	30 x 30 x 1	70	31	1.50	\$271	\$136	n/a
GSBTP36	36 x 36 x 1	70	42	2	\$343	\$172	n/a

GSBTP2430	24 x 30 x 1	70	20	.91	\$260	\$118	n/a
GSBTP2436	24 x 36 x 1	70	24	1.08	\$282	\$128	n/a
GSBTP3036	30 x 36 x 1	65	31	1.34	\$326	\$148	n/a

Tops feature metal inserts for ease of assembly to base. One base required.

BASE SIZE AND STYLE OPTIONS VALID FOR TOPS ABOVE:

Order the quantity of bases as indicated by each top size

GRB22H15	22 x 22 x 15	92.5	47.60	4.69	\$839	n/a	\$134
GRB22H21	22 x 22 x 21	125	48.60	6.45	\$853	n/a	\$134
GRB22H26	22 x 22 x 26	125	50	8.15	\$864	n/a	\$134
GRB22	22 x 22 x 28	150	55	9.33	\$805	n/a	\$134
GRB22H35	22 x 22 x 35	150	57.10	12	\$844	n/a	\$148
GRB22H41	22 x 22 x 40.5	150	58.30	14	\$859	n/a	\$154

GRB22H15 - coffee table height

GRB22H21 - end table height

GRB22H26 - lounge height

GRB22 - seated height

GRB22H35 - counter height

GRB22H41 - bar height

GSB19H15	18.5 x 18.5 x 15	85	43.70	3.52	\$853	n/a	\$123
GSB19H21	18.5 x 18.5 x 21	100	44.80	4.84	\$864	n/a	\$123
GSB19H26	18.5 x 18.5 x 26	100	47	5.61	\$929	n/a	\$123
GSB19	18.5 x 18.5 x 28	100	50	6.06	\$872	n/a	\$123
GSB19H35	18.5 x 18.5 x 35	125	51.80	7.52	\$925	n/a	\$134
GSB19H41	18.5 x 18.5 x 40.5	125	53.20	8.77	\$957	n/a	\$148

GSB19H15 - coffee table height

GSB19H21 - end table height

GSB19H26 - lounge height

GSB19 - seated height

GSB19H35 - counter height

GSB19H41 - bar height

Base comes fully assembled and features 0.5" adjustable glides to level on uneven surfaces. Screws included with base for attaching to appropriate top(s). Base top plate and base plate include pass-through for single port power or USB module (sold separately). Available in painted and plated finishes as listed on page 661. Upcharge on plated finishes.

SPUSBRW72	2.25 x - x 2.75	70	1.20	1.18	\$324
SPUSBRB72	2.25 x - x 2.75	70	1.20	1.18	\$324

Single port module with dual USB-A charging ports. Specify top with Q2 cut-out to accommodate.

SPSMXRW72	2.25 x - x 2.75	70	1.75	1.18	\$146
SPSMXRB72	2.25 x - x 2.75	70	1.75	1.18	\$146

Single port module with one simplex. Specify top with Q2 cut-out to accommodate.

Required Specifications

Finish

Optional Specifications

HP laminate*
Plated base
Cutout for single port module*

Accessories

Single port power or USB module

S SWAP TABLES

TOPS 42" - 48" WIDE AND BASES

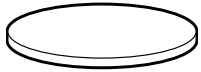

Round Tops*

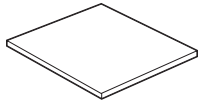

Square Tops*

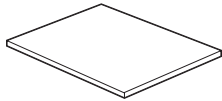

Rectangular Tops*

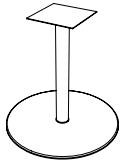

28" Round Base

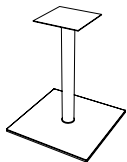

23" Square Base

MODEL#	DIMENSIONS D x W x H	FREIGHT CLASS	WT./LBS.	CUBIC FT.	LIST PRICE	HP ADD	CHROME ADD
GRBTP42	42 x 42 x 1	70	48	2.50	\$465	\$235	n/a
GRBTP48	48 x 48 x 1	70	64	3	\$497	\$249	n/a
GSBTP42	42 x 42 x 1	70	50	2.50	\$474	\$239	n/a
GSBTP3042	30 x 42 x 1	65	36	1.55	\$383	\$173	n/a
GSBTP3642	36 x 42 x 1	65	43	1.86	\$480	\$218	n/a

Tops feature metal inserts for ease of assembly to base. One base required.

BASE SIZE AND STYLE OPTIONS VALID FOR TOPS ABOVE: Order the quantity of bases as indicated by each top size

GRB28	28 x 28 x 28	125	100	15.63	\$1387	n/a	\$148
seated height							
GSB23	22.5 x 22.5 x 28	100	82	9.33	\$1275	n/a	\$82
seated height							

Base comes fully assembled and features 0.5" adjustable glides to level on uneven surfaces. Screws included with base for attaching to appropriate top(s). Available in painted and plated finishes as listed on page 661. Upcharge on plated finishes.

Required Specifications
Finish

Optional Specifications
HP laminate (tops)
Plated base

TOPS 54"- 60" WIDE AND BASES

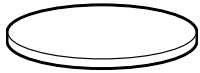

Round Tops*

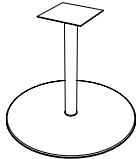

34" Round Base

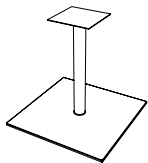

28" Square Base

MODEL#	DIMENSIONS	FREIGHT CLASS	WT/LBS.	CUBIC FT.	LIST PRICE	HP ADD	CHROME ADD
	D x W x H						
GRBTP54	54 x 54 x 1	70	78	3.75	\$663	\$333	n/a
GRBTP60	60 x 60 x 1	70	98	4.50	\$686	\$345	n/a

Tops feature metal inserts for ease of assembly to base. One base required.

BASE SIZE AND STYLE OPTIONS VALID FOR TOPS ABOVE:
Order the quantity of bases as indicated by each top size

GRB34	34 x 34 x 28	125	135	20.56	\$1695	n/a	\$148
-------	--------------	-----	-----	-------	---------------	-----	--------------

seated height

GSB28	28.5 x 28.5 x 28	125	125	15.63	\$1583	n/a	\$69
-------	------------------	-----	-----	-------	---------------	-----	-------------

seated height

Base comes fully assembled and features 0.5" adjustable glides to level on uneven surfaces. Screws included with base for attaching to appropriate top(s). Available in painted and plated finishes as listed on page 661. Upcharge on plated finishes.

Required Specifications
 Finish

Optional Specifications
 HP laminate*
 Plated base

S SWAP TABLES

24"D LOUNGE TOPS AND BASES

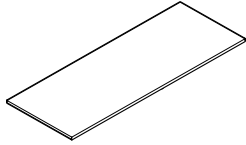

Rectangular Tops*

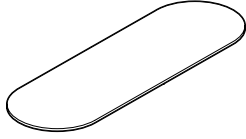

Racetrack Tops*

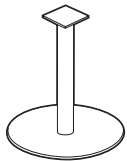

22" Round Bases

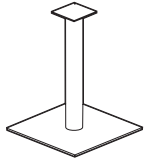

18.5" Square Bases

MODEL#	DIMENSIONS D x W x H	FREIGHT CLASS	WT/LBS.	CUBIC FT.	LIST PRICE	HP ADD	CHROME ADD
GRT5STP	24 x 60 x 1	65	41	1.79	\$437	\$198	n/a
GRT5HSTP	24 x 66 x 1	65	46	1.97	\$511	\$233	n/a
GRT6STP	24 x 72 x 1	65	49	2.14	\$533	\$240	n/a
GRT7STP	24 x 84 x 1	65	57	2.49	\$616	\$279	n/a
GRT8STP	24 x 96 x 1	65	66	2.84	\$662	\$298	n/a

GRC5STP	24 x 60 x 1	65	41	1.79	\$437	\$198	n/a
GRC5HSTP	24 x 66 x 1	65	46	1.97	\$511	\$233	n/a
GRC6STP	24 x 72 x 1	65	49	2.14	\$533	\$240	n/a
GRC7STP	24 x 84 x 1	65	57	2.49	\$616	\$279	n/a
GRC8STP	24 x 96 x 1	65	66	2.84	\$662	\$298	n/a

BASE SIZE AND STYLE OPTIONS VALID FOR TOPS ABOVE:

Order the quantity of bases as indicated by each top size

GRB22H26	22 x 22 x 26	125	50	8.15	\$864	n/a	\$134
loung height							

GSB19H26	18.5 x 18.5 x 26	100	47	5.61	\$929	n/a	\$123
loung height							

Base comes fully assembled and features 0.5" adjustable glides to level on uneven surfaces. Screws included with base for attaching to appropriate top(s). Available in painted and plated finishes as listed on page 661. Upcharge on plated finishes.

Required Specifications

Finish

Optional Specifications

HP laminate
Plated base

TOPS 60"-96" WIDE AND BASES

MODEL# DIMENSIONS FREIGHT CLASS WT./LBS. CUBIC FT. LIST PRICE HP ADD CHROME ADD

D x W x H

GRT5NTP	30 x 60 x 1	85	56	3.75	\$498	\$251	n/a
GRT5NHTP	30 x 66 x 1	65	56	2.44	\$502	\$227	n/a
GRT6NTP	30 x 72 x 1	100	61	6.50	\$540	\$272	n/a
GRT7NTP	30 x 84 x 1	100	72	7.50	\$673	\$338	n/a
GRT8NTP	30 x 96 x 1	100	80	8.50	\$732	\$367	n/a
GRT5TP	36 x 60 x 1	100	56	6.60	\$510	\$229	n/a
GRT5HTP	36 x 66 x 1	92.5	79	7.21	\$537	\$243	n/a
GRT6TP	36 x 72 x 1	92.5	75	7.50	\$623	\$312	n/a
GRT7TP	36 x 84 x 1	100	85	8.75	\$724	\$364	n/a
GRT8TP	36 x 96 x 1	92.5	94	9	\$792	\$399	n/a

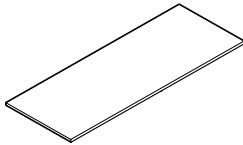

Rectangular Tops*

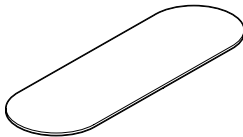

Racetrack Tops*

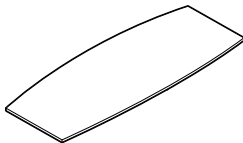

Boat Tops*

GRC5NTP	30 x 60 x 1	85	52	3.75	\$506	\$254	n/a
GRC5NHTP	30 x 66 x 1	65	56	2.44	\$512	\$233	n/a
GRC6NTP	30 x 72 x 1	100	57	6.50	\$550	\$276	n/a
GRC7NTP	30 x 84 x 1	100	68	7.50	\$685	\$344	n/a
GRC8NTP	30 x 96 x 1	100	76	8.50	\$747	\$375	n/a
GRC5TP	36 x 60 x 1	92.5	70	6.60	\$520	\$236	n/a
GRC5HTP	36 x 66 x 1	92.5	79	7.21	\$547	\$247	n/a
GRC6TP	36 x 72 x 1	100	71	7.50	\$633	\$318	n/a
GRC7TP	36 x 84 x 1	92.5	81	7.75	\$739	\$371	n/a
GRC8TP	36 x 96 x 1	92.5	91	9	\$808	\$405	n/a

GBT5NTP	30 x 60 x 1	85	52	3.75	\$506	\$254	n/a
GBT5NHTP	30 x 66 x 1	65	56	2.44	\$512	\$233	n/a
GBT6NTP	30 x 72 x 1	100	57	6.50	\$550	\$276	n/a
GBT7NTP	30 x 84 x 1	100	68	7.50	\$685	\$344	n/a
GBT8NTP	30 x 96 x 1	100	76	8.50	\$747	\$375	n/a
GBT5TP	36 x 60 x 1	92.5	70	6.60	\$520	\$236	n/a
GBT5HTP	36 x 66 x 1	92.5	79	7.21	\$547	\$247	n/a
GBT6TP	36 x 72 x 1	100	71	7.50	\$633	\$318	n/a
GBT7TP	36 x 84 x 1	100	81	8.75	\$739	\$371	n/a
GBT8TP	36 x 96 x 1	92.5	91	9	\$808	\$405	n/a

Tops feature metal inserts for ease of assembly to base. Two bases required for all top sizes listed above.

- GBTxNTP - 30" deep across center and 24" deep across ends
- GBTxTP - 36" deep across center and 28" deep across ends

BASE SIZE AND STYLE OPTIONS VALID FOR TOPS ABOVE:

Order the quantity of bases as indicated by each top size

GRB22H26	22 x 22 x 25	125	50	8.15	\$864	n/a	\$134
GRB22	22 x 22 x 28	150	55	9.33	\$805	n/a	\$134
GRB22H35	22 x 22 x 35	150	57.10	12	\$844	n/a	\$148
GRB22H41	22 x 22 x 40.5	150	58.30	14	\$859	n/a	\$154

GRB22H26 - lounge height **GRB22** - seated height **GRB22H35** - counter height **GRB22H41** - bar height

GSB19H26	18.5 x 18.5 x 25	100	47	5.61	\$929	n/a	\$123
GSB19	18.5 x 18.5 x 28	100	50	6.06	\$872	n/a	\$123
GSB19H35	18.5 x 18.5 x 35	125	51.80	7.52	\$925	n/a	\$134
GSB19H41	18.5 x 18.5 x 40.5	125	53.20	8.77	\$957	n/a	\$148

GSB19H26 - lounge height **GSB19** - seated height **GSB19H35** - counter height **GSB19H41** - bar height

Base comes fully assembled and features 0.5" adjustable glides to level on uneven surfaces. Screws included with base for attaching to appropriate top(s). Available in painted and plated finishes as listed on page 661. Upcharge on plated finishes.

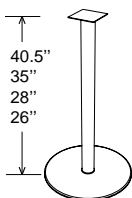

22" Dia Round Bases

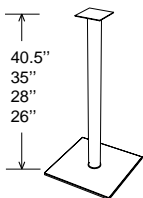

18.5" Square Bases

Required Specifications

Finish

Optional Specifications

HP laminate
Plated base

Accessories

Power block

S SWAP TABLES

TOPS 96"-144" WIDE AND BASES

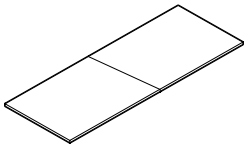

Rectangular Tops*

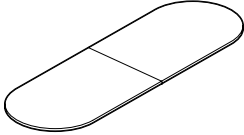

Racetrack Tops*

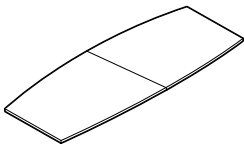

Boat Tops

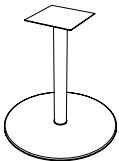

28" Dia Round Base

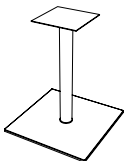

23" Square Base

MODEL#	DIMENSIONS	FREIGHT CLASS	WT/LBS.	CUBIC FT.	LIST PRICE	HP ADD	CHROME ADD
--------	------------	---------------	---------	-----------	------------	--------	------------

D x W x H

1 Piece top - 2 bases required

GRT8MTP	42 x 96 x 1	92.5	128	11.84	\$1335	\$603	n/a
GRT8WTP	48 x 96 x 1	85	190	14	\$1351	\$514	n/a

2 Piece tops - 3 bases required

GRT10WTP	48 x 120 x 1	85	220	18	\$1700	\$688	n/a
GRT12WTP	48 x 144 x 1	85	262	21.50	\$1980	\$779	n/a

1 Piece top - 2 bases required

GRC8MTP	42 x 96 x 1	92.5	128	11.84	\$1335	\$603	n/a
GRC8WTP	48 x 96 x 1	85	190	14	\$1351	\$524	n/a

2 Piece tops - 3 bases required

GRC10WTP	48 x 120 x 1	85	220	18	\$1700	\$703	n/a
GRC12WTP	48 x 144 x 1	85	262	21.50	\$1980	\$795	n/a

1 Piece top - 2 bases required

GBT8MTP	42 x 96 x 1	92.5	128	11.84	\$1335	\$603	n/a
GBT8WTP	48 x 96 x 1	85	190	14	\$1351	\$524	n/a

2 Piece tops - 3 bases required

GBT10WTP	48 x 120 x 1	85	220	18	\$1700	\$703	n/a
GBT12WTP	48 x 144 x 1	85	262	21.50	\$1980	\$795	n/a

Tops feature metal inserts for ease of assembly to base. Two bases required for one piece top. Three bases required for two piece top.

Boat tops:

- 42" deep across center and 33" deep across ends
- 48" deep across center and 38" deep across ends

BASE SIZE AND STYLE OPTIONS VALID FOR TOPS ABOVE:

Order the quantity of bases as indicated by each top size

GRB28	28 x 28 x 28	125	100	15.63	\$1387	n/a	\$148
-------	--------------	-----	-----	-------	---------------	-----	--------------

seated height

GSB23	22.5 x 22.5 x 28	100	82	9.33	\$1275	n/a	\$82
-------	------------------	-----	----	------	---------------	-----	-------------

seated height

Base comes fully assembled and features 0.5" adjustable glides to level on uneven surfaces. Screws included with base for attaching to appropriate top(s). Available in painted and plated finishes as listed on page 661. Upcharge on plated finishes.

Required Specifications

Finish

Optional Specifications

HP laminate*
Plated base
Grommet position or power block cut-out

Accessories

Power block*

DUAL COLUMN TOPS AND BASES

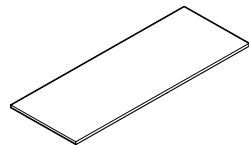

Rectangular Top*

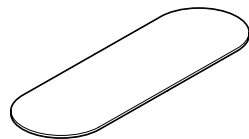

Racetrack Top*

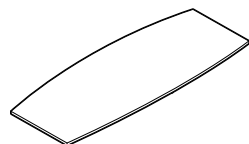

Boat Top*

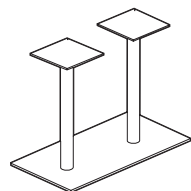

28"H Dual Column Base

MODEL#	DIMENSIONS	FREIGHT CLASS	WT/LBS.	CUBIC FT.	LIST PRICE	HP ADD	CHROME ADD
D x W x H							
GRTD5TP	36 x 60 x 1	92.5	70	6.60	\$606	\$282	n/a
GRTD5HTP	36 x 66 x 1	92.5	79	7.20	\$662	\$309	n/a
GRTD6TP	36 x 72 x 1	92.5	85	7.80	\$682	\$317	n/a
GRTD5MTP	42 x 60 x 1	92.5	83	7.60	\$673	\$312	n/a
GRTD5HMTP	42 x 66 x 1	92.5	91	8.30	\$718	\$334	n/a
GRTD6MTP	42 x 72 x 1	92.5	99	9	\$739	\$343	n/a

GRCD5TP	36 x 60 x 1	100	60	6.60	\$606	\$282	n/a
GRCD5HTP	36 x 66 x 1	100	69	7.20	\$662	\$309	n/a
GRCD6TP	36 x 72 x 1	100	75	7.80	\$682	\$317	n/a
GRCD5MTP	42 x 60 x 1	100	73	7.60	\$673	\$312	n/a
GRCD5HMTP	42 x 66 x 1	100	81	8.30	\$718	\$334	n/a
GRCD6MTP	42 x 72 x 1	100	89	9	\$739	\$343	n/a

GBTD5TP	36 x 60 x 1	100	60	6.60	\$606	\$282	n/a
GBTD5HTP	36 x 66 x 1	100	69	7.20	\$662	\$309	n/a
GBTD6TP	36 x 72 x 1	100	75	7.80	\$682	\$317	n/a
GBTD5MTP	42 x 60 x 1	100	73	7.60	\$673	\$312	n/a
GBTD5HMTP	42 x 66 x 1	100	81	8.30	\$718	\$334	n/a
GBTD6MTP	42 x 72 x 1	100	89	9	\$739	\$343	n/a

Top features metal inserts for ease of assembly to base. One dual column base required. Limited cut-out options available for power modules include A2, E2, J2, V2 or AG2 only. Power modules corresponding to applicable cut-out codes ordered separately.

Boat tops:

- 36" wide, across center are 28" wide across ends
- 42" wide across center are 33" wide across ends

BASE SIZE AND STYLE OPTIONS VALID FOR TOPS ABOVE:

Order the quantity of bases as indicated by each top size

GDCB36H28	19 x 36 x 28	100	116.23	12.16	\$2250	n/a	\$582
-----------	--------------	-----	--------	-------	---------------	-----	--------------

seated height

Base ships knocked-down; assembly required. Features 0.5" adjustable glides to level on uneven surfaces. Screws included with base for attaching to appropriate top(s). Available in painted and plated finishes as listed on page 661. Upcharge on plated finishes.

Required Specifications

Finish

Optional Specifications

HP laminate*
Plated base
Cutout for single port module*

Accessories

Single port power or USB module

S SWAP TABLES

HUDDLE TABLES OVERVIEW

D x W x H

- Three heights available: seated desk height - 29", counter height - 36", bar height - 41.5" with D top, wedge, rectangular or soft ellipse shaped tops
- Bring teams together to huddle, share and collaborate.
- Tops include metal inserts for ease of assembly to metal base. All tops are standard with an edge scoop to help manage cables from wall mounted flat screen monitors and/or edge mounting power module (PS305057/PS305002 as an example). Support channels are included with tops over 60" wide.
- Optional cut-out available in standard worksurface location: center. E2, U2, A2, J2, K2, M2, V2 - Add **\$88**.
- Laminate kits are sold separately from metal bases for huddle tables.
- Metal bases ship fully assembled and include 0.5" adjustable glides and metal screws for attaching to the top. Be sure to specify bases specific to huddle tables GRHB22Hxx or GSB19Hxx.

D-TOP HUDDLE TABLES

MODEL#	DIMENSIONS	FREIGHT CLASS	WT/LBS.	CUBIC FT.	LIST PRICE	HP ADD	CHROME ADD
--------	------------	---------------	---------	-----------	------------	--------	------------

D x W x H

GDH364829	48 x 36 x 29	70	77.05	3.94	\$988	\$308	n/a
GDH366029	60 x 36 x 29	70	86.95	4.46	\$1205	\$437	n/a
GDH367229	72 x 36 x 29	70	97	4.98	\$1344	\$521	n/a
GDH426029	60 x 42 x 29	70	99.82	5.18	\$1352	\$500	n/a
GDH427229	72 x 42 x 29	70	111.5	5.78	\$1515	\$596	n/a
GDH428429	84 x 42 x 29	92.5	123.1	11.98	\$1676	\$695	n/a
GDH429629	96 x 42 x 29	92.5	134.74	13.3	\$1812	\$774	n/a
GDH486029	60 x 48 x 29	70	112.6	5.88	\$1508	\$565	n/a
GDH487229	72 x 48 x 29	70	126	6.58	\$1688	\$675	n/a
GDH488429	84 x 48 x 29	92.5	139.24	13.5	\$1805	\$745	n/a
GDH489629	96 x 48 x 29	92.5	152.56	15	\$1952	\$834	n/a

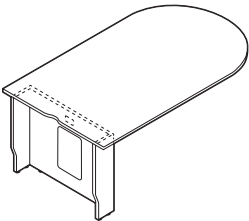

29"H D-Top Huddle

Laminate u-base support is 8"D with 7" inside clearance to wall. Access wall through 14.5"H x 9.5"W hinged door with touch latch in front panel of u-base support. U-base includes 0.5" adjustable glides. U-base side panels are tapered at the bottom to clear most baseboards.

- Metal bases sold separately. Compatible with GRHB22H28 or GSHB19H28 only.

GDH364836	48 x 36 x 36	70	85.95	4.3	\$1020	\$308	n/a
GDH366036	60 x 36 x 36	70	95.85	4.84	\$1236	\$437	n/a
GDH367236	72 x 36 x 36	70	105.9	5.36	\$1373	\$521	n/a
GDH426036	60 x 42 x 36	70	109.82	5.6	\$1386	\$500	n/a
GDH427236	72 x 42 x 36	70	121.5	6.22	\$1548	\$596	n/a
GDH428436	84 x 42 x 36	92.5	133.1	12.4	\$1710	\$695	n/a
GDH429636	96 x 42 x 36	92.5	144.74	13.74	\$1846	\$774	n/a
GDH486036	60 x 48 x 36	70	123.6	6.38	\$1545	\$565	n/a
GDH487236	72 x 48 x 36	70	137	7.08	\$1726	\$675	n/a
GDH488436	84 x 48 x 36	92.5	150.24	14	\$1843	\$745	n/a
GDH489636	96 x 48 x 36	92.5	163.56	15.5	\$1989	\$834	n/a

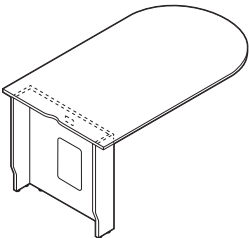

36"H D-Top Huddle

Laminate u-base support is 8"D with 7" inside clearance to wall. Access wall through 14.5"H x 9.5"W hinged door with touch latch in front panel of u-base support. U-base includes 0.5" adjustable glides. U-base side panels are tapered at the bottom to clear most baseboards.

- Metal bases sold separately. Compatible with GRHB22H35 or GSHB19H35 only.

Required Specifications

Top finish
Laminate base finish

Optional Specifications

HP laminate
Power block cut-out

Accessories

Power block

D-TOP HUDDLE TABLES

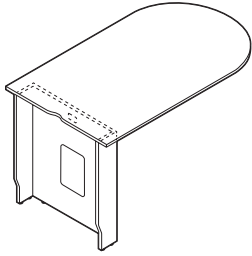

41.5"H D-Top Huddle

MODEL#	DIMENSIONS D x W x H	FREIGHT CLASS	WT/LBS.	CUBIC FT.	LIST PRICE	HP ADD	CHROME ADD
GDH364841	48 x 36 x 41.5	70	92.65	4.58	\$1072	\$308	n/a
GDH366041	60 x 36 x 41.5	70	102.55	5.1	\$1287	\$437	n/a
GDH367241	72 x 36 x 41.5	70	112.6	5.62	\$1427	\$521	n/a
GDH426041	60 x 42 x 41.5	70	117.32	5.92	\$1445	\$500	n/a
GDH427241	72 x 42 x 41.5	70	129	6.52	\$1609	\$596	n/a
GDH428441	84 x 42 x 41.5	92.5	140.6	12.72	\$1773	\$695	n/a
GDH429641	96 x 42 x 41.5	92.5	152.24	14.06	\$1906	\$774	n/a
GDH486041	60 x 48 x 41.5	70	130.1	6.74	\$1612	\$565	n/a
GDH487241	72 x 48 x 41.5	70	143.5	7.42	\$1792	\$675	n/a
GDH488441	84 x 48 x 41.5	92.5	156.74	14.52	\$1911	\$745	n/a
GDH489641	96 x 48 x 41.5	92.5	170.06	15.84	\$2058	\$834	n/a

Laminate u-base support is 8"D with 7" inside clearance to wall. Access wall through 14.5"H x 9.5"W hinged door with touch latch in front panel of u-base support. U-base includes 0.5" adjustable glides. U-base side panels are tapered at the bottom to clear most baseboards.

- Metal bases sold separately. Compatible with GRHB22H41 or GSHB19H41 only.

Required Specifications

Top finish
Laminate base finish

Optional Specifications

HP laminate
Power block cut-out

Accessories

Power block

S SWAP TABLES

WEDGE HUDDLE TABLES

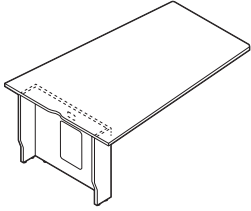

29"H Wedge Huddle

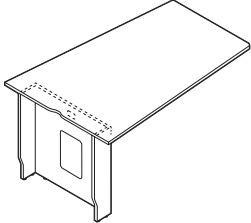

36"H Wedge Huddle

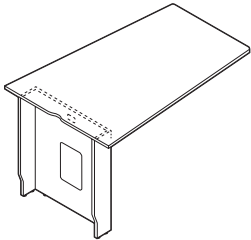

41.5"H Wedge Huddle

MODEL#	DIMENSIONS D x W x H	FREIGHT CLASS	WT/LBS.	CUBIC FT.	LIST PRICE	HP ADD	CHROME ADD
GWH486029	60 x 48 x 29	70	112.6	5.88	\$1505	\$562	n/a
GWH487229	72 x 48 x 29	70	126	6.58	\$1688	\$675	n/a
GWH488429	84 x 48 x 29	92.5	139.24	13.5	\$1805	\$745	n/a
GWH489629	96 x 48 x 29	92.5	152.56	15	\$1952	\$834	n/a

Laminate u-base support is 8"D with 7" inside clearance to wall. Access wall through 14.5"H x 9.5"W hinged door with touch latch in front panel of u-base support. U-base includes 0.5" adjustable glides. U-base side panels are tapered at the bottom to clear most baseboards.

- Metal bases sold separately. Compatible with GRHB22H28 or GSHB19H28 only.

GWH486036	60 x 48 x 36	70	123.6	6.38	\$1541	\$562	n/a
GWH487236	72 x 48 x 36	70	137	7.08	\$1726	\$675	n/a
GWH488436	84 x 48 x 36	92.5	150.24	14	\$1843	\$745	n/a
GWH489636	96 x 48 x 36	92.5	163.56	15.5	\$1989	\$834	n/a

Laminate u-base support is 8"D with 7" inside clearance to wall. Access wall through 14.5"H x 9.5"W hinged door with touch latch in front panel of u-base support. U-base includes 0.5" adjustable glides. U-base side panels are tapered at the bottom to clear most baseboards.

- Metal bases sold separately. Compatible with GRHB22H35 or GSHB19H35 only.

GWH486041	60 x 48 x 41.5	70	130.1	6.74	\$1607	\$562	n/a
GWH487241	72 x 48 x 41.5	70	143.5	7.42	\$1792	\$675	n/a
GWH488441	84 x 48 x 41.5	92.5	156.74	14.34	\$1911	\$745	n/a
GWH489641	96 x 48 x 41.5	92.5	170.06	15.84	\$2058	\$834	n/a

Laminate u-base support is 8"D with 7" inside clearance to wall. Access wall through 14.5"H x 9.5"W hinged door with touch latch in front panel of u-base support. U-base includes 0.5" adjustable glides. U-base side panels are tapered at the bottom to clear most baseboards.

- Metal bases sold separately. Compatible with GRHB22H41 or GSHB19H41 only.

Required Specifications

Top finish
Laminate base finish

Optional Specifications

HP laminate
Power block cut-out

Accessories

Power block

RECTANGULAR HUDDLE TABLES

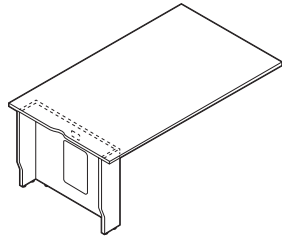

29"H Rectangular Huddle

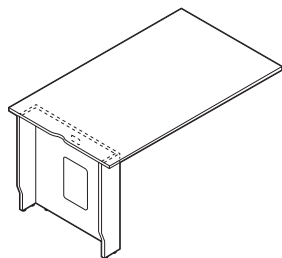

36"H Rectangular Huddle

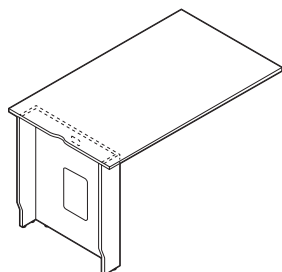

41.5"H Rectangular Huddle*

MODEL#	DIMENSIONS D x W x H	FREIGHT CLASS	WT./LBS.	CUBIC FT.	LIST PRICE	HP ADD	CHROME ADD
GRH364829	48 x 36 x 29	70	77.05	3.94	\$988	\$308	n/a
GRH366029	60 x 36 x 29	70	86.95	4.46	\$1205	\$437	n/a
GRH367229	72 x 36 x 29	70	97	4.98	\$1344	\$521	n/a
GRH426029	60 x 42 x 29	70	99.82	5.18	\$1352	\$500	n/a
GRH427229	72 x 42 x 29	100	111.5	5.78	\$1515	\$596	n/a
GRH428429	84 x 42 x 29	92.5	123.1	11.98	\$1676	\$695	n/a
GRH429629	96 x 42 x 29	150	134.74	13.3	\$1812	\$774	n/a
GRH486029	60 x 48 x 29	70	112.6	5.88	\$1508	\$565	n/a
GRH487229	72 x 48 x 29	70	126	6.58	\$1688	\$675	n/a
GRH488429	84 x 48 x 29	92.5	139.24	13.5	\$1805	\$745	n/a
GRH489629	96 x 48 x 29	92.5	152.56	15	\$1952	\$834	n/a

Laminate u-base support is 8"D with 7" inside clearance to wall. Access wall through 14.5"H x 9.5"W hinged door with touch latch in front panel of u-base support. U-base includes 0.5" adjustable glides. U-base side panels are tapered at the bottom to clear most baseboards.

- Metal bases sold separately. Compatible with GRHB22H28 or GSHB19H28 only.

GRH364836	48 x 36 x 36	70	85.95	4.3	\$1020	\$308	n/a
GRH366036	60 x 36 x 36	70	95.85	4.84	\$1236	\$437	n/a
GRH367236	72 x 36 x 36	70	105.9	5.36	\$1373	\$521	n/a
GRH426036	60 x 42 x 36	70	109.82	5.6	\$1386	\$500	n/a
GRH427236	72 x 42 x 36	70	121.5	6.22	\$1548	\$596	n/a
GRH428436	84 x 42 x 36	92.5	133.1	12.4	\$1710	\$695	n/a
GRH429636	96 x 42 x 36	92.5	144.74	13.74	\$1846	\$774	n/a
GRH486036	60 x 48 x 36	70	123.6	6.38	\$1545	\$565	n/a
GRH487236	72 x 48 x 36	70	137	7.08	\$1726	\$675	n/a
GRH488436	84 x 48 x 36	92.5	150.24	14	\$1843	\$745	n/a
GRH489636	96 x 48 x 36	150	163.56	15.5	\$1989	\$834	n/a

Laminate u-base support is 8"D with 7" inside clearance to wall. Access wall through 14.5"H x 9.5"W hinged door with touch latch in front panel of u-base support. U-base includes 0.5" adjustable glides. U-base side panels are tapered at the bottom to clear most baseboards.

- Metal bases sold separately. Compatible with GRHB22H35 or GSHB19H35 only.

GRH364841	48 x 36 x 41.5	70	92.65	4.58	\$1072	\$308	n/a
GRH366041	60 x 36 x 41.5	70	102.55	5.1	\$1287	\$437	n/a
GRH367241	72 x 36 x 41.5	70	112.6	5.62	\$1427	\$521	n/a
GRH426041	60 x 42 x 41.5	70	117.32	5.92	\$1445	\$500	n/a
GRH427241	72 x 42 x 41.5	70	129	6.52	\$1609	\$596	n/a
GRH428441	84 x 42 x 41.5	92.5	140.6	12.72	\$1773	\$695	n/a
GRH429641	96 x 42 x 41.5	92.5	152.24	14.06	\$1906	\$774	n/a
GRH486041	60 x 48 x 41.5	70	130.1	6.74	\$1612	\$565	n/a
GRH487241	72 x 48 x 41.5	70	143.5	7.42	\$1792	\$675	n/a
GRH488441	84 x 48 x 41.5	92.5	156.74	14.34	\$1911	\$745	n/a
GRH489641	96 x 48 x 41.5	92.5	170.06	15.84	\$2058	\$834	n/a

Laminate u-base support is 8"D with 7" inside clearance to wall. Access wall through 14.5"H x 9.5"W hinged door with touch latch in front panel of u-base support. U-base includes 0.5" adjustable glides. U-base side panels are tapered at the bottom to clear most baseboards.

- Metal bases sold separately. Compatible with **GRHB22H41** or **GSHB19H41** only.

Required Specifications

Top finish
Laminate base finish

Optional Specifications

HP laminate
Power block cut-out

Accessories

Power block

S SWAP TABLES

SOFT ELLIPSE HUDDLE TABLES

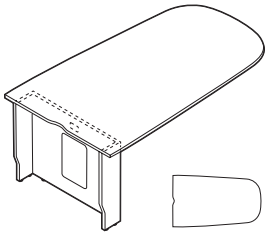

29"H Soft Ellipse Huddle

MODEL#	DIMENSIONS D x W x H	FREIGHT CLASS	WT./LBS.	CUBIC FT.	LIST PRICE	HP ADD	CHROME ADD
GSEH364829	48 x 36 x 29	70	77.05	3.94	\$988	\$308	n/a
GSEH366029	60 x 36 x 29	70	86.95	4.46	\$1205	\$437	n/a
GSEH367229	72 x 36 x 29	70	97	4.98	\$1344	\$521	n/a
GSEH426029	60 x 42 x 29	70	99.82	5.18	\$1352	\$500	n/a
GSEH427229	72 x 42 x 29	70	111.5	5.78	\$1515	\$596	n/a
GSEH428429	84 x 42 x 29	92.5	123.1	11.98	\$1676	\$695	n/a
GSEH429629	96 x 42 x 29	92.5	134.7	13.3	\$1812	\$774	n/a
GSEH486029	60 x 48 x 29	70	112.6	11.78	\$1508	\$565	n/a
GSEH487229	72 x 48 x 29	70	126	6.58	\$1688	\$675	n/a
GSEH488429	84 x 48 x 29	92.5	139.2	13.5	\$1805	\$745	n/a
GSEH489629	96 x 48 x 29	92.5	152.6	15	\$1952	\$834	n/a

Laminate u-base support is 8"D with 7" inside clearance to wall. Access wall through 14.5"H x 9.5"W hinged door with touch latch in front panel of u-base support. U-base includes 0.5" adjustable glides. U-base side panels are tapered at the bottom to clear most baseboards.

- Metal bases sold separately. Compatible with **GRHB22H28** or **GSHB19H28** only.

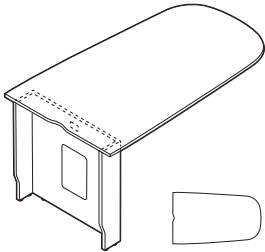

36"H Soft Ellipse Huddle

GSEH364836	48 x 36 x 36	70	86	4.3	\$1020	\$308	n/a
GSEH366036	60 x 36 x 36	70	95.9	4.84	\$1236	\$437	n/a
GSEH367236	72 x 36 x 36	70	105.9	5.36	\$1373	\$521	n/a
GSEH426036	60 x 42 x 36	70	109.8	5.6	\$1386	\$500	n/a
GSEH427236	72 x 42 x 36	70	121.5	6.22	\$1548	\$596	n/a
GSEH428436	84 x 42 x 36	92.5	133.1	12.4	\$1710	\$695	n/a
GSEH429636	96 x 42 x 36	92.5	144.74	13.74	\$1846	\$774	n/a
GSEH486036	60 x 48 x 36	70	123.6	12.76	\$1545	\$565	n/a
GSEH487236	72 x 48 x 36	70	137	7.08	\$1726	\$675	n/a
GSEH488436	84 x 48 x 36	92.5	150.24	14	\$1843	\$745	n/a
GSEH489636	96 x 48 x 36	92.5	163.56	15.5	\$1989	\$834	n/a

Laminate u-base support is 8"D with 7" inside clearance to wall. Access wall through 14.5"H x 9.5"W hinged door with touch latch in front panel of u-base support. U-base includes 0.5" adjustable glides. U-base side panels are tapered at the bottom to clear most baseboards.

- Metal bases sold separately. Compatible with **GRHB22H35** or **GSHB19H35** only.

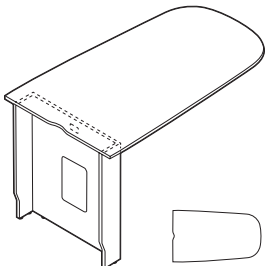

41.5"H Soft Ellipse Huddle*

GSEH364841	48 x 36 x 41.5	70	92.65	9.16	\$1072	\$308	n/a
GSEH366041	60 x 36 x 41.5	70	102.55	5.1	\$1287	\$437	n/a
GSEH367241	72 x 36 x 41.5	70	112.6	5.62	\$1427	\$521	n/a
GSEH426041	60 x 42 x 41.5	70	117.32	5.92	\$1445	\$500	n/a
GSEH427241	72 x 42 x 41.5	70	129	6.52	\$1609	\$596	n/a
GSEH428441	84 x 42 x 41.5	92.5	140.6	12.72	\$1773	\$695	n/a
GSEH429641	96 x 42 x 41.5	92.5	152.24	14.06	\$1906	\$774	n/a
GSEH486041	60 x 48 x 41.5	70	130.1	6.74	\$1612	\$565	n/a
GSEH487241	72 x 48 x 41.5	70	143.5	14.86	\$1792	\$675	n/a
GSEH488441	84 x 48 x 41.5	92.5	156.74	14.34	\$1911	\$745	n/a
GSEH489641	96 x 48 x 41.5	92.5	170.06	15.84	\$2058	\$834	n/a

Laminate u-base support is 8"D with 7" inside clearance to wall. Access wall through 14.5"H x 9.5"W hinged door with touch latch in front panel of u-base support. U-base includes 0.5" adjustable glides. U-base side panels are tapered at the bottom to clear most baseboards.

- Metal bases sold separately. Compatible with **GRHB22H41** or **GSHB19H41** only.

Required Specifications

Top finish
Laminate base finish

Optional Specifications

HP laminate
Power block cut-out

Accessories

Power block

HUDDLE BASES

MODEL# DIMENSIONS FREIGHT CLASS WT/LBS. CUBIC FT. LIST PRICE HP ADD CHROME ADD

D x W x H

SELECT BASE COMPATIBLE WITH TOP HEIGHT:

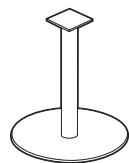

22" Round Huddle Base

GRHB22H28	22 x 22 x 28	92.5	10	1	\$970	n/a	\$115
GRHB22H35	22 x 22 x 35	150	62	12.67	\$970	n/a	\$138
GRHB22H41	22 x 22 x 40.5	150	63	14.17	\$1012	n/a	\$145

GRHB22H28 - seated height **GRHB22H35** - counter height **GRHB22H41** - bar height

Metal base ships fully assembled. Features 0.5" adjustable glides to level on uneven surfaces. Screws included with base for attaching to appropriate huddle table laminate pieces. Available in painted and plated finishes as listed on page 661. Upcharge on plated finishes. Be sure to double check huddle table laminate pieces and metal bases are correct corresponding heights.

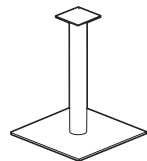

18.5" Square Huddle Base

GSHB19H28	18.5 x 18.5 x 28	125	55	6.94	\$1037	n/a	\$126
GSHB19H35	18.5 x 18.5 x 35	125	57	8.80	\$1037	n/a	\$126
GSHB19H41	18.5 x 18.5 x 40.5	150	58	9.84	\$1086	n/a	\$138

GSHB19H28 - seated height **GSHB19H35** - counter height **GSHB19H41** - bar height

Metal base ships fully assembled. Features 0.5" adjustable glides to level on uneven surfaces. Screws included with base for attaching to appropriate huddle table laminate pieces. Available in painted and plated finishes as listed on page 661. Upcharge on plated finishes. Be sure to double check huddle table laminate pieces and metal bases are correct corresponding heights.

Required Specifications

Finish

Optional Specifications

Plated base



Terina is a simple flip top table series that transforms any space into sophisticated areas for training, meetings and collaboration. Terina features unique and elegant aluminum, angled t-leg design paired with high pressure laminate or veneer surface, with optional modesty panels. Surface power modules offer an easy way to charge electronic devices without the need to drop down cords. Wires are managed below the worksurface with snap-in cable clips. Terina can be ganged together with optional flush ganging plates. Single hand release mechanism is active from the center of the user side of the table. Tables can be nested together in an upright position to minimize storage space.

Features and Benefits

- Training, meeting or conferencing. A multi-purpose table that allows you quickly and simply adapt your space to suit your needs.
- Simple flip top mechanism designed for single handed operation.
- Tops offered in high pressure laminate or wood veneer
- 10" modesty panel articulates when tables fold down
- Legs and crossbeam offered in 7 paint finishes
- Optional flush ganging plates
- Tables can be nested together when not in use.

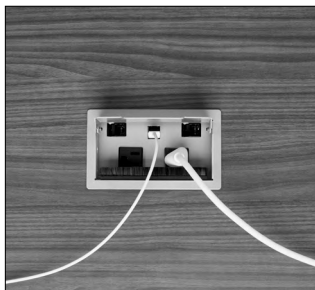

Optional power block includes power and data



Optional ganging plates and daisy chain power management



Tables can be nested together when not in use.

GENERAL INFORMATION

- Terina flip top tables transform any space into sophisticated areas for training, meetings and collaboration.
- Simple flip top mechanism is designed for one handed operation.
- Unique, angled “T” leg design.
- Shipped R.T.A. (Ready to Assemble).
- Global laminate products are in compliance with stringent emission guidelines set out by the Greenguard Environmental Institute under the standards for low emitting products and materials. www.greenguard.org.
- **Level 3 Certified**

WORKSURFACES

- Laminate surfaces are 1-1/16” thick tops constructed of 45 lb. density particle board with high pressure laminate and finished on the underside of the surface with a kraft paper backing.
- Veneer surfaces are 1-3/16” thick tops constructed of 45 lb. density particle board and are balanced on the underside with veneer (unfinished)
- Worksurfaces are pre-drilled for alignment of the Terina base

BASE

- Tables feature an aluminum leg, cross beam and die-cast foot.
- Legs and cross beam are available in (7) different finish options.
- Die-cast foot is always in polished aluminum finish.
- Foot span is 23”

EDGING

- Laminate surfaces offer a selection of matching + coordinated edgeband. Specify separately from the surface finish.
- Veneer tops are finished with a 6mm hardwood edge, stained to match

CASTERS

- Casters are standard on all tables.
- 2-3/8” dual wheel casters with manual lock. Full 360° swivel.
- Suggested for carpeted surfaces.
- Available in grey only

GANGING PLATES

- Ganging plates are available for ganging adjoining tables together.
- Ganging plates are black epoxy coated steel plates with two thumbscrews

WIRE MANAGEMENT

- Wire management option is a snap-in channel that fits on the interior of the leg or on the underside of the flip-top cross beam

FLIP TOP TABLE NESTING DIAGRAM

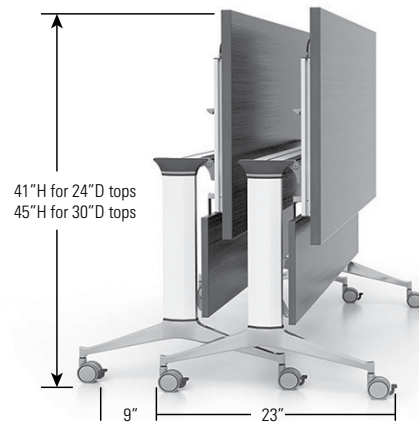

MODESTY PANELS

- 10” modesty panel affixes to the top and base, articulating when it folds down.
- Available in all standard laminates
- Modesty panels up to 60”w have vertical grain. Modesty panels 66” and wider will have horizontal grain.

LAMINATE FINISHES

ACJ	Absolute Acajou	NGL	Noce Grigio
ASN	Asian Night	NEL	Noce Leggero
AWC	Avant Cherry	NML	Noce Medio
AWH	Avant Honey	QTM	Quartered Mahogany
BLK	Black	SOG	Storm Grey
BRC	Brushed Cobalt	TFW	Tiger Fruitwood
CMB	Clear Maple	TWL	Tiger Walnut
DES	Dark Espresso	WHE	Walnut Heights
DWT	Designer White	WHC	White Chocolate
HGT	Hayden Grey	WGY	Willow Grey
NBL	Noce Biondo	WCR	Winter Cherry

EDGE FINISHES (Laminate Surfaces Only)

AAE	Absolute Acajou	DWE	Designer White
ASE	Asian Night	QTM	Quartered Mahogany
ACE	Avant Cherry	SIL	Silver (use w/WGY)
AHE	Avant Honey	TPE	Taupe (use w/HGT)
BLK	Black	TFE	Tiger Fruitwood
BRC	Brushed Cobalt	TWE	Tiger Walnut
CHR	Charcoal (use w/SOG)	WHE	Walnut Heights
CME	Clear Maple	CBE	White Chocolate
DEE	Dark Espresso	WCE	Winter Cherry

LEG FINISHES

BLK	Black	CHR	Charcoal
DWT	Designer White	NEV	Nevada
SIL	Silver	TPE	Taupe
TUN	Tungsten		

GROMMETS

- Grommets are available in all tops (left, center or right). Order as: **AG1, AG2 or AG3. Add \$88.**
- Grommet hole dimensions are 3 1/4" wide x 1 7/8" deep.
- Available on all table widths and depths
- Please note limited user space when cutouts are specified. See dimensions on diagram below.**

Grommet hole dimensions Grommet

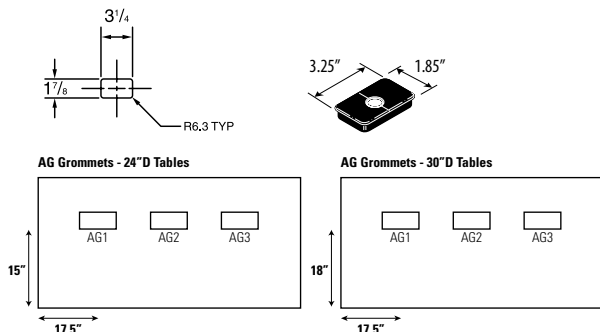

- Grommets may be placed at non-standard locations. Order as: **AGS - Add \$88.** A drawing must be supplied with vertical and horizontal dimensions to the center of the cut-out (as in drawing above). Please refer to CUSTOM GROMMET LOCATION FORM in the back reference section.

POWER BLOCK

- A Power Block (model **PMSPDM**) may be ordered on all worksurfaces.
- A Power Block is a rectangular worksurface power/data module with one electrical duplex receptacle and two data (RJ45) receptacles. 9' black cord included. Power Block dimensions are 3 1/2" deep x 6 1/2" wide x 2 3/4" high.
- A Power Block cutout (for model **PMSPDM**) may be ordered for **tops 60" and up in any standard location.** Order as **E1, E2 or E3. Add \$88.**
- A Power Block cutout (for model **PMSPDM**) may be ordered in the **center position only for 48" and 54" tops.** Order as **E2. Add \$88.**

VENEER FINISHES:

Code	Finish	Veneer Type	Cut
AMW	Almond Cherry	Cherry	Flat Sliced
CAW	Cocoa Walnut	Walnut	Flat Sliced
CRW	Coral	White Oak	Rift
DCW	Dark Cherry	Cherry	Flat Sliced
EWV	Espresso Walnut	Walnut	Flat Sliced
EVW	Evening Oak	White Oak	Rift
GRW	Grey on Oak	White Oak	Rift
HAW	Hazelnut	Maple	Flat Sliced
SMW	Honey Maple	Maple	Flat Sliced
JAW	Java	White Oak	Rift
LTW	Latte Walnut	Walnut	Flat Sliced
MTW	Milestone	White Oak	Rift
MCW	Mocha	White Oak	Rift
MPW	Natural Maple	Maple	Flat Sliced
RCW	Red Cherry	Cherry	Flat Sliced
VNW	Vintage Cherry	Cherry	Flat Sliced
WLW	Walnut	Walnut	Flat Sliced
WCW	Warm Cherry	Cherry	Flat Sliced
WMW	White Maple	Maple	Flat Sliced

- To purchase a Power Block, you must specify both the Power Block cut-out location and the Power Block model #. Order Power Block as **PMSPDM, Add \$330.**
- Please note limited user space when cutouts are specified. See dimensions on diagram below.**



Power Block **PMSPDM, Add \$330**

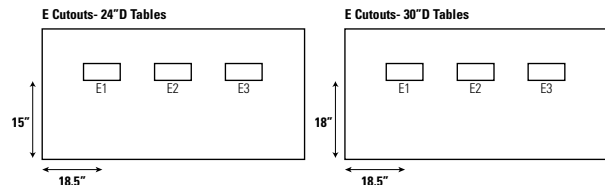

VILLA CUTOUTS

- A Villa cutout may be ordered for **tops 60" and up in any standard location.** Order as: **V1, V2 or V3 - Add \$88 for each cutout.**
- A Villa cutout may be ordered in the **center position only for 48" and 54" tops.** Order as: **V2 - Add \$88.**
- Villa with USB is not compatible with Terina tables**
- Please note limited user space when cutouts are specified. See dimensions on diagram below.**

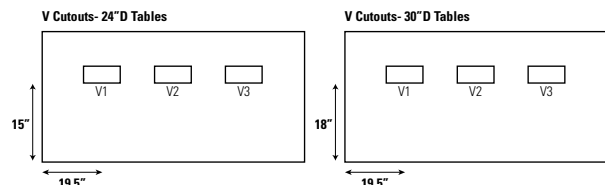

RECTANGULAR TABLES



Rectangular Table - Laminate Top*



Rectangular Table - Veneer Top

MODEL#	DIMENSIONS D x W x H	FREIGHT CLASS	WT/LBS.	CUBIC FT.	LIST PRICE
GFT2472R	24 x 72 x 29	100	66	6.98	\$1727
GFT2466R	24 x 66 x 29	250	61	20.96	\$1693
GFT2460R	24 x 60 x 29	250	55	20.96	\$1665
GFT2454R	24 x 54 x 29	250	53	17.96	\$1627
GFT2448R	24 x 48 x 29	250	48	17.96	\$1489
GFT3072R	30 x 72 x 29	100	68	6.98	\$1780
GFT3066R	30 x 66 x 29	100	66	6.98	\$1761
GFT3060R	30 x 60 x 29	100	61	6.98	\$1733
GFT3054R	30 x 54 x 29	100	55	5.99	\$1693
GFT3048R	30 x 48 x 29	100	53	5.99	\$1590

Tables feature a flip-top **laminated** worksurface for ease of storage. Single hand release mechanism is active from the center of the user side of the table. Leg can be painted in a variety of finishes. Foot is always in polished aluminum. Each table can be ganged together with GNCNGFP ganging plates (see next page). Modesty panels are available (see GFTxxM).

- Casters are available in grey only.

GFT2472RV	24 x 72 x 29	100	66	6.98	\$2867
GFT2466RV	24 x 66 x 29	250	61	20.96	\$2726
GFT2460RV	24 x 60 x 29	250	55	20.96	\$2583
GFT2454RV	24 x 54 x 29	250	53	17.96	\$2502
GFT2448RV	24 x 48 x 29	250	48	17.96	\$2418
GFT3072RV	30 x 72 x 29	100	68	6.98	\$3296
GFT3066RV	30 x 66 x 29	100	66	6.98	\$3116
GFT3060RV	30 x 60 x 29	100	66	6.98	\$2935
GFT3054RV	30 x 54 x 29	100	55	5.99	\$2748
GFT3048RV	30 x 48 x 29	100	53	5.99	\$2565

Tables feature a flip-top **veneered** worksurface for ease of storage. Single hand release mechanism is active from the center of the user side of the table. Leg can be painted in a variety of finishes. Foot is always in polished aluminum. Each table can be ganged together with GNCNGFP ganging plates (see next page). Modesty panels are available (see GFTxxMx).

- Casters are available in grey only.

Required Specifications

Top finish
Leg finish
Edge finish*

Optional Specifications

Grommet

Accessories

Power block
Wire management
Ganging plate

MODESTY PANELS

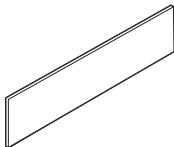

Modesty Panel - Laminate*

MODEL# DIMENSIONS FREIGHT CLASS WT/LBS. CUBIC FT. LIST PRICE

D x W x H

GFT72M	.75 x 70 x 10	92.5	20	2	\$314
GFT66M	.75 x 64 x 10	100	18	2	\$299
GFT60M	.75 x 58 x 10	70	15	1	\$287
GFT54M	.75 x 52 x 10	85	13	1	\$275
GFT48M	.75 x 46 x 10	92.5	11	1	\$261

Laminate modesty panel for use on GFTxxxxR Tables. Articulating modesty panel includes necessary hardware to attach. Can be retrofitted.

- Modesty panels up to 60" w have vertical grain. Modesty panels 66" and wider will have horizontal grain.

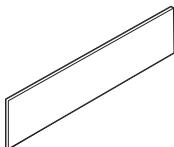

Modesty Panel - Veneer

GFT72MV	.75 x 70 x 10	92.5	20	2	\$876
GFT66MV	.75 x 64 x 10	100	18	2	\$814
GFT60MV	.75 x 58 x 10	70	15	1	\$740
GFT54MV	.75 x 52 x 10	85	13	1	\$665
GFT48MV	.75 x 46 x 10	92.5	11	1	\$603

Veneer modesty panel for use on GFTxxxxR Tables. Articulating modesty panel includes necessary hardware to attach. Can be retrofitted.

- Modesty panels up to 60" w have vertical grain. Modesty panels 66" and wider will have horizontal grain.

WIRE MANAGEMENT

MODEL# DIMENSIONS FREIGHT CLASS WT/LBS. CUBIC FT. LIST PRICE



Wire Manager

GFTCM04BLK	2 x 10 x 2	70	1	1	\$49
------------	------------	----	---	---	-------------

Set of four, 10" long grey plastic extrusions. Can be snapped into the inside of each leg for wire management from the surface to the floor, or snapped into the cross beam of the table to keep wires tucked neatly below the worksurface.

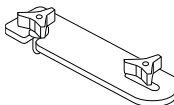

Ganging Flush Plate

GFCNGFP	.1 x 5 x 2.5	70	1	.01	\$49
---------	--------------	----	---	-----	-------------

Black epoxy coated steel plates with 2 thumbscrews included. Used to connect worksurfaces together. Holes with steel inserts are located in the corner of the tops to accommodate this plate. Sold individually.

Required Specifications

- Finish
- Edge finish*



Zook was designed for today's dynamic and diverse learning environments. The tables are lightweight and can be reconfigured easily to create interactive environments and support collaboration.

Choose from a variety of organic and geometric shaped table tops to optimize flexibility. They are available in a wide array of sizes and finishes in both thermally fused laminate and high pressure laminate. Zook's color palette also includes nine new bold finishes available in high pressure laminate only.

Tops are available in 1" thick thermally fused laminate or 1-1/16" high pressure laminate with Global's preferred matching edge or a new optional ergo friendly edge.

Features and Benefits

- Tops are 1" thick thermally fused laminate or 1-1/16" high pressure laminate.
- Tops are constructed of 45 lb. density particle board.
- Global's preferred matching edge or optional ergo friendly edge.
- Tops are available in organic and geometric shapes.
- Surfaces include factory installed metal inserts for solid and secure leg connections.
- Group table's cable tower is constructed from thermally fused laminate with a removable access panel and inside clearance of 9" x 9". Available on group tables ZK44848P, ZK45959P and ZK65990 only.
- Easy to assemble



Variety of organic and geometric shapes



Multiple table configurations. Ideal for group study and encouraging collaboration.

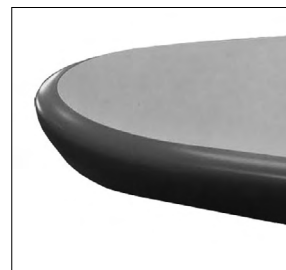

Optional ergo friendly edge

GENERAL INFORMATION

- Zook is a series of tables designed for classrooms and diverse learning environments.
- Organic shapes and rectangular tops are available to create a variety of configurations that naturally bring people together.
- Choose from Zook group tables for groups of 4 to 6 people comfortably, pod tables for individuals, activity tables, or flip top tables.
- Create spaces that encourage discussion and the sharing of ideas
- Supports multi-use, active learning spaces and a variety of teaching styles
- Materials and workmanship stand up to the rigorous demands of today's learning environments
- Shipped easy to assemble. Tops include factory installed metal inserts to accept leg attachment.
- For environmental certifications, please visit globalfurnituregroup.com.

ZOOK GROUP TABLES

- Organic shaped tops available in three sizes: 48" x 48", 59" x 59" or 59" x 90".
- Tops supported by 3" diameter fixed height post legs.
- Select models available with cut-out options for power modules; these select models also include a cable tower for managing cables to floor monuments..

ZOOK POD TABLES

- Available in four geometric shapes; three that when used adjacent to one another, can create various pod configurations as well as rectangular tables in a number of sizes.
- ADA compliant heights available for select models.
- 1.5" diameter fixed height post legs.
- Tables may be specified on levelers or with casters for greater mobility and flexibility

ZOOK ACTIVITY TABLES

- Available in three shapes, all based on a 54" wide footprint.
- Tops are available with two types of mating edges: curved or straight. When planning to mate tables, do not mix mating edge styles.
- 2" diameter tapered legs on levelers or casters.

ZOOK FLIP-TOP TABLES

- Available in three sizes, 30"w x 22"d with concave shaped top; 30"w x 24"d and 60"w x 24"d rectangular top with radius corners.
- Supported by Y legs, equipped with smooth glide casters (two locking). H-legs are in Tungsten (TTU) finish only.
- 60"w tables optional with AG1, AG2, AG3 grommet; ZKFR3024 available with optional AG2 grommet
- Modesty panels are available separately in Tungsten (TUN) finish only.

WORKSURFACES

- Tops are available in 1" thick thermally fused laminate or 1-1/16" thick high pressure laminate
- Available in many finishes in both thermally fused laminate or high pressure laminate, including nine bold finishes available in high pressure laminate only.
- Worksurface core is made of 45 lb. density particleboard
- Surfaces include factory-installed metal inserts for solid and secure leg connections

WRITEABLE SURFACE OPTION

- Available on group, pod, activity, flip-top and rectangular tables
- High gloss White, non-magnetic dry-erase surface
- Complementary or contrasting edge to be specified, darker edge finish recommended
- Specify (WRW) for top finish. For upcharge, refer to finish option per product.

EDGE DETAIL

- Global's preferred (2mm flat edge) matching edge is standard
- Optional ergo-friendly edge is available at an upcharge (varies by item; see product for details).
- Rectangular tops feature rounded 2.5" radius corners

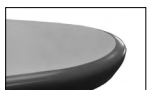

Ergo friendly edge

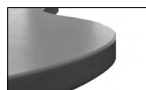

2mm flat edge

LEGS

- **Group tables:** 3" diameter steel post legs, 28" high with adjustable 3" diameter plastic glides. Each leg includes a 6" x 6" metal top plate and ships with truss head screws to connect to tops. See page 710 for available finishes.
- **Pod tables:** 1.5" diameter tube steel legs, available with adjustable levelers or dual wheel locking casters. Each leg includes top plate and hardware for mounting. See page 710 for available finishes. Optional Chrome (CHM) finish is available for pod tables only. **Add \$72** for three-legged models or **add \$94** for four-legged models
- **Activity tables:** 2" diameter tapered legs available with adjustable levelers or optional locking casters. Each leg includes top plate and hardware for mounting. See page 710 for available finishes. Optional Chrome (CHM) finish is available. **Add \$151.**

Group tables

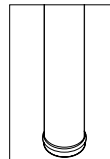

3" dia. leg

Pod tables



1.5" dia. leg

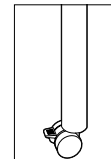

1.5" dia. leg with caster

Activity Tables

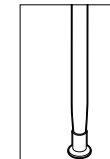

Tapered leg with leveler

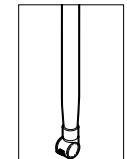

Tapered leg with caster

CASTERS

- Pod table models ending in C indicate legs equipped with 1.5" dia locking casters. Casters are black only.
- Activity table models ending in C indicate legs equipped with 2" dia locking casters. Casters are black only.

GROUP TABLE with CABLE TOWER

- Constructed from thermally fused laminate with a removable access panel
- Inside clearance of 8" x 8.6" will conceal most floor monuments, but still provide easy access.
- Available on group tables ZK44848P, ZK45959P and ZK65990P only.
- Must specify cut-out option when ordering group tables to accommodate select power module. Power modules sold separately.
- Available in Black (BLK), Brushed Cobalt (BRC) or Designer White (DWT) finish

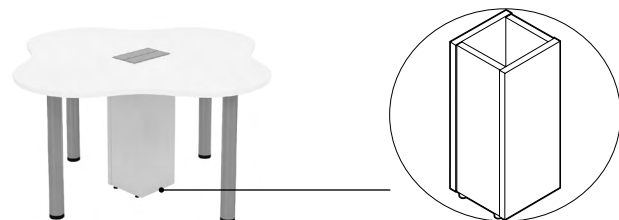

Cable tower

1. SPECIFY MODEL NUMBER

2. SPECIFY TOP FINISH

Thermally Fused and High Pressure Laminate Finishes:

ACJ	Absolute Acajou	NEL	Noce Leggero
ASN	Asian Night	NML	Noce Medio
AWC	Avant Cherry	QTM	Quartered Mahogany
AWH	Avant Honey	SOG	Storm Grey
BLK	Black	TFW	Tiger Fruitwood
BRC	Brushed Cobalt	TWL	Tiger Walnut
CMB	Clear Maple	WHE	Walnut Heights
DES	Dark Espresso	WHC	White Chocolate
DWT	Designer White	WGY	Willow Grey
HGT	Hayden Grey	WCR	Winter Cherry
NBL	Noce Biondo	WRW	Writable Surface
NGL	Noce Grigio		

High Pressure Laminate Finishes** (optional - upcharge applies):

BTT	Blue Titanium	KKW	Kool Kiwi
BBY	Blueberry	LBR	Liberty Red
CBB	Caribbean Blue	MYL	Morning Yellow
FJT	Fiji Teal	RPL	Royal Purple
FPY	Fresh Papaya		

**select edge finish separately from above (see step #3).

Upcharge varies for high pressure laminate by product. Refer to products for details.

3. SPECIFY EDGE FINISH

2mm Thick Edgebanding:

ACJ	Absolute Acajou	LAB	Latte
ASN	Asian Night	NBL	Noce Biondo
AWC	Avant Cherry	NGL	Noce Grigio
AWH	Avant Honey	NEL	Noce Leggero
BLK	Black	NML	Noce Medio
BRC	Brushed Cobalt	QTM	Quartered Mahogany
BZB	Buzz Blue	SAR	Scarlet
CCT	Cactus	SHW	Shadow
CRO	Carrot	SOG	Storm Grey
CMB	Clear Maple	TFW	Tiger Fruitwood
DES	Dark Espresso	TWL	Tiger Walnut
DWT	Designer White	WHE	Walnut Heights
DJN	Dijon	WHC	White Chocolate
FOG	Fog	WGY	Willow Grey
HGT	Hayden Grey	WCR	Winter Cherry

Ergo Friendly Edge Finishes (optional - upcharge applies)

EBL	Black
ECP	Latte
ECG	Charcoal Grey
EDW	Designer White
EGR	Grey

4. SPECIFY LEG FINISH

Legs:

TBL	Black
TBZ	Buzz Blue
TCC	Cactus
TCR	Carrot
TIV	Cloud
TDW	Designer White
TDJ	Dijon
TEG	Eggplant
TFO	Fog
TFR	Frost
TIN	Ink
TKA	Kalua
TLA	Latte
TMO	Mocha
TNE	Nevada
TSN	Sand
TSR	Scarlet
TSH	Shadow
TOA	Toast
TTU	Tungsten
CHM	Chrome**

**Upcharges apply for CHM. Refer to model for upcharges.

Note: Leg finish is not optional for flip-top tables. Available in Tungsten (TTU) only.

FINISH	ACTIVITY	FLIP-TOP	GROUP	POD
Black TBL	•	N/A	•	•
Buzz Blue TBZ	•	N/A	•	•
Cactus TCC	•	N/A	•	•
Carrot TCR	•	N/A	•	•
Chrome CHM	•	N/A	N/A	•
Cloud TIV	•	N/A	•	•
Designer White TDW	•	N/A	•	•
Dijon TDJ	•	N/A	•	•
Eggplant TEG	•	N/A	•	•
Fog TFO	•	N/A	•	•
Frost TFR	•	N/A	•	•
Ink TIN	•	N/A	•	•
Kalua TKA	•	N/A	•	•
Latte TLA	•	N/A	•	•
Mocha TMO	•	N/A	•	•
Nevada TNE	•	N/A	•	•
Sand TSN	•	N/A	•	•
Scarlet TSR	•	N/A	•	•
Shadow TSH	•	N/A	•	•
Toast TOA	•	N/A	•	•
Tungsten TTU	•	•	•	•

SPECIFY CABLE TOWER FINISH - ZK44848P, ZK45959P and ZK65990P only

Cable Tower Finishes:

- BLK Black
- BRC Brushed Cobalt
- DWT Designer White

SPECIFY CUT-OUT OPTION - remember to order power module separately

POWER BLOCK AND CUT-OUT OPTIONS

- A power block delivers power/data to the table surface.
- Power block modules must be ordered separately and available for models ZK44848P, ZK45959P and ZK46590P only.
- Must specify the power block cut-out option when ordering the table.
- This center cut-out corresponds to select power modules. Order as **A2, J2, K2** or **U2**, depending on the power module ordered.
- For a custom size cut-out (must be in center position), please contact Customer Care
- Select power block option on page 713.

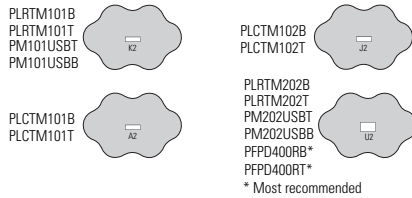

- Match power block desired with cut-out code and location from above grid
- Example: For power block module # PLRTM101B, specify cut-out option K2.

EXAMPLE ZOOK ORDER CODES:

Group table

ZK65590P	-ACJ	-HPL	-ECG	-TTU	-BRC	-U2
Model #	Top finish	High pressure laminate	Ergo friendly edge and finish	Leg finish	Cable tower finish	Cut out option

Pod table

ZK412529L	-ACJ	-HPL	-WHT	-TTU
Model #	Top finish	High pressure laminate	2mm edge finish	Leg finish

4-6 PERSON GROUP TABLES



4-Person Table

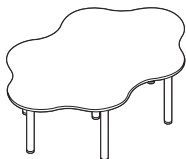

6-Person Table

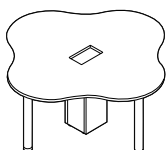

4-Person Table w/Cable Tower*

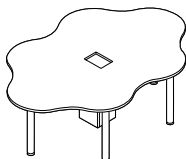

6-Person Table w/Cable Tower*

MODEL#	DIMENSIONS D x W x H	FREIGHT CLASS	WT/LBS.	CUBIC FT.	LIST PRICE	HP ADD	ERGO EDGE	WRW
ZK44848	48 x 48 x 29	60	215	7.10	\$1073	\$293	\$84	\$315
ZK45959	59 x 59 x 29	65	220	9.20	\$1103	\$347	\$178	\$472

4-person table includes top and four steel post legs. Top includes factory installed metal inserts for solid and secure leg connections. Legs are 3" in diameter x 28" high each with an adjustable 3" diameter plastic glide and a 6" x 6" metal top plate. Shipped easy to assemble in 5 cartons.

ZK65990	59 x 90 x 29	70	245	13.43	\$1705	\$608	\$263	\$782
---------	--------------	----	-----	-------	---------------	--------------	--------------	--------------

6-person table includes top and six steel post legs. Top includes factory installed metal inserts for solid and secure leg connections. Legs are 3" in diameter x 28" high each with an adjustable 3" diameter plastic glide and a 6" x 6" metal top plate. Shipped easy to assemble in 7 cartons.

ZK44848P	48 x 48 x 29	65	265	8.86	\$1463	\$293	\$84	\$315
ZK45959P	59 x 59 x 29	65	270	10.96	\$1493	\$347	\$178	\$472

4-person table includes top, four steel post legs and cable tower. Top includes factory installed metal inserts for solid and secure leg connections. Legs are 3" in diameter x 28" high each with an adjustable 3" diameter plastic glide and a 6" x 6" metal top plate. Shipped easy to assemble in 6 cartons. For power block options, see page 713.

ZK65990P	59 x 90 x 29	70	295	15.28	\$2018	\$608	\$263	\$782
----------	--------------	----	-----	-------	---------------	--------------	--------------	--------------

6-person table includes top, six steel post legs and cable tower. Top includes factory installed metal inserts for solid and secure leg connections. Legs are 3" in diameter x 28" high with an adjustable 3" diameter plastic glide and a 6" x 6" metal top plate. Shipped easy to assemble in 7 cartons. For power block options, see page 713.

Required specifications

Top finish
Edge finish
Leg finish

Optional specifications

HP laminate
Ergo friendly edge and finish
Power block cut-out*
Writeable surface (WRW)

Accessories

Power block*

POWER / DATA - RECOMMENDED FOR GROUP TABLES

MODEL # DIMENSIONS FREIGHT CLASS WT/LBS. CUBIC FT. LIST PRICE

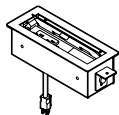

Voice/Data Block

	D x W x H				
PLRTM101B	11 x 4.3 x 3.5	125	4.65	0.67	\$531
PLRTM101T	11 x 4.3 x 3.5	125	4.65	0.67	\$531

Power module with recessed door. Power only included, specify telecom options separately. Includes one duplex outlet on top (two receptacles) and one simplex on the bottom. 10' cord. Includes one telecom knockout. Available in Black (**B**) and Tungsten (**T**) - indicated by last letter of model number. Use with Zook tables ZK44848P, ZK45959P or ZK65990P - corresponding cut-out option is **K2**.

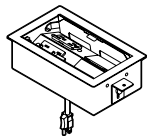

Voice/Data Block

PLRTM202B	11 x 6.8 x 3.5	92.5	7	0.67	\$617
PLRTM202T	11 x 6.8 x 3.5	92.5	7	0.67	\$617

Power only included, specify telecom options separately. Includes four simplex outlets on top and one on bottom. 10' cord. Includes two telecom knockouts. Available in Black (**B**) and Tungsten (**T**) - indicated by last letter of model number. Surface access door. Cut-out option U1, U2 or U3 to be specified when ordering. Use with Zook tables ZK44848P, ZK45959P or ZK65990P - corresponding cut-out option is **U2**.

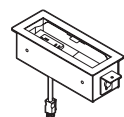

Power/USB Block

PM101USBB	11 x 4.3 x 3.5	70	6	0.3	\$653
PM101USBT	11 x 4.3 x 3.5	70	6	0.3	\$653

Power module with recessed door. Includes one duplex with two AC outlets and two USB-A charging ports, one telecom knockout and one simplex convenience plug on the bottom of the unit. 10' power cord. Available in Black (**B**) or Tungsten (**T**) as indicated by the last character of the model number. Duplex is White only. Use with Zook tables ZK44848P, ZK45959P or ZK65990P - corresponding cut-out option is **K2**. Units are not approved for daisy chaining.

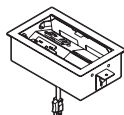

Power/USB Block

PM202USBB	11 x 6.8 x 3.5	92.5	7	0.67	\$863
PM202USBT	11 x 6.8 x 3.5	92.5	7	0.67	\$863

Power module with recessed doors. Includes: one duplex with two AC outlets and one duplex with two AC outlets and two USB-A charging ports, two telecom knockouts and one simplex convenience plug on the bottom. 10' power cord. Available in Black (**B**) or Tungsten (**T**) as indicated by the last character of the model number. Duplexes are White only. Use with Zook tables ZK44848P, ZK45959P or ZK65990P - corresponding cut-out option is **U2**. Units are not approved for daisy chaining.

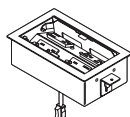

Power/USB Block

PFPD400RB	11.02 x 6.77 x --	92.5	7	0.67	\$882
PFPD400RT	11.02 x 6.77 x --	92.5	7	0.67	\$882

Power module with recessed doors. Includes four duplexes: two AC only duplexes and two AC with USB-A duplexes (each with two AC outlets and two USB-A charging ports) and one simplex on the bottom. In total, eight AC outlets, four USB-A and one convenience plug on the bottom of the unit. 10' power cord. Available in Black (**B**) or Tungsten (**T**) as indicated by last character of model number. Duplexes are white only. Use with Zook tables ZK44848P, ZK45959P or ZK65990P - corresponding cut-out option is **U2**. Units are not approved for daisy chaining.

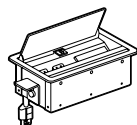

Power/Data Block

PLCTM101B	9 x 5.5 x -	70	6	0.3	\$279
PLCTM101T	9 x 5.5 x -	70	6	0.33	\$279



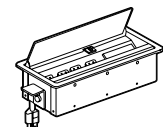

Power only included, specify telecom options separately, see above. Includes two simplex outlets on top and one on bottom. 10' cord. Includes one telecom knockout. Available in Black (**B**) and Tungsten (**T**) - indicated by last letter of model number. Surface access door. Use with Zook tables ZK44848P, ZK45959P or ZK65990P - corresponding cut-out option is **A2**.



Power/Data Block

PLCTM102B	12 x 5.5 x -	125	5	0.67	\$402
PLCTM102T	12 x 5.5 x -	125	5	0.67	\$402

Power only included, specify telecom options separately, see above. Includes four simplex outlets on top and one on bottom. 10' cord. Includes one telecom knockout. Available in Black (**B**) and Tungsten (**T**) - indicated by last letter of model number. Surface access door. Use with Zook tables ZK44848P, ZK45959P or ZK65990P - corresponding cut-out option is **J2**.

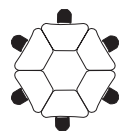
POD TABLES	MODEL#	DIMENSIONS	FREIGHT CLASS	WT./LBS.	CUBIC FT.	LIST PRICE	HP ADD	ERGO EDGE	WRW
Sample pod table configurations	D x W x H								
	ZK412529L shown in left, forward and right facing position	ZK302529L x 4 shown in alternating straight line orientation	ZK412529L x 4	ZK302529L x 6	ZK312129L x 6				
									

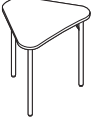
POD TABLES - 29" HIGH	MODEL#	DIMENSIONS	FREIGHT CLASS	WT./LBS.	CUBIC FT.	LIST PRICE	HP ADD	ERGO EDGE	WRW
	ZK302529L	24.6 x 30 x 29	70	37	2	\$362	\$63	\$28	\$144

Small Pod Table w/3 Legs

Triangular table with three round tube 18 gauge steel legs. Can be used individually, can alternate front-to-back in a straight row, or can be arranged in groups of six to create a round table effect. Top includes factory installed metal inserts for solid and secure leg connections. Legs are 1.5" in diameter x 28" high with adjustable levelers. Shipped easy to assemble in 4 cartons, top separate from legs; legs individually packed.

- Chrome (CHM) is available on legs. **Add \$72** list.



Medium Pod Table w/4 Legs

ZK352129L	20.9 x 35 x 29	70	41	2.40	\$455	\$76	\$34	\$144
-----------	----------------	----	----	------	-------	------	------	-------

Trapezoid table with four round tube 18 gauge steel legs. Can be used individually or can be arranged in groups of six to create a round table effect. Top includes factory installed metal inserts for solid and secure leg connections. Legs are 1.5" in diameter x 28" high with adjustable levelers. Shipped easy to assemble in 5 cartons, top separate from legs; legs individually packed.

- Chrome (CHM) is available on legs. **Add \$94** list.



Large Pod Table w/3 Legs

ZK412529L	25.7 x 41 x 29	70	48	2.24	\$467	\$98	\$40	\$168
-----------	----------------	----	----	------	-------	------	------	-------

Triangular table with three round tube 18 gauge steel legs. Can be used individually or can be arranged in groups of four to create a square table effect. Top includes factory installed metal inserts for solid and secure leg connections. Legs are 1.5" in diameter x 28" high with adjustable levelers. Shipped easy to assemble in 4 cartons, top separate from legs; legs individually packed.

- Chrome (CHM) is available on legs. **Add \$72** list.

Required specifications

Top finish
Edge finish
Leg finish

Optional specifications

HP laminate
Ergo friendly edge and finish
Writeable surface (WRW)
Chrome (CHM) legs

POD TABLES - 32" HIGH



Medium Pod Table w/4 Legs

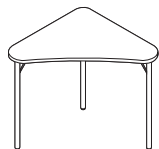

Large Pod Table w/3 Legs



Small Mobile Pod Table w/3 Legs

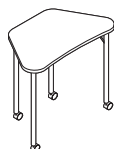

Medium Mobile Pod Table w/4 Legs

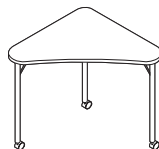

Large Mobile Pod Table w/3 Legs

MODEL#	DIMENSIONS	FREIGHT CLASS	WT/LBS.	CUBIC FT.	LIST PRICE	HP ADD	ERGO EDGE	WRW
--------	------------	---------------	---------	-----------	------------	--------	-----------	-----

D x W x H

ZK352132L	20.9 x 35 x 32	70	41	2.55	\$464	\$76	\$34	\$144
-----------	----------------	----	----	------	-------	------	------	-------

ADA compliant table with four round tube 18 gauge steel legs. Can be used individually or can be arranged in groups of six to create a round table effect. Top includes factory installed metal inserts for solid and secure leg connections. Legs are 1.5" in diameter x 31" high with adjustable levelers. Shipped easy to assemble in 5 cartons, top separate from legs; legs individually packed.

- Chrome (CHM) is available on legs. **Add \$94** list.

ZK412532L	25.7 x 41 x 32	70	48	2.36	\$472	\$98	\$40	\$168
-----------	----------------	----	----	------	-------	------	------	-------

ADA compliant table with three round tube 18 gauge steel legs. Can be used individually or can be arranged in groups of four to create a square table effect. Top includes factory installed metal inserts for solid and secure leg connections. Legs are 1.5" in diameter x 31" high with adjustable levelers. Shipped easy to assemble in 4 cartons, top separate from legs; legs individually packed.

- Chrome (CHM) is available on legs. **Add \$72** list.

ZK302529C	24.6 x 30 x 29	70	37	2	\$387	\$63	\$28	\$144
-----------	----------------	----	----	---	-------	------	------	-------

Triangular table with three round tube 18 gauge steel legs. Can be used individually, can alternate front-to-back in a straight row, or can be arranged in groups of six to create a round table effect. Top includes factory installed metal inserts for solid and secure leg connections. Legs are 1.5" in diameter x 28" high with 1.5" dual wheel locking casters. Shipped easy to assemble in 4 cartons, top separate from legs; legs individually packed.

- Chrome (CHM) is available on legs. **Add \$72** list.

ZK352129C	20.9 x 35 x 29	70	41	2.40	\$491	\$76	\$34	\$144
-----------	----------------	----	----	------	-------	------	------	-------

Trapezoid table with four round tube 18 gauge steel legs. Can be used individually or can be arranged in groups of six to create a round table effect. Top includes factory installed metal inserts for solid and secure leg connections. Legs are 1.5" in diameter x 28" high with 1.5" dual wheel locking casters. Shipped easy to assemble in 5 cartons, top separate from legs; legs individually packed.

- Chrome (CHM) is available on legs. **Add \$94** list.

ZK412529C	25.7 x 41 x 29	70	48	2.24	\$494	\$98	\$40	\$168
-----------	----------------	----	----	------	-------	------	------	-------

Triangular table with three round tube 18 gauge steel legs. Can be used individually or can be arranged in groups of four to create a square table effect. Top includes factory installed metal inserts for solid and secure leg connections. Legs are 1.5" in diameter x 28" high with 1.5" dual wheel locking casters. Shipped easy to assemble in 4 cartons, top separate from legs; legs individually packed.

- Chrome (CHM) is available on legs. **Add \$72** list.

Required specifications

Top finish
Edge finish
Leg finish

Optional specifications

HP laminate
Ergo friendly edge and finish
Writeable surface (WRW)
Chrome (CHM) legs

RECTANGULAR TABLES - 29" HIGH

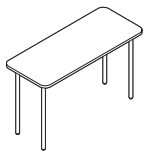

Rectangular Table, 20" Deep

MODEL #	DIMENSIONS D x W x H	FREIGHT CLASS	WT/LB.	CUBIC FT.	LIST PRICE	HP ADD	ERGO EDGE	WRW
ZKR3020L	20 x 30 x 29	70	50	2.55	\$430	\$101	\$32	\$133
ZKR3620L	20 x 36 x 29	70	51	2.65	\$445	\$120	\$34	\$144
ZKR4820L	20 x 48 x 29	70	58	2.95	\$491	\$158	\$40	\$163
ZKR5420L	20 x 54 x 29	70	64	3.15	\$570	\$179	\$44	\$173
ZKR6020L	20 x 60 x 29	70	70	3.25	\$592	\$198	\$48	\$183
ZKR7220L	20 x 72 x 29	65	85	3.55	\$648	\$238	\$53	\$198

Table with four round tube 18 gauge steel legs. Legs are 1.5" in diameter x 28" high with adjustable levelers. Top features 2.5" radius rounded corners and includes factory installed metal inserts for solid and secure leg connections. Tables 54" and wider include support channel. Shipped easy to assemble in 5 cartons, top separate from legs; legs individually packed.

- Chrome (CHM) is available on legs. **Add \$94** list.

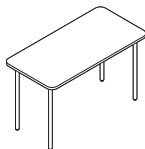

Rectangular Table, 24" Deep

ZKR3024L	24 x 30 x 29	70	51	2.75	\$433	\$120	\$33	\$144
ZKR3624L	24 x 36 x 29	70	53	2.85	\$467	\$146	\$35	\$153
ZKR4824L	24 x 48 x 29	70	59	3.25	\$521	\$190	\$41	\$178
ZKR5424L	24 x 54 x 29	70	65	3.35	\$604	\$214	\$46	\$187
ZKR6024L	24 x 60 x 29	70	71	3.55	\$630	\$237	\$49	\$198
ZKR7224L	24 x 72 x 29	70	86	3.95	\$689	\$284	\$55	\$222

Table with four round tube 18 gauge steel legs. Legs are 1.5" in diameter x 28" high with adjustable levelers. Top features 2.5" radius rounded corners and includes factory installed metal inserts for solid and secure leg connections. Tables 54" and wider include support channel. Shipped easy to assemble in 5 cartons, top separate from legs; legs individually packed.

- Chrome (CHM) is available on legs. **Add \$94** list.

MOBILE RECTANGULAR TABLES - 29" HIGH

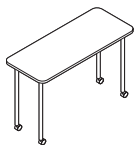

Mobile Rectangular Table, 20" Deep

MODEL #	DIMENSIONS	FREIGHT CLASS	WT/LB.	CUBIC FT.	LIST PRICE	HP ADD	ERGO EDGE	WRW
ZKR3020C	20 x 30 x 29	70	50	2.55	\$466	\$101	\$32	\$133
ZKR3620C	20 x 36 x 29	70	51	2.65	\$477	\$120	\$34	\$144
ZKR4820C	20 x 48 x 29	70	58	2.95	\$524	\$158	\$40	\$163
ZKR5420C	20 x 54 x 29	70	64	3.15	\$605	\$179	\$44	\$173
ZKR6020C	20 x 60 x 29	70	70	3.25	\$627	\$198	\$48	\$183
ZKR7220C	20 x 72 x 29	65	85	3.55	\$682	\$238	\$53	\$198

Table with four round tube 18 gauge steel legs. Legs are 1.5" in diameter x 28" high with 1.5" dual wheel locking casters. Top features 2.5" radius rounded corners and includes factory installed metal inserts for solid and secure leg connections. Tables 54" and wider include support channel. Shipped easy to assemble in 5 cartons, top separate from legs; legs individually packed.

- Chrome (CHM) is available on legs. **Add \$94** list.

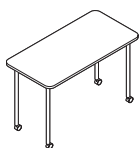

Mobile Rectangular Table, 24" Deep

ZKR3024C	24 x 30 x 29	70	51	2.75	\$469	\$120	\$33	\$144
ZKR3624C	24 x 36 x 29	70	53	2.85	\$502	\$146	\$35	\$153
ZKR4824C	24 x 48 x 29	70	59	3.25	\$557	\$190	\$41	\$178
ZKR5424C	24 x 54 x 29	70	65	3.35	\$639	\$214	\$46	\$187
ZKR6024C	24 x 60 x 29	70	71	3.55	\$665	\$237	\$49	\$198
ZKR7224C	24 x 72 x 29	70	86	3.95	\$726	\$284	\$55	\$222

Table with four round tube 18 gauge steel legs. Legs are 1.5" in diameter x 28" high with 1.5" dual wheel locking casters. Top features 2.5" radius rounded corners and includes factory installed metal inserts for solid and secure leg connections. Tables 54" and wider include support channel. Shipped easy to assemble in 5 cartons, top separate from legs; legs individually packed.

- Chrome (CHM) is available on legs. **Add \$94** list.

Required specifications

Top finish
Edge finish
Leg finish

Optional specifications

HP laminate
Ergo friendly edge and finish
Writeable surface (WRW)
Chrome (CHM) legs

ACTIVITY TABLES

Sample activity table configurations

D x W x H

Straight mating edges



Curved mating edges

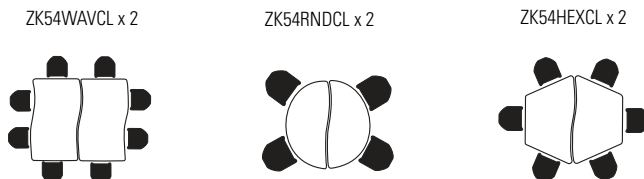

Mixed shapes
Curved mating edges shown.
Can also do the same with
straight mating edge tables.

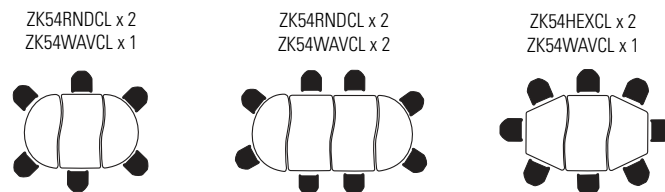

ACTIVITY TABLES - 29" HIGH, CURVED

MODEL# DIMENSIONS FREIGHT CLASS WT/LBS. CUBIC FT. LIST PRICE HP ADD ERGO EDGE WRW

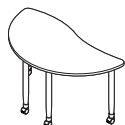

Curved Half Round w/Casters

ZK54RNDCC 28.4 x 54 x 29 65 67.4 1.40 \$867 \$198 \$51 \$187

44.3" inside clearance between legs on curved edge, 22.9" on narrow depth side and 24" on other side. Dual leg position on front interferes with users sitting on ends in a racetrack configuration, oriented to seat two - one on either side. Top includes factory installed inserts for metal-to-metal leg connection. Shipped easy to assemble in 2 cartons, top separate from leg.
• Chrome (CHM) is available on legs. **Add \$151** list.

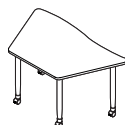

Curved Half Hex w/Casters

ZK54HEXCC 32.4 x 54 x 29 65 76.4 1.49 \$935 \$227 \$61 \$187

42.9" inside clearance between legs on curved edge, 22.3" on narrow depth side and 24" on other side. 22.8" on straight end. Top includes factory installed inserts for metal-to-metal leg connection. Shipped easy to assemble in 2 cartons, top separate from leg.
• Chrome (CHM) is available on legs. **Add \$151** list.

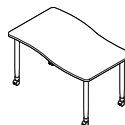

Wave w/Casters

ZK54WAVCC 33.8 x 54 x 29 65 77.4 1.52 \$964 \$242 \$73 \$187

44.9" inside clearance between legs on curved edge, 21.9" on sides. Top includes factory installed inserts for metal-to-metal leg connection. Shipped easy to assemble in 2 cartons, top separate from leg.
• Chrome (CHM) is available on legs. **Add \$151** list.

Required specifications

Top finish
Edge finish
Leg finish

Optional specifications

HP laminate
Ergo friendly edge and finish
Writeable surface (WRW)
Chrome (CHM) legs

ACTIVITY TABLES - 29" HIGH, CURVED



Curved Half Round w/Levelers*

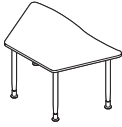

Curved Half Hex w/Levelers*

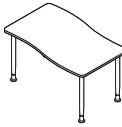

Wave w/Levelers*





MODEL #	DIMENSIONS D x W x H	FREIGHT CLASS	WT/LB.	CUBIC FT.	LIST PRICE	HP ADD	ERGO EDGE	WRW
ZK54RNDCL	28.4 x 54 x 29	65	67.4	1.40	\$860	\$198	\$51	\$187
<p>44.3" inside clearance between legs on curved edge, 22.9" on narrow depth side and 24" on other side. Dual leg position on front interferes with users sitting on ends in a racetrack configuration, oriented to seat two - one on either side. Top includes factory installed inserts for metal-to-metal leg connection. Shipped easy to assemble in 2 cartons, top separate from leg.</p> <ul style="list-style-type: none"> • Chrome (CHM) is available on legs. Add \$151 list. 								
ZK54HEXCL	32.4 x 54 x 29	65	76.4	1.49	\$928	\$227	\$61	\$187
<p>42.9" inside clearance between legs on curved edge, 22.3" on narrow depth side and 24" on other side. 22.8" on straight end. Top includes factory installed inserts for metal-to-metal leg connection. Shipped easy to assemble in 2 cartons, top separate from leg.</p> <ul style="list-style-type: none"> • Chrome (CHM) is available on legs. Add \$151 list. 								
ZK54WAVCL	33.8 x 54 x 29	65	77.4	1.52	\$957	\$242	\$73	\$187
<p>44.9" inside clearance between legs on curved edge, 21.9" on sides. Top includes factory installed inserts for metal-to-metal leg connection. Shipped easy to assemble in 2 cartons, top separate from leg.</p> <ul style="list-style-type: none"> • Chrome (CHM) is available on legs. Add \$151 list. 								

Required specifications

Top finish
Edge finish
Leg finish

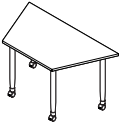
Optional specifications

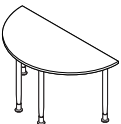
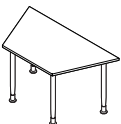
HP laminate
Ergo friendly edge and finish
Writeable surface (WRW)
Chrome (CHM) legs

ACTIVITY TABLES - 29" HIGH, STRAIGHT		MODEL #	DIMENSIONS D x W x H	FREIGHT CLASS	WT/LB.	CUBIC FT.	LIST PRICE	HP ADD	ERGO EDGE	WRW	
	Straight Half Round w/Casters	ZK54RNDSC	28.4 x 54 x 29	65	67.4	1.40	\$819	\$175	N/A	\$187	
44.2" inside clearance between legs on long side, 23.7" on the sides. Dual leg position on front interferes with users sitting on ends in a racetrack configuration, oriented to seat two - one on either side. Top includes factory installed inserts for metal-to-metal leg connection. Shipped easy to assemble in 2 cartons, top separate from leg. • Chrome (CHM) is available on legs. Add \$151 list.											
	Straight Half Hex w/Casters	ZK54HEXSC	32.4 x 54 x 29	65	73.4	1.49	\$846	\$188	N/A	\$187	
40.6" inside clearance between legs on long side, 21.4" on sides and 22.3" on short side. Top includes factory installed inserts for metal-to-metal leg connection. Shipped easy to assemble in 2 cartons, top separate from leg. • Chrome (CHM) is available on legs. Add \$151 list.											
	Rectangular w/Casters	ZK54RECTC	33.8 x 54 x 29	65	73.4	1.52	\$893	\$210	N/A	\$187	
45.3" inside clearance between legs on long sides and 22.3" on short sides. Top includes factory installed inserts for metal-to-metal leg connection. Shipped easy to assemble in 2 cartons, top separate from leg. • Chrome (CHM) is available on legs. Add \$151 list.											
	Straight Half Round w/Levelers	ZK54RNDSL	28.4 x 54 x 29	65	67.4	1.40	\$812	\$175	N/A	\$187	
44.2" inside clearance between legs on long side, 23.7" on the sides. Dual leg position on front interferes with users sitting on ends in a racetrack configuration, oriented to seat two - one on either side. Top includes factory installed inserts for metal-to-metal leg connection. Shipped easy to assemble in 2 cartons, top separate from leg. • Chrome (CHM) is available on legs. Add \$151 list.											
	Straight Half Hex w/Levelers	ZK54HEXSL	32.4 x 54 x 29	65	73.4	1.49	\$839	\$188	N/A	\$187	
40.6" inside clearance between legs on long side, 21.4" on sides and 22.3" on short side. Top includes factory installed inserts for metal-to-metal leg connection. Shipped easy to assemble in 2 cartons, top separate from leg. • Chrome (CHM) is available on legs. Add \$151 list.											
	Rectangular w/Levelers	ZK54RECTL	33.8 x 54 x 29	65	73.4	1.52	\$887	\$210	N/A	\$187	
45.3" inside clearance between legs on long sides and 22.3" on short sides. Top includes factory installed inserts for metal-to-metal leg connection. Shipped easy to assemble in 2 cartons, top separate from leg. • Chrome (CHM) is available on legs. Add \$151 list.											

Required specifications

Top finish
Edge finish
Leg finish

Optional specifications

HP laminate
Writeable surface (WRW)
Chrome (CHM) legs

FLIP-TOP TABLES

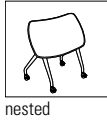

nested

Flip-Top Table, Contoured Top

MODEL#	DIMENSIONS D x W x H	FREIGHT CLASS	WT/LBS.	CUBIC FT.	LIST PRICE	HP ADD	ERGO EDGE	WRW
ZKFC3022	22 x 30 x 29.5	92.5	53.5	4.07	\$863	\$117	\$86	\$138

Mobile flip-top table with smooth glide locking casters. Easy to operate twist knob with integrated thumb tab. Top includes factory installed inserts for metal-to-metal leg connection. When nested, each additional table adds 5.25" to footprint needed for storage. Optional modesty (ZKFTM30) available separately. Shipped easy to assemble in 2 cartons, top and base shipped separately. Legs available in Tungsten (TUN) only.

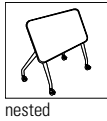

nested

Flip-Top Table, Rectangular Top**

ZKFR3024	24 x 30 x 29.5	92.5	48	4.07	\$890	\$128	\$100	\$144
----------	----------------	------	----	------	-------	-------	-------	-------

Mobile flip-top table with smooth glide locking casters. Easy to operate twist knob with integrated thumb tab. Top includes factory installed inserts for metal-to-metal leg connection. When nested, each additional table adds 5.25" to footprint needed for storage. Optional modesty (ZKFTM30) available separately. Shipped easy to assemble in 2 cartons, top and base shipped separately. Legs available in Tungsten (TUN) only.

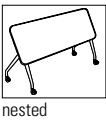

nested

Flip-Top Table, Rectangular Top*

ZKFR6024	24 x 60 x 29.5	92.5	73.9	5.28	\$1095	\$191	\$103	\$198
----------	----------------	------	------	------	--------	-------	-------	-------

Mobile flip-top table with smooth glide locking casters. Easy to operate twist knob with integrated thumb tab. Top includes factory installed inserts for metal-to-metal leg connection. When nested, each additional table adds 5.25" to footprint needed for storage. Optional modesty (ZKFTM60) available separately. Shipped easy to assemble in 3 cartons, top and base shipped separately. Legs available in Tungsten (TUN) only.

Required Specifications

Top finish
Edge finish
Leg finish

Optional Specifications

HP laminate
Ergo friendly edge and finish
Writeable surface (WRW)
Chrome (CHM) legs

MODESTY PANELS FOR FLIP-TOP TABLES



Modesty for ZKFC3022 and ZKFC3024

MODEL#	DIMENSIONS D x W x H	FREIGHT CLASS	WT/LBS.	CUBIC FT.	LIST PRICE
ZKFTM30	0.5 x 17.8 x 13.8	60	6.6	0.22	\$61

Hardware included to attach to ZKFC3022 or ZKFR3024. Tungsten finish only. Shipped in 1 carton.

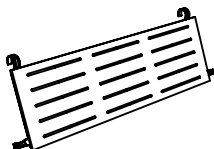

Modesty for ZKFR6024

ZKFTM60	0.5 x 47.3 x 13.8	65	14.3	0.57	\$119
---------	-------------------	----	------	------	--------------

Hardware included to attach **ZKFR6024**. Tungsten finish only. Shipped in 1 carton.

C CITI TABLES

CITI TABLES	MODEL#	DIMENSIONS D x W x H	FREIGHT CLASS	WT/LBS.	CUBIC FT.	LIST PRICE
-------------	--------	-------------------------	---------------	---------	-----------	------------

Notes

- Citi tables complement the contemporary timeless decor of many offices.
- Legs are **standard** in Tungsten (**TTU**) and also available in Black (**TBL**) or Shadow (**TSH**) at no charge. A Chrome (**CHM**) finish is available. **Add \$101.**
- Table tops are available in either tempered glass or laminate
- Citi tables are offered in the following finishes to coordinate with Global casegoods and wood seating:

ACJ	Absolute Acajou	NGL	Noce Grigio
ASN	Asian Night	NEL	Noce Leggero
AWC	Avant Cherry	NML	Noce Medio
AWH	Avant Honey	QTM	Quartered Mahogany
BLK	Black	SOG	Storm Grey
BRC	Brushed Cobalt	TFW	Tiger Fruitwood
CMB	Clear Maple	TWL	Tiger Walnut
DES	Dark Espresso	WHE	Walnut Heights
DWT	Designer White	WHC	White Chocolate
HGT	Hayden Grey	WGY	Willow Grey
NBL	Noce Biondo	WCR	Winter Cherry

CITI TABLES	MODEL#	DIMENSIONS	FREIGHT CLASS	WT/LBS.	CUBIC FT.	LIST PRICE
-------------	--------	------------	---------------	---------	-----------	------------

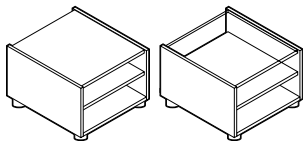

End Table

7885 (laminate top)	20 x 24 x 20	100	53	6	\$765
7886 (glass top)	20 x 24 x 20	92.5	60	6	\$1079

Metal tubular legs. Laminate or tempered glass tops available.

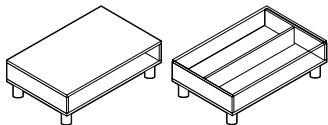

Coffee Table - Rectangular

7887 (laminate top)	20 x 40 x 15	100	60	6.50	\$799
7888 (glass top)	20 x 40 x 15	92.5	75	6.50	\$1243

Metal tubular legs. Laminate or tempered glass tops available.

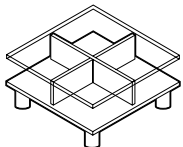

Coffee Table - Square

7889 (glass top)	33 x 33 x 15	92.5	90	8.75	\$1509
---------------------	--------------	------	----	------	---------------

Metal tubular legs. Tempered glass top.

Required Specifications

Finish

COAT TREES

MODEL# DIMENSIONS FREIGHT CLASS WT/LBS. CUBIC FT. LIST PRICE



Coat Tree

	D x W x H				
PCOS2	25 x 25 x 60	300	8	4.67	\$463
PCOS3	25 x 25 x 60	300	8	4.67	\$463

Square tube metal frame, complete with four Chrome double hooks. Adjustable glides. 60" high. Ships UPS.

- 3 per carton
- PCOS2 is finished in **Black**.
- PCOS3 is finished in **Chrome**.



Coat Tree

PCT	25 x 25 x 65	250	6	3	\$594
-----	--------------	-----	---	---	--------------

Square tube wood frame. Complete with four satin brass double hooks. 65" high. Available in the following finishes: Absolute (AAM), Black (BKM), Cherry (ACM), English Oak (EOM), Gray (HGM), Honey (AHM), Maple (AVM), Medium Walnut (MWM), Night (ASM), Sandy Beach (SBM), Mahogany (TMM), Fruitwood (TFM), White (WHM), Winter Cherry (WCM) and Walnut (TWM). Ships assembled via UPS.

- 1 per carton

Required Specifications

Finish

L LAMINATE OCCASIONAL TABLES

LAMINATE OCCASIONAL TABLES	MODEL#	DIMENSIONS	FREIGHT CLASS	WT/LBS.	CUBIC FT.	LIST PRICE
----------------------------	--------	------------	---------------	---------	-----------	------------

D x W x H

Notes:

- High pressure laminate exterior with adjustable plastic glides
- Premium cylinder tables have a flexible plywood core construction ideal for institutional and high traffic environments
- Ideal for reception areas - colors coordinate with all Global desks, conference tables and accessories.
- Ships assembled in one carton.
- Available to either match or coordinate with most Global laminate desk series. Available finishes:

ACJ	Absolute Acajou	NGL	Noce Grigio
ASN	Asian Night	NEL	Noce Leggero
AWC	Avant Cherry	NML	Noce Medio
AWH	Avant Honey	QTM	Quartered Mahogany
BLK	Black	SOG	Storm Grey
BRC	Brushed Cobalt	TFW	Tiger Fruitwood
CMB	Clear Maple	TWL	Tiger Walnut
DES	Dark Espresso	WHE	Walnut Heights
DWT	Designer White	WHC	White Chocolate
HGT	Hayden Grey	WGY	Willow Grey
NBL	Noce Biondo	WCR	Winter Cherry

LAMINATE OCCASIONAL TABLES	MODEL#	DIMENSIONS	FREIGHT CLASS	WT/LBS.	CUBIC FT.	LIST PRICE
----------------------------	--------	------------	---------------	---------	-----------	------------

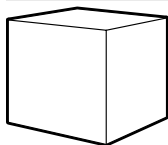

Cube Table

GCU1816	18 x 18 x 16	85	40	3.30	\$569
GCU1821	18 x 18 x 21	92.5	46	4	\$663
GCU2416	24 x 24 x 16	92.5	63	6	\$663
GCU2421	24 x 24 x 21	92.5	83	7	\$663

¾" plywood covered in high pressure laminate. Plastic glides. **Flush base.**

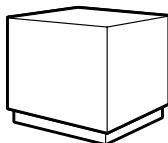

Plinth Cube Table

GCUP1816	18 x 18 x 16	85	40	3	\$629
GCUP1821	18 x 18 x 21	92.5	46	4	\$726
GCUP2416	24 x 24 x 16	92.5	63	6	\$726
GCUP2421	24 x 24 x 21	92.5	83	7	\$726

¾" plywood covered in high pressure laminate. Plastic glides. **Recessed base.**

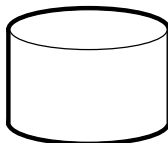

Cylinder Table

GCY1816	18 x 18 x 16	85	43	3.30	\$569
GCY1821	18 x 18 x 21	92.5	49	4.30	\$663
GCY2416	24 x 24 x 16	125	47	6	\$663
GCY2421	24 x 24 x 21	100	66	7	\$663
GCY3016	30 x 30 x 16	125	59	8	\$754
GCY3021	30 x 30 x 21	125	78	11	\$754

3/8" foundation board covered in high pressure laminate. Plastic glides. **Flush base.**

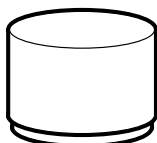

Plinth Cylinder Table

GCYP1816	18 x 18 x 16	85	43	3.30	\$629
GCYP1821	18 x 18 x 21	92.5	49	4.30	\$726
GCYP2416	24 x 24 x 16	125	47	6	\$726
GCYP2421	24 x 24 x 21	100	66	7	\$726
GCYP3016	30 x 30 x 16	125	59	8	\$825
GCYP3021	30 x 30 x 21	125	78	11	\$825

3/8" foundation board covered in high pressure laminate. Plastic glides. **Recessed base.**

Required Specifications

Finish

LAMINATE OCCASIONAL TABLES

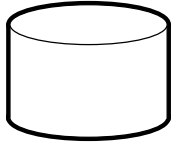

Premium Cylinder Table

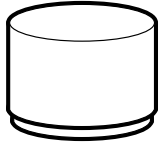

Premium Plinth Cylinder Table

MODEL# DIMENSIONS FREIGHT CLASS WT/LBS. CUBIC FT. LIST PRICE

D x W x H

CPFD1816	18 x 18 x 16	150	30	7	\$948
CPFD1821	18 x 18 x 21	150	30	7	\$975
CPFD2416	24 x 24 x 16	250	42	11.50	\$984
CPFD2421	24 x 24 x 21	250	42	11.50	\$1010
CPFD3016	30 x 30 x 16	250	52	17	\$1113
CPFD3021	30 x 30 x 21	250	52	17	\$1228

1 1/32" plywood covered in high pressure laminate. Plastic glides. **Flush base.**

CPPD1816	18 x 18 x 16	150	30	7	\$998
CPPD1821	18 x 18 x 21	150	30	7	\$1024
CPPD2416	24 x 24 x 16	250	42	11.50	\$1034
CPPD2421	24 x 24 x 21	250	42	11.50	\$1059
CPPD3016	30 x 30 x 16	250	52	17	\$1182
CPPD3021	30 x 30 x 21	250	52	17	\$1296

1 1/32" plywood covered in high pressure laminate. Plastic glides. **Recessed base.**

Required Specifications

Finish

L LITE LIFT II

LITE LIFT II	MODEL#	DIMENSIONS D x W x H	FREIGHT CLASS	WT/LBS.	CUBIC FT.	LIST PRICE
--------------	--------	-------------------------	---------------	---------	-----------	------------

Notes:

- Lightweight construction allows tables to easily and safely be lifted and moved by one person.
- Polypropylene top is fully water resistant and easy to clean and maintain.
- Thick, high impact radius corner helps protect individuals from injury.
- Folding legs automatically lock by a gravity activated mechanism when opened.
- Non-marring plastic glides protect floors from scratching when tables are moved.
- Structural side aprons allow tables to easily stack.
- Lite Lift II tables pass all BIFMA standards for strength and stability.
- **Available in Oyster Grey finish only.**

LITE LIFT II TABLES	MODEL#	DIMENSIONS	FREIGHT CLASS	WT/LBS.	CUBIC FT.	LIST PRICE
---------------------	--------	------------	---------------	---------	-----------	------------



MVLFRT48 MVLFRT60-MVLFRT96

Rectangular Folding Table

MVLFRT48	24 x 48 x 29.25	85	23	1.57	\$287
MVLFRT60	30 x 60 x 29.25	92.5	30	2.54	\$382
MVLFRT72	30 x 72 x 29.25	92.5	36	3.06	\$449
MVLFRT96	30 x 96 x 29.25	92.5	50	4.79	\$659

Lightweight, textured, polypropylene Oyster Grey finish top. High impact radius corners. 19 gauge 11/8" diameter steel tubular legs with welded crossbars automatically lock. Legs finished in scuff resistant textured Charcoal Grey epoxy paint. Shipped fully assembled.

- Available in Oyster Grey finish with Charcoal Grey legs only.
- **Note:** Prices shown are for Global Distribution Center, not delivered pricing. All orders will be charged freight, except orders containing other Global products totaling \$2,000 list or more, before adding folding tables and folding chairs. Any Inside Delivery & Set-up charge for these products must be quoted separately.

SIRENA TABLES	MODEL#	DIMENSIONS	FREIGHT CLASS	WT/LBS.	CUBIC FT.	LIST PRICE
---------------	--------	------------	---------------	---------	-----------	------------

D x W x H

Notes:

- Modern tables for reception areas, meeting rooms, and private office use.
- Sirena tables are offered in the following finishes to coordinate with Global desking and wood seating:

ACJ	Absolute Acajou	NBL	Noce Biondo
ASN	Asian Night	NGL	Noce Grigio
AWC	Avant Cherry	NEL	Noce Leggero
AWH	Avant Honey	NML	Noce Medio
CMB	Clear Maple	TWL	Tiger Walnut
DES	Dark Espresso	WHE	Walnut Heights
DWT	Designer White	WHC	White Chocolate
HGT	Hayden Grey	WCR	Winter Cherry

- Laminate tops are 1.5" thick to coordinate with Global desking and wood seating
- Table legs are available in Black (**TBL**) or Tungsten (**TTU**) at no upcharge. Not available in Chrome.
- Legs are 1.5" steel tubing, tapered toward the bottom of the leg to 0.875", equipped with self-leveling pivoting steel glide.

SIRENA TABLES	MODEL#	DIMENSIONS	FREIGHT CLASS	WT/LBS.	CUBIC FT.	LIST PRICE
---------------	--------	------------	---------------	---------	-----------	------------

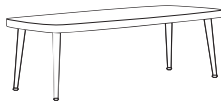

Coffee Table

3400	22 x 48 x 15	250	52	17.25	\$1718
------	--------------	-----	----	-------	---------------

Rectangular coffee table.



Coffee Table

3401	22 x 56 x 15	250	60	19.75	\$1900
------	--------------	-----	----	-------	---------------

Rectangular coffee table.



End Table

3402	22 x 17 x 15	250	26	7.75	\$1378
------	--------------	-----	----	------	---------------

Rectangular end table.

Required Specifications

- Top finish
- Leg finish

W WIND TABLES

WIND TABLES	MODEL#	DIMENSIONS	FREIGHT CLASS	WT/LBS.	CUBIC FT.	LIST PRICE
-------------	--------	------------	---------------	---------	-----------	------------

Notes: D x W x H

- Wind tables complement the modern decor of many offices.
- Legs are standard in Chrome (**CHM**). Also available in Black (**TBL**), Shadow (**TSH**) or Tungsten (**TTU**) finish at no upcharge.
- 1" laminate tops are offered in the following finishes to coordinate with Global casegoods and wood seating:

ACJ	Absolute Acajou	NGL	Noce Grigio
ASN	Asian Night	NEL	Noce Leggero
AWC	Avant Cherry	NML	Noce Medio
AWH	Avant Honey	QTM	Quartered Mahogany
BLK	Black	SOG	Storm Grey
BRC	Brushed Cobalt	TFW	Tiger Fruitwood
CMB	Clear Maple	TWL	Tiger Walnut
DES	Dark Espresso	WHE	Walnut Heights
DWT	Designer White	WHC	White Chocolate
HGT	Hayden Grey	WGY	Willow Grey
NBL	Noce Biondo	WCR	Winter Cherry

- Table tops are available in high pressure laminate at a 20% upcharge for the following model numbers: 3366, 3367, 3368, 3870 and 3871; specify (**HPL**) in addition to the finish. HPL is not available on 3878, 3879 or 3880.

WIND TABLES	MODEL#	DIMENSIONS	FREIGHT CLASS	WT/LBS.	CUBIC FT.	LIST PRICE
-------------	--------	------------	---------------	---------	-----------	------------



Square Corner Table

3366	24 x 24 x 17	250	36	11.50	\$863
------	--------------	-----	----	-------	--------------

Steel tubular base. Tops are available with a laminate finish. Shipped assembled in 1 carton.



Rectangular Coffee Table

3367	20 x 48 x 15	250	52	16	\$1142
------	--------------	-----	----	----	---------------

Steel tubular base. Tops are available with a laminate finish. Shipped assembled in 1 carton.



Square Coffee Table

3368	36 x 36 x 15	250	66	22	\$1546
------	--------------	-----	----	----	---------------

Steel tubular base. Tops are available with a laminate finish. Shipped assembled in 1 carton.



Round Corner Table

3870	24 x 24 x 17	250	35	11.50	\$944
------	--------------	-----	----	-------	--------------

Steel tubular base. Tops are available with a laminate finish. Shipped assembled in 1 carton.



Round Coffee Table

3871	36 x 36 x 15	250	57	22	\$1389
------	--------------	-----	----	----	---------------

Steel tubular base in Chrome finish.

Required Specifications
Top finish

Optional Specifications
Leg finish
HP laminate

WIND LINEAR TABLES

MODEL# DIMENSIONS FREIGHT CLASS WT/LBS. CUBIC FT. LIST PRICE

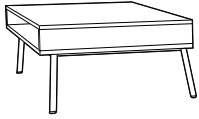

Freestanding Rectangular End Table

D x W x H					
3878	25 x 20 x 16	250	38	11.50	\$1235

Steel tubular base. Laminate top is 5" thick with opening on front for storage and visual recess at rear. Shipped assembled in 1 carton.

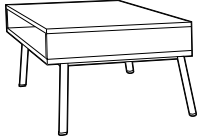

Freestanding Corner Table

3879	25 x 25 x 16	250	40	11.50	\$1347
------	--------------	-----	----	-------	---------------

Steel tubular base. Laminate top is 5" thick with opening on front for storage and visual recess at rear. Shipped assembled in 1 carton.

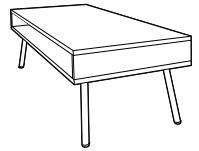

Freestanding Coffee Table

3880	54 x 20 x 15	250	52	16	\$1502
------	--------------	-----	----	----	---------------

Steel tubular base. Laminate top is 5" thick with opening on front for storage and visual recess at rear. Shipped assembled in 1 carton.

Required Specifications

Top finish

Optional Specifications

Leg finish

WORK TABLES	MODEL#	DIMENSIONS	FREIGHT CLASS	WT/LBS.	CUBIC FT.	LIST PRICE
		D x W x H				

Notes:

- Work tables are offered in the following top finishes to coordinate with Global casegoods and wood seating:

ACJ	Absolute Acajou	NGL	Noce Grigio
ASN	Asian Night	NEL	Noce Leggero
AWC	Avant Cherry	NML	Noce Medio
AWH	Avant Honey	QTM	Quartered Mahogany
BLK	Black	SOG	Storm Grey
BRC	Brushed Cobalt	TFW	Tiger Fruitwood
CMB	Clear Maple	TWL	Tiger Walnut
DES	Dark Espresso	WHE	Walnut Heights
DWT	Designer White	WHC	White Chocolate
HGT	Hayden Grey	WGY	Willow Grey
NBL	Noce Biondo	WCR	Winter Cherry

- Legs available in Chrome (**CHM**) or Black (**TBL**)

WORK TABLES	MODEL#	DIMENSIONS	FREIGHT CLASS	WT/LBS.	CUBIC FT.	LIST PRICE
-------------	--------	------------	---------------	---------	-----------	------------

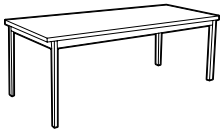
**Work Tables**

GATMS6030	30 x 60 x 29	70	132	8	\$638
GATMS7230	30 x 72 x 29	92.5	87	8	\$727
GATMS7236	36 x 72 x 29	70	132	8	\$896

1" high performance thermally fused laminate with self edge top. Black metal skirt. Rectangular top with metal legs and leveling glides. Self edge is standard. Shipped easy to assemble in 1 carton.

Required Specifications
Finish

Optional Specifications
Leg finish

textiles and finishes

Care and Cleaning

Textiles

Fabrics: To extend the life of your seating upholstered in fabric, regularly dust the chair to prevent airborne particles from penetrating the fabric surface.

For light soiling, use a damp cloth and blot the spot with very slight pressure, taking care never to soak the fabric. Dry with a clean cloth by blotting - never rub fabric. More intense stains can be treated the same way, but with a mild detergent. Always test fabric first in an unseen area before using any cleaning method.

Leather: For regular cleaning, simply use a soft damp cloth, taking care not to soak the leather. For more thorough treatment, soak a soft cloth in mild soap solution and wipe surface in a light circular motion. Repeat with clean water. Allow to dry and polish with a soft dry cloth. Do not use detergents, aerosol sprays or other polishes.

Hard Surfaces

Wood Veneer Finishes: Waxing or polishing catalyzed finishes is not recommended because this will give a greasy, cloudy or uneven appearance to the product and could void your warranty. Global's conversion varnish is best cleaned by wiping the surface with a damp cloth, followed by a soft dry cloth in the direction of the grain. If the surfaces are heavily soiled, a gentle product like "Windex" can be used, following the same instructions as above.

Laminate & painted metal finishes: Simply wipe the surface with a clean soft damp cloth; if needed, a mild soap solution (i.e. Ivory dishwashing liquid) may be used. To prevent streaks, dry the surface with a clean, dry soft cloth moving in a circular motion.

Textiles

- **Water-Based Cleaner:** Spot clean, using the foam only from a water-based cleaning agent, such as a mild detergent or non-solvent upholstery shampoo product. Apply foam with a soft brush in a circular motion. Vacuum when dry. Pretest small area before proceeding.
- **Solvent Cleaner:** Spot clean, using a mild water-free solvent or dry cleaning product. Clean only in a well-ventilated room and avoid any product containing carbon tetrachloride or other toxic materials. Pretest a small area before proceeding.
- **Water/Solvent Cleaner:** Spot clean with a mild solvent, an upholstery shampoo, or the foam from a mild detergent. When using a solvent or dry cleaning product, follow instructions carefully and clean only in a well-ventilated room. Avoid any product that contains carbon tetrachloride or other toxic materials. With either method, pretest a small area before proceeding.
- **Vacuum Only:** Clean this fabric only by vacuuming or light brushing to prevent accumulation of dust and grime. Water-based foam cleaning agents of any kind may cause excessive shrinking, staining, or distortion of the surface pile and therefore, should not be used.
- **Crypton Cleaning:** Generally stains are removed with plain water and powdered enzyme detergent. Upholstery foam shampoo, waterbased cleaning products and germicidal detergents can be used. Be sure to remove all residue from cleaning products with clean water. Do not use solvent-based cleaners or dry cleaning products.
- These recommendations and codes were developed by fabric specialists. However, because of the various ways fabric can be stained or damaged, there is no guarantee that the results will be completely successful. Use suggested methods on your own responsibility. To help prevent overall soil, frequent vacuuming or light brushing to remove dust and grime is recommended. Use professional furniture cleaning services when overall soiled condition has been reached.

TEXTILES + FINISHES

Textile Price Grades - Global Textiles

Grade 1	Carrera, Dobby, Fusion, Hudson, Illusion, Jenny, Quilt, Terrace, Trak, Urban, Waterfall, Wavelength
Grade 2	Allante FRee, Couture, Elevate, Etch, GC Linen, Imprint, Luxhide, Match, Release, Replay, Silhouette
Grade 3	Pure, Vital, non standard GLOBAL textiles
Grade 4	Non standard GLOBAL textiles
Grade 5	Non standard GLOBAL textiles
Grade 6	Novaro Genuine Leather, non standard GLOBAL textiles
Grade 7	Non standard GLOBAL textiles
Grade 8	Non standard GLOBAL textiles
Grade 9	Non standard GLOBAL textiles
Grade 11	Non standard GLOBAL textiles
Grade 10	Non standard GLOBAL textiles
Grade 12	Non standard GLOBAL textiles

Please refer to individual seating series for availability of a particular textile.

The charts above do not include Textiles offered by Alliance Partners: Arc-Com Fabrics, CF Stinson, Designtex, Knoll Textiles, Green Hides, LDI Interiors, Luum Textiles, Maharam, Mayer Fabrics, Momentum, and Ultrafabrics.

Blend Seating Textiles

The grid below outlines the grade structure for using multiple textiles on select seating series. Blended textiles occur when one textile is chosen for one part of the chair and a different textile is selected for another part of the chair, resulting in a revised blended grade. For opportunities regarding more than two different textiles, please contact Global CustomerCare for approval process and grading.

FIRST TEXTILE SELECTED

		FIRST TEXTILE SELECTED																	
		1	2	3	4	5	6	7	8	9	10	11	12	13	14	15	16	17	18
SECOND TEXTILE SELECTED	1	1																	
	2	2	2																
	3	3	3	3															
	4	3	4	4	4														
	5	4	4	5	5	5													
	6	5	5	5	6	6	6												
	7	5	6	6	6	7	7	7											
	8	6	6	7	7	7	8	8	8										
	9	7	7	7	8	8	8	9	9	9									
	10	8	8	8	8	9	9	9	10	10	10								
	11	9	9	9	9	9	10	10	10	11	11	11							
	12	10	10	10	10	10	10	11	11	11	12	12	12						
	13	11	11	11	11	11	11	12	12	12	12	13	13	13					
	14	11	12	12	12	12	12	12	13	13	13	13	14	14	14				
	15	12	12	13	13	13	13	13	13	14	14	14	14	15	15	15			
	16	13	13	13	14	14	14	14	14	14	15	15	15	15	16	16	16		
	17	14	14	14	14	15	15	15	15	15	15	16	16	16	16	17	17	17	
	18	15	15	15	15	15	16	16	16	16	16	16	17	17	17	17	18	18	18

TEXTILE AND COLOR LISTINGS

Grade 1

Carrera 100% Polyester

CE84 Zest	CE85 Savannah	CE86 Slate	CE87 Rainforest	CE88 Aspen	CE89 Dune	CE90 Flannel
CE91 Azure	CE92 Chili	CE93 Jute	CE95 Ink	CE96 Sangria	CE97 Java	CE98 Charcoal

Dobby 96% Recycled Polyester / 4% Virgin Polyester

DB30 Snowcap	DB31 Bonsai	DB32 Cloud	DB33 Sand	DB34 Pewter	DB35 Santa Fe	DB36 Corfu
DB37 Medium Taupe	DB38 Charcoal	DB39 Berry	DB40 Royal	DB41 Titanium	DB42 Black	

Fusion 90% Virgin Polyester / 10% Post-Consumer Recycled Polyester

FU71 Tangerine	FU72 Fresh	FU73 Moss	FU74 Tomato	FU75 Aqua	FU76 Sandstone	FU77 Granite
FU78 Poppy	FU79 Cadet	FU80 Oasis	FU81 Graphite	FU82 Viola	FU83 Cobalt	FU84 Flax
FU85 Carbon						

Hudson 100% Post-Consumer Recycled Polyester

HD02 Cordovan	HD03 Ruby	HD04 Orange	HD05 Wheat	HD06 Meadow	HD07 Coffee	HD08 Grey
HD09 Mocha	HD10 Thyme	HD11 Carbon	HD12 Midnight	HD13 Ocean	HD14 Cerulean	

Illusion 100% Virgin Polyester

II01 Cappuccino	II02 Paprika	II03 Tropic	II04 Wicker	II05 Hemp	II06 Cayenne	II07 Maui
II08 Dusk	II09 Smoke	II10 Currant	II11 Fiji	II12 Ozone	II13 Ebony	

Jenny 100% Polyester

JN01 Midnite	JN02 Ebony	JN03 Slate	JN07 Vermilion	JN08 Admiral	JN11 Charcoal	JN25 Silver Lining
JN26 Oatmeal	JN27 Sunflower	JN28 Cascade	JN29 Harvest	JN30 Melon	JN31 Berry	JN32 Green Grass
JN33 Roast						

Quilt 100% Polyester

QL10 Black	QL11 Charcoal Grey	QL14 Navy	QL16 Wine	QL19 Silver	QL20 Feather	QL21 Dune
QL22 Meadow	QL23 Cadet	QL24 Geranium	QL25 Daisy	QL26 Quest	QL27 Punch	QL28 Tangerine
QL29 Cocoa						

Terrace 70% Virgin Polyester / 30% Post-Consumer Recycled Polyester

TC61 Tigerlily	TC62 Shadow	TC63 Cobble	TC64 Cherry Blossom	TC65 Bluebell	TC66 Apple	TC67 Haze
TC68 Cerise	TC69 Twilight	TC70 Wintergreen	TC71 Ironwork	TC72 Pine Cone	TC73 Flirt	TC74 Echo
TC75 Glacier						

Trak 100% Recycled Polyester

TK40 Taupe	TK41 Mustard	TK42 Latte	TK43 Cement	TK44 Silver	TK45 Copper	TK46 Teal
TK47 Apple	TK48 Steel	TK49 Merlot	TK50 Midnight Sky	TK51 Mocha	TK52 Carbon	

Urban 62% Recycled Polyester / 32% Polyester

UR10 Red Rose	UR11 Ocean Blue	UR12 Blue Bayou	UR13 Green Grass	UR14 Sandcastle	UR15 Beach Day	UR16 Boardwalk
UR17 Earth	UR18 Brown Ridge	UR19 White Sand	UR20 Granite Rock	UR21 Gravel Road	UR22 Black Coal	

Waterfall 60% Virgin Polyester / 40% Post-Consumer Recycled Polyester

WA40 Trance	WA41 Tryst	WA42 Splash	WA43 Victoria	WA44 Imagine	WA45 Sky	WA46 Rainforest
WA47 Rumble	WA48 Prism	WA49 Tranquility	WA50 Grand	WA51 Rushing	WA52 Magestic	WA53 Pacific
WA54 Dance						

Wavelength 100% Virgin Polyester

WV01 Lime	WV02 Mint	WV03 Stone	WV04 Flame	WV05 Mykonos	WV06 Savannah	WV07 Mesa
WV08 Plasma	WV09 Cancun	WV10 Quartz	WV11 Moonrock	WV12 Rubine	WV13 Corfu	WV14 Bluejay
WV14 Panther						

Grade 2

Couture 100% Post-Consumer Polyester

CE71 Mocha	CE74 Sapphire	CE75 Neptune	CE76 Lake	CE77 Willow	CE78 Sassy	CE80 Persimmon
CE81 Carbon	CE82 Sterling					

Elevate 80% Post-Consumer Recycled Polyester / 20% Rayon

EL51 Halo	EL52 Dove	EL53 Safari	EL54 Sunglow	EL55 Margarita	EL56 Fiji	EL57 Mist
EL58 Blaze	EL59 Wasabi	EL60 Mystic	EL61 Mica	EL62 Cherry	EL63 Scuba	EL64 Lapis
EL65 Onyx						

TEXTILES + FINISHES

Grade 2 (continued)

Etch 80% Post-Consumer Recycled Polyester / 20% Rayon

ET81 Drift	ET82 Citron	ET83 Calypso	ET84 Mandarin	ET85 Crisp	ET86 Iris	ET87 Nickel
ET88 Paprika	ET89 Nutmeg	ET90 Marine	ET91 Magnet	ET92 Infrared	ET93 Espresso	ET94 Indigo
ET95 Anthracite						

Imprint 100% Post-Consumer Polyester

IM70 Almond	IM71 Cork	IM72 Sand	IM73 Currie	IM74 Candy Apple	IM75 Ocean	IM76 Navy
IM77 Green Tea	IM78 Celery	IM79 Oregano	IM80 Walnut	IM81 Paprika	IM82 Graphite	IM83 Slate
IM84 Licorice						

Match 100% Recycled Polyester. **Discontinued effective December 1, 2022.**

MT20 Desert	MT21 Sand	MT22 Moss	MT23 Orange	MT25 Blue	MT27 Green	MT28 Chocolate
MT31 Quarry	MT33 Arctic					

Replay 100% Post-Consumer Recycled Polyester

RP21 Caramel	RP25 Navy	RP29 Teal	RP30 Autumn	RP32 Slate	RP33 Dove	RP34 Coal
--------------	-----------	-----------	-------------	------------	-----------	-----------

Silhouette 100% Nylon with Teflon

SL20 Asphalt	SL22 Indigo	SL26 Camel	SL30 Charcoal
--------------	-------------	------------	---------------

Grade 2 (Vinyl) For availability of chair series in Vinyl, please contact a Global Sales Representative.

Allante FFree 100% Vinyl Face / 100% Polyester Backing

A01F Illusion	A02F Bright White	A03F White Crush	A04F Ivory	A05F Ice	A06F Bleached Sand	A07F Taupe Fawn
A08F Warm Smoke	A09F Autumn Rain	A10F Cookie	A11F Sierra Brick	A12F Gibraltar	A13F Chateau Grey	A14F Garden Green
A15F Oasis Green	A16F Ink Black	A17F Purple Impulse	A18F Italian Rose	A19F Mountain Sky	A20F Old Navy	A21F Galaxy
A22F Red Truffle	A23F Chocolate Sundae	A24F Province Blue	A25F Eclipse			

GC Linen 100% Vinyl Face

LE50 Potters Clay	LE51 Pearl	LE52 Tan	LE53 Storm	LE54 Butter	LE55 Haystack	LE56 Ganache
LE57 Sunset	LE58 Burnt Orange	LE59 Cayenne	LE60 Navy	LE61 Bamboo	LE62 Gray	LE63 Charcoal
LE64 Moss						

Luxhide 100% Vinyl Face / Bonded Leather Backing

BL20 Black	BL22 Parchment	BL23 Saddle	BL24 Dark Brown	BL26 Burgundy	BL27 Charcoal	BL28 White
BL34 Light Grey						

Release 100% Vinyl Face

RL11 White	RL12 Chalk	RL13 Stone	RL14 Taupe	RL15 Orange	RL16 Country	RL17 Tuscan
RL18 Cottage	RL19 Yellow	RL21 Red Barn	RL22 Brave Red	RL23 Gypsy Red	RL24 Cajun	RL25 Vineyard
RL26 Olive	RL27 Bonsai	RL28 Summer's Dream	RL29 Calico	RL31 Green	RL32 Blue	RL33 Black
RL34 Cool Grey	RL35 Thunder Grey	RL36 Navy	RL37 Dark Chocolate	RL38 Espresso		

Grade 3

Pure 73% Post-Consumer Polyester / 27% Post-Industrial Polyester. **Discontinued effective December 1, 2022.**

PU74 Fresh	PU75 Frosty	PU76 Crisp	PU77 Clear	PU78 Loam	PU79 Amber	PU80 Rich
PU81 Silent	PU82 Flawless	PU83 Deep				

Vital 86% Post-Consumer Polyester / 14% Post-Industrial Polyester. **Discontinued effective December 1, 2022.**

VT29 Spray	VT30 Twig	VT31 Sprout	VT32 Breath	VT33 Boost	VT34 Surge	VT35 Soar
VT36 Rise	VT37 Hike	VT38 Stem				

Grade 6

Novaro Genuine Leather 100% Leather

NO50 Ash	NO51 Asphalt	NO52 Bison	NO53 Blueberry	NO54 Cloud	NO55 Clove	NO56 Cordovan
NO57 Doe	NO58 Linen	NO59 Marina	NO60 Phantom	NO61 Pigeon	NO62 Scarlet	NO63 Turtle
NO64 Wheat						

PANEL/TACKBOARD FABRICS

GRADE 2

Lola 100% Polyester.

LL11 Medium Taupe LL12 Caramel Cream LL14 Blue Mist LL35 Spray LL36 Granite LL37 Cinder LL38 Sandstone

GRADE 3

Anchorage 65% Pre-consumer Polyester / 35% Post-consumer Polyester

AN40 Birch AN41 Green Apple AN42 Lapis AN43 Straw AN44 Wolf AN45 Goose AN46 Angora
 AN47 Cumin AN48 Asteroid AN49 Geranium AN50 Thistle AN51 Graphite AN52 Slate AN53 Quarry Blue
 AN54 Onyx AN55 Pumpkin AN56 Red Delicious AN57 Sunshine AN59 Waterfall AN61 Vanilla AN62 Cobalt
 AN64 Cloud

Merge 100% Polyester / 75% Post-consumer Recycled Polyester

MG20 Fawn MG21 Marshmallow MG22 Driftwood MG23 Dove MG24 Graphite MG25 Slate MG26 Eucalyptus
 MG27 Fire Engine MG28 Mediterranean MG29 Midnight

FINISHES

Seating Finishes - Metal & Polymer: *Please consult each Seating Series for finish availability.*

Black (BK) Charcoal Grey (CHR) Chrome (CHM) Fog (FG) Polished Aluminum (ALU) Tungsten (TUN)

Seating Finishes - Plastic (Duet, Popcorn, Sonic and Stream)

Buzz Blue (BZB) Cactus (CCT) Carrot (CRO) Cloud (IVC) Dijon (DJN) Eggplant (EGP) Fog (FOG)
 Frost (FRO) Ink (INK) Latte (LAB) Night (BLK) Sand (SND) Scarlet (SAR) Shadow (SHW)

Seating Finishes - Wood Seating finishes will not necessarily match Casegoods finishes. This is due to the fact that Seating and Casegoods finishes use different wood species and are manufactured at multiple locations.

Absolute (AAM) Black (BKM) Cherry (ACM) Espresso Cafe (ECM) English Oak (EOM) Fruitwood (TFM) Gray (HGM)
 Honey (AHM) Mahogany (TMM) Maple (AVM) Medium Walnut (MWM) Natural Walnut (NLW) Night (ASM) Noce Biondo (NBM)
 Noce Grigio (NGM) Noce Leggero (NEM) Noce Medio (NMM) Shaker Cherry (SKM) Walnut (TWM) WC Cream (WTM) White (WHM)
 Winter Cherry (WCM)

Desks, Workstations, Tables and Accessories - Laminate

Absolute Acajou (ACJ) Asian Night (ASN) Avant Cherry (AWC) Avant Honey (AWH) Black (BLK) Brushed Cobalt (BRC) Clear Maple (CMB)
 Dark Espresso (DES) Designer White (DWT) Hayden Grey (HGT) Noce Biondo (NBL) Noce Grigio (NGL) Noce Leggero (NEL) Noce Medio (NML)
 Quartered Mahogany (QTM) Storm Grey (SOG) Tiger Fruitwood (TFW) Tiger Walnut (TWL) Walnut Heights (WHE) White Chocolate (WHC) Willow Grey (WGY)
 Winter Cherry (WCR)

Desks, Workstations, Tables and Accessories - Wood Veneer

Almond Cherry (AMW) Cocoa Walnut (CAW) Coral (CRW) Dark Cherry (DCW) Espresso Walnut (EWW) Evening Oak (EVW) Grey on Oak (GRW)
 Hazelnut (HAW) Honey Maple (SMW) Java (JAW) Latte Walnut (LTW) Milestone (MTW) Mocha (MCW) Natural Maple (MPW)
 Red Cherry (RCW) Vintage Cherry (VNW) Walnut (WLW) Warm Cherry (WCW) White Maple (WMW)

Metal Leg Finishes (*check series for applicable finishes*)

Antique Copper (ACO) Black (TBL) Brushed Chrome (BCH) Buzz Blue (TBZ) Cactus (TCC) Carrot (TCR) Cloud (TIV)
 Chrome (CHM) Designer White (TDW) Dijon (TDJ) Eggplant (TEG) Fog (TFO) Frost (TFR) Ink (TIN)
 Kalua (TKA) Latte (TLA) Mocha (TMO) Nevada (TNE) Sand (TSN) Satin Brass (SBR) Scarlet (TSR)
 Shadow (TSH) Toast (TOA) Tungsten (TTU)

Metal File + Storage Finishes

Business Grey (BGR) Black Coffee Textured (BKC) Black (BLK) Bone (BNE) Blizzard Textured (BZD) Charcoal (CHR)
 Claret (CLT) Dark Chocolate Textured (DCH) Desert Putty (DPT) Designer White (DWT) Fog (FOG) Grey (GRY)
 Light Grey (LGR) Ice (ICE) Ivory (IVR) Mocha Textured (MCH) Metro (MET) Moss (MOS)
 Nevada (NEV) Navy (NVY) Oyster (OYS) Stonedust Textured (SDT) Storm Grey (SGR) Silver (SIL)
 Sky (SKY) Stone (STN) Taupe (TPE) Tahiti Sand (TSA) Tungsten (TUN)* Willow (WIL)

*10% upcharge applies

TEXTILES + FINISHES - LAMINATE FINISH CHART

FINISH CODE:	ACJ	ASN	AWC	AWH	BLK	BRC	CMB	CGY	DES	DWT	HGT	NBL	NGL	NEL	NML	QTM	SOG	STG	TFW	TWL	WHC	WHE	WGY	WCR	
LAMINATE DESKING																									
Adaptabilities	•	•	•	•	•	•	•		•	•	•	•	•	•	•	•	•		•	•	•	•	•	•	•
Genoa	•	•	•	•	•	•	•		•	•	•	•	•	•	•	•			•	•	•	•	•	•	•
Princeton	•	•	•	•			•		•	•	•	•	•	•	•					•	•	•		•	•
Zira	•	•	•	•	•	•	•		•	•	•	•	•	•	•	•	•			•	•	•	•	•	•
METAL DESKING																									
StreamLINE II	•	•	•	•	•	•	•		•	•	•	•	•	•	•	•	•			•	•	•	•	•	•
BENCHING																									
Bridges II	•	•	•	•	•*	•*	•	•	•	•	•*	•	•	•	•		•*	•	•	•	•	•	•	•	•
FreeFit	•	•	•	•	•	•	•	•	•	•	•	•	•	•	•	•	•	•	•	•	•	•	•	•	•
Intelli Beam	•	•	•	•	•	•	•		•	•	•	•	•	•	•	•	•			•	•	•	•		•
PANELS + COMPONENTS																									
Divide	•	•	•	•	•	•	•		•	•	•	•	•	•	•	•	•			•	•	•	•	•	•
TABLES - MEETING + CONFERENCE																									
Boardroom	•	•	•	•	•	•	•		•	•	•	•	•	•	•	•	•			•	•	•	•	•	•
Bungee / Bungee SL	•	•	•	•	•	•	•		•	•	•	•	•	•	•	•	•			•	•	•	•	•	•
Connectables	•	•	•	•	•	•	•		•	•	•	•	•	•	•	•	•			•	•	•	•	•	•
Junction	•	•	•	•	•	•	•		•	•	•	•	•	•	•	•	•			•	•	•	•	•	•
Kadin	•	•	•	•	•	•			•	•	•	•	•	•	•		•			•	•	•			
Swap	•	•	•	•	•	•	•		•	•	•	•	•	•	•	•	•			•	•	•	•	•	•
Terina	•	•	•	•	•	•	•		•	•	•	•	•	•	•	•	•			•	•	•	•		•
Zira Boardroom	•	•	•	•	•	•	•		•	•	•	•	•	•	•	•	•			•	•	•	•	•	•
TABLES - RECEPTION + OCCASIONAL																									
Citi	•	•	•	•	•	•	•		•	•	•	•	•	•	•	•	•			•	•	•	•	•	•
Occasional Tables	•	•	•	•	•	•	•		•	•	•	•	•	•	•	•	•			•	•	•	•	•	•
Reception Tables	•	•	•	•	•	•	•		•	•	•	•	•	•	•	•	•			•	•	•	•	•	•
Work Tables	•	•	•	•	•	•	•		•	•	•	•	•	•	•	•	•			•	•	•	•	•	•
Sirena Tables	•	•	•	•			•		•	•	•	•	•	•	•	•					•	•	•		•
Wind Tables	•	•	•	•	•	•	•		•	•	•	•	•	•	•	•	•			•	•	•	•	•	•
TABLES - TRAINING																									
2gether	•	•	•	•	•	•	•		•	•	•	•	•	•	•	•	•			•	•	•	•		•
TABLES - HEIGHT ADJUSTABLE																									
Foli Tables	•	•	•	•	•	•	•		•	•	•	•	•	•	•	•	•			•	•	•	•	•	•
FILING + STORAGE																									
Lateral File Tops	•	•	•	•	•	•	•		•	•	•	•	•	•	•	•	•			•	•	•	•	•	•
WOOD VENEER DESKING																									
Corby - Laminate chassis	•	•			•		•	•	•	•	•	•	•	•	•	•	•					•	•		•
Dufferin - Laminate chassis					•		•		•	•							•	•							

* Bridges II finishes coordinate with metal paint finishes as follows: Black (BLK) - Black Paint (BLK); Brushed Cobalt (BRC) - Tungsten Paint (TUN); Hayden Grey (HGT) - Taupe Paint (TPE); Storm Grey (SOG) - Charcoal Paint (CHR); Designer White (DWT) - Designer White Paint (DWT); Custom Grey (CGY) - Silver Paint (SIL); String (STG) - Nevada Paint (NEV).

LAMINATE FINISHES COORDINATION CHART			
LAMINATE FINISH		COORDINATING WOOD FINISH	
ACJ	Absolute Acajou	AAM	Absolute
ASN	Asian Night	ASM	Night
AWC	Avant Cherry	ACM	Cherry
AWH	Avant Honey	AHM	Honey
BLK	Black	BKM	Black
CMB	Clear Maple	AVM*	Maple
DES	Dark Espresso	ECM	Espresso Cafe
DWT	Designer White	WHM	White
HGT	Hayden Grey	HGM	Grey
NBL	Noce Biondo	NBM	Noce Biondo
NEL	Noce Leggero	NEM	Noce Leggero
NGL	Noce Grigio	NGM	Noce Grigio
NML	Noce Medio	NMM	Noce Medio
QTM	Quartered Mahogany	TMM	Mahogany
TFW	Tiger Fruitwood	TFM	Fruitwood
TWL	Tiger Walnut	TWM	Walnut
WCR	Winter Cherry	WCM	Winter Cherry
WHC	White Chocolate	WTM	WC Cream
WHE	Walnut Heights	MWM	Medium Walnut
LAMINATE FINISHES WITH NO COORDINATING WOOD FINISHES		WOOD FINISHES WITH NO COORDINATING LAMINATE FINISHES	
BRC	Brushed Cobalt	EOM	English Oak
SOG	Storm Grey	NLW	Natural Walnut
WGY	Willow Grey	SKM	Shaker Cherry
CGY	Custom Grey		
STG	String		

THINK GLOBAL/THINK GREEN



LEVEL 3 CERTIFIED
Many programs in various categories



LEED PARTNERSHIP PROGRAM
Products can help you earn credits



GREENGUARD CERTIFIED
Children & Schools Certified

THE ENVIRONMENT We believe now more than ever, that it is our responsibility to protect the environment and our precious natural resources for future generations. The growing importance of energy and environmental concerns continues to challenge us in this ever changing marketplace.

As an industry leader, Global continues to take proactive steps towards reducing the negative impacts on the environment. We are building "healthier" offices; investing in Research & Development and new technologies; reducing waste and the consumption of energy; and improving the quality of the air we breathe, all which can have a significant impact on our quality of life.



Epoxy Powder coating process is solvent free. No harmful VOC's or lead. No toxins are released into the atmosphere.

Global's recycled fabrics offer affordable, environmentally responsible alternatives to commercial textiles. We recycle 35,000 lbs of fabric offcuts weekly.



Global has the products and resources to help your projects achieve LEED certification.

New technology allows us to reduce glue usage by 50%. In addition, our polyurethane glue reduces emissions and requires less energy to apply.



powder paint process:
98% paint recovery and reuse

more recycled fabric
less to the landfill

talk to us about our
leed partnership program

we've diverted
90% of our wood waste from landfill in four years

For further information on Global's environmental initiatives, please visit <https://www.globalfurnituregroup.com/us/company/environmental-commitment>

CUSTOM GROMMET LOCATION FORM

This form is for use with rectangular and square units only. Application drawings must be provided for any other shape units.

Model # _____ (Please use one page for each model #)

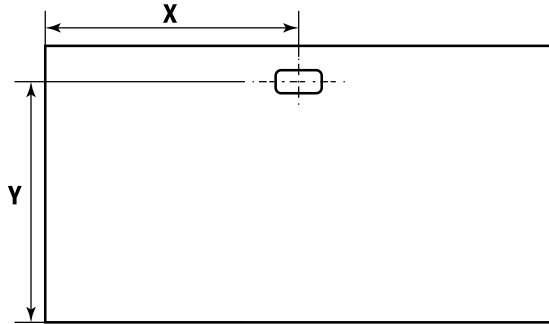

Operator Side

Template for Tops

X = _____

Y = _____

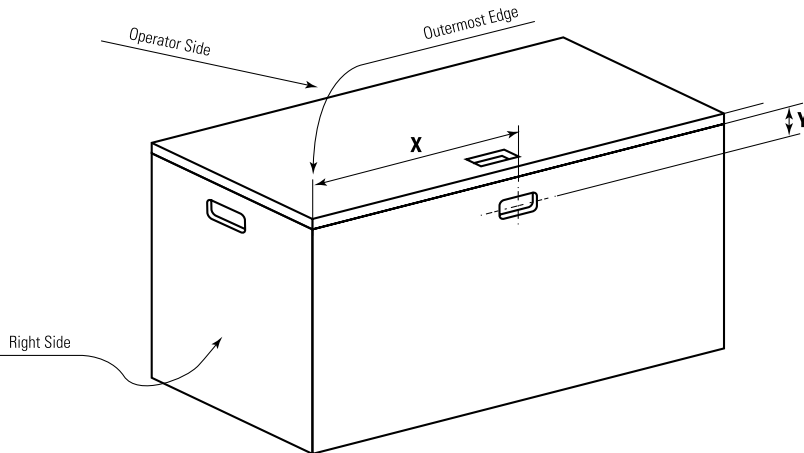
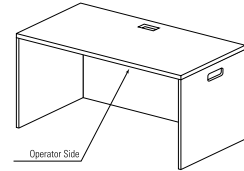

Template for Modesty Panels

X = _____

Y = _____

Note: X = Taken from outermost edge

Note: Y = Taken from underside of top

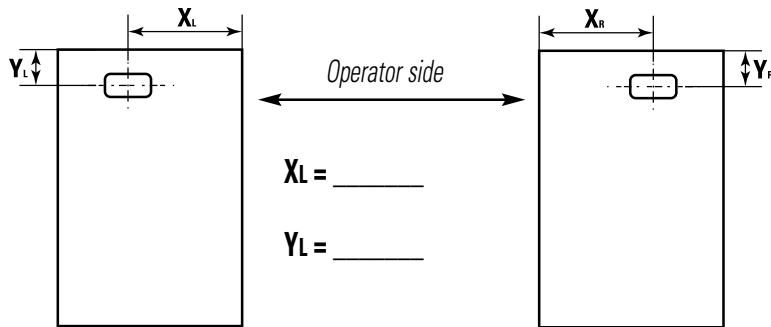

Left Leg

Right Leg

Template for Legs

X_R = _____

Y_R = _____

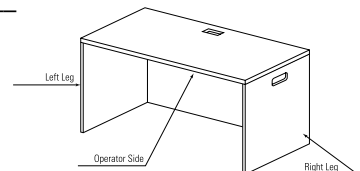

THIS FORM IS TO BE USED FOR NON-STANDARD CUT-OUT SIZES

Zira boardroom tables only (96" table)

Model # _____ (please use one page for each model #)

Please check all that apply. Note: Shaded grey areas represent position of bases.

CUT-OUT POSITION(S)

- Position 1 - over left base - always 24.6" to center point of cut-out from left edge - use option code **CCU1**
- Position 2 - center of table - use option code **CCU2**
- Position 3 - over right base - always 24.6" to center point of cut-out from right edge - use option code **CCU3**
- Custom position(s) - indicate on diagram below w/dimensions to **center point** of cut-outs - use option code **CCUS**

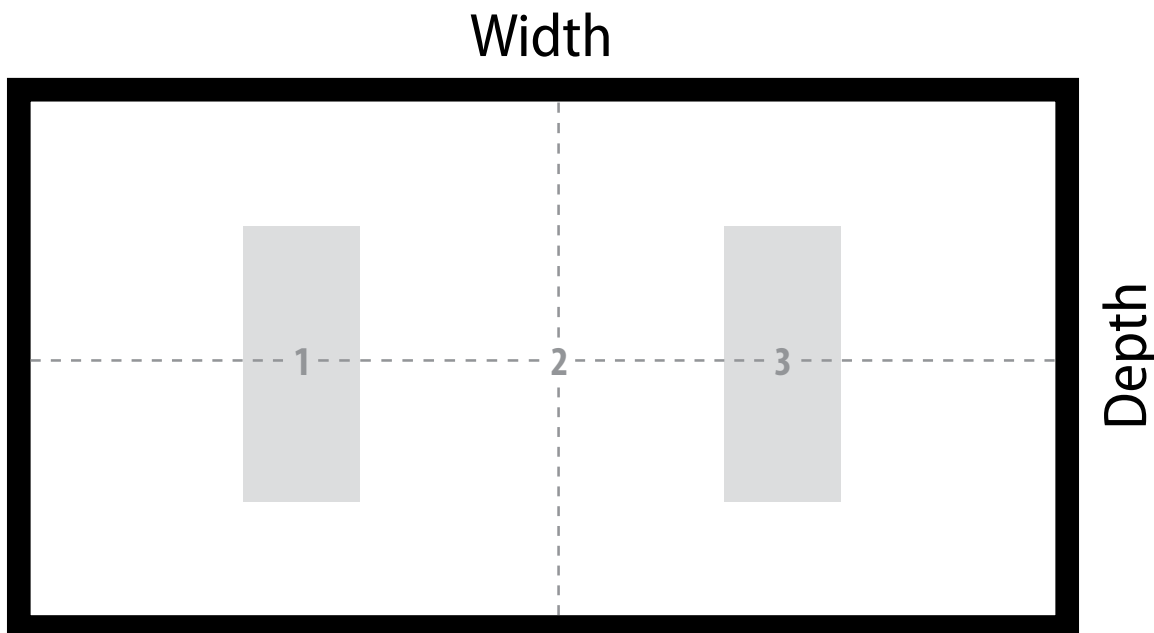

CUT-OUT CRITERIA

All cut-outs require a minimum 8mm radius at each corner.

Cut-outs **must be centered** on the depth of each table due to wire management runners below the worksurface.

Power and data modules that extend more than 3.75" below the worksurface **CANNOT** be positioned over bases.

Indicate cut-out size:

_____ " X dimension of cut-out runs the width of the table.

_____ " Y dimension of cut-out runs the depth of the table.
Y dimension not to exceed 14"

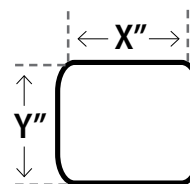

Dealer PO# _____

Internal use only

Global order# _____

Global trailer/load #: L _____ ID #: _____

THIS FORM IS TO BE USED FOR NON-STANDARD CUT-OUT SIZES

Zira boardroom tables only (120" - 168" table)

Model # _____ (please use one page for each model #)

Please check all that apply. Note: Shaded grey areas represent position of bases.

CUT-OUT POSITION(S)

- Position 1 - over left base - always 25.2" to center point of cut-out from left edge - use option code **CCU1**
- Position 2 - center of table - use option code **CCU2**
- Position 3 - over right base - always 25.2" to center point of cut-out from right edge - use option code **CCU3**
- Custom position(s) - indicate on diagram below w/dimensions to **center point** of cut-outs - use option code **CCUS**

Width

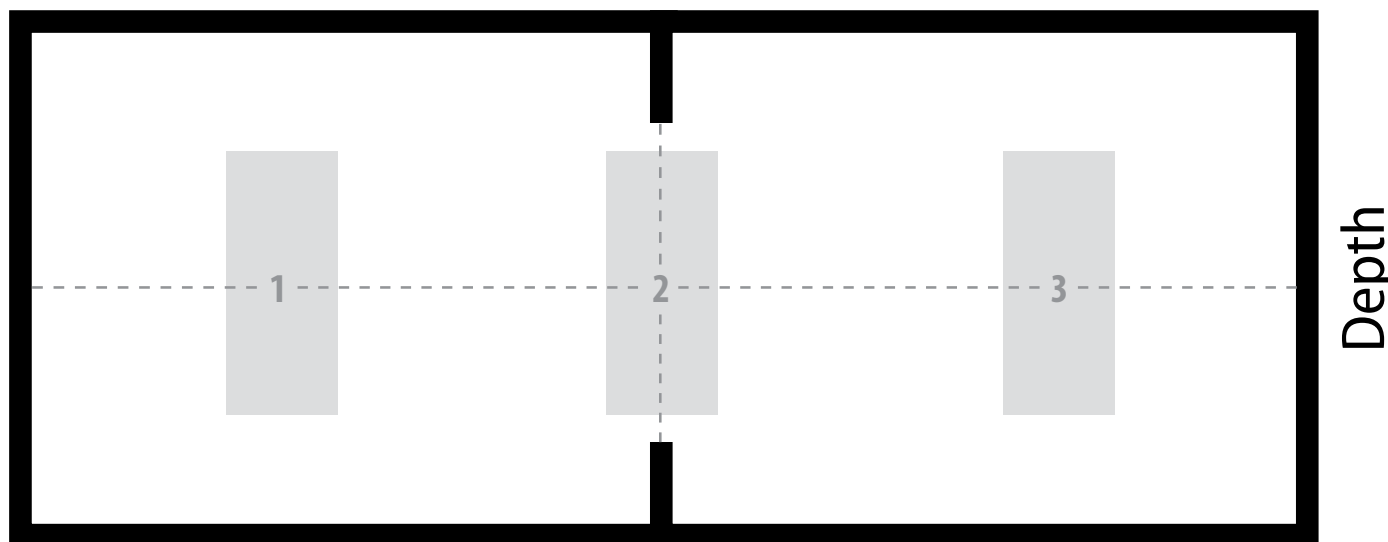

CUT-OUT CRITERIA

All cut-outs require a minimum 8mm radius at each corner.

Cut-outs **must be centered** on the depth of each table due to wire management runners below the worksurface.

Power and data modules that extend more than 3.75" below the worksurface **CANNOT** be positioned over bases.

Indicate cut-out size:

_____ " X dimension of cut-out runs the width of the table.

_____ " Y dimension of cut-out runs the depth of the table.

Y dimension not to exceed 14"

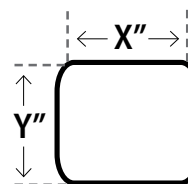

Dealer PO# _____

Internal use only

Global order# _____

Global trailer/load #: L _____ ID #: _____

THIS FORM IS TO BE USED FOR NON-STANDARD CUT-OUT SIZES

Zira boardroom tables only (192" - 288" table)

Model # _____ (please use one page for each model #)

Please check all that apply. Note: Shaded grey areas represent position of bases.

CUT-OUT POSITION(S)

- Position 1 - over left base - always 25.2" to center point of cut-out from left edge - use option code **CCU1**
- Position 2 - center of table - use option code **CCU2**
- Position 3 - over right base - always 25.2" to center point of cut-out from right edge - use option code **CCU3**
- Custom position(s) - indicate on diagram below w/dimensions to **center point** of cut-outs - use option code **CCUS**

Width

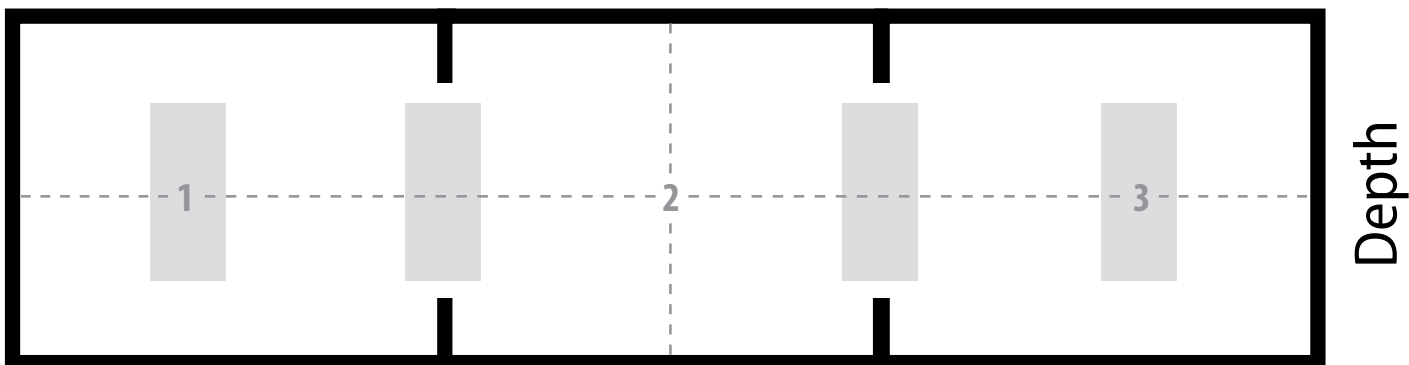

CUT-OUT CRITERIA

All cut-outs require a minimum 8mm radius at each corner.

Cut-outs **must be centered** on the depth of each table due to wire management runners below the worksurface.

Power and data modules that extend more than 3.75" below the worksurface **CANNOT** be positioned over bases.

Indicate cut-out size:

_____ " X dimension of cut-out runs the width of the table.

_____ " Y dimension of cut-out runs the depth of the table.

Y dimension not to exceed 14"

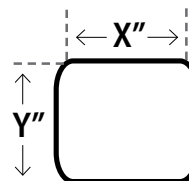

Dealer PO# _____

Internal Use Only

Global Order# _____

Global Trailer/Load #: L _____ ID #: _____

THIS FORM IS TO BE USED FOR NON-STANDARD CUT-OUT SIZES

Zira boardroom tables only (square tables)

Model # _____ (please use one page for each model #)

Please check all that apply. Note: Shaded grey area represents position of base.

CUT-OUT POSITION(S)

Position 2 - center of table - use option code **CCU2**

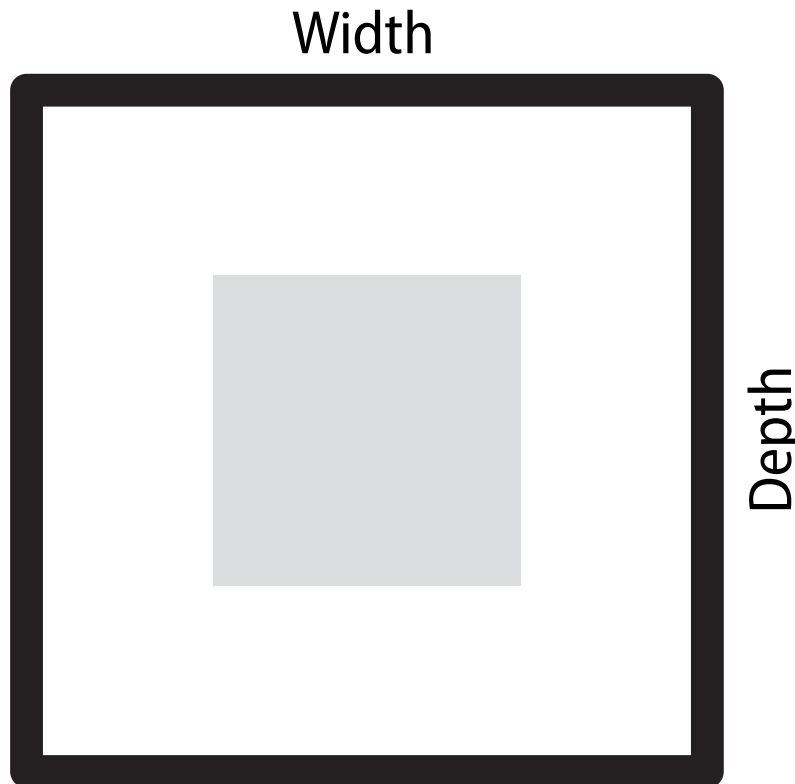

CUT-OUT CRITERIA

All cut-outs require a minimum 8mm radius at each corner.

Cut-outs **must be centered** on the depth of each table.

Power and data modules that extend more than 3.75" below the worksurface **CANNOT** be positioned over bases.

_____ " X dimension of cut-out runs the width of the table.

_____ " Y dimension of cut-out runs the depth of the table.
Y dimension not to exceed 11"

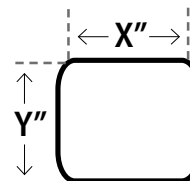

Dealer PO# _____

Internal use only

Global order# _____

Global trailer/load #: L _____ ID #: _____

THIS FORM IS TO BE USED FOR NON-STANDARD CUT-OUT SIZES

Zira media tables only

Model # _____ (please use one page for each model #)

Please check all that apply. Note: Shaded grey area represents position of base.

CUT-OUT POSITION(S)

- Position 1 - over left base - always 24.6" to center point of cut-out from left edge - use option code **CCU1**
- Custom position(s) - indicate on diagram below w/ dimensions to **center point** of cut-outs - use option code **CCUS**

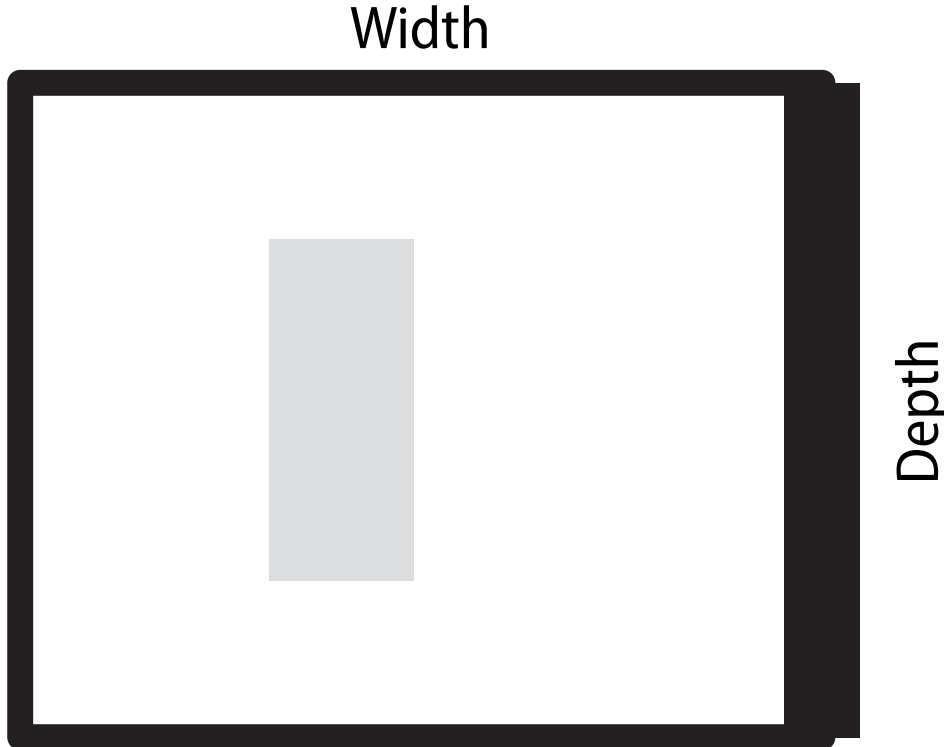

CUT-OUT CRITERIA

All cut-outs require a minimum 8mm radius at each corner.

Cut-outs **must be centered** on the depth of each table due to wire management runners below the worksurface.

Power and data modules that extend more than 3.75" below the worksurface **CANNOT** be positioned over bases.

_____ " X dimension of cut-out runs the width of the table.

_____ " Y dimension of cut-out runs the depth of the table.
Y dimension not to exceed 14"

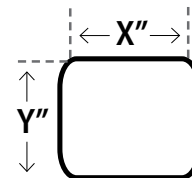

Dealer PO# _____

Internal use only

Global order# _____

Global trailer/load #: L _____ ID #: _____

THIS FORM IS TO BE USED FOR NON-STANDARD CUT-OUT SIZES

Zira collaborative tables only

Model # _____ (please use one page for each model #)

Please check all that apply.

CUT-OUT POSITION(S)

- Position 1 - always 24.6" to center point of cut-out from left edge - use option code **CCU1**
- Position 2 - center of table - use option code **CCU2**
- Position 3 - always 24.6" to center point of cut-out from right edge - use option code **CCU3**
- Custom position(s) - Please indicate on diagram below with dimensions to **center point** of cut-outs - use option code **CCUS**

Width

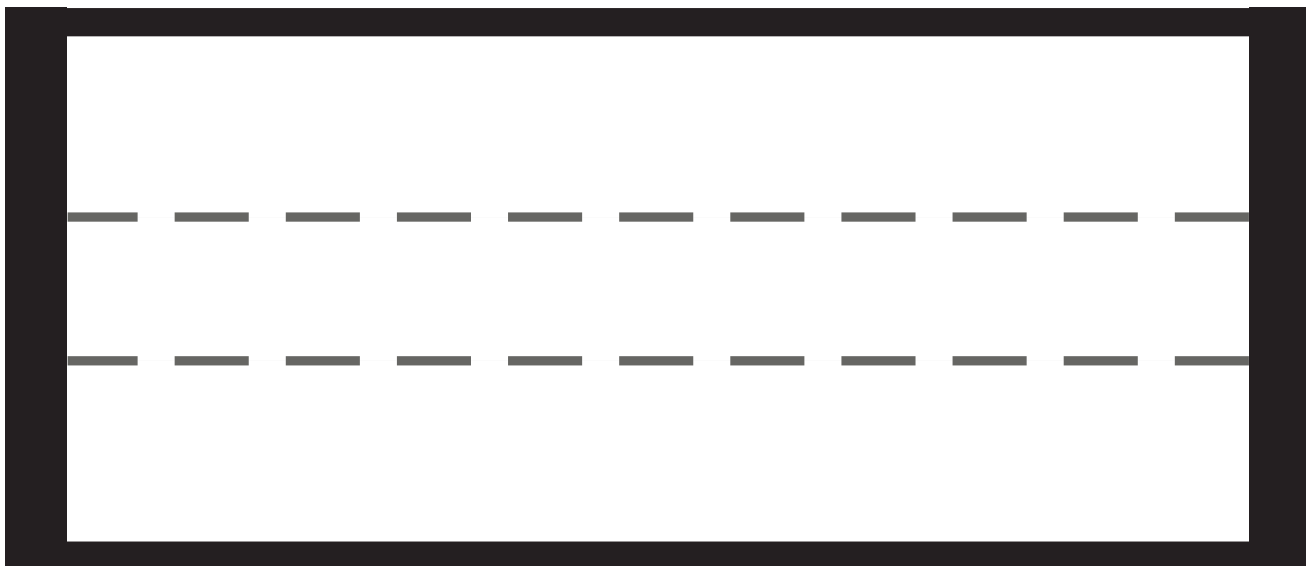

Depth

CUT-OUT CRITERIA

All cut-outs require a minimum 8mm radius at each corner.

Cut-outs **must be centered** on the depth of each table due to wire management runners below the worksurface.

_____ " X dimension of cut-out runs the width of the table.

_____ " Y dimension of cut-out runs the depth of the table.
Y dimension not to exceed 10"

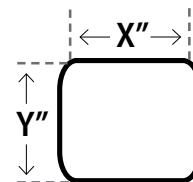

Dealer PO# _____

Internal use only

Global order# _____

Global trailer/load #: L _____ ID #: _____

This illustrated price list has been designed to facilitate fast reference and easy use. Products are categorized into "seating", "desks", "files", "panels", or "tables", and are listed numerically within their categories. The line drawings match actual photographs (where possible) to aid in instant recognition of the total range within a series.

Sales of Global Furniture Group ("Global") products are made only on Global's standard Terms and Conditions of sale which are contained in this list price book. These standard terms and conditions may be modified or supplemented only by a separately written document signed by Global's authorized personnel at its head office in Marlton, NJ. Any term or condition contained in any purchase order or other form used by dealer/purchaser to order goods (including standard, printed language) which is different from, in addition to, or in any way inconsistent with Global's standard terms and conditions shall be of no force or effect whatsoever.

All illustrations, specifications and prices in this list price book are based on the latest product information available at time of publication. Global reserves the right to make changes at any time and without prior notice to prices, colors, materials, specifications and models offered.

Description

Each product shown or described in this list price book is standard Global product. Available options are noted at the beginning of each series. Available options may require additional delivery time and cost, and may affect the warranty given. Sizes and weights shown are approximate and are subject to slight changes from time to time.

Prices and Payment

The prices shown in this book, as well as those quoted by Global, are in United States dollars for orders shipped to destinations in the U.S. and Mexico.

If shipping date requested is more than 90 days from date of order, Global shall reserve right to use published list prices effective at the time of shipment.

Orders are invoiced at the time of shipment. Terms of payment are net 30 days from date of invoice (1% 15 days) unless otherwise stated. The Purchaser agrees that Global reserve the right to enforce a charge amounting to 1.5% per month (18% per year) on invoices outstanding more than 30 days.

If the Purchaser's most recent annual net volume is less than \$5,000.00, payment must be made in advance.

Any products sold by Global shall remain the personal property of Global until fully paid.

Prices are suggested list prices only and are subject to change without notice. Global will, however, attempt to keep dealer/purchasers up-to-date on all developments including price changes.

Taxes

All prices shown in this book are exclusive of sales, use, excise and other applicable taxes and are the dealer/purchaser's responsibility as per the invoice issued by Global. If dealer/purchaser claims an exemption from such taxes, it shall be the dealer/purchaser's responsibility to furnish Global with an appropriate exemption certificate at time of order.

Ordering Information

Global requires that all orders be submitted in writing and will be acknowledged on Global's acknowledgment forms governing the transaction.

The details appearing on this acknowledgment will describe the items to be shipped and the approximate shipping date. It is the Purchaser's responsibility to determine that the information in the acknowledgment is correct. In the event of an error, the Purchaser must notify their Global Customer Service representative immediately by telephone followed by written confirmation. Shipping dates are assigned to orders based on the items having the longest manufacturing lead time (unless instructed to partial ship).

At time of order, please provide the following information:

1. Account number (if possible)
2. PO number
3. "Bill to" and "Ship to" name and address
4. Complete model number and selected options including textiles/finishes
5. Special instructions and tag information
6. Shipping instructions, please indicate:
 - a. pick up
 - b. Global trailer program
 - c. common carrier, provide name of carrier, your account number
7. Special quote (SQ) # or MTM # (if applicable)
8. Customer's Own Material (COM), Global Purchased Material (GPM), Customer's Own Leather (COL), see below.
9. For specials and custom quoted product, please indicate the custom quote # on your PO. If changes are made to the quote a new quote must be issued prior to submitting the order. It is the Purchaser's responsibility to determine that the information on the quote is correct. Global will not be responsible for wrong product due to errors in the quote

The above points will be checked by Global for accuracy. Global will process orders using the codes provided by the Purchaser. Price discrepancy is the responsibility of the Purchaser. The Purchaser must notify Global prior to invoicing.

The Purchaser is responsible for providing correct information at time of order. If no option(s) are selected the system will default to standard feature(s). Orders with missing/incorrect information (finish, etc.) will be put on hold until all information is complete. Orders will be scheduled for manufacturing upon receipt of complete information.

Changes and Cancellations

After the date of Global's acknowledgment of the Purchaser's order, the order may not be changed or canceled by the Purchaser without the written consent of Global. Special order items, C.O.M. and fabric-covered items already in production are not subject to change or cancellation under any circumstances. Textile-covered items are considered to be in production once the textile is scheduled for cutting. Other standard items already in production are subject to a minimum 35% cancellation charge.

Errors and Omissions

All quotations, acknowledgements and invoices are subject to corrections for any errors and omissions.

FINISHES

Seating Finishes

Where painted frames are not a standard color, there is a one time charge of \$578.00 list price per-order for custom wood staining/color matching. Restrictions may apply. The customer must provide a 3" x 3" color chip/sample. Non-standard finishes must be approved by Global prior to acceptance of order.

File Finishes

All non-standard finishes must be approved by Global prior to acceptance of order and may be subject to an upcharge.

Laminated Tops - Pricing for all non-standard finishes and sizes must be provided by Global Customer Service and may be subject to an upcharge.

Desk Finishes

Because the distinctive characteristics and the nature of wood products cause variations, exact matches are not always possible.

Global has launched a finishes program between marketing companies within the Global Group to match products as best as possible when same finishes are specified.

Customers Own Material (COM)

Use of COM must be approved by Global prior to acceptance of order. Please refer to back of the Seating List Price Book and fill out the Authorization Request Form. Photocopy and use this form as often as necessary. The customer must provide a 12" x 12" fabric sample and advise how the fabric is to be applied. **Textile yardage requirement will be advised by the factory, and additional yardage may be required if pattern requires matching.** Yardage shown in the List Price Book does not allow for pattern repeat/matching. Send to the address provided on shipping document upon approval from Global. If C.O.M. is difficult to apply or if product shall be modified, extra charges shall be made. Global reserves the right to cancel an order at any time if C.O.M. is inadequate for any reason. Customer's Own Material must be shipped freight and duties paid to our factory. Such shipment must be fully identified with purchaser's order number, RGA # provided by Global, and the item for which material is intended. Performance of C.O.M. when applied to product is the sole responsibility of the purchaser. Global's standard product warranty shall not apply to C.O.M. Use of C.O.M. will not reduce the published list price.

Textile Grading

All products are priced according to their standard textile grade. Lower grade textiles may be available but at the same price as standard textile grade. See Textiles and Finishes section for graded textiles.

Combining two grades of textiles may result in a revised grade. Please refer to "Two Grades Combination Chart" in the Textiles and Finishes section. For more than two textiles a special quotation is required.

Global Purchased Material, Customer Specified (GPM)

Global may purchase material specified by the customer. Use of GPM must be approved by Global prior to acceptance of order. If it is difficult to apply or if product is required to be modified, extra charges will apply. Global reserves the right to cancel an order at any time if GPM is inadequate for any reason. Performance of GPM when applied to product is the sole responsibility of the textile vendor. Global's standard warranty will not apply to GPM materials.

Customer's Own Leather (COL)

Not all seating can be upholstered in leather. Please consult series notes for availability. COL price is the lowest published grade for the series (leather or fabric).

Upholstery Coverings

Slight variations in color may occur between dye lots. Although Global attempts to minimize these variances, they do occur and must be accepted as normal and will not be considered defects.

Leather is a Natural Product

Natural variations occur in the color, grain and texture of leather. As a result, a degree of variation should be expected. As leather is used it develops a patina. Its color changes slightly, it will get marked and it will stretch and pull, these are the hallmarks of genuine leather and are not considered defects.

Yardage

Required yardage (ydg) is based on unmatched materials with widths of 54" for seating, 63" for panels. Yardage calculations are based on imperial measurements.

Arms

A wide selection of arms are available for some series. See Arm Chart in the Seating price list for details.

Delays

Global's order acknowledgement will state a shipping date which is Global's best estimate at the time the order is acknowledged. However, Global shall not incur any obligation or liability to Purchaser for failure to ship by specified date unless Global has agreed to an unequivocal shipping date in a separately signed written document executed by its authorized personnel at its head office. In addition, Global shall not be liable for any loss or damage resulting from any delay or failure in shipment or other failure to perform all or any part of the agreement between the parties with respect to the goods shown on the face of the order acknowledgement where such delay, failure, loss or damage is the proximate result of any act of any governmental authority or political subdivision thereof, revolution, riot, civil disorder or disturbance, delay or default in transportation, strike disputes among or between labor unions or other labor disputes, delay or inability in obtaining materials and facilities, fire, flood, act of God or any cause not within the reasonable control of the company, whether of the class of causes enumerated or otherwise.

F.O.B.

F.O.B. point is Global's Factory, Downsview, Ontario, Canada, or any Global Regional Distribution Center.

UPS Shipments

Seating products marked with a UPS symbol are packaged for UPS-able shipments.

Handling

A \$25. net handling charge per shipment will be applied for non UPS-able orders of less than \$2000 list.

Special Delivery Requirements

Global's delivered pricing provides for dock delivery during normal business hours (considered to be 8 am to 4 pm Monday through Friday) to customer/end user only. Additional delivery requirements such as inside delivery, lift gate, limited access sites, installations and weekend deliveries will incur an additional expense and will be the responsibility of the dealer.

Service

Service requests are normally the responsibility of Global's authorized dealers. Where this cannot be accomplished on a local level, service problems should be referred to Global's Customer Service Department in the nearest distribution center.

Returns

No returns of goods will be accepted without written consent and shipping instruction of Global. A minimum re-stocking charge of 35% is made on all authorized returns for credit or refund, provided goods are received by Global in the

condition in which they left the factory. This may increase depending on the type of product. Global's Return Goods Authorization (R.G.A.) numbers must appear prominently on all authorized returns. Global will not be responsible for freight costs. No credit will be given if goods cannot be reused as new. Special order items, non-stock items and C.O.M. products are in no event subject to return. All returns must be approved and authorized in writing by Global Customer Service. Global reserves the right to refuse delivery of any unauthorized returns.

Claims

All goods are sold FOB plant or Global Distribution Center. Global is not responsible for damage which occurs in transit (or in storage). The carrier signs for all goods received in apparently good order. It is the Purchaser's responsibility to examine goods upon receipt and to file any claims with the carrier for losses or damage to the product occurring during transit, including concealed damage.

Any claims made against Global for apparent defects, errors or shortages must be made by the Purchaser, in writing, within 15 working days after any delivery. Failure by the dealer/purchaser to make any claim against Global within 15 days shall constitute acceptance of the goods and a waiver of any apparent defects, errors or shortages.

Suspension

In the event that the dealer/purchaser defaults in the payment of any sum due to Global, or in the event the dealer/purchaser's financial condition becomes unsatisfactory to Global, Global shall have the right to defer or discontinue shipment of any goods until such time as the default is cured or the dealer/purchaser provides assurance of payment to Global.

Copyright

All catalogs, photographs, drawings, price lists and other printed material are protected by copyright. All rights reserved.

Trademarks

All trademarks are owned by Global Furniture Group other than OBUSFORME™ which is owned by OBUSFORME LTD. and are used under license. OBUSFORME® and the distinctive backrest design are registered trademarks of OBUSFORME LTD.

Designs and Patents

Many of the products produced by Global are protected by design registrations, design patents and/or patents. Design and specifications are subject to change, discontinuance or additions without notice.

For a full listing of issued trademarks, please visit globalfurnituregroup.com.

Cubic Measure

The stated volume is an approximate cubic foot measure that may be used to calculate freight costs. The figure shown is the total shipping volume of a unit (e.g. if a part is sent in 2 cartons the volume indicated reflects both cartons together) and is subject to change without notice. It is most economical to purchase the specified number per carton.

Combined Shipments

Global will make every effort to combine shipments and orders on written request. However, Global cannot be held responsible where such request is not complied with.

Offer of Sale

Possession of this price list or any other literature shall not imply the company's willingness to sell to the holder and shall not be construed as a direct offer of sale.

If a conflict arises between: (i) prices found in software support packages furnished to the customer by Global or by any other source on behalf of Global; and (ii) Global's current pricing found on Global's website, then the most current shall prevail.

Disclaimer

All dimensions are in inches. Prices shown are current manufacturer's suggested list prices at the time of printing. Updated pricing is available on Global's website. All applicable taxes are extra. Descriptions, specifications and prices are subject to change without notice. Errors and omissions are subject to correction.

Testing Qualifications

Many Global products pass or exceed the most stringent industry testing standards.

Flammability

The foam used in Global chairs meets the requirements of California TB117:2013. In addition to the foam, upholstery materials must also meet the California TB117 smolder resistant requirements. Please contact Customer Care to determine if a selected textile meets the California TB117 requirement.

This list price book is effective as of July 5, 2022.

For periodic updates, please check the PDF at globalfurnituregroup.com. Select Resources then Price Lists. From here you will have the option to select either the Seating, Desking + Tables or Metal Filing + Storage price list books. Global warrants that all commercial products are free from defects in material and workmanship, for the life of the product, to the original Purchaser.

Global will repair or replace, at Global's option, as the sole remedy for any defect covered by the warranty. The warranty applies to products manufactured after March 22, 2016.

Global makes no warranty that any of its products are suitable for any particular purpose and makes no other warranties, express or implied, other than those set out here. As codes and standards vary from one jurisdiction to another, references to compliance are solely for convenience and without any representation as to accuracy or suitability. Users must verify the suitability of such information or product for their specific application. In no event shall Global be liable in either tort or contract for any loss or direct, special, incidental, consequential, or exemplary damages. The warranty applies to single shift, standard commercial usage, defined as a standard eight (8) hour day, forty (40) hour week for users weighing up to 300 pounds.

General Commercial Seating

Global's warranty for general commercial seating covers all chair components including pneumatic cylinders, bases, casters, glides, frames, arms, plastic seats, backs and other structural components.

Exceptions to the warranty for general commercial seating are as follows:

- Foam, textiles (as sampled on Global branded and textile program cards), mesh material and electrical devices, are warranted for five (5) Years
- Control mechanisms are warranted for twelve (12) Years
- Heavy duty seating and Indoor/Outdoor Furniture are not defined as General commercial seating (see below for warranty exceptions)

Heavy Duty Seating

Global offers products designed for multiple shift applications (24 hours a day / 7 days a week) and larger individuals weighing up to 400, 500 and/or 600 pounds (depending on series and/or model). Global warrants these products for twelve (12) years to the original purchaser. All components (including control mechanisms, pneumatic cylinders, bases, casters, glides, frames, arms, plastic seats/backs, etc.) are covered for 24/7 applications under the warranty. The exceptions are foam, upholstery and textiles, which are covered for five (5) years. Fabric or upholstery material on these products must exceed 100,000 double rubs for the textile portion of the warranty to apply. Heavy Duty product series that apply under this warranty can be found in the Heavy Duty section of this list price book.

Outdoor Furniture

Global offers products designed for use indoors or outdoors. Global warrants these products for three (3) years to the original purchaser. This warranty applies to single shift (eight (8) hour day, forty (40) hour week) for users weighing up to 275 pounds, unless noted otherwise. Outdoor furniture must be stored indoors during inclement or extreme weather such as extreme cold, extreme heat, or excessive wind.

Exceptions to the warranty for indoor/outdoor furniture is as follows:

- Only Global branded textiles and Alliance Partner carded textile program materials expressly identified for outdoor application are covered for three (3) years when used outdoors.

Global's Warranty does not apply (for any product category) to the following:

- Products not purchased directly from authorized Global resellers
- Nominal or normal amount of wear and tear that can occur over time
- Failures which result from negligence, abuse, accident or misuse
- Failure to apply, install or maintain products according to Global's written instructions and warnings
- Modifications, attachments or repair methods not approved by Global
- Damage caused by a carrier in transit, or delivery/installation contractors
- The matching of colors, grains or textures (wood, leather, etc.) of natural materials
- Products exposed to extreme hot or cold temperatures or excessively dry or humid environments
- Colorfastness or the matching of color of textiles, dye lots of textile can vary
- Damage by markings or staining; damage by sharp objects or imprinting from instruments
- Damage to textiles or laminate and wood surfaces/edges from exposure to sunlight (including UV rays)
- Products used for rental purposes
- Purchased parts are warranted for one (1) year
- Failure to follow specific cleaning and disinfecting instructions posted on globalfurnituregroup.com

Seating Warranty Summary

Seating Type	Components Warranty For Original Purchaser	Use Time For Warranty Coverage	Exceptions
General Commercial Seating	Lifetime	8 Hours/5 Days Per Week	Foam/Upholstery/Textiles/Mesh/Electrical Devices - 5 Years Control Mechanisms - 12 Years
Heavy Duty Seating	12 Years	24 Hours/7 Days Per Week	Foam/Upholstery/Textiles - 5 Years
Indoor/Outdoor Furniture	3 Years	8 Hours/5 Days Per Week	Outdoor Use Textiles – 3 Years

Textiles

Global warrants Global branded textiles and Alliance Partner carded textile programs inclusive of fabrics, vinyls and leather products for five (5) years. Global does not warrant COM (Customer Own Materials) or graded-in materials (non-carded) and purchased by Global for a customer. For graded-in or COM products, please contact the textile supplier for performance information and warranty details. Please refer to our website at globalfurnituregroup.com for detailed information on cleaning and disinfecting procedures. Improper usage of disinfecting/cleaning products may void the warranty.

Global textiles and finishes are updated periodically to meet the demand and trends of the market. As a result, some textiles and finishes may be discontinued by Global or the manufacturer. In the event that a textile or finish is discontinued, Global will make every reasonable effort to provide an alternative product(s) of comparable function.

Global warrants that all commercial products are free from defects in material and workmanship, for the life of the product, to the original Purchaser.

Global will repair or replace, at Global's option, as the sole remedy for any defect covered by the warranty. The warranty applies to products manufactured after March 22, 2016.

Global makes no warranty that any of its products are suitable for any particular purpose and makes no other warranties, express or implied, other than those set out here. As codes and standards vary from one jurisdiction to another, references to compliance are solely for convenience and without any representation as to accuracy or suitability. Users must verify the suitability of such information or product for their specific application. In no event shall Global be liable in either tort or contract for any loss or direct, special, incidental, consequential, or exemplary damages.

Files, Desks, Modular Furniture, Tables, Panels & Accessories

Global warrants all components of metal storage and filing, laminate and wood veneer desks, laminate and wood veneer tables, metal leg components and panels for the lifetime of the product to the original purchaser.

The warranty applies to single shift, standard commercial usage, defined as a standard eight (8) hour day, forty (40) hour week. Load restrictions apply, refer to individual product descriptions.

Exceptions to the warranty for files/desks/tables and panels are as follows:

- Electrical devices, panel and tackboard textiles, adjustable keyboard mechanisms, non-electrical table mechanisms, monitor arms, lecterns, coat trees and task lights - five (5) years
- Laminate folding tables - one (1) year
- Motorized electrical components - two (2) years
- Keyless lock options - two (2) years

Files, Desks, Modular Furniture, Tables, Panels & Accessories Warranty Summary

Product Type	Components Warranty For Original Purchaser	Exceptions
Metal storage and filing	Lifetime	keyless lock options - 2 years
Laminate/wood veneer desks and modular furniture	Lifetime	tackboard textiles, electrical devices, task lights - 5 years
Boardroom, conference and training tables	Lifetime	electrical devices - 5 years moving parts - 5 years
Panels	Lifetime	panel textiles, electrical devices, task lights - 5 years
Coat racks and lecterns	5 years	none
Folding tables (laminate & molded)	1 year	none
Height adjustable tables	5 years	motorized parts (on electrical tables) - 2 years

Global's Warranty does not apply (for any product category) to the following:

- Nominal or normal amount of wear and tear that can occur over time
- Failures which result from negligence, abuse, accident or misuse
- Failure to apply, install or maintain products according to Global's written instructions and warnings
- Modifications, attachments or repair methods not approved by Global
- Damage caused by a carrier in transit, or delivery/installation contractors
- The matching of colors, grains or textures (wood, leather, etc.) of natural materials
- Products exposed to extreme hot or cold temperatures or excessively dry or humid environments
- Colorfastness or the matching of color of textiles, dye lots of textile can vary
- Damage by markings or staining; damage by sharp objects or imprinting from instruments
- Damage to textiles or laminate and wood surfaces/edges from exposure to sunlight (including UV rays)
- Products used for rental purposes
- Purchased parts are warranted for one (1) year
- Failure to follow specific cleaning and disinfecting instructions posted on globalfurnituregroup.com

Global's warranty does not cover the costs of transportation or labor. Repair or replacement will be at Global's option.

Global makes no warranty that any of its products are suitable for any particular purpose and makes no other warranties, express or implied, other than those set out here. As codes and standards vary from one jurisdiction to another, references to compliance are solely for convenience and without any representation as to accuracy or suitability. Users must verify the suitability of such information or product for their specific application. In no event shall Global be liable in either tort or contract for any loss or direct, special, incidental, consequential, or exemplary damages.

Global's warranty applies to products sold within the United States of America, Mexico, the Commonwealth of Puerto Rico and Canada.

Textiles and Finishes

Global textiles and finishes are updated periodically to meet the demand and trends of the market. As a result, some textiles and finishes may be discontinued by Global or the manufacturer. In the event that a textile or finish is discontinued, Global will make every reasonable effort to provide an alternative product(s) of comparable function.

Global US Headquarters/Distribution Center

17 West Stow Road, P.O. Box 562
 Marlton, New Jersey U.S.A. 08053
 T (856) 596-3390
 T (800) 220-1900

A \$25 net handling charge per shipment
 will be applied for non-UPSable orders of
 less than \$2,000 list.

Showrooms**Atlanta**

10 10th Street
 Suite 150
 Atlanta, GA 30309
 T (404) 879-0998

Boston

One Harbor Street
 Suite 104
 Boston, MA 02210
 T (617) 406-5435

Chicago

222 Merchandise
 Mart Plaza
 10th Floor, Suite 1035
 Chicago, IL 60654
 T (312) 755-0843

Miami

112 NE 41st Street
 6th floor
 Miami, FL 33137

New York City

386 Park Avenue South
 7th floor
 New York, NY 10016
 T (212) 545-9900

Philadelphia

1735 Market Street
 38th Floor
 Philadelphia PA, 19103
 T (215) 861-0963

New Jersey (Southern)

119 West Greentree Road
 Marlton, NJ 08053
 T (856) 596-3390

Phoenix

4675 E Cotton Center Blvd.
 Suite 165
 Phoenix, AZ 85040
 T (602) 426-0666
 T (602) 426-0777

Washington, DC

1130 Connecticut Avenue
 10th Floor, Suite 1000
 Washington, DC 20036
 T (202) 659-0230
 T (202) 659-0236

Distribution Centers**Atlanta Area**

6715 Maple Ave.
 Suite 100
 Buford, GA 30518
 T (678) 602-4130

Baltimore Area

Troy Hill
 Corporate Center
 7030 Troy Hill Drive
 Elkridge, MD 21075
 T (410) 379-8021

Boston Area

19 Connector Road
 Unit 1
 Andover, MA 01810
 T (978) 470-8463

Chicago Area

27W501 North Ave.
 Suite 300
 West Chicago, IL 60185
 T (630) 681-2818

Cincinnati Area

8712 LeSaint Drive
 Fairfield, OH 45014
 T (513) 777-0009

Dallas Area

2025 West Beltline Road
 #100
 Carrollton, TX 75006
 T (972) 236-1366

Denver Area

16401 East 33rd Drive
 Suite 50
 Aurora, CO 80011
 T (303) 340-1617

Ft. Lauderdale Area

560 Sawgrass
 Corporate Pkwy
 Sunrise, FL 33325
 T (954) 846-8888

Houston Area

7865 Northcourt Road
 Suite 200
 Houston, TX 77040
 T (713) 695-5777

Los Angeles Area

3629 Workman Mill Road
 Whittier, CA 90670
 T (562) 484-9686

Seattle Area

Oakesdale Commerce Ctr.
 820 Southwest 34th Street
 Building W7, Suite A
 Renton, WA 98057
 T (425) 291-9282

Kansas City Area

11617 West 81st Street
 Lenexa, KS 66214
 T (913) 310-9963

Tampa Area

10351 Windhorst Road
 Tampa, FL 33619
 T (813) 621-6272

