



evolve systems



ISO 14001:2004 Registered
CGSB #006b



level™
the BIFMA sustainability standard
SCS-SCF0245-4
SCS-SCF0245-4

PROTECTING THE ENVIRONMENT FOR FUTURE GENERATIONS

Our environmental success story began with the challenge to create an office system that would meet today's business requirements while maintaining a firm commitment to save and protect the environment.

Sustainability became a part of the creative focus and development of Evolve that incorporates the latest technology and design features to provide excellent performance at a competitive price.

As government and industry environment ratings such as LEEDS & Greenguard become more prevalent, Evolve offers designers and architects functional, attractive, and economical office designs that meet these standards.

Evolve is a leader in reducing waste in the manufacturing of its products as well as utilizing recycled materials wherever possible. We make extensive use of recycled plastic and wood waste from other Global factories.

Evolve is committed to the continuous improvement of our environmental systems, the prevention of pollution, and to comply with both the spirit and the letter of all relevant environmental legislation.

Evolve Panels are 100% recyclable at the end of their lifespan. Nothing from an Evolve Panel needs to end up in a landfill.

PRODUCT INFORMATION

Evolve offers fabrics that are made from 100% recycled polyester, which means less waste going to landfills. These fabrics also reduced the demand for petroleum products, and decrease the environmental impacts of processing those petroleum products into polyester.

Evolve has developed a Panel interior made from 100% recycled wood and polypropylene. Through innovative design and technology, Evolve utilizes waste that would have normally been sent to landfill.

Evolve Panels are insulated with Roxul, a mineral wood insulation made from slag, an inert steel by-product, and basalt rock. Roxul is a high density product that provides maximum sound absorption to reduce noise in the work environment. Roxul insulation is fire resistant, water repellent and will not support the growth of fungi or mildew.

Evolve's epoxy powder coating process involves no liquids and is solvent free. It contains no harmful VOC's or lead. Up to 99% of over sprayed powdered is reclaimed, mixed with virgin powder and reused.

BEAM

Power Beam

- All metal components are painted with environmentally friendly epoxy powder.
- Raceway Interiors are coated with recycled epoxy powder.
- The entire Evolve Power Beam and the processes used to manufacture it are designed to save and protect the environment. Evolve panels are made from recycled materials and are 100% recyclable.
- Components conform to CGSB and ANSI/BIFMA Standards
- The quality and performance level of these panels have been tested to equal or exceed the requirements of the U.S. Government.
- Power Beam has a steel frame and is 2 7/8" thick. Corner posts create a panel creep of 3 1/4".
- Leveling Glides extend 1 1/2" high.

Power Beam Options

- Power Beams are available in the following heights: 24", 30", and 36".
- Module widths come in seven (7) sizes: 36", 42", 48", 54", 60", 66" and 72"
- Straight, 90 Degree & 120 Degree

Extension Module Options

- Acoustic Fabric (Tackable), Glazed, Open, Laminate, Whiteboard, Air Flow.
- Attaches to the top of the Power Beam or another extension module (not to exceed 42"h above finished floor).
- Offered in 6", 12", and 18" heights
- Can be stacked up to 42" high above the finished floor (A.F.F.)

Beam Reconfiguration

- Extension Modules can be modified on site by replacing fabric modules with Glazed, Open, Laminate, Whiteboard or Air Flow at any time after the initial installation.
- Fabric can be replaced easily; using pre-cut segments of fabric, a drawstring (C-Jex) is sewn in around the edges. Then a rubber spline is used to 'screen' the fabric in place.

VOICE/DATA AND ELECTRICAL POWER

- NOTE: Panels and Electric components are CSA/UL approved. Tools are not required to install electrical in the Power Beam.

Electric Information

- Electric can be run in all three Power Beam heights (24"h, 30"h or 36"h)
 - 8-Wire, 4-Circuit Capability
 - 2 Utility + 2 Dedicated Circuits
 - 10 Gauge (oversized) Neutrals
- All circuits can support up to 20 amps (15 CSA)
- Contact Evolve customer care for additional wiring options.

Raceway Information

- Raceway knockouts sizes conform to the ANSI/TIA/EIA Furniture Opening Standard of 1.38" x 2.71".
- Power Beam raceway is available at 36"- 72" wide.
- 36"- 60" - 2 electric / 1 data on each side.
- 66" & 72" - 4 electric / 1 data on each side. (When specifying 4 duplexes on one side 2 i-connectors are required per side.)
- Standard data face mount plates can be used without the need of adapter plates (supplied by others).
- **Cabling Capacities** (calculations below are based on .25" diameter communication cables.)
- **Power Modules**
 - Without Electric – 65 Cables
 - With Electric – 54 Cables
- **Panel Connectors - 90 Degree Connector Posts**
 - Without Electric – 45 cables
 - With Electric – 25 Cables

WORK TABLES

Freestanding Tables

- Foli height adjustable (23" or 29"d)
- Bungee (20", 24" or 30"d)
- Junction (20", 24" or 30"d)
- 2gether (18" or 24"d)

- **Power Beam is a freestanding beam system and does not support attachment of an Evolve brackets or overhead storage including cantilevers or other support brackets.**

WARRANTIES AND PERFORMANCE

- A Lifetime Warranty
- Non Obsolescence Warranty
- Reduced cost of assembly and reconfiguration
- ISO9001:2000 Registered
- ISO14001:2004 Registered
- GreenGuard Certified
- ANSI/BIFMA CGSB testing on all products
- For piece of mind over the long term, we cover you with a comprehensive warranty that is supported by our dealer network.
- Some installation companies claim that the Evolve Panels System can be installed in half the time it takes to install most of our competitor's segmented panels. This cost saving can amount to thousands of dollars over the lifetime of our furniture.
- Your assurance of consistent quality to an international standard. Evolve Systems is committed to design, manufacture and distribute superior quality office furniture, which meets or exceeds the requirements of our customers.
- Confirmation that Evolve is committed (1) to providing product that, through their entire life cycle, minimize negative environmental impacts on the environment, (2) to continuous improvement to our environmental systems and programs and (3) to comply to all relevant environmental legislation and regulations.
- Evolve Systems can help a company meet LEED requirements for office furniture.
- Evolve components are tested to the highest standard in the industry. This is your assurance of quality and longevity.



TECHNICAL FEATURES OF POWER BEAM:

- Evolve Power Beam is 2 7/8" thick.
- An aluminum low profile top cap is included with Power Beams.
- Power Beam will accommodate 65 .25" diameter communication cables without electrical or 54 .25" diameter communication cables with electrical.
- 90-degree post extension accommodates 45 .25" diameter communication cables without electrical and 25 .25" diameter communication cables with electric.
- Raceway knockout openings are 1.38" x 2.71".

BASIC FEATURES OF POWER BEAM:

- Power Beam is available in three (3) heights: 24"h, 30"h and 36"h; and seven (7) widths: 36"w, 42"w, 48"w, 54"w, 60"w, 66"w and 72"w.
- There is no panel creep in a straight Beam-to-Beam configuration; however, a corner post (2, 3, 4 way) will add 3.25" inches to a beam run.

BASIC FEATURES OF EXTENSION MODULES:

- Extension modules stack on the top of a Power Beam or another extension module (maximum height - 42"h, above finished floor).
- Fabric extension modules may have different fabrics on opposite sides within the same grade with no up-charge.
- If different grades of fabric are used on one module, the entire modules will be priced utilizing the fabric with the highest grade.

GENERAL WARRANTY INFORMATION:

- Panel and tackboard textiles, adjustable keyboard mechanisms, tasklights and electrical devices = ten (10) Years
- Other parts = Lifetime Warranty

POWER BEAM

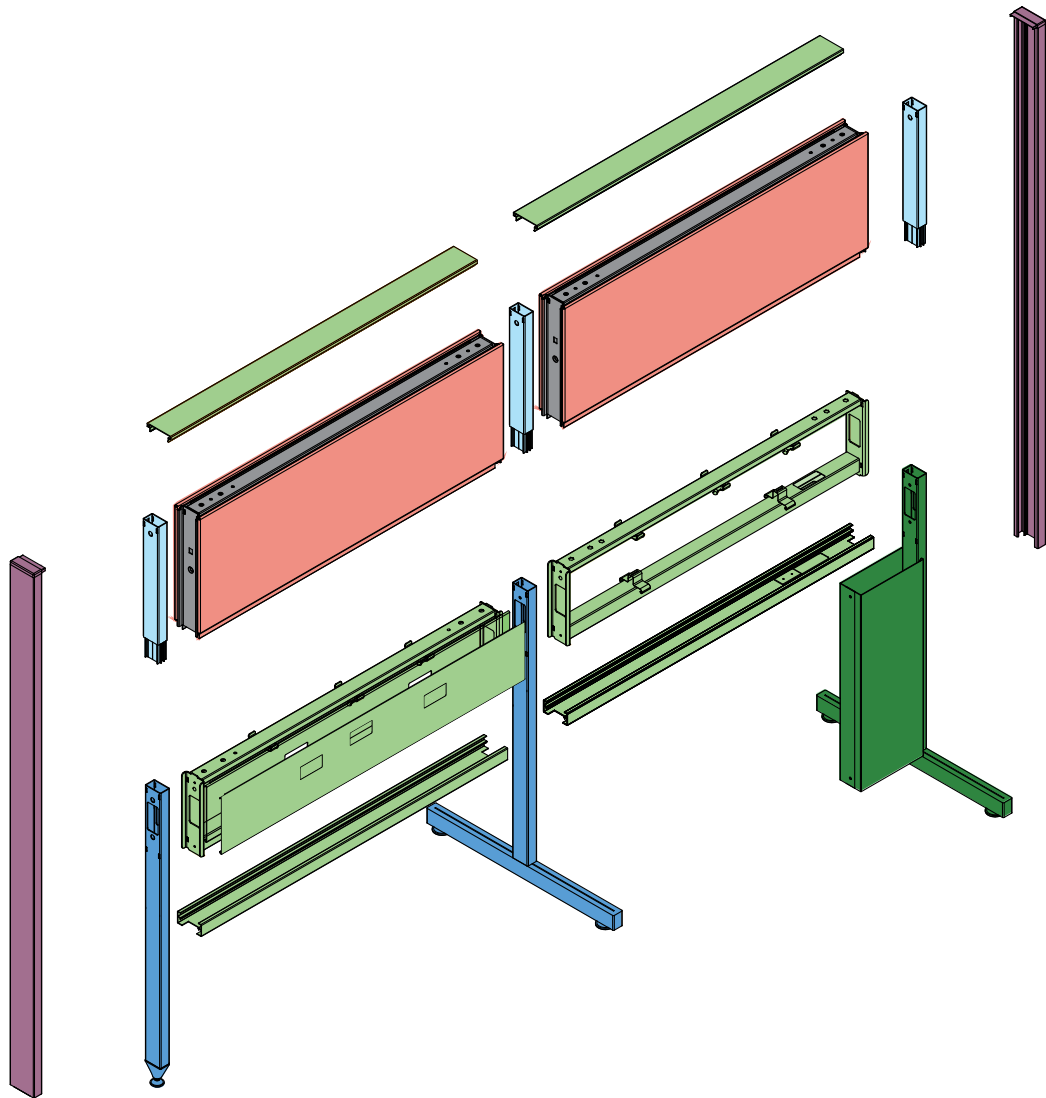

**POWER BEAM
RACEWAY**



**VERTICAL
BASE INFEED
COVER**



LEGS



**EXTENSION
MODULE
CONNECTOR**



**EXTENSION
MODULE**



**END OF RUN
TRIM**

EXTENSION MODULE MATERIALS

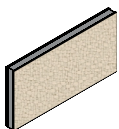

FABRIC



LAMINATE

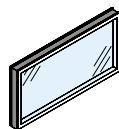

GLASS



WRITE BOARD

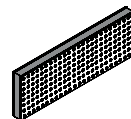

AIRFLOW

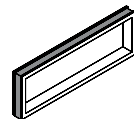

OPEN



POWER BEAM KITS

EVPBE - 6" HIGH POWER BEAM KIT WITH ELECTRICAL CUTOUT FOR BASE INFEED (36"W TO 60"W)

- Power beam with bottom cut out (on one end) for base infeed
- Aluminum top trim and bottom trim included
- Bottom trim has a cut out on one side for electrical access and a bracket to connect to the vertical base infeed cover (ordered separately)
- Vertical base infeed cover with support leg ordered separately

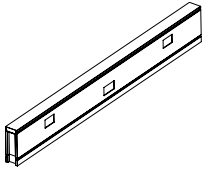
DESCRIPTION	PRODUCT CODE	LIST PRICE LP	DIMENSIONS/INCHES		
			H	W	D
	EVPBE36	247	6	36	2 7/8
	EVPBE42	268	6	42	2 7/8
	EVPBE48	291	6	48	2 7/8
	EVPBE54	318	6	54	2 7/8
	EVPBE60	330	6	60	2 7/8

EVPBE - 6" HIGH POWER BEAM KIT WITH ELECTRICAL CUT OUT FOR BASE INFEED (66"W AND 72"W)

- Power beam with bottom cut out (on one end) for base infeed
- Aluminum top trim and bottom trim included
- Bottom trim has a cut out on one side for electrical access and a bracket to connect to the vertical base infeed cover (ordered separately)
- Vertical base infeed cover with support leg ordered separately

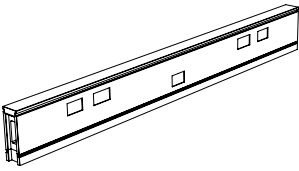
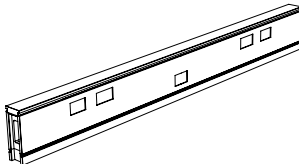
DESCRIPTION	PRODUCT CODE	LIST PRICE LP	DIMENSIONS/INCHES		
			H	W	D
	EVPBE66	530	6	66	2 7/8
	EVPBE72	551	6	72	2 7/8

POWER BEAM KITS

EVPB - 6" HIGH POWER BEAM RACEWAY (36"W TO 60"W)

- Aluminum top trim and bottom trim included
- No access for base infeed
- Support legs ordered separately

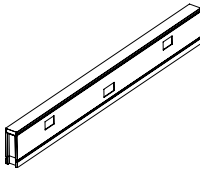

DESCRIPTION	PRODUCT CODE	LIST PRICE LP	DIMENSIONS/INCHES		
			H	W	D
	EVPB36	236	6	36	2 7/8
	EVPB42	251	6	42	2 7/8
	EVPB48	274	6	48	2 7/8
	EVPB54	299	6	54	2 7/8
	EVPB60	312	6	60	2 7/8

EVPB - 6" HIGH POWER BEAM RACEWAY (66"W AND 72"W)

- 66" Power Beam Kit consists of (1) 30" Power Beam and (1) 36" Power Beam Inline connector and hardware included
- 72" Power Beam Kit consists of (1) 36" Power Beam and (1) 36" Power Beam with bottom cut out for a base feed. Inline connector and hardware included
- One piece aluminum top trim and one piece aluminum bottom trim included
- No access for base infeed
- Support legs ordered separately

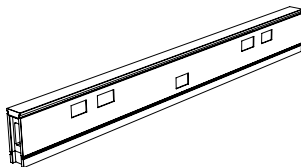
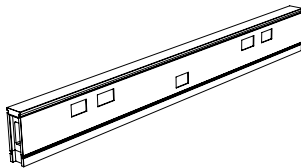

DESCRIPTION	PRODUCT CODE	LIST PRICE LP	DIMENSIONS/INCHES		
			H	W	D
	EVPB66	502	6	66	2 7/8
	EVPB72	521	6	72	2 7/8

EVPBEP - POWER BEAM WITH ELECTRICAL CUT OUT FOR PASS THROUGH CABINET

- Power beam with electrical cut out for base feed from pass through cabinet
- Aluminum top trim included
- 60" Power beam kit includes two 30" power distribution housing (EVE8PD30) and jumper cable (EVE8CP17)
- 72" Power beam kit includes two 36" power distribution housing (EVE8PD36) and jumper cable (EVE8CP17)
- Provides two duplex receptacle per panel side
- Power beam base feed to be ordered separately
- Power Beam Storage cabinet with pass through needs to be ordered separately (EVPBSCGDP or EVPBSCP) See page 34

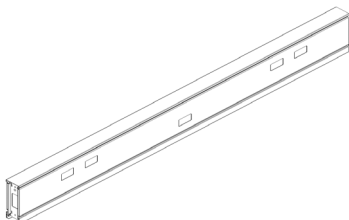

DESCRIPTION	PRODUCT CODE	LIST PRICE LP	DIMENSIONS/INCHES		
			H	W	D
	EVPBEP60KIT	816	6	60	2 7/8
	EVPBEP72KIT	1082	6	72	2 7/8

NOTE: To be used with cable pass through cabinet



POWER BEAM KITS / VERTICAL BASE INFEED COVER W/LEG

EVPBEP - POWER BEAM WITH ELECTRICAL CUT OUT FOR PASS THROUGH CABINET

- Power beam with electrical cut out for base feed from pass through cabinet
- Aluminum top trim included
- 60" Power beam kit includes two 30" raceway covers per side
- 72" Power beam kit includes two 36" raceway covers per side
- 60" Power beam kit includes two 30" power distribution housing (EVE8PD30) and jumper cable (EVE8CP17)
- 72" Power beam kit includes two 36" power distribution housing (EVE8PD36) and jumper cable (EVE8CP17)
- Provides four duplex receptacle per panel side
- Power beam base feed to be ordered separately
- Power Beam Storage cabinet with pass through be ordered separately (EVPBSCGDP or EVPBSCP)

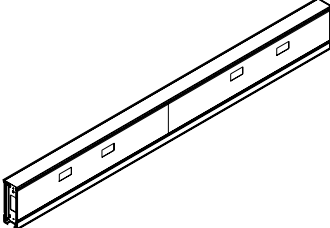
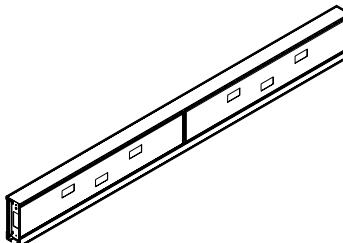
DESCRIPTION	PRODUCT CODE	LIST PRICE LP	DIMENSIONS/INCHES		
			H	W	D
	EVPBEP60KIT01	837	6	60	2 7/8
	EVPBEP72KIT01	1082	6	72	2 7/8

NOTE: To be used with cable pass through cabinet

EVPBFCL - VERTICAL BASE INFEED COVER INCLUDING SUPPORT LEG WITH FOOT

- Connects to Power Beam Kit with electrical cut out
- Includes vertical cover and slotted connector support leg with foot
- Power Beam kit with electrical cut out ordered separately
- Base infeed ordered separately

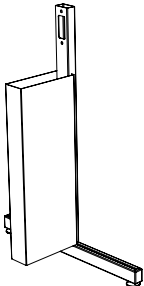
DESCRIPTION	PRODUCT CODE	LIST PRICE LP	DIMENSIONS/INCHES		
			H	W	D
	EVPBFCL24	200	24	6	18
	EVPBFCL30	224	30	6	18
	EVPBFCL36	246	36	6	18

VERTICAL BASE INFEED COVER W/LEG FOR NY POWER BOX ENTRY

EVPBFCSL - VERTICAL BASE POWER FEED COVER WITH SINGLE LEG

- Connects to electrical cut out power beam
- Includes vertical covers and slotted connector with single leg
- For one sided Power beam application
- Laminate end panels must be attached to single leg at end of power beam run for stability
- Laminate end panels to be ordered separately
- End of run trim below power beam included
- Power beam with electrical cut out to be ordered separately

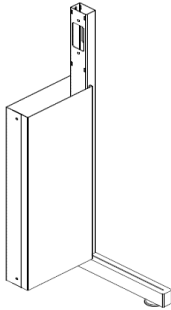

DESCRIPTION	PRODUCT CODE	LIST PRICE LP	DIMENSIONS/INCHES		
			H	W	D
	EVPBFCSL24	200	24	15	
	EVPBFCSL30	225	30	15	
	EVPBFCSL36	246	36	15	

EVPBFBG - VERTICAL BASE INFEED COVER INCLUDING SUPPORT LEG WITH GLIDE

- Connects to Power Beam Kit with electrical cut out
- Includes vertical cover and slotted connector support leg with glide
- Power Beam Kit with electrical cut out ordered separately
- Base infeed ordered separately



DESCRIPTION	PRODUCT CODE	LIST PRICE LP	DIMENSIONS/INCHES		
			H	W	D
	EVPBFCG24	168	24	6	2 7/8
	EVPBFCG30	191	30	6	2 7/8
	EVPBFCG36	215	36	6	2 7/8

EVPBFCLXXNY - VERTICAL COVER WITH LEG FOR NY BOX POWER ENTRY

- Connects to electrical cut out power beam
- Includes vertical covers and slotted connector with leg
- End of run trim below power beam included
- Power Beam with electrical cut out to be ordered separately

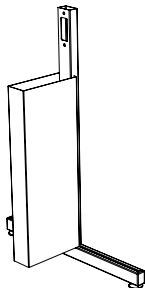

DESCRIPTION	PRODUCT CODE	LIST PRICE LP	DIMENSIONS/INCHES		
			H	W	D
	EVPBFCL24NY	200	24	6	21
	EVPBFCL30NY	224	30	6	21
	EVPBFCL36NY	246	36	6	21



VERTICAL BASE INFEED COVER W/LEG FOR NY POWER BOX ENTRY / SUPPORT LEGS

EVPBFBGXXNY - VERTICAL COVER WITH GLIDE FOR NY BOX POWER ENTRY

- Connects to Power Beam Kit with electrical cut out.
- Includes vertical covers and slotted connector with glide base.
- End of run trim below power beam included.
- Power Beam with electrical cut out to be ordered seperately.



DESCRIPTION	PRODUCT CODE	LIST PRICE LP	DIMENSIONS/INCHES		
			H	W	D
	EVPBFCG24NY	168	24	6	2 7/8
	EVPBFCG30NY	191	30	6	2 7/8
	EVPBFCG36NY	215	36	6	2 7/8

EVPBL - POWER BEAM CONNECTOR SUPPORT LEG WITH FOOT

- Connects two Power Beams in a straight run.
- 24" h -- 18" open to floor
- 30" h -- 24" open to floor
- 36" h -- 30" open to floor

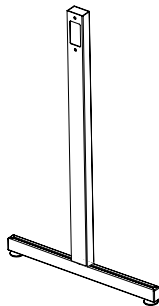

DESCRIPTION	PRODUCT CODE	LIST PRICE LP	DIMENSIONS/INCHES		
			H	W	D
	EVPBL24	99	24	18	
	EVPBL30	104	30	18	
	EVPBL36	109	36	18	

EVPBLFF - POWER BEAM LEG WITH FLAT FOOT

- Connects two Power Beams on equal height.
- Includes connector with flat foot, connecting hardware.
- Note: Leg has to be used next to Post legs with glides. When specifying please keep sequence post leg with glide, leg with flat foot, post leg with glide. Only post legs with glide provides adjustment for leveling power beams run.

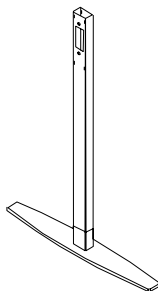

DESCRIPTION	PRODUCT CODE	LIST PRICE LP	DIMENSIONS/INCHES		
			H	W	D
	EVPBLFF24	117	24	21	
	EVPBLFF30	123	30	21	
	EVPBLFF36	131	36	21	

SUPPORT LEGS

EVPBSL - POWER BEAM SINGLE LEG

- Connects two Power Beams in a straight run.
- Includes non slotted connector with leg, glides and connecting hardware
- For one sided Power beam application
- Laminate end panels must be attached to single leg at end of power beam run for stability
- Laminate end panels to be ordered separately

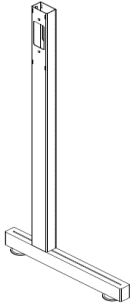
DESCRIPTION	PRODUCT CODE	LIST PRICE LP	DIMENSIONS/INCHES		
			H	W	D
	EVPBSL24	99	24	15	
	EVPBSL30	104	30	15	
	EVPBSL36	109	36	15	

EVPBCB - POWER BEAM CONNECTOR SUPPORT LEG WITH GLIDE

- Connects two Power Beams in a straight run.
- 24" h -- 18" open to floor
- 30" h -- 24" open to floor
- 36" h -- 30" open to floor

DESCRIPTION	PRODUCT CODE	LIST PRICE LP	DIMENSIONS/INCHES		
			H	W	D
	EVPBGICB24	66	24	2	
	EVPBGICB30	72	30	2	
	EVPBGICB36	77	36	2	

EVPB24CPA - ONE WAY POST WITH T LEG FOR 24" H POWER BEAM

- One way post attaches to end of power beam run
- Post and connecting hardware add 3.25" to power beam run
- Includes post, power beam T leg, post with trim all around, levelling glide, hardware and trim kit
- Includes two floor mount plates to secure post to floor

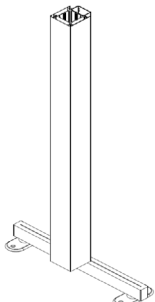
DESCRIPTION	PRODUCT CODE	LIST PRICE LP	DIMENSIONS/INCHES		
			H	W	D
	EVPB24CPA124	310	24	3	2 7/8
	EVPB24CPA130	328	30	3	2 7/8
	EVPB24CPA136	340	36	3	2 7/8
	EVPB24CPA142	385	42	3	2 7/8



SUPPORT LEGS / CORNER POST - 90-DEGREE

EVPB30CPA - ONE WAY POST WITH T LEG FOR 30" H POWER BEAM

- One way post attaches to end of power beam run
- Post and connecting hardware add 3.25" to power beam run
- Includes post, power beam T leg, post with trim all around, levelling glide, hardware and trim kit
- Includes two floor mount plates to secure post to floor

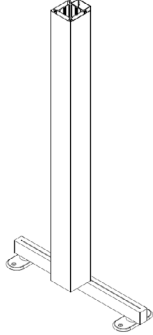
DESCRIPTION	PRODUCT CODE	LIST PRICE LP	DIMENSIONS/INCHES		
			H	W	D
	EVPB30CPA130	328	30	3	2 7/8
	EVPB30CPA136	340	36	3	2 7/8
	EVPB30CPA142	385	42	3	2 7/8

EVPB36CPA - ONE WAY POST WITH T LEG FOR 36" H POWER BEAM

- One way post attaches to end of power beam run
- Post and connecting hardware add 3.25" to power beam run
- Includes post, power beam T leg, post with trim all around, levelling glide, hardware and trim kit
- Includes two floor mount plates to secure post to floor

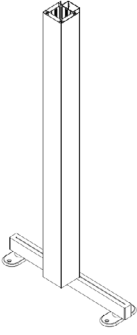
DESCRIPTION	PRODUCT CODE	LIST PRICE LP	DIMENSIONS/INCHES		
			H	W	D
	EVPB36CPA136	340	36	3	2 7/8
	EVPB36CPA142	385	42	3	2 7/8

EVPBCEPLA - POWER BEAM 2 WAY CORNER POST

- Connects two power beams of equal height in 90 degree configuration
- Post and connecting hardware add 3.25" to power beam run
- Includes one post, two nonslotted power beam connectors, post with trim all around, levelling glide, hardware and trim kit

DESCRIPTION	PRODUCT CODE	LIST PRICE	DIMENSIONS/INCHES		
			H	W	D
	EVPBCEPLA224	159	24	3	3
	EVPBCEPLA230	164	30	3	3
	EVPBCEPLA236	172	36	3	3

CORNER POST - 90-DEGREE

EVPBCEPLA - POWER BEAM 3 WAY CORNER POST

- Connects three power beams of equal height in 90 degree configuration
- Post and connecting hardware add 3.25" to power beam run
- Includes one post, three nonslotted power beam connectors, post with trim all around, levelling glide, hardware and trim kit

DESCRIPTION	PRODUCT CODE	LIST PRICE	DIMENSIONS/INCHES		
			H	W	D
	EVPBCEPLA324	174	24	3	3
	EVPBCEPLA330	181	30	3	3
	EVPBCEPLA336	190	36	3	3

EVPBCEPLA - POWER BEAM 4 WAY CORNER POST

- Includes one post, four nonslotted power beam connectors, post with trim all around, levelling glide, hardware and trim kit
- Connects four power beams of equal height in 90 degree configuration
- Post and connecting hardware add 3.25" to power beam run

DESCRIPTION	PRODUCT CODE	LIST PRICE	DIMENSIONS/INCHES		
			H	W	D
	EVPBCEPLA424	208	24	3	3
	EVPBCEPLA430	223	30	3	3
	EVPBCEPLA436	229	36	3	3

EVPBCIPLA - POWER BEAM INLINE 2 WAY CORNER POST

- Connects two power beams of equal height in inline configuration
- Post and connecting hardware add 3.25" to power beam run
- Includes one post, two nonslotted power beam connectors, post with trim all around, levelling glide, hardware and trim kit

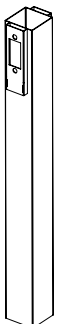
DESCRIPTION	PRODUCT CODE	LIST PRICE	DIMENSIONS/INCHES		
			H	W	D
	EVPBCIPLA224	159	24	3	3
	EVPBCIPLA230	164	30	3	3
	EVPBCIPLA236	172	36	3	3



CORNER POST - 90-DEGREE

EVPB24CPA - PANEL TO 24" H POWER BEAM 2 WAY CORNER POST

- Connects one panel and one 24" H power beam in 90 degree configuration
- Includes post, panel connectors and power beam connectors, post with trim all around, levelling glide, hardware and trim kit
- Post and connecting hardware add 3.25" to power beam run
- Pass thru only for power beam

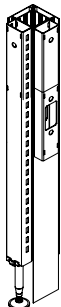
DESCRIPTION	PRODUCT CODE	LIST PRICE LP	DIMENSIONS/INCHES		
			H	W	D
	EVPB24CPA230	161	30	3	3
	EVPB24CPA236	199	36	3	3
	EVPB24CPA242	199	42	3	3

EVPB30CPA - PANEL TO 30" H POWER BEAM 2 WAY CORNER POST

- Connects one panel and one 30" H power beam in 90 degree configuration
- Includes post, panel connectors and power beam connectors, post with trim all around, levelling glide, hardware and trim kit
- Post and connecting hardware add 3.25" to power beam run
- Pass thru only for power beam

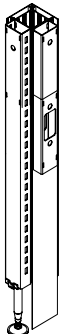
DESCRIPTION	PRODUCT CODE	LIST PRICE	DIMENSIONS/INCHES		
			H	W	D
	EVPB30CPA230	161	30	3	3
	EVPB30CPA236	199	36	3	3
	EVPB30CPA242	199	42	3	3

EVPB36CPA - PANEL TO 36" H POWER BEAM 2 WAY CORNER POST

- Connects one panel and one 36" H power beam in 90 degree configuration
- Includes post, panel connectors and power beam connectors, post with trim all around, levelling glide, hardware and trim kit
- Post and connecting hardware add 3.25" to power beam run
- Pass thru only for power beam

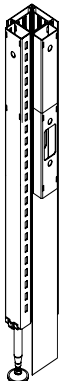
DESCRIPTION	PRODUCT CODE	LIST PRICE	DIMENSIONS/INCHES		
			H	W	D
	EVPB36CPA236	199	36	3	3
	EVPB36CPA242	199	42	3	3

CORNER POST - 90-DEGREE

EVPB24CPA - PANEL TO 24" H POWER BEAM 3 WAY CORNER POST

- Connects two panels and one 24" H power beam in 90 degree configuration
- Includes post, panel connectors and power beam connectors, post with trim all around, levelling glide, hardware and trim kit
- Post and connecting hardware add 3.25" to power beam run
- Pass thru only for power beam

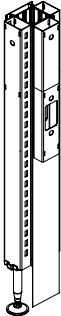
DESCRIPTION	PRODUCT CODE	LIST PRICE LP	DIMENSIONS/INCHES		
			H	W	D
	EVPB24CPA330	198	30	3	3
	EVPB24CPA336	257	36	3	3
	EVPB24CPA342	257	42	3	3

EVPB30CPA - PANEL TO 30" H POWER BEAM 3 WAY CORNER POST

- Connects two panels and one 30" H power beam in T degree configuration
- Includes post, panel connectors and power beam connectors, post with trim all around, levelling glide, hardware and trim kit
- Post and connecting hardware add 3.25" to power beam run
- Pass thru only for power beam

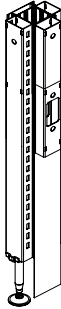
DESCRIPTION	PRODUCT CODE	LIST PRICE	DIMENSIONS/INCHES		
			H	W	D
	EVPB30CPA330	198	30	3	3
	EVPB30CPA336	264	36	3	3
	EVPB30CPA342	264	42	3	3

EVPB36CPA - PANEL TO 36" H POWER BEAM 3 WAY CORNER POST

- Connects two panels and one 36" H power beams in T degree configuration
- Includes post, panel connectors and power beam connectors, post with trim all around, levelling glide, hardware and trim kit
- Post and connecting hardware add 3.25" to power beam run
- Pass thru only for power beam

DESCRIPTION	PRODUCT CODE	LIST PRICE	DIMENSIONS/INCHES		
			H	W	D
	EVPB36CPA336	264	36	3	3
	EVPB36CPA342	264	42	3	3



CORNER POST - 90-DEGREE

EVPB24CPA - PANEL TO 24" H POWER BEAM 3 WAY CORNER POST

- Connects two 24" H power beams with panel in T configuration
- Includes post, panel connectors and power beam connectors, post with trim all around, levelling glide, hardware and trim kit
- Post and connecting hardware add 3.25" to power beam run
- Pass thru only for power beam

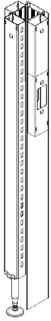
DESCRIPTION	PRODUCT CODE	LIST PRICE LP	DIMENSIONS/INCHES		
			H	W	D
	EVPB24CPA330P	198	30	3	3
	EVPB24CPA336P	264	36	3	3
	EVPB24CPA342P	264	42	3	3

EVPB30CPA - PANEL TO 30" H POWER BEAM 3 WAY CORNER POST

- Connects two 30" H power beams with panel in T configuration
- Includes post, panel connectors and power beam connectors, post with trim all around, levelling glide, hardware and trim kit
- Post and connecting hardware add 3.25" to power beam run
- Pass thru only for power beam

DESCRIPTION	PRODUCT CODE	LIST PRICE	DIMENSIONS/INCHES		
			H	W	D
	EVPB30CPA330P	198	30	3	3
	EVPB30CPA336P	264	36	3	3
	EVPB30CPA342P	264	42	3	3

EVPB36CPA - PANEL TO 36" H POWER BEAM 3 WAY CORNER POST

- Connects two panels and two 36" H power beams in T configuration
- Includes post, panel connectors and power beam connectors, post with trim all around, levelling glide, hardware and trim kit
- Post and connecting hardware add 3.25" to power beam run
- Pass thru only for power beam

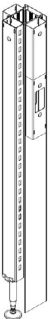
DESCRIPTION	PRODUCT CODE	LIST PRICE	DIMENSIONS/INCHES		
			H	W	D
	EVPB36CPA336P	264	24	3	3
	EVPB36CPA342P	264	30	3	3

CORNER POST - 90-DEGREE

EVPB24CPA - PANEL TO 24" H POWER BEAM 4 WAY CORNER POST

- Connects two panels and two 24" H power beams in X configuration
- Includes post, panel connectors and power beam connectors, post with trim all around, levelling glide, hardware and trim kit
- Post and connecting hardware add 3.25" to power beam run
- Pass thru only for power beam

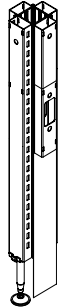
DESCRIPTION	PRODUCT CODE	LIST PRICE LP	DIMENSIONS/INCHES		
			H	W	D
	EVPB24CPA430	243	30	3	3
	EVPB24CPA436	310	36	3	3
	EVPB24CPA442	310	42	3	3

EVPB30CPA - PANEL TO 30" H POWER BEAM 4 WAY CORNER POST

- Connects two panels and two 30" H power beams in X configuration
- Includes post, panel connectors and power beam connectors, post with trim all around, levelling glide, hardware and trim kit
- Post and connecting hardware add 3.25" to power beam run
- Pass thru only for power beam

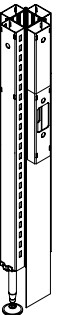
DESCRIPTION	PRODUCT CODE	LIST PRICE	DIMENSIONS/INCHES		
			H	W	D
	EVPB30CPA430	243	30	3	3
	EVPB30CPA436	310	36	3	3
	EVPB30CPA442	310	42	3	3

EVPB36CPA - PANEL TO 36" H POWER BEAM 4 WAY CORNER POST

- Connects two panels and two 36" H power beams in X configuration
- Includes post, panel connectors and power beam connectors, post with trim all around, levelling glide, hardware and trim kit
- Post and connecting hardware add 3.25" to power beam run
- Pass thru only for power beam

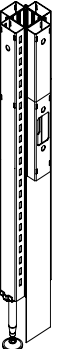
DESCRIPTION	PRODUCT CODE	LIST PRICE	DIMENSIONS/INCHES		
			H	W	D
	EVPB36CPA436	310	24	3	3
	EVPB36CPA442	310	30	3	3



CORNER POST - 120-DEGREE

EVPB6CEPLA - POWER BEAM 2-WAY 120-DEGREE CORNER POST

- Connects two power beams of equal height in 120 degree configuration
- Includes one post, two nonslotted power beam connectors, post with trim all around, levelling glide, hardware and trim kit

DESCRIPTION	PRODUCT CODE	LIST PRICE	DIMENSIONS/INCHES		
			H	W	D
	EVPB6CEPLA224	184	24	3	3
	EVPB6CEPLA230	190	30	3	3
	EVPB6CEPLA236	199	36	3	3

EVPB6CEPLA - POWER BEAM 3-WAY 120-DEGREE CORNER POST

- Connects three power beams of equal height in 120 degree configuration
- Includes one post, three nonslotted power beam connectors, post with trim all around, levelling glide, hardware and trim kit

DESCRIPTION	PRODUCT CODE	LIST PRICE	DIMENSIONS/INCHES		
			H	W	D
	EVPB6CEPLA324	200	24	3	3
	EVPB6CEPLA330	206	30	3	3
	EVPB6CEPLA336	215	36	3	3

EXTENSION CONNECTORS / POSTS

EVPBIEC - EXTENSION CONNECTOR FOR POWER BEAM

- Attaches to power beam connector
- Includes non slotted extension connector and connecting hardware
- Must be attached to power beam connector with provided screw before installing power beam

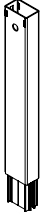
DESCRIPTION	PRODUCT CODE	LIST PRICE	DIMENSIONS/INCHES		
			H	W	D
	EVPBIEC06	44	6	2 7/8	
	EVPBIEC12	44	12	2 7/8	
	EVPBIEC18	52	18	2 7/8	
	EVPBIEC24	52	24	2 7/8	

EVPBCEPA1 - POWER BEAM CORNER EXTENSION POST 1 WAY

- Connects at end of a run of extension modules
- Post and connecting hardware add 3.25" to power beam run
- Includes one extension post, one non slotted extension connectors for power beam, connecting hardware and trim kit
- Power Beam Corner Extension Post are not stackable

DESCRIPTION	PRODUCT CODE	LIST PRICE	DIMENSIONS/INCHES		
			H	W	D
	EVPBCEPA106	81	6	3	3
	EVPBCEPA112	81	12	3	3
	EVPBCEPA118	103	18	3	3
	EVPBCEPA124	103	24	3	3

EVPBCEIPA2 - POWER BEAM INLINE 2 WAY CORNER EXTENSION POST

- Connects two extension modules in inline configuration
- Post and connecting hardware add 3.25" to power beam run
- Includes one extension post, two non slotted extension connectors for power beam, connecting hardware and trim kit
- Power Beam Corner Extension Post are not stackable

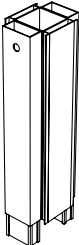
DESCRIPTION	PRODUCT CODE	LIST PRICE	DIMENSIONS/INCHES		
			H	W	D
	EVPBCEIPA206	88	6	3	3
	EVPBCEIPA212	88	12	3	3
	EVPBCEIPA218	143	18	3	3
	EVPBCEIPA224	143	24	3	3



CORNER EXTENSION POST - 90 - DEGREE

EVPBCEPA2 - POWER BEAM CORNER EXTENSION POST 2 WAY

- Connects two extension modules in 90 degree configuration
- Post and connecting hardware add 3.25" to power beam run
- Includes one extension post, two non slotted extension connectors for power beam , connecting hardware and trim kit
- Power Beam Corner Extension Post are not stackable

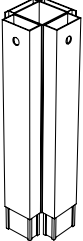
DESCRIPTION	PRODUCT CODE	LIST PRICE	DIMENSIONS/INCHES		
			H	W	D
	EVPBCEPA206	83	6	3	3
	EVPBCEPA212	83	12	3	3
	EVPBCEPA218	131	18	3	3
	EVPBCEPA224	131	24	3	3

EVPBCEPA3 - POWER BEAM CORNER EXTENSION POST 3 WAY

- Connects three extension modules in 90 degree configuration
- Post and connecting hardware add 3.25" to power beam run
- Includes one extension post, three non slotted extension connectors for power beam , connecting hardware and trim kit
- Power Beam Corner Extension Post are not stackable

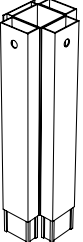
DESCRIPTION	PRODUCT CODE	LIST PRICE	DIMENSIONS/INCHES		
			H	W	D
	EVPBCEPA306	100	6	3	3
	EVPBCEPA312	100	12	3	3
	EVPBCEPA318	154	18	3	3
	EVPBCEPA324	154	24	3	3

EVPBCEP4 - POWER BEAM CORNER EXTENSION POST 4 WAY

- Connects four extension modules in 90 degree configuration
- Post and connecting hardware add 3.25" to power beam run
- Includes one extension post, four non slotted extension connectors for power beam connecting hardware and trim kit
- Power Beam Corner Extension Post are not stackable

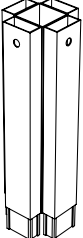
DESCRIPTION	PRODUCT CODE	LIST PRICE	DIMENSIONS/INCHES		
			H	W	D
	EVPBCEP406	115	6	3	3
	EVPBCEP412	115	12	3	3
	EVPBCEP418	170	18	3	3
	EVPBCEP424	170	24	3	3

CORNER EXTENSION POST - 120 - DEGREE

EVPB6CEPA1 - POWER BEAM 120 DEGREE CORNER EXTENSION POST 1 WAY

- Connects one extension module in 120 degree configuration
- Includes one extension post, three non slotted extension connectors for power beam , connecting hardware and trim kit
- Power Beam Corner Extension Post are not stackable

DESCRIPTION	PRODUCT CODE	LIST PRICE	DIMENSIONS/INCHES		
			H	W	D
	EVPB6CEPA124	134	24	3	3

EVPB6CEPA2 - POWER BEAM 120-DEGREE CORNER EXTENSION POST 2 WAY

- Connects two extension modules in 120 degree configuration
- Includes one extension post, two non slotted extension connectors for power beam , connecting hardware and trim kit
- Power Beam Corner Extension Post are not stackable

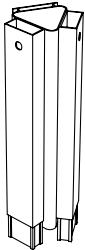
DESCRIPTION	PRODUCT CODE	LIST PRICE	DIMENSIONS/INCHES		
			H	W	D
	EVPB6CEPA206	83	6	3	3
	EVPB6CEPA212	83	12	3	3
	EVPB6CEPA218	129	18	3	3
	EVPB6CEPA224	129	24	3	3

EVPB6CEP3 - POWER BEAM 120 DEGREE CORNER EXTENSION POST 3 WAY

- Connects three extension modules in 120 degree configuration
- Includes one extension post, three non slotted extension connectors for power beam , connecting hardware and trim kit
- Power Beam Corner Extension Post are not stackable

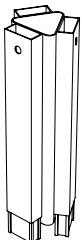
DESCRIPTION	PRODUCT CODE	LIST PRICE	DIMENSIONS/INCHES		
			H	W	D
	EVPB6CEP306	99	6	3	3
	EVPB6CEP312	99	12	3	3
	EVPB6CEP318	154	18	3	3
	EVPB6CEP324	154	24	3	3



POWER BEAM FLX

EVPB24CPSANR - NR PANEL TO 24"H POWER BEAM 4 WAY CORNER POST

- Connects two NR panels and two 24"H power beams in 90 degree configuration
- Post and connecting hardware ad 3.25" to power beam run
- Includes post, panel connectors and power beam connectors, post with trim all around, levelling glide, hardware and trim kit. Pass through only for power beam, power beam leg slotted

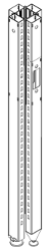
DESCRIPTION	PRODUCT CODE	LIST PRICE	DIMENSIONS/INCHES		
			H	W	D
	EVPB24CPSA430NR	242	30	3	3
	EVPB24CPSA436NR	310	36	3	3
	EVPB24CPSA442NR	310	42	3	3

EVPB30CPSANR - NR PANEL TO 30"H POWER BEAM 4 WAY CORNER POST

- Connects two NR panels and two 30"H power beams in 90 degree configuration
- Post and connecting hardware ad 3.25" to power beam run
- Includes post, panel connectors and power beam connectors, post with trim all around, levelling glide, hardware and trim kit. Pass through only for power beam, power beam leg slotted

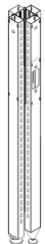
DESCRIPTION	PRODUCT CODE	LIST PRICE	DIMENSIONS/INCHES		
			H	W	D
	EVPB30CPSA430NR	242	30	3	3
	EVPB30CPSA436NR	310	36	3	3
	EVPB30CPSA442NR	310	42	3	3

EVPB36CPSANR - NR PANEL TO 36"H POWER BEAM 4 WAY CORNER POST

- Connects two NR panels and two 36"H power beams in 90 degree configuration
- Post and connecting hardware ad 3.25" to power beam run
- Includes post, panel connectors and power beam connectors, post with trim all around, levelling glide, hardware and trim kit. Pass through only for power beam, power beam leg slotted

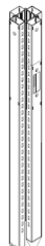
DESCRIPTION	PRODUCT CODE	LIST PRICE	DIMENSIONS/INCHES		
			H	W	D
	EVPB36CPSA436NR	310	36	3	3
	EVPB36CPSA442NR	310	42	3	3

POWER BEAM FLX

EVPB24CPSANR - NR PANEL TO 24"H POWER BEAM 3 WAY CORNER POST

- Connects NR panels and 24"H power beams in 90 degree configuration
- Post and connecting hardware ad 3.25" to power beam run
- Includes post, panel connectors and power beam connectors, post with trim all around, levelling glide, hardware and trim kit. Pass through only for power beam, power beam leg slotted

DESCRIPTION	PRODUCT CODE	LIST PRICE	DIMENSIONS/INCHES		
			H	W	D
	EVPB24CPSA330NR	197	30	3	3
	EVPB24CPSA336NR	263	36	3	3
	EVPB24CPSA342NR	263	42	3	3

EVPB24CPSANR - NR PANEL TO 30"H POWER BEAM 3 WAY CORNER POST

- Connects NR panels and 30"H power beams in 90 degree configuration
- Post and connecting hardware ad 3.25" to power beam run
- Includes post, panel connectors and power beam connectors, post with trim all around, levelling glide, hardware and trim kit. Pass through only for power beam, power beam leg slotted

DESCRIPTION	PRODUCT CODE	LIST PRICE	DIMENSIONS/INCHES		
			H	W	D
	EVPB30CPSA330NR	197	30	3	3
	EVPB30CPSA336NR	263	36	3	3
	EVPB30CPSA342NR	263	42	3	3

EVPB24CPSANR - NR PANEL TO 36"H POWER BEAM 3 WAY CORNER POST

- Connects NR panels and 36"H power beams in 90 degree configuration
- Post and connecting hardware ad 3.25" to power beam run
- Includes post, panel connectors and power beam connectors, post with trim all around, levelling glide, hardware and trim kit. Pass through only for power beam, power beam leg slotted

DESCRIPTION	PRODUCT CODE	LIST PRICE	DIMENSIONS/INCHES		
			H	W	D
	EVPB36CPSA336NR	263	36	3	3
	EVPB36CPSA342NR	263	42	3	3



POWER BEAM FLX

EVPB24CPSANR - NR PANEL TO 24"H POWER BEAM 2 WAY CORNER POST

- Connects one NR panel and one 24"H power beam in 90 degree configuration
- Post and connecting hardware ad 3.25" to power beam run
- Includes post, panel connectors and power beam connectors, post with trim all around, levelling glide, hardware and trim kit. Pass through only for power beam, power beam leg slotted

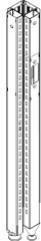
DESCRIPTION	PRODUCT CODE	LIST PRICE	DIMENSIONS/INCHES		
			H	W	D
	EVPB24CPSA230NR	159	30	3	3
	EVPB24CPSA236NR	198	36	3	3
	EVPB24CPSA242NR	198	42	3	3

EVPB30CPSANR - NR PANEL TO 30"H POWER BEAM 2 WAY CORNER POST

- Connects one NR panel and one 30"H power beam in 90 degree configuration
- Post and connecting hardware ad 3.25" to power beam run
- Includes post, panel connectors and power beam connectors, post with trim all around, levelling glide, hardware and trim kit. Pass through only for power beam, power beam leg slotted

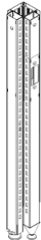
DESCRIPTION	PRODUCT CODE	LIST PRICE	DIMENSIONS/INCHES		
			H	W	D
	EVPB30CPSA230NR	159	30	3	3
	EVPB30CPSA236NR	198	36	3	3
	EVPB30CPSA242NR	198	42	3	3

EVPB36CPSANR - NR PANEL TO 36"H POWER BEAM 2 WAY CORNER POST

- Connects one NR panel and one 36"H power beam in 90 degree configuration
- Post and connecting hardware ad 3.25" to power beam run
- Includes post, panel connectors and power beam connectors, post with trim all around, levelling glide, hardware and trim kit. Pass through only for power beam, power beam leg slotted

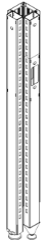
DESCRIPTION	PRODUCT CODE	LIST PRICE	DIMENSIONS/INCHES		
			H	W	D
	EVPB36CPSA236NR	198	30	3	3
	EVPB36CPSA242NR	198	36	3	3

POWER BEAM FLX

EVPB24CPSANR - NR PANEL TO 24"H POWER BEAM 3 WAY CORNER POST

- Connects two 24"H power beams with NR panel in "T" configuration
- Post and connecting hardware ad 3.25" to power beam run
- Includes post, panel connectors and power beam connectors, post with trim all around, levelling glide, hardware and trim kit. Pass through only for power beam, power beam leg slotted

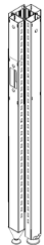
DESCRIPTION	PRODUCT CODE	LIST PRICE	DIMENSIONS/INCHES		
			H	W	D
	EVPB24CPSA330PNR	197	30	3	3
	EVPB24CPSA336PNR	263	36	3	3
	EVPB24CPSA342PNR	263	42	3	3

EVPB30CPSANR - NR PANEL TO 30"H POWER BEAM 3 WAY CORNER POST

- Connects two 30"H power beams with NR panel in "T" configuration
- Post and connecting hardware ad 3.25" to power beam run
- Includes post, panel connectors and power beam connectors, post with trim all around, levelling glide, hardware and trim kit. Pass through only for power beam, power beam leg slotted

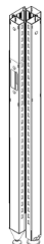
DESCRIPTION	PRODUCT CODE	LIST PRICE	DIMENSIONS/INCHES		
			H	W	D
	EVPB30CPSA330PNR	197	30	3	3
	EVPB30CPSA336PNR	263	36	3	3
	EVPB30CPSA342PNR	263	42	3	3

EVPB36CPSANR - NR PANEL TO 36"H POWER BEAM 3 WAY CORNER POST

- Connects two 36"H power beams with NR panel in "T" configuration
- Post and connecting hardware ad 3.25" to power beam run
- Includes post, panel connectors and power beam connectors, post with trim all around, levelling glide, hardware and trim kit. Pass through only for power beam, power beam leg slotted

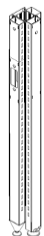
DESCRIPTION	PRODUCT CODE	LIST PRICE	DIMENSIONS/INCHES		
			H	W	D
	EVPB36CPSA336PNR	263	36	3	3
	EVPB36CPSA342PNR	263	42	3	3



POWER BEAM FLX

EVPBGICBS - POWER BEAM SLOTTED CONNECTOR WITH BASE FOR GLIDE

- Slotted connector allows to attached brackets for worksurfaces
- Connects two power beams on equal height
- Includes slotted connector with glide and connecting hardware

DESCRIPTION	PRODUCT CODE	LIST PRICE	DIMENSIONS/INCHES		
			H	W	D
	EVPBGICBS24	64	24	2	
	EVPBGICBS30	70	30	2	
	EVPBGICBS36	76	36	2	

Note: Power Beam to be installed in stable configuration using two way posts, three way posts, four way posts to provide support for worksurfaces.

EVPBLS - POWER BEAM SLOTTED CONNECTOR WITH LEG

- Slotted connector allows to attached brackets for worksurfaces
- Connects two power beams on equal height
- Includes slotted connector with leg, glides and connecting hardware

DESCRIPTION	PRODUCT CODE	LIST PRICE	DIMENSIONS/INCHES		
			H	W	D
	EVPBLS24	98	24	18	
	EVPBLS30	103	30	18	
	EVPBLS36	108	36	18	

Note: Power Beam to be installed in stable configuration using two way posts, three way posts, four way posts to provide support for worksurfaces.

EVPBFCGS - VERTICAL BASE POWER FEED COVER WITH GLIDE

- Slotted connector allows to attached brackets for worksurfaces
- Connects to electrical cut out power beam
- Includes vertical covers and slotted connector with glide base, end-of-run trim below power beam. Power Beam with electrical cut out to be ordered separately.

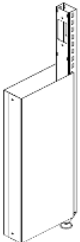
DESCRIPTION	PRODUCT CODE	LIST PRICE	DIMENSIONS/INCHES		
			H	W	D
	EVPBFCGS24	168	24	6	3
	EVPBFCGS30	190	30	6	3
	EVPBFCGS36	216	36	6	3

Note: Power Beam to be installed in stable configuration using two way posts, three way posts, four way posts to provide support for worksurfaces.

POWER BEAM FLX

EVPBFCLS - VERTICAL BASE POWER FEED COVER WITH SLOTTED LEG

- Slotted connector allows to attached brackets for worksurfaces
- Connects to electrical cut out power beam
- Includes vertical covers and slotted connector with leg, end-of-run trim below power beam. Power Beam with electrical cut out to be ordered separately

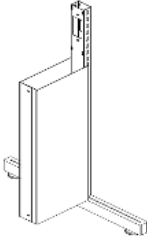
DESCRIPTION	PRODUCT CODE	LIST PRICE	DIMENSIONS/INCHES		
			H	W	D
	EVPBFCLS24	199	24	6	21
	EVPBFCLS30	223	30	6	21
	EVPBFCLS36	246	36	6	21

Note: Power Beam to be installed in stable configuration using two way posts, three way posts, four way posts to provide support for worksurfaces.

EVPBIEC - EXTENSION CONNECTOR SLOTTED FOR POWER

- Attaches to power beam connector
- Includes slotted extension connector and connecting hardware
- Must be attached to power beam connector with provided screw before installing power beam

DESCRIPTION	PRODUCT CODE	LIST PRICE	DIMENSIONS/INCHES		
			H	W	D
	EVPBIECS06	44	6	2.875	
	EVPBIECS12	44	12	2.875	
	EVPBIECS18	52	18	2.875	
	EVPBIECS24	52	24	2.875	

EVPBLERT - END OF RUN TRIM FOR CONNECTOR

- Finishes exposed connector at the end of a run of Power Beam
- Power Beam connector nor included

DESCRIPTION	PRODUCT CODE	LIST PRICE	DIMENSIONS/INCHES		
			H	W	D
	EVPBLERT48	77	45.4	2.875	
	EVPBLERT54	81	51.4	2.875	
	EVPBLERT66	86	63.4	2.875	

Note: Power Beam to be installed in stable configuration using two way posts, three way posts, four way posts to provide support for worksurfaces.



POWER BEAM MOBILE

EVPBGICBM - POWER BEAM CONNECTOR WITH BASE AND CASTOR

- Connects two power beams on equal height
- Includes connector with castor and connecting hardware
- Castors are lockable
- Laminate end panel with castors must be used at end with T leg for stability

DESCRIPTION	PRODUCT CODE	LIST PRICE	DIMENSIONS/INCHES		
			H	W	D
	EVPBGICB24M	80	25	2	
	EVPBGICB30M	86	31	2	
	EVPBGICB36M	91	37	2	

Note: Castors to be locked when power feed is connected to wall outlet. Disconnect power feed from power before moving power beam.

EVPBLM - POWER BEAM CONNECTOR WITH LEG AND CASTORS

- Connects two power beams on equal height
- Includes connector with leg, castors and connecting hardware
- Castors are lockable
- Laminate end panel with castors must be used at end for stability

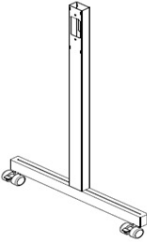
DESCRIPTION	PRODUCT CODE	LIST PRICE	DIMENSIONS/INCHES		
			H	W	D
	EVPBL24M	129	25	18	
	EVPBL30M	133	31	18	
	EVPBL36M	138	37	18	

Note: Castors to be locked when power feed is connected to wall outlet. Disconnect power feed from power before moving power beam.

EVPBFCGM - VERTICAL BASE POWER FEED COVER WITH CASTOR

- Connects to electrical cut out power beam
- Includes vertical covers and connector with castor
- Castors are lockable
- End of run trim below power beam included
- Power beam with electrical cut out to be ordered separately
- Power beam base feed with plug to be used, to be ordered separately
- Laminate end panel with castors must be used at end with T leg for stability

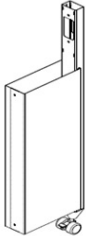
DESCRIPTION	PRODUCT CODE	LIST PRICE	DIMENSIONS/INCHES		
			H	W	D
	EVPBFCG24M	182	25	6	3
	EVPBFCG30M	206	31	6	3
	EVPBFCG36M	231	37	6	3

Note: Castors to be locked when power feed is connected to wall outlet. Disconnect power feed from power before moving power beam.

POWER BEAM MOBILE

EVPBFCLM - VERTICAL BASE POWER FEED COVER WITH LEG AND CASTORS

- Connects to electrical cut out power beam
- Includes vertical covers and connector with leg with castors
- Castors are lockable
- End of run trim below power beam included
- Power beam with electrical cut out to be ordered separately
- Power beam base feed with plug to be used, to be ordered separately
- Laminate end panel with castors must be used at end with T leg for stability

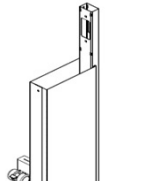
DESCRIPTION	PRODUCT CODE	LIST PRICE	DIMENSIONS/INCHES		
			H	W	D
	EVPBFCL24M	231	25	6	21
	EVPBFCL30M	253	31	6	21
	EVPBFCL36M	278	37	6	21

Note: Castors to be locked when power feed is connected to wall outlet. Disconnect power feed from power before moving power beam.

EVPBLEPM - POWER BEAM LAMINATE END PANEL WITH CASTORS

- Attaches to power beam connector with leg
- Includes brackets to attached to leg
- Finished in thermally fused laminate, if wood grain is selected, grain runs horizontally
- Laminate End Panel height is inclusive of castors

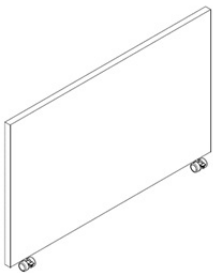
DESCRIPTION	PRODUCT CODE	LIST PRICE	DIMENSIONS/INCHES		
			H	W	D
	EVPBLEP2451M	379	25	51	1
	EVPBLEP3051M	465	31	51	1
	EVPBLEP3651M	557	37	51	1
	EVPBLEP4251M	800	43	51	1
	EVPBLEP2463M	455	25	63	1
	EVPBLEP3063M	560	31	63	1
	EVPBLEP3663M	661	37	63	1
	EVPBLEP4263M	890	43	63	1

Note: Castors to be locked when power feed is connected to wall outlet. Disconnect power feed from power before moving power beam.

EVE8FR3PBP - POWER ENTRY FOR POWER BEAM WITH PLUG FOR WALL PLATE INFEEED

- Snaps in to power distribution housing
- Includes 48" long flexible vinyl conduit with Dekko plug
- Includes bracket to attach to Vertical raceway panel
- Power beam with electrical cut out must be ordered
- 71" long base feed will work with 24" and 36" H Power beam
- Power beam base feed with Dekko plug will fit only into wall plate infeed
- Wall plate infeed must be hardwired to source by licensed electrician

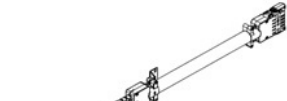
DESCRIPTION	PRODUCT CODE	LIST PRICE	DIMENSIONS/INCHES		
			H	W	D
	EVE8FR3PBP	312		71	

Note: Only compatible with wall plate infeed EVE8WPIPB



POWER BEAM MOBILE

EVE8WPIPB - WALL PLATE INFEEED FOR POWER BEAM WITH DEKKO PLUG

- Wall plate infeed must be installed and hardwired to source by licensed electrician
- Only Power beam base feed with Dekko plug will fit into Wall plate infeed
- Power beam base feed with Dekko plug to be ordered separately

DESCRIPTION	PRODUCT CODE	LIST PRICE	DIMENSIONS/INCHES		
			H	W	D

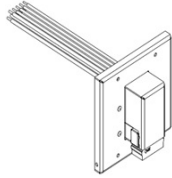

EVE8WPIPB	509	5.25	5.25	1.75
-----------	-----	------	------	------

Note: Only compatible with power beam base feed with Dekko plug EVE8FR3PBP

EVE8CP-H - CEILING PASS THRU CABLES WITH WIRE MESH

- Pass thru cable to connect from ceiling to power beam
- Pass thru cables with wire mesh allows to connect thru ceiling post to Panels, Beltline and Power beam
- In ceiling connects thru "I" connector to hardwired standard ceiling feed laying in ceiling
- "I" connector and standard ceiling feed to be ordered separately

DESCRIPTION	PRODUCT CODE	LIST PRICE	DIMENSIONS/INCHES		
			H	W	D

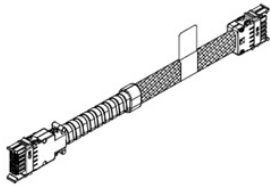

EVE8CP120-H	305	120		
EVE8CP180-H	405	180		
EVE8CP240-H	503	240		

Note: Only compatible with wall plate infeed EVE8WPIPB

EXTENSION MODULES

EXTENSION MODULES BY MATERIALS

Fabric Panel Extension Module

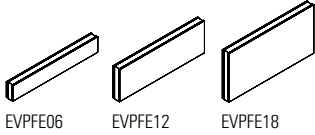

Tempered Glass Panel Extension Module

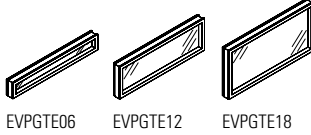

Write Board Extension Module - Single Sided



Write Board Extension Module - Double Sided



Laminate Extension Module - Single Sided

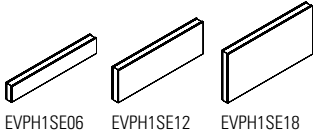

Laminate Extension Module - Double Sided

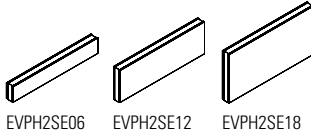

Air Flow Extension Module

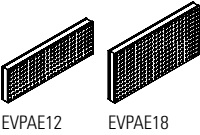

Privacy Glass



PET Felt

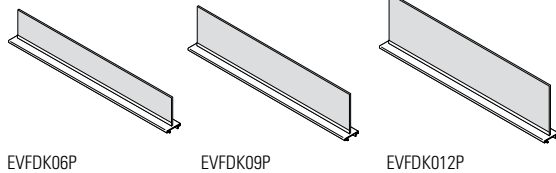



When ordering Beam Extension Modules, Inline Extension Connectors (EVPBIEC) must be ordered separately. Please see EVPBIEC for details.

Inline Extension Connectors for Power Beam connect two Beam Extension Modules of equal height in a straight run.

Extension connectors do **not** provide support for hang-on storage components.

EVPFE - FABRIC PANEL EXTENSION MODULE

- Attaches on top of a panel.
- Modules can be stacked to add privacy or divide space.
- Each side of the fabric module may have a different fabric within the same grade at no charge.
- Panel Extension Modules cannot install higher than 42" high above finished floor.
- If different grades of fabric are used on one module, the entire module must be priced at highest grade.
- When ordering Panel Extension Modules, additional connectors are required.
- Fabric on 66" and 72" wide fabric panel extension modules is applied railroaded. Any connecting beams in other widths should be specified with railroaded fabric as well to match.
- *Top Trims are not included with Extension Modules.

	DESCRIPTION	PRODUCT CODE	LIST PRICE		DIMENSIONS/INCHES		
			Gr1	Gr2	H	W	D
	Fabric Panel Extension Module - 6" High	EVPFE0636	207	223	6	36	2 7/8
		EVPFE0642	234	247	6	42	2 7/8
		EVPFE0648	251	270	6	48	2 7/8
		EVPFE0654	271	290	6	54	2 7/8
		EVPFE0660	291	315	6	60	2 7/8
		EVPFE0666	310	336	6	66	2 7/8
	Fabric Panel Extension Module - 12" High	EVPFE1236	207	223	12	36	2 7/8
		EVPFE1242	234	247	12	42	2 7/8
		EVPFE1248	251	270	12	48	2 7/8
		EVPFE1254	271	290	12	54	2 7/8
		EVPFE1260	291	315	12	60	2 7/8
		EVPFE1266	310	336	12	66	2 7/8
	Fabric Panel Extension Module - 18" High	EVPFE1836	264	288	18	36	2 7/8
		EVPFE1842	290	321	18	42	2 7/8
		EVPFE1848	317	349	18	48	2 7/8
		EVPFE1854	343	380	18	54	2 7/8
		EVPFE1860	373	413	18	60	2 7/8
		EVPFE1866	402	444	18	66	2 7/8
	Fabric Panel Extension Module - 24" High	EVPFE2436	264	288	24	36	2 7/8
		EVPFE2442	290	321	24	42	2 7/8
		EVPFE2448	317	349	24	48	2 7/8
		EVPFE2454	343	380	24	54	2 7/8
		EVPFE2460	373	413	24	60	2 7/8
		EVPFE2466	402	444	24	66	2 7/8
		EVPFE2472	429	477	24	72	2 7/8

EVPGTE - TEMPERED GLASS PANEL EXTENSION MODULE

- Attaches on top of beam.
- Modules can be stacked to add privacy or to divide space.
- Panel Extension Modules cannot install higher than 42" h above finished floor
- Standard in clear (CLR) or smoked glass (SMK) as an option.
- Frosted Glass (FRST) 20% upcharge. Contact EVOLVE Customer Support for details.
- When ordering Panel Extension Modules, additional connectors are required.
- *Top Trims are not included with Extension Modules.

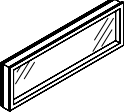
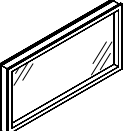
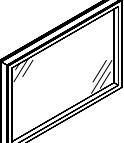
	DESCRIPTION	PRODUCT CODE	LIST PRICE	DIMENSIONS/INCHES		
				H	W	D
	Tempered Glass Panel Extension Module - 6" High	EVPGTE0636	437	6	36	2 7/8
		EVPGTE0642	534	6	42	2 7/8
		EVPGTE0648	596	6	48	2 7/8
		EVPGTE0654	651	6	54	2 7/8
		EVPGTE0660	702	6	60	2 7/8
		EVPGTE0666	752	6	66	2 7/8
		EVPGTE0672	806	6	72	2 7/8
	Tempered Glass Panel Extension Module - 12" High	EVPGTE1236	437	12	36	2 7/8
		EVPGTE1242	534	12	42	2 7/8
		EVPGTE1248	596	12	48	2 7/8
		EVPGTE1254	651	12	54	2 7/8
		EVPGTE1260	702	12	60	2 7/8
		EVPGTE1266	752	12	66	2 7/8
		EVPGTE1272	806	12	72	2 7/8
	Tempered Glass Panel Extension Module - 18" High	EVPGTE1836	582	18	36	2 7/8
		EVPGTE1842	660	18	42	2 7/8
		EVPGTE1848	739	18	48	2 7/8
		EVPGTE1854	801	18	54	2 7/8
		EVPGTE1860	860	18	60	2 7/8
		EVPGTE1866	917	18	66	2 7/8
		EVPGTE1872	979	18	72	2 7/8
	Tempered Glass Panel Extension Module - 24" High	EVPGTE2436	582	24	36	2 7/8
		EVPGTE2442	660	24	42	2 7/8
		EVPGTE2448	739	24	48	2 7/8
		EVPGTE2454	801	24	54	2 7/8
		EVPGTE2460	860	24	60	2 7/8
		EVPGTE2466	917	24	66	2 7/8
		EVPGTE2472	979	24	72	2 7/8



EVPW1SE - WRITE BOARD EXTENSION MODULE - SINGLE SIDED

- Attaches on top of a beam.
- Provides writing surface on one side and fabric on the other side.
- Modules can be stacked to add privacy or to divide space.
- Panel Extension Modules cannot install higher than 42" high above finished floor.
- When ordering Beam Extension Modules, additional connectors are required.
- *Top Trims are not included with Extension Modules.

	DESCRIPTION	PRODUCT CODE	LIST PRICE		DIMENSIONS/INCHES		
			Gr1	Gr2	H	W	D
	Write Board Extension Module - Single Sided 6" High	EVPW1SE0636	337	346	6	36	2 7/8
		EVPW1SE0642	381	386	6	42	2 7/8
		EVPW1SE0648	415	426	6	48	2 7/8
		EVPW1SE0654	468	479	6	54	2 7/8
		EVPW1SE0660	492	503	6	60	2 7/8
		EVPW1SE0666	515	525	6	66	2 7/8
		EVPW1SE0672	570	578	6	72	2 7/8
	Write Board Extension Module - Single Sided 12" High	EVPW1SE1236	337	346	12	36	2 7/8
		EVPW1SE1242	381	386	12	42	2 7/8
		EVPW1SE1248	415	426	12	48	2 7/8
		EVPW1SE1254	468	479	12	54	2 7/8
		EVPW1SE1260	492	503	12	60	2 7/8
		EVPW1SE1266	515	525	12	66	2 7/8
		EVPW1SE1272	570	578	12	72	2 7/8
	Write Board Extension Module - Single Sided 18" High	EVPW1SE1836	367	380	18	36	2 7/8
		EVPW1SE1842	411	426	18	42	2 7/8
		EVPW1SE1848	451	467	18	48	2 7/8
		EVPW1SE1854	491	507	18	54	2 7/8
		EVPW1SE1860	529	547	18	60	2 7/8
		EVPW1SE1866	568	588	18	66	2 7/8
		EVPW1SE1872	607	627	18	72	2 7/8
	Write Board Extension Module - Single Sided 24" High	EVPW1SE2436	367	380	24	36	2 7/8
		EVPW1SE2442	411	427	24	42	2 7/8
		EVPW1SE2448	451	468	24	48	2 7/8
		EVPW1SE2454	491	507	24	54	2 7/8
		EVPW1SE2460	529	548	24	60	2 7/8
		EVPW1SE2466	568	591	24	66	2 7/8
		EVPW1SE2472	607	629	24	72	2 7/8

EVPW2SE - WRITE BOARD EXTENSION MODULE - DOUBLE SIDED

- Attaches on top of a panel.
- Provides writing surface on two sides.
- Modules can be stacked to add privacy or to divide space.
- Panel Extension Modules cannot install higher than 42" above finished floor
- When ordering Panel Extension Modules, additional connectors are required.
- *Top Trims are not included with Extension Modules.

DESCRIPTION	PRODUCT CODE	LIST PRICE	DIMENSIONS/INCHES		
			H	W	D
 Write Board Extension Module - Double Sided - 6"High	EVPW2SE0636	383	6	36	2 7/8
	EVPW2SE0642	435	6	42	2 7/8
	EVPW2SE0648	485	6	48	2 7/8
	EVPW2SE0654	560	6	54	2 7/8
	EVPW2SE0660	574	6	60	2 7/8
	EVPW2SE0666	587	6	66	2 7/8
	EVPW2SE0672	663	6	72	2 7/8
Write Board Extension Module - Double Sided - 12"High	EVPW2SE1236	383	12	36	2 7/8
	EVPW2SE1242	435	12	42	2 7/8
	EVPW2SE1248	485	12	48	2 7/8
	EVPW2SE1254	560	12	54	2 7/8
	EVPW2SE1260	574	12	60	2 7/8
	EVPW2SE1266	587	12	66	2 7/8
	EVPW2SE1272	663	12	72	2 7/8
Write Board Extension Module - Double Sided - 18"High	EVPW2SE1836	468	18	36	2 7/8
	EVPW2SE1842	529	18	42	2 7/8
	EVPW2SE1848	590	18	48	2 7/8
	EVPW2SE1854	652	18	54	2 7/8
	EVPW2SE1860	712	18	60	2 7/8
	EVPW2SE1866	771	18	66	2 7/8
	EVPW2SE1872	834	18	72	2 7/8
Write Board Extension Module - Double Sided - 24"High	EVPW2SE2436	468	24	36	2 7/8
	EVPW2SE2442	529	24	42	2 7/8
	EVPW2SE2448	590	24	48	2 7/8
	EVPW2SE2454	652	24	54	2 7/8
	EVPW2SE2460	712	24	60	2 7/8
	EVPW2SE2466	771	24	66	2 7/8
	EVPW2SE2472	834	24	72	2 7/8



EVPH1SE - LAMINATE EXTENSION MODULE - SINGLE SIDED

- Attaches on top of a beam.
- Laminate module provides a durable, washable surface on one side and fabric on the other side.
- Modules can be stacked to add privacy or to divide space.
- Panel Extension Modules cannot install higher than 42”h above finished floor.
- When ordering Panel Extension Modules, additional connectors are required.
- Available in high pressure laminate finishes only.
- *Top Trims are not included with Extension Modules.

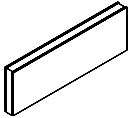
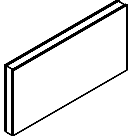
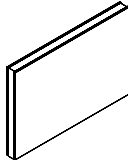
	DESCRIPTION	PRODUCT CODE	LIST PRICE		DIMENSIONS/INCHES		
			Gr1	Gr2	H	W	D
	Laminate Extension Module - Single Sided	EVPH1SE0636	337	341	6	36	2 7/8
		EVPH1SE0642	381	383	6	42	2 7/8
		EVPH1SE0648	415	427	6	48	2 7/8
		EVPH1SE0654	468	479	6	54	2 7/8
		EVPH1SE0660	492	497	6	60	2 7/8
		EVPH1SE0666	515	525	6	66	2 7/8
		EVPH1SE0672	570	578	6	72	2 7/8
	Laminate Extension Module - Single Sided	EVPH1SE1236	337	348	12	36	2 7/8
		EVPH1SE1242	381	389	12	42	2 7/8
		EVPH1SE1248	415	427	12	48	2 7/8
		EVPH1SE1254	468	480	12	54	2 7/8
		EVPH1SE1260	492	504	12	60	2 7/8
		EVPH1SE1266	515	525	12	66	2 7/8
		EVPH1SE1272	570	578	12	72	2 7/8
	Laminate Extension Module - Single Sided	EVPH1SE1836	472	485	18	36	2 7/8
		EVPH1SE1842	533	546	18	42	2 7/8
		EVPH1SE1848	585	599	18	48	2 7/8
		EVPH1SE1854	633	651	18	54	2 7/8
		EVPH1SE1860	697	716	18	60	2 7/8
		EVPH1SE1866	758	782	18	66	2 7/8
		EVPH1SE1872	657	667	18	72	2 7/8
	Laminate Extension Module - Single Sided	EVPH1SE2436	472	487	24	36	2 7/8
		EVPH1SE2442	533	548	24	42	2 7/8
		EVPH1SE2448	585	601	24	48	2 7/8
		EVPH1SE2454	633	654	24	54	2 7/8
		EVPH1SE2460	697	719	24	60	2 7/8
		EVPH1SE2466	758	783	24	66	2 7/8
		EVPH1SE2472	820	834	24	72	2 7/8

EVPH2SE - LAMINATE EXTENSION MODULE - DOUBLE SIDED

- Attaches on top of a beam.
- Laminate faces on both sides of the module provide durable, washable surfaces
- Modules can be stacked to add privacy or to divide space.
- Panel Extension Modules cannot install higher than 42”h above finished floor.
- When ordering Panel Extension Modules, additional connectors are required.
- Available in high pressure laminate finishes only.
- *Top Trims are not included with Extension Modules.

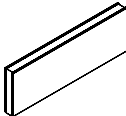
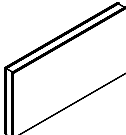
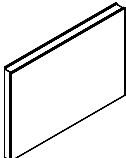
	DESCRIPTION	PRODUCT CODE	LIST PRICE	DIMENSIONS/INCHES		
				H	W	D
	Laminate Extension Module - Double Sided	EVPH2SE0636	383	6	36	2 7/8
		EVPH2SE0642	435	6	42	2 7/8
		EVPH2SE0648	485	6	48	2 7/8
		EVPH2SE0654	560	6	54	2 7/8
		EVPH2SE0660	587	6	60	2 7/8
		EVPH2SE0666	574	6	66	2 7/8
		EVPH2SE0672	663	6	72	2 7/8
	Laminate Extension Module - Double Sided	EVPH2SE1236	383	12	36	2 7/8
		EVPH2SE1242	435	12	42	2 7/8
		EVPH2SE1248	485	12	48	2 7/8
		EVPH2SE1254	560	12	54	2 7/8
		EVPH2SE1260	574	12	60	2 7/8
		EVPH2SE1266	574	12	66	2 7/8
		EVPH2SE1272	663	12	72	2 7/8
	Laminate Extension Module - Double Sided	EVPH2SE1836	571	18	36	2 7/8
		EVPH2SE1842	645	18	42	2 7/8
		EVPH2SE1848	731	18	48	2 7/8
		EVPH2SE1854	801	18	54	2 7/8
		EVPH2SE1860	863	18	60	2 7/8
		EVPH2SE1866	925	18	66	2 7/8
		EVPH2SE1872	997	18	72	2 7/8
	Laminate Extension Module - Double Sided	EVPH2SE2436	571	24	36	2 7/8
		EVPH2SE2442	645	24	42	2 7/8
		EVPH2SE2448	731	24	48	2 7/8
		EVPH2SE2454	801	24	54	2 7/8
		EVPH2SE2460	863	24	60	2 7/8
		EVPH2SE2466	925	24	66	2 7/8
		EVPH2SE2472	997	24	72	2 7/8



EVPAE - AIR FLOW EXTENSION MODULE

- Metal air flow panel extension.
- Attaches to top of beam.
- Modules can be stacked to add privacy or to divide space.
- Panel Extension Modules cannot install higher than 42" h above finished floor.
- When ordering Panel Extension Modules, additional connectors are required.
- *Top Trims are not included with Extension Modules.

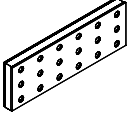
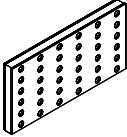
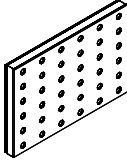
	DESCRIPTION	PRODUCT CODE	LIST PRICE	DIMENSIONS/INCHES		
				H	W	D
	Air Flow Extension Module - 12" High	EVPAE1236	399	12	36	2 7/8
		EVPAE1242	440	12	42	2 7/8
		EVPAE1248	498	12	48	2 7/8
		EVPAE1254	575	12	54	2 7/8
		EVPAE1260	655	12	60	2 7/8
		EVPAE1266	736	12	66	2 7/8
		EVPAE1272	810	12	72	2 7/8
	Air Flow Extension Module - 18" High	EVPAE1836	480	18	36	2 7/8
		EVPAE1842	525	18	42	2 7/8
		EVPAE1848	604	18	48	2 7/8
		EVPAE1854	694	18	54	2 7/8
		EVPAE1860	780	18	60	2 7/8
		EVPAE1866	867	18	66	2 7/8
		EVPAE1872	957	18	72	2 7/8
	Air Flow Extension Module - 24" High	EVPAE2436	480	24	24	2 7/8
		EVPAE2442	525	24	42	2 7/8
		EVPAE2448	604	24	48	2 7/8
		EVPAE2454	688	24	54	2 7/8
		EVPAE2460	780	24	60	2 7/8
		EVPAE2466	867	24	66	2 7/8
		EVPAE2472	957	24	72	2 7/8

EVPOE - OPEN PANEL EXTENSION MODULE

- Attaches to top portion of a beam.
- Modules can be stacked to add privacy or to divide space
- Panel Extension Modules cannot install higher than 42”h above finished floor.
- When ordering Panel Extension Modules, additional connectors are required.
- *Top Trims are not included with Extension Modules.

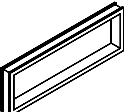
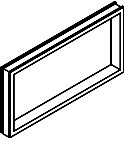
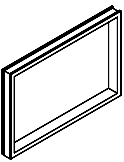
	DESCRIPTION	PRODUCT CODE	LIST PRICE	DIMENSIONS/INCHES		
				H	W	D
	Open Panel Extension Module - 6" High	EVPOE0636	341	6	36	2 7/8
		EVPOE0642	414	6	42	2 7/8
		EVPOE0648	465	6	48	2 7/8
		EVPOE0654	507	6	54	2 7/8
		EVPOE0660	547	6	60	2 7/8
		EVPOE0666	589	6	66	2 7/8
		EVPOE0672	631	6	72	2 7/8
	Open Panel Extension Module - 12" High	EVPOE1236	341	12	36	2 7/8
		EVPOE1242	414	12	42	2 7/8
		EVPOE1248	466	12	48	2 7/8
		EVPOE1254	507	12	54	2 7/8
		EVPOE1260	549	12	60	2 7/8
		EVPOE1266	589	12	66	2 7/8
		EVPOE1272	631	12	72	2 7/8
	Open Panel Extension Module - 18" High	EVPOE1836	453	18	36	2 7/8
		EVPOE1842	510	18	42	2 7/8
		EVPOE1848	575	18	48	2 7/8
		EVPOE1854	623	18	54	2 7/8
		EVPOE1860	671	18	60	2 7/8
		EVPOE1866	721	18	66	2 7/8
		EVPOE1872	769	18	72	2 7/8
	Open Panel Extension Module - 24" High	EVPOE2436	453	24	36	2 7/8
		EVPOE2442	510	24	42	2 7/8
		EVPOE2448	575	24	48	2 7/8
		EVPOE2454	623	24	54	2 7/8
		EVPOE2460	671	24	60	2 7/8
		EVPOE2466	721	24	66	2 7/8
		EVPOE2472	769	24	72	2 7/8



PRIVACY GLASS DIVIDER

EVPMPXXGI6P - 6" H BEAM MOUNT PRIVACY GLASS W/ ALUMINUM TRIM

- Attaches on top of Power Beam or extension modules to add privacy or divide space.
- Privacy Glass is integrated into the aluminum top trim.
- Includes aluminum trim with channel and glass tile.
- Glass and attachment hardware ship separately.
- Standard in clear (CLR) or frosted (FRST) glass.
- Privacy glass modules may stack on top of Power Beam or extension modules at 42" high to achieve a height up to 54"h above finished floor.
- *Top Trims are not included with Extension Modules.

	DESCRIPTION	PRODUCT CODE	LIST PRICE		DIMENSIONS/INCHES		
			Clear	Frosted	H	W	D
 36"W Shown	6" H Panel Mount Privacy Glass w/ Aluminum Trim - 36" Wide	EVPMP36GI6P	304	333	6	36	2 7/8
	6" H Panel Mount Privacy Glass w/ Aluminum Trim - 42" Wide	EVPMP42GI6P	318	367	6	42	2 7/8
	6" H Panel Mount Privacy Glass w/ Aluminum Trim - 48" Wide	EVPMP48GI6P	326	401	6	48	2 7/8
	6" H Panel Mount Privacy Glass w/ Aluminum Trim - 54" Wide	EVPMP54GI6P	338	432	6	54	2 7/8
	6" H Panel Mount Privacy Glass w/ Aluminum Trim - 60" Wide	EVPMP60GI6P	348	467	6	60	2 7/8
	6" H Panel Mount Privacy Glass w/ Aluminum Trim - 66" Wide	EVPMP66GI6P	402	533	6	66	2 7/8
	6" H Panel Mount Privacy Glass w/ Aluminum Trim - 72" Wide	EVPMP72GI6P	414	534	6	72	2 7/8

EVPMPXXGI9P - 9" H BEAM MOUNT PRIVACY GLASS W/ ALUMINUM TRIM

- Attaches on top of Power Beam or extension modules to add privacy or divide space.
- Privacy Glass is integrated into the aluminum top trim.
- Includes aluminum trim with channel and glass tile.
- Glass and attachment hardware ship separately.
- Standard in clear (CLR) or frosted (FRST) glass.
- Privacy glass modules may stack on top of Power Beam or extension modules at 42" high to achieve a height up to 54"h above finished floor.
- *Top Trims are not included with Extension Modules.

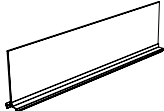
	DESCRIPTION	PRODUCT CODE	LIST PRICE		DIMENSIONS/INCHES		
			Clear	Frosted	H	W	D
 36"W Shown	9" H Panel Mount Privacy Glass w/ Aluminum Trim - 36" Wide	EVPMP36GI9P	304	333	9	36	2 7/8
	9" H Panel Mount Privacy Glass w/ Aluminum Trim - 42" Wide	EVPMP42GI9P	318	370	9	42	2 7/8
	9" H Panel Mount Privacy Glass w/ Aluminum Trim - 48" Wide	EVPMP48GI9P	326	382	9	48	2 7/8
	9" H Panel Mount Privacy Glass w/ Aluminum Trim - 54" Wide	EVPMP54GI9P	338	413	9	54	2 7/8
	9" H Panel Mount Privacy Glass w/ Aluminum Trim - 60" Wide	EVPMP60GI9P	348	447	9	60	2 7/8
	9" H Panel Mount Privacy Glass w/ Aluminum Trim - 66" Wide	EVPMP66GI9P	402	534	9	66	2 7/8
	9" H Panel Mount Privacy Glass w/ Aluminum Trim - 72" Wide	EVPMP72GI9P	414	556	9	72	2 7/8

PRIVACY GLASS DIVIDER

EVPMPXXGIP - 12" PANEL MOUNT PRIVACY GLASS W/ ALUMINUM TRIM

- Attaches on top of Evolve Panels to add privacy or divide space.
- Privacy Glass is integrated into the aluminum top trim.
- Includes aluminum trim with channel and glass tile.
- Standard in clear (CLR), frosted (FRST) or writeable (WRW) glass.

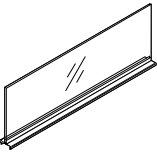
	DESCRIPTION	PRODUCT CODE	LIST PRICE			DIMENSIONS/INCHES		
			CLR	FRST	WRW	H	W	D
	Panel Mount Privacy Glass w/ Aluminum Trim - 36" Wide	EVPMP36GIP	304	333	447	12	36	2 7/8
	Panel Mount Privacy Glass w/ Aluminum Trim - 42" Wide	EVPMP42GIP	318	367	492	12	42	2 7/8
	Panel Mount Privacy Glass w/ Aluminum Trim - 48" Wide	EVPMP48GIP	335	401	538	12	48	2 7/8
	Panel Mount Privacy Glass w/ Aluminum Trim - 54" Wide	EVPMP54GIP	349	433	580	12	54	2 7/8
	Panel Mount Privacy Glass w/ Aluminum Trim - 60" Wide	EVPMP60GIP	359	467	626	12	60	2 7/8
	Panel Mount Privacy Glass w/ Aluminum Trim - 66" Wide	EVPMP66GIP	402	533	713	12	66	2 7/8
	Panel Mount Privacy Glass w/ Aluminum Trim - 72" Wide	EVPMP72GIP	427	556	745	12	72	2 7/8

EVPMPXXGI18P - 18" H PANEL MOUNT PRIVACY GLASS

- Privacy Glass integrated with aluminum top trim.
- Attaches on top of panels to add privacy or divide space.
- Includes aluminum trim with channel and glass tile.
- Aluminium trim must be specified for entire station when ordering panel mount privacy glass.
- Glass and attachment hardware to ship separately.

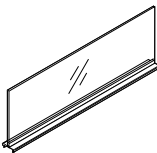
	DESCRIPTION	PRODUCT CODE	LIST PRICE		DIMENSIONS/INCHES		
			Clear	Frosted	H	W	D
	18" H Panel Mount Privacy Glass w/ Aluminum Trim - 36" Wide	EVPMP36G118P	455	498	18	36	2 7/8
	18" H Panel Mount Privacy Glass w/ Aluminum Trim - 42" Wide	EVPMP42G118P	475	549	18	42	2 7/8
	18" H Panel Mount Privacy Glass w/ Aluminum Trim - 48" Wide	EVPMP48G118P	503	599	18	48	2 7/8
	18" H Panel Mount Privacy Glass w/ Aluminum Trim - 54" Wide	EVPMP54G118P	521	649	18	54	2 7/8
	18" H Panel Mount Privacy Glass w/ Aluminum Trim - 60" Wide	EVPMP60G118P	539	702	18	60	2 7/8
	18" H Panel Mount Privacy Glass w/ Aluminum Trim - 66" Wide	EVPMP66G118P	604	797	18	66	2 7/8
	18" H Panel Mount Privacy Glass w/ Aluminum Trim - 72" Wide	EVPMP72G118P	639	833	18	72	2 7/8



PRIVACY GLASS DIVIDER

EVPMPNXXGI18P - 18" H PANEL MOUNT PRIVACY GLASS WITH NOTCHED TOP TRIM FOR VARIABLE HEIGHT CONNECTOR

- Privacy Glass integrated with aluminum top trim.
- Attaches on top of panels to add privacy or divide space.
- Includes aluminum trim with channel and glass tile.
- Standard in clear (CLR) or frosted (FRST) glass.
- Aluminium trim must be specified for entire station when ordering panel mount privacy glass.
- Glass and attachment hardware to ship separately.

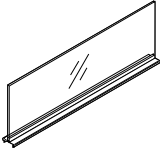
	DESCRIPTION	PRODUCT CODE	LIST PRICE		DIMENSIONS/INCHES		
			Clear	Frosted	H	W	D
	18" H Panel Mount Privacy Glass w/ Aluminum Trim - 36" Wide	EVPMPN36GI18P	455	498	18	36	2 7/8
	18" H Panel Mount Privacy Glass w/ Aluminum Trim - 42" Wide	EVPMPN42GI18P	475	549	18	42	2 7/8
	18" H Panel Mount Privacy Glass w/ Aluminum Trim - 48" Wide	EVPMPN48GI18P	503	599	18	48	2 7/8
	18" H Panel Mount Privacy Glass w/ Aluminum Trim - 54" Wide	EVPMPN54GI18P	521	649	18	54	2 7/8
	18" H Panel Mount Privacy Glass w/ Aluminum Trim - 60" Wide	EVPMPN60GI18P	539	702	18	60	2 7/8
	18" H Panel Mount Privacy Glass w/ Aluminum Trim - 66" Wide	EVPMPN66GI18P	604	797	18	66	2 7/8
	18" H Panel Mount Privacy Glass w/ Aluminum Trim - 72" Wide	EVPMPN72GI18P	639	833	18	72	2 7/8

PRIVACY GLASS DIVIDER

EVPMPDNXXGI18P-18"H PANEL MOUNT PRIVACY GLASS WITH DOUBLE NOTCHED TOP TRIM FOR VARIABLE HEIGHT CONNECTOR

- Privacy Glass integrated with aluminum top trim.
- Attaches on top of panels to add privacy or divide space.
- Includes aluminum trim with channel and glass tile.
- Standard in clear (CLR) or frosted (FRST) glass.
- Aluminium trim must be specified for entire station when ordering panel mount privacy glass.
- Glass and attachment hardware to ship separately.

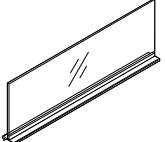
	DESCRIPTION	PRODUCT CODE	LIST PRICE		DIMENSIONS/INCHES		
			Clear	Frosted	H	W	D
	18" H Panel Mount Privacy Glass w/ Aluminum Trim - 36" Wide	EVPMPDN36GI18P	455	498	18	36	2 7/8
	18" H Panel Mount Privacy Glass w/ Aluminum Trim - 42" Wide	EVPMPDN42GI18P	475	549	18	42	2 7/8
	18" H Panel Mount Privacy Glass w/ Aluminum Trim - 48" Wide	EVPMPDN48GI18P	503	599	18	48	2 7/8
	18" H Panel Mount Privacy Glass w/ Aluminum Trim - 54" Wide	EVPMPDN54GI18P	521	649	18	54	2 7/8
	18" H Panel Mount Privacy Glass w/ Aluminum Trim - 60" Wide	EVPMPDN60GI18P	539	702	18	60	2 7/8
	18" H Panel Mount Privacy Glass w/ Aluminum Trim - 66" Wide	EVPMPDN66GI18P	604	797	18	66	2 7/8
	18" H Panel Mount Privacy Glass w/ Aluminum Trim - 72" Wide	EVPMPDN72GI18P	639	833	18	72	2 7/8



PRIVACY GLASS DIVIDER

EVMPMPXXGI6W - 6" H PRIVACY GLASS W/ ALUMINUM TRIM FOR 1" LAMINATE PANEL

- Attaches on top of Evolve 1" Laminate Panels to add privacy or divide space.
- Privacy Glass is integrated into the aluminum top trim.
- Aluminum trim has rail for accessories.
- Includes aluminum trim with end caps and glass tile
- Glass and attachment hardware ship separately.
- Standard in clear (CLR) or frosted (FRST) glass.
- *Top Trims are not included with Extension Modules.

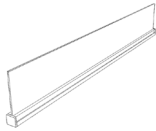
	DESCRIPTION	PRODUCT CODE	LIST PRICE		DIMENSIONS/INCHES		
			Clear	Frosted	H	W	D
 <p>36"W Shown</p>	6" H Privacy Glass w/ Aluminum Trim for 1" Laminate Panel - 24" Wide	EVMPMP24GI6W	263	323	6	24	1
	6" H Privacy Glass w/ Aluminum Trim for 1" Laminate Panel- 30" Wide	EVMPMP30GI6W	286	328	6	30	1
	6" H Privacy Glass w/ Aluminum Trim for 1" Laminate Panel - 36" Wide	EVMPMP36GI6W	304	334	6	36	1
	6" H Privacy Glass w/ Aluminum Trim for 1" Laminate Panel- 42" Wide	EVMPMP42GI6W	318	368	6	42	1
	6" H Privacy Glass w/ Aluminum Trim for 1" Laminate Panel- 48" Wide	EVMPMP48GI6W	335	400	6	48	1

EVMPMPXXGI9W - 9" H PRIVACY GLASS W/ ALUMINUM TRIM FOR 1" LAMINATE PANEL

- Attaches on top of Evolve 1" Laminate Panels to add privacy or divide space.
- Privacy Glass is integrated into the aluminum top trim.
- Aluminum trim has rail for accessories.
- Includes aluminum trim with end caps and glass tile.
- Glass and attachment hardware ship separately.
- Standard in clear (CLR) or frosted (FRST) glass.
- *Top Trims are not included with Extension Modules.

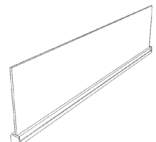
	DESCRIPTION	PRODUCT CODE	LIST PRICE		DIMENSIONS/INCHES		
			Clear	Frosted	H	W	D
 <p>36"W Shown</p>	9" H Privacy Glass w/ Aluminum Trim for 1" Laminate Panel - 24" Wide	EVMPMP24GI9W	263	323	9	24	1
	9" H Privacy Glass w/ Aluminum Trim for 1" Laminate Panel- 30" Wide	EVMPMP30GI9W	286	328	9	30	1
	9" H Privacy Glass w/ Aluminum Trim for 1" Laminate Panel - 36" Wide	EVMPMP36GI9W	304	334	9	36	1
	9" H Privacy Glass w/ Aluminum Trim for 1" Laminate Panel- 42" Wide	EVMPMP42GI9W	318	368	9	42	1
	9" H Privacy Glass w/ Aluminum Trim for 1" Laminate Panel- 48" Wide	EVMPMP48GI9W	335	400	9	48	1

PRIVACY GLASS DIVIDER

EVPMPXXGIW - 12" H PRIVACY GLASS W/ ALUMINUM TRIM FOR 1" LAMINATE PANEL

- Attaches on top of Evolve 1" Laminate Panels to add privacy or divide space.
- Privacy Glass is integrated into the aluminum top trim.
- Aluminum trim has rail for accessories.
- Includes aluminum trim with end caps and glass tile
- Glass and attachment hardware ship separately.
- Standard in clear (CLR), frosted (FRST) or writeable (WRW) glass.

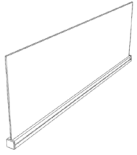
	DESCRIPTION	PRODUCT CODE	LIST PRICE			DIMENSIONS/INCHES		
			CLR	FRST	WRW	H	W	D
	12" H Privacy Glass w/ Aluminum Trim for 1" Laminate Panel - 24" Wide	EVPMP24GIW	263	323	429	12	24	1
	12" H Privacy Glass w/ Aluminum Trim for 1" Laminate Panel - 30" Wide	EVPMP30GIW	286	328	437	12	30	1
	12" H Privacy Glass w/ Aluminum Trim for 1" Laminate Panel - 36" Wide	EVPMP36GIW	304	334	446	12	36	1
	12" H Privacy Glass w/ Aluminum Trim for 1" Laminate Panel - 42" Wide	EVPMP42GIW	318	368	492	12	42	1
	12" H Privacy Glass w/ Aluminum Trim for 1" Laminate Panel - 48" Wide	EVPMP48GIW	335	400	537	12	48	1

EVPFDW - 6" H FELT DIVIDER W/ ALUMINUM TRIM FOR 1" LAMINATE PANEL

- Privacy Felt Divider integrated with aluminum top trim.
- Attaches on top of laminate panels to add privacy or divide space.
- Includes aluminum trim with channel and felt tile.
- Felt and attachment hardware to ship separately.
- 9 mm felt material is tackable and comes in 9 different colors. Please specify color.
- Aluminum top trim available in standard paint finishes.

	DESCRIPTION	PRODUCT CODE	LIST PRICE	DIMENSIONS/INCHES		
				H	W	D
	6" H Felt Divider w/ Aluminum Trim for 1" Laminate Panel	EVPFD0624W	105	6	24	1
		EVPFD0630W	122	6	30	1
		EVPFD0636W	145	6	36	1
		EVPFD0642W	163	6	42	1
		EVPFD0648W	240	6	48	1
		EVPFD0654W	262	6	54	1
		EVPFD0660W	281	6	60	1
		EVPFD0666W	297	6	66	1
		EVPFD0672W	335	6	72	1

EVPFDW - 9" H FELT DIVIDER W/ ALUMINUM TRIM FOR 1" LAMINATE PANEL

- Privacy Felt Divider integrated with aluminum top trim.
- Attaches on top of laminate panels to add privacy or divide space.
- Includes aluminum trim with channel and felt tile.
- Felt and attachment hardware to ship separately.
- 9 mm felt material is tackable and comes in 9 different colors. Please specify color.
- Aluminum top trim available in standard paint finishes.

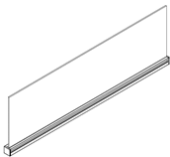
	DESCRIPTION	PRODUCT CODE	LIST PRICE	DIMENSIONS/INCHES		
				H	W	D
	9" H Felt Divider w/ Aluminum Trim for 1" Laminate Panel	EVPFD0924W	105	9	24	1
		EVPFD0930W	122	9	30	1
		EVPFD0936W	145	9	36	1
		EVPFD0942W	163	9	42	1
		EVPFD0948W	240	9	48	1
		EVPFD0954W	262	9	54	1
		EVPFD0960W	281	9	60	1
		EVPFD0966W	297	9	66	1
		EVPFD0972W	335	9	72	1



PET FELT DIVIDER

EVFPDW - 12" H FELT DIVIDER W/ ALUMINUM TRIM FOR 1" LAMINATE PANEL

- Privacy Felt Divider integrated with aluminum top trim.
- Attaches on top of laminate panels to add privacy or divide space.
- Includes aluminum trim with channel and felt tile.
- Felt and attachment hardware to ship separately.
- 9 mm felt material is tackable and comes in 9 different colors. Please specify color.
- Aluminum top trim available in standard paint finishes.

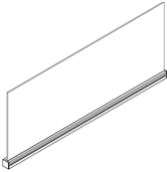
DESCRIPTION	PRODUCT CODE	LIST PRICE	DIMENSIONS/INCHES		
			H	W	D
 12" H Felt Divider w/ Aluminum Trim for 1" Laminate Panel	EVFPD1224W	105	12	24	1
	EVFPD1230W	122	12	30	1
	EVFPD1236W	145	12	36	1
	EVFPD1242W	163	12	42	1
	EVFPD1248W	240	12	48	1
	EVFPD1254W	262	12	54	1
	EVFPD1260W	281	12	60	1
	EVFPD1266W	297	12	66	1
	EVFPD1272W	335	12	72	1

EVFPDW - 18" H FELT DIVIDER W/ ALUMINUM TRIM FOR 1" LAMINATE PANEL

- Privacy Felt Divider integrated with aluminum top trim.
- Attaches on top of laminate panels to add privacy or divide space.
- Includes aluminum trim with channel and felt tile.
- Felt and attachment hardware to ship separately.
- 9 mm felt material is tackable and comes in 9 different colors. Please specify color.
- Aluminum top trim available in standard paint finishes.

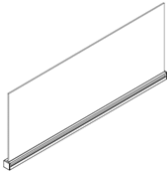
DESCRIPTION	PRODUCT CODE	LIST PRICE	DIMENSIONS/INCHES		
			H	W	D
 18" H Felt Divider w/ Aluminum Trim for 1" Laminate Panel	EVFPD1824W	131	18	24	1
	EVFPD1830W	153	18	30	1
	EVFPD1836W	181	18	36	1
	EVFPD1842W	202	18	42	1
	EVFPD1848W	299	18	48	1
	EVFPD1854W	326	18	54	1
	EVFPD1860W	352	18	60	1
	EVFPD1866W	370	18	66	1
	EVFPD1872W	420	18	72	1

PET FELT DIVIDER

EVFDK06P - 6" PANEL MOUNTED FELT DIVIDER

- Privacy felt panel integrated with aluminum top trim.
- Attaches on top of panels to add privacy or divide space. Includes aluminum trim with channel and felt tile.
- Aluminum trim must be specified for entire station when ordering panel mount privacy felt.
- Felt and attachment hardware to ship separately.
- 9mm thick Felt material is tackable and comes in 9 different colors. Please specify color: Graphite (GPH), Mist (MTS), Pewter (PWT), Harvest (HVT), Shamrock (SHR), Brick (BRI), Denim (DEN), Black (BLK) or White (WHT).

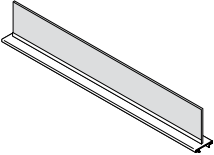
DESCRIPTION	PRODUCT CODE	LIST PRICE Gr1	DIMENSIONS/INCHES		
			H	W	D
 6" Privacy felt panel integrated with aluminum top trim	EVFDK0624P	105	6	24	2 7/8
	EVFDK0630P	122	6	30	2 7/8
	EVFDK0636P	145	6	36	2 7/8
	EVFDK0642P	163	6	42	2 7/8
	EVFDK0648P	240	6	48	2 7/8
	EVFDK0654P	262	6	54	2 7/8
	EVFDK0660P	281	6	60	2 7/8
	EVFDK0666P	297	6	66	2 7/8
	EVFDK0672P	335	6	72	2 7/8

EVFDK09P - 9" PANEL MOUNTED FELT DIVIDER

- Privacy felt panel integrated with aluminum top trim.
- Attaches on top of panels to add privacy or divide space. Includes aluminum trim with channel and felt tile.
- Aluminum trim must be specified for entire station when ordering panel mount privacy felt.
- Felt and attachment hardware to ship separately.
- 9mm thick Felt material is tackable and comes in 9 different colors. Please specify color: Graphite (GPH), Mist (MTS), Pewter (PWT), Harvest (HVT), Shamrock (SHR), Brick (BRI), Denim (DEN), Black (BLK) or White (WHT).

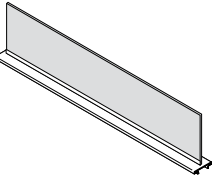
DESCRIPTION	PRODUCT CODE	LIST PRICE Gr1	DIMENSIONS/INCHES		
			H	W	D
 9" Privacy felt panel integrated with aluminum top trim	EVFDK0924P	105	9	24	2 7/8
	EVFDK0930P	122	9	30	2 7/8
	EVFDK0936P	145	9	36	2 7/8
	EVFDK0942P	163	9	42	2 7/8
	EVFDK0948P	240	9	48	2 7/8
	EVFDK0954P	262	9	54	2 7/8
	EVFDK0960P	281	9	60	2 7/8
	EVFDK0966P	297	9	66	2 7/8
	EVFDK0972P	335	9	72	2 7/8

EVFDK12P - 12" PANEL MOUNTED FELT DIVIDER

- Privacy felt panel integrated with aluminum top trim.
- Attaches on top of panels to add privacy or divide space. Includes aluminum trim with channel and felt tile.
- Aluminum trim must be specified for entire station when ordering panel mount privacy felt.
- Felt and attachment hardware to ship separately.
- 9mm thick Felt material is tackable and comes in 9 different colors. Please specify color: Graphite (GPH), Mist (MTS), Pewter (PWT), Harvest (HVT), Shamrock (SHR), Brick (BRI), Denim (DEN), Black (BLK) or White (WHT).

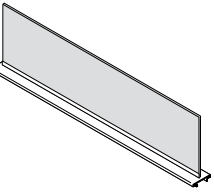
DESCRIPTION	PRODUCT CODE	LIST PRICE Gr1	DIMENSIONS/INCHES		
			H	W	D
 12" Privacy felt panel integrated with aluminum top trim	EVFDK1224P	105	12	24	2 7/8
	EVFDK1230P	122	12	30	2 7/8
	EVFDK1236P	145	12	36	2 7/8
	EVFDK1242P	163	12	42	2 7/8
	EVFDK1248P	240	12	48	2 7/8
	EVFDK1254P	262	12	54	2 7/8
	EVFDK1260P	281	12	60	2 7/8
	EVFDK1266P	297	12	66	2 7/8
	EVFDK1272P	335	12	72	2 7/8



PET FELT DIVIDER

EVFDK12PN - 12" PANEL MOUNTED FELT DIVIDER, 1 NOTCH

- Privacy felt panel integrated with aluminum top trim.
- Attaches on top of panels to add privacy or divide space. Includes aluminum trim with channel and felt tile.
- Aluminum trim must be specified for entire station when ordering panel mount privacy felt.
- Felt and attachment hardware to ship separately.
- 9mm thick Felt material is tackable and comes in 9 different colors. Please specify color. Graphite (GPH), Mist (MTS), Pewter (PWT), Harvest (HVT), Shamrock (SHR), Brick (BRI), Denim (DEN), Black (BLK) or White (WHT).

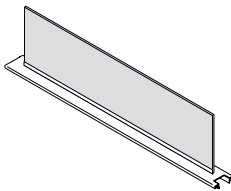
DESCRIPTION	PRODUCT CODE	LIST PRICE Gr1	DIMENSIONS/INCHES		
			H	W	D
 12" Privacy felt panel integrated with aluminum top trim with 1 Notch	EVFDK1224PN	105	12	22.68	2 7/8
	EVFDK1230PN	122	12	28.68	2 7/8
	EVFDK1236PN	145	12	34.68	2 7/8
	EVFDK1242PN	163	12	40.68	2 7/8
	EVFDK1248PN	240	12	46.68	2 7/8
	EVFDK1254PN	262	12	52.68	2 7/8
	EVFDK1260PN	281	12	58.68	2 7/8

EVFDK12PDN - 12" PANEL MOUNTED FELT DIVIDER, 2 NOTCHES

- Privacy felt panel integrated with aluminum top trim.
- Attaches on top of panels to add privacy or divide space. Includes aluminum trim with channel and felt tile.
- Aluminum trim must be specified for entire station when ordering panel mount privacy felt.
- Felt and attachment hardware to ship separately.
- 9mm thick Felt material is tackable and comes in 9 different colors. Please specify color. Graphite (GPH), Mist (MTS), Pewter (PWT), Harvest (HVT), Shamrock (SHR), Brick (BRI), Denim (DEN), Black (BLK) or White (WHT).

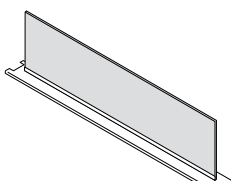
DESCRIPTION	PRODUCT CODE	LIST PRICE Gr1	DIMENSIONS/INCHES		
			H	W	D
 12" Privacy felt panel integrated with aluminum top trim with 2 Notches	EVFDK1224PDN	105	12	21.44	2 7/8
	EVFDK1230PDN	122	12	27.44	2 7/8
	EVFDK1236PDN	145	12	33.44	2 7/8
	EVFDK1242PDN	163	12	39.44	2 7/8
	EVFDK1248PDN	240	12	45.44	2 7/8
	EVFDK1254PDN	262	12	51.44	2 7/8
	EVFDK1260PDN	281	12	57.44	2 7/8

EVFDK18P - 18" PANEL MOUNTED FELT DIVIDER

- Privacy felt panel integrated with aluminum top trim.
- Attaches on top of panels to add privacy or divide space. Includes aluminum trim with channel and felt tile.
- Aluminum trim must be specified for entire station when ordering panel mount privacy felt.
- Felt and attachment hardware to ship separately.
- 9mm thick Felt material is tackable and comes in 9 different colors. Please specify color. Graphite (GPH), Mist (MTS), Pewter (PWT), Harvest (HVT), Shamrock (SHR), Brick (BRI), Denim (DEN), Black (BLK) or White (WHT).

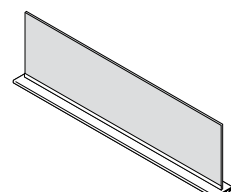
DESCRIPTION	PRODUCT CODE	LIST PRICE Gr1	DIMENSIONS/INCHES		
			H	W	D
 18" Privacy felt panel integrated with aluminum top trim	EVFDK1824P	131	18	24	2 7/8
	EVFDK1830P	153	18	30	2 7/8
	EVFDK1836P	181	18	36	2 7/8
	EVFDK1842P	202	18	42	2 7/8
	EVFDK1848P	299	18	48	2 7/8
	EVFDK1854P	326	18	54	2 7/8
	EVFDK1860P	352	18	60	2 7/8
	EVFDK1866P	370	18	66	2 7/8
	EVFDK1872P	420	18	72	2 7/8

GALLERY PANELS

EVPPGT - GLAZED PRIVACY PANEL

- Includes panel with two connectors with T legs with glides and end of run trims
- 3" thick mobile or freestanding panels.
- 22" deep T-legs for stability (9.5" on each side)
- 66" high. Additional widths, heights and configurations available.
- All Modules are Tempered Glass.
- Includes end of run trim.

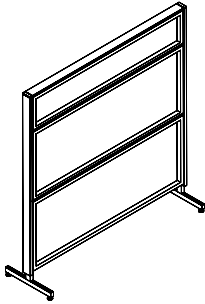
	DESCRIPTION	PRODUCT CODE	LIST PRICE		DIMENSIONS/INCHES		
			Clear	Frosted	H	W	D
	Freestanding Glazed Privacy Panel	EVPPGT6660	1845	2428	66	60	2 7/8
	Mobile Glazed Privacy Panel	EVPPGT6660M	1907	2493	66	60	2 7/8

EVPPHGT - LAMINATE GLAZED PRIVACY PANEL

- Includes panel with two connectors with T legs with glides and end of run trims
- 3" thick mobile or freestanding panels.
- 22" deep T-legs for stability (9.5" on each side)
- 66" high. Additional widths, heights and configurations available.
- Laminate Base Module w/36" Tempered Glass above.
- Includes end of run trim.

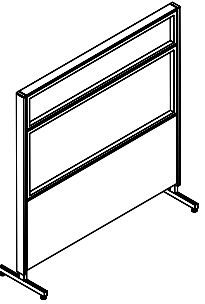
	DESCRIPTION	PRODUCT CODE	LIST PRICE		DIMENSIONS/INCHES		
			Clear	Frosted	H	W	D
	Freestanding Laminate Glazed Privacy Panel	EVPPHGT6660	1953	2267	66	60	2 7/8
	Mobile Laminate Glazed Privacy Panel	EVPPHGT6660M	2018	2331	66	60	2 7/8

EVPPHGTU - LAMINATE GLAZED PRIVACY PANEL

- Includes panel with two connectors with T legs with glides and end of run trims
- 3" thick mobile or freestanding panels.
- 22" deep T-legs for stability (9.5" on each side)
- 66" high. Additional widths, heights and configurations available.
- Bottom Two Modules are Laminate w/12" Tempered Glass on top.
- Includes end of run trim.

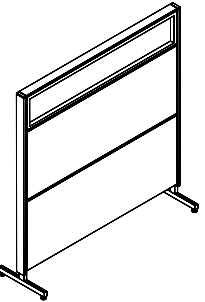
	DESCRIPTION	PRODUCT CODE	LIST PRICE		DIMENSIONS/INCHES		
			Clear	Frosted	H	W	D
	Freestanding Laminate Glazed Privacy Panel	EVPPHGTU6660	2064	2401	66	60	2 7/8
	Mobile Laminate Glazed Privacy Panel	EVPPHGTU6660M	2128	2465	66	60	2 7/8



GALLERY PANELS

EVPPH2S - LAMINATE PRIVACY PANEL

- Includes panel with two connectors with T legs with glides and end of run trims
- 3" thick mobile or freestanding panels.
- 22" deep T-legs for stability (9.5" on each side)
- 66" high. Additional widths, heights and configurations available.
- All Modules are Laminate.
- Includes end of run trim.

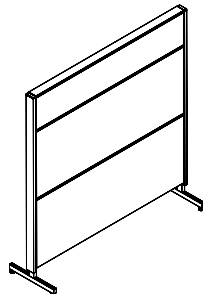

DESCRIPTION	PRODUCT CODE	LIST PRICE	DIMENSIONS/INCHES		
			H	W	D
Freestanding Laminate Privacy Panel	EVPPH2S6660	2091	66	60	2 7/8
Mobile Laminate Privacy Panel	EVPPH2S6660M	2155	66	60	2 7/8

EVPPF2W - WRITE BOARD PRIVACY PANEL

- Includes panel with two connectors with T legs with glides and end of run trims
- 3" thick mobile or freestanding panels.
- 22" deep T-legs for stability (9.5" on each side)
- 66" high. Additional widths, heights and configurations available.
- Fabric Base Module w/36" Writeboard.
- Includes end of run trim.

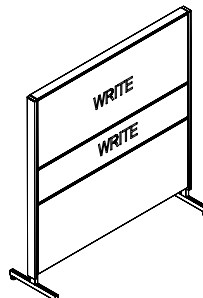

DESCRIPTION	PRODUCT CODE	LIST PRICE		DIMENSIONS/INCHES		
		Gr1	Gr2	H	W	D
Freestanding Write Board Privacy Panel	EVPPF2W6660	2154	2192	66	60	2 7/8
Mobile Write Board Privacy Panel	EVPPF2W6660M	2218	2255	66	60	2 7/8

EVPPH2W - WRITE BOARD PRIVACY PANEL

- Includes panel with two connectors with T legs with glides and end of run trims
- 3" thick mobile or freestanding panels.
- 22" deep T-legs for stability (9.5" on each side)
- 66" high. Additional widths, heights and configurations available.
- Laminate Base Module w/36" Writeboard.
- Includes end of run trim.

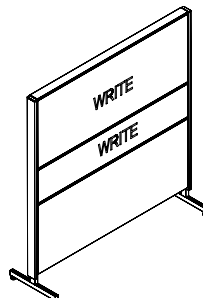

DESCRIPTION	PRODUCT CODE	LIST PRICE	DIMENSIONS/INCHES		
			H	W	D
Freestanding Write Board Privacy Panel	EVPPH2W6660	2314	66	60	2 7/8
Mobile Write Board Privacy Panel	EVPPH2W6660M	2377	66	60	2 7/8

GALLERY PANELS

EVPP - FREESTANDING GLAZED PRIVACY PANEL

- Includes panel with two connectors with T legs.
- 3" thick freestanding panels with leveling glides.
- 22" deep T-legs for stability (9.5" on each side)
- All Modules are Tempered Glass.
- Includes end of run trim.

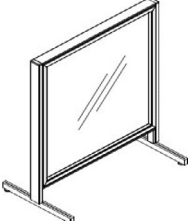
DESCRIPTION	PRODUCT CODE	LIST PRICE		DIMENSIONS/INCHES		
		CLR	FRST	H	W	D
 Freestanding Glazed Monolithic Privacy Panel	EVPPXGT4218	650	783	42	18	27/8
	EVPPXGT4224	715	875	42	24	27/8
	EVPPXGT4230	777	961	42	30	27/8
	EVPPXGT4236	836	1044	42	36	27/8
	EVPPXGT4242	903	1138	42	42	27/8

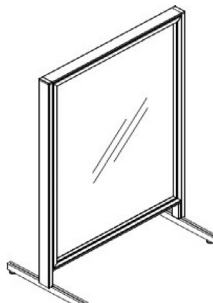
DESCRIPTION	PRODUCT CODE	LIST PRICE		DIMENSIONS/INCHES		
		CLR	FRST	H	W	D
 Freestanding Glazed Monolithic Privacy Panel	EVPPXGT5418	757	918	54	18	27/8
	EVPPXGT5424	835	1027	54	24	27/8
	EVPPXGT5430	908	1129	54	30	27/8
	EVPPXGT5436	977	1228	54	36	27/8
	EVPPXGT5442	1055	1338	54	42	27/8

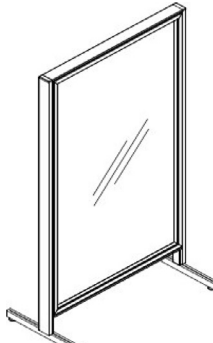
DESCRIPTION	PRODUCT CODE	LIST PRICE		DIMENSIONS/INCHES		
		CLR	FRST	H	W	D
 Freestanding Glazed Monolithic Privacy Panel	EVPPXGT6618	872	1068	66	18	27/8
	EVPPXGT6624	958	1188	66	24	27/8
	EVPPXGT6630	1045	1306	66	30	27/8
	EVPPXGT6636	1124	1419	66	36	27/8
	EVPPXGT6642	1218	1551	66	42	27/8



GALLERY PANELS

EVPP - GLAZED MOBILE PRIVACY PANEL

- Includes panel with two connectors with T legs.
- 3" thick freestanding panels with 1" locking casters.
- 22" deep T-legs for stability (9.5" on each side)
- All Modules are Tempered Glass.
- Includes end of run trim.
-

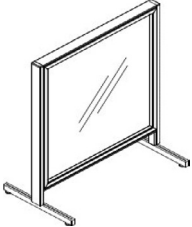
DESCRIPTION	PRODUCT CODE	LIST PRICE		DIMENSIONS/INCHES		
		CLR	FRST	H	W	D
 Monolithic Mobile Glazed Privacy Panel	EVPPXGT4218M	714	846	42	18	2 7/8
	EVPPXGT4224M	780	939	42	24	2 7/8
	EVPPXGT4230M	841	1024	42	30	2 7/8
	EVPPXGT4236M	899	1106	42	36	2 7/8
	EVPPXGT4242M	966	1203	42	42	2 7/8

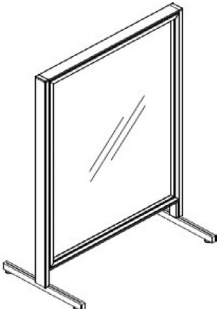
DESCRIPTION	PRODUCT CODE	LIST PRICE			DIMENSIONS/INCHES		
		CLR	FRST	WRW	H	W	D
 Mobile Glazed Monolithic Privacy Panel	EVPPXGT5418M	822	982	1374	54	18	2 7/8
	EVPPXGT5424M	898	1091	1582	54	24	2 7/8
	EVPPXGT5430M	971	1193	1783	54	30	2 7/8
	EVPPXGT5436M	1041	1293	1984	54	36	2 7/8
	EVPPXGT5442M	1120	1401	2195	54	42	2 7/8

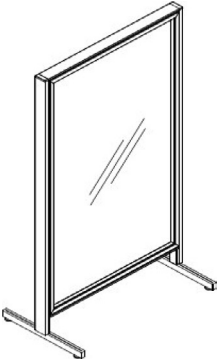
DESCRIPTION	PRODUCT CODE	LIST PRICE			DIMENSIONS/INCHES		
		CLR	FRST	WRW	H	W	D
 Mobile Glazed Monolithic Privacy Panel	EVPPXGT6618M	935	1133	1615	66	18	2 7/8
	EVPPXGT6624M	1021	1252	1860	66	24	2 7/8
	EVPPXGT6630M	1108	1371	2105	66	30	2 7/8
	EVPPXGT6636M	1188	1482	2341	66	36	2 7/8
	EVPPXGT6642M	1281	1615	2598	66	42	2 7/8

GALLERY PANELS

EVPBLERT - END OF RUN TRIM

- Specify to match height of beam or total height with extension modules

DESCRIPTION	PRODUCT CODE	LIST PRICE	DIMENSIONS/INCHES		
			H	W	D
	EVPBLERT24	49	21.4	2 7/8	
	EVPBLERT30	66	27.4	2 7/8	
	EVPBLERT36	70	33.4	2 7/8	
	EVPBLERT42	74	39.4	2 7/8	

GALLERY PANELS

EVPBLEPDSNC - POWER BEAM LAMINATE DOUBLE SIDED GALLERY PANEL, FINISHED ENDS

- Attaches to power beam channel.
- To be installed at end of power beam run.
- Finished in thermally fused laminate.
- No connection both sides.
- Laminate Gallery Panel height is inclusive of panel glides extended to their full height.
- If wood grain is selected, grain runs horizontally.
- Power beam channel and bottom connecting bracket to be ordered separately.

	DESCRIPTION	PRODUCT CODE	LIST PRICE LP	DIMENSIONS/INCHES		
				H	W	D
	Laminate Double Sided Connecting Gallery Panel - Finished Ends - 42" High	EVPBLEPDS4251NC	629	42	51	1
		EVPBLEPDS4263NC	818	42	63	1
		EVPBLEPDS4275NC	1009	42	75	1
	Laminate Double Sided Connecting Gallery Panel - Finished Ends - 48" High	EVPBLEPDS4851NC	685	48	51	1
		EVPBLEPDS4863NC	908	48	63	1
		EVPBLEPDS4875NC	1103	48	75	1
	Laminate Double Sided Connecting Gallery Panel - Finished Ends - 54" High	EVPBLEPDS5451NC	795	54	51	1
		EVPBLEPDS5463NC	1039	54	63	1
		EVPBLEPDS5475NC	1201	54	75	1

EVPBLEPDS - POWER BEAM LAMINATE DOUBLE SIDED CONNECTING GALLERY PANEL, CONNECTOR ENDS

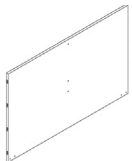

- Attaches to power beam channel.
- To be installed at end of power beam run.
- Finished in thermally fused laminate.
- No connection both sides.
- Locking connection both sides.
- Laminate Gallery Panel height is inclusive of panel glides extended to their full height.
- If wood grain is selected, grain runs horizontally.
- Power beam channel and bottom connecting bracket to be ordered separately.

	DESCRIPTION	PRODUCT CODE	LIST PRICE LP	DIMENSIONS/INCHES		
				H	W	D
	Laminate Double Sided Connecting Gallery Panel - Finished Ends - 42" High	EVPBLEPDS4251	629	42	51	1
		EVPBLEPDS4263	818	42	63	1
		EVPBLEPDS4275	1009	42	75	1
	Laminate Double Sided Connecting Gallery Panel - Finished Ends - 48" High	EVPBLEPDS4851	685	48	51	1
		EVPBLEPDS4863	908	48	63	1
		EVPBLEPDS4875	1103	48	75	1
	Laminate Double Sided Connecting Gallery Panel - Finished Ends - 52" High	EVPBLEPDS5451	795	54	51	1
		EVPBLEPDS5463	1039	54	63	1
		EVPBLEPDS5475	1201	54	75	1

GALLERY PANELS

EVPBLEPSSNC- POWER BEAM LAMINATE SINGLE SIDED GALLERY PANEL, FINISHED ENDS

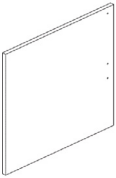
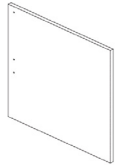
- Attaches to power beam channel.
- To be installed at end of power beam run on one side.
- Finished in thermally fused laminate.
- No connection both sides.
- Laminate Gallery Panel height is inclusive of panel glides extended to their full height.
- If wood grain is selected, grain runs horizontally.
- Power beam channel and bottom connecting bracket to be ordered separately.

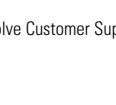
	DESCRIPTION	PRODUCT CODE	LIST PRICE LP	DIMENSIONS/INCHES		
				H	W	D
	Laminate Single Sided Connecting Gallery Panel - Finished Ends - Left - 42" High	EVPBLEPSSL4227NC	409	42	27	1
		EVPBLEPSSL4233NC	456	42	33	1
		EVPBLEPSSL4239NC	512	42	39	1
		EVPBLEPSSL4245NC	587	42	45	1
		EVPBLEPSSL4251NC	629	42	51	1
	Laminate Single Sided Connecting Gallery Panel - Finished Ends - Left - 48" High	EVPBLEPSSL4827NC	447	48	27	1
		EVPBLEPSSL4833NC	507	48	33	1
		EVPBLEPSSL4839NC	568	48	39	1
		EVPBLEPSSL4845NC	629	48	45	1
		EVPBLEPSSL4851NC	712	48	51	1
	Laminate Single Sided Connecting Gallery Panel - Finished Ends - Left - 54" High	EVPBLEPSSL5427NC	491	54	27	1
		EVPBLEPSSL5433NC	561	54	33	1
		EVPBLEPSSL5439NC	640	54	39	1
		EVPBLEPSSL5445NC	749	54	45	1
		EVPBLEPSSL5451NC	795	54	51	1
	Laminate Single Sided Connecting Gallery Panel - Finished Ends -Right - 42" High	EVPBLEPSSR4227NC	409	42	27	1
		EVPBLEPSSR4233NC	456	42	33	1
		EVPBLEPSSR4239NC	512	42	39	1
		EVPBLEPSSR4245NC	587	42	45	1
		EVPBLEPSSR4251NC	629	42	51	1
	Laminate Single Sided Connecting Gallery Panel - Finished Ends -Right - 48" High	EVPBLEPSSR4827NC	447	48	27	1
		EVPBLEPSSR4833NC	507	48	33	1
		EVPBLEPSSR4839NC	568	48	39	1
		EVPBLEPSSR4845NC	629	48	45	1
		EVPBLEPSSR4851NC	712	48	51	1
	Laminate Single Sided Connecting Gallery Panel - Finished Ends - Right - 54" High	EVPBLEPSSR5427NC	491	54	27	1
		EVPBLEPSSR5433NC	561	54	33	1
		EVPBLEPSSR5439NC	640	54	39	1
		EVPBLEPSSR5445NC	749	54	45	1
		EVPBLEPSSR5451NC	795	54	51	1



GALLERY PANELS

EVPBLEPSS - POWER BEAM LAMINATE SINGLE SIDED GALLERY PANEL, CONNECTOR ENDS

- Attaches to power beam channel.
- To be installed at end of power beam run on one side.
- Finished in thermally fused laminate.
- Locking connection both sides.
- Laminate Gallery Panel height is inclusive of panel glides extended to their full height.
- If wood grain is selected, grain runs horizontally.
- Power beam channel and bottom connecting bracket to be ordered separately.

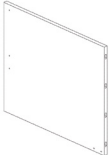
	DESCRIPTION	PRODUCT CODE	LIST PRICE	DIMENSIONS/INCHES		
			LP	H	W	D
	Laminate Single Sided Connecting Gallery Panel Connector Ends - Left - 42" High	EVPBLEPSSL4227	409	42	27	1
		EVPBLEPSSL4233	456	42	33	1
		EVPBLEPSSL4239	512	42	39	1
		EVPBLEPSSL4245	587	42	45	1
		EVPBLEPSSL4251	629	42	51	1
	Laminate Single Sided Connecting Gallery Panel Connector Ends - Left - 48" High	EVPBLEPSSL4827	447	48	27	1
		EVPBLEPSSL4833	507	48	33	1
		EVPBLEPSSL4839	568	48	39	1
		EVPBLEPSSL4845	629	48	45	1
		EVPBLEPSSL4851	712	48	51	1
	Laminate Single Sided Connecting Gallery Panel Connector Ends - Left - 54" High	EVPBLEPSSL5427	491	54	27	1
		EVPBLEPSSL5433	561	54	33	1
		EVPBLEPSSL5439	640	54	39	1
		EVPBLEPSSL5445	749	54	45	1
		EVPBLEPSSL5451	795	54	51	1
	Laminate Single Sided Connecting Gallery Panel Connector Ends -Right - 42" High	EVPBLEPSSR4227	409	42	27	1
		EVPBLEPSSR4233	456	42	33	1
		EVPBLEPSSR4239	512	42	39	1
		EVPBLEPSSR4245	587	42	45	1
		EVPBLEPSSR4251	629	42	51	1
	Laminate Single Sided Connecting Gallery Panel Connector Ends -Right - 48" High	EVPBLEPSSR4827	447	48	27	1
		EVPBLEPSSR4833	629	48	33	1
		EVPBLEPSSR4839	568	48	39	1
		EVPBLEPSSR4845	629	48	45	1
		EVPBLEPSSR4851	712	48	51	1
	Laminate Single Sided Connecting Gallery Panel Connector Ends - Right - 54" High	EVPBLEPSSR5427	491	54	27	1
		EVPBLEPSSR5433	561	54	33	1
		EVPBLEPSSR5439	640	54	39	1
		EVPBLEPSSR5445	749	54	45	1
		EVPBLEPSSR5451	795	54	51	1

GALLERY PANELS

EVPBLEPDCNC - POWER BEAM LAMINATE DOUBLE SIDED MIDDLE GALLERY PANEL, 24" ELECTRICAL CUTOUT, FINISHED ENDS

- Attaches to power beam channel.
- To be installed in middle between two power beam in straight run.
- Cut out for electric at 24" power beam height
- Finished in thermally fused laminate.
- No connection both sides.
- Laminate Gallery Panel height is inclusive of panel glides extended to their full height.
- If wood grain is selected, grain runs horizontally.
- Power beam channel and bottom connecting bracket to be ordered separately.

	DESCRIPTION	PRODUCT CODE	LIST PRICE LP	DIMENSIONS/INCHES		
				H	W	D
	Laminate Double Sided Middle Gallery Panel - 24" Electrical Cutout - 42" High	EVPBLEPDC4251NC	629	42	51	1
		EVPBLEPDC4263NC	818	42	63	1
		EVPBLEPDC4275NC	1009	42	75	1
	Laminate Double Sided Middle Gallery Panel - 24" Electrical Cutout - 48" High	EVPBLEPDC4851NC	685	48	51	1
		EVPBLEPDC4863NC	908	48	63	1
		EVPBLEPDC4875NC	1103	48	75	1
	Laminate Double Sided Middle Gallery Panel - 24" Electrical Cutout - 54" High	EVPBLEPDC5451NC	795	54	51	1
		EVPBLEPDC5463NC	1039	54	63	1
		EVPBLEPDC5475NC	1201	54	75	1

EVPBLEPDBNC - POWER BEAM LAMINATE DOUBLE SIDED MIDDLE GALLERY PANEL, 30" ELECTRICAL CUTOUT, FINISHED ENDS

- Attaches to power beam channel.
- To be installed in middle between two power beam in straight run.
- Cut out for electric at 30" power beam height
- Finished in thermally fused laminate.
- No connection both sides.
- Laminate Gallery Panel height is inclusive of panel glides extended to their full height.
- If wood grain is selected, grain runs horizontally.
- Power beam channel and bottom connecting bracket to be ordered separately.

	DESCRIPTION	PRODUCT CODE	LIST PRICE LP	DIMENSIONS/INCHES		
				H	W	D
	Laminate Double Sided Middle Gallery Panel - 30" Electrical Cutout - 42" High	EVPBLEPDC4251BNC	629	42	51	1
		EVPBLEPDC4263BNC	818	42	63	1
		EVPBLEPDC4275BNC	1009	42	75	1
	Laminate Double Sided Middle Gallery Panel - 30" Electrical Cutout - 48" High	EVPBLEPDC4851BNC	685	48	51	1
		EVPBLEPDC4863BNC	908	48	63	1
		EVPBLEPDC4875BNC	1103	48	75	1
	Laminate Double Sided Middle Gallery Panel - 30" Electrical Cutout - 54" High	EVPBLEPDC5451BNC	795	54	51	1
		EVPBLEPDC5463BNC	1039	54	63	1
		EVPBLEPDC5475BNC	1201	54	75	1



GALLERY PANELS

EVPBLEPDCNC - POWER BEAM LAMINATE DOUBLE SIDED MIDDLE GALLERY PANEL, 36" ELECTRICAL CUTOUT, FINISHED ENDS

- Attaches to power beam channel.
- To be installed in middle between two power beam in straight run.
- Cut out for electric at 36" power beam height
- Finished in thermally fused laminate.
- No connection both sides.
- Laminate Gallery Panel height is inclusive of panel glides extended to their full height.
- If wood grain is selected, grain runs horizontally.
- Power beam channel and bottom connecting bracket to be ordered separately.

	DESCRIPTION	PRODUCT CODE	LIST PRICE LP	DIMENSIONS/INCHES		
				H	W	D
	Laminate Double Sided Middle Gallery Panel - 36" Electrical Cutout - 42" High	EVPBLEPDC4251CNC	629	42	51	1
		EVPBLEPDC4263CNC	818	42	63	1
		EVPBLEPDC4275CNC	1009	42	75	1
	Laminate Double Sided Middle Gallery Panel - 36" Electrical Cutout - 48" High	EVPBLEPDC4851CNC	685	48	51	1
		EVPBLEPDC4863CNC	908	48	63	1
		EVPBLEPDC4875CNC	1103	48	75	1
	Laminate Double Sided Middle Gallery Panel - 36" Electrical Cutout - 54" High	EVPBLEPDC5451CNC	795	54	51	1
		EVPBLEPDC5463CNC	1039	54	63	1
		EVPBLEPDC5475CNC	1201	54	75	1

GALLERY PANELS

EVPBLEPDC - POWER BEAM LAMINATE DOUBLE SIDED MIDDLE CONNECTING GALLERY PANEL, 24"H ELECTRICAL CUTOUT

- Attaches to power beam channel.
- To be installed in middle between two power beams in straight run.
- Cut out for electric at 24" power beam height.
- Finished in thermally fused laminate.
- No connection both sides.
- Laminate Gallery Panel height is inclusive of panel glides extended to their full height.
- If wood grain is selected, grain runs horizontally.
- Power beam channel and bottom connecting bracket to be ordered separately.

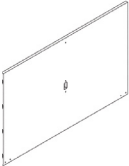
	DESCRIPTION	PRODUCT CODE	LIST PRICE LP	DIMENSIONS/INCHES		
				H	W	D
	Laminate Double Sided Middle Connecting Gallery Panel - Electrical Cutout - 42" High	EVPBLEPDC4251	629	42	51	1
		EVPBLEPDC4263	818	42	63	1
		EVPBLEPDC4275	1009	42	75	1
	Laminate Double Sided Middle Connecting Gallery Panel - Electrical Cutout - 48" High	EVPBLEPDC4851	685	48	51	1
		EVPBLEPDC4863	908	48	63	1
		EVPBLEPDC4875	1103	48	75	1
	Laminate Double Sided Middle Connecting Gallery Panel - Electrical Cutout - 54" High	EVPBLEPDC5451	795	54	51	1
		EVPBLEPDC5463	1039	54	63	1
		EVPBLEPDC5475	1201	54	75	1

EVPBLEPDC - POWER BEAM LAMINATE DOUBLE SIDED MIDDLE CONNECTING GALLERY PANEL, 30"H ELECTRICAL CUTOUT

- Attaches to power beam channel.
- To be installed in middle between two power beams in straight run.
- Cut out for electric at 30" power beam height
- Finished in thermally fused laminate.
- Locking connection both sides.
- Laminate Gallery Panel height is inclusive of panel glides extended to their full height.
- If wood grain is selected, grain runs horizontally.
- Power beam channel and bottom connecting bracket to be ordered separately.

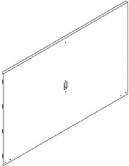
	DESCRIPTION	PRODUCT CODE	LIST PRICE LP	DIMENSIONS/INCHES		
				H	W	D
	Laminate Double Sided Middle Connecting Gallery Panel - 30" Electrical Cutout - 42" High	EVPBLEPDC4251B	629	42	51	1
		EVPBLEPDC4263B	818	42	63	1
		EVPBLEPDC4275B	1009	42	75	1
	Laminate Double Sided Middle Connecting Gallery Panel - 30" Electrical Cutout - 48" High	EVPBLEPDC4851B	685	48	51	1
		EVPBLEPDC4863B	908	48	63	1
		EVPBLEPDC4875B	1103	48	75	1
	Laminate Double Sided Middle Connecting Gallery Panel - 30" Electrical Cutout - 54" High	EVPBLEPDC5451B	795	54	51	1
		EVPBLEPDC5463B	1039	54	63	1
		EVPBLEPDC5475B	1201	54	75	1



GALLERY PANELS

EVPBLEPDC - POWER BEAM LAMINATE DOUBLE SIDED MIDDLE CONNECTING GALLERY PANEL, 36"H ELECTRICAL CUTOUT

- Attaches to power beam channel.
- To be installed in middle between two power beams in straight run.
- Cut out for electric at 36" power beam height
- Finished in thermally fused laminate.
- Locking connection both sides.
- Laminate Gallery Panel height is inclusive of panel glides extended to their full height.
- If wood grain is selected, grain runs horizontally.
- Power beam channel and bottom connecting bracket to be ordered separately.

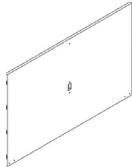
	DESCRIPTION	PRODUCT CODE	LIST PRICE LP	DIMENSIONS/INCHES		
				H	W	D
	Laminate Double Sided Middle Connecting	EVPBLEPDC4251C	629	42	51	1
	Gallery Panel - 30" Electrical Cutout - 42" High	EVPBLEPDC4263C	818	42	63	1
		EVPBLEPDC4275C	1009	42	75	1
	Laminate Double Sided Middle Connecting	EVPBLEPDC4851C	685	48	51	1
	Gallery Panel - 30" Electrical Cutout - 48" High	EVPBLEPDC4863C	908	48	63	1
		EVPBLEPDC4875C	1103	48	75	1
	Laminate Double Sided Middle Connecting	EVPBLEPDC5451C	795	54	51	1
	Gallery Panel - 30" Electrical Cutout - 54" High	EVPBLEPDC5463C	1039	54	63	1
		EVPBLEPDC5475C	1201	54	75	1

EVPBLEPSCNC - POWER BEAM LAMINATE SINGLE SIDED MIDDLE GALLERY PANEL, FINISHED ENDS, 24"H ELECTRICAL CUTOUT

- Attaches to power beam channel.
- To be installed in middle between two power beam in straight run on one side.
- Cut out for electric at 24" power beam height.
- Finished in thermally fused laminate.
- No connection both sides.
- Laminate Gallery Panel height is inclusive of panel glides extended to their full height.
- If wood grain is selected, grain runs horizontally.
- Power beam channel and bottom connecting bracket to be ordered separately.

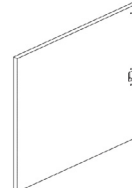
	DESCRIPTION	PRODUCT CODE	LIST PRICE LP	DIMENSIONS/INCHES		
				H	W	D
	Laminate Single Sided Middle Gallery	EVPBLEPSC4227NC	409	42	27	1
	Panel - Finished Ends - 42" High	EVPBLEPSC4233NC	456	42	33	1
		EVPBLEPSC4239NC	512	42	39	1
		EVPBLEPSC4245NC	587	42	45	1
		EVPBLEPSC4251NC	629	42	51	1
	Laminate Single Sided Middle Gallery	EVPBLEPSC4827NC	447	48	27	1
	Panel - Finished Ends - 48" High	EVPBLEPSC4833NC	507	48	33	1
		EVPBLEPSC4839NC	568	48	39	1
		EVPBLEPSC4845NC	629	48	45	1
		EVPBLEPSC4851NC	712	48	51	1
	Laminate Single Sided Middle Gallery	EVPBLEPSC5427NC	491	54	27	1
	Panel - Finished Ends - 54" High	EVPBLEPSC5433NC	561	54	33	1
		EVPBLEPSC5439NC	640	54	39	1
		EVPBLEPSC5445NC	629	54	45	1
		EVPBLEPSC5451NC	795	54	51	1

GALLERY PANELS

EEVPBLEPSCNC - POWER BEAM LAMINATE SINGLE SIDED MIDDLE GALLERY PANEL, FINISHED ENDS, 30" H ELECTRICAL CUTOUT

- Attaches to power beam channel.
- To be installed in middle between two power beam in straight run on one side.
- Cut out for electric at 30" power beam height
- Finished in thermally fused laminate.
- No connection both sides.
- Laminate Gallery Panel height is inclusive of panel glides extended to their full height.
- If wood grain is selected, grain runs horizontally.
- Power beam channel and bottom connecting bracket to be ordered separately.

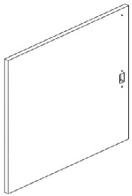
	DESCRIPTION	PRODUCT CODE	LIST PRICE LP	DIMENSIONS/INCHES		
				H	W	D
	Laminate Single Sided Middle Gallery Panel - Finished Ends - 42" High	EVPBLEPSC4227BNC	409	42	27	1
		EVPBLEPSC4233BNC	456	42	33	1
		EVPBLEPSC4239BNC	512	42	39	1
		EVPBLEPSC4245BNC	587	42	45	1
		EVPBLEPSC4251BNC	629	42	51	1
	Laminate Single Sided Middle Gallery Panel - Finished Ends - 48" High	EVPBLEPSC4827BNC	447	48	27	1
		EVPBLEPSC4833BNC	507	48	33	1
		EVPBLEPSC4839BNC	568	48	39	1
		EVPBLEPSC4845BNC	629	48	45	1
		EVPBLEPSC4851BNC	712	48	51	1
	Laminate Single Sided Middle Gallery Panel - Finished Ends - 54" High	EVPBLEPSC5427BNC	491	54	27	1
		EVPBLEPSC5433BNC	561	54	33	1
		EVPBLEPSC5439BNC	640	54	39	1
		EVPBLEPSC5445BNC	749	54	45	1
		EVPBLEPSC5451BNC	795	54	51	1



GALLERY PANELS

EVPBLEPSCNC - POWER BEAM LAMINATE SINGLE SIDED MIDDLE GALLERY PANEL, FINISHED ENDS, 36"H ELECTRICAL CUTOUT

- Attaches to power beam channel.
- To be installed in middle between two power beam in straight run on one side.
- Cut out for electric at 36" power beam height
- Finished in thermally fused laminate.
- No connection both sides.
- Laminate Gallery Panel height is inclusive of panel glides extended to their full height.
- If wood grain is selected, grain runs horizontally.
- Power beam channel and bottom connecting bracket to be ordered separately.

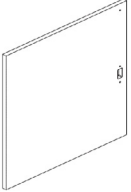
	DESCRIPTION	PRODUCT CODE	LIST PRICE LP	DIMENSIONS/INCHES		
				H	W	D
	Laminate Single Sided Middle Gallery Panel - Finished Ends - 42" High	EVPBLEPSC4227CNC	409	42	27	1
		EVPBLEPSC4233CNC	456	42	33	1
		EVPBLEPSC4239CNC	512	42	39	1
		EVPBLEPSC4245CNC	587	42	45	1
		EVPBLEPSC4251CNC	629	42	51	1
	Laminate Single Sided Middle Gallery Panel - Finished Ends - 48" High	EVPBLEPSC4827CNC	447	48	27	1
		EVPBLEPSC4833CNC	507	48	33	1
		EVPBLEPSC4839CNC	568	48	39	1
		EVPBLEPSC4845CNC	629	48	45	1
		EVPBLEPSC4851CNC	712	48	51	1
	Laminate Single Sided Middle Gallery Panel - Finished Ends - 54" High	EVPBLEPSC5427CNC	491	54	27	1
		EVPBLEPSC5433CNC	561	54	33	1
		EVPBLEPSC5439CNC	640	54	39	1
		EVPBLEPSC5445CNC	749	54	45	1
		EVPBLEPSC5451CNC	795	54	51	1

GALLERY PANELS

EVPBLEPSC - POWER BEAM LAMINATE SINGLE SIDED MIDDLE CONNECTING GALLERY PANEL, 24"H ELECTRICAL CUTOUT

- Attaches to power beam channel.
- To be installed in middle between two power beam in straight run on one side.
- Cut out for electrics at 24" power beam height
- Finished in thermally fused laminate.
- Locking connection one side.
- Laminate Gallery Panel height is inclusive of panel glides extended to their full height.
- If wood grain is selected, grain runs horizontally.
- Power beam channel and bottom connecting bracket to be ordered separately.

	DESCRIPTION	PRODUCT CODE	LIST PRICE LP	DIMENSIONS/INCHES		
				H	W	D
	Laminate Single Sided Connecting Gallery Panel - 24" Electrical Cutout - 42" High	EVPBLEPSC4227	409	42	27	1
		EVPBLEPSC4233	456	42	33	1
		EVPBLEPSC4239	512	42	39	1
		EVPBLEPSC4245	587	42	45	1
		EVPBLEPSC4251	629	42	51	1
	Laminate Single Sided Connecting Gallery Panel - 24" Electrical Cutout - 48" High	EVPBLEPSC4827	447	48	27	1
		EVPBLEPSC4833	507	48	33	1
		EVPBLEPSC4839	568	48	39	1
		EVPBLEPSC4845	629	48	45	1
		EVPBLEPSC4851	712	48	51	1
	Laminate Single Sided Connecting Gallery Panel - 24" Electrical Cutout - 54" High	EVPBLEPSC5427	491	54	27	1
		EVPBLEPSC5433	561	54	33	1
		EVPBLEPSC5439	640	54	39	1
		EVPBLEPSC5445	749	54	45	1
		EVPBLEPSC5451	795	54	51	1

EVPBLEPSC - POWER BEAM LAMINATE SINGLE SIDED MIDDLE CONNECTING GALLERY PANEL, 30"H ELECTRICAL CUTOUT

- Attaches to power beam channel.
- To be installed in middle between two power beam in straight run on one side.
- Cut out for electrics at 30" power beam height.
- Finished in thermally fused laminate.
- Locking connection on one side.
- Laminate Gallery Panel height is inclusive of panel glides extended to their full height.
- If wood grain is selected, grain runs horizontally.
- Power beam channel and bottom connecting bracket to be ordered separately.

	DESCRIPTION	PRODUCT CODE	LIST PRICE LP	DIMENSIONS/INCHES		
				H	W	D
	Laminate Single Sided Connecting Gallery Panel - 30" Electrical Cutout - 42" High	EVPBLEPSC4227B	409	42	27	1
		EVPBLEPSC4233B	456	42	33	1
		EVPBLEPSC4239B	512	42	39	1
		EVPBLEPSC4245B	587	42	45	1
		EVPBLEPSC4251B	629	42	51	1
	Laminate Single Sided Connecting Gallery Panel - 30" Electrical Cutout - 48" High	EVPBLEPSC4827B	447	48	27	1
		EVPBLEPSC4833B	507	48	33	1
		EVPBLEPSC4839B	568	48	39	1
		EVPBLEPSC4845B	629	48	45	1
		EVPBLEPSC4851B	712	48	51	1
	Laminate Single Sided Connecting Gallery Panel - 30" Electrical Cutout - 54" High	EVPBLEPSC5427B	491	54	27	1
		EVPBLEPSC5433B	561	54	33	1
		EVPBLEPSC5439B	640	54	39	1
		EVPBLEPSC5445B	749	54	45	1
		EVPBLEPSC5451B	795	54	51	1



GALLERY PANELS

EVPBLEPSC - POWER BEAM LAMINATE SINGLE SIDED MIDDLE CONNECTING GALLERY PANEL, 36" H ELECTRICAL CUTOUT



- Attaches to power beam channel.
- To be installed in middle between two power beam in straight run on one side.
- Cut out for electric at 36" power beam height
- Finished in thermally fused laminate.
- Locking connection on one side.
- Laminate Gallery Panel height is inclusive of panel glides extended to their full height.
- If wood grain is selected, grain runs horizontally.
- Power beam channel and bottom connecting bracket to be ordered separately.

	DESCRIPTION	PRODUCT CODE	LIST PRICE LP	DIMENSIONS/INCHES		
				H	W	D
	Laminate Single Sided Connecting Gallery Panel - 36" Electrical Cutout - 42" High	EVPBLEPSC4227C	409	42	27	1
		EVPBLEPSC4233C	456	42	33	1
		EVPBLEPSC4239C	512	42	39	1
		EVPBLEPSC4245C	587	42	45	1
		EVPBLEPSC4251C	629	42	51	1
	Laminate Single Sided Connecting Gallery Panel - 36" Electrical Cutout - 48" High	EVPBLEPSC4827C	447	48	27	1
		EVPBLEPSC4833C	507	48	33	1
		EVPBLEPSC4839C	568	48	39	1
		EVPBLEPSC4845C	629	48	45	1
		EVPBLEPSC4851C	712	48	51	1
	Laminate Single Sided Connecting Gallery Panel - 36" Electrical Cutout - 54" High	EVPBLEPSC5427C	491	54	27	1
		EVPBLEPSC5433C	561	54	33	1
		EVPBLEPSC5439C	640	54	39	1
		EVPBLEPSC5445C	749	54	45	1
		EVPBLEPSC5451C	795	54	51	1

GALLERY PANELS

EVLXPMNC - LAMINATE GALLERY EXTENSION PANEL, FINISHED END

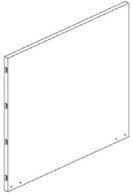
- Locking connection on one side, no connection at end.
- Finished in thermally fused laminate.
- Laminate Gallery Extension Panel height is inclusive of panel glides extended to their full height.
- If wood grain is selected, grain runs horizontally.
- Bottom connecting brackets to be ordered separately.



	DESCRIPTION	PRODUCT CODE	LIST PRICE LP	DIMENSIONS/INCHES		
				H	W	D
	Laminate Gallery Extension Panel	EVLPML4224NC	335	42	24	1
	Finished End - 42" High	EVLPML4230NC	409	42	30	1
		EVLPML4236NC	456	42	36	1
		EVLPML4242NC	511	42	42	1
		EVLPML4248NC	586	42	48	1
	Laminate Gallery Extension Panel	EVLPML4824NC	385	48	24	1
	Finished End - 48" High	EVLPML4830NC	447	48	30	1
		EVLPML4836NC	507	48	36	1
		EVLPML4842NC	568	48	42	1
		EVLPML4848NC	629	48	48	1
	Laminate Gallery Extension Panel	EVLPML5424NC	420	54	24	1
	Finished End - 54" High	EVLPML5430NC	491	54	30	1
		EVLPML5436NC	561	54	36	1
		EVLPML5442NC	640	54	42	1
		EVLPML5448NC	749	54	48	1
	Laminate Gallery Extension Panel	EVLPMR4224NC	335	42	24	1
	Finished End - 42" High	EVLPMR4230NC	409	42	30	1
		EVLPMR4236NC	456	42	36	1
		EVLPMR4242NC	511	42	42	1
		EVLPMR4248NC	586	42	48	1
	Laminate Gallery Extension Panel	EVLPMR4824NC	385	48	24	1
	Finished End - 48" High	EVLPMR4830NC	447	48	30	1
		EVLPMR4836NC	507	48	36	1
		EVLPMR4842NC	568	48	42	1
		EVLPMR4848NC	629	48	48	1
	Laminate Gallery Extension Panel	EVLPMR5424NC	420	54	24	1
	Finished End - 54" High	EVLPMR5430NC	491	54	30	1
		EVLPMR5436NC	561	54	36	1
		EVLPMR5442NC	640	54	42	1
		EVLPMR5448NC	749	54	48	1



GALLERY PANELS

EVLXPM - LAMINATE GALLERY STRAIGHT EXTENSION PANEL, CONNECTOR ENDS

- Locking connection both sides.
- Finished in thermally fused laminate.
- Laminate Gallery Panel height is inclusive of panel glides extended to their full height.
- If wood grain is selected, grain runs horizontally.
- Bottom connecting brackets to be ordered separately.

	DESCRIPTION	PRODUCT CODE	LIST PRICE LP	DIMENSIONS/INCHES		
				H	W	D
	Laminate Gallery Straight Extension	EVLXPML4224	335	42	24	1
	Panel - Connector Ends - Left - 42" High	EVLXPML4230	409	42	30	1
		EVLXPML4236	456	42	36	1
		EVLXPML4242	511	42	42	1
		EVLXPML4248	586	42	48	1
	Laminate Gallery Straight Extension	EVLXPML4824	385	48	24	1
	Panel - Connector Ends - Left - 48" High	EVLXPML4830	447	48	30	1
		EVLXPML4836	629	48	36	1
		EVLXPML4842	568	48	42	1
		EVLXPML4848	629	48	48	1
	Laminate Gallery Straight Extension	EVLXPML5424	420	54	24	1
	Panel - Connector Ends - Left - 54" High	EVLXPML5430	491	54	30	1
		EVLXPML5436	561	54	36	1
		EVLXPML5442	640	54	42	1
		EVLXPML5448	749	54	48	1
	Laminate Gallery Straight Extension	EVLXPMR4224	335	42	24	1
	Panel - Connector Ends - Right - 42" High	EVLXPMR4230	409	42	30	1
		EVLXPMR4236	456	42	36	1
		EVLXPMR4242	511	42	42	1
		EVLXPMR4248	586	42	48	1
	Laminate Gallery Straight Extension	EVLXPMR4824	385	48	24	1
	Panel - Connector Ends - Right - 48" High	EVLXPMR4830	447	48	30	1
		EVLXPMR4836	507	48	36	1
		EVLXPMR4842	568	48	42	1
		EVLXPMR4848	629	48	48	1
	Laminate Gallery Straight Extension	EVLXPMR5424	420	54	24	1
	Panel - Connector Ends - Right - 54" High	EVLXPMR5430	491	54	30	1
		EVLXPMR5436	561	54	36	1
		EVLXPMR5442	640	54	42	1
		EVLXPMR5448	749	54	48	1

GALLERY PANELS

EV2LXP - LAMINATE GALLERY TWO-WAY EXTENSION PANEL, FINISHED ENDS

- Panel connects at 90 degree with extension panel.
- Finished in thermally fused laminate.
- Laminate Gallery Extension Panel height is inclusive of panel glides extended to their full height.
- If wood grain is selected, grain runs horizontally.
- Corner connecting brackets to be ordered separately.

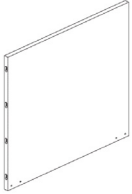
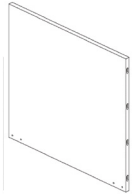
	DESCRIPTION	PRODUCT CODE	LIST PRICE LP	DIMENSIONS/INCHES		
				H	W	D
	Laminate Gallery Two-Way Extension Panel - Finished Ends - Left - 42" High	EV2LXPL4225	337	42	25	1
		EV2LXPL4231	409	42	31	1
		EV2LXPL4237	456	42	37	1
		EV2LXPL4243	512	42	43	1
		EV2LXPL4249	587	42	49	1
	Laminate Gallery Two-Way Extension Panel - Finished Ends - Left - 48" High	EV2LXPL4825	385	48	25	1
		EV2LXPL4831	447	48	31	1
		EV2LXPL4837	507	48	37	1
		EV2LXPL4843	568	48	43	1
		EV2LXPL4849	629	48	49	1
	Laminate Gallery Two-Way Extension Panel - Finished Ends - Left - 54" High	EV2LXPL5425	451	54	25	1
		EV2LXPL5431	516	54	31	1
		EV2LXPL5437	580	54	37	1
		EV2LXPL5443	705	54	43	1
		EV2LXPL5449	795	54	49	1
	Laminate Gallery Two-Way Extension Panel - Finished Ends - Right - 42" High	EV2LXPR4225	337	42	25	1
		EV2LXPR4231	409	42	33	1
		EV2LXPR4237	456	42	37	1
		EV2LXPR4243	512	42	43	1
		EV2LXPR4249	587	42	49	1
	Laminate Gallery Two-Way Extension Panel - Finished Ends - Right - 48" High	EV2LXPR4825	385	48	25	1
		EV2LXPR4831	447	48	33	1
		EV2LXPR4837	507	48	37	1
		EV2LXPR4843	568	48	43	1
		EV2LXPR4849	629	48	49	1
	Laminate Gallery Two-Way Extension Panel - Finished Ends - Right - 54" High	EV2LXPR5425	451	54	25	1
		EV2LXPR5431	516	54	31	1
		EV2LXPR5437	580	54	37	1
		EV2LXPR5443	705	54	43	1
		EV2LXPR5449	795	54	49	1



GALLERY PANELS

EV3LXP - LAMINATE GALLERY THREE-WAY EXTENSION PANEL, FINISHED ENDS

- Panel connects "T" configuration with extension panel.
- Finished in thermally fused laminate.
- Laminate Gallery Extension Panel height is inclusive of panel glides extended to their full height.
- If wood grain is selected, grain runs horizontally.
- Corner connecting brackets to be ordered separately.

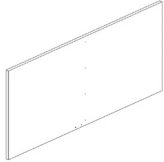
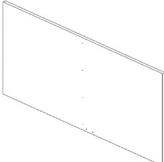
	DESCRIPTION	PRODUCT CODE	LIST PRICE LP	DIMENSIONS/INCHES		
				H	W	D
	Laminate Gallery Three-Way Extension Panel - Finished Ends - Left - 42" High	EV3LXPL4249	629	42	49	1
		EV3LXPL4261	749	42	61	1
		EV3LXPL4273	871	42	73	1
	Laminate Gallery Three-Way Extension Panel - Finished Ends - Left - 48" High	EV3LXPL4849	712	48	49	1
		EV3LXPL4861	875	48	61	1
		EV3LXPL4873	1039	48	73	1
	Laminate Gallery Three-Way Extension Panel - Finished Ends - Left - 54" High	EV3LXPL5449	795	54	49	1
		EV3LXPL5461	1039	54	61	1
		EV3LXPL5473	1201	54	73	1
	Laminate Gallery Three-Way Extension Panel - Finished Ends - Left - 42" High	EV3LXPR4249	629	42	49	1
		EV3LXPR4261	749	42	61	1
		EV3LXPR4273	871	42	73	1
	Laminate Gallery Three-Way Extension Panel - Finished Ends - Left - 48" High	EV3LXPR4849	712	48	49	1
		EV3LXPR4861	875	48	61	1
		EV3LXPR4873	1039	48	73	1
	Laminate Gallery Three-Way Extension Panel - Finished Ends - Left - 54" High	EV3LXPR5449	795	54	49	1
		EV3LXPR5461	1039	54	61	1
		EV3LXPR5473	1201	54	73	1

GALLERY PANELS

EV4LXP - LAMINATE DOUBLE GALLERY PANEL FOR FOUR-WAY, FINISHED ENDS

- Panel connects "+" configuration with extension panel.
- Finished in thermally fused laminate.
- Laminate Gallery Extension Panel height is inclusive of panel glides extended to their full height.
- If wood grain is selected, grain runs horizontally.
- Corner connecting brackets to be ordered separately

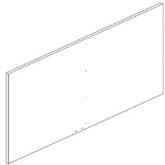
	DESCRIPTION	PRODUCT CODE	LIST PRICE LP	DIMENSIONS/INCHES		
				H	W	D
	Laminate Double Gallery Panel	EV4LXP4249	629	42	49	1
	Four-Way - Finished Ends - 42" High	EV4LXP4261	819	42	61	1
		EV4LXP4273	1009	42	73	1
	Laminate Double Gallery Panel	EV4LXP4849	685	48	49	1
	Four-Way - Finished Ends - 48" High	EV4LXP4861	908	48	61	1
		EV4LXP4873	1103	48	73	1
	Laminate Double Gallery Panel	EV4LXP5449	795	54	49	1
	Four-Way - Finished Ends - 48" High	EV4LXP5461	1039	54	61	1
		EV4LXP5473	1201	54	73	1

EV4LXPM - LAMINATE GALLERY EXTENSION PANEL FOR FOUR-WAY CONFIGURATION, FINISHED ENDS

- Locking connection on one side only for four way panel.
- Finished in thermally fused laminate.
- Universal to be used on both sides of four way laminate panel.
- Laminate Gallery Extension Panel height is inclusive of panel glides extended to their full height.
- If wood grain is selected, grain runs horizontally.
- Bottom connecting brackets to be ordered separately.

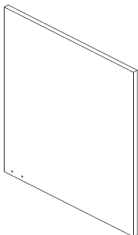
	DESCRIPTION	PRODUCT CODE	LIST PRICE LP	DIMENSIONS/INCHES		
				H	W	D
	Laminate Gallery Extension Panel	EV4LXPM4224	335	42	24	1
	Four-Way - Finished Ends - 42" High	EV4LXPM4230	409	42	30	1
		EV4LXPM4236	456	42	36	1
		EV4LXPM4242	511	42	42	1
		EV4LXPM4248	586	42	58	1
	Laminate Gallery Extension Panel	EV4LXPM4824	385	48	24	1
	Four-Way - Finished Ends - 42" High	EV4LXPM4830	447	48	30	1
		EV4LXPM4836	507	48	36	1
		EV4LXPM4842	568	48	42	1
		EV4LXPM4848	629	48	48	1
	Laminate Gallery Extension Panel	EV4LXPM5424	420	54	24	1
	Four-Way - Finished Ends - 42" High	EV4LXPM5430	491	54	30	1
		EV4LXPM5436	561	54	36	1
		EV4LXPM5442	640	54	42	1
		EV4LXPM5448	749	54	48	1



GALLERY PANELS

EVPBIECH - POWER BEAM CONNECTOR CHANNEL

- One piece channel for power beam and extension module above, attaches to laminate panels with screws.
- Power beam attaches to channel with clamps and extension module attaches above.
- Channel has cut out for power beam electric to run thru laminate panel.
- Note: not stackable. Channel has cut out for power beam electric to run thru laminate panel.

DESCRIPTION	PRODUCT CODE	LIST PRICE LP	DIMENSIONS/INCHES		
			H	W	D
 Connector Channel	EVPBIECH12	46	12	2.875	
	EVPBIECH18	52	18	2.875	
	EVPBIECH24	62	24	2.875	
	EVPBIECH30	68	30	2.875	
	EVPBIECH36	73	36	2.875	

EVHLPBB01 - LAMINATE GALLERY PANEL BOTTOM BRACKET

- Laminate panel bottom bracket connects two laminate end panels at bottom with screws.
- Available in standard paint colors.
- Bracket and screws included.

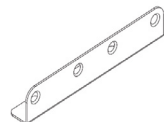
DESCRIPTION	PRODUCT CODE	LIST PRICE LP	DIMENSIONS/INCHES		
			H	W	D
 Bottom Bracket	EVHLPBB01	42	1.5	8	1

EVHLPB01 - LAMINATE GALLERY PANEL CORNER BRACKET

- Laminate panel corner bottom bracket connects two laminate panels at 90 degree.
- Available in standard paint colors.
- Bracket and screws included.

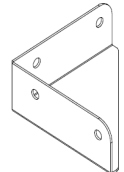
DESCRIPTION	PRODUCT CODE	LIST PRICE LP	DIMENSIONS/INCHES		
			H	W	D
 Corner Bracket	EVHLPB01	41	1.5	4	4

GALLERY PANELS

EVPBGFC - GALLERY PANEL BASE FEED COVER

- Connects to gallery panels, underneath power beam with electrical cutout.
- Includes vertical covers and slotted connector.
- Power beam with electrical cut out to be ordered separately.

	DESCRIPTION	PRODUCT CODE	LIST PRICE	DIMENSIONS/INCHES		
			LP	H	W	D
	Gallery Panel Base Feed Cover	EVPBGFC24	168	24	6	3
		EVPBGFC30	191	30	6	3
		EVPBGFC36	215	36	6	3

EVPBGDP - GALLERY PANEL POWER DATA POST / COMM LAY-IN

- Attaches to Power beam gallery end panel to bring power and/or data cables from ceiling to power beam.
- Three-sided power pole with snap-on fourth side.
- Made of aluminum and can be field cut.
- Accommodates up to 25 CAT 5 cables with electric.
- Accommodates up to 45 CAT 5 cables without electric.
- Standard data post extension used above.
- Standard data post extension to be ordered separately.

	DESCRIPTION	PRODUCT CODE	LIST PRICE	DIMENSIONS/INCHES		
			LP	H	W	D
	Gallery Panel Power Data Post 24" High	EVPBGDP42	146	42	2	
		EVPBGDP48	165	48	2	
		EVPBGDP54	200	54	2	
	Gallery Panel Power Data Post 30" High	EVPBGDP42B	146	42	2	
		EVPBGDP48B	165	48	2	
		EVPBGDP54B	200	54	2	
	Gallery Panel Power Data Post 36" High	EVPBGDP42C	146	42	2	
		EVPBGDP48C	165	48	2	
		EVPBGDP54C	200	54	2	



GALLERY PANELS

EVPBLEP - LAMINATE END PANEL FOR POWER BEAM

- Connects to a power beam support leg with foot at the end of a run
- Includes brackets to attach to support leg with foot
- Finished in thermally fused laminate. If wood grain is selected, grain runs horizontally
- Laminate End Panel height is inclusive of panel glides extended to their full height
- Laminate end panel must connect to a support leg with foot and will not connect to a support leg with glide
- Must be used with Connectors with T-Leg

DESCRIPTION	PRODUCT CODE	LIST PRICE	DIMENSIONS/INCHES		
			H	W	D
 Laminate End Panel for Power Beam	EVPBLEP2451	349	24	51	1
	EVPBLEP3051	435	30	51	1
	EVPBLEP3651	525	36	51	1
	EVPBLEP4251	770	42	51	1
	EVPBLEP2463	426	24	63	1
	EVPBLEP3063	530	30	63	1
	EVPBLEP3663	630	36	63	1
	EVPBLEP4263	860	42	63	1

EVPBLEP - LAMINATE END PANEL FOR POWER BEAM, SINGLE LEG

- Attaches to power beam connector with single leg
- For one sided Power beam application
- Includes brackets to attached to leg
- Finished in thermally fused laminate, if wood grain is selected, grain runs horizontally
- Laminate End Panel height is inclusive of panel glides extended to their full height
- EVPBLEPxx30 to be used for 24" deep worksurface
- EVPBLEPxx36 to be used for 30" deep worksurface

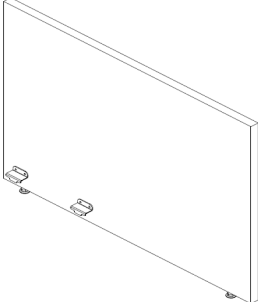
DESCRIPTION	PRODUCT CODE	LIST PRICE	DIMENSIONS/INCHES		
			H	W	D
	EVPBLEP2430	315	24	30	1
	EVPBLEP3030	340	30	30	1
	EVPBLEP3630	364	36	30	1
	EVPBLEP4230	427	42	30	1
	EVPBLEP2436	367	24	36	1
	EVPBLEP3036	380	30	36	1
	EVPBLEP3636	427	36	36	1
	EVPBLEP4236	511	42	36	1

ELECTRICAL

EVE8PD - POWER DISTRIBUTION HOUSING

- Power housing is specified per beam size (e.g. EVE8PD36 is for use in a 36" beam).
- 8 wire, 4 circuits (2+2 configuration).
- Accommodates two duplex receptacles per panel side.

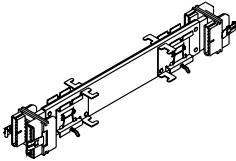
DESCRIPTION	PRODUCT CODE	LIST PRICE	DIMENSIONS/INCHES		
			H	L	D
 Power Distribution Housing	EVE8PD36	210		17 1/2	
	EVE8PD42	215		23 1/2	
	EVE8PD48	233		29 1/2	
	EVE8PD54	234		39 1/4	
	EVE8PD60	235		41 1/2	
	EVE8PD66	244		41 1/2	
	EVE8PD72	258		41 1/2	

EVE8CP - FLEXIBLE MESH JUMPER CABLE

- Used to connect two power distribution housings in a straight run, 90-degree or 120-degree connections.
- 18.5" flexible mesh jumper replaces EVE8CP20 jumper for corner post applications.

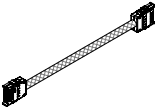
DESCRIPTION	PRODUCT CODE	LIST PRICE	DIMENSIONS/INCHES		
			H	L	D
 Flexible Mesh Jumper Cable	EVE8CP17	114		17 1/2	
	EVE8CP18	141		18 1/2	

EVE8CPXX-H - PASS-THROUGH CABLE

- Flexible metal conduit with wire mesh distributes electrical power through non-powered beams.
- To calculate the length of a Pass-Through Cable, add the widths of the non-powered beam separating the powered panels (panels with distribution housing attached). To this, add 16" (distance from the edge of the panel to the distribution housing x 2).
- Add additional 3" when passing through a post. See the Tips at the beginning of the section for more details.
- Hybrid pass-through cables with wire mesh allows connection at 90 degree post at one end for Evolve panels including Beltline and Power Beam.

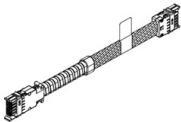
DESCRIPTION	PRODUCT CODE	LIST PRICE	DIMENSIONS/INCHES		
			H	L	D
 Pass-Through Cable	EVE8CP40-H	191		40	
	EVE8CP46-H	198		46	
	EVE8CP52-H	203		52	
	EVE8CP58-H	216		58	
	EVE8CP64-H	225		64	
	EVE8CP70-H	232		70	
	EVE8CP76-H	234		76	
	EVE8CP82-H	244		82	
	EVE8CP88-H	252		88	
	EVE8CP94-H	259		88	
	EVE8CP100-H	267		100	
	EVE8CP106-H	280		106	
	EVE8CP118-H	293		118	
	EVE8CP130-H	322		130	
	EVE8CP142-H	337		142	
	EVE8CP154-H	352		154	
	EVE8CP172-H	379		172	
	EVE8CP190-H	397		190	
	EVE8CP208-H	412		208	



ELECTRICAL

EVE8CP50-H - JUMPER CABLE PANEL TO POWER BEAM

- Jumper cable to connect panel power distribution housing to power beam
- Hybrid jumper cable with metal conduit and with 24" long wire mesh end to be able to plug into power beam
- Panel to Power beam Post with vertical base feed covers to be ordered separately
- Power beam with electrical cut out must be ordered
- 50" long Jumper cable will work with 24", 30" and 36" H Power beam

	DESCRIPTION	PRODUCT CODE	LIST PRICE	DIMENSIONS/INCHES		
				H	L	D
	Jumper cable Panel to Power Beam	EVE8CP50-H	194		50	

EVE8CI-1 - "I" CONNECTOR

- Female - Female connector used to connect two Pass-Through Cables
- Connects receptacles for 66" w and 72" w modules when two are required on one end

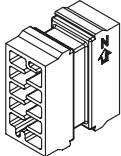
	DESCRIPTION	PRODUCT CODE	LIST PRICE	DIMENSIONS/INCHES		
				H	W	D
	"I" Connector	EVE8CI-1	85			

EVE8RD - DUPLEX RECEPTACLE

- Duplex receptacles are rated for 15 Amps.
- EVE8RD1 = Circuit #1 (utility circuit)
- EVE8RD2 = Circuit #2 (utility circuit)
- EVE8RDA = Circuit A (dedicated)
- EVE8RDB = Circuit B (dedicated)

NOTE:

- EVE8RD1 and EVE8RD2 (#1 and #2 share common ground)
- EVE8RDA and EVE8RDB (A and B share common ground)
- Up to 8 receptacles on average per circuit (24 per infeed), not to exceed total of 15 Amps per circuit.
- Actual quantity of receptacles is determined by individual electrical requirements as determined by the customer.
- Standard in black. Available in White or Nevada with upcharge, add \$3.00.

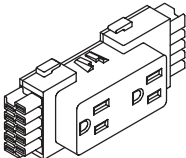
	DESCRIPTION	PRODUCT CODE	LIST PRICE	DIMENSIONS/INCHES		
				H	W	D
	Duplex Receptacle	EVE8RD1	32	2	4 5/8	1 1/4
		EVE8RD2	32	2	4 5/8	1 1/4
		EVE8RDA	32	2	4 5/8	1 1/4
		EVE8RDB	32	2	4 5/8	1 1/4

ELECTRICAL

EVE8RD1CA - CALIFORNIA CONTROLLED DUPLEX RECEPTACLE

- California Title 24 meets federal and LEED certification guidelines
- Allows circuit to be controlled or switched off when utility is not in use.
- Duplex receptacles are rated for 15 Amps.
- EVE8RD1CA = Circuit #1 (utility circuit)
- EVE8RD2CA = Circuit #2 (utility circuit)
- EVE8RDACA = Circuit A (dedicated)
- EVE8RDBCA = Circuit B (dedicated)

NOTE:

- EVE8RD1CA and EVE8RD2CA (#1 and #2 share common ground)
- EVE8RDACA and EVE8RDBCA (A and B share common ground)
- Up to 6 receptacles per circuit (24 per infeed), not to exceed total of 15 Amps per circuit.
- Available in BLK finish only.

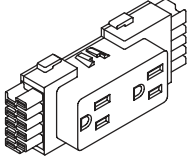
DESCRIPTION	PRODUCT CODE	LIST PRICE	DIMENSIONS/INCHES		
			H	W	D
	EVE8RD1CA	35	2	4 5/8	1 1/4
	EVE8RD2CA	35	2	4 5/8	1 1/4
	EVE8RDACA	35	2	4 5/8	1 1/4
	EVE8RDBCA	35	2	4 5/8	1 1/4



ELECTRICAL

EVEUSB01 - USB MODULE

- Includes two USB ports.
- Available in White and Black.

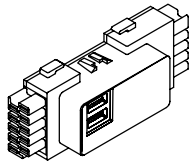

DESCRIPTION	PRODUCT CODE	LIST PRICE	DIMENSIONS/INCHES		
			H	L	D
USB Module - White	EVEUSB01WHT	205	2	4 5/8	1 1/4
USB Module - Black	EVEUSB01BLK	205	2	4 5/8	1 1/4

EVE8FR3PB - POWER ENTRY FOR POWER BEAM

- Snaps in to power distribution housing
- Includes 84" long flexible vinyl conduit
- Includes bracket to attach within vertical infeed cover
- Must be hardwired to source by licensed electrician

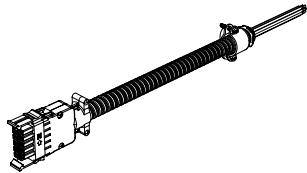

DESCRIPTION	PRODUCT CODE	LIST PRICE	DIMENSIONS/INCHES		
			H	W	D
	EVE8FR3PB	440		84	

EVE8FR3PBD - DOUBLE POWER ENTRY FOR POWER BEAM

- Each power feed entry snaps into separate power distribution housing
- Includes two 84" long flexible vinyl conduit
- Includes double bracket to attach to Vertical base power feed cover leg
- Must be installed in middle between two power beams, one base feed plugs to power beam on opposite side of leg than attached bracket
- Vertical base power feed cover with leg to be ordered separately
- Must be hardwired to source by licensed electrician

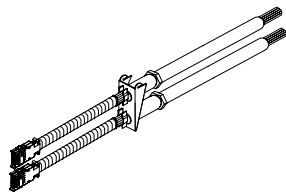

DESCRIPTION	PRODUCT CODE	LIST PRICE	DIMENSIONS/INCHES		
			H	W	D
	EVE8FR3PBD	734		84	

NOTE: Always determine that each individual harness is electrically connected to only one power supply.

EVE8EC - CEILING POWER ENTRY

- Must specify at a 90 or 120 Degree Post
- Post extension specified separate
- Floor plate must be separate on post with ceiling infeed

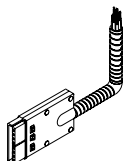

DESCRIPTION	PRODUCT CODE	LIST PRICE	DIMENSIONS/INCHES		
			H	L	D
Ceiling Power Entry	EVE8EC1	258		132	
	EVE8EC2	451		144	
	EVE8EC3	509		180	

ELECTRICAL

EVEENY-2PB - HARDWARE POWER ENTRY BOX - NEW YORK FOR POWER BEAM

- A licensed electrician must provide hard wire connection within the junction box.
- Box attaches vertically with screws to leg between Vertical base feed covers
- Vertical base power feed cover with leg to be ordered separately
- Must be installed in middle between two power beams, plugs to power beam on opposite side of leg than attached box
- For use with Power Beam only

DESCRIPTION	PRODUCT CODE	LIST PRICE	DIMENSIONS/INCHES		
			H	W	D

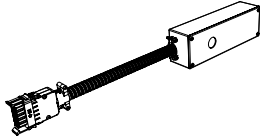

Hardware Power Entry Box - New York	EVEENY2PB	427	3	28	2 1/5
-------------------------------------	-----------	-----	---	----	-------

EVEJBC-1PB - HARDWARE JUNCTION BOX - CHICAGO FOR POWER BEAM

- Can be retrofitted in any size of power beam at the receptacle location.
- Gives access from one side only at each location.
- Customer to supply conduit, wiring, receptacle, and face plate.
- A licensed electrician must provide hardware connection with the junction box.
- 2 per power beam
- For use with Power Beam only

DESCRIPTION	PRODUCT CODE	LIST PRICE	DIMENSIONS/INCHES		
			H	W	D

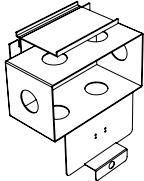

Hardware Junction Box - Chicago	EVEJBC-1PB	98			
---------------------------------	------------	----	--	--	--

EVDPE - POST EXTENSION DATA/ COMM LAY-IN

- Attaches to the top of post to bring power and/or data cables from ceiling to panel power way
- Three-sided power pole with snap-on fourth side
- Post extension can be open on one side for lay-in or power and/or data cables
- Made of aluminum and can be field cut
- Accommodates up to 25 CAT 5 cables with electric. Accommodates up to 45 CAT 5 cables without electric
- Ceiling infeed installed on one way post with T Leg requires securing post with two Floor mount plates
- Post extension bigger then 82"H is made from two parts

DESCRIPTION	PRODUCT CODE	LIST PRICE	DIMENSIONS/INCHES		
			H	W	D

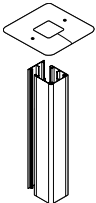

Post Extension Data/Comm Lay-in	EVDPE64	165	64	2	
	EVDPE82	200	84	2	
	EVDPE88	297	88	2	
	EVDPE94	318	94	2	
	EVDPE100	338	100	2	



ELECTRICAL

EVAFMB01 - FLOOR MOUNT PLATE

- Attaches to floor.
- Secures beam to floor.
- Attachment screws are not included.
- Care should be taken to use correct fasteners for type of floor.
- Available in chrome finish only.

DESCRIPTION	PRODUCT CODE	LIST PRICE	DIMENSIONS/INCHES		
			H	W	D
Floor Mount Plate	EVAFMB01	82	0.25	5	2.5



EVPBECH34 - E-CHAIN WITH BRACKET

- E-Chain provides cable management from the Power Beam to a height adjustable table
- Includes bracket to attach to bottom of Power Beam
- E-chain provides wire management for all height adjustable table heights
- Available in black only

DESCRIPTION	PRODUCT CODE	LIST PRICE	DIMENSIONS/INCHES		
			H	W	D
E-Chain with Bracket	EVPBECH34	380	41	1	2

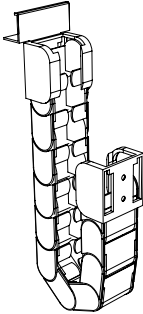

EVPBT01 - POWER BEAM TRAY

- Power beam tray provides support for wires
- Can be used with power beam only
- Available in standard and premium paint finishes

DESCRIPTION	PRODUCT CODE	LIST PRICE	DIMENSIONS/INCHES		
			H	W	D
Power Beam Tray	EVPBT01	40	12	1.25	3.5

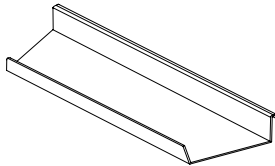

STORAGE

EVAFWMXXP - WIRE MANAGER

- PET Wire manager installed under worksurface
- Including attachment brackets
- Available in standard felt colors

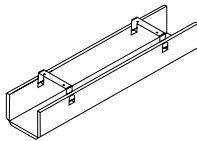
	DESCRIPTION	PRODUCT CODE	LIST PRICE	DIMENSIONS/INCHES		
				H	W	D
	PET Wire Manager	EVAFWM22P	116	3.375	22	4
		EVAFWM28P	133	3.375	28	4
		EVAFWM34P	147	3.375	34	4

EVAFWMXXPL - WIRE MANAGER FOR 90 DEGREE CORNER-LEFT

- PET Wire manager installed under worksurface
- Including attachment brackets
- Available in standard felt colors

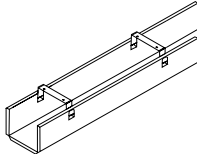
	DESCRIPTION	PRODUCT CODE	LIST PRICE	DIMENSIONS/INCHES		
				H	W	D
	PET Wire Manager	EVAFWM26PL	128	3.375	26	4
	90 Degree Corner - Left	EVAFWM32PL	143	3.375	32	4
		EVAFWM38PL	156	3.375	38	4

EVAFWMXXPR - FELT WIRE MANAGER FOR 90 DEGREE CORNER-RIGHT

- Felt Wire manager installed under worksurface
- Including attachment brackets
- Available in standard felt colors

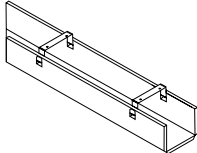
	DESCRIPTION	PRODUCT CODE	LIST PRICE	DIMENSIONS/INCHES		
				H	W	D
	PET Wire Manager	EVAFWM26PR	128	3.375	26	4
	90 Degree Corner - Right	EVAFWM32PR	143	3.375	32	4
		EVAFWM38PR	156	3.375	38	4



STORAGE

EVSDAOH - POWER BEAM DUAL ACCESS OVERHEAD

- Inside dimensions 6.500"high x 13"deep
- Laminate Overhead
- Available in standard Evolve laminate finishes
- Top mount on power beam
- Dual Access Overhead Support Brackets to be ordered separately
- Horizontal tube with trim and power beam legs for storage to be ordered separately
- Power Beam shared storage cabinet must be installed at bottom for stability
- Power beam legs for storage must be used

DESCRIPTION	PRODUCT CODE	LIST PRICE	DIMENSIONS/INCHES		
			H	W	D
Dual Access Overhead	EVSDAOH60	1214	8.5	60	16
	EVSDAOH72	1233	8.6	72	16

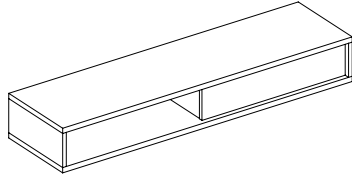

EVPBSCGD - POWER BEAM SHARED STORAGE CABINET WITH SLIDING GLASS DOOR

- Inside dimensions 13"high x 13"deep
- Laminate storage cabinet, available in standard Evolve laminate finishes
- Available in Temperete Frosted Glass only, glass with hole to pull
- Tracks for sliding glass available in Tungsten only
- To be used with 24" H Power beam only
- To be installed under power beam between T legs
- Power Beam Storage cabinet attaches to bottom of power beam with brackets
- For ease of installation, levelers in middle included

DESCRIPTION	PRODUCT CODE	LIST PRICE	DIMENSIONS/INCHES		
			H	W	D
Storage Cabinet with Sliding Glass Right	EVPBSCGDR60	1825	15	58.75	16
	EVPBSCGDR72	2036	15	70.75	16
Storage Cabinet with Sliding Glass Left	EVPBSCGDL60	1825	15	58.75	16
	EVPBSCGDL72	2036	15	70.75	16

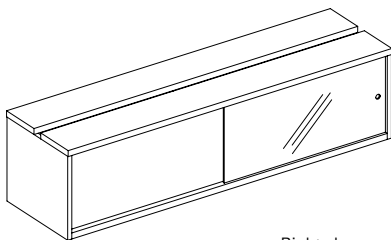

Right shown
(opening on right)

STORAGE

EVPBSCP - POWER BEAM STORAGE CABINET AND CABLE PASS THROUGH

- Inside dimensions 13" high x 13" deep
- Laminate storage cabinet, available in standard Evolve laminate finishes
- To be used with 24" H Power beam only and 60" and 72" widths only
- To be installed under power beam between two T legs
- Power Beam Storage cabinet attaches to bottom of power beam with brackets
- For ease of installation, levelers in middle included
- Cabinet with cable pass through in middle to bring power to power beam above
- Includes metal cover for easy access to wires
- Electrics not included
- Power beam base feed to be ordered separately
- Power beam kit with electrical cut out in middle to be ordered separately (EVPBEPxxKIT) See page 7

DESCRIPTION	PRODUCT CODE	LIST PRICE	DIMENSIONS/INCHES		
			H	W	D
Storage Cabinet Right	EVPBSCP60	1634	15	58.75	16
	EVPBSCP72	1728	15	70.75	16
Storage Cabinet Left	EVPBSCPL60	1634	15	58.75	16
	EVPBSCPL72	1728	15	70.75	16

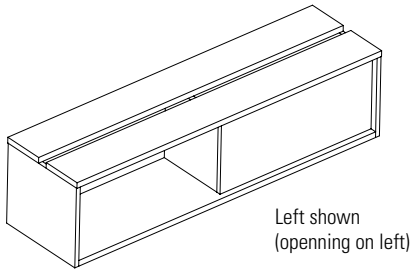

**NOTE: Can not be converted to cabinet with glass door.
To be used with 24" H Power Beam only**

EVPBSCGDP - POWER BEAM STORAGE CABINET WITH SLIDING GLASS DOOR AND CABLE PASS THROUGH

- Inside dimensions 13" high x 13" deep
- Laminate storage cabinet, available in standard Evolve laminate finishes
- Available in Temperate Frosted Glass only, with handle
- Tracks for sliding glass available in Tungsten only
- To be used with 24" H Power beam only and 60" and 72" widths only
- To be installed under power beam between two T legs
- Power Beam Storage cabinet attaches to bottom of power beam with brackets
- For ease of installation, levelers in middle included
- Cabinet with cable pass through in middle to bring power to power beam above
- Includes metal cover for easy access to wires
- Electrics not included
- Power beam base feed to be ordered separately
- Power beam kit with electrical cut out in middle to be ordered separately (EVPBEPxxKIT) See page 7

DESCRIPTION	PRODUCT CODE	LIST PRICE	DIMENSIONS/INCHES		
			H	W	D
Storage Cabinet with Sliding Glass Right	EVPBSCGDP60	2766	15	58.75	16
	EVPBSCGDP72	2924	15	70.75	16
Storage Cabinet with Sliding Glass Left	EVPBSCGDPL60	2766	15	58.75	16
	EVPBSCGDPL72	2924	15	70.75	16

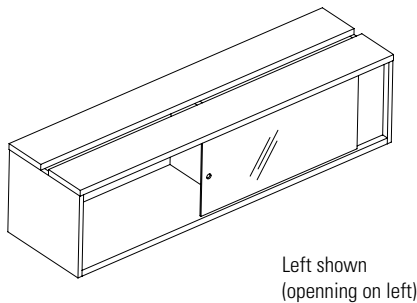

NOTE: To be used with 24" H Power Beam only



STORAGE

VPBL - 36" H POWER BEAM CONNECTOR WITH LEG FOR STORAGE

- Connects 24" H power beams on equal height
- Includes non slotted connector with leg, glides and connecting hardware
- Horizontal tube to be ordered separately
- Must be used with overhead

DESCRIPTION	PRODUCT CODE	LIST PRICE	DIMENSIONS/INCHES		
			H	W	D
Connector with Leg for Storage	EVPBL36S	109	36	18	16

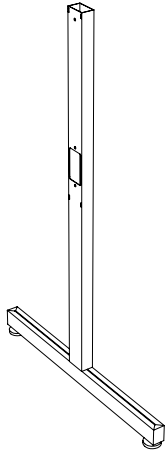

NOTES

A series of horizontal lines intended for writing notes.



textiles and finishes

Care and Cleaning

The following guide encompasses the Power Beam System line.

The guide was compiled using information from our "raw" material suppliers and is relevant only to our standard offering finishes and textiles.

FABRICS

To extend the life of your upholstered panels, regularly dust the panel to prevent airborne particles from penetrating the fabric surface.

For light soiling, use a damp cloth and blot the spot with very slight pressure, taking care never to soak the fabric. Dry with a clean cloth by blotting - never rub fabric. More intense stains can be treated the same way, but with a mild detergent. Always test fabric first in an unseen area before using any cleaning method.

PANEL FRAMES

The panel frames are manufactured out of sturdy aluminum with a powder coated enamel paint finish. To clean the frames of the panels, and all hardware associated with the Evolve line, simply utilize a clean, damp cloth. For stubborn stains on the panel frames, you may consider adding a mild detergent.

GLAZED PANELS

Cleaning of the glazing in panels should only be done with a damp lint-free cloth. A mild detergent can be used if necessary. Do not use paper towels in combination with a window cleaner-this may cause scratches to the glazing.

WORKSURFACES

The worksurfaces are manufactured using primarily Nevamar Brand laminates as the exposed surface. To properly clean these areas, it is best to use a clean, damp cloth and circular motion to prevent streaks. For stubborn stains, you are able to add a mild detergent to the water. Be certain not to use an ammonia-based solution. It will react with the PVC, or wood edge trim, causing permanent damage to the contacted areas.

ACCESSORIES

The accessories sold with the Evolve product line can be simply cleaned with a clean, damp cloth. If they are really dirty, a mild, non-abrasive solution may be added. Wipe with a damp cloth after the solution, and finally, a dry cloth.

LAMINATES – THERMALLY FUSED & HIGH PRESSURE

Absolute Acajou*	ACJ
Asian Night*	ASN
Avant Cherry*	AWC
Avant Honey*	AWH
Black*	BLK
Blizzard*	BZD
Blizzard Matrix	BMX
Brushed Cobalt*	BRC
Clear Maple*	CMB
Custom Grey	CGY
Dark Espresso*	DES
Designer White*	DWT
Grey Matrix	GRX
Hayden Grey	HGT
Hayden Linen	HLN
Noce Biondo	(NBL)
Noce Grigio	(NGL)
Noce Leggero	(NEL)
Noce Medio	(NML)
Quartered Mahogany*	QTM
Stone Dust	SDT
Stone Linen	SLN
Storm Grey	SOG
Studio White Matrix	SWX
String	STG
Tiger Fruitwood*	TFW
Tiger Walnut*	TWL
Walnut Heights*	WHE
Willow Grey	WGY
Winter Cherry*	WCR
White Chocolate*	WHC

Additional paint and laminates may be available. Contact Evolve Customer Support for details.

* Matching Wood Grain PVC edge available.

* PVC panel and connector trims are discontinued. Effective 12/2014

* 1 1/8" Worksurfaces are discontinued. Effective December 2014

PVC EDGE TRIM

Absolute Acajou	AAE
Asian Night	ASE
Avant Cherry	ACE
Avant Honey	AHE
Black	BLK
Blizzard	BZD
Brushed Cobalt	BRC
Charcoal	CHR
Clear Maple	CME
Dark Espresso*	DES
Designer White	DWE
Nevada	NEV
Quartered Mahogany*	QTM
Shaker Cherry*	SKE
Silver	SIL
Taupe	TPE
Tiger Fruitwood*	TFW
Tiger Maple*	TMP
Tiger Walnut*	TWL
Tungsten	TUN
Walnut Heights	WHE
Winter Cherry*	WCR
White Chocolate*	CBE

* 1 7/16" HPW PVC Trim for Worksurfaces is not available in Dark Espresso (DES), Tiger Fruitwood (TFW), Tiger Maple (TMP) and Tiger Walnut (TWL).

WOOD VENEER WORKSURFACES*

Almond Cherry	AMW
Cocoa Walnut	CAW
Coral	CRW
Dark Cherry	DCW
Espresso Walnut	EWV
Evening Oak	EVW
Grey on Oak	GRW
Hazlenut	HAW
Honey Maple	SMW
Java	JAW
Latte Walnut	LTW
Milestone	MTW
Mocha	MCW
Natural Maple	MPW
Red Cherry	RCW
Vintage Cherry	VNW
Walnut	WLW
Warm Cherry	WCW
White Maple	WMW

All wood veneer worksurfaces are 1.38" thick.

*Note: Wood veneer options for worksurfaces are available at an up charge and with an extended lead time. Contact Evolve Customer Support for details.

ACCENT PAINTED FINISHES

Crystal Blue	CYB
Lime Green	LMG
Orange Flame	ORF
Steel Blue	STB
Vermilion Red	VLR

Accessory painted finishes are subject to 10% upcharge and minimum order of 50 pieces, orders under 50 pieces subject to \$500 net fee

STANDARD PAINT & FRAME COLORS

(for application to trim, steel components, PVC, vertical and horizontal members)

Black	BLK
Blizzard (Textured)	BZD
Charcoal	CHR
Designer White	DWT
Fog	FOG
Nevada	NEV
Silver	SIL
Stone Dust (Textured)	SDT
Taupe	TPE
Tungsten ^o	TUN

Additional paint and laminates may be available. Contact Evolve Customer Support for details.

^oTungsten paint is subject to 10% upcharge EXCEPT on Worksurfaces, PVC items, or when PVC trim components are ordered separately.

PREMIUM PAINT & FRAME COLORS

Black Coffee*	BKC
Bone*	BNE
Business Grey*	BGR
Claret*	CLT
Dark Chocolate*	DCH
Desert Putty*	DPT
Grey*	GRY
Ice*	ICE
Ivory*	IVR
Light Grey*	LGR
Metro*	MET
Mocha*	MCH
Moss*	MOS
Navy*	NAV
Oyster*	OYS
Sky*	SKY
Stone*	STN
Storm Grey	SGR
Tahiti Sand*	TSA
Willow*	WIL

*Premium paint selections are available on the following components: Panels (top trim and frame), Hardware, End-of run/Post Kits, and Accessories at a 22% upcharge. Storage with no upcharge.

*Please note all Double Wall Storage units must be ordered in a minimum quantity of 50 when ordering in a premium paint finish. Different model types can be combined to achieve the minimum quantity required. See pages 192-193 for affected models.

All special and premium paint match orders of 50 panels or less will incur a \$500 net setup fee. Panels, hardware, accessories and storage may be combined on orders to achieve minimum of 50 pieces or more and will not be subject to \$500 net set up fee. Add on orders will not have that charge for 90 days after the original order has shipped and must have the original PO# quoted otherwise they will not qualify for the program.

Global matte paint finishes are available on most Evolve Storage pieces without an up charge regardless of quantities.

All Mica and Metallic paint finishes will incur a minimum up charge of 10%.

All non-standard paint finishes must be approved by Evolve prior to placing an order.

ADA Overheads are not available in Evolve premium color paints. ADA Overheads are available in Evolve standard paint colors only.

Frames for all Open Panel models, all panel retainers, PVC components for panels and connectors are unavailable in premium or special/custom paint colors. They are available in standard Evolve paint colors only.



PANEL FABRICS – GRADE 1

Anchorage - 35% Post - consumer Recycled Polyester and 65% Pre -consumer Recycled Polyester

Birch	AN40
Green Apple	AN41
Lapis	AN42
Straw	AN43
Wolf	AN44
Goose	AN45
Angora	AN46
Cumin	AN47
Asteriod	AN48
Geranium	AN49
Thistle	AN50
Graphite	AN51
Slate	AN52
Quarry Blue	AN53
Onyx	AN54
Pumpkin	AN55
Red Delicious	AN56
Sunshine	AN57
Waterfall	AN59
Vanilla	AN61
Cobalt	AN62
Cloud	AN64

Aurora - 100% Polyester, 80% minimum Post-Consumer Recycled Polyester

Cloud	AU20
Seal	AU21
Fog	AU22
Pewter	AU23
Granite	AU24
Oat	AU25
Coconut	AU26
Latte	AU27
Lake	AU28
Frost	AU29

Chance - 63% Virgin Polyester, 37% Post-Consumer Recycled Polyester

Mist	CN51
Dill	CN52
Island	CN53
Plaza	CN54
Tranquil	CN55
Malt	CN56
Navajo	CN57
Prairie	CN58
Cinder	CN59
Oasis	CN66

Linea - 100% Post Consumer Recycled Polyester

Queue	LN41
Cord	LN42
Twine	LN43
Thread	LN44
Contour	LN45
Silhouette	LN46
Cable	LN47
Route	LN48

Loopy - 100% Recycled Polyester

Oyster	LP60
Putty	LP61
Marble	LP62
Hazelnut	LP63
Latte	LP64
Bay	LP65
Wild Rice	LP66
Harbor	LP67

Melody - 100% Recycled Polyester

Spray	ME40
Pond	ME41
Sand Bar	ME42
Silt	ME43
Pebble	ME44
Lake	ME45
Gravel	ME46
Boulder	ME47

Merge - 100% Polyester, 75% minimum Post-Consumer Recycled Polyester

Fawn	MG20
Marshmallow	MG21
Driftwood	MG22
Dove	MG23
Graphite	MG24
Slate	MG25
Eucalyptus	MG26
Fire Engine	MG27
Mediterranean	MG28
Midnight	MG29

Pinpoint - 100% Post-Consumer Recycled Polyester

Bliss	PN11
Delight	PN12
Dune	PN13
Infusion	PN14
Ebony	PN15
Fresh	PN16
Carrot	PN17
Splash	PN18
Vibe	PN19
Gala	PN20

Streak - 100% Recycled Polyester

Beach	SR81
Shade	SR86
Stretch	SR88
Sprint	SR89
Roll	SR91
Dart	SR92
Zoom	SR93
Splash	SR94
Whiz	SR95
Flash	SR96

Tek - 100% Recycled Polyester

Finesse	TX60
Grain	TX61
Essence	TX62
Warp	TX64
Mesh	TX67
Form	TX69
Spice	TX71
Glacier	TX72
Spring	TX73
Harmony	TX74
Smoke	TX75
Pebble	TX76

Terrace - 100% Post-Consumer Recycled Polyester

Lotus	TC60
Tigerlily	TC61
Shadow	TC62
Cobble	TC63
Cherry Blossom	TC64
Bluebell	TC65
Apple	TC66
Haze	TC67
Cerise	TC68
Twilight	TC69
Wintergreen	TC70
Ironwork	TC71
Flirt	TC73
Echo	TC74
Glacier	TC75

PANEL FABRICS— GRADE 2

Cyclone - 56% post-consumer recycled polyester and 44% polyester.

Stove Pipe	IM37
Stainless.....	IM40
Polished Pewter	IM41
Welded Steel	IM43
Etched Bronze.....	IM44
Fired Titanium.....	IM46
Chrome.....	IM49
Dark Annealed.....	IM50
Karat.....	IM54
Red Metal.....	IM55
Oxidized Bronze.....	IM56
Bright Ray.....	IM57
Bismuth Crystal.....	IM58
Gallium Blue.....	IM59

Dashing -100% Post-Consumer Recycled Polyester

Classic Silver.....	DS21
Refined Marble.....	DS22
Antique Sage.....	DS23
Polished Slate	DS24
Genteel Beige	DS25
Bespoke Tan	DS26
Dapper Grey.....	DS27

Mesh - 100% Recycled Polyester

Canyon.....	B33A
Napa Valley.....	B34A
Huntington.....	B36A
Huron.....	B37A
Heartland.....	B39A
Oat.....	B81A
Pepper	B82A
Limestone.....	B84A
Zinc.....	B86A

Quadrille - 52.5% Polyester / 47.5% Recycled Polyester
*Maximum panel width is 48'

Escapade.....	QU30
Shenanigan	QU31
Revelry	QU32
Spring.....	QU33
Regalia	QU34
Soiree.....	QU35
Zest.....	QU36
Gambol.....	QU37
Leisure	QU38
Fair	QU39
Fiesta.....	QU40
Carnival	QU41
Spree.....	QU42
Opus.....	QU43
Jubilee.....	QU44
Masquerade	QU45
Cabarets	QU46

PET PANEL FABRICS

Graphite.....	GPH
Mist.....	MTS
Pewter.....	PWT
Harvest.....	HVT
Shamrock.....	SHR
Brick.....	BRI
Denim.....	DEN
Black.....	BLK
White.....	WHT



GRADE 1

Dobby - 96% Recycled Polyester / 4% Virgin Polyester

Snowcap.....	DB30
Bonsai.....	DB31
Cloud.....	DB32
Sand.....	DB33
Pewter.....	DB34
Sante Fe.....	DB35
Corfu.....	DB36
Medium Taupe.....	DB37
Charcoal.....	DB38
Berry.....	DB39
Royal.....	DB40
Titanium.....	DB41
Black.....	DB42

Fusion - 90% Virgin Polyester/ 10% Post-Consumer Recycled Polyester

Tangerine.....	FU71
Fresh.....	FU72
Moss.....	FU73
TomatoF.....	FU74
Aqua.....	FU75
Sandstone.....	FU76
Granite.....	FU77
Poppy.....	FU78
Cadet.....	FU79
Oasis.....	FU80
Graphite.....	FU81
Viola.....	FU82
Cobalt.....	FU83
Flax.....	FU84
Carbon.....	FU85

Hudson - 100% Post-Consumer Recycled Polyester

Cordovan.....	HD02
Ruby.....	HD03
Orange.....	HD04
Wheat.....	HD05
Meadow.....	HD06
Coffee.....	HD07
Grey.....	HD08
Mocha.....	HD09
Thyme.....	HD10
Carbon.....	HD11
Midnight.....	HD12
Ocean.....	HD13
Cerulean.....	HD14

Illusion - 100% Virgin Polyester

Cappuccino.....	II01
Paprika.....	II02
Tropic.....	II03
Wicker.....	II04
Hemp.....	II05
Cayenne.....	II06
Maui.....	II07
Dusk.....	II08
Smoke.....	II09
Currant.....	II10
Fiji.....	II11
Ozone.....	II12
Ebony.....	II13

Jenny - 100% Polyester

Midnite.....	JN01
Ebony.....	JN02
Slate.....	JN03
Vermilion.....	JN07
Admiral.....	JN08
Charcoal.....	JN11
Silver Lining.....	JN25
Oatmeal.....	JN26
Sunflower.....	JN27
Cascade.....	JN28
Harvest.....	JN29
Mellon.....	JN30
Berry.....	JN31
Green Grass.....	JN32
Roast.....	JN33

Quilt - 100% Polyester

Black.....	QL10
Charcoal Grey.....	QL11
Navy.....	QL14
Wine.....	QL16
Silver.....	QL19
Feather.....	QL20
Dune.....	QL21
Meadow.....	QL22
Cadet.....	QL23
Geranium.....	QL24
Daisy.....	QL25
Quest.....	QL26
Punch.....	QL27
Tangerine.....	QL28
Cocoa.....	QL29

Terrace - 100% Post-Consumer Recycled Polyester

Lotus.....	TC60
Tigerlily.....	TC61
Shadow.....	TC62
Cobble.....	TC63
Cherry Blossom.....	TC64
Bluebell.....	TC65
Apple.....	TC66
Haze.....	TC67
Cerise.....	TC68
Twilight.....	TC69
Wintergreen.....	TC70
Ironwork.....	TC71
Pine Cone.....	TC72
Flirt.....	TC73
Echo.....	TC74

Trak - 100% Recycled Polyester

Taupe.....	TK40
Mustard.....	TK41
Latte.....	TK42
Cement.....	TK43
Silver.....	TK44
Copper.....	TK45
Teal.....	TK46
Apple.....	TK47
Steel.....	TK48
Merlot.....	TK49
Midnight Sky.....	TK50
Mocha.....	TK51
Carbon.....	TK52

Urban - 62% Recycled Polyester / 32% Polyester

Red Rose.....	UR10
Ocean Blue.....	UR11
Blue Bayou.....	UR12
Green Grass.....	UR13
Sandcastle.....	UR14
Beach Day.....	UR15
Boardwalk.....	UR16
Earth.....	UR17
Brown Ridge.....	UR18
White Sand.....	UR19
Granite Rock.....	UR20
Gravel Road.....	UR21
Black Coal.....	UR22

Waterfall - 60% Virgin Polyester /40% Post - Consumer Recycled Polyester

Trance.....	WA40
Tryst.....	WA41
Splash.....	WA42
Victoria.....	WA43
Imagine.....	WA44
Sky.....	WA45
Rainforest.....	WA46
Rumble.....	WA47
Prism.....	WA48
Tranquility.....	WA49
Grand.....	WA50
Rushing.....	WA51
Majestic.....	WA52
Pacific.....	WA53
Dance.....	WA54

Waterfall - 60% Virgin Polyester /40% Post - Consumer Recycled Polyester

Lime.....	WV01
Tigerlily.....	WV02
Stone.....	WV03
Flame.....	WV04
Mykonos.....	WV05
Savannah.....	WV06
Mesa.....	WV07
Plasma.....	WV08
Cancun.....	WV09
Quartz.....	WV10
Moonrock.....	WV11
Rubine.....	WV12
Corfu.....	WV13
Bluejay.....	WV14

GRADE 2 (FABRIC)

Imprint - 100% Post-Consumer Polyester

Almond.....	IM70
Cork.....	IM71
Sand.....	IM72
Currie.....	IM73
Candy Apple.....	IM74
Ocean.....	IM75
Navy.....	IM76
Green Tea.....	IM77
Celery.....	IM78
Oregano.....	IM79
Walnut.....	IM80
Paprika.....	IM81
Graphite.....	IM82
Slate.....	IM83
Licorice.....	IM84

Match - 100% Recycled Polyester

Desert.....	MT20
Sand.....	MT21
Moss.....	MT22
Orange.....	MT23
Blue.....	MT25
Green.....	MT27
Chocolate.....	MT28
Quarry.....	MT31
Arctic.....	MT33

GRADE 2 (FABRIC) - CONTINUED

Replay - 100% Post-Consumer Recycled Polyester

Caramel	RP21
Navy	RP25
Teal	RP29
Autumn	RP30
Slate	RP32
Dove	RP33
Coal	RP34

Silhouette - 100% Nylon with Teflon
Designed to color coordinate with Cumulus and Oxygen fabrics.

Asphalt	SL20
Indigo	SL22
Camel	SL26
Charcoal	SL30
Hunter.....	SL35

GRADE 2 (VINYL)

For availability of chair series in Vinyl, please contact a Global Sales Representative.

Allante FRee - 100% Vinyl Face / 100% Polyester Backing

Illusion	A01F
Bright White	A02F
White Crush	A03F
Ivory	A04F
Ice	A05F
Bleached Sand	A06F
Taupe Fawn	A07F
Warm Smoke	A08F
Autumn Rain	A09F
Cookie	A10F
Sierra Brick	A11F
Gibraltar	A12F
Chateau Grey	A13F
Golden Green	A14F
Oasis Green	A15F
Ink Black	A16F
Purple impulse	A17F
Italian Rose	A18F
Mountain Sky	A19F
Old Navy.....	A20F
Galaxy	A21F
Red Truffle	A22F
Chocolate Sundae	A23F
Province Blue	A24F
Eclipse	A25F

GRADE 3 (RECYCLED)

Couture - 100% Post-Consumer Polyester

Mocha	CE71
Sapphire.....	CE74
Neptune.....	CE75
Lake.....	CE76
Willow.....	CE77
Sassy.....	CE78
Persimmon.....	CE80
Carbon.....	CE81
Sterling.....	CE82



PANEL C.O.M REQUEST FOR APPLICATION TEST

SEND COMPLETED FORM AND FABRIC TO:

Evolve Furniture Group
555 Petrolia Road
Toronto, Ontario M3J2X8
Attn: Eliza Porres

Requested By: _____

Phone #: _____

Fax #: _____

Product Name _____

Dealer/Specifier _____

Dealer Contact: _____

Evolve CSR: _____

Phone #: _____

Fax #: _____

FABRIC INFORMATION

Fabric Manufacturer: _____

Color Name: _____

Color #: _____

Pattern Name: _____

Pattern #: _____

Content: _____

Weight: _____

Width: _____

Repeat Horizontal: _____

Repeat Vertical: _____

Other Comments: _____

REQUEST FOR APPLICATION TEST (THIS REQUIRES 2 YARDS OF FABRIC)

_____ Evolve Panel

_____ Evolve Tackboard

_____ OH Doors

Total Number of yards for testing: _____

Please Note:

Evolve is not responsible for the duty and brokerage fees for C.O.M. Fabric to clear customs. These charges will be billed to the dealer on a separate invoice.

PANEL FABRIC SPECIFICATION SHEET

SEND COMPLETED FORM TO:

EVOLVE Furniture Group
 555 Petrolia Road
 Toronto, Ontario M3J2X8
 Attn: Eliza Porres

SUPPLIER PATTERN WIDTH CONTENT	REMARKS: _____ _____ _____ _____	
LIGHT FASTNESS FLAMMABILITY TUNNER TEST	REMARKS: _____ _____ _____ _____	
CUT PRICE 1 - 3 ROLLS 4 ROLLS	REMARKS: _____ _____ _____ _____	
DIRECTIONAL PANELS CORNERS RACEWAY COVER RACEWAY CORNERS STRETCH	REMARKS: _____ _____ _____ _____	EASY HARD X-HARD
APPROVED <input type="checkbox"/> NOT APPROVED <input type="checkbox"/> CONDITIONAL APPROVAL <input type="checkbox"/>		
REMARKS: _____ _____ _____		
* This fabric is approved for upholster-ability only. The approval does not account for the durability of the fabric at the time of, and after installation of the product		
SIGNATURE: _____ PRINT NAME: _____ DATE: _____		



TOP

**STAPLE
MINIMUM 6" X 6"
FABRIC SAMPLE HERE
IN THE DIRECTION IT IS TO BE
APPLIED TO THE PRODUCT**

BOTTOM



APPENDIX

The Evolve Furniture Group has partnered with the software vendors listed below to provide you with an online source for viewing the 2014 Evolve Electronic Catalog. Please visit their websites for additional information and download details.

2020 Technologies

www.2020technologies.com
5503 Mile Road NW
Grand Rapids, MI 49544
Phone: 800-638-6002

Ice Edge Business Solutions

www.ice-edge.com
4001 S 700 East, Suite 450
Salt Lake City, UT 84107
Phone: 801-747-0373

KISP

www.kisp.com
Customer Support: 416-499-2457
Cad Services Team: 416-499-2457 x3
Customer Service e-mail: tellmemore@kisp.com
CAD Services requests CadServices@kispstech.com

Project Matrix

www.projectmatrix.com
11655 Lebanon Rd.
Cincinnati, OH 45241
Tech Support Instant Messenger: projectmatrixtech@yahoo.com
Phone: 513.554.1665
Fax: 513.554.1255

Quintero-Smith Incorporated/Midnight Oil

www.midnight-oil.com
10469 Kinnard Avenue
Los Angeles, CA 90024
voice: 800-350-7434 (US Only)
international: 310-478-5140
fax: 310-478-4572
e-mail: jimsr@q-si.com



TERMS & CONDITIONS

APPLICATION OF STANDARD TERMS

Sales of Evolve products are made only on Evolve standard terms and conditions of sale which are contained in the Price Book and in Evolve's order acknowledgments. These standard terms and conditions may be modified or supplemented only by a separately written document signed by Evolve's authorized personnel at its head office in Marlton, New Jersey. An offer by Purchaser of said terms and conditions shall not be binding until accepted by Evolve in writing.

All illustrations, specifications and prices in this Price List are based on the latest product information available at the time of publication. Evolve reserves the right to make changes, at any time and without prior notice, to prices, colors, materials, specifications and models offered.

PRICES AND PAYMENT

The prices shown in this Price List, as well as those quoted by Evolve, shall be in US dollars for orders shipped to destinations within the continental United States.

Prices listed herein are for standard product. Quotations for special product are available through Evolve Customer Support Department in Marlton, New Jersey.

If shipping date requested is more than 90 days from date of order Evolve shall use published list prices effective at the time of shipment.

Not included in the list price are special or export packing, unpacking and installation. Orders are invoiced at the time of shipment. The Customer agrees to pay a charge of 2% per month of invoices outstanding more than 30 days.

FOR PAYMENTS ONLY, MAIL TO:

Evolve Furniture Group, a division of:
Global Industries, Inc.
17 West Stow Road
P.O. Box 562
Marlton, New Jersey 08053

Any products sold shall remain the property of Evolve until fully paid for in cash. The Purchaser agrees to perform all acts which may be necessary to perfect and assure retention of title to such products to Evolve until such time as the goods have been paid for in full.

Freight charges will be prepaid by Evolve to destinations within the contiguous United States on shipments of \$10,000 list and greater. For shipments less than \$10,000 list, the freight charge will be 5% of the total list price.

Please note exception below:

All showroom and mock-up orders will be subject to actual freight charges.

Evolve shall, in its sole discretion, determine the most appropriate method of shipment routing and carrier. Shipments of less than a full trailer load (LTL) shall ship via common carrier. **These LTL shipments are not subject to specific delivery days or times.** Full trailer loads will provide for dedicated delivery time and schedule. Purchaser may request special packaging or method of shipment at Purchaser's sole expense.

TAXES

All sales, use, excise and other applicable taxes and the collection and reporting thereof (excluding only taxes on the net income of Evolve) are the Purchaser's responsibility and will be invoiced to the Purchaser. If Purchaser claims an exemption from such taxes, it shall be the Purchaser's responsibility to furnish an appropriate exemption certificate to Evolve.

ORDER INFORMATION

Evolve requires that **all orders be submitted in writing** to avoid errors and/or duplication. Orders will be acknowledged with Evolve's acknowledgement forms governing the transaction. The details appearing on the acknowledgement will describe the items to be shipped to Purchaser who must ascertain that they are correct. If not correct, Purchaser should notify Evolve immediately by telephone or fax followed by written confirmation. Acknowledgment shows approximate shipping date of items ordered. **Shipping dates are assigned to orders based on the item having the longest manufacturing lead time.** Orders with Customer's Own Material (C.O.M.), or missing or incorrect information (finish selections, fabric selections, etc.) will be scheduled for manufacturing upon receipt of COM or correct complete information. Purchaser must indicate if multiple shipping schedules are required including noting if the shipping date requested is longer than standard posted lead time. Each shipment will be invoiced at time of shipping and will be subject to payment terms described herein.

C.O.M. CUSTOMER'S OWN MATERIAL

Should Purchaser request a fabric, not standard to the Evolve upholstery line, Purchaser shall submit a sample of not less than two yards for approval. Evolve will determine whether fabric is suitable to manufacturing process and applicable UL or code requirements. Should Evolve be required to test such fabric, it shall so advise Purchaser, and Purchaser shall be responsible for all costs associated therewith. This includes all duty and brokerage fees.

Fabric yardage requirement will be determined by Evolve. An additional charge may be made to cover the cost of cutting, matching or sewing unusual or directional patterns. Evolve shall have no responsibility for condition, quality, performance, physical properties or any other aspect of C.O.M. For panels, price as if grade 1 fabric is used.

Evolve reserves the right to reject any C.O.M. deemed unsuitable.

Evolve reserves the right to cancel an order at any time if C.O.M. is, in the sole judgement of Evolve, inadequate for any reason.

CHANGES AND CANCELLATION

The order may not be changed or cancelled by Purchaser without the written consent of Evolve. This charge can be as much as 100% based upon proximity to scheduled shipment date. Special order items and fabric-covered items already in production are not subject to change or cancellation under any circumstances. Fabric-covered items are considered to be in production once the fabric has been cut.

DEPOSIT ON SPECIAL ORDERS

Orders for nonstandard products may, at Evolve's discretion, require deposit prior to scheduling of production, the amount of the deposit being credited against the total price of the project.

SUSPENSION

In the event that the Purchaser defaults in the payment of any sum due Evolve, or in the event the Purchaser's financial condition becomes unsatisfactory to Evolve, Evolve shall have the right at its option, upon written notice to the Purchaser, to cancel shipment of any goods, unless within ten (10) days of Purchaser's receipt of such notice Purchaser provides assurance of payment to Evolve in such form, content and/or amounts as Evolve, in its sole discretion, deems adequate.

COMBINED SHIPMENTS

Evolve will make every effort to combine shipments and orders on written request. However, acceptance of such request shall be with Evolve's sole discretion.

CODE RESTRICTIONS

Evolve portable furniture may be subject to local fire, electrical and/or building codes applicable to portable furniture. It shall be Purchaser's sole responsibility for the proper application of Evolve items within the limitations of such local codes, which may be different from area to area.

SERVICE

Service problems shall be handled by the authorized Evolve dealer. Where this cannot be accomplished on a local level, service problems should be referred to:

Evolve Furniture Group
Customer Support
17 West Stow Road
Marlton, New Jersey USA 08053
856-552-4000 888-827-2500
Attention: Evolve Operations Manager



TERMS & CONDITIONS

STORAGE

In the event Purchaser requests postponement of delivery beyond the acknowledged shipping date, Evolve may transfer the goods to storage on Purchaser's account and at Purchaser's risk and expense subject to a daily storage rate. Such transfer to storage shall be deemed shipment to Purchaser for all purposes, including invoicing and payment.

DELAYS

Evolve's order acknowledgement will state a shipping date which is Evolve's best estimate at the time the order is acknowledged. However, Evolve shall not incur any obligation or liability to Purchaser for failure to ship by a specified date. In addition, Evolve shall not be liable for any loss or damage resulting from any delay or failure in shipment or other failure to perform all or any part of the agreement between the parties with respect to the goods shown on the face of the order acknowledgement where such delay, failure, loss or damage is the proximate result of any act of any governmental authority or political subdivision thereof, revolution, riot, civil disorder or disturbance, act of enemies, delay or default in transportation, strike disputes among or between unions or other labor disputes, delay or inability in obtaining materials and facilities, fire, flood, act of God or any cause not within the reasonable control of Evolve, whether of the class of causes enumerated or otherwise. Without limiting the generality of the foregoing, Evolve may, without causing any breach or incurring liability, allocate goods which are in short supply, regardless of the reasons therefore, among purchasers, in any manner which Evolve, in its sole discretion, deems advisable.

BACK CHARGES

Evolve will not accept charges for expense incurred by the Purchaser in expediting shipments or otherwise. Evolve will not accept charges for the repair of damage by others.

CLAIMS

All goods are sold F.O.B. Toronto, Canada, unless otherwise agreed to in writing by Evolve. Evolve is not responsible for damage which occurs in transit or in storage. The carrier signs for all goods received in good order. It is the Purchaser's responsibility to examine goods upon receipt and to file any claims with the carrier. Any claims made against Evolve for apparent defects, errors or shortages must be made by the Purchaser in writing, within fifteen (15) working days after any delivery. Failure by the Purchaser to make any claim against Evolve within the above-described fifteen days shall constitute acceptance of the goods and a waiver of any apparent defects, errors or shortages.

RETURNS

No returns of goods will be accepted without written consent and shipping instructions, including Evolve's Return Goods Authorization (R.G.A.) numbers, to Evolve. A minimum restocking charge of 35% is made on all authorized returns for credit or refund, provided goods are received by Evolve in the condition in which they left the factory. No credit will be given if goods cannot be reused. Special order items and fabric-covered items are in no event subject to return. All returns must be approved and authorized in writing by Evolve Customer Support, Marlton, New Jersey.

LIFETIME WARRANTY

Evolve warrants that all commercial products are free from defects in material and workmanship, for the life of the product, to the original purchaser. This warranty is made by Evolve only to original customers acquiring the product directly from Evolve's authorized dealers. The customer's sole remedy pursuant to this warranty is limited to repair or replacement of parts or product at Evolve's option. Consent from Evolve must be obtained before any warranty work is performed. This warranty shall not apply to any products which must be replaced because of normal wear and tear, negligence, abuse or "accident", shipping damage, or product use and installation other than in accordance with written instructions or warnings. It shall also not apply when product has been modified or altered, repaired or refurbished by someone other than Evolve or an authorized dealer or because of natural variations over which Evolve has no control. In the event of repair and/or replacement of any defective product, Evolve does not warrant matching color, grain, texture or dye lots. Evolve's warranty does not cover the cost of transportation or labor. Repair or replacement will be at Evolve's option. Evolve makes no warranty that any of its products are suitable for any particular purpose and makes no other warranties, expressed or implied, other than those set forth in this Price List. As codes and standards vary from one jurisdiction to another, references to compliance are solely for convenience and without any representation as to accuracy or suitability. Users must verify the suitability of such information or product for their specific application. In no event shall Evolve be liable in either tort or contract for any loss or direct, special, incidental, consequential, or exemplary damages.

This Lifetime Warranty is NOT applicable to customers who use Evolve products for rental purposes and is effective only for products, parts or components manufactured after January 1, 2011.

Exceptions to this warranty include:

- Global fabrics and wood veneers, which are warranted for five years from date of delivery.
- Electrical components, which are warranted for ten years from the date of delivery.
- Moving parts such as glides, slides, casters, user-adjustable worksurface mechanisms, which are warranted for five years from date of delivery.

- Fading on fabric and wood veneers can be caused by exposure to U.V. rays/sunlight. Natural wood veneer, being a natural material, will have shade differences between veneer sheers, the difference will be more apparent between dye lots.

Evolve does not warrant color fastness on Customer's Own Material.

Because of natural variations over which Evolve has no control, this warranty does not extend to color, grain or texture of wood, and Evolve does not warrant matching of color, grain or texture.

Evolve makes no warranties, including implied warranties of merchantability and fitness for a particular purpose, other than the express warranties contained herein.

LIMITATION OF REMEDY

Purchaser's sole and exclusive remedy (excluding the repair or replacement of goods for breach of the express warranty above) for any matter or claim arising under or relating to these terms and conditions, the goods covered hereby and any transaction involving or relating to such goods, whether in contract, tort (including negligence) or otherwise, shall be payment of the lesser of the cost to repair or replace said product or the purchase price for the goods to which the claim relates. In no event shall Evolve be liable for any special, indirect, consequential, or incidental damages, including without limitation, damages for loss of business profits, business interruptions, or loss of information.

EVOLVE'S WARRANTY DOES NOT APPLY (FOR ANY PRODUCT CATEGORY) TO THE FOLLOWING:

- Failures due to wear and tear
- Failures which result from negligence, abuse, accident or misuse
- Failure to apply, install or maintain products according to Evolve's written instructions and warnings
- Modifications, attachments or repair methods not approved by Evolve
- Damage caused by a carrier in transit, or delivery/installation contractors
- The matching of colors, grains or textures (wood, leather, etc.) of natural materials and color matching of textiles
- Products exposed to extreme hot or cold temperatures or excessively dry or humid environments
- Colorfastness or the matching of color of textiles
- Damage by markings or staining; damage by sharp objects or imprinting from instruments
- Damage to textiles or laminate and wood surfaces/edges from exposure to sunlight (including UV rays)
- Products used for rental purposes

Evolve's warranty applies to products sold within the United States of America, Mexico, the Commonwealth of Puerto Rico and Canada.

showrooms and distribution centers throughout the united states

SHOWROOMS

Atlanta

10 10th Street, Suite 150
Atlanta, GA 30309
T 404.879.0998

Chicago

The Merchandise Mart
10th Floor, Suite 1035
Chicago, IL 60654
T 312.755.0843

New Jersey (Southern)

119 Greentree Road
Marlton, NJ 08053
T 856.596.3390

Philadelphia

1735 Market Street
38th Floor
Philadelphia PA, 19103
215.861.0963

Washington, DC

1130 Connecticut
Avenue
Washington, DC 20036
T 202.659.0230

Boston

One Harbor Street,
Suite 104
Boston, MA 02210
T 617.406.5435

Miami

112 NE 41st Street
6th floor
Miami, FL 33137

New York City

386 Park Avenue South,
7th floor
New York, NY 10016
T 212.545.9900

Phoenix

4675 East Cotton
Center Boulevard,
Suite 165
Phoenix, AZ 85040
T 602.426.0666

SHOWROOMS + DISTRIBUTION CENTERS

Atlanta Area

6715 Maple Ave.
Suite 100
Buford, GA 30518
T 678.602.4130

Chicago Area

27W501 North Avenue
West Chicago, IL 60185
T 630.681.2818

Denver Area

16401 E. 33rd Dr., Ste. 50
Aurora, CO 80011
T 303.340.1617

Kansas Area

11617 West 81st Street
Lenexa, KS 66214
T 913.310.9963

Tampa Area

10351 Windhorst Road
Tampa, FL 33619
T 813.621.6272

Baltimore Area

Troy Hill Corporate
Center
7030 Troy Hill Drive
Elkridge, MD 21075
T 410.379.8021

Cincinnati Area

8712 LeSaint Drive
Fairfield, OH 45014
T 513.777.0009

Ft. Lauderdale Area

560 Sawgrass
Corporate Parkway
Sunrise, FL 33325
T 954.846.8888

Los Angeles Area

12320 Bloomfield
Avenue, Unit A
Santa Fe Springs, CA
90670
T 562.484.9686

Boston Area

19 Connector Rd., Unit 1
Andover, MA 01810
T 978.470.8463

Dallas Area

2025 W. Beltline Rd.,
#100
Carrollton, TX 75006
T 972.236.1366

Houston

7865 Northcourt Road,
Building D, Suite 200
Houston, TX 77040
T 713.695.5777

Seattle Area

Oakesdale Commerce
Center
820 Southwest 34th St.
Building W7, Suite A
Renton, WA 98057
T 425.291.9282

Global - USA Headquarters

17 West Stow Road P.O. Box 562
Marlton, New Jersey U.S.A. 08053
Tel (856) 596-3390 (800) 220-1900
Fax (856) 596-5684
www.globalfurnituregroup.com

Global - Canada Headquarters

1350 Flint Road
Downsview, ON Canada M3J 2J7
Sales & Marketing: Tel (1-877) 446-2251
Customer Service: Fax (800) 361-3182
Government Customer Service: Fax (416) 739-6319



Association of Canadian Ergonomists
Association Canadienne d'Ergonomie