

Seating

Effective July 5, 2022 USA

Updated December 1, 2022



PRICE LIST seating



think global

THE GLOBAL EDGE

ERGONOMICS IN THE TOTAL OFFICE

- One stop shopping for a full range of office furniture.
- Seating, desks, tables, files, modular furniture, panels and accessories.
- Ergonomics, competitive pricing and built-in value.

STRENGTH AND STABILITY

- Established in 1966.
- One of North America's largest office furniture manufacturers.
- Manufacturing and showrooms worldwide.

QUICK SHIP - INSTOCK

- Thousands of products available in a 2 day quickship program.
- Hundreds of products in stock for immediate delivery.

STRONG LOCAL REPRESENTATION

- Service and expert advice where you are, when you need it!

MANUFACTURING CAPABILITY

- Vertical integration ensures "start to finish" control.
- Ongoing research and investment in new, innovative production technology.

QUALITY ASSURANCE

- Quality Assurance Program is qualified by C.G.S.B. ISO9001 standards.
- On-site furniture testing facility.
- Product and components are tested to meet or exceed ANSI/BIFMA standards.

ENVIRONMENTAL COMMITMENT

- Continuous development of "earth friendly" programs.
- One of the first molded foam manufacturers to create ozone friendly, CFC and HFC-free process.
- Seat and back pans are made from recyclable plastics and wood waste, enabling little waste and cost effective products.

SYMBOL IDENTIFICATION

Each seating product with an RTA code identifies the assembly requirements.

RTA 00 FULLY ASSEMBLED

RTA 1 SIMPLE ASSEMBLY (No Tools Required)

Parts to Install:

- Casters
- Base
- Pneumatic Cylinder/Cover can

RTA 2 MODEST ASSEMBLY (Tools Supplied, if necessary)

Parts to Install:

- Casters
- Base
- Pneumatic Cylinder/Cover can
- Back

RTA 4 MODERATE ASSEMBLY (Tools Supplied)

Parts to Install:

- Casters
- Base
- Pneumatic Cylinder/Cover can
- Back
- Armrest

RTA 8 FULL ASSEMBLY (Tools Supplied)

Parts to Install:

- Casters
- Base
- Pneumatic Cylinder/Cover can
- Back
- Armrest
- Mechanism



Global's Certified Products are in compliance with the stringent emission guidelines set by the GREENGUARD Environmental Institute and include all Upholstered Seating. To obtain a GREENGUARD or GREENGUARD Gold Certificate for any product, please go to the Environmental Commitment section on our website www.globalfurnituregroup.com and click on "GREENGUARD".



level™ certification, based on the ANSI/BIFMA e3-2012 furniture sustainability standard, sets furniture manufacturers on a path toward greater sustainability over time. Based on environmental and social criteria set forth in the standard, a product's entire supply chain is assessed.

Certification assessment includes an evaluation of specific corporate policies and guidelines and an assessment of associated company manufacturing facilities. Products must meet quantifiable milestones of environmental and social performance at every step of development.

The quantitative assessment addresses four categories: material use, energy and atmosphere impacts, human and ecosystem health and social responsibility.

Manufacturers earn points in each of the four categories. The level™ brand and its numeric rating of 1, 2 or 3 indicate what threshold of certification a product has achieved. level™ 3 is the highest rating.



All products with this designation are suitable for UPS shipment throughout the United States.

TABLE OF CONTENTS

A		K
Academic Task399	Enterprise30	Kate304
Arno22	Erin172	
Arturo23	F	L
Aspen24	Factor34	Layne178
Auburn26	File Buddy174	Lite180
	Flap175	Loover57
B		Luray61
Bakhita128	G	Lux305
Ballara248	G136	
Beach131	G2038	M
Beam Seating132	Global Accord39	Malaga64
Braden260	Goal43	Malaga TS379
Bridges II Collaborative Seating263	Graham45	Marche185
	Granada46	Mayne187
C	Granada Deluxe51	Mirage65
Calidon271	Granada Deluxe TS379	ML307
Camino277	Graphic55	ML Park307
Caprice142		Moda Four-Legged188
Chap144	I	Moda Stacking189
Citi282	Industrial Seating401	
Citi Square287	Industrial ESD406	N
Comet146	Industrial Clean Room410	Novello66
Concorde27	Industrial Anti-Microbial415	
	Industrial Wipe Down418	
D	Islands177	
Diplomat29		
Drift296	J	
Duet150	Jeo301	
Duet tables169		

O

ObusForme Comfort + XL	70
Orion.....	310

P

Popcorn	191
Prairie	311
Prefer	76

R

River	312
River Personal Harbor.....	328
River+	330
Robust	385
Roma	78
Roma Nester	196

S

Sas	198
Saxon	386
Sidero	200
Sirena	362
Solar	83
Solo	85
Sonic	204
Sora	87
Spritz	89
Spritz multi-purpose	220
Spyker	223
Stream	224
Supra	94
Supra X	96
Synopsis	99

T

Tamiri	102
Traditional	104
Triumph	108
Truform	109
Twilight	236
Tye	112

V

Venture.....	366
Vion	115
Vion guest	239
Vitrola.....	369

W

Weev	123
Wind.....	371
Wind Linear.....	373

Z

Zoma	244
------------	-----



































REFERENCES/PROGRAMS

Seating by Category Types.....	4-11
Suggested Applications by Series	12-13
Ergonomic Features and Benefits	14
Mechanism Adjustments	15
How to Order Seating	16
Act Performance Symbols	17
2Day Lightning.....	18
Heavy Duty/24 Hour	378
How to select armrests	390
Arm selections	391
Caster selections	394
Cylinder chart	396
Duet + Popcorn glide selections	397
Specialty seating.....	406
Textiles + Finishes	424
COM Authorization Form.....	429
Terms/Conditions/Warranty	432

SEATING BY CATEGORY TYPE



















Task

 Arno.....22	 Luray61	 Stream.....91
 Aspen24	 Malaga64	 Supra94
 Duet.....128	 Novello66	 Supra X96
 Enterprise30	 ObusForme Comfort + XL70	 Synopsis99
 Factor34	 Popcorn191	 Tamiri102
 G136	 Prefer76	 Triumph108
 G2038	 Roma78	 Truform109
 Goal43	 Solar83	 Tye112
 Graham45	 Solo85	 Vion115
 Granada46	 Sonic204	 Weev123
 Granada Deluxe51	 Sora87	
 Graphic55	 Spritz89	
 Loover57		

SEATING BY CATEGORY TYPE

Conference/Management

























 Arno22	 Kate.....304	 Solar83
 Arturo23	 Luray61	 Solo85
 Diplomat29	 Mirage65	 Supra94
 Enterprise30	 Roma78	 Synopsis99
 Global Accord39		 Tamiri102
 Graphic55		 Traditional104
 Jeo301		

SEATING BY CATEGORY TYPE

Executive

 Arno22	 Enterprise.....30	
 Arturo23	 Global Accord39	 Synopsis.....99
 Auburn26	 Luray61	 Tamiri102
 Concorde27	 Mirage65	 Traditional104
 Diplomat.....29		













Height Adjustable Stools

 Aspen24	 Loover57	 Spritz89
 Duet.....150	 Malaga64	 Stream.....91
 Factor34	 Novello66	 Supra X.....96
 G1 Ergo Select36	 ObusForme Comfort + XL70	 Synopsis99
 Global Accord39	 Prefer76	 Truform109
 Goal43	 Roma78	 Tye112
 Granada46	 Solar83	 Vion115
 Granada Deluxe51		 Weev123
 Graphic55		



















MULTI-PURPOSE SEATING

Stacking





 Bakhita128	 Popcorn191	 Stream224
 Comet146	 Sas198	 Vion guest239
 Duet150	 Sidero200	 Zoma244
 Flap.....175	 Sonic204	
 Moda.....189	 Spyker223	

Guest (Metal)

 Arno.....22	 Kate.....304	 Stream224
 Caprice142	 Lite180	 Twilight236
 Comet146	 Marche185	 Vion guest239
 Diplomat149	 Popcorn191	
 Enterprise.....30	 Sas198	
 Erin.....172	 Sidero200	
 Jeo301	 Sonic204	

SEATING BY CATEGORY TYPE















Guest (Wood)

 Beach131	 Islands177	 Mayne187
 Chap144	 Layne178	













Nesting

 Roma Nester196	 Spritz Nester220
--	--

Tandem/Beam/Pedestal

 Duet (Beam)137	 Roma (Pedestal).....78	 Synopsis (Pedestal).....99
 Duet (Pedestal).....150	 Sidero (Beam)139	 Vion (Beam)140
 Global Accord (Pedestal).....39	 Sonic (Beam)139	 Vion (Pedestal).....115
 Luray (Pedestal).....61	 Sonic (Pedestal).....204	Beam Seating132
 Novello (Pedestal).....66	 Spritz (Pedestal).....220	
 Popcorn (Beam)138	 Stream (Pedestal).....224	











Stools

 Diplomat149	 ML.....307	 Sonic204
 Duet150	 Popcorn191	 Stream224
 Drift.....296	 Sas198	 Twilight236
 File Buddy174	 Sidero200	 Vion guest239
 Marche185		



EDUCATION

Classroom

 Academic Task399	 Novello66	 Sonic204
 Duet150	 Popcorn191	 Spritz Nester220
Duet tables169	 Roma Nester196	 Supra X96
 Graphic55	 Sidero200	 Vion115

Work + Task





 G136	 Novello66	 Spritz89
 Granada46	 ObusForme Comfort + XL70	 Supra X96
 Graphic55	 Prefer76	 Truform109
 Loover57	 Roma78	 Vion115
	 Sora87	

Guest

 Caprice142	 Islands177	 Sonic204
 Duet150	 Roma Nester196	 Vion guest239
 Graphic55	 Sidero200	 Zoma244

SEATING BY CATEGORY TYPE

Lecture Hall

 Duet (Beam)137	 Sidero (Beam)139	 Vion (Beam)140
 Popcorn (Beam)138	 Sonic (Beam)139	

Lab Seating + Stools

 Caprice142	 Novello66	 Spritz89
 Duet150	 Sidero200	 Supra X96
 Graphic55	 Sonic204	 Vion115











Cafeteria

 Bakhita128	 Sas198	 Sonic204
 Duet150	 Popcorn191	 Spyker223

Lounge

 Ballara248	 Citi Square287	 River+330
 Citi282	 Orion310	 Sirena362
 Drift296	 River312	 Wind Linear373

Stacking & Nesting

 Bakhita128	 Sas198	 Spyker223
 Duet150	 Sidero200	 Stream224
 Popcorn191	 Sonic204	 Zoma244
 Roma Nester196	 Spritz Nester220	



LOUNGE SEATING

Ballara.....248	Kate.....304	River+330
Braden.....260	Lux.....305	Sirena.....362
Bridges II Collaborative Seating...263	ML.....307	Venture.....366
Camino.....277	ML Park309	Vitrola.....369
Citi.....282	Orion.....310	Wind.....371
Drift.....296	Prairie.....311	
Jeo301	River312	

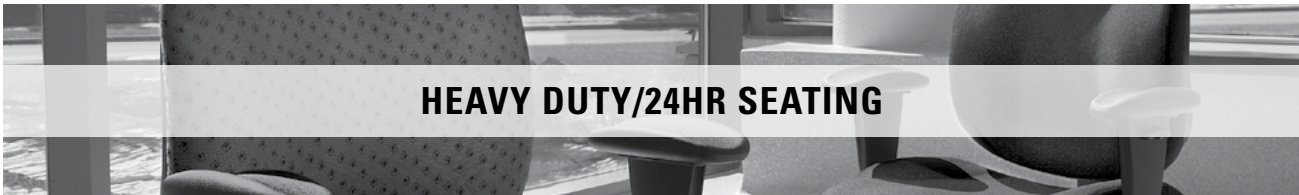

HEAVY DUTY/24HR SEATING

Concorde Executive 24HR382	Malaga TS379	Saxon386
G1 Ergo Select TS383	ObusForme Comfort TS380	Truform TS381
Granada TS378	Robust385	Vion TS387
Granada Deluxe TS379		

SUGGESTED APPLICATIONS BY SERIES

SERIES	SUGGESTED APPLICATION	ACADEMIC SEATING	CAFETERIA SEATING	CONFERENCE ROOM SEATING	ERGONOMIC AND TASK	EXECUTIVE TASK SEATING	HEAVY DUTY SEATING	HOSPITALITY SEATING	GUEST SEATING	LOUNGE/RECEPTION SEATING	MANAGEMENT SEATING	MEETING ROOM SEATING	MULTI PURPOSE SEATING	PUBLIC SEATING	STACKING SEATING	STOODLS	TABLET SEATING	TECHNICAL SEATING	WOOD GUEST SEATING
ARNO			•					•		•	•								
ARTURO			•							•									
ASPEN				•	•					•	•								
AUBURN			•							•									
BAKHITA	•	•										•		•					
BALLARA							•		•							•			
BEACH						•	•	•				•	•						•
BEAM SEATING	•	•				•	•												
BRADEN								•											
BRIDGES II COLLAB. SEATING						•	•	•				•							
CAMINO						•	•	•											
CAPRICE		•						•				•				•			
CHAP						•	•	•											•
CITI & CITI SQUARE								•	•				•				•		
COMET		•						•	•		•	•							
CONCORDE				•	•														
DIPLOMAT			•					•		•	•					•			•
DUET	•	•	•	•					•		•	•	•	•	•	•	•		
ENTERPRISE			•	•				•		•	•								
FACTOR			•	•						•						•			
FILE BUDDY													•			•			
G1 ERGO SELECT			•	•	•					•							•		
G20			•	•	•					•	•								
GLOBAL ACCORD			•							•	•		•			•			
GOAL	•			•															•
GRAHAM				•															
GRANADA & GRANADA DELUXE	•			•		•		•								•		•	
GRAPHIC			•								•					•			
ISLANDS						•	•	•											•
JEO								•	•				•						
KATE			•					•											
LAYNE						•	•												•
LITE	•	•				•	•	•				•							
LOOVER			•	•				•		•									
LURAY			•	•						•			•						
LUX								•	•										
MALAGA	•			•		•		•								•			
MARCHE						•	•				•					•			

SUGGESTED APPLICATIONS BY SERIES

SERIES	SUGGESTED APPLICATION	ACADEMIC SEATING	CAFETERIA SEATING	CONFERENCE ROOM SEATING	ERGONOMIC AND TASK	EXECUTIVE TASK SEATING	HEAVY DUTY SEATING	HOSPITALITY SEATING	GUEST SEATING	LOUNGE/RECEPTION SEATING	MANAGEMENT SEATING	MEETING ROOM SEATING	MULTI PURPOSE SEATING	PUBLIC SEATING	STACKING SEATING	STOODLS	TABLET SEATING	TECHNICAL SEATING	WOOD GUEST SEATING
MAYNE								•	•										•
MIRAGE																			
ML			•					•	•	•							•		
ML PARK			•					•	•	•							•		
MODA			•						•						•				
NOVELLO	•			•	•			•			•	•	•			•			
OBUSFORME COMFORT				•	•					•									
ORION				•	•	•		•	•										
POPCORN			•	•				•	•		•	•	•	•					
PRAIRIE								•	•										
RIVER								•	•	•				•					
ROBUST						•				•									
ROMA			•	•	•						•	•	•			•			
ROMA NESTER												•	•						
SAS			•					•	•					•	•				•
SAXON						•													
SIDERO			•					•	•			•		•	•				
SIRENA								•	•								•		
SOLAR				•	•			•											
SOLO				•					•	•									
SONIC			•		•			•	•		•	•	•	•	•	•			
SPRITZ	•	•		•				•	•		•	•	•	•	•				
SPYKER			•									•		•					
STREAM	•	•		•				•	•		•	•	•	•	•	•			
SUPRA				•				•		•									
SUPRA X	•			•													•		
SYNOPSIS				•	•			•		•	•					•			
TAMIRI				•				•		•									
TRADITIONAL								•	•	•									
TRIUMPH					•					•									
TRUFORM				•		•				•								•	
TWILIGHT			•					•			•	•						•	
TYE				•	•			•			•							•	
VENTURE								•	•				•						
VION				•	•	•	•	•	•	•			•	•	•				
VITROLA								•					•						
WEEV				•	•					•								•	
WIND & WIND LINEAR									•										
ZOMA			•					•	•		•	•	•		•				

ERGONOMIC FEATURES & BENEFITS

EACH GLOBAL CHAIR IS BUILT WITH FEATURES THAT ARE ERGONOMICALLY DESIGNED TO PROMOTE GOOD POSTURE AND PROVIDE MAXIMUM COMFORT. WHILE FULLY SUPPORTING YOUR BODY, THESE FEATURES SHOULD ALSO ALLOW YOU TO ADJUST YOUR CHAIR TO FIT YOU.



A TENSION ADJUSTMENT

Increase or decrease to match body weight. Allows you to rock comfortably, without heavy pushing, reducing muscle fatigue.



B CHAIR TILT LOCK

Lock the tilt movement in position(s) to accommodate your working posture. Allows you to lock your chair in a comfortable and supportive position. (Can be either single position or infinite style).



C SEAT HEIGHT

Raise or lower to allow your feet to rest flat on the floor. Avoids pressure under your thighs, easing blood flow.



D BACK HEIGHT

Raise or lower to position lumbar support in your lumbar area. Reduces likelihood of back pain.



E SEAT DEPTH

Change the depth of the seat to accommodate the length of your thighs. Keeps your back in contact with the backrest while avoiding pressure behind your knees.



F FORWARD SEAT ANGLE

Allows chair to tilt forward changing the angle of your thighs in relation to the floor. Helps reduce disc pressure during forward leaning tasks.



G BACK ANGLE

Adjust to change the angle of your torso in relation to your thighs. Helps reduce disc pressure and relaxes your back muscles.



H ARM HEIGHT

Raise or lower to support your forearms. Reduces muscular effort in neck and shoulders, minimizing risk of pain.



J KNEE-TILT MOVEMENT

Chair tilt pivot point is toward the front of the seat. Stability is maintained as the user reclines, keeping their feet on the floor and maintaining the same torso to thigh angle.



L SYNCHRO-TILT MOVEMENT

The seat pivots at the center point, while the backrest reclines at a faster rate than the seat, increasing the angle between the user's torso and thighs. Enhances comfort and encourages dynamic body movement.



M WATERFALL SEAT EDGE

Reduces pressure at the back of the knee, contributing to good blood flow.



N CONTOURED CUSHION

Supports the body effectively, allowing you to sit longer without discomfort.



P VIBRATING SEAT & BACK

Soothing effect contributes to your relaxation during work breaks.



Q WIDTH ADJUSTABLE ARMS

Allows outward movement of armrests to match shoulder breadth. Ensures armrests properly support forearms, reducing muscular efforts in neck and shoulders.



R ARM ROTATION

Rotate armcaps to support your forearms in various positions. Reduces muscular effort in neck and shoulders minimizing risk of pain.



S CENTER TILT

Chair tilts at the center point of the seat allowing you to recline while maintaining the same torso to thigh angle. When your feet are well supported, blood flow is enhanced.



U SOFT DESCENT PNEUMATIC LIFT

Gently and gradually lowering the seat helps you easily select proper seat height without causing a jerking motion.



V LUMBAR DEPTH ADJUSTMENT

Increase or decrease curvature of the back to match the profile of your lower back. Enhances comfort and support in the lower lumbar area.

MAXIMIZING YOUR ERGONOMIC SEATING

- Always select a chair that is designed for the type of work you perform and make certain the chair is comfortable for the length of time spent using it.
- Ensure that the seat and back cushions are contoured to fit your body, which will help eliminate pressure points.
- An ergonomically designed chair should allow changing positions easily.
- As you work, reposition yourself throughout the day to reduce strain and stress on specific muscle groups. If you change job functions, adjust your chair to fit the new task.
- Proper ergonomic seating should help eliminate many of the work related injuries that result from poor posture and poorly designed chairs.

TASK (-6)



ADJUSTMENTS

- (2) Pneumatic seat height
- (8) Manual seat depth
- Back height **
- Swivel

POSTURE TASK (-7)

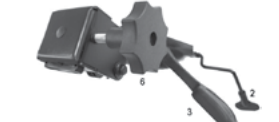

ADJUSTMENTS

- (2) Pneumatic seat height
- (3) Back angle
- (6) Back height **
- Seat depth *
- Swivel

TILTER (-4)

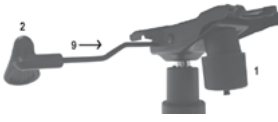

ADJUSTMENTS

- (2) Pneumatic seat height
- (9) Chair tilt lock *
- Center-tilt action
- Swivel

KNEE-TILTER (-2)



ADJUSTMENTS

- (1) Tilt tension
- (2) Pneumatic seat height
- (9) Chair tilt-lock *
- Back height **
- Knee-tilt action
- Swivel
- Optional sliding seat depth adjustment (MD)

MULTI-TILTER (-3)



ADJUSTMENTS

- (1) Tilt tension
- (2) Pneumatic seat height
- (3) Back angle adjustment
- (9) Infinite position seat tilt lock
- (7) Forward tilt lock *
- (8) Sliding seat depth adjustment (MD)
- Back height **
- Center-tilt action
- Swivel

SYNCHRO-TILTER (-0, -1, -8)



ADJUSTMENTS

- (1) Tilt tension
- (2) Pneumatic seat height
- (3) Back angle adjustment
- (8) Sliding seat depth adjustment (MD)
- (9) Chair tilt lock Synchro-tilt action
- Anti-kickback *
- Back height **
- Swivel

POSTURE-TILTER *



ADJUSTMENTS

- (1) Tilt tension
- (2) Pneumatic seat height
- (8) Sliding seat depth adjustment (MD)
- (9) Infinite position seat tilt lock
- Back height **
- Swivel

OPERATOR (-5)



ADJUSTMENTS

- (2) Pneumatic seat height
- (3) Back angle *(Free Float/lock)
- (4) Seat angle *(Free Float/lock)
- (4) Seat angle / Back angle
- Back height **
- Free floating seat and back *
- With single lever operator mechanism, seat and back angle are controlled using lever 4 *
- Swivel

NOTES

- * Selected models only.
- ** RATCHET back height adjustment on selected models.
- *** Mechanisms shown are generic depictions and may differ from one chair to another.

HOW TO ORDER SEATING



5451-3

MODEL NUMBER

+



MD

MECHANISM OPTION

+



BK

FRAME FINISH

+



AX27

FABRIC CODE

FABRIC CHAIR EXAMPLE

If there are any options for the chair they would be inserted between the Model Number with Arm Style and Frame Finish. For example (see above):

5451-3 BK AX27

This would be the **Truform Medium Back Multi-Tilter** with standard Height Adjustable Arms and Multi-Tilter. Black Frame **BK** and Oxygen fabric in Axis, Noir **AX27**, complete the chair.

CHAIR SAFETY TIPS

Common sense guidelines to ensure that your Global chair will provide many years of comfort and service in a safe and productive environment:

- Always read and follow assembly instructions. Make sure that all of the pieces of your Global chair are installed in the proper order to ensure structural integrity.
- Ensure that chair casters are fully inserted into the base of the unit.
- Inspect your chair for loose or worn parts at least once a year.
- Always keep the base of your chair completely on the floor.
- Most Global chairs are equipped with casters for use on carpeted surfaces. Other flooring surfaces may require different casters.
- Speak to your Global Sales Representative or refer to the Casters Section of this Price Book for appropriate custom selections.
- Many Global office chairs are equipped with tilt tension controls on the seating mechanism. The tension control compensates for different body weights and postures. Always ensure that the control is properly adjusted for a smooth and controlled tilt motion. Your Global Sales Representative can demonstrate the proper use of all the adjustments on your office chair.
- Do not stand on your Global chair or sit on the arms of your chair.
- Do not put electrical appliances on chairs. Even fire retardant fabrics can be damaged when exposed to direct heat or flame.
- Choose the right chair for your work environment. Global offers a full line of Intensive Use, Multi-Shift and Specialized chairs for environments with demanding health or safety requirements. Your Global Sales Representative is trained to help you make the right choice for your workplace.

THE ASSOCIATION FOR CONTRACT TEXTILES (ACT) HAS DEVELOPED THE FOLLOWING PERFORMANCE GUIDELINES TO MAKE FABRIC SPECIFICATION EASIER. THE FIVE SYMBOLS GIVE ARCHITECTS, DESIGNERS AND END USERS A VAST AMOUNT OF PERFORMANCE INFORMATION IN A SUCCINCT, VISUAL WAY. THIS CHART LISTS THE REQUIRED TESTS THAT CORRESPOND TO SPECIFIC END USES. AN EXPLANATION OF THE SYMBOL ALSO APPEARS.

FIRE RETARDANCY



Flammability testing determines a fabric's performance and resistance to burning.

APPLICATION

Upholstery
Panels and upholstered walls

PASSES

California bulletin 117, section E.
ASTM E 84-03 Class A or Class 1 (unadhered method).

COLOR FASTNESS TO WET & DRY CROCKING



Color fastness to wet & dry crocking refers to the rubbing off of color from the fabric onto clothing, hands or other materials and can occur under wet or dry conditions.

APPLICATION

Upholstery
Panels and upholstered walls

PASSES

AATCC 8-2001 Dry crocking. Class 4 minimum.
Wet crocking, Class 3 minimum.
AATCC 8-2001 E 84 (unadhered method).

COLOR FASTNESS TO LIGHT



Color fastness to light is the degree to which fabric will retain its color when exposed to light.

APPLICATION

Upholstery
Panels and upholstered walls

PASSES

AATCC option 2-2003 or AATCC - option 3-2003.
Class 4 minimum of 40 hours.
AATCC option 2-2003 or AATCC - option 3-2003.
Class 4 minimum of 40 hours.

PHYSICAL PROPERTIES



Three physical property tests include: 1 - Brush pill test to determine a fabric's pilling (the formation of fuzzy galls of fiber on the surface of a fabric). 2 - Breaking/tensile strength is the ability of a fabric to withstand tension without breaking or tearing. 3 - Seam slippage is the pulling apart of fabrics at the seams.

APPLICATION

Upholstery
Panels and upholstered walls

PASSES

Brush pill ASTM D3511-02, 3 minimum.
Breaking strength ASTM D5034-95 (2001) 50 lbs. minimum in warp & weft.
Seam slippage ASTM D4034 25 lbs. minimum in warp & weft.
Breaking strength ASTM D5034-95 (2001) (grab test).
35 lbs. minimum in warp & weft.

ABRASION



Abrasion is the ability of a fabric to withstand damage from wear and rubbing. There is a general contract specification as well as a heavy duty specification.

APPLICATION

General contract upholstery
Heavy duty upholstery

PASSES

ASTM D4157-02 (#10 cotton duck) 15,000 double rubs, Wyzenbeek method.
ASTM D4966-98 (12 KPA pressure) 20,000 double rubs, Martindale method.
ASTM D4157-02 (#10 cotton duck) 30,000 double rubs, Wyzenbeek method.
ASTM D4966-98 (12 KPA pressure) 40,000 double rubs, Martindale method.

2 DAY —
lightning

2DAY LIGHTNING PROGRAM IS TEMPORARILY UNAVAILABLE

WE LOOK FORWARD TO REINTRODUCING THE PROGRAM SOON

Global's 2 DAY LIGHTNING program offers many of our best-selling models upholstered in your choice of our most popular textiles.

The 2 DAY LIGHTNING program features easy customization with extensive upholstery choices. Global's lightning fast production and shipping make it simple to order and ideal for tight deadlines!

- 14 Series, 100+ Models, 300+ Textiles to Customize your order
- No Special Order Forms Required
- Everything is UPSable

Need quick, simple and custom seating? Think Global!

Color it your way

GRADE 1

Carrera Terrace
Fusion Urban
Illusion Waterfall
Jenny Wavelength
Quilt

GRADE 2

Allante FRee Imprint
Couture Match
Elevate Release Vinyl
Etch Replay
GC Linen Vinyl Silhouette

GRADE 6

Novaro Genuine Leather

Textiles are subject to change, please confirm current selection.

TERMS AND CONDITIONS

- All product series have **MAXIMUM order quantities which can be fulfilled within the 2 Day Lightning program. These are noted next to each series. For greater quantities, please contact CustomerCare for lead times and terms.**
- Orders must clearly state, "2 Day Lightning" at the time of submittal
- Program is limited to exact models within series listed above
- Program is limited to exact textile patterns listed and exact colorways carded
- Orders cannot be changed or canceled after order acknowledgment
- Current Global list pricing applies at the time of order
- All eligible models are UPSable; Global reserves the right to ship "best way"
- Bakhiita, Popcorn, Duet and Sonic models may be multiple packaged and shipped "best way"
- Orders must be clean with correct model numbers, options, textiles, correct pricing, etc., to apply
- Dealer must be in good standing and within terms for order to be processed without delay
- Finished products will ship from our factories in as little as two business days
- Program available in the 48 contiguous United States
- Orders to ship outside Global's distribution model; order shipment address can be to the dealer or end-user directly
- Standard model options listed under Optional Features section in the price list are available. Standard model options include aluminum bases, painted frame finishes, ballistic nylon backs, glide options and hard surface casters. Memory Foam as a standard option is not available (standard lead-times apply).























2 DAY LIGHTNING QUICKSHIP PROGRAM

Series	Model Numbers		Series	Model Numbers		Series	Model Numbers	
Duet (maximum 100)	6620 6621 6621-2	6620-1 6621-1 6624	Popcorn (maximum 100)	6710 6710-2 6711-1 6715 6716	6710-1 6711 6711-2 Clear Glides (set of 2)	Spritz Nester (maximum 50)	6764C 6765C	Black Mesh only
	5 Plastic Colors: Cloud (IVC) Latte (LAB) Night (BLK) Scarlet (SAR) Shadow (SHW)			5 Plastic Colors: Cloud (IVC) Latte (LAB) Night (BLK) Scarlet (SAR) Shadow (SHW)				
Factor (maximum 50)	5540-4	5541-4	Roma (maximum 50)	1901 1906RA	1906	Vion (Black Frame) (maximum 50)	6321-0 6321-4 6322-0 6322-4 6324 6324C 6327-6 6331-0 6331-4 6332-0 6332-4 6335	6321-3 6321-8 6322-3 6322-8 6325 6325C 6328-6 6331-3 6331-8 6332-3 6332-4 TS6321-3
	Black Mesh + Frame / U2 arms only			Black Mesh only				
Global Accord (maximum 50)	2670-2 2670-4 2671-2 2671-4 2672-6		Roma Nester (maximum 50)	1890 1899	1899			5 Vion Mesh colors: Black (MS69) Blue (MS72) Natural (MS74) Stone (MS71)
				Black Mesh only				
Global Accord Mesh (maximum 50)	2676-2 2676-4 2677-2 2677-4 2678-6			3 Frame Finishes: Black (BLK) Blue (MS72) Natural (MS74) Stone (MS71)		Vion (Fog Frame) (maximum 50)	6321-0FG 6321-4FG 6322-0FG 6322-4FG 6324FG 6324CFG 6327-6FG 6331-0FG 6331-4FG 6332-0FG 6332-4FG	6321-3FG 6321-8FG 6322-3FG 6322-8FG 6325FG 6325CFG 6328-6FG 6331-3FG 6331-8FG 6332-3FG
	5 Vue Mesh colors: Coal Black (VU19) Desert Sand (VU11) Quarry Grey (VU15) Sandy Beach (VU10) Tidal Wave (VU16)						5 Vion Mesh colors: Black (MS69) Blue (MS72) Natural (MS74) Stone (MS71) Rope (MS73)	
Graham (maximum 50)	3144		Sonic (maximum 50)	6508 6508MB 6509 6509MB 6511 6513 6513MB 6514 6514MB 6515 6517WS	6508-1 6508MB-1 6509-1 6509MB-1 6511-1 6513-1 6513MB-1 6514-1 6514MB-1 6515-1			
								
Novello (maximum 50)	6400 6410	6401 6411		5 Plastic Colors: Cloud (IVC) Latte (LAB) Night (BLK) Scarlet (SAR) Shadow (SHW)				
	Black Shell / Arm/ Armcap only							

2DAY LIGHTNING PROGRAM IS TEMPORARILY UNAVAILABLE

WE LOOK FORWARD TO REINTRODUCING THE PROGRAM SOON

work + task

	Arno22		G1 Ergo Select36		Luray61
	Arturo23		G2038		Malaga64
	Aspen24		Global Accord39		Mirage65
	Auburn26		Goal43		Novello66
	Concorde27		Graham45		ObusForme Comfort + XL70
	Diplomat29		Granada46		Prefer76
	Enterprise30		Granada Deluxe51		
	Factor34		Graphic55		
			Loover57		

work + task

 Roma78	 Synopsis99
 Solar83	 Tamiri102
 Solo85	 Traditional104
 Sora87	 Triumph108
 Spritz89	 Truform109
 Supra94	 Tye112
 Supra X96	 Vion115
	 Weev123

ARNO™



model 4003



HB Tilter

COM Yardage: 2.50
Freight Class: 250
Product Weight (lbs.): 39
Cubic Feet Per Carton: 11.50

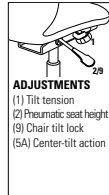

Ergonomic Features:
A, B, C, N, S



HB Conference Chair

COM Yardage: 2.50
Freight Class: 250
Product Weight (lbs.): 39
Cubic Feet Per Carton: 11.50



Armchair w/ Sled Base

COM Yardage: 2.50
Freight Class: 250
Product Weight (lbs.): 33
Cubic Feet Per Carton: 13

Ergonomic Features:
N

STANDARD FEATURES

- Perforated leather inserts in the seat and back surfaces.
- Standard Black (BK) molded flared loop arms and a five-legged injection molded base with C65 casters.
- Model 4003-SC features a self centering cylinder which swivels and automatically returns to the starting seat location. Standard with a flat 5 star base in Black (BK) with C7 glides.
- Standard in Luxhide. Not available in fabric. Starting at grade 5 pricing.
- Check textile availability prior to specifying upholstery material.

OPTIONAL FEATURES

- Please refer to the "Casters Selection" section of the price book for caster options. Optional casters may be priced higher than the standard casters for your chair and the difference will be charged. Lower priced optional casters will not be credited.
- An optional abrasion resistant outer back fabric (polyester) is available. Resistant to impact damage. Available in Black only. Add \$21.
- For hard surface flooring casters, please specify C10R. Add \$109.
- For fully assembled in box, please specify SU. Add \$70.

	1	2	3	4	5	6	7	8	9	10	11	12
4003	-	-	-	-	500	568	-	913	1039	1245	1552	1922

OVERALL DIMENSIONS			SEAT DIMENSIONS			BACK DIMENSIONS	
W	D	H	W	D	H	W	H
25	29	42	20.5	19	16-20	21	24



	1	2	3	4	5	6	7	8	9	10	11	12
4003-SC	-	-	-	-	568	635	-	986	1115	1323	1640	2016

OVERALL DIMENSIONS			SEAT DIMENSIONS			BACK DIMENSIONS	
W	D	H	W	D	H	W	H
25	29	44	20.5	18	18.5	21	24



	1	2	3	4	5	6	7	8	9	10	11	12
4004	-	-	-	-	500	568	-	913	1039	1245	1552	1922

OVERALL DIMENSIONS			SEAT DIMENSIONS			BACK DIMENSIONS	
W	D	H	W	D	H	W	H
24.5	26.5	36	20	19	18	20.5	19



ARTURO™



model 3991







model 3992

STANDARD FEATURES

- Stitched seat and back design, padded headrest (model 3991) and upholstered open arms.
- All models are standard with a five prong, injection molded, fiberglass reinforced nylon Black spider base with (C65) dual wheel carpet casters.
- Base and frame are available in Black only.
- Standard in Luxhide. Not available in fabric. Starting at grade 5 pricing.
- Check textile availability prior to specifying upholstery material.

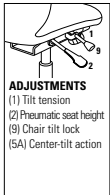
OPTIONAL FEATURES

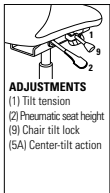
- There are no arm options for this series.
- An optional abrasion resistant outer back fabric (polyester) is available. Resistant to impact damage. Available in Black only. Specify (BKB). Add \$21.
- For hard surface flooring casters, specify (C65R). Add \$66.
- Please refer to the "Casters Selection" section of the price book for caster options. Optional casters may be priced higher than the standard casters for your chair and the difference will be charged. Lower priced optional casters will not be credited.
- For fully assembled in box, specify (SU). Add \$70.

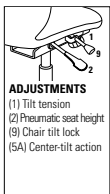
DESCRIPTION	FEATURES	MODEL#	STANDARD TEXTILE GRADES														
			1	2	3	4	5	6	7	8	9	10	11	12			
 <p>Extended HB Tilter COM Yardage: 4 Freight Class: 250 Product Weight (lbs.): 54 Cubic Feet Per Carton: 14</p>	 <p>ADJUSTMENTS (1) Tilt tension (2) Pneumatic seat height (9) Chair tilt lock (5A) Center-tilt action</p>	3991	-	-	-	-	1425	1529	1725	2080	2280	2608	3102	3696			
		OVERALL DIMENSIONS			SEAT DIMENSIONS			BACK DIMENSIONS									
		W	D	H	W	D	H	W	H								
		26	30.5	50	21	20	16.5-20.5	21.5	30.5								
			RTA 1														
 <p>HB Tilter COM Yardage: 3.50 Freight Class: 250 Product Weight (lbs.): 52 Cubic Feet Per Carton: 13.25</p>	 <p>ADJUSTMENTS (1) Tilt tension (2) Pneumatic seat height (9) Chair tilt lock (5A) Center-tilt action</p>	3992	-	-	-	-	1318	1410	1581	1891	2068	2354	2788	3306			
		OVERALL DIMENSIONS			SEAT DIMENSIONS			BACK DIMENSIONS									
		W	D	H	W	D	H	W	H								
		26	30	43	20.5	19.5	16.5-20.5	20.5	25								
			RTA 1														
 <p>LB Tilter COM Yardage: 3.50 Freight Class: 250 Product Weight (lbs.): 44 Cubic Feet Per Carton: 11.50</p>	 <p>ADJUSTMENTS (1) Tilt tension (2) Pneumatic seat height (9) Chair tilt lock (5A) Center-tilt action</p>	3993	-	-	-	-	1268	1362	1533	1843	2021	2308	2740	3256			
		OVERALL DIMENSIONS			SEAT DIMENSIONS			BACK DIMENSIONS									
		W	D	H	W	D	H	W	H								
		26	29.5	37	20.5	19.5	16.5-20.5	20.5	18								
			RTA 1														

ASPEN™



model 2850-3



model 2851-3



Lumbar Support

Back height can be adjusted to enable a user to reposition the contact zone of lumbar support.

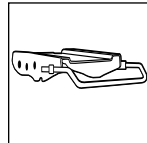

Multi-Depth Mechanism

Standard on Multi - Tilter. Allows seat to move forward and backward over a 2" range with 5 locking positions to provide a more shallow or deeper seat.



model 2852-3

STANDARD FEATURES

- Aspen features a slender design and sensitive profile with a superior level of comfort.
- Extended back models are standard with a height adjustable headrest.
- All models offer 2.25" back/lumbar height adjustment via a concealed ratchet system.
- All models are standard with height and width adjustable arms (AS) that feature a sliding armcap providing extra support for all users.
- Models feature braille on the underside of all paddles.
- Model **2852-6SC** features a self centering cylinder which swivels and automatically returns to the starting seat location. This model is standard with a flat 5 star base in Black (BK) with C7 glides.
- Base and arm detail is standard in Black.
- All models are shipped partially KD.
- C82 dual wheel carpet casters are standard.
- Multi-depth mechanism is standard on multi-tilter models. Allows seat to move forward and backward over a 2" range with 5 locking positions to provide a shallower or deeper seat.
- Check textile availability prior to specifying upholstery material.

OPTIONAL FEATURES

- Polished Aluminum base is available. Specify (ALU). Add \$145.
- Coordinating Chrome finished arms are available at no upcharge. Specify (AC).
- Please refer to "Arm Selection" section of the price book for additional arm options.
- Please refer to "Cylinder Selection" section of the price book for additional cylinder options.
- For hard surface flooring casters, specify C9R. Add \$87
- For fully assembled in box, specify SU. Add \$70.



DESCRIPTION FEATURES MODEL# STANDARD FABRIC GRADES



Extended Back Multi - Tilter
COM Yardage: 2.50
Freight Class: 150
Product Weight (lbs.): 66
Cubic Feet Per Carton: 14.75

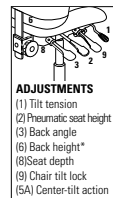

ADJUSTMENTS
(1) Tilt tension
(2) Pneumatic seat height
(3) Back angle
(6) Back height*
(8) Seat depth
(9) Chair tilt lock
(5A) Center-tilt action

Ergonomic Features:
A, B, C, D, E, F, G, H, M, N, Q, S, V

MODEL#	1	2	3	4	5	6	7	8	9	10	11	12
2850-3	1416	1499	1564	1660	1797	1845	1965	2192	2304	2515	2801	3160

OVERALL DIMENSIONS			SEAT DIMENSIONS			BACK DIMENSIONS	
W	D	H	W	D	H	W	H
25	24	45	19.5	19.5-21	16.5-20.5	18.5	26.5-29



HB Multi - Tilter
COM Yardage: 2.25
Freight Class: 150
Product Weight (lbs.): 64
Cubic Feet Per Carton: 14.75

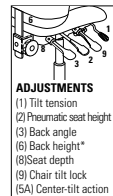

ADJUSTMENTS
(1) Tilt tension
(2) Pneumatic seat height
(3) Back angle
(6) Back height*
(8) Seat depth
(9) Chair tilt lock
(5A) Center-tilt action

Ergonomic Features:
A, B, C, D, E, F, G, H, M, N, Q, S, V

MODEL#	1	2	3	4	5	6	7	8	9	10	11	12
2851-3	1265	1338	1397	1483	1606	1650	1757	1963	2060	2253	2511	2833

OVERALL DIMENSIONS			SEAT DIMENSIONS			BACK DIMENSIONS	
W	D	H	W	D	H	W	H
25	24	41	19.5	18-19.5	16.5-20.5	19.5	22.5



MB Multi - Tilter
COM Yardage: 2
Freight Class: 150
Product Weight (lbs.): 62
Cubic Feet Per Carton: 13

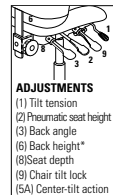



ADJUSTMENTS
(1) Tilt tension
(2) Pneumatic seat height
(3) Back angle
(6) Back height*
(8) Seat depth
(9) Chair tilt lock
(5A) Center-tilt action

Ergonomic Features:
A, B, C, D, E, F, G, H, M, N, Q, S, V

MODEL#	1	2	3	4	5	6	7	8	9	10	11	12
2852-3	1228	1294	1346	1421	1531	1572	1666	1849	1937	2105	2334	2623

OVERALL DIMENSIONS			SEAT DIMENSIONS			BACK DIMENSIONS	
W	D	H	W	D	H	W	H
25	24	37	19.5	18.5-21	16.5-20.5	18.5	18.5-21



DESCRIPTION	FEATURES	MODEL#	STANDARD FABRIC GRADES												
			1	2	3	4	5	6	7	8	9	10	11	12	
 <p>MB Conference Chair COM Yardage: 2 Freight Class: 250 Product Weight (lbs.): 44 Cubic Feet Per Carton: 13</p>	Ergonomic Features: A, B, D, H, M, N, Q, S	2852-6SC	1128	1192	1245	1321	1431	1471	1566	1749	1837	2005	2234	2523	
		OVERALL DIMENSIONS			SEAT DIMENSIONS			BACK DIMENSIONS							
		W	D	H	W	D	H	W	H						
25	24	37	19.5	18.5	18.5	18.5	18.5-21								
		RTA 2													

AUBURN



model 3767



Wood-capped base



Polished Aluminum



Optional Base
Polished Aluminum (ALU) finish is available on arm frame and base at an upcharge. Add \$344.



Optional Base
Wood-capped steel base with C1 casters is available at an upcharge (B4M). Add \$433.

STANDARD FEATURES

- This transitional style judge's chair offers a scrolled urethane arm for durability and comfort.
- Arm frame is made from Black cast aluminum for exceptional strength and quality
- Standard with soft, durable, self-skinned urethane (SSU) armcaps that are warm to the touch
- Five prong, injection molded, fiberglass reinforced nylon Black spider base with **C10** dual wheel carpet casters.
- Standard in Luxhide. Not available in fabric. Starting at grade 5 pricing.
- Check textile availability prior to specifying upholstery material.

OPTIONAL FEATURES

- Oval style wood-capped steel base (**B4M**) with (**C1**) casters is available. Genuine maple faced veneers and solids are used. Available in Absolute (AAM), Black (BKM), Cherry (ACM), Espresso Cafe (ECM), English Oak (EOM), Fruitwood (TFM), Gray (HGM), Honey (AHM), Mahogany (TMM), Maple (AVM), Medium Walnut (MWM), Natural Walnut (NLW), Night (ASM), Noce Biondo (NBM), Noce Grigio (NGM), Noce Leggero (NEM), Noce Medio (NMM), Shaker Cherry (SKM), Walnut (TWM), WC Cream (WTM), White (WHM) and Winter Cherry (WCM). Please specify. Add \$408.
- Polished Aluminum base is available. A **B2** aluminum base with black scuff tips and **C10** casters. Add \$154.
- For hard flooring surface casters with wood-capped base, please specify **C9R**. Add \$16.
- For hard surface flooring please specify **C10R** casters. Add \$60.
- Please refer to the "Casters Selection" section of the price book for caster options. Optional casters may be priced higher than the standard casters for your chair and the difference will be charged. Lower priced optional casters will not be credited.

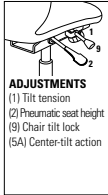
DESCRIPTION	FEATURES	MODEL#	STANDARD TEXTILE GRADES														
			1	2	3	4	5	6	7	8	9	10	11	12			
 <p>HB Tilter COM Yardage: 3 Freight Class: 250 Product Weight (lbs.): 63 Cubic Feet Per Carton: 22.25</p>	 <p>ADJUSTMENTS (1) Tilt tension (2) Pneumatic seat height (3) Chair tilt lock (5A) Center-tilt action</p>	<p>3767</p>	-	-	-	-	1615	1688	-	2074	2218	2447	2793	3209			
			OVERALL DIMENSIONS			SEAT DIMENSIONS			BACK DIMENSIONS								
			W	D	H	W	D	H	W	H							
28	28	46.5	21.5	18	16.5-20.5	21.5	27.5										
			RTA 00														
Ergonomic Features: A, B, C, M, N, S																	

CONCORDE™



model 2400-18



model 2400-18



Push Button
Location within reach increases your adjustment. Promotes good posture as you move to various positions.



model 2409



Polished Aluminum Base
Concorde Presidential models are standard with a polished aluminum base.

STANDARD FEATURES

- All adjustments are made with easy-use button controls that are conveniently located in full view.
- Compound curved molded foam seat and back cushions.
- Standard with Allen-bolted width adjustable arms (Allen key included). Arms adjust 1.25" wider on each side for a total of 2.5" extra width.
- Push button controlled tilt lock and push button controlled seat height.
- Seat cushions are easily removed without tools for ease of cleaning.
- Five prong, injection molded, fiberglass reinforced nylon Black base with (C10) dual wheel carpet casters.
- Upholstery options: Brisa, Brisa Distressed, Novaro Genuine Leather, Ultraleather or any leather. Not available in vinyl.
- Model 2424 is rated for multi-shift use for persons up to 350 pounds.
- For 24 hour application, Global's limited lifetime warranty is applicable only on fabrics that are rated for 100,000 double rubs.
- Concorde is fully assembled in box, as standard.
- Check textile availability prior to specifying upholstery material.

OPTIONAL FEATURES

- There are no arm options for this series.
- Optional aluminum base is available. Add. \$154.
- For hard surface flooring casters, please specify (C10R). Add \$60.
- For additional caster options, please refer to the Arm and Caster section. Optional casters may be priced higher than the standard casters for your chair and the difference will be charged. Lower priced optional casters will not be credited.



CONCORDE PRESIDENTIAL (MODEL #2409)

STANDARD FEATURES

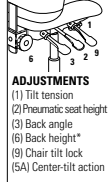

- Only available in Leather.
- Has a larger headrest, wider back and closed upholstered arms.
- Features decorative stitching, standard in a heavy gauge off-white stitch detail to show contrast with leather upholstery.
- Features perforated leather inserts in the seat and back cushions.
- Standard with (C25) dual wheel carpet casters.
- Standard with a Black arm button trim
- Standard with a Polished Aluminum base.

OPTIONAL FEATURES

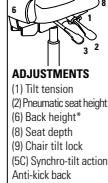
- Normal gauge color coordinated thread can be used upon request. Specify "matching thread" on order. No upcharge.
- Non-perforated leather inserts in the seat and back cushions are optional. Specify (NR).
- Optional with a Black base at no additional charge. Specify (BK).

DESCRIPTION	FEATURES	MODEL#	STANDARD TEXTILE GRADES												
			1	2	3	4	5	6	7	8	9	10	11	12	
 <p>HB Multi - Tilter Concorde Executive COM Yardage: 2.50 Freight Class: 250 Product Weight (lbs.): 76 Cubic Feet Per Carton: 23.50</p>	 <p>ADJUSTMENTS (1) Tilt tension (2) Pneumatic seat height (3) Back angle (6) Back height* (9) Chair tilt lock (5A) Center-tilt action</p>	<p>Ergonomic Features: A, B, C, D, G, M, N, Q, S, T</p>	2400-18	-	3956	4023	4124	4266	4318	4442	4672	4785	5002	5304	5674
			OVERALL DIMENSIONS			SEAT DIMENSIONS			BACK DIMENSIONS						
			W	D	H	W	D	H	W	H					
	26	28	48	21	19.5	17.5-21.5	21	31							
 <p>HB Synchro - Tilter Deluxe Concorde Presidential COM Yardage: 23.50 Freight Class: 250 Product Weight (lbs.): 78 Cubic Feet Per Carton: 23.50</p>	 <p>ADJUSTMENTS (1) Tilt tension (2) Pneumatic seat height (6) Back height* (8) Seat depth (9) Chair tilt lock (5C) Synchro-tilt action Anti-kick back</p>	<p>Ergonomic Features: A, B, C, D, E, L, M, N, Q, T</p>	2409	-	-	-	-	-	-	-	-	-	6489	6976	7492
			OVERALL DIMENSIONS			SEAT DIMENSIONS			BACK DIMENSIONS						
			W	D	H	W	D	H	W	H					
	28.5	27	50	21	18-20	18-22	21	28-31							

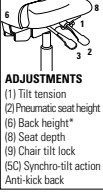

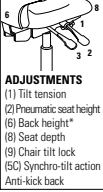
DESCRIPTION	FEATURES	MODEL#	STANDARD TEXTILE GRADES													
			1	2	3	4	5	6	7	8	9	10	11	12		
 <p>HB Synchro - Tilter Concorde Executive 24HR COM Yardage: 2.50 Freight Class: 250 Product Weight (lbs.): 78 Cubic Feet Per Carton: 23.50</p>	 <p>ADJUSTMENTS (1) Tilt tension (2) Pneumatic seat height (6) Back height* (8) Seat depth (9) Chair tilt lock (5C) Synchro-tilt action Anti-kick back</p>	2424	-	2962	3030	3128	3272	3325	3446	3679	3791	4008	4306	4678		
			OVERALL DIMENSIONS			SEAT DIMENSIONS			BACK DIMENSIONS							
			W	D	H	W	D	H	W	H						
			28.5	27	50	21	17.5-19	18-22	21	28-31						
			RTA 00													
 <p>HB Synchro - Tilter Concorde Executive 24HR COM Yardage: 2.50 Freight Class: 250 Product Weight (lbs.): 78 Cubic Feet Per Carton: 23.50</p>	 <p>ADJUSTMENTS (1) Tilt tension (2) Pneumatic seat height (6) Back height* (8) Seat depth (9) Chair tilt lock (5C) Synchro-tilt action Anti-kick back</p>	2424-18	-	3010	3082	3180	3318	3374	3497	3728	3845	4060	4360	4730		
			OVERALL DIMENSIONS			SEAT DIMENSIONS			BACK DIMENSIONS							
			W	D	H	W	D	H	W	H						
			28.5	27	50	21	17.5-19	18-22	21	28-31						
			RTA 00													

DIPLOMAT



model 2106



model 2107

Also see Diplomat Guest Chairs



For Diplomat guest chairs, please see 149.

STANDARD FEATURES



- A contoured seat and back are accented by wood arms and base (on tilter models), providing comfort and classic styling.
- Series includes tilters, guest chairs and bar stool. See page 163 for additional series
- C1 casters are standard on tilter models.
- When upholstered in Leather, models will be in all Leather.
- Check textile availability prior to specifying upholstery material.

OPTIONAL FEATURES

- Wood-capped base and arms are available in Absolute (AAM), Black (BKM), Cherry (ACM), Espresso Cafe (ECM), English Oak (EOM), Fruitwood (TFM), Gray (HGM), Honey (AHM), Mahogany (TMM), Maple (AVM), Medium

Walnut (MWM), Night (ASM), Shaker Cherry (SKM), Walnut (TWM), WC Cream (WTM), White (WHM) and Winter Cherry (WCM). Please Specify. Genuine maple faced veneers and solids are used.

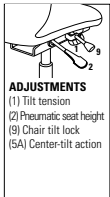
- Please refer to the "Casters Selection" section of the price book for caster options. Optional casters may be priced higher than the standard casters for your chair and the difference will be charged. Lower priced optional casters will not be credited.
- For fully assembled in box, specify **SU**. Add \$70.

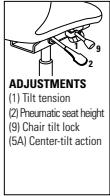
DESCRIPTION	FEATURES	MODEL#	STANDARD TEXTILE GRADES													
			1	2	3	4	5	6	7	8	9	10	11	12		
 <p>HB Tilter COM Yardage: 11.75 Freight Class: 250 Product Weight (lbs.): 40 Cubic Feet Per Carton: 11.75</p>	 <p>ADJUSTMENTS (1) Tilt tension (2) Pneumatic seat height (9) Chair tilt lock (5A) Center-tilt action</p>	<p>Ergonomic Features: A, B, C, M, N, S</p>	<p>RTA 1</p>	2106	1076	1143	1195	1273	1382	1420	1516	1699	1786	1955	2186	2473
				OVERALL DIMENSIONS			SEAT DIMENSIONS			BACK DIMENSIONS						
				W	D	H	W	D	H	W	H					
				24.5	27	43.5	21	18.5	17.5-21.5	21	27.5					
 <p>MB Tilter COM Yardage: 1.75 Freight Class: 250 Product Weight (lbs.): 39 Cubic Feet Per Carton: 11.50</p>	 <p>ADJUSTMENTS (1) Tilt tension (2) Pneumatic seat height (9) Chair tilt lock (5A) Center-tilt action</p>	<p>Ergonomic Features: A, B, C, M, N, S</p>	<p>RTA 1</p>	2107	1048	1107	1152	1219	1315	1348	1433	1591	1669	1817	2017	2269
				OVERALL DIMENSIONS			SEAT DIMENSIONS			BACK DIMENSIONS						
				W	D	H	W	D	H	W	H					
				24.5	26.5	37	19	20	17-21	22	19					

ENTERPRISE®



model 4560



model 4565

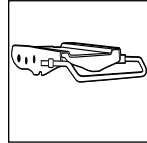

Multi-Depth Mechanism
Seat depth option is available on multi-tilter models. (see notes for more details)







model 4571-3





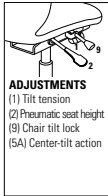

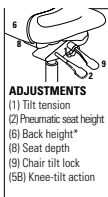

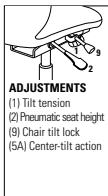

STANDARD FEATURES

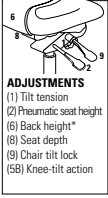



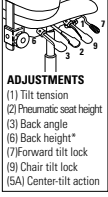

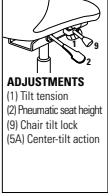

- Gently sculpted seat and back provide lateral and lumbar support.
- Fixed height, impact and scuff resistant curved arms are standard on models 4560, 4561 and 4565. All other models are standard with adjustable height T-arms with teardrop shaped urethane armcaps (TD).
- All models (except armchair) are standard with a five prong, injection molded, fiberglass reinforced nylon Black base with dual wheel carpet casters (C65).
- Arms are available in Black (BK) only.
- Vari-Width (WA) width adjustable arm extensions are standard when chair is ordered with adjustable arms. Allows the arms to move away from the seat by 2" on each side to allow space if desired for broader hip widths.
- Model 4561-SC features a self centering cylinder which swivels and automatically returns to the starting seat location. This model is standard with a flat 5 star base in Black (BK) with C7 glides.
- Check textile availability prior to specifying upholstery material.

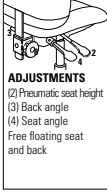

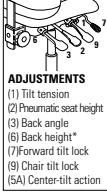
OPTIONAL FEATURES

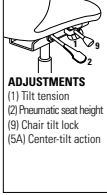
- An optional abrasion resistant outer back fabric (polyester) is available. Resistant to impact damage. Available in Black only (BKB). Add \$21.
- Available with back edge vinyl bumper guard option (VBG). Add \$24.
- Multi-Depth Mechanism a seat depth option available on multi-tilter models 4570-3 and 4571-3. Allows seat to move forward and backward over a 2" range with 5 locking positions to provide a more shallow or deeper seat. Specify "MD". Add \$119.
- For hard surface flooring casters, specify C65R. Add \$66.
- For additional arm/caster options, please refer to the Arm and Caster section. Optional casters may be priced higher than the standard casters for your chair and the difference will be charged. Lower priced optional casters will not be credited.
- For fully assembled in box, specify SU. Add \$70.

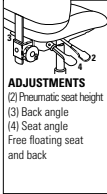
DESCRIPTION	FEATURES	MODEL#	STANDARD TEXTILE GRADES													
			1	2	3	4	5	6	7	8	9	10	11	12		
 <p>HB Tilter w/ Fixed Height Loop Arms COM Yardage: 2 Freight Class: 250 Product Weight (lbs.): 39 Cubic Feet Per Carton: 11.50</p> <p>Ergonomic Features: A, B, C, M, N, S</p>	 <p>ADJUSTMENTS (1) Tilt tension (2) Pneumatic seat height (9) Chair tilt lock (5A) Center-tilt action</p>	4560	642	710	761	841	953	995	1093	1283	1372	1547	1782	2080		
		OVERALL DIMENSIONS			SEAT DIMENSIONS			BACK DIMENSIONS								
		W	D	H	W	D	H	W	H							
	24.5	27	45	20.5	18.5	17-22	20	26								
 <p>HB Knee - Tilter w/ Fixed Height Loop Arms COM Yardage: 2 Freight Class: 250 Product Weight (lbs.): 41 Cubic Feet Per Carton: 13.25</p> <p>Ergonomic Features: A, B, C, J, M, N</p>	 <p>ADJUSTMENTS (1) Tilt tension (2) Pneumatic seat height (6) Back height* (8) Seat depth (9) Chair tilt lock (5B) Knee-tilt action</p>	4560-2	882	951	1005	1084	1200	1241	1340	1533	1626	1806	2046	2345		
		OVERALL DIMENSIONS			SEAT DIMENSIONS			BACK DIMENSIONS								
		W	D	H	W	D	H	W	H							
	24.5	27	45	21	19.5	17-21	21	25								
 <p>LB Tilter w/ Fixed Height Loop Arms COM Yardage: 1.75 Freight Class: 250 Product Weight (lbs.): 36 Cubic Feet Per Carton: 9.75</p> <p>Ergonomic Features: A, B, C, M, N, S</p>	 <p>ADJUSTMENTS (1) Tilt tension (2) Pneumatic seat height (9) Chair tilt lock (5A) Center-tilt action</p>	4561	613	672	719	786	886	922	1008	1172	1252	1404	1612	1870		
		OVERALL DIMENSIONS			SEAT DIMENSIONS			BACK DIMENSIONS								
		W	D	H	W	D	H	W	H							
	24.5	26.5	39	20.5	18.5	17-22	20	21								

DESCRIPTION	FEATURES	MODEL#	STANDARD TEXTILE GRADES											
			1	2	3	4	5	6	7	8	9	10	11	12
 MB Conference Chair w/ Fixed Height Loop Arms COM Yardage: 1.75 Freight Class: 250 Product Weight (lbs.): 36 Cubic Feet Per Carton: 9.75		4561-SC	671	731	779	846	949	984	1072	1242	1321	1477	1689	1952
			OVERALL DIMENSIONS			SEAT DIMENSIONS			BACK DIMENSIONS					
			W	D	H	W	D	H	W	H				
			24.5	26.5	37	21	19.5	18	21	19				
			RTA 1											
 LB Knee - Tilter w/ Fixed Height Loop Arms COM Yardage: 1.75 Freight Class: 250 Product Weight (lbs.): 39 Cubic Feet Per Carton: 11.50	 ADJUSTMENTS (1) Tilt tension (2) Pneumatic seat height (6) Back height* (8) Seat depth (9) Chair tilt lock (5B) Knee-tilt action	4561-2	844	906	953	1025	1128	1161	1249	1415	1496	1650	1864	2125
			OVERALL DIMENSIONS			SEAT DIMENSIONS			BACK DIMENSIONS					
			W	D	H	W	D	H	W	H				
			25	26.5	39	12	19.5	17-21	21	19				
			RTA 1		Ergonomic Features: A, B, C, J, M, N									
 Armchair w/ Fixed Height Loop Arms COM Yardage: 1.75 Freight Class: 250 Product Weight (lbs.): 33 Cubic Feet Per Carton: 10		4565	613	672	719	786	886	922	1008	1172	1252	1404	1612	1870
			OVERALL DIMENSIONS			SEAT DIMENSIONS			BACK DIMENSIONS					
			W	D	H	W	D	H	W	H				
			24.5	26.5	37	19.5	18-19.5	16.5-20.5	18	22.5				
			RTA 2		Ergonomic Features: M, N									
 HB Multi - Tilter w/ Adjustable (TD) Arms COM Yardage: 2 Freight Class: 150 Product Weight (lbs.): 54 Cubic Feet Per Carton: 11	 ADJUSTMENTS (1) Tilt tension (2) Pneumatic seat height (3) Back angle (6) Back height* (7) Forward tilt lock (9) Chair tilt lock (5A) Center-tilt action	4570-3	1175	1242	1295	1375	1487	1532	1626	1816	1906	2081	2316	2613
			OVERALL DIMENSIONS			SEAT DIMENSIONS			BACK DIMENSIONS					
			W	D	H	W	D	H	W	H				
			26.5	26.5	47	22	19	17-21	21.5	26-28				
			RTA 2		Ergonomic Features: A, B, C, D, F, G, H, M, N, Q, S									
 HB Tilter w/ Adjustable (TD) Arms COM Yardage: 2 Freight Class: 150 Product Weight (lbs.): 47 Cubic Feet Per Carton: 11.50	 ADJUSTMENTS (1) Tilt tension (2) Pneumatic seat height (9) Chair tilt lock (5A) Center-tilt action	4570-4	1049	1119	1172	1255	1362	1406	1503	1692	1783	1955	2489	1049
			OVERALL DIMENSIONS			SEAT DIMENSIONS			BACK DIMENSIONS					
			W	D	H	W	D	H	W	H				
			26.5	27	47.5	22	19	17-21	21.5	26-28				
			RTA 2		Ergonomic Features: A, B, C, H, M, N, Q, S									

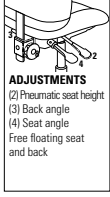
DESCRIPTION	FEATURES	MODEL#	STANDARD TEXTILE GRADES												
			1	2	3	4	5	6	7	8	9	10	11	12	
 <p>HB Operator w/ Adjustable (TD) Arms COM Yardage: 2 Freight Class: 150 Product Weight (lbs.): 46 Cubic Feet Per Carton: 11</p>	 <p>ADJUSTMENTS (2) Pneumatic seat height (3) Back angle (4) Seat angle Free floating seat and back</p>	<p>Ergonomic Features: C, D, F, G, H, M, N, Q</p>	<p>RTA 2</p> 	1158	1226	1278	1357	1470	1514	1609	1798	1891	2063	2302	2593
				OVERALL DIMENSIONS			SEAT DIMENSIONS			BACK DIMENSIONS					
				W	D	H	W	D	H	W	H				
				26.5	26.5	47	22	19.5	17-21	21.5	26-28				
 <p>MB Multi-Tiler w/ Adjustable (TD) Arms COM Yardage: 1.75 Freight Class: 150 Product Weight (lbs.): 52 Cubic Feet Per Carton: 9.50</p>	 <p>ADJUSTMENTS (1) Tilt tension (2) Pneumatic seat height (3) Back angle (6) Back height* (7) Forward tilt lock (9) Chair tilt lock (5A) Center-tilt action</p>	<p>Ergonomic Features: A, B, C, D, F, G, H, M, N, Q, S</p>	<p>RTA 2</p> 	1057	1117	1163	1229	1330	1365	1453	1616	1695	1849	2054	2314
				OVERALL DIMENSIONS			SEAT DIMENSIONS			BACK DIMENSIONS					
				W	D	H	W	D	H	W	H				
				26.5	26	41	22	19	17-21	21.5	20.5-22.5				
 <p>MB Tilter w/ Adjustable (TD) Arms COM Yardage: 1.75 Freight Class: 150 Product Weight (lbs.): 46 Cubic Feet Per Carton: 11.50</p>	 <p>ADJUSTMENTS (1) Tilt tension (2) Pneumatic seat height (9) Chair tilt lock (5A) Center-tilt action</p>	<p>Ergonomic Features: A, B, C, H, M, N, Q, S</p>	<p>RTA 2</p> 	949	1009	1055	1123	1222	1260	1343	1508	1589	1741	1948	2206
				OVERALL DIMENSIONS			SEAT DIMENSIONS			BACK DIMENSIONS					
				W	D	H	W	D	H	W	H				
				26.5	26	41.5	22	19	17-21	21.5	20.5-22.5				
 <p>LB Operator w/ Adjustable (TD) Arms COM Yardage: 1.75 Freight Class: 150 Product Weight (lbs.): 43 Cubic Feet Per Carton: 8.25</p>	 <p>ADJUSTMENTS (2) Pneumatic seat height (3) Back angle (4) Seat angle Free floating seat and back</p>	<p>Ergonomic Features: C, D, F, G, H, M, N, Q</p>	<p>RTA 2</p> 	1030	1091	1135	1205	1305	1341	1426	1592	1670	1822	2030	2287
				OVERALL DIMENSIONS			SEAT DIMENSIONS			BACK DIMENSIONS					
				W	D	H	W	D	H	W	H				
				26.5	25	38	22	19.5	17-21	19	18.5-20.5				

DESCRIPTION	FEATURES	MODEL#	STANDARD TEXTILE GRADES											
			1	2	3	4	5	6	7	8	9	10	11	12
 <p>LB Operator Armless COM Yardage: 1.75 Freight Class: 150 Product Weight (lbs.): 36 Cubic Feet Per Carton: 7</p>	 <p>ADJUSTMENTS (2) Pneumatic seat height (3) Back angle (4) Seat angle Free floating seat and back</p>	4577-5	854	914	960	1027	1127	1164	1248	1415	1493	1646	1852	2112
			OVERALL DIMENSIONS W D H			SEAT DIMENSIONS W D H			BACK DIMENSIONS W H					
			26.5	25.5	40.5	22	19.5	17-21	19	18.5-20.5				
	Ergonomic Features: C, D, F, G, H, M, N	 												

FACTOR



model 5540



model 5541

STANDARD MODEL MECHANISM:

Task Basic Swivel mechanism (-6)

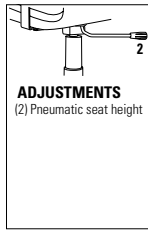

ADJUSTMENTS
(2) Pneumatic seat height

Ergonomic features:
C

MECHANISM OPTIONS:

Tilter mechanism (-4)

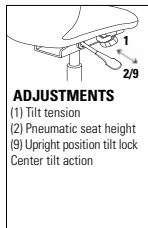

ADJUSTMENTS
(1) Tilt tension
(2) Pneumatic seat height
(9) Upright position tilt lock
Center tilt action

Ergonomic features:
A, B, C, S

Weight sensing Synchro-tilter mechanism (-8)

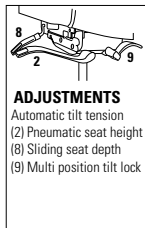

ADJUSTMENTS
Automatic tilt tension
(2) Pneumatic seat height
(8) Sliding seat depth
(9) Multi position tilt lock

Ergonomic features:
A, B, C, E, L

STANDARD FEATURES

- Factor, a value seating series with a full spectrum of mesh colors.
- Adjustable lumbar support is standard on all models. Height adjustable and split down the middle to flex independently side-to-side.
- Standard with (-6) Task Basic Swivel mechanism.
- (U1)** Standard with fixed, forward swept arms. Self-skinned urethane **(SSU)** armcaps will match the selected frame color (Black or Shadow); Cloud frame comes with coordinating Fog armcaps.
- Standard with five prong, injection molded, fiberglass reinforced nylon Black base with (C82) dual wheel carpet casters. Base will match frame color selection; casters coordinate with base color.
- Upholstery options: fabric, vinyl or leather.
- Check textile availability prior to specifying upholstery material.
- Standard Ergonomic features: C, D, M, N, U (see Ergonomic Features & Benefits page).

OPTIONAL FEATURES

- Weight Sensing Synchro-Tilter control mechanism **(-8)** includes side activated sliding seat depth adjustment.
- Optional Tilter mechanism **(-4)** is also available.
- (U2)** Optional height adjustable arms are available. Ergonomic Feature: H
- (U3)** Optional height adjustable arms with sliding armcaps are available. Ergonomic Feature: H,Q
- For additional arms/caster options, please refer to the Arm and Caster section. Optional casters may be priced higher than the standard casters for your chair and the difference will be charged. Lower priced optional casters will not be credited.
- For fully assembled in box, please specify **(SU)**. Add \$70.

Please add option codes in the following order:

- Model number**
5540 High back with arms.
5540NA High back, no arms.
5541 Medium back with arms.
5541NA Medium back, no arms.
5546 Medium task stool with arms (Task Basic Swivel mechanism only).
5546NA Medium task stool, no arms (Task Basic Swivel mechanism only).
- Mesh back** (colors shown on website)
(P-1) Snow **(P-8)** Mocha
(P-2) Sand **(P-9)** Eggplant
(P-3) Pewter **(Q-1)** Buzz Blue
(P-4) Silver Grey **(Q-2)** Poppy
(P-5) Charcoal **(Q-3)** Pumpkin
(P-6) Black **(Q-4)** Lime
- Textile**
Specify textile code for seat.
- Frame color**
(BK) Black. (Standard).
(SH) Shadow. Add \$45 for armless models. Add \$59 for models with arms.
(IC) Cloud. Add \$45 for armless models. Add \$59 for models with arms.
- Arms**
(A-U1) Fixed height arms. (Standard).
(A-U2) Height adjustable arms. Add \$21.
(A-U3) Height adjustable arms w/sliding armcaps. Add \$51
- Base**
(B7) Nylon base. (Color matches frame).
(A7) Polished Aluminum base. Add \$154.
- Mechanism**
(-4) Tilter mechanism. Add \$21.
(-6) Task Basic Swivel mechanism (standard). No upcharge.
(-8) Weight sensing synchro-tilter mechanism w/ standard seat slider. Add \$109.
- Casters**
(C82) Carpet Casters (Standard).
(C82R) Rubber Hard Floor Casters. Add \$87

EXAMPLE FACTOR ORDER CODE:

5541	-P-5	-FU75	-8	-SH	A-U3	-B7	-C82R
------	------	-------	----	-----	------	-----	-------

Model # Mesh Back Textile Mechanism Frame Color Arms Base Casters

DESCRIPTION

FEATURES

MODEL#

STANDARD TEXTILE GRADES



High Back











COM Yardage: 1
Freight Class: 250
Product Weight (lbs.): 37 (armless 31)
Cubic Feet Per Carton: 10.5

MODEL#	STANDARD TEXTILE GRADES											
	1	2	3	4	5	6	7	8	9	10	11	12
5540 With arms	662	707	721	758	808	833	878	953	1009	1073	1199	1337
OVERALL DIMENSIONS				SEAT DIMENSIONS			BACK DIMENSIONS					
W	D	H	W	D	H	W	H					
26.5	24	41.5	20	17.5	16-20	18.5	23					

RTA 1



1 per carton

DESCRIPTION	FEATURES	MODEL#	STANDARD TEXTILE GRADES												
			1	2	3	4	5	6	7	8	9	10	11	12	
 High Back COM Yardage: 1 Freight Class: 250 Product Weight (lbs.): 37 (armless 31) Cubic Feet Per Carton: 10.5			1	2	3	4	5	6	7	8	9	10	11	12	
	5540NA	617	657	676	713	769	788	838	914	970	1034	1166	1311		
	Armless														
	OVERALL DIMENSIONS	W	D	H	SEAT DIMENSIONS	W	D	H	BACK DIMENSIONS	W	H				
		20	24	41.5	20	17.5	16-20	18.5	23						
				RTA 1		1 per carton									
 Medium Back COM Yardage: 1 Freight Class: 250 Product Weight (lbs.): 36 (armless 30) Cubic Feet Per Carton: 10.5			1	2	3	4	5	6	7	8	9	10	11	12	
	5541	624	657	683	720	770	789	833	909	965	1022	1153	1286		
	With arms														
	OVERALL DIMENSIONS	W	D	H	SEAT DIMENSIONS	W	D	H	BACK DIMENSIONS	W	H				
		26.5	24	39	20	17.5	16-20	18.5	20						
				RTA 1		1 per carton									
 Medium Back COM Yardage: 1 Freight Class: 250 Product Weight (lbs.): 36 (armless 30) Cubic Feet Per Carton: 10.5			1	2	3	4	5	6	7	8	9	10	11	12	
	5541NA	579	612	638	675	725	750	795	870	926	990	1121	1259		
	Armless														
	OVERALL DIMENSIONS	W	D	H	SEAT DIMENSIONS	W	D	H	BACK DIMENSIONS	W	H				
		20	24	39	20	17.5	16-20	18.5	20						
				RTA 1		1 per carton									
 Stool COM Yardage: 1 Freight Class: 250 Product Weight (lbs.): 40 (armless 34) Cubic Feet Per Carton: 10.5			1	2	3	4	5	6	7	8	9	10	11	12	
	5546	769	802	828	865	915	940	985	1060	1116	1180	1311	1449		
	With arms														
	OVERALL DIMENSIONS	W	D	H	SEAT DIMENSIONS	W	D	H	BACK DIMENSIONS	W	H				
		26.5	23.5	49	20	17.5	23.75-33.75	18.5	20.5						
				RTA 1		1 per carton									
 Stool COM Yardage: 1 Freight Class: 250 Product Weight (lbs.): 40 (armless 34) Cubic Feet Per Carton: 10.5			1	2	3	4	5	6	7	8	9	10	11	12	
	5546NA	724	764	788	820	883	902	945	1021	1084	1146	1279	1423		
	Armless														
	OVERALL DIMENSIONS	W	D	H	SEAT DIMENSIONS	W	D	H	BACK DIMENSIONS	W	H				
		20	23.5	49	20	17.5	23.75-33.75	18.5	20.5						
				RTA 1		1 per carton									

G1 ERGO SELECT™



model 7331



model 7333

MECHANISM OPTIONS:

Synchro-tilter mechanism (-0)

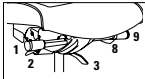

ADJUSTMENTS
 (1) Tilt tension
 (2) Pneumatic seat height/lumbar height
 (3) Back angle adjustment
 (8) Sliding seat depth
 (9) Multi position tilt lock
 Synchro tilt action
 Anti kick back

Ergonomic features:
 A, B, C, D, E, G, H, L, M, N, Q, R, U

Multi-tilter mechanism (-3)

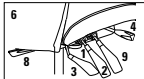

ADJUSTMENTS
 (1) Tilt tension
 (2) Pneumatic seat height
 (3) Back angle
 (4) Seat angle
 (6) Back/lumbar height
 (8) Sliding seat depth
 (9) Infinite position tilt lock
 Center tilt action

Ergonomic features:
 A, B, C, D, E, F, G, H, M, N, Q, R, S, U

Weight sensing synchro-tilter mechanism (-8)

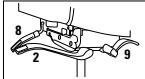

ADJUSTMENTS
 Weight sensing auto tension adjustment
 (2) Pneumatic seat height back/lumbar height
 (8) Sliding seat depth
 (9) Multi position tilt lock

Ergonomic features:
 A, B, C, D, E, H, L, M, N, Q, R, U

Posture task mechanism (-7)

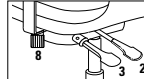

ADJUSTMENTS
 (2) Pneumatic seat height
 (3) Back angle
 Back/lumbar height
 (8) Manual seat depth
 20" diameter Chrome footrest

Ergonomic features:
 C, D, G, H, M, N, Q, R, U, V

STANDARD FEATURES

- G1 Ergo Select was designed to provide exceptional support and comfort throughout the work day.
- Available in three back heights and three seat sizes, varying in depth and width, to fit a person's body type and movements while at work.
- Adjustable lumbar support standard on all models.
- Stitch detail on edges of seat and back is discrete, using matched thread as standard.
- Choice of three mechanisms; synchro-tilter, multi-tilter and weight sensing synchro-tilter. Stool model available with posture task mechanism only.
- Standard with Global's high quality Soft Descent™ pneumatic lift which slowly and gently lowers the seat height of the chair making it easy to obtain the exact seat height you desire.
- Standard with height and width adjustable (G5) arms with sliding armcaps. Armcaps also articulate inwards and outwards to aim toward the keyboard or mouse area.
- G1 Ergo Select is fully compliant with latest BIFMA G1, GSA, and CGSB specifications.
- Five prong, injection molded, fiberglass reinforced nylon Black base with (C82) dual wheel carpet casters.
- Upholstery options: fabric, vinyl or leather.
- Check textile availability prior to specifying upholstery material.

OPTIONAL FEATURES

- Upholstery is available with exaggerated top stitch detail (heavier thread). Fourteen coordinating or contrasting colors may be selected. Please specify.
- Optional Ergo Select arms are height (4") and width adjustable with sliding armcaps. Armcaps also articulate inwards (25°) and outwards (25°) to aim toward the keyboard or mouse area.
- For additional arms/caster options, please refer to the Arm and Caster section (page 394). Optional casters may be priced higher than the standard casters for your chair and the difference will be charged. Lower priced optional casters will not be credited.





Please add option codes in the following order:

- Model number**
7331 Medium back with arms
7332 High back with arms
7333 Extended high back with arms
7336 Medium task stool with arms (posture task mechanism only)
7336NA Medium task stool, armless (posture task mechanism only)
- Textile**
 Specify textile codes for back and seat
- Mechanism (No Upcharge)**
 (-0) Synchro-tilter mechanism
 (-3) Multi-tilter mechanism
 (-8) Weight sensing synchro-tilter mechanism
 (-7) Posture task mechanism (models 7336 / 7336NA only)
- Seat Size**
 (P) Petite seat
 (STAN) Standard seat
 (GS) Generous seat
- Arms**
 (G5) G5 arms **Standard**
 (H1) Ergo Select arms **Add \$83**
 (H2) Ergo Select arms w/wide armcaps **Add \$114**
- Base**
 (B7) Black nylon B7B base **Standard**
 (A7) Polished aluminum B7A base.... **Add \$154**
- Cylinder**
 Please refer to "Cylinder Selection" section of the price book for cylinder options.
- Casters**
 (C82) Dual wheel carpet casters..... **Standard**
 (C82R) Dual wheel hard floor casters **Add \$87**
- Stitch detail**
 (MS) Color matched stitching
 Decorative top stitch **No upcharge**
 (XP) Black (XB) Beige
 (XG) Copen (XA) Graphite
 (XK) Mahogany (XJ) Natural
 (XH) Navy #3 (XD) New Grey
 (XF) Nickel (XN) Off-White
 (XL) Rubytone (XI) Scarlett
 (XC) Smoke (XE) Taupe
 (colors shown on website)

EXAMPLE G1 ERGO SELECT ORDER CODE:

7332	-WA53	-WA53	-8	-STAN	-H1	-B7	-4L	-C82	-MS
Model #	Back fabric	Seat fabric	Mechanism	Seat size	Arms	Base	Cylinder	Casters	Stitch detail

G1 Ergo Select dimensional information: based on measurements with multi-tilter mechanism				
	Distance between arms	Standard arm height	Seat depth range	Standard seat height
Petite seat (P) Soft Descent 4" lift & (H1) arms	15.25" - 20.75" = 5.5" adjustment	7.3" - 11.4"	15.75" - 18.75"	16.5" - 20.5"
Standard seat (STAN) Soft Descent 4" lift & (H1) arms	16" - 21.5" = 5.5" adjustment		16.5" - 19.5"	
Generous seat (GS) Soft Descent 4" lift & (H1) arms	17.25" - 22.75" = 5.5" adjustment		17.25" - 19.5"	

DESCRIPTION	FEATURES	MODEL#	STANDARD TEXTILE GRADES													
			1	2	3	4	5	6	7	8	9	10	11	12		
 <p>Medium Back COM Yardage: 1.65 Freight Class: 125 Product Weight (lbs.): 66 Cubic Feet Per Carton: 10.50</p>	<p>See series notes for mechanism options.</p> <p>* Standard seat</p>	7331	1200	1255	1296	1359	1447	1490	1571	1700	1798	1909	2136	2376		
			OVERALL DIMENSIONS			SEAT DIMENSIONS*			BACK DIMENSIONS							
			W	D	H	W	D	H	W	H						
			24	21.5	41	19.75	16.5-19.5	16.5-20.5	19	22						
			RTA 1			1 per carton										
 <p>High Back COM Yardage: 1.75 Freight Class: 125 Product Weight (lbs.): 68 Cubic Feet Per Carton: 10.50</p>	<p>See series notes for mechanism options.</p> <p>* Standard seat</p>	7332	1266	1325	1367	1436	1530	1576	1661	1799	1906	2021	2265	2524		
			OVERALL DIMENSIONS			SEAT DIMENSIONS*			BACK DIMENSIONS							
			W	D	H	W	D	H	W	H						
			24.5	23	44.5	19.75	16.5-19.5	16.5-20.5	19	24.5						
			RTA 1			1 per carton										
 <p>Extended High Back COM Yardage: 2 Freight Class: 125 Product Weight (lbs.): 70 Cubic Feet Per Carton: 11</p>	<p>See series notes for mechanism options.</p> <p>* Standard seat</p>	7333	1330	1397	1448	1526	1636	1687	1786	1943	2066	2201	2480	2778		
			OVERALL DIMENSIONS			SEAT DIMENSIONS*			BACK DIMENSIONS							
			W	D	H	W	D	H	W	H						
			26	24	50	19.75	16.5-19.5	16.5-20.5	19	27						
			RTA 1			1 per carton										
 <p>Medium Back Stool COM Yardage: 1.65 Freight Class: 150 Product Weight (lbs.): 59 Cubic Feet Per Carton: 10.50</p>	<p>See series notes for mechanism options.</p> <p>* Standard seat</p>	7336	1297	1353	1394	1458	1546	1588	1670	1798	1896	2009	2236	2478		
			7336NA Armless	1200	1258	1298	1363	1453	1495	1577	1707	1808	1919	2149	2395	
		OVERALL DIMENSIONS			SEAT DIMENSIONS*			BACK DIMENSIONS								
		W	D	H	W	D	H	W	H							
24	22.5	46	18.5	16.5	22-30	19	22									
			RTA 1			1 per carton										

G G20

G20



model 6007



Lumbar Support

Automatic lumbar tension mechanism naturally adjusts to your posture while in upright or reclined position. The lumbar is also height adjustable.



Optional Fixed "C" Arm



WORK & TASK

STANDARD FEATURES

- The striped mesh back is composed of an alternating vertical rows of clear elastomeric yarns and polyester yarns. This provides a very responsive back support.
- The inside of the mesh back is Black while the outside of the mesh is Silver to coordinate with the Polished Aluminum trim. Only available in a Black mesh back with Black arms and frame.
- Synchronized mechanism allows the back to smoothly tilt, while the seat gently reclines and slides to the rear. The seat does not lift up and keeps feet planted on floor. Four tilt positions, locks and infinite free float.
- Height adjustable self-skinned urethane (SSU) arms with sliding and pivoting armcaps.
- Independent lumbar adjustment on back (2.5" of height adjustment range on each side).
- Adjustable tilt tension knob located beside the seat. Simply rotate the knob for user preference.
- Side activated sliding seat depth adjustment (**MD**) is standard and provides 2" of adjustment.
- Base and frame are standard in Polished Aluminum with dual wheel carpet casters (**C82**).
- Check textile availability prior to specifying upholstery material.

OPTIONAL FEATURES

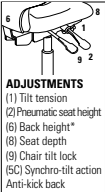
- An optional black nylon base (**B7B**) is available. No upcharge.
- Optional fixed aluminum "C" arms with SSU armcaps (**DF**) are available. No upcharge.
- Please refer to "Cylinder Selection" section of the price book for additional cylinder options.
- For hard surface flooring casters, please specify (**C9R**). Add \$87
- For fully assembled in box, specify **SU**. Add \$70.

DESCRIPTION	FEATURES	MODEL#	STANDARD TEXTILE GRADES																					
			1	2	3	4	5	6	7	8	9	10	11	12										
 <p>Synchro - Tilter COM Yardage: 1 Freight Class: 150 Product Weight (lbs.): 53 Cubic Feet Per Carton: 11</p>	 <p>ADJUSTMENTS (1) Tilt tension (2) Pneumatic seat height (6) Back height* (8) Seat depth (9) Chair tilt lock (5C) Synchro-tilt action Anti-kick back</p>	6007	1636	1671	1698	1736	1790	1809	1856	1948	1993	2076	2193	2335										
		<p>OVERALL DIMENSIONS</p> <table border="1"> <thead> <tr> <th>W</th> <th>D</th> <th>H</th> </tr> </thead> <tbody> <tr> <td>25.5</td> <td>23</td> <td>41.5</td> </tr> </tbody> </table>			W	D	H	25.5	23	41.5	<p>SEAT DIMENSIONS</p> <table border="1"> <thead> <tr> <th>W</th> <th>D</th> <th>H</th> </tr> </thead> <tbody> <tr> <td>19.5</td> <td>18.5</td> <td>17-21</td> </tr> </tbody> </table>			W	D	H	19.5	18.5	17-21	<p>BACK DIMENSIONS</p> <table border="1"> <thead> <tr> <th>W</th> <th>H</th> </tr> </thead> <tbody> <tr> <td>19</td> <td>22</td> </tr> </tbody> </table>			W	H
W	D	H																						
25.5	23	41.5																						
W	D	H																						
19.5	18.5	17-21																						
W	H																							
19	22																							
		<p>RTA 4 </p>																						

Ergonomic Features:
A, B, C, D, E, H, L, M, N, Q, R, U

GLOBAL ACCORD™



model 2670-2



model 2670-2



Polished Aluminum Base
Arched aluminum spider base on all models add a distinctive look to the Global Accord series.



model 2671-4



model 2676-2



model 2670-4PB



STANDARD FEATURES







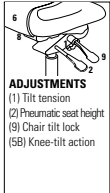

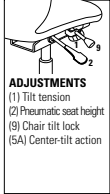
- Global Accord offers an elegant and refined design that features a sling back style that molds to and evenly supports the back and spine.
- Cast aluminum with a mirror finish accent the arms and base.
- Soft touch self-skinned urethane armcaps are available in Black Only.
- All models are standard with a five prong, polished cast aluminum spider base with dual wheel carpet casters (C1).
- Pedestal base models are offered on (-4) Tilter mechanisms only. These models provide fixed location seating for use in auditoriums, classrooms, jury boxes, public venues and more. The base must be mounted to the floor (mounting hardware not included). See Pedestal Base Installation Guide for details.
- Mesh back models are available featuring a breathable mesh sling style back in 24 brilliant Vue colors: Sandy Beach (VU10), Desert Sand (VU11), Orange Sunset (VU12), Chocolate Fountain (VU13), Arctic Blue (VU14), Quarry Grey (VU15), Tidal Wave (VU16), Ivy Moss (VU17), Red Rose (VU18), Coal Black (VU19), White (VU20), Lime (VU21), Chartreuse (VU23), Pool Blue (VU26), Sky (VU28), Primary Blue (VU32), Tangerine (VU34), Paprika (VU37), Grain (VU40), Yellow (VU43), Silver Grey (VU55), Silver (VU63), Hot Pink (VU65) and Red Mittens (VU70). Please specify
- Check textile availability prior to specifying upholstery material.



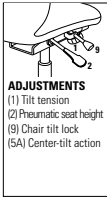

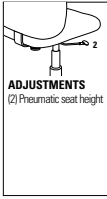

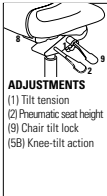

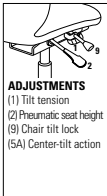

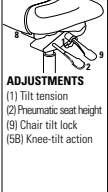
OPTIONAL FEATURES

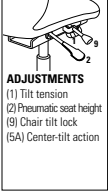

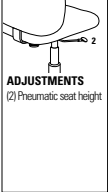

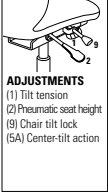
- There are no arm options for the Accord series.
- Optional (B5) black plastic base with aluminum arms combination. No upcharge.
- For hard surface flooring casters, please specify (C9R). Add \$66
- Please refer to the "Casters Selection" section of the price book for caster options. Optional casters may be priced higher than the standard casters for your chair and the difference will be charged. Lower priced optional casters will not be credited.
- Pedestal Base models have Black bases with 2" height adjustable cylinders. Please specify: (SCC) Swivel, auto return to max height. No upcharge. (SN) Non-swivel, auto return to max height. Add \$19. (SC) Swivel, self-centering and return to max height. Add \$30.
- For Memory Foam, specify (MF) and add \$108.
- For fully assembled in box, specify SU. Add \$70.

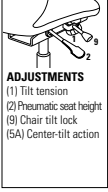

DESCRIPTION	FEATURES	MODEL#	STANDARD TEXTILE GRADES											
			1	2	3	4	5	6	7	8	9	10	11	12
 <p>HB Knee - Tilter COM Yardage: 2 Freight Class: 150 Product Weight (lbs.): 56 Cubic Feet Per Carton: 13</p>	 <p>ADJUSTMENTS (1) Tilt tension (2) Pneumatic seat height (9) Chair tilt lock (5B) Knee-tilt action</p>	<p>2670-2</p>	1469	1533	1584	1659	1781	1826	1920	2108	2199	2374	2610	2906
			OVERALL DIMENSIONS			SEAT DIMENSIONS			BACK DIMENSIONS					
			W	D	H	W	D	H	W	H				
	25	25	44	20	19	18-22	18.5	23						
 <p>HB Tilter COM Yardage: 2 Freight Class: 150 Product Weight (lbs.): 43 Cubic Feet Per Carton: 10.75</p>	 <p>ADJUSTMENTS (1) Tilt tension (2) Pneumatic seat height (9) Chair tilt lock (5A) Center-tilt action</p>	<p>2670-4</p>	1207	1274	1323	1397	1504	1564	1660	1802	1940	2052	2351	2645
			OVERALL DIMENSIONS			SEAT DIMENSIONS			BACK DIMENSIONS					
			W	D	H	W	D	H	W	H				
	25	25	42.5	20	19	17-21	18.5	23						

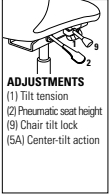
DESCRIPTION	FEATURES	MODEL#	STANDARD TEXTILE GRADES																													
			1	2	3	4	5	6	7	8	9	10	11	12																		
 <p>MB Knee - Tilter COM Yardage: 1.75 Freight Class: 150 Product Weight (lbs.): 50 Cubic Feet Per Carton: 10.75</p>	 <p>ADJUSTMENTS (1) Tilt tension (2) Pneumatic seat height (9) Chair tilt lock (5B) Knee-tilt action</p>	<p>Ergonomic Features: A, B, C, J, M, N, U</p>	<table border="1"> <tr> <td>2671-2</td> <td>1431</td> <td>1495</td> <td>1546</td> <td>1619</td> <td>1724</td> <td>1739</td> <td>1826</td> <td>2024</td> <td>2069</td> <td>2275</td> <td>2429</td> <td>2687</td> </tr> </table>												2671-2	1431	1495	1546	1619	1724	1739	1826	2024	2069	2275	2429	2687					
			2671-2	1431	1495	1546	1619	1724	1739	1826	2024	2069	2275	2429	2687																	
			<table border="1"> <tr> <th colspan="3">OVERALL DIMENSIONS</th> <th colspan="3">SEAT DIMENSIONS</th> <th colspan="2">BACK DIMENSIONS</th> </tr> <tr> <th>W</th> <th>D</th> <th>H</th> <th>W</th> <th>D</th> <th>H</th> <th>W</th> <th>H</th> </tr> <tr> <td>25</td> <td>25</td> <td>38.5</td> <td>20</td> <td>19</td> <td>18-22</td> <td>18.5</td> <td>18</td> </tr> </table>			OVERALL DIMENSIONS			SEAT DIMENSIONS			BACK DIMENSIONS		W	D	H	W	D	H	W	H	25	25	38.5	20	19	18-22	18.5	18	<p>RTA 1 </p>		
			OVERALL DIMENSIONS			SEAT DIMENSIONS			BACK DIMENSIONS																							
W	D	H	W	D	H	W	H																									
25	25	38.5	20	19	18-22	18.5	18																									
 <p>MB Tilter COM Yardage: 1.75 Freight Class: 250 Product Weight (lbs.): 40 Cubic Feet Per Carton: 10.75</p>	 <p>ADJUSTMENTS (1) Tilt tension (2) Pneumatic seat height (9) Chair tilt lock (5A) Center-tilt action</p>	<p>Ergonomic Features: A, B, C, M, N, S, U</p>	<table border="1"> <tr> <td>2671-4</td> <td>1170</td> <td>1234</td> <td>1287</td> <td>1360</td> <td>1467</td> <td>1480</td> <td>1569</td> <td>1765</td> <td>1809</td> <td>2015</td> <td>2169</td> <td>2429</td> </tr> </table>												2671-4	1170	1234	1287	1360	1467	1480	1569	1765	1809	2015	2169	2429					
			2671-4	1170	1234	1287	1360	1467	1480	1569	1765	1809	2015	2169	2429																	
			<table border="1"> <tr> <th colspan="3">OVERALL DIMENSIONS</th> <th colspan="3">SEAT DIMENSIONS</th> <th colspan="2">BACK DIMENSIONS</th> </tr> <tr> <th>W</th> <th>D</th> <th>H</th> <th>W</th> <th>D</th> <th>H</th> <th>W</th> <th>H</th> </tr> <tr> <td>25</td> <td>25</td> <td>37</td> <td>20</td> <td>19</td> <td>17-21</td> <td>18.5</td> <td>18</td> </tr> </table>			OVERALL DIMENSIONS			SEAT DIMENSIONS			BACK DIMENSIONS		W	D	H	W	D	H	W	H	25	25	37	20	19	17-21	18.5	18	<p>RTA 1 </p>		
			OVERALL DIMENSIONS			SEAT DIMENSIONS			BACK DIMENSIONS																							
W	D	H	W	D	H	W	H																									
25	25	37	20	19	17-21	18.5	18																									
 <p>MB Stool COM Yardage: 1.75 Freight Class: 150 Product Weight (lbs.): 48 Cubic Feet Per Carton: 10.75</p>	 <p>ADJUSTMENTS (2) Pneumatic seat height</p>	<p>Ergonomic Features: C, M, N, U</p>	<table border="1"> <tr> <td>2672-6</td> <td>1437</td> <td>1497</td> <td>1538</td> <td>1608</td> <td>1701</td> <td>1732</td> <td>1815</td> <td>1972</td> <td>2047</td> <td>2192</td> <td>2390</td> <td>2637</td> </tr> </table>												2672-6	1437	1497	1538	1608	1701	1732	1815	1972	2047	2192	2390	2637					
			2672-6	1437	1497	1538	1608	1701	1732	1815	1972	2047	2192	2390	2637																	
			<table border="1"> <tr> <th colspan="3">OVERALL DIMENSIONS</th> <th colspan="3">SEAT DIMENSIONS</th> <th colspan="2">BACK DIMENSIONS</th> </tr> <tr> <th>W</th> <th>D</th> <th>H</th> <th>W</th> <th>D</th> <th>H</th> <th>W</th> <th>H</th> </tr> <tr> <td>25</td> <td>26</td> <td>46.5</td> <td>20</td> <td>19</td> <td>22.75-32.75</td> <td>18.5</td> <td>18</td> </tr> </table>			OVERALL DIMENSIONS			SEAT DIMENSIONS			BACK DIMENSIONS		W	D	H	W	D	H	W	H	25	26	46.5	20	19	22.75-32.75	18.5	18	<p>RTA 1 </p>		
			OVERALL DIMENSIONS			SEAT DIMENSIONS			BACK DIMENSIONS																							
W	D	H	W	D	H	W	H																									
25	26	46.5	20	19	22.75-32.75	18.5	18																									
 <p>Mesh HB Knee - Tilter COM Yardage: 1 Freight Class: 150 Product Weight (lbs.): 56 Cubic Feet Per Carton: 13</p>	 <p>ADJUSTMENTS (1) Tilt tension (2) Pneumatic seat height (9) Chair tilt lock (5B) Knee-tilt action</p>	<p>Ergonomic Features: A, B, C, J, M, N, U</p>	<table border="1"> <tr> <td>2676-2</td> <td>1590</td> <td>1624</td> <td>1651</td> <td>1689</td> <td>1742</td> <td>1762</td> <td>1809</td> <td>1901</td> <td>1946</td> <td>2029</td> <td>2145</td> <td>2288</td> </tr> </table>												2676-2	1590	1624	1651	1689	1742	1762	1809	1901	1946	2029	2145	2288					
			2676-2	1590	1624	1651	1689	1742	1762	1809	1901	1946	2029	2145	2288																	
			<table border="1"> <tr> <th colspan="3">OVERALL DIMENSIONS</th> <th colspan="3">SEAT DIMENSIONS</th> <th colspan="2">BACK DIMENSIONS</th> </tr> <tr> <th>W</th> <th>D</th> <th>H</th> <th>W</th> <th>D</th> <th>H</th> <th>W</th> <th>H</th> </tr> <tr> <td>25</td> <td>25</td> <td>44</td> <td>20</td> <td>19</td> <td>18-22</td> <td>18.5</td> <td>23</td> </tr> </table>			OVERALL DIMENSIONS			SEAT DIMENSIONS			BACK DIMENSIONS		W	D	H	W	D	H	W	H	25	25	44	20	19	18-22	18.5	23	<p>RTA 1 </p>		
			OVERALL DIMENSIONS			SEAT DIMENSIONS			BACK DIMENSIONS																							
W	D	H	W	D	H	W	H																									
25	25	44	20	19	18-22	18.5	23																									
 <p>Mesh HB Tilter COM Yardage: 1 Freight Class: 150 Product Weight (lbs.): 43 Cubic Feet Per Carton: 10.75</p>	 <p>ADJUSTMENTS (1) Tilt tension (2) Pneumatic seat height (9) Chair tilt lock (5A) Center-tilt action</p>	<p>Ergonomic Features: A, B, C, M, N, S, U</p>	<table border="1"> <tr> <td>2676-4</td> <td>1329</td> <td>1364</td> <td>1391</td> <td>1428</td> <td>1483</td> <td>1502</td> <td>1549</td> <td>1641</td> <td>1686</td> <td>1769</td> <td>1886</td> <td>2028</td> </tr> </table>												2676-4	1329	1364	1391	1428	1483	1502	1549	1641	1686	1769	1886	2028					
			2676-4	1329	1364	1391	1428	1483	1502	1549	1641	1686	1769	1886	2028																	
			<table border="1"> <tr> <th colspan="3">OVERALL DIMENSIONS</th> <th colspan="3">SEAT DIMENSIONS</th> <th colspan="2">BACK DIMENSIONS</th> </tr> <tr> <th>W</th> <th>D</th> <th>H</th> <th>W</th> <th>D</th> <th>H</th> <th>W</th> <th>H</th> </tr> <tr> <td>25</td> <td>25</td> <td>42.5</td> <td>20</td> <td>19</td> <td>17-21</td> <td>18.5</td> <td>23</td> </tr> </table>			OVERALL DIMENSIONS			SEAT DIMENSIONS			BACK DIMENSIONS		W	D	H	W	D	H	W	H	25	25	42.5	20	19	17-21	18.5	23	<p>RTA 1 </p>		
			OVERALL DIMENSIONS			SEAT DIMENSIONS			BACK DIMENSIONS																							
W	D	H	W	D	H	W	H																									
25	25	42.5	20	19	17-21	18.5	23																									

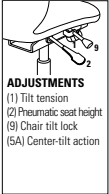
DESCRIPTION	FEATURES	MODEL#	STANDARD TEXTILE GRADES													
			1	2	3	4	5	6	7	8	9	10	11	12		
 <p>Mesh MB Knee - Tilter COM Yardage: 1 Freight Class: 150 Product Weight (lbs.): 50 Cubic Feet Per Carton: 10.75</p>	 <p>ADJUSTMENTS (1) Tilt tension (2) Pneumatic seat height (9) Chair tilt lock (5B) Knee-tilt action</p>	2677-2	1539	1573	1599	1637	1691	1711	1758	1850	1895	1978	2094	2237		
			OVERALL DIMENSIONS			SEAT DIMENSIONS			BACK DIMENSIONS							
			W	D	H	W	D	H	W	H						
			25	25	38.5	20	19	18-22	18.5	18						
			RTA 1													
 <p>Mesh MB Tilter COM Yardage: 1 Freight Class: 250 Product Weight (lbs.): 40 Cubic Feet Per Carton: 10.75</p>	 <p>ADJUSTMENTS (1) Tilt tension (2) Pneumatic seat height (9) Chair tilt lock (5A) Center-tilt action</p>	2677-4	1277	1312	1338	1375	1431	1450	1497	1589	1634	1716	1832	1976		
			OVERALL DIMENSIONS			SEAT DIMENSIONS			BACK DIMENSIONS							
			W	D	H	W	D	H	W	H						
			25	25	37	20	19	17-21	18.5	18						
			RTA 1													
 <p>Mesh MB Stool COM Yardage: 1 Freight Class: 150 Product Weight (lbs.): 48 Cubic Feet Per Carton: 10.75</p>	 <p>ADJUSTMENTS (2) Pneumatic seat height</p>	2678-6	1528	1563	1589	1626	1680	1701	1748	1840	1885	1967	2083	2227		
			OVERALL DIMENSIONS			SEAT DIMENSIONS			BACK DIMENSIONS							
			W	D	H	W	D	H	W	H						
			25	26	47	20	19	23.5-33.5	18.5	18						
			RTA 1													
 <p>HB Tilter with Pedestal Base COM Yardage: Empty Field! Freight Class: Empty Field! Product Weight (lbs.): Empty Field! Cubic Feet Per Carton: Empty Field!</p>	 <p>ADJUSTMENTS (1) Tilt tension (2) Pneumatic seat height (9) Chair tilt lock (5A) Center-tilt action</p>	2670-4PB	1422	1491	1544	1624	1737	1790	1892	2056	2183	2321	2609	2915		
			OVERALL DIMENSIONS			SEAT DIMENSIONS			BACK DIMENSIONS							
			W	D	H	W	D	H	W	H						
			SC	1452	Empty Field!	20	19	16.5-18.5	18.5	23						
			RTA 1													
 <p>MB Tilter with Pedestal Base COM Yardage: Empty Field! Freight Class: Empty Field! Product Weight (lbs.): Empty Field! Cubic Feet Per Carton: Empty Field!</p>	 <p>ADJUSTMENTS (1) Tilt tension (2) Pneumatic seat height (9) Chair tilt lock (5A) Center-tilt action</p>	2671-4PB	1384	1443	1498	1582	1700	1757	1797	1939	2050	2172	2424	2691		
			OVERALL DIMENSIONS			SEAT DIMENSIONS			BACK DIMENSIONS							
			W	D	H	W	D	H	W	H						
			SC	1414	Empty Field!	20	19	16.5-18.5	18.5	18						
			RTA 1													

DESCRIPTION	FEATURES	MODEL#	STANDARD TEXTILE GRADES													
			1	2	3	4	5	6	7	8	9	10	11	12		
 <p>Mesh HB Tilter with Pedestal Base COM Yardage: Empty Field! Freight Class: Empty Field! Product Weight (lbs.): Empty Field! Cubic Feet Per Carton: Empty Field!</p>	 <p>ADJUSTMENTS (1) Tilt tension (2) Pneumatic seat height (9) Chair tilt lock (5A) Center-tilt action</p>	2676-4PB	1543	1580	1606	1644	1702	1729	1780	1860	1924	1993	2137	2289		
			OVERALL DIMENSIONS			SEAT DIMENSIONS			BACK DIMENSIONS							
			W	D	H	W	D	H	W	H						
			SC	1573	Empty Field!	20	19	16.5-18.5	18.5	23						
			RTA 1													
 <p>Mesh MB Tilter with Pedestal Base COM Yardage: Empty Field! Freight Class: Empty Field! Product Weight (lbs.): Empty Field! Cubic Feet Per Carton: Empty Field!</p>	 <p>ADJUSTMENTS (1) Tilt tension (2) Pneumatic seat height (9) Chair tilt lock (5A) Center-tilt action</p>	2677-4PB	1491	1526	1553	1592	1649	1675	1727	1808	1872	1940	2085	2237		
			OVERALL DIMENSIONS			SEAT DIMENSIONS			BACK DIMENSIONS							
			W	D	H	W	D	H	W	H						
			SC	1521	Empty Field!	20	19	16-18.5	18.5	18						
			RTA 1													

GOAL™



model 2237-3



model 2239-6

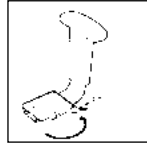

Vari-Width Adapter Plate (WA)

Available when chair is ordered with adjustable height arms.

STANDARD FEATURES

- Designed with substantial upholstery and cushioning treatment.
- Standard with adjustable height T-arms with curved urethane armcaps (3N) in Black only.
- All models are standard with a five-legged, injection molded "spider" base and C65 casters
- Base and frame available in Black (BK) only.
- Vari-Width Adapter Plate (WA) allows each arm to move outward an additional 2". Add \$80. Also height adjustable.
- Check textile availability prior to specifying upholstery material.

- Please refer to the "Casters Selection" section of the price book for caster options. Optional casters may be priced higher than the standard casters for your chair and the difference will be charged. Lower priced optional casters will not be credited.
- For hard surface flooring casters, specify C65R. Add \$66.
- For fully assembled in box, please specify SU. Add \$70.

OPTIONAL FEATURES

- Please refer to "Arms Selection" section of the price book for arm options.
- An optional abrasion resistant outer back fabric (polyester) is available. Resistant to impact damage. Available in Black only (BKB). Add \$21.
- Available with back edge vinyl bumper guard option (VBG). Add \$21.

DESCRIPTION	FEATURES	MODEL#	STANDARD TEXTILE GRADES											
			1	2	3	4	5	6	7	8	9	10	11	12



LB Multi - Tilter
COM Yardage: 1.50
Freight Class: 150
Product Weight (lbs.): 53
Cubic Feet Per Carton: 9.25

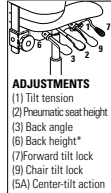

ADJUSTMENTS
(1) Tilt tension
(2) Pneumatic seat height
(3) Back angle
(6) Back height*
(7) Forward tilt lock
(9) Chair tilt lock
(SA) Center-tilt action

Ergonomic Features:
A, B, C, D, F, G, H, N, S

2237-3	709	758	800	859	943	974	1048	1191	1258	1387	1564	1786
--------	-----	-----	-----	-----	-----	-----	------	------	------	------	------	------

OVERALL DIMENSIONS			SEAT DIMENSIONS			BACK DIMENSIONS	
W	D	H	W	D	H	W	H
25	22.5	36	20	17	16.5-20.5	18.5	18-21

RTA 2



LB Tilter
COM Yardage: 1.50
Freight Class: 150
Product Weight (lbs.): 43
Cubic Feet Per Carton: 9.25

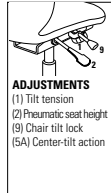

ADJUSTMENTS
(1) Tilt tension
(2) Pneumatic seat height
(9) Chair tilt lock
(SA) Center-tilt action

Ergonomic Features:
A, B, C, H, N, S

2237-4	613	663	705	763	847	877	952	1095	1160	1290	1467	1689
--------	-----	-----	-----	-----	-----	-----	-----	------	------	------	------	------

OVERALL DIMENSIONS			SEAT DIMENSIONS			BACK DIMENSIONS	
W	D	H	W	D	H	W	H
25	25	36.5	20	17	15.5-20.5	18.5	19

RTA 2



LB Operator w/ Arms
COM Yardage: 1.50
Freight Class: 125
Product Weight (lbs.): 44
Cubic Feet Per Carton: 6.25

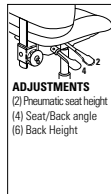











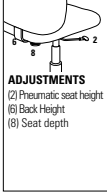



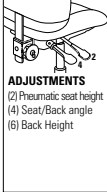

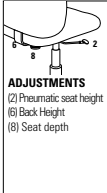

ADJUSTMENTS
(2) Pneumatic seat height
(4) Seat/Back angle
(6) Back Height

Ergonomic Features:
C, D, F, G, H, N

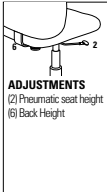
2237-5	558	611	650	710	793	822	897	1040	1107	1235	1413	1635
--------	-----	-----	-----	-----	-----	-----	-----	------	------	------	------	------

OVERALL DIMENSIONS			SEAT DIMENSIONS			BACK DIMENSIONS	
W	D	H	W	D	H	W	H
25	22.5	36	20	17	15.5-20.5	18.5	18-21

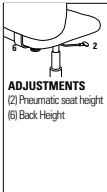
RTA 2

DESCRIPTION	FEATURES	MODEL#	STANDARD TEXTILE GRADES													
			1	2	3	4	5	6	7	8	9	10	11	12		
 <p>LB Task w/ Arms COM Yardage: 1.50 Freight Class: 125 Product Weight (lbs.): 36 Cubic Feet Per Carton: 5.75</p>	 <p>ADJUSTMENTS (2) Pneumatic seat height (6) Back Height (8) Seat depth</p>	2237-6	465	518	559	617	702	728	805	947	1014	1143	1321	1546		
			OVERALL DIMENSIONS			SEAT DIMENSIONS			BACK DIMENSIONS							
			W	D	H	W	D	H	W	H						
			25	24.5	39	20	17-18.5	15.5-20.5	18.5	20.5-22						
<p>Ergonomic Features: C, D, E, H, N</p>	 															
		 <p>LB Operator Armless COM Yardage: 1.50 Freight Class: 125 Product Weight (lbs.): 30 Cubic Feet Per Carton: 4.90</p>	 <p>ADJUSTMENTS (2) Pneumatic seat height (4) Seat/Back angle (6) Back Height</p>	2239-5	465	518	559	617	702	728	805	947	1014	1143	1321	1546
					OVERALL DIMENSIONS			SEAT DIMENSIONS			BACK DIMENSIONS					
					W	D	H	W	D	H	W	H				
20.5	22.5				36	20	17	15.5-20.5	18.5	18-21						
<p>Ergonomic Features: C, D, F, G, H, N</p>	 															
		 <p>LB Task Armless COM Yardage: 1.50 Freight Class: 125 Product Weight (lbs.): 30 Cubic Feet Per Carton: 4.90</p>	 <p>ADJUSTMENTS (2) Pneumatic seat height (6) Back Height (8) Seat depth</p>	2239-6	359	410	451	509	594	624	699	841	905	1037	1214	1436
					OVERALL DIMENSIONS			SEAT DIMENSIONS			BACK DIMENSIONS					
					W	D	H	W	D	H	W	H				
20.5	24.5				39	20	17-18.5	15.5-20.5	18.5	20.5-22						
<p>Ergonomic Features: C, D, E, N</p>	 															
		 <p>Drafting Task Chair w/ Arms COM Yardage: 1.50 Freight Class: 125 Product Weight (lbs.): 44 Cubic Feet Per Carton: 6.75</p>	 <p>ADJUSTMENTS (2) Pneumatic seat height (6) Back Height</p>	2235-6	604	657	699	756	841	872	945	1088	1155	1284	1460	1685
					OVERALL DIMENSIONS			SEAT DIMENSIONS			BACK DIMENSIONS					
					W	D	H	W	D	H	W	H				
25	24.5				48	20	17	23.5-33.5	18.5	20.5-22						
<p>Ergonomic Features: C, D, H, N</p>	 															
		 <p>Drafting Task Chair Armless COM Yardage: 1.50 Freight Class: 150 Product Weight (lbs.): 36 Cubic Feet Per Carton: 6.75</p>	 <p>ADJUSTMENTS (2) Pneumatic seat height (6) Back Height</p>	2236-6	532	583	623	683	766	796	871	1011	1077	1208	1387	1611
					OVERALL DIMENSIONS			SEAT DIMENSIONS			BACK DIMENSIONS					
					W	D	H	W	D	H	W	H				
20.5	24.5				48	20	17	23.5-33.5	18.5	20.5-22						
<p>Ergonomic Features: C, D, H, N</p>	 															

GRAHAM™



model 3144 (3N)

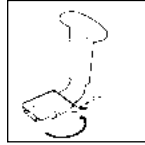

Vari-Width Adapter Plate (WA)
Available when chair is ordered with adjustable height arms.

STANDARD FEATURES

- Features a multi-curved backrest with an impact resistant outer back shell.
- Standard with adjustable height T-arms with curved urethane armcaps (3N) in Black Only.
- All models are standard with a five-legged, injection molded "spider" base and C10 casters
- Base and frame available in Black (BK) Only.
- Check textile availability prior to specifying upholstery material.
- Vari-Width Adapter Plate (WA) allows each arm to move outward an additional 2". Specify "WA". Add \$80 also height adjustable.

OPTIONAL FEATURES

- Please refer to "Arms Selection" section of the price book for arm options.
- An optional abrasion resistant outer back fabric (polyester) is available. Resistant to impact damage. Available in Black only (BKB). Add \$21.
- Please refer to the "Casters Selection" section of the price book for caster options. Optional casters may be priced higher than the standard casters for your chair and the difference will be charged. Lower priced optional casters will not be credited.
- For hard surface flooring casters, specify C10R. Add \$60.
- For fully assembled in box, please specify SU. Add \$70.

DESCRIPTION	FEATURES	MODEL#	STANDARD TEXTILE GRADES													
			1	2	3	4	5	6	7	8	9	10	11	12		
 <p>LB Ergo - Tilter COM Yardage: 1.50 Freight Class: 150 Product Weight (lbs.): 50 Cubic Feet Per Carton: 9.25</p>	<p>ADJUSTMENTS</p> <ul style="list-style-type: none"> (1) Tilt tension (2) Pneumatic seat height (3) Back angle (6) Back height* (9) Chair tilt lock (5A) Center-tilt action 	3144	708	757	798	858	941	973	1047	1190	1255	1384	1563	1785		
		OVERALL DIMENSIONS			SEAT DIMENSIONS			BACK DIMENSIONS								
		W	D	H	W	D	H	W	H							
25	26	37.5	20	19.5	17-21	19.5	17.5-20									
		Ergonomic Features: A, B, C, D, G, H, M, N, S		RTA 2		ups										

GRANADA®



model 3212 (3N)



model 3212 (3N)

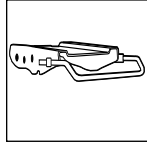

Multi-Depth Mechanism
Seat depth option is available on multi-tilter models. (see notes for more details)



model 3217









model 3121



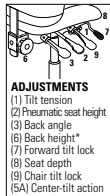

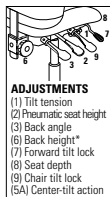

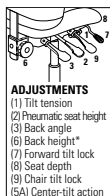

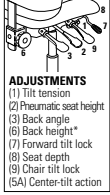

STANDARD FEATURES

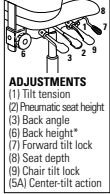



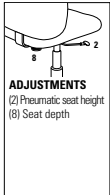

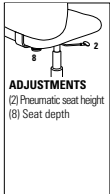

- Features a sculpted back with pronounced lumbar support.
- Standard with adjustable height T-arms with curved urethane armcaps (3N) in Black Only.(except for model 3262 which has a fixed height version of this same arm style.)
- Standard when chair is ordered with adjustable height arms (AA, O, OJ, SB, TD, UB, ZH, ZT, 3M, 3N, 4J, 4M, 4T, 6L, 9B and 9S). Allows each arm to move outward an additional 2" (for a total of 4" extra seat width) and locks with the use of an easy to maneuver lever.
- All models (except armchair and side chair styles) are standard with a five-legged, injection molded base.
- Base and frame are available in Black (BK) Only.
- All models (except high back, side chair, armchair and drafting models) are shipped partially KD.
- Drafting chairs are equipped with height adjustable chrome foot ring.
- C65 casters are standard except for heavy duty models.
- Check textile availability prior to specifying upholstery material.



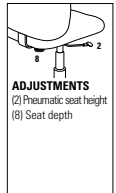

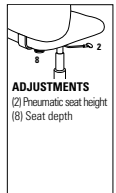

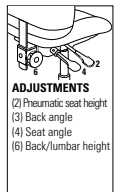

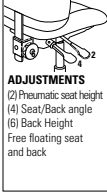

OPTIONAL FEATURES

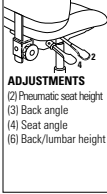

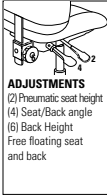
- Available with back edge vinyl bumper guard option (VBG). Add \$24.
- Please refer to "Arms Selection" section of the price book for arm options.
- An optional abrasion resistant outer back fabric (polyester) is available. Resistant to impact damage. Available in Black only (BKB). Add \$21
- For hard surface flooring please specify C10R. Add \$109.
- Please refer to the "Casters Selection" section of the price book for caster options. Optional casters may be priced higher than the standard casters for your chair and the difference will be charged. Lower priced optional casters will not be credited.
- For fully assembled in box, specify SU. Add \$70.

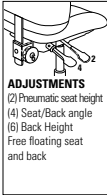
DESCRIPTION	FEATURES	MODEL#	STANDARD TEXTILE GRADES											
			1	2	3	4	5	6	7	8	9	10	11	12
 <p>LB Multi - Tilter Plain Back Ratchet Back COM Yardage: 1.50 Freight Class: 150 Product Weight (lbs.): 52 Cubic Feet Per Carton: 9.25</p> <p>Ergonomic Features: A, B, C, D, E, F, G, M, N, S</p>	 <p>ADJUSTMENTS (1) Tilt tension (2) Pneumatic seat height (3) Back angle (6) Back height* (7) Forward tilt lock (8) Seat depth (9) Chair tilt lock (5A) Center-tilt action</p>	3121	1297	1348	1388	1444	1526	1555	1627	1764	1830	1958	2129	2345
		OVERALL DIMENSIONS			SEAT DIMENSIONS			BACK DIMENSIONS						
		W	D	H	W	D	H	W	H					
		26	24.5	40	20.5	16.5	17-21	19	17.5-20.5					
			RTA 2											
 <p>HB Multi - Tilter Plain Back Ratchet Back COM Yardage: 1.75 Freight Class: 150 Product Weight (lbs.): 55 Cubic Feet Per Carton: 9.25</p> <p>Ergonomic Features: A, B, C, D, E, F, G, H, M, N, Q, S</p>	 <p>ADJUSTMENTS (1) Tilt tension (2) Pneumatic seat height (3) Back angle (6) Back height* (7) Forward tilt lock (8) Seat depth (9) Chair tilt lock (5A) Center-tilt action</p>	3123	1431	1501	1554	1646	1764	1784	1881	2117	2161	2397	2572	2866
		OVERALL DIMENSIONS			SEAT DIMENSIONS			BACK DIMENSIONS						
		W	D	H	W	D	H	W	H					
		26	24.5	43	20.5	17-19.5	17-21	19	22-25					
			RTA 2											
 <p>LB Multi - Tilter Detailed/Styled Back COM Yardage: 1.50 Freight Class: 150 Product Weight (lbs.): 52 Cubic Feet Per Carton: 9.25</p> <p>Ergonomic Features: A, B, C, D, E, F, G, M, N, S</p>	 <p>ADJUSTMENTS (1) Tilt tension (2) Pneumatic seat height (3) Back angle (6) Back height* (7) Forward tilt lock (8) Seat depth (9) Chair tilt lock (5A) Center-tilt action</p>	3202	1071	1124	1163	1225	1307	1338	1412	1553	1620	1750	1926	2150
		OVERALL DIMENSIONS			SEAT DIMENSIONS			BACK DIMENSIONS						
		W	D	H	W	D	H	W	H					
		26	22.5	40	19	16.5	18-22	18.5	21					
			RTA 2											

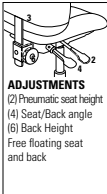
DESCRIPTION	FEATURES	MODEL#	STANDARD TEXTILE GRADES												
			1	2	3	4	5	6	7	8	9	10	11	12	
 <p>LB Multi - Tilter Plain Back COM Yardage: 1.50 Freight Class: 125 Product Weight (lbs.): 58 Cubic Feet Per Carton: 9.25</p>	 <p>ADJUSTMENTS (1) Tilt tension (2) Pneumatic seat height (3) Back angle (6) Back height* (7) Forward tilt lock (8) Seat depth (9) Chair tilt lock (5A) Center-tilt action</p>	<p>Ergonomic Features: A, B, C, D, E, F, G, H, M, N, Q, S</p>	3212	949	1002	1041	1101	1186	1219	1289	1433	1498	1626	1803	2026
			OVERALL DIMENSIONS			SEAT DIMENSIONS			BACK DIMENSIONS						
			W	D	H	W	D	H	W		H				
			26	24	40	19	16.5	18-22	18.5		21				
			RTA 2												
 <p>HB Multi - Tilter Plain Back COM Yardage: 1.75 Freight Class: 150 Product Weight (lbs.): 57 Cubic Feet Per Carton: 10.50</p>	 <p>ADJUSTMENTS (1) Tilt tension (2) Pneumatic seat height (3) Back angle (6) Back height* (7) Forward tilt lock (8) Seat depth (9) Chair tilt lock (5A) Center-tilt action</p>	<p>Ergonomic Features: A, B, C, D, E, F, G, H, M, N, Q, S</p>	3217	1067	1128	1172	1242	1340	1375	1461	1626	1706	1859	2066	2323
			OVERALL DIMENSIONS			SEAT DIMENSIONS			BACK DIMENSIONS						
			W	D	H	W	D	H	W		H				
			26	24.5	43	19	17.5	18-22	18.5		26				
			RTA 2												
 <p>Side Chair Plain Back COM Yardage: 1.50 Freight Class: 300 Product Weight (lbs.): 32 Cubic Feet Per Carton: 17.25</p>		<p>Ergonomic Features: M, N</p>	3253	764	817	858	918	1001	1032	1107	1248	1316	1443	1623	1843
			OVERALL DIMENSIONS			SEAT DIMENSIONS			BACK DIMENSIONS						
			W	D	H	W	D	H	W		H				
			20.5	23.5	37.5	19	16.5	19	18.5		21				
			RTA 00												
 <p>LB Task Armless/Plain Back COM Yardage: 1.50 Freight Class: 250 Product Weight (lbs.): 32 Cubic Feet Per Carton: 9.25</p>	 <p>ADJUSTMENTS (2) Pneumatic seat height (8) Seat depth</p>	<p>Ergonomic Features: C, E, M, N</p>	3254	613	663	705	763	847	877	952	1095	1160	1290	1467	1689
			OVERALL DIMENSIONS			SEAT DIMENSIONS			BACK DIMENSIONS						
			W	D	H	W	D	H	W		H				
			21	24	38	19	16.5	17-22	18.5		21				
			RTA 1												
 <p>LB Task w/Arm/Plain Back COM Yardage: 1.50 Freight Class: 150 Product Weight (lbs.): 40 Cubic Feet Per Carton: 9.25</p>	 <p>ADJUSTMENTS (2) Pneumatic seat height (8) Seat depth</p>	<p>Ergonomic Features: C, E, H, M, N, Q</p>	3255	773	822	863	923	1008	1037	1111	1255	1320	1450	1626	1849
			OVERALL DIMENSIONS			SEAT DIMENSIONS			BACK DIMENSIONS						
			W	D	H	W	D	H	W		H				
			26	24	38	19	16.5	17-22	18.5		21				
			RTA 1												

DESCRIPTION	FEATURES	MODEL#	STANDARD TEXTILE GRADES											
			1	2	3	4	5	6	7	8	9	10	11	12
 Armchair Detailed/Styled Back COM Yardage: 1.50 Freight Class: 250 Product Weight (lbs.): 40 Cubic Feet Per Carton: 17	Ergonomic Features: M, N	3262	1004	1053	1096	1155	1237	1267	1343	1486	1550	1681	1860	2081
			OVERALL DIMENSIONS			SEAT DIMENSIONS			BACK DIMENSIONS					
			W	D	H	W	D	H	W	H				
			26	23.5	37.5	19	16.5	19	18.5	21				
			RTA 00											
 Side Chair Detailed/Styled Back COM Yardage: 1.50 Freight Class: 300 Product Weight (lbs.): 32 Cubic Feet Per Carton: 17.25	Ergonomic Features: M, N	3263	814	864	905	965	1049	1077	1154	1296	1361	1491	1669	1891
			OVERALL DIMENSIONS			SEAT DIMENSIONS			BACK DIMENSIONS					
			W	D	H	W	D	H	W	H				
			20.5	23.5	37.5	19	16.5	19	18.5	21				
			RTA 00											
 LB Task Armless/Detailed/Styled Back COM Yardage: 1.50 Freight Class: 250 Product Weight (lbs.): 32 Cubic Feet Per Carton: 9.25	 ADJUSTMENTS (2) Pneumatic seat height (8) Seat depth	3264	649	702	744	800	885	916	990	1132	1198	1326	1505	1728
			OVERALL DIMENSIONS			SEAT DIMENSIONS			BACK DIMENSIONS					
			W	D	H	W	D	H	W	H				
			21	23.5	39	19	16.5	17-22	18.5	21				
			RTA 2											
 LB Task w/Arm/Detailed/Styled Back COM Yardage: 1.50 Freight Class: 150 Product Weight (lbs.): 40 Cubic Feet Per Carton: 9.25	 ADJUSTMENTS (2) Pneumatic seat height (8) Seat depth	3265	814	864	905	965	1049	1077	1154	1296	1361	1491	1669	1891
			OVERALL DIMENSIONS			SEAT DIMENSIONS			BACK DIMENSIONS					
			W	D	H	W	D	H	W	H				
			26	23.5	39	19	16.5	17-22	18.5	21				
			RTA 2 											
 LB Operator w/Arm/Plain Back COM Yardage: 1.50 Freight Class: 150 Product Weight (lbs.): 46 Cubic Feet Per Carton: 9.25	 ADJUSTMENTS (2) Pneumatic seat height (3) Back angle (4) Seat angle (6) Back/Lumbar height	3275	920	973	1011	1071	1156	1187	1260	1403	1467	1596	1775	1997
			OVERALL DIMENSIONS			SEAT DIMENSIONS			BACK DIMENSIONS					
			W	D	H	W	D	H	W	H				
			26	22.5	39	19	16.5	17-22	18.5	21				
			RTA 2 											

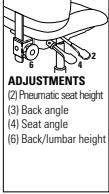
DESCRIPTION	FEATURES	MODEL#	STANDARD TEXTILE GRADES												
			1	2	3	4	5	6	7	8	9	10	11	12	
 <p>Drafting Chair Armless/Detailed/Styled Back COM Yardage: 1.50 Freight Class: 150 Product Weight (lbs.): 43 Cubic Feet Per Carton: 9.25</p>	 <p>ADJUSTMENTS (2) Pneumatic seat height (4) Seat/Back angle (6) Back Height Free floating seat and back</p>	<p>Ergonomic Features: C, D, F, G, H, M, N</p>	3277	1338	1391	1432	1489	1574	1606	1679	1821	1887	2016	2194	2415
			OVERALL DIMENSIONS			SEAT DIMENSIONS			BACK DIMENSIONS						
			W	D	H	W	D	H	W	H					
	21	22.5	48	19	16.5	24-34	18.5	21							
 <p>Drafting Stool Armless/Plain Back COM Yardage: 1.50 Freight Class: 150 Product Weight (lbs.): 43 Cubic Feet Per Carton: 9.25</p>	 <p>ADJUSTMENTS (2) Pneumatic seat height (3) Back angle (4) Seat angle (6) Back/lumbar height</p>	<p>Ergonomic Features: C, D, F, G, H, M, N</p>	3278	1286	1337	1377	1437	1521	1550	1625	1765	1833	1963	2140	2367
			OVERALL DIMENSIONS			SEAT DIMENSIONS			BACK DIMENSIONS						
			W	D	H	W	D	H	W	H					
	21	23.5	48	19	16.5	24-34	18.5	21							
				RTA 2											
 <p>LB Operator Armless Detailed/Styled Back COM Yardage: 1.50 Freight Class: 150 Product Weight (lbs.): 40 Cubic Feet Per Carton: 9.25</p>	 <p>ADJUSTMENTS (2) Pneumatic seat height (4) Seat/Back angle (6) Back Height Free floating seat and back</p>	<p>Ergonomic Features: C, D, F, G, M, N</p>	3284	798	853	890	949	1034	1066	1139	1282	1347	1477	1654	1877
			OVERALL DIMENSIONS			SEAT DIMENSIONS			BACK DIMENSIONS						
			W	D	H	W	D	H	W	H					
	21	22.5	39	20.5	16.5	17-22	19	21							
				RTA 2											
 <p>LB Operator w/Arms/Detailed/Styled Back COM Yardage: 1.50 Freight Class: 150 Product Weight (lbs.): 46 Cubic Feet Per Carton: 9.25</p>	 <p>ADJUSTMENTS (2) Pneumatic seat height (4) Seat/Back angle (6) Back Height Free floating seat and back</p>	<p>Ergonomic Features: C, D, F, G, H, M, N, Q</p>	3285	959	1010	1050	1110	1194	1226	1298	1441	1508	1638	1815	2040
			OVERALL DIMENSIONS			SEAT DIMENSIONS			BACK DIMENSIONS						
			W	D	H	W	D	H	W	H					
	26	22.5	39	19	16.5	17-22	18.5	21							
				RTA 2											
 <p>Drafting Stool w/Arms/Detailed/Styled Back COM Yardage: 1.50 Freight Class: 150 Product Weight (lbs.): 51 Cubic Feet Per Carton: 9.25</p>	 <p>ADJUSTMENTS (2) Pneumatic seat height (4) Seat/Back angle (6) Back Height Free floating seat and back</p>	<p>Ergonomic Features: C, D, F, G, H, M, N, Q</p>	3287	1524	1577	1616	1678	1761	1794	1865	2008	2071	2201	2378	2605
			OVERALL DIMENSIONS			SEAT DIMENSIONS			BACK DIMENSIONS						
			W	D	H	W	D	H	W	H					
	26	22.5	48	19	16.5	24-34	18.5	21							
				RTA 2											

DESCRIPTION	FEATURES	MODEL#	STANDARD TEXTILE GRADES														
			1	2	3	4	5	6	7	8	9	10	11	12			
 <p>Drafting Stool w/Arms/Plain Back COM Yardage: 1.50 Freight Class: 150 Product Weight (lbs.): 51 Cubic Feet Per Carton: 9.25</p>	 <p>ADJUSTMENTS (2) Pneumatic seat height (3) Back angle (4) Seat angle (6) Back/lumbar height</p> <p>Ergonomic Features: C, D, F, G, H, M, N, Q</p>	3288	1476	1527	1570	1626	1710	1740	1816	1958	2023	2154	2331	2553			
			OVERALL DIMENSIONS			SEAT DIMENSIONS			BACK DIMENSIONS								
			W	D	H	W	D	H	W	H							
26	23.5	48	19	16.5	24-34	18.5	21										
		RTA 2															

3

6

GRANADA® DELUXE



model 1170-3











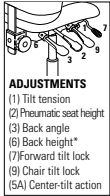

model 1171-3



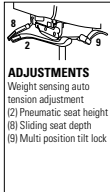



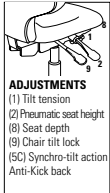

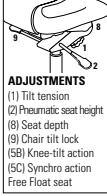

STANDARD FEATURES

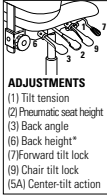

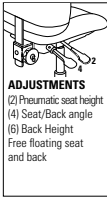

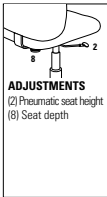

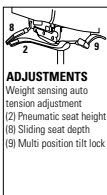

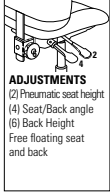

- Granada Deluxe offers dramatic seating comfort with a more contoured seat.
- Standard with height and width adjustable height T-arms with teardrop shaped urethane armcaps (3B).
- All models except the armchair and sidechair are standard with a five legged, injection molded reinforced nylon spider base with C65 casters.
- Base and frames are standard in Black (BK).
- Check textile availability prior to specifying upholstery material.

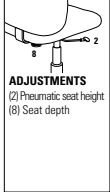





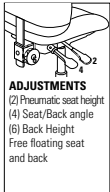

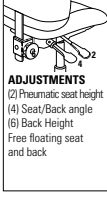

OPTIONAL FEATURES

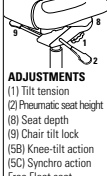
- Seat depth is optional on model 1171-2. Please specify (MD). Add \$104
- An optional abrasion resistant outer back fabric (polyester) is available. Resistant to impact damage. Available in Black only (BKB), add \$21.
- Available with back edge vinyl bumper guard option (VBG). Add \$24.
- Polished Aluminum base with black scuff tips. Specify "B2". Add \$154
- For hard surface flooring casters, specify C65R. Add \$66.
- For fully assembled in box, please specify SU. Add \$70.
- Please refer to "Arms Selection" section of the price book for arm options.
- Please refer to "Cylinder Selection" section of the price book for additional cylinder options.

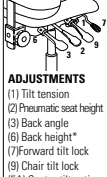
DESCRIPTION	FEATURES	MODEL#	STANDARD TEXTILE GRADES													
			1	2	3	4	5	6	7	8	9	10	11	12		
 <p>HB Multi - Tilter COM Yardage: 2 Freight Class: 125 Product Weight (lbs.): 65 Cubic Feet Per Carton: 9.25</p>	 <p>ADJUSTMENTS (1) Tilt tension (2) Pneumatic seat height (3) Back angle (6) Back height* (7) Forward tilt lock (9) Chair tilt lock (SA) Center-tilt action</p>	1170-3	1132	1193	1238	1312	1412	1445	1533	1703	1782	1938	2150	2412		
		OVERALL DIMENSIONS			SEAT DIMENSIONS			BACK DIMENSIONS								
		W	D	H	W	D	H	W	H							
	26	23.5	45	21	18-20.5	16-20	20	23-28.25								
																
 <p>HB Weight Sensing Synchro - Tilter COM Yardage: 2 Freight Class: 125 Product Weight (lbs.): 61 Cubic Feet Per Carton: 9.25</p>	 <p>ADJUSTMENTS Weight sensing auto tension adjustment (2) Pneumatic seat height (8) Sliding seat depth (9) Multi position tilt lock</p>	1170-8	1132	1193	1238	1312	1412	1445	1533	1703	1782	1938	2150	2412		
		OVERALL DIMENSIONS			SEAT DIMENSIONS			BACK DIMENSIONS								
		W	D	H	W	D	H	W	H							
	26	23.5	44	21	18-20.5	16.5-20.5	20	23-28.2								
																
 <p>HB Synchro - Tilter w/Back Angle Adjustment COM Yardage: 1.75 Freight Class: 125 Product Weight (lbs.): 60 Cubic Feet Per Carton: 9.25</p>	 <p>ADJUSTMENTS (1) Tilt tension (2) Pneumatic seat height (8) Seat depth (9) Chair tilt lock (5C) Synchro-tilt action Anti-Kick back</p>	1171-0	1016	1069	1110	1168	1258	1288	1362	1506	1576	1709	1890	2116		
		OVERALL DIMENSIONS			SEAT DIMENSIONS			BACK DIMENSIONS								
		W	D	H	W	D	H	W	H							
	26	23.5	43	21	18-20.5	17.25-21.25	20	20-25.2								
																

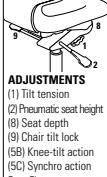
DESCRIPTION	FEATURES	MODEL#	STANDARD TEXTILE GRADES											
			1	2	3	4	5	6	7	8	9	10	11	12
 <p>MB Synchro Knee - Tilter COM Yardage: 1.75 Freight Class: 125 Product Weight (lbs.): 61 Cubic Feet Per Carton: 9.25</p>	 <p>ADJUSTMENTS (1) Tilt tension (2) Pneumatic seat height (8) Seat depth (9) Chair tilt lock (5B) Knee-tilt action (5C) Synchro action Free Float seat</p>	1171-2	1155	1204	1247	1307	1394	1425	1500	1642	1712	1846	2027	2254
			OVERALL DIMENSIONS			SEAT DIMENSIONS			BACK DIMENSIONS					
			W	D	H	W	D	H	W	H				
			26	23.5	42.5	21	18-20.5	16-20	20	23-28.51				
			RTA 2											
 <p>MB Multi - Tilter COM Yardage: 1.75 Freight Class: 125 Product Weight (lbs.): 61 Cubic Feet Per Carton: 9.25</p>	 <p>ADJUSTMENTS (1) Tilt tension (2) Pneumatic seat height (3) Back angle (6) Back height* (7) Forward tilt lock (9) Chair tilt lock (5A) Center-tilt action</p>	1171-3	1016	1069	1110	1168	1258	1288	1362	1506	1576	1709	1890	2116
			OVERALL DIMENSIONS			SEAT DIMENSIONS			BACK DIMENSIONS					
			W	D	H	W	D	H	W	H				
			26	23.5	42	21	18-20.5	16-20	20	23-28.25				
			RTA 2											
 <p>MB Operator COM Yardage: 1.75 Freight Class: 150 Product Weight (lbs.): 54 Cubic Feet Per Carton: 9.25</p>	 <p>ADJUSTMENTS (2) Pneumatic seat height (4) Seat/Back angle (6) Back Height Free floating seat and back</p>	1171-5	980	1033	1074	1135	1223	1252	1326	1471	1540	1673	1854	2081
			OVERALL DIMENSIONS			SEAT DIMENSIONS			BACK DIMENSIONS					
			W	D	H	W	D	H	W	H				
			26	23.5	39	21	18	16.5-20.5	20	19-24.25				
			RTA 2											
 <p>MB Task COM Yardage: 1.75 Freight Class: 150 Product Weight (lbs.): 49 Cubic Feet Per Carton: 9.25</p>	 <p>ADJUSTMENTS (2) Pneumatic seat height (8) Seat depth</p>	1171-6	826	879	921	980	1068	1098	1173	1318	1386	1520	1701	1926
			OVERALL DIMENSIONS			SEAT DIMENSIONS			BACK DIMENSIONS					
			W	D	H	W	D	H	W	H				
			26	23.5	38	21	17-18	16-21	20	19				
			RTA 2											
 <p>MB Weight Sensing Synchro - Tilter COM Yardage: 1.75 Freight Class: 125 Product Weight (lbs.): 61 Cubic Feet Per Carton: 9.25</p>	 <p>ADJUSTMENTS Weight sensing auto tension adjustment (2) Pneumatic seat height (8) Sliding seat depth (9) Multi position tilt lock</p>	1171-8	1016	1069	1110	1168	1258	1288	1362	1506	1576	1709	1890	2116
			OVERALL DIMENSIONS			SEAT DIMENSIONS			BACK DIMENSIONS					
			W	D	H	W	D	H	W	H				
			26	23.5	41	21	18-20.5	16.25-20.25	20	20 - 25.2				
			RTA 2											

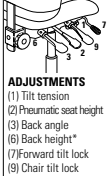
DESCRIPTION	FEATURES	MODEL#	STANDARD TEXTILE GRADES												
			1	2	3	4	5	6	7	8	9	10	11	12	
 <p>MB Operator Armless COM Yardage: 1.75 Freight Class: 150 Product Weight (lbs.): 49 Cubic Feet Per Carton: 9.25</p>	 <p>ADJUSTMENTS (2) Pneumatic seat height (4) Seat/Back angle (6) Back Height Free floating seat and back</p>	<p>Ergonomic Features: C, D, E, F, G, M, N, Q, S, U</p>	1172-5	810	861	904	964	1049	1078	1157	1298	1369	1501	1682	1911
			OVERALL DIMENSIONS			SEAT DIMENSIONS			BACK DIMENSIONS						
			W	D	H	W	D	H	W	H					
	21	23.5	39	21	18	16.5-20.5	20	19-24.25							
				RTA 2											
 <p>MB Task Armless COM Yardage: 1.75 Freight Class: 150 Product Weight (lbs.): 21. Cubic Feet Per Carton: 9.25</p>	 <p>ADJUSTMENTS (2) Pneumatic seat height (8) Seat depth</p>	<p>Ergonomic Features: C, E, H, M, N, U Q</p>	1172-6	658	711	752	812	897	929	1005	1148	1217	1351	1531	1758
			OVERALL DIMENSIONS			SEAT DIMENSIONS			BACK DIMENSIONS						
			W	D	H	W	D	H	W	H					
	21	23.5	38	21	17-18	16-21	20	19							
				RTA 2											
 <p>Side Chair COM Yardage: 1.75 Freight Class: 250 Product Weight (lbs.): 35 Cubic Feet Per Carton: 10</p>		<p>Ergonomic Features: M, N</p>	1174	587	636	681	742	826	857	933	1075	1144	1278	1459	1686
			OVERALL DIMENSIONS			SEAT DIMENSIONS			BACK DIMENSIONS						
			W	D	H	W	D	H	W	H					
	21	24	38	21	18	18	20	20.5							
				RTA 2											
 <p>Armchair COM Yardage: 1.75 Freight Class: 150 Product Weight (lbs.): 40 Cubic Feet Per Carton: 10</p>		<p>Ergonomic Features: M, N</p>	1175	785	838	879	937	1024	1055	1132	1276	1343	1478	1658	1885
			OVERALL DIMENSIONS			SEAT DIMENSIONS			BACK DIMENSIONS						
			W	D	H	W	D	H	W	H					
	24.5	24	38	21	18	18	20	20.5							
				RTA 2											
 <p>Drafting Stool Operator Armless COM Yardage: 1.75 Freight Class: 150 Product Weight (lbs.): 52 Cubic Feet Per Carton: 9.25</p>	 <p>ADJUSTMENTS (2) Pneumatic seat height (4) Seat/Back angle (6) Back Height Free floating seat and back</p>	<p>Ergonomic Features: C, D, F, G, H, M, N, S, U</p>	1177-5	1019	1070	1111	1171	1259	1290	1365	1509	1578	1710	1892	2119
			OVERALL DIMENSIONS			SEAT DIMENSIONS			BACK DIMENSIONS						
			W	D	H	W	D	H	W	H					
	21	23.5	48	20	18	23.5-33.5	20	19-24.25							
				RTA 2											

DESCRIPTION	FEATURES	MODEL#	STANDARD TEXTILE GRADES														
			1	2	3	4	5	6	7	8	9	10	11	12			
 <p>Drafting Stool Operator w/Arm COM Yardage: 1.75 Freight Class: 125 Product Weight (lbs.): 57 Cubic Feet Per Carton: 9.25</p>	 <p>ADJUSTMENTS (2) Pneumatic seat height (4) Seat/Back angle (6) Back Height Free floating seat and back</p>	<p>1178-5</p>	1189	1238	1283	1341	1428	1459	1534	1677	1747	1880	2061	2288			
			OVERALL DIMENSIONS			SEAT DIMENSIONS			BACK DIMENSIONS								
			W	D	H	W	D	H	W	H							
			26	23.5	48	21	18	23.5-33.5	20	19-24.25							
<p>COM Yardage: 1.75 Freight Class: 125 Product Weight (lbs.): 57 Cubic Feet Per Carton: 9.25</p>	<p>Ergonomic Features: C, D, F, G, H, M, N, S, U</p>	<p>RTA 2 </p>															
			 <p>HB Synchro Knee - Tilter w/ Schukra Lumbar COM Yardage: 2 Freight Class: 125 Product Weight (lbs.): 63 Cubic Feet Per Carton: 9.25</p>	 <p>ADJUSTMENTS (1) Tilt tension (2) Pneumatic seat height (8) Seat depth (9) Chair tilt lock (5B) Knee-tilt action (5C) Synchro action Free Float seat</p>	<p>1190-2</p>	1545	1614	1668	1750	1865	1903	2006	2195	2287	2467	2708	3009
						OVERALL DIMENSIONS			SEAT DIMENSIONS			BACK DIMENSIONS					
						W	D	H	W	D	H	W	H				
26	23.5	45.5				21	18-20.5	16.5-20.5	20	23-28.25							
<p>COM Yardage: 2 Freight Class: 125 Product Weight (lbs.): 63 Cubic Feet Per Carton: 9.25</p>	<p>Ergonomic Features: A, B, C, D, E, G, H, J, M, N, Q, R, V</p>	<p>RTA 2 </p>															
			 <p>HB Multi - Tilter COM Yardage: 2 Freight Class: 125 Product Weight (lbs.): 65 Cubic Feet Per Carton: 9.25</p>	 <p>ADJUSTMENTS (1) Tilt tension (2) Pneumatic seat height (3) Back angle (6) Back height* (7) Forward tilt lock (9) Chair tilt lock (5A) Center-tilt action</p>	<p>1190-3</p>	1397	1466	1522	1602	1717	1759	1858	2049	2141	2321	2561	2862
						OVERALL DIMENSIONS			SEAT DIMENSIONS			BACK DIMENSIONS					
						W	D	H	W	D	H	W	H				
26	23.5	45				21	18-20.5	16-20	20	23-28.25							
<p>COM Yardage: 2 Freight Class: 125 Product Weight (lbs.): 65 Cubic Feet Per Carton: 9.25</p>	<p>Ergonomic Features: A, B, C, D, E, F, G, H, M, N, Q, S, U</p>	<p>RTA 2 </p>															
			 <p>MB Synchro Knee - Tilter w/ Schukra Lumbar COM Yardage: 1.75 Freight Class: 125 Product Weight (lbs.): 61 Cubic Feet Per Carton: 9.25</p>	 <p>ADJUSTMENTS (1) Tilt tension (2) Pneumatic seat height (8) Seat depth (9) Chair tilt lock (5B) Knee-tilt action (5C) Synchro action Free Float seat</p>	<p>1191-2</p>	1419	1482	1530	1599	1703	1737	1827	1992	2071	2228	2439	2702
						OVERALL DIMENSIONS			SEAT DIMENSIONS			BACK DIMENSIONS					
						W	D	H	W	D	H	W	H				
26	23.5	42.5				21	18-20.5	16-20	20	23-28.51							
<p>COM Yardage: 1.75 Freight Class: 125 Product Weight (lbs.): 61 Cubic Feet Per Carton: 9.25</p>	<p>Ergonomic Features: A, B, C, D, E, G, H, J, M, N, Q, R, V</p>	<p>RTA 2 </p>															
			 <p>MB Multi - Tilter COM Yardage: 1.75 Freight Class: 125 Product Weight (lbs.): 61 Cubic Feet Per Carton: 9.25</p>	 <p>ADJUSTMENTS (1) Tilt tension (2) Pneumatic seat height (3) Back angle (6) Back height* (7) Forward tilt lock (9) Chair tilt lock (5A) Center-tilt action</p>	<p>1191-2</p>	1419	1482	1530	1599	1703	1737	1827	1992	2071	2228	2439	2702
						OVERALL DIMENSIONS			SEAT DIMENSIONS			BACK DIMENSIONS					
						W	D	H	W	D	H	W	H				
26	23.5	42				21	18-20.5	16-20	20	23-28.25							
<p>COM Yardage: 1.75 Freight Class: 125 Product Weight (lbs.): 61 Cubic Feet Per Carton: 9.25</p>	<p>Ergonomic Features: A, B, C, D, E, F, G, H, M, N, Q, S, U</p>	<p>RTA 2 </p>															

GRAPHIC™



model 2739



model 2738MB



Optional Base
An optional five-legged, arched steel base in Tungsten finish is available. Specify (TTU). Add \$83.









STANDARD FEATURES

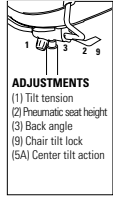

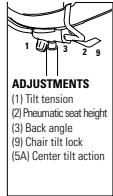

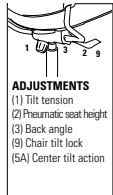

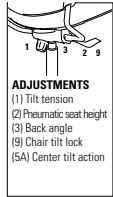

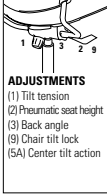

- European detailing and a clean slim profile.
- Features a generous compound curved back and seat.
- Three distinctive back styles: upholstered back, perforated Black nylon back and breathable Black mesh back.
- Posture back chairs with arms are standard with height adjustable, forward swept arms and sliding armcaps (G4).
- Vari-Width (WA) width adjustable arm extensions are standard when chair is ordered with adjustable arms. Allows the arms to move away from the seat by 2" on each side to allow space if desired for broader hip widths.
- Check textile availability prior to specifying upholstery material.

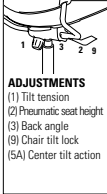
- Posture mechanism offers exceptional back support, two position tilt lock adjustment and tilt tension control.
- Five prong, injection molded, fiberglass reinforced nylon Black spider base with dual wheel carpet casters (C1).

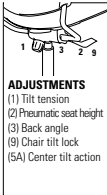
OPTIONAL FEATURES

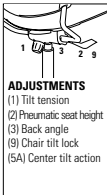
- For hard surface flooring please specify C9R. Add \$66.
- A steel base with Tungsten finish is available. Specify (TTU). Add \$83.
- Please refer to "Arms and Casters" section of the price book for arm and caster options.
- For fully assembled in box, specify SU. Add \$70.

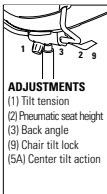
DESCRIPTION	FEATURES	MODEL#	STANDARD TEXTILE GRADES											
			1	2	3	4	5	6	7	8	9	10	11	12
 <p>Medium Posture Nylon Back Armless COM Yardage: 1 Freight Class: 250 Product Weight (lbs.): 34 Cubic Feet Per Carton: 9.75</p> <p>Ergonomic Features: A, C, G, M, N</p>	 <p>ADJUSTMENTS (1) Tilt tension (2) Pneumatic seat height (3) Back angle (9) Chair tilt lock (5A) Center tilt action</p>	2736	680	717	743	778	836	854	901	993	1038	1121	1235	1380
		OVERALL DIMENSIONS			SEAT DIMENSIONS			BACK DIMENSIONS						
		W	D	H	W	D	H	W		H				
		20	24	36	20	19	16.5-20.5	19		19				
			RTA 1											
 <p>Medium Posture Mesh Back Armless COM Yardage: 1 Freight Class: 250 Product Weight (lbs.): 34 Cubic Feet Per Carton: 9.75</p> <p>Ergonomic Features: A, C, G, M, N</p>	 <p>ADJUSTMENTS (1) Tilt tension (2) Pneumatic seat height (3) Back angle (9) Chair tilt lock (5A) Center tilt action</p>	2736MB	754	793	816	854	912	929	977	1069	1112	1197	1312	1456
		OVERALL DIMENSIONS			SEAT DIMENSIONS			BACK DIMENSIONS						
		W	D	H	W	D	H	W		H				
		20	24	36	20	19	16.5-20.5	19		19				
			RTA 1											
 <p>Medium Posture Back - Fully Upholstered Armless COM Yardage: 1.25 Freight Class: 250 Product Weight (lbs.): 34 Cubic Feet Per Carton: 9.75</p> <p>Ergonomic Features: A, C, G, M, N</p>	 <p>ADJUSTMENTS (1) Tilt tension (2) Pneumatic seat height (3) Back angle (9) Chair tilt lock (5A) Center tilt action</p>	2737	754	797	830	877	945	971	1028	1144	1199	1304	1449	1626
		OVERALL DIMENSIONS			SEAT DIMENSIONS			BACK DIMENSIONS						
		W	D	H	W	D	H	W		H				
		20	24	36	20	19	16.5-20.5	19		19				
			RTA 1											
 <p>Medium Posture Nylon Back w/Arms COM Yardage: 1 Freight Class: 150 Product Weight (lbs.): 45 Cubic Feet Per Carton: 9.75</p> <p>Ergonomic Features: A, C, G, H, M, N, Q</p>	 <p>ADJUSTMENTS (1) Tilt tension (2) Pneumatic seat height (3) Back angle (9) Chair tilt lock (5A) Center tilt action</p>	2738	754	791	815	853	908	927	975	1067	1111	1195	1311	1454
		OVERALL DIMENSIONS			SEAT DIMENSIONS			BACK DIMENSIONS						
		W	D	H	W	D	H	W		H				
		25	24	36	20	19	16.5-20.5	19		19				
			RTA 1											

DESCRIPTION	FEATURES	MODEL#	STANDARD TEXTILE GRADES														
			1	2	3	4	5	6	7	8	9	10	11	12			
 <p>Medium Posture Mesh Back w/Arms COM Yardage: 1 Freight Class: 150 Product Weight (lbs.): 45 Cubic Feet Per Carton: 9.75</p>	 <p>ADJUSTMENTS (1) Tilt tension (2) Pneumatic seat height (3) Back angle (9) Chair tilt lock (5A) Center tilt action</p>	<p>2738MB</p>	832	869	893	931	986	1006	1052	1144	1190	1273	1389	1531			
			OVERALL DIMENSIONS			SEAT DIMENSIONS			BACK DIMENSIONS								
			W	D	H	W	D	H	W		H						
			25	24	36	20	19	16.5-20.5	19		19						
<p>COM Yardage: 1 Freight Class: 150 Product Weight (lbs.): 45 Cubic Feet Per Carton: 9.75</p>	<p>Ergonomic Features: A, C, G, H, M, N, Q</p>	<p>RTA 1 </p>															
			 <p>Medium Posture Back - Fully Upholstered w/Arms COM Yardage: 1.25 Freight Class: 150 Product Weight (lbs.): 45 Cubic Feet Per Carton: 9.75</p>	 <p>ADJUSTMENTS (1) Tilt tension (2) Pneumatic seat height (3) Back angle (9) Chair tilt lock (5A) Center tilt action</p>	<p>2739</p>	832	874	905	952	1022	1048	1106	1222	1275	1381	1526	1704
						OVERALL DIMENSIONS			SEAT DIMENSIONS			BACK DIMENSIONS					
						W	D	H	W	D	H	W		H			
25	24	36				20	19	16.5-20.5	19		19						
<p>COM Yardage: 1.25 Freight Class: 150 Product Weight (lbs.): 45 Cubic Feet Per Carton: 9.75</p>	<p>Ergonomic Features: A, C, G, H, M, N, Q</p>	<p>RTA 1 </p>															
			 <p>Medium Posture Stool Nylon Back w/Arms COM Yardage: 1 Freight Class: 150 Product Weight (lbs.): 50 Cubic Feet Per Carton: 9.75</p>	 <p>ADJUSTMENTS (1) Tilt tension (2) Pneumatic seat height (3) Back angle (9) Chair tilt lock (5A) Center tilt action</p>	<p>2748</p>	\$951	\$986	\$1015	\$1055	\$1113	\$1134	\$1185	\$1278	\$1325	\$1415	\$1534	\$1685
						OVERALL DIMENSIONS			SEAT DIMENSIONS			BACK DIMENSIONS					
						W	D	H	W	D	H	W		H			
25	24	46				20	19	23-33	19		19						
<p>COM Yardage: 1 Freight Class: 150 Product Weight (lbs.): 50 Cubic Feet Per Carton: 9.75</p>	<p>Ergonomic Features: A, C, G, H, M, N, Q</p>	<p>RTA 1 </p>															
			 <p>Medium Posture Stool Mesh Back w/Arms COM Yardage: 1 Freight Class: 150 Product Weight (lbs.): 51 Cubic Feet Per Carton: 9.75</p>	 <p>ADJUSTMENTS (1) Tilt tension (2) Pneumatic seat height (3) Back angle (9) Chair tilt lock (5A) Center tilt action</p>	<p>2748MB</p>	\$1031	\$1068	\$1095	\$1136	\$1193	\$1212	\$1265	\$1358	\$1405	\$1495	\$1616	\$1765
						OVERALL DIMENSIONS			SEAT DIMENSIONS			BACK DIMENSIONS					
						W	D	H	W	D	H	W		H			
25	24	46				20	19	23-33	19		19						
<p>COM Yardage: 1 Freight Class: 150 Product Weight (lbs.): 51 Cubic Feet Per Carton: 9.75</p>	<p>Ergonomic Features: A, C, G, H, M, N, Q</p>	<p>RTA 1 </p>															
			 <p>Medium Posture Stool - Fully Upholstered w/Arms COM Yardage: 1.25 Freight Class: 150 Product Weight (lbs.): 52 Cubic Feet Per Carton: 9.75</p>	 <p>ADJUSTMENTS (1) Tilt tension (2) Pneumatic seat height (3) Back angle (9) Chair tilt lock (5A) Center tilt action</p>	<p>2749</p>	\$1027	\$1071	\$1107	\$1158	\$1228	\$1253	\$1318	\$1437	\$1494	\$1605	\$1755	\$1943
						OVERALL DIMENSIONS			SEAT DIMENSIONS			BACK DIMENSIONS					
						W	D	H	W	D	H	W		H			
25	24	46				20	19	23-33	19		19						
<p>COM Yardage: 1.25 Freight Class: 150 Product Weight (lbs.): 52 Cubic Feet Per Carton: 9.75</p>	<p>Ergonomic Features: A, C, G, H, M, N, Q</p>	<p>RTA 1 </p>															

LOOVER



model 2660-8



model 2660-3



Memory Foam
Available, use code "MF" and Add \$108.



model 2661-8



model 2662-3



STANDARD FEATURES









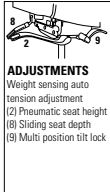

- Global's first chair to feature a weight sensing synchro-tilter mechanism that requires no tilt tension adjustment.
- A live lumber support is incorporated into the back design which is height adjustable via a concealed ratchet system, offering a 2.25" height adjustment.
- Standard with Global's high quality Soft Descent™ pneumatic lift which slowly and gently lowers the seat height of the chair making it easy to obtain the exact seat height you desire.
- Side activated sliding seat depth adjustment, **(MD)** is standard on for Mutil-Tilters, Synchro-Tilters, and Weight Sensing Synchro-Tilter. Provides 2"-3" of seat depth adjustment.
- Height and width **(WA)** adjustable **G5** lockable arms. Armcaps are soft to the touch Self Skinned Urethane, depth adjustable (slide forward and backward) movements can be locked to avoid unintentional movement). Armcaps also articulate inwards and outwards 30° to aim toward the keyboard or mouse arena.
- Vari-Width **(WA)** Width Adjustable Arm Extensions are standard, allowing the arms to move away from the seat by 2" on each side to allow space if desired for broader hip widths.
- Five prong, injection molded, fiberglass reinforced, Nylon medium rise base **B7B** with **C1** dual wheel carpet casters.

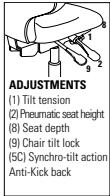

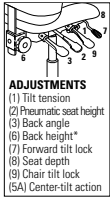

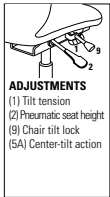

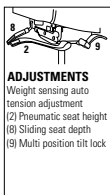

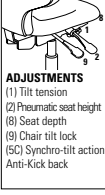

- Check textile availability prior to specifying upholstery material.
- Mesh backs are available in 24 brilliant Vue colors: Sandy Beach (VU10), Desert Sand (VU11), Orange Sunset (VU12), Chocolate Fountain (VU13), Arctic Blue (VU14), Quarry Grey (VU15), Tidal Wave (VU16), Ivy Moss (VU17), Red Rose (VU18), Coal Black (VU19), White (VU20), Lime (VU21), Chartreuse (VU23), Pool Blue (VU26), Sky (VU28), Primary Blue (VU32), Tangerine (VU34), Paprika (VU37), Grain (VU40), Yellow (VU43), Silver Grey (VU55), Silver (VU63), Hot Pink (VU65) and Red Mittens (VU70). Please specify

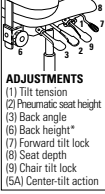

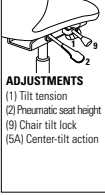

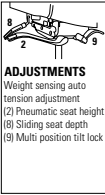

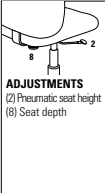
OPTIONAL FEATURES

- Petite models are available at no upcharge. Please specify P. Seat is overall 1 inch smaller in depth and 1.5 inch smaller in width. Model numbers are listed below.
- Seat available in memory foam **(MF)**. Add \$108.
- Optional Polished Aluminum base **(B7A)** Please specify **(ALU)** base. Add \$154.
- For hard surface flooring casters, please specify **C9R**. Add \$66.
- Please refer to "Arms Selection" section of the price book for arm options. Please refer to "Cylinder Selection" section of the price book for additional cylinder options.
- For fully assembled in box, specify **SU**. Add \$66.

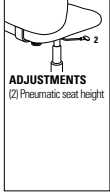
DESCRIPTION	FEATURES	MODEL#	STANDARD TEXTILE GRADES													
			1	2	3	4	5	6	7	8	9	10	11	12		
 <p>Extended HB Synchro - Tilter w/Back Angle Adjustment COM Yardage: 1 Freight Class: 125 Product Weight (lbs.): 68 Cubic Feet Per Carton: 11</p> <p>Ergonomic Features: A, B, C, D, E, G, H, L, M, N, Q, R, U</p>	<p>ADJUSTMENTS (1) Tilt tension (2) Pneumatic seat height (8) Seat depth (9) Chair tilt lock (5C) Synchro-tilt action Anti-Kick back</p>	2660-0	\$1123	\$1160	\$1186	\$1224	\$1279	\$1296	\$1346	\$1438	\$1482	\$1564	\$1680	\$1823		
		2660P-0 Small Seat														
		OVERALL DIMENSIONS			SEAT DIMENSIONS			BACK DIMENSIONS								
		W	D	H	W	D	H	W	H	25.5	25	45.5	20	19-21.5	16.25-20.25	19.5
 <p>Extended HB Multi Tilter COM Yardage: 1 Freight Class: 125 Product Weight (lbs.): 68 Cubic Feet Per Carton: 11</p> <p>Ergonomic Features: A, B, C, D, E, F, G, H, M, N, Q, R, S, U</p>	<p>ADJUSTMENTS (1) Tilt tension (2) Pneumatic seat height (3) Back angle (6) Back height* (7) Forward tilt lock (8) Seat depth (9) Chair tilt lock (5A) Center-tilt action</p>	2660-3	\$1123	\$1160	\$1186	\$1224	\$1279	\$1296	\$1346	\$1438	\$1482	\$1564	\$1680	\$1823		
		2660P-3 Small Seat														
		OVERALL DIMENSIONS			SEAT DIMENSIONS			BACK DIMENSIONS								
		W	D	H	W	D	H	W	H	25.5	25	45.5	20	19-21.5	16-20	19.5
 <p>Extended HB Tilter COM Yardage: 1 Freight Class: 150 Product Weight (lbs.): 62 Cubic Feet Per Carton: 11</p> <p>Ergonomic Features: A, B, C, D, H, M, N, Q, R, S, U</p>	<p>ADJUSTMENTS (1) Tilt tension (2) Pneumatic seat height (9) Chair tilt lock (5A) Center-tilt action</p>	2660-4	\$981	\$1016	\$1043	\$1080	\$1136	\$1153	\$1202	\$1292	\$1338	\$1421	\$1536	\$1680		
		2660P-4 Small Seat														
		OVERALL DIMENSIONS			SEAT DIMENSIONS			BACK DIMENSIONS								
		W	D	H	W	D	H	W	H	25.5	25	45.5	20	19-20	16-20	19.5

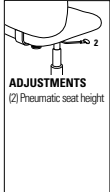
DESCRIPTION	FEATURES	MODEL#	STANDARD TEXTILE GRADES																																					
			1	2	3	4	5	6	7	8	9	10	11	12																										
 <p>Extended HB Weight Sensing Synchro - Tilter COM Yardage: 1 Freight Class: 125 Product Weight (lbs.): 66 Cubic Feet Per Carton: 11</p>	 <p>ADJUSTMENTS Weight sensing auto tension adjustment (2) Pneumatic seat height (8) Sliding seat depth (9) Multi position tilt lock</p>	<p>Ergonomic Features: A, B, C, D, E, H, L, M, N, Q, R, U</p>	<table border="1"> <tr> <td>2660-8</td> <td>\$1123</td> <td>\$1160</td> <td>\$1186</td> <td>\$1224</td> <td>\$1279</td> <td>\$1296</td> <td>\$1346</td> <td>\$1438</td> <td>\$1482</td> <td>\$1564</td> <td>\$1680</td> <td>\$1823</td> </tr> <tr> <td colspan="13">2660P-8 Small Seat</td> </tr> </table>												2660-8	\$1123	\$1160	\$1186	\$1224	\$1279	\$1296	\$1346	\$1438	\$1482	\$1564	\$1680	\$1823	2660P-8 Small Seat												
			2660-8	\$1123	\$1160	\$1186	\$1224	\$1279	\$1296	\$1346	\$1438	\$1482	\$1564	\$1680	\$1823																									
			2660P-8 Small Seat																																					
			<table border="1"> <tr> <th colspan="3">OVERALL DIMENSIONS</th> <th colspan="3">SEAT DIMENSIONS</th> <th colspan="3">BACK DIMENSIONS</th> </tr> <tr> <th>W</th> <th>D</th> <th>H</th> <th>W</th> <th>D</th> <th>H</th> <th>W</th> <th>H</th> </tr> <tr> <td>25.5</td> <td>25</td> <td>45.5</td> <td>20</td> <td>19-21.5</td> <td>16-20</td> <td>19.5</td> <td>25-27.5</td> </tr> </table>			OVERALL DIMENSIONS			SEAT DIMENSIONS			BACK DIMENSIONS			W	D	H	W	D	H	W	H	25.5	25	45.5	20	19-21.5	16-20	19.5	25-27.5	<p>RTA 2 </p>									
OVERALL DIMENSIONS			SEAT DIMENSIONS			BACK DIMENSIONS																																		
W	D	H	W	D	H	W	H																																	
25.5	25	45.5	20	19-21.5	16-20	19.5	25-27.5																																	
 <p>HB Synchro - Tilter w/Back Angle Adjustment COM Yardage: 1 Freight Class: 125 Product Weight (lbs.): 66 Cubic Feet Per Carton: 10.5</p>	 <p>ADJUSTMENTS (1) Tilt tension (2) Pneumatic seat height (8) Seat depth (9) Chair tilt lock (5C) Synchro-tilt action Anti-Kick back</p>	<p>Ergonomic Features: A, B, C, D, E, G, H, L, M, N, Q, R, U</p>	<table border="1"> <tr> <td>2661-0</td> <td>\$1048</td> <td>\$1082</td> <td>\$1109</td> <td>\$1146</td> <td>\$1202</td> <td>\$1220</td> <td>\$1269</td> <td>\$1359</td> <td>\$1405</td> <td>\$1488</td> <td>\$1601</td> <td>\$1747</td> </tr> <tr> <td colspan="13">2661P-0 Small Seat</td> </tr> </table>												2661-0	\$1048	\$1082	\$1109	\$1146	\$1202	\$1220	\$1269	\$1359	\$1405	\$1488	\$1601	\$1747	2661P-0 Small Seat												
			2661-0	\$1048	\$1082	\$1109	\$1146	\$1202	\$1220	\$1269	\$1359	\$1405	\$1488	\$1601	\$1747																									
			2661P-0 Small Seat																																					
			<table border="1"> <tr> <th colspan="3">OVERALL DIMENSIONS</th> <th colspan="3">SEAT DIMENSIONS</th> <th colspan="3">BACK DIMENSIONS</th> </tr> <tr> <th>W</th> <th>D</th> <th>H</th> <th>W</th> <th>D</th> <th>H</th> <th>W</th> <th>H</th> </tr> <tr> <td>25.5</td> <td>24</td> <td>42.5</td> <td>20</td> <td>19-21.5</td> <td>16-20</td> <td>19.5</td> <td>25-27.5</td> </tr> </table>			OVERALL DIMENSIONS			SEAT DIMENSIONS			BACK DIMENSIONS			W	D	H	W	D	H	W	H	25.5	24	42.5	20	19-21.5	16-20	19.5	25-27.5	<p>RTA 2 </p>									
OVERALL DIMENSIONS			SEAT DIMENSIONS			BACK DIMENSIONS																																		
W	D	H	W	D	H	W	H																																	
25.5	24	42.5	20	19-21.5	16-20	19.5	25-27.5																																	
 <p>HB Multi - Tilter COM Yardage: 1 Freight Class: 125 Product Weight (lbs.): 68 Cubic Feet Per Carton: 10.5</p>	 <p>ADJUSTMENTS (1) Tilt tension (2) Pneumatic seat height (3) Back angle (6) Back height* (7) Forward tilt lock (8) Seat depth (9) Chair tilt lock (5A) Center-tilt action</p>	<p>Ergonomic Features: A, B, C, D, E, F, G, H, M, N, Q, R, S, U</p>	<table border="1"> <tr> <td>2661-3</td> <td>\$1048</td> <td>\$1082</td> <td>\$1109</td> <td>\$1146</td> <td>\$1202</td> <td>\$1220</td> <td>\$1269</td> <td>\$1359</td> <td>\$1405</td> <td>\$1488</td> <td>\$1601</td> <td>\$1747</td> </tr> <tr> <td colspan="13">2661P-3 Small Seat</td> </tr> </table>												2661-3	\$1048	\$1082	\$1109	\$1146	\$1202	\$1220	\$1269	\$1359	\$1405	\$1488	\$1601	\$1747	2661P-3 Small Seat												
			2661-3	\$1048	\$1082	\$1109	\$1146	\$1202	\$1220	\$1269	\$1359	\$1405	\$1488	\$1601	\$1747																									
			2661P-3 Small Seat																																					
			<table border="1"> <tr> <th colspan="3">OVERALL DIMENSIONS</th> <th colspan="3">SEAT DIMENSIONS</th> <th colspan="3">BACK DIMENSIONS</th> </tr> <tr> <th>W</th> <th>D</th> <th>H</th> <th>W</th> <th>D</th> <th>H</th> <th>W</th> <th>H</th> </tr> <tr> <td>25.5</td> <td>25</td> <td>42.5</td> <td>20</td> <td>19-21.5</td> <td>16-20</td> <td>19.5</td> <td>25-27.5</td> </tr> </table>			OVERALL DIMENSIONS			SEAT DIMENSIONS			BACK DIMENSIONS			W	D	H	W	D	H	W	H	25.5	25	42.5	20	19-21.5	16-20	19.5	25-27.5	<p>RTA 2 </p>									
OVERALL DIMENSIONS			SEAT DIMENSIONS			BACK DIMENSIONS																																		
W	D	H	W	D	H	W	H																																	
25.5	25	42.5	20	19-21.5	16-20	19.5	25-27.5																																	
 <p>HB Tilter COM Yardage: 1 Freight Class: 150 Product Weight (lbs.): 62 Cubic Feet Per Carton: 10.5</p>	 <p>ADJUSTMENTS (1) Tilt tension (2) Pneumatic seat height (9) Chair tilt lock (5A) Center-tilt action</p>	<p>Ergonomic Features: A, B, C, D, H, M, N, Q, R, S, U</p>	<table border="1"> <tr> <td>2661-4</td> <td>\$921</td> <td>\$955</td> <td>\$981</td> <td>\$1019</td> <td>\$1073</td> <td>\$1092</td> <td>\$1141</td> <td>\$1232</td> <td>\$1277</td> <td>\$1361</td> <td>\$1476</td> <td>\$1619</td> </tr> <tr> <td colspan="13">2661P-4 Small Seat</td> </tr> </table>												2661-4	\$921	\$955	\$981	\$1019	\$1073	\$1092	\$1141	\$1232	\$1277	\$1361	\$1476	\$1619	2661P-4 Small Seat												
			2661-4	\$921	\$955	\$981	\$1019	\$1073	\$1092	\$1141	\$1232	\$1277	\$1361	\$1476	\$1619																									
			2661P-4 Small Seat																																					
			<table border="1"> <tr> <th colspan="3">OVERALL DIMENSIONS</th> <th colspan="3">SEAT DIMENSIONS</th> <th colspan="3">BACK DIMENSIONS</th> </tr> <tr> <th>W</th> <th>D</th> <th>H</th> <th>W</th> <th>D</th> <th>H</th> <th>W</th> <th>H</th> </tr> <tr> <td>25.5</td> <td>25</td> <td>42.5</td> <td>20</td> <td>19-20</td> <td>16-20</td> <td>19.5</td> <td>25-27.5</td> </tr> </table>			OVERALL DIMENSIONS			SEAT DIMENSIONS			BACK DIMENSIONS			W	D	H	W	D	H	W	H	25.5	25	42.5	20	19-20	16-20	19.5	25-27.5	<p>RTA 2 </p>									
OVERALL DIMENSIONS			SEAT DIMENSIONS			BACK DIMENSIONS																																		
W	D	H	W	D	H	W	H																																	
25.5	25	42.5	20	19-20	16-20	19.5	25-27.5																																	
 <p>HB Weight Sensing Synchro - Tilter COM Yardage: 1 Freight Class: 125 Product Weight (lbs.): 66 Cubic Feet Per Carton: 10.5</p>	 <p>ADJUSTMENTS Weight sensing auto tension adjustment (2) Pneumatic seat height (8) Sliding seat depth (9) Multi position tilt lock</p>	<p>Ergonomic Features: A, B, C, D, E, H, L, M, N, Q, R, U</p>	<table border="1"> <tr> <td>2661-8</td> <td>\$1048</td> <td>\$1082</td> <td>\$1109</td> <td>\$1146</td> <td>\$1202</td> <td>\$1220</td> <td>\$1269</td> <td>\$1359</td> <td>\$1405</td> <td>\$1488</td> <td>\$1601</td> <td>\$1747</td> </tr> <tr> <td colspan="13">2661P-8 Small Seat</td> </tr> </table>												2661-8	\$1048	\$1082	\$1109	\$1146	\$1202	\$1220	\$1269	\$1359	\$1405	\$1488	\$1601	\$1747	2661P-8 Small Seat												
			2661-8	\$1048	\$1082	\$1109	\$1146	\$1202	\$1220	\$1269	\$1359	\$1405	\$1488	\$1601	\$1747																									
			2661P-8 Small Seat																																					
			<table border="1"> <tr> <th colspan="3">OVERALL DIMENSIONS</th> <th colspan="3">SEAT DIMENSIONS</th> <th colspan="3">BACK DIMENSIONS</th> </tr> <tr> <th>W</th> <th>D</th> <th>H</th> <th>W</th> <th>D</th> <th>H</th> <th>W</th> <th>H</th> </tr> <tr> <td>25.5</td> <td>24</td> <td>42.5</td> <td>20</td> <td>17.5-19.5</td> <td>16-20</td> <td>19.5</td> <td>25-27.5</td> </tr> </table>			OVERALL DIMENSIONS			SEAT DIMENSIONS			BACK DIMENSIONS			W	D	H	W	D	H	W	H	25.5	24	42.5	20	17.5-19.5	16-20	19.5	25-27.5	<p>RTA 2 </p>									
OVERALL DIMENSIONS			SEAT DIMENSIONS			BACK DIMENSIONS																																		
W	D	H	W	D	H	W	H																																	
25.5	24	42.5	20	17.5-19.5	16-20	19.5	25-27.5																																	

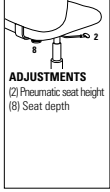
DESCRIPTION	FEATURES	MODEL#	STANDARD TEXTILE GRADES											
			1	2	3	4	5	6	7	8	9	10	11	12
 <p>MB Synchro - Tilter w/Back Angle Adjustment COM Yardage: 1 Freight Class: 125 Product Weight (lbs.): 64 Cubic Feet Per Carton: 10.5</p>	 <p>ADJUSTMENTS (1) Tilt tension (2) Pneumatic seat height (8) Seat depth (9) Chair tilt lock (5C) Synchro-tilt action Anti-Kick back</p>	<p>2662-0 \$1002 \$1036 \$1063 \$1100 \$1156 \$1175 \$1223 \$1314 \$1360 \$1442 \$1557 \$1701 2662P-0 Small Seat</p>	OVERALL DIMENSIONS			SEAT DIMENSIONS			BACK DIMENSIONS					
			W	D	H	W	D	H	W	H				
			25.5	24	39.5	20	17.5-19.5	16.25-20.25	19.5	22-24.5				
			Ergonomic Features: A, B, C, D, E, G, H, L, M, N, Q, R, U		RTA 2									
 <p>MB Multi Tilter COM Yardage: 1 Freight Class: 125 Product Weight (lbs.): 66 Cubic Feet Per Carton: 10.5</p>	 <p>ADJUSTMENTS (1) Tilt tension (2) Pneumatic seat height (3) Back angle (6) Back height* (7) Forward tilt lock (8) Seat depth (9) Chair tilt lock (5A) Center-tilt action</p>	<p>2662-3 \$1002 \$1036 \$1063 \$1100 \$1156 \$1175 \$1223 \$1314 \$1360 \$1442 \$1557 \$1701 2662P-3 Small Seat</p>	OVERALL DIMENSIONS			SEAT DIMENSIONS			BACK DIMENSIONS					
			W	D	H	W	D	H	W	H				
			25.5	25	39.5	20	19-21.5	16-20	19.5	22-24.5				
			Ergonomic Features: A, B, C, D, E, F, G, H, M, N, Q, R, S, U		RTA 2									
 <p>MB Tilter COM Yardage: 1 Freight Class: 150 Product Weight (lbs.): 60 Cubic Feet Per Carton: 10.5</p>	 <p>ADJUSTMENTS (1) Tilt tension (2) Pneumatic seat height (9) Chair tilt lock (5A) Center-tilt action</p>	<p>2662-4 \$891 \$926 \$953 \$990 \$1046 \$1063 \$1112 \$1203 \$1248 \$1332 \$1448 \$1590 2662P-4 Small Seat</p>	OVERALL DIMENSIONS			SEAT DIMENSIONS			BACK DIMENSIONS					
			W	D	H	W	D	H	W	H				
			25.5	25	39.5	20	19-20	16-20	19.5	22-24.5				
			Ergonomic Features: A, B, C, D, H, M, N, Q, R, S, U		RTA 2									
 <p>MB Weight Sensing Synchro - Tilter COM Yardage: 1 Freight Class: 125 Product Weight (lbs.): 64 Cubic Feet Per Carton: 10.5</p>	 <p>ADJUSTMENTS Weight sensing auto tension adjustment (2) Pneumatic seat height (8) Sliding seat depth (9) Multi position tilt lock</p>	<p>2662-8 \$1002 \$1036 \$1063 \$1100 \$1156 \$1175 \$1223 \$1314 \$1360 \$1442 \$1557 \$1701 2662P-8 Small Seat</p>	OVERALL DIMENSIONS			SEAT DIMENSIONS			BACK DIMENSIONS					
			W	D	H	W	D	H	W	H				
			25.5	24	39.5	20	17.5-19.5	16-20	19.5	22-24.5				
			Ergonomic Features: A, B, C, D, E, H, L, M, N, Q, R, U		RTA 2									
 <p>MB Task COM Yardage: 1 Freight Class: 150 Product Weight (lbs.): 45 Cubic Feet Per Carton: 10.5</p>	 <p>ADJUSTMENTS (2) Pneumatic seat height (8) Seat depth</p>	<p>2662-6 \$947 \$981 \$1008 \$1046 \$1102 \$1118 \$1170 \$1258 \$1304 \$1388 \$1502 \$1646 2662P-6 Small Seat</p>	OVERALL DIMENSIONS			SEAT DIMENSIONS			BACK DIMENSIONS					
			W	D	H	W	D	H	W	H				
			25.5	25	39.5	20	19-20	16.5-20.5	19.5	21				
			Ergonomic Features: C, E, H, M, N, Q, R, U		RTA 2									

DESCRIPTION	FEATURES	MODEL#	STANDARD TEXTILE GRADES																																			
			1	2	3	4	5	6	7	8	9	10	11	12																								
 <p>MB Drafting Stool - Task COM Yardage: 1 Freight Class: 150 Product Weight (lbs.): 50 Cubic Feet Per Carton: 10.5</p>	 <p>ADJUSTMENTS (2) Pneumatic seat height</p>	<p>Ergonomic Features: C, E, H, M, N, Q, R, U</p>	<table border="1"> <tr> <th colspan="3">OVERALL DIMENSIONS</th> <th colspan="3">SEAT DIMENSIONS</th> <th colspan="2">BACK DIMENSIONS</th> </tr> <tr> <th>W</th> <th>D</th> <th>H</th> <th>W</th> <th>D</th> <th>H</th> <th>W</th> <th>H</th> </tr> <tr> <td>25.5</td> <td>25</td> <td>50</td> <td>20</td> <td>19-20</td> <td>24-34</td> <td>19.5</td> <td>21</td> </tr> </table>												OVERALL DIMENSIONS			SEAT DIMENSIONS			BACK DIMENSIONS		W	D	H	W	D	H	W	H	25.5	25	50	20	19-20	24-34	19.5	21
			OVERALL DIMENSIONS			SEAT DIMENSIONS			BACK DIMENSIONS																													
			W	D	H	W	D	H	W	H																												
			25.5	25	50	20	19-20	24-34	19.5	21																												
<table border="1"> <tr> <th colspan="12">STANDARD TEXTILE GRADES</th> </tr> <tr> <td>2663-6</td> <td>\$1301</td> <td>\$1335</td> <td>\$1362</td> <td>\$1399</td> <td>\$1455</td> <td>\$1473</td> <td>\$1521</td> <td>\$1612</td> <td>\$1657</td> <td>\$1741</td> <td>\$1858</td> <td>\$1999</td> </tr> </table>												STANDARD TEXTILE GRADES												2663-6	\$1301	\$1335	\$1362	\$1399	\$1455	\$1473	\$1521	\$1612	\$1657	\$1741	\$1858	\$1999		
STANDARD TEXTILE GRADES																																						
2663-6	\$1301	\$1335	\$1362	\$1399	\$1455	\$1473	\$1521	\$1612	\$1657	\$1741	\$1858	\$1999																										
<p>RTA 2 </p>																																						
 <p>MB Drafting Stool - Task COM Yardage: 1 Freight Class: 150 Product Weight (lbs.): 44 Cubic Feet Per Carton: 10.5</p>	 <p>ADJUSTMENTS (2) Pneumatic seat height</p>	<p>Ergonomic Features: C, E, M, N, U</p>	<table border="1"> <tr> <th colspan="3">OVERALL DIMENSIONS</th> <th colspan="3">SEAT DIMENSIONS</th> <th colspan="2">BACK DIMENSIONS</th> </tr> <tr> <th>W</th> <th>D</th> <th>H</th> <th>W</th> <th>D</th> <th>H</th> <th>W</th> <th>H</th> </tr> <tr> <td>20</td> <td>25</td> <td>50</td> <td>20</td> <td>19-20</td> <td>24-34</td> <td>19.5</td> <td>21</td> </tr> </table>												OVERALL DIMENSIONS			SEAT DIMENSIONS			BACK DIMENSIONS		W	D	H	W	D	H	W	H	20	25	50	20	19-20	24-34	19.5	21
			OVERALL DIMENSIONS			SEAT DIMENSIONS			BACK DIMENSIONS																													
			W	D	H	W	D	H	W	H																												
			20	25	50	20	19-20	24-34	19.5	21																												
<table border="1"> <tr> <th colspan="12">STANDARD TEXTILE GRADES</th> </tr> <tr> <td>2664-6</td> <td>\$1183</td> <td>\$1216</td> <td>\$1243</td> <td>\$1281</td> <td>\$1335</td> <td>\$1354</td> <td>\$1403</td> <td>\$1493</td> <td>\$1539</td> <td>\$1623</td> <td>\$1736</td> <td>\$1881</td> </tr> </table>												STANDARD TEXTILE GRADES												2664-6	\$1183	\$1216	\$1243	\$1281	\$1335	\$1354	\$1403	\$1493	\$1539	\$1623	\$1736	\$1881		
STANDARD TEXTILE GRADES																																						
2664-6	\$1183	\$1216	\$1243	\$1281	\$1335	\$1354	\$1403	\$1493	\$1539	\$1623	\$1736	\$1881																										
<p>RTA 2 </p>																																						
 <p>MB Task COM Yardage: 1 Freight Class: 250 Product Weight (lbs.): 39 Cubic Feet Per Carton: 10.5</p>	 <p>ADJUSTMENTS (2) Pneumatic seat height (8) Seat depth</p>	<p>Ergonomic Features: C, E, M, N, U</p>	<table border="1"> <tr> <th colspan="3">OVERALL DIMENSIONS</th> <th colspan="3">SEAT DIMENSIONS</th> <th colspan="2">BACK DIMENSIONS</th> </tr> <tr> <th>W</th> <th>D</th> <th>H</th> <th>W</th> <th>D</th> <th>H</th> <th>W</th> <th>H</th> </tr> <tr> <td>20</td> <td>25</td> <td>39.5</td> <td>20</td> <td>19-20</td> <td>16.5-20.5</td> <td>19.5</td> <td>21</td> </tr> </table>												OVERALL DIMENSIONS			SEAT DIMENSIONS			BACK DIMENSIONS		W	D	H	W	D	H	W	H	20	25	39.5	20	19-20	16.5-20.5	19.5	21
			OVERALL DIMENSIONS			SEAT DIMENSIONS			BACK DIMENSIONS																													
			W	D	H	W	D	H	W	H																												
			20	25	39.5	20	19-20	16.5-20.5	19.5	21																												
<table border="1"> <tr> <th colspan="12">STANDARD TEXTILE GRADES</th> </tr> <tr> <td>2665-6</td> <td>\$824</td> <td>\$857</td> <td>\$884</td> <td>\$922</td> <td>\$976</td> <td>\$995</td> <td>\$1044</td> <td>\$1135</td> <td>\$1180</td> <td>\$1264</td> <td>\$1377</td> <td>\$1522</td> </tr> </table>												STANDARD TEXTILE GRADES												2665-6	\$824	\$857	\$884	\$922	\$976	\$995	\$1044	\$1135	\$1180	\$1264	\$1377	\$1522		
STANDARD TEXTILE GRADES																																						
2665-6	\$824	\$857	\$884	\$922	\$976	\$995	\$1044	\$1135	\$1180	\$1264	\$1377	\$1522																										
<p>RTA 2 </p>																																						

LURAY



Luray is offered in three back heights.



Standard Black Nylon Base/Arms with Self Skinned Urethane Armcaps

Optional Aluminum Base/Arms with Self Skinned Urethane Armcaps

Optional Aluminum Base/Arms with Wood Armcaps



Model 6460PB

MECHANISMS OPTIONS

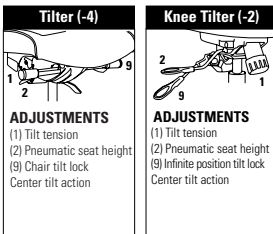

Ergonomic Features:
A, B, C, M, N, S, U

Ergonomic Features:
A, B, C, J, M, N, U

STANDARD FEATURES

- Luray is designed for boardrooms, meeting rooms and executive offices.
- Luray offers a choice of finishes to match any environment: from durable nylon components to sophisticated polished aluminum and elegant wood trim.
- Three back heights are available, featuring horizontal sewing details.
- Stitch detail on edges of seat and back is discrete, using matched thread as standard.
- Choice of two mechanisms; tilter and knee-tilter.
- Standard with Global's high quality Soft Descent™ pneumatic lift which slowly and gently lowers the seat height of the chair making it easy to obtain the exact seat height you desire.
- Fixed loop arm design comes standard in Black fiberglass reinforced nylon with a self-skinned urethane (SSU) armcap; which is soft, durable and warm to the touch. The armcap overhangs the front and side of the arm so that chair to table contact is cushioned by the pliable edge.
- Five prong, injection molded, fiberglass reinforced, nylon medium rise base (B7B) with (C1) dual wheel carpet casters.
- Check textile availability prior to specifying upholstery material.
- Pedestal base models are offered on (-4) Tilter mechanisms only. These models provide fixed location seating for use in auditoriums, classrooms, jury boxes, public venues and more. The base must be mounted to the floor (mounting hardware not included). See Pedestal Base Installation Guide for details.

OPTIONAL FEATURES

- Upholstery is available with exaggerated top stitch detail (heavier thread). Fourteen coordinating or contrasting colors may be selected. Please specify.
- For Additional caster options, please refer to the Arm and Caster section of the Price Book. Optional casters may be priced higher than the standard casters for your chair and the difference will be charged. Lower priced optional casters will not be credited.
- Please refer to "Cylinder Selection" section of the price book for additional cylinder options.
- For Memory Foam, specify (MF) and add \$108.
- Pedestal Base models have black bases with 2" height adjust cylinders. Specify (SCC) swivel, auto return to max height (no upcharge); (SN) non-swivel, auto return to max height (Add \$19); or (SC) swivel, self-centering and return to max height (Add \$30).

OPTION CODES





Please Add option codes in the following order:

- Model number**
6460 Extended high back
6461 High back
6462 Medium back

- Fabric**
Specify fabric code.
- Mechanism**
(-4) Tilter mechanism **No Upcharge**
(-2) Knee-tilt mechanism **Add \$140**
- Arms**
(SS) Black nylon arms w/SSU armcaps **No Upcharge**
(AN) Aluminum arms w/SSU armcaps **Add \$208!**
Aluminum arms w/Wood armcaps **Add \$208**
Specify finish from the following:
(AB) Absolute (AAM)
(B2) Black (BKM)
(AE) Cherry (ACM)
(EO) English Oak (EOM)
(EC) Espresso Café (ECM)
(HG) Gray (HGM)
(AH) Honey (AHM)
(TM) Mahogany (TMM)
(AV) Maple (AVM)
(MW) Medium walnut (MWM)
(NT) Natural Walnut (NLW)
(AT) Night (ASM)
(BI) Noce Biondo (NBM)
(GI) Noce Grigio (NGM)
(NI) Noce Leggero (NEM)
(MI) Noce Medio (NMM)
(SK) Shaker Cherry (SKM)
(TF) Fruitwood (TFM)
(W4) Walnut (TWM)
(WR) WC Cream (WTM)
(WH) White (WHM)
(WC) Winter Cherry (WCM)
(colors shown on website)
- Base**
(B7) Black nylon base.
(A7) Polished aluminum **Add \$154**
- Casters**
(C1) Dual wheel carpet casters.
(C9R) Dual wheel hard floor casters **Add \$66**
- Stitch detail**
(MS) Color matched stitching
Decorative top stitch **No Upcharge**
(XP) Black (XB) Beige
(XG) Copen (XA) Graphite
(XK) Mahogany (XJ) Natural
(XH) Navy (XD) New Grey
(XF) Nickel (XN) Off White
(XL) Rubytone (XI) Scarlet
(XC) Smoke (XE) Taupe
(colors shown on website)
- Seat foam**
(SF) Standard foam
(MF) Memory foam **Add \$108**
- Chair assembly**
(SU) Assembled in Box **Add \$70**
- Cylinder (for Pedestal Base)**
(SCC) Swivel, auto return turn to max height
(SN) Non-swivel, auto return turn to max height **Add \$19**
(SC) Swivel, self-centering and return to max height **Add \$30**

EXAMPLE OF ORDER CODE:

6460	WA50	4	AH	A7	C1	MS	SF	SU
Model Number	Fabric	Mechanism	Arms	Base	Casters	Stitch Detail	Seat Foam	Chair Assembly

DESCRIPTION	FEATURES	MODEL#	STANDARD TEXTILE GRADES											
			1	2	3	4	5	6	7	8	9	10	11	12
 <p>Extended High Back COM Yardage: 2.25 Freight Class: 250 Product Weight (lbs.): 46 Cubic Feet Per Carton: 14.75</p>		6460	1191	1273	1335	1429	1564	1626	1748	1940	2089	2256	2595	2957
			OVERALL DIMENSIONS			SEAT DIMENSIONS			BACK DIMENSIONS					
			W	D	H	W	D	H	W	H				
			25	26.5	46	20	19	16.5-21.5	20	27.5				
			RTA 1											
 <p>High Back COM Yardage: 2 Freight Class: 44 Product Weight (lbs.): 44 Cubic Feet Per Carton: 13.75</p>		6461	1156	1228	1283	1367	1486	1542	1650	1823	1955	2101	2404	2727
			OVERALL DIMENSIONS			SEAT DIMENSIONS			BACK DIMENSIONS					
			W	D	H	W	D	H	W	H				
			25	26.5	42.5	20	19	16.5-21.5	20	24				
			RTA 1											
 <p>Medium Back COM Yardage: 1.75 Freight Class: 250 Product Weight (lbs.): 40 Cubic Feet Per Carton: 13.75</p>		6462	1121	1187	1235	1309	1413	1461	1556	1707	1821	1950	2215	2497
			OVERALL DIMENSIONS			SEAT DIMENSIONS			BACK DIMENSIONS					
			W	D	H	W	D	H	W	H				
			25	26.5	39.5	20	19	16.5-21.5	20	21				
			RTA 1											
 <p>Extended High Back with Pedestal Base COM Yardage: 2.25 Freight Class: 250 Product Weight (lbs.): 47 Cubic Feet Per Carton: 14.75</p>		6460PB	1404	1483	1541	1630	1756	1817	1931	2114	2255	2411	2734	3077
			OVERALL DIMENSIONS			SEAT DIMENSIONS			BACK DIMENSIONS					
			W	D	H	W	D	H	W	H				
			25	26.5	44	20	19	16.5-21.5	20	27.5				
			RTA 1											
 <p>High Back with Pedestal Base COM Yardage: 2 Freight Class: 45 Product Weight (lbs.): 45 Cubic Feet Per Carton: 13.75</p>		6461PB	1370	1438	1490	1569	1682	1735	1836	1997	2122	2262	2547	2851
			OVERALL DIMENSIONS			SEAT DIMENSIONS			BACK DIMENSIONS					
			W	D	H	W	D	H	W	H				
			25	26.5	41	20	19	16.5-21.5	20	24				
			RTA 1											

DESCRIPTION	FEATURES	MODEL#	STANDARD TEXTILE GRADES											
			1	2	3	4	5	6	7	8	9	10	11	12
 <p>Medium Back with Pedestal Base COM Yardage: 1.75 Freight Class: 250 Product Weight (lbs.): 40 Cubic Feet Per Carton: 13.75</p>		6462PB	1334	1394	1440	1507	1606	1652	1742	1881	1992	2111	2361	2627
			OVERALL DIMENSIONS			SEAT DIMENSIONS			BACK DIMENSIONS					
				W	D	H	W	D	H	W	H			
			25	26.5	37	20	19	16.5-21.5	20	21				
			RTA 1											

MALAGA®



model 3140-3 (TD)



model 3140-3 (TD/PSB)



Memory Foam
Available, use code "MF" and Add \$108.



model 3141-3



model 3141-3

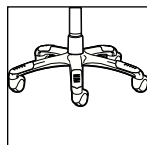

Optional Base
Polished Aluminum base with black scuff tips. Specify "B2". Add \$145.



STANDARD FEATURES

- A contoured molded foam seat, built-in lumbar support and an upholstered outer back shell is standard on all models.
- Standard with adjustable height T-arms with teardrop shaped (TD) self-skinned urethane (SSU) armcaps.
- All models are standard with a five prong, injection molded, fiberglass reinforced nylon Black spider base with dual wheel carpet casters (C10).
- Base and frame are available in Black (BK) Only.
- All models (except high back) are shipped partially KD.
- Check textile availability prior to specifying upholstery material.

- Optional abrasion resistant outer back fabric (polyester) is available. Resistant to impact damage. Available in Black only (BK). Add \$21.
- Optional Polished Aluminum base with black scuff tips. Specify "B2". Add \$154
- Please refer to the "Casters Selection" section of the price book for caster options. Optional casters may be priced higher than the standard casters for your chair and the difference will be charged. Lower priced optional casters will not be credited.
- Please refer to "Cylinder Selection" section of the price book for additional cylinder options.
- For hard surface flooring please specify C10R. Add \$60.
- For fully assembled in box, specify SU. Add \$70.

OPTIONAL FEATURES

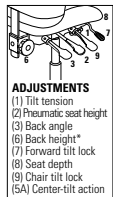
- To order a Malaga arm kit as a separate stand-alone item without a chair, use model number 3200 with the appropriate letter from the Arm Chart Price List for the arm style of your choice. Please refer to "Arms Selection" section of the price book.
- Available with an impact resistant polypropylene back shroud in Black Only. Specify (PSB). No upcharge.

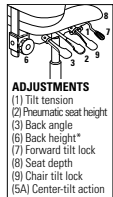
DESCRIPTION	FEATURES	MODEL#	STANDARD TEXTILE GRADES														
			1	2	3	4	5	6	7	8	9	10	11	12			
 <p>HB Multi - Tilter COM Yardage: 1.75 Freight Class: 150 Product Weight (lbs.): 54 Cubic Feet Per Carton: 9.25</p>	 <p>ADJUSTMENTS (1) Tilt tension (2) Pneumatic seat height (3) Back angle (6) Back height* (7) Forward tilt lock (8) Seat depth (9) Chair tilt lock (5A) Center-tilt action</p>	<p>Ergonomic Features: A, B, C, D, E, F, G, H, M, N, Q, S</p>	3140-3	\$1338	\$1398	\$1444	\$1511	\$1613	\$1648	\$1736	\$1898	\$1978	\$2130	\$2338	\$2597		
			OVERALL DIMENSIONS			SEAT DIMENSIONS			BACK DIMENSIONS								
			W	D	H	W	D	H	W	H							
26	25	41	20	18	16.5-20.5	18.5	22.5-25										
 <p>LB Multi - Tilter COM Yardage: 1.5 Freight Class: 150 Product Weight (lbs.): 52 Cubic Feet Per Carton: 9.25</p>	 <p>ADJUSTMENTS (1) Tilt tension (2) Pneumatic seat height (3) Back angle (6) Back height* (7) Forward tilt lock (8) Seat depth (9) Chair tilt lock (5A) Center-tilt action</p>	<p>Ergonomic Features: A, B, C, D, E, F, G, H, M, N, Q, S</p>	3141-3	\$1222	\$1270	\$1313	\$1372	\$1456	\$1486	\$1559	\$1704	\$1768	\$1898	\$2075	\$2299		
			OVERALL DIMENSIONS			SEAT DIMENSIONS			BACK DIMENSIONS								
			W	D	H	W	D	H	W	H							
26	24	37	20	18	16.5-20.5	18.5	19-21.5										

MIRAGE™



model 2790-4



model 2791-4



Standard with a polished aluminum loop arm with SSU armcap.

STANDARD FEATURES

- Ideal for management seating and meeting rooms, Mirage offers both function and style.
- There are no arm options for this series.
- Base and frame are standard in polished aluminum only.
- **C10** carpet casters are standard.
- Check textile availability prior to specifying upholstery material.

OPTIONAL FEATURES

- For hard surface flooring casters, specify **C10R** and Add \$60.
- For fully assembled in box, please specify **SU**. Add \$70..

DESCRIPTION

FEATURES

MODEL#

STANDARD TEXTILE GRADES



HB Tilter

COM Yardage: 2
 Freight Class: 250
 Product Weight (lbs.): 0
 Cubic Feet Per Carton: 20.25

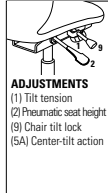

Ergonomic Features:
 A, B, C, M, N, S

	1	2	3	4	5	6	7	8	9	10	11	12
2790-4	\$1154	\$1221	\$1271	\$1350	\$1457	\$1497	\$1592	\$1776	\$1864	\$2031	\$2260	\$2548

OVERALL DIMENSIONS			SEAT DIMENSIONS			BACK DIMENSIONS	
W	D	H	W	D	H	W	H
0	0	0	20.5	19	16-20	20.5	24.5

RTA 00



MB Tilter

COM Yardage: 1.75
 Freight Class: 250
 Product Weight (lbs.): 50
 Cubic Feet Per Carton: 15.75

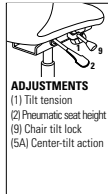

Ergonomic Features:
 A, B, C, M, N, S

	1	2	3	4	5	6	7	8	9	10	11	12
2791-4	\$1122	\$1182	\$1227	\$1293	\$1390	\$1421	\$1507	\$1667	\$1743	\$1892	\$2093	\$2345

OVERALL DIMENSIONS			SEAT DIMENSIONS			BACK DIMENSIONS	
W	D	H	W	D	H	W	H
0	0	0	19	19	16-20	19.5	17

RTA 00

NOVELLO



Novello is offered in three frame finishes: Black, Fog and Ivory Cloud.



Model 6400PB

STANDARD MECHANISMS

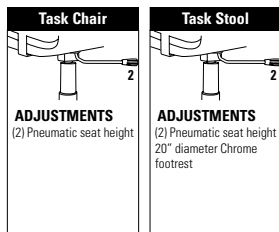

Ergonomic Features:
C, M

Ergonomic Features:
C, M

STANDARD FEATURES

- A revolutionary new task chair that can go anywhere - it requires no adjustments and provides exceptional comfort for any size user.
- Novello features a special polymer shell that flexes, allowing the seat to glide smoothly on a concealed track system. It is strong and durable, with clean lines and offers effective support.
- Chairs are molded with one-piece flexible shells; available in Black (BK), Fog (FG) or Cloud (IC). Black is the base list price.
- Chairs with Black shells are standard with five prong, injection molded, fiberglass reinforced nylon Black base (B5) with (C82) dual wheel carpet casters.
- Chairs with Fog or Cloud shells are standard with a five prong, polished cast aluminum base with Black accents (BA) and black (C82) dual wheel carpet casters.
- Fog and Cloud chairs and Black models with an aluminum base come with a chrome gas cylinder.
- All models with arms are standard with Black armcaps.
- Standard with Global's high quality Soft Descent™ pneumatic lift which slowly and gently lowers the seat height of the chair making it easy to obtain the exact seat height you desire.
- Check textile availability prior to specifying upholstery material.
- Pedestal base models are offered on with Tilter mechanisms only. These models provide fixed location seating for use in auditoriums, classrooms, jury boxes, public venues and more. The base must be mounted to the floor (mounting hardware not included). See Pedestal Base Installation Guide for details.

OPTIONAL FEATURES

- There are no arm options for this series.
- For Additional caster options, please refer to the Arm and Caster section.
- Optional casters may be priced higher than the standard casters for your chair and the difference will be charged. Lower priced optional casters will not be credited.
- Please refer to "Cylinder Selection" section of the price book for additional cylinder options.
- Pedestal Base models have black bases with 2" height adjust cylinders. Specify (SCC) swivel, auto return to max height (no upcharge); (SN) non-swivel, auto return to max height (Add \$19; or (SC) swivel, self-centering and return to max height (Add \$30).









OPTION CODES

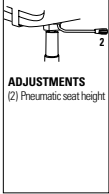

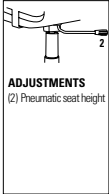

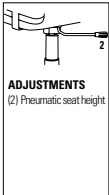

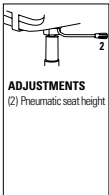

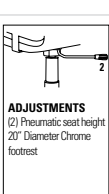
Please Add option codes in the following order:

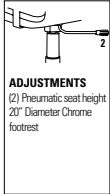

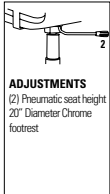
- **Model Number**
 - 6400 Chair with arms
 - 6401 Chair, armless
 - 6402 Chair with arms, fully upholstered
 - 6403 Chair, armless, fully upholstered
 - 6410 Stool with arms
 - 6411 Stool, armless
 - 6412 Stool with arms, fully upholstered
 - 6413 Stool, armless, fully upholstered
- **Fabric**
Specify fabric code
- **Shell/arm color**
 - (BK) Black shell..... **No Upcharge**
 - (FG) Fog shell **Add \$31**
 - (IC) Cloud shell..... **Add \$31**
- **Armcaps (No Upcharge)**
 - (BP) Black self-skinned urethane.
 - (FP) Fog self-skinned urethane.
 - (CP) Cloud self-skinned urethane.
- **Base**
 - (BB5) Black nylon base..... **No Upcharge**
 - (FB5) Fog nylon base..... **Add \$43**
 - (CB5) Cloud nylon base **Add \$43**
 - (BBA) Polished aluminum w/Black accent **Add \$70**
 - (FBA) Polished aluminum w/Fog accent **Add \$70**
 - (CBA) Polished aluminum w/Cloud accent..... **Add \$70**
- **Adjustable Footring (stool models)**
 - (R3) Black footring..... **No Upcharge**
 - (R4) Polished aluminum footring..... **Add \$31**
- **Casters**
 - (C82) Black dual wheel carpet casters..... **No Upcharge**
 - (C82R) Black dual wheel hard floor casters **Add \$87**
 - (C82F) Fog dual wheel carpet casters **No Upcharge**
 - (C82FR) Fog dual wheel hard floor casters..... **Add \$87**
- **Seat foam**
 - (SF) Standard foam..... **No Upcharge**
 - (PF) Extra plush cushion **No Upcharge**
- **Chair Assembly**
 - (SU) Assembled in Box **\$70**
- **Cylinder (for Pedestal Base)**
 - (SCC) Swivel, auto return turn to max height
 - (SN) Non-swivel, auto return turn to max height **Add \$19**
 - (SC) Swivel, self-centering and return to max height **Add \$30**

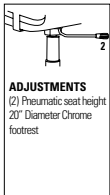
EXAMPLE OF ORDER CODE:

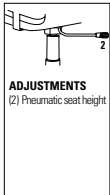
6400BK	WA50	EG	BK	AL	R3	C9R	SU
Model Number	Fabric	Shell/Arms	Armcaps	Base	Footring	Casters	Chair Assembly

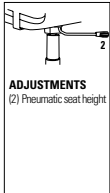
DESCRIPTION	FEATURES	MODEL#	STANDARD TEXTILE GRADES																														
			1	2	3	4	5	6	7	8	9	10	11	12																			
 <p>Task Chair w/Arms COM Yardage: 0.75 Freight Class: 150 Product Weight (lbs.): 40 Cubic Feet Per Carton: 8.25</p>	 <p>ADJUSTMENTS (2) Pneumatic seat height</p>	<p>Upholstered seat/ Polypropylene back</p> <p>Ergonomic Features: C, M</p>	<table border="1"> <tr> <td>6400</td> <td>929</td> <td>959</td> <td>979</td> <td>1014</td> <td>1060</td> <td>1074</td> <td>1116</td> <td>1192</td> <td>1229</td> <td>1302</td> <td>1397</td> <td>1519</td> </tr> </table>												6400	929	959	979	1014	1060	1074	1116	1192	1229	1302	1397	1519						
			6400	929	959	979	1014	1060	1074	1116	1192	1229	1302	1397	1519																		
			<table border="1"> <tr> <th colspan="3">OVERALL DIMENSIONS</th> <th colspan="3">SEAT DIMENSIONS</th> <th colspan="3">BACK DIMENSIONS</th> </tr> <tr> <th>W</th> <th>D</th> <th>H</th> <th>W</th> <th>D</th> <th>H</th> <th>W</th> <th>H</th> </tr> <tr> <td>25</td> <td>22</td> <td>36</td> <td>18.5</td> <td>18</td> <td>16.5-21.5</td> <td>20.5</td> <td>18.5</td> </tr> </table>			OVERALL DIMENSIONS			SEAT DIMENSIONS			BACK DIMENSIONS			W	D	H	W	D	H	W	H	25	22	36	18.5	18	16.5-21.5	20.5	18.5	<p>RTA 2</p>		
			OVERALL DIMENSIONS			SEAT DIMENSIONS			BACK DIMENSIONS																								
W	D	H	W	D	H	W	H																										
25	22	36	18.5	18	16.5-21.5	20.5	18.5																										
 <p>Armless Task Chair COM Yardage: 0.75 Freight Class: 150 Product Weight (lbs.): 35 Cubic Feet Per Carton: 6.75</p>	 <p>ADJUSTMENTS (2) Pneumatic seat height</p>	<p>Upholstered seat/ Polypropylene back</p> <p>Ergonomic Features: C, M</p>	<table border="1"> <tr> <td>6401</td> <td>841</td> <td>871</td> <td>890</td> <td>923</td> <td>966</td> <td>986</td> <td>1028</td> <td>1093</td> <td>1141</td> <td>1198</td> <td>1311</td> <td>1433</td> </tr> </table>												6401	841	871	890	923	966	986	1028	1093	1141	1198	1311	1433						
			6401	841	871	890	923	966	986	1028	1093	1141	1198	1311	1433																		
			<table border="1"> <tr> <th colspan="3">OVERALL DIMENSIONS</th> <th colspan="3">SEAT DIMENSIONS</th> <th colspan="3">BACK DIMENSIONS</th> </tr> <tr> <th>W</th> <th>D</th> <th>H</th> <th>W</th> <th>D</th> <th>H</th> <th>W</th> <th>H</th> </tr> <tr> <td>21.5</td> <td>22</td> <td>36</td> <td>18.5</td> <td>18</td> <td>16.5-21.5</td> <td>20.5</td> <td>18.5</td> </tr> </table>			OVERALL DIMENSIONS			SEAT DIMENSIONS			BACK DIMENSIONS			W	D	H	W	D	H	W	H	21.5	22	36	18.5	18	16.5-21.5	20.5	18.5	<p>RTA 2</p>		
			OVERALL DIMENSIONS			SEAT DIMENSIONS			BACK DIMENSIONS																								
W	D	H	W	D	H	W	H																										
21.5	22	36	18.5	18	16.5-21.5	20.5	18.5																										
 <p>Task Chair w/Arms COM Yardage: 0.75 Freight Class: 150 Product Weight (lbs.): 40 Cubic Feet Per Carton: 8.25</p>	 <p>ADJUSTMENTS (2) Pneumatic seat height</p>	<p>Upholstered seat & back</p> <p>Ergonomic Features: C, M</p>	<table border="1"> <tr> <td>6402</td> <td>1004</td> <td>1030</td> <td>1053</td> <td>1086</td> <td>1130</td> <td>1150</td> <td>1191</td> <td>1256</td> <td>1304</td> <td>1361</td> <td>1474</td> <td>1594</td> </tr> </table>												6402	1004	1030	1053	1086	1130	1150	1191	1256	1304	1361	1474	1594						
			6402	1004	1030	1053	1086	1130	1150	1191	1256	1304	1361	1474	1594																		
			<table border="1"> <tr> <th colspan="3">OVERALL DIMENSIONS</th> <th colspan="3">SEAT DIMENSIONS</th> <th colspan="3">BACK DIMENSIONS</th> </tr> <tr> <th>W</th> <th>D</th> <th>H</th> <th>W</th> <th>D</th> <th>H</th> <th>W</th> <th>H</th> </tr> <tr> <td>25</td> <td>22</td> <td>36</td> <td>18.5</td> <td>17.5</td> <td>16.5-21.5</td> <td>20.5</td> <td>18.5</td> </tr> </table>			OVERALL DIMENSIONS			SEAT DIMENSIONS			BACK DIMENSIONS			W	D	H	W	D	H	W	H	25	22	36	18.5	17.5	16.5-21.5	20.5	18.5	<p>RTA 2</p>		
			OVERALL DIMENSIONS			SEAT DIMENSIONS			BACK DIMENSIONS																								
W	D	H	W	D	H	W	H																										
25	22	36	18.5	17.5	16.5-21.5	20.5	18.5																										
 <p>Armless Task Chair COM Yardage: 0.75 Freight Class: 150 Product Weight (lbs.): 37 Cubic Feet Per Carton: 6.75</p>	 <p>ADJUSTMENTS (2) Pneumatic seat height</p>	<p>Upholstered seat & back</p> <p>Ergonomic Features: C, M</p>	<table border="1"> <tr> <td>6403</td> <td>924</td> <td>954</td> <td>974</td> <td>1006</td> <td>1050</td> <td>1070</td> <td>1112</td> <td>1177</td> <td>1226</td> <td>1281</td> <td>1394</td> <td>1514</td> </tr> </table>												6403	924	954	974	1006	1050	1070	1112	1177	1226	1281	1394	1514						
			6403	924	954	974	1006	1050	1070	1112	1177	1226	1281	1394	1514																		
			<table border="1"> <tr> <th colspan="3">OVERALL DIMENSIONS</th> <th colspan="3">SEAT DIMENSIONS</th> <th colspan="3">BACK DIMENSIONS</th> </tr> <tr> <th>W</th> <th>D</th> <th>H</th> <th>W</th> <th>D</th> <th>H</th> <th>W</th> <th>H</th> </tr> <tr> <td>21.5</td> <td>22</td> <td>36</td> <td>18.5</td> <td>17.5</td> <td>16.5-21.5</td> <td>20.5</td> <td>18.5</td> </tr> </table>			OVERALL DIMENSIONS			SEAT DIMENSIONS			BACK DIMENSIONS			W	D	H	W	D	H	W	H	21.5	22	36	18.5	17.5	16.5-21.5	20.5	18.5	<p>RTA 2</p>		
			OVERALL DIMENSIONS			SEAT DIMENSIONS			BACK DIMENSIONS																								
W	D	H	W	D	H	W	H																										
21.5	22	36	18.5	17.5	16.5-21.5	20.5	18.5																										
 <p>Task Stool w/Arms COM Yardage: 0.75 Freight Class: 150 Product Weight (lbs.): 44 Cubic Feet Per Carton: 8.25</p>	 <p>ADJUSTMENTS (2) Pneumatic seat height 20" Diameter Chrome footrest</p>	<p>Upholstered seat/ Polypropylene back</p> <p>Ergonomic Features: C, M</p>	<table border="1"> <tr> <td>6410</td> <td>1067</td> <td>1098</td> <td>1117</td> <td>1150</td> <td>1193</td> <td>1214</td> <td>1255</td> <td>1320</td> <td>1369</td> <td>1425</td> <td>1539</td> <td>1660</td> </tr> </table>												6410	1067	1098	1117	1150	1193	1214	1255	1320	1369	1425	1539	1660						
			6410	1067	1098	1117	1150	1193	1214	1255	1320	1369	1425	1539	1660																		
			<table border="1"> <tr> <th colspan="3">OVERALL DIMENSIONS</th> <th colspan="3">SEAT DIMENSIONS</th> <th colspan="3">BACK DIMENSIONS</th> </tr> <tr> <th>W</th> <th>D</th> <th>H</th> <th>W</th> <th>D</th> <th>H</th> <th>W</th> <th>H</th> </tr> <tr> <td>25</td> <td>22</td> <td>46</td> <td>18.5</td> <td>18</td> <td>24-34</td> <td>20.5</td> <td>18.5</td> </tr> </table>			OVERALL DIMENSIONS			SEAT DIMENSIONS			BACK DIMENSIONS			W	D	H	W	D	H	W	H	25	22	46	18.5	18	24-34	20.5	18.5	<p>RTA 2</p>		
			OVERALL DIMENSIONS			SEAT DIMENSIONS			BACK DIMENSIONS																								
W	D	H	W	D	H	W	H																										
25	22	46	18.5	18	24-34	20.5	18.5																										

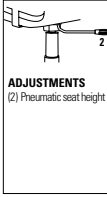
DESCRIPTION	FEATURES	MODEL#	STANDARD TEXTILE GRADES											
			1	2	3	4	5	6	7	8	9	10	11	12
 <p>Armless Task Stool COM Yardage: 0.75 Freight Class: 150 Product Weight (lbs.): 39 Cubic Feet Per Carton: 8.25</p>	 <p>ADJUSTMENTS (2) Pneumatic seat height 20" Diameter Chrome footrest</p>	6411	977	1007	1026	1059	1102	1122	1164	1229	1277	1334	1447	1569
			OVERALL DIMENSIONS			SEAT DIMENSIONS			BACK DIMENSIONS					
			W	D	H	W	D	H	W	H				
			25	21.5	46	18.5	17.5	24-34	20.5	18.5				
			RTA 2											
 <p>Task Stool w/Arms COM Yardage: 0.75 Freight Class: 150 Product Weight (lbs.): 46 Cubic Feet Per Carton: 8.25</p>	 <p>ADJUSTMENTS (2) Pneumatic seat height 20" Diameter Chrome footrest</p>	6412	1142	1172	1192	1227	1273	1288	1329	1406	1441	1512	1611	1732
			OVERALL DIMENSIONS			SEAT DIMENSIONS			BACK DIMENSIONS					
			W	D	H	W	D	H	W	H				
			25	22	46	18.5	18	24-34	20.5	18.5				
			RTA 2											
 <p>Armless Task Stool COM Yardage: 0.75 Freight Class: 150 Product Weight (lbs.): 39 Cubic Feet Per Carton: 8.25</p>	 <p>ADJUSTMENTS (2) Pneumatic seat height 20" Diameter Chrome footrest</p>	6413	1053	1083	1102	1135	1179	1199	1240	1305	1353	1410	1523	1643
			OVERALL DIMENSIONS			SEAT DIMENSIONS			BACK DIMENSIONS					
			W	D	H	W	D	H	W	H				
			25	21.5	46	18.5	18	24-34	20.5	18.5				
			RTA 2											
 <p>Task Chair w/Arms and Pedestal Base COM Yardage: 0.75 Freight Class: 150 Product Weight (lbs.): 42 Cubic Feet Per Carton: 8.25</p>	 <p>ADJUSTMENTS (2) Pneumatic seat height</p>	6400PB	1144	1169	1188	1214	1254	1271	1307	1362	1405	1453	1552	1655
			OVERALL DIMENSIONS			SEAT DIMENSIONS			BACK DIMENSIONS					
			W	D	H	W	D	H	W	H				
			25	22	34	18.5	18	16.5-21.5	20.5	18.5				
			RTA 2											
 <p>Armless Task Chair with Pedestal Base COM Yardage: 0.75 Freight Class: 150 Product Weight (lbs.): 39 Cubic Feet Per Carton: 6.75</p>	 <p>ADJUSTMENTS (2) Pneumatic seat height</p>	6401PB	1054	1078	1097	1123	1163	1180	1216	1271	1314	1362	1459	1564
			OVERALL DIMENSIONS			SEAT DIMENSIONS			BACK DIMENSIONS					
			W	D	H	W	D	H	W	H				
			21.5	22	34	18.5	18	16.5-21.5	20.5	18.5				
			RTA 2											

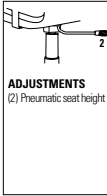
DESCRIPTION	FEATURES	MODEL#	STANDARD TEXTILE GRADES													
			1	2	3	4	5	6	7	8	9	10	11	12		
 <p>Task Chair w/Arms with Pedestal Base COM Yardage: 0.75 Freight Class: 150 Product Weight (lbs.): 44 Cubic Feet Per Carton: 8.25</p>	 <p>ADJUSTMENTS (2) Pneumatic seat height</p> <p>Upholstered seat & back</p> <p>Ergonomic Features: C, M</p>	6402PB	1219	1243	1262	1288	1328	1345	1381	1436	1479	1527	1624	1729		
			OVERALL DIMENSIONS			SEAT DIMENSIONS			BACK DIMENSIONS							
			W	D	H	W	D	H	W	H						
			25	22	34	18.5	17.5	16.5-21.5	20.5	18.5						
			RTA 2													
 <p>Armless Task Chair COM Yardage: 0.75 Freight Class: 125 Product Weight (lbs.): 41 Cubic Feet Per Carton: 6.75</p>	 <p>ADJUSTMENTS (2) Pneumatic seat height</p> <p>Upholstered seat & back</p> <p>Ergonomic Features: C, M</p>	6403PB	1138	1162	1181	1208	1247	1265	1301	1356	1399	1447	1546	1650		
			OVERALL DIMENSIONS			SEAT DIMENSIONS			BACK DIMENSIONS							
			W	D	H	W	D	H	W	H						
			21.5	22	34	18.5	17.5	16.5-21.5	20.5	18.5						
			RTA 2													

OBUSFORME® COMFORT



model 1240-3



model 1241-3



Memory Foam
Available, use code "MF" and Add \$108.



model 1261-3



STANDARD FEATURES

- ObusForme Comfort is recommended by chiropractors worldwide.
- Features a new elastomeric back support system that provides impressive, comfortable support with no pressure points along the spine.
- Height, width and depth adjustable (**G3**) arms with self-skinned urethane (SSU) arm pads. Armcaps articulate inwards 30°
- Five prong, injection molded, fiberglass reinforced nylon Black spider base with dual wheel carpet casters (**C65**).
- Standard seat foam is a dual cushion with a soft top layer and a firmly supportive lower layer.
- Sliding seat depth is standard on all synchro-tilter and multi-tilter models.
- Schukra™ depth adjustable lumbar support for personalized back support and comfort is standard on select models.
- Vari-Width (**WA**) width adjustable arm extensions
- are standard when chair is ordered with adjustable arms. Allows the arms to move away from the seat by 2" on each side to allow space if desired for broader hip widths.
- All models are shipped partially KD.
- Check textile availability prior to specifying upholstery material.

- "P" petite seat models have a seat that is 0.75" shallower and 1.5" narrower than the standard seat.
- Petite seats have the same list prices as standard models.

OPTIONAL FEATURES

- Optional Memory Foam (**MF**) seats are available. This slow release foam molds to your contour and evenly distributes body weight. Please specify. Add \$108.
- An optional Polished Aluminum base with scuff resistant tips is available. Please specify (**ALU**). Add \$154
- Please refer to the "Casters Selection" section of the price book for caster options. Optional casters may be priced higher than the standard casters for your chair and the difference will be charged. Lower priced optional casters will not be credited.
- Please refer to "Cylinder Selection" section of the price book for additional cylinder options.
- Please specify **C65R** for hard surface flooring. Add \$66
- For fully assembled in box, please **SU**. Add \$70.

DESCRIPTION FEATURES MODEL# STANDARD TEXTILE GRADES



HB Knee - Tilter
COM Yardage: 2.25
Freight Class: 125
Product Weight (lbs.): 67
Cubic Feet Per Carton: 11

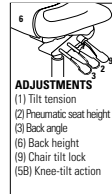

ADJUSTMENTS
(1) Tilt tension
(2) Pneumatic seat height
(3) Back angle
(6) Back height
(9) Chair tilt lock
(5B) Knee-tilt action

Ergonomic Features:
A, B, C, D, E, G, H, J, M, N, Q, R, U

MODEL#	1	2	3	4	5	6	7	8	9	10	11	12
1240-2	\$1339	\$1422	\$1487	\$1585	\$1724	\$1774	\$1894	\$2126	\$2236	\$2450	\$2742	\$3104
1240P-2 Petite seat												

OVERALL DIMENSIONS			SEAT DIMENSIONS			BACK DIMENSIONS	
W	D	H	W	D	H	W	H
26	25	48.5	21	17.5-20	16.5-20.5	19	27.5



HB Multi - Tilter
COM Yardage: 2.25
Freight Class: 125
Product Weight (lbs.): 69
Cubic Feet Per Carton: 11

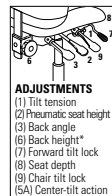

ADJUSTMENTS
(1) Tilt tension
(2) Pneumatic seat height
(3) Back angle
(6) Back height*
(7) Forward tilt lock
(8) Seat depth
(9) Chair tilt lock
(5A) Center-tilt action

Ergonomic Features:
A, B, C, D, E, F, G, H, M, N, Q, R, S, U

MODEL#	1	2	3	4	5	6	7	8	9	10	11	12
1240-3	\$1144	\$1229	\$1292	\$1390	\$1529	\$1579	\$1701	\$1931	\$2041	\$2256	\$2547	\$2909
1240P-3 Petite seat												

OVERALL DIMENSIONS			SEAT DIMENSIONS			BACK DIMENSIONS	
W	D	H	W	D	H	W	H
26	25	48	21	17.5-20	16-20	19	27



MB Knee - Tilter
COM Yardage: 2
Freight Class: 125
Product Weight (lbs.): 67
Cubic Feet Per Carton: 10.5

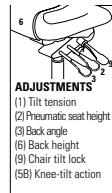









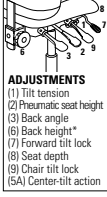

ADJUSTMENTS
(1) Tilt tension
(2) Pneumatic seat height
(3) Back angle
(6) Back height
(9) Chair tilt lock
(5B) Knee-tilt action

Ergonomic Features:
A, B, C, D, E, G, H, J, M, N, Q, R, U

MODEL#	1	2	3	4	5	6	7	8	9	10	11	12
1241-2	\$1283	\$1359	\$1416	\$1502	\$1626	\$1669	\$1777	\$1982	\$2081	\$2272	\$2530	\$2852

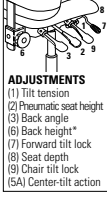
OVERALL DIMENSIONS			SEAT DIMENSIONS			BACK DIMENSIONS	
W	D	H	W	D	H	W	H
26	25	44.5	21	17.5-20	16.5-20.5	19.5	22-27.5

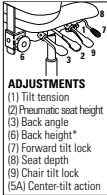

DESCRIPTION	FEATURES	MODEL#	STANDARD TEXTILE GRADES													
			1	2	3	4	5	6	7	8	9	10	11	12		
 <p>MB Multi -Tilter COM Yardage: 2 Freight Class: 125 Product Weight (lbs.): 67 Cubic Feet Per Carton: 10.5</p>	 <p>ADJUSTMENTS (1) Tilt tension (2) Pneumatic seat height (3) Back angle (6) Back height* (7) Forward tilt lock (8) Seat depth (9) Chair tilt lock (SA) Center-tilt action</p>	<p>Ergonomic Features: A, B, C, D, E, F, G, H, M, N, Q, R, S, U</p>	1241-3	\$1087	\$1160	\$1220	\$1305	\$1428	\$1473	\$1579	\$1785	\$1884	\$2073	\$2331	\$2655	
			OVERALL DIMENSIONS			SEAT DIMENSIONS			BACK DIMENSIONS							
			W	D	H	W	D	H	W	H						
			26	25	44	21	17.5-20	16-20	19.5	22						
			RTA 2													
 <p>Armchair - Sled Base COM Yardage: 1.75 Freight Class: 250 Product Weight (lbs.): 35 Cubic Feet Per Carton: 10</p>		<p>Ergonomic Features: M, N</p>	1246	\$700	\$762	\$810	\$880	\$980	\$1015	\$1103	\$1270	\$1351	\$1506	\$1718	\$1981	
			OVERALL DIMENSIONS			SEAT DIMENSIONS			BACK DIMENSIONS							
			W	D	H	W	D	H	W	H						
			21	24	38	21	18	18	20	20.5						
			RTA 2													
 <p>Armchair - Sled Base COM Yardage: 1.75 Freight Class: 250 Product Weight (lbs.): 40 Cubic Feet Per Carton: 13</p>		<p>Ergonomic Features: M, N</p>	1247	\$921	\$982	\$1030	\$1101	\$1201	\$1236	\$1323	\$1491	\$1572	\$1729	\$1940	\$2200	
			OVERALL DIMENSIONS			SEAT DIMENSIONS			BACK DIMENSIONS							
			W	D	H	W	D	H	W	H						
			26.5	24	38	21	18	18	20	20.5						
			RTA 2													
 <p>HB Multi -Tilter w/Schukra COM Yardage: 2.25 Freight Class: 125 Product Weight (lbs.): 69 Cubic Feet Per Carton: 11</p>	 <p>ADJUSTMENTS (1) Tilt tension (2) Pneumatic seat height (3) Back angle (6) Back height* (7) Forward tilt lock (8) Seat depth (9) Chair tilt lock (SA) Center-tilt action</p>	<p>Ergonomic Features: A, B, C, D, E, F, G, H, M, N, Q, R, S, U, V</p>	1260-3	\$1295	\$1380	\$1443	\$1541	\$1680	\$1730	\$1850	\$2082	\$2192	\$2406	\$2698	\$3060	
			OVERALL DIMENSIONS			SEAT DIMENSIONS			BACK DIMENSIONS							
			W	D	H	W	D	H	W	H						
			26	25	48	21	17.5-20	16-20	19.5	27-32.25						
			RTA 2													
 <p>MB Multi -Tilter w/Schukra COM Yardage: 2 Freight Class: 125 Product Weight (lbs.): 67 Cubic Feet Per Carton: 10.5</p>	 <p>ADJUSTMENTS (1) Tilt tension (2) Pneumatic seat height (3) Back angle (6) Back height* (7) Forward tilt lock (8) Seat depth (9) Chair tilt lock (SA) Center-tilt action</p>	<p>Ergonomic Features: A, B, C, D, E, F, G, H, M, N, Q</p>	1261-3	\$1239	\$1315	\$1372	\$1458	\$1582	\$1625	\$1733	\$1937	\$2037	\$2228	\$2486	\$2808	
			OVERALL DIMENSIONS			SEAT DIMENSIONS			BACK DIMENSIONS							
			W	D	H	W	D	H	W	H						
			26	25	44	21	17.5-20	16-20	19.5	22						
			RTA 2													

OBUSFORME® COMFORT XL



model 1251-0



model 1252-8







Memory Foam
Available, use code "MF"
and Add \$108





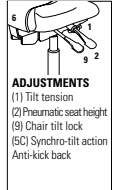

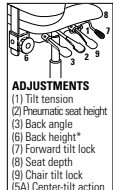

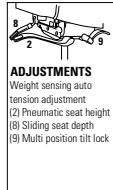
STANDARD FEATURES

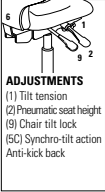

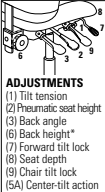

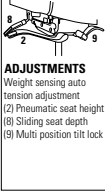

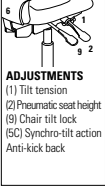

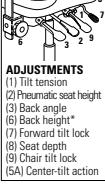
- ObusForme Comfort XL is the newest Addition to the ObusForme family and is recommended by chiropractors worldwide.
- All models provided Additional height and/or seat depth, design to meet the requirements of the large occupant chair.
- Features a elastomeric back support system that provides impressive comfortable support with no pressure points along the spine, with a compound curved back and seat.
- Standard seat foam is extra thick dual cushion with a soft top layer and a firmly supportive lower layer.
- Standard with height and width adjustable forward swept arms with "sliding armcaps" (G3).
- Standard with Global's high quality Soft Descent™ Pneumatic lift which slowly and gently lowers the seat height of the chair making it easy to obtain exactly the right seat height you desire.
- Vari - Width Adapter Plate (WA) is standard. Allows each arm to move outward an Additional 2" (for a total of 4" extra seat width) and locks with the use of an easy to maneuver lever.
- Check textile availability prior to specifying upholstery material.
- Sliding seat depth is standard on all models.
- Vertical back height ratchet adjustment of 5 1/4", standard on all models.
- Standard five-legged, injection moulded, fiberglass reinforced nylon black spider base.
- C65 dual wheel carpet casters are standard.
- All models are rated for 400lbs.
- All models ship fully assembled in the box.

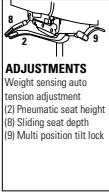

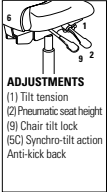

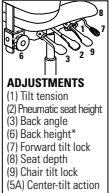

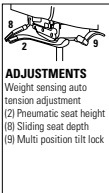

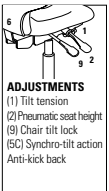

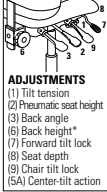



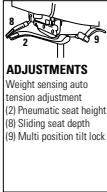

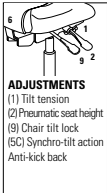

OPTIONAL FEATURES

- Please specify C65R for hard surface flooring. Add \$66.

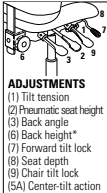
DESCRIPTION	FEATURES	MODEL#	STANDARD TEXTILE GRADES											
			1	2	3	4	5	6	7	8	9	10	11	12
 <p>Extended Back Synchro - Tilter w/ Back Angle Adj. COM Yardage: 2.75 Freight Class: 250 Product Weight (lbs.): 69 Cubic Feet Per Carton: 24.25</p>	 <p>ADJUSTMENTS (1) Tilt tension (2) Pneumatic seat height (9) Chair tilt lock (5C) Synchro-tilt action Anti-kick back</p>	1251-0	1751	1842	1913	2016	2169	2221	2353	2604	2724	2956	3274	3668
		OVERALL DIMENSIONS			SEAT DIMENSIONS			BACK DIMENSIONS						
		W	D	H	W	D	H	W	H					
28	26	53	23.5	19-21.5	17-21	22	31-36.25							
			RTA 00											
 <p>Extended Back Multi - Tilter COM Yardage: 2.75 Freight Class: 250 Product Weight (lbs.): 71 Cubic Feet Per Carton: 24.25</p>	 <p>ADJUSTMENTS (1) Tilt tension (2) Pneumatic seat height (3) Back angle (6) Back height* (7) Forward tilt lock (8) Seat depth (9) Chair tilt lock (5A) Center-tilt action</p>	1251-3	1751	1842	1913	2016	2169	2221	2353	2604	2724	2956	3274	3668
		OVERALL DIMENSIONS			SEAT DIMENSIONS			BACK DIMENSIONS						
		W	D	H	W	D	H	W	H					
28	26	53	23.5	19-21.5	17-21	22	31-36.25							
			RTA 00											
 <p>Extended Back Weight Sensing Synchro - Tilter COM Yardage: 2.75 Freight Class: 250 Product Weight (lbs.): 66 Cubic Feet Per Carton: 24.25</p>	 <p>ADJUSTMENTS Weight sensing auto tension adjustment (2) Pneumatic seat height (8) Sliding seat depth (9) Multi position tilt lock</p>	1251-8	1751	1842	1913	2016	2169	2221	2353	2604	2724	2956	3274	3668
		OVERALL DIMENSIONS			SEAT DIMENSIONS			BACK DIMENSIONS						
		W	D	H	W	D	H	W	H					
28	26	53	23.5	19-21.5	17-21	22	31-36.25							
			RTA 00											

DESCRIPTION	FEATURES	MODEL#	STANDARD TEXTILE GRADES											
			1	2	3	4	5	6	7	8	9	10	11	12
 <p>High Back Synchro - Tilter w/ Back Angle Adj. COM Yardage: 2.50 Freight Class: 250 Product Weight (lbs.): 65 Cubic Feet Per Carton: 22.25</p>	 <p>ADJUSTMENTS (1) Tilt tension (2) Pneumatic seat height (9) Chair tilt lock (5C) Synchro-tilt action Anti-kick back</p>	1252-0	1674	1756	1821	1917	2052	2102	2221	2448	2561	2771	3058	3418
			OVERALL DIMENSIONS			SEAT DIMENSIONS			BACK DIMENSIONS					
			W	D	H	W	D	H	W	H				
			28	26	48.5	23.5	19-21.5	17-21	22	26.5-31.75				
			RTA 00											
 <p>High Back Multi - Tilter COM Yardage: 2.50 Freight Class: 250 Product Weight (lbs.): 67 Cubic Feet Per Carton: 22.25</p>	 <p>ADJUSTMENTS (1) Tilt tension (2) Pneumatic seat height (3) Back angle (6) Back height* (7) Forward tilt lock (8) Seat depth (9) Chair tilt lock (5A) Center-tilt action</p>	1252-3	1674	1756	1821	1917	2052	2102	2221	2448	2561	2771	3058	3418
			OVERALL DIMENSIONS			SEAT DIMENSIONS			BACK DIMENSIONS					
			W	D	H	W	D	H	W	H				
			28	26	48.5	23.5	19-21.5	17-21	22	26.5-31.75				
			RTA 00											
 <p>High Back Weight Sensing Synchro - Tilter COM Yardage: 2.50 Freight Class: 250 Product Weight (lbs.): 62 Cubic Feet Per Carton: 22.25</p>	 <p>ADJUSTMENTS Weight sensing auto tension adjustment (2) Pneumatic seat height (8) Sliding seat depth (9) Multi position tilt lock</p>	1252-8	1674	1756	1821	1917	2052	2102	2221	2448	2561	2771	3058	3418
			OVERALL DIMENSIONS			SEAT DIMENSIONS			BACK DIMENSIONS					
			W	D	H	W	D	H	W	H				
			28	26	48.5	23.5	19-21.5	17-21	22	26.5-31.75				
			RTA 00											
 <p>Mid Back Synchro - Tilter w/ Back Angle Adj. COM Yardage: 1.75 Freight Class: 150 Product Weight (lbs.): 46 Cubic Feet Per Carton: 10.50</p>	 <p>ADJUSTMENTS (1) Tilt tension (2) Pneumatic seat height (9) Chair tilt lock (5C) Synchro-tilt action Anti-kick back</p>	1253-0	1598	1681	1746	1842	1979	2027	2147	2374	2486	2697	2983	3342
			OVERALL DIMENSIONS			SEAT DIMENSIONS			BACK DIMENSIONS					
			W	D	H	W	D	H	W	H				
			28	26	44.5	23.5	19-21.5	17-21	22	22-27.25				
			RTA 00											
 <p>Mid Back Multi - Tilter COM Yardage: 1.75 Freight Class: 150 Product Weight (lbs.): 41 Cubic Feet Per Carton: 10.50</p>	 <p>ADJUSTMENTS (1) Tilt tension (2) Pneumatic seat height (3) Back angle (6) Back height* (7) Forward tilt lock (8) Seat depth (9) Chair tilt lock (5A) Center-tilt action</p>	1253-3	1598	1681	1746	1842	1979	2027	2147	2374	2486	2697	2983	3342
			OVERALL DIMENSIONS			SEAT DIMENSIONS			BACK DIMENSIONS					
			W	D	H	W	D	H	W	H				
			28	26	44.5	23.5	19-21.5	17-21	22	22-27.25				
			RTA 00											

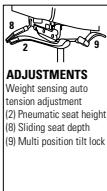
DESCRIPTION	FEATURES	MODEL#	STANDARD TEXTILE GRADES																								
			1	2	3	4	5	6	7	8	9	10	11	12													
 <p>Mid Back Weight Sensing Synchro - Tilter COM Yardage: 1.75 Freight Class: 150 Product Weight (lbs.): 35 Cubic Feet Per Carton: 10</p>	 <p>ADJUSTMENTS Weight sensing auto tension adjustment (2) Pneumatic seat height (8) Sliding seat depth (9) Multi position tilt lock</p>	<p>Mid/Wide Back. Wide/Deep Seat.</p> <p>Ergonomic Features: A, B, C, D, E, H, L, M, N, Q, R, U</p>	<table border="1"> <tr> <td>1253-8</td><td>1598</td><td>1681</td><td>1746</td><td>1842</td><td>1979</td><td>2027</td><td>2147</td><td>2374</td><td>2486</td><td>2697</td><td>2983</td><td>3342</td> </tr> </table>												1253-8	1598	1681	1746	1842	1979	2027	2147	2374	2486	2697	2983	3342
			1253-8	1598	1681	1746	1842	1979	2027	2147	2374	2486	2697	2983	3342												
			<table border="1"> <thead> <tr> <th colspan="3">OVERALL DIMENSIONS</th> <th colspan="3">SEAT DIMENSIONS</th> <th colspan="3">BACK DIMENSIONS</th> </tr> <tr> <th>W</th><th>D</th><th>H</th> <th>W</th><th>D</th><th>H</th> <th>W</th><th>H</th> </tr> </thead> <tbody> <tr> <td>28</td><td>26</td><td>44.5</td> <td>23.5</td><td>19-21.5</td><td>17-21</td> <td>22</td><td>22-27.25</td> </tr> </tbody> </table>			OVERALL DIMENSIONS			SEAT DIMENSIONS			BACK DIMENSIONS			W	D	H	W	D	H	W	H	28	26	44.5	23.5	19-21.5
OVERALL DIMENSIONS			SEAT DIMENSIONS			BACK DIMENSIONS																					
W	D	H	W	D	H	W	H																				
28	26	44.5	23.5	19-21.5	17-21	22	22-27.25																				
<p>RTA 00</p>																											
 <p>Extended Back Synchro - Tilter w/ Back Angle Adj. COM Yardage: 1.75 Freight Class: 250 Product Weight (lbs.): 40 Cubic Feet Per Carton: 10</p>	 <p>ADJUSTMENTS (1) Tilt tension (2) Pneumatic seat height (9) Chair tilt lock (5C) Synchro-tilt action Anti-kick back</p>	<p>Extra Tall/Wide Back. Standard Seat.</p> <p>Ergonomic Features: A, B, C, D, E, G, H, L, M, N, Q, R, U</p>	<table border="1"> <tr> <td>1254-0</td><td>1674</td><td>1764</td><td>1835</td><td>1941</td><td>2092</td><td>2144</td><td>2277</td><td>2527</td><td>2648</td><td>2879</td><td>3197</td><td>3591</td> </tr> </table>												1254-0	1674	1764	1835	1941	2092	2144	2277	2527	2648	2879	3197	3591
			1254-0	1674	1764	1835	1941	2092	2144	2277	2527	2648	2879	3197	3591												
			<table border="1"> <thead> <tr> <th colspan="3">OVERALL DIMENSIONS</th> <th colspan="3">SEAT DIMENSIONS</th> <th colspan="3">BACK DIMENSIONS</th> </tr> <tr> <th>W</th><th>D</th><th>H</th> <th>W</th><th>D</th><th>H</th> <th>W</th><th>H</th> </tr> </thead> <tbody> <tr> <td>28</td><td>24.5</td><td>53</td> <td>23.5</td><td>17-19.5</td><td>17-21</td> <td>22</td><td>31-36.25</td> </tr> </tbody> </table>			OVERALL DIMENSIONS			SEAT DIMENSIONS			BACK DIMENSIONS			W	D	H	W	D	H	W	H	28	24.5	53	23.5	17-19.5
OVERALL DIMENSIONS			SEAT DIMENSIONS			BACK DIMENSIONS																					
W	D	H	W	D	H	W	H																				
28	24.5	53	23.5	17-19.5	17-21	22	31-36.25																				
<p>RTA 00</p>																											
 <p>Extended Back Multi - Tilter COM Yardage: 1.75 Freight Class: 250 Product Weight (lbs.): 49 Cubic Feet Per Carton: 10.50</p>	 <p>ADJUSTMENTS (1) Tilt tension (2) Pneumatic seat height (3) Back angle (6) Back height* (7) Forward tilt lock (8) Seat depth (9) Chair tilt lock (5A) Center-tilt action</p>	<p>Extra Tall/Wide Back. Standard Seat.</p> <p>Ergonomic Features: A, B, C, D, E, F, G, H, M, N, Q, R, S, U</p>	<table border="1"> <tr> <td>1254-3</td><td>1674</td><td>1764</td><td>1835</td><td>1941</td><td>2092</td><td>2144</td><td>2277</td><td>2527</td><td>2648</td><td>2879</td><td>3197</td><td>3591</td> </tr> </table>												1254-3	1674	1764	1835	1941	2092	2144	2277	2527	2648	2879	3197	3591
			1254-3	1674	1764	1835	1941	2092	2144	2277	2527	2648	2879	3197	3591												
			<table border="1"> <thead> <tr> <th colspan="3">OVERALL DIMENSIONS</th> <th colspan="3">SEAT DIMENSIONS</th> <th colspan="3">BACK DIMENSIONS</th> </tr> <tr> <th>W</th><th>D</th><th>H</th> <th>W</th><th>D</th><th>H</th> <th>W</th><th>H</th> </tr> </thead> <tbody> <tr> <td>28</td><td>24.5</td><td>53</td> <td>23.5</td><td>17-19.5</td><td>17-21</td> <td>22</td><td>31-36.25</td> </tr> </tbody> </table>			OVERALL DIMENSIONS			SEAT DIMENSIONS			BACK DIMENSIONS			W	D	H	W	D	H	W	H	28	24.5	53	23.5	17-19.5
OVERALL DIMENSIONS			SEAT DIMENSIONS			BACK DIMENSIONS																					
W	D	H	W	D	H	W	H																				
28	24.5	53	23.5	17-19.5	17-21	22	31-36.25																				
<p>RTA 00</p>																											
 <p>Extended Back Weight Sensing Synchro - Tilter COM Yardage: 1.75 Freight Class: 250 Product Weight (lbs.): 54 Cubic Feet Per Carton: 10.50</p>	 <p>ADJUSTMENTS Weight sensing auto tension adjustment (2) Pneumatic seat height (8) Sliding seat depth (9) Multi position tilt lock</p>	<p>Extra Tall/Wide Back. Standard Seat.</p> <p>Ergonomic Features: A, B, C, D, E, H, L, M, N, Q, R, U</p>	<table border="1"> <tr> <td>1254-8</td><td>1674</td><td>1764</td><td>1835</td><td>1941</td><td>2092</td><td>2144</td><td>2277</td><td>2527</td><td>2648</td><td>2879</td><td>3197</td><td>3591</td> </tr> </table>												1254-8	1674	1764	1835	1941	2092	2144	2277	2527	2648	2879	3197	3591
			1254-8	1674	1764	1835	1941	2092	2144	2277	2527	2648	2879	3197	3591												
			<table border="1"> <thead> <tr> <th colspan="3">OVERALL DIMENSIONS</th> <th colspan="3">SEAT DIMENSIONS</th> <th colspan="3">BACK DIMENSIONS</th> </tr> <tr> <th>W</th><th>D</th><th>H</th> <th>W</th><th>D</th><th>H</th> <th>W</th><th>H</th> </tr> </thead> <tbody> <tr> <td>28</td><td>24.5</td><td>53</td> <td>23.5</td><td>17-19.5</td><td>17-21</td> <td>22</td><td>31-36.25</td> </tr> </tbody> </table>			OVERALL DIMENSIONS			SEAT DIMENSIONS			BACK DIMENSIONS			W	D	H	W	D	H	W	H	28	24.5	53	23.5	17-19.5
OVERALL DIMENSIONS			SEAT DIMENSIONS			BACK DIMENSIONS																					
W	D	H	W	D	H	W	H																				
28	24.5	53	23.5	17-19.5	17-21	22	31-36.25																				
<p>RTA 00</p>																											
 <p>High Back Synchro - Tilter w/ Back Angle Adj. COM Yardage: 2.25 Freight Class: 250 Product Weight (lbs.): 67 Cubic Feet Per Carton: 11</p>	 <p>ADJUSTMENTS (1) Tilt tension (2) Pneumatic seat height (9) Chair tilt lock (5C) Synchro-tilt action Anti-kick back</p>	<p>High/Wide Back. Standard Seat.</p> <p>Ergonomic Features: A, B, C, D, E, G, H, L, M, N, Q, R, U</p>	<table border="1"> <tr> <td>1255-0</td><td>1598</td><td>1681</td><td>1746</td><td>1842</td><td>1979</td><td>2027</td><td>2147</td><td>2374</td><td>2486</td><td>2697</td><td>2983</td><td>3342</td> </tr> </table>												1255-0	1598	1681	1746	1842	1979	2027	2147	2374	2486	2697	2983	3342
			1255-0	1598	1681	1746	1842	1979	2027	2147	2374	2486	2697	2983	3342												
			<table border="1"> <thead> <tr> <th colspan="3">OVERALL DIMENSIONS</th> <th colspan="3">SEAT DIMENSIONS</th> <th colspan="3">BACK DIMENSIONS</th> </tr> <tr> <th>W</th><th>D</th><th>H</th> <th>W</th><th>D</th><th>H</th> <th>W</th><th>H</th> </tr> </thead> <tbody> <tr> <td>28</td><td>24.5</td><td>48</td> <td>23.5</td><td>17-19.5</td><td>17-21</td> <td>22</td><td>26.5-31.75</td> </tr> </tbody> </table>			OVERALL DIMENSIONS			SEAT DIMENSIONS			BACK DIMENSIONS			W	D	H	W	D	H	W	H	28	24.5	48	23.5	17-19.5
OVERALL DIMENSIONS			SEAT DIMENSIONS			BACK DIMENSIONS																					
W	D	H	W	D	H	W	H																				
28	24.5	48	23.5	17-19.5	17-21	22	26.5-31.75																				
<p>RTA 00</p>																											

DESCRIPTION	FEATURES	MODEL#	STANDARD TEXTILE GRADES														
			1	2	3	4	5	6	7	8	9	10	11	12			
 <p>High Back Multi - Tilter COM Yardage: 2.25 Freight Class: 250 Product Weight (lbs.): 69 Cubic Feet Per Carton: 11</p>	 <p>ADJUSTMENTS (1) Tilt tension (2) Pneumatic seat height (3) Back angle (6) Back height* (7) Forward tilt lock (8) Seat depth (9) Chair tilt lock (5A) Center-tilt action</p>	1255-3	1598	1681	1746	1842	1979	2027	2147	2374	2486	2697	2983	3342			
			OVERALL DIMENSIONS			SEAT DIMENSIONS			BACK DIMENSIONS								
			W	D	H	W	D	H	W		H						
			28	24.5	48.5	23.5	17-19.5	17-21	22		26.5-31.75						
<p>High/Wide Back. Standard Seat.</p> <p>Ergonomic Features: A, B, C, D, E, F, G, H, M, N, Q, R, S, U</p>																	
			 <p>High Back Weight Sensing Synchro - Tilter COM Yardage: 2 Freight Class: 250 Product Weight (lbs.): 67 Cubic Feet Per Carton: 10.50</p>	 <p>ADJUSTMENTS Weight sensing auto tension adjustment (2) Pneumatic seat height (8) Sliding seat depth (9) Multi position tilt lock</p>	1255-8	1598	1681	1746	1842	1979	2027	2147	2374	2486	2697	2983	3342
						OVERALL DIMENSIONS			SEAT DIMENSIONS			BACK DIMENSIONS					
						W	D	H	W	D	H	W		H			
28	24.5	48.5				23.5	17-19.5	17-21	22		26.5-31.75						
<p>High/Wide Back. Standard Seat.</p> <p>Ergonomic Features: A, B, C, D, E, H, L, M, N, Q, R, U</p>																	
			 <p>Mid Back Synchro - Tilter w/ Back Angle Adj. COM Yardage: 2 Freight Class: 150 Product Weight (lbs.): 67 Cubic Feet Per Carton: 10.50</p>	 <p>ADJUSTMENTS (1) Tilt tension (2) Pneumatic seat height (9) Chair tilt lock (5C) Synchro-tilt action Anti-kick back</p>	1256-0	1523	1605	1669	1765	1900	1952	2070	2299	2408	2620	2907	3266
						OVERALL DIMENSIONS			SEAT DIMENSIONS			BACK DIMENSIONS					
						W	D	H	W	D	H	W		H			
28	24.5	44.5				23.5	17-19.5	17-21	22		22-27.25						
<p>Mid/Wide Back. Standard Seat.</p> <p>Ergonomic Features: A, B, C, D, E, G, H, L, M, N, Q, R, U</p>																	
			 <p>Mid Back Multi - Tilter COM Yardage: 2 Freight Class: 150 Product Weight (lbs.): 67 Cubic Feet Per Carton: 10.50</p>	 <p>ADJUSTMENTS (1) Tilt tension (2) Pneumatic seat height (3) Back angle (6) Back height* (7) Forward tilt lock (8) Seat depth (9) Chair tilt lock (5A) Center-tilt action</p>	1256-3	1523	1605	1669	1765	1900	1952	2070	2299	2408	2620	2907	3266
						OVERALL DIMENSIONS			SEAT DIMENSIONS			BACK DIMENSIONS					
						W	D	H	W	D	H	W		H			
28	24.5	44.5				23.5	17-19.5	17-21	22		22-27.25						
<p>Mid/Wide Back. Standard Seat.</p> <p>Ergonomic Features: A, B, C, D, E, F, G, H, M, N, Q</p>																	
			 <p>Mid Back Weight Sensing Synchro - Tilter COM Yardage: 2 Freight Class: 150 Product Weight (lbs.): 67 Cubic Feet Per Carton: 10.50</p>	 <p>ADJUSTMENTS Weight sensing auto tension adjustment (2) Pneumatic seat height (8) Sliding seat depth (9) Multi position tilt lock</p>	1256-8	1523	1605	1669	1765	1900	1952	2070	2299	2408	2620	2907	3266
						OVERALL DIMENSIONS			SEAT DIMENSIONS			BACK DIMENSIONS					
						W	D	H	W	D	H	W		H			
28	24.5	44.5				23.5	17-19.5	17-21	22		22-27.25						
<p>Mid/Wide Back. Standard Seat.</p> <p>Ergonomic Features: A, B, C, D, E, H, L, M, N, Q, R, U</p>																	

PREFER



model 8458NA



model 8459



STANDARD FEATURES

- A sleek and comfortable all-purpose chair beautifully suited for conference, collaboration and training environments. Designed by Norbert Geelen.
- Swivel tilt function with no visible levers or mechanism.
- Standard with Asphalt or Alabaster frame and base, armless or with fixed arms.
- Integrated seat height adjustment lever is intuitive and easy to utilize.
- Dual wheel carpet casters are standard. Black (C82) casters standard on Asphalt models. Fog Grey (C82F) casters standard on Alabaster models.
- Check textile availability prior to specifying upholstery material.

OPTIONAL FEATURES

- Dimension Mesh is available in Black (DBK), Charcoal (DCH), Citrus (DCT), Pool Blue (DPB), Sand (DSD), Fog (DST), Chalk (DCL), Shadow (DGM), Cobalt (DCO) and Berry (DBE).
- Polished Aluminum (ALU) base available for Asphalt and Alabaster frames. Add \$158.
- Polished Aluminum (AL) arms available for Asphalt and Alabaster fixed arm models. Add \$158.
- For Alabaster base on the Asphalt frame, please specify (ABR). For Asphalt base on the Alabaster frame, please specify (ABT). Add \$70.
- Optional low black glides (G) are available at no upcharge.
- For hard floor surface casters, please specify (C82R) for Black and (C82FR) for Fog. Add \$87.
- For fully assembled in the box, specify (SU). Add \$70.

DESCRIPTION	FEATURES	MODEL#	STANDARD TEXTILE GRADES											
-------------	----------	--------	-------------------------	--	--	--	--	--	--	--	--	--	--	--



Multi-task chair- Asphalt Base/Frame

COM Yardage: 1
 Freight Class: 250
 Product Weight (lbs.): 29
 Cubic Feet Per Carton: 9

Ergonomic Features:
 C, M

8458	1	2	3	4	5	6	7	8	9	10	11	12
	1142	1173	1197	1230	1279	1303	1347	1417	1471	1533	1656	1789

OVERALL DIMENSIONS			SEAT DIMENSIONS			BACK DIMENSIONS	
W	D	H	W	D	H	W	H
25.5	25	36	20	20	17.5-22	21	20



Multi-task chair, armless- Asphalt Base/Frame

COM Yardage: 0.75
 Freight Class: 250
 Product Weight (lbs.): 29
 Cubic Feet Per Carton: 9

Ergonomic Features:
 C, M

8458NA	1	2	3	4	5	6	7	8	9	10	11	12
	1000	1031	1052	1086	1134	1155	1199	1267	1321	1380	1500	1629

OVERALL DIMENSIONS			SEAT DIMENSIONS			BACK DIMENSIONS	
W	D	H	W	D	H	W	H
22	25	36	20	20	17.5-22	21	20



Drafting Stool- Asphalt Base/Frame

COM Yardage: 0.75
 Freight Class: 250
 Product Weight (lbs.): 36
 Cubic Feet Per Carton: 9

Ergonomic Features:
 C, M

8458S	1	2	3	4	5	6	7	8	9	10	11	12
	1314	1338	1356	1381	1418	1434	1468	1521	1561	1607	1700	1800

OVERALL DIMENSIONS			SEAT DIMENSIONS			BACK DIMENSIONS	
W	D	H	W	D	H	W	H
25.5	25	42	20	20	23-31	21	20



Drafting stool, armless- Asphalt Base/Frame







COM Yardage: 0.75
 Freight Class: 250
 Product Weight (lbs.): 36
 Cubic Feet Per Carton: 9

Ergonomic Features:
 C, M

8458NAS	1	2	3	4	5	6	7	8	9	10	11	12
	1198	1228	1251	1285	1334	1357	1401	1472	1526	1585	1710	1843

OVERALL DIMENSIONS			SEAT DIMENSIONS			BACK DIMENSIONS	
W	D	H	W	D	H	W	H
25.5	25	42	20	20	23-31	21	20



DESCRIPTION	FEATURES	MODEL#	STANDARD TEXTILE GRADES													
			1	2	3	4	5	6	7	8	9	10	11	12		
 Multi-task chair- Alabaster Base/Frame COM Yardage: 0.75 Freight Class: 250 Product Weight (lbs.): 29 Cubic Feet Per Carton: 9	Ergonomic Features: C, M	RTA 1 	8459	1198	1228	1251	1285	1334	1357	1401	1472	1526	1585	1710	1843	
			OVERALL DIMENSIONS			SEAT DIMENSIONS			BACK DIMENSIONS							
			W	D	H	W	D	H	W	H						
			25.5	25	36	20	20	17.5-22	21	20						
 Multi-task chair, armless- Alabaster Base/Frame COM Yardage: 0.75 Freight Class: 250 Product Weight (lbs.): 29 Cubic Feet Per Carton: 9	Ergonomic Features: C, M	RTA 1 	8459NA	1097	1128	1150	1185	1234	1258	1303	1373	1428	1490	1616	1749	
			OVERALL DIMENSIONS			SEAT DIMENSIONS			BACK DIMENSIONS							
			W	D	H	W	D	H	W	H						
			22	25	36	20	20	17.5-22	21	20						
 Drafting Stool- Alabaster Base/Frame COM Yardage: 0.75 Freight Class: 250 Product Weight (lbs.): 36 Cubic Feet Per Carton: 9	Ergonomic Features: C, M	RTA 1 	8459S	1370	1401	1425	1458	1507	1531	1575	1645	1699	1760	1884	2017	
			OVERALL DIMENSIONS			SEAT DIMENSIONS			BACK DIMENSIONS							
			W	D	H	W	D	H	W	H						
			25.5	25	42	20	20	23-31	21	20						
 Drafting stool, armless- Alabaster Base/Frame COM Yardage: 0.75 Freight Class: 250 Product Weight (lbs.): 36 Cubic Feet Per Carton: 9	Ergonomic Features: C, M	RTA 1 	8459NAS	1259	1291	1314	1347	1396	1420	1464	1534	1589	1650	1774	1907	
			OVERALL DIMENSIONS			SEAT DIMENSIONS			BACK DIMENSIONS							
			W	D	H	W	D	H	W	H						
			25.5	25	42	20	20	23-31	21	20						

ROMA®



model 1906



model 1908



Optional Arms

A height adjustable arm is optionally available for task seating. Please specify (RA). Add \$74.



model 1901PB

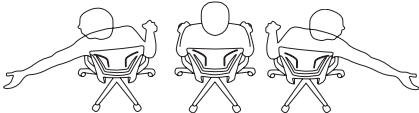

The Polypropylene Medium Back and the Upholstered Medium Back feature a flexible back construction that provides support, proper spinal alignment and comfort when moving or reaching in a seated position.

STANDARD FEATURES

- Flexible, elegant and affordable, Roma offers a family of seating with simple clean lines.
- Roma features an exclusive chair control mechanism which allows the chair back and arms to recline together while the chair seat moves just enough to ensure comfort.
- The series includes nesting chairs, task seating and drafting stools, with and without arms.
- For Nesting chairs see page 196.
- Four back versions are available: mesh, upholstered, flexible polypropylene or honeycomb polypropylene.
- Flexible polypropylene back chair features a built in lumbar support designed to move as you move and is available exclusively in black.
- The task chair upholstered back features a removable cover for on-site replacement and cleaning.
- Fixed arms are durable fiberglass reinforced nylon, fixed height. Standard with soft, durable, self-skinned urethane (SSU) armcaps that are warm to the touch.
- Standard with Global's high quality Soft Descent™ pneumatic lift which slowly and gently lowers the seat height of the chair making it easy to obtain the exact seat height you desire.
- Task chairs and stools are standard with a five prong, injection molded, fiberglass reinforced nylon Black spider base with dual wheel carpet casters (C1).
- Pedestal base models are offered with tilter mechanisms only. These models provide fixed location seating for use in auditoriums, classrooms, jury boxes, public venues and more. The base must be mounted to the floor (mounting hardware not included). See Pedestal Base Installation Guide for details.
- All models upholstered in leather have two-piece seats with a radius towards the rear of the seat.
- Check textile availability prior to specifying upholstery material.

OPTIONAL FEATURES

- Breathable mesh back is available in six colors: Autumn Orange (AO), Spring Green (SG) Winter Grey (WG), Midnight Black (MB), Summer Blue (SB), Fall Burgundy (FB).
- An optional polished aluminum base is available at an upcharge. Specify (ALU). Add \$154.
- Please refer to "Cylinder Selection" section of the price book for additional cylinder options.
- Optional height adjustable arms are available, on task models. Please specify (RA). Add \$79.
- For hard surface flooring casters, please specify C9R. Add \$66.
- For fully assembled in box, please specify SU. Add \$70.
- Pedestal Base models have black bases with 2" height adjustable cylinders. Specify: (SCC) Swivel, auto return to max height. No upcharge. (SN) Non-swivel, auto return to max height. Add \$19. (SC) Swivel, self-centering and return to max height. Add \$30.

DESCRIPTION

FEATURES

MODEL#

STANDARD TEXTILE GRADES



Mesh MB - Armless Drafting Stool











COM Yardage: 1
Freight Class: 150
Product Weight (lbs.): 43
Cubic Feet Per Carton: 9.25











Ergonomic Features:
B, C, M, N









	1	2	3	4	5	6	7	8	9	10	11	12
1871	1022	1059	1084	1121	1177	1195	1243	1334	1380	1462	1579	1721





OVERALL DIMENSIONS			SEAT DIMENSIONS			BACK DIMENSIONS	
W	D	H	W	D	H	W	H
19.5	23.5	48	19.5	18	24.5-34.5	18.5	19

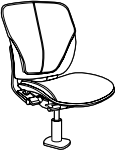

DESCRIPTION	FEATURES	MODEL#	STANDARD TEXTILE GRADES											
			1	2	3	4	5	6	7	8	9	10	11	12
 <p>Polypropylene MB - Armless Drafting Stool COM Yardage: 1 Freight Class: 150 Product Weight (lbs.): 43 Cubic Feet Per Carton: 9.25</p>	Ergonomic Features: B, C, M, N	1872	1022	1059	1084	1121	1177	1195	1243	1334	1380	1462	1579	1721
			OVERALL DIMENSIONS W D H			SEAT DIMENSIONS W D H			BACK DIMENSIONS W H					
			19.5	23.5	48	19.5	18	24.5-34.5	18.5	19				
			RTA 2											
 <p>Honeycomb MB - Armless Drafting Stool COM Yardage: 1 Freight Class: 150 Product Weight (lbs.): 43 Cubic Feet Per Carton: 9.25</p>	Ergonomic Features: B, C, M, N	1874	1062	1096	1121	1160	1213	1233	1280	1372	1418	1501	1617	1759
			OVERALL DIMENSIONS W D H			SEAT DIMENSIONS W D H			BACK DIMENSIONS W H					
			19.5	23.5	48	19.5	18	24.5-34.5	18.5	19				
			RTA 2											
 <p>Mesh MB - Drafting Stool COM Yardage: 1 Freight Class: 150 Product Weight (lbs.): 50 Cubic Feet Per Carton: 9.25</p>	Ergonomic Features: B, C, M, N	1876	1087	1121	1147	1186	1239	1259	1307	1398	1444	1527	1642	1785
			OVERALL DIMENSIONS W D H			SEAT DIMENSIONS W D H			BACK DIMENSIONS W H					
			25.5	23.5	48	19.5	18	24.5-34.5	18.5	19				
			RTA 2											
 <p>Polypropylene MB - Drafting Stool COM Yardage: 1 Freight Class: 150 Product Weight (lbs.): 50 Cubic Feet Per Carton: 9.25</p>	Ergonomic Features: B, C, M, N	1877	1087	1121	1147	1186	1239	1259	1307	1398	1444	1527	1642	1785
			OVERALL DIMENSIONS W D H			SEAT DIMENSIONS W D H			BACK DIMENSIONS W H					
			25.5	23.5	48	19.5	18	24.5-34.5	18.5	19				
			RTA 2											
 <p>Honeycomb MB - Drafting Stool COM Yardage: 1 Freight Class: 150 Product Weight (lbs.): 50 Cubic Feet Per Carton: 9.25</p>	Ergonomic Features: B, C, M, N	1879	1126	1159	1185	1224	1277	1296	1346	1436	1482	1565	1679	1824
			OVERALL DIMENSIONS W D H			SEAT DIMENSIONS W D H			BACK DIMENSIONS W H					
			25.5	23.5	48	19.5	18	24.5-34.5	18.5	19				
			RTA 2											

DESCRIPTION	FEATURES	MODEL#	STANDARD TEXTILE GRADES														
			1	2	3	4	5	6	7	8	9	10	11	12			
 <p>Honeycomb MB - Armless COM Yardage: 1 Freight Class: 150 Product Weight (lbs.): 38 Cubic Feet Per Carton: 9.25</p>	<p>Ergonomic Features: B, C, M, N</p>	<p>RTA 2 </p>	1896	825	859	886	924	979	998	1046	1137	1182	1266	1382	1524		
			OVERALL DIMENSIONS			SEAT DIMENSIONS			BACK DIMENSIONS								
			W	D	H	W	D	H	W	H							
			19.5	23.5	38	19.5	18	15-19	18.5	19							
 <p>Honeycomb MB - w/Arms COM Yardage: 1 Freight Class: 150 Product Weight (lbs.): 45 Cubic Feet Per Carton: 9.25</p>	<p>Ergonomic Features: B, C, M, N</p>	<p>RTA 2 </p>	1897	881	915	941	979	1035	1052	1101	1192	1237	1321	1436	1579		
			OVERALL DIMENSIONS			SEAT DIMENSIONS			BACK DIMENSIONS								
			W	D	H	W	D	H	W	H							
			25.5	23.5	38	19.5	18	15-19	18.5	19							
 <p>Mesh MB - Armless COM Yardage: 1 Freight Class: 150 Product Weight (lbs.): 38 Cubic Feet Per Carton: 9.25</p>	<p>Ergonomic Features: B, C, M, N</p>	<p>RTA 2 </p>	1901	825	860	888	929	986	1007	1056	1152	1199	1289	1410	1558		
			OVERALL DIMENSIONS			SEAT DIMENSIONS			BACK DIMENSIONS								
			W	D	H	W	D	H	W	H							
			19.5	23.5	36.25	19.5	18	15-19	18.5	19							
 <p>Polypropylene MB - Armless COM Yardage: 1 Freight Class: 150 Product Weight (lbs.): 36.25 Cubic Feet Per Carton: 9.25</p>	<p>Ergonomic Features: B, C, M, N</p>	<p>RTA 2 </p>	1902	825	860	888	929	986	1007	1056	1152	1199	1289	1410	1558		
			OVERALL DIMENSIONS			SEAT DIMENSIONS			BACK DIMENSIONS								
			W	D	H	W	D	H	W	H							
			19.5	23.5	36.25	19.5	18	15-19	18.5	19							
 <p>Upholstered MB - Armless COM Yardage: 1.75 Freight Class: 150 Product Weight (lbs.): 38 Cubic Feet Per Carton: 9.25</p>	<p>Ergonomic Features: B, C, M, N</p>	<p>RTA 2 </p>	1903	888	950	997	1069	1168	1203	1291	1459	1539	1697	1908	2169		
			OVERALL DIMENSIONS			SEAT DIMENSIONS			BACK DIMENSIONS								
			W	D	H	W	D	H	W	H							
			19.5	23.5	36.25	19.5	18	15-19	18.5	19							

DESCRIPTION	FEATURES	MODEL#	STANDARD TEXTILE GRADES														
			1	2	3	4	5	6	7	8	9	10	11	12			
 <p>Mesh MB - w/Arms COM Yardage: 1 Freight Class: 150 Product Weight (lbs.): 45 Cubic Feet Per Carton: 9.25</p>	<p>Ergonomic Features: B, C, M, N</p>	<p>RTA 2 </p>	1906	881	916	944	982	1043	1063	1112	1206	1254	1344	1463	1615		
			<p>OVERALL DIMENSIONS</p> <p>W D H</p>			<p>SEAT DIMENSIONS</p> <p>W D H</p>			<p>BACK DIMENSIONS</p> <p>W H</p>								
			25.5	23.5	36.25	19.5	18	15-19	18.5	19							
 <p>Polypropylene MB - w/Arms COM Yardage: 1 Freight Class: 150 Product Weight (lbs.): 45 Cubic Feet Per Carton: 9.25</p>	<p>Ergonomic Features: B, C, M, N</p>	<p>RTA 2 </p>	1907	881	916	944	982	1043	1063	1112	1206	1254	1344	1463	1615		
			<p>OVERALL DIMENSIONS</p> <p>W D H</p>			<p>SEAT DIMENSIONS</p> <p>W D H</p>			<p>BACK DIMENSIONS</p> <p>W H</p>								
			25.5	23.5	36.25	19.5	18	15-19	18.5	19							
 <p>Upholstered MB - w/Arms COM Yardage: 1.75 Freight Class: 150 Product Weight (lbs.): 45 Cubic Feet Per Carton: 9.25</p>	<p>Ergonomic Features: B, C, M, N</p>	<p>RTA 2 </p>	1908	947	1006	1051	1117	1214	1247	1332	1490	1569	1716	1917	2169		
			<p>OVERALL DIMENSIONS</p> <p>W D H</p>			<p>SEAT DIMENSIONS</p> <p>W D H</p>			<p>BACK DIMENSIONS</p> <p>W H</p>								
			25.5	23.5	36.25	19.5	18	16.5-20.5	18.5	19							
 <p>Upholstered Back Pad COM Yardage: 1 Freight Class: 70 Product Weight (lbs.): 1.5 Cubic Feet Per Carton: 1.1</p>		<p>RTA 00 </p>	1909	178	213	241	283	340	360	411	504	552	641	763	913		
			<p>OVERALL DIMENSIONS</p> <p>W D H</p>			<p>SEAT DIMENSIONS</p> <p>W D H</p>			<p>BACK DIMENSIONS</p> <p>W H</p>								
			20.5	19	0.38	21	18	18	20	20.5							
 <p>Mesh MB - Armless with Pedestal Base COM Yardage: 1 Freight Class: 150 Product Weight (lbs.): 44 Cubic Feet Per Carton: 9.25</p>	<p>Ergonomic Features: B, C, M, N</p>	<p>RTA 2</p>	1901PB	1039	1074	1102	1143	1201	1227	1278	1361	1425	1497	1643	1800		
			<p>OVERALL DIMENSIONS</p> <p>W D H</p>			<p>SEAT DIMENSIONS</p> <p>W D H</p>			<p>BACK DIMENSIONS</p> <p>W H</p>								
			19.5	23.5	36	19.5	18	15-19	18.5	19							

DESCRIPTION	FEATURES	MODEL#	STANDARD TEXTILE GRADES												
			1	2	3	4	5	6	7	8	9	10	11	12	
 <p>Polypropylene MB - Armless with Pedestal Base COM Yardage: 1 Freight Class: 150 Product Weight (lbs.): 36 Cubic Feet Per Carton: 9.25</p>	<p>Ergonomic Features: B, C, M, N</p>	<p>RTA 2</p>	1902PB	1039	1074	1102	1143	1201	1227	1278	1361	1425	1497	1643	1800
			OVERALL DIMENSIONS			SEAT DIMENSIONS			BACK DIMENSIONS						
			W	D	H	W	D	H	W	H					
			19.5	23.5	36	19.5	18	15-19	18.5	19					
 <p>Upholstered MB - Armless with Pedestal Base COM Yardage: 1.75 Freight Class: 150 Product Weight (lbs.): 44 Cubic Feet Per Carton: 9.25</p>	<p>Ergonomic Features: B, C, M, N</p>	<p>RTA 2</p>	1903PB	1101	1162	1209	1281	1379	1426	1516	1661	1772	1896	2151	2423
			OVERALL DIMENSIONS			SEAT DIMENSIONS			BACK DIMENSIONS						
			W	D	H	W	D	H	W	H					
			19.5	23.5	36	19.5	18	15-19	18.5	19					
 <p>Mesh MB - w/Arms and Pedestal Base COM Yardage: 1 Freight Class: 150 Product Weight (lbs.): 50 Cubic Feet Per Carton: 9.25</p>	<p>Ergonomic Features: B, C, M, N</p>	<p>RTA 2</p>	1906PB	1095	1132	1158	1199	1256	1282	1333	1415	1478	1546	1691	1845
			OVERALL DIMENSIONS			SEAT DIMENSIONS			BACK DIMENSIONS						
			W	D	H	W	D	H	W	H					
			25.5	23.5	36	19.5	18	15-19	18.5	19					
 <p>Polypropylene MB - w/Arms COM Yardage: 1 Freight Class: 150 Product Weight (lbs.): 50 Cubic Feet Per Carton: 9.25</p>	<p>Ergonomic Features: B, C, M, N</p>	<p>RTA 2</p>	1907PB	1095	1132	1158	1199	1256	1282	1333	1415	1478	1546	1691	1845
			OVERALL DIMENSIONS			SEAT DIMENSIONS			BACK DIMENSIONS						
			W	D	H	W	D	H	W	H					
			25.5	23.5	36	19.5	18	15-19	18.5	19					
 <p>Upholstered MB - w/Arms and Pedestal Base COM Yardage: 1.75 Freight Class: 150 Product Weight (lbs.): 50 Cubic Feet Per Carton: 9.25</p>	<p>Ergonomic Features: B, C, M, N</p>	<p>RTA 2</p>	1908PB	1161	1222	1269	1336	1436	1483	1573	1714	1826	1948	2200	2468
			OVERALL DIMENSIONS			SEAT DIMENSIONS			BACK DIMENSIONS						
			W	D	H	W	D	H	W	H					
			25.5	23.5	36	19.5	18	16.5-20.5	18.5	19					

SOLAR



model 8456



model 8457



model 8456NA









model 8457NA











STANDARD FEATURES

- A sophisticated and versatile seating solution for conference and collaborative environments. Designed by Paul Brooks.
- One piece molded frame is extremely light (chair weighs 24 lbs.) and exceeds BIFMA standard for commercial applications.
- Cascading forward seat surface and reverse edge profile provide better leg clearance and comfort.
- Integrated seat height adjustment lever is intuitive and easy to utilize.
- The under seat structure maintains the seamless and fluid aesthetic that defines Solar.
- All bases are standard with Black (C1) dual wheel carpet casters.
- Check textile availability prior to specifying upholstery material.

OPTIONAL FEATURES

- Mesh is available in Midnight (MDN), Storm (STM), and Dove (DVE).
- Polished Aluminum (ALU) base is available. Add \$154.
- Alabaster (ABR) base can be ordered on an Asphalt frame, please specify. Add \$70
- Asphalt (APT) base can be ordered on an Alabaster frame, please specify. Add \$70.
- Optional hard surface Black Glide (C7) is available. No upcharge.
- For hard floor surface casters please specify C9R, please add \$66.

DESCRIPTION	FEATURES	MODEL#	STANDARD TEXTILE GRADES												
			1	2	3	4	5	6	7	8	9	10	11	12	
 <p>MB Mesh Tilter - Asphalt Base/Frame COM Yardage: N/A Freight Class: 250 Product Weight (lbs.): 27 Cubic Feet Per Carton: 9.5</p> <p>Ergonomic Features: C, M</p>		8456	1007	-	-	-	-	-	-	-	-	-	-	-	
		OVERALL DIMENSIONS			SEAT DIMENSIONS			BACK DIMENSIONS							
		W	D	H	W	D	H	W	H						
		23.25	25	36	19.25	18	17-21	19	19						
				RTA 1											
 <p>MB Mesh Tilter - Alabaster Base/Frame COM Yardage: N/A Freight Class: 250 Product Weight (lbs.): 27 Cubic Feet Per Carton: 9.5</p> <p>Ergonomic Features: C, M</p>		8457	1104	-	-	-	-	-	-	-	-	-	-	-	
		OVERALL DIMENSIONS			SEAT DIMENSIONS			BACK DIMENSIONS							
		W	D	H	W	D	H	W	H						
		23.25	25	36	19.25	18	17-21	19	19						
				RTA 1											
 <p>MB Mesh Stool - Asphalt Base/Frame COM Yardage: N/A Freight Class: 250 Product Weight (lbs.): 31 Cubic Feet Per Carton: 9.5</p> <p>Ergonomic Features: C, M</p>		8456S	1284	-	-	-	-	-	-	-	-	-	-	-	
		OVERALL DIMENSIONS			SEAT DIMENSIONS			BACK DIMENSIONS							
		W	D	H	W	D	H	W	H						
		23.25	25	42	19.25	18	22.5-30.5	19	19						
				RTA 1											

DESCRIPTION	FEATURES	MODEL#	STANDARD TEXTILE GRADES											
			1	2	3	4	5	6	7	8	9	10	11	12
 <p>MB Mesh Stool - Alabaster Base/Frame COM Yardage: N/A Freight Class: 250 Product Weight (lbs.): 31 Cubic Feet Per Carton: 9.5</p>	Ergonomic Features: C, M	8457S	1381	-	-	-	-	-	-	-	-	-	-	-
			OVERALL DIMENSIONS			SEAT DIMENSIONS			BACK DIMENSIONS					
			W	D	H	W	D	H	W	H				
			23.25	25	42	19.25	18	22.5-30.5	19	19				
			RTA 1											
 <p>MB Mesh Tilter - Asphalt Base/Frame COM Yardage: N/A Freight Class: 250 Product Weight (lbs.): 25 Cubic Feet Per Carton: 9.5</p>	Ergonomic Features: C, M	8456NA	966	-	-	-	-	-	-	-	-	-	-	
			OVERALL DIMENSIONS			SEAT DIMENSIONS			BACK DIMENSIONS					
			W	D	H	W	D	H	W	H				
			23.25	25	36	19.25	18	17-21	19	19				
			RTA 1											
 <p>MB Mesh Tilter - Alabaster Base/Frame COM Yardage: N/A Freight Class: 250 Product Weight (lbs.): 25 Cubic Feet Per Carton: 9.5</p>	Ergonomic Features: C, M	8457NA	1064	-	-	-	-	-	-	-	-	-	-	
			OVERALL DIMENSIONS			SEAT DIMENSIONS			BACK DIMENSIONS					
			W	D	H	W	D	H	W	H				
			23.25	25	36	19.25	18	17-21	19	19				
			RTA 1											
 <p>MB Mesh Stool - Asphalt Base/Frame COM Yardage: N/A Freight Class: 250 Product Weight (lbs.): 29 Cubic Feet Per Carton: 9.5</p>	Ergonomic Features: C, M	8456SNA	1243	-	-	-	-	-	-	-	-	-	-	
			OVERALL DIMENSIONS			SEAT DIMENSIONS			BACK DIMENSIONS					
			W	D	H	W	D	H	W	H				
			23.25	25	42	19.25	18	22.5-30.5	19	19				
			RTA 1											
 <p>MB Mesh Stool - Alabaster Base/Frame COM Yardage: N/A Freight Class: 250 Product Weight (lbs.): 31 Cubic Feet Per Carton: 9</p>	Ergonomic Features: C, M	8457SNA	1340	-	-	-	-	-	-	-	-	-	-	
			OVERALL DIMENSIONS			SEAT DIMENSIONS			BACK DIMENSIONS					
			W	D	H	W	D	H	W	H				
			23.25	25	42	19.25	18	22.5-30.5	19	19				
			RTA 1											

WORK & TASK

SOLO®



model 5227



model 5226

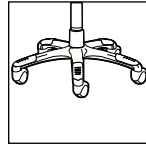





Optional Base
Polished Aluminum base with black scuff tips. Specify "B2". Add \$154.

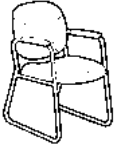

STANDARD FEATURES

- Contoured seat and back, waterfall seat edge and SSU armcaps provide extended comfort.
- All models (except armchairs and side chairs) are standard with a five prong, injection molded base with dual wheel carpet casters (**C65**).
- Seat frame and arm frame are standard in Black.
- Ganging clamp 5233 used for models 5225 and 5226 sled base models. Can be used for Supra models 5332 and 5332L.
- Ganging Clamp 2755 For model 5226. Zinc plated.
- Specifications and pricing is for 1 chair.
- Armchair models are standard with Black glides.
- Check textile availability prior to specifying upholstery material.
- An optional abrasion resistant outer back fabric (polyester) is available. Resistant to impact damage. Available in Black only. Add \$21.
- Vinyl Bumper Guard available with back edge vinyl bumper guard option (**VBG**). Add \$24.
- Non-marking (**NM**) glides are available at no charge to replace Black glides. Please Specify.
- Polished Aluminum base with black scuff tips. Specify "**B2**". Add \$154.
- Please refer to the "Casters Selection" section of the price book for caster options. Optional casters may be priced higher than the standard casters for your chair and the difference will be charged. Lower priced optional casters will not be credited.
- For hard surface flooring casters, specify **C65R**, add \$66.
- For fully assembled in box, specify **SU**. Add \$70.

OPTIONAL FEATURES

- Chrome upper finish with Black base available on models 5227 and 5228 Add 10% of opening published grade price.
- Model 5225 and 5226 frame finishes are standard in Black (**TBL**), Shadow (**TSH**), and Tungsten (**TTU**). Chrome (**CHM**) is also available. Add \$39.5

DESCRIPTION	FEATURES	MODEL#	STANDARD TEXTILE GRADES													
			1	2	3	4	5	6	7	8	9	10	11	12		
 <p>Armchair COM Yardage: 1.25 Freight Class: 250 Product Weight (lbs.): 25 Cubic Feet Per Carton: 10.13 (2 per carton)</p> <p>Ergonomic Features: M, N</p>	<p>RTA 00</p>	5225	395	437	471	521	592	616	680	795	853	960	1109	1293		
		OVERALL DIMENSIONS			SEAT DIMENSIONS			BACK DIMENSIONS								
		W	D	H	W	D	H	W	H							
		24	25	34	20	18	18	20	18							
 <p>Side Chair COM Yardage: 1.25 Freight Class: 250 Product Weight (lbs.): 21 Cubic Feet Per Carton: 8.75 (2 per carton)</p> <p>Ergonomic Features: M, N</p>	<p>RTA 00</p>	5226	365	410	445	496	564	590	651	767	823	934	1081	1293		
		OVERALL DIMENSIONS			SEAT DIMENSIONS			BACK DIMENSIONS								
		W	D	H	W	D	H	W	H							
		22	25.5	34	20	18	18	20	18							
 <p>Ganging Clamp COM Yardage: N/A Freight Class: 70 Product Weight (lbs.): 0.3 Cubic Feet Per Carton: 0.1</p>	<p></p>	2755	32	-	-	-	-	-	-	-	-	-	-	-		
		OVERALL DIMENSIONS			SEAT DIMENSIONS			BACK DIMENSIONS								
		W	D	H	W	D	H	W	H							
		0	00	0	-	-	-	-	-							

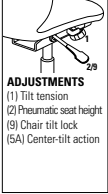
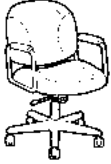
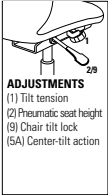
DESCRIPTION	FEATURES	MODEL#	STANDARD TEXTILE GRADES												
			1	2	3	4	5	6	7	8	9	10	11	12	
 <p>Ganging Clamps - Set of 2 COM Yardage: N/A Freight Class: 70 Product Weight: .20 Cubic Feet Per Carton: .04</p>		5233	30	-	-	-	-	-	-	-	-	-	-	-	-
			OVERALL DIMENSIONS			SEAT DIMENSIONS			BACK DIMENSIONS						
			W	D	H	W	D	H	W	H					
			.87	7.75	1.5										
															
 <p>HB Tilter COM Yardage: 1.5 Freight Class: 250 Product Weight (lbs.): 34 Cubic Feet Per Carton: 10.13 (2 per carton)</p>	 <p>ADJUSTMENTS (1) Tilt tension (2) Pneumatic seat height (9) Chair tilt lock (5A) Center-tilt action</p>		1	2	3	4	5	6	7	8	9	10	11	12	
		5227	582	632	674	730	817	846	922	1066	1131	1260	1437	1659	
			OVERALL DIMENSIONS			SEAT DIMENSIONS			BACK DIMENSIONS						
			W	D	H	W	D	H	W	H					
			24	25.5	38	20	18.5	17.75-21.75	20	19.5					
			RTA 00												
 <p>LB Tilter COM Yardage: 1.25 Freight Class: 250 Product Weight (lbs.): 32 Cubic Feet Per Carton: 10.13 (2 per carton)</p>	 <p>ADJUSTMENTS (1) Tilt tension (2) Pneumatic seat height (9) Chair tilt lock (5A) Center-tilt action</p>		1	2	3	4	5	6	7	8	9	10	11	12	
		5228	523	566	597	649	720	746	808	923	979	1088	1236	1420	
			OVERALL DIMENSIONS			SEAT DIMENSIONS			BACK DIMENSIONS						
			W	D	H	W	D	H	W	H					
			24	24.5	34	20	18.5	17.75-21.75	20	17.5					
			RTA 00												

SORA™



model 6941

model 6942

MECHANISM:

Weight sensing synchro-tilter mechanism (-8)

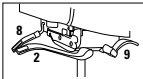

ADJUSTMENTS

- Weight sensing auto tension adjustment
- (2) Pneumatic seat height back/lumbar height
- (8) Sliding seat depth
- (9) Multi position tilt lock

Ergonomic features:

B, C, D, E, H, L, M, N, Q, R, U, V

STANDARD FEATURES

- Designed in three seat sizes and two back sizes to accommodate many body shapes.
- The upper back shape encourages free lateral movement.
- Features a weight sensing synchro-tilter mechanism (-8) that requires no tilt tension adjustment.
- Side activated sliding seat depth adjustment (MD).
- 4.4" adjustable lumbar area for personalized comfort and support is standard.
- Standard with Global's high quality Soft Descent™ 4" travel pneumatic lift which slowly and gently lowers the seat height of the chair making it easy to obtain the exact seat height you desire.
- 4.5" travel height adjustable arms.
- Five prong, injection molded, fiberglass reinforced nylon base with dual wheel casters.
- Sora is fully compliant with the latest BIFMA G1, GSA, and CGSB specifications.
- Frame is only available in Black.
- Check textile availability prior to specifying upholstery material.

OPTIONAL FEATURES

- Height (E2), height and width adjustable (E3), and fully ergonomic arms (E4) are available.
- Fully ergonomic arms (E4) are height and width (1.4" travel) adjustable arms with sliding armcaps. Sliding armcaps travel 1" in width and 2" in depth, and articulate 20° inwards and 10° outwards to aim toward the keyboard or mouse area.
- Mesh backs are available in 24 brilliant Vue colors.

Please add option codes in the following order:



- **Model number**
6941 High back
6942 Medium back
- **Fabric**
Specify fabric code
- **Mechanism**
(-8) Weight sensing synchro-tilt
- **Arms**
(E2) Height adjustable arms..... **No upcharge**
(E3) Height and width adjustable arms..... **Add \$88**
(E4) Fully ergonomic arms..... **Add \$197**
- **Base**
(B7) Black nylon base..... **No upcharge**
(A7) Polished aluminum base..... **Add \$154**
- **Casters**
(C82) Dual wheel carpet casters..... **No upcharge**
(C82R) Dual wheel hard floor casters..... **Add \$87**
- **Mesh** (colors shown on website)
(VU10) Sandy Beach (VU23) Chartreuse
(VU11) Desert Sand (VU26) Pool Blue
(VU12) Orange Sunset (VU28) Sky
(VU13) Chocolate Fountain (VU32) Primary Blue
(VU14) Arctic Blue (VU34) Tangerine
(VU15) Quarry Grey (VU37) Paprika
(VU16) Tidal Wave (VU40) Grain
(VU17) Ivy Moss (VU43) Yellow
(VU18) Red Rose (VU55) Silver Grey
(VU19) Coal Black (VU63) Silver
(VU20) White (VU65) Hot Pink
(VU21) Lime (VU70) Red Mittens
- **Seat Size**
(P) Petite seat, 17" wide
(STAN) Standard seat, 18.5" wide
(GS) Generous seat, 19.5" wide
- **Cylinder (No Upcharge)**
(4L) Standard (4")
(5L) High (5")
(4S) Short (4"). Seat height: 14.8" - 18.7"
Seat height range achieved using (C1) casters.

EXAMPLE SORA ORDER CODE

6942	-HD08	-8	-E4	-A7	-C82	-VU32	-STAN	-4L
Model #	Fabric	Mechanism	Arm	Base	Casters	Mesh	Seat	Cylinder

Sora recommended dimensional information: based on measurements with weight sensing synchro-tilter mechanism				
	Distance between arms (pivot not included)	Standard arm height	Seat depth range	Standard seat height
Petite seat (P) Soft Descent 4" lift & (E4) arm	14.7" - 17.5" = 2.8" adjustment	7" - 11.5"	15.5" - 18.5"	16.1" - 20.1"
Standard seat (STAN) Soft Descent 4" lift & (E4) arm	16.2" - 19" = 2.8" adjustment		16.5" - 19.5"	
Generous seat (GS) Soft Descent 4" lift & (E4) arm	17.2" - 20" = 2.8" adjustment		17.5" - 19.75"	

Measurements shown are measured to the requirements of BIFMA G1-2013 / CGSB 44.232-2008.

DESCRIPTION	FEATURES	MODEL#	STANDARD TEXTILE GRADES											
			1	2	3	4	5	6	7	8	9	10	11	12
 <p>HB Weight Sensing Synchro-Tilter COM Yardage: 1 Freight Class: 250 Product Weight (lbs.): 60 Cubic Feet Per Carton: 20.5</p>		6941	1271	1306	1332	1369	1423	1451	1497	1578	1636	1704	1842	1988
			OVERALL DIMENSIONS			SEAT DIMENSIONS			BACK DIMENSIONS					
			W	D	H	W	D	H	W	H				
			25	24	42.5	18.5	16.5-19.5	16.1-20.1	18.5	26				
					RTA 1	1 per carton								
 <p>MB Weight Sensing Synchro-Tilter COM Yardage: 1 Freight Class: 250 Product Weight (lbs.): 58 Cubic Feet Per Carton: 20.5</p>		6942	1221	1255	1282	1319	1373	1401	1448	1529	1587	1656	1794	1940
			OVERALL DIMENSIONS			SEAT DIMENSIONS			BACK DIMENSIONS					
			W	D	H	W	D	H	W	H				
			25	24	40.5	18.5	16.5-19.5	16.1-20.1	18.5	24				
					RTA 1	1 per carton								

SPRITZ™



Spritz is offered in two back heights, with or without an optional lumbar support

MECHANISMS OPTIONS

<p>Tilter (-4)</p>	<p>Weight Sensing (-8)</p>
<p>ADJUSTMENTS (1) Tilt tension (2) Pneumatic seat height (9) Upright position tilt lock Center tilt action</p>	<p>ADJUSTMENTS Weight sensing auto tension adjustment (2) Pneumatic seat height (8) Sliding seat depth (9) Multi position tilt lock</p>

Ergonomic Features:
A, B, C, D, H, M, N, Q, S, U

Ergonomic Features:
A, B, C, E, H, L, M, N, Q, U

SPRITZ NESTING/MULTI-PURPOSE CHAIRS



For Spritz Nesting/Multi-Purpose chairs, please refer to Multi-Purpose section of price book.

STANDARD FEATURES

- An exceptionally comfortable chair series featuring a sophisticated, translucent mesh and models for all applications.
- Side activated sliding seat depth adjustment (**MD**) is standard on weight sensing synchro tilter control mechanism.
- Standard with height adjustable, forward swept arms and sliding armcaps (**G4**).
- Standard with Global's high quality Soft Descent™ pneumatic lift which slowly and gently lowers the seat height of the chair making it easy to obtain the exact seat height you desire.
- Five prong, injection molded, fiberglass reinforced nylon Black base with **C10** dual wheel carpet casters.
- Check textile availability prior to specifying upholstery material.
- Models can be ordered in Leather using appropriate grade.

OPTIONAL FEATURES

- For additional caster options, please refer to the Arm and Caster section.
- Optional casters may be priced higher than the standard casters for your chair and the difference will be charged. Lower priced optional casters will not be credited.

OPTION CODES





Please add option codes in the following order:

- **Model number**
6760 Task Chair w/Adjustable Headrest
6761 Task Chair
- Add **(-4)** to model number if ordering Tilter mechanism
 Add **(-8)** to model number if ordering Weight Sensing Synchro-Tilter mechanism
- **Fabric**
 Specify fabric code for seat.
- **Arms**
(G4) Black nylon arms w/SSU armcaps..... **Standard**
- **Lumbar Pad Option**
(LSP) Lumbar Pad..... **Add \$37**
- **Base**
(BK) Black nylon base..... **Standard**
- **Casters**
(C10) Dual wheel carpet casters **Standard**
(C10R) Dual wheel hard floor casters..... **Add \$60**
- **Mesh Back**
(U1) Black
(U2) Burgundy
(U3) Blue
(U4) Green
 (colors shown on website)
- **Vari-Width**
(WA) Width adjustable arm extensions..... **Add \$80**
- **Chair Assembly**
(-SU) Assembled in Box..... **Add \$70**

EXAMPLE OF ORDER CODE:

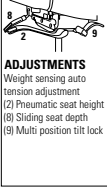
6760-4	WA50	G4	LSP	SD	C10	U2	WA	SU
Model Number	Fabric	Arms	Lumbar Pad	Base	Casters	Mesh Back	Vari-Width	Chair Assembly

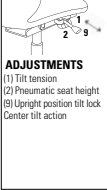
DESCRIPTION	FEATURES	MODEL#	STANDARD TEXTILE GRADES											
			1	2	3	4	5	6	7	8	9	10	11	12
 Tilter w/Adjustable Headrest COM Yardage: 1 Freight Class: 150 Product Weight (lbs.): 49 Cubic Feet Per Carton: 11		6760-4	962	996	1023	1061	1116	1143	1191	1271	1330	1399	1538	1686
			OVERALL DIMENSIONS			SEAT DIMENSIONS			BACK DIMENSIONS					
			W	D	H	W	D	H	W	H				
			26	24	45	19.5	19	16-20	17.5	27				
			RTA 2											

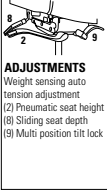
DESCRIPTION	FEATURES	MODEL#	STANDARD TEXTILE GRADES											
			1	2	3	4	5	6	7	8	9	10	11	12
 <p>Weight Sensing Sychro-Tilter w/Adjustable Headrest COM Yardage: 1 Freight Class: 150 Product Weight (lbs.): 55 Cubic Feet Per Carton: 11</p>	 <p>ADJUSTMENTS Weight sensing auto tension adjustment (2) Pneumatic seat height (8) Sliding seat depth (9) Multi position tilt lock</p>	6760-8	1091	1125	1152	1190	1245	1272	1320	1400	1461	1529	1668	1815
		OVERALL DIMENSIONS			SEAT DIMENSIONS			BACK DIMENSIONS						
		W	D	H	W	D	H	W	H					
		26	24	45	19.5	19-21.5	16-20	17.5	27					
			RTA 2											
 <p>Tilter COM Yardage: 1 Freight Class: 150 Product Weight (lbs.): 48 Cubic Feet Per Carton: 10.5</p>	 <p>ADJUSTMENTS (1) Tilt tension (2) Pneumatic seat height (9) Upright position tilt lock Center tilt action</p>	6761-4	901	935	962	1000	1055	1081	1130	1208	1268	1336	1476	1623
		OVERALL DIMENSIONS			SEAT DIMENSIONS			BACK DIMENSIONS						
		W	D	H	W	D	H	W	H					
		26	24	38.5	19.5	19	16-20	17.5	20					
			RTA 2											
 <p>Weight Sensing Sychro-Tilter COM Yardage: 1 Freight Class: 150 Product Weight (lbs.): 54 Cubic Feet Per Carton: 10.5</p>	 <p>ADJUSTMENTS Weight sensing auto tension adjustment (2) Pneumatic seat height (8) Sliding seat depth (9) Multi position tilt lock</p>	6761-8	1031	1065	1092	1130	1185	1211	1260	1339	1399	1467	1607	1754
		OVERALL DIMENSIONS			SEAT DIMENSIONS			BACK DIMENSIONS						
		W	D	H	W	D	H	W	H					
		26	24	38.5	19.5	19-21.5	16-20	17.5	20					
			RTA 2											

STREAM



model 2073APP



model 2074AUU

MECHANISMS OPTIONS

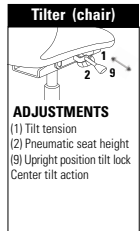

Ergonomic Features:
A, B, C, M, N, S.

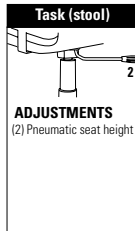

Ergonomic Features:
C, M, N

STANDARD FEATURES

- Our popular Stream series now features 5-star base task chairs and heights adjustable stools.
- Task chairs are available with tilter mechanism only.
- Height adjustable stools are available with simple swivel mechanism only.
- Task chairs and height adjustable stools have a five-prong base with dual wheel casters.
- Units available with or without arms. Arms match seat/back finish.
- Perforated Polypropylene seats and backs are available in 14 colors.
- Check textile availability prior to specifying upholstery material.

OPTIONAL FEATURES

- Base is Black nylon, no upcharge, or Polished Aluminum, add **\$154**.
- Choose (82) carpet casters, no upcharge, or (8R) hard floor casters, add **\$77**.

Please add option codes in the following order:

- **Model number**
2073 Task chair
2074 Height adjustable stool
- **Textile**
 Specify textile code for back (UU models only).
 Specify textile code for seat (PU, UU models only).
- **Seat/back finish** (no upcharge)
(BZB) Buzz Blue **(FRO)** Frost
(CCT) Cactus **(INK)** Ink
(CRO) Carrot **(LAB)** Latte
(IVC) Cloud **(BLK)** Night
(DJN) Dijon **(SND)** Sand
(EGP) Eggplant **(SAR)** Scarlet
(FOG) Fog **(SHW)** Shadow
- **Frame finish**
(BK) Black. No upcharge.
(TN) Tungsten. No upcharge.
(CM) Chrome. Add \$44.
- **Base**
(B7) Black nylon base. No upcharge.
(A7) Polished Aluminum base. Add \$154.
- **Casters**
(82) 82 dual wheel carpet casters. No upcharge.
(8R) 8R dual wheel hard floor casters. Add **\$82**.



Stream Multi-Purpose Chairs











For Stream multi-purpose chairs, please see page 224.

EXAMPLE STREAM TASK ORDER CODE:

2073APP	-	-	-IVC	-CM	-A7	-82
Model #	Back Textile	Seat Textile	Seat/back finish	Frame finish	Base	Caster

DESCRIPTION	FEATURES	MODEL#	STANDARD TEXTILE GRADES												
			1	2	3	4	5	6	7	8	9	10	11	12	
 Tilter Chair w/Arms COM Yardage: N/A Freight Class: 250 Product Weight (lbs.):34 Cubic Feet Per Carton: 15.5		2073APP	807	Polypropylene seat & back											
				OVERALL DIMENSIONS			SEAT DIMENSIONS			BACK DIMENSIONS					
				W	D	H	W	D	H	W	H				
				24	23.5	33.5	18	18	15.5	16	16.5				
		RTA 00	1 per carton												
  2073APU 2073AUU		2073APU	977	1003	1020	1049	1088	1106	1142	1200	1244	1292	1394	1500	
				Upholstered seat											
			2073AUU	1084	1109	1127	1154	1194	1213	1248	1305	1348	1397	1498	1605
				Upholstered seat & back											
				OVERALL DIMENSIONS			SEAT DIMENSIONS			BACK DIMENSIONS					
			W	D	H	W	D	H	W	H					
			24	23.5	33.5	18	18	17.5	16	16					
		RTA 00	1 per carton												

DESCRIPTION	FEATURES	MODEL#	STANDARD TEXTILE GRADES												
			1	2	3	4	5	6	7	8	9	10	11	12	
 <p>Armless Tilter Chair COM Yardage: N/A Freight Class: 300 Product Weight (lbs.): 30 Cubic Feet Per Carton:</p>		2073NPP	721	Polypropylene seat & back											
	OVERALL DIMENSIONS			SEAT DIMENSIONS			BACK DIMENSIONS								
	W	D	H	W	D	H	W	H							
	20.5	23.5	33.5	18	18	15.5	16	16.5							
	RTA 00			1 per carton											
  <p>Armless Tilter Chair COM Yardage: 0.75 Freight Class: 250 Product Weight: 33 Cubic Feet Per Carton: 15.5</p>	2073NPU	2073NUU		1	2	3	4	5	6	7	8	9	10	11	12
	2073NPU			Upholstered seat											
	2073NUU			Upholstered seat & back											
	OVERALL DIMENSIONS			SEAT DIMENSIONS			BACK DIMENSIONS								
	W	D	H	W	D	H	W	H							
20.5	23.5	33.5	18	18	16	16	16								
RTA 00			1 per carton												
 <p>Height Adjustable Stool w/Arms COM Yardage: N/A Freight Class: 300 Product Weight (lbs.): 37 Cubic Feet Per Carton: 19.5</p>		2074APP	911	Polypropylene seat & back											
	OVERALL DIMENSIONS			SEAT DIMENSIONS			BACK DIMENSIONS								
	W	D	H	W	D	H	W	H							
	24	23.5	43	18	18	22	16	16.5							
	RTA 00			1 per carton											
  <p>Height Adjustable Stool w/Arms COM Yardage: 0.75 Freight Class: 250 Product Weight: 40 Cubic Feet Per Carton: 19.5</p>	2074APU	2074AUU		1	2	3	4	5	6	7	8	9	10	11	12
	2074APU			Upholstered seat											
	2074AUU			Upholstered seat & back											
	OVERALL DIMENSIONS			SEAT DIMENSIONS			BACK DIMENSIONS								
	W	D	H	W	D	H	W	H							
24	23.5	43	18	18	22.5	16	16								
RTA 00			1 per carton												
 <p>Armless Height Adjustable Stool COM Yardage: N/A Freight Class: 300 Product Weight (lbs.): 33 Cubic Feet Per Carton: 19.5</p>		2074NPP	805	Polypropylene seat & back											
	OVERALL DIMENSIONS			SEAT DIMENSIONS			BACK DIMENSIONS								
	W	D	H	W	D	H	W	H							
	20.5	23.5	43	18	18	22	16	16.5							
	RTA 00			1 per carton											

DESCRIPTION	FEATURES	MODEL#	STANDARD TEXTILE GRADES											
			1	2	3	4	5	6	7	8	9	10	11	12
 <p>2074NPU</p> <p>Armless Height Adjustable Stool COM Yardage: 0.75 Freight Class: 300 Product Weight: 38 Cubic Feet Per Carton: 19.5</p>	 <p>2074NUU</p>	2074NPU	974	999	1018	1047	1088	1106	1143	1201	1246	1296	1400	1508
			Upholstered seat											
		2074NUU	1081	1107	1126	1154	1195	1214	1250	1307	1353	1402	1503	1613
			Upholstered seat & back											
			OVERALL DIMENSIONS			SEAT DIMENSIONS			BACK DIMENSIONS					
			W	D	H	W	D	H	W	H				
			20.5	23.5	43	18	18	22.5	16	16				
			RTA 00		1 per carton									

SUPRA™



model 5330-4 (UB)



model 5332 (TUN)



Impact Resistant Back
All models are standard with an impact resistant back cover, in Black Only.



model 5332









Optional Base
Arched aluminum base available as an option on models that are standard with a black arched base. Specify "B5". Add \$154.



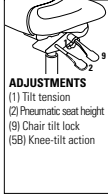

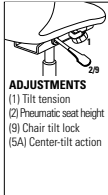

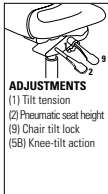

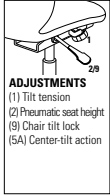

STANDARD FEATURES

- Contoured cushions support the user in a comfortable, contemporary style.
- Stylish arm/frame design sweeps from under the seat through the back and culminates in a hoop at the rear of the seat.
- Tilters are standard with a Tungsten (TUN) finish and Black base. Armchairs are standard with a Tungsten finish (TUN).
- Molded self-skinned urethane waterfall armrests are available in Black (BK) Only.
- The impact resistant outer back shell adds a decorative look and protects from damage. Available in Black (BK) Only.
- All models (except armchairs) are standard with a five-legged, injection molded "spider" base with C65 casters are standard.
- Model 5331-4SC features a self centering cylinder which swivels and automatically returns to the starting seat location. This model is standard with a flat 5 star base in Black (BK) with C7 glides.
- Check textile availability prior to specifying upholstery material.

OPTIONAL FEATURES

- Models 5332 and 5332L can be joined together using ganging clamp model 5233.
- Optional steel cushioned glides (B) are available on models 5332 and 5332L. Specify. Add \$31.
- Optional frame finishes include: Please Specify a Tungsten finish with Tungsten base (UT)* on Tilter models. Add \$83. (* Equipped with a 3" cylinder instead of the standard 4" cylinder to maintain seat height range.)
- Armchair optional frame finishes include: (TBL) Black, (TSH) Shadow, and (TTU) Tungsten. For a Chrome (CHM) finish on armchairs, add \$117.
- Please refer to the "Casters Selection" section of the price book for caster options. Optional casters may be priced higher than the standard casters for your chair and the difference will be charged. Lower priced optional casters will not be credited.
- For hard surface flooring casters, please specify C65R casters. Add \$66.
- For fully assembled in box, please specify SU. Add \$70.

DESCRIPTION	FEATURES	MODEL#	STANDARD TEXTILE GRADES											
			1	2	3	4	5	6	7	8	9	10	11	12
 <p>HB Knee - Tilter COM Yardage: 1.5 Freight Class: 250 Product Weight (lbs.): 41 Cubic Feet Per Carton: 13.25</p> <p>Ergonomic Features: A, B, C, J, M, N</p>	 <p>ADJUSTMENTS (1) Tilt tension (2) Pneumatic seat height (9) Chair tilt lock (5B) Knee-tilt action</p>	5330-2	885	936	977	1037	1120	1150	1226	1367	1435	1564	1740	1962
			OVERALL DIMENSIONS			SEAT DIMENSIONS			BACK DIMENSIONS					
			W	D	H	W	D	H	W	H				
			26	27	42.5	21	18.5	17.5-21.5	20	24				
			RTA 2											
 <p>HB Tilter COM Yardage: 1.5 Freight Class: 250 Product Weight (lbs.): 40 Cubic Feet Per Carton: 12</p> <p>Ergonomic Features: A, B, C, M, N, S</p>	 <p>ADJUSTMENTS (1) Tilt tension (2) Pneumatic seat height (9) Chair tilt lock (5A) Center-tilt action</p>	5330-4	671	721	762	821	905	935	1010	1153	1221	1350	1526	1748
			OVERALL DIMENSIONS			SEAT DIMENSIONS			BACK DIMENSIONS					
			W	D	H	W	D	H	W	H				
			26	27	42	21	18.5	16.5-20.5	20	24				
			RTA 2											
 <p>MB Knee - Tilter COM Yardage: 1.25 Freight Class: 250 Product Weight (lbs.): 39 Cubic Feet Per Carton: 13.25</p> <p>Ergonomic Features: A, B, C, J, M, N</p>	 <p>ADJUSTMENTS (1) Tilt tension (2) Pneumatic seat height (9) Chair tilt lock (5B) Knee-tilt action</p>	5331-2	838	882	917	964	1036	1061	1123	1237	1295	1405	1552	1737
			OVERALL DIMENSIONS			SEAT DIMENSIONS			BACK DIMENSIONS					
			W	D	H	W	D	H	W	H				
			26	26	39.5	21	18.5	17.5-21.5	20	19.5				
			RTA 2											

DESCRIPTION	FEATURES	MODEL#	STANDARD TEXTILE GRADES												
			1	2	3	4	5	6	7	8	9	10	11	12	
 5331-4	 5331L-4	 <p>ADJUSTMENTS (1) Tilt tension (2) Pneumatic seat height (3) Chair tilt lock (5A) Center-tilt action</p>	5331-4	627	670	707	752	823	851	912	1028	1085	1192	1341	1526
			OVERALL DIMENSIONS			SEAT DIMENSIONS			BACK DIMENSIONS						
			W	D	H	W	D	H	W	H					
			26	26	39	21	18.5	16.5-20.5	20	19.5					
<p>MB Tilter COM Yardage: 1.25 Freight Class: 250 Product Weight (lbs.): 37 Cubic Feet Per Carton: 12</p>			Ergonomic Features: A, B, C, M, N, S			RTA 2			ups						
 5331-4SC	 5331L-4SC		5331-4SC	697	743	776	826	899	923	986	1107	1164	1275	1425	1614
			OVERALL DIMENSIONS			SEAT DIMENSIONS			BACK DIMENSIONS						
			W	D	H	W	D	H	W	H					
			26	26	37	21	18.5	18	20	19.5					
<p>MB Conference Chair COM Yardage: 1.25 Freight Class: 250 Product Weight (lbs.): 37 Cubic Feet Per Carton: 11.5</p>			Ergonomic Features: A, B, C, M, N, S			RTA 2			ups						
 5332	 5332L		5332	523	566	597	649	720	746	808	923	979	1088	1236	1420
			OVERALL DIMENSIONS			SEAT DIMENSIONS			BACK DIMENSIONS						
			W	D	H	W	D	H	W	H					
			25	25.5	36	21	18.5	17.5	20	19.5					
<p>Armchair COM Yardage: 1.25 Freight Class: 300 Product Weight (lbs.): 28 Cubic Feet Per Carton: 17</p>			Ergonomic Features: M, N			RTA 00									
 5332C	 5332LC		5332C	688	732	768	819	889	915	979	1099	1156	1266	1416	1608
			OVERALL DIMENSIONS			SEAT DIMENSIONS			BACK DIMENSIONS						
			W	D	H	W	D	H	W	H					
			25	25.5	38	21	18.5	17.5	20	19.5					
<p>Armchair Casters COM Yardage: 1.25 Freight Class: 300 Product Weight (lbs.): 28 Cubic Feet Per Carton: 17</p>			Ergonomic Features: M, N			RTA 00									
 5335	 5335L		5335	627	670	707	752	823	851	912	1028	1085	1192	1341	1526
			OVERALL DIMENSIONS			SEAT DIMENSIONS			BACK DIMENSIONS						
			W	D	H	W	D	H	W	H					
			25	28	38	21	18.5	18.5	20	19.5					
<p>Armchair Sled base COM Yardage: 1.25 Freight Class: 300 Product Weight (lbs.): 33 Cubic Feet Per Carton: 17.5</p>			Ergonomic Features: M, N			RTA 00			ups						

SUPRA X™



model 5336-3 (UG)



model 5336-5



Impact Resistant Back
All models are standard with an impact resistant back cover, in Black Only.



model 5337-6



Additional stitch detail for leather upholstery







Optional Base
An optional five-legged, arched metal base in Tungsten finish is available. (No Cover Can Used) Specify (UG). Add \$78





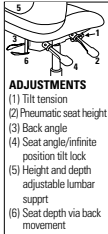

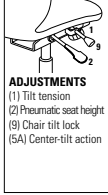

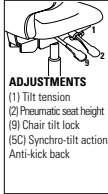
STANDARD FEATURES

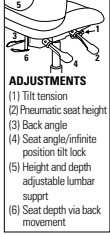

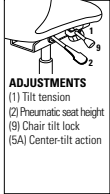
- Ergonomic office seating with height adjustable lumbar support.
- Control knobs on the outside of the back allow the adjustment of the lumbar support.
- An impact resistant outer back shell adds a distinctive look to this series and protects against damage.
- Height and depth adjustable lumbar support.
- Standard with adjustable height forward swept arms with kidney shaped urethane armcaps (SC).
- Base and frame are standard in Black (BK).
- All models are standard with a five-legged, injection molded "spider" base.
- C65 casters are standard.
- Check textile availability prior to specifying upholstery material.

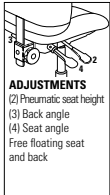
OPTIONAL FEATURES

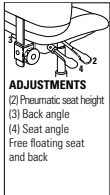
- Please refer to "Arms Selection" section of the price book for arm options.
- Please refer to "Cylinder Selection" section of the price book for additional cylinder options.
- Please refer to the "Casters Selection" section of the price book for caster options. Optional casters may be priced higher than the standard casters for your chair and the difference will be charged. Lower priced optional casters will not be credited.
- For hard surface flooring casters, please specify C65R casters. Add \$66
- Vari-Width Adapter Plate (WA) is standard when chair is ordered with adjustable height arms. Allows each arm to move outward an additional 2" (for a total of 4" extra seat width) and locks with the use of an easy to maneuver lever (WA).
- For fully assembled in box, please SU. Add \$70.

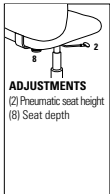
DESCRIPTION	FEATURES	MODEL#	STANDARD TEXTILE GRADES													
 <p>HB Multi - Tilter COM Yardage: 1.5 Freight Class: 150 Product Weight (lbs.): 58 Cubic Feet Per Carton: 10.5</p>	 <p>ADJUSTMENTS (1) Tilt tension (2) Pneumatic seat height (3) Back angle (4) Seat angle/infinite position tilt lock (5) Height and depth adjustable lumbar support (6) Seat depth via back movement</p>	<p>Ergonomic Features: A, B, C, E, G, H, M, N, S</p>	5333-3	1006	1059	1100	1160	1246	1277	1352	1497	1565	1700	1879	2105	
			<p>OVERALL DIMENSIONS</p>			<p>SEAT DIMENSIONS</p>			<p>BACK DIMENSIONS</p>							
			W	D	H	W	D	H	W	H						
			26	26.5	41	20	19-20	16-20	18	23.5						
 <p>HB Tilter COM Yardage: 1.5 Freight Class: 150 Product Weight (lbs.): 55 Cubic Feet Per Carton: 10.5</p>	 <p>ADJUSTMENTS (1) Tilt tension (2) Pneumatic seat height (9) Chair tilt lock (5A) Center-tilt action</p>	<p>Ergonomic Features: A, B, C, E, H, M, N, S</p>	5333-4	938	991	1033	1094	1180	1208	1285	1429	1498	1629	1811	2039	
			<p>OVERALL DIMENSIONS</p>			<p>SEAT DIMENSIONS</p>			<p>BACK DIMENSIONS</p>							
			W	D	H	W	D	H	W	H						
			26	25.5	41.5	21	18-19	16-20	18	23						
 <p>MB Synchro - Tilter COM Yardage: 1.25 Freight Class: 150 Product Weight (lbs.): 57 Cubic Feet Per Carton: 10.5</p>	 <p>ADJUSTMENTS (1) Tilt tension (2) Pneumatic seat height (9) Chair tilt lock (5C) Synchro-tilt action Anti-kick back</p>	<p>Ergonomic Features: A, B, C, H, L, M, N, Q</p>	5336-1	1175	1223	1255	1307	1376	1402	1466	1586	1642	1754	1901	2092	
			<p>OVERALL DIMENSIONS</p>			<p>SEAT DIMENSIONS</p>			<p>BACK DIMENSIONS</p>							
			W	D	H	W	D	H	W	H						
			26	26.5	37.5	20	19-20	16-20	18	16.5						

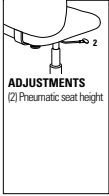
DESCRIPTION	FEATURES	MODEL#	STANDARD TEXTILE GRADES														
			1	2	3	4	5	6	7	8	9	10	11	12			
 <p>MB Multi - Tilter COM Yardage: 1.25 Freight Class: 150 Product Weight (lbs.): 55 Cubic Feet Per Carton: 10.5</p>	 <p>ADJUSTMENTS (1) Tilt tension (2) Pneumatic seat height (3) Back angle (4) Seat angle/infinite position tilt lock (5) Height and depth adjustable lumbar support (6) Seat depth via back movement</p>	<p>Ergonomic Features: A, B, C, E, G, H, M, N, Q, S</p>	5336-3	855	896	924	970	1034	1063	1120	1212	1283	1361	1523	1696		
			OVERALL DIMENSIONS			SEAT DIMENSIONS			BACK DIMENSIONS								
			W	D	H	W	D	H	W	H							
			26	26.5	37.5	20	17-18.5	17-21	18	20							
 <p>HB Tilter COM Yardage: 1.25 Freight Class: 150 Product Weight (lbs.): 53 Cubic Feet Per Carton: 10.5</p>	 <p>ADJUSTMENTS (1) Tilt tension (2) Pneumatic seat height (9) Chair tilt lock (5A) Center-tilt action</p>	<p>Ergonomic Features: A, B, C, E, H, M, N, Q, S</p>	5336-4	855	898	931	981	1051	1083	1147	1248	1325	1413	1591	1782		
			OVERALL DIMENSIONS			SEAT DIMENSIONS			BACK DIMENSIONS								
			W	D	H	W	D	H	W	H							
			26	25.5	37.5	21	18-19	16-20	19	19							
 <p>MB Operator COM Yardage: 1.25 Freight Class: 150 Product Weight (lbs.): 49 Cubic Feet Per Carton: 9.25</p>	 <p>ADJUSTMENTS (2) Pneumatic seat height (3) Back angle (4) Seat angle Free floating seat and back</p>	<p>Ergonomic Features: C, E, F, G, H, M, N, Q, S</p>	5336-5	826	867	898	945	1012	1044	1104	1200	1275	1356	1526	1708		
			OVERALL DIMENSIONS			SEAT DIMENSIONS			BACK DIMENSIONS								
			W	D	H	W	D	H	W	H							
			26	27.5	37.5	20	17-18.5	16.5-21.5	18	20							
 <p>MB Operator Armless COM Yardage: 1.25 Freight Class: 150 Product Weight (lbs.): 43 Cubic Feet Per Carton: 9.25</p>	 <p>ADJUSTMENTS (2) Pneumatic seat height (3) Back angle (4) Seat angle Free floating seat and back</p>	<p>Ergonomic Features: C, E, F, G, M, N, Q, S</p>	5337-5	685	726	758	804	872	904	965	1062	1136	1220	1391	1574		
			OVERALL DIMENSIONS			SEAT DIMENSIONS			BACK DIMENSIONS								
			W	D	H	W	D	H	W	H							
			20	27.5	37.5	20	17-18.5	16.5-21.5	18	20							
 <p>MB Task Armless COM Yardage: 1.25 Freight Class: 150 Product Weight (lbs.): 30 Cubic Feet Per Carton: 6.75</p>	 <p>ADJUSTMENTS (2) Pneumatic seat height (8) Seat depth</p>	<p>Ergonomic Features: C, E, M, N, Q</p>	5337-6	555	598	632	682	753	786	849	953	1031	1119	1300	1493		
			OVERALL DIMENSIONS			SEAT DIMENSIONS			BACK DIMENSIONS								
			W	D	H	W	D	H	W	H							
			20	25	38.5	20	17-18.5	16.5-21.5	18	20							

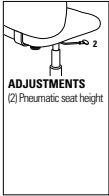
DESCRIPTION	FEATURES	MODEL#	STANDARD TEXTILE GRADES											
			1	2	3	4	5	6	7	8	9	10	11	12
 <p>Drafting Chair Task COM Yardage: 1.25 Freight Class: 125 Product Weight (lbs.): 42 Cubic Feet Per Carton: 6.75</p>	 <p>ADJUSTMENTS (2) Pneumatic seat height</p> <p>Ergonomic Features: C, M, N, Q</p>	5338-6	1142	1187	1221	1271	1343	1377	1441	1545	1625	1713	1896	2090
			OVERALL DIMENSIONS W D H			SEAT DIMENSIONS W D H			BACK DIMENSIONS W H					
			26	25	46.5	20	18.5-19.5	23.5-33.5	18	19				
 <p>Drafting Chair Task Armless COM Yardage: 1.25 Freight Class: 150 Product Weight (lbs.): 36 Cubic Feet Per Carton: 6.75</p>	 <p>ADJUSTMENTS (2) Pneumatic seat height</p> <p>Ergonomic Features: C, M, N, Q</p>	5339-6	997	1042	1076	1128	1200	1234	1300	1405	1485	1575	1760	1956
			OVERALL DIMENSIONS W D H			SEAT DIMENSIONS W D H			BACK DIMENSIONS W H					
			20	25	46.5	20	18.5-19.5	23.5-33.5	18	19				

SYNOPSIS®



model 5080-3



model 5091-4





model 5090-4PB





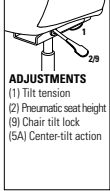

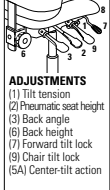

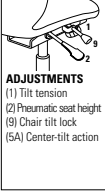

STANDARD FEATURES

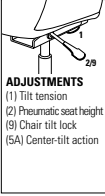

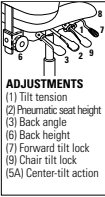

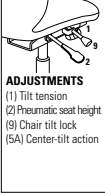

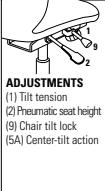

- A compound curved back adds a distinct look while maximizing comfort.
- Fixed height, impact and scuff resistant curved arms are standard on models 5090-4, 5091-4 and 5092
- Tilter, Synchro-Tilter, and Multi-Tilter models (starting with 5080) are standard with adjustable height T arms with teardrop shaped urethane armcaps (3B).
- Ratchet style back height and pneumatic seat height adjustments is standard on Synchro-Tilter and Multi-Tilter models.
- Vari-Width (WA), Width adjustable arm extensions are standard with adjustable height T arms.
- Synchro-Tilter and Multi-Tilters feature a black impact resistant outer back shell. Drafting stools have a plastic back panel. All other models feature a fully upholstered outer back.
- Sliding seat depth is available on Synchro-Tilters and Multi-Tilters. Seat depth can be adjusted with a lever on the side of the chair.
- All models (except armchair) are standard with a five-legged, injection molded base.
- Base and arms are available in Black (BK) Only.
- C65 casters are standard.
- Pedestal base models are offered on 5090 and 5091 (-4) Tilter mechanisms only. These models provide fixed location seating for use in auditoriums, classrooms, jury boxes, public venues and more. The base must be mounted to the floor (mounting hardware not included). See Pedestal Base Installation Guide for details.
- Check textile availability prior to specifying upholstery material.

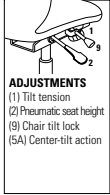
OPTIONAL FEATURES

- Polished Aluminum base with black scuff tips. Specify "B2". Add \$154. Available on select models: 5080-0, 5080-4, 5081-0, 5081-4, 5090-4, and 5091-4.
- Please refer to "Arms Selection" section of the price book for arm options.
- Please refer to "Cylinder Selection" section of the price book for additional cylinder options.
- For hard surface flooring casters, specify C65R, add \$66.
- Please refer to the "Casters Selection" section of the price book for caster options. Optional casters may be priced higher than the standard casters for your chair and the difference will be charged. Lower priced optional casters will not be credited.
- For fully assembled in box, specify SU. Add \$70
- Pedestal Base models have black bases with 2" height adjust cylinders. Specify (SCC) swivel, auto return to max height (no upcharge); (SN) non-swivel, auto return to max height (Add \$19); or (SC) swivel, self-centering and return to max height (Add \$30).

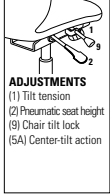
DESCRIPTION	FEATURES	MODEL#	STANDARD TEXTILE GRADES													
			1	2	3	4	5	6	7	8	9	10	11	12		
 <p>HB Synchro - Tilter w/Back Angle Adjustment COM Yardage: 2 Freight Class: 150 Product Weight (lbs.): 65 Cubic Feet Per Carton: 14.25</p>	 <p>ADJUSTMENTS (1) Tilt tension (2) Pneumatic seat height (9) Chair tilt lock (5A) Center-tilt action</p>	5080-0	1113	1235	1287	1365	1476	1513	1610	1792	1878	2049	2278	2565		
		OVERALL DIMENSIONS			SEAT DIMENSIONS			BACK DIMENSIONS								
		W	D	H	W	D	H	W	H							
	24	25	46	19.5	18-20.5	17-21	19	26-28.5								
				RTA 1												
 <p>HB Multi - Tilter COM Yardage: 2 Freight Class: 150 Product Weight (lbs.): 67 Cubic Feet Per Carton: 14.25</p>	 <p>ADJUSTMENTS (1) Tilt tension (2) Pneumatic seat height (3) Back angle (6) Back height (7) Forward tilt lock (9) Chair tilt lock (5A) Center-tilt action</p>	5080-3	1113	1235	1287	1365	1476	1513	1610	1792	1878	2049	2278	2565		
		OVERALL DIMENSIONS			SEAT DIMENSIONS			BACK DIMENSIONS								
		W	D	H	W	D	H	W	H							
	24	25	46	19.5	18-20.5	17-21	19	26-28.5								
				RTA 1												

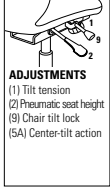
DESCRIPTION	FEATURES	MODEL#	STANDARD TEXTILE GRADES													
			1	2	3	4	5	6	7	8	9	10	11	12		
 <p>HB Tilter COM Yardage: 2 Freight Class: 150 Product Weight (lbs.): 45 Cubic Feet Per Carton: 9.75</p>	 <p>ADJUSTMENTS (1) Tilt tension (2) Pneumatic seat height (9) Chair tilt lock (5A) Center-tilt action</p>	<p>Ergonomic Features: A, B, C, M, N, S</p>	<p>RTA 2 </p>	5080-4	954	1020	1071	1150	1257	1297	1392	1575	1663	1831	2060	2349
				OVERALL DIMENSIONS			SEAT DIMENSIONS			BACK DIMENSIONS						
				W	D	H	W	D	H	W	H					
				24.5	26.5	43.5	19.5	18-19.5	16.5-20.5	19	25.5					
 <p>MB Synchro - Tilter w/Back Angle Adjustment COM Yardage: 1.75 Freight Class: 150 Product Weight (lbs.): 62 Cubic Feet Per Carton: 14.25</p>	 <p>ADJUSTMENTS (1) Tilt tension (2) Pneumatic seat height (9) Chair tilt lock (5A) Center-tilt action</p>	<p>Ergonomic Features: A, B, C, E, H, L, M, N, R</p>	<p>RTA 1 </p>	5081-0	1007	1116	1162	1228	1324	1359	1443	1602	1678	1827	2028	2278
				OVERALL DIMENSIONS			SEAT DIMENSIONS			BACK DIMENSIONS						
				W	D	H	W	D	H	W	H					
				24	25	42	19.5	18-20.5	17-21	19	22-24.5					
 <p>MB Multi - Tilter COM Yardage: 1.75 Freight Class: 150 Product Weight (lbs.): 64 Cubic Feet Per Carton: 14.25</p>	 <p>ADJUSTMENTS (1) Tilt tension (2) Pneumatic seat height (3) Back angle (6) Back height (7) Forward tilt lock (9) Chair tilt lock (5A) Center-tilt action</p>	<p>Ergonomic Features: A, B, C, D, E, F, G, H, M, N, Q, S</p>	<p>RTA 1 </p>	5081-3	1007	1116	1162	1228	1324	1359	1443	1602	1678	1827	2028	2278
				OVERALL DIMENSIONS			SEAT DIMENSIONS			BACK DIMENSIONS						
				W	D	H	W	D	H	W	H					
				24	25	42	19.5	18-20.5	17-21	19	22-24.5					
 <p>MB Tilter COM Yardage: 1.75 Freight Class: 150 Product Weight (lbs.): 45 Cubic Feet Per Carton: 9.75</p>	 <p>ADJUSTMENTS (1) Tilt tension (2) Pneumatic seat height (9) Chair tilt lock (5A) Center-tilt action</p>	<p>Ergonomic Features: A, B, C, M, N, S</p>	<p>RTA 2 </p>	5081-4	838	901	951	1024	1129	1177	1271	1420	1536	1664	1930	2213
				OVERALL DIMENSIONS			SEAT DIMENSIONS			BACK DIMENSIONS						
				W	D	H	W	D	H	W	H					
				24.5	26.5	43.5	19.5	18-19.5	16.5-20.5	19	25.5					
 <p>HB Tilter w/ Fixed Arm COM Yardage: 2 Freight Class: 250 Product Weight (lbs.): 41 Cubic Feet Per Carton: 11.5</p>	 <p>ADJUSTMENTS (1) Tilt tension (2) Pneumatic seat height (9) Chair tilt lock (5A) Center-tilt action</p>	<p>Ergonomic Features: A, B, C, M, N, S</p>	<p>RTA 1 </p>	5090-4	696	796	847	925	1036	1073	1168	1351	1438	1611	1838	2126
				OVERALL DIMENSIONS			SEAT DIMENSIONS			BACK DIMENSIONS						
				W	D	H	W	D	H	W	H					
				24.5	26.5	43.5	19.5	19.5	16.5-20.5	19	25.5					

DESCRIPTION	FEATURES	MODEL#	STANDARD TEXTILE GRADES													
			1	2	3	4	5	6	7	8	9	10	11	12		
 <p>MB Tilter w/ Fixed Arm COM Yardage: 1.75 Freight Class: 250 Product Weight (lbs.): 38 Cubic Feet Per Carton: 11.5</p>	 <p>ADJUSTMENTS (1) Tilt tension (2) Pneumatic seat height (9) Chair tilt lock (5A) Center-tilt action</p>	5091-4	652	744	788	854	950	985	1069	1228	1304	1453	1654	1905		
			OVERALL DIMENSIONS			SEAT DIMENSIONS			BACK DIMENSIONS							
			W	D	H	W	D	H	W	H						
			24.5	26.5	39.5	19.5	19.5	16.5-20.5	19	21.5						
	Ergonomic Features: A, B, C, M, N, S		RTA 1													
 <p>Armchair COM Yardage: 1.75 Freight Class: 250 Product Weight (lbs.): 40 Cubic Feet Per Carton: 17</p>		5092	662	754	799	864	962	999	1079	1238	1317	1463	1666	1915		
			OVERALL DIMENSIONS			SEAT DIMENSIONS			BACK DIMENSIONS							
			W	D	H	W	D	H	W	H						
			25	26	37	19.5	19	16.5	19	27						
	Ergonomic Features: M, N		RTA 00													
 <p>HB Tilter with Pedestal Base COM Yardage: 2 Freight Class: 250 Product Weight (lbs.): 44 Cubic Feet Per Carton: 11.5</p>	 <p>ADJUSTMENTS (1) Tilt tension (2) Pneumatic seat height (9) Chair tilt lock (5A) Center-tilt action</p>	5090-4PB	910	973	1024	1098	1202	1251	1347	1499	1615	1746	2013	2299		
			OVERALL DIMENSIONS			SEAT DIMENSIONS			BACK DIMENSIONS							
			W	D	H	W	D	H	W	H						
			24.5	26.5	39.5	19.5	19.5	16.5-20.5	19	25.5						
	Ergonomic Features: A, B, C, M, N, S		RTA 1													
 <p>MB Tilter with Pedestal Base COM Yardage: 1.75 Freight Class: 250 Product Weight (lbs.): 41 Cubic Feet Per Carton: 11.5</p>	 <p>ADJUSTMENTS (1) Tilt tension (2) Pneumatic seat height (9) Chair tilt lock (5A) Center-tilt action</p>	5091-4PB	867	925	966	1032	1124	1166	1251	1385	1487	1601	1836	2086		
			OVERALL DIMENSIONS			SEAT DIMENSIONS			BACK DIMENSIONS							
			W	D	H	W	D	H	W	H						
			24.5	26.5	37.5	19.5	19.5	16.5-20.5	19	21.5						
	Ergonomic Features: A, B, C, M, N, S		RTA 1													

TAMIRI®



model 4520-3 (TD)

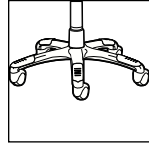

Optional Base





Polished aluminum base with black scuff tips (B2) is available at an upcharge. Add \$145.





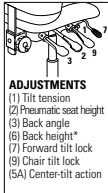

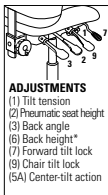
STANDARD FEATURES

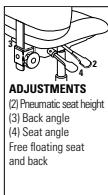
- Perforated, breathable leather panels in the seat and back provide long-term comfort through better ventilation.
- Fixed height, impact and scuff resistant curved arms with perforated leather pads are standard on managerial, executive and armchair models.
- All other models are standard with adjustable height T-arms with teardrop shaped urethane armcaps (TD).
- Models 4522, 4526 and 4527 are standard with upholstered armcaps. All polypropylene arms are available at no charge. Please specify "PA" when ordering.
- All models (except armchair) are standard with a five-legged, injection molded "spider" base.
- Base and arms are available in Black (BK) Only.
- C10 casters are standard.
- Upholstery options: vinyl or leather. Not available in fabric.
- Standard in Luxhide. Not available in fabric. Starting at grade 5 pricing.
- Vari-Width (WA) Width Adjustable Arm Extensions are standard.

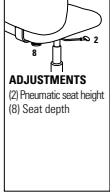
OPTIONAL FEATURES

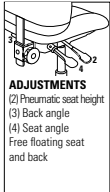
- Available with back edge vinyl bumper guard option (VBG). Add \$24.
- Polished Aluminum base with black scuff tips. Specify "B2". Add \$154.
- Please refer to "Arms Selection" section of the price book for arm options.
- For hard surface flooring casters Please Specify C10R, Add \$60.
- Please refer to the "Casters Selection" section of the price book for caster options. Optional casters may be priced higher than the standard casters for your chair and the difference will be charged. Lower priced optional casters will not be credited.
- For fully assembled in box, please specify SU. Add \$70.

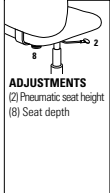
DESCRIPTION	FEATURES	MODEL#	STANDARD FABRIC GRADES												
			1	2	3	4	5	6	7	8	9	10	11	12	
 <p>HB Multi - Tilter w/Adj. Teardrop Arms COM Yardage: 2.25 Freight Class: 150 Product Weight (lbs.): 56 Cubic Feet Per Carton: 11</p> <p>Ergonomic Features: A, B, C, D, F, G, H, M, N, Q, S</p>	 <p>ADJUSTMENTS (1) Tilt tension (2) Pneumatic seat height (3) Back angle (6) Back height* (7) Forward tilt lock (9) Chair tilt lock (5A) Center-tilt action</p>	4520-3	-	-	-	-	1181	1237	-	1548	1663	1848	2126	2458	
		OVERALL DIMENSIONS			SEAT DIMENSIONS			BACK DIMENSIONS							
		W	D	H	W	D	H	W	H						
		25.5	26.5	47.5	22	19.5	17-21	21	26-28						
 <p>MB Multi - Tilter w/Adj. Teardrop Arms COM Yardage: 2 Freight Class: 150 Product Weight (lbs.): 53 Cubic Feet Per Carton: 9.5</p> <p>Ergonomic Features: A, B, C, D, F, G, H, M, N, Q, S</p>	 <p>ADJUSTMENTS (1) Tilt tension (2) Pneumatic seat height (3) Back angle (6) Back height* (7) Forward tilt lock (9) Chair tilt lock (5A) Center-tilt action</p>	4521-3	-	-	-	-	1069	1124	-	1397	1500	1662	1912	2205	
		OVERALL DIMENSIONS			SEAT DIMENSIONS			BACK DIMENSIONS							
		W	D	H	W	D	H	W	H						
		25	26	41	22	19	17-21	21	20.5-22.5						
 <p>LB Operator w/Adj. Teardrop Arms COM Yardage: 1.75 Freight Class: 150 Product Weight (lbs.): 46 Cubic Feet Per Carton: 7.5</p> <p>Ergonomic Features: C, D, F, G, H, M, N, Q</p>	 <p>ADJUSTMENTS (2) Pneumatic seat height (3) Back angle (4) Seat angle Free floating seat and back</p>	4528-5	-	-	-	-	989	1035	-	1277	1364	1508	1725	1984	
		OVERALL DIMENSIONS			SEAT DIMENSIONS			BACK DIMENSIONS							
		W	D	H	W	D	H	W	H						
		25	39	39	22	19.5	17-22	19	19-21						

DESCRIPTION	FEATURES	MODEL#	STANDARD FABRIC GRADES												
			1	2	3	4	5	6	7	8	9	10	11	12	
 <p>LB Task w/Adj. Teardrop Arms COM Yardage: 1.75 Freight Class: 150 Product Weight (lbs.): 41 Cubic Feet Per Carton: 7</p>	 <p>ADJUSTMENTS (2) Pneumatic seat height (8) Seat depth</p>	<p>4528-6</p>	-	-	-	-	770	815	-	1055	1144	1289	1506	1764	
			OVERALL DIMENSIONS			SEAT DIMENSIONS			BACK DIMENSIONS						
			W	D	H	W	D	H	W	H					
			26.5	25	41	22	17-18.5	16.5-21.5	19	21					
			RTA 2												
Ergonomic Features: C, E, H, M, N, Q															
 <p>LB Operator Armless COM Yardage: 1.75 Freight Class: 150 Product Weight (lbs.): 41 Cubic Feet Per Carton: 7</p>	 <p>ADJUSTMENTS (2) Pneumatic seat height (3) Back angle (4) Seat angle Free floating seat and back</p>	<p>4529-5</p>	-	-	-	-	806	852	-	1094	1182	1324	1542	1800	
			OVERALL DIMENSIONS			SEAT DIMENSIONS			BACK DIMENSIONS						
			W	D	H	W	D	H	W	H					
			26.5	25	41	22	19.5	17-22	19	19-21					
			RTA 2												
Ergonomic Features: C, D, F, G, M, N															
 <p>LB Task Armless COM Yardage: 1.75 Freight Class: 150 Product Weight (lbs.): 34 Cubic Feet Per Carton: 7</p>	 <p>ADJUSTMENTS (2) Pneumatic seat height (8) Seat depth</p>	<p>4529-6</p>	-	-	-	-	625	670	-	913	1000	1143	1360	1619	
			OVERALL DIMENSIONS			SEAT DIMENSIONS			BACK DIMENSIONS						
			W	D	H	W	D	H	W	H					
			22.5	25	41	22	17-18.5	16.5-21.5	19	21					
			RTA 2												
Ergonomic Features: C, E, M, N															

TRADITIONAL™



model 3720



model 3722



Standard Feature
Attractive brass-colored nail head trim is standard on all models



model 3747



STANDARD FEATURES







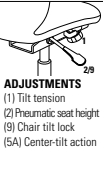

- Tilter chairs are standard with a traditional style wood capped steel base.
- All models are Tufted design with brass-colored nail head trim and vinyl bumper guards. Pneumatic seat height adjustment and tilt tension control.
- **C1** casters are standard.
- All models ship fully assembled in the box.
- Check textile availability prior to specifying upholstery material.

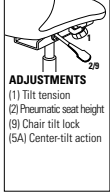

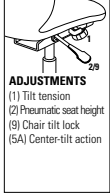

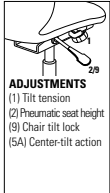

- Please refer to the “Casters Selection” section of the price book for caster options. Optional casters may be priced higher than the standard casters for your chair and the difference will be charged. Lower priced optional casters will not be credited.
- For hard surface flooring casters. Specify **C9R**, Add \$66.

OPTIONAL FEATURES

- Wood base, arms and frames are available in Absolute (**AAM**), Black (**BKM**), Cherry (**ACM**), Espresso Cafe (**ECM**), English Oak (**EOM**), Fruitwood (**TFM**), Gray (**HGM**), Honey (**AHM**), Mahogany (**TMM**), Maple (**AVM**), Medium Walnut (**MWM**), Natural Walnut (**NLW**), Night (**ASM**), Noce Biondo (**NBM**), Noce Grigio (**NGM**), Noce Leggero (**NEM**), Noce Medio (**NMM**), Shaker Cherry (**SKM**), Walnut (**TWM**), WC Cream (**WTM**), White (**WHM**) and Winter Cherry (**WCM**). Please Specify. Genuine maple faced veneers and solids are used.
- Tilter models can be ordered with an optional Black nylon base upon request, at no upcharge.

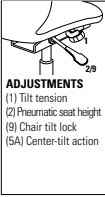
DESCRIPTION	FEATURES	MODEL#	STANDARD FABRIC GRADES												
			1	2	3	4	5	6	7	8	9	10	11	12	
 <p>HB Tilter Queen Anne Style COM Yardage: 4.75 Freight Class: 250 Product Weight (lbs.): 64 Cubic Feet Per Carton: 22.25</p>	 <p>ADJUSTMENTS (1) Tilt tension (2) Pneumatic seat height (3) Chair tilt lock (SA) Center-tilt action</p>	3720	1527	1686	1813	--	2267	2366	--	3043	3256	3673	4234	4936	
		OVERALL DIMENSIONS			SEAT DIMENSIONS			BACK DIMENSIONS							
		W	D	H	W	D	H	W	H						
		29	30	44.5	19.5	19.5	19-23	19	26						
 <p>ArmChair Banker's Style COM Yardage: 2 Freight Class: 250 Product Weight (lbs.): 31 Cubic Feet Per Carton: 11.25</p>	<p>*Fabrics Limited, See notes</p> <p>Ergonomic Features: A, C, M, N, S</p>	3722	767	837	--	--	1078	1124	--	1410	1500	1672	1912	2204	
		OVERALL DIMENSIONS			SEAT DIMENSIONS			BACK DIMENSIONS							
		W	D	H	W	D	H	W	H						
		25	22.5	31	25	18	19.5	23	11						
			3722C	817	886	--	--	1133	1173	--	1459	1551	1723	1961	2258
			with casters												
				OVERALL DIMENSIONS			SEAT DIMENSIONS			BACK DIMENSIONS					
				W	D	H	W	D	H	W	H				
				25	22.5	31	25	18	19.5	23	11				

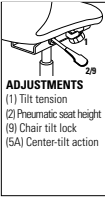
DESCRIPTION	FEATURES	MODEL#	STANDARD FABRIC GRADES												
 <p>HB Tilter Martha Washington Style COM Yardage: 3 Freight Class: 250 Product Weight (lbs.): 52 Cubic Feet Per Carton: 20.25</p>	 <p>ADJUSTMENTS (1) Tilt tension (2) Pneumatic seat height (9) Chair tilt lock (5A) Center-tilt action</p>	3730	1	2	3	4	5	6	7	8	9	10	11	12	
			1476	1576	--	--	1944	2008	--	2435	2570	2830	3184	3628	
		OVERALL DIMENSIONS			SEAT DIMENSIONS			BACK DIMENSIONS							
		W	D	H	W	D	H	W	H						
	0	0	0	18	18	17.5-21.5	19	23							
				RTA 00											
*Fabrics Limited, See notes															
Ergonomic Features: A, C, M, N, S															
 <p>LB Tilter Martha Washington Style COM Yardage: 2.75 Freight Class: 250 Product Weight (lbs.): 46 Cubic Feet Per Carton: 15.75</p>	 <p>ADJUSTMENTS (1) Tilt tension (2) Pneumatic seat height (9) Chair tilt lock (5A) Center-tilt action</p>	3731	1	2	3	4	5	6	7	8	9	10	11	12	
			1369	1461	--	--	1800	1853	--	2246	2371	2611	2937	3344	
		OVERALL DIMENSIONS			SEAT DIMENSIONS			BACK DIMENSIONS							
		W	D	H	W	D	H	W	H						
	25.5	26	36	18	18	17.5-21.5	19	18							
				RTA 00											
*Fabrics Limited, See notes															
Ergonomic Features: A, C, M, N, S															
 <p>LB Armchair Martha Washington Style COM Yardage: 2.75 Freight Class: 300 Product Weight (lbs.): 28 Cubic Feet Per Carton: 15.75</p>	 <p>ADJUSTMENTS (1) Tilt tension (2) Pneumatic seat height (9) Chair tilt lock (5A) Center-tilt action</p>	3732	1	2	3	4	5	6	7	8	9	10	11	12	
			1136	1230	--	--	1567	1621	--	2014	2138	2378	2705	3110	
		OVERALL DIMENSIONS			SEAT DIMENSIONS			BACK DIMENSIONS							
		W	D	H	W	D	H	W	H						
	25.5	24.5	34	20	18	19	19	18							
				RTA 00											
*Fabrics Limited, See notes															
Ergonomic Features: M, N															
 <p>HB Armchair Martha Washington Style COM Yardage: 3 Freight Class: 300 Product Weight (lbs.): 32 Cubic Feet Per Carton: 20.25</p>	 <p>ADJUSTMENTS (1) Tilt tension (2) Pneumatic seat height (9) Chair tilt lock (5A) Center-tilt action</p>	3735	1	2	3	4	5	6	7	8	9	10	11	12	
			1243	1341	--	--	1709	1771	--	2199	2337	2597	2952	3396	
		OVERALL DIMENSIONS			SEAT DIMENSIONS			BACK DIMENSIONS							
		W	D	H	W	D	H	W	H						
	25	27.5	39.5	20	18	19	19	22.5							
				RTA 00											
*Fabrics Limited, See notes															
Ergonomic Features: M, N															
 <p>LB Tilter Martha Washington Style COM Yardage: 2.75 Freight Class: 250 Product Weight (lbs.): 47 Cubic Feet Per Carton: 15.75</p>	 <p>ADJUSTMENTS (1) Tilt tension (2) Pneumatic seat height (9) Chair tilt lock (5A) Center-tilt action</p>	3741	1	2	3	4	5	6	7	8	9	10	11	12	
			1388	1480	--	--	1817	1872	--	2265	2390	2630	2956	3363	
		OVERALL DIMENSIONS			SEAT DIMENSIONS			BACK DIMENSIONS							
		W	D	H	W	D	H	W	H						
	0	0	0	20	18	17.5-21.5	19	18							
				RTA 00											
*Fabrics Limited, See notes															
Ergonomic Features: A, C, M, N, S															

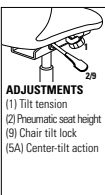
DESCRIPTION	FEATURES	MODEL#	STANDARD FABRIC GRADES											
			1	2	3	4	5	6	7	8	9	10	11	12
 <p>LB Armchair Martha Washington Style COM Yardage: 2.75 Freight Class: 300 Product Weight (lbs.): 28 Cubic Feet Per Carton: 15.75</p>	<p>*Fabrics Limited, See notes</p> <p>Ergonomic Features: M, N</p>	3742	1155	1250	--	--	1586	1641	--	2034	2157	2398	2723	3129
			OVERALL DIMENSIONS			SEAT DIMENSIONS			BACK DIMENSIONS					
			W	D	H	W	D	H	W	H				
			25	34.5	34.5	20	18	19	19	18				
						RTA 00								
 <p>HB Armchair Martha Washington Style COM Yardage: 3 Freight Class: 300 Product Weight (lbs.): 26 Cubic Feet Per Carton: 20.25</p>	<p>*Fabrics Limited, See notes</p> <p>Ergonomic Features: M, N</p>	3745	1264	1364	--	--	1733	1797	--	2225	2358	2620	2973	3421
			OVERALL DIMENSIONS			SEAT DIMENSIONS			BACK DIMENSIONS					
			W	D	H	W	D	H	W	H				
			25	27.5	39.5	20	18	19	19	22.5				
						RTA 00								
 <p>MB Tilter Martha Washington Style COM Yardage: 3 Freight Class: 300 Product Weight (lbs.): 40 Cubic Feet Per Carton: 20.25</p>	 <p>ADJUSTMENTS (1) Tilt tension (2) Pneumatic seat height (9) Chair tilt lock (5A) Center-tilt action</p>	3746	1369	1469	--	--	1837	1897	--	2330	2463	2722	3079	3523
			OVERALL DIMENSIONS			SEAT DIMENSIONS			BACK DIMENSIONS					
			W	D	H	W	D	H	W	H				
			26.5	29	38	20	18	17-21	20	24				
						RTA 00								
 <p>MB Tilter Martha Washington Style COM Yardage: 3 Freight Class: 250 Product Weight (lbs.): 48 Cubic Feet Per Carton: 20.25</p>	 <p>ADJUSTMENTS (1) Tilt tension (2) Pneumatic seat height (9) Chair tilt lock (5A) Center-tilt action</p>	3747	1345	1445	--	--	1813	1877	--	2306	2439	2701	3056	3498
			OVERALL DIMENSIONS			SEAT DIMENSIONS			BACK DIMENSIONS					
			W	D	H	W	D	H	W	H				
			0	0	0	20	18	17-21	20	24				
						RTA 00								
 <p>HB Tilter Judge's Style COM Yardage: 5 Freight Class: 250 Product Weight (lbs.): 63 Cubic Feet Per Carton: 28.25</p>	 <p>ADJUSTMENTS (1) Tilt tension (2) Pneumatic seat height (9) Chair tilt lock (5A) Center-tilt action</p>	3760	1700	1868	--	--	2480	2579	--	3296	3522	3955	4551	5286
			OVERALL DIMENSIONS			SEAT DIMENSIONS			BACK DIMENSIONS					
			W	D	H	W	D	H	W	H				
			29	32	48	20.5	18.5	18-22	20.5	26				
						RTA 00								

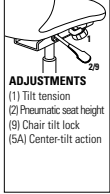
DESCRIPTION	FEATURES	MODEL#		STANDARD FABRIC GRADES											
		1	2	3	4	5	6	7	8	9	10	11	12		
 <p>HB Tilter Judge's Style COM Yardage: 4.75 Freight Class: 250 Product Weight (lbs.): 70 Cubic Feet Per Carton: 28.25</p>	 <p>ADJUSTMENTS (1) Tilt tension (2) Pneumatic seat height (9) Chair tilt lock (5A) Center-tilt action</p>	3766	1737	1896	--	--	2479	2574	--	3253	3467	3882	4446	5146	
		OVERALL DIMENSIONS			SEAT DIMENSIONS			BACK DIMENSIONS							
		W	D	H	W	D	H	W	H						
29	32	48	20.5	18.5	18-22	20.5	26								
		*Fabrics Limited, See notes													
		Ergonomic Features: A, C, M, N, S		<div style="border: 1px solid black; padding: 2px; display: inline-block;">RTA 00</div>											

TRIUMPH™



model 3650-3

model 3651-3



Lumbar Support







Adjusted in and out by turning the knob and vertically by moving up and down the slider.

STANDARD FEATURES

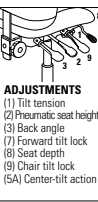
- Contemporary seating series featuring exceptional comfort, support and adjustment.
- Standard with adjustable height, forward swept arms with "sliding armcaps" (G1).
- Outer back knob can be adjusted in and out for lumbar support and vertically for optimal positioning.
- Frame is standard with a polished aluminum arched base and accentuated with polished aluminum back trim.
- Side activated sliding seat depth adjustment (MD), is standard on both control mechanisms. Provides 2" of seat depth adjustment.
- C1 casters are standard.

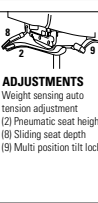
OPTIONAL FEATURES

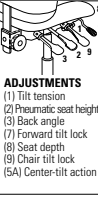
- For hard surface flooring please specify C9R. Add \$66.
- Check textile availability prior to specifying upholstery material.
- Please refer to the "Casters Selection" section of the price book for caster options.
- Please refer to "Cylinder Selection" section of the price book for additional cylinder options.
- For fully assembled in box, please specify SU. Add \$70.

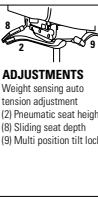
DESCRIPTION	FEATURES	MODEL#	STANDARD FABRIC GRADES											
			1	2	3	4	5	6	7	8	9	10	11	12
 <p>HB Multi-Tilter COM Yardage: 2 Freight Class: 250 Product Weight (lbs.): 66 Cubic Feet Per Carton: 23.5</p>	 <p>ADJUSTMENTS (1) Tilt tension (2) Pneumatic seat height (3) Back angle (7) Forward tilt lock (8) Seat depth (9) Chair tilt lock (5A) Center-tilt action</p>	<p>3650-3</p>	1519	1665	1717	1799	1914	1956	2054	2245	2338	2517	2758	3060
			OVERALL DIMENSIONS			SEAT DIMENSIONS			BACK DIMENSIONS					
			W	D	H	W	D	H	W	H				
	26	25	46.5	21	18-20.5	17-21	20	27						
									RTA 00					
 <p>HB Weight Sensing Synchro - Tilter COM Yardage: 2 Freight Class: 250 Product Weight (lbs.): 66 Cubic Feet Per Carton: 23.5</p>	 <p>ADJUSTMENTS Weight sensing auto tension adjustment (2) Pneumatic seat height (8) Sliding seat depth (9) Multi position tilt lock</p>	<p>3650-8</p>	1519	1665	1717	1799	1914	1956	2054	2245	2338	2517	2758	3060
			OVERALL DIMENSIONS			SEAT DIMENSIONS			BACK DIMENSIONS					
			W	D	H	W	D	H	W	H				
	26	25	46.5	21	18-20.5	17-21	20	27						
									RTA 00					
 <p>MB Multi - Tilter COM Yardage: 1.75 Freight Class: 250 Product Weight (lbs.): 64 Cubic Feet Per Carton: 20.5</p>	 <p>ADJUSTMENTS (1) Tilt tension (2) Pneumatic seat height (3) Back angle (7) Forward tilt lock (8) Seat depth (9) Chair tilt lock (5A) Center-tilt action</p>	<p>3651-3</p>	1488	1632	1686	1766	1883	1924	2023	2215	2307	2486	2726	3030
			OVERALL DIMENSIONS			SEAT DIMENSIONS			BACK DIMENSIONS					
			W	D	H	W	D	H	W	H				
	26	25	39.5	21	18-20.5	17-21	20	21						
									RTA 00					
 <p>MB Weight Sensing Synchro - Tilter COM Yardage: 1.75 Freight Class: 250 Product Weight (lbs.): 64 Cubic Feet Per Carton: 20.5</p>	 <p>ADJUSTMENTS Weight sensing auto tension adjustment (2) Pneumatic seat height (8) Sliding seat depth (9) Multi position tilt lock</p>	<p>3651-8</p>	1488	1632	1686	1766	1883	1924	2023	2215	2307	2486	2726	3030
			OVERALL DIMENSIONS			SEAT DIMENSIONS			BACK DIMENSIONS					
			W	D	H	W	D	H	W	H				
	26	25	39.5	21	18-20.5	17-21	20	21						
									RTA 00					

TRUFORM™



model 5450-3



model 5451-3

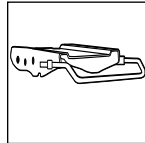

Multi-Depth Mechanism
Seat depth option is available on multi-tilter models. (see notes for more details)

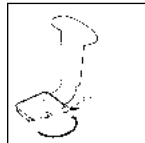







Vari-Width (WA)
Width Adjustable Arm Extensions is standard when order with adjustable height arms.



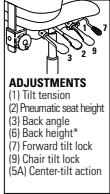

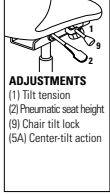

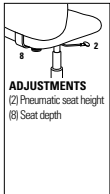



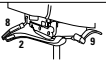



STANDARD FEATURES

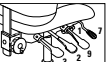



- Sixteen different models available, all featuring gently curved, streamlined seat and back cushions
- Standard with adjustable height **SC** arms.
- All models are standard with a high rise, injection molded base, standard in black.
- All models are shipped partially **KD**.
- **C1** casters are standard.
- Check textile availability prior to specifying upholstery material.

OPTIONAL FEATURES

- Seat depth is standard on models 5450-3, 5450-8, 5451-0, 5451-3.
- An optional polished aluminum base is available, specify **ALU**. Add \$154.
- Please refer to "Arms Selection" section of the price book for arm options.
- Please refer to "Cylinder Selection" section of the price book for additional cylinder options.
- Please refer to the "Casters Selection" section of the price book for caster options. Optional casters may be priced higher than the standard casters for your chair and the difference will be charged. Lower priced optional casters will not be credited.
- For hard surface flooring please specify **C9R** and Add \$66.
- For fully assembled in box, please specify **SU**. Add \$70.

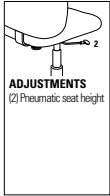
DESCRIPTION	FEATURES	MODEL#	STANDARD FABRIC GRADES													
			1	2	3	4	5	6	7	8	9	10	11	12		
 HB Multi - Tilter COM Yardage: 2 Freight Class: 125 Product Weight (lbs.): 63 Cubic Feet Per Carton: 10.5	 ADJUSTMENTS (1) Tilt tension (2) Pneumatic seat height (3) Back angle (6) Back height* (7) Forward tilt lock (9) Chair tilt lock (5A) Center-tilt action	5450-3	893	963	1013	1093	1204	1243	1341	1527	1617	1792	2023	2318		
		OVERALL DIMENSIONS			SEAT DIMENSIONS			BACK DIMENSIONS								
		W	D	H	W	D	H	W	H							
	26	25	42	20	18-20.5	16.5-20.5	20	23.5-26								
				RTA 2												
 HB Tilter COM Yardage: 2 Freight Class: 150 Product Weight (lbs.): 50 Cubic Feet Per Carton: 10.5	 ADJUSTMENTS (1) Tilt tension (2) Pneumatic seat height (9) Chair tilt lock (5A) Center-tilt action	5450-4	794	861	914	994	1106	1144	1242	1428	1518	1691	1924	2218		
		OVERALL DIMENSIONS			SEAT DIMENSIONS			BACK DIMENSIONS								
		W	D	H	W	D	H	W	H							
	26	25	42	20	18-20.5	16.5-20.5	20	23-26								
				RTA 2												
 HB Task COM Yardage: 2 Freight Class: 250 Product Weight (lbs.): 44 Cubic Feet Per Carton: 10.5	 ADJUSTMENTS (2) Pneumatic seat height (8) Seat depth	5450-6	731	799	853	932	1044	1084	1181	1366	1455	1628	1864	2156		
		OVERALL DIMENSIONS			SEAT DIMENSIONS			BACK DIMENSIONS								
		W	D	H	W	D	H	W	H							
	26	25	41.5	20	18-20.5	16-20	20	23.5-26								
				RTA 2												

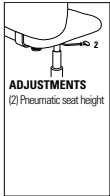
DESCRIPTION	FEATURES	MODEL#	STANDARD FABRIC GRADES														
			1	2	3	4	5	6	7	8	9	10	11	12			
 <p>HB Weight Sensing Synchro - Tilter COM Yardage: 2 Freight Class: 125 Product Weight (lbs.): 64 Cubic Feet Per Carton: 10.5</p>	 <p>ADJUSTMENTS Weight sensing auto tension adjustment (2) Pneumatic seat height (8) Sliding seat depth (9) Multi position tilt lock</p>	5450-8	893	960	1012	1091	1200	1237	1333	1517	1605	1772	2003	2288			
			OVERALL DIMENSIONS			SEAT DIMENSIONS			BACK DIMENSIONS								
			W	D	H	W	D	H	W	H							
			26	25	41.5	20	18-20.5	16.5-20.5	20	23.5-26							
<p>COM Yardage: 2 Freight Class: 125 Product Weight (lbs.): 64 Cubic Feet Per Carton: 10.5</p>	<p>Ergonomic Features: A, B, C, E, H, M, N, Q</p>	<p>RTA 2 </p>															
			 <p>MB Synchro - Tilter w/Back Angle Adjustment COM Yardage: 1.75 Freight Class: 125 Product Weight (lbs.): 63 Cubic Feet Per Carton: 10.5</p>	 <p>ADJUSTMENTS (1) Tilt tension (2) Pneumatic seat height (6) Back height (9) Chair tilt lock (5C) Synchro-tilt action Anti-knock back</p>	5451-0	856	917	965	1030	1130	1164	1249	1413	1490	1642	1847	2102
						OVERALL DIMENSIONS			SEAT DIMENSIONS			BACK DIMENSIONS					
						W	D	H	W	D	H	W	H				
26	25	38.5				20	18-20.5	17-21	20	23.5-26							
<p>COM Yardage: 1.75 Freight Class: 125 Product Weight (lbs.): 63 Cubic Feet Per Carton: 10.5</p>	<p>Ergonomic Features: A, B, C, J, M, N</p>	<p>RTA 2 </p>															
			 <p>MB Multi - Tilter COM Yardage: 1.75 Freight Class: 150 Product Weight (lbs.): 60 Cubic Feet Per Carton: 10.5</p>	 <p>ADJUSTMENTS (1) Tilt tension (2) Pneumatic seat height (3) Back angle (6) Back height* (7) Forward tilt lock (9) Chair tilt lock (5A) Center-tilt action</p>	5451-3	856	917	965	1030	1130	1164	1249	1413	1490	1642	1847	2102
						OVERALL DIMENSIONS			SEAT DIMENSIONS			BACK DIMENSIONS					
						W	D	H	W	D	H	W	H				
26	25	38.5				20	18-20.5	16.5-20.5	20	20-22.5							
<p>COM Yardage: 1.75 Freight Class: 150 Product Weight (lbs.): 60 Cubic Feet Per Carton: 10.5</p>	<p>Ergonomic Features: A, B, C, D, F, G, H, M, N, Q, S</p>	<p>RTA 2 </p>															
			 <p>MB Tilter COM Yardage: 1.75 Freight Class: 150 Product Weight (lbs.): 48 Cubic Feet Per Carton: 10.5</p>	 <p>ADJUSTMENTS (1) Tilt tension (2) Pneumatic seat height (9) Chair tilt lock (5A) Center-tilt action</p>	5451-4	758	819	863	932	1030	1067	1151	1313	1392	1543	1749	2004
						OVERALL DIMENSIONS			SEAT DIMENSIONS			BACK DIMENSIONS					
						W	D	H	W	D	H	W	H				
26	25	38.5				20	18-20.5	16.5-20.5	20	20-22.5							
<p>COM Yardage: 1.75 Freight Class: 150 Product Weight (lbs.): 48 Cubic Feet Per Carton: 10.5</p>	<p>Ergonomic Features: A, B, C, J, M, N</p>	<p>RTA 2 </p>															
			 <p>MB Operator COM Yardage: 1.75 Freight Class: 150 Product Weight (lbs.): 45 Cubic Feet Per Carton: 10.5</p>	 <p>ADJUSTMENTS (2) Pneumatic seat height (3) Back angle (4) Seat angle Free floating seat and back</p>	5451-5	851	911	956	1023	1123	1159	1243	1406	1485	1636	1842	2095
						OVERALL DIMENSIONS			SEAT DIMENSIONS			BACK DIMENSIONS					
						W	D	H	W	D	H	W	H				
26	25	38.5				20	18-20.5	16.5-20.5	20	20-22.5							
<p>COM Yardage: 1.75 Freight Class: 150 Product Weight (lbs.): 45 Cubic Feet Per Carton: 10.5</p>	<p>Ergonomic Features: A, B, C, J, M, N</p>	<p>RTA 2 </p>															

DESCRIPTION	FEATURES	MODEL#	STANDARD FABRIC GRADES											
			1	2	3	4	5	6	7	8	9	10	11	12
 <p>MB Drafting Stool Armless COM Yardage: 1.75 Freight Class: 250 Product Weight (lbs.): 38 Cubic Feet Per Carton: 10.5</p>	 <p>ADJUSTMENTS (2) Pneumatic seat height</p>	5457-6	1017	1077	1125	1191	1290	1324	1411	1574	1651	1803	2009	2263
			OVERALL DIMENSIONS			SEAT DIMENSIONS			BACK DIMENSIONS					
			W	D	H	W	D	H	W	H				
			20	25	47	20	17.5-19	22-30	20	20				
			RTA 2											
 <p>MB Drafting Stool COM Yardage: 1.75 Freight Class: 150 Product Weight (lbs.): 44 Cubic Feet Per Carton: 10.5</p>	 <p>ADJUSTMENTS (2) Pneumatic seat height</p>	5458-6	1188	1247	1293	1361	1459	1495	1580	1741	1820	1969	2177	2434
			OVERALL DIMENSIONS			SEAT DIMENSIONS			BACK DIMENSIONS					
			W	D	H	W	D	H	W	H				
			26	25	47	20	17.5-19	22-30	20	20				
			RTA 2											

TYE™



model 1950-4 (3N)



model 1951-4 (3N)

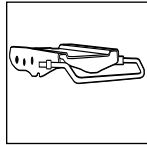

Multi-Depth Mechanism
Seat depth option is available on multi-tilter models. (see notes for more details)



model 1953

STANDARD FEATURES

- Contemporary mesh fabric and upholstered panels are used on chair backs.
- Standard with adjustable height T-arms with curved urethane armcaps (3N) in Black Only, (except model 1953 which has a fixed height version of this same arm style). All models (except armchair) are standard with a five-legged, injection molded "spider" base.
- C65 casters are standard.
- Where fabric is approved for use only on seat, Luxhide Bonded Leather is recommended for the back textile selection.
- Seat depth and pneumatic seat height adjustments. Tilt tension adjustment with tilt lock.
- Mesh available in Black only.
- Check textile availability prior to specifying upholstery material.

OPTIONAL FEATURES

- Cantilever frame on armchair (model 1953) is available in Black (TBL) or Tungsten (TTU). No upcharge. For Chrome (CHM) finish, add 10% of opening published grade price.. Please refer to "Arms Selection" section of the price book for arm options.
- Please refer to the "Casters Selection" section of the price book for caster options. Optional casters may be priced higher than the standard casters for your chair and the difference will be charged. Lower priced optional casters will not be credited.
- For hard surface flooring, specify C65R. Add \$66.
- For fully assembled in box, specify SU. Add \$70.

DESCRIPTION FEATURES MODEL# STANDARD TEXTILE GRADES



HB Synchro - Tilter
COM Yardage: 1.5
Freight Class: 150
Product Weight (lbs.): 56
Cubic Feet Per Carton: 11

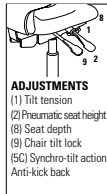

ADJUSTMENTS
(1) Tilt tension
(2) Pneumatic seat height
(8) Seat depth
(9) Chair tilt lock
(5C) Synchro-tilt action
Anti-kick back

Ergonomic Features:
A, B, C, E, H, L, M, N

MODEL#	1	2	3	4	5	6	7	8	9	10	11	12
1950-1	977	1032	1071	1131	1214	1245	1320	1460	1527	1657	1833	2058

OVERALL DIMENSIONS			SEAT DIMENSIONS			BACK DIMENSIONS	
W	D	H	W	D	H	W	H
25	26	45	21	19-20.5	17.5-21.5	19.5	27



HB Multi - Tilter
COM Yardage: 1.5
Freight Class: 150
Product Weight (lbs.): 55
Cubic Feet Per Carton: 11

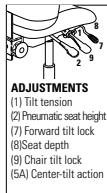

ADJUSTMENTS
(1) Tilt tension
(2) Pneumatic seat height
(7) Forward tilt lock
(8) Seat depth
(9) Chair tilt lock
(5A) Center-tilt action

Ergonomic Features:
A, B, C, E, F, H, M, N, S

MODEL#	1	2	3	4	5	6	7	8	9	10	11	12
1950-3	959	1010	1050	1110	1194	1226	1298	1441	1508	1638	1815	2040

OVERALL DIMENSIONS			SEAT DIMENSIONS			BACK DIMENSIONS	
W	D	H	W	D	H	W	H
25	26	45	21	19-20.5	17.5-21.5	19.5	27



HB Tilter
COM Yardage: 1.5
Freight Class: 150
Product Weight (lbs.): 52
Cubic Feet Per Carton: 11

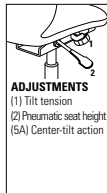









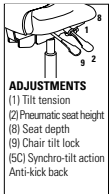

ADJUSTMENTS
(1) Tilt tension
(2) Pneumatic seat height
(5A) Center-tilt action

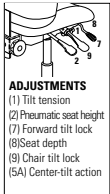

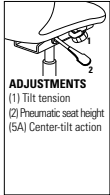

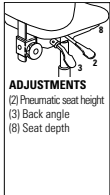

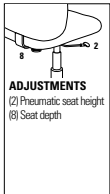

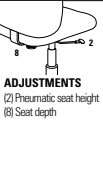

Ergonomic Features:
A, C, E, H, M, N

MODEL#	1	2	3	4	5	6	7	8	9	10	11	12
1950-4	815	865	906	969	1050	1078	1156	1297	1362	1492	1670	1894

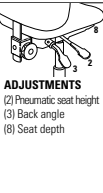
OVERALL DIMENSIONS			SEAT DIMENSIONS			BACK DIMENSIONS	
W	D	H	W	D	H	W	H
25	26	45.5	21	19-20.5	16.5-20.5	19.5	27

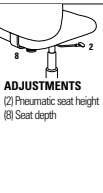

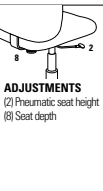
DESCRIPTION	FEATURES	MODEL#	STANDARD TEXTILE GRADES																											
			1	2	3	4	5	6	7	8	9	10	11	12																
 <p>MB Synchro - Tilter COM Yardage: 1.25 Freight Class: 150 Product Weight (lbs.): 54 Cubic Feet Per Carton: 10.5</p>	 <p>ADJUSTMENTS (1) Tilt tension (2) Pneumatic seat height (8) Seat depth (9) Chair tilt lock (5C) Synchro-tilt action Anti-kick back</p>	<p>Ergonomic Features: A, B, C, E, H, L, M, N</p>	<table border="1"> <tr> <td>1951-1</td> <td>946</td> <td>990</td> <td>1025</td> <td>1072</td> <td>1143</td> <td>1167</td> <td>1230</td> <td>1347</td> <td>1404</td> <td>1511</td> <td>1661</td> <td>1845</td> </tr> </table>												1951-1	946	990	1025	1072	1143	1167	1230	1347	1404	1511	1661	1845			
			1951-1	946	990	1025	1072	1143	1167	1230	1347	1404	1511	1661	1845															
			<p>OVERALL DIMENSIONS</p> <table border="1"> <tr> <th>W</th> <th>D</th> <th>H</th> </tr> <tr> <td>25</td> <td>26</td> <td>40.5</td> </tr> </table>			W	D	H	25	26	40.5	<p>SEAT DIMENSIONS</p> <table border="1"> <tr> <th>W</th> <th>D</th> <th>H</th> </tr> <tr> <td>21</td> <td>19-20.5</td> <td>17-21</td> </tr> </table>			W	D	H	21	19-20.5	17-21	<p>BACK DIMENSIONS</p> <table border="1"> <tr> <th>W</th> <th>H</th> </tr> <tr> <td>19.5</td> <td>23</td> </tr> </table>						W	H	19.5	23
			W	D	H																									
25	26	40.5																												
W	D	H																												
21	19-20.5	17-21																												
W	H																													
19.5	23																													
<p>RTA 2 </p>																														
 <p>MB Multi - Tilter COM Yardage: 1.25 Freight Class: 150 Product Weight (lbs.): 53 Cubic Feet Per Carton: 10.5</p>	 <p>ADJUSTMENTS (1) Tilt tension (2) Pneumatic seat height (7) Forward tilt lock (8) Seat depth (9) Chair tilt lock (5A) Center-tilt action</p>	<p>Ergonomic Features: A, B, C, E, F, H, M, N, S</p>	<table border="1"> <tr> <td>1951-3</td> <td>925</td> <td>969</td> <td>1004</td> <td>1050</td> <td>1123</td> <td>1146</td> <td>1207</td> <td>1325</td> <td>1382</td> <td>1490</td> <td>1641</td> <td>1825</td> </tr> </table>												1951-3	925	969	1004	1050	1123	1146	1207	1325	1382	1490	1641	1825			
			1951-3	925	969	1004	1050	1123	1146	1207	1325	1382	1490	1641	1825															
			<p>OVERALL DIMENSIONS</p> <table border="1"> <tr> <th>W</th> <th>D</th> <th>H</th> </tr> <tr> <td>25</td> <td>26</td> <td>40.5</td> </tr> </table>			W	D	H	25	26	40.5	<p>SEAT DIMENSIONS</p> <table border="1"> <tr> <th>W</th> <th>D</th> <th>H</th> </tr> <tr> <td>21</td> <td>19-20.5</td> <td>17-21</td> </tr> </table>			W	D	H	21	19-20.5	17-21	<p>BACK DIMENSIONS</p> <table border="1"> <tr> <th>W</th> <th>H</th> </tr> <tr> <td>19.5</td> <td>23</td> </tr> </table>						W	H	19.5	23
			W	D	H																									
25	26	40.5																												
W	D	H																												
21	19-20.5	17-21																												
W	H																													
19.5	23																													
<p>RTA 2 </p>																														
 <p>MB Tilter COM Yardage: 1.25 Freight Class: 150 Product Weight (lbs.): 50 Cubic Feet Per Carton: 10.5</p>	 <p>ADJUSTMENTS (1) Tilt tension (2) Pneumatic seat height (5A) Center-tilt action</p>	<p>Ergonomic Features: A, C, E, H, M, N</p>	<table border="1"> <tr> <td>1951-4</td> <td>779</td> <td>822</td> <td>858</td> <td>905</td> <td>977</td> <td>1003</td> <td>1067</td> <td>1182</td> <td>1236</td> <td>1347</td> <td>1496</td> <td>1679</td> </tr> </table>												1951-4	779	822	858	905	977	1003	1067	1182	1236	1347	1496	1679			
			1951-4	779	822	858	905	977	1003	1067	1182	1236	1347	1496	1679															
			<p>OVERALL DIMENSIONS</p> <table border="1"> <tr> <th>W</th> <th>D</th> <th>H</th> </tr> <tr> <td>25</td> <td>26</td> <td>41</td> </tr> </table>			W	D	H	25	26	41	<p>SEAT DIMENSIONS</p> <table border="1"> <tr> <th>W</th> <th>D</th> <th>H</th> </tr> <tr> <td>21</td> <td>19-20.5</td> <td>17-21</td> </tr> </table>			W	D	H	21	19-20.5	17-21	<p>BACK DIMENSIONS</p> <table border="1"> <tr> <th>W</th> <th>H</th> </tr> <tr> <td>19.5</td> <td>23</td> </tr> </table>						W	H	19.5	23
			W	D	H																									
25	26	41																												
W	D	H																												
21	19-20.5	17-21																												
W	H																													
19.5	23																													
<p>RTA 2 </p>																														
 <p>MB Posture Task w/Arms COM Yardage: 1.25 Freight Class: 150 Product Weight (lbs.): 45 Cubic Feet Per Carton: 9.25</p>	 <p>ADJUSTMENTS (2) Pneumatic seat height (3) Back angle (8) Seat depth</p>	<p>Ergonomic Features: C, E, H, G, M, N</p>	<table border="1"> <tr> <td>1951-7</td> <td>844</td> <td>887</td> <td>923</td> <td>973</td> <td>1042</td> <td>1068</td> <td>1130</td> <td>1246</td> <td>1301</td> <td>1412</td> <td>1558</td> <td>1742</td> </tr> </table>												1951-7	844	887	923	973	1042	1068	1130	1246	1301	1412	1558	1742			
			1951-7	844	887	923	973	1042	1068	1130	1246	1301	1412	1558	1742															
			<p>OVERALL DIMENSIONS</p> <table border="1"> <tr> <th>W</th> <th>D</th> <th>H</th> </tr> <tr> <td>25</td> <td>26</td> <td>40</td> </tr> </table>			W	D	H	25	26	40	<p>SEAT DIMENSIONS</p> <table border="1"> <tr> <th>W</th> <th>D</th> <th>H</th> </tr> <tr> <td>21</td> <td>19-20.5</td> <td>16-20</td> </tr> </table>			W	D	H	21	19-20.5	16-20	<p>BACK DIMENSIONS</p> <table border="1"> <tr> <th>W</th> <th>H</th> </tr> <tr> <td>19.5</td> <td>23</td> </tr> </table>						W	H	19.5	23
			W	D	H																									
25	26	40																												
W	D	H																												
21	19-20.5	16-20																												
W	H																													
19.5	23																													
<p>RTA 2 </p>																														
 <p>LB Task w/Arms COM Yardage: 1 Freight Class: 150 Product Weight (lbs.): 43 Cubic Feet Per Carton: 9.25</p>	 <p>ADJUSTMENTS (2) Pneumatic seat height (8) Seat depth</p>	<p>Ergonomic Features: C, E, H, M, N</p>	<table border="1"> <tr> <td>1952-6</td> <td>676</td> <td>711</td> <td>739</td> <td>776</td> <td>834</td> <td>856</td> <td>902</td> <td>998</td> <td>1040</td> <td>1130</td> <td>1247</td> <td>1395</td> </tr> </table>												1952-6	676	711	739	776	834	856	902	998	1040	1130	1247	1395			
			1952-6	676	711	739	776	834	856	902	998	1040	1130	1247	1395															
			<p>OVERALL DIMENSIONS</p> <table border="1"> <tr> <th>W</th> <th>D</th> <th>H</th> </tr> <tr> <td>25</td> <td>26</td> <td>35</td> </tr> </table>			W	D	H	25	26	35	<p>SEAT DIMENSIONS</p> <table border="1"> <tr> <th>W</th> <th>D</th> <th>H</th> </tr> <tr> <td>21</td> <td>19-20.5</td> <td>17-20</td> </tr> </table>			W	D	H	21	19-20.5	17-20	<p>BACK DIMENSIONS</p> <table border="1"> <tr> <th>W</th> <th>H</th> </tr> <tr> <td>19.5</td> <td>16</td> </tr> </table>						W	H	19.5	16
			W	D	H																									
25	26	35																												
W	D	H																												
21	19-20.5	17-20																												
W	H																													
19.5	16																													
<p>RTA 2 </p>																														

DESCRIPTION	FEATURES	MODEL#	STANDARD TEXTILE GRADES														
			1	2	3	4	5	6	7	8	9	10	11	12			
 <p>Armchair COM Yardage: 1 Freight Class: 250 Product Weight (lbs.): 36 Cubic Feet Per Carton: 10.25</p>	<p>Ergonomic Features: M, N</p>	<p>RTA 1 </p>	1953	604	644	666	709	763	786	837	929	972	1061	1179	1325		
			OVERALL DIMENSIONS			SEAT DIMENSIONS			BACK DIMENSIONS								
			W	D	H	W	D	H	W	H							
			27	23	35	21	18.5	18	19.5	18							
 <p>LB Task Armless COM Yardage: 1 Freight Class: 150 Product Weight (lbs.): 37 Cubic Feet Per Carton: 9.25</p>	 <p>ADJUSTMENTS (2) Pneumatic seat height (8) Seat depth</p>	<p>RTA 2 </p>	1954-6	579	621	655	706	776	799	861	978	1036	1143	1293	1477		
			OVERALL DIMENSIONS			SEAT DIMENSIONS			BACK DIMENSIONS								
			W	D	H	W	D	H	W	H							
			25	26	35	21	19-20.5	17-22	19.5	16							
 <p>MB Posture Task Armless COM Yardage: 1.25 Freight Class: 150 Product Weight (lbs.): 39 Cubic Feet Per Carton: 9.25</p>	 <p>ADJUSTMENTS (2) Pneumatic seat height (3) Back angle (8) Seat depth</p>	<p>RTA 2 </p>	1957-7	750	794	827	877	948	974	1036	1152	1207	1319	1466	1649		
			OVERALL DIMENSIONS			SEAT DIMENSIONS			BACK DIMENSIONS								
			W	D	H	W	D	H	W	H							
			25	26	40	21	19-20.5	16-20	19.5	23							
 <p>LB Task Drafting Chair COM Yardage: 1 Freight Class: 150 Product Weight (lbs.): 47 Cubic Feet Per Carton: 9.25</p>	 <p>ADJUSTMENTS (2) Pneumatic seat height (8) Seat depth</p>	<p>RTA 2 </p>	1922-6	809	844	872	914	971	990	1043	1136	1183	1272	1392	1543		
			OVERALL DIMENSIONS			SEAT DIMENSIONS			BACK DIMENSIONS								
			W	D	H	W	D	H	W	H							
			25	26	44.5	21	19-20.5	24-34	19.5	16							
 <p>LB Task Drafting Chair Armless COM Yardage: 1 Freight Class: 150 Product Weight (lbs.): 40 Cubic Feet Per Carton: 9.25</p>	 <p>ADJUSTMENTS (2) Pneumatic seat height (8) Seat depth</p>	<p>RTA 2 </p>	1924-6	712	747	773	811	864	885	932	1024	1069	1152	1269	1411		
			OVERALL DIMENSIONS			SEAT DIMENSIONS			BACK DIMENSIONS								
			W	D	H	W	D	H	W	H							
			25	26	44.5	21	19-20.5	24-34	19.5	16							

VION



model 6321-8



model 6331-8



Optional Live Lumbar Support Pad (LS)

Lumbar Pad is spring loaded, providing pressure sensitive depth adjustment and 3 inches of height adjustment.



model 6322-4 (C)



model 6321-4PB



Vion Guest Chair please see page 239

VION FINISHES - TASK SEATING				
Back Frame	Base	Specify Code	Arm Option	Specify Code
Black	Black	BLK no upcharge	Adj. "T" arm (Black) Adj. "T" arm, fixed armcap (Black) Adj. "T" arm (Black , Chrome accent)	AS AF AC
Black	Polished Aluminum	BAU Add \$154	Adj. "T" arm, fixed armcap (Black , Chrome accent) Fixed "C" arm (Black) Fixed "C" arm (Polished Aluminum)	A C CA - Add \$187
Shadow	Shadow	SHW Add \$70	Adj. "T" arm (Shadow) Adj. "T" arm, fixed armcap (Shadow) Adj. "T" arm (Shadow , Chrome accent)	SHA SHF SHR
Shadow	Polished Aluminum	SAU Add \$223	Adj. "T" arm, fixed armcap (Shadow , Chrome accent) Fixed "C" arm (Shadow) Fixed "C" arm (Polished Aluminum)	SHD SHC CA - Add \$187
Fog	Fog	FOG Add \$70	Adj. "T" arm (Fog) Adj. "T" arm, fixed armcap (Fog) Adj. "T" arm (Fog , Chrome accent)	FA FF FC
Fog	Polished Aluminum	FAU Add \$223	Adj. "T" arm, fixed armcap (Fog , Chrome accent) Fixed "C" arm (Fog) Fixed "C" arm (Polished Aluminum)	CF CC CA - Add \$187

* All arms have Black SSU Armcaps.

STANDARD FEATURES

- Vion is a comprehensive seating series offering a family of models to address multiple applications: task, management, conference, guest, pedestal base, heavy duty 24/7 and stools.
- Vion Care Compliant models, with "GC" model code prefix, are available for select models (GC6322-0, GC6322-4, GC6331-0, GC6331-4). These models have standard high density, ultracell foam and polyurethane seat underside with sealed connections. Optional sealed seat seams and moisture barrier are available on these models only.
- Vion Heavy Duty models can be found in the Heavy Duty section of the price book (page 387).
- Series offers mid and high back models with either a mesh or upholstered back.
- Five different control mechanism options to suit all price points and ergonomic requirements.
- All models are standard with height and width adjustable arms (**AS**) that feature a front to back sliding armcap.
- Standard with Global's high quality Soft Descent™ pneumatic lift which slowly and gently lowers the seat height of the chair, making it easy to obtain the desired position.
- Side activated sliding seat depth adjustment (**MD**) is standard on multi-tilter, synchro tilter with back angle adjustment and weight sensing synchro tilter control mechanisms.
- Standard with Black five prong, injection molded, fiberglass reinforced nylon Governor base (**B7**) with dual wheel carpet casters (**C1**).
- Mesh back models are available in 10 standard Vion colors: Aqua (**MS75**), Black (**MS69**), Black Cherry (**MS76**), Blue (**MS72**), Dust (**MS77**), Ivory (**MS78**), Natural (**MS74**), Paprika (**MS79**), Rope (**MS73**) and Stone (**MS71**).
- Upholstered back models feature black fabric Jenny (**JN02**) on the back side as standard.
- Check textile availability prior to specifying upholstery material.
- Pedestal base models are offered on (-4) Tilter and (-6) Task (basic swivel) mechanisms only. These models provide fixed location seating for use in auditoriums, classrooms, jury boxes, public venues and more. The base must be mounted to the floor (mounting hardware not included). See Pedestal Base Installation Guide for details.

OPTIONAL FEATURES

- Vion back frames, arms and bases are available in three colors: Black, Shadow and Fog. See Vion finishes chart for options and upcharges. Armcaps are always Black.
- Mesh back models are also available in 10 Dimension Mesh colors: Black (**DBK**), Fog (**DST**), Chalk (**DCL**), Shadow (**DGM**), Charcoal (**DCH**), Sand (**DSD**), Cobalt (**DCO**), Pool Blue (**DPB**), Citrus (**DCT**) and Berry (**DBE**). Add \$25.
- Upholstered back models offer a Matching Outer (**MO**) upholstery option. Due to the Additional material needed, these models are listed separately and are priced differently than the standard upholstered back models.
- Optional lumbar pad can be added at the time of order. Please specify (**LS**) and add \$37 Lumbar pad can also be ordered after sale as a kit, specify model 6339 at \$39 list. The lumbar pad is adjustable up to 3".
- Seat available in memory foam. Please specify (**MF**) and add \$108.
- Petite seat models (2" shorter and 2" narrower than the standard size seat) are available. Specify (**ST**) for standard foam or (**P**) for petite seat, no upcharge.
- A moisture barrier is available for the seat cushion on GC Vion models only. Specify (**NB**) for no moisture barrier, no upcharge, or (**MB**) for Moisture Barrier. Add \$108.
- Sealed seams are available on the seat of GC Vion models when specified with approved coated textile. Contact Customer Care for availability. Specify (**NS**) for no sealed seams, no upcharge, or (**SE**) for sealed seat seams. Add \$24.
- For hard surface flooring casters, please specify (**C9R**). Add \$66.
- Two featured "T" arm options that include height and width adjusting arms, one with sliding arm caps (**AS**) and one without sliding arm caps (**AF**). Also, available is a stylish fixed urethane arm (**C**) for conference/management environments.
- For additional arm/caster options, please refer to the Arm and Caster section (page 389). Optional casters may be priced higher than the standard casters for your chair and the difference will be charged. Lower priced optional casters will not be credited.
- Please refer to "Cylinder Selection" section of the price book for additional cylinder options.
- For fully assembled in box, please specify **SU**. Add \$70.
- Pedestal Base models have black bases with 2" height adjust cylinders. Specify (**SCC**) swivel, auto return to max height (no upcharge); (**SN**) non-swivel, auto return to max height (Add \$19); or (**SC**) swivel, self-centering and return to max height (Add \$30).

DESCRIPTION



HB Synchro - Tilter w/Back Angle Adjustment
COM Yardage: 1
Freight Class: 150
Product Weight (lbs.): 60
Cubic Feet Per Carton: 10.5

FEATURES

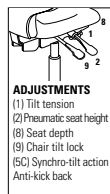

ADJUSTMENTS
(1) Tilt tension
(2) Pneumatic seat height
(8) Seat depth
(9) Chair tilt lock
(5C) Synchro-tilt action
Anti-kick back

Mesh Back

Ergonomic Features:
A, B, C, E, G, H, L, M, N, Q, U









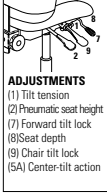

MODEL#

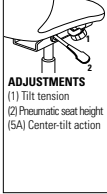

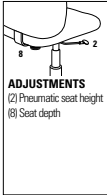

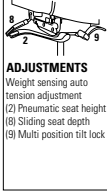

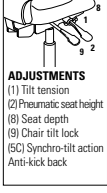

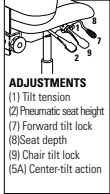

STANDARD TEXTILE GRADES

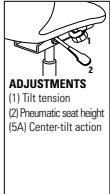

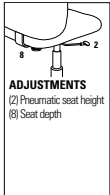

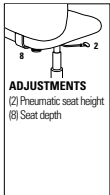

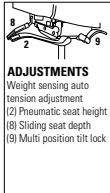

	1	2	3	4	5	6	7	8	9	10	11	12
6321-0	924	958	984	1022	1075	1096	1143	1235	1280	1363	1479	1621

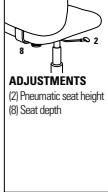

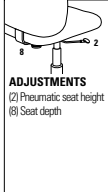

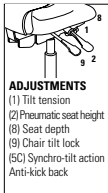

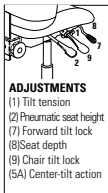

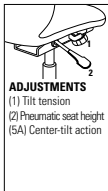

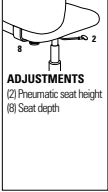
OVERALL DIMENSIONS			SEAT DIMENSIONS			BACK DIMENSIONS	
W	D	H	W	D	H	W	H
25.5	24	41.5	20	17-20	17.5-22.5	18.5	23

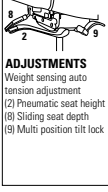

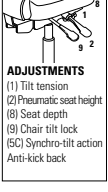

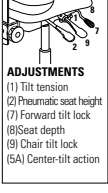

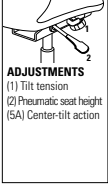



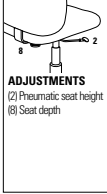

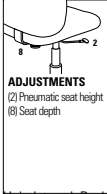

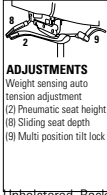

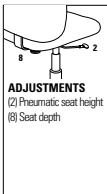

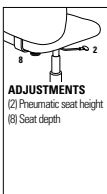
DESCRIPTION	FEATURES	MODEL#	STANDARD TEXTILE GRADES											
			1	2	3	4	5	6	7	8	9	10	11	12
 <p>HB Multi - Tilter COM Yardage: 1 Freight Class: 150 Product Weight (lbs.): 62 Cubic Feet Per Carton: 10.5</p>	 <p>ADJUSTMENTS (1) Tilt tension (2) Pneumatic seat height (7) Forward tilt lock (8) Seat depth (9) Chair tilt lock (5A) Center-tilt action</p>	6321-3	924	958	984	1022	1075	1096	1143	1235	1280	1363	1479	1621
			OVERALL DIMENSIONS			SEAT DIMENSIONS			BACK DIMENSIONS					
			W	D	H	W	D	H	W	H				
			25.5	24	41	20	17-20	17.25-22.25	18.5	23				
<p>Mesh Back</p> <p>Ergonomic Features: A, B, C, E, F, G, H, M, N, Q, U, S</p> <p>RTA 2 </p>			1	2	3	4	5	6	7	8	9	10	11	12
			OVERALL DIMENSIONS			SEAT DIMENSIONS			BACK DIMENSIONS					
			W	D	H	W	D	H	W	H				
			25.5	24	39.25	20	17.5	16-21	18.5	23				
 <p>HB Tilter COM Yardage: 1 Freight Class: 150 Product Weight (lbs.): 54 Cubic Feet Per Carton: 10.5</p>	 <p>ADJUSTMENTS (1) Tilt tension (2) Pneumatic seat height (5A) Center-tilt action</p>	6321-4	826	860	887	925	978	999	1046	1138	1183	1266	1381	1524
			OVERALL DIMENSIONS			SEAT DIMENSIONS			BACK DIMENSIONS					
			W	D	H	W	D	H	W	H				
			25.5	24	39.25	20	17.5	16-21	18.5	23				
<p>Mesh Back</p> <p>Ergonomic Features: A, B, C, E, H, M, N, Q, S, U</p> <p>RTA 2 </p>			1	2	3	4	5	6	7	8	9	10	11	12
			OVERALL DIMENSIONS			SEAT DIMENSIONS			BACK DIMENSIONS					
			W	D	H	W	D	H	W	H				
			25.5	24	39.25	20	17.5	17-22	18.5	23				
 <p>HB Task COM Yardage: 1 Freight Class: 150 Product Weight (lbs.): 49 Cubic Feet Per Carton: 10.5</p>	 <p>ADJUSTMENTS (2) Pneumatic seat height (8) Seat depth</p>	6321-6	792	826	853	890	944	964	1012	1104	1148	1231	1347	1489
			OVERALL DIMENSIONS			SEAT DIMENSIONS			BACK DIMENSIONS					
			W	D	H	W	D	H	W	H				
			25.5	24	39.25	20	17.5	17-22	18.5	23				
<p>Mesh Back</p> <p>Ergonomic Features: C, E, M, N, U</p> <p>RTA 2 </p>			1	2	3	4	5	6	7	8	9	10	11	12
			OVERALL DIMENSIONS			SEAT DIMENSIONS			BACK DIMENSIONS					
			W	D	H	W	D	H	W	H				
			25.5	24	40	20	17-20	16.5-21.5	18.5	23				
 <p>HB Weight Sensing Synchro - Tilter COM Yardage: 1 Freight Class: 150 Product Weight (lbs.): 57 Cubic Feet Per Carton: 10.5</p>	 <p>ADJUSTMENTS Weight sensing auto tension adjustment (2) Pneumatic seat height (8) Sliding seat depth (9) Multi position tilt lock</p>	6321-8	924	958	984	1022	1075	1096	1143	1235	1280	1363	1479	1621
			OVERALL DIMENSIONS			SEAT DIMENSIONS			BACK DIMENSIONS					
			W	D	H	W	D	H	W	H				
			25.5	24	40	20	17-20	16.5-21.5	18.5	23				
<p>Mesh Back</p> <p>Ergonomic Features: A, B, C, E, H, L, M, N, Q, U</p> <p>RTA 2 </p>			1	2	3	4	5	6	7	8	9	10	11	12
			OVERALL DIMENSIONS			SEAT DIMENSIONS			BACK DIMENSIONS					
			W	D	H	W	D	H	W	H				
			25.5	24	39.5	20	17-20	17.5-22.5	18.5	21				
 <p>MB Synchro - Tilter w/Back Angle Adjustment COM Yardage: 1 Freight Class: 150 Product Weight (lbs.): 58 Cubic Feet Per Carton: 10.5</p>	 <p>ADJUSTMENTS (1) Tilt tension (2) Pneumatic seat height (8) Seat depth (9) Chair tilt lock (5C) Synchro-tilt action Anti-kick back</p>	6322-0	875	908	935	973	1026	1047	1094	1186	1231	1314	1430	1572
			OVERALL DIMENSIONS			SEAT DIMENSIONS			BACK DIMENSIONS					
			W	D	H	W	D	H	W	H				
			25.5	24	39.5	20	17-20	17.5-22.5	18.5	21				
<p>Mesh Back</p> <p>Ergonomic Features: A, B, C, E, G, H, L, M, N, Q, U</p> <p>RTA 2 </p>			1	2	3	4	5	6	7	8	9	10	11	12
			OVERALL DIMENSIONS			SEAT DIMENSIONS			BACK DIMENSIONS					
			W	D	H	W	D	H	W	H				
			25.5	24	39.5	20	17-20	17.5-22.5	18.5	21				



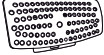

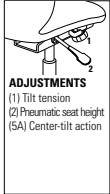

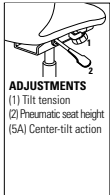

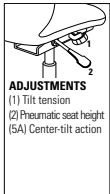
DESCRIPTION	FEATURES	MODEL#	STANDARD TEXTILE GRADES											
			1	2	3	4	5	6	7	8	9	10	11	12
 <p>MB Multi - Tilter COM Yardage: 1 Freight Class: 150 Product Weight (lbs.): 60 Cubic Feet Per Carton: 10.5</p>	 <p>ADJUSTMENTS (1) Tilt tension (2) Pneumatic seat height (7) Forward tilt lock (8) Seat depth (9) Chair tilt lock (5A) Center-tilt action</p>	<p>6322-3</p>	875	908	935	973	1026	1047	1094	1186	1231	1314	1430	1572
			OVERALL DIMENSIONS			SEAT DIMENSIONS			BACK DIMENSIONS					
			W	D	H	W	D	H	W	H				
			25.5	24	39	20	17-20	17.25-22.25	18.5	21				
	Mesh Back		<p>Ergonomic Features: A, B, C, E, F, G, H, M, N, Q, U, S</p>											
			RTA 2											
 <p>MB Tilter COM Yardage: 1 Freight Class: 150 Product Weight (lbs.): 52 Cubic Feet Per Carton: 10.5</p>	 <p>ADJUSTMENTS (1) Tilt tension (2) Pneumatic seat height (5A) Center-tilt action</p>	<p>6322-4</p>	777	812	839	877	931	950	998	1090	1135	1218	1334	1476
			OVERALL DIMENSIONS			SEAT DIMENSIONS			BACK DIMENSIONS					
			W	D	H	W	D	H	W	H				
			25.5	24	37.5	20	17.5	16-21	18.5	21				
	Mesh Back		<p>Ergonomic Features: A, B, C, E, H, M, N, O, S, U</p>											
			RTA 2											
 <p>MB Task COM Yardage: 1 Freight Class: 150 Product Weight (lbs.): 52 Cubic Feet Per Carton: 10.5</p>	 <p>ADJUSTMENTS (2) Pneumatic seat height (8) Seat depth</p>	<p>6322-6</p>	751	786	812	849	903	924	971	1063	1108	1190	1306	1449
			OVERALL DIMENSIONS			SEAT DIMENSIONS			BACK DIMENSIONS					
			W	D	H	W	D	H	W	H				
			25.5	24	37.5	20	17.5	17-22	18.5	21				
	Mesh Back		<p>Ergonomic Features: C, E, M, N, Q, U</p>											
			RTA 2											
 <p>MB Task - Armless COM Yardage: 1 Freight Class: 250 Product Weight (lbs.): 41 Cubic Feet Per Carton: 10.5</p>	 <p>ADJUSTMENTS (2) Pneumatic seat height (8) Seat depth</p>	<p>6323-6</p>	710	745	771	809	862	883	930	1022	1067	1150	1267	1408
			OVERALL DIMENSIONS			SEAT DIMENSIONS			BACK DIMENSIONS					
			W	D	H	W	D	H	W	H				
			20	24	37.5	20	17.5	17-22	18.5	21				
	Mesh Back		<p>Ergonomic Features: C, E, M, N, U</p>											
			RTA 2											
 <p>MB Weight Sensing Synchro - Tilter COM Yardage: 1 Freight Class: 150 Product Weight (lbs.): 55 Cubic Feet Per Carton: 10.5</p>	 <p>ADJUSTMENTS Weight sensing auto tension adjustment (2) Pneumatic seat height (8) Sliding seat depth (9) Multi position tilt lock</p>	<p>6322-8</p>	875	908	935	973	1026	1047	1094	1186	1231	1314	1430	1572
			OVERALL DIMENSIONS			SEAT DIMENSIONS			BACK DIMENSIONS					
			W	D	H	W	D	H	W	H				
			25.5	24	38	20	17-20	16.5-21.5	18.5	21				
	Mesh Back		<p>Ergonomic Features: A, B, C, E, H, L, M, N, Q, U</p>											
			RTA 2											

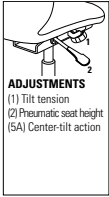
DESCRIPTION	FEATURES	MODEL#	STANDARD TEXTILE GRADES																																																		
			1	2	3	4	5	6	7	8	9	10	11	12																																							
 <p>MB Drafting Stool - Task Armless COM Yardage: 1 Freight Class: 150 Product Weight (lbs.): 50 Cubic Feet Per Carton: 10.5</p>	 <p>ADJUSTMENTS (2) Pneumatic seat height (8) Seat depth</p>	<p>Mesh Back</p> <p>Ergonomic Features: C, E, M, N, U</p>	<table border="1"> <tr> <td>6327-6</td> <td>792</td> <td>827</td> <td>854</td> <td>891</td> <td>946</td> <td>966</td> <td>1013</td> <td>1105</td> <td>1150</td> <td>1232</td> <td>1349</td> <td>1492</td> </tr> </table>												6327-6	792	827	854	891	946	966	1013	1105	1150	1232	1349	1492																										
			6327-6	792	827	854	891	946	966	1013	1105	1150	1232	1349	1492																																						
			<table border="1"> <tr> <th colspan="3">OVERALL DIMENSIONS</th> <th colspan="3">SEAT DIMENSIONS</th> <th colspan="3">BACK DIMENSIONS</th> </tr> <tr> <th>W</th> <th>D</th> <th>H</th> <th>W</th> <th>D</th> <th>H</th> <th>W</th> <th>H</th> </tr> <tr> <td>20</td> <td>24</td> <td>48</td> <td>20</td> <td>17.5</td> <td>23.5-33.5</td> <td>18.5</td> <td>21</td> </tr> </table>			OVERALL DIMENSIONS			SEAT DIMENSIONS			BACK DIMENSIONS			W	D	H	W	D	H	W	H	20	24	48	20	17.5	23.5-33.5	18.5	21	<p>RTA 2</p> <p>ups</p>																						
			OVERALL DIMENSIONS			SEAT DIMENSIONS			BACK DIMENSIONS																																												
W	D	H	W	D	H	W	H																																														
20	24	48	20	17.5	23.5-33.5	18.5	21																																														
 <p>MB Drafting Stool - Task COM Yardage: 1 Freight Class: 150 Product Weight (lbs.): 44 Cubic Feet Per Carton: 10.5</p>	 <p>ADJUSTMENTS (2) Pneumatic seat height (8) Seat depth</p>	<p>Mesh Back</p> <p>Ergonomic Features: C, E, H, M, N, Q, U</p>	<table border="1"> <tr> <td>6328-6</td> <td>894</td> <td>929</td> <td>956</td> <td>993</td> <td>1048</td> <td>1067</td> <td>1114</td> <td>1206</td> <td>1251</td> <td>1334</td> <td>1451</td> <td>1592</td> </tr> </table>												6328-6	894	929	956	993	1048	1067	1114	1206	1251	1334	1451	1592																										
			6328-6	894	929	956	993	1048	1067	1114	1206	1251	1334	1451	1592																																						
			<table border="1"> <tr> <th colspan="3">OVERALL DIMENSIONS</th> <th colspan="3">SEAT DIMENSIONS</th> <th colspan="3">BACK DIMENSIONS</th> </tr> <tr> <th>W</th> <th>D</th> <th>H</th> <th>W</th> <th>D</th> <th>H</th> <th>W</th> <th>H</th> </tr> <tr> <td>20</td> <td>24</td> <td>48</td> <td>20</td> <td>17.5</td> <td>23.5-33.5</td> <td>18.5</td> <td>21</td> </tr> </table>			OVERALL DIMENSIONS			SEAT DIMENSIONS			BACK DIMENSIONS			W	D	H	W	D	H	W	H	20	24	48	20	17.5	23.5-33.5	18.5	21	<p>RTA 2</p> <p>ups</p>																						
			OVERALL DIMENSIONS			SEAT DIMENSIONS			BACK DIMENSIONS																																												
W	D	H	W	D	H	W	H																																														
20	24	48	20	17.5	23.5-33.5	18.5	21																																														
 <p>HB Synchro - Tilter w/Back Angle Adjustment COM Yardage: 1.25 Freight Class: 150 Product Weight (lbs.): 61 Cubic Feet Per Carton: 10.50</p>	 <p>ADJUSTMENTS (1) Tilt tension (2) Pneumatic seat height (8) Seat depth (9) Chair tilt lock (5C) Synchro-tilt action Anti-kick back</p>	<p>Upholstered Back</p> <p>Ergonomic Features: A, B, C, E, G, H, L, M, N, Q, U</p>	<table border="1"> <tr> <td>6331-0</td> <td>1047</td> <td>1091</td> <td>1121</td> <td>1169</td> <td>1238</td> <td>1265</td> <td>1322</td> <td>1438</td> <td>1492</td> <td>1597</td> <td>1742</td> <td>1920</td> </tr> <tr> <td>6331-0MO</td> <td>1103</td> <td>1167</td> <td>1221</td> <td>1296</td> <td>1406</td> <td>1446</td> <td>1541</td> <td>1724</td> <td>1811</td> <td>1980</td> <td>2211</td> <td>2497</td> </tr> <tr> <td>GC6331-0</td> <td>-</td> <td>1285</td> <td>1315</td> <td>1357</td> <td>1417</td> <td>1446</td> <td>1500</td> <td>1587</td> <td>1653</td> <td>1728</td> <td>1881</td> <td>2044</td> </tr> </table>												6331-0	1047	1091	1121	1169	1238	1265	1322	1438	1492	1597	1742	1920	6331-0MO	1103	1167	1221	1296	1406	1446	1541	1724	1811	1980	2211	2497	GC6331-0	-	1285	1315	1357	1417	1446	1500	1587	1653	1728	1881	2044
			6331-0	1047	1091	1121	1169	1238	1265	1322	1438	1492	1597	1742	1920																																						
			6331-0MO	1103	1167	1221	1296	1406	1446	1541	1724	1811	1980	2211	2497																																						
			GC6331-0	-	1285	1315	1357	1417	1446	1500	1587	1653	1728	1881	2044																																						
<table border="1"> <tr> <th colspan="3">OVERALL DIMENSIONS</th> <th colspan="3">SEAT DIMENSIONS</th> <th colspan="3">BACK DIMENSIONS</th> </tr> <tr> <th>W</th> <th>D</th> <th>H</th> <th>W</th> <th>D</th> <th>H</th> <th>W</th> <th>H</th> </tr> <tr> <td>25.5</td> <td>24</td> <td>41.5</td> <td>20</td> <td>17-20</td> <td>17.5-22.5</td> <td>18.5</td> <td>23</td> </tr> </table>			OVERALL DIMENSIONS			SEAT DIMENSIONS			BACK DIMENSIONS			W	D	H	W	D	H	W	H	25.5	24	41.5	20	17-20	17.5-22.5	18.5	23	<p>RTA 2</p> <p>ups</p>																									
OVERALL DIMENSIONS			SEAT DIMENSIONS			BACK DIMENSIONS																																															
W	D	H	W	D	H	W	H																																														
25.5	24	41.5	20	17-20	17.5-22.5	18.5	23																																														
 <p>HB Multi - Tilter COM Yardage: 1.25 Freight Class: 125 Product Weight (lbs.): 63 Cubic Feet Per Carton: 10.5</p>	 <p>ADJUSTMENTS (1) Tilt tension (2) Pneumatic seat height (7) Forward tilt lock (8) Seat depth (9) Chair tilt lock (5A) Center-tilt action</p>	<p>Upholstered back</p> <p>Ergonomic Features: A, B, C, E, F, G, H, M, N, Q, U, S</p>	<table border="1"> <tr> <td>6331-3</td> <td>1047</td> <td>1091</td> <td>1121</td> <td>1169</td> <td>1238</td> <td>1265</td> <td>1322</td> <td>1438</td> <td>1492</td> <td>1597</td> <td>1742</td> <td>1920</td> </tr> <tr> <td>6331-3MO</td> <td>1103</td> <td>1167</td> <td>1221</td> <td>1296</td> <td>1406</td> <td>1446</td> <td>1541</td> <td>1724</td> <td>1811</td> <td>1980</td> <td>2211</td> <td>2497</td> </tr> </table>												6331-3	1047	1091	1121	1169	1238	1265	1322	1438	1492	1597	1742	1920	6331-3MO	1103	1167	1221	1296	1406	1446	1541	1724	1811	1980	2211	2497													
			6331-3	1047	1091	1121	1169	1238	1265	1322	1438	1492	1597	1742	1920																																						
			6331-3MO	1103	1167	1221	1296	1406	1446	1541	1724	1811	1980	2211	2497																																						
			<table border="1"> <tr> <th colspan="3">OVERALL DIMENSIONS</th> <th colspan="3">SEAT DIMENSIONS</th> <th colspan="3">BACK DIMENSIONS</th> </tr> <tr> <th>W</th> <th>D</th> <th>H</th> <th>W</th> <th>D</th> <th>H</th> <th>W</th> <th>H</th> </tr> <tr> <td>25.5</td> <td>24</td> <td>41</td> <td>20</td> <td>17-20</td> <td>17.25-22.25</td> <td>18.5</td> <td>23</td> </tr> </table>			OVERALL DIMENSIONS			SEAT DIMENSIONS			BACK DIMENSIONS			W	D	H	W	D	H	W	H	25.5	24	41	20	17-20	17.25-22.25	18.5	23	<p>RTA 2</p> <p>ups</p>																						
OVERALL DIMENSIONS			SEAT DIMENSIONS			BACK DIMENSIONS																																															
W	D	H	W	D	H	W	H																																														
25.5	24	41	20	17-20	17.25-22.25	18.5	23																																														
 <p>HB Tilter COM Yardage: 1.25 Freight Class: 150 Product Weight (lbs.): 55 Cubic Feet Per Carton: 10.5</p>	 <p>ADJUSTMENTS (1) Tilt tension (2) Pneumatic seat height (5A) Center-tilt action</p>	<p>Upholstered back</p> <p>Ergonomic Features: A, B, C, E, H, M, N, Q, S, U</p>	<table border="1"> <tr> <td>6331-4</td> <td>936</td> <td>980</td> <td>1013</td> <td>1061</td> <td>1129</td> <td>1154</td> <td>1211</td> <td>1327</td> <td>1382</td> <td>1487</td> <td>1632</td> <td>1809</td> </tr> <tr> <td>6331-4MO</td> <td>992</td> <td>1059</td> <td>1110</td> <td>1188</td> <td>1295</td> <td>1336</td> <td>1431</td> <td>1614</td> <td>1702</td> <td>1870</td> <td>2100</td> <td>2389</td> </tr> <tr> <td>GC6331-4</td> <td>-</td> <td>1123</td> <td>1154</td> <td>1197</td> <td>1259</td> <td>1288</td> <td>1344</td> <td>1433</td> <td>1503</td> <td>1579</td> <td>1736</td> <td>1905</td> </tr> </table>												6331-4	936	980	1013	1061	1129	1154	1211	1327	1382	1487	1632	1809	6331-4MO	992	1059	1110	1188	1295	1336	1431	1614	1702	1870	2100	2389	GC6331-4	-	1123	1154	1197	1259	1288	1344	1433	1503	1579	1736	1905
			6331-4	936	980	1013	1061	1129	1154	1211	1327	1382	1487	1632	1809																																						
			6331-4MO	992	1059	1110	1188	1295	1336	1431	1614	1702	1870	2100	2389																																						
			GC6331-4	-	1123	1154	1197	1259	1288	1344	1433	1503	1579	1736	1905																																						
<table border="1"> <tr> <th colspan="3">OVERALL DIMENSIONS</th> <th colspan="3">SEAT DIMENSIONS</th> <th colspan="3">BACK DIMENSIONS</th> </tr> <tr> <th>W</th> <th>D</th> <th>H</th> <th>W</th> <th>D</th> <th>H</th> <th>W</th> <th>H</th> </tr> <tr> <td>25.5</td> <td>24</td> <td>39.25</td> <td>20</td> <td>17.5</td> <td>16-21</td> <td>18.5</td> <td>23</td> </tr> </table>			OVERALL DIMENSIONS			SEAT DIMENSIONS			BACK DIMENSIONS			W	D	H	W	D	H	W	H	25.5	24	39.25	20	17.5	16-21	18.5	23	<p>RTA 2</p> <p>ups</p>																									
OVERALL DIMENSIONS			SEAT DIMENSIONS			BACK DIMENSIONS																																															
W	D	H	W	D	H	W	H																																														
25.5	24	39.25	20	17.5	16-21	18.5	23																																														

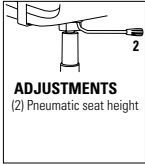
DESCRIPTION	FEATURES	MODEL#	STANDARD TEXTILE GRADES												
			1	2	3	4	5	6	7	8	9	10	11	12	
 <p>HB Task COM Yardage: 1.25 Freight Class: 150 Product Weight (lbs.): 49 Cubic Feet Per Carton: 10.5</p>	 <p>ADJUSTMENTS (2) Pneumatic seat height (8) Seat depth</p>	<p>Upholstered Back</p> <p>Ergonomic Features: C, E, M, N</p>	6331-6	909	952	983	1031	1100	1125	1184	1299	1354	1459	1604	1782
			6331-6MO	964	1030	1082	1160	1270	1308	1403	1586	1673	1842	2072	2359
			OVERALL DIMENSIONS			SEAT DIMENSIONS			BACK DIMENSIONS						
			W	D	H	W	D	H	W	H					
	25.5	24	39.25	20	17.5	17-22	18.5	23							
									RTA 2						
 <p>HB Weight Sensing Synchro - Tilter COM Yardage: 1.25 Freight Class: 150 Product Weight (lbs.): 58 Cubic Feet Per Carton: 10.5</p>	 <p>ADJUSTMENTS Weight sensing auto tension adjustment (2) Pneumatic seat height (8) Sliding seat depth (9) Multi position tilt lock</p>	<p>Upholstered Back</p> <p>Ergonomic Features: A, B, C, E, H, L, M, N, Q, U</p>	6331-8	1047	1091	1121	1169	1238	1265	1322	1438	1492	1597	1742	1920
			6331-8MO	1103	1167	1221	1296	1406	1446	1541	1724	1811	1980	2211	2497
			OVERALL DIMENSIONS			SEAT DIMENSIONS			BACK DIMENSIONS						
			W	D	H	W	D	H	W	H					
	25.5	24	40	20	17-20	16.5-21.5	18.5	23							
									RTA 2						
 <p>MB Synchro - Tilter w/Back Angle Adjustment COM Yardage: 1.25 Freight Class: 150 Product Weight (lbs.): 59 Cubic Feet Per Carton: 10.5</p>	 <p>ADJUSTMENTS (1) Tilt tension (2) Pneumatic seat height (8) Seat depth (9) Chair tilt lock (5C) Synchro-tilt action Anti-kick back</p>	<p>Upholstered Back</p> <p>Ergonomic Features: A, B, C, E, G, H, L, M, N, Q, U</p>	6332-0	999	1043	1073	1121	1190	1216	1274	1390	1444	1549	1694	1872
			6332-0MO	1053	1123	1182	1267	1383	1439	1547	1719	1851	1999	2302	2624
			OVERALL DIMENSIONS			SEAT DIMENSIONS			BACK DIMENSIONS						
			W	D	H	W	D	H	W	H					
	25.5	24	39.5	20	17-20	17.5-22.5	18.5	21							
									RTA 2						
 <p>MB Multi - Tilter COM Yardage: 1.25 Freight Class: 150 Product Weight (lbs.): 61 Cubic Feet Per Carton: 10.5</p>	 <p>ADJUSTMENTS (1) Tilt tension (2) Pneumatic seat height (7) Forward tilt lock (8) Seat depth (9) Chair tilt lock (5A) Center-tilt action</p>	<p>Upholstered Back</p> <p>Ergonomic Features: A, B, C, E, F, G, H, M, N, Q, U, S</p>	6332-3	999	1043	1073	1121	1190	1216	1274	1390	1444	1549	1694	1872
			6332-3MO	1053	1123	1182	1267	1383	1439	1547	1719	1851	1999	2302	2624
			OVERALL DIMENSIONS			SEAT DIMENSIONS			BACK DIMENSIONS						
			W	D	H	W	D	H	W	H					
	25.5	24	39	20	17-20	17.25-22.25	18.5	21							
									RTA 2						
 <p>MB Tilter COM Yardage: 1.25 Freight Class: 150 Product Weight (lbs.): 53 Cubic Feet Per Carton: 10.5</p>	 <p>ADJUSTMENTS (1) Tilt tension (2) Pneumatic seat height (5A) Center-tilt action</p>	<p>Upholstered Back</p> <p>Ergonomic Features: A, B, C, E, H, M, N, Q, S, U</p>	6332-4	894	937	970	1017	1086	1111	1168	1284	1339	1444	1589	1767
			6332-4MO	951	1018	1069	1147	1254	1295	1390	1573	1661	1829	2059	2348
			OVERALL DIMENSIONS			SEAT DIMENSIONS			BACK DIMENSIONS						
			W	D	H	W	D	H	W	H					
	25.5	24	37.5	20	17.5	16-21	18.5	21							
									RTA 2						

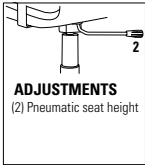
DESCRIPTION	FEATURES	MODEL#	STANDARD TEXTILE GRADES											
			1	2	3	4	5	6	7	8	9	10	11	12
 <p>MB Task COM Yardage: 1.25 Freight Class: 150 Product Weight (lbs.): 48 Cubic Feet Per Carton: 10.5</p>	 <p>ADJUSTMENTS (2) Pneumatic seat height (8) Seat depth</p> <p>Upholstered Back</p> <p>Ergonomic Features: C, E, M, N, Q, U</p>	6332-6	869	913	945	992	1061	1087	1144	1260	1315	1419	1565	1742
		6332-6MO	925	991	1043	1118	1228	1269	1363	1546	1634	1802	2031	2320
		OVERALL DIMENSIONS	W	D	H	SEAT DIMENSIONS			BACK DIMENSIONS					
		25.5	24	37.5	20	17.5	17-22	18.5	21					
							RTA 2							
 <p>MB Task - Armless COM Yardage: 1.25 Freight Class: 150 Product Weight (lbs.): 42 Cubic Feet Per Carton: 10.5</p>	 <p>ADJUSTMENTS (2) Pneumatic seat height (8) Seat depth</p> <p>Upholstered Back</p> <p>Ergonomic Features: C, E, M, N, U</p>	6333-6	826	869	900	948	1017	1043	1100	1216	1271	1375	1521	1699
		6333-6MO	891	958	1009	1088	1197	1235	1329	1512	1600	1769	2001	2285
		OVERALL DIMENSIONS	W	D	H	SEAT DIMENSIONS			BACK DIMENSIONS					
		20	24	37.5	20	17.5	17-22	18.5	21					
							RTA 2							
 <p>MB Weight Sensing Synchro - Tilter COM Yardage: 1.25 Freight Class: 150 Product Weight (lbs.): 56 Cubic Feet Per Carton: 10.5</p>	 <p>ADJUSTMENTS Weight sensing auto tension adjustment (2) Pneumatic seat height (8) Sliding seat depth (9) Multi position tilt lock</p> <p>Upholstered Back</p> <p>Ergonomic Features: A, B, C, E, H, L, M, N, Q, U</p>	6332-8	999	1043	1073	1121	1190	1216	1274	1390	1444	1549	1694	1872
		6332-8MO	1053	1123	1182	1267	1383	1439	1547	1719	1851	1999	2302	2624
		OVERALL DIMENSIONS	W	D	H	SEAT DIMENSIONS			BACK DIMENSIONS					
		25.5	24	38	20	17-20	16.5-21.5	18.5	21					
							RTA 2							
 <p>MB Drafting Stool - Task Armless COM Yardage: 1.25 Freight Class: 150 Product Weight (lbs.): 45 Cubic Feet Per Carton: 10.5</p>	 <p>ADJUSTMENTS (2) Pneumatic seat height (8) Seat depth</p> <p>Upholstered Back</p> <p>Ergonomic Features: C, E, M, N, U</p>	6337-6	894	938	971	1019	1087	1112	1170	1285	1340	1445	1590	1768
		6337-6MO	956	1022	1073	1152	1259	1299	1394	1577	1665	1833	2062	2351
		OVERALL DIMENSIONS	W	D	H	SEAT DIMENSIONS			BACK DIMENSIONS					
		20	24	48	20	17.5	23.5-33.5	18.5	21					
							RTA 2							
 <p>MB Drafting Stool - Task COM Yardage: 1.25 Freight Class: 150 Product Weight (lbs.): 51 Cubic Feet Per Carton: 10.5</p>	 <p>ADJUSTMENTS (2) Pneumatic seat height (8) Seat depth</p> <p>Upholstered Back</p> <p>Ergonomic Features: C, E, H, M, N, Q, U</p>	6338-6	1004	1048	1080	1129	1196	1222	1279	1395	1450	1554	1700	1877
		6338-6MO	1064	1131	1182	1260	1367	1408	1502	1685	1773	1941	2172	2458
		OVERALL DIMENSIONS	W	D	H	SEAT DIMENSIONS			BACK DIMENSIONS					
		20	24	48	20	17.5	23.5-33.5	18.5	21					
							RTA 2							

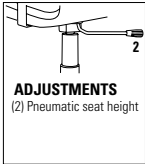
DESCRIPTION	FEATURES	MODEL#	STANDARD TEXTILE GRADES														
			1	2	3	4	5	6	7	8	9	10	11	12			
 <p>Lumbar Pad Kit COM Yardage: N/A Freight Class: 70 Product Weight (lbs.): 1.5 Cubic Feet Per Carton: 0.5</p>		6339	39	-	-	-	-	-	-	-	-	-	-	-	-		
 <p>HB Tilter with Pedestal Base COM Yardage: 1 Freight Class: 150 Product Weight (lbs.): 55 Cubic Feet Per Carton: 10.5</p>	 <p>ADJUSTMENTS (1) Tilt tension (2) Pneumatic seat height (5A) Center-tilt action</p>																
		6321-4PB	1040	1072	1096	1132	1183	1206	1254	1326	1383	1445	1575	1713			
 <p>MB Tilter with Pedestal Base COM Yardage: 1 Freight Class: 150 Product Weight (lbs.): 52 Cubic Feet Per Carton: 10.5</p>	 <p>ADJUSTMENTS (1) Tilt tension (2) Pneumatic seat height (5A) Center-tilt action</p>																
		6322-4PB	992														
 <p>HB Tilter with Pedestal Base COM Yardage: 1.9 Freight Class: 150 Product Weight (lbs.): 56 Cubic Feet Per Carton: 10.5</p>	 <p>ADJUSTMENTS (1) Tilt tension (2) Pneumatic seat height (5A) Center-tilt action</p>																
		6331-4PB	1150	1214	1265	1340	1447	1497	1595	1747	1867	1997	2271	2559			

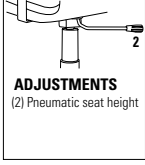
DESCRIPTION	FEATURES	MODEL#	STANDARD TEXTILE GRADES																														
			1	2	3	4	5	6	7	8	9	10	11	12																			
 <p>MB Tilter with Pedestal Base COM Yardage: 1.25 Freight Class: 150 Product Weight (lbs.): 54 Cubic Feet Per Carton: 10.5</p>	 <p>ADJUSTMENTS (1) Tilt tension (2) Pneumatic seat height (5A) Center-tilt action</p>	<p>Upholstered Back</p> <p>Ergonomic Features: A, B, C, E, H, M, N, O, S, U</p>	<table border="1"> <tr> <td>6332-4PB</td> <td>1108</td><td>1153</td><td>1188</td><td>1239</td><td>1308</td><td>1343</td><td>1406</td><td>1509</td><td>1591</td><td>1678</td><td>1860</td><td>2054</td> </tr> </table>												6332-4PB	1108	1153	1188	1239	1308	1343	1406	1509	1591	1678	1860	2054						
			6332-4PB	1108	1153	1188	1239	1308	1343	1406	1509	1591	1678	1860	2054																		
			<table border="1"> <tr> <th colspan="3">OVERALL DIMENSIONS</th> <th colspan="3">SEAT DIMENSIONS</th> <th colspan="3">BACK DIMENSIONS</th> </tr> <tr> <th>W</th><th>D</th><th>H</th> <th>W</th><th>D</th><th>H</th> <th>W</th><th>H</th> </tr> <tr> <td>25.5</td><td>24</td><td>39</td> <td>20</td><td>17.5</td><td>16-21</td> <td>18.5</td><td>21</td> </tr> </table>			OVERALL DIMENSIONS			SEAT DIMENSIONS			BACK DIMENSIONS			W	D	H	W	D	H	W	H	25.5	24	39	20	17.5	16-21	18.5	21	<p>RTA 2 1 per carton</p>		
			OVERALL DIMENSIONS			SEAT DIMENSIONS			BACK DIMENSIONS																								
			W	D	H	W	D	H	W	H																							
25.5	24	39	20	17.5	16-21	18.5	21																										
 <p>mesh back</p> <p>Armless Task with Pedestal Base COM Yardage: 1 Freight Class: 150 Product Weight (lbs.): 33 Cubic Feet Per Carton: 15.75</p>	 <p>ADJUSTMENTS (2) Pneumatic seat height</p>	<p>Ergonomic features: M, N</p>	<table border="1"> <tr> <td>6364-6PB</td> <td>\$1046</td><td>\$1081</td><td>\$1107</td><td>\$1145</td><td>\$1200</td><td>\$1227</td><td>\$1275</td><td>\$1354</td><td>\$1414</td><td>\$1482</td><td>\$1621</td><td>\$1768</td> </tr> </table>												6364-6PB	\$1046	\$1081	\$1107	\$1145	\$1200	\$1227	\$1275	\$1354	\$1414	\$1482	\$1621	\$1768						
			6364-6PB	\$1046	\$1081	\$1107	\$1145	\$1200	\$1227	\$1275	\$1354	\$1414	\$1482	\$1621	\$1768																		
			<table border="1"> <tr> <th colspan="3">OVERALL DIMENSIONS</th> <th colspan="3">SEAT DIMENSIONS</th> <th colspan="3">BACK DIMENSIONS</th> </tr> <tr> <th>W</th><th>D</th><th>H</th> <th>W</th><th>D</th><th>H</th> <th>W</th><th>H</th> </tr> <tr> <td>23.5</td><td>29</td><td>35.5</td> <td>19</td><td>18</td><td>16-21</td> <td>19</td><td>17</td> </tr> </table>			OVERALL DIMENSIONS			SEAT DIMENSIONS			BACK DIMENSIONS			W	D	H	W	D	H	W	H	23.5	29	35.5	19	18	16-21	19	17	<p>RTA 00 1 per carton</p>		
			OVERALL DIMENSIONS			SEAT DIMENSIONS			BACK DIMENSIONS																								
			W	D	H	W	D	H	W	H																							
23.5	29	35.5	19	18	16-21	19	17																										
 <p>mesh back</p> <p>Armless Task w/Tablet and Pedestal Base COM Yardage: 1 Freight Class: 150 Product Weight (lbs.): 33 Cubic Feet Per Carton: 17.75</p>	 <p>ADJUSTMENTS (2) Pneumatic seat height</p>	<p>Ergonomic features: M, N</p> <p>Specify (L) left or (R) right tablet. (Example: 6364-6L or 6364-6R).</p>	<table border="1"> <tr> <td>6364-6LPB 6364-6RPB</td> <td>1345</td><td>1379</td><td>1405</td><td>1443</td><td>1497</td><td>1525</td><td>1572</td><td>1653</td><td>1712</td><td>1781</td><td>1919</td><td>2067</td> </tr> </table>												6364-6LPB 6364-6RPB	1345	1379	1405	1443	1497	1525	1572	1653	1712	1781	1919	2067						
			6364-6LPB 6364-6RPB	1345	1379	1405	1443	1497	1525	1572	1653	1712	1781	1919	2067																		
			<table border="1"> <tr> <th colspan="3">OVERALL DIMENSIONS</th> <th colspan="3">SEAT DIMENSIONS</th> <th colspan="3">BACK DIMENSIONS</th> </tr> <tr> <th>W</th><th>D</th><th>H</th> <th>W</th><th>D</th><th>H</th> <th>W</th><th>H</th> </tr> <tr> <td>23.5</td><td>29</td><td>35.5</td> <td>19</td><td>18</td><td>16-21</td> <td>19</td><td>17</td> </tr> </table>			OVERALL DIMENSIONS			SEAT DIMENSIONS			BACK DIMENSIONS			W	D	H	W	D	H	W	H	23.5	29	35.5	19	18	16-21	19	17	<p>RTA 00 1 per carton</p>		
			OVERALL DIMENSIONS			SEAT DIMENSIONS			BACK DIMENSIONS																								
			W	D	H	W	D	H	W	H																							
23.5	29	35.5	19	18	16-21	19	17																										
 <p>upholstered back</p> <p>Armless Task with Pedestal Base COM Yardage: 1.25 Freight Class: 150 Product Weight (lbs.): 33 Cubic Feet Per Carton: 15.75</p>	 <p>ADJUSTMENTS (2) Pneumatic seat height</p>	<p>Ergonomic features: M, N</p>	<table border="1"> <tr> <td>6374-6PB</td> <td>1046</td><td>1089</td><td>1122</td><td>1169</td><td>1237</td><td>1270</td><td>1332</td><td>1430</td><td>1505</td><td>1589</td><td>1763</td><td>1947</td> </tr> </table>												6374-6PB	1046	1089	1122	1169	1237	1270	1332	1430	1505	1589	1763	1947						
			6374-6PB	1046	1089	1122	1169	1237	1270	1332	1430	1505	1589	1763	1947																		
			<table border="1"> <tr> <th colspan="3">OVERALL DIMENSIONS</th> <th colspan="3">SEAT DIMENSIONS</th> <th colspan="3">BACK DIMENSIONS</th> </tr> <tr> <th>W</th><th>D</th><th>H</th> <th>W</th><th>D</th><th>H</th> <th>W</th><th>H</th> </tr> <tr> <td>23.5</td><td>29</td><td>35.5</td> <td>19</td><td>18</td><td>16-21</td> <td>19</td><td>17</td> </tr> </table>			OVERALL DIMENSIONS			SEAT DIMENSIONS			BACK DIMENSIONS			W	D	H	W	D	H	W	H	23.5	29	35.5	19	18	16-21	19	17	<p>RTA 00 1 per carton</p>		
			OVERALL DIMENSIONS			SEAT DIMENSIONS			BACK DIMENSIONS																								
			W	D	H	W	D	H	W	H																							
23.5	29	35.5	19	18	16-21	19	17																										
 <p>upholstered back</p> <p>Armless Task w/Tablet and Pedestal Base COM Yardage: 1.25 Freight Class: 250 Product Weight (lbs.): 44 Cubic Feet Per Carton: 11.75</p>	 <p>ADJUSTMENTS (2) Pneumatic seat height</p>	<p>Ergonomic features: M, N</p> <p>Specify (L) left or (R) right tablet. (Example: 6374-6L or 6374-6R, 6374-6MOL or 6374-6MOR).</p>	<table border="1"> <tr> <td>6374-6LPB 6374-6RPB</td> <td>1345</td><td>1387</td><td>1419</td><td>1467</td><td>1535</td><td>1568</td><td>1630</td><td>1728</td><td>1804</td><td>1888</td><td>2062</td><td>2246</td> </tr> </table>												6374-6LPB 6374-6RPB	1345	1387	1419	1467	1535	1568	1630	1728	1804	1888	2062	2246						
			6374-6LPB 6374-6RPB	1345	1387	1419	1467	1535	1568	1630	1728	1804	1888	2062	2246																		
			<table border="1"> <tr> <th colspan="3">OVERALL DIMENSIONS</th> <th colspan="3">SEAT DIMENSIONS</th> <th colspan="3">BACK DIMENSIONS</th> </tr> <tr> <th>W</th><th>D</th><th>H</th> <th>W</th><th>D</th><th>H</th> <th>W</th><th>H</th> </tr> <tr> <td>23.5</td><td>29</td><td>35.5</td> <td>19</td><td>18</td><td>16-21</td> <td>19</td><td>17</td> </tr> </table>			OVERALL DIMENSIONS			SEAT DIMENSIONS			BACK DIMENSIONS			W	D	H	W	D	H	W	H	23.5	29	35.5	19	18	16-21	19	17	<p>RTA 00 1 per carton</p>		
			OVERALL DIMENSIONS			SEAT DIMENSIONS			BACK DIMENSIONS																								
			W	D	H	W	D	H	W	H																							
23.5	29	35.5	19	18	16-21	19	17																										

WEEV



model 2220-3



model 2221-4

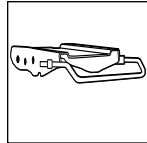

Multi-Depth Mechanism
Seat depth is standard on Multi-tilter and Synchro-Tilter models. (see notes for more details)



Stitch detail on Leather upholstered seat



Vari-Width (WA)
Width Adjustable Arm Extensions is standard when order with adjustable height arms.





STANDARD FEATURES





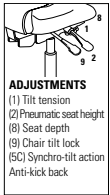

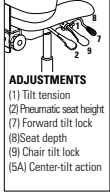

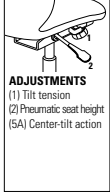
- A beautiful, breathable mesh, functional task seating series, at affordable pricing.
- Weev series includes six mechanisms, a Synchro-Tilter with Back Angle, Weight Sensing Synchro-Tilter, Multi-Tilter, Tilter, and Task.
- The Black mesh for the back of the chair is woven to breathe and give as the user leans into it removing pressure points along the spine.
- The lumbar support built into the design of the back is flexible and reshapes itself to match and support the user's body profile.
- Side activated sliding seat depth adjustment (**MD**), is standard on Multi-Tilters and Synchro-Tilters providing 2" of seat depth adjustment.
- Height and width (**WA**) adjustable GL arms. Armcaps are soft to the touch Self-Skinned Urethane. Armcaps are depth adjustable (slide forward and backward) to suit user preference.
- Vari-Width (**WA**) Width Adjustable Arm Extensions are standard, allowing the arms to move away from the seat by 2" on each side to allow space for broader hip widths. Five legged, injection molded, fiberglass reinforced, nylon base **B7B** is standard.
- **C1** dual wheel carpet casters are standard.

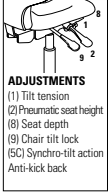

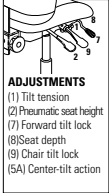

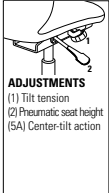

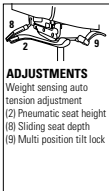
- Models upholstered in leather have a straight seam across the seat.
- Check textile availability prior to specifying upholstery material.

OPTIONAL FEATURES

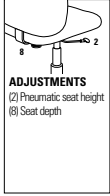
- Please refer to the "Arm Selection" section of the price book for arm options.
- Please refer to "Cylinder Selection" section of the price book for additional cylinder options.
- For optional polished Aluminum base (**B7A**) Please specify **ALU** base. Add \$154.
- For hard surface flooring casters, specify **C9R**. Add \$66.
- Please refer to the "Casters Selection" section of the price book for caster options. Optional casters may be priced higher than the standard casters for your chair and the difference will be charged. Lower priced optional casters will not be credited.
- For fully assembled in box, specify **SU**. Add \$70.

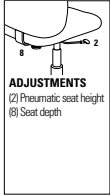
DESCRIPTION	FEATURES	MODEL#	STANDARD TEXTILE GRADES													
			1	2	3	4	5	6	7	8	9	10	11	12		
 <p>HB Synchro - Tilter w/Back Angle Adjustment COM Yardage: 1 Freight Class: 125 Product Weight (lbs.): 68 Cubic Feet Per Carton: 10.5</p>	 <p>ADJUSTMENTS (1) Tilt tension (2) Pneumatic seat height (8) Seat depth (9) Chair tilt lock (5C) Synchro-tilt action Anti-kick back</p>	<p>2220-0</p>	856	891	918	956	1012	1029	1077	1168	1214	1297	1414	1555		
			OVERALL DIMENSIONS			SEAT DIMENSIONS			BACK DIMENSIONS							
			W	D	H	W	D	H	W	H						
			25	24	42	19	18-20.5	16-20	19	27						
 <p>HB Multi - Tilter COM Yardage: 1 Freight Class: 125 Product Weight (lbs.): 70 Cubic Feet Per Carton: 10.5</p>	 <p>ADJUSTMENTS (1) Tilt tension (2) Pneumatic seat height (7) Forward tilt lock (8) Seat depth (9) Chair tilt lock (5A) Center-tilt action</p>	<p>2220-3</p>	856	891	918	956	1012	1029	1077	1168	1214	1297	1414	1555		
			OVERALL DIMENSIONS			SEAT DIMENSIONS			BACK DIMENSIONS							
			W	D	H	W	D	H	W	H						
			25	24	42	19	18-20.5	16-20	19	27						
 <p>HB Tilter COM Yardage: 1 Freight Class: 150 Product Weight (lbs.): 59 Cubic Feet Per Carton: 10.5</p>	 <p>ADJUSTMENTS (1) Tilt tension (2) Pneumatic seat height (5A) Center-tilt action</p>	<p>2220-4</p>	734	769	796	835	889	907	957	1047	1093	1177	1292	1434		
			OVERALL DIMENSIONS			SEAT DIMENSIONS			BACK DIMENSIONS							
			W	D	H	W	D	H	W	H						
			25	24	42.5	19	18-20.5	16-20	19	27						

DESCRIPTION	FEATURES	MODEL#	STANDARD TEXTILE GRADES													
			1	2	3	4	5	6	7	8	9	10	11	12		
 <p>HB Weight Sensing Synchro - Tilter COM Yardage: 1 Freight Class: 125 Product Weight (lbs.): 70 Cubic Feet Per Carton: 10.5</p>	 <p>ADJUSTMENTS Weight sensing auto tension adjustment (2) Pneumatic seat height (8) Sliding seat depth (9) Multi position tilt lock</p>	2220-8	856	891	918	956	1012	1029	1077	1168	1214	1297	1414	1555		
			OVERALL DIMENSIONS			SEAT DIMENSIONS			BACK DIMENSIONS							
			W	D	H	W	D	H	W	H						
			25	24	42	19	18-20.5	16-20	19	27						
<p>Ergonomic Features: A, B, C, E, H, J, M, N, Q</p>	<p>RTA 2</p> 															
		 <p>MB Synchro - Tilter w/Back Angle Adjustment COM Yardage: 1 Freight Class: 125 Product Weight (lbs.): 66 Cubic Feet Per Carton: 10.5</p>	 <p>ADJUSTMENTS (1) Tilt tension (2) Pneumatic seat height (8) Seat depth (9) Chair tilt lock (5C) Synchro-tilt action Anti-kick back</p>	2221-0	828	861	888	926	980	1000	1048	1139	1184	1268	1383	1526
					OVERALL DIMENSIONS			SEAT DIMENSIONS			BACK DIMENSIONS					
					W	D	H	W	D	H	W	H				
25	24				39	19	18-20.5	16-20	19	24						
<p>Ergonomic Features: A, B, C, E, H, L, M, N, Q</p>	<p>RTA 2</p> 															
		 <p>MB Multi - Tilter COM Yardage: 1 Freight Class: 125 Product Weight (lbs.): 68 Cubic Feet Per Carton: 10.5</p>	 <p>ADJUSTMENTS (1) Tilt tension (2) Pneumatic seat height (7) Forward tilt lock (8) Seat depth (9) Chair tilt lock (5A) Center-tilt action</p>	2221-3	828	861	888	926	980	1000	1048	1139	1184	1268	1383	1526
					OVERALL DIMENSIONS			SEAT DIMENSIONS			BACK DIMENSIONS					
					W	D	H	W	D	H	W	H				
25	24				39	19	18-20.5	16-20	19	24						
<p>Ergonomic Features: A, B, C, E, F, G, H, M, N, Q, S</p>	<p>RTA 2</p> 															
		 <p>MB Tilter COM Yardage: 1 Freight Class: 150 Product Weight (lbs.): 57 Cubic Feet Per Carton: 10.5</p>	 <p>ADJUSTMENTS (1) Tilt tension (2) Pneumatic seat height (5A) Center-tilt action</p>	2221-4	708	743	768	807	860	880	928	1019	1065	1147	1263	1406
					OVERALL DIMENSIONS			SEAT DIMENSIONS			BACK DIMENSIONS					
					W	D	H	W	D	H	W	H				
25	24				39.5	19	18-20.5	16-20	19	24						
<p>Ergonomic Features: A, B, C, E, H, M, N, Q, S</p>	<p>RTA 2</p> 															
		 <p>MB Weight Sensing Synchro - Tilter COM Yardage: 1 Freight Class: 125 Product Weight (lbs.): 68 Cubic Feet Per Carton: 10.5</p>	 <p>ADJUSTMENTS Weight sensing auto tension adjustment (2) Pneumatic seat height (8) Sliding seat depth (9) Multi position tilt lock</p>	2221-8	828	861	888	926	980	1000	1048	1139	1184	1268	1383	1526
					OVERALL DIMENSIONS			SEAT DIMENSIONS			BACK DIMENSIONS					
					W	D	H	W	D	H	W	H				
25	24				39	19	18-20.5	16-20	19	24						
<p>Ergonomic Features: A, B, C, E, H, J, M, N, Q</p>	<p>RTA 2</p> 															

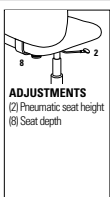
DESCRIPTION	FEATURES	MODEL#	STANDARD TEXTILE GRADES													
			1	2	3	4	5	6	7	8	9	10	11	12		
 <p>MB Task COM Yardage: 1 Freight Class: 150 Product Weight (lbs.): 48 Cubic Feet Per Carton: 10.5</p>	 <p>ADJUSTMENTS (2) Pneumatic seat height (8) Seat depth</p> <p>Ergonomic Features: C, E, H, M, N, Q</p>	2221-6	708	743	768	807	860	880	928	1019	1065	1147	1263	1406		
			OVERALL DIMENSIONS			SEAT DIMENSIONS			BACK DIMENSIONS							
			W	D	H	W	D	H	W	H						
			25	24	41	19	17.5-18.5	16.5-20.5	19	24						
			RTA 2													
 <p>MB Task Armless COM Yardage: 1 Freight Class: 150 Product Weight (lbs.): 42 Cubic Feet Per Carton: 10.5</p>	 <p>ADJUSTMENTS (2) Pneumatic seat height (8) Seat depth</p> <p>Ergonomic Features: C, E, M, N</p>	2222-6	592	629	655	692	748	765	815	905	950	1033	1149	1292		
			OVERALL DIMENSIONS			SEAT DIMENSIONS			BACK DIMENSIONS							
			W	D	H	W	D	H	W	H						
			25	24	41	19	17.5-18.5	16.5-20.5	19	24						
			RTA 2													
 <p>MB Drafting Stool Task COM Yardage: 1 Freight Class: 150 Product Weight (lbs.): 51 Cubic Feet Per Carton: 10.5</p>	 <p>ADJUSTMENTS (2) Pneumatic seat height (8) Seat depth</p> <p>Ergonomic Features: C, E, H, M, N, Q</p>	2223-6	1104	1138	1164	1202	1258	1275	1324	1415	1460	1544	1659	1802		
			OVERALL DIMENSIONS			SEAT DIMENSIONS			BACK DIMENSIONS							
			W	D	H	W	D	H	W	H						
			20.5	24.5	48	19	17.5-18.5	24-34	19	24						
			RTA 2													
 <p>MB Drafting Stool Task Armless COM Yardage: 1 Freight Class: 150 Product Weight (lbs.): 45 Cubic Feet Per Carton: 10.5</p>	 <p>ADJUSTMENTS (2) Pneumatic seat height (8) Seat depth</p> <p>Ergonomic Features: C, E, M, N</p>	2224-6	985	1020	1047	1085	1140	1158	1206	1297	1342	1426	1543	1684		
			OVERALL DIMENSIONS			SEAT DIMENSIONS			BACK DIMENSIONS							
			W	D	H	W	D	H	W	H						
			19	24	50.5	19	17.5-18.5	24-34	19	24						
			RTA 2													

multi-purpose

Bakhita	128	Islands	177	Sidero	200
Beach	131	Layne	178	Sonic	204
Beam Seating	132	Lite	180	Spritz	220
Caprice	142	Marche	185	Spyker	223
Chap	144	Mayne	187	Stream	224
Comet	146	Moda Four-Legged	188	Twilight	236
Diplomat	149	Moda Stacking	189	Vion guest	239
Duet	150	Popcorn	191	Zoma	244
Erin	172	Roma Nester	196		
File Buddy	174	Sas	198		

BAKHITA



model 6750



model 6751





model 6754







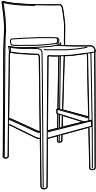
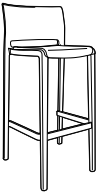

model 6785

STANDARD FEATURES

- A comfortable, high-quality, lightweight, stacking chair that is incredibly strong and durable.
- Bakhita is an all polymer chair intended for use indoors or outdoors. Products must be stored inside during extreme and inclement weather. See Global's Outdoor Furniture warranty for additional information.
- Weather resistant, UV and stain resistant, with a modern design.
- Standard height models (6750, 6751) are suitable for use in MRI rooms.
- Chairs are simultaneously molded with two different materials. Inside is a structural fiberglass frame for strength. Outside is a durable polypropylene light fast compound.
- Armchairs and Armless Chairs are finished with a smooth surface. Bar Stools and Counter Stools are finished with a slightly textured surface.
- Upholstered seats will only fit on a frame made for this purpose, it is not possible to add an upholstered seat onto an existing all plastic chair in the field.
- Upholstered seats are fixed and non-removable.
- Chair legs are equipped with translucent non-marking glides as standard. Suitable for outdoor environments, carpet and hard surface flooring.
- Check textile availability prior to specifying upholstery material.
- All Bakhita products (except upholstered models) are only available through Global's InStock program. Contact CustomerCare for lead times and quotation for quantities beyond InStock inventory.
- For outdoor use Global recommends marine grade vinyls or Sunbrella fabrics with UV resistance.
- Chairs are available in 3 plastic colors: Alloy (ALY), Char (CHA), and Milk (MLK).
- Tables are available in standard or bar height and are suitable for outdoor use.
- Tables are available with a Silver base and Milk (MLK) top only.
- Table tops are constructed from technopolymer compounds with high structural, heat and abrasion resistance. Tops are UV, shock and stain resistant.

DESCRIPTION	FEATURES	MODEL#	STANDARD TEXTILE GRADES														
			1	2	3	4	5	6	7	8	9	10	11	12			
 <p>Armchair Poly Seat & Back COM Yardage: N/A Freight Class: 150 Product Weight (lbs.): 14.25 Cubic Feet Per Carton: 3.38(4 per carton)</p>	<p>Stacks 8 high on floor. Stacks 10 high on dolly.</p>	6750	294														
			OVERALL DIMENSIONS			SEAT DIMENSIONS			BACK DIMENSIONS								
			W	D	H	W	D	H	W	H							
			22.5	21	31.5	16	16	17.25	17	14.5							
			RTA 00 4 per carton (pricing and specifications are for one chair)														
 <p>Armless Chair Poly Seat & Back COM Yardage: N/A Freight Class: 150 Product Weight (lbs.): 13 Cubic Feet Per Carton: 2.88(4 per carton)</p>	<p>Stacks 8 high on floor. Stacks 12 high on dolly</p>	6751	261														
			OVERALL DIMENSIONS			SEAT DIMENSIONS			BACK DIMENSIONS								
			W	D	H	W	D	H	W	H							
			18	21	31.5	16	16	17.25	17	14.5							
			RTA 00 4 per carton (pricing and specifications are for one chair)														
 <p>Armchair Uph Seat & Poly Back COM Yardage: 0.75 Freight Class: 250 Product Weight (lbs.): 16 Cubic Feet Per Carton: 4.5 (3 per carton)</p>	<p>Stacks 8 high on floor. Stacks 10 high on dolly</p>	6752	489	513	530	556	593	609	644	697	738	783	880	979			
			OVERALL DIMENSIONS			SEAT DIMENSIONS			BACK DIMENSIONS								
			W	D	H	W	D	H	W	H							
			22.5	21	31.5	16	16	18	17	14.5							
			RTA 00 3 per carton (pricing and specifications are for one chair)														

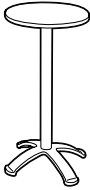
DESCRIPTION	FEATURES	MODEL#	STANDARD TEXTILE GRADES													
			1	2	3	4	5	6	7	8	9	10	11	12		
 <p>Armless Chair Uph Seat & Poly Back COM Yardage: 0.75 Freight Class: 250 Product Weight (lbs.): 14.67 Cubic Feet Per Carton: 3.83(3 per carton)</p>	Stacks 8 high on floor. Stacks 12 high on dolly	6753	\$448	\$472	\$489	\$515	\$552	\$568	\$603	\$656	\$697	\$742	\$839	\$938		
			OVERALL DIMENSIONS			SEAT DIMENSIONS			BACK DIMENSIONS							
			W	D	H	W	D	H	W	H						
			18	21	31.5	16	16	18	17	14.5						
			RTA 00		3 per carton (pricing and specifications are for one chair)											
 <p>Armless Bar Stool Poly Seat & Back COM Yardage: 0.75 Freight Class: 250 Product Weight (lbs.): 14.67 Cubic Feet Per Carton: 3.19 (4 per carton)</p>	Stacks 4 high on floor.	6754	1	2	3	4	5	6	7	8	9	10	11	12		
			W	D	H	W	D	H	W	H						
			19.25	18.75	40.5	14	15	30	17	10.5						
			RTA 00		4 per carton (pricing and specifications are for one chair)											
 <p>Armless Bar Stool Uph Seat & Poly Back COM Yardage: 0.75 Freight Class: 250 Product Weight (lbs.): 14.67 Cubic Feet Per Carton: 4.25 (3 per carton)</p>	Stacks 4 high on floor.	6755	1	2	3	4	5	6	7	8	9	10	11	12		
			W	D	H	W	D	H	W	H						
			19	18	40	14	15	30.75	17	10.5						
			RTA 00		3 per carton (pricing and specifications are for one chair)											
 <p>Chair Dolly COM Yardage: N/A Freight Class: 250 Product Weight (lbs.): 11 Cubic Feet Per Carton: 2.9</p>		6783	1	2	3	4	5	6	7	8	9	10	11	12		
			W	D	H	W	D	H	W	H						
			19.75	23.25	9.75	-	-	-	-	-						
			RTA 00			1 per carton										

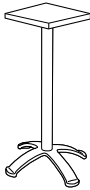
DESCRIPTION	FEATURES	MODEL#	STANDARD TEXTILE GRADES											
			1	2	3	4	5	6	7	8	9	10	11	12
 <p>Round Table - Café Height COM Yardage: N/A Freight Class: 100 Product Weight (lbs.): 40 Cubic Feet Per Carton: 4.49 (3 cartons per one model)</p>		6780	568											
 <p>Round Table - Bar Height COM Yardage: N/A Freight Class: 100 Product Weight (lbs.): 41 Cubic Feet Per Carton: 4.49 (3 cartons per one model)</p>		6781	581											
 <p>Square Table - Café Height COM Yardage: N/A Freight Class: 100 Product Weight (lbs.): 42.5 Cubic Feet Per Carton: 4.49 (3 cartons per one model)</p>		6785	621											
 <p>Square Table - Bar Height COM Yardage: N/A Freight Class: 100 Product Weight (lbs.): 43.5 Cubic Feet Per Carton: 4.49 (3 cartons per one model)</p>		6786	634											

BEACH™



model 4077





model 4078

STANDARD FEATURES

- Elegant wood seating with a choice of an upholstered or vertical wood slat back.
- Frame construction is beech hardwood.
- Furniture legs are equipped with white non marking polypropylene glides as standard. Suitable for both carpet and hard surface flooring.
- All cushions are fixed and non-removable.
- Cushions are highly resilient foam and seats are equipped with a synthetic rubberized webbing suspension system for extra comfort.

OPTIONAL FEATURES

- Frame available in Absolute (AAM), Black (BKM), Cherry (ACM), Espresso Cafe (ECM), English Oak (EOM), Fruitwood (TFM), Gray (HGM), Honey (AHM), Mahogany (TMM), Maple (AVM), Medium Walnut (MWM), Natural Walnut (NLW), Night (ASM), NoceBiondo (NBM), Noce Grigio (NGM), Noce Leggero (NEM), Noce Medio (NMM), Shaker Cherry (SKM), Walnut (TWM), WC Cream (WTM), White (WHM) and Winter Cherry (WCM). Please Specify.
- Check textile availability prior to specifying upholstery material.

DESCRIPTION	FEATURES	MODEL#	STANDARD TEXTILE GRADES											
			1	2	3	4	5	6	7	8	9	10	11	12
 <p>Armchair w/Upholstered back. COM Yardage: 1.50 Freight Class: 300 Product Weight (lbs.): 20 Cubic Feet Per Carton: 11.75</p>	Does not stack.	4077	\$827	\$861	\$888	\$925	\$979	\$1007	\$1054	\$1135	\$1193	\$1262	\$1400	\$1546
		OVERALL DIMENSIONS			SEAT DIMENSIONS			BACK DIMENSIONS						
		W	D	H	W	D	H	W	H					
		22	23	33.5	19.5	18.5	18.75	19.5	15.5					
			RTA 00											
 <p>Armchair w/Vertical Wood Slat back. COM Yardage: 1.00 Freight Class: 300 Product Weight (lbs.): 20 Cubic Feet Per Carton: 11.75</p>	Does not stack.	4078	\$869	\$903	\$931	\$970	\$1028	\$1056	\$1107	\$1189	\$1252	\$1323	\$1467	\$1622
		OVERALL DIMENSIONS			SEAT DIMENSIONS			BACK DIMENSIONS						
		W	D	H	W	D	H	W	H					
		22	23	33.5	19.5	18.5	18.75	19.5	15.5					
			RTA 00											

BEAM SEATING



*see sample layout SON507 for models included above.

STANDARD FEATURES

- The universal beam units and tables listed are shown here, along with beam seating upper components from several seating lines.
- Beams are standard in Black. The “T” shaped legs are available in Chrome only with Black anti scuff tips and trim.
- Corner beam creates 90° turn in beam seating. Only table units can be attached.
- Beams and legs are shipped fully assembled.
- Upper seating units include mounting brackets and all necessary hardware for attachment to beam.
- Upper seating units and/or tables can be placed in any order along the beam.
- Power monument has two AC outlets, dual 2.1 amp USB ports.
- **Specifications and pricing are for 1 chair.**

OPTIONAL FEATURES

- Check textile availability prior to specifying upholstery material.
- Optional universal aluminum arm with soft pad available for mounting on beam in multiple positions, model 6500A8. \$149 list.
- Sonic seating units are available in mesh back, Black only.
- Vion seating units available in 10 mesh colors: Black (**MS69**), Stone (**MS71**), Blue (**MS72**), Rope (**MS73**), Natural (**MS74**), Aqua (**MS75**), Black Cherry (**MS76**), Dust (**MS77**), Ivory (**MS78**) and Paprika (**MS79**). Please specify. No upcharge.

OPTIONAL FEATURES (continued)

- Vion is available with a Black (**BLK**) Back Frame as standard or an optional Fog (**FOG**) Back Frame, please add \$53 list.
- Duet, Popcorn and Sonic seating units are available in 14 designer colors. Choose from Buzz Blue (**BZB**), Cactus (**CTT**), Carrot (**CRO**), Cloud (**IVC**), Dijon (**DJN**), Eggplant (**EGP**), Fog (**FOG**), Frost (**FRO**), Ink (**INK**), Latte (**LAB**), Night (**BLK**), Sand (**SND**), Scarlet (**SAR**), and Shadow (**SHW**).
- Duet arms will match the specified polypropylene color.
- Sidero, Sonic and Vion arm models are standard in Black only.
- Sonic is available in the following frame finishes: Chrome (**CHM**), Black (**TBL**), Buzz Blue (**TBZ**), Cactus (**TCC**), Carrot (**TCR**), Dijon (**TDJ**), Designer White (**TDW**), Eggplant (**TEG**), Fog (**TFO**), Frost (**TFR**), Ink (**TIN**), Cloud (**TIV**), Kalua (**TKA**), Latte (**TLA**), Mocha (**TMO**), Nevada (**TNE**), Toast (**TOA**), Shadow (**TSH**), Sand (**TSN**), Scarlet (**TSR**) and Tungsten (**TTU**). Please specify
- Duet and Popcorn are standard in a Chrome (**CH**) frame finish. Sidero and Vion are standard in Black (**BK**) frame finish.
- Beam seating laminate table tops are available in Absolute Acajou (**ACJ**), Asian Night (**ASN**), Avant Cherry (**AWC**), Avant Honey (**AWH**), Brushed Cobalt (**BRC**), Clear Maple (**CMB**), Dark Espresso (**DES**), Designer White (**DWWT**), Hayden Grey (**HGT**), Noce Biondo (**NBL**), Noce Grigio (**NGL**), Noce Leggero (**NEL**), Noce Medio (**NML**), (**HGT**), Tiger Walnut (**TWL**), Walnut Heights (**WHE**), Winter Cherry (**WCR**), White Chocolate (WHC). Please specify. No upcharge.

SAMPLE LAYOUTS

VON501 - Shown



Approximate dimensions: 74”W x 24”D

Kit Layout	Description	Total (Grd. 1)
VON501	Vion armless seat units with Beam components: 6340 (3 seats), 6500S3 (1 beam)	\$3127
DUT501	Duet armless seat units with Beam components: 6691 (3 seats), 6500S3 (1 beam)	\$1663
POP501	Popcorn armless seat units with Beam components: 6717 (3 seats), 6500S3 (1 beam)	\$1780
SID501	Sidero armless seat units with Beam components: 6931 (3 seats), 6500S3 (1 beam)	\$2653
SON501	Sonic armless seat units with Beam components: 6501 (3 seats), 6500S3 (1 beam)	\$2653

*See next pages for individual model description, dimensions and starting list price.

SON502 - Shown



Approximate dimensions: 100”W x 24”D

Kit Layout	Description	Total (Grd. 1)
SON502	Sonic arm seat units with Beam components: 6506 (4 seats), 6500S4 (1 beam)	\$3443
DUT502	Duet arm seat units with Beam components: 6690 (4 seats), 6500S4 (1 beam)	\$2683
POP502	Popcorn armless seat units with Universal arms and Beam components: 6717 (4 seats), 6500S4 (1 beam), and 6500A8 (5 arms)	\$3168
SID502	Sidero arm seat units with Beam components: 6930 (4 seats), 6500S4 (1 beam)	\$3815
VON502	Vion arm seat units with Beam components: 6342 (4 seats), 6500S4 (1 beam)	\$3991

*See next pages for individual model description, dimensions and starting list price.

SAMPLE LAYOUTS

DUT503 - Shown



Approximate dimensions: 100"W x 24"D

Kit Layout	Description	Total (Grd. 1)
DUT503	Duet armless seat units with Beam components: 6691 (3 seats), 6500S4 (1 beam), 6507 (1 table)	\$2291
POP503	Popcorn armless seat units with Beam components: 6717 (3 seats), 6500S4 (1 beam), 6507 (1 table)	\$2408
SID503	Sidero armless seat units with Beam components: 6931 (3 seats), 6500S4 (1 beam), 6507 (1 table)	\$3281
SON503	Sonic armless seat units with Beam components: 6501 (3 seats), 6500S4 (1 beam), 6507 (1 table)	\$2651
VON503	Vion armless seat units with Beam components: 6340 (3 seats), 6500S4 (1 beam), 6507 (1 table)	\$3755

*See next pages for individual model description, dimensions and starting list price.

POP504 - Shown



Approximate dimensions: 122"W x 24"D

Kit Layout	Description	Total (Grd. 1)
POP504	Popcorn seat units with Universal arms and Beam components: 6717 (4 seats), 6500A8 (6 arms), 6500S3 (1 beam), 6500A2 (1 beam), 6507 (1 table), 6591B (1 Module)	\$4250
DUT504	Duet arm seat units with Beam components: 6690 (4 seats), 6500S3 (1 beam), 6500A2 (1 beam), 6507 (1 table), 6591B (1 Module)	\$3765
SID504	Sidero arm seat units with Beam components: 6930 (4 seats), 6500S3 (1 beam), 6500A2 (1 beam), 6507 (1 table), 6591B (1 Module)	\$4897
SON504	Sonic arm seat units with Beam components: 6504 (4 seats), 6500S3 (1 beam), 6500A2 (1 beam), 6507 (1 table), 6591B (1 Module)	\$4117
VON504	Vion arm seat units with Beam components: 6342 (4 seats), 6500S3 (1 beam), 6500A2 (1 beam), 6507 (1 table), 6591B (1 Module)	\$5073

*See next pages for individual model description, dimensions and starting list price.

SID505 - Shown



Approximate dimensions: 147"W x 24"D

Kit Layout	Description	Total (Grd. 1)
SID505	Sidero armless seat units with Beam components: 6931 (4 seats), 6500S3 (1 beam), 6500A3 (1 beam), 6507 (2 table)	\$4558
DUT505	Duet armless seat units with Beam components: 6691 (4 seats), 6500S3 (1 beam), 6500A3 (1 beam), 6507 (2 table)	\$3238
POP505	Popcorn armless seat units with Beam components: 6717 (4 seats), 6500S3 (1 beam), 6500A3 (1 beam), 6507 (2 table)	\$3394
SON505	Sonic armless seat units with Beam components: 6501 (4 seats), 6500S3 (1 beam), 6500A3 (1 beam), 6507 (2 table)	\$3718
VON505	Vion armless seat units with Beam components 6340 (4 seats), 6500S3 (1 beam), 6500A3 (1 beam), 6507 (2 table)	\$5190

*See next pages for individual model description, dimensions and starting list price.

VON506 - Shown



Approximate dimensions: 103"W x 103"D

Kit Layout	Description	Total (Grd. 1)
VON506	Vion arm seat units with Beam components: 6342 (6 seats), 6500S3 (2 beams), 6507-T2 (1 table), 6500A9 (1 Connector)	\$6609
DUT504	Duet arm seat units with Beam components: 6690 (6 seats), 6500S3 (2 beams), 6507-T2 (1 table), 6500A9 (1 Connector)	\$4647
POP505	Popcorn armless seat units with Universal arms and Beam components: 6717 (6 seats), 6500A8 (8 arms), 6500S3 (2 beams), 6507-T2 (1 table), 6500A9 (1 Connector)	\$5449
SID504	Sidero arm seat units with Beam components: 6930 (6 seats), 6500S3 (2 beams), 6507-T2 (1 table), 6500A9 (1 Connector)	\$6345
SON504	Sonic arm seat units with Beam components: 6504 (6 seats), 6500S3 (2 beams), 6507-T2 (1 table), 6500A9 (1 Connector)	\$5175

*See next pages for individual model description, dimensions and starting list price.

SAMPLE LAYOUTS

SON507 - Shown



Approximate dimensions: 103"W x 103"D

Kit Layout	Description	Total (Grd. 1)
SON507	Sonic arm seat units with Beam components: 6506 (6 seats), 6500S3 (2 beams), 6507-T2 (1 table), 6500A9 (1 connector)	\$5787
DUT507	Duet arm seat units with Beam components: 6690 (6 seats), 6500S3 (2 beams), 6507-T2 (1 table), 6500A9 (1 connector)	\$4647
POP507	Popcorn armless seat units with Universal arms and Beam components: 6717 (6 seats), 6500S3 (2 beams), 6507-T2 (1 table), 6500A9 (1 connector) and 6500A8 (8 arms)	\$5449
SID507	Sidero arm seat units with Beam components: 6930 (6 seats), 6500S3 (2 beams), 6507-T2 (1 table), 6500A9 (1 connector)	\$6345
VON507	Vion arm seat units with Beam components: 6342 (6 seats), 6500S3 (2 beams), 6507-T2 (1 table), 6500A9 (1 connector)	\$6609

*See next pages for individual model description, dimensions and starting list price.

DUT508 - Shown



Approximate dimensions: 131"W x 78"D

Kit Layout	Description	Total (Grd. 1)
DUT508	Duet armless seat units with Beam components: 6691 (7 seats), 6500S3 (1 Beam), 6500S2 (2 Beams), 6507-T2 (2 Tables), 6500A9 (2 Connector), 6591B (2 Modules)	\$6709
POP508	Popcorn armless seat units with Beam components: 6717 (7 seats), 6500S3 (1 Beam), 6500S2 (2 Beams), 6507-T2 (2 Tables), 6500A9 (2 Connector), 6591B (2 Modules)	\$6982
SID508	Sidero armless seat units with Beam components: 6931 (7 seats), 6500S3 (1 Beam), 6500S2 (2 Beams), 6507-T2 (2 Tables), 6500A9 (2 Connector), 6591B (2 Modules)	\$9019
SON508	Sonic armless seat units with Beam components: 6501 (7 seats), 6500S3 (1 Beam), 6500S2 (2 Beams), 6507-T2 (2 Tables), 6500A9 (2 Connector), 6591B (2 Modules)	\$7549
VON507	Vion armless seat units with Beam components: 6340 (7 seats), 6500S3 (1 Beam), 6500S2 (2 Beams), 6507-T2 (2 Tables), 6500A9 (2 Connector), 6591B (2 Modules)	\$10125

*See next pages for individual model description, dimensions and starting list price.

DESCRIPTION

FEATURES

MODEL#

STANDARD TEXTILE GRADES

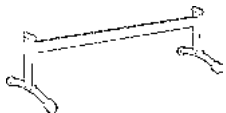

Beam - Accommodates 2 Seats
COM Yardage: N/A
Freight Class: 250
Product Weight (lbs.): 37
Cubic Feet Per Carton: 11 (1 per carton)

Freestanding

	1	2	3	4	5	6	7	8	9	10	11	12
6500S2	\$692	-	-	-	-	-	-	-	-	-	-	-

OVERALL DIMENSIONS			SEAT DIMENSIONS			BACK DIMENSIONS	
W	D	H	W	D	H	W	H

49.5	24	16	-	-	-	-	-
------	----	----	---	---	---	---	---

RTA 00

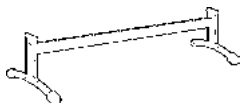

Beam - Accommodates 3 Seats
COM Yardage: N/A
Freight Class: 250
Product Weight (lbs.): 43
Cubic Feet Per Carton: 16 (1 per carton)





Freestanding





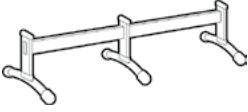

	1	2	3	4	5	6	7	8	9	10	11	12
6500S3	\$799	-	-	-	-	-	-	-	-	-	-	-



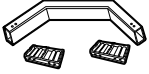



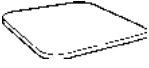

OVERALL DIMENSIONS			SEAT DIMENSIONS			BACK DIMENSIONS	
W	D	H	W	D	H	W	H

74	24	16	-	-	-	-	-
----	----	----	---	---	---	---	---









RTA 00









DESCRIPTION	FEATURES	MODEL#	STANDARD TEXTILE GRADES												
			1	2	3	4	5	6	7	8	9	10	11	12	
 <p>Beam - Accommodates 4 Seats COM Yardage: N/A Freight Class: 250 Product Weight (lbs.): 58 Cubic Feet Per Carton: 22 (1 per carton)</p>	Freestanding	6500S4	\$1115	-	-	-	-	-	-	-	-	-	-	-	-
		OVERALL DIMENSIONS			SEAT DIMENSIONS			BACK DIMENSIONS							
		W	D	H	W	D	H	W	H						
		100	24	16	-	-	-	-	-						
			RTA 00												
 <p>Beam Extender - Accommodates 2 Seats COM Yardage: N/A Freight Class: 85 Product Weight (lbs.): 36 Cubic Feet Per Carton: 10.5 (1 per carton)</p>	Not Freestanding. Includes hardware.	6500A2	\$528	-	-	-	-	-	-	-	-	-	-	-	-
		OVERALL DIMENSIONS			SEAT DIMENSIONS			BACK DIMENSIONS							
		W	D	H	W	D	H	W	H						
		47.5	24	16	-	-	-	-	-						
			RTA 00												
 <p>Beam Extender - Accommodates 3 Seats COM Yardage: N/A Freight Class: 85 Product Weight (lbs.): 43 Cubic Feet Per Carton: 16 (1 per carton)</p>	Not Freestanding. Includes hardware.	6500A3	\$663	-	-	-	-	-	-	-	-	-	-	-	-
		OVERALL DIMENSIONS			SEAT DIMENSIONS			BACK DIMENSIONS							
		W	D	H	W	D	H	W	H						
		72	24	16	-	-	-	-	-						
			RTA 00												
 <p>Beam Extender - Accommodates 4 Seats COM Yardage: N/A Freight Class: 85 Product Weight (lbs.): 58 Cubic Feet Per Carton: 21.75 (1 per carton)</p>	Not Freestanding. Includes hardware.	6500A4	\$994	-	-	-	-	-	-	-	-	-	-	-	-
		OVERALL DIMENSIONS			SEAT DIMENSIONS			BACK DIMENSIONS							
		W	D	H	W	D	H	W	H						
		98	24	16	-	-	-	-	-						
			RTA 00												
 <p>Universal Aluminum Arm w/Pad COM Yardage: N/A Freight Class: 85 Product Weight (lbs.): 3.5 Cubic Feet Per Carton: 0.5 (1 per carton)</p>	Includes hardware.	6500A8	\$149	-	-	-	-	-	-	-	-	-	-	-	-
		OVERALL DIMENSIONS			SEAT DIMENSIONS			BACK DIMENSIONS							
		W	D	H	W	D	H	W	H						
		2.5	10	14	-	-	-	-	-						
			RTA 00												

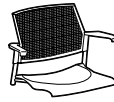

DESCRIPTION	FEATURES	MODEL#	STANDARD TEXTILE GRADES											
			1	2	3	4	5	6	7	8	9	10	11	12
 <p>Corner Connector Beam COM Yardage: N/A Freight Class: 85 Product Weight (lbs.): 9 Cubic Feet Per Carton: 0.07 (1 per carton)</p>	Not Freestanding. Includes hardware.	6500A9	\$289	-	-	-	-	-	-	-	-	-	-	-
		OVERALL DIMENSIONS			SEAT DIMENSIONS			BACK DIMENSIONS						
		W	D	H	W	D	H	W	H					
		1.75	24	3.25	-	-	-	-	-					
			RTA 00											
 <p>Bolt Down Kit COM Yardage: N/A Freight Class: 85 Product Weight (lbs.): 8 Cubic Feet Per Carton: 0.6 (1 per carton)</p>	Set of 4 brackets. Includes hardware.	6500BD	\$137	-	-	-	-	-	-	-	-	-	-	
		OVERALL DIMENSIONS			SEAT DIMENSIONS			BACK DIMENSIONS						
		W	D	H	W	D	H	W	H					
		17.75	17.75	1	-	-	-	-	-					
			RTA 00 											
 <p>Power Module COM Yardage: N/A Freight Class: 85 Product Weight (lbs.): 3.2 Cubic Feet Per Carton: 0.5 (1 per carton)</p>	Under mount, 10 ft. cord. Black only.	6591B	\$558	-	-	-	-	-	-	-	-	-	-	
		OVERALL DIMENSIONS			SEAT DIMENSIONS			BACK DIMENSIONS						
		W	D	H	W	D	H	W	H					
		21	21	1	-	-	-	-	-					
			RTA 00											
 <p>End Table Top COM Yardage: N/A Freight Class: 85 Product Weight (lbs.): 8 Cubic Feet Per Carton: 0.6 (1 per carton)</p>	Includes hardware. Use on beams.	6507	\$312	-	-	-	-	-	-	-	-	-	-	
		OVERALL DIMENSIONS			SEAT DIMENSIONS			BACK DIMENSIONS						
		W	D	H	W	D	H	W	H					
		17.75	17.75	1	-	-	-	-	-					
			RTA 00 											
 <p>Square Corner Table Top COM Yardage: N/A Freight Class: 85 Product Weight (lbs.): 14 Cubic Feet Per Carton: 1.9 (1 per carton)</p>	Includes hardware. Use on beams.	6507-T1	370	-	-	-	-	-	-	-	-	-	-	
		OVERALL DIMENSIONS			SEAT DIMENSIONS			BACK DIMENSIONS						
		W	D	H	W	D	H	W	H					
		21	21	1	-	-	-	-	-					
			RTA 00											

DESCRIPTION	FEATURES	MODEL#	STANDARD TEXTILE GRADES											
			1	2	3	4	5	6	7	8	9	10	11	12
 <p>Radius Corner Table Top COM Yardage: N/A Freight Class: 85 Product Weight (lbs.): 14 Cubic Feet Per Carton: 1.9 (1 per carton)</p>	Includes hardware. Use on beams.	6507-T2	\$408	-	-	-	-	-	-	-	-	-	-	
			OVERALL DIMENSIONS			SEAT DIMENSIONS			BACK DIMENSIONS					
			W	D	H	W	D	H	W	H				
			21	21	1	-	-	-	-	-				
			RTA 00											
 <p>Coffee Table COM Yardage: N/A Freight Class: 85 Product Weight (lbs.): 52 Cubic Feet Per Carton: 12.25 (1 per carton)</p>		6507-CT	\$902	-	-	-	-	-	-	-	-	-	-	
			OVERALL DIMENSIONS			SEAT DIMENSIONS			BACK DIMENSIONS					
			W	D	H	W	D	H	W	H				
			24	42	17.5	-	-	-	-	-				
			RTA 00											
 <p>Seat Unit w/Arms COM Yardage: N/A Freight Class: 250 Product Weight (lbs.): 19 Cubic Feet Per Carton: 4.88 (2 per carton)</p>	Duet Use with beams.	6690	\$392	-	-	-	-	-	-	-	-	-	-	
			OVERALL DIMENSIONS			SEAT DIMENSIONS			BACK DIMENSIONS					
			W	D	H	W	D	H	W	H				
			25.5	21	18	18	17.5	-	18	16				
			RTA 00 											
 <p>Armless Seat Unit COM Yardage: N/A Freight Class: 150 Product Weight (lbs.): 18 Cubic Feet Per Carton: 3.25 (2 per carton)</p>	Duet Use with beams.	6691	\$288	-	-	-	-	-	-	-	-	-	-	
			OVERALL DIMENSIONS			SEAT DIMENSIONS			BACK DIMENSIONS					
			W	D	H	W	D	H	W	H				
			18	21	18	18	17.5	-	18	16				
			RTA 00 											
 <p>Seat Unit w/Arms COM Yardage: 0.75 Freight Class: 250 Product Weight (lbs.): 19 Cubic Feet Per Carton: 4.88 (2 per carton)</p>	Duet Upholstered Seat. Use with beams.	6692	\$480	\$515	\$541	\$579	\$635	\$652	\$701	\$791	\$837	\$921	\$1037	\$1179
			OVERALL DIMENSIONS			SEAT DIMENSIONS			BACK DIMENSIONS					
			W	D	H	W	D	H	W	H				
			25.5	21	18	18	17.5	-	18	16				
			RTA 00 											

DESCRIPTION	FEATURES	MODEL#	STANDARD TEXTILE GRADES											
			1	2	3	4	5	6	7	8	9	10	11	12
 Armless Seat Unit COM Yardage: 0.75 Freight Class: 150 Product Weight (lbs.): 19 Cubic Feet Per Carton: 3.25 (2 per carton)	Duet Upholstered Seat. Use with beams.	6693	\$373	\$406	\$432	\$471	\$525	\$544	\$592	\$683	\$729	\$812	\$926	\$1070
			OVERALL DIMENSIONS			SEAT DIMENSIONS			BACK DIMENSIONS					
			W	D	H	W	D	H	W	H				
			18	21	18	18	17.5	-	18	16				
			RTA 00											
 Seat Unit w/Arms COM Yardage: 0.75 Freight Class: 150 Product Weight (lbs.): 20 Cubic Feet Per Carton: 4.88 (2 per carton)	Duet Upholstered Seat and Back. Use with beams.	6697	\$509	\$542	\$568	\$607	\$660	\$680	\$728	\$819	\$865	\$948	\$1062	\$1206
			OVERALL DIMENSIONS			SEAT DIMENSIONS			BACK DIMENSIONS					
			W	D	H	W	D	H	W	H				
			25.5	21	18	18	17.5	-	18	16				
			RTA 00											
 Armless Seat Unit COM Yardage: 0.75 Freight Class: 150 Product Weight (lbs.): 19 Cubic Feet Per Carton: 3.25 (2 per carton)	Duet Upholstered Seat and Back. Use with beams.	6698	\$415	\$448	\$475	\$513	\$567	\$586	\$635	\$726	\$771	\$855	\$968	\$1113
			OVERALL DIMENSIONS			SEAT DIMENSIONS			BACK DIMENSIONS					
			W	D	H	W	D	H	W	H				
			18	21	18	18	17.5	-	18	16				
			RTA 00											
 Armless Seat Unit COM Yardage: N/A Freight Class: 150 Product Weight (lbs.): 17 Cubic Feet Per Carton: 6.5 (2 per carton)	Popcorn Polypropylene Seat and Back. use with beam	6717	327	-	-	-	-	-	-	-	-	-	-	-
			OVERALL DIMENSIONS			SEAT DIMENSIONS			BACK DIMENSIONS					
			W	D	H	W	D	H	W	H				
			20	21	18	18	18	-	19.5	16				
			RTA 00											
 Armless Seat Unit COM Yardage: 0.75 Freight Class: 150 Product Weight (lbs.): 18 Cubic Feet Per Carton: 6.5 (2 per carton)	Popcorn Upholstered Seat and Polypropylene Back. Use with beam.	6719	427	455	476	509	553	572	614	679	727	784	897	1019
			OVERALL DIMENSIONS			SEAT DIMENSIONS			BACK DIMENSIONS					
			W	D	H	W	D	H	W	H				
			20	21	18	18	18	-	19.5	16				
			RTA 00											

DESCRIPTION	FEATURES	MODEL#	STANDARD TEXTILE GRADES											
			1	2	3	4	5	6	7	8	9	10	11	12
 <p>Seat Unit w/Arms COM Yardage: 1.25 Freight Class: 300 Product Weight (lbs.): 20 Cubic Feet Per Carton: 9.75</p>	<p>Sidero Upholstered Seat and Back. Use with beam.</p>	6930	675	719	756	808	883	917	985	1092	1175	1267	1455	1656
		OVERALL DIMENSIONS			SEAT DIMENSIONS			BACK DIMENSIONS						
		W	D	H	W	D	H	W	H					
		25.5	23.5	19	19.5	18	-	19	15.5					
			RTA 00											
 <p>Armless Seat Unit COM Yardage: 1.25 Freight Class: 300 Product Weight (lbs.): 18 Cubic Feet Per Carton: 9.75</p>	<p>Sidero Upholstered Seat and Back. Use with beam.</p>	6501	618	663	700	752	826	861	928	1035	1119	1211	1398	1600
		OVERALL DIMENSIONS			SEAT DIMENSIONS			BACK DIMENSIONS						
		W	D	H	W	D	H	W	H					
		21	23.5	19	19.5	18	-	19	15.5					
			RTA 00											
 <p>Armless Seat Unit COM Yardage: N/A Freight Class: 250 Product Weight (lbs.): 12 Cubic Feet Per Carton: 3.25 (2 per carton)</p>	<p>Sonic Polypropylene Seat and Back. Use with Beam.</p>	6501	\$408	-	-	-	-	-	-	-	-	-	-	-
		OVERALL DIMENSIONS			SEAT DIMENSIONS			BACK DIMENSIONS						
		W	D	H	W	D	H	W	H					
		20	21.5	17	17	16	-	17	15					
			RTA 00											
 <p>Armless Seat Unit COM Yardage: 0.75 Freight Class: 250 Product Weight (lbs.): 12 Cubic Feet Per Carton: 3.25 (2 per carton)</p>	<p>Sonic Upholstered Seat and Polypropylene Back. Use with Beam.</p>	6502	\$460	\$488	\$506	\$537	\$582	\$595	\$634	\$705	\$740	\$806	\$897	\$1011
		OVERALL DIMENSIONS			SEAT DIMENSIONS			BACK DIMENSIONS						
		W	D	H	W	D	H	W	H					
		20	22	17	17	16	-	17	15					
			RTA 00											
 <p>Armless Seat Unit COM Yardage: 0.75 Freight Class: 150 Product Weight (lbs.): 13 Cubic Feet Per Carton: 3.25 (2 per carton)</p>	<p>Sonic Upholstered Seat and Back. Use with Beam.</p>	6503	\$509	\$535	\$555	\$586	\$629	\$645	\$681	\$754	\$789	\$855	\$947	\$1059
		OVERALL DIMENSIONS			SEAT DIMENSIONS			BACK DIMENSIONS						
		W	D	H	W	D	H	W	H					
		20	22	17	17	16	-	17	15					
			RTA 00											

DESCRIPTION	FEATURES	MODEL#	STANDARD TEXTILE GRADES												
			1	2	3	4	5	6	7	8	9	10	11	12	
 6504	 6504MB (Mesh Back)	Sonic Polypropylene Seat. Use with Beam.	\$480	-	-	-	-	-	-	-	-	-	-		
			\$520	-	-	-	-	-	-	-	-	-	-	-	
Seat Unit w/Arms COM Yardage: N/A Freight Class: 150 Product Weight (lbs.): 13 Cubic Feet Per Carton: 3.25 (2 per carton)			OVERALL DIMENSIONS W D H			SEAT DIMENSIONS W D H			BACK DIMENSIONS W H						
			23	21.5	17	17	16	-	17	15					
			RTA 00												
 6505	 6505MB (Mesh Back)	Sonic Upholstered Seat. Use with Beam.	\$533	\$558	\$579	\$609	\$653	\$667	\$706	\$776	\$811	\$878	\$970	\$1083	
			\$665	\$695	\$714	\$747	\$791	\$810	\$852	\$917	\$965	\$1022	\$1135	\$1257	
Seat Unit w/Arms COM Yardage: 0.75 Freight Class: 22. Product Weight (lbs.): 13 Cubic Feet Per Carton: 3.25 (2 per carton)			OVERALL DIMENSIONS W D H			SEAT DIMENSIONS W D H			BACK DIMENSIONS W H						
			23	22	17	17	16	-	17	15					
			RTA 00												
 6506			\$582	\$610	\$630	\$661	\$704	\$719	\$756	\$828	\$864	\$930	\$1022	\$1133	
			\$661	\$690	\$710	\$741	\$784	\$799	\$836	\$908	\$944	\$1010	\$1102	\$1213	
Seat Unit w/Arms COM Yardage: 0.75 Freight Class: 150 Product Weight (lbs.): 14 Cubic Feet Per Carton: 3.25 (2 per carton)			OVERALL DIMENSIONS W D H			SEAT DIMENSIONS W D H			BACK DIMENSIONS W H						
			23	22	17	17	16	-	17	15					
			RTA 00												
 6340			\$776	\$815	\$842	\$885	\$944	\$972	\$1025	\$1111	\$1177	\$1250	\$1402	\$1565	
			\$944	\$983	\$1010	\$1053	\$1112	\$1140	\$1193	\$1265	\$1347	\$1430	\$1513	\$1687	
Armless Seat Unit COM Yardage: 1 Freight Class: 250 Product Weight (lbs.): 20 Cubic Feet Per Carton: 7.25			OVERALL DIMENSIONS W D H			SEAT DIMENSIONS W D H			BACK DIMENSIONS W H						
			21	23.5	20.5	17.5	18	-	19	17					
			RTA 00												
 6341			\$905	\$950	\$986	\$1039	\$1113	\$1147	\$1215	\$1323	\$1406	\$1498	\$1685	\$1887	
			\$1073	\$1118	\$1154	\$1207	\$1281	\$1315	\$1383	\$1475	\$1558	\$1650	\$1837	\$2040	
Armless Seat Unit COM Yardage: 1 Freight Class: 250 Product Weight (lbs.): 20 Cubic Feet Per Carton: 7.25			OVERALL DIMENSIONS W D H			SEAT DIMENSIONS W D H			BACK DIMENSIONS W H						
			21	23.5	20.5	17.5	18	-	19	17					
			RTA 00												

DESCRIPTION	FEATURES	MODEL#	STANDARD TEXTILE GRADES											
			1	2	3	4	5	6	7	8	9	10	11	12
 <p>Seat Unit w/Arms COM Yardage: 1 Freight Class: 250 Product Weight (lbs.): 21 Cubic Feet Per Carton: 9.75</p>	<p>Vion Upholstered Seat and Mesh Back. Use with beam.</p>	<p>6342</p>	\$719	\$756	\$785	\$827	\$885	\$912	\$968	\$1053	\$1118	\$1192	\$1344	\$1506
			<p>OVERALL DIMENSIONS</p>			<p>SEAT DIMENSIONS</p>			<p>BACK DIMENSIONS</p>					
			W	D	H	W	D	H	W	H				
			25.5	23.5	20.5	17.5	18	-	19	17				
			<p>RTA 00</p>											
 <p>Seat Unit w/Arms COM Yardage: 1 Freight Class: 250 Product Weight (lbs.): 21 Cubic Feet Per Carton: 9.75</p>	<p>Vion Upholstered Seat and Back. Use with beam.</p>	<p>6343</p>	\$832	\$877	\$913	\$965	\$1039	\$1072	\$1141	\$1247	\$1330	\$1422	\$1612	\$1813
			<p>OVERALL DIMENSIONS</p>			<p>SEAT DIMENSIONS</p>			<p>BACK DIMENSIONS</p>					
			W	D	H	W	D	H	W	H				
			25.5	23.5	20.5	17.5	18	-	19	17				
			<p>RTA 00</p>											

CAPRICE™



model 3365 (TUN)



model 3365C (TUN)

STANDARD FEATURES

- Modern light scale guest seating.
- Durable molded armcaps in Black Only.
- Frame is standard in a Tungsten colored finish (TUN).
- Standard with Black “bullet style” glides.
- Non-castered models can be joined together using ganging clamp model 6522.
- **C1** dual wheel carpet casters are standard on models 3365C and 3365CLM.
- Does not stack.
- Check textile availability prior to specifying upholstery material.





OPTIONAL FEATURES



- Optional steel cushioned glides (**B**) are available. Add \$31. Please specify.
- For hard surface flooring casters, specify **C9R**. Add \$66.

Frame finish

- (CHR) Charcoal
- (TBL) Black
- (TBZ) Buzz Blue
- (TCC) Cactus
- (TCR) Carrot
- (TDJ) Dijon
- (TDW) Designer White
- (TEG) Eggplant
- (TFO) Fog
- (TFR) Frost
- (TIN) Ink
- (TIV) Cloud
- (TKA) Kalua
- (TLA) Latte
- (TOA) Toast
- (TSH) Shadow
- (TSN) Sand
- (TSR) Scarlet
- (TTU) Tungsten
- (ACO) Antique Copper. Add **\$320**
- (BCH) Brushed Chrome. Add **\$210**
- (CHM) Chrome. **Upcharge varies.**
- (SBR) Satin Brass. Add **\$320**

- A Chrome (**CHM**) finish is also available. Add \$75 for side chairs. Add \$125 for counter and bar stools.

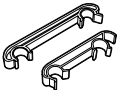
DESCRIPTION	FEATURES	MODEL#	STANDARD TEXTILE GRADES													
			1	2	3	4	5	6	7	8	9	10	11	12		
 <p>Armchair 4 Legged COM Yardage: 1.25 Freight Class: 300 Product Weight (lbs.): 22 Cubic Feet Per Carton: 14.5</p>	Does not stack.	3365	\$824	\$866	\$901	\$951	\$1020	\$1047	\$1109	\$1226	\$1283	\$1392	\$1540	\$1723		
			OVERALL DIMENSIONS			SEAT DIMENSIONS			BACK DIMENSIONS							
			W	D	H	W	D	H	W	H						
			25	24	31.5	19.5	19.5	18.5	18	13						
			RTA 00													
 <p>Armchair 4 Legged w/casters COM Yardage: 1.25 Freight Class: 300 Product Weight (lbs.): 23 Cubic Feet Per Carton: 14.5</p>	Does not stack.	3365C	\$958	\$1002	\$1035	\$1089	\$1156	\$1183	\$1247	\$1367	\$1424	\$1534	\$1685	\$1874		
			OVERALL DIMENSIONS			SEAT DIMENSIONS			BACK DIMENSIONS							
			W	D	H	W	D	H	W	H						
			25	23.5	32.5	19.5	18.5	18	18	14.5						
			RTA 00													
 <p>Barstool - 4 Legged COM Yardage: 1.25 Freight Class: 300 Product Weight (lbs.): 32 Cubic Feet Per Carton: 20</p>	Does not stack.	3369	\$1041	\$1085	\$1118	\$1170	\$1242	\$1268	\$1330	\$1451	\$1506	\$1618	\$1767	\$1958		
			OVERALL DIMENSIONS			SEAT DIMENSIONS			BACK DIMENSIONS							
			W	D	H	W	D	H	W	H						
			25	26.5	45.5	19.5	19.5	30.5	18	13						
			RTA 00													

DESCRIPTION	FEATURES	MODEL#	STANDARD TEXTILE GRADES											
			1	2	3	4	5	6	7	8	9	10	11	12
 <p>Ganging Brackets COM Yardage: N/A Freight Class: 70 Product Weight (lbs.): 0.16 Cubic Feet Per Carton: 1 (25 per Carton)</p>		6522	\$32	-	-	-	-	-	-	-	-	-	-	-
	OVERALL DIMENSIONS			SEAT DIMENSIONS			BACK DIMENSIONS							
	W	D	H	W	D	H	W	H						
	00.87	7.75	1.5	-	-	-	-	-						
														

CHAP™



Wood Back Armchair model 1010



Upholstered Back Armchair model 1015



Upholstered Round Back Armchair model 1002





Wood Round Back Armchair model 1003



STANDARD FEATURES

- Chap offers mid-century modern styling in a finely crafted beechwood armchair series.
- Upholstered, wood and open frame backs available.
- Straight back models are available with exposed wood or upholstered front seat rails.
- Custom stain matching is not available on models 1002 and 1003.
- Check textile availability prior to specifying upholstery material.
- Does not stack.

OPTIONAL FEATURES

- Round back models 1002 and 1003: frame is available in select finishes only (*).
- **Frame finish**
 (AAM) Absolute*
 (BKM) Black*
 (ACM) Cherry*
 (EOM) English Oak
 (ECM) Espresso Cafe*
 (TFM) Fruitwood
 (HGM) Gray
 (AHM) Honey
 (TMM) Mahogany*
 (AVM) Maple
 (MWM) Medium Walnut*
 (NLW) Natural Walnut
 (ASM) Night*
 (NMM) Noce Medio*
 (SKM) Shaker Cherry*
 (TWM) Walnut*
 (WTM) WC Cream*
 (WHM) White*
 (WCM) Winter Cherry
 Please Specify.
 *Round back models 1002 and 1003 available in these finishes only.

DESCRIPTION	FEATURES	MODEL#	STANDARD FABRIC GRADES													
			1	2	3	4	5	6	7	8	9	10	11	12		
 Wood Back Armchair w/ Upholstered Seat Front COM Yardage: 1 Freight Class: 250 Product Weight (lbs.): 33 Cubic Feet Per Carton: 15.75	Does not stack. Ergonomic Features M, N	1010	1254	1288	1313	1349	1401	1425	1472	1547	1604	1669	1803	1943		
		OVERALL DIMENSIONS			SEAT DIMENSIONS			BACK DIMENSIONS								
		W	D	H	W	D	H	W	H							
		25.5	25	31	21	20	18	20.5	13.5							
 Upholstered Back Armchair w/ Upholstered Seat Front COM Yardage: 1.5 Freight Class: 250 Product Weight (lbs.): 33 Cubic Feet Per Carton: 15.75	Does not stack. Ergonomic Features M, N	1011	1260	1316	1358	1422	1511	1553	1634	1763	1863	1974	2202	2438		
		OVERALL DIMENSIONS			SEAT DIMENSIONS			BACK DIMENSIONS								
		W	D	H	W	D	H	W	H							
		25.5	25	31.5	21	20	18	20.5	13.5							
 Wood Back Armchair w/ Wood Front Rail COM Yardage: 1 Freight Class: 250 Product Weight (lbs.): 33 Cubic Feet Per Carton: 15.75	Does not stack. Ergonomic Features M, N	1014	1254	1288	1313	1349	1401	1425	1472	1547	1604	1669	1803	1943		
		OVERALL DIMENSIONS			SEAT DIMENSIONS			BACK DIMENSIONS								
		W	D	H	W	D	H	W	H							
		25.5	25	31	21	20	18	20.5	13.5							

DESCRIPTION	FEATURES	MODEL#	STANDARD FABRIC GRADES													
			1	2	3	4	5	6	7	8	9	10	11	12		
 <p>Upholstered Back Armchair w/ Wood Front Rail COM Yardage: 1.5 Freight Class: 250 Product Weight (lbs.): 33 Cubic Feet Per Carton: 15.75</p>	<p>Does not stack.</p> <p>Ergonomic Features M, N</p>	1015	1260	1316	1358	1422	1511	1553	1634	1763	1863	1974	2202	2438		
			OVERALL DIMENSIONS			SEAT DIMENSIONS			BACK DIMENSIONS							
			W	D	H	W	D	H	W	H						
			25.5	25	31.5	21	20	18	20.5	13.5						
			RTA 00													
 <p>Upholstered Round Back Armchair w/ Upholstered Seat Front COM Yardage: 1.5 Freight Class: 300 Product Weight (lbs.): 26 Cubic Feet Per Carton: 13.25</p>	<p>Does not stack.</p> <p>Ergonomic Features M, N</p>	1002	1418	1464	1499	1552	1625	1660	1727	1833	1915	2006	2194	2394		
			OVERALL DIMENSIONS			SEAT DIMENSIONS			BACK DIMENSIONS							
			W	D	H	W	D	H	W	H						
			24.5	24.5	30	22	20	18	20	12.5						
			RTA 00													
 <p>Wood Round Back Armchair w/ Upholstered Seat Front COM Yardage: 1 Freight Class: 300 Product Weight (lbs.): 25 Cubic Feet Per Carton: 13.25</p>	<p>Does not stack.</p> <p>Ergonomic Features M, N</p>	1003	1254	1288	1313	1349	1401	1425	1472	1547	1604	1669	1803	1943		
			OVERALL DIMENSIONS			SEAT DIMENSIONS			BACK DIMENSIONS							
			W	D	H	W	D	H	W	H						
			24.5	24.5	30	22	20	18	20	12.5						
			RTA 00													

COMET™



model 2171 (BK)



model 2172 (TUN)



model 2174 (TUN)



model 2183 (BK)

STANDARD FEATURES

- Reinforced models incorporate welded corner gussets for additional strength and support.
- Heavy Duty models 2173 and 2174 use Ultracell seat foam for lasting comfort.
- Models 2171 and 2172 stack 5 high on floor or 8 high on dolly 2125WS for easy storage.
- **WS** models have a wall saver frame design.
- Models with corner gussets are not recommended for stacking due to their heavy duty design.
- Stacked chairs may leave frame impressions in chair(s) below.
- Two ganging plates are packed at no charge with each table to attach to two chairs only. Order separately for additional chair-to-chair ganging.
- All Specifications and Pricing are for 1 chair.

OPTIONAL FEATURES

- Optional steel cushioned glides (**B**) are available on models 2171, 2172, 2173, 2174, 2183, and 2184. Add \$31. Please specify.
- **Frame finish**

(TBL) Black	(TBZ) Buzz Blue
(TCC) Cactus	(TCR) Carrot
(TDJ) Dijon	(TDW) Designer White
(TEG) Eggplant	(TFO) Fog
(TFR) Frost	(TIN) Ink
(TIV) Cloud	(TKA) Kalua
(TLA) Latte	(TMO) Mocha
(TOA) Toast	(TNE) Nevada
(TSH) Shadow	(TSN) Sand
(TSR) Scarlet	(TTU) Tungsten
- Check textile availability prior to specifying upholstery material.

DESCRIPTION FEATURES MODEL# STANDARD TEXTILE GRADES



2171



2171WS

Nesting Chair

COM Yardage: 1
 Freight Class: 250
 Product Weight (lbs.): 15.33
 Cubic Feet Per Carton: 3.92 (3 per carton)

Stacks 5 high on floor.
 Stacks 8 high on dolly.
 Ergonomic Features:
 M, N

MODEL#	STANDARD TEXTILE GRADES																								
	1	2	3	4	5	6	7	8	9	10	11	12													
2171	\$331	\$366	\$393	\$430	\$487	\$512	\$556	\$651	\$697	\$787	\$902	\$1052													
2171WS Wall Saver	\$381	\$420	\$444	\$486	\$544	\$562	\$614	\$707	\$756	\$845	\$966	\$1116													
OVERALL DIMENSIONS			SEAT DIMENSIONS			BACK DIMENSIONS																			
W	D	H	W	D	H	W	H																		
0	0	0	18	17	18.5	17.5	15																		
<table border="0"> <tr> <td></td> <td></td> <td colspan="11"></td> </tr> </table>																									

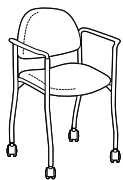

Reinforced Armchair w/casters

COM Yardage: 1
 Freight Class: 250
 Product Weight (lbs.): 46
 Cubic Feet Per Carton: 11.75 (1 per carton)

Does not stack.
 Ergonomic Features:
 M, N

MODEL#	STANDARD TEXTILE GRADES																								
	1	2	3	4	5	6	7	8	9	10	11	12													
2171C	\$497	\$532	\$558	\$594	\$649	\$670	\$715	\$807	\$845	\$932	\$1043	\$1185													
OVERALL DIMENSIONS			SEAT DIMENSIONS			BACK DIMENSIONS																			
W	D	H	W	D	H	W	H																		
23	22	32.5	18	17.5	18.5	17	14																		
<table border="0"> <tr> <td></td> <td></td> <td colspan="11"></td> </tr> </table>																									

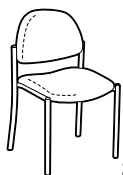

2172













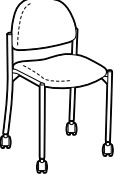

2172WS







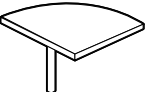

Armless Stacking Chair

COM Yardage: 1
 Freight Class: 250
 Product Weight (lbs.): 14.33
 Cubic Feet Per Carton: 3.83 (3 per carton)

Stacks 5 high on floor.
 Ergonomic Features:
 M, N

MODEL#	STANDARD TEXTILE GRADES																								
	1	2	3	4	5	6	7	8	9	10	11	12													
2172	\$250	\$284	\$311	\$350	\$408	\$425	\$476	\$571	\$615	\$700	\$821	\$969													
2172WS Wall Saver	\$302	\$341	\$366	\$406	\$464	\$484	\$536	\$630	\$676	\$766	\$887	\$1036													
OVERALL DIMENSIONS			SEAT DIMENSIONS			BACK DIMENSIONS																			
W	D	H	W	D	H	W	H																		
0	0	0	18	17.5	18.5	17.5	14																		
<table border="0"> <tr> <td></td> <td></td> <td colspan="11"></td> </tr> </table>																									

DESCRIPTION	FEATURES	MODEL#	STANDARD TEXTILE GRADES											
			1	2	3	4	5	6	7	8	9	10	11	12
 <p>Reinforced Armless Chair w/casters COM Yardage: 1 Freight Class: 250 Product Weight (lbs.): 14.33 Cubic Feet Per Carton: 4.5 (3 per carton)</p>	<p>Does not stack. Ergonomic Features: M, N</p>	2172C	\$409	\$443	\$468	\$507	\$557	\$578	\$625	\$716	\$759	\$841	\$954	\$1094
			OVERALL DIMENSIONS			SEAT DIMENSIONS			BACK DIMENSIONS					
			W	D	H	W	D	H	W	H				
			19	22	32.5	17.5	17.5	14	17	15				
			RTA 00											
  <p>2173 2173WS</p> <p>Reinforced Armchair COM Yardage: 1 Freight Class: 250 Product Weight (lbs.): 15.33 Cubic Feet Per Carton: 3.92 (3 per carton)</p>	<p>Does not stack. Ergonomic Features: M, N</p>	2173	\$461	\$495	\$522	\$560	\$617	\$641	\$687	\$783	\$829	\$915	\$1034	\$1182
			2173WS Wall Saver	OVERALL DIMENSIONS			SEAT DIMENSIONS			BACK DIMENSIONS				
				W	D	H	W	D	H	W	H			
				23	22	32	18	17.5	18.5	17.5	14			
			RTA 00											
  <p>2174 2174WS</p> <p>Reinforced Armless Chair COM Yardage: 1 Freight Class: 250 Product Weight (lbs.): 14.33 Cubic Feet Per Carton: 3.83 (3 per carton)</p>	<p>Does not stack. Ergonomic Features: M, N</p>	2174	\$376	\$413	\$438	\$476	\$531	\$554	\$603	\$698	\$741	\$830	\$949	\$1093
			2174WS Wall Saver	OVERALL DIMENSIONS			SEAT DIMENSIONS			BACK DIMENSIONS				
				W	D	H	W	D	H	W	H			
				20	22	32	18	17	18.5	17.5	13.5			
			RTA 00											
 <p>Ganging Plate COM Yardage: N/A Freight Class: 70 Product Weight (lbs.): 2.1 Cubic Feet Per Carton: 0.1</p>		2176	\$79	-	-	-	-	-	-	-	-	-	-	-
	OVERALL DIMENSIONS			SEAT DIMENSIONS			BACK DIMENSIONS							
	W		D	H	W	D	H	W	H					
	13.25		4.75	00.06	-	-	-	-	-					
			RTA 00											
 <p>Corner Table Radius COM Yardage: N/A Freight Class: 70 Product Weight (lbs.): 23 Cubic Feet Per Carton: 1.3</p>		2178 Radius	\$301	-	-	-	-	-	-	-	-	-	-	
	OVERALL DIMENSIONS			SEAT DIMENSIONS			BACK DIMENSIONS							
	W		D	H	W	D	H	W	H					
	18		18	17.5	-	-	-	-	-					
			RTA 8											

DESCRIPTION	FEATURES	MODEL#	STANDARD TEXTILE GRADES													
			1	2	3	4	5	6	7	8	9	10	11	12		
 <p>Corner Table Crescent COM Yardage: N/A Freight Class: 85 Product Weight (lbs.): 43 Cubic Feet Per Carton: 3.5</p>		2179 Crescent	\$421	-	-	-	-	-	-	-	-	-	-	-	-	
			OVERALL DIMENSIONS			SEAT DIMENSIONS			BACK DIMENSIONS							
			W	D	H	W	D	H	W	H						
			0	0	0	-	-	-	-	-						
			RTA 6													
 <p>Ganging Clamp COM Yardage: N/A Freight Class: 70 Product Weight (lbs.): 0.2 Cubic Feet Per Carton: 0.04</p>		2180	\$32	-	-	-	-	-	-	-	-	-	-	-	-	
			OVERALL DIMENSIONS			SEAT DIMENSIONS			BACK DIMENSIONS							
			W	D	H	W	D	H	W	H						
			00.87	7.75	1.5	-	-	-	-	-						
			RTA 00													
 <p>Reinforced Armchair Square Back COM Yardage: 1 Freight Class: 250 Product Weight (lbs.): 15.33 Cubic Feet Per Carton: 4.17 (3 per carton)</p> <p>Does not stack. Ergonomic Features: M, N</p>		2183	\$396	\$431	\$458	\$496	\$554	\$577	\$622	\$719	\$764	\$853	\$969	\$1118		
			OVERALL DIMENSIONS			SEAT DIMENSIONS			BACK DIMENSIONS							
			W	D	H	W	D	H	W	H						
			23	20	32	18	17.5	18.5	18	13.5						
			RTA 00													
 <p>Reinforced Armless Chair Square Back COM Yardage: 1 Freight Class: 250 Product Weight (lbs.): 14.33 Cubic Feet Per Carton: 4.17 (3 per carton)</p> <p>Does not stack. Ergonomic Features: M, N</p>		2184	\$312	\$347	\$374	\$413	\$470	\$487	\$541	\$633	\$677	\$765	\$883	\$1030		
			OVERALL DIMENSIONS			SEAT DIMENSIONS			BACK DIMENSIONS							
			W	D	H	W	D	H	W	H						
			19.5	20	32	18	17.5	18.5	18	13.5						
			RTA 00													

DIPLOMAT





model 2105

STANDARD FEATURES

- A contoured seat and back are accented by wood arms providing comfort and classic styling.
- For complementary task chairs see page 42.
- Models 2105 and 2108 can be joined together using model 6526 ganging clamp.
- Does not stack.
- When upholstered in Leather, models will be in all Leather.
- Check textile availability prior to specifying upholstery material.

OPTIONAL FEATURES

- Frames are standard in a Black (TBL), Tungsten (TTU), or (TSH) Shadow frame finish at no upcharge and Chrome (CHM) frame finish, please add \$59.
- Wood capped arms are available in Absolute (AAM), Black (BKM), Cherry (ACM), Espresso Cafe (ECM), English Oak (EOM), Fruitwood (TFM), Gray (HGM), Honey (AHM), Mahogany (TMM), Maple (AVM), Medium Walnut (MWM), Natural Walnut (NLW), Night (ASM), Noce Biondo (NBM), Noce Grigio (NGM), Noce Leggero (NEM), Noce Medio (NMM), Shaker Cherry (SKM), Walnut (TWM), WC Cream (WTM), White (WHM) and Winter Cherry (WCM). Please Specify. Genuine maple faced veneers and solids are used.
- Optional steel cushioned glides (B) on model 2105. Add \$31. Please specify.

DESCRIPTION	FEATURES	MODEL#	STANDARD TEXTILE GRADES													
			1	2	3	4	5	6	7	8	9	10	11	12		
 <p>Armchair Wood caps arms COM Yardage: 1.25 Freight Class: 250 Product Weight (lbs.): 25 Cubic Feet Per Carton: 11.75</p>	<p>Does not stack.</p> <p>Ergonomic Features: M, N</p>	<p>2105</p>	\$700	\$743	\$773	\$820	\$890	\$916	\$974	\$1090	\$1143	\$1249	\$1394	\$1572		
			OVERALL DIMENSIONS			SEAT DIMENSIONS			BACK DIMENSIONS							
			W	D	H	W	D	H	W	H						
			24	22	34.5	20.5	17	18.5	20.5	16						
			RTA 00													
 <p>Armless Side Chair COM Yardage: 1.25 Freight Class: 300 Product Weight (lbs.): 22 Cubic Feet Per Carton: 11.75</p>	<p>Does not stack.</p> <p>Ergonomic Features: M, N</p>	<p>2108</p>	\$496	\$539	\$572	\$625	\$696	\$721	\$786	\$905	\$963	\$1072	\$1224	\$1412		
			OVERALL DIMENSIONS			SEAT DIMENSIONS			BACK DIMENSIONS							
			W	D	H	W	D	H	W	H						
			21.5	22	34.5	20.5	17	18.5	20.5	16						
			RTA 00													
 <p>Armless Barstool COM Yardage: 1.25 Freight Class: 250 Product Weight (lbs.): 30 Cubic Feet Per Carton: 14.75</p>	<p>Does not stack.</p> <p>Ergonomic Features: M, N</p>	<p>2109</p>	\$715	\$757	\$792	\$842	\$915	\$939	\$1005	\$1124	\$1181	\$1291	\$1442	\$1629		
			OVERALL DIMENSIONS			SEAT DIMENSIONS			BACK DIMENSIONS							
			W	D	H	W	D	H	W	H						
			21	23.5	44.5	20	17	28	20.5	17.5						
			RTA 00													

DUET™



model 6620



model 6621G



model 6627



model 6621TR



model 6632



model 6720PB



model 6720



model 6692 (2 units) on 6500S2 (Beam)

STANDARD FEATURES

- Unique high density seating that is both comfortable and durable.
- Tablet arms are extremely rugged and meets ANSI-BIFMA testing requirements. Tablet hinges up to allow ease of egress. Tablet slides forward and back to accommodate any body size comfortably. Tablet models do not stack.
- Standard tablet (D8) size is 18"D x 14 1/2"W and is made of black polymer. Tablets are attached at the left or right (as seated). Tablet arms are not available on stools. Tablet models do not stack.
- All sled-base models have a wall saver frame design with rear legs contacting the wall first leaving clearance between the seat back and wall.
- Armless "G" models feature a patented interlocking feature that allows chairs to be ganged together in rows.
- Model 6626 ganging clamp set is available for use on all armchairs and standard armless models. These brackets snap on the front and rear of the sled base allowing these models to connect together in rows. In Black finish only.
- Clear polycarbonate glides (CG) are standard and suitable for carpet, rubber or concrete flooring.
- Weight capacity for this series is 300 lbs.
- Dual wheel carpet casters (C1) are standard on task chairs.
- Duet beam seating consists of upper seat units (models 6690, 6691, 6692, 6693, 6697 and 6698) including mounting brackets and all hardware necessary for attachment to beam.
- For all beam components, tables and a complete list of available upper seat units, see Beam Seating series.
- **Specifications and pricing are for 1 chair.**
- Pedestal base models provide fixed location seating for use in auditoriums, classrooms, jury boxes, public venues and more. The base must be mounted to the floor (mounting hardware not included). See Pedestal Base Installation Guide for details.
- Check textile availability prior to specifying upholstery material.





OPTIONAL FEATURES





- Polypropylene seats, backs and coordinating arms are available in 14 designer colors. Choose from Buzz Blue (BZB), Cactus (CCT), Carrot (CRO), Cloud (IVC), Dijon (DJN), Eggplant (EGP), Fog (FOG), Frost (FRO), Ink (INK), Latte (LAB), Night (BLK), Sand (SND), Scarlet (SAR), and Shadow (SHW).
- An optional 18.5"D x 18.5"W high pressure laminate writing tablet is available. The core is hardwood veneer plywood with radiused edge finished in clear lacquer. This writing tablet is offered in the following finishes: Black (BLK), Clear Maple (CMB), Designer White (DWT) and Noce Grigio (NGL). Please specify. Add \$59.
- Chairs will have additional stitch details when upholstered in vinyl.
- A selection of glide options is available. Glide must be chosen to best suit flooring type and site conditions.
- Chrome frame is optionally available without glides (WS) and is suitable for rubberized and carpeted floors, please specify. No upcharge
- Glides with felt pads (FG) are available for vinyl sheet, cork or laminate flooring, please specify. Add \$31
- Glides with rubber pads (RG) are available for vinyl, hardwood, laminate, stone or ceramic flooring, please specify. Add \$31.
- Glides with stainless steel pads (SG) are available for carpet or rubber flooring, please specify. Add \$31.
- For task base models, hard surface flooring casters are available. Specify (C9R). Add \$66.
- Pedestal base models have black base with 2" height adjustable cylinders. Specify (SCC) swivel, auto return to max height (no upcharge); (SN) non-swivel, auto return to max height (Add \$19); or, (SC) swivel, self-centering and return to max height (add \$30).



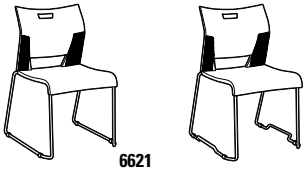

	Duet Chairs Stacking Capability		Duet Stools Stacking Capability	
	Stacking on floor	Stacking on dolly #6624	Stacking on floor	Stacking on dolly
Armless				
Polypropylene seat & back	up to 12 high	up to 40* high	up to 12 high	N/A
Polypropylene back & upholstered seat	up to 5 high	up to 12 high	up to 5 high	N/A
Upholstered seat & back	up to 5 high	up to 12 high	up to 5 high	N/A
With Arms				
Polypropylene seat & back	up to 5 high	up to 24 high	up to 5 high	N/A
Polypropylene back & upholstered seat	up to 5 high	up to 12 high	up to 5 high	N/A
Upholstered seat & back	up to 5 high	up to 12 high	up to 5 high	N/A

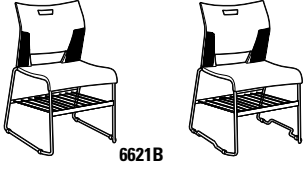
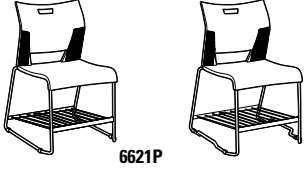





* THROUGH 80" DOORWAY, STACKS 36 HIGH







MULTI-PURPOSE





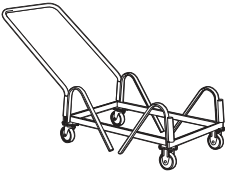

DESCRIPTION	FEATURES	MODEL#	STANDARD TEXTILE GRADES													
			1	2	3	4	5	6	7	8	9	10	11	12		
 <p>ArmChair COM Yardage: N/A Freight Class: 150 Product Weight (lbs.): 19 Cubic Feet Per Carton: 4.63 (4 per carton)</p>	Stacks 5 high on floor. Stacks 24 high on dolly.	6620	\$340	-	-	-	-	-	-	-	-	-	-	-		
			OVERALL DIMENSIONS			SEAT DIMENSIONS			BACK DIMENSIONS							
			W	D	H	W	D	H	W	H						
			25.5	22.75	33.25	18	17.5	16.5	18	16						
			RTA 00													
 <p>Armchair w/Bookrack COM Yardage: N/A Freight Class: 300 Product Weight (lbs.): 25 Cubic Feet Per Carton: 13.25 (1 per carton)</p>	Does not stack.	6620B	\$478	-	-	-	-	-	-	-	-	-	-			
			OVERALL DIMENSIONS			SEAT DIMENSIONS			BACK DIMENSIONS							
			W	D	H	W	D	H	W	H						
			25.5	22.75	33.25	18	17.5	16.5	18	16						
			RTA 00													
 <p>Armchair w/Back pack rack COM Yardage: N/A Freight Class: 300 Product Weight (lbs.): 25.5 Cubic Feet Per Carton: 13.25 (1 per carton)</p>	Does not stack.	6620P	\$501	-	-	-	-	-	-	-	-	-	-			
			OVERALL DIMENSIONS			SEAT DIMENSIONS			BACK DIMENSIONS							
			W	D	H	W	D	H	W	H						
			25.5	22.75	33.25	18	17.5	16.5	18	16						
			RTA 00													
 <p>Armchair w/Tablet COM Yardage: N/A Freight Class: 150 Product Weight (lbs.): 33 Cubic Feet Per Carton: 8 (2 per carton)</p>	Does not stack.	6620TR 6620TL	\$706	-	-	-	-	-	-	-	-	-	-			
			OVERALL DIMENSIONS			SEAT DIMENSIONS			BACK DIMENSIONS							
			W	D	H	W	D	H	W	H						
			26.25	27.75	33.25	18	17.5	16.5	18	16						
			RTA 00													
 <p>Armchair w/Tablet and Bookrack COM Yardage: N/A Freight Class: 250 Product Weight (lbs.): 34 Cubic Feet Per Carton: 16.25 (1 per carton)</p>	Does not stack.	6620TRB 6620TLB	\$863	-	-	-	-	-	-	-	-	-	-			
			OVERALL DIMENSIONS			SEAT DIMENSIONS			BACK DIMENSIONS							
			W	D	H	W	D	H	W	H						
			26.25	27.75	33.25	18	17.5	16.5	18	16						
			RTA 00													









DESCRIPTION	FEATURES	MODEL#	STANDARD TEXTILE GRADES											
			1	2	3	4	5	6	7	8	9	10	11	12
 <p>Armchair w/Tablet and Back pack rack COM Yardage: N/A Freight Class: 250 Product Weight (lbs.): 34 Cubic Feet Per Carton: 16.25 (1 per carton)</p>	Does not stack.	6620TRP 6620TLP	\$886	-	-	-	-	-	-	-	-	-	-	
			OVERALL DIMENSIONS			SEAT DIMENSIONS			BACK DIMENSIONS					
		W	D	H	W	D	H	W	H					
		26.25	27.75	33.25	18	17.5	16.5	18	16					
			RTA 00											
 <p>Armless Chair COM Yardage: N/A Freight Class: 150 Product Weight (lbs.): 20.5 Cubic Feet Per Carton: 3.5(4 per carton)</p>	Stacks 12 high on floor. Stacks 40 high on dolly.	6621 6621G Ganging	\$241	-	-	-	-	-	-	-	-	-		
			OVERALL DIMENSIONS			SEAT DIMENSIONS			BACK DIMENSIONS					
		W	D	H	W	D	H	W	H					
		20.75	22.75	33.25	18	17.5	17	18	16					
			RTA 00 											
 <p>Armless chair w/Bookrack COM Yardage: N/A Freight Class: 250 Product Weight (lbs.): 25 Cubic Feet Per Carton: 11.25 (1 per carton)</p>	Does not stack.	6621B 6621GB Ganging	\$379	-	-	-	-	-	-	-	-	-		
			OVERALL DIMENSIONS			SEAT DIMENSIONS			BACK DIMENSIONS					
		W	D	H	W	D	H	W	H					
		20.75	22.75	33.25	18	17.5	16.5	18	16					
			RTA 00											
 <p>Armless Chair w/Back pack rack COM Yardage: N/A Freight Class: 250 Product Weight (lbs.): 25 Cubic Feet Per Carton: 11.25 (1 per carton)</p>	Does not stack.	6621P 6621GP Ganging	\$402	-	-	-	-	-	-	-	-	-		
			OVERALL DIMENSIONS			SEAT DIMENSIONS			BACK DIMENSIONS					
		W	D	H	W	D	H	W	H					
		20.75	22.75	33.25	18	17.5	16.5	18	16					
			RTA 00											
 <p>Armless Chair w/Tablet COM Yardage: N/A Freight Class: 150 Product Weight (lbs.): 32 Cubic Feet Per Carton: 8 (2 per carton)</p>	Does not stack.	6621TR 6621TL	\$605	-	-	-	-	-	-	-	-	-		
			OVERALL DIMENSIONS			SEAT DIMENSIONS			BACK DIMENSIONS					
		W	D	H	W	D	H	W	H					
		24.5	27.75	33.25	18	17.5	16.5	18	16					
			RTA 00											





DESCRIPTION	FEATURES	MODEL#	STANDARD TEXTILE GRADES											
			1	2	3	4	5	6	7	8	9	10	11	12
 <p>Armless Chair w/ Tablet and Bookrack COM Yardage: N/A Freight Class: 300 Product Weight (lbs.): 27 Cubic Feet Per Carton: 16.25 (1 per carton)</p>	Does not stack.	6621TRB 6621TLB	\$762	-	-	-	-	-	-	-	-	-	-	
		OVERALL DIMENSIONS W D H			SEAT DIMENSIONS W D H			BACK DIMENSIONS W H						
		24.5	27.75	33.25	18	17.5	16.5	18	16					
		RTA 00												
 <p>Armless Chair w/ Tablet and Back pack rack COM Yardage: N/A Freight Class: 300 Product Weight (lbs.): 27 Cubic Feet Per Carton: 16.25 (1 per carton)</p>	Does not stack.	6621TRP 6621TLP	\$787	-	-	-	-	-	-	-	-	-		
		OVERALL DIMENSIONS W D H			SEAT DIMENSIONS W D H			BACK DIMENSIONS W H						
		24.5	27.75	33.25	18	17.5	16.5	18	16					
		RTA 00												
 <p>Armchair COM Yardage: 0.75 Freight Class: 150 Product Weight (lbs.): 25 Cubic Feet Per Carton: 5.56 (4 per carton)</p>	Upholstered Seat. Stacks 5 high on floor. Stacks 12 high on dolly.	6622	\$440	\$474	\$501	\$538	\$592	\$612	\$659	\$751	\$796	\$879	\$995	\$1138
		OVERALL DIMENSIONS W D H			SEAT DIMENSIONS W D H			BACK DIMENSIONS W H						
		25.5	23	33.25	18	17.5	17	18	16					
		RTA 00												
 <p>Armchair w/ Bookrack COM Yardage: 0.75 Freight Class: 250 Product Weight (lbs.): 29 Cubic Feet Per Carton: 13.25 (1 per carton)</p>	Upholstered Seat. Does not stack.	6622B	\$584	\$619	\$647	\$688	\$746	\$766	\$817	\$911	\$958	\$1047	\$1167	\$1318
		OVERALL DIMENSIONS W D H			SEAT DIMENSIONS W D H			BACK DIMENSIONS W H						
		25.5	23	33.25	18	17.5	17	18	16					
		RTA 00												
 <p>Armchair w/ Back pack rack COM Yardage: 0.75 Freight Class: 250 Product Weight (lbs.): 29 Cubic Feet Per Carton: 13.25 (1 per carton)</p>	Upholstered Seat. Does not stack.	6622P	\$607	\$642	\$668	\$708	\$769	\$785	\$838	\$932	\$978	\$1070	\$1189	\$1340
		OVERALL DIMENSIONS W D H			SEAT DIMENSIONS W D H			BACK DIMENSIONS W H						
		25.5	23	33.25	18	17.5	17	18	16					
		RTA 00												





DESCRIPTION	FEATURES	MODEL#	STANDARD TEXTILE GRADES											
			1	2	3	4	5	6	7	8	9	10	11	12
 <p>Armchair w/Tablet COM Yardage: 1 Freight Class: 250 Product Weight (lbs.): 27 Cubic Feet Per Carton: 16 (2 per carton)</p>	Upholstered Seat. Does not stack. Must specify (L) Left or (R) Right Tablet.	6622TR 6622TL	\$803	\$840	\$870	\$913	\$974	\$995	\$1049	\$1152	\$1202	\$1296	\$1426	\$1589
			OVERALL DIMENSIONS W D H			SEAT DIMENSIONS W D H			BACK DIMENSIONS W H					
			26.25	27.75	33.25	18	17.5	17	18	15.5				
			RTA 00											
 <p>Armchair w/Tablet and Bookrack COM Yardage: 1 Freight Class: 250 Product Weight (lbs.): 37 Cubic Feet Per Carton: 16.25 (1 per carton)</p>	Upholstered Seat. Does not stack.	6622TRB 6622TLB	\$960	\$1000	\$1027	\$1070	\$1131	\$1152	\$1207	\$1309	\$1359	\$1453	\$1583	\$1746
			OVERALL DIMENSIONS W D H			SEAT DIMENSIONS W D H			BACK DIMENSIONS W H					
			26.25	27.75	33.25	18	17.5	17	18	15.5				
			RTA 00											
 <p>Armchair w/Tablet and Back pack rack COM Yardage: 1 Freight Class: 250 Product Weight (lbs.): 37 Cubic Feet Per Carton: 16.25 (1 per carton)</p>	Upholstered Seat. Does not stack.	6622TRP 6622TLP	\$983	\$1022	\$1051	\$1094	\$1154	\$1176	\$1230	\$1332	\$1383	\$1477	\$1607	\$1769
			OVERALL DIMENSIONS W D H			SEAT DIMENSIONS W D H			BACK DIMENSIONS W H					
			26.25	27.75	33.25	18	17.5	17	18	15.5				
			RTA 00											
  <p>6623 6623G</p> <p>Armless Chair COM Yardage: 0.75 Freight Class: 150 Product Weight (lbs.): 21 Cubic Feet Per Carton: 4.63 (4 per carton)</p>	Upholstered Seat. Stacks 5 high on floor. Stacks 12 high on dolly.	6623 6623G Ganging	\$335	\$370	\$396	\$434	\$487	\$508	\$555	\$647	\$692	\$774	\$892	\$1034
			OVERALL DIMENSIONS W D H			SEAT DIMENSIONS W D H			BACK DIMENSIONS W H					
			20.5	23	33.25	18	17.5	17	18	16				
			RTA 00											
  <p>6623B 6623GB</p> <p>Armless chair w/Bookrack COM Yardage: 0.75 Freight Class: 250 Product Weight (lbs.): 28 Cubic Feet Per Carton: 11.25 (1 per carton)</p>	Upholstered Seat. Does not stack.	6623B 6623GB Ganging	\$474	\$513	\$537	\$579	\$637	\$655	\$707	\$800	\$848	\$938	\$1059	\$1209
			OVERALL DIMENSIONS W D H			SEAT DIMENSIONS W D H			BACK DIMENSIONS W H					
			20.5	23	33.25	18	17.5	17	18	16				
			RTA 00											





DESCRIPTION	FEATURES	MODEL#	STANDARD TEXTILE GRADES												
			1	2	3	4	5	6	7	8	9	10	11	12	
 6623P  6623GP	Upholstered Seat. Does not stack.		6623P	\$499	\$536	\$563	\$603	\$661	\$682	\$733	\$826	\$873	\$963	\$1082	\$1233
			6623GP Ganging	\$523	\$560	\$586	\$627	\$685	\$705	\$756	\$850	\$897	\$987	\$1106	\$1257
			OVERALL DIMENSIONS			SEAT DIMENSIONS			BACK DIMENSIONS						
			W	D	H	W	D	H	W	H					
			20.5	23	33.25	18	17.5	17	18	16					
			RTA 00												
 6623TR 6623TL	Upholstered Seat. Does not stack.		6623TR	\$702	\$742	\$770	\$813	\$873	\$894	\$949	\$1051	\$1101	\$1195	\$1325	\$1488
			6623TL												
			OVERALL DIMENSIONS			SEAT DIMENSIONS			BACK DIMENSIONS						
			W	D	H	W	D	H	W	H					
			24.5	27.75	33.25	18	17.5	17	18	15.5					
			RTA 00												
 6623TRB 6623TLB	Upholstered Seat. Does not stack.		6623TRB	\$859	\$898	\$927	\$970	\$1030	\$1052	\$1106	\$1208	\$1258	\$1353	\$1483	\$1645
			6623TLB												
			OVERALL DIMENSIONS			SEAT DIMENSIONS			BACK DIMENSIONS						
			W	D	H	W	D	H	W	H					
			24.5	27.75	33.25	18	17.5	17	18	15.5					
			RTA 00												
 6623TRP 6623TLP	Upholstered Seat. Does not stack.		6623TRP	\$883	\$922	\$950	\$992	\$1054	\$1075	\$1128	\$1232	\$1282	\$1376	\$1506	\$1669
			6623TLP												
			OVERALL DIMENSIONS			SEAT DIMENSIONS			BACK DIMENSIONS						
			W	D	H	W	D	H	W	H					
			24.5	27.75	33.25	18	17.5	17	18	15.5					
			RTA 00												
 6624			6624	\$714	-	-	-	-	-	-	-	-	-	-	-
			OVERALL DIMENSIONS			SEAT DIMENSIONS			BACK DIMENSIONS						
			W	D	H	W	D	H	W	H					
			22.5	51	38.25	-	-	-	-	-					
			RTA 1 												

DESCRIPTION	FEATURES	MODEL#	STANDARD TEXTILE GRADES											
			1	2	3	4	5	6	7	8	9	10	11	12
		6626	\$27	-	-	-	-	-	-	-	-	-	-	-
			OVERALL DIMENSIONS			SEAT DIMENSIONS			BACK DIMENSIONS					
			W	D	H	W	D	H	W	H				
Ganging Clamp Set - 2 Clamps COM Yardage: N/A Freight Class: 70 Product Weight (lbs.): 0.3 Cubic Feet Per Carton: 0.01 (1 set per carton)			1	6.5	00.75	-	-	-	-	-				
			RTA 00											
		6627	\$486	\$547	\$573	\$612	\$672	\$688	\$741	\$835	\$881	\$971	\$1091	\$1245
			OVERALL DIMENSIONS			SEAT DIMENSIONS			BACK DIMENSIONS					
			W	D	H	W	D	H	W	H				
Armchair COM Yardage: 0.75 Freight Class: 150 Product Weight (lbs.): 27 Cubic Feet Per Carton: 5.56 (4 per carton)			25.5	23	33.25	18	17.5	17	18	16				
			RTA 00											
		6627B	\$628	\$663	\$691	\$733	\$791	\$809	\$862	\$955	\$1003	\$1093	\$1213	\$1363
			OVERALL DIMENSIONS			SEAT DIMENSIONS			BACK DIMENSIONS					
			W	D	H	W	D	H	W	H				
Armchair w/Bookrack COM Yardage: 0.75 Freight Class: 250 Product Weight (lbs.): 31 Cubic Feet Per Carton: 13.25 (1 per carton)			25.5	23	33.25	18	17.5	17	18	16				
			RTA 00											
		6627P	\$653	\$688	\$715	\$754	\$815	\$834	\$886	\$979	\$1027	\$1116	\$1235	\$1387
			OVERALL DIMENSIONS			SEAT DIMENSIONS			BACK DIMENSIONS					
			W	D	H	W	D	H	W	H				
Armchair w/Back pack rack COM Yardage: 0.75 Freight Class: 250 Product Weight (lbs.): 31 Cubic Feet Per Carton: 13.25 (1 per carton)			25.5	23	33.25	18	17.5	17	18	16				
			RTA 00											
		6627TR 6627TL	\$844	\$883	\$911	\$954	\$1015	\$1036	\$1090	\$1193	\$1243	\$1337	\$1467	\$1630
			OVERALL DIMENSIONS			SEAT DIMENSIONS			BACK DIMENSIONS					
			W	D	H	W	D	H	W	H				
Armchair w/Tablet COM Yardage: 1 Freight Class: 250 Product Weight (lbs.): 32 Cubic Feet Per Carton: 16 (2 per carton)			26.25	27.75	33.25	18	17	17	18	15.5				
			RTA 00											















DESCRIPTION	FEATURES	MODEL#	STANDARD TEXTILE GRADES												
			1	2	3	4	5	6	7	8	9	10	11	12	
 <p>Armchair w/Tablet and Bookrack COM Yardage: 1 Freight Class: 250 Product Weight (lbs.): 34 Cubic Feet Per Carton: 16.25 (1 per carton)</p>	Upholstered Seat and Back. Does not stack.	6627TRB 6627TLB	\$1001	\$1041	\$1069	\$1112	\$1172	\$1193	\$1248	\$1350	\$1400	\$1495	\$1624	\$1787	
			OVERALL DIMENSIONS			SEAT DIMENSIONS			BACK DIMENSIONS						
		W	D	H	W	D	H	W	H						
		26.25	27.75	33.25	18	17	17	18	15.5						
			RTA 00												
 <p>Armchair w/Tablet and Back pack rack COM Yardage: 1 Freight Class: 250 Product Weight (lbs.): 39 Cubic Feet Per Carton: 16.25 (1 per carton)</p>	Upholstered Seat and Back. Does not stack.	6627TRP 6627TLP	\$1025	\$1064	\$1092	\$1135	\$1195	\$1217	\$1271	\$1374	\$1424	\$1519	\$1648	\$1811	
			OVERALL DIMENSIONS			SEAT DIMENSIONS			BACK DIMENSIONS						
		W	D	H	W	D	H	W	H						
		26.25	27.75	33.25	18	17	17	18	15.5						
			RTA 00												
  <p>6628 6628G</p> <p>Armless Chair COM Yardage: 0.75 Freight Class: 150 Product Weight (lbs.): 23 Cubic Feet Per Carton: 4.63 (4 per carton)</p>	Upholstered Seat and Back. Stacks 5 high on floor. Stacks 12 high on dolly.	6628	\$393	\$449	\$476	\$515	\$575	\$594	\$644	\$739	\$786	\$875	\$995	\$1147	
			6628G Ganging	\$408	\$466	\$491	\$530	\$590	\$610	\$660	\$757	\$803	\$892	\$1011	\$1161
		OVERALL DIMENSIONS			SEAT DIMENSIONS			BACK DIMENSIONS							
		W	D	H	W	D	H	W	H						
20.5	23	33.25	18	17	17	18	15.5								
			RTA 00												
  <p>6628B 6628GB</p> <p>Armless chair w/Bookrack COM Yardage: 0.75 Freight Class: 250 Product Weight (lbs.): 30 Cubic Feet Per Carton: 11.25 (1 per carton)</p>	Upholstered Seat and Back. Does not stack.	6628B	\$540	\$577	\$606	\$645	\$703	\$722	\$774	\$867	\$914	\$1004	\$1125	\$1275	
			6628GB Ganging	\$558	\$593	\$620	\$659	\$719	\$739	\$791	\$884	\$931	\$1021	\$1140	\$1292
		OVERALL DIMENSIONS			SEAT DIMENSIONS			BACK DIMENSIONS							
		W	D	H	W	D	H	W	H						
20.5	23	33.25	18	17	17	18	15.5								
			RTA 00												
  <p>6628P 6628GP</p> <p>Armless Chair w/Back pack rack COM Yardage: 0.75 Freight Class: 250 Product Weight (lbs.): 30 Cubic Feet Per Carton: 11.25 (1 per carton)</p>	Upholstered Seat and Back. Does not stack.	6628P	\$563	\$598	\$626	\$667	\$725	\$745	\$796	\$889	\$938	\$1027	\$1145	\$1297	
			6628GP Ganging	\$579	\$614	\$642	\$683	\$741	\$759	\$812	\$905	\$952	\$1042	\$1162	\$1313
		OVERALL DIMENSIONS			SEAT DIMENSIONS			BACK DIMENSIONS							
		W	D	H	W	D	H	W	H						
20.5	23	33.25	18	17	17	18	15.5								
			RTA 00												









DESCRIPTION	FEATURES	MODEL#	STANDARD TEXTILE GRADES												
			1	2	3	4	5	6	7	8	9	10	11	12	
 <p>Armless Chair w/Tablet COM Yardage: 1 Freight Class: 250 Product Weight (lbs.): 31 Cubic Feet Per Carton: 16 (2 per carton)</p>	Upholstered Seat and Back. Does not stack.	6628TR 6628TL	\$739	\$779	\$806	\$849	\$911	\$932	\$985	\$1088	\$1139	\$1233	\$1362	\$1525	
			OVERALL DIMENSIONS			SEAT DIMENSIONS			BACK DIMENSIONS						
		W	D	H	W	D	H	W	H						
		24.5	27.75	33.25	18	17	17	18	15.5						
		RTA 00													
 <p>Armless Chair w/Tablet and Bookrack COM Yardage: 1 Freight Class: 250 Product Weight (lbs.): 38 Cubic Feet Per Carton: 16.25 (1 per carton)</p>	Upholstered Seat and Back. Does not stack.	6628TRB 6628TLB	\$902	\$942	\$970	\$1013	\$1074	\$1098	\$1149	\$1252	\$1302	\$1398	\$1527	\$1689	
			OVERALL DIMENSIONS			SEAT DIMENSIONS			BACK DIMENSIONS						
		W	D	H	W	D	H	W	H						
		24.5	16.25	33.25	18	17	17	18	15.5						
		RTA 00													
 <p>Armless Chair w/Tablet and Back pack rack COM Yardage: 1 Freight Class: 250 Product Weight (lbs.): 38 Cubic Feet Per Carton: 16.25 (1 per carton)</p>	Upholstered Seat and Back. Does not stack.	6628TRP 6628TLP	\$925	\$964	\$992	\$1035	\$1097	\$1118	\$1171	\$1275	\$1325	\$1419	\$1549	\$1712	
			OVERALL DIMENSIONS			SEAT DIMENSIONS			BACK DIMENSIONS						
		W	D	H	W	D	H	W	H						
		24.5	27.75	33.25	18	17	17	18	15.5						
		RTA 00													
 <p>Barstool with Arms COM Yardage: N/A Freight Class: 250 Product Weight (lbs.): 30 Cubic Feet Per Carton: 10.75 (2 per carton)</p>	Stacks 5 high on floor.	6630	\$593	-	-	-	-	-	-	-	-	-	-	-	
			OVERALL DIMENSIONS			SEAT DIMENSIONS			BACK DIMENSIONS						
		W	D	H	W	D	H	W	H						
		25.5	23.5	45	18	17.5	29.5	18	16						
		RTA 00													
 <p>Armless Barstool COM Yardage: N/A Freight Class: 250 Product Weight (lbs.): 29 Cubic Feet Per Carton: 8.75 (2 per carton)</p>	Stacks 8 high on floor.	6631	\$441	-	-	-	-	-	-	-	-	-	-	-	
			OVERALL DIMENSIONS			SEAT DIMENSIONS			BACK DIMENSIONS						
		W	D	H	W	D	H	W	H						
		20.75	23.5	45	18	17.5	29.5	18	16						
		RTA 00													



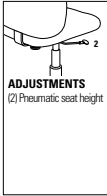

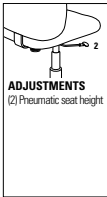

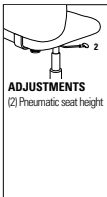

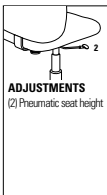
DESCRIPTION	FEATURES	MODEL#	STANDARD TEXTILE GRADES											
			1	2	3	4	5	6	7	8	9	10	11	12
 <p>Barstool with Arms COM Yardage: 0.75 Freight Class: 250 Product Weight (lbs.): 31 Cubic Feet Per Carton: 10.75 (2 per carton)</p>	Upholstered Seat Stacks 5 high on floor	6632	\$684	\$717	\$745	\$783	\$839	\$856	\$907	\$997	\$1041	\$1125	\$1239	\$1383
			OVERALL DIMENSIONS			SEAT DIMENSIONS			BACK DIMENSIONS					
			W	D	H	W	D	H	W	H				
			25.5	23.5	45	18	17.5	30	18	15.5				
			RTA 00											
 <p>Armless Barstool COM Yardage: 0.75 Freight Class: 250 Product Weight (lbs.): 30 Cubic Feet Per Carton: 17.5 (2 per carton)</p>	Upholstered Seat. Stacks 5 high on floor.	6633	\$528	\$563	\$590	\$627	\$683	\$701	\$749	\$840	\$885	\$969	\$1086	\$1227
			OVERALL DIMENSIONS			SEAT DIMENSIONS			BACK DIMENSIONS					
			W	D	H	W	D	H	W	H				
			20.75	23.5	45	18	17.5	30	18	15.5				
			RTA 00											
 <p>Barstool with Arms COM Yardage: 0.75 Freight Class: 250 Product Weight (lbs.): 31.5 Cubic Feet Per Carton: 10.75 (2 per carton)</p>	Upholstered Seat and Back. Stacks 3 high on floor.	6637	\$723	\$757	\$784	\$823	\$878	\$895	\$946	\$1036	\$1081	\$1166	\$1280	\$1423
			OVERALL DIMENSIONS			SEAT DIMENSIONS			BACK DIMENSIONS					
			W	D	H	W	D	H	W	H				
			25.5	23.5	45	18	17.5	30	18	15.5				
			RTA 00											
 <p>Armless Barstool COM Yardage: 0.75 Freight Class: 250 Product Weight (lbs.): 30.5 Cubic Feet Per Carton: 8.75 (2 per carton)</p>	Upholstered Seat and Back. Stacks 3 high on floor.	6638	\$620	\$655	\$682	\$718	\$775	\$792	\$841	\$932	\$977	\$1060	\$1175	\$1319
			OVERALL DIMENSIONS			SEAT DIMENSIONS			BACK DIMENSIONS					
			W	D	H	W	D	H	W	H				
			20.75	23.5	45	18	17.5	30	18	15.5				
			RTA 00											
 <p>Counter Stool with Arms COM Yardage: N/A Freight Class: 250 Product Weight (lbs.): 25 Cubic Feet Per Carton: 10.75 (2 per carton)</p>	Stacks 5 high on floor.	6660	\$593	-	-	-	-	-	-	-	-	-	-	-
			OVERALL DIMENSIONS			SEAT DIMENSIONS			BACK DIMENSIONS					
			W	D	H	W	D	H	W	H				
			25.5	23.5	39.5	18	17.5	24	18	16				
			RTA 00											

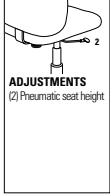

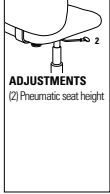

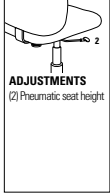

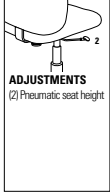

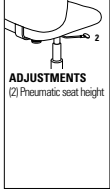
DESCRIPTION	FEATURES	MODEL#	STANDARD TEXTILE GRADES											
			1	2	3	4	5	6	7	8	9	10	11	12
 Armless Counter Stool COM Yardage: N/A Freight Class: 250 Product Weight (lbs.): 24 Cubic Feet Per Carton: 8.75 (2 per carton)	Stacks 5 high on floor.	6661	\$441	-	-	-	-	-	-	-	-	-	-	-
			OVERALL DIMENSIONS			SEAT DIMENSIONS			BACK DIMENSIONS					
			W	D	H	W	D	H	W	H				
			20.75	23.5	39.5	18	17.5	24	18	16				
			RTA 00											
 Counter Stool w/Arms COM Yardage: 0.75 Freight Class: 250 Product Weight (lbs.): 26 Cubic Feet Per Carton: 10.75 (2 per carton)	Upholstered Seat. Stacks 5 high on floor.	6662	\$684	\$717	\$745	\$783	\$839	\$856	\$907	\$997	\$1041	\$1125	\$1239	\$1383
			OVERALL DIMENSIONS			SEAT DIMENSIONS			BACK DIMENSIONS					
			W	D	H	W	D	H	W	H				
			20.75	23.5	39.5	18	17.5	24	18	16				
			RTA 00											
 Armless Counter Stool COM Yardage: 0.75 Freight Class: 250 Product Weight (lbs.): 25 Cubic Feet Per Carton: 8.75 (2 per carton)	Upholstered Seat. Stacks 5 high on floor.	6663	\$528	\$563	\$590	\$627	\$683	\$701	\$749	\$840	\$885	\$969	\$1086	\$1227
			OVERALL DIMENSIONS			SEAT DIMENSIONS			BACK DIMENSIONS					
			W	D	H	W	D	H	W	H				
			20.75	23.5	39.5	18	17.5	24	18	16				
			RTA 00											
 Counter Stool w/Arms COM Yardage: 0.75 Freight Class: 250 Product Weight (lbs.): 26.5 Cubic Feet Per Carton: 10.75 (2 per carton)	Upholstered Seat and Back. Stacks 3 high on floor.	6667	\$723	\$757	\$784	\$823	\$878	\$895	\$946	\$1036	\$1081	\$1166	\$1280	\$1423
			OVERALL DIMENSIONS			SEAT DIMENSIONS			BACK DIMENSIONS					
			W	D	H	W	D	H	W	H				
			25.5	23.5	39.5	18	17.5	24	18	16				
			RTA 00											
 Armless Counter Stool COM Yardage: 0.75 Freight Class: 250 Product Weight (lbs.): 25.5 Cubic Feet Per Carton: 8.75 (2 per carton)	Upholstered Seat and Back. Stacks 3 high on floor.	6668	\$620	\$655	\$682	\$718	\$775	\$792	\$841	\$932	\$977	\$1060	\$1175	\$1319
			OVERALL DIMENSIONS			SEAT DIMENSIONS			BACK DIMENSIONS					
			W	D	H	W	D	H	W	H				
			20.75	23.5	39.5	18	17.5	24	18	16				
			RTA 00											

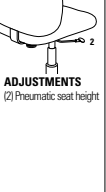

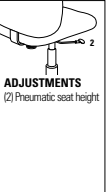
MULTI-PURPOSE

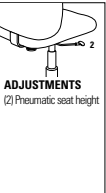

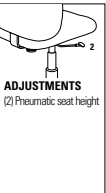

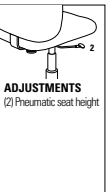

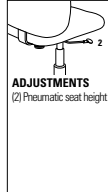

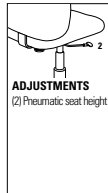
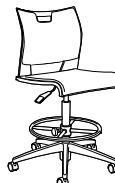
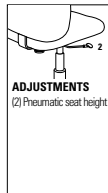
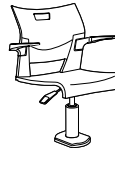
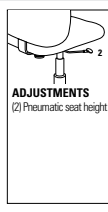
DESCRIPTION	FEATURES	MODEL#	STANDARD TEXTILE GRADES												
			1	2	3	4	5	6	7	8	9	10	11	12	
 <p>Seat Unit w/Arms COM Yardage: N/A Freight Class: 250 Product Weight (lbs.): 19 Cubic Feet Per Carton: 4.88 (2 per carton)</p>	Use with beams.	6690	\$392	-	-	-	-	-	-	-	-	-	-	-	
		OVERALL DIMENSIONS			SEAT DIMENSIONS			BACK DIMENSIONS							
		W	D	H	W	D	H	W	H						
		25.5	21	18	18	17.5	-	18	16						
															
 <p>Armless Seat Unit COM Yardage: N/A Freight Class: 150 Product Weight (lbs.): 18 Cubic Feet Per Carton: 3.25 (2 per carton)</p>	Use with beams.	6691	\$288	-	-	-	-	-	-	-	-	-	-	-	
		OVERALL DIMENSIONS			SEAT DIMENSIONS			BACK DIMENSIONS							
		W	D	H	W	D	H	W	H						
		18	21	18	18	17.5	-	18	16						
															
 <p>Seat Unit w/Arms COM Yardage: 0.75 Freight Class: 250 Product Weight (lbs.): 19 Cubic Feet Per Carton: 4.88 (2 per carton)</p>	Upholstered Seat. Use with beams.	6692	\$480	\$515	\$541	\$579	\$635	\$652	\$701	\$791	\$837	\$921	\$1037	\$1179	
		OVERALL DIMENSIONS			SEAT DIMENSIONS			BACK DIMENSIONS							
		W	D	H	W	D	H	W	H						
		25.5	21	18	18	17.5	-	18	15.5						
															
 <p>Armless Seat Unit COM Yardage: 0.75 Freight Class: 150 Product Weight (lbs.): 19 Cubic Feet Per Carton: 3.25 (2 per carton)</p>	Upholstered Seat. Use with beams.	6693	\$373	\$406	\$432	\$471	\$525	\$544	\$592	\$683	\$729	\$812	\$926	\$1070	
		OVERALL DIMENSIONS			SEAT DIMENSIONS			BACK DIMENSIONS							
		W	D	H	W	D	H	W	H						
		18	21	18	18	17.5	-	18	15.5						
															
 <p>Seat Unit w/Arms COM Yardage: 0.75 Freight Class: 150 Product Weight (lbs.): 20 Cubic Feet Per Carton: 4.88 (2 per carton)</p>	Upholstered Seat and Back. Use with beams.	6697	\$509	\$542	\$568	\$607	\$660	\$680	\$728	\$819	\$865	\$948	\$1062	\$1206	
		OVERALL DIMENSIONS			SEAT DIMENSIONS			BACK DIMENSIONS							
		W	D	H	W	D	H	W	H						
		25.5	21	18	18	17	-	18	15.5						
															

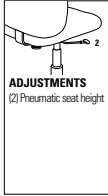

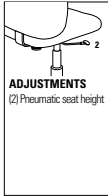

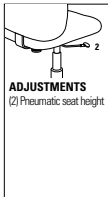

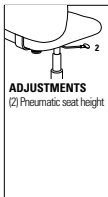

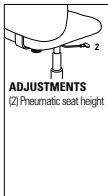
DESCRIPTION	FEATURES	MODEL#	STANDARD TEXTILE GRADES													
			1	2	3	4	5	6	7	8	9	10	11	12		
 <p>Armless Seat Unit COM Yardage: 0.75 Freight Class: 150 Product Weight (lbs.): 19 Cubic Feet Per Carton: 3.25 (2 per carton)</p>	<p>Upholstered Seat and Back. Use with beams.</p>	<p>6698</p>	\$415	\$448	\$475	\$513	\$567	\$586	\$635	\$726	\$771	\$855	\$968	\$1113		
			OVERALL DIMENSIONS			SEAT DIMENSIONS			BACK DIMENSIONS							
			W	D	H	W	D	H	W	H						
			18	21	18	18	17	-	18	15.5						
		<p>RTA 00</p> 														
 <p>Task w/Arms COM Yardage: N/A Freight Class: 250 Product Weight (lbs.): 32 Cubic Feet Per Carton: 9.75</p>	 <p>ADJUSTMENTS (2) Pneumatic seat height</p>	<p>6720</p>	\$564	-	-	-	-	-	-	-	-	-	-	-		
			OVERALL DIMENSIONS			SEAT DIMENSIONS			BACK DIMENSIONS							
			W	D	H	W	D	H	W	H						
			25.5	21.5	32.5	18	17.5	14-19	18	16						
		<p>RTA 1</p>														
 <p>Task w/Arms and Tablet COM Yardage: N/A Freight Class: 250 Product Weight (lbs.): 40 Cubic Feet Per Carton: 15.75</p>	 <p>ADJUSTMENTS (2) Pneumatic seat height</p>	<p>6720TR 6720TL</p>	\$972	-	-	-	-	-	-	-	-	-	-	-		
			OVERALL DIMENSIONS			SEAT DIMENSIONS			BACK DIMENSIONS							
			W	D	H	W	D	H	W	H						
			26.5	25.5	33.25	18	17.5	14-19	18	16						
		<p>RTA 1</p>														
 <p>Task Armless COM Yardage: N/A Freight Class: 250 Product Weight (lbs.): 31 Cubic Feet Per Carton: 9.75</p>	 <p>ADJUSTMENTS (2) Pneumatic seat height</p>	<p>6721</p>	\$433	-	-	-	-	-	-	-	-	-	-			
			OVERALL DIMENSIONS			SEAT DIMENSIONS			BACK DIMENSIONS							
			W	D	H	W	D	H	W	H						
			18	21.5	32.5	18	17.5	14-19	18	16						
		<p>RTA 1</p>														
 <p>Task Armless w/Tablet COM Yardage: N/A Freight Class: 250 Product Weight (lbs.): 39 Cubic Feet Per Carton: 15.75</p>	 <p>ADJUSTMENTS (2) Pneumatic seat height</p>	<p>6721TR 6721TL</p>	\$825	-	-	-	-	-	-	-	-	-	-			
			OVERALL DIMENSIONS			SEAT DIMENSIONS			BACK DIMENSIONS							
			W	D	H	W	D	H	W	H						
			23.5	25.5	33.25	18	17.5	14-19	18	16						
		<p>RTA 1</p>														

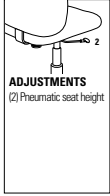

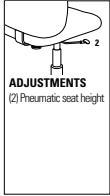
DESCRIPTION	FEATURES	MODEL#	STANDARD TEXTILE GRADES											
			1	2	3	4	5	6	7	8	9	10	11	12
 <p>Task w/Arms COM Yardage: 0.75 Freight Class: 250 Product Weight (lbs.): 33 Cubic Feet Per Carton: 9.75</p>	 <p>ADJUSTMENTS (2) Pneumatic seat height</p>	<p>6722</p>	\$621	\$656	\$683	\$720	\$775	\$794	\$841	\$933	\$978	\$1060	\$1176	\$1320
			OVERALL DIMENSIONS			SEAT DIMENSIONS			BACK DIMENSIONS					
			W	D	H	W	D	H	W	H				
			25.5	21.5	32.5	18	17.5	14.5-19.5	18	15.5				
			RTA 1											
 <p>Task w/Arms and Tablet COM Yardage: 0.75 Freight Class: 250 Product Weight (lbs.): 41 Cubic Feet Per Carton: 15.75</p>	 <p>ADJUSTMENTS (2) Pneumatic seat height</p>	<p>6722TR 6722TL</p>	\$1013	\$1037	\$1054	\$1081	\$1118	\$1136	\$1169	\$1224	\$1268	\$1312	\$1408	\$1509
			OVERALL DIMENSIONS			SEAT DIMENSIONS			BACK DIMENSIONS					
			W	D	H	W	D	H	W	H				
			26.5	25.5	33.25	18	17.5	14.5-19.5	18	15.5				
			RTA 1											
 <p>Task Armless COM Yardage: 0.75 Freight Class: 250 Product Weight (lbs.): 32 Cubic Feet Per Carton: 9.75</p>	 <p>ADJUSTMENTS (2) Pneumatic seat height</p>	<p>6723</p>	\$508	\$542	\$569	\$607	\$660	\$680	\$727	\$819	\$865	\$947	\$1063	\$1205
			OVERALL DIMENSIONS			SEAT DIMENSIONS			BACK DIMENSIONS					
			W	D	H	W	D	H	W	H				
			18	21.5	32.5	18	17	14.5-19.5	18	15.5				
			RTA 1											
 <p>Task Armless w/Tablet COM Yardage: 0.75 Freight Class: 250 Product Weight (lbs.): 41 Cubic Feet Per Carton: 15.75</p>	 <p>ADJUSTMENTS (2) Pneumatic seat height</p>	<p>6723TR 6723TL</p>	\$893	\$918	\$935	\$961	\$998	\$1016	\$1049	\$1102	\$1145	\$1190	\$1285	\$1385
			OVERALL DIMENSIONS			SEAT DIMENSIONS			BACK DIMENSIONS					
			W	D	H	W	D	H	W	H				
			23.5	25.5	33.25	18	17	14.5-19.5	18	15.5				
			RTA 1											
 <p>Task w/Arms COM Yardage: 0.75 Freight Class: 250 Product Weight (lbs.): 34 Cubic Feet Per Carton: 9.75</p>	 <p>ADJUSTMENTS (2) Pneumatic seat height</p>	<p>6727</p>	\$708	\$742	\$768	\$806	\$860	\$880	\$927	\$1019	\$1064	\$1147	\$1263	\$1405
			OVERALL DIMENSIONS			SEAT DIMENSIONS			BACK DIMENSIONS					
			W	D	H	W	D	H	W	H				
			25.5	21.5	32.5	18	17	14.5-19.5	18	16				
			RTA 1											

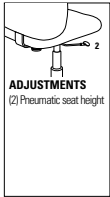
DESCRIPTION	FEATURES	MODEL#	STANDARD TEXTILE GRADES																																					
			1	2	3	4	5	6	7	8	9	10	11	12																										
 <p>Task w/Arms w/Tablet COM Yardage: 0.75 Freight Class: 250 Product Weight (lbs.): 42 Cubic Feet Per Carton: 15.75</p>	 <p>ADJUSTMENTS (2) Pneumatic seat height</p>	<p>Upholstered Seat and Back Specify (L) left or (R) right tablet.</p> <p>Ergonomic Features: C, M</p>	<table border="1"> <tr> <td>6727TR</td> <td>\$1137</td> <td>\$1162</td> <td>\$1182</td> <td>\$1210</td> <td>\$1252</td> <td>\$1272</td> <td>\$1309</td> <td>\$1370</td> <td>\$1413</td> <td>\$1465</td> <td>\$1572</td> <td>\$1683</td> </tr> <tr> <td>6727TL</td> <td></td> <td></td> <td></td> <td></td> <td></td> <td></td> <td></td> <td></td> <td></td> <td></td> <td></td> <td></td> </tr> </table>												6727TR	\$1137	\$1162	\$1182	\$1210	\$1252	\$1272	\$1309	\$1370	\$1413	\$1465	\$1572	\$1683	6727TL												
			6727TR	\$1137	\$1162	\$1182	\$1210	\$1252	\$1272	\$1309	\$1370	\$1413	\$1465	\$1572	\$1683																									
			6727TL																																					
			<table border="1"> <tr> <th colspan="3">OVERALL DIMENSIONS</th> <th colspan="3">SEAT DIMENSIONS</th> <th colspan="2">BACK DIMENSIONS</th> </tr> <tr> <th>W</th> <th>D</th> <th>H</th> <th>W</th> <th>D</th> <th>H</th> <th>W</th> <th>H</th> </tr> <tr> <td>26.5</td> <td>25.5</td> <td>33.25</td> <td>18</td> <td>17</td> <td>14.5-19.5</td> <td>18</td> <td>16</td> </tr> </table>			OVERALL DIMENSIONS			SEAT DIMENSIONS			BACK DIMENSIONS		W	D	H	W	D	H	W	H	26.5	25.5	33.25	18	17	14.5-19.5	18	16	<p>RTA 1</p>										
OVERALL DIMENSIONS			SEAT DIMENSIONS			BACK DIMENSIONS																																		
W	D	H	W	D	H	W	H																																	
26.5	25.5	33.25	18	17	14.5-19.5	18	16																																	
 <p>Task Armless COM Yardage: 0.75 Freight Class: 250 Product Weight (lbs.): 33 Cubic Feet Per Carton: 9.75</p>	 <p>ADJUSTMENTS (2) Pneumatic seat height</p>	<p>Upholstered Seat and Back</p> <p>Ergonomic Features: C, M</p>	<table border="1"> <tr> <td>6728</td> <td>\$577</td> <td>\$612</td> <td>\$639</td> <td>\$676</td> <td>\$731</td> <td>\$750</td> <td>\$797</td> <td>\$889</td> <td>\$934</td> <td>\$1017</td> <td>\$1134</td> <td>\$1275</td> </tr> </table>												6728	\$577	\$612	\$639	\$676	\$731	\$750	\$797	\$889	\$934	\$1017	\$1134	\$1275													
			6728	\$577	\$612	\$639	\$676	\$731	\$750	\$797	\$889	\$934	\$1017	\$1134	\$1275																									
			<table border="1"> <tr> <th colspan="3">OVERALL DIMENSIONS</th> <th colspan="3">SEAT DIMENSIONS</th> <th colspan="2">BACK DIMENSIONS</th> </tr> <tr> <th>W</th> <th>D</th> <th>H</th> <th>W</th> <th>D</th> <th>H</th> <th>W</th> <th>H</th> </tr> <tr> <td>18</td> <td>21.5</td> <td>32.5</td> <td>18</td> <td>17</td> <td>14.5-19.5</td> <td>18</td> <td>15.5</td> </tr> </table>			OVERALL DIMENSIONS			SEAT DIMENSIONS			BACK DIMENSIONS		W	D	H	W	D	H	W	H	18	21.5	32.5	18	17	14.5-19.5	18	15.5	<p>RTA 1</p>										
			OVERALL DIMENSIONS			SEAT DIMENSIONS			BACK DIMENSIONS																															
W	D	H	W	D	H	W	H																																	
18	21.5	32.5	18	17	14.5-19.5	18	15.5																																	
 <p>Task Armless w/Tablet COM Yardage: 0.75 Freight Class: 250 Product Weight (lbs.): 42 Cubic Feet Per Carton: 15.75</p>	 <p>ADJUSTMENTS (2) Pneumatic seat height</p>	<p>Upholstered Seat and Back Specify (L) left or (R) right tablet.</p> <p>Ergonomic Features: C, M</p>	<table border="1"> <tr> <td>6728TR</td> <td>\$996</td> <td>\$1022</td> <td>\$1040</td> <td>\$1069</td> <td>\$1110</td> <td>\$1130</td> <td>\$1165</td> <td>\$1223</td> <td>\$1269</td> <td>\$1318</td> <td>\$1419</td> <td>\$1530</td> </tr> <tr> <td>6728TL</td> <td></td> <td></td> <td></td> <td></td> <td></td> <td></td> <td></td> <td></td> <td></td> <td></td> <td></td> <td></td> </tr> </table>												6728TR	\$996	\$1022	\$1040	\$1069	\$1110	\$1130	\$1165	\$1223	\$1269	\$1318	\$1419	\$1530	6728TL												
			6728TR	\$996	\$1022	\$1040	\$1069	\$1110	\$1130	\$1165	\$1223	\$1269	\$1318	\$1419	\$1530																									
			6728TL																																					
			<table border="1"> <tr> <th colspan="3">OVERALL DIMENSIONS</th> <th colspan="3">SEAT DIMENSIONS</th> <th colspan="2">BACK DIMENSIONS</th> </tr> <tr> <th>W</th> <th>D</th> <th>H</th> <th>W</th> <th>D</th> <th>H</th> <th>W</th> <th>H</th> </tr> <tr> <td>23.5</td> <td>25.5</td> <td>33.25</td> <td>18</td> <td>17</td> <td>14.5-19.5</td> <td>18</td> <td>15.5</td> </tr> </table>			OVERALL DIMENSIONS			SEAT DIMENSIONS			BACK DIMENSIONS		W	D	H	W	D	H	W	H	23.5	25.5	33.25	18	17	14.5-19.5	18	15.5	<p>RTA 1</p>										
OVERALL DIMENSIONS			SEAT DIMENSIONS			BACK DIMENSIONS																																		
W	D	H	W	D	H	W	H																																	
23.5	25.5	33.25	18	17	14.5-19.5	18	15.5																																	
 <p>Drafting Stool w/Arms COM Yardage: N/A Freight Class: 250 Product Weight (lbs.): 38 Cubic Feet Per Carton: 9.75</p>	 <p>ADJUSTMENTS (2) Pneumatic seat height</p>	<p>Polypropylene Seat and Back</p> <p>Ergonomic Features: C, M</p>	<table border="1"> <tr> <td>6730</td> <td>\$751</td> <td>-</td> <td>-</td> <td>-</td> <td>-</td> <td>-</td> <td>-</td> <td>-</td> <td>-</td> <td>-</td> <td>-</td> <td>-</td> </tr> </table>												6730	\$751	-	-	-	-	-	-	-	-	-	-	-													
			6730	\$751	-	-	-	-	-	-	-	-	-	-	-																									
			<table border="1"> <tr> <th colspan="3">OVERALL DIMENSIONS</th> <th colspan="3">SEAT DIMENSIONS</th> <th colspan="2">BACK DIMENSIONS</th> </tr> <tr> <th>W</th> <th>D</th> <th>H</th> <th>W</th> <th>D</th> <th>H</th> <th>W</th> <th>H</th> </tr> <tr> <td>25.5</td> <td>21.5</td> <td>41</td> <td>18</td> <td>17.5</td> <td>21-31</td> <td>18</td> <td>16</td> </tr> </table>			OVERALL DIMENSIONS			SEAT DIMENSIONS			BACK DIMENSIONS		W	D	H	W	D	H	W	H	25.5	21.5	41	18	17.5	21-31	18	16	<p>RTA 1</p>										
			OVERALL DIMENSIONS			SEAT DIMENSIONS			BACK DIMENSIONS																															
W	D	H	W	D	H	W	H																																	
25.5	21.5	41	18	17.5	21-31	18	16																																	
 <p>Drafting Stool - Armless COM Yardage: N/A Freight Class: 250 Product Weight (lbs.): 37 Cubic Feet Per Carton: 9.75</p>	 <p>ADJUSTMENTS (2) Pneumatic seat height</p>	<p>Polypropylene Seat and Back</p> <p>Ergonomic Features: C, M</p>	<table border="1"> <tr> <td>6731</td> <td>\$664</td> <td>-</td> <td>-</td> <td>-</td> <td>-</td> <td>-</td> <td>-</td> <td>-</td> <td>-</td> <td>-</td> <td>-</td> <td>-</td> </tr> </table>												6731	\$664	-	-	-	-	-	-	-	-	-	-	-													
			6731	\$664	-	-	-	-	-	-	-	-	-	-	-																									
			<table border="1"> <tr> <th colspan="3">OVERALL DIMENSIONS</th> <th colspan="3">SEAT DIMENSIONS</th> <th colspan="2">BACK DIMENSIONS</th> </tr> <tr> <th>W</th> <th>D</th> <th>H</th> <th>W</th> <th>D</th> <th>H</th> <th>W</th> <th>H</th> </tr> <tr> <td>18</td> <td>21.5</td> <td>41</td> <td>18</td> <td>17.5</td> <td>21.5-31.5</td> <td>18</td> <td>15.5</td> </tr> </table>			OVERALL DIMENSIONS			SEAT DIMENSIONS			BACK DIMENSIONS		W	D	H	W	D	H	W	H	18	21.5	41	18	17.5	21.5-31.5	18	15.5	<p>RTA 1</p>										
			OVERALL DIMENSIONS			SEAT DIMENSIONS			BACK DIMENSIONS																															
W	D	H	W	D	H	W	H																																	
18	21.5	41	18	17.5	21.5-31.5	18	15.5																																	

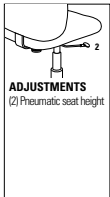
DESCRIPTION	FEATURES	MODEL#	STANDARD TEXTILE GRADES													
			1	2	3	4	5	6	7	8	9	10	11	12		
 <p>Drafting Stool w/Arms COM Yardage: 0.75 Freight Class: 150 Product Weight (lbs.): 39 Cubic Feet Per Carton: 9.75</p>	 <p>ADJUSTMENTS (2) Pneumatic seat height</p>	<p>Upholstered Seat</p> <p>Ergonomic Features: C, M</p>	6732	\$836	\$873	\$898	\$936	\$990	\$1010	\$1057	\$1149	\$1194	\$1276	\$1394	\$1535	
			OVERALL DIMENSIONS			SEAT DIMENSIONS			BACK DIMENSIONS							
			W	D	H	W	D	H	W	H						
			25.5	21.5	41	18	17.5	21.5-31.5	18	15.5						
			RTA 1													
 <p>Drafting Stool - Armless COM Yardage: 0.75 Freight Class: 250 Product Weight (lbs.): 38 Cubic Feet Per Carton: 9.75</p>	 <p>ADJUSTMENTS (2) Pneumatic seat height</p>	<p>Upholstered Seat</p> <p>Ergonomic Features: C, M</p>	6733	\$751	\$785	\$811	\$849	\$903	\$923	\$970	\$1062	\$1107	\$1190	\$1306	\$1448	
			OVERALL DIMENSIONS			SEAT DIMENSIONS			BACK DIMENSIONS							
			W	D	H	W	D	H	W	H						
			18	21.5	41	18	17.5	21.5-31.5	18	15.5						
			RTA 1													
 <p>Drafting Stool w/Arms COM Yardage: 0.75 Freight Class: 150 Product Weight (lbs.): 40 Cubic Feet Per Carton: 9.75</p>	 <p>ADJUSTMENTS (2) Pneumatic seat height</p>	<p>Upholstered Seat and Back</p> <p>Ergonomic Features: C, M</p>	6737	\$923	\$957	\$983	\$1021	\$1074	\$1095	\$1142	\$1234	\$1279	\$1362	\$1478	\$1621	
			OVERALL DIMENSIONS			SEAT DIMENSIONS			BACK DIMENSIONS							
			W	D	H	W	D	H	W	H						
			25.5	21.5	41	18	17	21.5-31.5	18	15.5						
			RTA 1													
 <p>Drafting Stool - Armless COM Yardage: 0.75 Freight Class: 150 Product Weight (lbs.): 39 Cubic Feet Per Carton: 9.75</p>	 <p>ADJUSTMENTS (2) Pneumatic seat height</p>	<p>Upholstered Seat and Back</p> <p>Ergonomic Features: C, M</p>	6738	\$836	\$871	\$897	\$935	\$988	\$1009	\$1056	\$1148	\$1193	\$1275	\$1391	\$1535	
			OVERALL DIMENSIONS			SEAT DIMENSIONS			BACK DIMENSIONS							
			W	D	H	W	D	H	W	H						
			18	21.5	41	18	17	21.5-31.5	18	16.5						
			RTA 1													
 <p>Task W/Arms and Pedestal Base COM Yardage: N/A Freight Class: 250 Product Weight (lbs.): 37 Cubic Feet Per Carton: 10.75</p>	 <p>ADJUSTMENTS (2) Pneumatic seat height</p>	<p>Polypropylene Seat and Back</p> <p>Ergonomic Features: C, M</p>	6720PB	\$787	-	-	-	-	-	-	-	-	-	-		
			OVERALL DIMENSIONS			SEAT DIMENSIONS			BACK DIMENSIONS							
			W	D	H	W	D	H	W	H						
			25.5	21.5	33	18	17.5	14-19	18	16						
			RTA 1													

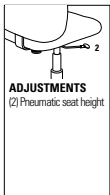
DESCRIPTION	FEATURES	MODEL#	STANDARD TEXTILE GRADES													
			1	2	3	4	5	6	7	8	9	10	11	12		
 <p>Task w/Arms, Tablet and Pedestal Base COM Yardage: N/A Freight Class: 150 Product Weight (lbs.): 45 Cubic Feet Per Carton: 10.75</p>	 <p>ADJUSTMENTS (2) Pneumatic seat height</p>	6720TRPB	\$1196	-	-	-	-	-	-	-	-	-	-	-		
		6720TLPB														
		OVERALL DIMENSIONS			SEAT DIMENSIONS			BACK DIMENSIONS								
		W	D	H	W	D	H	W	H							
			26.5	25.5	33	18	17.5	14-19	18	16						
			Ergonomic Features: C, M			RTA 1										
 <p>Task Armless w/ Pedestal Base COM Yardage: N/A Freight Class: 250 Product Weight (lbs.): 37 Cubic Feet Per Carton: 10.75</p>	 <p>ADJUSTMENTS (2) Pneumatic seat height</p>	6721PB	\$657	-	-	-	-	-	-	-	-	-	-	-		
		OVERALL DIMENSIONS			SEAT DIMENSIONS			BACK DIMENSIONS								
		W	D	H	W	D	H	W	H							
					18	21.5	33	18	17.5	14-19	18	16				
			Ergonomic Features: C, M			RTA 1										
 <p>Task Armless w/Tablet and Pedestal Base COM Yardage: N/A Freight Class: 150 Product Weight (lbs.): 43 Cubic Feet Per Carton: 10.75</p>	 <p>ADJUSTMENTS (2) Pneumatic seat height</p>	6721TRPB	\$1048	-	-	-	-	-	-	-	-	-	-	-		
		6721TLPB														
		OVERALL DIMENSIONS			SEAT DIMENSIONS			BACK DIMENSIONS								
		W	D	H	W	D	H	W	H							
			23.5	25.5	33	18	17.5	14-19	18	16						
			Ergonomic Features: C, M			RTA 1										
 <p>Task w/Arms and Pedestal Base COM Yardage: 0.75 Freight Class: 250 Product Weight (lbs.): 40 Cubic Feet Per Carton: 10.75</p>	 <p>ADJUSTMENTS (2) Pneumatic seat height</p>	6722PB	\$844	\$868	\$886	\$913	\$952	\$969	\$1005	\$1059	\$1101	\$1147	\$1244	\$1348		
		OVERALL DIMENSIONS			SEAT DIMENSIONS			BACK DIMENSIONS								
		W	D	H	W	D	H	W	H							
					25.5	21.5	32.5	18	17.5	14.5-19.5	18	15.5				
			Ergonomic Features: C, M			RTA 1										
 <p>Task w/Arms, Tablet and Pedestal Base COM Yardage: 0.75 Freight Class: 150 Product Weight (lbs.): 45 Cubic Feet Per Carton: 10.75</p>	 <p>ADJUSTMENTS (2) Pneumatic seat height</p>	6722TRPB	\$1237	\$1261	\$1279	\$1306	\$1345	\$1362	\$1396	\$1452	\$1494	\$1540	\$1637	\$1740		
		6722TLPB														
		OVERALL DIMENSIONS			SEAT DIMENSIONS			BACK DIMENSIONS								
		W	D	H	W	D	H	W	H							
			26.5	25.5	32.5	18	17.5	14.5-19.5	18	15.5						
			Ergonomic Features: C, M			RTA 1										

DESCRIPTION	FEATURES	MODEL#	STANDARD TEXTILE GRADES											
			1	2	3	4	5	6	7	8	9	10	11	12
 Task Armless w/Pedestal Base COM Yardage: 0.75 Freight Class: 250 Product Weight (lbs.): 38 Cubic Feet Per Carton: 10.75	 ADJUSTMENTS (2) Pneumatic seat height	6723PB Upholstered Seat Ergonomic Features: C, M RTA 1	\$716	\$740	\$757	\$783	\$820	\$836	\$871	\$924	\$965	\$1010	\$1106	\$1204
			OVERALL DIMENSIONS			SEAT DIMENSIONS			BACK DIMENSIONS					
			W	D	H	W	D	H	W	H				
			18	21.5	32.5	18	17	14.5-19.5	18	15.5				
 Task w/Arms, Tablet and Pedestal Base COM Yardage: 0.75 Freight Class: 150 Product Weight (lbs.): 45 Cubic Feet Per Carton: 10.75	 ADJUSTMENTS (2) Pneumatic seat height	6723TRPB 6723TLPB Upholstered Seat Specify (L) left or (R) right tablet. Ergonomic Features: C, M RTA 1	\$1104	\$1128	\$1145	\$1171	\$1208	\$1223	\$1258	\$1311	\$1350	\$1396	\$1489	\$1589
			OVERALL DIMENSIONS			SEAT DIMENSIONS			BACK DIMENSIONS					
			W	D	H	W	D	H	W	H				
			23.5	25.5	32.5	18	17	14.5-19.5	18	15.5				
 Task w/Arms and Pedestal Base COM Yardage: 0.75 Freight Class: 250 Product Weight (lbs.): 40 Cubic Feet Per Carton: 10.75	 ADJUSTMENTS (2) Pneumatic seat height	6727PB Upholstered Seat and Back Ergonomic Features: C, M RTA 1	\$932	\$960	\$978	\$1008	\$1048	\$1067	\$1104	\$1165	\$1208	\$1259	\$1364	\$1474
			OVERALL DIMENSIONS			SEAT DIMENSIONS			BACK DIMENSIONS					
			W	D	H	W	D	H	W	H				
			25.5	21.5	32.5	18	17	14.5-19.5	18	16				
 Task w/Arms, Tablet and Pedestal Base COM Yardage: 0.75 Freight Class: 150 Product Weight (lbs.): 46 Cubic Feet Per Carton: 10.75	 ADJUSTMENTS (2) Pneumatic seat height	6727TRPB 6727TLPB Upholstered Seat and Back Specify (L) left or (R) right tablet. Ergonomic Features: C, M RTA 1	\$1360	\$1388	\$1406	\$1436	\$1476	\$1496	\$1532	\$1593	\$1638	\$1688	\$1793	\$1905
			OVERALL DIMENSIONS			SEAT DIMENSIONS			BACK DIMENSIONS					
			W	D	H	W	D	H	W	H				
			26.5	25.5	32.25	18	17	14.5-19.5	18	16				
 Task Armless w/Tablet and Pedestal Base COM Yardage: 0.75 Freight Class: 250 Product Weight (lbs.): 40 Cubic Feet Per Carton: 10.75	 ADJUSTMENTS (2) Pneumatic seat height	6728PB Upholstered Seat and Back Ergonomic Features: C, M RTA 1	\$801	\$827	\$846	\$874	\$915	\$934	\$970	\$1027	\$1072	\$1122	\$1223	\$1333
			OVERALL DIMENSIONS			SEAT DIMENSIONS			BACK DIMENSIONS					
			W	D	H	W	D	H	W	H				
			18	21.5	32.5	18	17	14.5-19.5	18	15.5				

DESCRIPTION	FEATURES	MODEL#	STANDARD TEXTILE GRADES																															
			1	2	3	4	5	6	7	8	9	10	11	12																				
 <p>Task Armless w/Tablet and Pedestal Base COM Yardage: 0.75 Freight Class: 150 Product Weight (lbs.): 46 Cubic Feet Per Carton: 10.75</p>	 <p>ADJUSTMENTS (2) Pneumatic seat height</p>	6728TRPB 6728TLPB	\$1220	\$1245	\$1264	\$1293	\$1334	\$1353	\$1388	\$1446	\$1491	\$1541	\$1642	\$1752																				
		<table border="1"> <thead> <tr> <th colspan="3">OVERALL DIMENSIONS</th> <th colspan="3">SEAT DIMENSIONS</th> <th colspan="2">BACK DIMENSIONS</th> </tr> <tr> <th>W</th> <th>D</th> <th>H</th> <th>W</th> <th>D</th> <th>H</th> <th>W</th> <th>H</th> </tr> </thead> <tbody> <tr> <td>23.5</td> <td>25.5</td> <td>32.25</td> <td>18</td> <td>17</td> <td>14.5-19.5</td> <td>18</td> <td>15.5</td> </tr> </tbody> </table>	OVERALL DIMENSIONS			SEAT DIMENSIONS			BACK DIMENSIONS		W	D	H	W	D	H	W	H	23.5	25.5	32.25	18	17	14.5-19.5	18	15.5								
OVERALL DIMENSIONS			SEAT DIMENSIONS			BACK DIMENSIONS																												
W	D	H	W	D	H	W	H																											
23.5	25.5	32.25	18	17	14.5-19.5	18	15.5																											
	Upholstered Seat and Back Specify (L) left or (R) right tablet. Ergonomic Features: C, M	<div style="background-color: black; color: white; padding: 2px; display: inline-block;">RTA 1</div>																																



Duet tables are multi-purpose stacking tables that offer optimum space utilization and flexibility. Their personality and simple design make them ideal for use in any learning or training environment at post-secondary and adult levels. Temporarily and easily convert auditoriums and other spaces into examination and seminar spaces. They can be partnered with stacking chairs such as Duet or Popcorn in matching or complementary colors (stacking chairs can be found in the Multi-Purpose section of the Seating price list).

The one-piece molded top and modesty are gently contoured providing an eased edge with an elegant waterfall transition from top to modesty.

Tops are available in a wide array of colors in 0.5" thick polypropylene. Polypropylene material offers strength and ease of cleaning with a slightly textured surface to offer scratch resistance.



Features and Benefits

- One-piece molded top and modesty are 0.5" thick polypropylene.
- Tables are rated 250 lbs. capacity.
- Surface includes factory installed metal inserts for solid and secure connection to the sled frame.
- 0.5" diameter solid steel rod sled frame.
- Bumpers on the underside for protection when stacking.
- Model with ADA width compliant frame is available.
- Shipped fully assembled.



One-piece top and modesty.



Stacks 5 high on floor or 20 high on dolly.

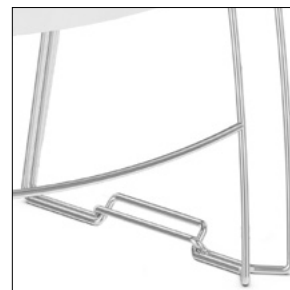

Ganging frame to keep tables evenly aligned.

GENERAL INFORMATION

- Duet tables are multi-purpose stacking tables ideal for auditoriums, seminars or any learning or training environment.
- Lightweight and easy to handle whether stacking for storage or setting up a room.
- Made of durable materials to withstand more demanding environments.
- Shipped fully assembled. Packaged 4 per carton.
- Global products are in compliance with stringent emission guidelines set out by the Greenguard Environmental Institute under the standards for low emitting products and materials. www.greenguard.org.
- Covered by Global's Lifetime Warranty.
- **Level 2 Certified.**

WORKSURFACES

- Top and modesty are a one-piece injection molded design in 0.5" thick polypropylene.
- Available in a wide array of colors (see right column "FINISHES") to complement any space or to define sections by color.
- One-piece molded top and modesty are contoured providing an eased user edge, with an elegant waterfall transition from top to modesty.

26" W x 18" D x 9.75" H

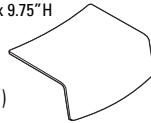

CONSTRUCTION

- Surface includes molded in threaded inserts to provide a secure metal-to-metal connection to the sled frame.
- Bumpers are included on the underside of top and inside modesty to protect surfaces when stacking.

FRAME

- 0.5" diameter solid steel rod sled frame.
- Available in a durable Chrome finish.
- Model with ganging frame keeps tables evenly positioned and aligned. No tools or fasteners required for ganging; the frames simply interlock.
- Model with ADA compliant frame is also available. The frame is 33" wide and the polypropylene top/modesty remain a constant size.
- Tables are standard without glides and are suitable for carpet, rubber or cork flooring.
- Glide options are available (see right column "GLIDES"). Glides must be chosen to best suit flooring type and site conditions. Upcharges apply.

DOLLY

- For space saving storage and transport.
- Constructed from 1.5" x 0.5" steel tubing with heavy duty casters (two locking) and a removable handle.
- Dolly can stack up to 20 tables.
- Stacking height on dolly is up to 68".

FINISHES

BZB	Buzz Blue	FRO	Frost
CCT	Cactus	INK	Ink
CRO	Carrot	LAB	Latte
IVC	Cloud	BLK	Night
DJN	Dijon	SND	Sand
EGP	Eggplant	SAR	Scarlet
FOG	Fog	SHW	Shadow

GLIDES

CG	Clear polycarbonate (for carpet, rubber or concrete flooring). Height added to table: 0.18". Add \$16/set.
SG	Glides with stainless steel pads (for carpet or rubber flooring). Height added to table: 0.17". Add \$31/set.
FG	Glides with felt pads (for vinyl, cork or laminate flooring). Height added to table: 0.24". Add \$31/set.
RG	Glides with rubber pads (for vinyl, hardwood, laminate, stone or ceramic flooring). Height added to table: 0.16". Add \$31/set.

SPECIFICATIONS

- Specifications marked with an * are applicable to only those products which have the* symbol beside the product name.

EXAMPLE DUET TABLE ORDER CODE:

Duet stacking table, polypropylene surface in Shadow, clear polycarbonate glides

DTS1828P	-SHW	-CG
Model #	Surface finish	Glides

Required specifications

Top finish*

Optional specifications

Glide option*

STACKING TABLES **MODEL#** **DIMENSIONS** **FREIGHT CLASS** **WT/LBS.** **CUBIC FT.** **LIST PRICE**

D x W x H

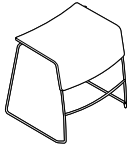

Stacking Table*

DTS1828P	25 x 29 x 28	150	26	17.75	\$477
----------	--------------	-----	----	-------	--------------

One-piece polypropylene top and modesty with Chrome frame. Shipped fully assembled, 4 per carton.

- Price shown is per table. It is recommended to order in multiples of 4.
- Please be sure to select the appropriate glide (see previous page) for the flooring surface, as scratches could occur.
- Worksurface is 18"D x 28"W

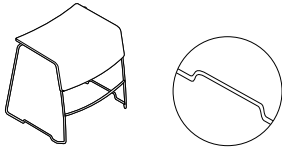

Stacking Table, Ganging Frame*

DTS1828PG	25 x 30.75 x 28	150	26	17.75	\$509
-----------	-----------------	-----	----	-------	--------------

One-piece polypropylene top and modesty with Chrome ganging frame.

Shipped fully assembled, 4 per carton.

- Price shown is per table. It is recommended to order in multiples of 4.
- Please be sure to select the appropriate glide (see previous page) for the flooring surface, as scratches could occur.
- Worksurface is 18"D x 28"W

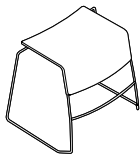

Stacking Table, 32" Wide*

DTA1832P	25 x 33 x 28	150	26	17.75	\$539
----------	--------------	-----	----	-------	--------------

ADA (American with Disabilities Act) compliant. 33" wide. One-piece polypropylene top and modesty with Chrome frame. Underside clearance is 27.1"H (extra height if glides are selected). Stacks up to 5 high on floor only; dolly does not accommodate. Shipped fully assembled, 4 per carton.

- Price shown is per table. It is recommended to order in multiples of 4.
- Please be sure to select the appropriate glide (see previous page) for the flooring surface, as scratches could occur.
- Worksurface is 18"D x 32"W

DOLLY



Dolly

DTD20	29.5 x 63 x 38.5	250	50	21	\$693
-------	------------------	-----	----	----	--------------

For use with tables DTS1828P and DTS1828PG. Can stack up to 20 tables. Black only. Removable handle for storage. Shipped fully assembled in 1 carton.

ERIN



model GC36531
Armless Guest Chair,
Metal Legs



model GC36532
Guest Armchair,
Wood Legs

STANDARD FEATURES

- Erin offers a streamlined silhouette brimming with mid-century modern style.
- A rounded arch gently curves around and under the seat to give extra support to a user's upper back and sides, while creating an open clean-out space at the back of the cushion.
- The series is available to specify with two textiles, one for the seat cushion and one for the back, arms and front rail (see model image).
- For pricing, start with the base price and add both back/arms graded textile upcharge and the seat graded textile upcharge.
- Tapered legs add style and elegance.
- Legs are available in wood or metal painted/plated finishes (noted).
- The seat underside is sealed with a non-porous material to support housekeeping and infection control protocols.
- Additional improved cleaning options include sealed seams (back and/or seat) and moisture barrier (seat). Upcharges apply.
- Assembled with tamper-resistant fasteners for greater security.
- For added comfort, the seat cushions are standard with high density Ultracell foam.
- Glides are self-leveling. Choose from standard non-marking glides, rubber non-slip glides or felt glides (upcharges apply).
- The Globalcare warranty (for healthcare and 24/7 environments) applies for all Erin GC models when performance textiles are selected. Visit the website at globalfurnituregroup.com/healthcare.
- Global's standard lifetime warranty applies when approved standard Global textiles are selected.
- For alternate textile applications, contact Global specials. The Blended Textile matrix does not apply to this series.
- Shipped fully assembled.

SUGGESTED APPLICATIONS

- Dining/Cafeteria
- Guest seating
- Lobbies
- Lounge/Waiting
- Patient rooms
- Resident rooms





OPTIONAL FEATURES

Please add option codes in the following order:

- **Model number**
GC36530 Guest armless chair, wood legs
GC36531 Guest armless chair, metal legs
GC36532 Guest armchair, wood legs
GC36533 Guest armchair, metal legs
- **Back/Arm Textile**
Specify textile code. See model grade upcharges.
- **Seat Textile**
Specify textile code. See model grade upcharges.
- **Wood leg finish** (models GC36530 and GC36532)
(AAM) Absolute **(MWM)** Medium Walnut
(BKM) Black **(NLW)** Natural Walnut
(CJM) Charcoal Java **(ASM)** Night
(ACM) Cherry **(NBM)** Noce Biondo
(EMM) Empire Mahogany **(NGM)** Noce Grigio
(EOM) English Oak **(NEM)** Noce Leggero
(ECM) Espresso Cafe **(NMM)** Noce Medio
(TFM) Fruitwood **(SBM)** Sandy Beach
(HGM) Grey **(SKM)** Shaker Cherry
(HOM) Harvest Oak **(SOM)** Silver Oak
(AHM) Honey **(TWM)** Walnut
(JOM) Jet Onyx **(WTM)** WC Cream
(LHM) Light Honey **(WHM)** White
(TMM) Mahogany **(WCM)** Winter Cherry
(AVM) Maple
- **Metal leg finish** (models GC36531 and GC36533)
(CHM) Chrome **(TTU)** Tungsten
(TBL) Black **(TKA)** Kalua
(TLA) Latte **(TMO)** Mocha
(TSH) Shadow **(TOA)** Toast
- **Glides**
(NM) Non-marking glide. No upcharge
(RG) Rubber, non-slip glide. Add \$55.
(FG) Felt glide. Add \$55.
- **Sealed Back Seams** (Contact Customer Care for approved textiles)
(NBS) No sealed back seams
(SBS) Sealed back seams. Upcharges vary, see model.
- **Sealed Seat Seams** (Contact Customer Care for approved textiles)
(NSS) No sealed seat seams
(SSS) Sealed seat seams. Add \$18.
- **Moisture Barrier** (Not available with Sealed Seams)
(NB) No moisture barrier.
(MB) Moisture barrier (seat only). Add \$101.

EXAMPLE ERIN ORDER CODE:

GC36530	CE90	CE90	AAM	NM	NBS	NSS	NB
Model #	Seat/Arm textile	Seat textile	Leg finish	Glide	Sealed Back Seams	Sealed Seat Seams	Moisture Barrier

DESCRIPTION	MODEL#/ FEATURES	STANDARD TEXTILE GRADES											
		1/COM	2	3	4	5	6	7	8	9	10	11	12
 <p>Armless Guest Chair, Wood Legs COM Yardage: Back/Arm: 1.75; Seat: 1 Freight Class: 250 Product Weight (lbs.): 32.5 Cubic Feet Per Carton: 13.25</p>	GC36530 Base Price:	\$1751											
	Back/Arm upcharge:	+0	+\$56	+\$100	+\$165	+\$256	+\$294	+\$373	+\$497	+\$590	+\$692	+\$903	+\$1126
	Seat upcharge:	+0	+\$32	+\$57	+\$94	+\$146	+\$168	+\$213	+\$284	+\$337	+\$395	+\$516	+\$643
	OVERALL DIMENSIONS	SEAT DIMENSIONS			BACK DIMENSIONS								
	W D H	W	D	H	W	D	H	W	H				
	24	22.25	34	19	18	19	15	15.5					
<p>Active weight 350 lbs. Add \$45 for (SBS), \$18 for (SSS)</p>													
 <p>Armless Guest Chair, Metal Legs COM Yardage: Back/Arm: 1.75; Seat: 1 Freight Class: 250 Product Weight (lbs.): 34.5 Cubic Feet Per Carton: 13.25</p>	GC36531 Base Price:	\$1667											
	Back/Arm upcharge:	+0	+\$56	+\$100	+\$165	+\$256	+\$294	+\$373	+\$497	+\$590	+\$692	+\$903	+\$1126
	Seat upcharge:	+0	+\$32	+\$57	+\$94	+\$146	+\$168	+\$213	+\$284	+\$337	+\$395	+\$516	+\$643
	OVERALL DIMENSIONS	SEAT DIMENSIONS			BACK DIMENSIONS								
	W D H	W	D	H	W	D	H	W	H				
	24	22.25	34	19	18	19	15	15.5					
<p>Active weight 350 lbs. Add \$45 for (SBS), \$18 for (SSS)</p>													
 <p>Guest Armchair, Wood Legs COM Yardage: Back/Arm: 1.75; Seat: 1 Freight Class: 250 Product Weight (lbs.): 33 Cubic Feet Per Carton: 13.25</p>	GC36532 Base Price:	\$1751											
	Back/Arm upcharge:	+0	+\$56	+\$100	+\$165	+\$256	+\$294	+\$373	+\$497	+\$590	+\$692	+\$903	+\$1126
	Seat upcharge:	+0	+\$32	+\$57	+\$94	+\$146	+\$168	+\$213	+\$284	+\$337	+\$395	+\$516	+\$643
	OVERALL DIMENSIONS	SEAT DIMENSIONS			BACK DIMENSIONS								
	W D H	W	D	H	W	D	H	W	H				
	24	22	34.25	19	18.5	18.5	17	15.75					
<p>Active weight 350 lbs. Add \$48 for (SBS), \$18 for (SSS)</p>													
 <p>Guest Armchair, Metal Legs COM Yardage: Back/Arm: 1.75; Seat: 1 Freight Class: 250 Product Weight (lbs.): 35 Cubic Feet Per Carton: 13.25</p>	GC36533 Base Price:	\$1667											
	Back/Arm upcharge:	+0	+\$56	+\$100	+\$165	+\$256	+\$294	+\$373	+\$497	+\$590	+\$692	+\$903	+\$1126
	Seat upcharge:	+0	+\$32	+\$57	+\$94	+\$146	+\$168	+\$213	+\$284	+\$337	+\$395	+\$516	+\$643
	OVERALL DIMENSIONS	SEAT DIMENSIONS			BACK DIMENSIONS								
	W D H	W	D	H	W	D	H	W	H				
	24	22	34.25	19	18.5	18.5	17	15.75					
<p>Active weight 350 lbs. Add \$48 for (SBS), \$18 for (SSS)</p>													

FILE BUDDY™







model 1105

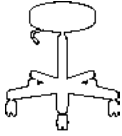

model 1110 Shown with 25-400 Vertical File

STANDARD FEATURES

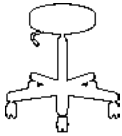
- Standard with C65 casters.
- Shipped R.T.A. (Ready to assemble).
- Pneumatic. Black, five-legged, injection molded base.
- 14" diameter seat.
- Check textile availability prior to specifying upholstery material.

DESCRIPTION	FEATURES	MODEL#	STANDARD TEXTILE GRADES											
			1	2	3	4	5	6	7	8	9	10	11	12
 <p>Swivel Stool 5" Pneumatic, 20" Base COM Yardage: 0.75 Freight Class: 150 Product Weight (lbs.): 14 Cubic Feet Per Carton: 2.9</p>		1105	\$387	\$412	\$432	\$464	\$504	\$527	\$557	\$629	\$661	\$725	\$815	\$926
			OVERALL DIMENSIONS			SEAT DIMENSIONS			BACK DIMENSIONS					
			W	D	H	W	D	H	W	H				
			14	14	18.5	14	-	16.5-21.5	-	-				
														
 <p>Swivel Stool 10" Pneumatic, 22" Base COM Yardage: 0.75 Freight Class: 150 Product Weight (lbs.): 14 Cubic Feet Per Carton: 2.9</p>		1110	\$453	\$475	\$497	\$529	\$569	\$590	\$619	\$690	\$724	\$790	\$880	\$991
			OVERALL DIMENSIONS			SEAT DIMENSIONS			BACK DIMENSIONS					
			W	D	H	W	D	H	W	H				
			14	14	18.5	14	-	22.5-32.5	-	-				
														

FLAP™



Folding Chair
model 6775

STANDARD FEATURES

- A modern design, high quality, lightweight, all polymer folding chair intended for use indoors or outdoors. Products must be stored inside during extreme and inclement weather. See Global's Outdoor Furniture warranty for additional information.
- Weather resistant, UV resistant, stain resistant, 100% non-ferrous, and recyclable design that is 1:10 bleach solution cleanable.
- Chair legs are equipped with clear non-marking glides as standard. Suitable for outdoor environments, carpet and hard surface flooring
- Chairs are stocked in 2 colors:
Alloy (**ALY**)
Milk (**MLK**)
- No upholstery options available
- Rated to 275 lbs.
- Single chair folds flat to 2.2" (55 mm).
- Flap achieves its strength and durability using glass filled polymer. Evidence of this material may be visible on the surface and is often more evident in darker colors.
- All Flap products are only available through Global's InStock program. Contact CustomerCare for lead times and quotation for quantities beyond InStock inventory.
- The Flap Wall Hook (6776), sold individually, supports up to two folded Flap chairs. This Milk (**MLK**) colored plastic hook mounts on walls or inside closets and wardrobe cabinets providing easy access to extra seating. Two chairs on Wall Hook measure 7.3" (185 mm) deep off wall. Mounting hardware not included. Recommended mounting into stud.
- Flap Ganging Brackets (6778) are sold 12 to a

box. These translucent, frosted plastic brackets attach across two adjacent chairs, just above or below the seat to provide temporary ganging for organized events.





- The Flap Dolly (6777), ordered separately, supports up to 24 chairs folded and stacked flat. Includes strap to secure chairs for storage and transport.



Please add option codes in the following order

- **Model number**
6775 Folding Chair
6776 Wall Hook
6777 Dolly
6778 Ganging Brackets
- **Chair Color**
(ALY) Alloy
(MLK) Milk

EXAMPLE OF FLAP ORDER CODE:

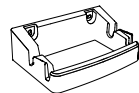
6775	ALY
Model Number	Finish

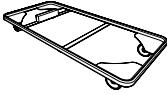
DESCRIPTION	FEATURES	MODEL#	STANDARD TEXTILE GRADES																										
			1	2	3	4	5	6	7	8	9	10	11	12															
 <p>Folding Chair COM Yardage: N/A Freight Class: 100 Product Weight (lbs.): 13.5 Cubic Feet Per Carton: 1.6</p>	<p>Shipped 2 per box. Ordered as each.</p>	6775	214																										
		<table border="1"> <thead> <tr> <th colspan="3">OVERALL DIMENSIONS</th> <th colspan="3">SEAT DIMENSIONS</th> <th colspan="2">BACK DIMENSIONS</th> </tr> <tr> <th>W</th><th>D</th><th>H</th> <th>W</th><th>D</th><th>H</th> <th>W</th><th>H</th> </tr> </thead> <tbody> <tr> <td>19</td><td>21.5</td><td>33.5</td> <td>16</td><td>16.5</td><td>18.5</td> <td>18.5</td><td>16</td> </tr> </tbody> </table>			OVERALL DIMENSIONS			SEAT DIMENSIONS			BACK DIMENSIONS		W	D	H	W	D	H	W	H	19	21.5	33.5	16	16.5	18.5	18.5	16	  2 per carton (pricing and specifications are for one chair)
		OVERALL DIMENSIONS			SEAT DIMENSIONS			BACK DIMENSIONS																					
		W	D	H	W	D	H	W	H																				
19	21.5	33.5	16	16.5	18.5	18.5	16																						
<table border="1"> <thead> <tr> <th colspan="3">OVERALL DIMENSIONS</th> <th colspan="3">SEAT DIMENSIONS</th> <th colspan="2">BACK DIMENSIONS</th> </tr> <tr> <th>W</th><th>D</th><th>H</th> <th>W</th><th>D</th><th>H</th> <th>W</th><th>H</th> </tr> </thead> <tbody> <tr> <td>9</td><td>6</td><td>2.75</td> <td></td><td></td><td></td> <td></td><td></td> </tr> </tbody> </table>			OVERALL DIMENSIONS			SEAT DIMENSIONS			BACK DIMENSIONS		W	D	H	W	D	H	W	H	9	6	2.75						  1 per carton		
OVERALL DIMENSIONS			SEAT DIMENSIONS			BACK DIMENSIONS																							
W	D	H	W	D	H	W	H																						
9	6	2.75																											
 <p>Flap Wall Hook COM Yardage: N/A Freight Class: 70 Product Weight (lbs.): 0.75 Cubic Feet Per Carton: 0.2</p>																													

DESCRIPTION	FEATURES	MODEL#	STANDARD TEXTILE GRADES																			
			1	2	3	4	5	6	7	8	9	10	11	12								
 <p>Dolly for Flap Folding Chairs COM Yardage: N/A Freight Class: 150 Product Weight (lbs.): 23 Cubic Feet Per Carton: 4.5</p>	Holds up to 24 Flap folded chairs. Includes tether strap.	6777	614																			
		OVERALL DIMENSIONS			SEAT DIMENSIONS			BACK DIMENSIONS														
		W	D	H	W	D	H	W	H													
		20.75	44	5.25																		
						RTA 00	ups	1 per carton														
 <p>Flap Ganging Bracket (box of 12) COM Yardage: N/A Freight Class: 70 Product Weight (lbs.): 0.29 Cubic Feet Per Carton: 0.03</p>		6778	188																			
		OVERALL DIMENSIONS			SEAT DIMENSIONS			BACK DIMENSIONS														
		W	D	H	W	D	H	W	H													
		0	0	0																		
						RTA 00	ups	12 per carton (pricing and specifications are for box of 12)														

ISLANDS™



model 4075



model 4076





Leather upholstered seat and back additional stitch detail shown.

STANDARD FEATURES

- Islands offers wood guest seating with contemporary styling.
- Offered in two styles; Upholstered back pad or Horizontal wood slat.
- Check textile availability prior to specifying upholstery material.
- When upholstered in Leather, there are additional stitching details with a seam across the middle of the back and two seams on the seat.
- Does not stack.

OPTIONAL FEATURES

- Frame available in Absolute (AAM), Black (BKM), Cherry (ACM), Espresso Cafe (ECM), English Oak (EOM), Fruitwood (TFM), Gray (HGM), Honey (AHM), Mahogany (TMM), Maple (AVM), Medium Walnut (MWM), Natural Walnut (NLW), Night (ASM), Noce Biondo (NBM), Noce Grigio (NGM), Noce Leggero (NEM), Noce Medio (NMM), Shaker Cherry (SKM), Walnut (TWM), WC Cream (WTM), White (WHM) and Winter Cherry (WCM). Please Specify. Genuine maple faced veneers and solids are used.

DESCRIPTION	FEATURES	MODEL#	STANDARD TEXTILE GRADES													
			1	2	3	4	5	6	7	8	9	10	11	12		
 <p>4075</p> <p>Armchair Upholstered back. COM Yardage: 1.5 Freight Class: 300 Product Weight (lbs.): 25 Cubic Feet Per Carton: 13.25</p>	<p>Does not stack.</p> <p>Ergonomic Features: M, N</p>	4075	\$891	\$941	\$981	\$1037	\$1118	\$1158	\$1232	\$1350	\$1441	\$1541	\$1751	\$1972		
		OVERALL DIMENSIONS			SEAT DIMENSIONS			BACK DIMENSIONS								
		W	D	H	W	D	H	W	H							
		24.5	23.5	32	20.5	18	18.5	19	13							
 <p>4076</p> <p>Armchair Horizontal wood slat back. COM Yardage: 1 Freight Class: 300 Product Weight (lbs.): 25 Cubic Feet Per Carton: 13.25</p>	<p>Does not stack.</p> <p>Ergonomic Features: M, N</p>	4076	\$945	\$980	\$1007	\$1044	\$1099	\$1125	\$1174	\$1253	\$1312	\$1380	\$1519	\$1666		
		OVERALL DIMENSIONS			SEAT DIMENSIONS			BACK DIMENSIONS								
		W	D	H	W	D	H	W	H							
		24.5	23.5	32	20.5	18	18.5	19	13							

LAYNE™



model 8520T







model 8525T

STANDARD FEATURES

- Layne offers classic styling and value in a finely crafted wood framed side chair series.
- Frame construction is beechwood.
- Legs are equipped with White non-marking polypropylene glides. Suitable for both carpet and hard surface flooring.
- Offered in four back styles; Fully Upholstered, Picture Frame or Vertical Wood Slat.
- Check textile availability prior to specifying upholstery material.
- Does not stack.

OPTIONAL FEATURES

- Wood frames are available in Absolute (AAM), Black (BKM), Cherry (ACM), Espresso Cafe (ECM), English Oak (EOM), Fruitwood (TFM), Gray (HGM), Honey (AHM), Mahogany (TMM), Maple (AVM), Medium Walnut (MWM), Natural Walnut (NLW), Night (ASM), Noce Biondo (NBM), Noce Grigio (NGM), Noce Leggero (NEM), Noce Medio (NMM), Shaker Cherry (SKM), Walnut (TWM), WC Cream (WTM), White (WHM) and Winter Cherry (WCM). Please Specify.

DESCRIPTION	FEATURES	MODEL#	STANDARD TEXTILE GRADES												
			1	2	3	4	5	6	7	8	9	10	11	12	
 <p>Armless Upholstered Side Chair COM Yardage: 1 Freight Class: 300 Product Weight (lbs.): 21 Cubic Feet Per Carton: 13.25</p>	<p>Does not stack.</p> <p>Ergonomic Features: M, N</p>	8520T	\$799	\$841	\$872	\$917	\$983	\$1007	\$1064	\$1174	\$1226	\$1326	\$1464	\$1636	
			OVERALL DIMENSIONS			SEAT DIMENSIONS			BACK DIMENSIONS						
			W	D	H	W	D	H	W	H					
			22.75	24	33	20	18.25	18	17.5	14					
			<div style="text-align: center;">RTA 00</div>												
 <p>Fully Upholstered Armchair COM Yardage: 2.25 Freight Class: 300 Product Weight (lbs.): 22 Cubic Feet Per Carton: 13.25</p>	<p>Does not stack</p> <p>Ergonomic Features: M, N</p>	8521T	\$861	\$943	\$1008	\$1105	\$1243	\$1308	\$1432	\$1631	\$1785	\$1954	\$2305	\$2679	
			OVERALL DIMENSIONS			SEAT DIMENSIONS			BACK DIMENSIONS						
			W	D	H	W	D	H	W	H					
			22.75	24	33	20	18.25	18	17.5	14					
			<div style="text-align: center;">RTA 00</div>												
 <p>Picture Frame Armchair COM Yardage: 1.25 Freight Class: 300 Product Weight (lbs.): 22 Cubic Feet Per Carton: 13.25</p>	<p>Does not stack</p> <p>Ergonomic Features: M, N</p>	8522T	\$974	\$1008	\$1033	\$1070	\$1121	\$1140	\$1188	\$1272	\$1315	\$1396	\$1507	\$1643	
			OVERALL DIMENSIONS			SEAT DIMENSIONS			BACK DIMENSIONS						
			W	D	H	W	D	H	W	H					
			22.75	24	33	20	18.25	18	17.5	14					
			<div style="text-align: center;">RTA 00</div>												
 <p>Upholstered Armchair COM Yardage: 1 Freight Class: 300 Product Weight (lbs.): 22 Cubic Feet Per Carton: 13.25</p>	<p>Does not stack</p> <p>Ergonomic Features: M, N</p>	8525T	\$909	\$952	\$983	\$1031	\$1100	\$1125	\$1184	\$1299	\$1354	\$1459	\$1604	\$1782	
			OVERALL DIMENSIONS			SEAT DIMENSIONS			BACK DIMENSIONS						
			W	D	H	W	D	H	W	H					
			22.75	24	33	20	18.25	18	17.5	14					
			<div style="text-align: center;">RTA 00</div>												

DESCRIPTION	FEATURES	MODEL#	STANDARD TEXTILE GRADES												
			1	2	3	4	5	6	7	8	9	10	11	12	
 <p>Vertical Wood Slat Armchair COM Yardage: 1 Freight Class: 300 Product Weight (lbs.): 22 Cubic Feet Per Carton: 13.25</p>	<p>Does not stack.</p> <p>Ergonomic Features: M, N</p>	8526T	\$944	\$976	\$1000	\$1038	\$1089	\$1113	\$1161	\$1235	\$1292	\$1357	\$1489	\$1630	
		OVERALL DIMENSIONS			SEAT DIMENSIONS			BACK DIMENSIONS							
		W	D	H	W	D	H	W	H						
22.75	24	33	20	18.25	18	17.5	14								
			RTA 00												

LITE



model 5940



model 5944



Closed Loop Arms.



model 5945



model 5951C



STANDARD FEATURES





- Lite is a modern series inspired by classic designs.
- Arms are standard in cantilevered or closed loop. Both are made from fiberglass reinforced nylon, available in Black only.
- Frame is heavy duty, equipped with Sytex™ high-strength polyester webbing suspension system for extra comfort.
- Cantilever frame models are 1" diameter 12 gauge tubular steel.
- Four legged frames are 1" diameter 12 gauge tubular steel front legs and 7/8" diameter 14 gauge tubular steel rear legs, depending on the model.
- Glides are non-marking polypropylene (NM) suitable for both carpet and hard surface flooring.
- All models are rated for active user load of 300 lbs. per seat.
- Dual wheel carpet casters (C82) are standard on caster models.
- Check textile availability prior to specifying upholstery material.





OPTIONAL FEATURES





- Mesh models are available in any of the 24 standard Vue Mesh colors. Seat and back will be the same color mesh. Specify color: Sandy Beach (VU10), Dessert Sand (VU11), Orange Sunset (VU12), Chocolate Fountain (VU13), Artic Blue (VU14), Quarry Grey (VU15), Tidal Wave (VU16), Ivy Moss (VU17), Red Rose (VU18), Black (VU19), White (VU20), Lime (VU21), Chartreuse (VU23), Pool Blue (VU26), Sky (VU28), Ice (VU30), Primary Blue (VU32), Tangerine (VU34), Paprika (VU37), Grain (VU40), Yellow (VU43), Silver Grey (VU55), Silver (VU63), Hot Pink (VU65) and Red Mittens (VU70)
 - A selection of glide options is available for four-legged chairs (models 5940, 5941, 5942, 5950, 5951 and 5952). Glides must be chosen to best suit flooring type and site conditions.
 - Glides with felt pads (FG) are available for vinyl sheet, cork or laminate flooring, please specify. Add \$55.
 - Glides with rubber pads (RG) are available for vinyl, hardwood, laminate, stone or ceramic flooring, please specify. Add \$55.
 - For hard floor surface flooring casters please specify C9R, add \$87.
 - **Frame finish**



(TBL) Black	(TBZ) Buzz Blue
(TCC) Cactus	(TCR) Carrot
(TDJ) Dijon	(TDW) Designer White
(TEG) Eggplant	(TFO) Fog
(TFR) Frost	(TIN) Ink
(TIV) Cloud	(TKA) Kalua
(TLA) Latte	(TMO) Mocha
(TOA) Toast	(TNE) Nevada
(TSH) Shadow	(TSN) Sand
(TSR) Scarlet	(TTU) Tungsten
 - (ACO) Antique Copper. Add 209
 - (BCH) Brushed Chrome. Add \$99
 - (CHM) Chrome. Add \$92
 - (SBR) Satin Brass. Add \$209
- Please Specify.

DESCRIPTION	FEATURES	MODEL#	STANDARD TEXTILE GRADES													
			1	2	3	4	5	6	7	8	9	10	11	12		
 <p>Four-legged Frame Armless COM Yardage: N/A Freight Class: 150 Product Weight (lbs.): 26 Cubic Feet Per Carton: 12.5</p>	Does not stack.	5940	\$741													
			OVERALL DIMENSIONS			SEAT DIMENSIONS			BACK DIMENSIONS							
			W	D	H	W	D	H	W	H						
			21.75	24.75	34.25	20	17	19	16	19						
			RTA 00													
 <p>Four-legged Frame Armless w/Casters COM Yardage: N/A Freight Class: 150 Product Weight (lbs.): 26 Cubic Feet Per Carton: 12.5</p>	Does not stack.	5940C	\$857													
			OVERALL DIMENSIONS			SEAT DIMENSIONS			BACK DIMENSIONS							
			W	D	H	W	D	H	W	H						
			21.75	24.75	34.25	20	17	19	16	19						
			RTA 00													

DESCRIPTION	FEATURES	MODEL#	STANDARD TEXTILE GRADES												
			1	2	3	4	5	6	7	8	9	10	11	12	
 <p>Four-legged Frame w/Cantilever Arms COM Yardage: N/A Freight Class: 150 Product Weight (lbs.): 29 Cubic Feet Per Carton: 13.75</p>	Does not stack.	5941	\$852												
		OVERALL DIMENSIONS			SEAT DIMENSIONS			BACK DIMENSIONS							
		W	D	H	W	D	H	W	H						
		24	25.5	34.25	20	17	19	16	19						
		RTA 00													
 <p>Four-legged Frame w/Cantilever Arms & Casters COM Yardage: N/A Freight Class: 150 Product Weight (lbs.): 29 Cubic Feet Per Carton: 13.75</p>	Does not stack.	5941C	\$968												
		OVERALL DIMENSIONS			SEAT DIMENSIONS			BACK DIMENSIONS							
		W	D	H	W	D	H	W	H						
		24	25.5	34.25	20	17	19	16	19						
		RTA 00													
 <p>Four-legged Frame w/ Loop Arms COM Yardage: N/A Freight Class: 150 Product Weight (lbs.): 29 Cubic Feet Per Carton: 13.75</p>	Does not stack.	5942	\$852												
		OVERALL DIMENSIONS			SEAT DIMENSIONS			BACK DIMENSIONS							
		W	D	H	W	D	H	W	H						
		23.75	25.5	34.25	20	17	19	16	19						
		RTA 00													
 <p>Four-legged Frame w/ Loop Arms & Casters COM Yardage: N/A Freight Class: 150 Product Weight (lbs.): 29 Cubic Feet Per Carton: 13.75</p>	Does not stack.	5942C	\$968												
		OVERALL DIMENSIONS			SEAT DIMENSIONS			BACK DIMENSIONS							
		W	D	H	W	D	H	W	H						
		23.75	25.5	34.25	20	17	19	16	19						
		RTA 00													

DESCRIPTION	FEATURES	MODEL#	STANDARD TEXTILE GRADES												
			1	2	3	4	5	6	7	8	9	10	11	12	
 Cantilever Frame Armless COM Yardage: N/A Freight Class: 150 Product Weight (lbs.): 27 Cubic Feet Per Carton: 12.5	Does not stack.	5943	\$803												
		OVERALL DIMENSIONS			SEAT DIMENSIONS			BACK DIMENSIONS							
		W	D	H	W	D	H	W	H						
		21.75	23.5	34.25	20	17	19	16	19						
		RTA 00													
 Cantilever Frame w/Cantilever Arms COM Yardage: N/A Freight Class: 150 Product Weight (lbs.): 35 Cubic Feet Per Carton: 13.75	Does not stack.	5944	\$913												
		OVERALL DIMENSIONS			SEAT DIMENSIONS			BACK DIMENSIONS							
		W	D	H	W	D	H	W	H						
		24	23.5	34.25	20	17	19	16	19						
		RTA 00													
 Cantilever Frame w/Loop Arms COM Yardage: N/A Freight Class: 150 Product Weight (lbs.): 35 Cubic Feet Per Carton: 13.75	Does not stack.	5945	\$913												
		OVERALL DIMENSIONS			SEAT DIMENSIONS			BACK DIMENSIONS							
		W	D	H	W	D	H	W	H						
		23.75	23.5	34.25	20	17	19	16	19						
		RTA 00													
 Upholstered Four-legged Frame Armless COM Yardage: 1.50 Freight Class: 150 Product Weight (lbs.): 26 Cubic Feet Per Carton: 12.5	Does not stack.	5950	\$613	\$668	\$709	\$774	\$862	\$904	\$984	\$1114	\$1211	\$1322	\$1551	\$1790	
		OVERALL DIMENSIONS			SEAT DIMENSIONS			BACK DIMENSIONS							
		W	D	H	W	D	H	W	H						
		21.75	24.75	34.25	20	17	19	16	19						
		RTA 00													
 Upholstered Four-legged Frame Armless w/Casters COM Yardage: 1.50 Freight Class: 150 Product Weight (lbs.): 26 Cubic Feet Per Carton: 12.5	Does not stack.	5950C	\$730	\$785	\$826	\$889	\$977	\$1019	\$1100	\$1230	\$1327	\$1439	\$1666	1362	
		OVERALL DIMENSIONS			SEAT DIMENSIONS			BACK DIMENSIONS							
		W	D	H	W	D	H	W	H						
		21.75	24.75	34.25	20	17	19	16	19						
		RTA 00													

DESCRIPTION	FEATURES	MODEL#	STANDARD TEXTILE GRADES											
			1	2	3	4	5	6	7	8	9	10	11	12
 <p>Upholstered Four-legged Frame w/Cantilever Arms COM Yardage: 1.50 Freight Class: 150 Product Weight (lbs.): 29 Cubic Feet Per Carton: 13.75</p>	Does not stack.	5951	\$721	\$779	\$819	\$882	\$970	\$1012	\$1094	\$1222	\$1320	\$1431	\$1659	1357
		OVERALL DIMENSIONS			SEAT DIMENSIONS			BACK DIMENSIONS						
		W	D	H	W	D	H	W	H					
		24	25.5	34.25	20	17	19	16	19					
		RTA 00												
 <p>Upholstered Four-legged Frame w/Cantilever Arms & Casters COM Yardage: 1.50 Freight Class: 150 Product Weight (lbs.): 29 Cubic Feet Per Carton: 13.75</p>	Does not stack.	5951C	\$839	\$895	\$936	\$1000	\$1088	\$1130	\$1212	\$1340	\$1438	\$1548	\$1777	1439
		OVERALL DIMENSIONS			SEAT DIMENSIONS			BACK DIMENSIONS						
		W	D	H	W	D	H	W	H					
		24	25.5	34.25	20	17	19	16	19					
		RTA 00												
 <p>Upholstered Four-legged Frame w/Loop Arms COM Yardage: 1.50 Freight Class: 150 Product Weight (lbs.): 29 Cubic Feet Per Carton: 13.75</p>	Does not stack.	5952	\$721	\$779	\$819	\$882	\$970	\$1012	\$1094	\$1222	\$1320	\$1431	\$1659	1357
		OVERALL DIMENSIONS			SEAT DIMENSIONS			BACK DIMENSIONS						
		W	D	H	W	D	H	W	H					
		23.75	25.5	34.25	20	17	19	16	19					
		RTA 00												
 <p>Upholstered Four-legged Frame w/Loop Arms & Casters COM Yardage: 1.50 Freight Class: 150 Product Weight (lbs.): 29 Cubic Feet Per Carton: 13.75</p>	Does not stack.	5952C	\$839	\$895	\$936	\$1000	\$1088	\$1130	\$1212	\$1340	\$1438	\$1548	\$1777	1439
		OVERALL DIMENSIONS			SEAT DIMENSIONS			BACK DIMENSIONS						
		W	D	H	W	D	H	W	H					
		23.75	25.5	34.25	20	17	19	16	19					
		RTA 00												
 <p>Upholstered Cantilever Frame Armless COM Yardage: 1.50 Freight Class: 150 Product Weight (lbs.): 27 Cubic Feet Per Carton: 12.5</p>	Does not stack.	5953	\$672	\$730	\$770	\$833	\$921	\$963	\$1045	\$1173	\$1271	\$1382	\$1610	1323
		OVERALL DIMENSIONS			SEAT DIMENSIONS			BACK DIMENSIONS						
		W	D	H	W	D	H	W	H					
		21.75	23.5	34.25	20	17	19	16	19					
		RTA 00												

DESCRIPTION	FEATURES	MODEL#	STANDARD TEXTILE GRADES											
			1	2	3	4	5	6	7	8	9	10	11	12
 <p>Upholstered Cantilever Frame w/Cantilever Arms COM Yardage: 1.50 Freight Class: 150 Product Weight (lbs.): 35 Cubic Feet Per Carton: 13.75</p>	Does not stack.	5954	\$784	\$839	\$880	\$943	\$1033	\$1074	\$1154	\$1284	\$1382	\$1493	\$1720	\$1961
		OVERALL DIMENSIONS			SEAT DIMENSIONS			BACK DIMENSIONS						
		W	D	H	W	D	H	W	H					
		24	23.5	34.25	20	17	19	16	19					
		RTA 00												
 <p>Upholstered Cantilever Frame w/Loop Arms COM Yardage: 1.50 Freight Class: 150 Product Weight (lbs.): 35 Cubic Feet Per Carton: 13.75</p>	Does not stack.	5955	\$784	\$839	\$880	\$943	\$1033	\$1074	\$1154	\$1284	\$1382	\$1493	\$1720	1400
		OVERALL DIMENSIONS			SEAT DIMENSIONS			BACK DIMENSIONS						
		W	D	H	W	D	H	W	H					
		23.75	23.5	34.25	20	17	19	16	19					
		RTA 00												

MARCHE™



STANDARD FEATURES

- A contemporary wood seating series.
- Legs are standard in Black with Black non-marking glides.
- Does not stack.
- Check textile availability prior to specifying upholstery material.





OPTIONAL FEATURES





- Wood backs are available in Absolute (AAM), Black (BKM), Cherry (ACM), English Oak (EOM), Espresso Cafe (ECM), Fruitwood (TFM), Gray (HGM), Honey (AHM), Mahogany (TMM), Maple (AVM), Medium Walnut (MWM), Night (ASM),

Noce Biondo (NBM), Noce Grigio (NGM), Noce Leggero (NEM), Noce Medio (NMM), Shaker Cherry (SKM), Walnut (TWM), WC Cream (WTM), White (WHM) and Winter Cherry (WCM). Please Specify.

- Optional finishes are available at an upcharge. For models 8621, 8622 or 8624 add \$87 for Chrome (CHM) or Brushed Chrome (BCH), Add \$60 for Tungsten (TTU).

For models 8621S, 8622S or 8624S add \$115 for Chrome (CHM) or Brushed Chrome (BCH), Add \$77 for Tungsten (TTU).

DESCRIPTION	FEATURES	MODEL#	STANDARD TEXTILE GRADES											
			1	2	3	4	5	6	7	8	9	10	11	12
 <p>Side Chair Open wood back COM Yardage: 1 Freight Class: 250 Product Weight (lbs.): 27 Cubic Feet Per Carton: 11.25</p>	Does not stack.	8621	\$1094	\$1128	\$1156	\$1195	\$1252	\$1278	\$1330	\$1412	\$1475	\$1545	\$1690	\$1844
			OVERALL DIMENSIONS			SEAT DIMENSIONS			BACK DIMENSIONS					
			W	D	H	W	D	H	W	H				
			20	21	31.5	19	16.5	19	20	13.5				
			RTA 00											
 <p>Side Chair Closed Upholstered Wood back COM Yardage: 2.25 Freight Class: 250 Product Weight (lbs.): 27 Cubic Feet Per Carton: 11.25</p>	Does not stack.	8622	\$1104	\$1198	\$1229	\$1275	\$1341	\$1365	\$1421	\$1531	\$1581	\$1683	\$1821	\$1993
			OVERALL DIMENSIONS			SEAT DIMENSIONS			BACK DIMENSIONS					
			W	D	H	W	D	H	W	H				
			20	21	31.5	19	16.5	19	20	13.5				
			RTA 00											
 <p>Side Chair Closed Wood Back COM Yardage: 1 Freight Class: 250 Product Weight (lbs.): 27 Cubic Feet Per Carton: 11.25</p>	Does not stack.	8624	\$1094	\$1128	\$1156	\$1195	\$1252	\$1278	\$1330	\$1412	\$1475	\$1545	\$1690	\$1844
			OVERALL DIMENSIONS			SEAT DIMENSIONS			BACK DIMENSIONS					
			W	D	H	W	D	H	W	H				
			20	21	31.5	19	16.5	19	20	13.5				
			RTA 00											
 <p>Counter Stool Open Wood Back COM Yardage: 1 Freight Class: 300 Product Weight (lbs.): 32 Cubic Feet Per Carton: 13</p>	Does not stack.	8621S26	\$1350	\$1380	\$1399	\$1431	\$1475	\$1496	\$1538	\$1602	\$1650	\$1707	\$1819	\$1940
			OVERALL DIMENSIONS			SEAT DIMENSIONS			BACK DIMENSIONS					
			W	D	H	W	D	H	W	H				
			20	21	38.5	19	16.5	26	20	13.5				
			RTA 00											

DESCRIPTION	FEATURES	MODEL#	STANDARD TEXTILE GRADES													
			1	2	3	4	5	6	7	8	9	10	11	12		
 Counter Stool Closed Upholstered Wood Back COM Yardage: 2.25 Freight Class: 250 Product Weight (lbs.): 32 Cubic Feet Per Carton: 13	Does not stack.	8622S26	\$1404	\$1480	\$1538	\$1627	\$1752	\$1813	\$1926	\$2107	\$2247	\$2403	\$2722	\$3066		
			OVERALL DIMENSIONS			SEAT DIMENSIONS			BACK DIMENSIONS							
			W	D	H	W	D	H	W	H						
			20	21	38.5	19	16.5	26	20	13.5						
			RTA 00													
 Counter Stool Closed Wood Back COM Yardage: 1 Freight Class: 250 Product Weight (lbs.): 32 Cubic Feet Per Carton: 13	Does not stack.	8624S26	\$1350	\$1380	\$1399	\$1431	\$1475	\$1496	\$1538	\$1602	\$1650	\$1707	\$1819	\$1940		
			OVERALL DIMENSIONS			SEAT DIMENSIONS			BACK DIMENSIONS							
			W	D	H	W	D	H	W	H						
			20	21	38.5	19	16.5	26	20	13.5						
			RTA 00													
 Barstool Open Wood Back COM Yardage: 1 Freight Class: 250 Product Weight (lbs.): 38 Cubic Feet Per Carton: 14	Does not stack.	8621S30	\$1422	\$1517	\$1533	\$1562	\$1603	\$1613	\$1648	\$1715	\$1745	\$1808	\$1890	\$1992		
			OVERALL DIMENSIONS			SEAT DIMENSIONS			BACK DIMENSIONS							
			W	D	H	W	D	H	W	H						
			20	21	42.5	19	16.5	30	20	13.5						
			RTA 00													
 Barstool Closed Upholstered Wood Back COM Yardage: 2.25 Freight Class: 250 Product Weight (lbs.): 38 Cubic Feet Per Carton: 14	Does not stack.	8622S30	\$1476	\$1552	\$1610	\$1699	\$1824	\$1884	\$1997	\$2179	\$2319	\$2475	\$2794	\$3136		
			OVERALL DIMENSIONS			SEAT DIMENSIONS			BACK DIMENSIONS							
			W	D	H	W	D	H	W	H						
			20	21	42.5	19	16.5	30	20	13.5						
			RTA 00													
 Barstool Closed Wood Back COM Yardage: 1 Freight Class: 250 Product Weight (lbs.): 38 Cubic Feet Per Carton: 14	Does not stack.	8624S30	\$1422	\$1517	\$1533	\$1562	\$1603	\$1613	\$1648	\$1715	\$1745	\$1808	\$1890	\$1992		
			OVERALL DIMENSIONS			SEAT DIMENSIONS			BACK DIMENSIONS							
			W	D	H	W	D	H	W	H						
			20	21	42.5	19	16.5	30	20	13.5						
			RTA 00													

MAYNE™



model 8335T





model 8336T

STANDARD FEATURES

- Mayne offers classic styling and value in a finely crafted wood framed side chair.
- Frame construction is beechwood.
- Legs are equipped with White non-marking polypropylene glides Suitable for both carpet and hard surface flooring.
- Offered in two back styles; Upholstered back or Vertical wood slat.
- Check textile availability prior to specifying upholstery material.
- Does not stack.

OPTIONAL FEATURES

- Wood frames available in Absolute (AAM), Black (BKM), Cherry (ACM), Espresso Cafe (ECM), English Oak (EOM), Fruitwood (TFM), Gray (HGM), Honey (AHM), Mahogany (TMM), Maple (AVM), Medium Walnut (MWM), Natural Walnut (NLW), Night (ASM), Noce Biondo (NBM), Noce Grigio (NGM), Noce Leggero (NEM), Noce Medio (NMM), Shaker Cherry (SKM), Walnut (TWM), WC Cream (WTM), White (WHM) and Winter Cherry (WCM). Please Specify..

DESCRIPTION	FEATURES	MODEL #	STANDARD TEXTILE GRADES													
			1	2	3	4	5	6	7	8	9	10	11	12		
 <p>Upholstered Armchair COM Yardage: 1 Freight Class: 250 Product Weight (lbs.): 27 Cubic Feet Per Carton: 13.25</p>	<p>Does not stack.</p> <p>Ergonomic Features: M, N</p>	<p>8335T</p>	\$964	\$1005	\$1036	\$1081	\$1147	\$1170	\$1228	\$1337	\$1390	\$1489	\$1627	\$1800		
			<p>OVERALL DIMENSIONS</p>			<p>SEAT DIMENSIONS</p>			<p>BACK DIMENSIONS</p>							
			W	D	H	W	D	H	W	H						
			23	24.5	33	20	18.25	18	17.5	14						
 <p>Vertical Wood Slat Armchair COM Yardage: 1 Freight Class: 300 Product Weight (lbs.): 25 Cubic Feet Per Carton: 13.25</p>	<p>Does not stack.</p> <p>Ergonomic Features: M, N</p>	<p>8336T</p>	\$999	\$1031	\$1055	\$1091	\$1142	\$1165	\$1213	\$1285	\$1342	\$1403	\$1533	\$1670		
			<p>OVERALL DIMENSIONS</p>			<p>SEAT DIMENSIONS</p>			<p>BACK DIMENSIONS</p>							
			W	D	H	W	D	H	W	H						
			23	24.5	33	20	18.25	18	17.5	14						

MODA™



model 6960



model 6961

Also see Moda Stacking Chairs



For Moda stacking chairs, please see page 189.

STANDARD FEATURES

- Moda is an upscale, classic looking multi-purpose product, ideal for conference rooms, training, break out and collaboration areas as well as light-use tasking.
- Chairs are molded with a one-piece shell. Available in Night (BLK), Cloud (IVC) or Shadow (SHW).
- Chair frame consists of a Polished Aluminum chassis on four steel legs in a durable Chrome finish.
- Standard with nylon glides (N1), suitable for carpet, rubber or concrete flooring.
- Check textile availability prior to specifying upholstery material.
- Four legged chairs do not stack.

OPTIONAL FEATURES

- All models are available with optional armcaps in Black self-skinned urethane (SSU), or in Black, White or Clear Grey finish hard plastic.
- Model 6961 armcaps can also be upholstered in the matching fabric, vinyl or leather.
- Glides with felt pads (FG) are available for vinyl sheet, cork or laminate flooring, please specify. Add \$34.
- Glides with felt pads (RG) are available for vinyl sheet, hardwood, laminate, stone or ceramic flooring, please specify. Add \$34.
- Adjustable swivel glides (SWG) are available for uneven floors, please specify. No upcharge



OPTION CODES

Please add option codes in the following order:

- **Model number**
6960 Armchair
6961 Armchair w/upholstered seat
- **Textile**
Specify textile code for seat (model 6961 only).
- **Shell color** (no upcharge)
(BLK) Night
(IVC) Cloud
(SHW) Shadow
- **Frame finish**
(CHM) Chrome. No upcharge.
(TBL) Black. Add \$80.
(TTU) Tungsten. Add \$80.
(BT) Butternut woodgrain. Add 164.
(EB) Ebony woodgrain. Add \$164.
(WU) Walnut woodgrain. Add \$164.
- **Armcaps**
(NC) No armcaps.
(SS) Black SSU. Add \$61.
(GC) Clear Grey hard plastic. Add 34.
(H3) Black hard plastic. Add 34.
(H4) White hard plastic. Add 34.
Armcaps (to match woodgrain frame finish only)
(BT) Butternut woodgrain. Add \$113.
(EB) Ebony woodgrain. Add \$113.
(WU) Walnut woodgrain. Add \$113.
Armcaps (upholstered model 6961 only)
(UP) Matching upholstery. Add \$67.
- **Glide style** (no upcharge)
(FX) Fixed glide (STD)
(SWG) Adjustable swivel
- **Glide type**
(N1) Standard nylon. No upcharge.
(FG) Felt. Add \$34.
(RG) Rubber. Add \$34.

EXAMPLE MODA ORDER CODE:

6960	-HD05	-IVC	-CHM	-NC	-FX	-N1
Model #	Textile	Shell	Frame	Armcaps	Glide style	Glide type

DESCRIPTION	FEATURES	MODEL #	STANDARD TEXTILE GRADES																										
			1	2	3	4	5	6	7	8	9	10	11	12															
 <p>Four-Legged Armchair COM Yardage: N/A Freight Class: 300 Product Weight (lbs.): 16 Cubic Feet Per Carton: 14.5</p>	Polypropylene seat & back.	6960	\$715																										
		<table border="1"> <thead> <tr> <th colspan="3">OVERALL DIMENSIONS</th> <th colspan="3">SEAT DIMENSIONS</th> <th colspan="2">BACK DIMENSIONS</th> </tr> <tr> <th>W</th> <th>D</th> <th>H</th> <th>W</th> <th>D</th> <th>H</th> <th>W</th> <th>H</th> </tr> </thead> <tbody> <tr> <td>25</td> <td>25</td> <td>31</td> <td>20.5</td> <td>18</td> <td>15.5</td> <td>20</td> <td>16</td> </tr> </tbody> </table>		OVERALL DIMENSIONS			SEAT DIMENSIONS			BACK DIMENSIONS		W	D	H	W	D	H	W	H	25	25	31	20.5	18	15.5	20	16	RTA 1	1 per carton
		OVERALL DIMENSIONS			SEAT DIMENSIONS			BACK DIMENSIONS																					
		W	D	H	W	D	H	W	H																				
25	25	31	20.5	18	15.5	20	16																						
6961	\$844	\$877	\$902	\$939	\$990	\$1015	\$1063	\$1139	\$1197	\$1263	\$1396	\$1539																	
<table border="1"> <thead> <tr> <th colspan="3">OVERALL DIMENSIONS</th> <th colspan="3">SEAT DIMENSIONS</th> <th colspan="2">BACK DIMENSIONS</th> </tr> <tr> <th>W</th> <th>D</th> <th>H</th> <th>W</th> <th>D</th> <th>H</th> <th>W</th> <th>H</th> </tr> </thead> <tbody> <tr> <td>25</td> <td>25</td> <td>31</td> <td>20.5</td> <td>18</td> <td>16</td> <td>20</td> <td>15.5</td> </tr> </tbody> </table>		OVERALL DIMENSIONS			SEAT DIMENSIONS			BACK DIMENSIONS		W	D	H	W	D	H	W	H	25	25	31	20.5	18	16	20	15.5	RTA 1	1 per carton		
OVERALL DIMENSIONS			SEAT DIMENSIONS			BACK DIMENSIONS																							
W	D	H	W	D	H	W	H																						
25	25	31	20.5	18	16	20	15.5																						
 <p>Four-Legged Armchair COM Yardage: 0.75 Freight Class: 300 Product Weight (lbs.): 17 Cubic Feet Per Carton: 14.5</p>	Upholstered seat/polypropylene back.	6961	\$844	\$877	\$902	\$939	\$990	\$1015	\$1063	\$1139	\$1197	\$1263	\$1396	\$1539															
		<table border="1"> <thead> <tr> <th colspan="3">OVERALL DIMENSIONS</th> <th colspan="3">SEAT DIMENSIONS</th> <th colspan="2">BACK DIMENSIONS</th> </tr> <tr> <th>W</th> <th>D</th> <th>H</th> <th>W</th> <th>D</th> <th>H</th> <th>W</th> <th>H</th> </tr> </thead> <tbody> <tr> <td>25</td> <td>25</td> <td>31</td> <td>20.5</td> <td>18</td> <td>16</td> <td>20</td> <td>15.5</td> </tr> </tbody> </table>		OVERALL DIMENSIONS			SEAT DIMENSIONS			BACK DIMENSIONS		W	D	H	W	D	H	W	H	25	25	31	20.5	18	16	20	15.5	RTA 1	1 per carton
		OVERALL DIMENSIONS			SEAT DIMENSIONS			BACK DIMENSIONS																					
		W	D	H	W	D	H	W	H																				
25	25	31	20.5	18	16	20	15.5																						
6961	\$844	\$877	\$902	\$939	\$990	\$1015	\$1063	\$1139	\$1197	\$1263	\$1396	\$1539																	
<table border="1"> <thead> <tr> <th colspan="3">OVERALL DIMENSIONS</th> <th colspan="3">SEAT DIMENSIONS</th> <th colspan="2">BACK DIMENSIONS</th> </tr> <tr> <th>W</th> <th>D</th> <th>H</th> <th>W</th> <th>D</th> <th>H</th> <th>W</th> <th>H</th> </tr> </thead> <tbody> <tr> <td>25</td> <td>25</td> <td>31</td> <td>20.5</td> <td>18</td> <td>16</td> <td>20</td> <td>15.5</td> </tr> </tbody> </table>		OVERALL DIMENSIONS			SEAT DIMENSIONS			BACK DIMENSIONS		W	D	H	W	D	H	W	H	25	25	31	20.5	18	16	20	15.5	RTA 1	1 per carton		
OVERALL DIMENSIONS			SEAT DIMENSIONS			BACK DIMENSIONS																							
W	D	H	W	D	H	W	H																						
25	25	31	20.5	18	16	20	15.5																						

MODA



model 6962



model 6963

Also see Moda Stacking Chairs



For Moda four-legged chairs, please see page 188.

STANDARD FEATURES

- Moda is an upscale, classic looking multi-purpose product, ideal for conference rooms, training, break out and collaboration areas as well as light-use tasking.
- Chairs are molded with a one-piece shell. Available in Night (BLK), Cloud (IVC) or Shadow (SHW).
- Chair frame consists of 0.5" diameter solid steel rod available exclusively in a durable Chrome finish. No crossbar to interfere with feet or leg positions.
- Chairs can be ganged together using ganging clamp set 6970.
- Standard with shell-matching nylon glides (N1), suitable for carpet, rubber or concrete flooring.
- Check textile availability prior to specifying upholstery material.

OPTIONAL FEATURES



- All models are available with optional armcaps in Black self-skinned urethane (SSU), or in Black, White or Clear Grey finish hard plastic.
- Model 6963 armcaps can also be upholstered in the matching fabric, vinyl or leather.
- Glides with felt pads (FG) are available for vinyl sheet, cork or laminate flooring, please specify. Add \$55.
- Glides with felt pads (RG) are available for vinyl sheet, hardwood, laminate, stone or ceramic flooring, please specify. Add \$55.



Please add option codes in the following order:

- **Model number**
6962 Armchair
6963 Armchair w/upholstered seat
- **Textile**
Specify textile code for seat (model 6963 only).
- **Shell color** (no upcharge)
(BLK) Night
(IVC) Cloud
(SHW) Shadow
- **Armcaps**
(NC) No armcaps.
(SS) Black SSU. Add \$57.
(GC) Clear Grey hard plastic. Add \$76
(H3) Black hard plastic. Add \$32.
(H4) White hard plastic. Add \$32.
(UP) Matching upholstery (upholstered model 6963 only). Add \$63.
- **Glides**
(N1) Standard nylon. No upcharge.
(FG) Felt. Add \$55.
(RG) Rubber. Add \$63.

EXAMPLE MODA ORDER CODE:

6963	-HD05	-IVC	-NC	-N1
Model #	Textile	Shell	Armcaps	Glides

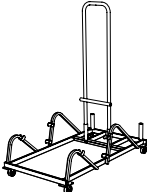
DESCRIPTION	FEATURES	MODEL #	STANDARD TEXTILE GRADES													
			1	2	3	4	5	6	7	8	9	10	11	12		
 <p>Armchair COM Yardage: N/A Freight Class: 300 Product Weight (lbs.): 16 Cubic Feet Per Carton: 15.75</p>	<p>Polypropylene seat & back. Stacks 5 high on floor Stacks 14 high on dolly</p>	6962	\$638													
				OVERALL DIMENSIONS		SEAT DIMENSIONS			BACK DIMENSIONS							
			W	D	H	W	D	H	W	H						
			25	25	31	20.5	18	17	20	15						
				RTA 1		2 per carton										
 <p>Armchair COM Yardage: 0.75 Freight Class: 300 Product Weight (lbs.): 17 Cubic Feet Per Carton: 15.75</p>	<p>Upholstered seat/polypropylene back. Stacks 4 high on floor Stacks 8 high on dolly.</p>	6963	\$767	\$800	\$825	\$862	\$914	\$938	\$985	\$1061	\$1119	\$1185	\$1317	\$1460		
				OVERALL DIMENSIONS		SEAT DIMENSIONS			BACK DIMENSIONS							
			W	D	H	W	D	H	W	H						
			25	25	31	20.5	18	17.5	20	15						
				RTA 1		2 per carton										

DESCRIPTION	FEATURES	MODEL #	STANDARD TEXTILE GRADES														
			1	2	3	4	5	6	7	8	9	10	11	12			
 <p>Medium Density Dolly COM Yardage: N/A Freight Class: 150 Product Weight (lbs.): 43 Cubic Feet Per Carton: 13.25</p>	For use w/ sled base chairs only	6969	\$954														
					OVERALL DIMENSIONS			SEAT DIMENSIONS			BACK DIMENSIONS						
					W	D	H	W	D	H	W	H					
					25	63	36.75	-	-	-	-	-					
				RTA 00				1 per carton									
 <p>Ganging Clamp COM Yardage: N/A Freight Class: 70 Product Weight (lbs.): 0.13 Cubic Feet Per Carton: 0.3</p>	Two per chair recommended. Packed 2 per bag For use w/ sled base chairs only	6970	\$55														
					OVERALL DIMENSIONS			SEAT DIMENSIONS			BACK DIMENSIONS						
					W	D	H	W	D	H	W	H					
					3.0	1.5	0.75	-	-	-	-	-					
				RTA 00					25 per carton								

POPCORN



model 6711



model 6712



model 6741TR



Hand Hold Feature



	Chair Stacking Capability		Stool Stacking Capability
	Stacks on floor	Stacks on dolly	Stacks on floor
Armless			
Polypropylene seat	up to 10 high	up to 34 high	up to 8 high
Upholstered seat	up to 8 high	up to 15 high	up to 8 high
With Arms			
Polypropylene seat	up to 10 high	up to 34 high	up to 8 high
Upholstered seat	up to 8 high	up to 15 high	up to 8 high





STANDARD FEATURES







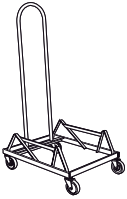

- Popcorn a high quality stacking chair that is ideal for multi-purpose stack applications within corporate, government and healthcare facilities.
- Chair frame is constructed of 1/2" diameter solid chrome steel rod available exclusively in a durable chrome finish. There is no crossbar to interfere with feet or leg positions. Chrome frame without glides is standard and suitable for cork, rubberized and carpeted floors.
- Wall saver frame design; the base touches the wall before the upper back to protect the wall from damage.
- Upper back features a cut out hand hold to assist in stacking and transportation.
- Seat and back is a one piece polypropylene shell for strength and ease of cleaning and disinfecting.
- Chairs can be ganged together using ganging clamp set (6626), providing a 2" space between armchair models and 5" space between armless models.
- Upholstered models are equipped with a smooth black shroud underneath the seat to help prevent frame imprints on the lower chair while stacked.
- Task chairs are available with a tablet. Tablet arms are extremely rugged and meets ANSI-BIFMA testing requirements. Tablet hinges up to allow ease of egress. Tablet slides forward and back to accommodate any body size comfortably. Tablet models do not stack.
- Standard tablet (D8) size is 18"D x 14.5"W and is made of Black polymer. Tablets are attached at the left or right (as seated) of the task chair.
- Popcorn beam seating consists of upper seat units (6717, 6719) including mounting brackets and all hardware necessary for attachment to beam.
- For all beam components, tables and a complete list of available upper seat units, see Beam Seating series.
- **Specifications and pricing are for 1 chair.**



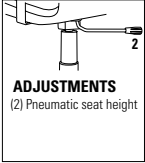

OPTIONAL FEATURES

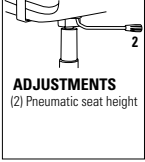

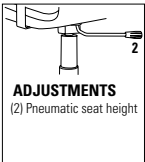

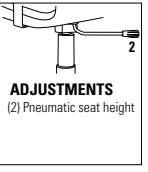
- Polypropylene shell and coordinating arms are available in 14 designer colors. Choose from Buzz Blue (BZB), Cactus (CCT), Carrot (CRO), Cloud (IVC), Dijon (DJN), Eggplant (EGP), Fog (FOG), Frost (FRO), Ink (INK), Latte (LAB), Night (BLK), Sand (SND), Scarlet (SAR), and Shadow (SHW).
- An optional 18.5"D x 18.5"W high pressure laminate writing tablet is available. The core is hardwood veneer plywood with radiused edge finished in clear lacquer. This writing tablet is offered in the following finishes: Black (BLK), Clear Maple (CMB), Designer White (DWT) and Noce Grigio (NGL). Please specify. Add \$55.
- Check textile availability prior to specifying upholstery material.
- Chairs will have additional stitch details when upholstered in vinyl.
- For hard surface flooring casters on Task chairs, please specify (C9R). Add \$66.
- A selection of glide options is available. Glides must be chosen to best suit flooring type and site conditions.
- Clear polycarbonate glides (CG) are available for carpet, rubber or concrete flooring, please specify. Add \$16.
- Glides with felt pads (FG) are available for vinyl sheet, cork or laminate flooring, please specify. Add \$31.
- Glides with rubber pads (RG) are available for vinyl, hardwood, laminate, stone or ceramic flooring, please specify. Add \$31.
- Glides with stainless steel pads (SG) are available for carpet or rubber flooring, specify. Add \$31.

DESCRIPTION	FEATURES	MODEL#	STANDARD TEXTILE GRADES											
			1	2	3	4	5	6	7	8	9	10	11	12
 <p>Armchair COM Yardage: N/A Freight Class: 150 Product Weight (lbs.): 23.5 Cubic Feet Per Carton: 4.44 (4 per carton)</p>	<p>Polypropylene Seat and Back. Stacks 10 high on floor. Stacks 34 high on dolly</p>	<p>6710</p>	<p>\$321</p>											
			<p>OVERALL DIMENSIONS</p>			<p>SEAT DIMENSIONS</p>			<p>BACK DIMENSIONS</p>					
			W	D	H	W	D	H	W	H				
			24.5	23.5	32.5	18	18	16.5	19.5	16				
			<p>RTA 00</p>											
 <p>Armless Chair COM Yardage: N/A Freight Class: 150 Product Weight (lbs.): 17.25 Cubic Feet Per Carton: 14.75 (4 per carton)</p>	<p>Polypropylene Seat and Back. Stacks 10 high on floor. Stacks 34 high on dolly</p>	<p>6711</p>	<p>\$211</p>											
			<p>OVERALL DIMENSIONS</p>			<p>SEAT DIMENSIONS</p>			<p>BACK DIMENSIONS</p>					
			W	D	H	W	D	H	W	H				
			20	23.5	32.5	18	18	16.5	19.5	16				
			<p>RTA 00</p>											

DESCRIPTION	FEATURES	MODEL#	STANDARD TEXTILE GRADES											
			1	2	3	4	5	6	7	8	9	10	11	12
 <p>Armchair COM Yardage: 0.75 Freight Class: 150 Product Weight (lbs.): 24.5 Cubic Feet Per Carton: 4.81 (4 per carton)</p>	<p>Upholstered seat and Polypropylene Back Stacks 8 high on floor. Stacks 15 high on dolly</p>	<p>6712</p>	\$420	\$446	\$466	\$494	\$536	\$553	\$588	\$656	\$688	\$751	\$837	945
			OVERALL DIMENSIONS			SEAT DIMENSIONS			BACK DIMENSIONS					
			W	D	H	W	D	H	W	H				
			24.5	23.5	32.5	18	18	17	19.5	15.5				
			<p>RTA 00</p>											
 <p>Armless Chair COM Yardage: 0.75 Freight Class: 250 Product Weight (lbs.): 16 Cubic Feet Per Carton: 9 (4 per carton)</p>	<p>Upholstered seat and Polypropylene Back Stacks 8 high on floor. Stacks 15 high on dolly</p>	<p>6713</p>	\$311	\$337	\$356	\$387	\$427	\$443	\$479	\$547	\$578	\$644	\$729	835
			OVERALL DIMENSIONS			SEAT DIMENSIONS			BACK DIMENSIONS					
			W	D	H	W	D	H	W	H				
			20	23.5	32.5	18	18	17	19.5	15.5				
			<p>RTA 00</p>											
 <p>Medium Density Dolly COM Yardage: N/A Freight Class: 250 Product Weight (lbs.): 29 Cubic Feet Per Carton: 9</p>	<p>For upholstered models Can stack chairs up to 15 high Fits through standard 80" door frame</p>	<p>6714</p>	\$714	-	-	-	-	-	-	-	-	-	-	-
			OVERALL DIMENSIONS			SEAT DIMENSIONS			BACK DIMENSIONS					
			W	D	H	W	D	H	W	H				
			23	31	18.5	-	-	-	-	-				
			<p>RTA 00</p>											
 <p>High Density Dolly COM Yardage: N/A Freight Class: 125 Product Weight (lbs.): 30 Cubic Feet Per Carton: 5.5</p>	<p>For polypropylene models Can stack chairs up to 34 high Fits through standard 80" door frame</p>	<p>6715</p>	\$714	-	-	-	-	-	-	-	-	-	-	-
			OVERALL DIMENSIONS			SEAT DIMENSIONS			BACK DIMENSIONS					
			W	D	H	W	D	H	W	H				
			21.37	31.75	51.75	-	-	-	-	-				
			<p>RTA 00 </p>											
 <p>Armless Seat Unit COM Yardage: N/A Freight Class: 150 Product Weight (lbs.): 17 Cubic Feet Per Carton: 6.5 (2 per carton)</p>	<p>Polypropylene Seat and Back. Use with beam.</p>	<p>6717</p>	\$327	-	-	-	-	-	-	-	-	-	-	
			OVERALL DIMENSIONS			SEAT DIMENSIONS			BACK DIMENSIONS					
			W	D	H	W	D	H	W	H				
			20	21	18	18	18	-	19.5	16				
			<p>RTA 00</p>											

DESCRIPTION	FEATURES	MODEL#	STANDARD TEXTILE GRADES													
			1	2	3	4	5	6	7	8	9	10	11	12		
 <p>Armless Seat Unit COM Yardage: 0.75 Freight Class: 150 Product Weight (lbs.): 18 Cubic Feet Per Carton: 6.5 (2 per carton)</p>	<p>Popcorn Upholstered Seat and Polypropylene Back. Use with beam.</p>	6719	\$427	\$455	\$476	\$509	\$553	\$572	\$614	\$679	\$727	\$784	\$897	\$1019		
		OVERALL DIMENSIONS			SEAT DIMENSIONS			BACK DIMENSIONS								
		W	D	H	W	D	H	W	H							
		20	21	18	18	18	-	19.5	16							
			<div style="display: flex; justify-content: space-between; align-items: center;"> RTA 00  </div>													
 <p>Ganging Clamp Set - 2 Clamps COM Yardage: N/A Freight Class: 70 Product Weight (lbs.): 0.3 Cubic Feet Per Carton: 0.01 (1 set per carton)</p>		6626	\$27	-	-	-	-	-	-	-	-	-	-	-		
		OVERALL DIMENSIONS			SEAT DIMENSIONS			BACK DIMENSIONS								
		W	D	H	W	D	H	W	H							
		1	6.5	00.75	-	-	-	-	-							
			<div style="display: flex; justify-content: space-between; align-items: center;"> RTA 00  </div>													
 <p>Armless Task COM Yardage: N/A Freight Class: 250 Product Weight (lbs.): 31 Cubic Feet Per Carton: 14.25</p>	 <p>ADJUSTMENTS (2) Pneumatic seat height</p>	List price		6741	466											
		OVERALL DIMENSIONS			SEAT DIMENSIONS			BACK DIMENSIONS								
		W	D	H	W	D	H	W	H							
		20	23	30.5	18	18	15.5	19.5	16							
			<div style="display: flex; justify-content: space-between; align-items: center;"> RTA 00 1 per carton </div>													
 <p>Armless Task w/ Tablet COM Yardage: N/A Freight Class: 250 Product Weight (lbs.): 40 Cubic Feet Per Carton: 15.75</p>	 <p>ADJUSTMENTS (2) Pneumatic seat height</p>	List price		6741TR	779	6741TL										
		OVERALL DIMENSIONS			SEAT DIMENSIONS			BACK DIMENSIONS								
		W	D	H	W	D	H	W	H							
		24.75	26	30.5	18	18	15.5	19.5	16							
			<div style="display: flex; justify-content: space-between; align-items: center;"> RTA 00 1 per carton </div>													
 <p>Armless Task COM Yardage: 0.75 Freight Class: 250 Product Weight (lbs.): 33 Cubic Feet Per Carton: 14.25</p>	 <p>ADJUSTMENTS (2) Pneumatic seat height</p>	List price		6743	571	601	620	653	697	716	758	823	871	928	1041	1163
		OVERALL DIMENSIONS			SEAT DIMENSIONS			BACK DIMENSIONS								
		W	D	H	W	D	H	W	H							
		20	23	30.5	18	18	16	19.5	16							
			<div style="display: flex; justify-content: space-between; align-items: center;"> RTA 00 1 per carton </div>													

DESCRIPTION	FEATURES	MODEL#	STANDARD TEXTILE GRADES													
			1	2	3	4	5	6	7	8	9	10	11	12		
 <p>Armless Task w/Tablet COM Yardage: 0.75 Freight Class: 250 Product Weight (lbs.): 42 Cubic Feet Per Carton: 15.75</p>	 <p>ADJUSTMENTS (2) Pneumatic seat height</p>	<p>6743TR 6743TL</p>	884	910	929	958	1000	1019	1056	1117	1160	1214	1317	1430		
			OVERALL DIMENSIONS			SEAT DIMENSIONS			BACK DIMENSIONS							
			W	D	H	W	D	H	W	H						
			24.75	26	30.5	18	18	16	19.5	16						
<p>Upholstered seat/polypropylene back. Ergonomic features: C Specify (L) left or (R) right tablet.</p>			RTA 00	1 per carton												
 <p>Barstool w/Arms COM Yardage: N/A Freight Class: 250 Product Weight (lbs.): 29 Cubic Feet Per Carton: 21.50 (2 per carton)</p>	<p>Polypropylene Seat and Back. Stacks 8 high on floor.</p>	<p>6710BS</p>	519													
			OVERALL DIMENSIONS			SEAT DIMENSIONS			BACK DIMENSIONS							
			W	D	H	W	D	H	W	H						
			24.5	23.5	32.5	18	18	29	19.5	16						
			RTA 00													
 <p>Counter stool w/Arms COM Yardage: N/A Freight Class: 250 Product Weight (lbs.): 24 Cubic Feet Per Carton: 21.50 (2 per carton)</p>	<p>Polypropylene Seat and Back. Stacks 8 high on floor.</p>	<p>6710CS</p>	519													
			OVERALL DIMENSIONS			SEAT DIMENSIONS			BACK DIMENSIONS							
			W	D	H	W	D	H	W	H						
			24.5	25.5	40.5	18	18	24	19.5	16						
			RTA 00													
 <p>Armless Barstool COM Yardage: N/A Freight Class: 250 Product Weight (lbs.): 27 Cubic Feet Per Carton: 17.50 (2 per carton)</p>	<p>Polypropylene Seat and Back. Stacks 8 high on floor.</p>	<p>6711BS</p>	375													
			OVERALL DIMENSIONS			SEAT DIMENSIONS			BACK DIMENSIONS							
			W	D	H	W	D	H	W	H						
			24.5	23.5	32.5	18	18	29	19.5	16						
			RTA 00													
 <p>Armless Counter Stool COM Yardage: N/A Freight Class: 250 Product Weight (lbs.): 22 Cubic Feet Per Carton: 17.50 (2 per carton)</p>	<p>Polypropylene Seat and Back. Stacks 8 high on floor.</p>	<p>6711CS</p>	375													
			OVERALL DIMENSIONS			SEAT DIMENSIONS			BACK DIMENSIONS							
			W	D	H	W	D	H	W	H						
			20	23.5	32.5	18	18	24	19.5	16						
			RTA 00													

DESCRIPTION	FEATURES	MODEL#	STANDARD TEXTILE GRADES											
			1	2	3	4	5	6	7	8	9	10	11	12
 <p>Barstool w/Arms COM Yardage: 0.75 Freight Class: 150 Product Weight (lbs.): 24.5 Cubic Feet Per Carton: 4.81 (2 per carton)</p>	Upholstered seat and Polypropylene Back Stacks 8 high on floor.	6712BS	\$624	\$655	\$674	\$706	\$750	\$771	\$813	\$876	\$926	\$981	\$1094	\$1216
			OVERALL DIMENSIONS			SEAT DIMENSIONS			BACK DIMENSIONS					
			W	D	H	W	D	H	W	H				
			24.5	23.5	32.5	18	18	29.5	19.5	16				
			RTA 00											
 <p>Counter Stool w/Arms COM Yardage: 0.75 Freight Class: 150 Product Weight (lbs.): 24.5 Cubic Feet Per Carton: 4.81 (2 per carton)</p>	Upholstered seat and Polypropylene Back Stacks 8 high on floor.	6712CS	\$624	\$655	\$674	\$706	\$750	\$771	\$813	\$876	\$926	\$981	\$1094	\$1216
			OVERALL DIMENSIONS			SEAT DIMENSIONS			BACK DIMENSIONS					
			W	D	H	W	D	H	W	H				
			24.5	23.5	32.5	18	18	24.5	19.5	16				
			RTA 00											
 <p>Armless Barstool COM Yardage: 0.75 Freight Class: 250 Product Weight (lbs.): 29 Cubic Feet Per Carton: 9 (2 per carton)</p>	Upholstered seat and Polypropylene Back Stacks 8 high on floor.	6713BS	\$510	\$538	\$559	\$591	\$635	\$655	\$697	\$762	\$810	\$866	\$979	\$1099
			OVERALL DIMENSIONS			SEAT DIMENSIONS			BACK DIMENSIONS					
			W	D	H	W	D	H	W	H				
			20	23.5	32.5	18	18	29.5	19.5	16				
			RTA 00											
 <p>Armless Counter Stool COM Yardage: 0.75 Freight Class: 250 Product Weight (lbs.): 29 Cubic Feet Per Carton: 9 (2 per carton)</p>	Upholstered seat and Polypropylene Back Stacks 8 high on floor.	6713CS	\$510	\$538	\$559	\$591	\$635	\$655	\$697	\$762	\$810	\$866	\$979	\$1099
			OVERALL DIMENSIONS			SEAT DIMENSIONS			BACK DIMENSIONS					
			W	D	H	W	D	H	W	H				
			20	23.5	32.5	18	18	24.5	19.5	16				
			RTA 00											

R ROMA® NESTER

ROMA® NESTER



model 1898



model 1899

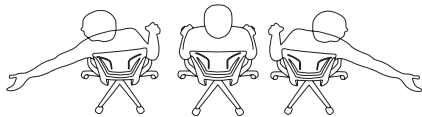

(Models 1890 and 1900)

The Polypropylene Medium Back and the Upholstered Medium Back feature a flexible back construction that provides support, proper spinal alignment and comfort when moving or reaching in a seated position.

MULTI-PURPOSE

STANDARD FEATURES



- Flexible, elegant and affordable, Roma offers a family of seating with simple clean lines.
- Please see Work + Task section for additional Roma models.
- Four back versions are available. Choose from Mesh, Flexible Polypropylene or Honeycomb Polypropylene back.
- Models upholstered in leather have a curved seam across the seat.
- Flexible polypropylene back chair features a built in lumbar support designed to move as you move and is available exclusively in black.
- The horizontal nesting chairs are easy to store. Simply flip the seat upward and then roll into nesting position, like a shopping cart.
- When nesting horizontal nesting chairs, each additional chair adds 8" to depth.
- Arms are durable fiberglass reinforced Nylon, fixed height. Armcaps are durable Polyurethane (SSU), soft and warm to the touch.
- C1 casters are standard.





OPTIONAL FEATURES

- Breathable mesh back is available in six colors. Choose from Autumn Orange (AO), Spring Green (SG) Winter Grey (WG), Midnight Black (MB), Summer Blue (SB), Fall Burgundy (FB).
- Nesting chairs are standard in Black (TBL), Tungsten (TTU) or Shadow (TSH). Optional Chrome (CHM) frame is available. Add \$40.
- Check textile availability prior to specifying upholstery material.

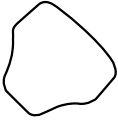

Stitch detail on Leather upholstered seat

DESCRIPTION	FEATURES	MODEL#	STANDARD TEXTILE GRADES											
			1	2	3	4	5	6	7	8	9	10	11	12
 <p>Honeycomb MB - Armless Flip Seat Nesting Chair COM Yardage: 1 Freight Class: 250 Product Weight (lbs.): 29 Cubic Feet Per Carton: 13.75</p>	Nesting chair. Ergonomic Features: M, N	1888	\$668	\$702	\$729	\$766	\$822	\$840	\$889	\$980	\$1025	\$1108	\$1221	\$1367
			OVERALL DIMENSIONS			SEAT DIMENSIONS			BACK DIMENSIONS					
			W	D	H	W	D	H	W	H				
			24.5	23.5	36	19.5	17	18	18.5	18				
 <p>Mesh MB - Armless Flip Seat Nesting Chair COM Yardage: 1 Freight Class: 250 Product Weight (lbs.): 29 Cubic Feet Per Carton: 13.75</p>	Nesting chair. Ergonomic Features: M, N	1889	\$659	\$693	\$720	\$757	\$813	\$831	\$880	\$971	\$1016	\$1099	\$1212	\$1358
			OVERALL DIMENSIONS			SEAT DIMENSIONS			BACK DIMENSIONS					
			W	D	H	W	D	H	W	H				
			24.5	23.5	36	19.5	17	18	18.5	18				
 <p>Polypropylene MB - Armless Flip Seat Nesting Chair COM Yardage: 1 Freight Class: 250 Product Weight (lbs.): 29 Cubic Feet Per Carton: 13.75</p>	Nesting chair. Ergonomic Features: M, N	1890	\$659	\$693	\$720	\$757	\$813	\$831	\$880	\$971	\$1016	\$1099	\$1212	\$1358
			OVERALL DIMENSIONS			SEAT DIMENSIONS			BACK DIMENSIONS					
			W	D	H	W	D	H	W	H				
			24.5	23.5	36	19.5	17	18	18.5	18				

DESCRIPTION	FEATURES	MODEL#	STANDARD TEXTILE GRADES											
			1	2	3	4	5	6	7	8	9	10	11	12
 <p>Honeycomb MB - Flip Seat Nesting Armchair COM Yardage: 1 Freight Class: 250 Product Weight (lbs.): 30 Cubic Feet Per Carton: 13.75</p>	Nesting chair. Ergonomic Features: M, N	1898	\$726	\$761	\$787	\$825	\$881	\$898	\$947	\$1038	\$1083	\$1167	\$1283	\$1425
			OVERALL DIMENSIONS W D H			SEAT DIMENSIONS W D H			BACK DIMENSIONS W H					
			24.5	23.5	36	19.5	17	18	18.5	18				
			RTA 00											
 <p>Mesh MB - Flip Seat Nesting Armchair COM Yardage: 1 Freight Class: 250 Product Weight (lbs.): 30 Cubic Feet Per Carton: 13.75</p>	Nesting chair. Ergonomic Features: M, N	1899	\$715	\$749	\$775	\$813	\$869	\$886	\$935	\$1025	\$1071	\$1155	\$1270	\$1413
			OVERALL DIMENSIONS W D H			SEAT DIMENSIONS W D H			BACK DIMENSIONS W H					
			24.5	23.5	36	19.5	17	18	18.5	18				
			RTA 00											
 <p>Polypropylene MB - Flip Seat Nesting Armchair COM Yardage: 1 Freight Class: 250 Product Weight (lbs.): 30 Cubic Feet Per Carton: 13.75</p>	Nesting chair. Ergonomic Features: M, N	1900	\$715	\$749	\$775	\$813	\$869	\$886	\$935	\$1025	\$1071	\$1155	\$1270	\$1413
			OVERALL DIMENSIONS W D H			SEAT DIMENSIONS W D H			BACK DIMENSIONS W H					
			24.5	23.5	36	19.5	17	18	18.5	18				
			RTA 00											
 <p>Upholstered Back Pad COM Yardage: 1 Freight Class: 70 Product Weight (lbs.): 1.5 Cubic Feet Per Carton: 1.1</p>		1909	\$178	\$213	\$241	\$283	\$340	\$360	\$411	\$504	\$552	\$641	\$763	\$913
			OVERALL DIMENSIONS W D H			SEAT DIMENSIONS W D H			BACK DIMENSIONS W H					
			20.5	19	0.38	21	18	18	20	20.5				
			RTA 00											

SAS™



Mid Back Side Chair
model 8647



Low Back Counter Stool
model 8648LBNS24



Mid Back Counter Stool
model 8648PS24



Mid Back Bar Stool
model 8648PS30

STANDARD FEATURES

- The Sas side chair and stools have a single, molded plywood shell of wood veneer.
- Available with two seat options: unupholstered seat and upholstered seat (P).
- Available in three heights: side chair, counter stool and bar stool.
- Sas side chair in mid back height only. Counter and bar height stools available with mid or low backs.
- Dimensions shown are for unupholstered models.
- Unupholstered side chairs can be stacked up to 4 high on the floor and up to 10 high on the available dolly. Unupholstered stools can be stacked up to 4 high on the floor only. Upholstered models cannot be stacked.
- Check textile availability prior to specifying upholstery material.

OPTIONAL FEATURES

Tubular frame is available in the following finishes:

- **Frame finish**
(TBL) Black
(TDW) Designer White
(TTU) Tungsten
(CHM) Chrome. **Add \$109**
- **Shell**
(AAM) Absolute
(BKM) Black
(ACM) Cherry
(EOM) English Oak
(ECM) Espresso Cafe
(TFM) Fruitwood
(HGM) Gray
(AHM) Honey
(TMM) Mahogany
(AVM) Maple
(MWM) Medium Walnut
(ASM) Night
(NBM) Noce Biondo
(NGM) Noce Grigio
(NEM) Noce Leggero
(NMM) Noce Medio
(SKM) Shaker Cherry
(TWM) Walnut
(WTM) WC Cream
(WHM) White. **Add \$100**
(WCM) Winter Cherry
Please Specify.

EXAMPLE SAS ORDER CODE:

8647P	-HD05	-TBL	-AAM
Model #	Textile	Frame Color	Shell

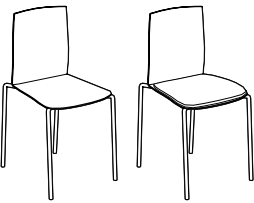
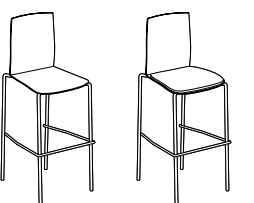
DESCRIPTION	FEATURES	MODEL#	STANDARD TEXTILE GRADES													
			1	2	3	4	5	6	7	8	9	10	11	12		
 <p>Mid Back Side Chair COM Yardage: 0.75 Freight Class: 250 Product Weight (lbs.): 12 Cubic Feet Per Carton: 12</p>	<p>Stacks 4 high on floor. Stacks 10 high on dolly. Upholstered models do not stack.</p>	8647	\$549	-	-	-	-	-	-	-	-	-	-	-		
		8647P	\$708	\$734	\$752	\$780	\$818	\$836	\$871	\$927	\$970	\$1018	\$1118	\$1222		
		OVERALL DIMENSIONS			SEAT DIMENSIONS			BACK DIMENSIONS								
		W	D	H	W	D	H	W	H							
			18.75	21	33	16	15.5	18	16	15						
 <p>Mid Back Counter Stool, 24" COM Yardage: 0.75 Freight Class: 400 Product Weight (lbs.): 16 Cubic Feet Per Carton: 14.5</p>	<p>Stacks 4 high on floor only. Upholstered models do not stack.</p>	8648S24	\$755	-	-	-	-	-	-	-	-	-	-	-		
		8648PS24	\$930	\$954	\$972	\$997	\$1034	\$1050	\$1084	\$1137	\$1177	\$1223	\$1316	\$1415		
		OVERALL DIMENSIONS			SEAT DIMENSIONS			BACK DIMENSIONS								
		W	D	H	W	D	H	W	H							
			19.5	22	39	16	15.5	24	16	15						

MULTI-PURPOSE

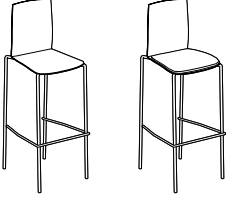
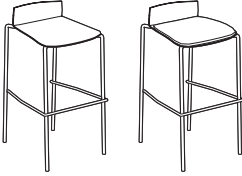
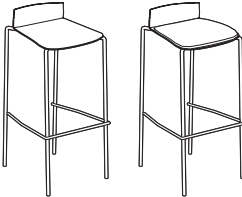
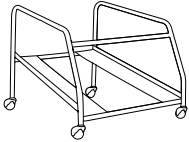
DESCRIPTION	FEATURES	MODEL#	STANDARD TEXTILE GRADES												
			1	2	3	4	5	6	7	8	9	10	11	12	
 <p>Mid Back Bar Stool, 30" COM Yardage: 0.75 Freight Class: 400 Product Weight (lbs.): 16 Cubic Feet Per Carton: 14.5</p>	Stacks 4 high on floor only. Upholstered models do not stack.	8648S30	\$755	-	-	-	-	-	-	-	-	-	-		
		8648PS30	\$930	\$954	\$972	\$997	\$1034	\$1050	\$1084	\$1137	\$1177	\$1223	\$1316	\$1415	
		OVERALL DIMENSIONS			SEAT DIMENSIONS			BACK DIMENSIONS							
		W	D	H	W	D	H	W	H						
		19.5	22	45	16	15.5	30	16	15						
			RTA 00		1 per carton										
 <p>Low Back Counter Stool, 24" COM Yardage: 0.75 Freight Class: 400 Product Weight (lbs.): 16 Cubic Feet Per Carton: 8.25</p>	Stacks 4 high on floor only. Upholstered models do not stack.	8648LBNS24	\$810	-	-	-	-	-	-	-	-	-	-		
		8648LBPS24	\$930	\$954	\$972	\$997	\$1034	\$1050	\$1084	\$1137	\$1177	\$1223	\$1316	\$1415	
		OVERALL DIMENSIONS			SEAT DIMENSIONS			BACK DIMENSIONS							
		W	D	H	W	D	H	W	H						
		19.5	22	26.25	16	15.5	24	16	2.25						
			RTA 00		1 per carton										
 <p>Low Back Bar Stool, 30" COM Yardage: 0.75 Freight Class: 400 Product Weight (lbs.): 22 Cubic Feet Per Carton: 17</p>	Stacks 4 high on floor only. Upholstered models do not stack.	8648LBNS30	\$810	-	-	-	-	-	-	-	-	-	-		
		8648LBPS30	\$930	\$954	\$972	\$997	\$1034	\$1050	\$1084	\$1137	\$1177	\$1223	\$1316	\$1415	
		OVERALL DIMENSIONS			SEAT DIMENSIONS			BACK DIMENSIONS							
		W	D	H	W	D	H	W	H						
		19.5	22	32.25	16	15.5	30	16	2.25						
			RTA 00		1 per carton										
 <p>Dolly COM Yardage: N/A Freight Class: 250 Product Weight (lbs.): 19 Cubic Feet Per Carton: 10.75</p>		8649	\$504	-	-	-	-	-	-	-	-	-	-		
		OVERALL DIMENSIONS			SEAT DIMENSIONS			BACK DIMENSIONS							
		W	D	H	W	D	H	W	H						
		25.75	28.5	22	-	-	-	-	-						
					RTA 00		1 per carton								

S SIDERO

SIDERO



model 6901 (BLK)



model 6900 (BLK) Stacked



model 6900TL



model 6900C



model 6905



model 6903

	Sidero Chairs Stacking Capability	
	Stacking on floor	Stacking on dolly
Models Types		
Arm Chairs without Casters	up to 5 high	up to 8 high
Arm Chairs with Casters	up to 3 high	N/A
Armless Chairs without Casters	up to 5 high	up to 8 high
Armless Chairs with Casters	up to 3 high	N/A
Preschool Armless Models	up to 4 high	N/A

STANDARD FEATURES

- Sidero seating has a sculptured appearance, featuring wide curved arms and a round tubular steel frame, with wall safe construction.
- Sidero series includes side chairs (arms and armless), available with casters or with a sled base, counter stools and barstools.
- Arms are 2 1/8 inches wide and full length, offering support to help stabilize users as they sit in or exit chairs.
- The gently curved arms are made from incredibly strong fiberglass reinforced nylon.
- The back of the chair is compound curved to provide comfort and support in multiple seating positions. No visible back attachment hardware. Backs are attached using concealed hardware only.
- The outer back is upholstered in the same material selection as the rest of the chair.
- Chairs are "Wall Safe." Rear legs hit the baseboard first leaving clearance between the back of the chair and the wall, saving both the chair and the wall from damage.
- Legs flair out to the rear to provide additional stability.
- The rugged steel frame is made from round welded steel tubing 7/8" dia.
- Armchairs (four legged and sled base) can be joined together using ganging clamp model 5233. Armless chairs (four legged and sled base) can be joined together using ganging clamp model 6526.
- Equipped with a polypropylene seat shroud that helps stabilize chairs when stacked and avoid frame imprints on upholstered seats.
- Four legged models can be stacked. Stools and sled base models do not stack. Please note when stacking painted frame chairs, paint may scratch.
- Standard glide is a durable Black Polypropylene foot.
- Four Legged chairs with casters are standard with (C82) dual wheel carpet casters.
- Sidero beam seating consists of upper seat units (6930, 6931) including mounting brackets and all hardware necessary for attachment to beam.
- For all beam components, tables and a complete

list of available upper seat units, see Beam Seating series.

- Tablet arms are extremely rugged and meet ANSI-BIFMA testing requirements. Tablet hinges up to allow ease of egress. Tablet slides forward and back to accommodate any body size comfortably. Tablet models do not stack.
- Standard tablet (D8) size is 18"D x 14.5"W and is made of Black polymer. Tablets are attached at the left or right (as seated) Tablet arms are not available on stools. Specify (L) left or (R) right tablet. (Example: 6900TL or 6900TR).
- Check textile availability prior to specifying upholstery material.

OPTIONAL FEATURES

- Frame finish**
 - (TBL) Black
 - (TFO) Fog
 - (TIV) Cloud
 - (TLA) Latte
 - (TNE) Nevada
 - (TSH) Shadow
 - (TTU) Tungsten
 - (CHM) Chrome. Add \$40. Please Specify.
 - (TDW) Designer White
 - (TFR) Frost
 - (TKA) Kalua
 - (TMO) Mocha
 - (TOA) Toast
 - (TSN) Sand
- An optional 18.5"D x 18.5"W high pressure laminate writing tablet is available. The core is hardwood veneer plywood with radiused edge finished in clear lacquer. This writing tablet is offered in the following finishes: Black (BLK), Clear Maple (CMB), Designer White (DWT) and Noce Grigio (NGL). Please specify. Add \$59.
- For chairs used on hard surface floors PLEASE SPECIFY Opaque (off White) Non-Marking Glides (NM). No upcharge.
- Steel self-leveling rubber cushioned glide is optionally available Please specify (B), add \$31
- For hard surface flooring please Specify (C9R), with rubber covered wheels. Add \$87.
- An optional abrasion-resistant outer back fabric (polyester) is available. Resistant to impact damage. Available in Black only. Add \$21.
- Optional 1 inch additional seat foam. Please specify (3F). Add \$39.

DESCRIPTION

FEATURES

MODEL#

STANDARD TEXTILE GRADES



Armchair

COM Yardage: 1.25
Freight Class: 250
Product Weight (lbs.): 29
Cubic Feet Per Carton: 13.5

Stacks 5 high on floor.
Stacks 8 high on dolly.
Tablet models do not stack.

Available with tablet:
Specify (L) left or (R) right tablet.

	1	2	3	4	5	6	7	8	9	10	11	12
6900	\$544	\$586	\$618	\$664	\$735	\$759	\$819	\$934	\$989	\$1094	\$1237	\$1417
6900T	\$854	\$896	\$927	\$974	\$1043	\$1074	\$1136	\$1231	\$1308	\$1392	\$1564	\$1746

OVERALL DIMENSIONS

W	D	H	W	D	H	W	H
25.5	24	33	19.5	18	17.5	19	15.5



Armchair w/ Casters

COM Yardage: 1.25
Freight Class: 250
Product Weight (lbs.): 29
Cubic Feet Per Carton: 13.5

Stacks 3 high on floor.
Tablet models do not stack.







Available with tablet:
Specify (L) left or (R) right tablet.

	1	2	3	4	5	6	7	8	9	10	11	12
6900C	\$620	\$662	\$694	\$743	\$812	\$837	\$896	\$1010	\$1065	\$1170	\$1314	\$1492
6900CT	\$911	\$951	\$979	\$1025	\$1089	\$1118	\$1176	\$1269	\$1338	\$1415	\$1578	\$1750



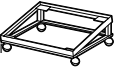

OVERALL DIMENSIONS

W	D	H	W	D	H	W	H
25.5	24	33	19.5	18	17.5	19	15.5

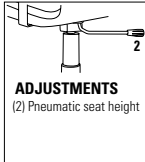

DESCRIPTION	FEATURES	MODEL#	STANDARD TEXTILE GRADES													
			1	2	3	4	5	6	7	8	9	10	11	12		
 <p>Side Chair COM Yardage: 1.25 Freight Class: 250 Product Weight (lbs.): 26 Cubic Feet Per Carton: 11.25</p>	<p>Stacks 5 high on floor. Stacks 8 high on dolly. Tablet models do not stack.</p> <p>Available with tablet: Specify (L) left or (R) right tablet.</p>	6901	\$491	\$533	\$565	\$613	\$682	\$707	\$767	\$881	\$936	\$1041	\$1185	\$1363		
		6901T	\$790	\$831	\$862	\$907	\$973	\$1005	\$1062	\$1156	\$1230	\$1311	\$1477	\$1654		
		OVERALL DIMENSIONS			SEAT DIMENSIONS			BACK DIMENSIONS								
		W	D	H	W	D	H	W	H							
			21	24	33	19.5	18	17.5	19	15.5						
											RTA 00					
 <p>Side Chair w/ Casters COM Yardage: 1.25 Freight Class: 250 Product Weight (lbs.): 26 Cubic Feet Per Carton: 11.25</p>	<p>Stacks 3 high on floor. Tablet models do not stack.</p> <p>Available with tablet: Specify (L) left or (R) right tablet.</p>	6901C	\$589	\$632	\$665	\$712	\$781	\$806	\$867	\$980	\$1035	\$1140	\$1285	\$1463		
		6901CT	\$901	\$942	\$973	\$1018	\$1085	\$1115	\$1174	\$1268	\$1340	\$1422	\$1588	\$1765		
		OVERALL DIMENSIONS			SEAT DIMENSIONS			BACK DIMENSIONS								
		W	D	H	W	D	H	W	H							
			21	24	33	19.5	18	17.5	19	15.5						
											RTA 00					
 <p>Armchair - Sled Base COM Yardage: 1.25 Freight Class: 250 Product Weight (lbs.): 32 Cubic Feet Per Carton: 13.5</p>	<p>Does not stack.</p> <p>Available with tablet: Specify (L) left or (R) right tablet.</p>	6902	\$680	\$723	\$756	\$803	\$872	\$896	\$956	\$1071	\$1126	\$1231	\$1375	\$1554		
		6902T	\$993	\$1036	\$1067	\$1115	\$1184	\$1216	\$1279	\$1377	\$1454	\$1538	\$1711	\$1896		
		OVERALL DIMENSIONS			SEAT DIMENSIONS			BACK DIMENSIONS								
		W	D	H	W	D	H	W	H							
			25.5	24	33	19.5	18	17.5	19	15.5						
											RTA 00					
 <p>Side Chair - Sled Base COM Yardage: 1.25 Freight Class: 250 Product Weight (lbs.): 29 Cubic Feet Per Carton: 11.25</p>	<p>Does not stack.</p> <p>Available with tablet: Specify (L) left or (R) right tablet.</p>	6903	\$631	\$674	\$707	\$753	\$822	\$847	\$907	\$1021	\$1076	\$1181	\$1325	\$1505		
		6903T	\$934	\$976	\$1006	\$1052	\$1120	\$1151	\$1209	\$1308	\$1380	\$1461	\$1631	\$1811		
		OVERALL DIMENSIONS			SEAT DIMENSIONS			BACK DIMENSIONS								
		W	D	H	W	D	H	W	H							
			21	24	33	19.5	18	17.5	19	15.5						
											RTA 00					
 <p>Dolly COM Yardage: N/A Freight Class: 150 Product Weight (lbs.): 16 Cubic Feet Per Carton: 3.8</p>		2125WS	\$418	-	-	-	-	-	-	-	-	-	-	-		
		OVERALL DIMENSIONS			SEAT DIMENSIONS			BACK DIMENSIONS								
		W	D	H	W	D	H	W	H							
					23.25	24.75	12.25	-	-	-	-	-				
											RTA 1					

DESCRIPTION	FEATURES	MODEL#	STANDARD TEXTILE GRADES											
			1	2	3	4	5	6	7	8	9	10	11	12
 <p>Counter Stool w/Arms COM Yardage: 1.25 Freight Class: 300 Product Weight (lbs.): 32 Cubic Feet Per Carton: 17.5</p>	Does not stack.	6904	\$736	\$780	\$812	\$859	\$927	\$954	\$1012	\$1128	\$1181	\$1287	\$1431	\$1610
			OVERALL DIMENSIONS			SEAT DIMENSIONS			BACK DIMENSIONS					
			W	D	H	W	D	H	W	H				
			25.5	24	40.5	19.5	18	24.5	19	15.5				
			RTA 00											
 <p>Armless Counter Stool COM Yardage: 1.25 Freight Class: 300 Product Weight (lbs.): 28 Cubic Feet Per Carton: 14.5</p>	Does not stack.	6905	\$678	\$719	\$752	\$798	\$869	\$893	\$953	\$1068	\$1123	\$1228	\$1371	\$1551
			OVERALL DIMENSIONS			SEAT DIMENSIONS			BACK DIMENSIONS					
			W	D	H	W	D	H	W	H				
			21	24	40.5	19.5	18	24.5	19	15.5				
			RTA 00											
 <p>Barstool w/Arms COM Yardage: 1.25 Freight Class: 300 Product Weight (lbs.): 34 Cubic Feet Per Carton: 20</p>	Does not stack.	6906	\$769	\$813	\$848	\$894	\$962	\$987	\$1049	\$1163	\$1216	\$1322	\$1466	\$1646
			OVERALL DIMENSIONS			SEAT DIMENSIONS			BACK DIMENSIONS					
			W	D	H	W	D	H	W	H				
			25.5	24	44.5	19.5	18	28.5	19	15.5				
			RTA 00											
 <p>Armless Barstool COM Yardage: 1.25 Freight Class: 300 Product Weight (lbs.): 30 Cubic Feet Per Carton: 15.75</p>	Does not stack.	6907	\$694	\$736	\$770	\$817	\$885	\$911	\$969	\$1084	\$1139	\$1243	\$1389	\$1567
			OVERALL DIMENSIONS			SEAT DIMENSIONS			BACK DIMENSIONS					
			W	D	H	W	D	H	W	H				
			21	24	44.5	19.5	18	28.5	19	15.5				
			RTA 00											

DESCRIPTION	FEATURES	MODEL#	STANDARD TEXTILE GRADES													
			1	2	3	4	5	6	7	8	9	10	11	12		
 <p>Armless Chair - 13" High Seat COM Yardage: 1 Freight Class: 250 Product Weight (lbs.): 15 Cubic Feet Per Carton: 4.1</p>	Stack up to 4 high on floor. For Preschool to Grade 2.	6909	\$440	\$475	\$501	\$539	\$594	\$612	\$660	\$751	\$797	\$880	\$997	\$1138		
		OVERALL DIMENSIONS			SEAT DIMENSIONS			BACK DIMENSIONS								
		W	D	H	W	D	H	W	H							
		15.5	15.5	24	14	10	13	13.5	11							
			RTA 00													
 <p>Armless Task COM Yardage: 1.25 Freight Class: 250 Product Weight (lbs.): 25 Cubic Feet Per Carton: 15.5</p>	 <p>ADJUSTMENTS (2) Pneumatic seat height</p> Upholstered seat & back. Ergonomic features: C, M, N Available with tablet: Specify (L) left or (R) right tablet.	6915	\$886	\$929	\$962	\$1009	\$1077	\$1110	\$1174	\$1271	\$1349	\$1433	\$1608	\$1793		
		6915T	\$1200	\$1243	\$1276	\$1323	\$1391	\$1424	\$1488	\$1585	\$1664	\$1747	\$1922	\$2107		
		OVERALL DIMENSIONS			SEAT DIMENSIONS			BACK DIMENSIONS								
		W	D	H	W	D	H	W	H							
21	29	35	19.5	18	16-21	19	15.5									
			RTA 00 1 per carton													
 <p>Seat Unit w/Arms COM Yardage: 1.25 Freight Class: 300 Product Weight (lbs.): 20 Cubic Feet Per Carton: 9.75</p>	Upholstered Seat and Back. Use with beam.	6930	\$675	\$719	\$756	\$808	\$883	\$917	\$985	\$1092	\$1175	\$1267	\$1455	\$1656		
		OVERALL DIMENSIONS			SEAT DIMENSIONS			BACK DIMENSIONS								
		W	D	H	W	D	H	W	H							
		25.5	23.5	19	19.5	18	-	19	15.5							
			RTA 00													
 <p>Armless Seat Unit COM Yardage: 1.25 Freight Class: 300 Product Weight (lbs.): 18 Cubic Feet Per Carton: 9.75</p>	Upholstered Seat and Back. Use with beam.	6931	618	\$663	\$700	\$752	\$826	\$861	\$928	\$1035	\$1119	\$1211	\$1398	\$1600		
		OVERALL DIMENSIONS			SEAT DIMENSIONS			BACK DIMENSIONS								
		W	D	H	W	D	H	W	H							
		21	23.5	19	19.5	18	-	19	15.5							
			RTA 00													

SONIC™



model 6514MB



model 6515



model 6511TR



model 6524TR



Model 6538



model 6537PB

STANDARD FEATURES

- Sonic multi-purpose series includes: four-leg, sled base, 5 star base task, and fixed pedestal base and beam seating in addition to bar, counter and height adjustable stools.
- Four-legged/freestanding models are standard with a straight leg or with a "WS" wall saver frame and durable polypropylene glides.
- WS models have a wall saver frame design; the base touches the wall before the upper back to protect the wall from damage.
- Four-legged/freestanding chairs are available with painted or chrome legs.
- Models are available with or without arms. Arms available in Black only.
- Freestanding models are stackable up to 5 high on floor and 10 high on dolly 6517WS. **Caster models do not stack.**
- Tablet arms are available on all seated height base types (not available on stools).
- Tablet arms are extremely rugged and meet ANSI-BIFMA testing requirements. Tablet hinges up to allow ease of egress. Tablet slides forward and back to accommodate any body size comfortably. Tablet models do not stack.
- Standard tablet (**D8**) size is 18" d x 14 1/2" w and is made of black polymer. Tablets are attached at the left or right (as seated). Please specify.
- Sonic beam seating consists of upper seat units (models 6501, 6502, 6503, 6504, 6505, and 6506) including mounting brackets and all hardware necessary for attachment to beam
- For all beam components, tables and a complete list of available upper seat units, see Beam Seating series.
- Task chairs and height adjustable stools have a five star, reinforced, black nylon base.
- All Sonic models with casters have black, dual-wheel casters. Select caster based on flooring type.
- Pedestal base models provide fixed location seating for use in auditoriums, classrooms, jury boxes, public venues and more. The base must be mounted to the floor (mounting hardware not included). See Pedestal Base Installation Guide for details.
- Upholstery inserts are simple to replace for ease of on-site long term maintenance.
- Mesh back (MB) models are available in Black mesh only.
- **Specifications and pricing are for 1 chair.**
- Check textile availability prior to specifying upholstery material.

OPTIONAL FEATURES

- Polypropylene seats, backs and coordinating arms are available in 14 designer colors. Choose from Buzz Blue (**BZB**), Cactus (**CCT**), Carrot (**CRO**), Cloud (**IVC**), Dijon (**DJN**), Eggplant (**EGP**), Fog (**FOG**), Frost (**FRO**), Ink (**INK**), Latte (**LAB**), Night (**BLK**), Sand (**SND**), Scarlet (**SAR**), and Shadow (**SHW**).
- An optional 18.5"D x 18.5"W high pressure laminate writing tablet is available. The core is hardwood veneer plywood with radiused edge finished in clear lacquer. This writing tablet is offered in the following finishes: Black (**BLK**), Clear Maple (**CMB**), Designer White (**DWT**) and Noce Grigio (**NGL**). Please specify. Add \$59.
- Frame finishes are available in Chrome (**CHM**), Black (**TBL**), Buzz Blue (**TBZ**), Cactus (**TCC**), Carrot (**TCR**), Dijon (**TDJ**), Designer White (**TDW**), Eggplant (**TEG**), Fog (**TFO**), Frost (**TFR**), Ink (**TIN**), Cloud (**TIV**), Kalua (**TKA**), Latte (**TLA**), Mocha (**TMO**), Nevada (**TNE**), Toast (**TOA**), Shadow (**TSH**), Sand (**TSN**), Scarlet (**TSR**) and Tungsten (**TTU**). Please specify
- For four-legged chairs with casters, specify (**C1**) 2" carpet casters, no upcharge, (**C9R**) 2-1/2" hard surface flooring casters, add \$53, (**C15**) 2" manual locking casters, add \$95 or (**C14R**) 2" auto-locking, rubber caster, add \$253.
- For five-star base models, specify (**C65**) 2" carpet casters or (**C65R**) 2" hard surface flooring casters.
- For sled base models, select (**GLD**) black, non-marking glides or (**NM**) opaque, offwhite, non-marking glides for hard surfaces.
- For four-legged chairs without casters, optional steel cushioned glides (**B**) are available. Please specify and add \$31. Glides with felt pads (**FG**) are available for vinyl sheet, cork or laminate flooring, please specify. Add \$55. Glides with rubber pads (**RG**) are available for vinyl, hardwood, laminate, stone or ceramic flooring, please specify. Add \$55.
- Pedestal base models have black metal base with 2" height adjust cylinders. Specify (**SCC**) swivel, auto return to max height (no upcharge); (**SN**) non-swivel, auto return to max height (Add \$19); or, (**SC**) swivel, self-centering and return to max height (add \$30).

DESCRIPTION FEATURES MODEL# STANDARD TEXTILE GRADES

	1	2	3	4	5	6	7	8	9	10	11	12
6500BR	\$218	-	-	-	-	-	-	-	-	-	-	-

OVERALL DIMENSIONS SEAT DIMENSIONS BACK DIMENSIONS















W	D	H	W	D	H	W	H
19.25	14.75	6	-	-	-	-	-



Book Rack
 COM Yardage: N/A
 Freight Class: 250
 Product Weight (lbs.): 5
 Cubic Feet Per Carton: 1.40 (1 per carton)

Use with Tablet models.



DESCRIPTION	FEATURES	MODEL#	STANDARD TEXTILE GRADES											
			1	2	3	4	5	6	7	8	9	10	11	12
 <p>Armless Seat Unit COM Yardage: N/A Freight Class: 250 Product Weight (lbs.): 12 Cubic Feet Per Carton: 3.25 (2 per carton)</p>	Polypropylene Seat and Back. Use with Beam.	6501	\$408	-	-	-	-	-	-	-	-	-	-	-
		OVERALL DIMENSIONS			SEAT DIMENSIONS			BACK DIMENSIONS						
		W	D	H	W	D	H	W	H					
		20	21.5	17	17	16	-	17	15					
														
 <p>Armless Seat Unit COM Yardage: 0.75 Freight Class: 250 Product Weight (lbs.): 12 Cubic Feet Per Carton: 3.25 (2 per carton)</p>	Upholstered Seat and Polypropylene Back. Use with Beam.	6502	\$460	\$488	\$506	\$537	\$582	\$595	\$634	\$705	\$740	\$806	\$897	\$1011
		OVERALL DIMENSIONS			SEAT DIMENSIONS			BACK DIMENSIONS						
		W	D	H	W	D	H	W	H					
		20	22	17	17	16	-	17	15					
														
 <p>Armless Seat Unit COM Yardage: 0.75 Freight Class: 150 Product Weight (lbs.): 13 Cubic Feet Per Carton: 3.25 (2 per carton)</p>	Upholstered Seat and Back. Use with Beam.	6503	\$509	\$535	\$555	\$586	\$629	\$645	\$681	\$754	\$789	\$855	\$947	\$1059
		OVERALL DIMENSIONS			SEAT DIMENSIONS			BACK DIMENSIONS						
		W	D	H	W	D	H	W	H					
		20	22	17	17	15.5	-	17	15					
														
 <p>Seat Unit w/Arms COM Yardage: N/A Freight Class: 150 Product Weight (lbs.): 13 Cubic Feet Per Carton: 3.25 (2 per carton)</p>	Polypropylene Seat and Back. Use with Beam.	6504	\$480	-	-	-	-	-	-	-	-	-	-	-
		OVERALL DIMENSIONS			SEAT DIMENSIONS			BACK DIMENSIONS						
		W	D	H	W	D	H	W	H					
		23	21.5	17	17	16	-	17	15					
														
 <p>Seat Unit w/Arms COM Yardage: 0.75 Freight Class: 22 Product Weight (lbs.): 13 Cubic Feet Per Carton: 3.25 (2 per carton)</p>	Upholstered Seat and Polypropylene Back. Use with Beam.	6505	\$533	\$558	\$579	\$609	\$653	\$667	\$706	\$776	\$811	\$878	\$970	\$1083
		OVERALL DIMENSIONS			SEAT DIMENSIONS			BACK DIMENSIONS						
		W	D	H	W	D	H	W	H					
		23	22	17	17	16	-	17	15					
														

DESCRIPTION	FEATURES	MODEL#	STANDARD TEXTILE GRADES											
			1	2	3	4	5	6	7	8	9	10	11	12



Seat Unit w/Arms

COM Yardage: 0.75
 Freight Class: 150
 Product Weight (lbs.): 14
 Cubic Feet Per Carton: 3.25 (2 per carton)

Upholstered Seat and Back
 Use with Beam.

6506	\$582	\$610	\$630	\$661	\$704	\$719	\$756	\$828	\$864	\$930	\$1022	\$1133
------	-------	-------	-------	-------	-------	-------	-------	-------	-------	-------	--------	--------

OVERALL DIMENSIONS			SEAT DIMENSIONS			BACK DIMENSIONS	
W	D	H	W	D	H	W	H

23	22	17	17	16	-	17	15
----	----	----	----	----	---	----	----



6508



6508MB (Mesh back)

Armless Chair

COM Yardage: N/A
 Freight Class: 250
 Product Weight (lbs.): 10
 Cubic Feet Per Carton: 13.5 (2 per carton)

Polypropylene Seat.
 Stacks 5 high on floor.
 Stacks 10 high on dolly.

	1	2	3	4	5	6	7	8	9	10	11	12
--	---	---	---	---	---	---	---	---	---	----	----	----

6508	\$306	-	-	-	-	-	-	-	-	-	-	-
6508WS	\$336	-	-	-	-	-	-	-	-	-	-	-
6508MB	\$366	-	-	-	-	-	-	-	-	-	-	-
6508WSMB	\$395	-	-	-	-	-	-	-	-	-	-	-

OVERALL DIMENSIONS			SEAT DIMENSIONS			BACK DIMENSIONS	
W	D	H	W	D	H	W	H

21.5	21.5	33	17	16	18	17	15
------	------	----	----	----	----	----	----



6508TR



6508TRMB (Mesh back)

Armless Chair w/Tablet

COM Yardage: N/A
 Freight Class: 250
 Product Weight (lbs.): 26
 Cubic Feet Per Carton: 14.25 (1 per carton)

Polypropylene Seat. Does not stack.
Must specify (L) Left or (R) Right Tablet
(Example: 6508TL or 6508TR)

	1	2	3	4	5	6	7	8	9	10	11	12
--	---	---	---	---	---	---	---	---	---	----	----	----

6508T	\$611	-	-	-	-	-	-	-	-	-	-	-
6508TWS	\$643	-	-	-	-	-	-	-	-	-	-	-
6508TMB	\$668	-	-	-	-	-	-	-	-	-	-	-
6508TWSMB	\$698	-	-	-	-	-	-	-	-	-	-	-

OVERALL DIMENSIONS			SEAT DIMENSIONS			BACK DIMENSIONS	
W	D	H	W	D	H	W	H

24.75	26.5	32.5	17	16	18	17	15
-------	------	------	----	----	----	----	----



6509



6509MB (Mesh Back)

Armless Chair

COM Yardage: 0.75
 Freight Class: 300
 Product Weight (lbs.): 10
 Cubic Feet Per Carton: 13.5 (2 per carton)

Upholstered Seat.
 Stacks 5 high on floor.
 Stacks 10 high on dolly.

	1	2	3	4	5	6	7	8	9	10	11	12
--	---	---	---	---	---	---	---	---	---	----	----	----

6509	\$353	\$381	\$398	\$432	\$472	\$488	\$526	\$598	\$629	\$696	\$782	\$896
6509MB	\$412	\$438	\$458	\$488	\$531	\$546	\$585	\$656	\$690	\$757	\$849	\$962
6509WS	\$412	\$436	\$456	\$488	\$529	\$544	\$581	\$651	\$684	\$749	\$838	\$952
6509WSMB	\$446	\$474	\$492	\$523	\$568	\$581	\$620	\$692	\$726	\$792	\$883	\$997

OVERALL DIMENSIONS			SEAT DIMENSIONS			BACK DIMENSIONS	
W	D	H	W	D	H	W	H

21.5	22	33	17	16	18.5	17	15
------	----	----	----	----	------	----	----



6509TR



6509TRMB (Mesh back)

Armless Chair w/Tablet

COM Yardage: 0.75
 Freight Class: 250
 Product Weight (lbs.): 28
 Cubic Feet Per Carton: 14.25 (1 per carton)

Upholstered Seat. Does not stack.
Must specify (L) Left or (R) Right Tablet
(Example: 6509TL or 6509TR)









	1	2	3	4	5	6	7	8	9	10	11	12
--	---	---	---	---	---	---	---	---	---	----	----	----

6509T	\$653	\$683	\$703	\$736	\$782	\$798	\$840	\$916	\$953	\$1024	\$1121	\$1241
6509TWS	\$684	\$712	\$734	\$769	\$815	\$829	\$871	\$947	\$984	\$1055	\$1151	\$1273
6509TMB	\$708	\$738	\$758	\$791	\$837	\$853	\$895	\$971	\$1008	\$1081	\$1176	\$1298
6509TWSMB	\$739	\$767	\$789	\$824	\$870	\$885	\$926	\$1003	\$1039	\$1110	\$1208	\$1328

OVERALL DIMENSIONS			SEAT DIMENSIONS			BACK DIMENSIONS	
W	D	H	W	D	H	W	H

24.75	26.5	32.5	17	16	18.5	17	15
-------	------	------	----	----	------	----	----



DESCRIPTION	FEATURES	MODEL#	STANDARD TEXTILE GRADES											
			1	2	3	4	5	6	7	8	9	10	11	12
 <p>6511</p> <p>Armless Chair COM Yardage: 0.75 Freight Class: 300 Product Weight (lbs.): 11 Cubic Feet Per Carton: 13.5 (2 per carton)</p>	<p>Upholstered Seat and Back. Stacks 5 high on floor. Stacks 10 high on dolly.</p>	6511	\$396	\$424	\$445	\$475	\$516	\$531	\$568	\$639	\$671	\$740	\$827	\$938
		6511WS	\$425	\$451	\$473	\$502	\$544	\$560	\$597	\$668	\$700	\$765	\$856	\$967
		OVERALL DIMENSIONS			SEAT DIMENSIONS			BACK DIMENSIONS						
		W	D	H	W	D	H	W	H					
	21.5	21.5	32	17	16	18.5	17	15						
			RTA 00											
 <p>6511TR</p> <p>Armless Chair w/Tablet COM Yardage: 0.75 Freight Class: 250 Product Weight (lbs.): 28 Cubic Feet Per Carton: 14.25 (1 per carton)</p>	<p>Upholstered Seat & Back. Does not stack. Must specify (L) Left or (R) Right Tablet (Example: 6511TL or 6511TR)</p>	6511T	\$703	\$733	\$753	\$786	\$832	\$848	\$890	\$966	\$1003	\$1076	\$1171	\$1292
		6511TWS	\$735	\$763	\$785	\$820	\$866	\$880	\$922	\$998	\$1035	\$1106	\$1202	\$1324
		OVERALL DIMENSIONS			SEAT DIMENSIONS			BACK DIMENSIONS						
		W	D	H	W	D	H	W	H					
	24.75	26.5	32.5	17	16	18.5	17	15						
			RTA 00											
 <p>6513</p>	 <p>6513MB (Mesh Back)</p>	6513	\$373	-	-	-	-	-	-	-	-	-	-	
		6513WS	\$412	-	-	-	-	-	-	-	-	-	-	-
		6513MB	\$431	-	-	-	-	-	-	-	-	-	-	-
		6513WSMB	\$470	-	-	-	-	-	-	-	-	-	-	-
OVERALL DIMENSIONS			SEAT DIMENSIONS			BACK DIMENSIONS								
W	D	H	W	D	H	W	H							
	23	21.5	33	17	16	18	17	15						
			RTA 00											
 <p>6513TR</p>	 <p>6513TRMB (Mesh back)</p>	6513T	\$683	-	-	-	-	-	-	-	-	-	-	
		6513TWS	\$716	-	-	-	-	-	-	-	-	-	-	-
		6513TMB	\$693	-	-	-	-	-	-	-	-	-	-	-
		6513TWSMB	\$723	-	-	-	-	-	-	-	-	-	-	-
OVERALL DIMENSIONS			SEAT DIMENSIONS			BACK DIMENSIONS								
W	D	H	W	D	H	W	H							
	25	26.5	32.5	17	16	18	17	15						
			RTA 00											
 <p>6514</p>	 <p>6514MB (Mesh Back)</p>	6514	\$417	\$442	\$462	\$493	\$535	\$549	\$588	\$657	\$690	\$755	\$845	\$957
		6514WS	\$447	\$473	\$492	\$524	\$565	\$579	\$617	\$687	\$721	\$786	\$875	\$988
		6514MB	\$479	\$510	\$528	\$560	\$604	\$616	\$654	\$726	\$761	\$826	\$917	\$1031
		6514WSMB	\$518	\$530	\$550	\$580	\$626	\$638	\$677	\$749	\$782	\$849	\$940	\$1053
OVERALL DIMENSIONS			SEAT DIMENSIONS			BACK DIMENSIONS								
W	D	H	W	D	H	W	H							
	23	22	33	17	16	18.5	17	15						
			RTA 00											

DESCRIPTION FEATURES MODEL# STANDARD TEXTILE GRADES



6514TR



6514TRMB (Mesh back)

Armchair w/Tablet

COM Yardage: 0.75
 Freight Class: 250
 Product Weight (lbs.): 29
 Cubic Feet Per Carton: 14.25 (1 per carton)

Upholstered Seat. Does not stack.
Must specify (L) Left or (R) Right Tablet
 (Example: 6514TL or 6514TR)

RTA 00

MODEL#	STANDARD TEXTILE GRADES											
	1	2	3	4	5	6	7	8	9	10	11	12
6514T	\$729	\$757	\$779	\$811	\$856	\$874	\$916	\$992	\$1028	\$1100	\$1196	\$1317
6514TWS	\$759	\$789	\$809	\$844	\$890	\$905	\$947	\$1023	\$1059	\$1132	\$1227	\$1349
6514TMB	\$731	\$759	\$781	\$813	\$860	\$876	\$918	\$994	\$1031	\$1102	\$1198	\$1320
6514TWSMB	\$760	\$790	\$810	\$845	\$891	\$906	\$948	\$1024	\$1060	\$1133	\$1229	\$1350
OVERALL DIMENSIONS			SEAT DIMENSIONS			BACK DIMENSIONS						
W	D	H	W	D	H	W	H					
25	26.5	32.5	17	16	18.5	17	15					



6515

Armchair

COM Yardage: 0.75
 Freight Class: 300
 Product Weight (lbs.): 11.50
 Cubic Feet Per Carton: 5.88 (2 per carton)

Upholstered Seat and Back.
 Stacks 5 high on floor.
 Stacks 10 high on dolly.

RTA 00

MODEL#	STANDARD TEXTILE GRADES											
	1	2	3	4	5	6	7	8	9	10	11	12
6515	\$457	\$482	\$502	\$534	\$574	\$591	\$628	\$699	\$730	\$796	\$884	\$998
6515WS	\$489	\$514	\$534	\$566	\$607	\$621	\$658	\$729	\$763	\$827	\$915	\$1030
OVERALL DIMENSIONS			SEAT DIMENSIONS			BACK DIMENSIONS						
W	D	H	W	D	H	W	H					
23	22	34	17	15.5	18.5	17	15					



6515TR

Armchair w/Tablet

COM Yardage: 0.75
 Freight Class: 250
 Product Weight (lbs.): 30
 Cubic Feet Per Carton: 14.25 (1 per carton)

Upholstered Seat & Back. Does not stack.
Must specify (L) Left or (R) Right Tablet
 (Example: 6515TL or 6515TR)

RTA 00

MODEL#	STANDARD TEXTILE GRADES											
	1	2	3	4	5	6	7	8	9	10	11	12
6515T	\$729	\$800	\$822	\$854	\$900	\$916	\$958	\$1034	\$1071	\$1143	\$1238	\$1359
6515TWS	\$800	\$830	\$850	\$883	\$929	\$945	\$987	\$1063	\$1100	\$1173	\$1268	\$1389
OVERALL DIMENSIONS			SEAT DIMENSIONS			BACK DIMENSIONS						
W	D	H	W	D	H	W	H					
25	26.5	32.5	17	16	18	17	15					

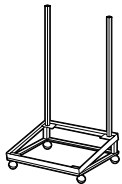

Dolly - Wall Saver

COM Yardage: N/A
 Freight Class: 150
 Product Weight (lbs.): 20
 Cubic Feet Per Carton: 4 (0.5 per carton)

Accommodates 10 chairs.

RTA 1



MODEL#	STANDARD TEXTILE GRADES											
	1	2	3	4	5	6	7	8	9	10	11	12
6517WS	\$531	-	-	-	-	-	-	-	-	-	-	-
OVERALL DIMENSIONS			SEAT DIMENSIONS			BACK DIMENSIONS						
W	D	H	W	D	H	W	H					
23.25	24.75	12.25	-	-	-	-	-					



6518



6518MB (Mesh Back)





Armless Chair w/Sled Base





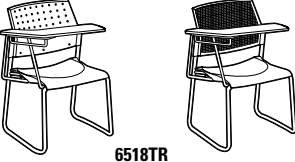
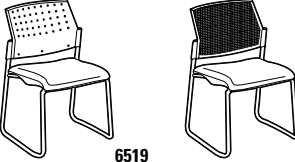

COM Yardage: N/A
 Freight Class: 250
 Product Weight (lbs.): 14
 Cubic Feet Per Carton: 11.75 (2 per carton)

Polypropylene Seat.
 Stacks 5 high on floor.
 Stacks 10 high on dolly.

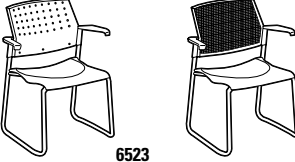

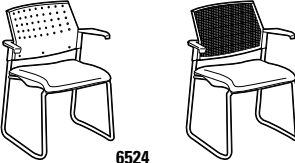
RTA 00



MODEL#	STANDARD TEXTILE GRADES											
	1	2	3	4	5	6	7	8	9	10	11	12
6518	\$367	-	-	-	-	-	-	-	-	-	-	-
6518WS	\$400	-	-	-	-	-	-	-	-	-	-	-
6518MB	\$429	-	-	-	-	-	-	-	-	-	-	-
6518WSMB	\$463	-	-	-	-	-	-	-	-	-	-	-
OVERALL DIMENSIONS			SEAT DIMENSIONS			BACK DIMENSIONS						
W	D	H	W	D	H	W	H					
22	21	32.5	17	16	17	17	15					

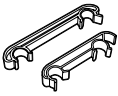

DESCRIPTION	FEATURES	MODEL#	STANDARD TEXTILE GRADES											
			1	2	3	4	5	6	7	8	9	10	11	12
 <p>6518TR 6518TRMB (Mesh back)</p> <p>Armless Chair w/Tablet and Sled Base COM Yardage: N/A Freight Class: 300 Product Weight (lbs.): 26 Cubic Feet Per Carton: 14.25 (1 per carton)</p> <p>Polypropylene Seat. Does not stack. Must specify (L) Left or (R) Right Tablet (Example: 6518TL or 6518TR)</p>			1	2	3	4	5	6	7	8	9	10	11	12
	<p>6518T \$679 - - - - - - - - - - - - - -</p> <p>6518TWS \$711 - - - - - - - - - - - - - -</p> <p>6518TMB \$729 - - - - - - - - - - - - - -</p> <p>6518TWSMB \$760 - - - - - - - - - - - - - -</p>	<p>OVERALL DIMENSIONS</p> <p>W D H</p>			<p>SEAT DIMENSIONS</p> <p>W D H</p>			<p>BACK DIMENSIONS</p> <p>W H</p>						
	24.75	26.5	32.5	17	16	18	17	15						
	RTA 00													
 <p>6519 6519MB (Mesh Back)</p> <p>Armless Chair w/Sled Base COM Yardage: 0.75 Freight Class: 250 Product Weight (lbs.): 14 Cubic Feet Per Carton: 5.88 (2 per carton)</p> <p>Upholstered Seat. Stacks 5 high on floor. Stacks 10 high on dolly.</p>			1	2	3	4	5	6	7	8	9	10	11	12
	<p>6519 \$413 \$438 \$458 \$489 \$530 \$545 \$582 \$652 \$685 \$750 \$839 \$953</p> <p>6519WS \$452 \$482 \$502 \$533 \$577 \$592 \$630 \$701 \$736 \$800 \$893 \$1004</p> <p>6519MB \$472 \$500 \$520 \$549 \$594 \$608 \$647 \$718 \$752 \$818 \$910 \$1023</p> <p>6519WSMB \$513 \$539 \$561 \$592 \$633 \$648 \$686 \$756 \$791 \$859 \$950 \$1063</p>	<p>OVERALL DIMENSIONS</p> <p>W D H</p>			<p>SEAT DIMENSIONS</p> <p>W D H</p>			<p>BACK DIMENSIONS</p> <p>W H</p>						
	22	21	33	17	16	17	17	15						
	RTA 00													
 <p>6519TR 6519TRMB (Mesh back)</p> <p>Armless Chair w/Tablet and Sled Base COM Yardage: 0.75 Freight Class: 300 Product Weight (lbs.): 28 Cubic Feet Per Carton: 14.25 (1 per carton)</p> <p>Upholstered Seat. Does not stack. Must specify (L) Left or (R) Right Tablet (Example: 6519TL or 6519TR)</p>			1	2	3	4	5	6	7	8	9	10	11	12
	<p>6519T \$719 \$750 \$772 \$804 \$850 \$866 \$907 \$983 \$1019 \$1093 \$1188 \$1309</p> <p>6519TWS \$745 \$776 \$796 \$830 \$876 \$891 \$933 \$1009 \$1047 \$1119 \$1214 \$1335</p> <p>6519TMB \$774 \$802 \$824 \$856 \$901 \$919 \$961 \$1037 \$1073 \$1145 \$1241 \$1362</p> <p>6519TWSMB \$853 \$886 \$932 \$949 \$990 \$1066 \$1103 \$1176 \$1271 \$1393 \$1271 \$1362</p>	<p>OVERALL DIMENSIONS</p> <p>W D H</p>			<p>SEAT DIMENSIONS</p> <p>W D H</p>			<p>BACK DIMENSIONS</p> <p>W H</p>						
	24.5	26.5	32.5	17	16	18	17	15						
	RTA 00													
 <p>6521</p> <p>Armless Chair w/Sled Base COM Yardage: 0.75 Freight Class: 250 Product Weight (lbs.): 15 Cubic Feet Per Carton: 13.5 (2 per carton)</p> <p>Upholstered Seat and Back. Stacks 5 high on floor. Stacks 10 high on dolly.</p>			1	2	3	4	5	6	7	8	9	10	11	12
	<p>6521 \$451 \$477 \$497 \$531 \$570 \$585 \$623 \$693 \$725 \$790 \$880 \$993</p> <p>6521WS \$486 \$512 \$531 \$560 \$602 \$617 \$652 \$722 \$751 \$817 \$903 \$1009</p>	<p>OVERALL DIMENSIONS</p> <p>W D H</p>			<p>SEAT DIMENSIONS</p> <p>W D H</p>			<p>BACK DIMENSIONS</p> <p>W H</p>						
	22	21	33	17	16	18.5	17	15						
	RTA 00													
 <p>6521TR</p> <p>Armless Chair w/Tablet and Sled Base COM Yardage: 0.75 Freight Class: 300 Product Weight (lbs.): 29 Cubic Feet Per Carton: 14.25 (1 per carton)</p> <p>Upholstered Seat & Back. Does not stack. Must specify (L) Left or (R) Right Tablet (Example: 6521TL or 6521TR)</p>			1	2	3	4	5	6	7	8	9	10	11	12
	<p>6521T \$721 \$752 \$774 \$806 \$852 \$868 \$910 \$985 \$1023 \$1095 \$1190 \$1311</p> <p>6521TWS \$749 \$779 \$799 \$832 \$878 \$894 \$936 \$1012 \$1049 \$1122 \$1217 \$1338</p>	<p>OVERALL DIMENSIONS</p> <p>W D H</p>			<p>SEAT DIMENSIONS</p> <p>W D H</p>			<p>BACK DIMENSIONS</p> <p>W H</p>						
	24.75	26.5	32.5	17	16	18.5	17	15						
	RTA 00													

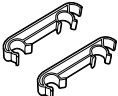

DESCRIPTION	FEATURES	MODEL#	STANDARD TEXTILE GRADES												
			1	2	3	4	5	6	7	8	9	10	11	12	
 <p>6523 6523MB (Mesh Back)</p>	Polypropylene Seat. Stacks 5 high on floor. Stacks 10 high on dolly.	6523	\$427	-	-	-	-	-	-	-	-	-	-	-	
		6523WS	\$470	-	-	-	-	-	-	-	-	-	-	-	-
			6523MB	\$498	-	-	-	-	-	-	-	-	-	-	
			6523WSMB	\$521	-	-	-	-	-	-	-	-	-	-	
			OVERALL DIMENSIONS			SEAT DIMENSIONS			BACK DIMENSIONS						
			W	D	H	W	D	H	W		H				
			23	21	32.5	17	16	17	17		15				
			RTA 00												
 <p>6523TR 6523TRMB (Mesh back)</p>	Polypropylene Seat. Does not stack. Must specify (L) Left or (R) Right Tablet (Example: 6523TL or 6523TR)	6523T	\$749	-	-	-	-	-	-	-	-	-	-		
		6523TWS	\$781	-	-	-	-	-	-	-	-	-	-	-	
			6523TMB	\$803	-	-	-	-	-	-	-	-	-	-	
			6523TWSMB	\$834	-	-	-	-	-	-	-	-	-	-	
			OVERALL DIMENSIONS			SEAT DIMENSIONS			BACK DIMENSIONS						
			W	D	H	W	D	H	W		H				
			25	26.5	32.5	17	16	18	17		15				
			RTA 00												
 <p>6524 6524MB (Mesh Back)</p>	Upholstered Seat. Stacks 5 high on floor. Stacks 10 high on dolly.	6524	\$470	\$496	\$515	\$547	\$589	\$605	\$641	\$713	\$745	\$811	\$899	\$1011	
		6524WS	\$528	\$556	\$574	\$607	\$651	\$663	\$701	\$774	\$810	\$875	\$967	\$1078	
			6524MB	\$544	\$572	\$593	\$623	\$664	\$680	\$719	\$789	\$824	\$889	\$983	\$1095
			6524WSMB	\$585	\$613	\$633	\$664	\$707	\$723	\$758	\$832	\$867	\$932	\$1025	\$1137
			OVERALL DIMENSIONS			SEAT DIMENSIONS			BACK DIMENSIONS						
			W	D	H	W	D	H	W		H				
			33	21	33	17	16	17.5	17		15				
			RTA 00 												
 <p>6524TR 6524TRMB (Mesh back)</p>	Upholstered Seat. Does not stack. Must specify (L) Left or (R) Right Tablet (Example: 6524TL or 6524TR)	6524T	\$786	\$814	\$836	\$871	\$917	\$931	\$973	\$1050	\$1086	\$1157	\$1255	\$1375	
		6524TWS	\$815	\$846	\$868	\$900	\$946	\$962	\$1004	\$1080	\$1117	\$1189	\$1284	\$1405	
			6524TMB	\$785	\$813	\$835	\$870	\$916	\$930	\$972	\$1049	\$1084	\$1155	\$1254	\$1374
			6524TWSMB	\$814	\$845	\$867	\$899	\$945	\$961	\$1002	\$1079	\$1114	\$1188	\$1283	\$1404
			OVERALL DIMENSIONS			SEAT DIMENSIONS			BACK DIMENSIONS						
			W	D	H	W	D	H	W		H				
			25	26.5	32.5	17	16	18.5	17		15				
			RTA 00												
 <p>6525</p>	Upholstered Seat and Back. Stacks 5 high on floor. Stacks 10 high on dolly.	6525	\$513	\$539	\$561	\$592	\$632	\$646	\$685	\$753	\$787	\$854	\$941	\$1053	
		6525WS	\$564	\$589	\$610	\$641	\$686	\$699	\$736	\$811	\$844	\$910	\$1002	\$1114	
			OVERALL DIMENSIONS			SEAT DIMENSIONS			BACK DIMENSIONS						
			W	D	H	W	D	H	W		H				
			23	21	33	17	15.5	17.5	17		15				
			RTA 00 												

DESCRIPTION	FEATURES	MODEL#	STANDARD TEXTILE GRADES												
			1	2	3	4	5	6	7	8	9	10	11	12	
 6525TR	Armchair w/Tablet and Sled Base COM Yardage: 0.75 Freight Class: 300 Product Weight (lbs.): 30 Cubic Feet Per Carton: 14.25 (1 per carton)	Upholstered Seat & Back. Does not stack. Must specify (L) Left or (R) Right Tablet (Example: 6525TL or 6525TR)	6525T	\$822	\$850	\$872	\$904	\$951	\$967	\$1009	\$1085	\$1122	\$1193	\$1289	\$1410
			6525TWS	\$852	\$882	\$902	\$935	\$981	\$998	\$1040	\$1115	\$1152	\$1225	\$1320	\$1442
			OVERALL DIMENSIONS			SEAT DIMENSIONS			BACK DIMENSIONS						
			W	D	H	W	D	H	W	H					
			25	26.5	32.5	17	16	18.5	17	15					
			RTA 00												

DESCRIPTION	FEATURES	MODEL#	STANDARD TEXTILE GRADES												
			1	2	3	4	5	6	7	8	9	10	11	12	
 6522	Ganging Brackets COM Yardage: N/A Freight Class: 70 Product Weight (lbs.): 0.2 Cubic Feet Per Carton: 1 (25 per carton)	For four legged models only.	6522	\$32	-	-	-	-	-	-	-	-	-	-	-
						OVERALL DIMENSIONS			SEAT DIMENSIONS			BACK DIMENSIONS			
			W	D	H	W	D	H	W	H					
			0.87	7.75	1.5	-	-	-	-	-					
			RTA 00 												

DESCRIPTION	FEATURES	MODEL#	STANDARD TEXTILE GRADES												
			1	2	3	4	5	6	7	8	9	10	11	12	
 6526	Ganging Brackets COM Yardage: N/A Freight Class: 70 Product Weight (lbs.): 0.25 Cubic Feet Per Carton: 1 (25 per carton)	Sled base models only.	6526	\$24	-	-	-	-	-	-	-	-	-	-	-
						OVERALL DIMENSIONS			SEAT DIMENSIONS			BACK DIMENSIONS			
			W	D	H	W	D	H	W	H					
			0.75	5.75	1.25	-	-	-	-	-					
			RTA 00 												

DESCRIPTION	FEATURES	MODEL#	STANDARD TEXTILE GRADES												
			1	2	3	4	5	6	7	8	9	10	11	12	
 6537	Armless LB Task COM Yardage: N/A Freight Class: 250 Product Weight (lbs.): 21.5 Cubic Feet Per Carton: 6.5	Polypropylene seat. Ergonomic features: C Available with tablet: Specify (L) left or (R) right tablet. (Example: 6537TL or 6537TR).	6537	\$496											
			6537T	\$875											
 6537MB			6537MB	\$558											
			6537MBT	\$940											
			OVERALL DIMENSIONS			SEAT DIMENSIONS			BACK DIMENSIONS						
			W	D	H	W	D	H	W	H					
			20.5	20.5	32.5	17	16	15.5-19.5	17	15					
			24	26	33	17	16	15.5-19.5	17	15					
			RTA 1 1 per carton												

DESCRIPTION	FEATURES	MODEL#	STANDARD TEXTILE GRADES												
			1	2	3	4	5	6	7	8	9	10	11	12	
 6538	Armless LB Task COM Yardage: 0.75 Freight Class: 250 Product Weight (lbs.): 22.5 Cubic Feet Per Carton: 6.5	Upholstered seat. Ergonomic features: C Available with tablet: Specify (L) left or (R) right tablet. (Example: 6538TL or 6538TR).	6538	\$537	\$565	\$582	\$614	\$656	\$672	\$708	\$781	\$813	\$878	\$965	\$1078
			6538T	\$905	\$936	\$960	\$993	\$1042	\$1064	\$1107	\$1178	\$1232	\$1291	\$1415	\$1547
 6538MB			6538MB	\$603	\$629	\$648	\$680	\$725	\$738	\$776	\$847	\$883	\$949	\$1041	\$1154
			6538MBT	\$981	\$1014	\$1037	\$1071	\$1119	\$1144	\$1189	\$1261	\$1316	\$1377	\$1502	\$1636
			OVERALL DIMENSIONS			SEAT DIMENSIONS			BACK DIMENSIONS						
			W	D	H	W	D	H	W	H					
			20.5	20.5	32.5	17	16	16-20	17	14.5					
			24	26	33	17	16	16-20	17	14.5					
			RTA 1  1 per carton												



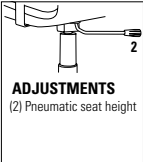







DESCRIPTION	FEATURES	MODEL#	STANDARD TEXTILE GRADES											
			1	2	3	4	5	6	7	8	9	10	11	12
 <p>Armless LB Task COM Yardage: 6.5 Freight Class: 250 Product Weight (lbs.): 23.5 Cubic Feet Per Carton: 6.5</p>	 <p>ADJUSTMENTS (2) Pneumatic seat height</p> <p>Upholstered seat & back. Ergonomic features: C</p> <p>Available with tablet: Specify (L) left or (R) right tablet. (Example: 6539TL or 6539TR).</p>													
		6539	\$577	\$605	\$623	\$657	\$696	\$711	\$750	\$821	\$852	\$917	\$1006	\$1119
		6539T	\$943	\$974	\$994	\$1029	\$1078	\$1101	\$1143	\$1211	\$1266	\$1325	\$1447	\$1577
			OVERALL DIMENSIONS			SEAT DIMENSIONS			BACK DIMENSIONS					
			W	D	H	W	D	H	W	H				
			20.5	20.5	33	17	15.5	16-20	17	15				
			24	26	33	17	16	16-20	17	14.5				
		RTA 1	1 per carton											



			1	2	3	4	5	6	7	8	9	10	11	12
		6558	\$478	-	-	-	-	-	-	-	-	-	-	-
		6558MB Mesh Back	\$558	-	-	-	-	-	-	-	-	-	-	-
			OVERALL DIMENSIONS			SEAT DIMENSIONS			BACK DIMENSIONS					
			W	D	H	W	D	H	W	H				
			22	23	42	17	16	28	17	15				
		RTA 00												

			1	2	3	4	5	6	7	8	9	10	11	12
		6558CS	\$478	-	-	-	-	-	-	-	-	-	-	-
		6558CSMB Mesh Back	\$558	-	-	-	-	-	-	-	-	-	-	-
			OVERALL DIMENSIONS			SEAT DIMENSIONS			BACK DIMENSIONS					
			W	D	H	W	D	H	W	H				
			22.5	22	38	17	16	24	17	15				
		RTA 00												

			1	2	3	4	5	6	7	8	9	10	11	12
		6559	\$519	\$547	\$567	\$598	\$638	\$654	\$690	\$762	\$792	\$860	\$947	\$1059
		6559MB Mesh Back	\$581	\$609	\$629	\$660	\$703	\$718	\$754	\$826	\$862	\$928	\$1020	\$1132
			OVERALL DIMENSIONS			SEAT DIMENSIONS			BACK DIMENSIONS					
			W	D	H	W	D	H	W	H				
			22	23	42	17	16	28.5	17	15				
		RTA 00												

			1	2	3	4	5	6	7	8	9	10	11	12
		6559CS	\$519	\$547	\$567	\$598	\$638	\$654	\$690	\$762	\$792	\$860	\$947	\$1059
		6559CSMB Mesh Back	\$581	\$609	\$629	\$660	\$703	\$718	\$754	\$826	\$862	\$928	\$1020	\$1132
			OVERALL DIMENSIONS			SEAT DIMENSIONS			BACK DIMENSIONS					
			W	D	H	W	D	H	W	H				
			22.5	22	38	17	16	24.5	17	15				
		RTA 00												

DESCRIPTION	FEATURES	MODEL#	STANDARD TEXTILE GRADES													
			1	2	3	4	5	6	7	8	9	10	11	12		
 Armless Bar Stool COM Yardage: 0.75 Freight Class: 300 Product Weight (lbs.): 18 Cubic Feet Per Carton: 14.75 (1 per carton)	Upholstered Seat and back. Stacks 5 high on floor. Stacks 10 high on dolly.	6561	\$564	\$589	\$610	\$641	\$684	\$697	\$734	\$804	\$838	\$904	\$993	\$1106		
			OVERALL DIMENSIONS			SEAT DIMENSIONS			BACK DIMENSIONS							
			W	D	H	W	D	H	W	H						
			22	23	42.5	17	16	28.5	17	15						
			RTA 00													
 Armless Counter Stool COM Yardage: 0.75 Freight Class: 300 Product Weight (lbs.): 27 Cubic Feet Per Carton: 14.75 (1 per carton)	Upholstered Seat and back. Stacks 5 high on floor.	6561CS	\$564	\$589	\$610	\$641	\$684	\$697	\$734	\$804	\$838	\$904	\$993	\$1106		
			OVERALL DIMENSIONS			SEAT DIMENSIONS			BACK DIMENSIONS							
			W	D	H	W	D	H	W	H						
			22.5	22	38	17	16	24.5	17	15						
			RTA 00													
  6563 6563MB (Mesh Back)	Polypropylene Seat. Stacks 5 high on floor. Stacks 10 high on dolly.	6563	\$543	-	-	-	-	-	-	-	-	-	-	-		
			6563MB Mesh Back	\$624	-	-	-	-	-	-	-	-	-	-	-	-
				OVERALL DIMENSIONS			SEAT DIMENSIONS			BACK DIMENSIONS						
			W	D	H	W	D	H	W	H						
23	23	42	17	16	28	17	15									
			RTA 00													
  6563CS 6563CSMB (Mesh Back)	Polypropylene Seat. Stacks 5 high on floor.	6563CS	\$543	-	-	-	-	-	-	-	-	-	-	-		
			6563CSMB Mesh Back	\$624	-	-	-	-	-	-	-	-	-	-	-	
				OVERALL DIMENSIONS			SEAT DIMENSIONS			BACK DIMENSIONS						
			W	D	H	W	D	H	W	H						
22.5	23	38	17	16	24	17	15									
			RTA 00													
  6564 6564MB (Mesh Back)	Upholstered Seat. Stacks 5 high on floor.	6564	\$579	\$609	\$627	\$658	\$697	\$713	\$751	\$822	\$855	\$918	\$1008	\$1120		
			6564MB Mesh Back	\$672	\$702	\$722	\$753	\$795	\$809	\$847	\$919	\$954	\$1020	\$1112	\$1223	
				OVERALL DIMENSIONS			SEAT DIMENSIONS			BACK DIMENSIONS						
			W	D	H	W	D	H	W	H						
23	23	42.5	17	16	28.5	17	15									
			RTA 00													

DESCRIPTION	FEATURES	MODEL#	STANDARD TEXTILE GRADES												
			1	2	3	4	5	6	7	8	9	10	11	12	
 6564CS	 6564CSMB (Mesh Back)		1	2	3	4	5	6	7	8	9	10	11	12	
			6564CS	\$579	\$609	\$627	\$658	\$697	\$713	\$751	\$822	\$855	\$918	\$1008	\$1120
			6564CSMB	\$672	\$702	\$722	\$753	\$795	\$809	\$847	\$919	\$954	\$1020	\$1112	\$1223
			Mesh Back												
			OVERALL DIMENSIONS			SEAT DIMENSIONS			BACK DIMENSIONS						
			W	D	H	W	D	H	W	H					
			22.5	23	38	17	16	24.5	17	15					
			RTA 00												

Counter Stool w/Arms
 COM Yardage: 0.75
 Freight Class: 300
 Product Weight (lbs.): 25
 Cubic Feet Per Carton: 14.75 (1 per carton)

Upholstered Seat.
 Stacks 5 high on floor.



Bar Stool w/Arms
 COM Yardage: 0.75
 Freight Class: 300
 Product Weight (lbs.): 19
 Cubic Feet Per Carton: 14.75 (1 per carton)

Upholstered seat and back.
 Stacks 5 high on floor.

	STANDARD TEXTILE GRADES													
	1	2	3	4	5	6	7	8	9	10	11	12		
6565	\$618	\$648	\$666	\$698	\$737	\$754	\$791	\$863	\$898	\$962	\$1050	\$1161		
			OVERALL DIMENSIONS			SEAT DIMENSIONS			BACK DIMENSIONS					
			W	D	H	W	D	H	W	H				
			23	23	42.5	17	16	28.5	17	15				
			RTA 00											



Counter Stool w/Arms
 COM Yardage: 0.75
 Freight Class: 300
 Product Weight (lbs.): 27
 Cubic Feet Per Carton: 14.75 (1 per carton)

Upholstered Seat.
 Stacks 5 high on floor.

	STANDARD TEXTILE GRADES													
	1	2	3	4	5	6	7	8	9	10	11	12		
6565CS	\$618	\$648	\$666	\$698	\$737	\$754	\$791	\$863	\$898	\$962	\$1050	\$1161		
			OVERALL DIMENSIONS			SEAT DIMENSIONS			BACK DIMENSIONS					
			W	D	H	W	D	H	W	H				
			22.5	23	38	17	16	24.5	17	15				
			RTA 00											



LB Task w/Arms
 COM Yardage: N/A
 Freight Class: 250
 Product Weight (lbs.): 23
 Cubic Feet Per Carton: 6.5



6567MB

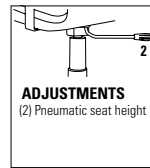

ADJUSTMENTS
 (2) Pneumatic seat height

Polypropylene seat.
 Ergonomic features: C

Available with tablet:
 Specify (L) left or (R) right tablet.
 (Example: 657TL or 6567TR).

List price														
6567	\$558													
6567T	\$926													
6567MB	\$624													
6567MBT	\$1006													
			OVERALL DIMENSIONS			SEAT DIMENSIONS			BACK DIMENSIONS					
			W	D	H	W	D	H	W	H				
			23	20.5	32.5	17	16	15.5-20.5	17	15				
			RTA 1  1 per carton											



LB Task w/Arms
 COM Yardage: N/A
 Freight Class: 250
 Product Weight (lbs.): 24
 Cubic Feet Per Carton: 6.5



6568MB

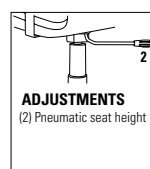









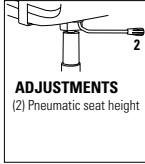









ADJUSTMENTS
 (2) Pneumatic seat height









Upholstered seat.
 Ergonomic features: C



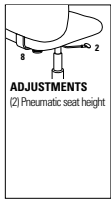

Available with tablet:
 Specify (L) left or (R) right tablet.
 (Example: 6568TL or 6568TR).

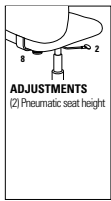

	STANDARD TEXTILE GRADES													
	1	2	3	4	5	6	7	8	9	10	11	12		
6568	\$598	\$623	\$643	\$675	\$716	\$731	\$769	\$840	\$871	\$939	\$1026	\$1138		
6568T	\$963	\$993	\$1014	\$1049	\$1096	\$1118	\$1161	\$1230	\$1283	\$1341	\$1463	\$1593		
6568MB	\$657	\$682	\$702	\$733	\$777	\$792	\$828	\$902	\$935	\$1002	\$1094	\$1207		
6568MBT	\$1025	\$1056	\$1078	\$1112	\$1160	\$1184	\$1227	\$1296	\$1350	\$1410	\$1532	\$1664		
			OVERALL DIMENSIONS			SEAT DIMENSIONS			BACK DIMENSIONS					
			W	D	H	W	D	H	W	H				
			23	20.5	32.5	17	16	16-21	17	14.5				
			RTA 1  1 per carton											

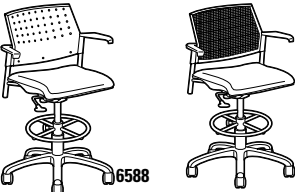
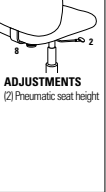
DESCRIPTION	FEATURES	MODEL#	STANDARD TEXTILE GRADES												
			1	2	3	4	5	6	7	8	9	10	11	12	
 <p>LB Task w/Arms COM Yardage: N/A Freight Class: 250 Product Weight (lbs.): 25 Cubic Feet Per Carton: 6.5</p>	 <p>ADJUSTMENTS (2) Pneumatic seat height</p>		1	2	3	4	5	6	7	8	9	10	11	12	
			6569	\$639	\$664	\$684	\$715	\$757	\$773	\$809	\$882	\$913	\$979	\$1066	\$1180
			6569T	\$996	\$1027	\$1049	\$1082	\$1130	\$1151	\$1193	\$1261	\$1314	\$1371	\$1490	\$1619
			OVERALL DIMENSIONS			SEAT DIMENSIONS			BACK DIMENSIONS						
			W	D	H	W	D	H	W	H					
			23	20.5	33	17	15.5	16-21	17	15					
						RTA 1		1 per carton							
	Upholstered seat & back. Ergonomic features: C														
	Available with tablet: Specify (L) left or (R) right tablet. (Example: 6569TL or 6569TR).														
 <p>6573</p>	 <p>6573MB (Mesh Back)</p>		1	2	3	4	5	6	7	8	9	10	11	12	
			6573	\$449	-	-	-	-	-	-	-	-	-	-	-
			6573MB	\$509	-	-	-	-	-	-	-	-	-	-	-
			OVERALL DIMENSIONS			SEAT DIMENSIONS			BACK DIMENSIONS						
			W	D	H	W	D	H	W	H					
			23	21	32	17	16	17.5	17	14.5					
						RTA 00									
	Propolylene Seat. Does not stack.														
 <p>6573TR</p>	 <p>6573TRMB (Mesh Back)</p>		1	2	3	4	5	6	7	8	9	10	11	12	
			6573T	\$762	-	-	-	-	-	-	-	-	-	-	-
			6573TMB	\$815	-	-	-	-	-	-	-	-	-	-	-
			OVERALL DIMENSIONS			SEAT DIMENSIONS			BACK DIMENSIONS						
			W	D	H	W	D	H	W	H					
			25	26.5	32.5	17	16	18	17	15					
						RTA 00									
	Propolylene Seat. Does not stack. Must specify (L) Left or (R) Right Tablet (Example: 6573TL or 6573TR)														
 <p>6574</p>	 <p>6574MB (Mesh Back)</p>		1	2	3	4	5	6	7	8	9	10	11	12	
			6574	\$492	\$518	\$538	\$571	\$610	\$626	\$664	\$732	\$766	\$833	\$923	\$1034
			6574MB	\$552	\$580	\$600	\$631	\$674	\$689	\$726	\$797	\$834	\$900	\$992	\$1103
			OVERALL DIMENSIONS			SEAT DIMENSIONS			BACK DIMENSIONS						
			W	D	H	W	D	H	W	H					
			23	21.5	33	17	16	18	17	14					
						RTA 00									
	Upholstered Seat. Does not stack.														
 <p>6574TR</p>	 <p>6574TRMB (Mesh Back)</p>		1	2	3	4	5	6	7	8	9	10	11	12	
			6574T	\$803	\$833	\$853	\$886	\$932	\$949	\$990	\$1066	\$1103	\$1176	\$1271	\$1393
			6574TMB	\$861	\$892	\$912	\$946	\$992	\$1008	\$1049	\$1126	\$1161	\$1235	\$1330	\$1451
			OVERALL DIMENSIONS			SEAT DIMENSIONS			BACK DIMENSIONS						
			W	D	H	W	D	H	W	H					
			25	26.5	32.5	17	16	18	17	15					
						RTA 00									
	Upholstered Seat. Does not stack. Must specify (L) Left or (R) Right Tablet (Example: 6574TL or 6574TR)														

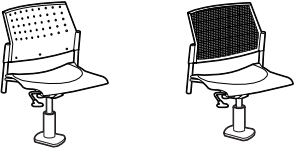
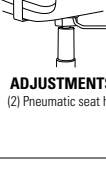
DESCRIPTION	FEATURES	MODEL#	STANDARD TEXTILE GRADES											
			1	2	3	4	5	6	7	8	9	10	11	12
 Armchair w/Casters COM Yardage: 0.75 Freight Class: 250 Product Weight (lbs.): 15 Cubic Feet Per Carton: 13.5 (2 per carton)	Upholstered Seat and Back. Does not stack.	6575	\$514	\$540	\$562	\$593	\$633	\$648	\$686	\$754	\$788	\$855	\$942	\$1054
		OVERALL DIMENSIONS			SEAT DIMENSIONS			BACK DIMENSIONS						
		W	D	H	W	D	H	W	H					
			23	21.5	32.5	17	15.5	18				17	14.5	
			RTA 00											
 6575TR Armchair w/Tablet and Casters COM Yardage: 0.75 Freight Class: 300 Product Weight (lbs.): 30 Cubic Feet Per Carton: 14.25 (1 per carton)	Upholstered Seat & Back. Does not stack. Must specify (L) Left or (R) Right Tablet (Example: 6575TL or 6575TR)	6575T	\$835	\$865	\$885	\$920	\$966	\$981	\$1022	\$1099	\$1135	\$1206	\$1304	\$1425
		OVERALL DIMENSIONS			SEAT DIMENSIONS			BACK DIMENSIONS						
		W	D	H	W	D	H	W	H					
			25	26.5	32.5	17	16	18.5				17	15	
			RTA 00											
 6577 Armless Chair w/Casters COM Yardage: N/A Freight Class: 300 Product Weight (lbs.): 12 Cubic Feet Per Carton: 13.5 (2 per carton)	Polypropylene Seat. Does not stack.	6577	\$390	-	-	-	-	-	-	-	-	-	-	-
		OVERALL DIMENSIONS			SEAT DIMENSIONS			BACK DIMENSIONS						
		W	D	H	W	D	H	W	H					
			21	21	33	17	16	17.5				17	14.5	
			RTA 00											
 6577MB (Mesh Back) Armless Chair w/Casters COM Yardage: N/A Freight Class: 300 Product Weight (lbs.): 12 Cubic Feet Per Carton: 13.5 (2 per carton)	Polypropylene Seat. Does not stack.	6577MB	\$446	-	-	-	-	-	-	-	-	-	-	
		OVERALL DIMENSIONS			SEAT DIMENSIONS			BACK DIMENSIONS						
		W	D	H	W	D	H	W	H					
			21	21	33	17	16	17.5				17	14.5	
			RTA 00											
 6577TR Armless Chair w/Tablet and Casters COM Yardage: N/A Freight Class: 300 Product Weight (lbs.): 27 Cubic Feet Per Carton: 14.25 (1 per carton)	Polypropylene Seat. Does not stack. Must specify (L) Left or (R) Right Tablet (Example: 6577TL or 6577TR)	6577T	\$694	-	-	-	-	-	-	-	-	-	-	
		OVERALL DIMENSIONS			SEAT DIMENSIONS			BACK DIMENSIONS						
		W	D	H	W	D	H	W	H					
			24.75	26.5	32.5	17	16	18				17	15	
			RTA 00											
 6577TRMB (Mesh Back) Armless Chair w/Tablet and Casters COM Yardage: N/A Freight Class: 300 Product Weight (lbs.): 27 Cubic Feet Per Carton: 14.25 (1 per carton)	Polypropylene Seat. Does not stack.	6577TMB	\$749	-	-	-	-	-	-	-	-	-		
		OVERALL DIMENSIONS			SEAT DIMENSIONS			BACK DIMENSIONS						
		W	D	H	W	D	H	W	H					
			24.75	26.5	32.5	17	16	18				17	15	
			RTA 00											
 6578 Armless Chair w/Casters COM Yardage: 0.75 Freight Class: 300 Product Weight (lbs.): 13 Cubic Feet Per Carton: 13.5 (2 per carton)	Upholstered Seat. Does not stack.	6578	\$431	\$461	\$477	\$511	\$551	\$567	\$604	\$674	\$706	\$775	\$862	\$972
		OVERALL DIMENSIONS			SEAT DIMENSIONS			BACK DIMENSIONS						
		W	D	H	W	D	H	W	H					
			21	21.5	33	17	16	18				17	14	
			RTA 00											
 6578MB (Mesh Back) Armless Chair w/Casters COM Yardage: 0.75 Freight Class: 300 Product Weight (lbs.): 13 Cubic Feet Per Carton: 13.5 (2 per carton)	Upholstered Seat. Does not stack.	6578MB	\$494	\$517	\$538	\$567	\$611	\$627	\$663	\$737	\$770	\$837	\$929	\$1041
		OVERALL DIMENSIONS			SEAT DIMENSIONS			BACK DIMENSIONS						
		W	D	H	W	D	H	W	H					
			21	21.5	33	17	16	18				17	14	
			RTA 00											

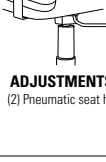
DESCRIPTION	FEATURES	MODEL#	STANDARD TEXTILE GRADES											
			1	2	3	4	5	6	7	8	9	10	11	12
 <p>6578TR</p> <p>Armless Chair w/Tablet and Casters COM Yardage: 0.75 Freight Class: 300 Product Weight (lbs.): 28 Cubic Feet Per Carton: 14.25 (1 per carton)</p>	 <p>6578TRMB (Mesh Back)</p> <p>Upholstered Seat. Does not stack. Must specify (L) Left or (R) Right Tablet (Example: 6578TL or 6578TR)</p>	6578T	\$736	\$764	\$786	\$821	\$867	\$881	\$923	\$1000	\$1036	\$1107	\$1204	\$1325
			6578TMB Mesh Back	\$786	\$814	\$836	\$871	\$917	\$931	\$973	\$1050	\$1086	\$1157	\$1255
OVERALL DIMENSIONS			SEAT DIMENSIONS			BACK DIMENSIONS								
W D H			W D H			W H								
24.75 26.5 32.5			17 16 18.5			17 15								
			RTA 00											
 <p>6579</p> <p>Armless chair w/Casters COM Yardage: 0.75 Freight Class: 250 Product Weight (lbs.): 13 Cubic Feet Per Carton: 13.5 (2 per carton)</p>	<p>Upholstered Seat and Back. Does not stack.</p>	6579	\$472	\$497	\$517	\$548	\$591	\$606	\$642	\$714	\$746	\$813	\$901	\$1012
			OVERALL DIMENSIONS			SEAT DIMENSIONS			BACK DIMENSIONS					
W D H			W D H			W H								
21 21.5 32.5			17 15.5 18			17 14.5								
			RTA 00											
 <p>6579T</p> <p>Armless Chair w/Tablet and Casters COM Yardage: 0.75 Freight Class: 300 Product Weight (lbs.): 18 Cubic Feet Per Carton: 11.75 (1 per carton)</p>	<p>Upholstered Seat & Back. Does not stack. Must specify (L) Left or (R) Right Tablet (Example: 6579TL or 6579TR)</p>	6579T	\$786	\$814	\$836	\$871	\$917	\$931	\$973	\$1050	\$1086	\$1157	\$1255	\$1375
			OVERALL DIMENSIONS			SEAT DIMENSIONS			BACK DIMENSIONS					
W D H			W D H			W H								
23.5 21.5 33			17 16 18.5			17 15								
			RTA 00											
 <p>6586</p> <p>LB Task Drafting Chair COM Yardage: 0.75 Freight Class: 250 Product Weight (lbs.): 28 Cubic Feet Per Carton: 8.25 (1 per carton)</p>	 <p>ADJUSTMENTS (2) Pneumatic seat height</p> <p>Upholstered Seat and Back. Ergonomic Features: C, M</p>	6586	\$874	\$899	\$922	\$953	\$992	\$1011	\$1047	\$1118	\$1154	\$1220	\$1311	\$1424
			OVERALL DIMENSIONS			SEAT DIMENSIONS			BACK DIMENSIONS					
W D H			W D H			W H								
24 21.5 21.5			17 16 22-32			17 14.5								
			RTA 1											
 <p>6587</p> <p>LB Task Drafting Chair COM Yardage: N/A Freight Class: 250 Product Weight (lbs.): 26 Cubic Feet Per Carton: 8.25 (1 per carton)</p>	 <p>ADJUSTMENTS (2) Pneumatic seat height</p> <p>Polypropylene Seat. Ergonomic Features: C, M</p>	6587	\$733	-	-	-	-	-	-	-	-	-	-	-
			OVERALL DIMENSIONS			SEAT DIMENSIONS			BACK DIMENSIONS					
W D H			W D H			W H								
24.0 21.5 42.5			17 16 22-32			17 14.5								
			RTA 1											

DESCRIPTION	FEATURES	MODEL#	STANDARD TEXTILE GRADES											
			1	2	3	4	5	6	7	8	9	10	11	12
 <p>6588 6588MB</p> <p>LB Task Drafting Chair COM Yardage: 0.75 Freight Class: 250 Product Weight (lbs.): 28 Cubic Feet Per Carton: 8.25 (1 per carton)</p>	 <p>ADJUSTMENTS (2) Pneumatic seat height</p> <p>Upholstered Seat. Ergonomic Features: C, M</p>	<p>6588 \$827 \$853 \$873 \$901 \$949 \$962 \$1000 \$1070 \$1107 \$1173 \$1265 \$1376</p> <p>6588MB \$809 \$835 \$857 \$889 \$929 \$945 \$983 \$1056 \$1090 \$1155 \$1247 \$1361</p>	<p>OVERALL DIMENSIONS</p> <p>W D H</p>			<p>SEAT DIMENSIONS</p> <p>W D H</p>			<p>BACK DIMENSIONS</p> <p>W H</p>					
		<p>24 21.5 42.5 17 16 22-32 17 14.5</p>	<p>RTA 1 </p>											
 <p>6537PB 6537MBPB</p> <p>Armless LB Task with Pedestal Base COM Yardage: N/A Freight Class: 250 Product Weight (lbs.): 28 Cubic Feet Per Carton: 9.75</p>	 <p>ADJUSTMENTS (2) Pneumatic seat height</p> <p>Polypropylene seat. Ergonomic features: C</p> <p>Available with tablet: Specify (L) left or (R) right tablet. (Example: 6537TL or 6537TR).</p>	<p>6537PB \$720</p> <p>6537TLPB \$1098</p> <p>6537TRPB \$1098</p>	<p>OVERALL DIMENSIONS</p> <p>W D H</p>			<p>SEAT DIMENSIONS</p> <p>W D H</p>			<p>BACK DIMENSIONS</p> <p>W H</p>					
		<p>20.5 20.5 31 17 16 15.5-19.5 17 15</p> <p>24 26 31 17 16 15.5-19.5 17 15</p>	<p>RTA 1 1 per carton</p>											
 <p>6539PB</p> <p>Armless LB Task with Pedestal Base COM Yardage: 6.5 Freight Class: 250 Product Weight (lbs.): 23.5 Cubic Feet Per Carton: 6.5</p>	 <p>ADJUSTMENTS (2) Pneumatic seat height</p> <p>Upholstered seat & back. Ergonomic features: C</p> <p>Available with tablet: Specify (L) left or (R) right tablet. (Example: 6539TL or 6539TR).</p>	<p>6539PB \$801 \$831 \$850 \$883 \$928 \$949 \$990 \$1056 \$1107 \$1161 \$1276 \$1398</p>	<p>OVERALL DIMENSIONS</p> <p>W D H</p>			<p>SEAT DIMENSIONS</p> <p>W D H</p>			<p>BACK DIMENSIONS</p> <p>W H</p>					
		<p>6539TLPB \$1167 \$1197 \$1217 \$1250 \$1298 \$1318 \$1359 \$1427 \$1478 \$1534 \$1652 \$1777</p> <p>6539TRPB</p>	<p>24 20.5 31 17 15.5 16-20 17 15</p> <p>24 26 31 17 16 16-20 17 14.5</p>	<p>RTA 1 1 per carton</p>										

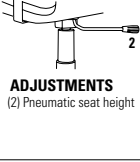
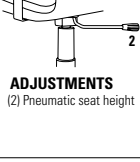
DESCRIPTION	FEATURES	MODEL#	STANDARD TEXTILE GRADES																
			1	2	3	4	5	6	7	8	9	10	11	12					
 6567PB	 6567MBPB	 ADJUSTMENTS (2) Pneumatic seat height	6567PB	\$781															
			65677LPB	\$1150															
			6567TRPB	\$1150															
			6567MBPB	849															
			6567MBTLPB	1199															
			6567MBTRPB	1199															
			OVERALL DIMENSIONS			SEAT DIMENSIONS			BACK DIMENSIONS										
			W	D	H	W	D	H	W	H									
			20.5	20.5	31	17	16	15.5-19.5	17	15									
			24	26	31	17	16	15.5-19.5	17	15									
			RTA 1	1 per carton															
LB Task w/Arms, plastic seat & back COM Yardage: N/A Freight Class: 250 Product Weight (lbs.): 28 Cubic Feet Per Carton: 9.75	Polypropylene seat. Ergonomic features: C	 ADJUSTMENTS (2) Pneumatic seat height	Available with tablet: Specify (L) left or (R) right tablet. (Example: 6537TL or 6537TR).																
			6569PB	\$862	\$892	\$912	\$944	\$989	\$1010	\$1051	\$1117	\$1165	\$1221	\$1335	\$1457				
			6569TLPB	\$1220	\$1250	\$1270	\$1302	\$1347	\$1368	\$1410	\$1476	\$1527	\$1583	\$1697	\$1823				
			6569TRPB																
			OVERALL DIMENSIONS			SEAT DIMENSIONS			BACK DIMENSIONS										
			W	D	H	W	D	H	W	H									
			24	20.5	31	17	15.5	16-20	17	15									
			24	26	31	17	16	16-20	17	14.5									
			RTA 1	1 per carton															

SPRITZ™



Model 6762-6



Model 6766



Model 6768-6



Model 6762-6PB

NESTING FEATURES



Articulating back on nesting chairs and drafting stools.



Flip up seat on nesting chairs.

MECHANISMS OPTIONS

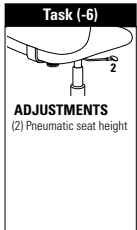

Ergonomic Features:
C, G, M, N, U

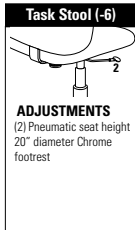

Ergonomic Features:
C, G, M, N, U

SPRITZ WORK & TASK CHAIRS



For Spritz Task chairs, please refer to Work + Task section of pricebook.

STANDARD FEATURES

- An exceptionally comfortable chair series featuring a sophisticated, translucent mesh and models for all applications.
- Features an auto-adjusting comfort back.
- Spring loaded back reacts to body pressure and articulates 12°.
- Multi-purpose models standard with Global's high quality Soft Descent™ pneumatic lift which slowly and gently lowers the seat height of the chair making it easy to obtain the exact seat height you desire.
- Five prong, injection molded, fiberglass reinforced nylon Black base with **C10** dual wheel carpet casters.
- Nesting chairs have a flip up seat allowing chairs to stack horizontally.
- When nesting horizontal nesting chairs, each additional chair adds 10" to depth.
- Nesting chairs are standard with four Black nylon glides, **C1** carpet casters or with two casters at front, two glides at rear.
- Chairs are "Wall Safe". Rear legs hit the baseboard first leaving clearance between the back of the chair and the wall, saving both the chair and the wall from damage.
- Check textile availability prior to specifying upholstery material.
- Models can be ordered in Leather using appropriate grade.
- Pedestal base models are offered with (-6) Task mechanisms only. These models provide fixed location seating for use in auditoriums, classrooms, jury boxes, public venues and more. The base must be mounted to the floor (mounting hardware not included). See Pedestal Base Installation Guide for details.

OPTIONAL FEATURES

- For additional caster options, please refer to the Arm and Caster section.
- Optional casters may be priced higher than the standard casters for your chair and the difference will be charged. Lower priced optional casters will not be credited.
- Pedestal base models have black base with 2" height adjust cylinders. Specify **(SCC)** swivel, auto return to max height (no upcharge); **(SN)** non-swivel, auto return to max height (Add \$19); or, **(SC)** swivel, self-centering and return to max height (add \$30).

OPTION CODES

Please add option codes in the following order:

- **Model number**
6762-6 Task Chair w/Arms
6763-6 Task Chair without Arms
6764 Nesting Chair on Glides
6765 Nesting Chair w/arms on Glides
6767-6 Drafting Stool without Arms
6768-6 Drafting Stool w/Arms
- Add **(-C)** to model number if ordering with casters. Add **(-FC)** to model number if ordering Front casters/rear glides.
- **Fabric**
Specify fabric code for seat.
- **Frame**
(TBL) Black frame finish..... **Standard**
(TSH) Shadow frame finish..... **Standard**
(TTU) Tungsten frame finish..... **Standard**
(CHM) Chrome frame finish..... **Add \$59**
- **Base** (task models/drafting stools only)
(B-BK) Black nylon base..... **Standard**
- **Casters** (task models /drafting stools only)
(C10) Dual wheel carpet casters **Standard**
(C10R) Dual wheel hard floor casters..... **Add \$60**
- **Casters** (nesting models only)
(C1) Dual wheel carpet casters **Standard**
(C9R) Dual wheel hard floor casters..... **Add \$66**
- **Mesh Back**
(U1) Black
(U2) Burgundy
(U3) Blue
(U4) Green
(colors shown on website)
- **Chair Assembly**
(task models /drafting stools only)
(-SU) Assembled in Box..... **Add \$70**
- **Cylinder (for Pedestal Base models)**
(SCC) Swivel, auto return to max height.
(SN) Non-swivel, auto return to center and return to max height. **Add \$19**
(SC) Swivel, self-centering and return to max height. **Add \$30.**

EXAMPLE OF ORDER CODE: (Task models/Drafting Stool Models)

6762-6	WA50	TBL	B-BK	C10	U2	SU
Model Number	Fabric	Frame	Base	Casters	Mesh	Chair Assembly

EXAMPLE OF ORDER CODE: (Nesting Models)

6764C	WA50	TTU	C9R	U2
Model Number	Fabric	Frame	Casters	Mesh

DESCRIPTION	FEATURES	MODEL#	STANDARD TEXTILE GRADES											
			1	2	3	4	5	6	7	8	9	10	11	12
 <p>Task Chair w/Arms COM Yardage: 00.75 Freight Class: 250 Product Weight (lbs.): 29 Cubic Feet Per Carton: 9.75</p>		6762-6	727	757	775	807	849	870	908	970	1017	1070	1178	1295
			OVERALL DIMENSIONS			SEAT DIMENSIONS			BACK DIMENSIONS					
			W	D	H	W	D	H	W	H				
			23.5	20.5	31	18	16.5	15.5	17	16.5				
			RTA 00											

DESCRIPTION	FEATURES	MODEL#	STANDARD TEXTILE GRADES											
			1	2	3	4	5	6	7	8	9	10	11	12
 <p>Task Chair without Arms COM Yardage: 00.75 Freight Class: 250 Product Weight (lbs.): 28 Cubic Feet Per Carton: 9.75</p>		6763-6	696	722	742	773	815	836	876	936	985	1037	1146	1264
			OVERALL DIMENSIONS			SEAT DIMENSIONS			BACK DIMENSIONS					
			W	D	H	W	D	H	W	H				
			20.5	20.5	31	18	16.5	15.5	17	16.5				
			RTA 00											

DESCRIPTION	FEATURES	MODEL#	STANDARD TEXTILE GRADES											
			1	2	3	4	5	6	7	8	9	10	11	12
 <p>Armless Flip Seat Nesting Chair w/Glides COM Yardage: 00.75 Freight Class: 300 Product Weight (lbs.): 22 Cubic Feet Per Carton: 11.25</p>		6764	604	632	650	681	723	745	785	844	893	945	1053	1169
			OVERALL DIMENSIONS			SEAT DIMENSIONS			BACK DIMENSIONS					
			W	D	H	W	D	H	W	H				
			20.5	23	33	18	17	17	17	16				
	Seat Flips up for nesting Ergonomic Features: G, M, N		RTA 00											

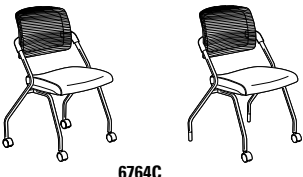
DESCRIPTION	FEATURES	MODEL#	STANDARD TEXTILE GRADES												
			1	2	3	4	5	6	7	8	9	10	11	12	
 <p>6764C 6764FC</p> <p>Armless Flip Seat Nesting Chair w/Casters COM Yardage: 00.75 Freight Class: 300 Product Weight (lbs.): 22 Cubic Feet Per Carton: 11.25</p>		6764C	604	632	650	681	723	745	785	844	893	945	1053	1169	
			6764FC	604	632	650	681	723	745	785	844	893	945	1053	1169
			OVERALL DIMENSIONS			SEAT DIMENSIONS			BACK DIMENSIONS						
			W	D	H	W	D	H	W	H					
	C= Casters all 4 legs FC= Casters on front legs only Seat Flips up for nesting Ergonomic Features: G, M, N		20.5	23	33	18	17	17	17	16					
			RTA 00												

DESCRIPTION	FEATURES	MODEL#	STANDARD TEXTILE GRADES											
			1	2	3	4	5	6	7	8	9	10	11	12
 <p>Flip Seat Nesting Chair w/Arms & Glides COM Yardage: 0.75 Freight Class: 300 Product Weight (lbs.): 23 Cubic Feet Per Carton: 11.75</p>		6765	643	671	689	722	763	786	824	885	933	986	1096	1212
			OVERALL DIMENSIONS			SEAT DIMENSIONS			BACK DIMENSIONS					
			W	D	H	W	D	H	W	H				
			23.75	23	33	18.5	17	17	17	16				
	Seat Flips up for nesting Ergonomic Features: G, M, N		RTA 00											

DESCRIPTION	FEATURES	MODEL#	STANDARD TEXTILE GRADES											
			1	2	3	4	5	6	7	8	9	10	11	12

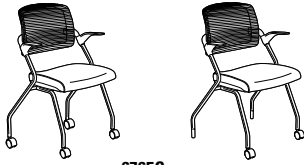

6765C 6765FC

Flip Seat Nesting Chair w/Arms & Casters
 COM Yardage: 00.75
 Freight Class: 300
 Product Weight (lbs.): 23
 Cubic Feet Per Carton: 11.75

C= Casters all 4 legs
 FC=Casters on front legs only
 Seat Flips up for nesting
 Ergonomic Features:
 G, M, N

RTA 00

MODEL#	1	2	3	4	5	6	7	8	9	10	11	12
	6765C	643	671	689	722	763	786	824	885	933	986	1096
6765FC	643	671	689	722	763	786	824	885	933	986	1096	1212

OVERALL DIMENSIONS			SEAT DIMENSIONS			BACK DIMENSIONS		
W	D	H	W	D	H	W	H	
23.75	23	33	18.5	17	17	17	16	



Armless Drafting Stool
 COM Yardage: 00.75
 Freight Class: 250
 Product Weight (lbs.): 28
 Cubic Feet Per Carton: 9.75

RTA 00

MODEL#	1	2	3	4	5	6	7	8	9	10	11	12
	6767-6	799	825	844	873	914	933	970	1028	1073	1124	1228

OVERALL DIMENSIONS			SEAT DIMENSIONS			BACK DIMENSIONS		
W	D	H	W	D	H	W	H	
20.5	20.5	42.5	18	16.5	22	17	16.5	



Drafting Stool w/Arms
 COM Yardage: 00.75
 Freight Class: 250
 Product Weight (lbs.): 31
 Cubic Feet Per Carton: 9.75

RTA 00 RTA 00

MODEL#	1	2	3	4	5	6	7	8	9	10	11	12
	6768-6	832	858	878	906	947	967	1003	1063	1107	1158	1263

OVERALL DIMENSIONS			SEAT DIMENSIONS			BACK DIMENSIONS		
W	D	H	W	D	H	W	H	
23.5	20.5	42.5	18	16.5	22	17	16.5	



Task Chair w/Arms and Pedestal Base
 COM Yardage: 0.75
 Freight Class: 250
 Product Weight (lbs.): 29
 Cubic Feet Per Carton: 9.75

RTA 00

MODEL#	1	2	3	4	5	6	7	8	9	10	11	12
	6762-6PB	942	968	988	1018	1059	1079	1116	1178	1226	1277	1383

OVERALL DIMENSIONS			SEAT DIMENSIONS			BACK DIMENSIONS		
W	D	H	W	D	H	W	H	
23.5	20.5	34	18	16.5	15.5	17	16.5	



Task Chair without Arms w/Pedestal Base
 COM Yardage: 0.75
 Freight Class: 250
 Product Weight (lbs.): 28
 Cubic Feet Per Carton: 9.75

RTA 00

MODEL#	1	2	3	4	5	6	7	8	9	10	11	12
	6763-6PB	910	938	958	987	1029	1050	1088	1148	1195	1248	1355

OVERALL DIMENSIONS			SEAT DIMENSIONS			BACK DIMENSIONS		
W	D	H	W	D	H	W	H	
20.5	20.5	34	18	16.5	15.5	17	16.5	

SPYKER™



Armless Chair
model 6791



Armchair
model 6790

	Chair Stacking Capability	
	Stacks on floor	Stacks on dolly
Armless		
6791	up to 10 high	up to 12 high (use 6783)
With Arms		
6790	up to 7 high	up to 7 high (use 6783)

STANDARD FEATURES

- A comfortable, high quality, lightweight, all polymer stacking chair intended for use indoors or outdoors. Products must be stored inside during extreme and inclement weather. See Global's Outdoor Furniture warranty for additional information.
- Perforations in the chair's seat and back provide ventilation and wet weather drainage.
- Weather resistant, UV resistant and stain resistant with a modern design.
- Chair legs are equipped with translucent non-marking glides as standard. Suitable for outdoor environments, carpet and hard surface flooring.
- All Spyker products are only available through Global's InStock program. Contact CustomerCare for lead times and quotation for quantities beyond InStock inventory.

- Chairs are stocked in 3 plastic finishes:
Alloy (**ALY**)
Char (**CHA**)
Milk (**MLK**)
- No upholstery options available.
- Rated to 300 lbs.
- Spyker achieves its strength and durability using glass filler polymer. Evidence of this material may be visible on the surface and is often more evident in darker colors.

EXAMPLE OF SPYKER ORDER CODE:

6791	ALY
Model Number	Finish

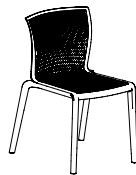
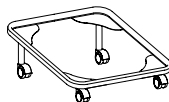
DESCRIPTION	FEATURES	MODEL#	STANDARD TEXTILE GRADES													
			1	2	3	4	5	6	7	8	9	10	11	12		
 <p>Arm Chair COM Yardage: N/A Freight Class: 92.5 Product Weight (lbs.): 9 Cubic Feet Per Carton: 16.24 (4 per carton)</p>	<p>Stacks 7 high on floor. Stacks 7 high on dolly.</p>	6790	261													
		OVERALL DIMENSIONS			SEAT DIMENSIONS			BACK DIMENSIONS								
		W	D	H	W	D	H	W	H							
		23.23	20.86	31.29	17	17.75	17.71	17	15							
			RTA 00			4 per carton (pricing and specifications are for one chair)										
 <p>Armless Chair COM Yardage: N/A Freight Class: 92.5 Product Weight (lbs.): 8.2 Cubic Feet Per Carton: 14.08 (4 per carton)</p>	<p>Stacks 10 high on floor. Stacks 12 high on dolly.</p>	6791	234													
		OVERALL DIMENSIONS			SEAT DIMENSIONS			BACK DIMENSIONS								
		W	D	H	W	D	H	W	H							
		17.91	20.86	31.29	17	17.75	17.71	17	15							
			RTA 00			4 per carton (pricing and specifications are for one chair)										
 <p>Dolly for Spyker and Bakhita Chairs COM Yardage: N/A Freight Class: 250 Product Weight (lbs.): 11 Cubic Feet Per Carton: 2.9</p>		6783	347													
		OVERALL DIMENSIONS			SEAT DIMENSIONS			BACK DIMENSIONS								
		W	D	H	W	D	H	W	H							
		19.75	23.25	9.75												
			RTA 00			1 per carton										

STREAM



model 2075APP
Stacking, 4-Leg Arm Chair



model 2076NPU
Stacking, Sled Base Chair, Armless



model 2075APPT
4-Leg Chair, w/Tablet



model 2075CSAPP
Stacking Bar Stool, w/Arms



model 2073APP
Tilter Chair w/Arms



model 2073NPPPB
Armless Tilter with Pedestal Base

STANDARD FEATURES

- Stream multi-purpose product family includes: four-leg, sled base, 5 star base and pedestal base chairs in addition to bar, counter and height adjustable stools.
- Seats and backs are made of perforated polypropylene, with or without arms. Choose from 14 finishes, arm colors match selected seat/back finish.
- For four-leg and sled base chairs: Bases are available painted or chrome (see upcharges)
- Specify bullet-shaped glide color on four-leg chairs.
- Glides are included on sled base chairs.
- Upholstered models are equipped with a color matching shroud beneath the seat.
- Tablet models are available on all but pedestal base chairs and backpack racks are available on four-leg models only.
- Chairs with tablet or backpack racks do not stack.
- Tablet arms are extremely rugged and meet ANSI-BIFMA testing requirements. Tablets hinge up to allow ease of egress and slide forward and back to comfortably fit most users.
- Standard tablet size is 18”D x 14.5”W and is made of Black polymer (DB). Tablets are specified left (LT) or right (RT) as seated.
- For 5-star base task chairs, height adjustable stools and pedestal bases:
- Task chairs are available with tilter mechanism only.
- Height adjustable stools are available with simple swivel mechanism only.
- Five-prong bases have dual wheel casters.
- Pedestal base are available for fixed location seating. The base must be mounted to the floor (mounting hardware not included). See installation guide for details. Models are available with simple swivel or tilt mechanisms.
- Check textile availability prior to specifying upholstery material.

OPTIONAL FEATURES

- Four-leg chairs are available with casters. Specify (FC). Add \$101. For carpet casters, please specify (DC). No additional upcharge. For hard floor casters specify (RC) and add additional \$21.
 - Five star bases are Black nylon, no upcharge, or Polished Aluminum, add \$154.
 - Choose casters type for five star base seating based on floor type.
 - Pedestal base models have black metal bases with 2” height adjust cylinders.
 - Specify (SCC) swivel, auto return to max height (no upcharge); (SN) non-swivel, auto return to max height (Add \$17); or (SC) swivel, self-center and return to max height (Add \$27).
 - An optional 18.5”D x 18.5”W high pressure laminate writing tablet is available. The core is hardwood veneer plywood with radiused edge finished in clear lacquer. This writing tablet is offered in the following finishes: Black (BLK), Clear Maple (CMB), Designer White (DWT) and Noce Grigio (NGL). Please specify. Add \$59.
 - Please specify models with option codes in the following order:
 - Model number**
Enter Model number.
- Textile**
Specify textile code for back (UU models only). Specify textile code for seat (PU, UU models only).
 - Seat/back finish** (no upcharge)

(BZB) Buzz Blue	(CCT) Cactus
(CRO) Carrot	(IVC) Cloud
(DJN) Dijon	(EGP) Eggplant
(FOG) Fog	(FRO) Frost
(INK) Ink	(LAB) Latte
(BLK) Night	(SND) Sand
(SAR) Scarlet	(SHW) Shadow
 - Frame with bullet glides/casters** (four-legged chair models only)

(FG) Glides	(FC) Casters. Add \$101
-------------	-------------------------
 - Bullet glide color** (four-legged chair and stool models only)

(BZB) Buzz Blue	(CCT) Cactus
(CRO) Carrot	(IVC) Cloud
(DJN) Dijon	(EGP) Eggplant
(FOG) Fog	(FRO) Frost
(INK) Ink	(LAB) Latte
(BLK) Night	(SND) Sand
(SAR) Scarlet	(SHW) Shadow
 - Sled chair glides** (sled chair models only)

(GL) Black glides.	(NM) Opaque non-marking glides.
--------------------	---------------------------------
 - Frame Finish** (Four-legged/sled chair models only)

(TBL) Black	(TBZ) Buzz Blue
(TCC) Cactus	(TCR) Carrot
(TDJ) Dijon	(TDW) Designer White
(TEG) Eggplant	(TFO) Fog
(TFR) Frost	(TIN) Ink
(TIV) Cloud	(TKA) Kalua
(TLA) Latte	(TMO) Mocha
(TOA) Toast	(TNE) Nevada
(TSH) Shadow	(TSN) Sand
(TSR) Scarlet	(TTU) Tungsten

(ACO) Chrome. Add \$295 for armchairs. Add \$384 for stools.
 (BCH) Brushed Chrome. Add \$161 for armchairs. Add \$239 for stools.
 (CHM) Chrome. Add \$161 for armchairs. Add \$85 for stools.
 (SBR) Satin Brass. Add \$295 for armchairs. Add \$384 for stools.
 - Base (task models)**

(B7) Black nylon base. No upcharge.
 (A7) Polished Aluminum base. Add \$154.
 - Caster type (four-leg with FC caster selection)**

(DC) C107 carpet.
 (RC) C107R hard floor. Add \$21.
 - Caster type (Five star base)**

(82) 82 dual wheel carpet casters. No upcharge.
 (8R) 8R dual wheel hard floor casters. Add \$82.
 - Tablet “T” models only**

(LT) Left
 (RT) Right
 - Tablet option “T” models only**







(DB) Black polymer. Black polymer 18”Dx14.5”W. No upcharge.
 Laminated finish (18.5”D x 18.5”W). Add \$59
 (BLK) Black laminate. Add \$59.
 (CMB) Clear Maple laminate. Add \$59.
 (DWT) Designer White laminate. Add \$59.
 (NGL) Noce Grigio laminate. Add \$59.
 - Cylinder Type (for pedestal base models only)**





(SCC) swivel, auto return to max height (no upcharge)
 (SC) swivel, self-centering and return to max height (add \$27).
 (SN) non-swivel, auto return to max height (Add \$17).







	Stream Chairs Stacking Capability		Stream Stools Stacking Capability
	Chair Stacking Capability		Stool Stacking Capability
	Stacks on floor	Stacks on dolly 2085	Stacks on floor only
Four-Leg (Glide/Caster) + Sled Base Models			
Polypropylene seat	up to 5 high	up to 15 high	up to 5 high
Poly back & Upholstered seat	up to 5 high	up to 10 high	up to 5 high
Upholstered seat & back	up to 5 high	up to 10 high	up to 5 high









EXAMPLE STREAM ORDER CODE:





2075NPP	-	-	-IVC	-FG	-BLK	-CHM	-	-	-
Model #	Back textile	Seat textile	Seat/back finish	Glides/Casters	Glide color	Frame finish	Caster type	Tablet	Tablet finish







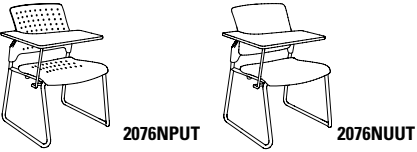

DESCRIPTION	FEATURES	MODEL#	STANDARD TEXTILE GRADES													
			1	2	3	4	5	6	7	8	9	10	11	12		
 <p>Armchair COM Yardage: N/A Freight Class: 250 Product Weight (lbs.): 15.5 Cubic Feet Per Carton: 14</p>	<p>Glides + Casters Stacks 5 high on floor. Stacks 15 high on dolly.</p>	<p>2075APP 458 Polypropylene seat & back</p>														
			OVERALL DIMENSIONS			SEAT DIMENSIONS			BACK DIMENSIONS							
			W	D	H	W	D	H	W	H						
			24	25	33.25	18	18	17	16	16.5						
			<p>RTA 00 4 per carton (pricing and specifications are for one seat unit)</p>													
 <p>2075APU</p>  <p>2075AAU</p>	<p>Glides + Casters Stacks 5 high on floor. Stacks 10 high on dolly.</p>	<p>2075APU 627 Upholstered seat</p> <p>2075AAU 733 Upholstered seat & back</p>														
			OVERALL DIMENSIONS			SEAT DIMENSIONS			BACK DIMENSIONS							
			W	D	H	W	D	H	W	H						
			24	25	33.25	17.5	18	17.5	16	16						
			<p>RTA 00 4 per carton (pricing and specifications are for one seat unit)</p>													
	<p>Glides + Casters Stacks 5 high on floor. Stacks 15 high on dolly.</p>	<p>2075NPP 356 Polypropylene seat & back</p>														
			OVERALL DIMENSIONS			SEAT DIMENSIONS			BACK DIMENSIONS							
			W	D	H	W	D	H	W	H						
			20.5	25	33.25	18	18	18	16	16.5						
			<p>RTA 00 4 per carton (pricing and specifications are for one seat unit)</p>													
 <p>2075NPU</p>  <p>2075NUU</p>	<p>Glides + Casters Stacks 5 high on floor. Stacks 10 high on dolly.</p>	<p>2075NPU 533 Upholstered seat</p> <p>2075NUU 635 Upholstered seat & back</p>														
			OVERALL DIMENSIONS			SEAT DIMENSIONS			BACK DIMENSIONS							
			W	D	H	W	D	H	W	H						
			20.5	25	33.25	18	18	17.5	16	16						
			<p>RTA 00 4 per carton (pricing and specifications are for one seat unit)</p>													
	<p>Specify (L) left or (R) right tablet (Example: 2075APPTL or 2075APPTR). Does not stack.</p>	<p>2075APPT 751 Polypropylene seat & back</p>														
			OVERALL DIMENSIONS			SEAT DIMENSIONS			BACK DIMENSIONS							
			W	D	H	W	D	H	W	H						
			26.5	27.25	33.25	18	18	17	16	16.5						
			<p>RTA 00 1 per carton</p>													

DESCRIPTION	FEATURES	MODEL#	STANDARD TEXTILE GRADES													
			1	2	3	4	5	6	7	8	9	10	11	12		
 <p>2075APUT</p> <p>Armless Chair w/Tablet COM Yardage: 0.75 Freight Class: 250 Product Weight: 31 Cubic Feet Per Carton: 14.75</p>	<p>Specify (L) left or (R) right tablet</p> <p>Does not stack.</p>	<p>2075APUT 921 947 966 997 1037 1056 1094 1155 1201 1251 1358 1471 Upholstered seat</p> <p>2075AUUT 1027 1053 1072 1101 1142 1161 1199 1258 1303 1355 1459 1572 Upholstered seat & back</p>	OVERALL DIMENSIONS			SEAT DIMENSIONS			BACK DIMENSIONS							
			W	D	H	W	D	H	W	H						
			26.5	27.25	33.25	18	18	17.5	16	16						
			RTA 00		1 per carton											
 <p>2075NPPT</p> <p>Armless Chair w/Tablet COM Yardage: N/A Freight Class: 300 Product Weight: 26 Cubic Feet Per Carton: 14.75</p>	<p>Specify (L) left or (R) right tablet</p> <p>Does not stack.</p>	<p>2075NPPT 650 Polypropylene seat & back</p>	OVERALL DIMENSIONS			SEAT DIMENSIONS			BACK DIMENSIONS							
			W	D	H	W	D	H	W	H						
			25	27.25	33.25	18	18	17	16.5	16						
			RTA 00		1 per carton											
 <p>2075NPUT</p> <p>Armless Chair w/Tablet COM Yardage: 0.75 Freight Class: 300 Product Weight: 29 Cubic Feet Per Carton: 14.75</p>	<p>Specify (L) left or (R) right tablet</p> <p>Does not stack.</p>	<p>2075NPUT 819 844 863 892 933 952 989 1047 1093 1144 1247 1357 Upholstered seat</p> <p>2075NUUT 925 950 969 998 1038 1057 1094 1151 1197 1246 1348 1458 Upholstered seat & back</p>	OVERALL DIMENSIONS			SEAT DIMENSIONS			BACK DIMENSIONS							
			W	D	H	W	D	H	W	H						
			25	27.25	33.25	18	18	17.5	16	16.5						
			RTA 00		1 per carton											
 <p>2075BRAPP</p> <p>Armchair w/Backpack Rack COM Yardage: N/A Freight Class: 300 Product Weight: 24 Cubic Feet Per Carton: 14</p>	<p>Does not stack.</p>	<p>2075BRAPP 597 Polypropylene seat & back</p>	OVERALL DIMENSIONS			SEAT DIMENSIONS			BACK DIMENSIONS							
			W	D	H	W	D	H	W	H						
			24	25	33.25	18	18	17	16	16.5						
			RTA 00		1 per carton											
 <p>2075BRAPU</p> <p>Armchair w/Backpack Rack COM Yardage: 0.75 Freight Class: 300 Product Weight: 27 Cubic Feet Per Carton: 14</p>	<p>Does not stack.</p>	<p>2075BRAPU 766 791 809 836 875 893 929 985 1028 1076 1176 1281 Upholstered seat</p> <p>2075BRAUU 873 897 916 942 982 1000 1035 1091 1134 1182 1281 1385 Upholstered seat & back</p>	OVERALL DIMENSIONS			SEAT DIMENSIONS			BACK DIMENSIONS							
			W	D	H	W	D	H	W	H						
			24	25	33.25	18	18	17.5	16	16						
			RTA 00		1 per carton											

DESCRIPTION	FEATURES	MODEL#	STANDARD TEXTILE GRADES											
			1	2	3	4	5	6	7	8	9	10	11	12
 <p>Armless Chair w/Backpack Rack COM Yardage: N/A Freight Class: 300 Product Weight: 20 Cubic Feet Per Carton: 13</p>	Does not stack.	2075BRNPP 502 Polypropylene seat & back	OVERALL DIMENSIONS			SEAT DIMENSIONS			BACK DIMENSIONS					
			W	D	H	W	D	H	W	H				
			20.5	25	33.25	18	18	18	16	16.5				
  <p>2075BRNPU 2075BRNUU</p> <p>Armless Chair w/Backpack Rack COM Yardage: 0.75 Freight Class: 300 Product Weight: 23 Cubic Feet Per Carton: 13</p>	Does not stack.	2075BRNPU 672 697 715 741 780 798 833 887 929 976 1072 1175 Upholstered seat 2075BRNUU 779 803 821 847 885 904 937 993 1034 1081 1178 1281 Upholstered seat & back	OVERALL DIMENSIONS			SEAT DIMENSIONS			BACK DIMENSIONS					
			W	D	H	W	D	H	W	H				
			20.5	25	33.25	18	18	17.5	16	16				
			RTA 00	1 per carton										
 <p>Armchair w/Backpack Rack and Tablet COM Yardage: N/A Freight Class: 23 Product Weight: 29 Cubic Feet Per Carton: 13.5</p>	Specify (L) left or (R) right tablet Does not stack.	2075BRAPPT 891 Polypropylene seat & back	OVERALL DIMENSIONS			SEAT DIMENSIONS			BACK DIMENSIONS					
			W	D	H	W	D	H	W	H				
			26.5	27.25	33.25	18	18	17	16	16.5				
  <p>2075BRAPUT 2075BRAUT</p> <p>Armchair w/Backpack Rack and Tablet COM Yardage: 0.75 Freight Class: 250 Product Weight: 35 Cubic Feet Per Carton: 14.75</p>	Specify (L) left or (R) right tablet Does not stack.	2075BRAPUT 1059 1084 1103 1132 1173 1192 1229 1287 1332 1382 1486 1597 Upholstered seat 2075BRAUT 1166 1191 1210 1239 1279 1298 1335 1392 1438 1487 1589 1699 Upholstered seat & back	OVERALL DIMENSIONS			SEAT DIMENSIONS			BACK DIMENSIONS					
			W	D	H	W	D	H	W	H				
			26.5	27.25	33.25	18	18	17.5	16	16				
			RTA 00	1 per carton										
 <p>Armless Chair w/Backpack Rack and Tablet COM Yardage: N/A Freight Class: 250 Product Weight: 30 Cubic Feet Per Carton: 14.75</p>	Specify (L) left or (R) right tablet Does not stack.	2075BRNPPT 789 Polypropylene seat & back	OVERALL DIMENSIONS			SEAT DIMENSIONS			BACK DIMENSIONS					
			W	D	H	W	D	H	W	H				
			27.25	27.25	33.25	18	18	17	16	16.5				







DESCRIPTION	FEATURES	MODEL#	STANDARD TEXTILE GRADES											
			1	2	3	4	5	6	7	8	9	10	11	12
 2075BRNPUT	 2075BRNUUT	2075BRNPUT \$958 Upholstered seat	\$983	\$1002	\$1030	\$1069	\$1089	\$1124	\$1182	\$1225	\$1274	\$1376	\$1483	
			2075BRNUUT 1065 Upholstered seat & back	1090	1108	1137	1175	1194	1230	1286	1330	1380	1480	1587
Overall Dimensions W D H			Seat Dimensions W D H			Back Dimensions W H								
25 27.25 33.25			18 18 17.5			16 16								
COM Yardage: 0.75 Freight Class: 250 Product Weight: 32 Cubic Feet Per Carton: 14.75			Specify (L) left or (R) right tablet Does not stack.			RTA 00 1 per carton								
		2076APP \$514 Polypropylene seat & back	1	2	3	4	5	6	7	8	9	10	11	12
			Overall Dimensions W D H			Seat Dimensions W D H			Back Dimensions W H					
25.5 24 33.25			18 18 17			16 16.5								
COM Yardage: N/A Freight Class: 250 Product Weight: 14 Cubic Feet Per Carton: 14			Stacks 5 high on floor. Stacks 15 high on dolly.			RTA 00 4 per carton (pricing and specifications are for one seat unit)								
 2076APU	 2076AAU	2076APU 683 Upholstered seat	707	724	750	786	803	837	890	930	976	1069	1170	
			2076AAU 790 Upholstered seat & back	815	832	858	895	912	945	998	1041	1085	1180	1280
Overall Dimensions W D H			Seat Dimensions W D H			Back Dimensions W H								
24 25 33.25			18 18 17.5			16 16								
COM Yardage: 0.75 Freight Class: 250 Product Weight: 19.5 Cubic Feet Per Carton: 14			Stacks 5 high on floor. Stacks 10 high on dolly.			RTA 00 4 per carton (pricing and specifications are for one seat unit)								
		2076NPP 412 Polypropylene seat & back	1	2	3	4	5	6	7	8	9	10	11	12
			Overall Dimensions W D H			Seat Dimensions W D H			Back Dimensions W H					
20.5 25 33.25			18 18 18			16 16.5								
COM Yardage: N/A Freight Class: 250 Product Weight: 12 Cubic Feet Per Carton: 13			Stacks 5 high on floor. Stacks 15 high on dolly.			RTA 00 4 per carton (pricing and specifications are for one seat unit)								
 2076NPU	 2076NUU	2076NPU 582 Upholstered seat	605	621	645	680	697	729	780	819	862	950	1047	
			2076NUU 689 Upholstered seat & back	712	729	753	788	805	837	889	927	971	1062	1158
Overall Dimensions W D H			Seat Dimensions W D H			Back Dimensions W H								
20.5 25 33.25			18 18 17.5			16 16								
COM Yardage: 0.75 Freight Class: 150 Product Weight: 15 Cubic Feet Per Carton: 13			Stacks 5 high on floor. Stacks 10 high on dolly.			RTA 00 4 per carton (pricing and specifications are for one seat unit)								





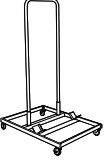

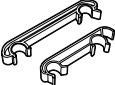
DESCRIPTION	FEATURES	MODEL#	STANDARD TEXTILE GRADES														
			1	2	3	4	5	6	7	8	9	10	11	12			
 <p>Armchair w/Sled Base and Tablet COM Yardage: N/A Freight Class: 300 Product Weight: 27 Cubic Feet Per Carton: 14.75</p>	<p>Specify (L) left or (R) right tablet</p> <p>Does not stack.</p>	<p>2076APPT 807 Polypropylene seat & back</p>															
			OVERALL DIMENSIONS			SEAT DIMENSIONS			BACK DIMENSIONS								
			W	D	H	W	D	H	W	H							
			26.5	27.25	33.25	18	18	17	16	16.5							
			RTA 00	1 per carton													
 <p>2076APUT 2076AUUT</p> <p>Armchair w/Sled Base and Tablet COM Yardage: 0.75 Freight Class: 250 Product Weight: 32 Cubic Feet Per Carton: 14.75</p>	<p>Specify (L) left or (R) right tablet</p> <p>Does not stack.</p>	<p>2076APUT 977 1003 1022 1051 1093 1112 1150 1211 1256 1307 1413 1526 Upholstered seat</p> <p>2076AUUT 1084 1111 1130 1160 1200 1219 1256 1317 1362 1412 1517 1629 Upholstered seat & back</p>															
			OVERALL DIMENSIONS			SEAT DIMENSIONS			BACK DIMENSIONS								
			W	D	H	W	D	H	W	H							
			26.5	27.25	33.25	18	18	17.5	16	16							
			RTA 00	1 per carton													
 <p>Armless Chair w/Sled Base and Tablet COM Yardage: N/A Freight Class: 300 Product Weight: 27 Cubic Feet Per Carton: 14.75</p>	<p>Specify (L) left or (R) right tablet</p> <p>Does not stack</p>	<p>2076NPPT 708 Polypropylene seat & back</p>															
			OVERALL DIMENSIONS			SEAT DIMENSIONS			BACK DIMENSIONS								
			W	D	H	W	D	H	W	H							
			26.5	27.25	33.25	18	18	17	16	16.5							
			RTA 00	1 per carton													
 <p>2076NPUT 2076NUUT</p> <p>Armless Chair w/Sled Base and Tablet COM Yardage: 0.75 Freight Class: 250 Product Weight: 30 Cubic Feet Per Carton: 14.75</p>	<p>Specify (L) left or (R) right tablet</p> <p>Does not stack</p>	<p>2076NPUT 875 901 920 949 990 1009 1046 1104 1149 1200 1304 1414 Upholstered seat</p> <p>2076NUUT 982 1007 1026 1055 1095 1114 1150 1208 1253 1303 1404 1515 Upholstered seat & back</p>															
			OVERALL DIMENSIONS			SEAT DIMENSIONS			BACK DIMENSIONS								
			W	D	H	W	D	H	W	H							
			25	27.25	33.25	18	18	17.5	16	16							
			RTA 00	1 per carton													
 <p>Bar Stool w/Arms COM Yardage: N/A Freight Class: 250 Product Weight: 25 Cubic Feet Per Carton: 10.75</p>	<p>Stacks 5 high on floor.</p>	<p>2075BSAPP 649 Polypropylene seat & back</p>															
			OVERALL DIMENSIONS			SEAT DIMENSIONS			BACK DIMENSIONS								
			W	D	H	W	D	H	W	H							
			24	24.75	45	18	18	29	16	16.5							
			RTA 00	2 per carton (pricing and specifications are for one seat unit)													









DESCRIPTION	FEATURES	MODEL#	STANDARD TEXTILE GRADES											
			1	2	3	4	5	6	7	8	9	10	11	12
 2075BSAPU	 2075BSAAU	2075BSAPU 817 Upholstered seat	841	859	886	923	942	976	1032	1074	1121	1218	1322	
			2075BSAAU 924 Upholstered seat & back	948	966	992	1030	1049	1083	1139	1180	1228	1325	1428
OVERALL DIMENSIONS W D H			SEAT DIMENSIONS W D H			BACK DIMENSIONS W H								
24 24.75 45			18 18 29.5			16 16								
Bar Stool w/Arms COM Yardage: 0.75 Freight Class: 250 Product Weight: 28 Cubic Feet Per Carton: 21.5			Stacks 5 high on floor.			RTA 00			2 per carton (pricing and specifications are for one seat unit)					
		2075BSNPP 548 Polypropylene seat & back	548											
	OVERALL DIMENSIONS W D H			SEAT DIMENSIONS W D H			BACK DIMENSIONS W H							
22 24.75 45			18 18 29			16 16.5								
Armless Bar Stool COM Yardage: N/A Freight Class: 250 Product Weight: 21 Cubic Feet Per Carton: 17.75			Stacks 5 high on floor.			RTA 00			2 per carton (pricing and specifications are for one seat unit)					
 2075BSNPU	 2075BSNUU	2075BSNPU 716 Upholstered seat	740	757	783	819	836	870	923	963	1009	1103	1203	
			2075BSNUU 823 Upholstered seat & back	848	865	891	928	945	978	1032	1074	1118	1214	1313
OVERALL DIMENSIONS W D H			SEAT DIMENSIONS W D H			BACK DIMENSIONS W H								
22 24.75 45			18 18 29.5			16 16								
Armless Bar Stool COM Yardage: 0.75 Freight Class: 250 Product Weight: 24 Cubic Feet Per Carton: 17.75			Stacks 5 high on floor.			RTA 00			2 per carton (pricing and specifications are for one seat unit)					
		2075CSAPP 649 Polypropylene seat & back	649											
	OVERALL DIMENSIONS W D H			SEAT DIMENSIONS W D H			BACK DIMENSIONS W H							
24 24.75 40			18 18 24			16 16.5								
Counter Stool w/Arms COM Yardage: N/A Freight Class: 250 Product Weight: 24 Cubic Feet Per Carton: 21.5			Stacks 5 high on floor.			RTA 00			2 per carton (pricing and specifications are for one seat unit)					
 2075CSAPU	 2075CSAAU	2075CSAPU 817 Upholstered seat	843	862	891	932	952	989	1048	1095	1145	1250	1362	
			2075CSAAU 924 Upholstered seat & back	949	968	997	1038	1057	1094	1152	1198	1249	1353	1463
OVERALL DIMENSIONS W D H			SEAT DIMENSIONS W D H			BACK DIMENSIONS W H								
24 24.75 40			18 18 24.5			16 16								
Counter Stool w/Arms COM Yardage: 0.75 Freight Class: 250 Product Weight: 27 Cubic Feet Per Carton: 21.5			Stacks 5 high on floor.			RTA 00			2 per carton (pricing and specifications are for one seat unit)					





MULTI-PURPOSE

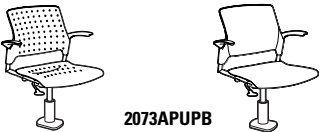

STREAM S

DESCRIPTION	FEATURES	MODEL#	STANDARD TEXTILE GRADES														
			1	2	3	4	5	6	7	8	9	10	11	12			
 <p>Armless Counter Stool COM Yardage: N/A Freight Class: 250 Product Weight: 20 Cubic Feet Per Carton: 19</p>	Stacks 5 high on floor.	2075CSNPP 548 Polypropylene seat & back															
			OVERALL DIMENSIONS			SEAT DIMENSIONS			BACK DIMENSIONS								
			W	D	H	W	D	H	W	H							
			22	24.75	40	18	18	24	16	16.5							
			RTA 00 2 per carton (pricing and specifications are for one seat unit)														
  <p>2075CSNPU 2075CSNUU</p> <p>Armless Counter Stool COM Yardage: 0.75 Freight Class: 250 Product Weight: 23 Cubic Feet Per Carton: 19</p>	Stacks 5 high on floor.	2075CSNPU 716 741 760 788 829 848 884 941 987 1036 1137 1246 Upholstered seat 2075CSNUU 823 848 867 895 934 954 989 1047 1091 1140 1241 1348 Upholstered seat & back															
			OVERALL DIMENSIONS			SEAT DIMENSIONS			BACK DIMENSIONS								
			W	D	H	W	D	H	W	H							
			22	24.75	40	18	18	24.5	16	16							
			RTA 00 2 per carton (pricing and specifications are for one seat unit)														
 <p>Dolly COM Yardage: N/A Freight Class: 125 Product Weight: 41 Cubic Feet Per Carton: 6.75</p>	Accommodates 10-15 chairs depending on model.	2085 731															
			OVERALL DIMENSIONS			SEAT DIMENSIONS			BACK DIMENSIONS								
			W	D	H	W	D	H	W	H							
			24	33.5	53												
			RTA 00 2 per carton														
 <p>Ganging Clamps - Set of 2 COM Yardage: N/A Freight Class: 70 Product Weight: 20 Cubic Feet Per Carton: .04</p>	For use with armchair models. Chair clearance 0.25"	5233 30															
			OVERALL DIMENSIONS			SEAT DIMENSIONS			BACK DIMENSIONS								
			W	D	H	W	D	H	W	H							
			.87	0.75	1												
			RTA 00  Pricing is for the set, specifications are for one clamp														
 <p>Ganging Brackets - Set of 2 COM Yardage: N/A Freight Class: 70 Product Weight: 0.01 Cubic Feet Per Carton: 0.02</p>	For use with armless models. Chair clearance 0.25"	6526 \$24															
			OVERALL DIMENSIONS			SEAT DIMENSIONS			BACK DIMENSIONS								
			W	D	H	W	D	H	W	H							
			0.75	5.75	1.25												
			RTA 00  Pricing is for the set, specifications are for one clamp														

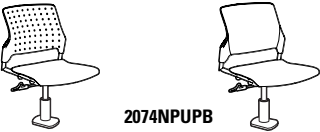
DESCRIPTION	FEATURES	MODEL#	STANDARD TEXTILE GRADES													
			1	2	3	4	5	6	7	8	9	10	11	12		
 <p>Tilter Chair w/Arms COM Yardage: N/A Freight Class: 250 Product Weight (lbs.):34 Cubic Feet Per Carton: 15.5</p>		2073APP	\$807													
			Polypropylene seat & back													
			OVERALL DIMENSIONS			SEAT DIMENSIONS			BACK DIMENSIONS							
			W	D	H	W	D	H	W	H						
			24	23.5	33.5	18	18	15.5	16	16.5						
		RTA 00	1 per carton													
 <p>2073APU</p>  <p>2073AUU</p> <p>Tilter Chair w/Arms COM Yardage: .75 Freight Class: 250 Product Weight: 39 Cubic Feet Per Carton: 15.5</p>		2073APU	\$977	\$1003	\$1020	\$1049	\$1088	\$1106	\$1142	\$1200	\$1244	\$1292	\$1394	\$1500		
			Upholstered seat													
			2073AUU	\$1084	\$1109	\$1127	\$1154	\$1194	\$1213	\$1248	\$1305	\$1348	\$1397	\$1498	\$1605	
				Upholstered seat & back												
				OVERALL DIMENSIONS			SEAT DIMENSIONS			BACK DIMENSIONS						
W	D	H		W	D	H	W	H								
24	23.5	33.5		18	18	17.5	16	16								
		RTA 00	1 per carton													
 <p>Armless Tilter Chair COM Yardage: N/A Freight Class: 300 Product Weight (lbs.): 30 Cubic Feet Per Carton:</p>		2073NPP	\$721													
			Polypropylene seat & back													
			OVERALL DIMENSIONS			SEAT DIMENSIONS			BACK DIMENSIONS							
			W	D	H	W	D	H	W	H						
			20.5	23.5	33.5	18	18	15.5	16	16.5						
		RTA 00	1 per carton													
 <p>2073NPU</p>  <p>2073NUU</p> <p>Armless Tilter Chair COM Yardage: 0.75 Freight Class: 250 Product Weight: 33 Cubic Feet Per Carton: 15.5</p>		2073NPU	\$891	\$916	\$934	\$961	\$1001	\$1019	\$1055	\$1111	\$1155	\$1203	\$1304	\$1411		
			Upholstered seat													
			2073NUU	\$997	\$1022	\$1040	\$1067	\$1106	\$1125	\$1160	\$1216	\$1260	\$1308	\$1408	\$1513	
				Upholstered seat & back												
				OVERALL DIMENSIONS			SEAT DIMENSIONS			BACK DIMENSIONS						
W	D	H		W	D	H	W	H								
20.5	23.5	33.5		18	18	16	16	16								
		RTA 00	1 per carton													
 <p>Height Adjustable Stool w/Arms COM Yardage: N/A Freight Class: 300 Product Weight (lbs.): 37 Cubic Feet Per Carton: 19.5</p>		2074APP	\$911													
			Polypropylene seat & back													
			OVERALL DIMENSIONS			SEAT DIMENSIONS			BACK DIMENSIONS							
			W	D	H	W	D	H	W	H						
			24	23.5	43	18	18	22	16	16.5						
		RTA 00	1 per carton													

DESCRIPTION	FEATURES	MODEL#	STANDARD TEXTILE GRADES											
			1	2	3	4	5	6	7	8	9	10	11	12
 2074APU	 2074AUU	2074APU \$1079 \$1106 \$1125 \$1155 \$1196 \$1215 \$1252 \$1313 \$1359 \$1409 \$1515 \$1628 Upholstered seat												
		2074AUU \$1186 \$1211 \$1231 \$1260 \$1301 \$1320 \$1357 \$1415 \$1461 \$1513 \$1617 \$1728 Upholstered seat & back												
Height Adjustable Stool w/Arms COM Yardage: 0.75 Freight Class: 250 Product Weight: 40 Cubic Feet Per Carton: 19.5		OVERALL DIMENSIONS W D H			SEAT DIMENSIONS W D H			BACK DIMENSIONS W H						
		24	23.5	43	18	18	22.5	16	16					
		RTA 00		1 per carton										
		2074NPP \$805 Polypropylene seat & back												
	OVERALL DIMENSIONS W D H			SEAT DIMENSIONS W D H			BACK DIMENSIONS W H							
		20.5	23.5	43	18	18	22	16	16.5					
		RTA 00		1 per carton										
 2074NPU	 2074NUU	2074NPU \$974 \$999 \$1018 \$1047 \$1088 \$1106 \$1143 \$1201 \$1246 \$1296 \$1400 \$1508 Upholstered seat												
		2074NUU \$1081 \$1107 \$1126 \$1154 \$1195 \$1214 \$1250 \$1307 \$1353 \$1402 \$1503 \$1613 Upholstered seat & back												
Armless Height Adjustable Stool COM Yardage: 0.75 Freight Class: 300 Product Weight: 38 Cubic Feet Per Carton: 19.5		OVERALL DIMENSIONS W D H			SEAT DIMENSIONS W D H			BACK DIMENSIONS W H						
		20.5	23.5	43	18	18	22.5	16	16					
		RTA 00		1 per carton										
		2073NPPPB 934 Polypropylene seat & back												
	OVERALL DIMENSIONS W D H			SEAT DIMENSIONS W D H			BACK DIMENSIONS W H							
		20.5	23.5	33.5	18	18	16.5	16	16					
		RTA 00		1 per carton										
 2073NPUPB	 2073NUUPB	2073NPUPB 1104 1129 1147 1174 1213 1231 1267 1323 1366 1414 1514 1619 Upholstered seat												
		2073NUUPB 1104 1127 1144 1167 1203 1104 1252 1303 1342 1385 1477 1572 Upholstered seat & back												
Armless Tilter with Pedestal Base COM Yardage: 0.75 Freight Class: 250 Product Weight: 33 Cubic Feet Per Carton: 10.25		OVERALL DIMENSIONS W D H			SEAT DIMENSIONS W D H			BACK DIMENSIONS W H						
		20.5	23.5	33.5	18	18	16.5	16	16					
		RTA 00		1 per carton										

DESCRIPTION	FEATURES	MODEL#	STANDARD TEXTILE GRADES												
			1	2	3	4	5	6	7	8	9	10	11	12	
 <p>Tilter Chair w/Arms and Pedestal Base COM Yardage: N/A Freight Class: 250 Product Weight (lbs.): 34 Cubic Feet Per Carton: 10.25</p>		2073APPPB	1021 Polypropylene seat & back												
					OVERALL DIMENSIONS			SEAT DIMENSIONS			BACK DIMENSIONS				
					W	D	H	W	D	H	W	H			
					20.5	23.5	33.5	18	18	16.5	16	16			
					RTA 00	1 per carton									
 <p>Tilter Chair w/Arms and Pedestal Base COM Yardage: 0.75 Freight Class: 250 Product Weight: 37 Cubic Feet Per Carton: 10.25</p>		2073APUPB	1190 1215 1233 1260 1300 1318 1354 1410 1453 1502 1602 1709 Upholstered seat												
		2073AUUPB	1297 1322 1340 1367 1406 1297 1460 1516 1560 1608 1708 1813 Upholstered seat & back												
					OVERALL DIMENSIONS			SEAT DIMENSIONS			BACK DIMENSIONS				
					W	D	H	W	D	H	W	H			
					20.5	23.5	33.5	18	18	16.5	16	16			
				RTA 00	1 per carton										
 <p>Armless Task Chair w/Pedestal Base COM Yardage: N/A Freight Class: 250 Product Weight (lbs.): 30 Cubic Feet Per Carton: 10.25</p>		2074NPPPB	1018 Polypropylene seat & back												
					OVERALL DIMENSIONS			SEAT DIMENSIONS			BACK DIMENSIONS				
					W	D	H	W	D	H	W	H			
					20.5	23.5	33.5	18	18	16.5	16	16			
					RTA 00	1 per carton									
 <p>Armless Task Chair w/Pedestal Base COM Yardage: 0.75 Freight Class: 250 Product Weight: 33 Cubic Feet Per Carton: 10.25</p>		2074NPUPB	1187 1213 1232 1260 1300 1319 1355 1412 1457 1505 1607 1715 Upholstered seat												
		2074NUUPB	1295 1321 1340 1368 1408 1295 1461 1519 1563 1612 1713 1820 Upholstered seat & back												
					OVERALL DIMENSIONS			SEAT DIMENSIONS			BACK DIMENSIONS				
					W	D	H	W	D	H	W	H			
					20.5	23.5	33.5	18	18	16.5	16	16			
				RTA 00	1 per carton										
 <p>Task Chair w/Pedestal Base COM Yardage: N/A Freight Class: 250 Product Weight (lbs.): 34 Cubic Feet Per Carton: 10.25</p>		2074APPPB	1124 Polypropylene seat & back												
					OVERALL DIMENSIONS			SEAT DIMENSIONS			BACK DIMENSIONS				
					W	D	H	W	D	H	W	H			
					20.5	23.5	33.5	18	18	16.5	16	16			
					RTA 00	1 per carton									

DESCRIPTION	FEATURES	MODEL#	STANDARD TEXTILE GRADES														
			1	2	3	4	5	6	7	8	9	10	11	12			
 2074APUPB Task Chair w/Pedestal Base COM Yardage: 0.75 Freight Class: 250 Product Weight: 37 Cubic Feet Per Carton: 10.25																	
		 2074AUUPB															
			OVERALL DIMENSIONS			SEAT DIMENSIONS			BACK DIMENSIONS								
			W	D	H	W	D	H	W	H							
			20.5	23.5	33.5	18	18	16.5	16	16							
			RTA 00			1 per carton											

TWILIGHT™



model 2194 (BK)





model 2198C (TUN)





STANDARD FEATURES

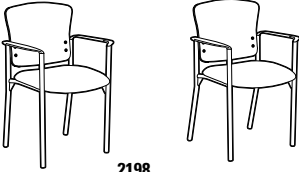

- Twilight series armchairs and barstools feature a flared back design.
- Chairs can stack 5 high on floor and 8 high on dolly 2125WS. Stools do not stack.
- Comet series tables and connecting brackets are compatible with Twilight models.
- Arm and Armless models can be joined together using ganging clamp model 2180.
- All Twilight models have welded corner gussets for additional strength & support.
- **Specifications and pricing are for 1 chair.**
- Check textile availability prior to specifying upholstery material.

OPTIONAL FEATURES

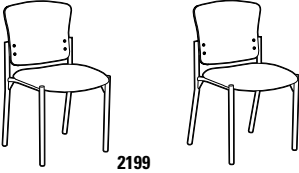
- Frames available in Black (TBL) or Tungsten (TTU).
- Optional steel cushioned glides (B) are available on all models. Add \$29. Please specify.
- Models featuring a wood veneer back are available in Absolute (AAM), Black (BKM), Cherry (ACM), Espresso Cafe (ECM), English Oak (EOM), Fruitwood (TFM), Gray (HGM), Honey (AHM), Mahogany (TMM), Maple (AVM), Medium Walnut (MWM), Night (ASM), Noce Biondo (NBM), Noce Grigio (NGM), Noce Leggero (NEM), Noce Medio (NMM), Shaker Cherry (SKM), Walnut (TWM), WC Cream (WTM), White (WHM) and Winter Cherry (WCM). Please Specify. Genuine maple faced veneers and solids are used.
- Models featuring wood veneer backs can incorporate a custom logo. Please contact Customer Service for further details.

DESCRIPTION	FEATURES	MODEL#	STANDARD TEXTILE GRADES												
			1	2	3	4	5	6	7	8	9	10	11	12	
 <p>2194</p> <p>Armchair Upholstered Back COM Yardage: 1.25 Freight Class: 250 Product Weight (lbs.): 21 Cubic Feet Per Carton: 6.25 (2 per carton)</p>	<p>Stacks 5 high on floor. Stacks 8 high on dolly. Ergonomic Features: M, N</p>	<p>2194</p>	\$598	\$642	\$674	\$716	\$785	\$822	\$884	\$972	\$1059	\$1130	\$1315	\$1501	
			<p>2194WS Wall Saver</p>	\$621	\$664	\$701	\$750	\$822	\$846	\$912	\$1032	\$1088	\$1197	\$1349	\$1537
		<p>OVERALL DIMENSIONS</p>			<p>SEAT DIMENSIONS</p>			<p>BACK DIMENSIONS</p>							
		W	D	H	W	D	H	W	H						
23.5	22	35	18	16	18	18	18								
			<p>RTA 00</p>												
 <p>2194C</p> <p>Armchair w/Casters Upholstered Back COM Yardage: 1.25 Freight Class: 250 Product Weight (lbs.): 21 Cubic Feet Per Carton: 6.25 (2 per carton)</p>	<p>Stacks 5 high on floor. Stacks 8 high on dolly. Ergonomic Features: M, N</p>	<p>2194C</p>	\$701	\$743	\$777	\$820	\$889	\$915	\$971	\$1084	\$1138	\$1239	\$1383	\$1560	
			<p>OVERALL DIMENSIONS</p>			<p>SEAT DIMENSIONS</p>			<p>BACK DIMENSIONS</p>						
		W	D	H	W	D	H	W	H						
		23.5	22	35	18	16	18	18	18.5						
			<p>RTA 00</p>												
 <p>2195</p> <p>Armless Chair Upholstered Back COM Yardage: 1.25 Freight Class: 250 Product Weight (lbs.): 18 Cubic Feet Per Carton: 6.25 (2 per carton)</p>	<p>Stacks 5 high on floor. Stacks 8 high on dolly. Ergonomic Features: M, N</p>	<p>2195</p>	\$518	\$559	\$590	\$637	\$705	\$739	\$802	\$888	\$975	\$1043	\$1231	\$1417	
			<p>2195WS Wall Saver</p>	\$539	\$583	\$618	\$668	\$740	\$766	\$829	\$949	\$1005	\$1117	\$1267	\$1456
		<p>OVERALL DIMENSIONS</p>			<p>SEAT DIMENSIONS</p>			<p>BACK DIMENSIONS</p>							
		W	D	H	W	D	H	W	H						
20	22	35	18	16	18.5	18	18								
			<p>RTA 00</p>												

DESCRIPTION	FEATURES	MODEL#	STANDARD TEXTILE GRADES														
			1	2	3	4	5	6	7	8	9	10	11	12			
 <p>Armless Chair w/Catsers Upholstered Back COM Yardage: 1.25 Freight Class: 250 Product Weight (lbs.): 18 Cubic Feet Per Carton: 6.25 (2 per carton)</p>	<p>Stacks 5 high on floor. Stacks 8 high on dolly. Ergonomic Features: M, N</p>	2195C	\$621	\$662	\$694	\$743	\$809	\$836	\$892	\$1005	\$1058	\$1162	\$1305	\$1480			
			OVERALL DIMENSIONS			SEAT DIMENSIONS			BACK DIMENSIONS								
			W	D	H	W	D	H	W	H							
			20	22	35	18	16	18	18.5	16							
			RTA 00														
 <p>2198 \$639WS</p> <p>Armchair Wood Veneer Back COM Yardage: 0.75 Freight Class: 250 Product Weight (lbs.): 20 Cubic Feet Per Carton: 6.25 (2 per carton)</p>	<p>Stacks 5 high on floor. Stacks 8 high on dolly. Ergonomic Features: M, N</p>	2198	\$639	\$662	\$683	\$711	\$750	\$774	\$809	\$863	\$913	\$956	\$1067	\$1178			
						RTA 00											
						RTA 00											
						RTA 00											
 <p>Armchair w/Catsers Wood Veneer Back COM Yardage: 0.75 Freight Class: 250 Product Weight (lbs.): 20 Cubic Feet Per Carton: 6.25 (2 per carton)</p>	<p>Stacks 5 high on floor. Stacks 8 high on dolly. Ergonomic Features: M, N</p>	2198C	\$663	\$691	\$711	\$740	\$779	\$794	\$829	\$896	\$926	\$989	\$1075	\$1181			
			OVERALL DIMENSIONS			SEAT DIMENSIONS			BACK DIMENSIONS								
			W	D	H	W	D	H	W	H							
			23.5	22	35	18	16	18	18.5	16							
			RTA 00														
 <p>2199 2199WS</p> <p>Armless Chair Wood Veneer Back COM Yardage: 0.75 Freight Class: 250 Product Weight (lbs.): 18 Cubic Feet Per Carton: 6.25 (2 per carton)</p>	<p>Stacks 5 high on floor. Stacks 8 high on dolly. Ergonomic Features: M, N</p>	2199	\$552	\$576	\$595	\$621	\$661	\$685	\$723	\$775	\$825	\$869	\$980	\$1093			
						RTA 00											
						RTA 00											
						RTA 00											
 <p>Armless Chair w/Catsers Wood Veneer Back COM Yardage: 0.75 Freight Class: 250 Product Weight (lbs.): 18 Cubic Feet Per Carton: 6.25 (2 per carton)</p>	<p>Stacks 5 high on floor. Stacks 8 high on dolly. Ergonomic Features: M, N</p>	2199C	\$587	\$615	\$631	\$660	\$703	\$714	\$751	\$820	\$849	\$912	\$998	\$1102			
			OVERALL DIMENSIONS			SEAT DIMENSIONS			BACK DIMENSIONS								
			W	D	H	W	D	H	W	H							
			20	22	35	18	17.5	18	18.5	16							
			RTA 00														

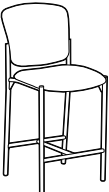
DESCRIPTION	FEATURES	MODEL#	STANDARD TEXTILE GRADES											
			1	2	3	4	5	6	7	8	9	10	11	12
 <p>Barstool w/Arms Wood Veneer Back COM Yardage: 0.75 Freight Class: 300 Product Weight (lbs.): 27 Cubic Feet Per Carton: 14.75 (1 per carton)</p>	<p>Does not stack.</p> <p>Ergonomic Features: M, N</p>	<p>2188</p>	\$920	\$948	\$969	\$1000	\$1045	\$1057	\$1094	\$1169	\$1202	\$1268	\$1360	\$1472
			OVERALL DIMENSIONS			SEAT DIMENSIONS			BACK DIMENSIONS					
			W	D	H	W	D	H	W	H				
			23	22	45	18	16	29	18.5	16				
			<p>RTA 00</p>											
 <p>Armless Barstool Wood Veneer Back COM Yardage: 0.75 Freight Class: 300 Product Weight (lbs.): 25 Cubic Feet Per Carton: 14.75 (1 per carton)</p>	<p>Does not stack.</p> <p>Ergonomic Features: M, N</p>	<p>2189</p>	\$832	\$862	\$881	\$914	\$955	\$970	\$1007	\$1081	\$1113	\$1180	\$1271	\$1385
			OVERALL DIMENSIONS			SEAT DIMENSIONS			BACK DIMENSIONS					
			W	D	H	W	D	H	W	H				
			20	22	45	18	16	29	18.5	16				
			<p>RTA 00</p>											
 <p>Barstool w/Arms Upholstered Back COM Yardage: 1.25 Freight Class: 300 Product Weight (lbs.): 28 Cubic Feet Per Carton: 14.75 (1 per carton)</p>	<p>Does not stack.</p> <p>Ergonomic Features: M, N</p>	<p>2196</p>	\$883	\$928	\$963	\$1015	\$1085	\$1110	\$1174	\$1294	\$1351	\$1460	\$1613	\$1801
			OVERALL DIMENSIONS			SEAT DIMENSIONS			BACK DIMENSIONS					
			W	D	H	W	D	H	W	H				
			23	22	45	18	16	29	18.5	16				
			<p>RTA 00</p>											
 <p>Armless Barstool w/ Upholstered Back COM Yardage: 1.25 Freight Class: 300 Product Weight (lbs.): 22 Cubic Feet Per Carton: 14.75 (1 per carton)</p>	<p>Does not stack.</p> <p>Ergonomic Features: M, N</p>	<p>2197</p>	\$796	\$840	\$875	\$923	\$996	\$1020	\$1085	\$1204	\$1263	\$1373	\$1523	\$1712
			OVERALL DIMENSIONS			SEAT DIMENSIONS			BACK DIMENSIONS					
			W	D	H	W	D	H	W	H				
			20	22	45	18	16	29	18.5	16				
			<p>RTA 00</p>											

VION



VION FINISHES - GUEST SEATING				
Back Frame	Specify Code	Frame	Specify Code	Arm Option
Black	BLK	Black	TBL	Fiber Glass Reinforced Nylon (Black)
Shadow	SHW Add \$70	Fog	TFO	
		Shadow	TSH	
		Tungsten	TTU	
Fog	FOG Add \$70	Chrome	CHM - Add \$37	





STANDARD FEATURES





- Vion is a comprehensive seating series offering a family of models to Address multiple applications: task, management, conference, guest, heavy duty 24-7, and drafting stools.
- Series offers models with either a mesh or upholstered back.
- Vion guest chairs offer a wall saver frame design, which is constructed from 7/8" diameter steel tubing.
- Vion guest chairs can stack 4 high on the floor.
- Arm design is gently curved and made from strong fiberglass reinforced black nylon.
- Guest chairs are standard with durable polypropylene glides.
- Dual wheel carpet casters (**C82**) are standard on guest models with casters.
- Mesh back models are available in 10 standard colors: Aqua (**MS75**), Black (**MS69**), Black Cherry (**MS76**), Blue (**MS72**), Dust (**MS77**), Ivory (**MS78**), Natural (**MS74**), Paprika (**MS79**), Rope (**MS73**) and Stone (**MS71**).
- Upholstered back models feature Black fabric (**Jenny JN02**) on the back side as standard.
- Check textile availability prior to specifying upholstery material.
- Vion beam seating consists of upper seat units (6340-6343) including mounting brackets and all hardware necessary for attachment to beam.
- For all beam components, tables and a complete list of available upper seat units, see Beam seating section.





OPTIONAL FEATURES

- Please refer to the chart for optional back frame and base frame finishes.
- Mesh back models are also available in 10 Dimension Mesh colors: Black (**DBK**), Fog (**DST**), Chalk (**DCL**), Shadow (**DGM**), Charcoal (**DCH**), Sand (**DSD**), Cobalt (**DCO**), Pool Blue (**DPB**), Citrus (**DCT**) and Berry (**DBE**). Add \$25.
- Upholstered back models offer a Matching Outer (**MO**) upholstery option. Due to the additional material needed, these models are listed separately and are priced differently than the standard upholstered back models.
- Seat available in memory foam. Please specify (**MF**). Add \$108.
- Opaque off-white non-marking glides for hard surface flooring are optional for guest chairs, please specify (**NM**). No upcharge.
- Felt glides (**FG**) and rubber glides (**RG**) are available on guest chairs, please specify and add \$55.
- Steel cushioned self-leveling glides (**B**) are available on guest chairs (adds 0.5" to seat height), please specify and add \$31.
- Dolly available for stacking guest chairs up to 8 high. Specify model 2125WS, \$418 List.
- Please refer to chart for optional Arms, Back, Base and Frame finishes.

DESCRIPTION	FEATURES	MODEL#	STANDARD TEXTILE GRADES																					
			1	2	3	4	5	6	7	8	9	10	11	12										
 <p>mesh back</p> <p>Armless Side Chair COM Yardage: 1 Freight Class: 250 Product Weight (lbs.):24 Cubic Feet Per Carton: 11.75</p>	<p>Stacks 4 high on floor. Stacks 8 high on dolly. Ergonomic Features: M, N</p>	6324	579	613	639	677	730	751	798	890	935	1018	1134	1277										
		<p>OVERALL DIMENSIONS</p> <table border="1"> <thead> <tr> <th>W</th> <th>D</th> <th>H</th> </tr> </thead> <tbody> <tr> <td>20</td> <td>24</td> <td>34.5</td> </tr> </tbody> </table>			W	D	H	20	24	34.5	<p>SEAT DIMENSIONS</p> <table border="1"> <thead> <tr> <th>W</th> <th>D</th> <th>H</th> </tr> </thead> <tbody> <tr> <td>19</td> <td>17.5</td> <td>17.5</td> </tr> </tbody> </table>			W	D	H	19	17.5	17.5	<p>BACK DIMENSIONS</p> <table border="1"> <thead> <tr> <th>W</th> <th>H</th> </tr> </thead> <tbody> <tr> <td>19</td> <td>17</td> </tr> </tbody> </table>			W	H
W	D	H																						
20	24	34.5																						
W	D	H																						
19	17.5	17.5																						
W	H																							
19	17																							
			RTA 00																					

DESCRIPTION	FEATURES	MODEL#	STANDARD TEXTILE GRADES													
			1	2	3	4	5	6	7	8	9	10	11	12		
 <p>mesh back</p> <p>Armless Side Chair w/Casters COM Yardage: 1 Freight Class: 250 Product Weight (lbs.): 24 Cubic Feet Per Carton: 11.75</p>	<p>Does not stack.</p> <p>Ergonomic Features: M, N</p>	6324C	647	681	708	746	799	819	866	959	1004	1087	1202	1345		
			OVERALL DIMENSIONS			SEAT DIMENSIONS			BACK DIMENSIONS							
			W	D	H	W	D	H	W	H						
			20	24	34.5	19	17.5	17.5	19	17						
			RTA 00													
 <p>mesh back</p> <p>Side Chair COM Yardage: 1 Freight Class: 300 Product Weight (lbs.): 26 Cubic Feet Per Carton: 13.75</p>	<p>Stacks 4 high on floor. Stacks 8 high on dolly.</p> <p>Ergonomic Features: M, N</p>	6325	621	656	682	720	773	794	841	933	978	1061	1178	1319		
			OVERALL DIMENSIONS			SEAT DIMENSIONS			BACK DIMENSIONS							
			W	D	H	W	D	H	W	H						
			25.5	24	34.5	19	17.5	17.5	19	17						
			RTA 00													
 <p>mesh back</p> <p>Side Chair w/Casters COM Yardage: 1 Freight Class: 300 Product Weight (lbs.): 26 Cubic Feet Per Carton: 13.75</p>	<p>Does not stack.</p> <p>Ergonomic Features: M, N</p>	6325C	687	722	749	787	841	860	907	1000	1045	1128	1244	1386		
			OVERALL DIMENSIONS			SEAT DIMENSIONS			BACK DIMENSIONS							
			W	D	H	W	D	H	W	H						
			25.5	24	34.5	19	17.5	17.5	19	17						
			RTA 00													
 <p>upholstered back</p> <p>Armless Side Chair COM Yardage: 1.25 Freight Class: 250 Product Weight (lbs.): 25 Cubic Feet Per Carton: 11.75 Cubic Feet Per Carton: 11.75</p>	<p>Stacks 4 high on floor. Stacks 8 high on dolly.</p> <p>Ergonomic Features: M, N</p>	<p>6334 6334MO</p>	634	678	712	762	834	868	933	1036	1117	1205	1388	1583		
			OVERALL DIMENSIONS			SEAT DIMENSIONS			BACK DIMENSIONS							
			W	D	H	W	D	H	W	H						
			20	24	34.5	19	17.5	17.5	19	17						
			RTA 00													
 <p>upholstered back</p> <p>Armless Side Chair w/Casters COM Yardage: 1.25 Freight Class: 250 Product Weight (lbs.): 25 Cubic Feet Per Carton: 11.75</p>	<p>Does not stack.</p> <p>Ergonomic Features: M, N</p>	<p>6334C 6334CMO</p>	709	751	782	829	898	930	991	1090	1166	1250	1423	1607		
			OVERALL DIMENSIONS			SEAT DIMENSIONS			BACK DIMENSIONS							
			W	D	H	W	D	H	W	H						
			20	24	34.5	19	17.5	17.5	19	17						
			RTA 00													

DESCRIPTION	FEATURES	MODEL#	STANDARD TEXTILE GRADES												
			1	2	3	4	5	6	7	8	9	10	11	12	
 <p>upholstered back</p> <p>Side Chair COM Yardage: 1.25 Freight Class: 300 Product Weight (lbs.): 27 Cubic Feet Per Carton: 13.75</p>	<p>Stacks 4 high on floor. Stacks 8 high on dolly.</p> <p>Ergonomic Features: M, N</p>	6335	676	720	754	804	875	909	973	1075	1153	1243	1423	1616	
		6335MO	728	795	846	925	1031	1072	1166	1350	1438	1607	1838	2125	
		OVERALL DIMENSIONS			SEAT DIMENSIONS			BACK DIMENSIONS							
		W	D	H	W	D	H	W	H						
	25.5	24	34.5	19	17.5	17.5	19	17							
				RTA 00											
 <p>upholstered back</p> <p>Side Chair w/Casters COM Yardage: 1.25 Freight Class: 300 Product Weight (lbs.): 27 Cubic Feet Per Carton: 13.75</p>	<p>Does not stack.</p> <p>Ergonomic Features: M, N</p>	6335C	750	792	823	870	938	970	1031	1128	1204	1287	1459	1642	
		6335CMO	800	866	918	996	1106	1144	1238	1421	1509	1678	1910	2195	
		OVERALL DIMENSIONS			SEAT DIMENSIONS			BACK DIMENSIONS							
		W	D	H	W	D	H	W	H						
	25.5	24	34.5	19	18	17.5	19	17							
				RTA 00											
 <p>Armless Seat Unit COM Yardage: 1 Freight Class: 250 Product Weight (lbs.): 20 Cubic Feet Per Carton: 7.25</p>	<p>Upholstered seat/mesh back. Use with beam.</p>	6340	\$776	\$815	\$842	\$885	\$944	\$972	\$1025	\$1111	\$1177	\$1250	\$1402	\$1565	
		OVERALL DIMENSIONS			SEAT DIMENSIONS			BACK DIMENSIONS							
		W	D	H	W	D	H	W	H						
			21	23.5	20.5	17.5	18	-	19	17					
				RTA 00											
 <p>Armless Seat Unit COM Yardage: 1 Freight Class: 250 Product Weight (lbs.): 26 Cubic Feet Per Carton: 7.25</p>	<p>Upholstered seat and back. Use with beam.</p>	6341	905	950	986	1039	1113	1147	1215	1323	1406	1498	1685	1887	
		OVERALL DIMENSIONS			SEAT DIMENSIONS			BACK DIMENSIONS							
		W	D	H	W	D	H	W	H						
			21	23.5	20.5	17.5	18	-	19	17					
				RTA 00											
 <p>Seat Unit w/Arms COM Yardage: 1 Freight Class: 250 Product Weight (lbs.): 26 Cubic Feet Per Carton: 9.75</p>	<p>Upholstered seat/mesh back. Use with beam.</p>	6342	719	756	785	827	885	912	968	1053	1118	1192	1344	1506	
		OVERALL DIMENSIONS			SEAT DIMENSIONS			BACK DIMENSIONS							
		W	D	H	W	D	H	W	H						
			25.5	23.5	20.5	17.5	18	-	19	17					
				RTA 00											

DESCRIPTION	FEATURES	MODEL#	STANDARD TEXTILE GRADES											
			1	2	3	4	5	6	7	8	9	10	11	12
 <p>Seat Unit w/Arms COM Yardage: 1 Freight Class: 250 Product Weight (lbs.): 27 Cubic Feet Per Carton: 9.75</p>	Upholstered seat and back. Use with beam.	6343	832	877	913	965	1039	1072	1141	1247	1330	1422	1612	1813
			OVERALL DIMENSIONS			SEAT DIMENSIONS			BACK DIMENSIONS					
			W	D	H	W	D	H	W	H				
			25.5	23.5	20.5	17.5	18	-	19	17				
			RTA 00											
 <p>Bar Height Stool w/Arms COM Yardage: 1.00 Freight Class: 300 Product Weight (lbs.): 35 Cubic Feet Per Carton: 20</p>	Mesh Back. Does not stack. Ergonomic Features: M, N	6350	806	843	870	914	972	999	1053	1140	1205	1279	1431	1593
			OVERALL DIMENSIONS			SEAT DIMENSIONS			BACK DIMENSIONS					
			W	D	H	W	D	H	W	H				
			25.5	25	44.5	19	17.5	28.5	18	16				
			RTA 00											
 <p>Armless Bar Height Stool COM Yardage: 1.00 Freight Class: 250 Product Weight (lbs.): 33 Cubic Feet Per Carton: 15.75</p>	Mesh Back. Does not stack. Ergonomic Features: M, N	6351	767	804	833	875	933	960	1016	1101	1166	1240	1392	1554
			OVERALL DIMENSIONS			SEAT DIMENSIONS			BACK DIMENSIONS					
			W	D	H	W	D	H	W	H				
			21	25	44.5	19	17.5	28.5	18	16				
			RTA 00											
 <p>Counter Height Stool w/Arms COM Yardage: 1.00 Freight Class: 300 Product Weight (lbs.): 25 Cubic Feet Per Carton: 18.5</p>	Mesh Back. Does not stack. Ergonomic Features: M, N	6352	806	843	870	914	972	999	1053	1140	1205	1279	1431	1593
			OVERALL DIMENSIONS			SEAT DIMENSIONS			BACK DIMENSIONS					
			W	D	H	W	D	H	W	H				
			25.5	24.5	40.5	19	17.5	24.5	18	16				
			RTA 00											
 <p>Armless Counter Height Stool COM Yardage: 1.00 Freight Class: 250 Product Weight (lbs.): 31 Cubic Feet Per Carton: 14.50</p>	Mesh Back. Does not stack. Ergonomic Features: M, N	6353	767	804	833	875	933	960	1016	1101	1166	1240	1392	1554
			OVERALL DIMENSIONS			SEAT DIMENSIONS			BACK DIMENSIONS					
			W	D	H	W	D	H	W	H				
			21	24.5	40.5	19	17.5	24.5	18	16				
			RTA 00											

DESCRIPTION	FEATURES	MODEL#	STANDARD TEXTILE GRADES															
			1	2	3	4	5	6	7	8	9	10	11	12				
 <p>Bar Height Stool w/Arms COM Yardage: 1.25 Freight Class: 300 Product Weight (lbs.): 35</p>	Upholstered Back Does not stack. Ergonomic Features:	6360	878	923	959	1011	1086	1118	1187	1293	1376	1470	1658	1859				
		6360MO	929	1001	1058	1140	1259	1315	1423	1595	1727	1874	2177	2500				
		OVERALL DIMENSIONS			SEAT DIMENSIONS			BACK DIMENSIONS										
		W	D	H	W	D	H	W	H									
			25.5	25	44.5	19	17.5	28.5	18	16								
 <p>Armless Bar Height Stool COM Yardage: 1.25 Freight Class: 250 Product Weight (lbs.): 33 Cubic Feet Per Carton: 15.75 Cubic Feet Per Carton: 18.5</p>	Upholstered Back Does not stack. Ergonomic Features: M, N M, N	6361	839	884	921	973	1048	1082	1150	1257	1340	1433	1620	1823				
		6361MO	891	963	1020	1102	1222	1277	1387	1557	1690	1837	2140	2462				
		OVERALL DIMENSIONS			SEAT DIMENSIONS			BACK DIMENSIONS										
		W	D	H	W	D	H	W	H									
			21	25	44.5	19	17.5	28.5	18	16								
			RTA 00															
			RTA 00															
 <p>Bar Counter Height Stool w/Arms COM Yardage: 1.25 Freight Class: 300 Product Weight (lbs.): 33 Cubic Feet Per Carton: 18.5</p>	Upholstered Back Does not stack. Ergonomic Features: M, N	6362	878	923	959	1011	1086	1118	1187	1293	1376	1470	1658	1859				
		6362MO	929	1001	1058	1140	1259	1315	1423	1595	1727	1874	2177	2500				
		OVERALL DIMENSIONS			SEAT DIMENSIONS			BACK DIMENSIONS										
		W	D	H	W	D	H	W	H									
			25.5	24.5	40.5	19	17.5	24.5	18	16								
			RTA 00															
 <p>Armless Counter Height Stool COM Yardage: 1.25 Freight Class: 250 Product Weight (lbs.): 31 Cubic Feet Per Carton: 14.50</p>	Upholstered Back Does not stack. Ergonomic Features: M, N	6363	839	884	921	973	1048	1082	1150	1257	1340	1433	1620	1823				
		6363MO	891	963	1020	1102	1222	1277	1387	1557	1690	1837	2140	2462				
		OVERALL DIMENSIONS			SEAT DIMENSIONS			BACK DIMENSIONS										
		W	D	H	W	D	H	W	H									
			21	25	40.5	19	17.5	24.5	18	16								
			RTA 00															

ZOMA™



model 6656

model 6657



STANDARD FEATURES

- Design sensitive guest seating featuring a wide flat, flared arms and elliptical tubular construction.
- The back of the chair is heavily compound curved to provide comfort and support in multiple seating positions.
- No visible back attachment hardware. Backs are attached using concealed hardware only.
- The outer back is upholstered in the same material selection as the rest of the chair.
- Arms are wide and full length, offering support to help stabilize the user as they sit in or exit chairs.
- The gently curved arms are made from incredibly strong black fiberglass reinforced nylon.
- The rugged frame is made from welded elliptical (oval) steel tubing 1.5" wide.
- Chairs are "Wall Safe," rear legs hit the baseboard first leaving clearance between the back of the chair and the wall; Thus saving both the chair and the wall from damage. Legs flair out to the rear to provide additional support.

- Zoma is equipped with a polypropylene seat shroud that helps stabilize chairs when stacked and avoid frame imprints on upholstered seats.
- Stacks up to 4 high on the floor or on a dolly (2125WS).
- Standard glide is a durable Black Polypropylene oval glide.
- Check textile availability prior to specifying upholstery material.

OPTIONAL FEATURES

- Frame is standard in a choice of Black (TBL), Shadow (TSH) or Tungsten (TTU) Finish must be specified. A chrome frame is optionally available. Please Specify (CHM), add \$40.
- A durable polypropylene outer back shroud is available at no charge. Optional shroud is Black only. Please specify (PSB).
- For chairs used on hard surface floors PLEASE SPECIFY Opaque (off White), Non-Marking Glides (NM).

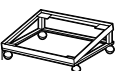
DESCRIPTION	FEATURES	MODEL#	STANDARD TEXTILE GRADES											
			1	2	3	4	5	6	7	8	9	10	11	12
 <p>Armchair COM Yardage: 1.25 Freight Class: 250 Product Weight (lbs.): 28 Cubic Feet Per Carton: 13.75</p>	Stacks 4 high on floor or dolly. Ergonomic Features: M, N	6656	\$570	\$613	\$646	\$692	\$761	\$787	\$845	\$960	\$1015	\$1119	\$1265	\$1443
		OVERALL DIMENSIONS W D H			SEAT DIMENSIONS W D H			BACK DIMENSIONS W H						
		26.5	24	32.5	20	19	17	18	15					
 <p>Armless Side Chair COM Yardage: 1.25 Freight Class: 250 Product Weight (lbs.): 26 Cubic Feet Per Carton: 11.75</p>	Stacks 4 high on floor or dolly. Ergonomic Features: M, N	6657	\$520	\$562	\$594	\$640	\$711	\$735	\$795	\$910	\$965	\$1070	\$1213	\$1393
		OVERALL DIMENSIONS W D H			SEAT DIMENSIONS W D H			BACK DIMENSIONS W H						
		22.5	24	32.5	20	19	17	18	15					
 <p>Dolly COM Yardage: N/A Freight Class: 150 Product Weight (lbs.): 16 Cubic Feet Per Carton: 3.8</p>		2125WS	\$418	-	-	-	-	-	-	-	-	-	-	-
		OVERALL DIMENSIONS W D H			SEAT DIMENSIONS W D H			BACK DIMENSIONS W H						
		23.25	24.75	12.25	-	-	-	-	-					

lounge

Ballara	248	Jeo	301	River+	330
Braden	260	Kate	304	Sirena	362
Bridges II Collaborative Seating	263	Lux	305	Venture	366
calidon tables	274	ML	307	Vitrola	369
Camino	277	ML Park	309	Wind	371
Citi	282	Orion	310	Wind Linear	373
Citi Square	287	Prairie	311		
Drift	296	River	312		

BALLARA™



model 9751

model 9751NA & 9757L



Quilted Seat Option
See optional features for more details.



model 9752NA Two Seat Sofa, 9755 Corner Table, 9751NA Lounge Chair, 9757L Left Tablet

STANDARD FEATURES

- An all inclusive, modular series which includes seating, storage, power, tables and tablets.
- Fulfill many space planning scenarios including corner, in-line, open concept as well as traditional reception.
- Furniture pieces, seating or tables can be used as stand alone items or linked together with ganging brackets to create infinite configurations.
- Four high back (banquette) models available in two different heights (42" or 48") and two sizes (two-seat or three-seat armless sofas).
- Banquettes are available as table back models (TB) which are equipped with an 8" laminate back table shelf.
- Tablets can be mounted outside or between seats to accommodate various work and collaborative settings. Tablets have a 14" round surface and come with a 2-point locking mechanism for easy handling and stability.
- Fixed cushions are accented by a metal base and frame.
- Tables features durable and matching 3mm edges.
- Power modules include one power outlet and two USB ports and can be mounted under any seat or table. Wire management is included.
- All models are standard with Black polypropylene foot glides.
- Check textile availability prior to specifying upholstery material.

OPTIONAL FEATURES

- Quilted Seat (Q) is available. Backless stools, add \$99 each. Single seat models, add \$196. Two seater sofa, add \$386. Three seater sofa, add \$579.
- **Seating and Table Frame Finish:** All chair frames, table frames, tablet metal components, ganging brackets and power modules are available in the following finishes (TBL) Black (TDW) Designer White (TTU) Tungsten (BCH) Brushed Chrome. **Upcharge varies.** (CHM) Chrome. **Upcharge varies.** Please Specify.
- Brushed Chrome (BCH) and Chrome (CHM) are available at an upcharge. Add \$208 for counter height and bar height stools. Add \$224 for single seat lounge chairs. Add \$297 for two seat sofas. Add \$371 for three seat sofas. Add \$224 for storage/end tables. Add \$297 for storage/coffee tables. Add \$114 for tablets. Add \$28 for ganging brackets. Add \$22 for power modules.

• **Table Tops**

Corner tables, storage tables and tablets are offered in the following High Pressure Laminate finishes:

- (ACJ) Absolute Acajou
- (AWC) Avant Cherry
- (BLK) Black
- (CMB) Clear Maple
- (DWT) Designer White
- (NBL) Noce Biondo
- (NEL) Noce Leggero
- (QTM) Quartered Mahogany
- (SOG) Storm Grey
- (TWL) Tiger Walnut
- (WCH) White Chocolate
- (WCR) Winter Cherry
- (ASN) Asian Night
- (AWH) Avant Honey
- (BRC) Brushed Cobalt
- (DES) Dark Espresso
- (HGT) Hayden Grey
- (NGL) Noce Grigio
- (NML) Noce Medio
- (TFW) Tiger Fruitwood
- (WHE) Walnut Heights
- (WGY) Willow Grey

SAMPLE LAYOUTS

Layout A



Qty	Model Number	Description	Dimensions	List Price
1	9751L	Lounge Chair - Left Arm	28.5 x 29.5 x 30	1953
1	9751R	Lounge Chair - Right Arm	28.5 x 29.5 x 30	1953
1	9755	Corner Table	27.25 x 27.25 x 16.5	777
2	9759	Ganging Bracket	1 x 0.75 x 10	23 x 2

SAMPLE LAYOUT TOTAL IN STANDARD BLACK FRAME

\$4729

SAMPLE LAYOUT TOTAL IN OPTIONAL FRAME FINISHES

\$5401

SAMPLE LAYOUTS

Layout B



Qty	Model Number	Description	Dimensions	List Price
1	9751L	Lounge Chair - Left Arm	28.5 x 29.5 x 30	1953
1	9751R	Lounge Chair - Right Arm	28.5 x 29.5 x 30	1953
1	9755	Corner Table	27.25 x 27.25 x 16.5	777
2	9759	Ganging Bracket	1 x 0.75 x 10	23 x 2

SAMPLE LAYOUT TOTAL IN STANDARD BLACK FRAME \$4729
SAMPLE LAYOUT TOTAL IN OPTIONAL FRAME FINISHES \$5401

Layout C



Qty	Model Number	Description	Dimensions	List Price
1	9751L	Lounge Chair - Left Arm	28.5 x 29.5 x 30	1953
1	9751R	Lounge Chair - Right Arm	28.5 x 29.5 x 30	1953
1	9751NA	Lounge Chair - No Arms	27.5 x 29.5 x 30	1619
2	9755	Corner Table	27.25 x 27.25 x 16.5	777 x 2
4	9759	Ganging Bracket	1 x 0.75 x 10	23 x 4

SAMPLE LAYOUT TOTAL IN STANDARD BLACK FRAME \$7171
SAMPLE LAYOUT TOTAL IN OPTIONAL FRAME FINISHES \$8291

Layout D



Qty	Model Number	Description	Dimensions	List Price
1	9751L	Lounge Chair - Left Arm	28.5 x 29.5 x 30	1953
1	9751R	Lounge Chair - Right Arm	28.5 x 29.5 x 30	1953
1	9751NA	Lounge Chair - Armless	27.5 x 29.5 x 30	1619
2	9755	Corner Table	27.25 x 27.25 x 16.5	777 x 2
1	9757L	Left Tablet	14 x 14 x 17.25	598
1	9758R	Right Tablet	14 x 14 x 17.25	598
4	9759	Ganging Bracket	1 x 0.75 x 10	23 x 4

SAMPLE LAYOUT TOTAL IN STANDARD BLACK FRAME \$8367
SAMPLE LAYOUT TOTAL IN OPTIONAL FRAME FINISHES \$9715

Layout E



Qty	Model Number	Description	Dimensions	List Price
1	9752L-OB	Two Seat Sofa Open Back - Left Arm	55 x 29.5 x 30	3182
1	9752NA	Two Seat Sofa - Armless	54 x 29.5 x 30	2923
1	9754	Storage Table	27.25 x 27.25 x 16.5	1234
1	9755	Corner Table	27.25 x 27.25 x 16.5	777
1	9757R	Right Tablet	14 x 14 x 17.25	598
2	9759	Ganging Bracket	1 x 0.75 x 10	23 x 2

SAMPLE LAYOUT TOTAL IN STANDARD BLACK FRAME \$8760
SAMPLE LAYOUT TOTAL IN OPTIONAL FRAME FINISHES \$9989

SAMPLE LAYOUTS

Layout F

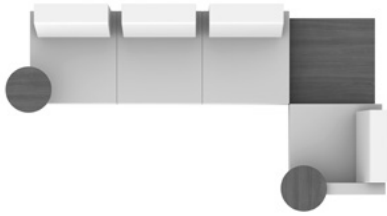

Qty	Model Number	Description	Dimensions	List Price
1	9753NA-OB	Three Seat Sofa Open Back - Armless	80.5 x 29.5 x 30	4098
1	9751L	Lounge Chair - Left Arm	28.5 x 29.5 x 30	1953
1	9755	Corner Table	27.25 x 27.25 x 16.5	777
1	9757L	Left Tablet	14 x 14 x 17.25	598
1	9758R	Right Tablet	14 x 14 x 17.25	598
2	9759	Ganging Bracket	1 x 0.75 x 10	23 x 2

SAMPLE LAYOUT TOTAL IN STANDARD BLACK FRAME
SAMPLE LAYOUT TOTAL IN OPTIONAL FRAME FINISHES

\$8070
\$9117

Layout G

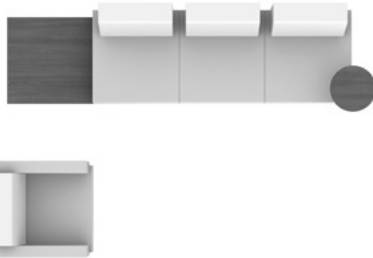

Qty	Model Number	Description	Dimensions	List Price
1	9753NA-OB	Three Seat Sofa Open Back - Armless	80.5 x 29.5 x 30	4098
1	9751	Lounge Chair	29.5 x 29.5 x 30	2284
1	9755	Corner Table	27.25 x 27.25 x 16.5	777
1	9757L	Left Tablet	14 x 14 x 17.25	598
1	9759	Ganging Bracket	1 x 0.75 x 10	23 x 1

SAMPLE LAYOUT TOTAL IN STANDARD BLACK FRAME
SAMPLE LAYOUT TOTAL IN OPTIONAL FRAME FINISHES

\$7780
\$8713

Layout H



Qty	Model Number	Description	Dimensions	List Price
1	9751L	Lounge Chair - Left Arm	28.5 x 29.5 x 30	1953
1	9751R	Lounge Chair - Right Arm	28.5 x 29.5 x 30	1953
1	9751NA	Lounge Chair - No Arms	27.5 x 29.5 x 30	1619
2	9755	Corner Table	27.25 x 27.25 x 16.5	777 x 2
4	9759	Ganging Bracket	1 x 0.75 x 10	23 x 4

SAMPLE LAYOUT TOTAL IN STANDARD BLACK FRAME
SAMPLE LAYOUT TOTAL IN OPTIONAL FRAME FINISHES

\$7171
\$8291

Layout I

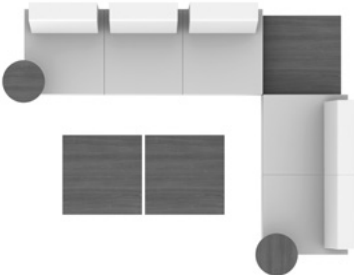

Qty	Model Number	Description	Dimensions	List Price
1	9753NA-OB	Three Seat Sofa Open Back - Armless	80.5 x 29.5 x 30	4098
1	9752NA	Two Seat Sofa - Armless	54 x 29.5 x 30	2923
2	9754	Storage Table	27.25 x 27.25 x 16.5	1234 x 2
1	9755	Corner Table	27.25 x 27.25 x 16.5	777
1	9757L	Left Tablet	14 x 14 x 17.25	598
1	9758R	Right Tablet	14 x 14 x 17.25	598
2	9759	Ganging Bracket	1 x 0.75 x 10	23 x 2

SAMPLE LAYOUT TOTAL IN STANDARD BLACK FRAME
SAMPLE LAYOUT TOTAL IN OPTIONAL FRAME FINISHES

\$11508
\$13222

SAMPLE LAYOUTS

Layout J

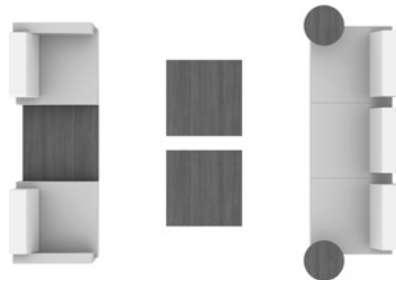

Qty	Model Number	Description	Dimensions	List Price
1	9753NA-OB	Three Seat Sofa Open Back - Armless	80.5 x 29.5 x 30	4098
1	9751L	Lounge Chair - Left Arm	28.5 x 29.5 x 30	1953
1	9751R	Lounge Chair - Right Arm	28.5 x 29.5 x 30	1953
2	9754	Storage Table	27.25 x 27.25 x 16.5	1234 x2
1	9755	Corner Table	27.25 x 27.25 x 16.5	777
1	9757L	Left Tablet	14 x 14 x 17.25	598
1	9758R	Right Tablet	14 x 14 x 17.25	598
2	9759	Ganging Bracket	1 x 0.75 x 10	23 x 2

SAMPLE LAYOUT TOTAL IN STANDARD BLACK FRAME \$12491
SAMPLE LAYOUT TOTAL IN OPTIONAL FRAME FINISHES \$14356

Layout K



Qty	Model Number	Description	Dimensions	List Price
2	9753NA-OB	Three Seat Sofa Open Back - Armless	80.5 x 29.5 x 30	4098 x 2
2	9755	Corner Table	27.25 x 27.25 x 16.5	777 x 2
2	9759	Ganging Bracket	1 x 0.75 x 10	23 x 2

SAMPLE LAYOUT TOTAL IN STANDARD BLACK FRAME \$9796
SAMPLE LAYOUT TOTAL IN OPTIONAL FRAME FINISHES \$10986

Layout L



Qty	Model Number	Description	Dimensions	List Price
1	9752NA	Two Seat Sofa - Armless	54 x 29.5 x 30	2923
1	9751L	Lounge Chair - Left Arm	28.5 x 29.5 x 30	1953
1	9751R	Lounge Chair - Right Arm	28.5 x 29.5 x 30	1953
2	9755	Corner Table	27.25 x 27.25 x 16.5	777 x 2
4	9759	Ganging Bracket	1 x 0.75 x 10	23 x 4

SAMPLE LAYOUT TOTAL IN STANDARD BLACK FRAME \$8475
SAMPLE LAYOUT TOTAL IN OPTIONAL FRAME FINISHES \$9668

Layout M

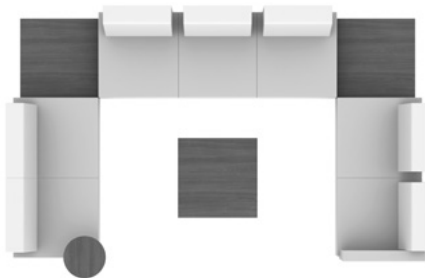

Qty	Model Number	Description	Dimensions	List Price
1	9753NA-OB	Three Seat Sofa Open Back - Armless	80.5 x 29.5 x 30	4098
1	9752L-OB	Two Seat Sofa Open Back - Left Arm	55 x 29.5 x 30	3182
1	9752NA	Two Seat Sofa - Armless	54 x 29.5 x 30	2923
2	9755	Corner Table	27.25 x 27.25 x 16.5	777 x 2
1	9754	Storage Table	27.25 x 27.25 x 16.5	1234
1	9758R	Right Tablet	14 x 14 x 17.25	598
4	9759	Ganging Bracket	1 x 0.75 x 10	23 x 4

SAMPLE LAYOUT TOTAL IN STANDARD BLACK FRAME \$13681
SAMPLE LAYOUT TOTAL IN OPTIONAL FRAME FINISHES \$15505

SAMPLE LAYOUTS

Layout N



Qty	Model Number	Description	Dimensions	List Price
1	9753NA-OB	Three Seat Sofa Open Back - Armless	80.5 x 29.5 x 30	4098
1	9751L	Lounge Chair - Left Arm	28.5 x 29.5 x 30	1953
1	9751R	Lounge Chair - Right Arm	28.5 x 29.5 x 30	1953
2	9755	Corner Table	27.25 x 27.25 x 16.5	777 x 2
4	9759	Ganging Bracket	1 x 0.75 x 10	23 x 4

SAMPLE LAYOUT TOTAL IN STANDARD BLACK FRAME \$8701
SAMPLE LAYOUT TOTAL IN OPTIONAL FRAME FINISHES \$9845

Layout O

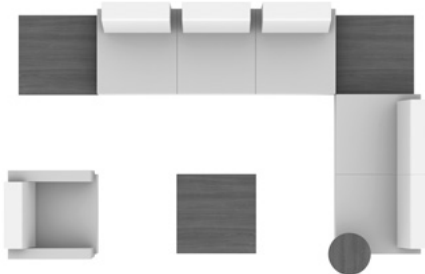

Qty	Model Number	Description	Dimensions	List Price
1	9753NA-OB	Three Seat Sofa Open Back - Armless	80.5 x 29.5 x 30	4098
1	9752NA	Two Seat Sofa - Armless	54 x 29.5 x 30	2923
1	9751	Lounge Chair	29.5 x 29.5 x 30	2284
1	9754	Storage Table	27.25 x 27.25 x 16.5	1234
2	9755	Corner Table	27.25 x 27.25 x 16.5	777 x 2
1	9757L	Left Tablet	14 x 14 x 17.25	598
3	9759	Ganging Bracket	1 x 0.75 x 10	23 x 3

SAMPLE LAYOUT TOTAL IN STANDARD BLACK FRAME \$11499
SAMPLE LAYOUT TOTAL IN OPTIONAL FRAME FINISHES \$13066

Layout P

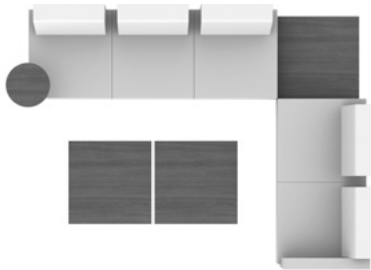

Qty	Model Number	Description	Dimensions	List Price
1	9753NA-OB	Three Seat Sofa Open Back - Armless	80.5 x 29.5 x 30	4098
1	9752L-OB	Two Seat Sofa Open Back - Left Arm	55 x 29.5 x 30	3182
2	9754	Storage Table	27.25 x 27.25 x 16.5	1234 x 2
1	9755	Corner Table	27.25 x 27.25 x 16.5	777
1	9758R	Right Tablet	14 x 14 x 17.25	598
2	9759	Ganging Bracket	1 x 0.75 x 10	23 x 2

SAMPLE LAYOUT TOTAL IN STANDARD BLACK FRAME \$10063
SAMPLE LAYOUT TOTAL IN OPTIONAL FRAME FINISHES \$11480

	1	2	3	4	5	6	7	8	9	10	11	12
9751	2284	2410	2508	2657	2863	2939	3122	3471	3638	3964	4403	4951



Lounge Chair
 COM Yardage: 4.25
 Freight Class: 250
 Product Weight (lbs.): 71
 Cubic Feet Per Carton: 21.5

	OVERALL DIMENSIONS			SEAT DIMENSIONS			BACK DIMENSIONS	
	W	D	H	W	D	H	W	H
	30.5	31	30	24	20.5	17.5	22	12.5

RTA 00



9751R



9751L

Lounge Chair - One Arm
 COM Yardage: 3.25
 Freight Class: 250
 Product Weight (lbs.): 61
 Cubic Feet Per Carton: 20

Ganging clip required for sectional use

	1	2	3	4	5	6	7	8	9	10	11	12
9751R	1953	2057	2140	2263	2438	2521	2679	2932	3127	3342	4263	4740
9751L												

	OVERALL DIMENSIONS			SEAT DIMENSIONS			BACK DIMENSIONS	
	W	D	H	W	D	H	W	H
	28.5	31	30	24	20.5	17.5	22	12.5

RTA 00



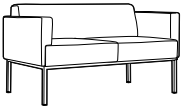

DESCRIPTION	FEATURES	MODEL#	STANDARD TEXTILE GRADES											
			1	2	3	4	5	6	7	8	9	10	11	12
 <p>Lounge Chair - Armless COM Yardage: 2.25 Freight Class: 250 Product Weight (lbs.): 51 Cubic Feet Per Carton: 18.75</p>	Ganging clip required for sectional use	9751NA	1619	1695	1752	1838	1960	2018	2129	2305	2442	2594	2905	3238
		OVERALL DIMENSIONS			SEAT DIMENSIONS			BACK DIMENSIONS						
		W	D	H	W	D	H	W	H					
		26.5	31	30	24	20.5	17.5	22	12.5					
			RTA 00											



DESCRIPTION	FEATURES	MODEL#	STANDARD TEXTILE GRADES											
			1	2	3	4	5	6	7	8	9	10	11	12
 <p>Corner Unit COM Yardage: 3 Freight Class: 250 Product Weight (lbs.): 72 Cubic Feet Per Carton: 18.5</p>	Ganging clip required for sectional use	9764	2100	2210	2293	2423	2607	2673	2834	3138	3286	3569	3954	4435
		OVERALL DIMENSIONS			SEAT DIMENSIONS			BACK DIMENSIONS						
		W	D	H	W	D	H	W	H					
		28.5	28.5	30	22	20.5	17.5	22	12.5					
			RTA 00											

DESCRIPTION	FEATURES	MODEL#	STANDARD TEXTILE GRADES											
			1	2	3	4	5	6	7	8	9	10	11	12
 <p>Two Seat Sofa COM Yardage: 6.25 Freight Class: 250 Product Weight (lbs.): 111 Cubic Feet Per Carton: 37.5</p>		9752	3595	3784	3932	4153	4465	4577	4852	5375	5626	6111	6772	7598
		OVERALL DIMENSIONS			SEAT DIMENSIONS			BACK DIMENSIONS						
		W	D	H	W	D	H	W	H					
		56	31	30	48	20.5	17.5	44	12.5					
			RTA 00											

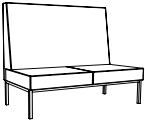

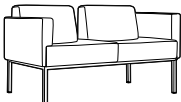

DESCRIPTION	FEATURES	MODEL#	STANDARD TEXTILE GRADES											
			1	2	3	4	5	6	7	8	9	10	11	12
 <p>Two Seat Sofa - One Arm COM Yardage: 5 Freight Class: 250 Product Weight (lbs.): 101 Cubic Feet Per Carton: 36.25</p>	Ganging clip required for sectional use	9752R	3218	3373	3498	3682	3941	4035	4265	4699	4911	5315	5866	6551
		9752L												
		OVERALL DIMENSIONS			SEAT DIMENSIONS			BACK DIMENSIONS						
		W	D	H	W	D	H	W	H					
			RTA 00											

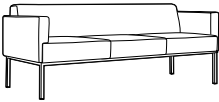
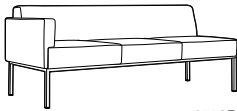
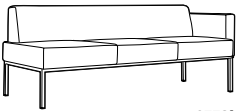
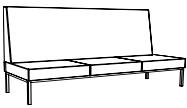

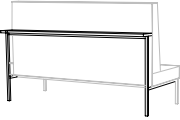
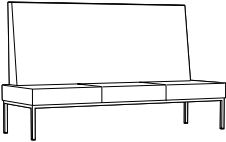
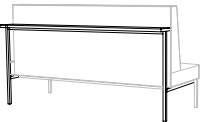
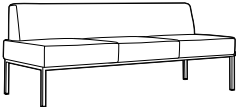
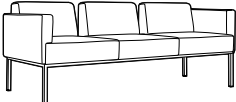

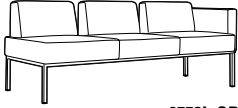
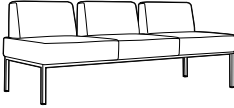







DESCRIPTION	FEATURES	MODEL#	STANDARD TEXTILE GRADES											
			1	2	3	4	5	6	7	8	9	10	11	12
 <p>Two Seat Sofa - Armless COM Yardage: 4 Freight Class: 250 Product Weight (lbs.): 91 Cubic Feet Per Carton: 35.5</p>	Ganging clip required for sectional use	9752NA	2923	3050	3148	3297	3506	3581	3764	4112	4279	4604	5045	5593
		OVERALL DIMENSIONS			SEAT DIMENSIONS			BACK DIMENSIONS						
		W	D	H	W	D	H	W	H					
		52	31	30	48	20.5	17.5	44	12.5					
			RTA 00											

DESCRIPTION	FEATURES	MODEL#	STANDARD TEXTILE GRADES											
			1	2	3	4	5	6	7	8	9	10	11	12
 <p>Two Seat Sofa - 42" High Back COM Yardage: 8 Freight Class: 250 Product Weight (lbs.): 120 Cubic Feet Per Carton: 48.5</p>	Ganging clip required for sectional use	9752NAHB42	2652	2909	3113	3417	3848	4052	4445	5068	5551	6085	7187	8360
			OVERALL DIMENSIONS			SEAT DIMENSIONS			BACK DIMENSIONS					
			W	D	H	W	D	H	W	H				
			52	31	42	48	20.5	17.5	44	24.5				
			RTA 00											
 <p>Two Seat Sofa - 42" High Back w/36" H Table Shelf COM Yardage: 6 Freight Class: 250 Product Weight (lbs.): 111 Cubic Feet Per Carton: 35.25</p>	Ganging clip required for sectional use	9752NAHB42TB	3555	3742	3889	4110	4424	4535	4808	5332	5584	6070	6731	7554
			OVERALL DIMENSIONS			SEAT DIMENSIONS			BACK DIMENSIONS					
			W	D	H	W	D	H	W	H				
			56	29.5	30	48	20.5	17.5	44	24.5				
			RTA 00											
 <p>Two Seat Sofa - 48" High Back COM Yardage: 6 Freight Class: 250 Product Weight (lbs.): 130 Cubic Feet Per Carton: 35.25</p>	Ganging clip required for sectional use	9752NAHB48	\$2744	\$3025	\$3247	\$3581	\$4051	\$4275	\$4703	\$5386	\$5913	\$6498	\$7703	\$8987
			OVERALL DIMENSIONS			SEAT DIMENSIONS			BACK DIMENSIONS					
			W	D	H	W	D	H	W	H				
			52	31	30	48	20.5	17.5	44	30.5				
			RTA 00											
 <p>Two Seat Sofa - 48" High Back w/42" H Table Shelf COM Yardage: 8.75 Freight Class: 250 Product Weight (lbs.): 145 Cubic Feet Per Carton: 71.25</p>	Ganging clip required for sectional use	9752NAHB48TB	\$3823	\$4014	\$4166	\$4392	\$4713	\$4863	\$5154	\$5617	\$5974	\$6372	\$7188	\$8059
			OVERALL DIMENSIONS			SEAT DIMENSIONS			BACK DIMENSIONS					
			W	D	H	W	D	H	W	H				
			28.5	41	30	48	20.5	17.5	44	30.5				
			RTA 00											
 <p>Two Seat Sofa - Open Back COM Yardage: 6.25 Freight Class: 250 Product Weight (lbs.): 111 Cubic Feet Per Carton: 35.25</p>		9752-OB	3555	3742	3889	4110	4424	4535	4808	5332	5584	6070	6731	7554
			OVERALL DIMENSIONS			SEAT DIMENSIONS			BACK DIMENSIONS					
			W	D	H	W	D	H	W	H				
			56	29.5	30	54	20.5	17.5	48	12.5				
			RTA 00											

DESCRIPTION	FEATURES	MODEL#	STANDARD TEXTILE GRADES												
			1	2	3	4	5	6	7	8	9	10	11	12	
 9752R-OB	 9752L-OB	9752R-OB 9752L-OB	3182	3337	3460	3645	3906	4000	4229	4664	4874	5279	5830	5279	
			OVERALL DIMENSIONS			SEAT DIMENSIONS			BACK DIMENSIONS						
			W	D	H	W	D	H	W	H					
Two Seat Sofa - Open Back - One Arm COM Yardage: 5.25 Freight Class: 250 Product Weight (lbs.): 101 Cubic Feet Per Carton: 36.25			Ganging clip required for sectional use			54	31	30	48	20.5	17.5	44	12.5		
			RTA 00												
			2884	3010	3109	3257	3466	3539	3723	4073	4240	4564	5003	5551	
	OVERALL DIMENSIONS			SEAT DIMENSIONS			BACK DIMENSIONS								
			W	D	H	W	D	H	W	H					
Two Seat Sofa - Open Back - Armless COM Yardage: 4.25 Freight Class: 250 Product Weight (lbs.): 91 Cubic Feet Per Carton: 35.5			Ganging clip required for sectional use			52	31	30	48	20.5	17.5	44	12.5		
			RTA 00												
			4809	5103	5338	5690	6191	6426	6878	7599	8157	8774	10047	11405	
	OVERALL DIMENSIONS			SEAT DIMENSIONS			BACK DIMENSIONS								
			W	D	H	W	D	H	W	H					
Three Seat Sofa COM Yardage: 9.5 Freight Class: 250 Product Weight (lbs.): 153 Cubic Feet Per Carton: 54.5			Ganging clip required for sectional use			82.5	31	30	76.5	20.5	17.5	66	12.5		
			RTA 00												
 9753R	 9753L	9753R 9753L	4494	4752	4958	5263	5699	5902	6296	6925	7411	7948	9057	10239	
			OVERALL DIMENSIONS			SEAT DIMENSIONS			BACK DIMENSIONS						
			W	D	H	W	D	H	W	H					
Three Seat Sofa - One Arm COM Yardage: 8.25 Freight Class: 250 Product Weight (lbs.): 143 Cubic Feet Per Carton: 54.5			Ganging clip required for sectional use			81.5	31	30	80.5	20.5	17.5	74	12.5		
			RTA 00												
			3996	4379	4682	5140	5788	6092	6679	7614	8336	9136	10787	12549	
	OVERALL DIMENSIONS			SEAT DIMENSIONS			BACK DIMENSIONS								
			W	D	H	W	D	H	W	H					
Three Seat Sofa - 42" High Back COM Yardage: 12.25 Freight Class: 300 Product Weight (lbs.): 143 Cubic Feet Per Carton: 72.50			Ganging clip required for sectional use			80.5	31	42	74	20.5	17.5	74	24.5		
			RTA 00												

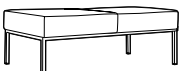
DESCRIPTION	FEATURES	MODEL#	STANDARD TEXTILE GRADES											
			1	2	3	4	5	6	7	8	9	10	11	12
 <p>Three Seat Sofa - 42" High Back w/36" H Table Shelf COM Yardage: 9 Freight Class: 300 Product Weight (lbs.): 158 Cubic Feet Per Carton: 93.50</p>	Ganging clip required for sectional use	9753NAHB42TB	4494	4752	4958	5263	5699	5902	6296	6925	7411	7948	9057	10239
			OVERALL DIMENSIONS			SEAT DIMENSIONS			BACK DIMENSIONS					
			W	D	H	W	D	H	W	H				
			81.5	31	30	80.5	20.5	17.5	74	24.5				
			RTA 00											
 <p>Three Seat Sofa - 48" High Back COM Yardage: 13.25 Freight Class: 250 Product Weight (lbs.): 168 Cubic Feet Per Carton: 82.25</p>	Ganging clip required for sectional use	9753NAHB48	4139	4358	4532	4792	5163	5336	5672	6208	6620	7077	8021	9027
			OVERALL DIMENSIONS			SEAT DIMENSIONS			BACK DIMENSIONS					
			W	D	H	W	D	H	W	H				
			80.5	31	48	80.5	20.5	17.5	74	30.5				
			RTA 00											
 <p>Three Seat Sofa - 48" High Back w/42" H Table Shelf COM Yardage: 9 Freight Class: 300 Product Weight (lbs.): 158 Cubic Feet Per Carton: 106</p>	Ganging clip required for sectional use	9753NAHB48TB	4139	4358	4532	4792	5163	5336	5672	6208	6620	7077	8021	9027
			OVERALL DIMENSIONS			SEAT DIMENSIONS			BACK DIMENSIONS					
			W	D	H	W	D	H	W	H				
			80.5	41	48	80.5	20.5	17.5	74	30.5				
			RTA 00											
 <p>Three Seat Sofa - Armless COM Yardage: 7 Freight Class: 250 Product Weight (lbs.): 133 Cubic Feet Per Carton: 51.5</p>	Ganging clip required for sectional use	9753NA	4139	4358	4532	4792	5163	5336	5672	6208	6620	7077	8021	9027
			OVERALL DIMENSIONS			SEAT DIMENSIONS			BACK DIMENSIONS					
			W	D	H	W	D	H	W	H				
			80.5	31	30	80.5	20.5	17.5	74	12.5				
			RTA 00											
 <p>Three Seat Sofa - Open Back COM Yardage: 8 Freight Class: 250 Product Weight (lbs.): 153 Cubic Feet Per Carton: 54.5</p>		9753-OB	4775	5021	5220	5515	5932	6081	6448	7146	7482	8129	9010	10105
			OVERALL DIMENSIONS			SEAT DIMENSIONS			BACK DIMENSIONS					
			W	D	H	W	D	H	W	H				
			82.5	31	30	80.5	20.5	17.5	74	12.5				
			RTA 00											

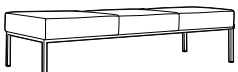
DESCRIPTION	FEATURES	MODEL#	STANDARD TEXTILE GRADES											
			1	2	3	4	5	6	7	8	9	10	11	12
 <p>9753R-OB</p> <p>Three Seat Sofa - Open Back - One Arm COM Yardage: 7 Freight Class: 250 Product Weight (lbs.): 143 Cubic Feet Per Carton: 54.5</p>	 <p>9753L-OB</p> <p>Ganging clip required for sectional use</p>	<p>9753R-OB 4453 4671 4843 5101 5466 5597 5917 6529 6824 7389 8159 9120</p> <p>9753L-OB</p>	OVERALL DIMENSIONS			SEAT DIMENSIONS			BACK DIMENSIONS					
			W	D	H	W	D	H	W	H				
			81.5	31	30	80.5	20.5	17.5	74	12.5				
			RTA 00											
 <p>9753NA-OB</p> <p>Three Seat Sofa - Open Back - Armless COM Yardage: 6.25 Freight Class: 250 Product Weight (lbs.): 133 Cubic Feet Per Carton: 51.5</p>	<p>Ganging clip required for sectional use</p>	<p>9753NA-OB 4098 4287 4435 4656 4968 5080 5355 5878 6131 6614 7276 8101</p>	OVERALL DIMENSIONS			SEAT DIMENSIONS			BACK DIMENSIONS					
			W	D	H	W	D	H	W	H				
			80.5	31	30	80.5	20.5	17.5	74	12.5				
			RTA 00											
 <p>9754</p> <p>Storage Table COM Yardage: N/A Freight Class: 125 Product Weight (lbs.): 65 Cubic Feet Per Carton: 11.5</p>	<p>Ganging clip required for sectional use</p>	<p>9754 1234 - - - - - - - - - - - -</p>	OVERALL DIMENSIONS			SEAT DIMENSIONS			BACK DIMENSIONS					
			W	D	H	W	D	H	W	H				
			27.25	27.25	16.5	-	-	-	-	-	-	-	-	
			RTA 00											
 <p>9755</p> <p>Corner Table COM Yardage: N/A Freight Class: 150 Product Weight (lbs.): 40 Cubic Feet Per Carton: 8</p>	<p>Ganging clip required for sectional use</p>	<p>9755 777 - - - - - - - - - - - -</p>	OVERALL DIMENSIONS			SEAT DIMENSIONS			BACK DIMENSIONS					
			W	D	H	W	D	H	W	H				
			27.25	27.25	12.5	-	-	-	-	-	-	-	-	
			RTA 00											
 <p>9759</p> <p>Ganging Bracket COM Yardage: N/A Freight Class: 70 Product Weight (lbs.): .052 Cubic Feet Per Carton: 0.02</p>	<p>Only one set is needed per connection.</p>	<p>9759 23 - - - - - - - - - - - -</p>	OVERALL DIMENSIONS			SEAT DIMENSIONS			BACK DIMENSIONS					
			W	D	H	W	D	H	W	H				
			1	0.75	10	-	-	-	-	-	-	-	-	
			RTA 00											

DESCRIPTION	FEATURES	MODEL#	STANDARD TEXTILE GRADES											
			1	2	3	4	5	6	7	8	9	10	11	12
 <p>Tablet COM Yardage: N/A Freight Class: 150 Product Weight (lbs.): 12 Cubic Feet Per Carton: 2.5</p>	Mounts underneath of seating.	9757L	598	-	-	-	-	-	-	-	-	-	-	-
		9758R												
		OVERALL DIMENSIONS			SEAT DIMENSIONS			BACK DIMENSIONS						
		W	D	H	W	D	H	W	H					
			14	17.25	14	-	-	-	-	-				
						 								
 <p>Power Module COM Yardage: N/A Freight Class: 125 Product Weight (lbs.): 3 Cubic Feet Per Carton: 0.5</p>	Mounts underneath of seating or tables.	9760	\$376	-	-	-	-	-	-	-	-	-	-	
			10 Ft. power cord											
		OVERALL DIMENSIONS			SEAT DIMENSIONS			BACK DIMENSIONS						
		W	D	H	W	D	H	W	H					
			6	2.75	2.75	-	-	-	-	-				
						 								
 <p>One Seat Bench COM Yardage: 2 Freight Class: 250 Product Weight (lbs.): 37 Cubic Feet Per Carton: 10.75</p>	Ganging clip required for sectional use	9761	1212	1276	1326	1401	1507	1558	1653	1808	1927	2058	2330	2618
		OVERALL DIMENSIONS			SEAT DIMENSIONS			BACK DIMENSIONS						
		W	D	H	W	D	H	W	H					
					27.5	28.5	17.5	-	-	-	-	-		
														
 <p>Two Seat Bench COM Yardage: 4 Freight Class: 250 Product Weight (lbs.): 57 Cubic Feet Per Carton: 21.25</p>	Ganging clip required for sectional use	9762	2156	2283	2383	2534	2749	2850	3043	3351	3590	3855	4399	4980
		OVERALL DIMENSIONS			SEAT DIMENSIONS			BACK DIMENSIONS						
		W	D	H	W	D	H	W	H					
					54	28.5	17.5	-	-	-	-	-		
														
 <p>Three Seat Bench COM Yardage: 6 Freight Class: 250 Product Weight (lbs.): 80 Cubic Feet Per Carton: 29.5</p>	Ganging clip required for sectional use	9763	3051	3240	3388	3611	3928	4077	4363	4819	5170	5563	6367	7228
		OVERALL DIMENSIONS			SEAT DIMENSIONS			BACK DIMENSIONS						
		W	D	H	W	D	H	W	H					
					80.5	28.5	17.5	-	-	-	-	-		
														

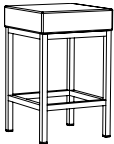
DESCRIPTION	FEATURES	MODEL#	STANDARD TEXTILE GRADES											
			1	2	3	4	5	6	7	8	9	10	11	12
 <p>Coffee Storage Table (2 Seat Length) COM Yardage: N/A Freight Class: 150 Product Weight (lbs.): 112 Cubic Feet Per Carton: 20.5</p>	Ganging clip required for sectional use	9765	2250	-	-	-	-	-	-	-	-	-	-	
		OVERALL DIMENSIONS			SEAT DIMENSIONS			BACK DIMENSIONS						
		W	D	H	W	D	H	W	H					
		53.75	27.25	16.5	-	-	-	-	-					
			RTA 00											
 <p>Coffee Table (2 Seat Length) COM Yardage: N/A Freight Class: 150 Product Weight (lbs.): 68 Cubic Feet Per Carton: 17.75</p>		9766	1455	-	-	-	-	-	-	-	-	-	-	
	OVERALL DIMENSIONS			SEAT DIMENSIONS			BACK DIMENSIONS							
	W	D	H	W	D	H	W	H						
	54	27.5	13	-	-	-	-	-						
			RTA 00											
 <p>24" Stool COM Yardage: 0.75 Freight Class: 150 Product Weight (lbs.): 22 Cubic Feet Per Carton: 4.75</p>		9769S24	\$794	\$819	\$837	\$864	\$904	\$922	\$958	\$1014	\$1057	\$1106	\$1206	\$1313
	OVERALL DIMENSIONS			SEAT DIMENSIONS			BACK DIMENSIONS							
	W	D	H	W	D	H	W	H						
	15	15	24	15	15	3	-	-						
			RTA 00											
 <p>30" Stool COM Yardage: .50 Freight Class: 150 Product Weight (lbs.): 23 Cubic Feet Per Carton: 5.5</p>		9769S30	\$865	\$890	\$908	\$935	\$974	\$992	\$1027	\$1082	\$1125	\$1173	\$1269	\$1374
	OVERALL DIMENSIONS			SEAT DIMENSIONS			BACK DIMENSIONS							
	W	D	H	W	D	H	W	H						
	15	15	30	15	15	30	-	-						
			RTA 00											

BRADEN™



model 7871

model 7870R, 7870, 7870L

STANDARD FEATURES

- A flexible modular seating system that is exceptionally durable. Combine these seating components into a configuration that suits your space.
- Braden uses a unique ganging feature which locks units solidly together, but allows them to be separated and reconfigured when necessary. Locking "Pins" will always be on the left side of a ganging unit, while the pin receptacle will always be on the right side, seated.
- Check textile availability prior to specifying upholstery material.

OPTIONAL FEATURES

- For ganging hardware please use the following codes: Add "GB" for both sides. Add "GR" for right side seated only. Add "GL" for left side seated only. Add "GC" for corner units only, both sides.
- For highly resilient, high density Ultracell foam on seat, Please specify (UC) after the model number. Add \$67 for the seat. Add \$132 for the seat and back.
- Optional Non-slip glide for hard surface flooring. Please specify (NSG). Add \$32.
- Model 7874 Table (top) is offered in all the standard laminates. Please specify.

DESCRIPTION	FEATURES	MODEL#	STANDARD TEXTILE GRADES											
-------------	----------	--------	-------------------------	--	--	--	--	--	--	--	--	--	--	--

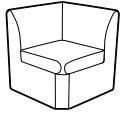

Corner Unit

COM Yardage: 16.5
 Freight Class:
 Product Weight (lbs.): 38
 Cubic Feet Per Carton: 16.5

	1	2	3	4	5	6	7	8	9	10	11	12
7867	1203	1344	1458	1624	1862	1973	2189	2533	2796	3090	3697	4342

OVERALL DIMENSIONS			SEAT DIMENSIONS			BACK DIMENSIONS	
W	D	H	W	D	H	W	H
24	27.5	30	20	17	20.5	19.5	12.5

RTA 00



Single Seater

COM Yardage: 2.75
 Freight Class:
 Product Weight (lbs.): 26
 Cubic Feet Per Carton: 16.5

	1	2	3	4	5	6	7	8	9	10	11	12
7868	325	388	438	511	614	663	758	907	1023	1151	1417	1698

OVERALL DIMENSIONS			SEAT DIMENSIONS			BACK DIMENSIONS	
W	D	H	W	D	H	W	H
24	27.5	30					

RTA 00



Single Seater

COM Yardage: 2.75
 Freight Class: 250
 Product Weight (lbs.): 38
 Cubic Feet Per Carton: 16.5

	1	2	3	4	5	6	7	8	9	10	11	12
7870	748	848	929	1048	1216	1277	1425	1707	1841	2104	2459	2903

OVERALL DIMENSIONS			SEAT DIMENSIONS			BACK DIMENSIONS	
W	D	H	W	D	H	W	H
24	27.5	30	24	19.5	16.5	24	13.5

RTA 00







Single Seater - Left Arm

COM Yardage: 3.75
 Freight Class: 250
 Product Weight (lbs.): 45
 Cubic Feet Per Carton: 16.5

	1	2	3	4	5	6	7	8	9	10	11	12
7870L	852	989	1098	1263	1492	1573	1776	2159	2345	2702	3187	3790

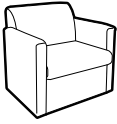
OVERALL DIMENSIONS			SEAT DIMENSIONS			BACK DIMENSIONS	
W	D	H	W	D	H	W	H
27	27.5	30	24	19.5	16.5	24	13.5

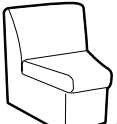
RTA 00

DESCRIPTION	FEATURES	MODEL#	STANDARD TEXTILE GRADES											
			1	2	3	4	5	6	7	8	9	10	11	12
 <p>Single Seater - Right Arm COM Yardage: 3.75 Freight Class: 250 Product Weight (lbs.): 45 Cubic Feet Per Carton: 16.5</p>		7870R	852	989	1098	1263	1492	1573	1776	2159	2345	2702	3187	3790
			OVERALL DIMENSIONS			SEAT DIMENSIONS			BACK DIMENSIONS					
			W	D	H	W	D	H	W	H				
			27	27.5	30	24	19.5	16.5	24	13.5				
			RTA 00											
 <p>Single Seater - with Arms COM Yardage: 4.75 Freight Class: 250 Product Weight (lbs.): 52 Cubic Feet Per Carton: 16.5</p>		7871	1051	1209	1336	1524	1788	1886	2118	2567	2781	3195	3758	4459
			OVERALL DIMENSIONS			SEAT DIMENSIONS			BACK DIMENSIONS					
			W	D	H	W	D	H	W	H				
			30	27.5	30	24	19.5	16.5	24	13.5				
			RTA 00											
 <p>Corner Unit COM Yardage: 2.75 Freight Class: 300 Product Weight (lbs.): 31 Cubic Feet Per Carton: 16.5</p>		7872	690	790	872	990	1159	1219	1367	1651	1784	2046	2401	2845
			OVERALL DIMENSIONS			SEAT DIMENSIONS			BACK DIMENSIONS					
			W	D	H	W	D	H	W	H				
			24	27.5	30	20	19.5	16.5	15	13.5				
			RTA 00											
 <p>Corner Unit COM Yardage: 2.75 Freight Class: 300 Product Weight (lbs.): 31 Cubic Feet Per Carton: 16.5</p>		7873	690	790	872	990	1159	1219	1367	1651	1784	2046	2401	2845
			OVERALL DIMENSIONS			SEAT DIMENSIONS			BACK DIMENSIONS					
			W	D	H	W	D	H	W	H				
			24	27.5	30	16	19.5	16.5	21.5	13.5				
			RTA 00											
 <p>Table - 24" Square w/Upholstered Sides COM Yardage: 1.75 Freight Class: 125 Product Weight (lbs.): 38 Cubic Feet Per Carton: 6.25</p>		7874	564	630	680	755	863	903	996	1176	1261	1428	1654	1937
			OVERALL DIMENSIONS			SEAT DIMENSIONS			BACK DIMENSIONS					
			W	D	H	W	D	H	W	H				
			24	24	14.5	-	-	-	-	-				
			RTA 00											

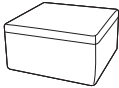
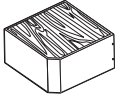
DESCRIPTION	FEATURES	MODEL#	STANDARD TEXTILE GRADES											
			1	2	3	4	5	6	7	8	9	10	11	12
 <p>Foot Stool/Single Bench - 24" Square COM Yardage: 1.75 Freight Class: 125 Product Weight (lbs.): 38 Cubic Feet Per Carton: 6.25</p>		7874FS	643	719	780	872	1002	1046	1162	1377	1479	1679	1949	2289
			OVERALL DIMENSIONS			SEAT DIMENSIONS			BACK DIMENSIONS					
			W	D	H	W	D	H	W	H				
			24	24	17.5	-	-	-	-	-				
			RTA 00											
 <p>Corner Table - 17" Square w/Upholstered Sides COM Yardage: 1.75 Freight Class: 125 Product Weight (lbs.): 38 Cubic Feet Per Carton: 6.25</p>		7880	769	833	883	957	1060	1108	1202	1354	1469	1597	1862	2144
			OVERALL DIMENSIONS			SEAT DIMENSIONS			BACK DIMENSIONS					
			W	D	H	W	D	H	W	H				
			24	24	14.5	-	-	-	-	-				
			RTA 00											

BRIDGES II COLLABORATIVE SEATING



model BRTSE2424B



model BRTSE6060B



model BRTST2448F

STANDARD FEATURES

- For all Bridges II components, please see the Bridges II section of the Desking Price Book.
- Bridges collaborative seating collection consists of seating, privacy screens, tables, tablets and power.
- It is a versatile modular furniture series which can be configured into many space planning scenarios, including corner, in-line, open concept, traditional reception, as well as secluded seating with high privacy partitions.
- Furniture pieces can be used as stand alone items or can be mechanically linked together to form a variety of seating configurations.
- Seat and backrest can be integrated with Bridges tables.
- Corner tables and in-line 6" table modules double as power delivery centers.
- Dedicated seat backrests feature dual USB charging port.
- Some in line 6" table modules are furnished with grommets to support tablets.
- Legs are available in standard Bridges metal painted finishes and anodized aluminum finish.
- Bridges Collaborative Seating upholstery features a single stitch, thick white thread around the edges. The white, wide stitch along with crisp corners are part of its distinctive personality.
- In order to achieve crisp edges and to minimize "pillow" effect caused by taut fabric, the upholstery material has been applied deliberately loose, which may over time, produce puckering of the upholstery surface material. This can be easily corrected by stretching the fabric by hand or during vacuuming.
- Freestanding 17"h table. Central partition divides space under top surface into two 11" deep compartments.

- In order to efficiently utilize fabric yield, all 60" seats and backs feature a seam in the middle. The double stitch seam is sewn with a thin thread, closely matching the upholstery material in color.
- Some complicated fabric patterns prevent pattern matching and will be upholstered without the seam at the discretion of the factory.
- Should you require no middle seam by cutting into the roll, please specify "NO SEAM" at time of your order.
- Check textile availability prior to specifying upholstery material.

OPTIONAL FEATURES

- Optional Anodized Aluminum Leg on all models. Add \$67.
- Models BRTS2406BT and BRTS2406BPT include 9.5" x 14.5" swivel tablet. If top is specified in high pressure laminate, tablet will also be manufactured in high pressure laminate.
- Bridges II tables and tablets are offered in the following laminate finishes: Absolute Acajou (ACJ), Asian Night (ASN), Avant Cherry (AWC), Avant Honey (AWH), Black (BLK), Brushed Cobalt (BRC), Clear Maple (CMB), Custom Grey (CGY), Dark Espresso (DES), Designer White (DWT), Hayden Grey (HGT), Noce Biondo (NBL), Noce Grigio (NGL), Noce Leggero (NEL), Noce Medio (NML), Quartered Mahogany (QTM), Storm Grey (SOG), Tiger Fruitwood (TFW), Tiger Walnut (TWL), Walnut Heights (WHE), White Chocolate (WHC), Willow Grey (WGY), and Winter Cherry (WCR). Please Specify.

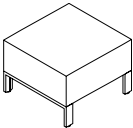
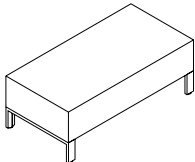
DESCRIPTION	FEATURES	MODEL#	STANDARD TEXTILE GRADES											
			1	2	3	4	5	6	7	8	9	10	11	12
 <p>Lounge Seat - 24" COM Yardage: 1.25 Freight Class: 150 Product Weight (lbs.): 22.70 Cubic Feet Per Carton: 5.57</p>		BRTSE24NB	715	784	784	827	888	917	972	1063	1132	1208	1364	1532
			OVERALL DIMENSIONS			SEAT DIMENSIONS			BACK DIMENSIONS					
			W	D	H	W	D	H	W	H				
			24	24	17	-	-	-	-	-				
		RTA 00												
 <p>Lounge Seat - 48" COM Yardage: 2 Freight Class: 250 Product Weight (lbs.): 36.90 Cubic Feet Per Carton: 11.33</p>		BRTSE48NB	1302	1411	1411	1480	1578	1625	1715	1857	1966	2090	2342	2608
			OVERALL DIMENSIONS			SEAT DIMENSIONS			BACK DIMENSIONS					
			W	D	H	W	D	H	W	H				
			24	48	17	-	-	-	-	-				
		RTA 00												

DESCRIPTION	FEATURES	MODEL#	STANDARD TEXTILE GRADES											
-------------	----------	--------	-------------------------	--	--	--	--	--	--	--	--	--	--	--

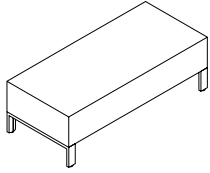

Lounge Seat - 60"
 COM Yardage: 2
 Freight Class: 250
 Product Weight (lbs.): 47
 Cubic Feet Per Carton: 14.17

	1	2	3	4	5	6	7	8	9	10	11	12
BRTSE60NB	1508	1584	1641	1727	1852	1909	2020	2199	2338	2490	2803	3139

OVERALL DIMENSIONS			SEAT DIMENSIONS			BACK DIMENSIONS	
W	D	H	W	D	H	W	H
24	60	17	-	-	-	-	-

RTA 00

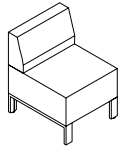

Lounge Seat, Full Backrest - 24"
 COM Yardage: 2.25
 Freight Class: 250
 Product Weight (lbs.): 33
 Cubic Feet Per Carton: 9.57

	1	2	3	4	5	6	7	8	9	10	11	12
BRTSE2424B	1126	1247	1247	1325	1435	1488	1589	1749	1873	2011	2295	2595

OVERALL DIMENSIONS			SEAT DIMENSIONS			BACK DIMENSIONS	
W	D	H	W	D	H	W	H
24	24	29	-	-	-	-	-

RTA 00

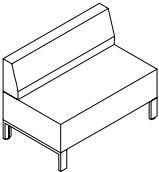

Lounge Seat, Full Backrest - 48"
 COM Yardage: 3.5
 Freight Class: 250
 Product Weight (lbs.): 55.50
 Cubic Feet Per Carton: 19.33

	1	2	3	4	5	6	7	8	9	10	11	12
BRTSE4848B	2078	2263	2263	2385	2559	2637	2796	3044	3237	3450	3892	4360

OVERALL DIMENSIONS			SEAT DIMENSIONS			BACK DIMENSIONS	
W	D	H	W	D	H	W	H
24	48	29	-	-	-	-	-

RTA 00

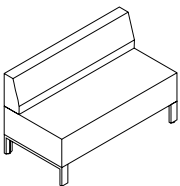

Lounge Seat, Full Backrest - 60"
 COM Yardage: 4.5
 Freight Class: 250
 Product Weight (lbs.): 70
 Cubic Feet Per Carton: 24.17

	1	2	3	4	5	6	7	8	9	10	11	12
BRTSE6060B	2408	2647	2647	2803	3024	3128	3332	3652	3898	4172	4739	5343

OVERALL DIMENSIONS			SEAT DIMENSIONS			BACK DIMENSIONS	
W	D	H	W	D	H	W	H
24	60	29	-	-	-	-	-

RTA 00

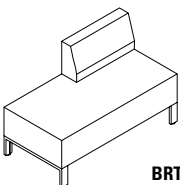

BRTSE2448BR

Lounge Seat, 24" Offset Backrest
 COM Yardage: 3
 Freight Class: 250
 Product Weight (lbs.): 46.1
 Cubic Feet Per Carton: 19.33

	1	2	3	4	5	6	7	8	9	10	11	12
BRTSE2448BR	1712	1874	1874	1975	2125	2194	2329	2544	2708	2889	3268	3669

	1	2	3	4	5	6	7	8	9	10	11	12
BRTSE2448BL	1712	1874	1874	1975	2125	2194	2329	2544	2708	2889	3268	3669

OVERALL DIMENSIONS			SEAT DIMENSIONS			BACK DIMENSIONS	
W	D	H	W	D	H	W	H
24	48	29	-	-	-	-	-

RTA 00

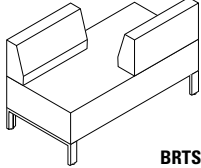
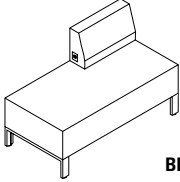
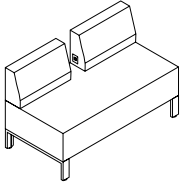
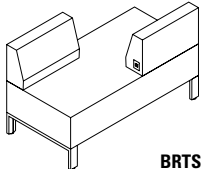
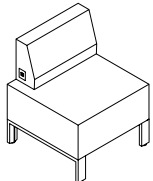
DESCRIPTION	FEATURES	MODEL#	STANDARD TEXTILE GRADES											
 <p>BRTSE2448BODR</p> <p>Lounge Seat, Two 24" Offset Backrests COM Yardage: 4 Freight Class: 250 Product Weight (lbs.): 46.5 Cubic Feet Per Carton: 19.33</p>			1	2	3	4	5	6	7	8	9	10	11	12
		BRTSE2448BODR	2123	2335	2335	2473	2672	2764	2944	3229	3447	3693	4196	4731
		BRTSE2448BODL	2123	2243	2335	2473	2672	2764	2944	3229	3447	3693	4196	4731
				OVERALL DIMENSIONS			SEAT DIMENSIONS			BACK DIMENSIONS				
			W	D	H	W	D	H	W	H				
			24	48	29	-	-	-	-	-				
			RTA 00											
 <p>BRTSE2148EBR</p> <p>Lounge Seat, 21" USB Backrest COM Yardage: 3 Freight Class: 250 Product Weight (lbs.): 33 Cubic Feet Per Carton: 9.67</p>			1	2	3	4	5	6	7	8	9	10	11	12
		BRTSE2148EBR	1985	2077	2146	2249	2398	2468	2601	2815	2981	3162	3539	3942
		BRTSE2148EBL	1985	2077	2146	2249	2398	2468	2601	2815	2981	3162	3539	3942
				OVERALL DIMENSIONS			SEAT DIMENSIONS			BACK DIMENSIONS				
			W	D	H	W	D	H	W	H				
			24	48	29	-	-	-	-	-				
			RTA 00											
 <p>BRTSE2148E2B</p> <p>Lounge Seat, Two 21" USB Backrests COM Yardage: 4 Freight Class: 250 Product Weight (lbs.): 57 Cubic Feet Per Carton: 19.33</p>			1	2	3	4	5	6	7	8	9	10	11	12
		BRTSE2148E2B	2667	2786	2877	3016	3214	3308	3487	3772	3991	4235	4738	5274
				OVERALL DIMENSIONS			SEAT DIMENSIONS			BACK DIMENSIONS				
				W	D	H	W	D	H	W	H			
			24	48	29	-	-	-	-	-				
			RTA 00											
 <p>BRTSE2148EBODR</p> <p>Lounge Seat, Two Offset USB Backrests COM Yardage: 4 Freight Class: 250 Product Weight (lbs.): 57 Cubic Feet Per Carton: 19.33</p>			1	2	3	4	5	6	7	8	9	10	11	12
		BRTSE2148EBODR	2667	2786	2877	3016	3214	3308	3487	3772	3991	4235	4738	5274
		BRTSE2148EBODL	2667	2786	2877	3016	3214	3308	3487	3772	3991	4235	4738	5274
				OVERALL DIMENSIONS			SEAT DIMENSIONS			BACK DIMENSIONS				
			W	D	H	H	W	D	H	H	WH			
			24	48	29	-	-	-	-	-	-			
			RTA 00											
 <p>BRTSE2124EBR</p> <p>Lounge Seat, 21" USB Backrest COM Yardage: 2.25 Freight Class: 250 Product Weight (lbs.): 46.10 Cubic Feet Per Carton: 19.33</p>			1	2	3	4	5	6	7	8	9	10	11	12
		BRTSE2124EBR	2667	1465	1519	1596	1707	1760	1861	2021	2144	2281	2564	2866
		BRTSE2124EBL	1398	1465	1519	1596	1707	1760	1861	2021	2144	2281	2564	2866
				OVERALL DIMENSIONS			SEAT DIMENSIONS			BACK DIMENSIONS				
			W	D	H	W	D	H	W	H				
			24	24	29	-	-	-	-	-				
			RTA 00											

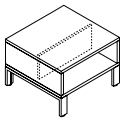
DESCRIPTION	FEATURES	MODEL#	STANDARD TEXTILE GRADES													
			1	2	3	4	5	6	7	8	9	10	11	12		
 <p>Low Table - 24" COM Yardage: N/A Freight Class: 125 Product Weight (lbs.): 40.70 Cubic Feet Per Carton: 5.67</p>		BRTST2424F	800	-	-	-	-	-	-	-	-	-	-	-	-	-
	OVERALL DIMENSIONS	SEAT DIMENSIONS	BACK DIMENSIONS	W		D	H	W		D	H	W		H		
			24	24	17	-	-	-	-	-	-	-	-			
		RTA 00														

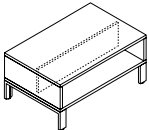
DESCRIPTION	FEATURES	MODEL#	STANDARD TEXTILE GRADES													
			1	2	3	4	5	6	7	8	9	10	11	12		
 <p>Low Table - 48" COM Yardage: N/A Freight Class: 125 Product Weight (lbs.): 69 Cubic Feet Per Carton: 11.33</p>		BRTST2448F	800	-	-	-	-	-	-	-	-	-	-	-	-	-
	OVERALL DIMENSIONS	SEAT DIMENSIONS	BACK DIMENSIONS	W		D	H	W		D	H	W		H		
			24	48	17	-	-	-	-	-	-	-	-			
		RTA 00														

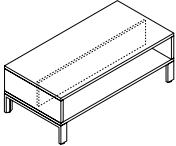
DESCRIPTION	FEATURES	MODEL#	STANDARD TEXTILE GRADES													
			1	2	3	4	5	6	7	8	9	10	11	12		
 <p>Low Table - 60" COM Yardage: N/A Freight Class: 150 Product Weight (lbs.): 83.60 Cubic Feet Per Carton: 14.17</p>		BRTST2460F	800	-	-	-	-	-	-	-	-	-	-	-	-	-
	OVERALL DIMENSIONS	SEAT DIMENSIONS	BACK DIMENSIONS	W		D	H	W		D	H	W		H		
			24	60	17	-	-	-	-	-	-	-	-			
		RTA 00														

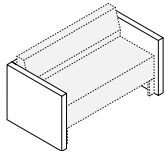
DESCRIPTION	FEATURES	MODEL#	STANDARD TEXTILE GRADES													
			1	2	3	4	5	6	7	8	9	10	11	12		
 <p>Seat Partitions - 24" COM Yardage: Freight Class: 250 Product Weight (lbs.): 32 Cubic Feet Per Carton: 12.04</p>		BRTPP2424L1	1320	-	-	-	-	-	-	-	-	-	-	-	-	-
	OVERALL DIMENSIONS	SEAT DIMENSIONS	BACK DIMENSIONS	W		D	H	W		D	H	W		H		
			53	28.7	25	-	-	-	-	-	-	-	-			
		RTA 00														

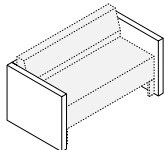
DESCRIPTION	FEATURES	MODEL#	STANDARD TEXTILE GRADES													
			1	2	3	4	5	6	7	8	9	10	11	12		
 <p>Seat Partitions - 48" COM Yardage: Freight Class: 300 Product Weight (lbs.): 41 Cubic Feet Per Carton: 22.01</p>		BRTPP2448L1	1764	-	-	-	-	-	-	-	-	-	-	-	-	-
	OVERALL DIMENSIONS	SEAT DIMENSIONS	BACK DIMENSIONS	W		D	H	W		D	H	W		H		
			53	28.7	25	-	-	-	-	-	-	-	-			
		RTA 00														

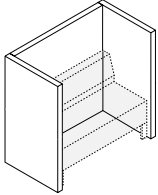
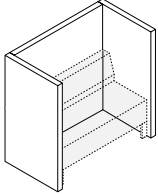
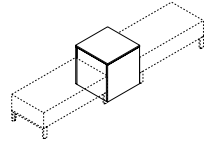
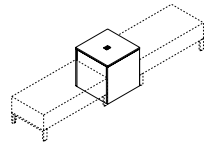
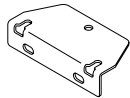
DESCRIPTION	FEATURES	MODEL#	STANDARD TEXTILE GRADES													
			1	2	3	4	5	6	7	8	9	10	11	12		
 <p>Seat Privacy Partitions - 24" COM Yardage: Freight Class: 300 Product Weight (lbs.): 32 Cubic Feet Per Carton: 24.08</p>	<p>Fully 3 - Part Kit Seating not included. Panel textiles only.</p>	BRTPP2424L2	1999	-	-	-	-	-	-	-	-	-	-	-		
			OVERALL DIMENSIONS			SEAT DIMENSIONS			BACK DIMENSIONS							
			W	D	H	W	D	H	W	H						
			53	28.7	50	-	-	-	-	-						
			RTA 00													
 <p>Seat Privacy Partitions - 48" COM Yardage: Freight Class: 400 Product Weight (lbs.): 41 Cubic Feet Per Carton: 44.01</p>	<p>Fully 3 - Part Kit Seating not included.</p>	BRTPP2448L2	2557	-	-	-	-	-	-	-	-	-	-	-		
			OVERALL DIMENSIONS			SEAT DIMENSIONS			BACK DIMENSIONS							
			W	D	H	W	D	H	W	H						
			53	28.7	50	-	-	-	-	-						
			RTA 00													
 <p>Square Table Block - No Power COM Yardage: N/A Freight Class: 250 Product Weight (lbs.): 32 Cubic Feet Per Carton: 12.04</p>	<p>Freestanding Table. Seating not included. Includes 2 brackets and screws</p>	BRTS2424B	562	-	-	-	-	-	-	-	-	-	-	-		
			OVERALL DIMENSIONS			SEAT DIMENSIONS			BACK DIMENSIONS							
			W	D	H	W	D	H	W	H						
			24	24	25	-	-	-	-	-						
			RTA 00													
 <p>Square Table Block w/ Center Power COM Yardage: N/A Freight Class: 125 Product Weight (lbs.): 59.30 Cubic Feet Per Carton: 8.33</p>	<p>Freestanding Table. Seating not included. Includes 2 brackets and screws</p>	BRTS2424BP	562	-	-	-	-	-	-	-	-	-	-	-		
			OVERALL DIMENSIONS			SEAT DIMENSIONS			BACK DIMENSIONS							
			W	D	H	W	D	H	W	H						
			24	24	25	-	-	-	-	-						
			RTA 00													
 <p>Square Table Block Ganging Bracket Kit COM Yardage: N/A Freight Class: 70 Product Weight (lbs.): 0.05 Cubic Feet Per Carton: 0.01</p>	<p>Includes 2 brackets and screws. Black Only.</p>	BRTSTBG	42	-	-	-	-	-	-	-	-	-	-	-		
			OVERALL DIMENSIONS			SEAT DIMENSIONS			BACK DIMENSIONS							
			W	D	H	W	D	H	W	H						
			2.5	5	1.1	-	-	-	-	-						
			RTA 00													

DESCRIPTION FEATURES MODEL# STANDARD TEXTILE GRADES

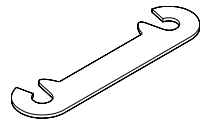

Ganging Bracket Kit
 COM Yardage: N/A
 Freight Class: 70
 Product Weight (lbs.): 0.03
 Cubic Feet Per Carton: 0.01

	1	2	3	4	5	6	7	8	9	10	11	12
BRTSTSB	19	-	-	-	-	-	-	-	-	-	-	-

OVERALL DIMENSIONS			SEAT DIMENSIONS			BACK DIMENSIONS	
W	D	H	W	D	H	W	H
29.5	6	17	-	-	-	-	-

RTA 00

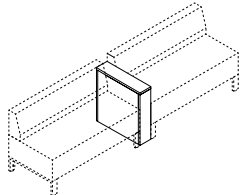

Inline 6" Table Block
 COM Yardage: N/A
 Freight Class: 92.50
 Product Weight (lbs.): 21
 Cubic Feet Per Carton: 2.08

Must use with seating.
 Seating not included.
 Includes 2 brackets and screws

	1	2	3	4	5	6	7	8	9	10	11	12
BRTS2406B	482	-	-	-	-	-	-	-	-	-	-	-

OVERALL DIMENSIONS			SEAT DIMENSIONS			BACK DIMENSIONS	
W	D	H	W	D	H	W	H
24	6	25	-	-	-	-	-

RTA 00

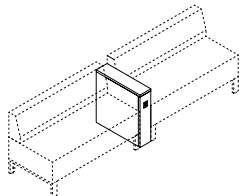

Inline 6" Table Block w/ Front Power
 COM Yardage: N/A
 Freight Class: 92.50
 Product Weight (lbs.): 23.30
 Cubic Feet Per Carton: 2.08

Must use with seating.
 Seating not included.
 Includes 2 brackets and screws

	1	2	3	4	5	6	7	8	9	10	11	12
BRTS2406BP	1040	-	-	-	-	-	-	-	-	-	-	-

OVERALL DIMENSIONS			SEAT DIMENSIONS			BACK DIMENSIONS	
W	D	H	W	D	H	W	H
24	6	25	-	-	-	-	-

RTA 00

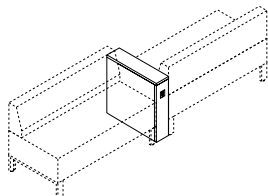

Inline 6" Table Block w/ Front & Rear Power
 COM Yardage: N/A
 Freight Class: 92.50
 Product Weight (lbs.): 24.30
 Cubic Feet Per Carton: 2.08

Must use with seating.
 Seating not included.
 Includes 2 brackets and screws

	1	2	3	4	5	6	7	8	9	10	11	12
BRTS2406B2P	1598	-	-	-	-	-	-	-	-	-	-	-

OVERALL DIMENSIONS			SEAT DIMENSIONS			BACK DIMENSIONS	
W	D	H	W	D	H	W	H
24	6	25	-	-	-	-	-

RTA 00

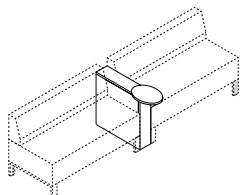

Inline 6" Table Block w/ Tablet Arm
 COM Yardage: N/A
 Freight Class: 85
 Product Weight (lbs.): 25.60
 Cubic Feet Per Carton: 2.08

Must use with seating.
 Seating not included.
 Includes 2 brackets and screws

	1	2	3	4	5	6	7	8	9	10	11	12
BRTS2406BT	921	-	-	-	-	-	-	-	-	-	-	-

OVERALL DIMENSIONS			SEAT DIMENSIONS			BACK DIMENSIONS	
W	D	H	W	D	H	W	H
24	6	25	-	-	-	-	-

RTA 00

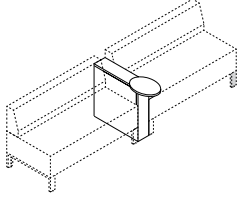
DESCRIPTION	FEATURES	MODEL#	STANDARD TEXTILE GRADES												
			1	2	3	4	5	6	7	8	9	10	11	12	
 <p>Inline 6" Table Block w/ Front Power & Tablet Arm COM Yardage: N/A Freight Class: 92.50 Product Weight (lbs.): 24.30 Cubic Feet Per Carton: 2.08</p>	<p>Must use with seating. Seating not included. Includes 2 brackets and screws</p>	BRTS2406BPT	1479	-	-	-	-	-	-	-	-	-	-	-	
		OVERALL DIMENSIONS			SEAT DIMENSIONS			BACK DIMENSIONS							
		W	D	H	W	D	H	W	H						
24	6	25	-	-	-	-	-								
			RTA 00												

CALIDON



GC36305
Wood Lounge Single Seat, Open Arms



GC36301
Wood Guest Single Seat, Open Arms



GC36308
Wood Lounge Single Seat, Closed Arms



For Calidon tables, see page 274

EXAMPLE CALIDON ORDER CODE:

GC36308	PU75	AAM	NBS
Model #	Textile	Frame Finish	Sealed Back Seams
NSS	NB	NM	SRT
Sealed Seat Seams	Moisture Barrier	Glides	Power

STANDARD FEATURES

- Calidon series consists of wood frame guest, lounge, bariatric and bench seating. Freestanding and tandem/bridge tables also available to complement the line.
- Calidon is designed for the rigors of high use environments. Lounge units include metal frame supports.
- The seating in this series is available to specify with two textiles, one for the seat cushion and one for the back and arms (see model image).
- For pricing, start with the base price and add both back/arms graded textile upcharge and the seat graded textile upcharge.
- Frame design features a wall saver leg to prevent back contact and damage to walls.
- All guest and lounge chairs feature a clean out between seat and back, replaceable seat cushions and tall legs for ease of cleaning.
- Lounge chairs with closed arms are fully upholstered.
- For added comfort, seats are standard with high density Ultracell foam.
- Active weight capacity up to 400 lbs/seat for standard seating; up to 600 lbs for bariatric seating.
- For healthcare textiles, visit the website at globalfurnituregroup.com.
- Textiles with a minimum of 100,000 double rubs must be specified to meet Global's 24/7 warranty coverage.
- Can be upholstered in standard Global textiles if Healthcare 24/7 warranty compliance is not required.
- For alternate textile applications, contact Global specials. The Blended Textile matrix does not apply to this series.
- Shipped fully assembled.

OPTIONAL FEATURES

- Guest chair models can be specified with urethane or Corian armcaps, securely fastened with metal-to-metal connectors, allowing for field replacement if required. Armcaps cannot be retrofitted in the field on units with no existing armcaps.
- Lounge seating with closed arms can be specified with a tamperproof power/USB unit, which includes one AC outlet, two 10 watt USB ports, and a 10 ft long, three-prong power cord. The power unit is black with matching face plate and cord. Power is factory installed and must be specified at time of order. Add \$219 each. Power locations vary by model. See power location diagram.
- For moisture barrier on seat, specify (MB). Upcharges vary, see model.
- To add sealed seams, specify (SBS) for seat back and arms and/or (SSS) for seat. Upcharges vary, see model.
- A tamperproof power unit is available to specify in various locations on closed arm lounge models only. See diagrams.

SUGGESTED APPLICATIONS



- Guest seating
- Lobby/Lounge
- Treatment/Exam rooms



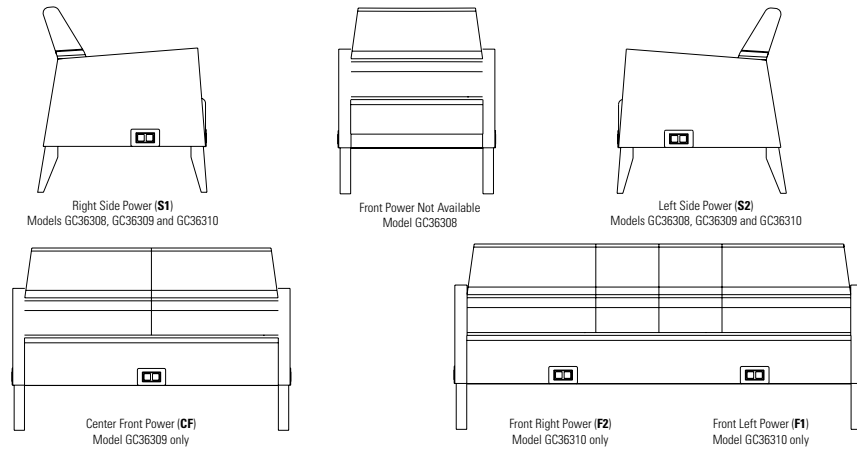

Please add option codes in the following order:





- **Model number**
GC36301 to GC36303 Guest chairs
GC36304 Bariatric guest chair
GC36305 to GC36307 Lounge, open arms
GC36308 to GC36310 Lounge, closed arms
GC36311 to GC36313 Benches
GC36318 to GC36321 Tandem/bridge tables
 For Calidon tables, refer topage 274
- **Back/Arm Textile**
Specify textile code. See model grade upcharges.
- **Seat Textile**
Specify textile code. See model grade upcharges.
- **Armcap option** (guest chairs only)
(FNA) No armcaps
(FAC) With armcaps. Upcharges vary, see model.
- **Frame finish**
(AAM) Absolute **(MWM)** Medium Walnut
(CJM) Charcoal Java **(ASM)** Night
(ACM) Cherry **(NBM)** Noce Biondo
(EMM) Empire Mahogany **(NGM)** Noce Grigio
(EOM) English Oak **(NEM)** Noce Leggero
(ECM) Espresso Cafe **(NMM)** Noce Medio
(TFM) Fruitwood **(SBM)** Sandy Beach
(HGM) Grey **(SKM)** Shaker Cherry
(HOM) Harvest Oak **(SOM)** Silver Oak
(AHM) Honey **(TWM)** Walnut
(JOM) Jet Onyx **(WTM)** WC Cream
(LHM) Light Honey **(WHM)** White
(TMM) Mahogany **(WCM)** Winter Cherry
(AVM) Maple
- **Armcap finish** (guest chairs only with **FAC**)
(SSU) Self-skinned urethane armcaps. Upcharges vary, see model.
(BLK) Black
(KAL) Kalua
(LAB) Latte
(J52) Mocha
(SHW) Shadow
(TOA) Toast
(CO) Solid Surface. Upcharges vary, see model.
(GWH) Glacier White
- **Sealed Back Seams** (Contact Customer Care for approved textiles.)
(NBS) No sealed back seams
(SBS) Sealed back seams. Upcharges vary, see model.
- **Sealed Seat Seams** (Contact Customer Care for approved textiles.)
(NSS) No sealed seat seams
(SSS) Sealed seat seams. Upcharges vary, see model.
- **Glides**
(NM) Non-marking
(NS) Non-slip
 Guest single seat, bariatric and lounge chairs, add \$26.
 Guest two seater, Add \$40.
 Guest three seater, add \$51.
- **Moisture Barrier** (seat only) (Not available with Sealed Seams)
(NB) No moisture barrier
(MB) Moisture barrier. Upcharges vary, see model.
- **Power/USB unit position** (closed arm, lounge models only). Add \$219.
(NPM) No power
(TPM) Tamperproof power unit
(J) Black
(SRT) Side right
(SLT) Side left
(FLT) Front left (three seater only)
(FRF) Front right (three seater only)
(CRF) Center front (two seater only)
(SLR) Side left and right. Add \$437.
(FLR) Front left and right. Add \$437.

POWER LOCATION DIAGRAM



DESCRIPTION	MODEL#/ FEATURES	STANDARD TEXTILE GRADES												
		1/COM	2	3	4	5	6	7	8	9	10	11	12	
 <p>Wood Guest Single Seat, Open Arms COM Yardage: Back: 0.9; Seat: 1 Freight Class: 250 Product Weight (lbs.): 38 Cubic Feet Per Carton: 16.5</p>	GC36301	Base Price:	\$1106											
	Back upcharge:	+0	+\$29	+\$52	+\$85	+\$132	+\$152	+\$192	+\$256	+\$304	+\$356	+\$465	+\$579	
	Seat upcharge:	+0	+\$32	+\$57	+\$94	+\$146	+\$168	+\$213	+\$284	+\$337	+\$395	+\$516	+\$643	
			OVERALL DIMENSIONS			SEAT DIMENSIONS			BACK DIMENSIONS					
			W	D	H	W	D	H	W	H				
		23.5	26.5	34.5	21.5	18	18	21.5	16.5					
		Active weight 400 lbs.												
		Add \$419 for Corian® armcaps Add \$117 for SSU armcaps Add \$116 for (MB) Add \$25 for (SSS), \$35 for (SBS)												
 <p>Wood Guest Two Seater, Full Center Arm, Open Arms COM Yardage: Back: 1.8; Seat: 2 Freight Class: 250 Product Weight (lbs.): 68 Cubic Feet Per Carton: 31.75</p>	GC36302	Base Price:	\$2047											
	Back upcharge:	+0	+\$58	+\$103	+\$170	+\$263	+\$303	+\$384	+\$512	+\$607	+\$711	+\$929	+\$1158	
	Seat upcharge:	+0	+\$64	+\$114	+\$188	+\$292	+\$336	+\$426	+\$568	+\$674	+\$790	+\$1032	+\$1286	
			OVERALL DIMENSIONS			SEAT DIMENSIONS			BACK DIMENSIONS					
			W	D	H	W	D	H	W	H				
		46	26.5	34.5	21.5	18	18	21.5	16.5					
		Active weight 400 lbs./seat												
		Add \$627 for Corian® armcaps Add \$175 for SSU armcaps Add \$231 for (MB) Add \$49 for (SSS), \$69 for (SBS)												
 <p>Wood Guest Three Seater, Full Center Arms, Open Arms COM Yardage: Back: 2.7; Seat: 3 Freight Class: 250 Product Weight (lbs.): 101 Cubic Feet Per Carton: 47.5</p>	GC36303	Base Price:	\$3013											
	Back upcharge:	+0	+\$87	+\$154	+\$254	+\$395	+\$454	+\$576	+\$767	+\$910	+\$1067	+\$1394	+\$1737	
	Seat upcharge:	+0	+\$96	+\$171	+\$282	+\$438	+\$504	+\$639	+\$852	+\$1011	+\$1185	+\$1548	+\$1929	
			OVERALL DIMENSIONS			SEAT DIMENSIONS			BACK DIMENSIONS					
			W	D	H	W	D	H	W	H				
		68	26.5	34.5	21.5	18	18	21.5	16.5					
		Active weight 400 lbs./seat												
		Add \$836 for Corian® armcaps Add \$234 for SSU armcaps Add \$345 for (MB) Add \$73 for (SSS), \$103 for (SBS)												

DESCRIPTION	MODEL#/ FEATURES	STANDARD TEXTILE GRADES											
		1/COM	2	3	4	5	6	7	8	9	10	11	12
 <p>Wood Guest Bariatric Chair, Open Arms COM Yardage: Back: 1.25; Seat: 1.25 Freight Class: 250 Product Weight (lbs.): 55 Cubic Feet Per Carton: 22.25</p>	GC36304 Base Price:	\$1691											
	Back upcharge:	+0	+\$40	+\$72	+\$118	+\$183	+\$210	+\$267	+\$355	+\$422	+\$494	+\$645	+\$804
	Seat upcharge:	+0	+\$40	+\$72	+\$118	+\$183	+\$210	+\$267	+\$355	+\$422	+\$494	+\$645	+\$804
	Active weight 600 lbs.	OVERALL DIMENSIONS			SEAT DIMENSIONS			BACK DIMENSIONS					
		W	D	H	W	D	H	W	H				
	32.75	26.5	34.5	31	18	18	30.5	16.5					
	Add \$836 for Corian® armcaps Add \$234 for SSU armcaps Add \$173 for (MB) Add \$25 for (SSS) , \$40 for (SBS)												
 <p>Wood Lounge Single Seat, Open Arms COM Yardage: Back: 1.25; Seat: 1.25 Freight Class: 250 Product Weight (lbs.): 49 Cubic Feet Per Carton: 18.25</p>	GC36305 Base Price:	\$1546											
	Back upcharge:	+0	+\$40	+\$72	+\$118	+\$183	+\$210	+\$267	+\$355	+\$422	+\$494	+\$645	+\$804
	Seat upcharge:	+0	+\$40	+\$72	+\$118	+\$183	+\$210	+\$267	+\$355	+\$422	+\$494	+\$645	+\$804
	Active weight 400 lbs.	OVERALL DIMENSIONS			SEAT DIMENSIONS			BACK DIMENSIONS					
		W	D	H	W	D	H	W	H				
	25.75	29.5	32.5	24	21	16	23.5	16.5					
	Add \$116 for (MB) Add \$30 for (SSS) , \$41 for (SBS)												
 <p>Wood Lounge Two Seater, Open Arms COM Yardage: Back: 1.75; Seat: 2.25 Freight Class: 250 Product Weight (lbs.): 77 Cubic Feet Per Carton: 32.75</p>	GC36306 Base Price:	\$2174											
	Back upcharge:	+0	+\$56	+\$100	+\$165	+\$256	+\$294	+\$373	+\$497	+\$590	+\$692	+\$903	+\$1126
	Seat upcharge:	+0	+\$72	+\$129	+\$212	+\$329	+\$378	+\$480	+\$639	+\$759	+\$889	+\$1161	+\$1447
	Active weight 400 lbs./seat	OVERALL DIMENSIONS			SEAT DIMENSIONS			BACK DIMENSIONS					
		W	D	H	W	D	H	W	H				
	47.5	29.5	32.5	45	21	16	44.5	16.5					
	Add \$231 for (MB) Add \$44 for (SSS) , \$58 for (SBS)												
 <p>Wood Lounge Three Seater, Open Arms COM Yardage: Back: 2.5; Seat: 2.75 Freight Class: 250 Product Weight (lbs.): 109 Cubic Feet Per Carton: 50.75</p>	GC36307 Base Price:	\$2718											
	Back upcharge:	+0	+\$80	+\$143	+\$235	+\$365	+\$420	+\$533	+\$710	+\$843	+\$988	+\$1290	+\$1608
	Seat upcharge:	+0	+\$88	+\$157	+\$259	+\$402	+\$462	+\$586	+\$781	+\$927	+\$1087	+\$1419	+\$1769
	Active weight 400 lbs./seat	OVERALL DIMENSIONS			SEAT DIMENSIONS			BACK DIMENSIONS					
		W	D	H	W	D	H	W	H				
	70.5	29.5	32.5	68	21	16	67.5	16.5					
	Add \$345 for (MB) Add \$58 for (SSS) , \$74 for (SBS)												
 <p>Wood Lounge Single Seat, Closed Arms COM Yardage: Back/Arm: 2.75; Seat: 1.25 Freight Class: 250 Product Weight (lbs.): 58 Cubic Feet Per Carton: 18.75</p>	GC36308 Base Price:	\$1752											
	Back/Arm upcharge:	+0	+\$88	+\$157	+\$259	+\$402	+\$462	+\$586	+\$781	+\$927	+\$1087	+\$1419	+\$1769
	Seat upcharge:	+0	+\$40	+\$72	+\$118	+\$183	+\$210	+\$267	+\$355	+\$422	+\$494	+\$645	+\$804
	Active weight 400 lbs.	OVERALL DIMENSIONS			SEAT DIMENSIONS			BACK DIMENSIONS					
		W	D	H	W	D	H	W	H				
	27.5	29.5	33.5	24	21	16	23.5	17.5					
	Add \$116 for (MB) Add \$33 for (SSS) , \$132 for (SBS) Power/USB unit available.												

DESCRIPTION	MODEL#/ FEATURES	STANDARD TEXTILE GRADES											
		1/COM	2	3	4	5	6	7	8	9	10	11	12
 <p>Wood Lounge Two Seater, Closed Arms COM Yardage: Back/Arm: 3.5; Seat: 2.25 Freight Class: 250 Product Weight (lbs.): 89 Cubic Feet Per Carton: 33.75</p>	<p>GC36309 Base Price: \$2356 Back/Arm upcharge: +0 Seat upcharge: +0 Active weight 400 lbs./seat</p>												
		<p>Add \$231 for (MB) Add \$48 for (SSS), \$148 for (SBS) Power/USB unit available.</p>											
		OVERALL DIMENSIONS			SEAT DIMENSIONS			BACK DIMENSIONS					
		W	D	H	W	D	H	W	H				
		49.5	29.5	33.5	44.5	18	16	45.5	17.5				
 <p>Wood Lounge Three Seater, Closed Arms COM Yardage: Back/Arm: 4.25; Seat: 2.75 Freight Class: 250 Product Weight (lbs.): 123 Cubic Feet Per Carton: 52</p>	<p>GC36310 Base Price: \$2959 Back/Arm upcharge: +0 Seat upcharge: +0 Active weight 400 lbs./seat</p>												
		<p>Add \$345 for (MB) Add \$61 for (SSS), \$165 for (SBS) Power/USB unit available.</p>											
		OVERALL DIMENSIONS			SEAT DIMENSIONS			BACK DIMENSIONS					
		W	D	H	W	D	H	W	H				
		71.5	29.5	33.5	66.5	18	16	67.5	17.5				
 <p>Single Seat Bench COM Yardage: 1 Freight Class: 150 Product Weight (lbs.): 41 Cubic Feet Per Carton: 10</p>	<p>GC36311 Base Price: \$1184 Seat upcharge: +0 Active weight 400 lbs.</p>												
		<p>Add \$116 for (MB) Add \$28 for (SSS)</p>											
		OVERALL DIMENSIONS			SEAT DIMENSIONS			BACK DIMENSIONS					
		W	D	H	W	D	H	W	H				
		24	28	18	24	26.75	18						
 <p>Two Seat Bench COM Yardage: 2 Freight Class: 250 Product Weight (lbs.): 61 Cubic Feet Per Carton: 18.75</p>	<p>GC36312 Base Price: \$1873 Seat upcharge: +0 Active weight 400 lbs./seat</p>												
		<p>Add \$231 for (MB) Add \$56 for (SSS)</p>											
		OVERALL DIMENSIONS			SEAT DIMENSIONS			BACK DIMENSIONS					
		W	D	H	W	D	H	W	H				
		48	28	18	48	26.75	18						
 <p>Three Seat Bench COM Yardage: 3 Freight Class: 250 Product Weight (lbs.): 97 Cubic Feet Per Carton: 27.75</p>	<p>GC36313 Base Price: \$2235 Seat upcharge: +0 Active weight 400 lbs./seat</p>												
		<p>Add \$345 for (MB) Add \$82 for (SSS)</p>											
		OVERALL DIMENSIONS			SEAT DIMENSIONS			BACK DIMENSIONS					
		W	D	H	W	D	H	W	H				
		72	28	18	72	26.75	18						

CALIDON TABLES



Square end table - 22"
GC36314



Rectangular Coffee Table
GC36317



Tandem Side Table, Right
GC36319R

EXAMPLE CALIDON TABLE ORDER CODE:

GC36319R	-HP	-ACJ	-CNT
Model #	Top material	Laminate finish	Power

TABLE STANDARD FEATURES

- A variety of wood leg tables are available. The wood legs/frames are specifiable in the same wood seating finishes.
- Table tops are 1" thick, available in thermally fused laminate (LP), high pressure laminate (HP), and Corian® solid surface (CO). Upcharges vary, see model for pricing.
- Laminate top tables include color coordinating vinyl edge band.
- Tandem/bridge table models (GC36318 to GC36321) connect to guest seating only and include ganging brackets.
- Tandem tables are specified left or right, as seated.

TABLE OPTIONAL FEATURES

- A tamperproof tabletop power unit may be specified on laminate top, tandem and square end tables only. Specify **CNT**. Add **\$331**. The power unit is located centered 1.5" from the edge of the surface. See power location diagrams for reference.

SUGGESTED APPLICATIONS

- Lounge/Lobby
- Patient rooms
- Resident rooms
- Private office

Please add option codes in the following order:

- **Table model number**
GC36314 to GC36317 Freestanding tables
GC36318 to GC36321 Tandem/bridge tables
For Calidon seating, refer to page 271.
- **Top Material (tables)**
(LP) Thermally fused laminate. Specify finish - See LP finishes.
(HP) High pressure laminate. Upcharges vary - see model. Specify finish - see HP finishes.
(CO) Solid surface. Upcharges vary - see model. Glacier White (GWH) finish only.
- **Leg finish**
(AAM) Absolute (MWM) Medium Walnut
(CJM) Charcoal Java (ASM) Night
(ACM) Cherry (NBM) Noce Biondo
(EMM) Empire Mahogany (NGM) Noce Grigio
(EOM) English Oak (NEM) Noce Leggero
(ECM) Espresso Cafe (NMM) Noce Medio
(TFM) Fruitwood (SBM) Sandy Beach
(HGM) Grey (SKM) Shaker Cherry
(HOM) Harvest Oak (SOM) Silver Oak
(AHM) Honey (TWM) Walnut
(JOM) Jet Onyx (WTM) WC Cream
(LHM) Light Honey (WHM) White
(TMM) Mahogany (WCM) Winter Cherry
(AVM) Maple
- **Power/USB unit position** (tandem and square side tables with laminate tops only).
(NPM) No power
(CNT) Center top power. Jet Black. Add **\$331**.

TABLE TOP FINISHES:

Thermally fused laminate (LP):

- Absolute Acajou (ACJ)
- Asian Night (ASN)
- Avant Cherry (AWC)
- Avant Honey (AWH)
- Black (BLK)
- Brushed Cobalt (BRC)
- Clear Maple (CMB)
- Dark Espresso (DES)
- Designer White (DWT)
- Hayden Grey (HGT)
- Noce Biondo (NBL)
- Noce Grigio (NGL)
- Noce Leggero (NEL)
- Noce Medio (NML)
- Quartered Mahogany (QTM)
- Tiger Fruitwood (TFW)
- Tiger Walnut (TWL)
- Walnut Heights (WHE)
- White Chocolate (WHC)
- Winter Cherry (WCR)

High pressure laminate (HP):

- Absolute Acajou (ACJ)
- Asian Night (ASN)
- Avant Cherry (AWC)
- Avant Honey (AWH)
- Black (BLK)
- Brushed Cobalt (BRC)
- Clear Maple (CMB)
- Dark Espresso (DES)
- Designer White (DWT)
- Hayden Grey (HGT)
- Noce Biondo (NBL)
- Noce Grigio (NGL)
- Noce Leggero (NEL)
- Noce Medio (NML)
- Quartered Mahogany (QTM)
- Tiger Fruitwood (TFW)
- Tiger Walnut (TWL)
- Walnut Heights (WHE)
- White Chocolate (WHC)
- Winter Cherry (WCR)

Corian Solid Surface (CO):

- Glacier White (GLW)

POWER LOCATION DIAGRAM

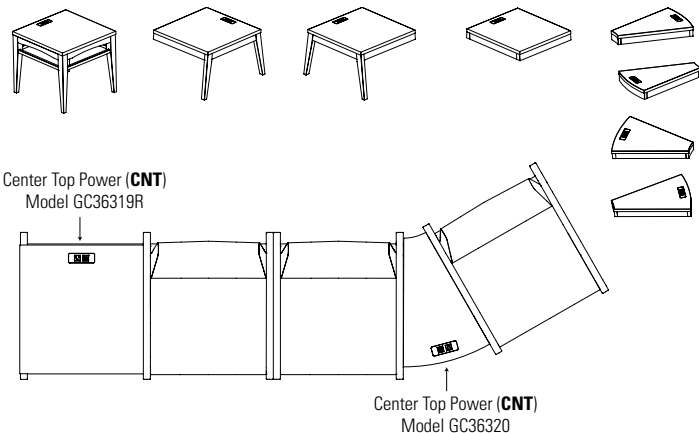

LOUNGE

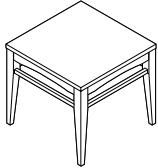
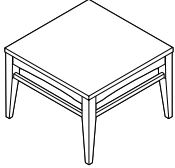
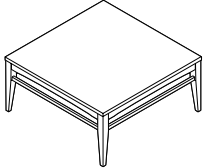
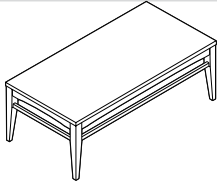
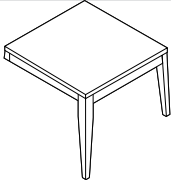
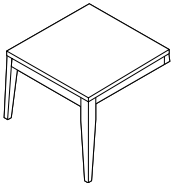
TABLES	MODEL#	DIMENSIONS	FREIGHT CLASS	WT/LBS.	CUBIC FT.	LIST PRICE
 <p>Square End Table - 22"</p>	GC36314	22 x 22 x 20.25	150	36	7.75	\$764
						<ul style="list-style-type: none"> • Pricing shown for a thermally fused laminate top (LP). • For a high pressure laminate top (HP), add \$60. • For a Corian solid surface top (CO), add \$1120. <p>Coordinating edge on laminate surfaces with solid wood frame and legs. 1 per carton. Power/USB unit can be specified in the surface of laminate top tables (CNT). Add \$312.</p>
 <p>Square Coffee Table - 24"</p>	GC36315	24 x 24 x 17.25	250	37	9.5	\$793
						<ul style="list-style-type: none"> • Pricing shown for a thermally fused laminate top (LP). • For a high pressure laminate top (HP), add \$60. • For a Corian solid surface top (CO), add \$1270. <p>Coordinating edge on laminate surfaces with solid wood frame and legs. 1 per carton.</p>
 <p>Square Coffee Table - 36"</p>	GC36316	36 x 36 x 17.25	250	65	18.25	\$949
						<ul style="list-style-type: none"> • Pricing shown for a thermally fused laminate top (LP). • For a high pressure laminate top (HP), add \$129. • For a Corian solid surface top (CO), add \$2859. <p>Coordinating edge on laminate surfaces with solid wood frame and legs. 1 per carton.</p>
 <p>Rectangular Coffee Table</p>	GC36317	24 x 48 x 17.25	250	56	16.5	\$1039
						<ul style="list-style-type: none"> • Pricing shown for a thermally fused laminate top (LP). • For a high pressure laminate top (HP), add \$117. • For a Corian solid surface top (CO), add \$2575. <p>Coordinating edge on laminate surfaces with solid wood frame and legs. 1 per carton.</p>
 <p>Tandem Side Table, Left</p>	GC36319L	26.5 x 22.25 x 15.75	250	20	6.75	\$662
						<ul style="list-style-type: none"> • Pricing shown for a thermally fused laminate top (LP). • For a high pressure laminate top (HP), add \$60. • For a Corian solid surface top (CO), add \$1207. <p>Coordinating edge on laminate surfaces with solid wood frame and legs. Must be connected to a guest chair. Includes one set of U-channel connectors and hardware. 1 per carton. Power/USB unit can be specified in the surface of laminate top tables (CNT). Add \$331.</p>
 <p>Tandem Side Table, Right</p>	GC36319R	26.5 x 22.25 x 15.75	250	20	6.75	\$662
						<ul style="list-style-type: none"> • Pricing shown for a thermally fused laminate top (LP). • For a high pressure laminate top (HP), add \$60. • For a Corian solid surface top (CO), add \$1207. <p>Coordinating edge on laminate surfaces with solid wood frame and legs. Must be connected to a guest chair. Includes one set of U-channel connectors and hardware. 1 per carton. Power/USB unit can be specified in the surface of laminate top tables (CNT). Add \$331.</p>

TABLES	MODEL#	DIMENSIONS	FREIGHT CLASS	WT/LBS.	CUBIC FT.	LIST PRICE
--------	--------	------------	---------------	---------	-----------	------------

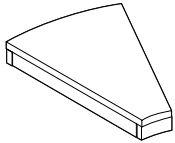

Corner Table, 30 Degree

GC36320	22.5 x 15.75 x 3	92.5	16	1.5	\$521
---------	------------------	------	----	-----	--------------

- Pricing shown for a thermally fused laminate top (LP).
- For a high pressure laminate top (HP), add **\$60**.
- For a Corian solid surface top (CO), add **\$952**.

Coordinating edge on laminate surfaces with solid wood frame and legs. Must be connected between two guest chairs. Includes two sets of U-channel connectors and hardware. 1 per carton. Power/USB unit can be specified in the surface of laminate top tables (CNT). Add **\$331**.

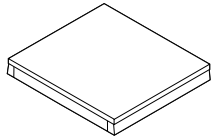

In-Line Table, Square

GC36321	21 x 23.5 x 3	92.5	20	1.9	\$552
---------	---------------	------	----	-----	--------------

- Pricing shown for a thermally fused laminate top (LP).
- For a high pressure laminate top (HP), add **\$60**.
- For a Corian solid surface top (CO), add **\$1148**.

Coordinating edge on laminate surfaces with solid wood frame and legs. Must be connected between two guest chairs. Includes two sets of U-channel connectors and hardware. 1 per carton. Power/USB unit can be specified in the surface of laminate top tables (CNT). Add **\$331**.

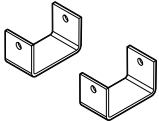

U-Channel (set of 2)

GC36322	2.87 x 1.5 x 1.62	70	0.75	0.03	\$44
---------	-------------------	----	------	------	-------------

Includes hardware. 4 sets per carton.

CAMINO



models shown: 5471-CP Lounge Chair, 5475-W End Table, 5472-CP Two Seat Sofa.



model 5471-CP



model 5476-W





model 5485-W

STANDARD FEATURES

- A transitional soft seating series composed of one, two and three seat units. The series also offers tables with coordinating details and finishes.
- Frame is a heavy duty, interlocking plywood, puzzle box construction suitable for public environments.
- The soft seating leg system utilizes a continuous visible frame between the front and rear leg. Each leg frame is bolted directly to the sofa frame with large bolts to provide a very durable leg construction.
- Legs are equipped with translucent non marking glides as standard. Suitable for both carpet and hard surface flooring.
- Seating features as standard, decorative double stitch detail, which make seams lay flat and add extra seam strength.
- Cushions are highly resilient foam and seats are equipped with a synthetic rubberized sheet webbing suspension system for extra comfort. Cushions are fixed and non-removable.
- Tables are made with a choice of tops: Genuine Wood tops (**W**) with a reverse beveled edge, Thermally Fused Laminate tops (**LP**) with matching PVC edging or High Pressure Laminate top (**HP**) with matching PVC edging. Custom high pressure laminate finishes will be considered upon requested.
- Regardless of top chosen all tables have wood aprons and a unique tapered leg design.
- Some table assembly required, see RTA code with each item below.
- Measurement shown for weight is for one unit, measurement for volume is per carton.
- Check textile availability prior to specifying upholstery material.

OPTIONAL FEATURES

- Optional cushions and arms can have tailored piping details.
- For piping made in fabric matching the rest of the upholstery fabric please use **MP** models (matching piping after the model number). This is no upcharge.
- For contrast piping made in a fabric that does not match the rest of the upholstery fabric, you can specify any grade 1 or 2 upholstery material for this purpose, please see model numbers ending in **CP** which reflect the appropriate upcharge.
- For contrast piping in a fabric higher than grade 2, you must ask for a special quotation. Per unit price will vary depending on the number of units being ordered.
- Seating unit and tables come with a choice of wood legs or a polished cast aluminum. The table leg finishes coordinate with the legs on the soft seating units.
- Seating and tables with polished aluminum legs are shown as separate skus.
- Tops finishes coordinate with the laminate finishes for Global Desking and wood seating finishes. Specify laminate finishes from the Adaptabilities or Zira sections of the price list.
- Wood legs for seating are available in select Global wood seating finishes - see seating finishes. Only finishes ending in **"M"** are available for this series.

DESCRIPTION	FEATURES	MODEL#	STANDARD TEXTILE GRADES											
			1	2	3	4	5	6	7	8	9	10	11	12
 <p>Lounge Chair w/ Wood Legs COM Yardage: 4 Freight Class: 250 Product Weight (lbs.): 60 Cubic Feet Per Carton: 19.25</p>	No Piping.	5471	2431	2572	2686	2852	3091	3201	3417	3761	4024	4318	4926	5570
		OVERALL DIMENSIONS			SEAT DIMENSIONS			BACK DIMENSIONS						
		W	D	H	W	D	H	W	H					
		29.5	29	30.5	21	19.5	18	20	11.5					
		RTA.00												
 <p>Lounge Chair w/ Wood Legs & Piping COM Yardage: 4 Freight Class: 250 Product Weight (lbs.): 60 Cubic Feet Per Carton: 19.25</p>	CP = Contrast Piping MP = Matching Piping	5471-CP	2617	2760	2872	3038	3277	3387	3603	3947	4210	4504	5111	5756
		5471-MP	2431	2572	2686	2852	3091	3201	3417	3761	4024	4318	4926	5570
		OVERALL DIMENSIONS			SEAT DIMENSIONS			BACK DIMENSIONS						
		W	D	H	W	D	H	W	H					
			29.5	29	30.5	21	19.5	18	20	11.5				
		RTA.00												

DESCRIPTION	FEATURES	MODEL#	STANDARD TEXTILE GRADES											
			1	2	3	4	5	6	7	8	9	10	11	12

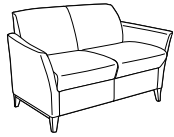

Two Seat Sofa w/ Wood Legs
 COM Yardage: 5.75
 Freight Class: 250
 Product Weight (lbs.): 84
 Cubic Feet Per Carton: 36

No Piping.

5472	3445	3647	3808	4049	4391	4549	4861	5352	5734	6157	7028	7956
-------------	------	------	------	------	------	------	------	------	------	------	------	------

OVERALL DIMENSIONS			SEAT DIMENSIONS			BACK DIMENSIONS	
W	D	H	W	D	H	W	H

51	29	30.5	42	19.5	18	41	11.5
----	----	------	----	------	----	----	------

RTA 00

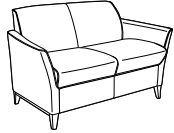

Two Seat Sofa w/ Wood Legs
 COM Yardage: 5.75
 Freight Class: 250
 Product Weight (lbs.): 84
 Cubic Feet Per Carton: 36

CP = Contrast Piping
 MP = Matching Piping

5472-CP	3691	3896	4054	4296	4638	4797	5108	5601	5980	6404	7274	8202
5472-MP	3445	3647	3808	4049	4391	4549	4861	5352	5734	6157	7028	7956

OVERALL DIMENSIONS			SEAT DIMENSIONS			BACK DIMENSIONS	
W	D	H	W	D	H	W	H

51	29	30.5	42	19.5	18	41	11.5
----	----	------	----	------	----	----	------

RTA 00

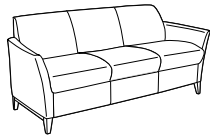

Three Seat Sofa w/ Wood Legs
 COM Yardage: 7.5
 Freight Class: 250
 Product Weight (lbs.): 110
 Cubic Feet Per Carton: 50.25

No Piping.

5473	4459	4723	4932	5247	5692	5901	6306	6949	7444	7997	9133	10342
-------------	------	------	------	------	------	------	------	------	------	------	------	-------

OVERALL DIMENSIONS			SEAT DIMENSIONS			BACK DIMENSIONS	
W	D	H	W	D	H	W	H

71	29	30.5	63	19.5	18	62	11.5
----	----	------	----	------	----	----	------

RTA 00

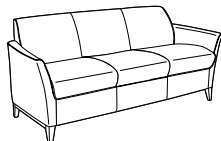

Three Seat Sofa w/ Wood Legs
 COM Yardage: 7.5
 Freight Class: 250
 Product Weight (lbs.): 110
 Cubic Feet Per Carton: 50.25

CP = Contrast Piping
 MP = Matching Piping

5473-CP	4765	5029	5239	5553	5997	6207	6613	7254	7750	8303	9437	10648
5473-MP	4459	4723	4932	5247	5692	5901	6306	6949	7444	7997	9133	10342

OVERALL DIMENSIONS			SEAT DIMENSIONS			BACK DIMENSIONS	
W	D	H	W	D	H	W	H

71	29	30.5	63	19.5	18	62	11.5
----	----	------	----	------	----	----	------

RTA 00



Coffee Table - 22" x 48" Rectangular w/Wood Legs
 COM Yardage: N/A
 Freight Class: 92.5
 Product Weight (lbs.): 40
 Cubic Feet Per Carton: 4





5474-LP	1879	-	-	-	-	-	-	-	-	-	-	-
5474-HP	2015	-	-	-	-	-	-	-	-	-	-	-
5474-W	2425	-	-	-	-	-	-	-	-	-	-	-



LP = Laminate Top HP = High Pressure Laminate Top W = Wood Top



OVERALL DIMENSIONS			SEAT DIMENSIONS			BACK DIMENSIONS	
W	D	H	W	D	H	W	H

22	48	17.5	-	-	-	-	-
----	----	------	---	---	---	---	---

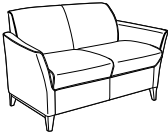
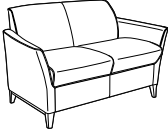
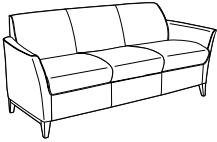
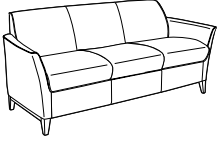
RTA 8

DESCRIPTION	FEATURES	MODEL#	STANDARD TEXTILE GRADES												
			1	2	3	4	5	6	7	8	9	10	11	12	
 <p>End Table - 21"x 21" Square w/Wood Legs COM Yardage: N/A Freight Class: 100 Product Weight (lbs.): 20 Cubic Feet Per Carton: 2.1</p>			1	2	3	4	5	6	7	8	9	10	11	12	
	5475-LP	1399	-	-	-	-	-	-	-	-	-	-	-	-	
	5475-HP	1538	-	-	-	-	-	-	-	-	-	-	-	-	
	5475-W	1694	-	-	-	-	-	-	-	-	-	-	-	-	
	LP = Laminate Top HP = High Pressure Laminate Top W = Wood Top			OVERALL DIMENSIONS			SEAT DIMENSIONS			BACK DIMENSIONS					
	W	D	H	W	D	H	W	H							
	21	21	17.5	-	-	-	-	-							
	RTA 8														
 <p>End Table - 24" Round w/Wood Legs COM Yardage: N/A Freight Class: 92.5 Product Weight (lbs.): 21 Cubic Feet Per Carton: 2.1</p>			1	2	3	4	5	6	7	8	9	10	11	12	
	5476-LP	1447	-	-	-	-	-	-	-	-	-	-	-	-	
	5476-HP	1588	-	-	-	-	-	-	-	-	-	-	-	-	
	5476-W	1840	-	-	-	-	-	-	-	-	-	-	-	-	
	LP = Laminate Top HP = High Pressure Laminate Top W = Wood Top			OVERALL DIMENSIONS			SEAT DIMENSIONS			BACK DIMENSIONS					
	W	D	H	W	D	H	W	H							
	24	24	17.5	-	-	-	-	-							
	RTA 8														
 <p>Coffee Table - 32" Round w/Wood Legs COM Yardage: N/A Freight Class: 125 Product Weight (lbs.): 35 Cubic Feet Per Carton: 4.4</p>			1	2	3	4	5	6	7	8	9	10	11	12	
	5477-LP	2186	-	-	-	-	-	-	-	-	-	-	-	-	
	5477-HP	2324	-	-	-	-	-	-	-	-	-	-	-	-	
	5477-W	2763	-	-	-	-	-	-	-	-	-	-	-	-	
	LP = Laminate Top HP = High Pressure Laminate Top W = Wood Top			OVERALL DIMENSIONS			SEAT DIMENSIONS			BACK DIMENSIONS					
	W	D	H	W	D	H	W	H							
	32	32	17.5	-	-	-	-	-							
	RTA 8														
 <p>Lounge Chair w/Aluminum Legs COM Yardage: 4 Freight Class: 250 Product Weight (lbs.): 62 Cubic Feet Per Carton: 19.25</p>			1	2	3	4	5	6	7	8	9	10	11	12	
	5481	2431	2572	2686	2852	3091	3201	3417	3761	4024	4318	4926	5570		
				OVERALL DIMENSIONS			SEAT DIMENSIONS			BACK DIMENSIONS					
		W	D	H	W	D	H	W	H						
		29.5	29	30.5	21	19.5	18	20	11.5						
	RTA 00														
 <p>Lounge Chair w/Aluminum Legs COM Yardage: 4 Freight Class: 250 Product Weight (lbs.): 62 Cubic Feet Per Carton: 19.25</p>			1	2	3	4	5	6	7	8	9	10	11	12	
	5481-CP	2617	2760	2872	3038	3277	3387	3603	3947	4210	4504	5111	5756		
	5481-MP	2431	2572	2686	2852	3091	3201	3417	3761	4024	4318	4926	5570		
				OVERALL DIMENSIONS			SEAT DIMENSIONS			BACK DIMENSIONS					
		W	D	H	W	D	H	W	H						
	29.5	29	30.5	21	19.5	18	20	11.5							
	RTA 00														

DESCRIPTION	FEATURES	MODEL#	STANDARD TEXTILE GRADES											
			1	2	3	4	5	6	7	8	9	10	11	12
 <p>Two Seat Sofa w/ Aluminum Legs COM Yardage: 5.75 Freight Class: 250 Product Weight (lbs.): 86 Cubic Feet Per Carton: 36</p>	No Piping.	5482	3445	3647	3808	4049	4391	4549	4861	5352	5734	6157	7028	7956
			OVERALL DIMENSIONS			SEAT DIMENSIONS			BACK DIMENSIONS					
			W	D	H	W	D	H	W	H				
			51	29	30.5	42	19.5	18	41	11.5				
			RTA 00											
 <p>Two Seat Sofa w/ Aluminum Legs COM Yardage: 5.75 Freight Class: 250 Product Weight (lbs.): 86 Cubic Feet Per Carton: 36</p>	CP = Contrast Piping. MP = Matching Piping.	5482-CP	3691	3896	4054	3896	4054	4296	4638	4797	5108	5601	5980	8202
			5482-MP	3445	3647	3808	4049	4391	4549	4861	5352	5734	6157	7028
		OVERALL DIMENSIONS			SEAT DIMENSIONS			BACK DIMENSIONS						
		W	D	H	W	D	H	W	H					
51	29	30.5	42	19.5	18	41	11.5							
			RTA 00											
 <p>Three Seat Sofa w/ Aluminum Legs COM Yardage: 7.5 Freight Class: 250 Product Weight (lbs.): 112 Cubic Feet Per Carton: 50.25</p>	No Piping.	5483	4459	4723	4932	4723	5692	5901	6306	6949	7444	7997	9133	10342
			OVERALL DIMENSIONS			SEAT DIMENSIONS			BACK DIMENSIONS					
			W	D	H	W	D	H	W	H				
			71	29	30.5	63	19.5	18	62	11.5				
			RTA 00											
 <p>Three Seat Sofa w/Aluminum Legs COM Yardage: 7.5 Freight Class: 250 Product Weight (lbs.): 112 Cubic Feet Per Carton: 50.25</p>	CP = Contrast Piping. MP = Matching Piping.	5483-CP	4765	5029	5239	5553	5997	6207	6613	7254	7750	10648	9437	10648
			5483-MP	4459	4723	4932	5247	5692	5901	6306	6949	7444	7997	9133
		OVERALL DIMENSIONS			SEAT DIMENSIONS			BACK DIMENSIONS						
		W	D	H	W	D	H	W	H					
30.5	29	30.5	63	19.5	18	62	11.5							
			RTA 00											
 <p>Coffee Table - 22" x 48" Rectangular w/Aluminum Legs COM Yardage: N/A Freight Class: 92.5 Product Weight (lbs.): 46 Cubic Feet Per Carton: 4</p>		5484-LP	1983	-	-	-	-	-	-	-	-	-	-	
			5484-HP	2121	-	-	-	-	-	-	-	-	-	-
		5484-W	2528	-	-	-	-	-	-	-	-	-	-	
		LP = Laminate Top HP = High Pressure Laminate Top W = Wood Top												
OVERALL DIMENSIONS			SEAT DIMENSIONS			BACK DIMENSIONS								
W	D	H	W	D	H	W	H							
22	48	17.5	-	-	-	-	-							
			RTA 6											

DESCRIPTION	FEATURES	MODEL#	STANDARD TEXTILE GRADES												
			1	2	3	4	5	6	7	8	9	10	11	12	
 <p>End Table - 21" x 21" Square w/Aluminum Legs COM Yardage: N/A Freight Class: 85 Product Weight (lbs.): 26 Cubic Feet Per Carton: 2.1</p>															
	5485-LP	1502	-	-	-	-	-	-	-	-	-	-	-	-	
	5485-HP	1642	-	-	-	-	-	-	-	-	-	-	-	-	
	5485-W	1798	-	-	-	-	-	-	-	-	-	-	-	-	
	LP = Laminate Top HP = High Pressure Laminate Top W = Wood Top														
	OVERALL DIMENSIONS			SEAT DIMENSIONS			BACK DIMENSIONS								
	W D H			W D H			W H								
	21 21 17.5			-			-								
	RTA 6														
	 <p>End Table - 24" Round w/Aluminum Legs COM Yardage: N/A Freight Class: 85 Product Weight (lbs.): 27 Cubic Feet Per Carton: 2.1</p>														
5486-LP		1551	-	-	-	-	-	-	-	-	-	-	-	-	
5486-HP		1691	-	-	-	-	-	-	-	-	-	-	-	-	
5486-W		1945	-	-	-	-	-	-	-	-	-	-	-	-	
LP = Laminate Top HP = High Pressure Laminate Top W = Wood Top															
OVERALL DIMENSIONS			SEAT DIMENSIONS			BACK DIMENSIONS									
W D H			W D H			W H									
24 24 17.5			-			-									
RTA 6															
 <p>Coffee Table - 32" Round w/Aluminum Legs COM Yardage: N/A Freight Class: 100 Product Weight (lbs.): 41 Cubic Feet Per Carton: 4.4</p>															
	5487-LP	2289	-	-	-	-	-	-	-	-	-	-	-	-	
	5487-HP	2428	-	-	-	-	-	-	-	-	-	-	-	-	
	5487-W	2868	-	-	-	-	-	-	-	-	-	-	-	-	
	LP = Laminate Top HP = High Pressure Laminate Top W = Wood Top														
	OVERALL DIMENSIONS			SEAT DIMENSIONS			BACK DIMENSIONS								
	W D H			W D H			W H								
	32 32 17.5			-			-								
	RTA 6														

CITI™



model 7875LTM (BK)



model 7889



Citi Modular Group & Tables - Shown in Tungsten

STANDARD FEATURES

- Fully upholstered contemporary design, complements the timeless decor of many offices. Proportions are compact, 31" deep, and work well in public spaces.
- All models have fixed, non-removable cushions.
- Arm height on all models is 25".
- Casters are not available on this series.
- Citi seating and table legs are 5" high tubular metal. Seating also available with wood, tapered, softened square legs.
- Citi table tops are available in either tempered glass or laminate.
- Laminate tablet seating models (TL suffix) are available specified as seated. Specify right (RTL) or left (LTL). The tablet is 0.75" thick with thermally fused laminate and measure 12"D x 16.5"W.
- Ganging brackets (7892) are sold separately.
- Ganging brackets are to be used on armless seating if interconnection to another armless seating unit is required. Bench and ottomans only gang to other benches/ottomans, cannot gang with seating units. Brackets come with a template for installation.
- Upholstery options: fabric, vinyl or leather. Starting at grade 5 pricing. Leather models feature a stitch detail across the seat and/or back cushions, if applicable.
- Combination fabric and leather models (ending in LF) are available. These models have fabric (or vinyl) on the shell of the chair with leather seat and back cushions. Reverse specification is not available (leather on the shell with fabric).

OPTIONAL FEATURES

- **Seating Leg Finishes:**
(TBL) Black
(TTU) Tungsten
(CHM) Chrome. **Add \$101.**
Please Specify.
- **Table Leg Finishes:**
(TBL) Black
(TTU) Tungsten
(CHM) Chrome. **Add \$101**
Please Specify.
- Wood feet are available as an option (non-cylindrical) for Citi Seating only. Add \$288. Please inquire with Customer Care for available finishes.
- Citi tables and tablets are offered in the following laminate finishes: Absolute Acajou (ACJ), Asian Night (ASN), Avant Cherry (AWC), Avant Honey (AWH), Black (BLK), Brushed Cobalt (BRC), Clear Maple (CMB), Dark Espresso (DES), Designer White (DWT), Hayden Grey (HGT), Noce Biondo (NBL), Noce Grigio (NGL), Noce Leggero (NEL), Noce Medio (NML), Quartered Mahogany (QTM), Storm Grey (SOG), Tiger Fruitwood (TFW), Tiger Walnut (TWL), Walnut Heights (WHE), White Chocolate (WHC), Willow Grey (WGY), and Winter Cherry (WCR). Please specify.
- For highly resilient, high density Ultracell foam on seat, please specify (UC) after the model number. One seater add \$126. Two Seater add \$249. Three Seater add \$373.

SAMPLE LAYOUTS

Layout A

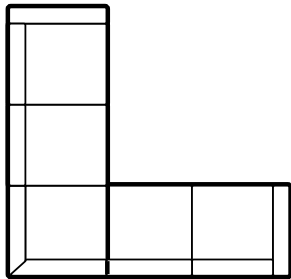

Qty	Model Number	Description	Dimensions	List Price
1	7890LNB	Two Seat Sofa w/Left Arm	48 x 31 x 30.75	1975
1	7862	Corner Seat	37 x 37 x 31	2144
1	7890RNB	Two Seat Sofa w/Right Arm	48 x 31 x 30.75	1975
2	7892	Ganging Bracket	0.5 x 3.87 x 2	29
SAMPLE LAYOUT TOTAL IN STANDARD FEET FINISH				\$6152

Layout B

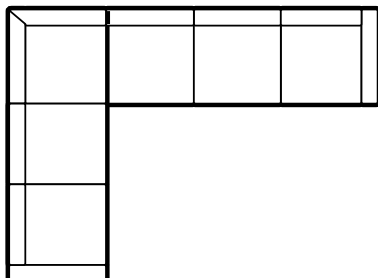

Qty	Model Number	Description	Dimensions	List Price
1	7890RNB	Two Seat Sofa w/Right Arm	48 x 31 x 30.75	1975
1	7862	Corner Seat	37 x 37 x 31	2144
1	7891LNB	Three Seat Sofa w/Left Arm	77 x 31 x 30.75	2638
2	7892	Ganging Bracket	0.5 x 3.87 x 2	29 x 2
SAMPLE LAYOUT TOTAL IN STANDARD FEET FINISH				\$6815



Ganging Bracket

COM Yardage: N/a
Freight Class: 70
Product Weight (lbs.): 0.25
Cubic Feet Per Carton: 0.01

Kit includes 2 brackets, 4 casters and a template.

	1	2	3	4	5	6	7	8	9	10	11	12
7892	29	-	-	-	-	-	-	-	-	-	-	-
OVERALL DIMENSIONS	W D H			SEAT DIMENSIONS			BACK DIMENSIONS					
	W	D	H	W	D	H	W	D	H			



DESCRIPTION	FEATURES	MODEL#	STANDARD TEXTILE GRADES											
			1	2	3	4	5	6	7	8	9	10	11	12
 <p>Corner Seat COM Yardage: 6.25 Freight Class: 250 Product Weight (lbs.): 65 Cubic Feet Per Carton: 30.25</p>		7862	-	-	-	-	2144	2300	2600	3137	3442	3939	4692	5587
		7862LF	-	-	-	-	2658	2816	3115	3652	3957	4455	5207	6101
			Fabric/vinyl shell + leather cushions											
			OVERALL DIMENSIONS			SEAT DIMENSIONS			BACK DIMENSIONS					
			W	D	H	W	D	H	W	H				
			37	37	30.75	26	26	17.5	26	13.5				
			RTA 00											

DESCRIPTION	FEATURES	MODEL#	STANDARD TEXTILE GRADES											
			1	2	3	4	5	6	7	8	9	10	11	12
 <p>Large Lounge Chair - for 6'+ Tall Users COM Yardage: 5.50 Freight Class: 250 Product Weight (lbs.): 70 Cubic Feet Per Carton: 24.25</p>		7864	-	-	-	-	1901	-	-	2775	3046	3482	4143	4932
			Fabric/vinyl shell + leather cushions											
				OVERALL DIMENSIONS			SEAT DIMENSIONS			BACK DIMENSIONS				
			W	D	H	W	D	H	W	H				
			34	33	30	23	20	19	23	13.5				
			RTA 00											

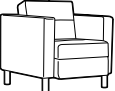
DESCRIPTION	FEATURES	MODEL#	STANDARD TEXTILE GRADES											
			1	2	3	4	5	6	7	8	9	10	11	12
 <p>Lounge Chair COM Yardage: 4.5 Freight Class: 250 Product Weight (lbs.): 67 Cubic Feet Per Carton: 21</p>		7875	-	-	-	-	1404	1522	1744	2144	2370	2737	3294	3959
		7875LF	-	-	-	-	1783	1901	2128	2534	2765	3140	3708	4385
			Fabric/vinyl shell + leather cushions											
			OVERALL DIMENSIONS			SEAT DIMENSIONS			BACK DIMENSIONS					
			W	D	H	W	D	H	W	H				
			30	31	30	21	19.5	17.5	21	12.5				
			RTA 00											

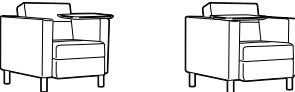
DESCRIPTION	FEATURES	MODEL#	STANDARD TEXTILE GRADES											
			1	2	3	4	5	6	7	8	9	10	11	12
 <p>Lounge Chair w/Laminate Tablet COM Yardage: 4.5 Freight Class: 250 Product Weight (lbs.): 75 Cubic Feet Per Carton: 22.5</p>		7875LTL	-	-	-	-	2106	2225	2452	2858	3090	3465	4035	4710
		7875RTL	-	-	-	-	2327	2447	2671	3078	3312	3685	4252	4931
			Fabric/vinyl shell + leather cushions											
			OVERALL DIMENSIONS			SEAT DIMENSIONS			BACK DIMENSIONS					
			W	D	H	W	D	H	W	H				
			31.5	33.5	33.5	21	19.5	17.5	21	12.5				
			RTA 00											

DESCRIPTION	FEATURES	MODEL#	STANDARD TEXTILE GRADES											
			1	2	3	4	5	6	7	8	9	10	11	12
 <p>Lounge Chair- Armless COM Yardage: 3 Freight Class: 250 Product Weight (lbs.): 45 Cubic Feet Per Carton: 15.5</p>		7895	-	-	-	-	1406	1482	1626	1883	2030	2269	2629	3059
		7895LF	-	-	-	-	1783	1860	2002	2260	2407	2646	3006	3436
			Fabric/vinyl shell + leather cushions											
			OVERALL DIMENSIONS			SEAT DIMENSIONS			BACK DIMENSIONS					
			W	D	H	W	D	H	W	H				
			22	31	30.75	21	19.5	17.5	21	14				
			RTA 00											

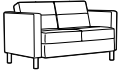
DESCRIPTION	FEATURES	MODEL#	STANDARD TEXTILE GRADES												
			1	2	3	4	5	6	7	8	9	10	11	12	
		7876	-	-	-	-	1894	2059	2364	2916	3234	3744	4519	5441	
			7876LF	-	-	-	-	2639	2805	3118	3684	4005	4526	5314	6254
			Fabric/vinyl shell + leather cushions												
			OVERALL DIMENSIONS			SEAT DIMENSIONS			BACK DIMENSIONS						
			W	D	H	W	D	H	W	H					
			51.25	31	30	42.5	19.5	17.5	42.5	12.5					
RTA 00															

Two Seat Sofa
 COM Yardage: 6.25
 Freight Class: 250
 Product Weight (lbs.): 125
 Cubic Feet Per Carton: 36

DESCRIPTION	FEATURES	MODEL#	STANDARD TEXTILE GRADES												
			1	2	3	4	5	6	7	8	9	10	11	12	
		7896	-	-	-	-	1750	1877	2116	2547	2790	3188	3787	4505	
			7896LF	-	-	-	-	2476	2602	2842	3271	3515	3913	4513	5230
			Fabric/vinyl shell + leather cushions												
			OVERALL DIMENSIONS			SEAT DIMENSIONS			BACK DIMENSIONS						
			W	D	H	W	D	H	W	H					
			43.25	31	30.75	42.5	19.5	17.5	42.5	12.5					
RTA 00															

Two Seat Sofa - Armless
 COM Yardage: 5
 Freight Class: 250
 Product Weight (lbs.): 93
 Cubic Feet Per Carton: 36

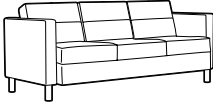
DESCRIPTION	FEATURES	MODEL#	STANDARD TEXTILE GRADES												
			1	2	3	4	5	6	7	8	9	10	11	12	
		7877	-	-	-	-	2384	2609	3039	3817	4260	4975	6057	7350	
			7877LF	-	-	-	-	3562	3791	4231	5022	5472	6201	7303	8624
			Fabric/vinyl shell + leather cushions												
			OVERALL DIMENSIONS			SEAT DIMENSIONS			BACK DIMENSIONS						
			W	D	H	W	D	H	W	H					
			72.5	31	30	63.5	19.5	17.5	63.5	12.5					
RTA 00															



Three Seat Sofa
 COM Yardage: 8.75
 Freight Class: 250
 Product Weight (lbs.): 163
 Cubic Feet Per Carton: 50.25

DESCRIPTION	FEATURES	MODEL#	STANDARD TEXTILE GRADES												
			1	2	3	4	5	6	7	8	9	10	11	12	
		7897	-	-	-	-	2303	2486	2835	3455	3811	4387	5258	6298	
			7897LF	-	-	-	-	3468	3650	3996	4619	4976	5550	6423	7463
			Fabric/vinyl shell + leather cushions												
			OVERALL DIMENSIONS			SEAT DIMENSIONS			BACK DIMENSIONS						
			W	D	H	W	D	H	W	H					
			64.5	31	30.75	63.5	19.5	17.5	63.5	12.5					
RTA 00															

Three Seat Sofa - Armless
 COM Yardage: 7.25
 Freight Class: 250
 Product Weight (lbs.): 131
 Cubic Feet Per Carton: 50.25

DESCRIPTION	FEATURES	MODEL#	STANDARD TEXTILE GRADES												
			1	2	3	4	5	6	7	8	9	10	11	12	
		7879	-	-	-	-	543	584	658	794	870	999	1186	1412	
			7879LF	-	-	-	-	685	726	802	936	1012	1138	1327	1555
			Fabric/vinyl shell + leather cushions												
			OVERALL DIMENSIONS			SEAT DIMENSIONS			BACK DIMENSIONS						
			W	D	H	W	D	H	W	H					
			22	22	17	-	-	17	-	-					
RTA 00															

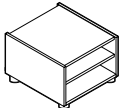
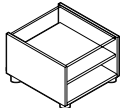
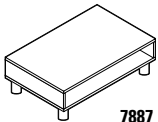
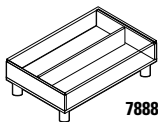
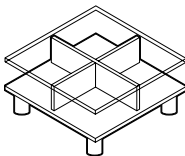
Ottoman
 COM Yardage: 1.5
 Freight Class: 250
 Product Weight (lbs.): 27
 Cubic Feet Per Carton: 7.5
 Freight Class: 250
 Product Weight (lbs.): 27

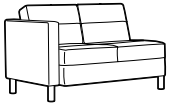
DESCRIPTION	FEATURES	MODEL#	STANDARD TEXTILE GRADES											
			1	2	3	4	5	6	7	8	9	10	11	12
 7885	 7886	7885	765	-	-	-	-	-	-	-	-	-	-	
		Laminate												
End Table COM Yardage: N/A Freight Class: 100 Product Weight (lbs.): 53 Cubic Feet Per Carton: 6			OVERALL DIMENSIONS			SEAT DIMENSIONS			BACK DIMENSIONS					
			W	D	H	W	D	H	W	H				
			20	24	20	-	-	-	-	-				
			RTA 1											
 7887	 7888	7887	799	-	-	-	-	-	-	-	-	-		
		Laminate												
Coffee Table Rectangular COM Yardage: N/A Freight Class: 100 Product Weight (lbs.): 60 Cubic Feet Per Carton: 6.5			OVERALL DIMENSIONS			SEAT DIMENSIONS			BACK DIMENSIONS					
			W	D	H	W	D	H	W	H				
			40	20	15	-	-	-	-	-				
			RTA 1											
		7889	1509	-	-	-	-	-	-	-	-	-		
			Glass Top											
Coffee Table Square COM Yardage: N/A Freight Class: 92.5 Product Weight (lbs.): 90 Cubic Feet Per Carton: 8.75			OVERALL DIMENSIONS			SEAT DIMENSIONS			BACK DIMENSIONS					
			W	D	H	W	D	H	W	H				
			33	33	15	-	-	-	-	-				
			RTA 1											
 7890LNB	 7890RNB	7890LNB	-	-	-	-	1975	2112	2376	2849	3120	3557	4221	5011
		7890RNB												
Two Seat Sofa - No Connector COM Yardage: 5.25 Freight Class: 250 Product Weight (lbs.): 107 Cubic Feet Per Carton: 36			OVERALL DIMENSIONS			SEAT DIMENSIONS			BACK DIMENSIONS					
			W	D	H	W	D	H	W	H				
			0	0	0	42.5	19.5	17.5	42.5	13.25				
			RTA 00											

**Intended to be free standing.
No connecting hardware.

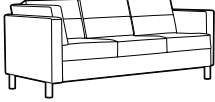
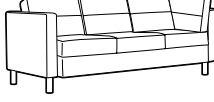
DESCRIPTION	FEATURES	MODEL#	STANDARD TEXTILE GRADES											
			1	2	3	4	5	6	7	8	9	10	11	12
	<p>7891LNB</p> <p>7891RNB</p>	<p>Three Seat Sofa - No Connector COM Yardage: 7.25 Freight Class: 250 Product Weight (lbs.): 138 Cubic Feet Per Carton: 50.25</p>	**Intended to be free standing. No connecting hardware.											
			<p>7891LNB</p> <p>7891RNB</p>	<p>7891RNB</p> <p>7891LNB</p>	<p>7891LNB</p> <p>7891RNB</p>	<p>7891LNB</p> <p>7891RNB</p>	<p>7891LNB</p> <p>7891RNB</p>	<p>7891LNB</p> <p>7891RNB</p>	<p>7891LNB</p> <p>7891RNB</p>	<p>7891LNB</p> <p>7891RNB</p>	<p>7891LNB</p> <p>7891RNB</p>	<p>7891LNB</p> <p>7891RNB</p>	<p>7891LNB</p> <p>7891RNB</p>	<p>7891LNB</p> <p>7891RNB</p>
			OVERALL DIMENSIONS			SEAT DIMENSIONS			BACK DIMENSIONS					
			W	D	H	W	D	H	W	H				
			0	0	0	63.5	19.5	17.5	63.5	13.25				
			RTA 00											
 	<p>7891L-RCNB</p> <p>7891R-RCNB</p>	<p>Three Seat Sofa - No Connector COM Yardage: 8.5 Freight Class: 250 Product Weight (lbs.): 154 Cubic Feet Per Carton: 55.5</p>	**Intended to be free standing. No connecting hardware.											
			<p>7891L-RCNB</p> <p>7891R-RCNB</p>	<p>7891R-RCNB</p> <p>7891L-RCNB</p>	<p>7891L-RCNB</p> <p>7891R-RCNB</p>	<p>7891L-RCNB</p> <p>7891R-RCNB</p>	<p>7891L-RCNB</p> <p>7891R-RCNB</p>	<p>7891L-RCNB</p> <p>7891R-RCNB</p>	<p>7891L-RCNB</p> <p>7891R-RCNB</p>	<p>7891L-RCNB</p> <p>7891R-RCNB</p>	<p>7891L-RCNB</p> <p>7891R-RCNB</p>	<p>7891L-RCNB</p> <p>7891R-RCNB</p>	<p>7891L-RCNB</p> <p>7891R-RCNB</p>	<p>7891L-RCNB</p> <p>7891R-RCNB</p>
			OVERALL DIMENSIONS			SEAT DIMENSIONS			BACK DIMENSIONS					
			W	D	H	W	D	H	W	H				
			0	0	0	60	19.5	17.5	60	13.25				
			RTA 00											
	<p>7893</p> <p>7893LF</p>	<p>Two Seat Bench COM Yardage: 2.25 Freight Class: 250 Product Weight (lbs.): 42 Cubic Feet Per Carton: 11.5</p>	**Intended to be free standing. No connecting hardware.											
			<p>7893</p> <p>7893LF</p>	<p>7893</p> <p>7893LF</p>	<p>7893</p> <p>7893LF</p>	<p>7893</p> <p>7893LF</p>	<p>7893</p> <p>7893LF</p>	<p>7893</p> <p>7893LF</p>	<p>7893</p> <p>7893LF</p>	<p>7893</p> <p>7893LF</p>	<p>7893</p> <p>7893LF</p>	<p>7893</p> <p>7893LF</p>	<p>7893</p> <p>7893LF</p>	<p>7893</p> <p>7893LF</p>
			OVERALL DIMENSIONS			SEAT DIMENSIONS			BACK DIMENSIONS					
			W	D	H	W	D	H	W	H				
			43	21.5	17	-	-	17	-	-				
			RTA 00											
	<p>7894</p> <p>7894LF</p>	<p>Three Seat Bench COM Yardage: 3.75 Freight Class: 250 Product Weight (lbs.): 62 Cubic Feet Per Carton: 16.75</p>	**Intended to be free standing. No connecting hardware.											
			<p>7894</p> <p>7894LF</p>	<p>7894</p> <p>7894LF</p>	<p>7894</p> <p>7894LF</p>	<p>7894</p> <p>7894LF</p>	<p>7894</p> <p>7894LF</p>	<p>7894</p> <p>7894LF</p>	<p>7894</p> <p>7894LF</p>	<p>7894</p> <p>7894LF</p>	<p>7894</p> <p>7894LF</p>	<p>7894</p> <p>7894LF</p>	<p>7894</p> <p>7894LF</p>	
			OVERALL DIMENSIONS			SEAT DIMENSIONS			BACK DIMENSIONS					
			W	D	H	W	D	H	W	H				
			64.5	21.5	17	-	-	17	-	-				
			RTA 00											

CITI™ SQUARE



model S7875LFLT



Sample Layout A - Models shown: S7875FUC and S7911



Sample Layout B - Models shown: S7890RFUC, S7862FUC (2), S7897FUC, S7890LFUC and S7912

STANDARD FEATURES

- Fully upholstered lounge series with a complete range of sectional components for all applications. Proportions are compact, 31" and 33.5" deep so it works well in public spaces.
- All models have fixed, non-removable cushions.
- Upholstery options: fabric, vinyl and leather. Leather models may feature a horizontal stitch detail across the seat and/or back cushions if applicable.
- The 5 inch high leg frame for seating and occasional tables lightens the look, it is available in Tungsten (S1) as standard or optionally available in Black (S2) Please specify finish, no upcharge added.
- Casters are not available on this series.
- Arm height on all models is 25"
- Tablet arms are made from thermally fused laminate, measure 12"D x 16.5"W 3/4" thick. Available right hand seated (RT), left Hand seated (LT) or both right and left hand (LRT).
- Ganging Brackets are sold separately. Ganging brackets are to be used on armless seating if interconnection to another armless seating unit is required. Bench and ottomans only gang to other benches/ottomans, cannot gang with seating units.
- Brackets come with a template for installation: unless noted otherwise all armless skus are equipped with the steel on steel connectors to receive this bracket.
- Upholstery options: fabric, vinyl and leather. Leather models feature a horizontal stitch detail across the seat and/or back cushions if applicable.
- Check textile availability prior to specifying upholstery material.
- Combination fabric and leather models (ending in LF) are available. These models have fabric (or vinyl) on the shell of the chair with leather seat and back cushions. Reverse specification is not available (leather on the shell with fabric).
- Measurement shown for weight is for one unit. Measurement for volume is per carton.

- (TFR) Frost
- (TIV) Cloud
- (TLA) Latte
- (TOA) Toast
- (TSH) Shadow
- (TSR) Scarlet
- (CHM) Chrome. Add \$189
- (TIN) Ink
- (TKA) Kalua
- (TMO) Mocha
- (TNE) Nevada
- (TSN) Sand
- (TTU) Tungsten

- (ACO) Antique Copper. Add \$424 for corner units. Add \$316 for single seat units. Add \$516 for two seat units. Add \$516 for three seat units. Add \$619 for four seat units.
- (BCH) Brushed Chrome. Add \$277 for corner units. Add \$199 for single seat units. Add \$248 for two seat units. Add \$304 for three seat units. Add \$360 for four seat units.
- (SBR) Satin Brass. Add \$424 for corner units. Add \$316 for single seat units. Add \$516 for two seat units. Add \$516 for three seat units. Add \$619 for four seat units.
- To order units in combination of Global carded leathers on seat and back cushions and fabric on balance of chair see models where "LF" shows after first 4 digits.
- Laminate Tables and Tablet arms are made with high pressure laminate and are offered in the following finishes: Absolute Acajou (ACJ), Asian Night (ASN), Avant Cherry (AWC), Avant Honey (AWH), Black (BLK), Brushed Cobalt (BRC), Clear Maple (CMB), Dark Espresso (DES), Designer White (DWT), Hayden Grey (HGT), Noce Biondo (NBL), Noce Grigio (NGL), Noce Leggero (NEL), Noce Medio (NML), Quartered Mahogany (QTM), Tiger Fruitwood (TFW), Tiger Walnut (TWL), Walnut Heights (WHE), White Chocolate (WHC), Willow Grey (WGY) and Winter Cherry (WCR). Please Specify. Custom high pressure laminate finishes will be considered upon request.
- For high resilient, high density Ultracell foam on seat, specify (UC) after the model number. One Seater, add \$126. Two Seater, add \$249. Three Seater, add \$373, and Four Seater, add \$496
- Power/USB modules are available in the Citi Square tables. Each module includes a double power outlet and two USB terminals. It is equipped with a 6' long three-prong power cord with standard three prong plug. The Power monuments are available in Jet Black (J1) or White (W1). Add \$875 per unit. Please see Electrical Placement below for predetermined locations.

OPTIONAL FEATURES

- Seating and Table Leg Finishes**
Metal legs are available in the following finishes:
(TBL) Black (TBZ) Buzz Blue
(TCC) Cactus (TCR) Carrot
(TDJ) Dijon (TDW) Designer White
(TEG) Eggplant (TFO) Fog

ELECTRICAL PLACEMENT

Coffee/End Tables: Predetermined Location is on the end/side of the unit J1 (black) or W1 (white).

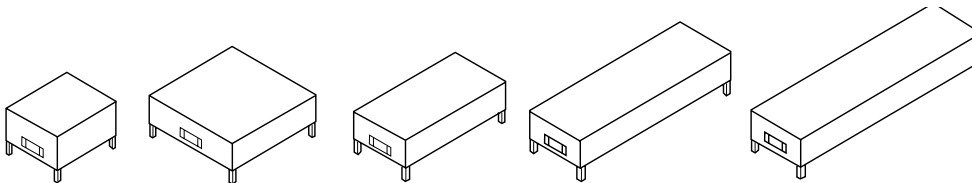

	1	2	3	4	5	6	7	8	9	10	11	12
7892	29	-	-	-	-	-	-	-	-	-	-	-





Ganging Bracket
COM Yardage: N/A
Freight Class: 70
Product Weight (lbs.): 00.25
Cubic Feet Per Carton: 00.01

Two brackets included.
Only one set is needed per connection.

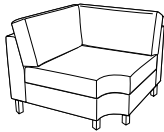
OVERALL DIMENSIONS			SEAT DIMENSIONS			BACK DIMENSIONS	
W	D	H	W	D	H	W	H
0.5	3.87	2	-	-	-	-	-

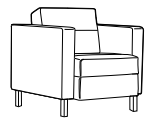

DESCRIPTION	FEATURES	MODEL#	STANDARD TEXTILE GRADES											
			1	2	3	4	5	6	7	8	9	10	11	12
 <p>Linking Corner Unit COM Yardage: 6.25 Freight Class: 250 Product Weight (lbs.): 75 Cubic Feet Per Carton: 30.25</p>	No ganging hardware Armless side(s) can be equipped with ganging brackets, model 7892.	S7862	-	-	-	-	2396	2576	2911	3448	3859	4319	5267	6275
		S7862LF	-	-	-	-	2935	3109	3449	3985	4398	4858	5804	6813
		Fabric/vinyl shell + leather cushions												
			OVERALL DIMENSIONS			SEAT DIMENSIONS			BACK DIMENSIONS					
			W	D	H	W	D	H	W	H				
			37	37	31	26	26	17.5	26	13.5				
RTA 00														



DESCRIPTION	FEATURES	MODEL#	STANDARD TEXTILE GRADES											
			1	2	3	4	5	6	7	8	9	10	11	12
 <p>Single Seat w/Arms COM Yardage: 4.5 Freight Class: 250 Product Weight (lbs.): 81 Cubic Feet Per Carton: 21</p>	Free standing unit only.	S7875	-	-	-	-	1693	1822	2063	2448	2747	3078	3760	4487
		S7875LF	-	-	-	-	1936	2065	2307	2694	2990	3323	4003	4730
		Fabric/vinyl shell + leather cushions												
			OVERALL DIMENSIONS			SEAT DIMENSIONS			BACK DIMENSIONS					
			W	D	H	W	D	H	W	H				
			30	31	30	21	19.5	17.5	21	12.5				
RTA 00														

DESCRIPTION	FEATURES	MODEL#	STANDARD TEXTILE GRADES											
			1	2	3	4	5	6	7	8	9	10	11	12
 <p>S7875RT</p>	Free standing unit only. Tablets are Right Hand Seated (RT) or Left Hand Seated (LT).	S7875RT	-	-	-	-	2266	2392	2636	3021	3319	3651	4332	5057
		S7875LT	-	-	-	-	2266	2392	2636	3021	3319	3651	4332	5057
		S7875LFR	-	-	-	-	2509	2638	2879	3264	3563	3896	4576	5303
S7875LFLT	-	-	-	-	2509	2638	2879	3264	3563	3896	4576	5303		
Fabric/vinyl shell + leather cushions														
			OVERALL DIMENSIONS			SEAT DIMENSIONS			BACK DIMENSIONS					
			W	D	H	W	D	H	W	H				
			31.5	33.5	30	21	19.5	17.5	21	12.5				
RTA 00														

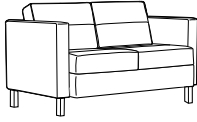
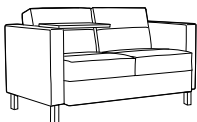
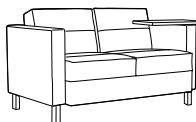
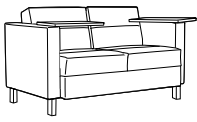
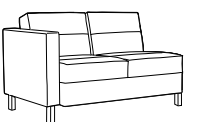
DESCRIPTION	FEATURES	MODEL#	STANDARD TEXTILE GRADES											
			1	2	3	4	5	6	7	8	9	10	11	12
 <p>S7901R</p>	No ganging hardware. Armless side can be equipped with ganging brackets, model 7892. Arms are Right Hand Seated (RT) or Left Hand Seated (LT).	S7901R	-	-	-	-	1693	1792	1983	2282	2513	2770	3300	3865
		S7901L	-	-	-	-	1693	1792	1983	2282	2513	2770	3300	3865
		S7901LFR	-	-	-	-	1936	2051	2267	2611	2874	3168	3773	4420
S7901LFL	-	-	-	-	1936	2051	2267	2611	2874	3168	3773	4420		
Fabric/vinyl shell + leather cushions														
			OVERALL DIMENSIONS			SEAT DIMENSIONS			BACK DIMENSIONS					
			W	D	H	W	D	H	W	H				
			26	31	30.75	21	19.5	17.5	21	12.5				
RTA 00														

DESCRIPTION	FEATURES	MODEL#	STANDARD TEXTILE GRADES											
			1	2	3	4	5	6	7	8	9	10	11	12
 <p>S7901RRT</p>	No ganging hardware. Armless side(s) can be equipped with ganging brackets, model 7892. Tablets are Arms are Right Hand Seated (RT) or Left Hand Seated (LT).	S7901RRT	-	-	-	-	2266	2554	1783	2855	3086	3342	3873	4438
		S7901LLT	-	-	-	-	2266	2365	2554	2855	3086	3342	3873	4438
		S7901LFRRT	-	-	-	-	2509	2624	2839	3180	3447	3740	4345	4991
S7901LFLRT	-	-	-	-	2509	2624	2839	3180	3447	3740	4345	4991		
Fabric/vinyl shell + leather cushions														
			OVERALL DIMENSIONS			SEAT DIMENSIONS			BACK DIMENSIONS					
			W	D	H	W	D	H	W	H				
			27.5	31	30.75	21	19.5	17.5	21	12.5				
RTA 00														

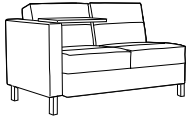
DESCRIPTION	FEATURES	MODEL#	STANDARD TEXTILE GRADES											
			1	2	3	4	5	6	7	8	9	10	11	12
 <p>Armless Single Seat COM Yardage: 3 Freight Class: 2250 Product Weight (lbs.): 45 Cubic Feet Per Carton: 15.5</p>	<p>No ganging hardware. Armless side(s) can be equipped with ganging brackets, model 7892.</p>													
		S7895	-	-	-	-	1693	1780	1940	2199	2396	2617	3071	3554
		S7895LF	-	-	-	-	1936	2022	2183	2442	2640	2862	3313	3797
		Fabric/vinyl shell + leather cushions												
		OVERALL DIMENSIONS			SEAT DIMENSIONS			BACK DIMENSIONS						
	W	D	H	W	D	H	W	H						
	22	31	30.75	21	18.5	17.5	21	12.5						
RTA 00														
 <p>Two Seater w/Arms COM Yardage: 6.25 Freight Class: 250 Product Weight (lbs.): 122 Cubic Feet Per Carton: 36</p>	<p>Free standing unit only.</p>													
		S7876	-	-	-	-	2396	2576	2911	3448	3859	4319	5267	6275
		S7876LF	-	-	-	-	2935	3109	3449	3985	4398	4858	5804	6813
		Fabric/vinyl shell + leather cushions												
		OVERALL DIMENSIONS			SEAT DIMENSIONS			BACK DIMENSIONS						
	W	D	H	W	D	H	W	H						
	51.25	31	30	42.5	19.5	17.5	42.5	12.5						
RTA 00														
 <p>S7876RT</p> <p>Two Seater w/Arms & Laminate Tablet COM Yardage: 6.25 Freight Class: 250 Product Weight (lbs.): 130 Cubic Feet Per Carton: 41.25</p>	 <p>S7876LT</p> <p>Free standing unit only. Tablets are Right Hand Seated (RT) or Left Hand Seated (LT).</p>													
		S7876RT	-	-	-	-	2970	3145	3485	4019	4433	4893	5841	6849
		S7876LT	-	-	-	-	2970	3145	3485	4019	4433	4893	5841	6849
		S7876LFRT	-	-	-	-	3509	3684	4023	4559	4972	5432	6377	7387
		S7876LFLT	-	-	-	-	3509	3684	4023	4559	4972	5432	6377	7387
Fabric/vinyl shell + leather cushions														
OVERALL DIMENSIONS			SEAT DIMENSIONS			BACK DIMENSIONS								
	W	D	H	W	D	H	W	H						
	52.75	33.5	30	42.5	19.5	17.5	42.5	12.5						
RTA 00														
 <p>Two Seater w/Arms & Laminate Tablets COM Yardage: 6.25 Freight Class: 250 Product Weight (lbs.): 138 Cubic Feet Per Carton: 41.25</p>	<p>Free standing unit only. With both Left and Right Tablets.</p>													
		S7876LRT	-	-	-	-	3545	3720	4060	4594	5008	5467	6414	7424
		S7876LFRT	-	-	-	-	4083	4257	4597	5131	5546	6005	6951	7960
		Fabric/vinyl shell + leather cushions												
		OVERALL DIMENSIONS			SEAT DIMENSIONS			BACK DIMENSIONS						
	W	D	H	W	D	H	W	H						
	54.25	33.5	30	42.5	19.5	17.5	42.5	12.5						
RTA 00														
 <p>S7890R</p> <p>Two Seater w/One Arm COM Yardage: 5.25 Freight Class: 250 Product Weight (lbs.): 106 Cubic Feet Per Carton: 36</p>	 <p>S7890L</p> <p>No ganging hardware. Armless side can be equipped with ganging brackets, model 7892. Arms are Right Hand Seated (RT) or Left Hand Seated (LT).</p>													
		S7890R	-	-	-	-	2225	2373	2657	3106	3454	3842	4634	5484
		S7890L	-	-	-	-	2225	2373	2657	3106	3454	3842	4634	5484
		S7890LFR	-	-	-	-	2763	2910	3192	3643	3991	4378	5172	6020
		S7890LFL	-	-	-	-	2763	2910	3192	3643	3991	4378	5172	6020
Fabric/vinyl shell + leather cushions														
OVERALL DIMENSIONS			SEAT DIMENSIONS			BACK DIMENSIONS								
	W	D	H	W	D	H	W	H						
	47.25	31	30.75	42.5	19.5	17.5	42.5	13.25						
RTA 00														

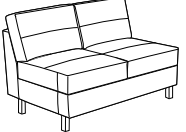
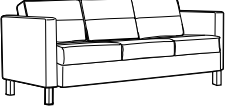
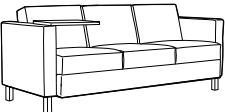
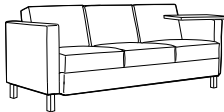
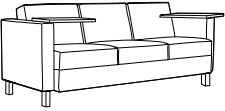
DESCRIPTION	FEATURES	MODEL#	STANDARD TEXTILE GRADES														
			1	2	3	4	5	6	7	8	9	10	11	12			
		S7890RRT S7890LLT S7890LFRRT S7890LFLLT Fabric/vinyl shell + leather cushions	-	-	-	-	2798	2948	3230	3681	4028	4415	5208	6056			
			-	-	-	-	2798	2948	3230	3681	4028	4415	5208	6056			
			-	-	-	-	3336	3484	3767	4217	4565	4952	5746	6594			
			-	-	-	-	3336	3484	3767	4217	4565	4952	5746	6594			
Two Seater w/One Arm and Laminate Tablet COM Yardage: 5.25 Freight Class: 250 Product Weight (lbs.): 114 Cubic Feet Per Carton: 41.25			No ganging hardware. Armless side(s) can be equipped with ganging brackets, model 7892. Tablets are Arms are Right Hand Seated (RT) or Left Hand Seated (LT).			RTA 00											
			OVERALL DIMENSIONS W D H			SEAT DIMENSIONS W D H			BACK DIMENSIONS W H								
			48.75	33.5	30.75	42.5	19.5	17.5	42.5	13.25							
		S7896 S7896LF Fabric/vinyl shell + leather cushions	-	-	-	-	2225	2366	2636	3066	3397	3764	4521	5328			
			-	-	-	-	2763	2904	3174	3602	3935	4300	5059	5864			
Armless Two Seater COM Yardage: 5 Freight Class: 250 Product Weight (lbs.): 43.25 Cubic Feet Per Carton: 36			No ganging hardware. Armless side(s) can be equipped with ganging brackets, model 7892.			RTA 00											
			OVERALL DIMENSIONS W D H			SEAT DIMENSIONS W D H			BACK DIMENSIONS W H								
			43.25	31	30.75	42.5	19.5	17.5	42.5	13.25							
		S7877 S7877LF Fabric/vinyl shell + leather cushions	-	-	-	-	3102	3349	3820	4572	5149	5792	7117	8531			
			-	-	-	-	3940	4184	4657	5410	5987	6630	7954	9367			
Three Seater w/Arms COM Yardage: 8.75 Freight Class: 250 Product Weight (lbs.): 163 Cubic Feet Per Carton: 50.25			Free standing unit only.			RTA 00											
			OVERALL DIMENSIONS W D H			SEAT DIMENSIONS W D H			BACK DIMENSIONS W H								
			72.5	31	30	63.5	19.5	17.5	63.5	12.5							
		S7877RT S7877LT S7877LFRRT S7877LFLRT Fabric/vinyl shell + leather cushions	-	-	-	-	3675	3919	4392	5145	5722	6365	7690	9102			
			-	-	-	-	3675	3919	4392	5145	5722	6365	7690	9102			
Three Seater w/Arms and Laminate Tablet COM Yardage: 8.75 Freight Class: 250 Product Weight (lbs.): 171 Cubic Feet Per Carton: 55.5			Free standing unit only. Tablets are Right Hand Seated (RT) or Left Hand Seated (LT).			RTA 00											
			OVERALL DIMENSIONS W D H			SEAT DIMENSIONS W D H			BACK DIMENSIONS W H								
			74	33.5	30	63.5	19.5	17.5	63.5	12.5							
		S7877LRT S7876LFLRT Fabric/vinyl shell + leather cushions	-	-	-	-	4248	4493	4966	5718	6296	6939	8263	9677			
			-	-	-	-	4083	4257	4597	5131	5546	6005	6951	7960			
Three Seater w/Arms and Laminate Tablets COM Yardage: 8.75 Freight Class: 250 Product Weight (lbs.): 250 Cubic Feet Per Carton: 55.5			Free standing unit only. With both Left and Right Tablets.			RTA 00											
			OVERALL DIMENSIONS W D H			SEAT DIMENSIONS W D H			BACK DIMENSIONS W H								
			75.5	33.5	30	63.5	19.5	17.5	63.5	12.5							

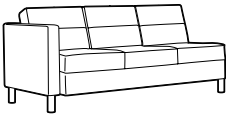
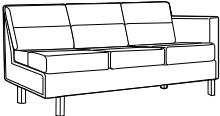
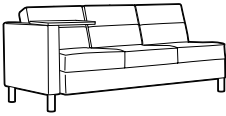
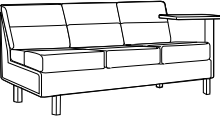
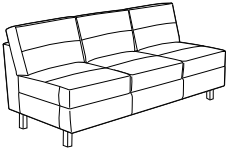
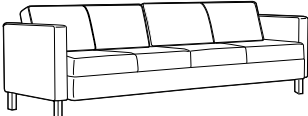
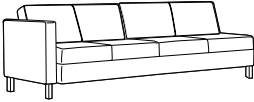
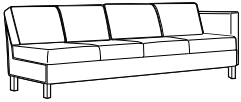
DESCRIPTION	FEATURES	MODEL#	STANDARD TEXTILE GRADES											
			1	2	3	4	5	6	7	8	9	10	11	12
 <p>S7891R</p> <p>Three Seater w/One Arm COM Yardage: 7.25 Freight Class: 250 Product Weight (lbs.): 147 Cubic Feet Per Carton: 50.25</p>	 <p>S7891L</p> <p>No ganging hardware. Armless side can be equipped with ganging brackets, model 7892. Arms are Right Hand Seated (RT) or Left Hand Seated (LT).</p>	<p>S7891R - - - - 3004 3210 3600 4222 4702 5233 6332 7502 S7891L - - - - 3004 3210 3600 4222 4702 5233 6332 7502 S7891LFR - - - - 3840 4046 4435 5058 5538 6070 7168 8339 S7891LFL - - - - 3840 4046 4435 5058 5538 6070 7168 8339</p> <p>Fabric/vinyl shell + leather cushions</p>	<p>OVERALL DIMENSIONS</p> <p>W D H</p>			<p>SEAT DIMENSIONS</p> <p>W D H</p>			<p>BACK DIMENSIONS</p> <p>W H</p>					
			68.5	31	30.75	63.5	19.5	17.5	63.5	13.25	<p>RTA 00</p>			
 <p>S7891RRT</p> <p>Three Seater w/One Arm and Laminate Tablet COM Yardage: 7.25 Freight Class: 250 Product Weight (lbs.): 155 Cubic Feet Per Carton: 55.5</p>	 <p>S7891LLT</p> <p>No ganging hardware. Armless side(s) can be equipped with ganging brackets, model 7892. Tablets are Arms are Right Hand Seated (RT) or Left Hand Seated (LT).</p>	<p>S7891RRT - - - - 3577 3779 4171 4795 5275 5806 6905 8075 S7891LLT - - - - 3577 3779 4171 4795 5275 5806 6905 8075 S7891LFRRT - - - - 4415 4620 5011 5633 6113 6645 7743 8913 S7891LFLT - - - - 4415 4620 5011 5633 6113 6645 7743 8913</p> <p>Fabric/vinyl shell + leather cushions</p>	<p>OVERALL DIMENSIONS</p> <p>W D H</p>			<p>SEAT DIMENSIONS</p> <p>W D H</p>			<p>BACK DIMENSIONS</p> <p>W H</p>					
			70	33.5	30.75	63.5	19.5	17.5	63.5	13.25	<p>RTA 00</p>			
 <p>S7897</p> <p>Armless Three Seater COM Yardage: 7.25 Freight Class: 250 Product Weight (lbs.): 131 Cubic Feet Per Carton: 50.25</p>	<p>No ganging hardware. Armless side(s) can be equipped with ganging brackets, model 7892.</p>	<p>S7897 - - - - 3004 3210 3600 4222 4702 5233 6332 7502 S7897LF - - - - 3840 4046 4435 5058 5538 6070 7168 8339</p> <p>Fabric/vinyl shell + leather cushions</p>	<p>OVERALL DIMENSIONS</p> <p>W D H</p>			<p>SEAT DIMENSIONS</p> <p>W D H</p>			<p>BACK DIMENSIONS</p> <p>W H</p>					
			64.5	31	30.75	63.5	19.5	17.5	63.5	13.25	<p>RTA 00</p>			
 <p>S7884</p> <p>Four Seater w/Arms COM Yardage: 10.25 Freight Class: 250 Product Weight (lbs.): 204 Cubic Feet Per Carton: 69</p>	<p>Free standing unit only.</p>	<p>S7884 - - - - 4563 4852 5404 6284 6961 7714 9266 10923 S7884LF - - - - 5721 6011 6562 7442 8119 8874 10425 12078</p> <p>Fabric/vinyl shell + leather cushions</p>	<p>OVERALL DIMENSIONS</p> <p>W D H</p>			<p>SEAT DIMENSIONS</p> <p>W D H</p>			<p>BACK DIMENSIONS</p> <p>W H</p>					
			93.5	31	30	84	19.5	17.5	84	12.5	<p>RTA 00</p>			
 <p>S7884R</p> <p>Four Seater w/One Arm COM Yardage: 9.5 Freight Class: 250 Product Weight (lbs.): 188 Cubic Feet Per Carton: 69</p>	 <p>S7884L</p> <p>No ganging hardware. Armless side can be equipped with ganging brackets, model 7892. Arms are Right Hand Seated (RT) or Left Hand Seated (LT).</p>	<p>S7884R - - - - 4465 4732 5245 6059 6689 7388 8825 10359 S7884L - - - - 4465 4732 5245 6059 6689 7388 8825 10359 S7884LFR - - - - 5624 5892 6404 7220 7847 8547 9984 11517 S7884LFL - - - - 5624 5892 6404 7220 7847 8547 9984 11517</p> <p>Fabric/vinyl shell + leather cushions</p>	<p>OVERALL DIMENSIONS</p> <p>W D H</p>			<p>SEAT DIMENSIONS</p> <p>W D H</p>			<p>BACK DIMENSIONS</p> <p>W H</p>					
			89.5	31	30.75	84	19.5	17.5	84	12.5	<p>RTA 00</p>			

DESCRIPTION	FEATURES	MODEL#	STANDARD TEXTILE GRADES											
			1	2	3	4	5	6	7	8	9	10	11	12

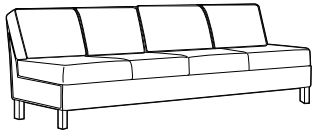

Armless Four Seater
 COM Yardage: 8.75
 Freight Class: 250
 Product Weight (lbs.): 172
 Cubic Feet Per Carton: 61.5

No ganging hardware.
 Armless side(s) can be equipped with ganging brackets, model 7892.

S7884NA	-	-	-	-	4465	4710	5183	5935	6513	7155	8480	9894
S7884LFNA	-	-	-	-	5624	5869	6341	7094	7671	8315	9639	11051

OVERALL DIMENSIONS			SEAT DIMENSIONS			BACK DIMENSIONS	
W	D	H	W	D	H	W	H
85.5	31	30.75	84	19.5	17.5	84	12.5

RTA 00

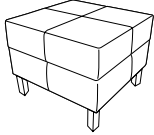

Square Ottoman
 COM Yardage: 1.5
 Freight Class: 250
 Product Weight (lbs.): 27
 Cubic Feet Per Carton: 7.5

No ganging hardware.
 Side(s) can be equipped with ganging brackets, model 7892.
 Does not gang to seating units.

S7879	-	-	-	-	702	746	827	957	1054	1166	1393	1634
S7879LF	-	-	-	-	847	891	972	1102	1199	1311	1538	1779

OVERALL DIMENSIONS			SEAT DIMENSIONS			BACK DIMENSIONS	
W	D	H	W	D	H	W	H
22	22	17	-	-	17	-	-

RTA 00

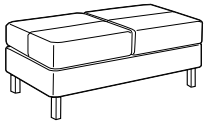

Two Seater Bench
 COM Yardage: 2.25
 Freight Class: 250
 Product Weight (lbs.): 42
 Cubic Feet Per Carton: 11.5

No ganging hardware.
 Side(s) can be equipped with ganging brackets, model 7892.
 Does not gang to seating units.

S7893	-	-	-	-	1350	1414	1538	1728	1879	2044	2385	2749
S7893LF	-	-	-	-	1643	1707	1830	2020	2170	2337	2678	3041

OVERALL DIMENSIONS			SEAT DIMENSIONS			BACK DIMENSIONS	
W	D	H	W	D	H	W	H
43	21.5	17	-	-	17	-	-

RTA 00

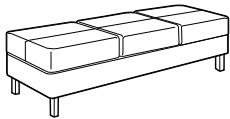

Three Seater Bench
 COM Yardage: 3.75
 Freight Class: 250
 Product Weight (lbs.): 62
 Cubic Feet Per Carton: 16.75

No ganging hardware.
 Side(s) can be equipped with ganging brackets, model 7892.
 Does not gang to seating units.

S7894	-	-	-	-	1922	2028	2231	2551	2800	3077	3644	4249
S7894LF	-	-	-	-	2359	2465	2668	2988	3237	3513	4080	4685

OVERALL DIMENSIONS			SEAT DIMENSIONS			BACK DIMENSIONS	
W	D	H	W	D	H	W	H
64.5	21.5	17	-	-	17	-	-

RTA 00

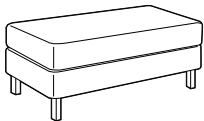







Two Seater Bench - Single Cushion
 COM Yardage: 2.25
 Freight Class: 250
 Product Weight (lbs.): 42
 Cubic Feet Per Carton: 11.5

No ganging hardware.
 Side(s) can be equipped with ganging brackets, model 7892.
 Does not gang to seating units.

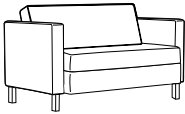
S7905	-	-	-	-	1061	1124	1248	1439	1588	1755	2096	2459
S7905LF	-	-	-	-	1352	1418	1539	1730	1880	2046	2387	2751

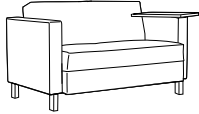
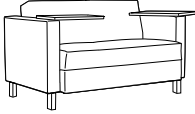
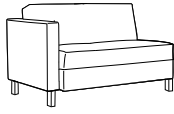
OVERALL DIMENSIONS			SEAT DIMENSIONS			BACK DIMENSIONS	
W	D	H	W	D	H	W	H
43	21.5	17	-	-	17	-	-

RTA 00

DESCRIPTION	FEATURES	MODEL#	STANDARD TEXTILE GRADES												
			1	2	3	4	5	6	7	8	9	10	11	12	
 <p>Two Seater w/Arms - Single Cushion COM Yardage: 6.5 Freight Class: 250 Product Weight (lbs.): 122 Cubic Feet Per Carton: 36</p>	Free standing unit only.		S7902	-	-	-	-	2396	2576	2911	3448	3859	4319	5267	6275
			S7902LF	-	-	-	-	2935	3121	3470	4027	4458	4935	5918	6969
			Fabric/vinyl shell + leather cushions												
			OVERALL DIMENSIONS			SEAT DIMENSIONS			BACK DIMENSIONS						
W D H			W D H			W H									
51.25 31 30			42.5 19.5 17.5			42.5 12.5									
			RTA 00												
  <p>S7902RT 2970T</p> <p>Two Seater w/Arms & Lam. Tablet - Single Cushion COM Yardage: 5.25 Freight Class: 250 Product Weight (lbs.): 114 Cubic Feet Per Carton: 36</p>	Free standing unit only. Tablets are Right Hand Seated (RT) or Left Hand Seated (LT).		S7902RT	-	-	-	-	2970	2354	2354	4062	2354	4970	5954	7003
			S7902LT	-	-	-	-	2970	2354	2354	4062	2354	4970	5954	7003
			S7902LFRT	-	-	-	-	3509	3693	4043	4600	5030	5508	6492	7542
			S7902LFLT	-	-	-	-	3509	3693	4043	4600	5030	5508	6492	7542
Fabric/vinyl shell + leather cushions															
OVERALL DIMENSIONS			SEAT DIMENSIONS			BACK DIMENSIONS									
W D H			W D H			W H									
48.75 33.5 30.75			42.5 19.5 17.5			42.5 13.25									
			RTA 00												
 <p>Two Seater w/Arms & Lam. Tablets - Single Cushion COM Yardage: 6.5 Freight Class: 250 Product Weight (lbs.): 127 Cubic Feet Per Carton: 41.25</p>	Free standing unit only. With both Left and Right Tablets.		S7902LRT	-	-	-	-	3545	3728	4080	4637	5068	5545	6529	7578
			S7902LFLT	-	-	-	-	4083	4267	4617	5174	5604	6082	7066	8116
			Fabric/vinyl shell + leather cushions												
			OVERALL DIMENSIONS			SEAT DIMENSIONS			BACK DIMENSIONS						
W D H			W D H			W H									
54.25 33.5 30			42.5 19.5 17.5			42.5 12.5									
			RTA 00												
  <p>S7902R S7902L</p> <p>Two Seater w/One Arm - Single Cushion COM Yardage: 5.25 Freight Class: 250 Product Weight (lbs.): 114 Cubic Feet Per Carton: 36</p>	No ganging hardware. Armless side can be equipped with ganging brackets, model 7892. Arms are Right Hand Seated (RT) or Left Hand Seated (LT).		S7902R	-	-	-	-	2225	2373	2657	3106	3454	3842	4634	5484
			S7902L	-	-	-	-	2225	2373	2657	3106	3454	3842	4634	5484
			S7902LFR	-	-	-	-	2763	2910	3192	3643	3991	4378	5172	6020
			S7902LFL	-	-	-	-	2763	2910	3192	3643	3991	4378	5172	6020
Fabric/vinyl shell + leather cushions															
OVERALL DIMENSIONS			SEAT DIMENSIONS			BACK DIMENSIONS									
W D H			W D H			W H									
47.25 31 30.75			42.5 19.5 17.5			42.5 13.25									
			RTA 00												
  <p>S7902RRT 2970T</p> <p>Two Seater w/One Arm & Lam. Tablet - Single Cushion COM Yardage: 5.25 Freight Class: 250 Product Weight (lbs.): 114 Cubic Feet Per Carton: 36</p>	Free standing unit only. Tablets are Right Hand Seated (RT) or Left Hand Seated (LT).		S7902RRT	-	-	-	-	2798	2948	3230	3681	4028	4415	5208	6056
			S7902LLT	-	-	-	-	2798	2948	3230	3681	4028	4415	5208	6056
			S7902LFRRT	-	-	-	-	3336	3484	3767	4219	4565	4953	5746	7542
			S7902LFLRT	-	-	-	-	3336	3484	3767	4219	4565	4953	5746	7542
Fabric/vinyl shell + leather cushions															
OVERALL DIMENSIONS			SEAT DIMENSIONS			BACK DIMENSIONS									
W D H			W D H			W H									
48.75 33.5 30.75			42.5 19.5 17.5			42.5 13.25									
			RTA 00												

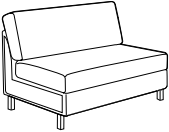
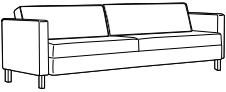
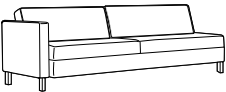
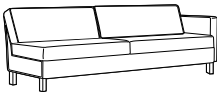
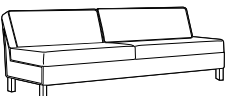
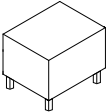
DESCRIPTION	FEATURES	MODEL#	STANDARD TEXTILE GRADES												
			1	2	3	4	5	6	7	8	9	10	11	12	
 <p>Armless Two Seater - Single Cushion COM Yardage: 6.5 Freight Class: 250 Product Weight (lbs.): 90 Cubic Feet Per Carton: 36</p>	<p>No ganging hardware. Armless side(s) can be equipped with ganging brackets, model 7892.</p>		S7902NA	-	-	-	-	2225	2354	2595	2980	3279	3612	4291	5016
			S7902LFNA	-	-	-	-	2763	2889	3133	3518	3816	4148	4829	5554
			Fabric/vinyl shell + leather cushions												
			OVERALL DIMENSIONS			SEAT DIMENSIONS			BACK DIMENSIONS						
			W	D	H	W	D	H	W	H					
			43.25	31	30.75	42.5	19.5	17.5	42.5	13.25					
			RTA 00												
 <p>Four Seater w/Arms - Duo Cushion COM Yardage: 10.25 Freight Class: 250 Product Weight (lbs.): 204 Cubic Feet Per Carton: 69</p>	<p>Free standing unit only.</p>		S7904	-	-	-	-	4563	4852	5404	6284	6961	7714	9266	10923
			S7904LF	-	-	-	-	5721	6011	6562	7442	8119	8874	10425	12078
			Fabric/vinyl shell + leather cushions												
			OVERALL DIMENSIONS			SEAT DIMENSIONS			BACK DIMENSIONS						
			W	D	H	W	D	H	W	H					
			93.5	31	30	84	19.5	17.5	84	12.5					
			RTA 00												
 <p>S7904R</p> <p>Four Seater w/One Arm - Duo Cushion COM Yardage: 9.5 Freight Class: 250 Product Weight (lbs.): 188 Cubic Feet Per Carton: 61.5</p>	 <p>S7904L</p> <p>No ganging hardware. Armless side can be equipped with ganging brackets, model 7892. Arms are Right Hand Seated (RT) or Left Hand Seated (LT) .</p>		S7904R	-	-	-	-	4465	4732	5245	6059	6689	7388	8825	10359
			S7904L	-	-	-	-	4465	4732	5245	6059	6689	7388	8825	10359
			S7904LFR	-	-	-	-	5624	5892	6404	7220	7847	8547	9984	11517
			S7904LFL	-	-	-	-	5624	5892	6404	7220	7847	8547	9984	11517
Fabric/vinyl shell + leather cushions															
OVERALL DIMENSIONS			SEAT DIMENSIONS			BACK DIMENSIONS									
			W	D	H	W	D	H	W	H					
			89.5	31	30.75	84	19.5	17.5	84	12.5					
			RTA 00												
 <p>Armless Four Seater - Single Cushion COM Yardage: 8.75 Freight Class: 250 Product Weight (lbs.): 172 Cubic Feet Per Carton: 61.5</p>	<p>No ganging hardware. Armless side(s) can be equipped with ganging brackets, model 7892.</p>		S7904NA	-	-	-	-	4465	4710	5183	5935	6513	7155	8480	9894
			S7904LFNA	-	-	-	-	5624	5869	6341	7094	7671	8315	9639	11051
			Fabric/vinyl shell + leather cushions												
			OVERALL DIMENSIONS			SEAT DIMENSIONS			BACK DIMENSIONS						
			W	D	H	W	D	H	W	H					
			85.5	31	30.75	84	19.5	17.5	84	12.5					
			RTA 00												
 <p>Cube End Table COM Yardage: N/A Freight Class: 100 Product Weight (lbs.): 51 Cubic Feet Per Carton: 5.5</p>	<p>Free standing unit only. No ganging hardware. For Power/USB module please see electrical placement chart.</p>		S7911	1773	-	-	-	-	-	-	-	-	-	-	-
			Fabric/vinyl shell + leather cushions												
			OVERALL DIMENSIONS			SEAT DIMENSIONS			BACK DIMENSIONS						
						W	D	H	W	D	H	W	H		
			20	24	16	-	-	-	-	-					
			RTA 00												

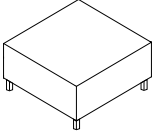
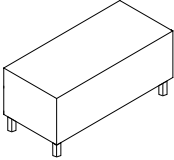
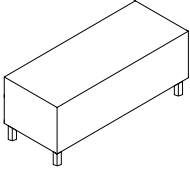
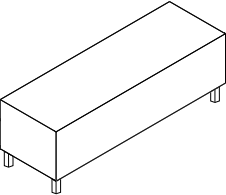
DESCRIPTION	FEATURES	MODEL#	STANDARD TEXTILE GRADES											
			1	2	3	4	5	6	7	8	9	10	11	12
 <p>Cube Square Coffee Table COM Yardage: N/A Freight Class: 100 Product Weight (lbs.): 86 Cubic Feet Per Carton: 10.75</p>	<p>Free standing unit only. No ganging hardware. For Power/USB module please see electrical placement chart.</p>	S7912	2252	-	-	-	-	-	-	-	-	-	-	-
		OVERALL DIMENSIONS			SEAT DIMENSIONS			BACK DIMENSIONS						
		W	D	H	W	D	H	W	H					
		33	33	14	-	-	-	-	-					
			RTA 00											
 <p>Cube 40" Coffee Table COM Yardage: N/A Freight Class: 100 Product Weight (lbs.): 66 Cubic Feet Per Carton: 8</p>	<p>Free standing unit only. No ganging hardware. For Power/USB module please see electrical placement chart.</p>	S7913	2132	-	-	-	-	-	-	-	-	-	-	
		OVERALL DIMENSIONS			SEAT DIMENSIONS			BACK DIMENSIONS						
		W	D	H	W	D	H	W	H					
		40	20	14	-	-	-	-	-					
			RTA 00											
 <p>Cube Extended 60" Coffee Table COM Yardage: N/A Freight Class: 125 Product Weight (lbs.): 93 Cubic Feet Per Carton: 12</p>	<p>Free standing unit only. No ganging hardware. For Power/USB module please see electrical placement chart.</p>	S7915	2785	-	-	-	-	-	-	-	-	-		
		OVERALL DIMENSIONS			SEAT DIMENSIONS			BACK DIMENSIONS						
		W	D	H	W	D	H	W	H					
		60	20	14	-	-	-	-	-					
			RTA 00											
 <p>Cube Extended 72" Coffee Table COM Yardage: N/A Freight Class: 125 Product Weight (lbs.): 107 Cubic Feet Per Carton: 14.25</p>	<p>Free standing unit only. No ganging hardware. For Power/USB module please see electrical placement chart.</p>	S7916	2850	-	-	-	-	-	-	-	-	-		
		OVERALL DIMENSIONS			SEAT DIMENSIONS			BACK DIMENSIONS						
		W	D	H	W	D	H	W	H					
		72	20	14	-	-	-	-	-					
			RTA 00											

DRIFT



Chrome Base model 8034
Low Back Lounge Chair



Wood Base model 8037
Mid Back Lounge Chair



Wood Base model 8030
Side Chair w/4 Leg



Wood Base model 8052
Counter Stool



Ottoman model 8026



Chrome Base model 8041R26C
Round Table w/4-Prong Base

EXAMPLE OF TABLE ORDER CODE:

8041R26W	ACJ	AAM
Model Number	Top HPL Finish	Base Finish - Wood Only

EXAMPLE OF CHAIR ORDER CODE:

8030	WA50	HGM
Model Number	Fabric	Legs

STANDARD FEATURES

- Drift's soft seat and contoured back and arms provide the perfect balance of style and comfort.
- Side chair bases include: fixed four leg wood, four prong wood swivel and four prong metal swivel.
- Lounge chair bases include: four prong wood swivel and four prong metal swivel.
- Stool bases include: fixed four leg wood, metal column swivel and fixed sled base; each available in counter or bar heights.
- Wood bases are made from Beech and are available in all standard wood finishes.
- Metal column bases are only available in Polished Chrome.
- Lounge models (8034, 8036, and 8038) with metal column swivel bases are free available with swivel or self-centering swivel.
- Sled bases are standard in painted metal or with metallic finish. See Frame Finish for upcharges.
- Wood fixed and swivel base seating models are standard with White non-marking polycarbonate glides. See Glide Type for additional glide options available on wood base models only.
- Sled base models are standard with clear polycarbonate glides. See Glide Type for additional glide options available on sled bases only.
- The ottoman (8026) has a weighted bottom to maintain upright position. Ottoman base has White, non-marking glides.
- Upholstery options: fabric, vinyl, or leather.

TABLES

- Tables include models with four prong wood or four prong metal column (polished chrome) bases. All are fixed orientation.
- Tables are available with high pressure laminate tops in three shapes and three sizes each.
- See finishes section in Price List for solid wood/laminate coordination chart.

OPTIONAL FEATURES

- **Wood Finish** (wood base models only)

(AAM) Absolute	(BKM) Black
(ACM) Cherry	(EOM) English Oak
(ECM) Espresso Cafe	(TFM) Fruitwood
(HGM) Grey	(AHM) Honey
(TMM) Mahogany	(AVM) Maple
(NLW) Natural Walnut	(MWM) Medium Walnut
(ASM) Night	(NBM) Noce Biondo
(NGM) Noce Grigio	(NEM) Noce Leggero
(NMM) Noce Medio	(SKM) Shaker Cherry
(TWM) Walnut	(WTM) WC Cream
(WHM) White	(WCM) Winter Cherry
- **Cylinder Selection** (models 8034, 8036 and 8038 only):

(DSC) Swivel
(DAC) Self-centering
- **Frame Finish** (sled base models only):

Paint Finishes	Metallic Finishes
(TBL) Black	(CHM) Chrome. Add \$61
(TTU) Tungsten	
(TSH) Shadow	
- **Glide Type** (wood base seating only)





(NM) White, non-marking nylon (standard)
(SG) Steel cushioned glides. Add \$31
(RG) Non-slip, rubber glides. Add \$31
(FG) Felt glides. Add \$31
- **Glide Type** (wire sled base seating)





(CG) Clear, polycarbonate glide (standard)
(XG) No glide
(FG) Felt glide. Add \$31
(SG) Steel cushioned glide. Add \$31
(RG) Rubber glide Add \$31
- **Table Tops**





Table Tops are available in the following High Pressure Laminate finishes:

(ACJ) Absolute Acajou	(ASN) Asian Night
(AWC) Avant Cherry	(AWH) Avant Honey
(BLK) Black	(BRC) Brushed Cobalt
(CMB) Clear Maple	(DES) Dark Espresso
(DWT) Designer White	(HGT) Hayden Grey
(NBL) Noce Biondo	(NGL) Noce Grigio
(NEL) Noce Leggero	(NML) Noce Medio
(QTM) Quartered Mahogany	
(SOG) Storm Grey	(TFW) Tiger Fruitwood
(TWL) Tiger Walnut	(WHE) Walnut Heights
(WHC) White Chocolate	
(WCR) Winter Cherry	(WGY) Willow Grey

DESCRIPTION	FEATURES	MODEL#	STANDARD TEXTILE GRADES											
			1	2	3	4	5	6	7	8	9	10	11	12
 <p>Ottoman COM Yardage: 1.75 Freight Class: 250 Product Weight (lbs.): 31 Cubic Feet Per Carton: 8.5</p>		8026	885	943	985	1050	1142	1185	1268	1401	1505	1617	1851	2101
			OVERALL DIMENSIONS			SEAT DIMENSIONS			BACK DIMENSIONS					
			W	D	H	W	D	H	W	D	H			
			18.5	18.5	18	-	-	-	-	-	-			
			RTA 00			1 per carton								

DESCRIPTION	FEATURES	MODEL#	STANDARD TEXTILE GRADES													
			1	2	3	4	5	6	7	8	9	10	11	12		
 <p>Side Chair w/4 Leg Wood Base COM Yardage: 2 Freight Class: 300 Product Weight (lbs.): 31 Cubic Feet Per Carton: 15.75</p>		8030	1501	1560	1606	1674	1772	1818	1905	2047	2156	2275	2525	2789		
			OVERALL DIMENSIONS			SEAT DIMENSIONS			BACK DIMENSIONS							
			W	D	H	W	D	H	W	H						
			24.5	23	31	18	17.5	18	15	13						
						RTA 00	1 per carton									
 <p>Side Chair w/Wood Swivel Base COM Yardage: 2 Freight Class: 300 Product Weight (lbs.): 31 Cubic Feet Per Carton: 15.75</p>		8031	1743	1803	1849	1917	2016	2061	2151	2290	2400	2520	2770	3035		
			OVERALL DIMENSIONS			SEAT DIMENSIONS			BACK DIMENSIONS							
			W	D	H	W	D	H	W	H						
			24.5	23	31	18	17.5	18	15	13						
						RTA 00	1 per carton									
 <p>Side Chair w/Chrome Base COM Yardage: 2 Freight Class: 300 Product Weight (lbs.): 31 Cubic Feet Per Carton: 15.75</p>		8032	1784	1844	1890	1958	2057	2102	2192	2331	2441	2561	2810	3076		
			OVERALL DIMENSIONS			SEAT DIMENSIONS			BACK DIMENSIONS							
			W	D	H	W	D	H	W	H						
			24.5	23	31	18	17.5	18	15	13						
						RTA 00	1 per carton									
 <p>Low Back Lounge Chair w/Wood Swivel Base COM Yardage: 3.25 Freight Class: 250 Product Weight (lbs.): 53 Cubic Feet Per Carton: 19</p>		8033	2563	2664	2745	2866	3036	3116	3271	3517	3708	3919	4354	4818		
			OVERALL DIMENSIONS			SEAT DIMENSIONS			BACK DIMENSIONS							
			W	D	H	W	D	H	W	H						
			29	30	33	21.5	20	17	21	16						
						RTA 00	per carton									
 <p>Low Back Lounge Chair w/Chrome Base COM Yardage: 3.25 Freight Class: 250 Product Weight (lbs.): 59 Cubic Feet Per Carton: 19.25</p>		8034	2573	2674	2755	2875	3046	3126	3281	3527	3717	3929	4364	4827		
			OVERALL DIMENSIONS			SEAT DIMENSIONS			BACK DIMENSIONS							
			W	D	H	W	D	H	W	H						
			29	30	33	21.5	20	17	21	16						
						RTA 00	1 per carton									

DESCRIPTION	FEATURES	MODEL#	STANDARD TEXTILE GRADES												
			1	2	3	4	5	6	7	8	9	10	11	12	
 <p>Mid Back Lounge Chair w/Wood Swivel Base COM Yardage: 3.5 Freight Class: 250 Product Weight (lbs.): 54 Cubic Feet Per Carton: 25.5</p>		8035	2666	2777	2864	2993	3177	3263	3430	3695	3900	4127	4597	5096	
	OVERALL DIMENSIONS			SEAT DIMENSIONS			BACK DIMENSIONS								
	W D H			W D H			W H								
	29 31.5 38.5			21.5 20 17			21 21.5								
				RTA 00			1 per carton								
 <p>Mid Back Lounge Chair w/Chrome Base COM Yardage: 3.5 Freight Class: 250 Product Weight (lbs.): 60 Cubic Feet Per Carton: 25.5</p>		8036	2681	2791	2878	3007	3190	3276	3443	3709	3913	4141	4610	5109	
	OVERALL DIMENSIONS			SEAT DIMENSIONS			BACK DIMENSIONS								
	W D H			W D H			W H								
	29 31.5 38.5			21.5 20 17			21 21.5								
				RTA 00			1 per carton								
 <p>High Back Lounge Chair w/Wood Swivel Base COM Yardage: 3.75 Freight Class: 250 Product Weight (lbs.): 57 Cubic Feet Per Carton: 28.25</p>		8037	2912	3029	3121	3260	3458	3551	3729	4013	4233	4476	4978	5514	
	OVERALL DIMENSIONS			SEAT DIMENSIONS			BACK DIMENSIONS								
	W D H			W D H			W H								
	29 31.5 44.5			21.5 20 17			21 27.5								
				RTA 00			1 per carton								
 <p>High Back Lounge Chair w/Chrome Base COM Yardage: 3.75 Freight Class: 250 Product Weight (lbs.): 63 Cubic Feet Per Carton: 28.25</p>		8038	2930	3048	3140	3279	3477	3570	3748	4032	4252	4495	4997	5533	
	OVERALL DIMENSIONS			SEAT DIMENSIONS			BACK DIMENSIONS								
	W D H			W D H			W H								
	29 31.5 44.5			21.5 20 17			21 27.5								
				RTA 00			1 per carton								
 <p>Counter Stool, Sled Base COM Yardage: 1.5 Freight Class: 250 Product Weight (lbs.): 32 Cubic Feet Per Carton: 9</p>		8051	1175	1223	1261	1316	1394	1427	1495	1601	1681	1768	1949	2140	
	OVERALL DIMENSIONS			SEAT DIMENSIONS			BACK DIMENSIONS								
	W D H			W D H			W H								
	19.25 19 35			15.5 15.75 24.75			12.5 10								
				RTA 00			1 per carton								

DESCRIPTION	FEATURES	MODEL#	STANDARD TEXTILE GRADES											
			1	2	3	4	5	6	7	8	9	10	11	12
 <p>Counter Stool, Wood Base COM Yardage: 1.5 Freight Class: 250 Product Weight (lbs.): 28 Cubic Feet Per Carton: 8</p>		8052	1840	1888	1926	1981	2059	2092	2160	2266	2346	2433	2614	2805
			OVERALL DIMENSIONS			SEAT DIMENSIONS			BACK DIMENSIONS					
			W	D	H	W	D	H	W	H				
			19.25	19	35	15.5	15.75	24.75	12.5	10				
					RTA 00	1 per carton								
 <p>Counter Stool, Metal Swivel Base COM Yardage: 1.5 Freight Class: 250 Product Weight (lbs.): 43 Cubic Feet Per Carton: 11.5</p>		8053	2239	2287	2325	2380	2458	2491	2559	2665	2745	2832	3013	3204
			OVERALL DIMENSIONS			SEAT DIMENSIONS			BACK DIMENSIONS					
			W	D	H	W	D	H	W	H				
			19.25	20	34.5	15.5	15.75	24.75	12.5	10				
					RTA 00	1 per carton								
 <p>Bar Stool, Sled Base COM Yardage: 1.5 Freight Class: 250 Product Weight (lbs.): 34.5 Cubic Feet Per Carton: 11</p>		8054	1264	1312	1350	1405	1483	1516	1584	1690	1770	1857	2038	2229
			OVERALL DIMENSIONS			SEAT DIMENSIONS			BACK DIMENSIONS					
			W	D	H	W	D	H	W	H				
			19.25	20	40.25	15.5	15.75	30.25	12.5	10				
					RTA 00	1 per carton								
 <p>Bar Stool, Wood Base COM Yardage: 1.5 Freight Class: 250 Product Weight (lbs.): 30 Cubic Feet Per Carton: 11</p>		8055	1929	1977	2015	2070	2148	2181	2249	2355	2435	2522	2703	2894
			OVERALL DIMENSIONS			SEAT DIMENSIONS			BACK DIMENSIONS					
			W	D	H	W	D	H	W	H				
			19.25	20	40	15.5	15.75	30	12.5	10				
					RTA 00	1 per carton								
 <p>Bar Stool, Metal Swivel Base COM Yardage: 1.5 Freight Class: 250 Product Weight (lbs.): 45.5 Cubic Feet Per Carton: 13.25</p>		8056	2327	2375	2413	2468	2546	2579	2647	2753	2833	2920	3101	3292
			OVERALL DIMENSIONS			SEAT DIMENSIONS			BACK DIMENSIONS					
			W	D	H	W	D	H	W	H				
			19.25	20	40	15.5	15.75	30	12.5	10				
					RTA 00	1 per carton								

DESCRIPTION	MODEL #	DIMENSIONS	FREIGHT CLASS	WT/LB	CUBIC FT.	LIST PRICE
	MODEL #	D x W x H	FREIGHT CLASS	WT/LBS	CUBIC FT	LIST PRICE
	8041R26C	26 x 26 x 16	150	41	10.75	1055
	8041R30C	30 x 30 x 16	250	45	13	1099
Round Table w/Polished Chrome 4-Prong Base	RTA 00				1 per carton	

DESCRIPTION	MODEL #	DIMENSIONS	FREIGHT CLASS	WT/LBS	CUBIC FT.	LIST PRICE
	MODEL #	D x W x H	FREIGHT CLASS	WT/LBS	CUBIC FT	LIST PRICE
	8041R26W	26 x 26 x 16	250	35	10.75	1038
	8041R30W	30 x 30 x 16	250	40	13	1088
Round Table w/Wooden 4-Prong Base	RTA 00				1 per carton	

DESCRIPTION	MODEL #	DIMENSIONS	FREIGHT CLASS	WT/LBS	CUBIC FT.	LIST PRICE
	MODEL #	D x W x H	FREIGHT CLASS	WT/LBS	CUBIC FT	LIST PRICE
	8042SQ22C	22.75 x 22.75 x 16	150	39	7.75	1055
	8042SQ28C	28.5 x 28.5 x 16	150	47	11.5	1099
Square Table w/Radiused Corners + Polished Chrome 4-Prong Base	RTA 00				1 per carton	

DESCRIPTION	MODEL #	DIMENSIONS	FREIGHT CLASS	WT/LBS	CUBIC FT.	LIST PRICE
	MODEL #	D x W x H	FREIGHT CLASS	WT/LBS	CUBIC FT	LIST PRICE
	8042SQ22W	22.75 x 22.75 x 16	150	33	7.75	1038
	8042SQ28W	28.5 x 28.5 x 16	250	41	11.5	1088
Square Table w/Radiused Corners + Wooden 4-Prong Base	RTA 00				1 per carton	

DESCRIPTION	MODEL #	DIMENSIONS	FREIGHT CLASS	WT/LBS	CUBIC FT.	LIST PRICE
	MODEL #	D x W x H	FREIGHT CLASS	WT/LBS	CUBIC FT	LIST PRICE
	8043OV26C	22 x 26 x 16	100	40	9.25	1055
	8043OV31C	26 x 31 x 16	250	45	11.75	1099
Oval Table w/Polished Chrome 4-Prong Base	RTA 00				1 per carton	

DESCRIPTION	MODEL #	DIMENSIONS	FREIGHT CLASS	WT/LBS	CUBIC FT.	LIST PRICE
	MODEL #	D x W x H	FREIGHT CLASS	WT/LBS	CUBIC FT	LIST PRICE
	8043OV26W	22 x 26 x 16	250	34	9.25	1038
	8043OV31W	26 x 31 x 16	250	40	11.75	1088
Oval Table w/Wooden 4-Prong Base	RTA 00				1 per carton	

JEO



model 8434



model 8433-4



Optional Quilted Stitch Back (Q).



model 8435-2224



model 8436-1530





Optional 5 prong base with glides (G).





STANDARD FEATURES



- JEO is a contemporary, retro - inspired series with versatility for a variety of workplace applications.
- The tailored box styling functions well in lounge, conferencing, collaboration and side/guest environments.
- Three seating models: swivel tilter with a 5 prong caster base, a swivel self-centering return with a stationary round pedestal base or a matching four legged Arm Chair.
- Model 8433-4 is standard with a five prong Black nylon base with carpet casters (C1).
- Model 8437 is standard with Black four-legged frame.
- JEO also offers two styles of matching pedestal base occasional tables with a round or square laminate top, available in two height sizes --- 15" and 22" high.
- Upholstery options: fabric, vinyl, leather or a combination of two or more materials. The upholstery surfaces are seamed together with tailored double stitch detailing.
- Check textile availability prior to specifying upholstery material.

OPTIONAL FEATURES

- Chairs are available with an Optional Quilted Stitch back. Please specify (Q). Add \$196.
- Model 8433-4 has an optional five prong Aluminum base. specify (AL). Add \$58.
- Optional 5 prong Aluminum base with hard glides. Please specify (C7).
- Optional soft casters are available on the 5 prong base. Please specify (C9R). Add \$66.
- Model 8434 round pedestal base available in Chrome (CHM) or Brushed Chrome (BCH). Please specify.
- Model 8437 has optional Chrome (CHM) or Brushed Chrome (BCH) four-legged frame.
- Occasional tables are available in the following laminate finishes to coordinate with Global Desking and wood seating: Absolute Acajou (ACJ), Asian Night (ASN), Avant Cherry (AWC), Avant Honey (AWH), Black (BLK), Brushed Cobalt (BRC), Clear Maple (CMB), Dark Espresso (DES), Designer White (DWT), Hayden Grey (HGT), Noce Biondo (NBL), Noce Grigio (NGL), Noce Leggero (NEL), Noce Medio (NML), Quartered Mahogany (QTM), Tiger Walnut (TWL), Tiger Fruitwood (TFW), Walnut Heights (WHE), White Chocolate (WHC), and Winter Cherry (WCR). Please Specify.

DESCRIPTION	FEATURES	MODEL#	STANDARD TEXTILE GRADES													
			1	2	3	4	5	6	7	8	9	10	11	12		
 <p>Self-Centering Lounge Chair on Pedestal Base COM Yardage: 2.75 Freight Class: 250 Product Weight (lbs.): 50 Cubic Feet Per Carton: 22</p>	Ergonomic Features: C	8434	2171	2254	2318	2415	2549	2600	2720	2947	3059	3270	3555	3915		
		OVERALL DIMENSIONS			SEAT DIMENSIONS			BACK DIMENSIONS								
		W	D	H	W	D	H	W	H							
	26	25	30-32.5	20	19	16.5-19	20	15								
 <p>Swivel Tilter Chair COM Yardage: 2.75 Freight Class: 250 Product Weight (lbs.): 50 Cubic Feet Per Carton: 22</p>	Ergonomic Features: A, B, C, S	8433-4	1473	1576	1655	1775	1945	2024	2178	2422	2612	2822	3254	3715		
		OVERALL DIMENSIONS			SEAT DIMENSIONS			BACK DIMENSIONS								
		W	D	H	W	D	H	W	H							
	26	25	30-32.5	20	19	16.5-19	20	15								
 <p>Arm Chair COM Yardage: 2.75 Freight Class: 250 Product Weight (lbs.): 50 Cubic Feet Per Carton: 22</p>		8437	1434	1525	1596	1699	1848	1918	2051	2266	2433	2617	2994	3400		
		OVERALL DIMENSIONS			SEAT DIMENSIONS			BACK DIMENSIONS								
		W	D	H	W	D	H	W	H							
	26	25	34	20	19	18	20	15								

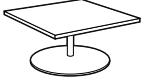
DESCRIPTION	FEATURES	MODEL#	STANDARD TEXTILE GRADES												
			1	2	3	4	5	6	7	8	9	10	11	12	
 <p>15" H Round End Table - 24" Dia. Top on Pedestal Base COM Yardage: n/a Freight Class: 150 Product Weight (lbs.): 44 Cubic Feet Per Carton: 10</p>		8435-1524	1335												
				OVERALL DIMENSIONS			SEAT DIMENSIONS			BACK DIMENSIONS					
				W	Dia.	H	W	D	H	W	H				
				24		15									
 <p>15" H Round Coffee Table - 30" Dia. Top on Pedestal Base COM Yardage: n/a Freight Class: 150 Product Weight (lbs.): 44 Cubic Feet Per Carton: 10</p>		8435-1530	1558												
				OVERALL DIMENSIONS			SEAT DIMENSIONS			BACK DIMENSIONS					
				W	Dia.	H	W	D	H	W	H				
				30		15									
 <p>22" H Round End Table - 24" Dia. Top on Pedestal Base COM Yardage: n/a Freight Class: 150 Product Weight (lbs.): 44 Cubic Feet Per Carton: 10</p>		8435-2224	1462												
				OVERALL DIMENSIONS			SEAT DIMENSIONS			BACK DIMENSIONS					
				W	Dia.	H	W	D	H	W	H				
				24		22									
 <p>22" H Round Coffee Table - 30" Dia. Top on Pedestal Base COM Yardage: n/a Freight Class: 150 Product Weight (lbs.): 44 Cubic Feet Per Carton: 10</p>		8435-2230	1684												
				OVERALL DIMENSIONS			SEAT DIMENSIONS			BACK DIMENSIONS					
				W	Dia.	H	W	D	H	W	H				
				30		22									
 <p>15" H Square End Table - 24" Top on Pedestal Base COM Yardage: n/a Freight Class: 150 Product Weight (lbs.): 44 Cubic Feet Per Carton: 10</p>		8436-1524	1335												
				OVERALL DIMENSIONS			SEAT DIMENSIONS			BACK DIMENSIONS					
				W	D	H	W	D	H	W	H				
				24	24	15									

DESCRIPTION	FEATURES	MODEL#	STANDARD TEXTILE GRADES																
			1	2	3	4	5	6	7	8	9	10	11	12					
 <p>15" H Square End Coffee - 30" Top on Pedestal Base COM Yardage: n/a Freight Class: 150 Product Weight (lbs.): 44 Cubic Feet Per Carton: 10</p>		8436-1530	1558																
 <p>22" H Square End Table - 24" Top on Pedestal Base COM Yardage: n/a Freight Class: 150 Product Weight (lbs.): 44 Cubic Feet Per Carton: 10</p>		8436-2224	1462																
 <p>22" H Square End Coffee - 30" Top on Pedestal Base COM Yardage: n/a Freight Class: 150 Product Weight (lbs.): 44 Cubic Feet Per Carton: 10</p>		8436-2230	1684																

KATE®



model 2811-4





model 2811-8

STANDARD FEATURES

- A contemporary, yet retro series featuring sculpted seat and back cushions.
- Fully upholstered closed arms offer a unique style and function in the workplace.
- Models are standard with a five legged Polished Aluminum base.
- **C10** casters are standard.
- Check textile availability prior to specifying upholstery material.

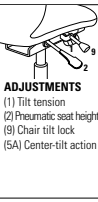
OPTIONAL FEATURES

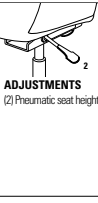
- An optional Black injection molded base is available at no upcharge, please specify **(BK)**.
- There are no caster options for this series. **C7** glides can be specified at no upcharge.
- For hard surface flooring please specify **C10R**. Add \$60.
- For fully assembled in box, specify **SU**. Add \$70.

DESCRIPTION	FEATURES	MODEL#	STANDARD TEXTILE GRADES																																				
			1	2	3	4	5	6	7	8	9	10	11	12																									
 <p>MB Tilter COM Yardage: 3.75 Freight Class: 250 Product Weight (lbs.): 47 Cubic Feet Per Carton: 15.75</p>	 <p>ADJUSTMENTS (1) Tilt tension (2) Pneumatic seat height (9) Chair tilt lock (5A) Center-tilt action</p>	<p>Ergonomic Features: A, B, C, N</p>	<table border="1"> <thead> <tr> <th colspan="3">OVERALL DIMENSIONS</th> <th colspan="3">SEAT DIMENSIONS</th> <th colspan="3">BACK DIMENSIONS</th> </tr> <tr> <th>W</th> <th>D</th> <th>H</th> <th>W</th> <th>D</th> <th>H</th> <th>W</th> <th>H</th> </tr> </thead> <tbody> <tr> <td>26</td> <td>24.5</td> <td>33</td> <td>17.5</td> <td>18</td> <td>17.5-21.50</td> <td>19</td> <td>15.5</td> </tr> </tbody> </table>												OVERALL DIMENSIONS			SEAT DIMENSIONS			BACK DIMENSIONS			W	D	H	W	D	H	W	H	26	24.5	33	17.5	18	17.5-21.50	19	15.5
			OVERALL DIMENSIONS			SEAT DIMENSIONS			BACK DIMENSIONS																														
			W	D	H	W	D	H	W	H																													
26	24.5	33	17.5	18	17.5-21.50	19	15.5																																
<p>RTA 00</p>																																							
 <p>MB Swivel COM Yardage: 3.75 Freight Class: 250 Product Weight (lbs.): 43 Cubic Feet Per Carton: 15.75</p>	 <p>ADJUSTMENTS (2) Pneumatic seat height</p>	<p>Ergonomic Features: C, N</p>	<table border="1"> <thead> <tr> <th colspan="3">OVERALL DIMENSIONS</th> <th colspan="3">SEAT DIMENSIONS</th> <th colspan="3">BACK DIMENSIONS</th> </tr> <tr> <th>W</th> <th>D</th> <th>H</th> <th>W</th> <th>D</th> <th>H</th> <th>W</th> <th>H</th> </tr> </thead> <tbody> <tr> <td>26</td> <td>24.5</td> <td>33</td> <td>17.5</td> <td>18</td> <td>17.5-21.50</td> <td>19</td> <td>15.5</td> </tr> </tbody> </table>												OVERALL DIMENSIONS			SEAT DIMENSIONS			BACK DIMENSIONS			W	D	H	W	D	H	W	H	26	24.5	33	17.5	18	17.5-21.50	19	15.5
			OVERALL DIMENSIONS			SEAT DIMENSIONS			BACK DIMENSIONS																														
			W	D	H	W	D	H	W	H																													
26	24.5	33	17.5	18	17.5-21.50	19	15.5																																
<p>RTA 00</p>																																							
 <p>Armchair COM Yardage: 3.75 Freight Class: 250 Product Weight (lbs.): 42 Cubic Feet Per Carton: 15.75</p>	<p>Ergonomic Features: N</p>	<table border="1"> <thead> <tr> <th colspan="3">OVERALL DIMENSIONS</th> <th colspan="3">SEAT DIMENSIONS</th> <th colspan="3">BACK DIMENSIONS</th> </tr> <tr> <th>W</th> <th>D</th> <th>H</th> <th>W</th> <th>D</th> <th>H</th> <th>W</th> <th>H</th> </tr> </thead> <tbody> <tr> <td>26.5</td> <td>26.5</td> <td>33.5</td> <td>17.5</td> <td>18</td> <td>18</td> <td>19</td> <td>15.5</td> </tr> </tbody> </table>												OVERALL DIMENSIONS			SEAT DIMENSIONS			BACK DIMENSIONS			W	D	H	W	D	H	W	H	26.5	26.5	33.5	17.5	18	18	19	15.5	
		OVERALL DIMENSIONS			SEAT DIMENSIONS			BACK DIMENSIONS																															
		W	D	H	W	D	H	W	H																														
26.5	26.5	33.5	17.5	18	18	19	15.5																																
<p>RTA 00</p>																																							
 <p>Ottoman COM Yardage: 1.5 Freight Class: 250 Product Weight (lbs.): 22 Cubic Feet Per Carton: 6</p>	<p>Ergonomic Features: N</p>	<table border="1"> <thead> <tr> <th colspan="3">OVERALL DIMENSIONS</th> <th colspan="3">SEAT DIMENSIONS</th> <th colspan="3">BACK DIMENSIONS</th> </tr> <tr> <th>W</th> <th>D</th> <th>H</th> <th>W</th> <th>D</th> <th>H</th> <th>W</th> <th>H</th> </tr> </thead> <tbody> <tr> <td>23.5</td> <td>18.75</td> <td>17.75</td> <td>20.5</td> <td>18.5</td> <td>17-22</td> <td>20</td> <td>21</td> </tr> </tbody> </table>												OVERALL DIMENSIONS			SEAT DIMENSIONS			BACK DIMENSIONS			W	D	H	W	D	H	W	H	23.5	18.75	17.75	20.5	18.5	17-22	20	21	
		OVERALL DIMENSIONS			SEAT DIMENSIONS			BACK DIMENSIONS																															
		W	D	H	W	D	H	W	H																														
23.5	18.75	17.75	20.5	18.5	17-22	20	21																																
<p>RTA 00</p>																																							

LUX



model LX2426AC



model LX8033S

STANDARD FEATURES

- Contemporary styling featuring luxurious cushioning.
- Sofa cushions are removable.
- Fully upholstered. Wood legs with non marking clear glides.
- Cylindrical bolsters included with lounge chair models. One bolster on single seat lounge chair and two bolsters on two-seat and three-seat sofas.
- This item may require a longer lead time. Please contact your Global sales representative for further information.
- Check textile availability prior to specifying upholstery material.

OPTIONAL FEATURES

- Wood frames are available in Absolute (**AAM**), Black (**BKM**), Cherry (**ACM**), English Oak (**EOM**), Espresso Cafe (**ECM**), Fruitwood (**TFM**), Gray (**HGM**), Honey (**AHM**), Mahogany (**TMM**), Maple (**AVM**), Medium Walnut (**MWM**), Night (**ASM**), Natural Walnut (**NLW**), Noce Biondo (**NBM**), Noce Grigio (**NGM**), Noce Leggero (**NEM**), Noce Medio (**NMM**), Shaker Cherry (**SKM**), Walnut (**TWM**), WC Cream (**WTM**), White (**WHM**) and Winter Cherry (**WCM**). Please Specify. Genuine maple faced veneers and solids are used.

DESCRIPTION	FEATURES	MODEL#	STANDARD TEXTILE GRADES											
-------------	----------	--------	-------------------------	--	--	--	--	--	--	--	--	--	--	--



Side Chair

COM Yardage: 3
 Freight Class: 250
 Product Weight (lbs.): 36
 Cubic Feet Per Carton: 17.75

	1	2	3	4	5	6	7	8	9	10	11	12
LX2226SC	1008	1113	1156	1222	1314	1345	1425	1577	1651	1794	1985	2226

OVERALL DIMENSIONS			SEAT DIMENSIONS			BACK DIMENSIONS	
W	D	H	W	D	H	W	H
25	27.75	36	19	19.5	19.5	19	18

RTA 00



Armchair

COM Yardage: 3
 Freight Class: 250
 Product Weight (lbs.): 40
 Cubic Feet Per Carton: 17.75

	1	2	3	4	5	6	7	8	9	10	11	12
LX2426AC	1309	1419	1505	1632	1813	1898	2063	2326	2528	2752	3214	3708

OVERALL DIMENSIONS			SEAT DIMENSIONS			BACK DIMENSIONS	
W	D	H	W	D	H	W	H
26	27.75	36	19	19.5	19.5	19	18

RTA 00



Lounge Chair

COM Yardage: 8.50
 Freight Class: 250
 Product Weight (lbs.): 77
 Cubic Feet Per Carton: 30.25

	1	2	3	4	5	6	7	8	9	10	11	12
LX3433CH	2550	2824	3042	3370	3835	4055	4474	5146	5664	6239	7423	8686

OVERALL DIMENSIONS			SEAT DIMENSIONS			BACK DIMENSIONS	
W	D	H	W	D	H	W	H
35	34	33	-	-	-	-	-

RTA 00



Ottoman

COM Yardage: 2.5
 Freight Class: 250
 Product Weight (lbs.): 48
 Cubic Feet Per Carton: 18.25

	1	2	3	4	5	6	7	8	9	10	11	12
LX3636OTT	2435	2632	2692	2783	2917	2960	3077	3295	3400	3601	3878	4221

OVERALL DIMENSIONS			SEAT DIMENSIONS			BACK DIMENSIONS	
W	D	H	W	D	H	W	H
36	36	16	-	-	-	-	-

RTA 00

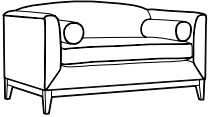
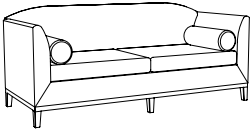

DESCRIPTION	FEATURES	MODEL#	STANDARD TEXTILE GRADES											
			1	2	3	4	5	6	7	8	9	10	11	12
 <p>Two Seat Sofa w/Cylindrical bolsters. COM Yardage: 12 Freight Class: 250 Product Weight (lbs.): 105 Cubic Feet Per Carton: 50.25</p>		LX6033S	2632	3018	3327	3788	4444	4751	5346	6293	7022	7833	9502	11283
			OVERALL DIMENSIONS			SEAT DIMENSIONS			BACK DIMENSIONS					
			W	D	H	W	D	H	W	H				
			61	34	33	20	18.5	18.5	20	16				
		RTA 00												
 <p>Three Seat Sofa w/Cylindrical bolsters. COM Yardage: 14.75 Freight Class: 300 Product Weight (lbs.): 125 Cubic Feet Per Carton: 66.25</p>		LX8033S	3788	4402	4745	5264	5993	6256	6896	8118	8705	9839	11378	13300
			OVERALL DIMENSIONS			SEAT DIMENSIONS			BACK DIMENSIONS					
			W	D	H	W	D	H	W	H				
			81	34	33	20	18.5	18.5	20	16				
		RTA 00												

ML™







model ML2630



STANDARD FEATURES

- Modern seating with a distinctive retro design.
- Features a steel tube frame, legs and arms.
- Fully upholstered continuous seat and back cushions.
- Standard with non marring, Black glides.
- Check textile availability prior to specifying upholstery material.

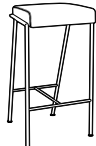
OPTIONAL FEATURES

- Available in five frame finish options. Please specify Chrome (**CHM**), Brushed Chrome (**BCH**), Black (**TBL**), Designer White (**TDW**) or Tungsten (**TTU**). No upcharge applies. Please specify.

DESCRIPTION	FEATURES	MODEL#	STANDARD TEXTILE GRADES											
			1	2	3	4	5	6	7	8	9	10	11	12
 <p>Counter Height Stool - 24" Seat Height COM Yardage: 1 Freight Class: 250 Product Weight (lbs.): 22 Cubic Feet Per Carton: 5.75</p>		ML171724	1463	1482	1497	1519	1548	1561	1589	1632	1663	1701	1776	1858
			OVERALL DIMENSIONS			SEAT DIMENSIONS			BACK DIMENSIONS					
			W	D	H	W	D	H	W	H				
			18	19	24	17	16	23	-	-				
			RTA 00											
 <p>Bar Height Stool - 30" Seat Height COM Yardage: 1 Freight Class: 250 Product Weight (lbs.): 23 Cubic Feet Per Carton: 8</p>		ML171730	1510	1527	1542	1561	1589	1598	1621	1666	1690	1731	1788	1860
			OVERALL DIMENSIONS			SEAT DIMENSIONS			BACK DIMENSIONS					
			W	D	H	W	D	H	W	H				
			18	20.5	30	17	16	29	-	-				
			RTA 00											
 <p>Bar Height Stool - 33" Seat Height COM Yardage: 1 Freight Class: 250 Product Weight (lbs.): 24 Cubic Feet Per Carton: 9</p>		ML171733	1539	1630	1644	1662	1687	1697	1721	1763	1784	1825	1879	1949
			OVERALL DIMENSIONS			SEAT DIMENSIONS			BACK DIMENSIONS					
			W	D	H	W	D	H	W	H				
			18	21.5	33	17	16	32	-	-				
			RTA 00											
 <p>Ottoman COM Yardage: 1.25 Freight Class: 150 Product Weight (lbs.): 28 Cubic Feet Per Carton: 5.75</p>		ML2121	1038	1121	1146	1183	1236	1254	1299	1386	1429	1508	1620	1757
			OVERALL DIMENSIONS			SEAT DIMENSIONS			BACK DIMENSIONS					
			W	D	H	W	D	H	W	H				
			21	21	17	-	-	-	-	-				
			RTA 00											

DESCRIPTION	FEATURES	MODEL#	STANDARD TEXTILE GRADES											
			1	2	3	4	5	6	7	8	9	10	11	12
 <p>Dining Chair COM Yardage: 1.75 Freight Class: 250 Product Weight (lbs.): 33 Cubic Feet Per Carton: 14.75</p>		ML2326	1219	1342	1391	1464	1568	1606	1696	1871	1955	2118	2338	2614
			OVERALL DIMENSIONS			SEAT DIMENSIONS			BACK DIMENSIONS					
			W	D	H	W	D	H	W	H				
			23.25	29.5	29.75	20	18.5	18.5	20	16				
			RTA 00											
 <p>Lounge Chair COM Yardage: 2.5 Freight Class: 250 Product Weight (lbs.): 54 Cubic Feet Per Carton: 21.25</p>		ML2630	1829	1997	2056	2149	2278	2325	2441	2658	2763	2966	3242	3584
			OVERALL DIMENSIONS			SEAT DIMENSIONS			BACK DIMENSIONS					
			W	D	H	W	D	H	W	H				
			26	34.5	35	23	20	18.5	18.5	20.5				
			RTA 00											

ML PARK



model ML4634CH



model ML8634

STANDARD FEATURES

- Armless modern lounge seating with a distinctive retro design.
- Features beautiful aluminum legs with Black glides.
- Fully upholstered continuous seat and back cushions with distinctive seams.
- Check textile availability prior to specifying upholstery material.

OPTIONAL FEATURES

- Optional fixed back cushion (FC) is available on lounge models with upcharge. Please specify. Model ML4634, add \$168. Model ML6634, add \$223. Model ML8634, add \$276.
- Available in five leg finish options. Specify: Black (TBL), Brushed Aluminum (BAL), Designer White (TDW), Polished Aluminum (ALU) or Tungsten (TTU). No upcharge applies.

DESCRIPTION	FEATURES	MODEL#	STANDARD TEXTILE GRADES											
-------------	----------	--------	-------------------------	--	--	--	--	--	--	--	--	--	--	--



Ottoman
COM Yardage: 1.50
Freight Class: 150
Product Weight (lbs.): 28
Cubic Feet Per Carton: 5.75

	1	2	3	4	5	6	7	8	9	10	11	12
ML2634	2015	2064	2102	2159	2240	2278	2352	2468	2557	2658	2865	3083

OVERALL DIMENSIONS			SEAT DIMENSIONS			BACK DIMENSIONS	
W	D	H	W	D	H	W	H
21	26.75	18.25	26.75	-	20	-	-

RTA 00



Lounge Chair
COM Yardage: 7.25
Freight Class: 250
Product Weight (lbs.): 54
Cubic Feet Per Carton: 21.25

	1	2	3	4	5	6	7	8	9	10	11	12
ML4634	3454	3669	3836	4086	4445	4610	4933	5449	5845	6286	7194	8164

OVERALL DIMENSIONS			SEAT DIMENSIONS			BACK DIMENSIONS	
W	D	H	W	D	H	W	H
26	34.5	35	42.75	22	19	27	13

RTA 00



Two Seat Sofa
COM Yardage: 7.50
Freight Class: 250
Product Weight (lbs.): 132
Cubic Feet Per Carton: 52

	1	2	3	4	5	6	7	8	9	10	11	12
ML6634	3729	4157	4351	4647	5065	5215	5580	6278	6615	7261	8142	9238

OVERALL DIMENSIONS			SEAT DIMENSIONS			BACK DIMENSIONS	
W	D	H	W	D	H	W	H
66	36	32	66	22	19	27	13

RTA 00

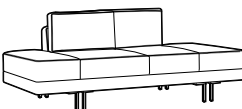

Three Seat Sofa
COM Yardage: 11
Freight Class: 250
Product Weight (lbs.): 132
Cubic Feet Per Carton: 52

	1	2	3	4	5	6	7	8	9	10	11	12
ML8634	4920	5496	5767	6171	6747	6953	7454	8414	8876	9766	10976	12487

OVERALL DIMENSIONS			SEAT DIMENSIONS			BACK DIMENSIONS	
W	D	H	W	D	H	W	H
66	36	32	86	22	19	52	13

RTA 00



ORION™



model 8481





model 8482

STANDARD FEATURES

- The clean, transitional Orion lounge collection provides a touch of sophistication with wood arm caps and matching legs.
- A full family of stylish products available in a lounge chair, two seater and three seater sofas as well as a coordinating ottoman.
- Standard with wood arm caps and wood legs made from maple solids and veneers. Available in all standard wood finishes.
- Standard with white glides.
- Check textile availability prior to specifying upholstery material.

OPTIONAL FEATURES

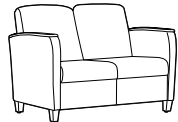
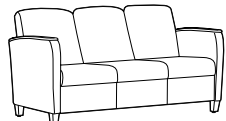
- Wood armcaps and wood legs available in Absolute (AAM), Black (BKM), Cherry (ACM), Espresso Cafe (ECM), English Oak (EOM), Fruitwood (TFM), Gray (HGM), Honey (AHM), Mahogany (TMM), Maple (AVM), Medium Walnut (MWM), Natural Walnut (NLW), Night (ASM), Noce Biondo (NBM), Noce Grigio (NGM), Noce Leggero (NEM), Noce Medio (NMM), Shaker Cherry (SKM), Walnut (TWM), WC Cream (WTM), White (WHM) and Winter Cherry (WCM). Please specify.
- Fully Upholstered armcaps are available (U). Please specify. No Upcharge.

DESCRIPTION	FEATURES	MODEL#	STANDARD TEXTILE GRADES												
			1	2	3	4	5	6	7	8	9	10	11	12	
 <p>Lounge Chair COM Yardage: 4.50 Freight Class: 250 Product Weight (lbs.): 68 Cubic Feet Per Carton: 22.75</p>			1483	1681	1778	1926	2134	2210	2393	2741	2909	3234	3672	4223	
		Wood armcaps													
		8481U	1483	1681	1778	1926	2134	2210	2393	2741	2909	3234	3672	4223	
		Upholstered arms													
		OVERALL DIMENSIONS	SEAT DIMENSIONS			BACK DIMENSIONS									
		W	D	H	W	D	H	W	H						
		29	31	34.5	21.5	19.5	17	21.5	20.5						
		RTA 00													
 <p>Two Seat Sofa COM Yardage: 6.75 Freight Class: 250 Product Weight (lbs.): 107 Cubic Feet Per Carton: 36</p>			1940	2252	2423	2681	3048	3180	3497	4110	4403	4971	5738	6701	
		Wood armcaps													
		8482U	1940	2252	2423	2681	3048	3180	3497	4110	4403	4971	5738	6701	
		Upholstered arms													
		OVERALL DIMENSIONS	SEAT DIMENSIONS			BACK DIMENSIONS									
		W	D	H	W	D	H	W	H						
		50	31	34.5	42.5	19.5	17	42.5	20.5						
		RTA 00													
 <p>Three Seat Sofa COM Yardage: 9.25 Freight Class: 250 Product Weight (lbs.): 140 Cubic Feet Per Carton: 50.75</p>			2455	2912	3182	3588	4162	4368	4871	5832	6293	7182	8395	9902	
		Wood armcaps													
		8483U	2455	2912	3182	3588	4162	4368	4871	5832	6293	7182	8395	9902	
		Upholstered arms													
		OVERALL DIMENSIONS	SEAT DIMENSIONS			BACK DIMENSIONS									
		W	D	H	W	D	H	W	H						
		71	31	34.5	63.5	19.5	17	63.5	20.5						
		RTA 00													
 <p>Ottoman COM Yardage: 1.5 Freight Class: 250 Product Weight (lbs.): 20 Cubic Feet Per Carton: 6</p>			581	673	722	796	902	939	1029	1204	1286	1451	1668	1945	
		OVERALL DIMENSIONS	SEAT DIMENSIONS			BACK DIMENSIONS									
		W	D	H	W	D	H	W	H						
			17	22	17	-	-	-	-	-					
		RTA 00													

PRAIRIE™



model 3481



model 3482

STANDARD FEATURES



- Featuring, gently barrel shaped arms that provide an attractive appearance.
- Fully upholstered. Tapered wood skirt and legs.
- Series includes lounge chair, two seat and three seat sofa.
- Check textile availability prior to specifying upholstery material.

OPTIONAL FEATURES

- Tapered wood legs are available in Absolute (AAM), Black (BKM), Cherry (ACM), Espresso Cafe (ECM), English Oak (EOM), Fruitwood (TFM), Gray (HGM), Honey (AHM), Mahogany (TMM), Maple (AVM), Medium Walnut (MWM), Natural Walnut (NLW), Night (ASM), Noce Biondo (NBM), Noce Grigio (NGM), Noce Leggero (NEM), Noce Medio (NMM), Shaker Cherry (SKM), Walnut (TWM), WC Cream (WTM), White (WHM) and Winter Cherry (WCM). Please specify. Genuine maple faced veneers and solids are used.

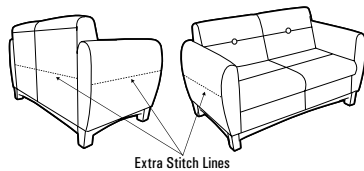
STITCH DETAIL WHEN UPHOLSTERED IN ALL LEATHER - ILLUSTRATIONS BELOW

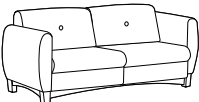

DESCRIPTION	FEATURES	MODEL#	STANDARD TEXTILE GRADES											
			1	2	3	4	5	6	7	8	9	10	11	12
 Lounge Chair COM Yardage: 4.25 Freight Class: 150 Product Weight (lbs.): 80 Cubic Feet Per Carton: 19.25		3481	1971	2140	2273	2471	2752	2852	3097	3568	3795	4228	4823	5560
			OVERALL DIMENSIONS			SEAT DIMENSIONS			BACK DIMENSIONS					
			W	D	H	W	D	H	W	H				
			32	29	30.5	21	19	16	21	14.5				
			RTA 00											
 Two Seat Sofa COM Yardage: 6.25 Freight Class: 250 Product Weight (lbs.): 106 Cubic Feet Per Carton: 41.25		3482	2797	3014	3187	3442	3811	3942	4260	4872	5161	5731	6501	7463
			OVERALL DIMENSIONS			SEAT DIMENSIONS			BACK DIMENSIONS					
			W	D	H	W	D	H	W	H				
			52.5	29	30.5	42	19	16	42	14.5				
			RTA 00											
 Three Seat Sofa COM Yardage: 9.5 Freight Class: 250 Product Weight (lbs.): 150 Cubic Feet Per Carton: 55.5		3483	3516	3820	4062	4425	4941	5183	5650	6394	6969	7606	8920	10321
			OVERALL DIMENSIONS			SEAT DIMENSIONS			BACK DIMENSIONS					
			W	D	H	W	D	H	W	H				
			73.5	29	30.5	63.5	19	16	63.5	14.5				
			RTA 00											

RIVER™



Sample Layout



Sample Layout

STANDARD FEATURES

- A modular seating series that is composed of modular linking units in straight, curved and corner units. Soft seating models are available with standard height, high and extended high backs. All linking units can be used together in any combination to create a wide variety of layouts.
- The unique tapered legs (swaged legs) are made of welded steel, heavy duty construction, with each leg bolted directly to the frame. The extremely robust construction insures trouble free performance in any environment. All units except for the Laptop Tables have the same leg height of 6.5". The leg height makes it easier to clean under the product.
- Each leg is standard with adjustable black leveling glides and are non-marking. Wood legs and casters are not available.
- All cushions are fixed and non-removable (cushions will not migrate). Perimeter seams feature a decorative single stitch detail, which makes seams lay flat and adds extra seam strength.
- Seating frames are heavy duty with interlocking plywood, puzzle box construction, made for rugged active environments. Seats are high density with highly resilient foam and are equipped with a synthetic rubberized webbing suspension system for extra comfort.
- Front edge or face of the seat, angles slightly inward, so feet have freedom of movement and shoe heels don't rub on the seat. This inward slanting matches the inward angles of the back. Benches and connecting end tables also reflect the inward angles on the front and back faces, so all units coordinate in visual appearance.
- For use in high traffic applications as well as 24/7 environments or for models with 600 lb. standard weight capacity, clean out space between seat and back and /or modular arms, please see the River+ series.
- Most units can be ganged together with a quick connect, disconnect feature. Ganging hardware is standard and is factory installed. Ganging hardware swivels out of sight when not in use.

OPTIONAL FEATURES

- Most tables and seating units can be specified with Power/USB terminals, which includes two power outlets, two double USB terminals and a black 60" three-prong power cord. Each Power/USB module is set in predetermined locations, as shown in the electrical illustrations below. Electrical units must be factory installed.
- To add a Power/USB module: From the electrical illustrations below, please specify **J1, W1, J2, W2, J3, W4, J4, W4, J6, W6** after the product model number. Please note on seating units, if both right and left locations are required, add both **J1/J3** or **W1/W3** to the model number. Add \$875 for each module/location required.
- Power/USB modules are available with either Jet Black (**J**) face plate with black Power/USB receptacles or with a White (**W**) face plate with white Power/USB receptacles.
- Tables are made with high pressure laminate and are offered in the following finishes: Absolute Acajou (**ACJ**), Asian Night (**ASN**), Avant Cherry (**AWC**), Avant Honey (**AWH**), Clear Maple (**CMB**), Dark Espresso (**DES**), Designer White (**DWT**), Hayden Grey (**HGT**), Noce Biondo (**NBL**), Noce Grigio (**NGL**), Noce Leggero (**NEL**), Noce Medio (**NML**), Quartered Mahogany (**QTM**), Tiger Walnut (**TWL**), Walnut Heights (**WHE**), White Chocolate (**WHC**) and Winter Cherry (**WCR**). Please Specify. Custom High Pressure laminate finishes will be considered upon request.
- **Seating and Table Leg Finish**
(CHM) Chrome **(TBL)** Black
(TDW) Designer White **(TFO)** Fog
(TFR) Frost **(TIV)** Cloud
(TLA) Latte **(TMO)** Mocha
(TNE) Nevada **(TOA)** Toast
(TSH) Shadow **(TSN)** Sand
(TTU) Tungsten **(TKA)** Kalua
- Check textile availability prior to specifying upholstery material. Leather not available on River series.
- If more than one fabric or a fabric/vinyl combination is required, please fill out a "Seating Multiple Textile" form, specifying each fabric location. Please contact Customer Care for more information.

ELECTRICAL PLACEMENT

Soft Seating

Locations available on left side J1 (black) or W1 (white), right side J3 (black), or W3 (white) or both sides J1/J3 (black) or W1/W3 (white).

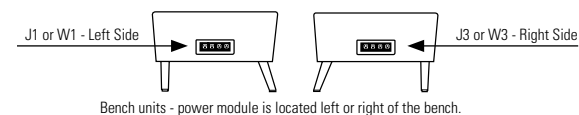
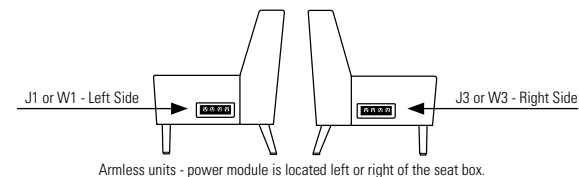
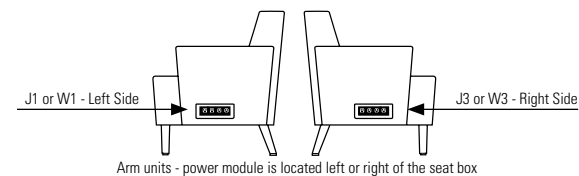

Coffee/End Tables

Primary location is on the top of the unit, centered J2 (black) or W2 (white). Secondary Location is end/side of the unit J1 (black) or W1 (white).

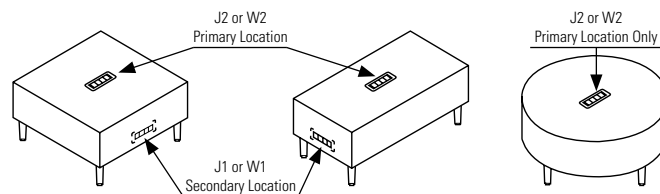

Primary location is on the top rear/edge of the unit J4 (black) or W4 (white). Secondary Location is the back side of the unit J6 (black) or W6 (white).

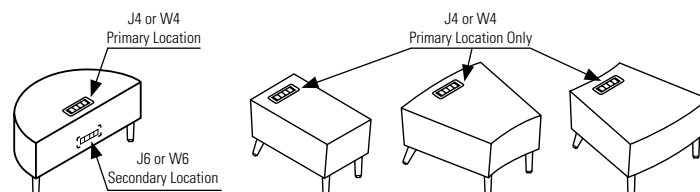

SAMPLE LAYOUTS

RVR101 (Layout 1)

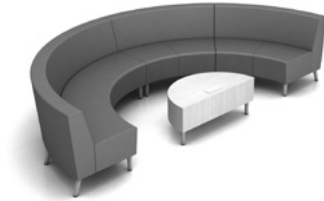

Qty	Model Number	Description	Dimensions	List Price
4	7710NA	Armless IS Curve - Two Seat - Standard Back	55 x 29.5 x 32	3016 x 4
1	7737W6	42" Half Round Laminate Coffee Table w/ W6 Rear Power/USB Module	42 x 21 x 17 upcharge	1281 825

SAMPLE LAYOUT TOTAL (Starting at Grade 1) \$14,170

RVR102 (Layout 2)



Qty	Model Number	Description	Dimensions	List Price
8	7714NA	Armless OS Curve - Two Seater - High Back	54 x 29.5 x 41.5	3597 x 8

SAMPLE LAYOUT TOTAL (Starting at Grade 1) \$28,776

RVR103 (Layout 3)

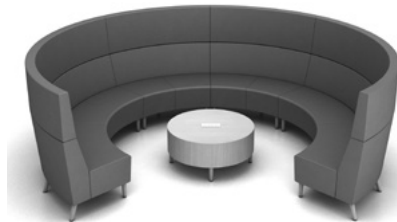

Qty	Model Number	Description	Dimensions	List Price
6	7712NA	Armless IS Curve - Two Seater - Extended Back	55 x 29.5 x 47	4215 x 6
1	7734W2	36" Dia - Round Laminate Coffee Table w/ W2 Center Power/USB Module	36 x 36 x 17 upcharge	1492 825

SAMPLE LAYOUT TOTAL (Starting at Grade 1) \$27,607

RVR104 (Layout 4)



Qty	Model Number	Description	Dimensions	List Price
2	7712NA	Armless IS Curve - Two Seater - Extended Back	55 x 29.5 x 47	4215 x 2
2	7712NAW3	Armless IS Curve - Two Seater - Extended Back w/ W3 Right Power/USB Module	55 x 29.5 x 47 upcharge	4215 x 2 825 x 2
2	7726	IS Curve - Two Seater Bench	54 x 28 x 17.5	2560 x 2
1	7734	36" Dia - Round Laminate Coffee Table	36 x 36 x 17	1492

SAMPLE LAYOUT TOTAL (Starting at Grade 1) \$25,122

RVR105 (Layout 5)



Qty	Model Number	Description	Dimensions	List Price
3	7711NA	Armless IS Curve - Two Seater - High Back	55 x 29.5 x 41.5	3830 x 3
3	7712NAW3	Armless IS Curve - Two Seater - Extended Back w/ W3 Right Power/USB Module	55 x 29.5 x 47 upcharge	4215 x 3 825 x 2
1	7738	Rectangular Laminate End Table	15 x 27.25 x 17	1212
2	7743	18" Dia. Round Laminate Laptop Table	18 x 18 x 25.25	733 x 2

SAMPLE LAYOUT TOTAL (Starting at Grade 1) \$28,463

SAMPLE LAYOUTS

RVR106 (Layout 6)



Qty	Model Number	Description	Dimensions	List Price
1	7709R	Three Seater - Extended Back w/Right Arm	75 x 29.5 x 47	5739
1	7709L	Three Seater - Extended Back w/Left Arm	75 x 29.5 x 47	5739
1	7718	Armless Corner Unit - Extended Back	38 x 38 x 47	4943
1	7732W2	36" Square Laminate Coffee Table w/ W2 Center Power/USB Module	36 x 36 x 17 upcharge	1367 825

SAMPLE LAYOUT TOTAL (Starting at Grade 1) \$18,613

RVR107 (Layout 7)



Qty	Model Number	Description	Dimensions	List Price
1	7704NA	Armless Two Seater - Standard. Back	75x 29.5 x 47	2611
2	7716	Armless Corner Unit - Standard. Back	75 x 29.5 x 47	3685 x 2
1	7725	Two Seater Bench	75x 29.5 x 47	1885
1	7728	Square Single Seater Bench	75 x 29.5 x 17.5	1288
1	7731	30" Square Laminate Coffee Table	75 x 30 x 47	1203

SAMPLE LAYOUT TOTAL (Starting at Grade 1) \$14,357

RVR108 (Layout 8)



Qty	Model Number	Description	Dimensions	List Price
2	7708NAW3	Armless Three Seater - High Back w/ W3 Right Power/USB Module	75 x 29.5 x 41.5 upcharge	4949 x 2 825 x 2
2	7708NAW1	Armless Three Seater - High Back w/ W1 Left Power/USB Module	72.5 x 29.5 x 41.5 upcharge	4949 x 2 825 x 2
2	7745	16" Square Laminate Laptop Table	16 x 16 x 25.25	750 x 2

SAMPLE LAYOUT TOTAL (Starting at Grade 1) \$24,596

RVR109 (Layout 9)



Qty	Model Number	Description	Dimensions	List Price
2	7702	Lounge Chair - High Back w/Arms	29.5 x 29.5 x 41.5	2792 x 2
1	7708NAW1	Armless Three Seater - High Back w/ W1 Left Power/USB Module	72.5 x 29.5 x 41.5 upcharge	4949 825
1	7708NAW3	Armless Three Seater - High Back w/ W3 Right Power/USB Module	72.5 x 29.5 x 41.5 upcharge	4949 825
1	7733	Rectangular Laminate Coffee Table	40 x 20 x 17	1209

SAMPLE LAYOUT TOTAL (Starting at Grade 1) \$18,341

RVR110 (Layout 10)



Qty	Model Number	Description	Dimensions	List Price
1	7705NAW3	Armless Two Seater - High Back w/ W3 Right Power/USB Module	48.5 x 29.5 x 41.5 upcharge	3200 825
1	7705NAW1	Armless Two Seater - High Back w/ W1 Left Power/USB Module	48.5 x 29.5 x 41.5 upcharge	3200 825
1	7708NA	Armless Three Seater - High Back	72.5 x 29.5 x 41.5	4949
1	7708NAW3	Armless Three Seater - High Back w/ W3 Right Power/USB Module	72.5 x 29.5 x 41.5 upcharge	4949 825
1	7708NAW1	Armless Three Seater - High Back w/ W1 Left Power/USB Module	72.5 x 29.5 x 41.5 upcharge	4949 825
2	7717	Armless Corner Unit - High Back	38 x 38 x 41.5	4667 x 2
3	7745	16" Square Laminate Laptop Table	16 x 16 x 25.25	750 x 3

SAMPLE LAYOUT TOTAL (Starting at Grade 1) \$36,131

DESCRIPTION	FEATURES	MODEL#	STANDARD TEXTILE GRADES		
RVR111 (Layout 11) 	Qty	Model Number	Description	Dimensions	List Price
	2	7701NA	Armless One Seater - Standard Back	24.5 x 29.5x 32	1673 x 2
	4	7710NA	Armless IS Curve - Two Seat - Standard Back	55 x 29.5 x 32	3016 x 4
	2	7743	18" Dia. Round Laminate Laptop Table	18 x 18 x 25.25	733 x 2
SAMPLE LAYOUT TOTAL (Starting at Grade 1)					\$16,876

RVR112 (Layout 12) 	Qty	Model Number	Description	Dimensions	List Price
	2	7711NA	Armless IS Curve - Two Seater - High Back	55 x 29.5 x 41.5	3830 x 2
	6	7712NA	Armless IS Curve - Two Seater - Extended Back	55 x 29.5 x 47	4215 x 6
	1	7709NA	Armless Three Seater - Extended Back	72.5 x 29.5 x 47	5357
	2	7734	36" Dia - Round Laminate Coffee Table	36 x 36 x 17	1492 x 2
SAMPLE LAYOUT TOTAL (Starting at Grade 1)					\$41,291

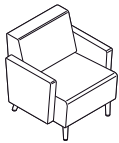

Lounge Chair - Standard Back w/Arms
 COM Yardage: 4
 Freight Class: 250
 Product Weight (lbs.): 57
 Cubic Feet Per Carton: 22.5

For Power/USB module please see electrical placement chart. No ganging hardware.

	1	2	3	4	5	6	7	8	9	10	11	12
7701	2436	2583	2698	2872	3118	3206	3421	3831	4028	4408	4926	5572

OVERALL DIMENSIONS			SEAT DIMENSIONS			BACK DIMENSIONS	
W	D	H	W	D	H	W	H
29.5	29.5	32	24	19	18	24	14

RTA 00

	1	2	3	4	5	6	7	8	9	10	11	12
7701L	2060	2182	2276	2417	2615	2687	2862	3196	3356	3665	4086	4610
7701R	2060	2182	2276	2417	2615	2687	2862	3196	3356	3665	4086	4610

OVERALL DIMENSIONS			SEAT DIMENSIONS			BACK DIMENSIONS	
W	D	H	W	D	H	W	H
27	29.5	32	24	19	18	24	14

RTA 00

	1	2	3	4	5	6	7	8	9	10	11	12
7701NA	1673	1768	1839	1948	2102	2158	2293	2547	2672	2909	3233	3636

OVERALL DIMENSIONS			SEAT DIMENSIONS			BACK DIMENSIONS	
W	D	H	W	D	H	W	H
24.5	29.5	32	24	19	18	24	14

RTA 00

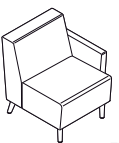

7701L (Left Arm)

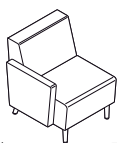

7701R (Right Arm)

Lounge Chair - Standard w/One Arm
 COM Yardage: 2.25
 Freight Class: 250
 Product Weight (lbs.): 47
 Cubic Feet Per Carton: 22.5

For Power/USB module please see electrical placement chart. Includes ganging hardware (1 side).

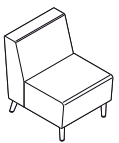

Armless Lounge Chair - Standard Back
 COM Yardage: 2.5
 Freight Class: 300
 Product Weight (lbs.): 37
 Cubic Feet Per Carton: 22.5

For Power/USB module please see electrical placement chart. Includes ganging hardware (2 sides).

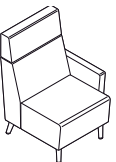
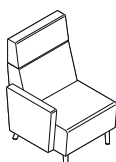
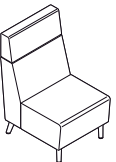
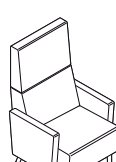
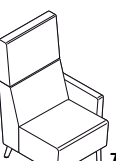
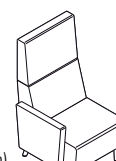
DESCRIPTION	FEATURES	MODEL#	STANDARD TEXTILE GRADES											
			1	2	3	4	5	6	7	8	9	10	11	12
 <p>Lounge Chair - High Back w/Arms COM Yardage: 4.5 Freight Class: 250 Product Weight (lbs.): 61 Cubic Feet Per Carton: 28.25</p>	<p>For Power/USB module please see electrical placement chart. No ganging hardware.</p>	7702	2792	2958	3089	3284	3560	3659	3900	4362	4585	5014	5595	6320
		OVERALL DIMENSIONS			SEAT DIMENSIONS			BACK DIMENSIONS						
		W	D	H	W	D	H	W	H					
		29.5	29.5	41.5	24	19	18	24	24					
			RTA 00											
  <p>7702L (Left Arm) 7702R (Right Arm)</p> <p>Lounge Chair - High Back w/One Arm COM Yardage: 4.5 Freight Class: 250 Product Weight (lbs.): 61 Cubic Feet Per Carton: 28.25</p>	<p>For Power/USB module please see electrical placement chart. Includes ganging hardware (1 side).</p>	7702L	2415	2553	2662	2826	3056	3138	3339	3722	3908	4266	4751	5356
		7702R	2415	2553	2662	2826	3056	3138	3339	3722	3908	4266	4751	5356
		OVERALL DIMENSIONS			SEAT DIMENSIONS			BACK DIMENSIONS						
		W	D	H	W	D	H	W	H					
			29.5	29.5	41.5	24	19	18	24	24				
			RTA 00											
 <p>Armless Lounge Chair - High Back COM Yardage: 3 Freight Class: 300 Product Weight (lbs.): 41 Cubic Feet Per Carton: 28.25</p>	<p>For Power/USB module please see electrical placement chart. Includes ganging hardware (2 sides).</p>	7702NA	2030	2143	2229	2358	2542	2608	2770	3079	3226	3512	3900	4385
		OVERALL DIMENSIONS			SEAT DIMENSIONS			BACK DIMENSIONS						
		W	D	H	W	D	H	W	H					
		24.5	29.5	41.5	24	19	18	24	24					
			RTA 00											
 <p>Lounge Chair - Extended Back w/Arms COM Yardage: 4.75 Freight Class: 250 Product Weight (lbs.): 68 Cubic Feet Per Carton: 32.75</p>	<p>For Power/USB module please see electrical placement chart. No ganging hardware.</p>	7703	3235	3408	3546	3753	4045	4149	4404	4891	5127	5578	6191	6957
		OVERALL DIMENSIONS			SEAT DIMENSIONS			BACK DIMENSIONS						
		W	D	H	W	D	H	W	H					
		29.5	29.5	47	24	19	18	24	29					
			RTA 00											
  <p>7703L (Left Arm) 7703R (Right Arm)</p> <p>Lounge Chair - Extended Back w/One Arm COM Yardage: 4 Freight Class: 300 Product Weight (lbs.): 58 Cubic Feet Per Carton: 32.75</p>	<p>For Power/USB module please see electrical placement chart. Includes ganging hardware (1 side).</p>	7703L	2859	3005	3121	3295	3538	3627	3840	4252	4449	4830	5346	5994
		7703R	2859	3005	3121	3295	3538	3627	3840	4252	4449	4830	5346	5994
		OVERALL DIMENSIONS			SEAT DIMENSIONS			BACK DIMENSIONS						
		W	D	H	W	D	H	W	H					
			29.5	29.5	47	24	19	18	24	29				
			RTA 00											

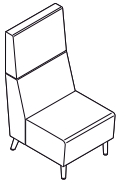
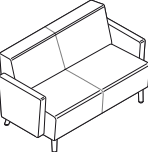
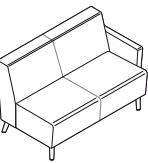
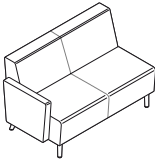
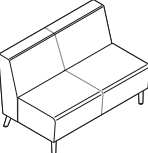
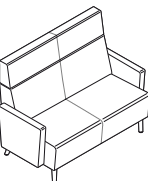
DESCRIPTION	FEATURES	MODEL#	STANDARD TEXTILE GRADES												
			1	2	3	4	5	6	7	8	9	10	11	12	
 <p>Armless Lounge Chair - Extended Back COM Yardage: 3.25 Freight Class: 300 Product Weight (lbs.): 48 Cubic Feet Per Carton: 32.75</p>	<p>For Power/USB module please see electrical placement chart. Includes ganging hardware (2 sides).</p>	7703NA	2474	2594	2689	2830	3029	3101	3276	3607	3769	4077	4499	5023	
		OVERALL DIMENSIONS			SEAT DIMENSIONS			BACK DIMENSIONS							
		W	D	H	W	D	H	W	H						
		24.5	29.5	47	24	19	18	24	29						
			RTA 00												
 <p>Two Seater - Standard Back w/Arms COM Yardage: 5.5 Freight Class: 250 Product Weight (lbs.): 95 Cubic Feet Per Carton: 39</p>	<p>For Power/USB module please see electrical placement chart. No ganging hardware.</p>	7704	3366	3567	3725	3963	4302	4422	4718	5283	5553	6077	6787	7675	
		OVERALL DIMENSIONS			SEAT DIMENSIONS			BACK DIMENSIONS							
		W	D	H	W	D	H	W	H						
		53.5	29.5	32	48	19	18	48	14						
			RTA 00												
 <p>7704L (Left Arm)</p>  <p>7704R (Right Arm)</p> <p>Two Seater - Standard Back w/One Arm COM Yardage: 4.75 Freight Class: 300 Product Weight (lbs.): 85 Cubic Feet Per Carton: 39</p>	<p>For Power/USB module please see electrical placement chart. Includes ganging hardware (1 side).</p>	7704L	2995	3169	3307	3514	3805	3910	4165	4652	4887	5339	5953	6719	
		7704R	2995	3169	3307	3514	3805	3910	4165	4652	4887	5339	5953	6719	
		OVERALL DIMENSIONS			SEAT DIMENSIONS			BACK DIMENSIONS							
		W	D	H	W	D	H	W	H						
51	29.5	32	48	19	18	48	14								
			RTA 00												
 <p>Armless Two Seater - Standard Back COM Yardage: 4.25 Freight Class: 300 Product Weight (lbs.): 75 Cubic Feet Per Carton: 39</p>	<p>For Power/USB module please see electrical placement chart. Includes ganging hardware (2 sides).</p>	7704NA	2611	2769	2893	3077	3337	3430	3658	4094	4304	4709	5259	5944	
		OVERALL DIMENSIONS			SEAT DIMENSIONS			BACK DIMENSIONS							
		W	D	H	W	D	H	W	H						
		48.5	29.5	32	48	19	18	48	14						
			RTA 00												
 <p>Two Seater - High Back w/Arms COM Yardage: 6.5 Freight Class: 300 Product Weight (lbs.): 97 Cubic Feet Per Carton: 54</p>	<p>For Power/USB module please see electrical placement chart. No ganging hardware.</p>	7705	3962	4201	4388	4671	5068	5212	5562	6229	6549	7167	8009	9056	
		OVERALL DIMENSIONS			SEAT DIMENSIONS			BACK DIMENSIONS							
		W	D	H	W	D	H	W	H						
		53.5	29.5	41.5	48	19	18	48	24						
			RTA 00												

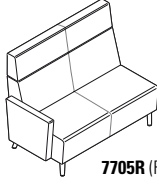
DESCRIPTION	FEATURES	MODEL#	STANDARD TEXTILE GRADES											
			1	2	3	4	5	6	7	8	9	10	11	12
 7705L (Left Arm)	 7705R (Right Arm)													
		7705L	3584	3794	3959	4208	4561	4688	4997	5587	5872	6418	7163	8089
			OVERALL DIMENSIONS			SEAT DIMENSIONS			BACK DIMENSIONS					
			W	D	H	W	D	H	W	H				
Two Seater - High Back w/One Arm COM Yardage: 5.75 Freight Class: 300 Product Weight (lbs.): 87 Cubic Feet Per Carton: 54			For Power/USB module please see electrical placement chart. Includes ganging hardware (1 side).			51	29.5	41.5	48	19	18	48	24	
			RTA 00											

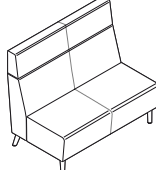
DESCRIPTION	FEATURES	MODEL#	STANDARD TEXTILE GRADES											
			1	2	3	4	5	6	7	8	9	10	11	12
 7705NA														
	7705NA	3200	3392	3545	3773	4094	4212	4493	5031	5291	5789	6468	7315	
			OVERALL DIMENSIONS			SEAT DIMENSIONS			BACK DIMENSIONS					
			W	D	H	W	D	H	W	H				
Armless Two Seater - High Back COM Yardage: 5.25 Freight Class: 300 Product Weight (lbs.): 77 Cubic Feet Per Carton: 54			For Power/USB module please see electrical placement chart. Includes ganging hardware (2 sides).			48.5	29.5	41.5	48	19	18	48	24	
			RTA 00											

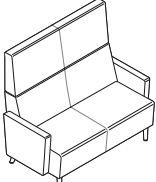
DESCRIPTION	FEATURES	MODEL#	STANDARD TEXTILE GRADES											
			1	2	3	4	5	6	7	8	9	10	11	12
 7706														
	7706	4181	4438	4639	4944	5373	5529	5903	6619	6966	7634	8538	9666	
			OVERALL DIMENSIONS			SEAT DIMENSIONS			BACK DIMENSIONS					
			W	D	H	W	D	H	W	H				
Two Seater - Extended Back w/Arms COM Yardage: 7 Freight Class: 300 Product Weight (lbs.): 107 Cubic Feet Per Carton: 56.75			For Power/USB module please see electrical placement chart. No ganging hardware.			53.5	29.5	47	48	19	18	48	29	
			RTA 00											

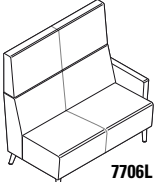
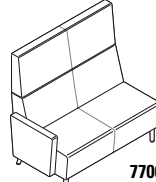
DESCRIPTION	FEATURES	MODEL#	STANDARD TEXTILE GRADES											
			1	2	3	4	5	6	7	8	9	10	11	12
 7706L (Left Arm)	 7706R (Right Arm)													
		7706L	3803	4030	4212	4482	4866	5001	5338	5981	6288	6885	7692	8700
			OVERALL DIMENSIONS			SEAT DIMENSIONS			BACK DIMENSIONS					
			W	D	H	W	D	H	W	H				
Two Seater - Extended Back w/One Arm COM Yardage: 6.25 Freight Class: 300 Product Weight (lbs.): 97 Cubic Feet Per Carton: 56.75			For Power/USB module please see electrical placement chart. Includes ganging hardware (1 side).			51	29.5	47	48	19	18	48	29	
			RTA 00											

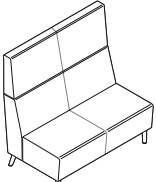
DESCRIPTION	FEATURES	MODEL#	STANDARD TEXTILE GRADES											
			1	2	3	4	5	6	7	8	9	10	11	12
 7706NA														
	7706NA	3416	3627	3793	4041	4396	4522	4832	5420	5705	6252	6996	7924	
			OVERALL DIMENSIONS			SEAT DIMENSIONS			BACK DIMENSIONS					
			W	D	H	W	D	H	W	H				
Armless Two Seater - Extended Back COM Yardage: 5.75 Freight Class: 300 Product Weight (lbs.): 87 Cubic Feet Per Carton: 56.75			For Power/USB module please see electrical placement chart. Includes ganging hardware (2 sides).			48.5	29.5	47	48	19	18	48	29	
			RTA 00											

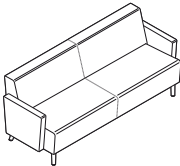
DESCRIPTION	FEATURES	MODEL#	STANDARD TEXTILE GRADES													
			1	2	3	4	5	6	7	8	9	10	11	12		
 <p>Three Seater - Standard Back w/Arms COM Yardage: 8.25 Freight Class: 250 Product Weight (lbs.): 139 Cubic Feet Per Carton: 55.5</p>	<p>For Power/USB module please see electrical placement chart. No ganging hardware.</p>	7707	5005	5304	5545	5902	6408	6589	7032	7880	8287	9072	10140	11469		
		OVERALL DIMENSIONS			SEAT DIMENSIONS			BACK DIMENSIONS								
		W	D	H	W	D	H	W	H							
			77.5	29.5	32	72	19	18				72	14			
			RTA 00													

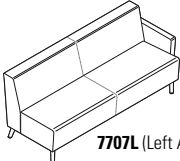
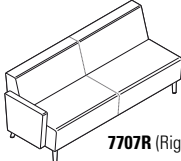
DESCRIPTION	FEATURES	MODEL#	STANDARD TEXTILE GRADES													
			1	2	3	4	5	6	7	8	9	10	11	12		
 <p>7707L (Left Arm)</p>	 <p>7707R (Right Arm)</p>	7707L	4630	4911	5136	5471	5946	6119	6534	7328	7711	8449	9451	10701		
		7707R	4630	4911	5136	5471	5946	6119	6534	7328	7711	8449	9451	10701		
		OVERALL DIMENSIONS			SEAT DIMENSIONS			BACK DIMENSIONS								
			W	D	H	W	D	H	W	H						
			75	29.5	32	72	19	18				72	14			
			RTA 00													

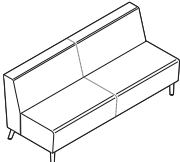
DESCRIPTION	FEATURES	MODEL#	STANDARD TEXTILE GRADES													
			1	2	3	4	5	6	7	8	9	10	11	12		
 <p>Armless Three Seater - Standard Back COM Yardage: 7 Freight Class: 250 Product Weight (lbs.): 119 Cubic Feet Per Carton: 55.5</p>	<p>For Power/USB module please see electrical placement chart. Includes ganging hardware (2 sides).</p>	7707NA	4244	4502	4703	5008	5438	5590	5967	6685	7031	7697	8602	9731		
		OVERALL DIMENSIONS			SEAT DIMENSIONS			BACK DIMENSIONS								
		W	D	H	W	D	H	W	H							
			72.5	29.5	32	72	19	18				72	14			
			RTA 00													

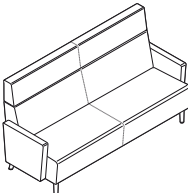
DESCRIPTION	FEATURES	MODEL#	STANDARD TEXTILE GRADES													
			1	2	3	4	5	6	7	8	9	10	11	12		
 <p>Three Seater - High Back w/Arms COM Yardage: 10.5 Freight Class: 250 Product Weight (lbs.): 148 Cubic Feet Per Carton: 69.75</p>	<p>For Power/USB module please see electrical placement chart. No ganging hardware.</p>	7708	5705	6086	6389	6845	7488	7721	8283	9361	9879	10878	12237	13930		
		OVERALL DIMENSIONS			SEAT DIMENSIONS			BACK DIMENSIONS								
		W	D	H	W	D	H	W	H							
			77.5	29.5	41.5	72	19	18				72	24			
			RTA 00													

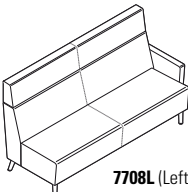
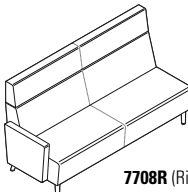
DESCRIPTION	FEATURES	MODEL#	STANDARD TEXTILE GRADES													
			1	2	3	4	5	6	7	8	9	10	11	12		
 <p>7708L (Left Arm)</p>	 <p>7708R (Right Arm)</p>	7708L	5334	5690	5972	6393	6991	7208	7730	8730	9211	10139	11401	12974		
		7708R	5334	5690	5972	6393	6991	7208	7730	8730	9211	10139	11401	12974		
		OVERALL DIMENSIONS			SEAT DIMENSIONS			BACK DIMENSIONS								
			W	D	H	W	D	H	W	H						
			75	29.5	41.5	72	19	18				72	24			
			RTA 00													

DESCRIPTION FEATURES MODEL# STANDARD TEXTILE GRADES

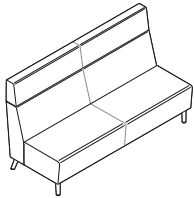

Armless Three Seater - High Back
 COM Yardage: 9.25
 Freight Class: 300
 Product Weight (lbs.): 126
 Cubic Feet Per Carton: 69.75

For Power/USB module please see electrical placement chart. Includes ganging hardware (2 sides).

MODEL#	1	2	3	4	5	6	7	8	9	10	11	12
7708NA	4949	5288	5554	5955	6523	6727	7223	8174	8630	9509	10705	12199

OVERALL DIMENSIONS			SEAT DIMENSIONS			BACK DIMENSIONS	
W	D	H	W	D	H	W	H
72.5	29.5	41.5	72	19	18	72	24

RTA 00

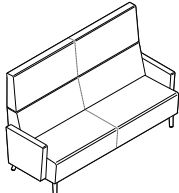

Three Seater - Extended Back w/Arms
 COM Yardage: 11
 Freight Class: 300
 Product Weight (lbs.): 144
 Cubic Feet Per Carton: 78.75

For Power/USB module please see electrical placement chart. No ganging hardware.

MODEL#	1	2	3	4	5	6	7	8	9	10	11	12
7709	6120	6520	6837	7315	7990	8233	8823	9951	10494	11542	12965	14738

OVERALL DIMENSIONS			SEAT DIMENSIONS			BACK DIMENSIONS	
W	D	H	W	D	H	W	H
77.5	29.5	47	72	19	18	72	29

RTA 00



7709L (Left Arm)

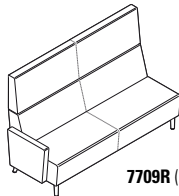

7709R (Right Arm)

Three Seater - Extended Back w/One Arm
 COM Yardage: 10.5
 Freight Class: 300
 Product Weight (lbs.): 134
 Cubic Feet Per Carton: 78.75

For Power/USB module please see electrical placement chart. Includes ganging hardware (1 side).

MODEL#	1	2	3	4	5	6	7	8	9	10	11	12
7709L	5739	6122	6424	6880	7525	7756	8321	9396	9913	10913	12271	13964
7709R	5739	6122	6424	6880	7525	7756	8321	9396	9913	10913	12271	13964

OVERALL DIMENSIONS			SEAT DIMENSIONS			BACK DIMENSIONS	
W	D	H	W	D	H	W	H
75	29.5	47	72	19	18	72	29

RTA 00

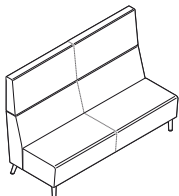

Armless Three Seater - Extended Back
 COM Yardage: 9.75
 Freight Class: 300
 Product Weight (lbs.): 124
 Cubic Feet Per Carton: 78.75

For Power/USB module please see electrical placement chart. Includes ganging hardware (2 sides).

MODEL#	1	2	3	4	5	6	7	8	9	10	11	12
7709NA	5357	5710	5995	6414	7013	7229	7751	8753	9234	10161	11424	12997

OVERALL DIMENSIONS			SEAT DIMENSIONS			BACK DIMENSIONS	
W	D	H	W	D	H	W	H
72.5	29.5	47	72	19	18	72	29

RTA 00

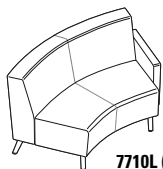

7710L (Left Arm)

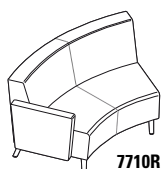

7710R (Right Arm)

IS Curve - Two Seater - Standard Back w/One Arm
 COM Yardage: 5.25
 Freight Class: 250
 Product Weight (lbs.): 88
 Cubic Feet Per Carton: 43

For Power/USB module please see electrical placement chart. Includes ganging hardware (1 side).

MODEL#	1	2	3	4	5	6	7	8	9	10	11	12
7710L	3403	3596	3748	3976	4297	4414	4697	5233	5494	5992	6670	7518
7710R	3403	3596	3748	3976	4297	4414	4697	5233	5494	5992	6670	7518

OVERALL DIMENSIONS			SEAT DIMENSIONS			BACK DIMENSIONS	
W	D	H	W	D	H	W	H
57	29.5	32	42	19	18	51	14

RTA 00

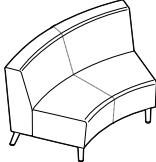
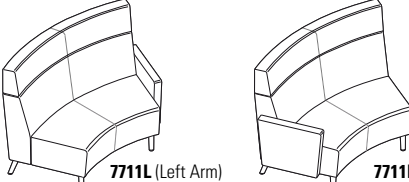
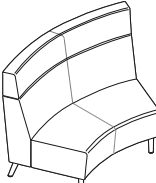
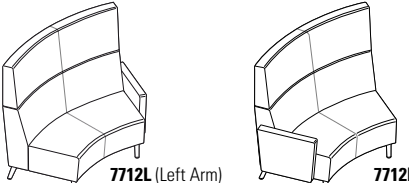
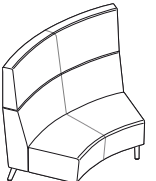
DESCRIPTION	FEATURES	MODEL#	STANDARD TEXTILE GRADES													
			1	2	3	4	5	6	7	8	9	10	11	12		
 <p>Armless IS Curve - Two Seat - Standard Back COM Yardage: 4.5 Freight Class: 300 Product Weight (lbs.): 78 Cubic Feet Per Carton: 43</p>	<p>For Power/USB module please see electrical placement chart. Includes ganging hardware (2 sides).</p>	7710NA	3016	3180	3310	3506	3783	3880	4124	4584	4807	5235	5817	6542		
		OVERALL DIMENSIONS			SEAT DIMENSIONS			BACK DIMENSIONS								
		W	D	H	W	D	H	W	H							
		55	29.5	32	42	19	18	51	14							
			RTA 00													
 <p>IS Curve - Two Seater - High Back w/One Arm COM Yardage: 6.5 Freight Class: 300 Product Weight (lbs.): 94 Cubic Feet Per Carton: 54</p>	<p>For Power/USB module please see electrical placement chart. Includes ganging hardware (1 side).</p>	7711L	4215	4452	4638	4920	5320	5464	5813	6479	6801	7419	8258	9309		
		7711R	4215	4452	4638	4920	5320	5464	5813	6479	6801	7419	8258	9309		
		OVERALL DIMENSIONS			SEAT DIMENSIONS			BACK DIMENSIONS								
		W	D	H	W	D	H	W	H							
			RTA 00													
 <p>Armless IS Curve - Two Seater - High Back COM Yardage: 6 Freight Class: 300 Product Weight (lbs.): 84 Cubic Feet Per Carton: 54</p>	<p>For Power/USB module please see electrical placement chart. Includes ganging hardware (2 sides).</p>	7711NA	3830	4050	4224	4483	4852	4986	5307	5925	6217	6790	7566	8534		
		OVERALL DIMENSIONS			SEAT DIMENSIONS			BACK DIMENSIONS								
		W	D	H	W	D	H	W	H							
		55	29.5	41.5	42	19	18	51	24							
			RTA 00													
 <p>IS Curve - Two Seater - Extended Back w/One Arm COM Yardage: 7 Freight Class: 300 Product Weight (lbs.): 99 Cubic Feet Per Carton: 62.75</p>	<p>For Power/USB module please see electrical placement chart. Includes ganging hardware (1 side).</p>	7712L	4599	4855	5057	5361	5791	5944	6320	7039	7384	8051	8956	10084		
		7712R	4599	4855	5057	5361	5791	5944	6320	7039	7384	8051	8956	10084		
		OVERALL DIMENSIONS			SEAT DIMENSIONS			BACK DIMENSIONS								
		W	D	H	W	D	H	W	H							
			RTA 00													
 <p>Armless IS Curve - Two Seater - Extended Back COM Yardage: 6.75 Freight Class: 29.5 Product Weight (lbs.): 89 Cubic Feet Per Carton: 6.75</p>	<p>For Power/USB module please see electrical placement chart. Includes ganging hardware (2 sides).</p>	7712NA	4215	4460	4655	4949	5362	5512	5873	6567	6900	7544	8415	9503		
		OVERALL DIMENSIONS			SEAT DIMENSIONS			BACK DIMENSIONS								
		W	D	H	W	D	H	W	H							
		55	29.5	47	42	19	18	51	29							
			RTA 00													

DESCRIPTION FEATURES MODEL# STANDARD TEXTILE GRADES



7713L (Left Arm)

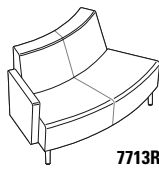

7713R (Right Arm)

OS Curve - Two Seater - Standard Back w/One Arm
 COM Yardage: 5.25
 Freight Class: 300
 Product Weight (lbs.): 82
 Cubic Feet Per Carton: 43

For Power/USB module please see electrical placement chart. Includes ganging hardware (1 side).

MODEL#	1	2	3	4	5	6	7	8	9	10	11	12
7713L	3403	3596	3748	3976	4297	4414	4697	5233	5494	5992	6670	7518
7713R	3403	3596	3748	3976	4297	4414	4697	5233	5494	5992	6670	7518

OVERALL DIMENSIONS			SEAT DIMENSIONS			BACK DIMENSIONS	
W	D	H	W	D	H	W	H
54.5	29.5	32	48	19	18	36	14

RTA 00

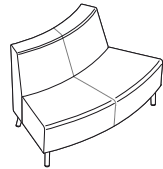

Armless OS Curve - Two Seater - Standard Back
 COM Yardage: 4.5
 Freight Class: 300
 Product Weight (lbs.): 72
 Cubic Feet Per Carton: 43

For Power/USB module please see electrical placement chart. Includes ganging hardware (2 sides).

MODEL#	1	2	3	4	5	6	7	8	9	10	11	12
7713NA	3016	3181	3310	3507	3784	3881	4124	4585	4808	5236	5819	6543

OVERALL DIMENSIONS			SEAT DIMENSIONS			BACK DIMENSIONS	
W	D	H	W	D	H	W	H
54	29.5	32	48	19	18	36	14

RTA 00



7714L (Left Arm)

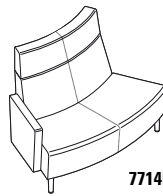

7714R (Right Arm)

OS Curve - Two Seater - High Back w/One Arm
 COM Yardage: 6.5
 Freight Class: 300
 Product Weight (lbs.): 88
 Cubic Feet Per Carton: 54

For Power/USB module please see electrical placement chart. Includes ganging hardware (1 side).

MODEL#	1	2	3	4	5	6	7	8	9	10	11	12
7714L	3974	4214	4401	4684	5082	5225	5574	6241	6561	7182	8022	9069
7714R	3974	4214	4401	4684	5082	5225	5574	6241	6561	7182	8022	9069

OVERALL DIMENSIONS			SEAT DIMENSIONS			BACK DIMENSIONS	
W	D	H	W	D	H	W	H
54.5	29.5	41.5	48	19	18	36	24

RTA 00

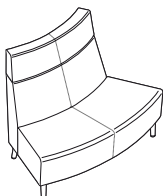

Armless OS Curve - Two Seater - High Back
 COM Yardage: 6
 Freight Class: 300
 Product Weight (lbs.): 78
 Cubic Feet Per Carton: 54

For Power/USB module please see electrical placement chart. Includes ganging hardware (2 sides).

MODEL#	1	2	3	4	5	6	7	8	9	10	11	12
7714NA	3597	3816	3990	4249	4618	4752	5073	5688	5984	6555	7332	8300

OVERALL DIMENSIONS			SEAT DIMENSIONS			BACK DIMENSIONS	
W	D	H	W	D	H	W	H
54	29.5	41.5	48	19	18	36	24

RTA 00

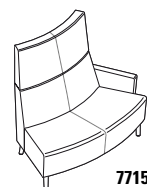

7715L (Left Arm)

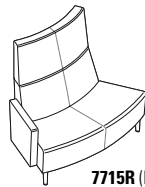

7715R (Right Arm)

OS Curve - Two Seater - Extended Back w/One Arm
 COM Yardage: 7
 Freight Class: 300
 Product Weight (lbs.): 93
 Cubic Feet Per Carton: 62.75

For Power/USB module please see electrical placement chart. Includes ganging hardware (1 side).

MODEL#	1	2	3	4	5	6	7	8	9	10	11	12
7715L	4338	4595	4797	5102	5531	5686	6061	6779	7124	7791	8696	9825
7715R	4338	4595	4797	5102	5531	5686	6061	6779	7124	7791	8696	9825

OVERALL DIMENSIONS			SEAT DIMENSIONS			BACK DIMENSIONS	
W	D	H	W	D	H	W	H
54.5	29.5	47	48	19	18	36	29

RTA 00

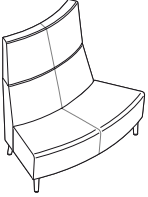
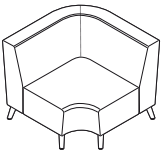
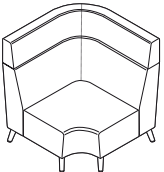
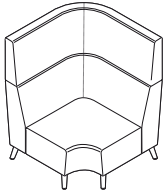
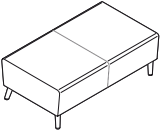
DESCRIPTION	FEATURES	MODEL#	STANDARD TEXTILE GRADES											
			1	2	3	4	5	6	7	8	9	10	11	12
 <p>Armless OS Curve - Two Seater - Ext. High Back COM Yardage: 6.75 Freight Class: 300 Product Weight (lbs.): 83 Cubic Feet Per Carton: 62.75</p>	For Power/USB module please see electrical placement chart. Includes ganging hardware (2 sides).	7715NA	3954	4200	4395	4688	5101	5251	5612	6307	6639	7283	8154	9243
			OVERALL DIMENSIONS			SEAT DIMENSIONS			BACK DIMENSIONS					
			W	D	H	W	D	H	W	H				
			54	29.5	47	48	19	18	36	28				
			RTA 00											
 <p>Armless Corner Unit - Standard Back COM Yardage: 5.5 Freight Class: 300 Product Weight (lbs.): 75 Cubic Feet Per Carton: 49</p>	For Power/USB module please see electrical placement chart. Includes ganging hardware (2 sides).	7716	3685	3887	4047	4284	4624	4742	5038	5604	5874	6399	7110	7997
			OVERALL DIMENSIONS			SEAT DIMENSIONS			BACK DIMENSIONS					
			W	D	H	W	D	H	W	H				
			38	38	32	24	19	18	24	14				
			RTA 00											
 <p>Armless Corner Unit - High Back COM Yardage: 7.75 Freight Class: 300 Product Weight (lbs.): 82 Cubic Feet Per Carton: 49</p>	For Power/USB module please see electrical placement chart. Includes ganging hardware (2 sides).	7717	4667	4948	5171	5509	5985	6156	6571	7366	7749	8487	9489	10738
			OVERALL DIMENSIONS			SEAT DIMENSIONS			BACK DIMENSIONS					
			W	D	H	W	D	H	W	H				
			38	38	41.5	24	19	18	24	24				
			RTA 00											
 <p>Armless Corner Unit - Extended Back COM Yardage: 8.5 Freight Class: 300 Product Weight (lbs.): 88 Cubic Feet Per Carton: 49</p>	For Power/USB module please see electrical placement chart. Includes ganging hardware (2 sides).	7718	4943	5252	5498	5865	6387	6576	7031	7903	8323	9133	10231	11602
			OVERALL DIMENSIONS			SEAT DIMENSIONS			BACK DIMENSIONS					
			W	D	H	W	D	H	W	H				
			38	38	47	24	19	18	24	29				
			RTA 00											
 <p>Two Seater Bench COM Yardage: 2.25 Freight Class: 300 Product Weight (lbs.): 41 Cubic Feet Per Carton: 21.25</p>	For Power/USB module please see electrical placement chart. Includes ganging hardware (2 sides).	7725	1885	1971	2036	2132	2271	2321	2442	2672	2783	2998	3289	3651
			OVERALL DIMENSIONS			SEAT DIMENSIONS			BACK DIMENSIONS					
			W	D	H	W	D	H	W	H				
			48.5	28	17.5									
			RTA 00											

DESCRIPTION FEATURES MODEL# STANDARD TEXTILE GRADES

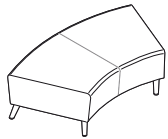

IS Curve - Two Seater Bench
 COM Yardage: 3
 Freight Class: 300
 Product Weight (lbs.): 41
 Cubic Feet Per Carton: 21.25

For Power/USB module please see electrical placement chart. Includes ganging hardware (2 sides).

MODEL#	1	2	3	4	5	6	7	8	9	10	11	12
7726	2560	2673	2760	2888	3072	3138	3300	3608	3756	4041	4429	4915

OVERALL DIMENSIONS			SEAT DIMENSIONS			BACK DIMENSIONS	
W	D	H	W	D	H	W	H

54 28 17.5

RTA 00

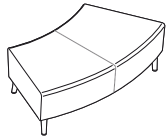

OS Curve - Two Seater Bench
 COM Yardage: 3
 Freight Class: 300
 Product Weight (lbs.): 41
 Cubic Feet Per Carton: 21.25

For Power/USB module please see electrical placement chart. Includes ganging hardware (2 sides).

MODEL#	1	2	3	4	5	6	7	8	9	10	11	12
7727	2560	2673	2760	2888	3072	3138	3300	3608	3756	4041	4429	4915

OVERALL DIMENSIONS			SEAT DIMENSIONS			BACK DIMENSIONS	
W	D	H	W	D	H	W	H

54 28 17.5

RTA 00

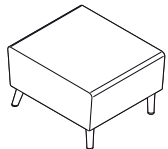

Square Single Seater Bench
 COM Yardage: 1.75
 Freight Class: 250
 Product Weight (lbs.): 30
 Cubic Feet Per Carton: 9.25

No Power/USB module. Includes ganging hardware (2 sides).

MODEL#	1	2	3	4	5	6	7	8	9	10	11	12
7728	1288	1352	1404	1479	1587	1627	1720	1900	1986	2152	2379	2661

OVERALL DIMENSIONS			SEAT DIMENSIONS			BACK DIMENSIONS	
W	D	H	W	D	H	W	H

24.5 28 17.5

RTA 00

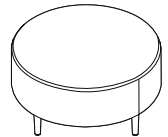

36\"/>

No Power/USB module. No ganging hardware.

MODEL#	1	2	3	4	5	6	7	8	9	10	11	12
7729	1891	2004	2091	2221	2405	2473	2632	2940	3088	3373	3761	4246

OVERALL DIMENSIONS			SEAT DIMENSIONS			BACK DIMENSIONS	
W	D	H	W	D	H	W	H

36 36 17.5

RTA 00

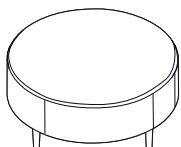

42\"/>

No Power/USB module. No ganging hardware.

MODEL#	1	2	3	4	5	6	7	8	9	10	11	12
7730	2176	2294	2387	2532	2728	2800	2975	3309	3470	3778	4198	4724

OVERALL DIMENSIONS			SEAT DIMENSIONS			BACK DIMENSIONS	
W	D	H	W	D	H	W	H

42 42 17.5

RTA 00

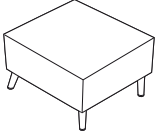
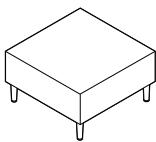
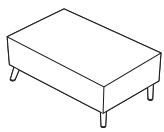
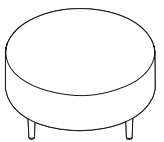
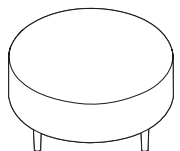
DESCRIPTION	FEATURES	MODEL#	STANDARD TEXTILE GRADES														
			1	2	3	4	5	6	7	8	9	10	11	12			
 <p>30" Square Laminate Coffee Table COM Yardage: N/A Freight Class: 150 Product Weight (lbs.): 61 Cubic Feet Per Carton: 11.5</p>	<p>For Power/USB module please see electrical placement chart. No ganging hardware.</p>	7731	1203														
			OVERALL DIMENSIONS			SEAT DIMENSIONS			BACK DIMENSIONS								
			W	D	H	W	D	H	W	H							
			30	30	17												
			RTA 00														
 <p>36" Square Laminate Coffee Table COM Yardage: N/A Freight Class: 150 Product Weight (lbs.): 85 Cubic Feet Per Carton: 16.5</p>	<p>For Power/USB module please see electrical placement chart. No ganging hardware.</p>	7732	1367														
			OVERALL DIMENSIONS			SEAT DIMENSIONS			BACK DIMENSIONS								
			W	D	H	W	D	H	W	H							
			36	36	17												
			RTA 00														
 <p>Rectangular Laminate Coffee Table COM Yardage: N/A Freight Class: 150 Product Weight (lbs.): 55 Cubic Feet Per Carton: 11.5</p>	<p>For Power/USB module please see electrical placement chart. No ganging hardware.</p>	7733	1209														
			OVERALL DIMENSIONS			SEAT DIMENSIONS			BACK DIMENSIONS								
			W	D	H	W	D	H	W	H							
			40	20	17												
			RTA 00														
 <p>36" Dia. - Round Laminate Coffee Table COM Yardage: N/A Freight Class: 250 Product Weight (lbs.): 63 Cubic Feet Per Carton: 16.5</p>	<p>For Power/USB module please see electrical placement chart. No ganging hardware.</p>	7734	1492														
			OVERALL DIMENSIONS			SEAT DIMENSIONS			BACK DIMENSIONS								
			W	D	H	W	D	H	W	H							
			36	36	17												
			RTA 00														
 <p>42" Dia. - Round Laminate Coffee Table COM Yardage: N/A Freight Class: 250 Product Weight (lbs.): 85 Cubic Feet Per Carton: 22</p>	<p>For Power/USB module please see electrical placement chart. No ganging hardware.</p>	7735	1631														
			OVERALL DIMENSIONS			SEAT DIMENSIONS			BACK DIMENSIONS								
			W	D	H	W	D	H	W	H							
			42	42	17												
			RTA 00														

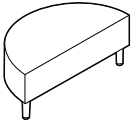
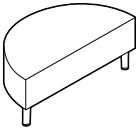
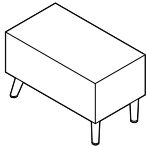
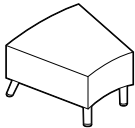
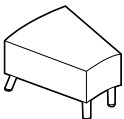
DESCRIPTION	FEATURES	MODEL#	STANDARD TEXTILE GRADES											
			1	2	3	4	5	6	7	8	9	10	11	12
 <p>36" Half Round Laminate Coffee Table COM Yardage: N/A Freight Class: 150 Product Weight (lbs.): 37 Cubic Feet Per Carton: 8.5</p>	<p>For Power/USB module please see electrical placement chart. No ganging hardware.</p>	7736	1058											
			OVERALL DIMENSIONS			SEAT DIMENSIONS			BACK DIMENSIONS					
			W	D	H	W	D	H	W	H				
			36	18	17									
			RTA 00											
 <p>42" Half Round Laminate Coffee Table COM Yardage: N/A Freight Class: 150 Product Weight (lbs.): 48 Cubic Feet Per Carton: 11.5</p>	<p>For Power/USB module please see electrical placement chart. No ganging hardware.</p>	7737	1281											
			OVERALL DIMENSIONS			SEAT DIMENSIONS			BACK DIMENSIONS					
			W	D	H	W	D	H	W	H				
			42	21	17									
			RTA 00											
 <p>Rectangular Laminate End Table COM Yardage: N/A Freight Class: 125 Product Weight (lbs.): 34 Cubic Feet Per Carton: 5.5</p>	<p>For Power/USB module please see electrical placement chart. Includes ganging hardware (2 sides).</p>	7738	1212											
			OVERALL DIMENSIONS			SEAT DIMENSIONS			BACK DIMENSIONS					
			W	D	H	W	D	H	W	H				
			15	27.25	17									
			RTA 00											
 <p>IS Curve Wide Wedge Laminate End Table COM Yardage: N/A Freight Class: 150 Product Weight (lbs.): 50 Cubic Feet Per Carton: 9.5</p>	<p>For Power/USB module please see electrical placement chart. Includes ganging hardware (2 sides).</p>	7739	1600											
			OVERALL DIMENSIONS			SEAT DIMENSIONS			BACK DIMENSIONS					
			W	D	H	W	D	H	W	H				
			27.25	27.25	17									
			RTA 00											
 <p>IS Curve Narrow Wedge Laminate End Table COM Yardage: N/A Freight Class: 150 Product Weight (lbs.): 34 Cubic Feet Per Carton: 6.5</p>	<p>For Power/USB module please see electrical placement chart. Includes ganging hardware (2 sides).</p>	7740	1296											
			OVERALL DIMENSIONS			SEAT DIMENSIONS			BACK DIMENSIONS					
			W	D	H	W	D	H	W	H				
			18.25	27.25	17									
			RTA 00											

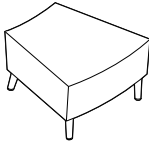
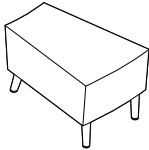
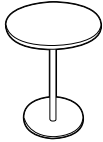
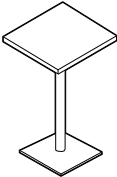
DESCRIPTION	FEATURES	MODEL#	STANDARD TEXTILE GRADES												
			1	2	3	4	5	6	7	8	9	10	11	12	
 <p>OS Curve - Wide Wedge Laminate End Table COM Yardage: N/A Freight Class: 150 Product Weight (lbs.): 50 Cubic Feet Per Carton: 9.5</p>	For Power/USB module please see electrical placement chart. Includes ganging hardware (2 sides).	7741	1600												
		OVERALL DIMENSIONS			SEAT DIMENSIONS			BACK DIMENSIONS							
		W	D	H	W	D	H	W	H						
		27.25	27.25	17											
			RTA 00												
 <p>OS Curve - Narrow Wedge Laminate End Table COM Yardage: N/A Freight Class: 150 Product Weight (lbs.): 34 Cubic Feet Per Carton: 6.5</p>	For Power/USB module please see electrical placement chart. Includes ganging hardware (2 sides).	7742	1296												
		OVERALL DIMENSIONS			SEAT DIMENSIONS			BACK DIMENSIONS							
		W	D	H	W	D	H	W	H						
		18.25	27.25	17											
			RTA 00												
 <p>18" Dia. Round Laminate Laptop Table COM Yardage: N/A Freight Class: 150 Product Weight (lbs.): 32 Cubic Feet Per Carton: 6</p>	No Power/USB module. No ganging hardware. Base only available in Black or Tungsten finish.	7743	733												
		OVERALL DIMENSIONS			SEAT DIMENSIONS			BACK DIMENSIONS							
		W	D	H	W	D	H	W	H						
		18	18	25.25											
			RTA 00												
 <p>16" Square Laminate Laptop Table COM Yardage: N/A Freight Class: 125 Product Weight (lbs.): 36 Cubic Feet Per Carton: 6</p>	No Power/USB module. No ganging hardware. Base only available in Black or Tungsten finish.	7745	750												
		OVERALL DIMENSIONS			SEAT DIMENSIONS			BACK DIMENSIONS							
		W	D	H	W	D	H	W	H						
		16	16	25.25											
			RTA 00												

RIVER™ PERSONAL HARBOR



Sample Layout

ELECTRICAL PLACEMENT

Locations available on left side J1 (black) or W1 (white), right side J3 (black) or W3 (white) or both sides J1/J3 (black) or W1/W3 (white).

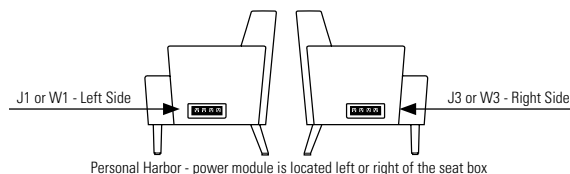

STANDARD FEATURES

- River Personal Harbor is a line extension of the popular River modular seating series. For modular series see River price book pages.
- The freestanding soft seating models are available with standard height, high and extended high backs.
- The unique tapered legs (swaged legs) are made of welded steel, heavy duty construction, with each leg bolted directly to the frame. The extremely robust construction insures trouble free performance in any environment. All units have the same leg height of 6.5". The leg height makes it easier to clean under the product.
- Each leg is standard with adjustable black leveling glides and are non-marking. Wood legs and casters are not available.
- All cushions are fixed and non-removable (cushions will not migrate). Perimeter seams feature a decorative single stitch detail, which makes seams lay flat and adds extra seam strength.
- Seating frames are heavy duty with interlocking plywood, puzzle box construction, made for rugged active environments. Seats are high density with highly resilient foam and are equipped with a synthetic rubberized webbing suspension system for extra comfort.
- Front edge or face of the seat, angles slightly inward, so feet have freedom of movement and shoe heels don't rub on the seat. This inward slanting matches the inward angles of the back. Benches and connecting end tables also reflect the inward angles on the front and back faces, so all units coordinate in visual appearance.
- High Traffic (HT) units are rated at 350 lbs. active load per seat and 24/7 use. These units have the same puzzle box frame construction except that the framing wood is 1" thick, rotary cut, birch plywood and all arms, seat and back cushions are made with Ultracell Foam.
- High Traffic (HT) models are recommend to be specified in textiles that meet or exceed 100,000 double rubs for added abrasion performance.

- Check textile availability prior to specifying upholstery material. Leather not available on River Personal Harbor.

OPTIONAL FEATURES

- Seating units can be specified with Power/USB terminals, which includes two power outlets, two double USB terminals and a black 60" three-prong power cord. Each Power/USB module is set in predetermined locations, as shown in the electrical illustrations below. Electrical units must be factory installed.
- To add a Power/USB module: From the electrical illustrations below, please specify **J1, W1, J2, W2, J3, W4, J4, W4, J6 or W6** after the product model number. Please note on seating units, if both right and left locations are required, add both **J1/J3 or W1/W3** to the model number. Add \$875 for each module/location required.
- Power/USB modules are available with either Jet Black (**J**) face plate with black Power/USB receptacles or with a White (**W**) face plate with white Power/USB receptacles.
- **Leg finish**

(CHM) Chrome	(TBL) Black
(TDW) Designer White	(TFO) Fog
(TFR) Frost	(TIV) Cloud
(TKA) Kalua	(TLA) Latte
(TMO) Mocha	(TNE) Nevada
(TOA) Toast	(TSH) Shadow
(TSN) Sand	(TTU) Tungsten
- If more than one fabric or a fabric/vinyl combination is required, please fill out a "Seating Multiple Textile" form, specifying each fabric location. Please contact Customer Care for more information.

DESCRIPTION

FEATURES

MODEL#

STANDARD TEXTILE GRADES

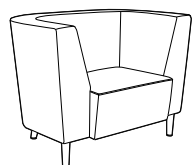

Personal Harbor - Standard Back

COM Yardage: 5.5
 Freight Class: 150
 Product Weight (lbs.): 50
 Cubic Feet Per Carton: 9.5

For Power/USB module please see electrical placement chart. Freestanding unit only.

	1	2	3	4	5	6	7	8	9	10	11	12
7746	\$3579	\$3787	\$3953	\$4203	\$4555	\$4723	\$5042	\$5551	\$5944	\$6382	\$7282	\$8243

OVERALL DIMENSIONS

SEAT DIMENSIONS

BACK DIMENSIONS

W	D	H	W	D	H	W	H
45	29.5	32	24	19	18	27	14

RTA 00

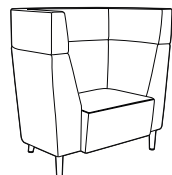

Personal Harbor - High Back

COM Yardage: 7.09
 Freight Class: 150
 Product Weight (lbs.): 86
 Cubic Feet Per Carton: 9.5

For Power/USB module please see electrical placement chart. Freestanding unit only.

	1	2	3	4	5	6	7	8	9	10	11	12
7747	\$5032	\$5326	\$5559	\$5910	\$6408	\$6642	\$7092	\$7812	\$8366	\$8981	\$10251	\$11603

OVERALL DIMENSIONS

SEAT DIMENSIONS

BACK DIMENSIONS

W	D	H	W	D	H	W	H
45	29.5	41.5	24	19	18	27	24

RTA 00

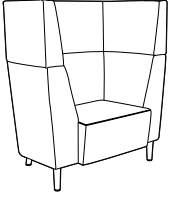
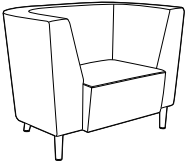
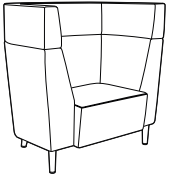
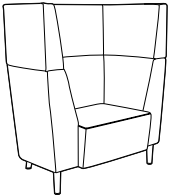
DESCRIPTION	FEATURES	MODEL#	STANDARD TEXTILE GRADES												
			1	2	3	4	5	6	7	8	9	10	11	12	
 <p>Personal Harbor - Extended Back COM Yardage: 8.5 Freight Class: 150 Product Weight (lbs.): 102 Cubic Feet Per Carton: 9.5</p>	<p>For Power/USB module please see electrical placement chart. Freestanding unit only.</p>	7748	\$5661	\$5982	\$6238	\$6625	\$7170	\$7427	\$7921	\$8709	\$9317	\$9992	\$11382	\$12865	
			OVERALL DIMENSIONS			SEAT DIMENSIONS			BACK DIMENSIONS						
			W	D	H	W	D	H	W	H					
			45	29.5	47	24	19	18	27	29					
			RTA 00												
 <p>Personal Harbor - Standard Back COM Yardage: 5.5 Freight Class: 150 Product Weight (lbs.): 50 Cubic Feet Per Carton: 9.5</p>	<p>High Traffic model For Power/USB module please see electrical placement chart. Freestanding unit only.</p>	7786	\$4088	\$4298	\$4463	\$4713	\$5065	\$5233	\$5553	\$6064	\$6458	\$6894	\$7795	\$8755	
			OVERALL DIMENSIONS			SEAT DIMENSIONS			BACK DIMENSIONS						
			W	D	H	W	D	H	W	H					
			45	29.5	32	24	19	18	27	14					
			RTA 00												
 <p>Personal Harbor - High Back COM Yardage: 7.09 Freight Class: 150 Product Weight (lbs.): 86 Cubic Feet Per Carton: 9.5</p>	<p>High Traffic model For Power/USB module please see electrical placement chart. Freestanding unit only.</p>	7787	\$5688	\$5982	\$6215	\$6567	\$7064	\$7299	\$7749	\$8469	\$9022	\$9638	\$10907	\$12257	
			OVERALL DIMENSIONS			SEAT DIMENSIONS			BACK DIMENSIONS						
			W	D	H	W	D	H	W	H					
			45	29.5	41.5	24	19	18	27	24					
			RTA 00												
 <p>Personal Harbor - Extended Back COM Yardage: 8.5 Freight Class: 150 Product Weight (lbs.): 102 Cubic Feet Per Carton: 9.5</p>	<p>High Traffic model For Power/USB module please see electrical placement chart. Freestanding unit only.</p>	7788	\$6170	\$6493	\$6749	\$7135	\$7680	\$7938	\$8431	\$9220	\$9830	\$10504	\$11894	\$13378	
			OVERALL DIMENSIONS			SEAT DIMENSIONS			BACK DIMENSIONS						
			W	D	H	W	D	H	W	H					
			45	29.5	47	24	19	18	27	29					
			RTA 00												

RIVER+ SEATING



Lounge Chair, High Back
model R27802

120 Corner, Standard Back
model R27824S

Loop arm
R2770

River+ Benches, Tables & Media Hearths



For River+ benches, please see page 349
For River+ media hearths, please see page 358
For River+ tables, please see page 354

EXAMPLE RIVER+ SEATING ORDER CODE:

R27802	-CE90	-FOG	-	-S6	-
--------	-------	------	---	-----	---

Model number	Back, arm and seat textile	Connector finish	Shelf finish	Leg Selection	Counterweight
--------------	----------------------------	------------------	--------------	---------------	---------------

-CHM	-SSB
------	------

Leg finish	Bottom selection
------------	------------------

Additional Options specify at end of order code.	SPECIFY CODE
Additional weight See each model for amount of added weight and upcharge.	CW
Sealed back seams Upcharges vary, see model.	SBS
Sealed seat seams Upcharges vary, see model.	SSS
Power unit finish Jet Black White	J W
Power/USB unit position (see electrical placement images, not available on corner units) Front left Front right Side left Side right Center back (models with shelf only)	\$612 per unit F1 F2 S1 S2 CB
Tamperproof fasteners Upcharges vary, see model.	TP
Moisture barrier Upcharges vary, see model.	MB
Accessory hook finish (for models with shelf) Night (BLK) Fog (FOG) Latte (LAB)	NHK FHK LHK

STANDARD FEATURES

- A modular series that is composed of straight, curved and corner sections.
 - Models with the same seat height can be ganged on ends with no upholstered arms. Ganging hardware is standard on armless ends of models (factory installed) and swivels out of the way when not in use.
 - Seating frames are constructed of heavy duty plywood, and are made for active environments. Seats are high density with highly resilient foam.
 - River+ seating is rated for an active weight up to 600 lbs. per seat and 24/7 use.
 - For 24/7 use and/or heavy duty application use, Global's Heavy Duty warranty is only on models specified with performance textiles, rated for 150,000 double rubs or more.
 - A clean-out gap is created by seat-to-back connector brackets available in three finishes.
 - The standard, 6.5" tapered legs are made of welded steel. Front legs of River+ lounge models are straight. Back legs are angled.
 - Models with a shelf are only available with 6.5" high legs. Back legs on these models are standard with (E6) EXTENDED legs.
 - Legs include Black, non-marking, height adjustable glides.
 - Upholstery options include fabric or vinyl. Leather upholstery is not available.
 - All units are shipped fully assembled.
 - Arms on upholstered arm models are factory installed and not removable.
 - Modular, aluminum loop arms are sold separately and available with or without nylon armcaps. These relocatable arms are field installed at any seat to back connector location.
 - A 10" deep, 1" thick shelf is available on the back of corner, curved, two and three seat models in many thermally fused laminate finishes with matching edge.
 - Shelf supports are aluminum with accessory hook in three finishes. Weight capacity: Shelf - 50lbs per seat; Hook - 20lbs each.
 - Back shelf heights align with the model's back height. See shelf heights diagrams for details.
 - Check textile availability prior to specifying upholstery material.
 - The series is available to specify with two textiles, one for the seat cushion and one for the back, arms and front rail (see model image).
 - For pricing, start with the base price and add both back/arms graded textile upcharge and the seat graded textile upcharge.
 - The blended textile matrix does not apply to this series.
- OPTIONAL FEATURES**
- Optional 6.5" floor mount legs (F6) are available. Shelf back models are available with EXTENDED floor mount legs (F6).
 - Optional 8" (S8) and 8" floor mount legs (F8) are available on models without shelves. Seat heights change to 19" high. Upcharges vary.
 - To match back legs of shelf-back models with models without shelf, select (C6) leg with counterweight. Upcharges vary.
 - Up to two power units are available on seating models, except 90 and 120 corner units. Add \$612 upcharge per unit.
 - Each power unit includes one AC outlet and two USB-A, 10 watt charging ports. Location options include front or side. Back power location option available on models with back shelf (except corners). See electrical placement diagrams.
 - Power units are available in either Jet Black (J) or White (W) with 120", three-prong matching cords.
 - Sealed seams are available only for approved coated textiles. Specify (SSS) for sealed seat seams or (SBS) for sealed back and arm seams. Contact customer care for details. See models for upcharge.
 - To reduce ease of movement, counterweights can be added to any model. Specify (CW). See individual model for weight and upcharge.

- For improved housekeeping and infection control practices, the underside of the seat can be finished with black vinyl and sealed to prevent penetration of liquids. Specify (SP) - see each model for upcharge.
- Steel bottom option provides tamperproof protection (includes tamperproof screws). Specify (BS). Upcharges vary. Note: electrical option and ganging are not available with steel bottom.

Add option codes in the following order:

- **Model number**
Specify model number.
- **Back/Arm Textile**
Specify textile code. See model grade upcharges.
- **Seat Textile**
Specify textile code. See model grade upcharges.
- **Seat to back connector finish (NGT)** Night (BLK). No upcharge.
(FOG) Fog. No upcharge.
(LAB) Latte. No upcharge.
- **Back shelf finish** (for "S" models with shelf)
See colors shown on website.
- **Accessory hook finish** (for "S" models with shelf)
(NHK) Night (BLK)
(FHK) Fog (FOG)
(LHK) Latte (LAB)
- **Leg selection** (models without shelf):
(S6) Standard seat height (17.5"), 6.5" leg w/adjustable glides. No upcharge.
(S8) High seat (19"), 8" leg w/adjustable glides. No upcharge.
(F6) Standard seat height (17.5"), 6.5" leg w/floor mount. Add \$92 for straight units; \$115 for curved, corner units.
(F8) High seat (19"), 8" leg w/floor mount. Add \$92 for straight units; \$115 for curved, corner units.
- **Leg selection** (for "S" models with shelf):
(E6) Standard seat height (17.5"), 6.5" EXTENDED leg with adjustable glides.
(C6) Standard seat height (17.5"), 6.5" leg, includes counterweight. Matches S6 leg. Upcharges vary, see model.
(F6) Standard seat height (17.5"), 6.5" EXTENDED leg w/floor mount. Add \$92 for straight unit; \$115 for curved, corner units.
- **Leg finish**
(CHM) Chrome **(TBL)** Black
(TDW) Designer White **(TFO)** Fog
(TFR) Frost **(TIV)** Cloud
(TKA) Kalua **(TLA)** Latte
(TMO) Mocha **(TNE)** Nevada
(TOA) Toast **(TSH)** Shadow
(TSN) Sand **(TTU)** Tungsten
- **Additional weight**
(CU) No counterweight.
(CW) Counterweight. Upcharges vary, see model.
- **Bottom selection**
(SSB) Standard seat bottom
(SP) Vinyl sealed bottom with staple strip. Upcharges vary, see model.*
(BS) Steel bottom. Upcharges vary, see model.**
- **Sealed back and arm seams**
(SBS) Sealed back seams. Upcharges vary, see model.
- **Sealed seat seams**
(SSS) Sealed seat seams. Upcharges vary, see model.
- **Moisture barrier**
(MB) Moisture Barrier. Upcharges vary, see model.
- **Power/USB unit position. Add \$612 per unit.**
(NP) No power (no upcharge)
(F1) Front left **(F2)** Front right
(S1) Side left **(S2)** Side right
(CB) Center back (models with shelf only)
- **Power unit finish**
(J) Jet Black **(W)** White
- **Tamperproof fasteners**
(TP) Tamperproof fasteners. Upcharges vary, see model.

*linking hardware is lowered to clear the staple strip. Units will only gang with other units with sealed bottom.
**cannot be combined with linking hardware or power units

SHELF HEIGHTS

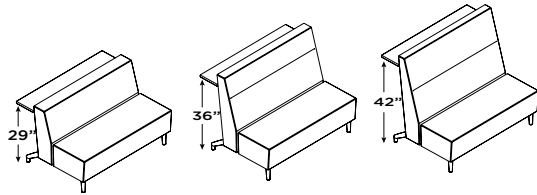

Standard height

High back



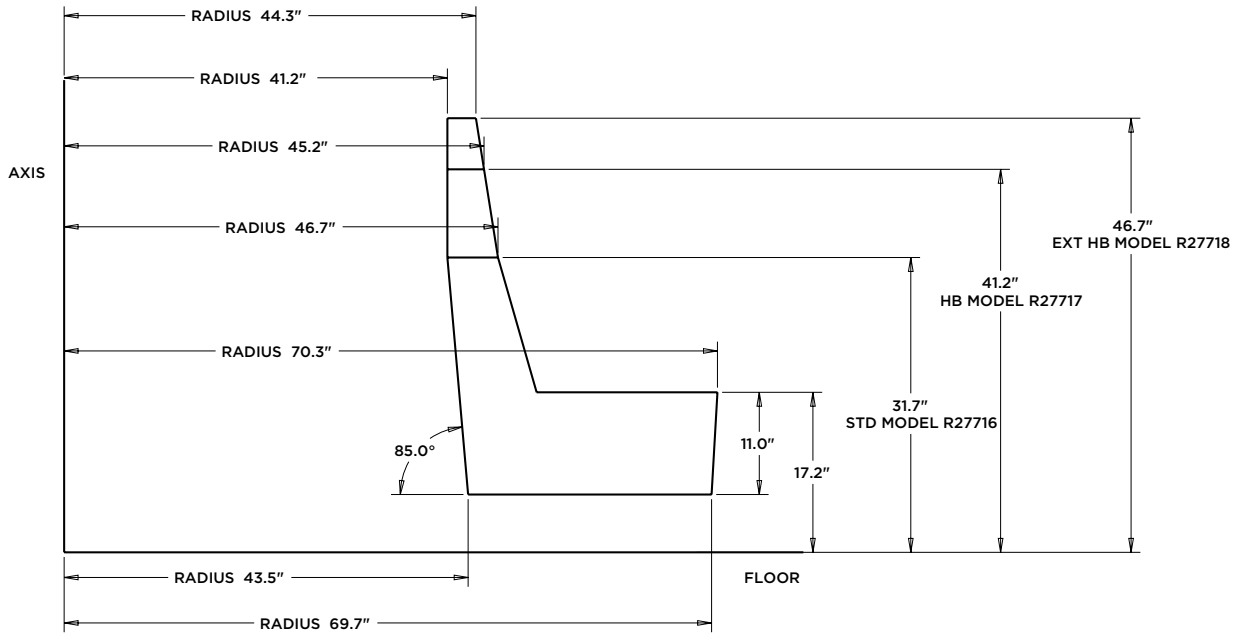

Extended high back

DIMENSIONS

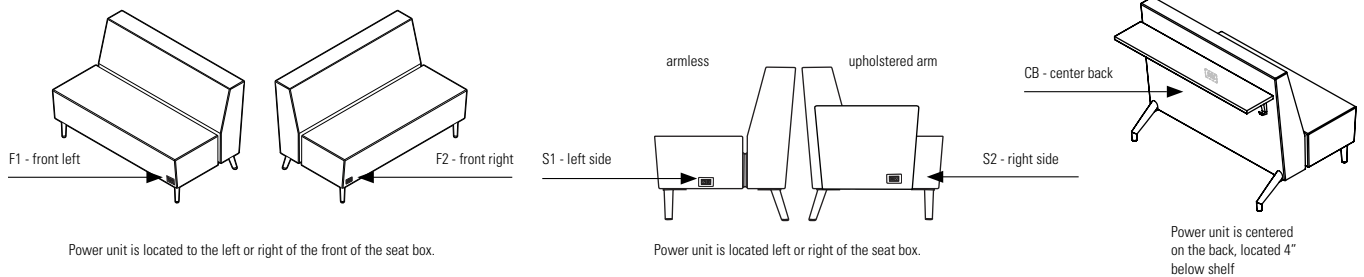

ELECTRICAL PLACEMENT

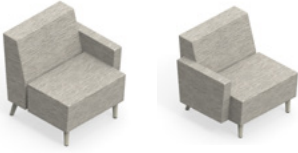

DESCRIPTION		MODEL#/ FEATURES	STANDARD TEXTILE GRADES													
			1/COM	2	3	4	5	6	7	8	9	10	11	12		
 <p>R27801</p> <p>Lounge Chair - Standard Back COM Yardage: Back: 2; Seat: 1.75 Freight class: 250 Product weight (lbs.): 61 Cubic feet per carton: 19.75</p>	<p>R27801 Base Price: \$1911</p> <p>Back upcharge: +0 +\$64 +\$114 +\$188 +\$292 +\$336 +\$426 +\$568 +\$674 +\$790 +\$1032 +\$1286</p> <p>Seat upcharge: +0 +\$56 +\$100 +\$165 +\$256 +\$294 +\$373 +\$497 +\$590 +\$692 +\$903 +\$1126</p> <p>For power/USB unit, see electrical placement chart. Includes ganging hardware (2 sides). Add \$60 for (SSS), \$64 (SBS) Add \$585 for 36 lbs. (CW) Add \$95 for (SP) or \$450 for (BS) Add \$37 for (TP) Add \$117 for (MB)</p>															
		OVERALL DIMENSIONS			SEAT DIMENSIONS			BACK DIMENSIONS								
		W D H			W D H			W H								
		26 30 32			26 19 18			26 14								
			RTA 00			1 per carton										
 <p>R27801B</p> <p>Lounge Chair - Standard Back COM Yardage: Back: 4; Seat: 1.75 Freight class: 250 Product weight (lbs.): 82 Cubic feet per carton: 24.5</p>	<p>R27801B Base Price: \$2593</p> <p>Back/Arm upcharge: +0 +\$128 +\$228 +\$376 +\$584 +\$672 +\$852 +\$1136 +\$1348 +\$1580 +\$2064 +\$2572</p> <p>Seat upcharge: +0 +\$56 +\$100 +\$165 +\$256 +\$294 +\$373 +\$497 +\$590 +\$692 +\$903 +\$1126</p> <p>For power/USB unit, see electrical placement chart. Ganging not available. Add \$60 for (SSS), \$113 (SBS) Add \$585 for 36 lbs. (CW) Add \$95 for (SP) or \$450 for (BS) Add \$37 for (TP) Add \$117 for (MB)</p>															
		OVERALL DIMENSIONS			SEAT DIMENSIONS			BACK DIMENSIONS								
		W D H			W D H			W H								
		33 30 32			26 19 18			26 14								
			RTA 00			1 per carton										
 <p>R27801L R27801R</p> <p>Lounge Chair - Standard Back COM Yardage: Back: 3; Seat: 1.75 Freight class: 250 Product weight (lbs.): 72 Cubic feet per carton: 24.5</p>	<p>R27801L Base Price: \$2253</p> <p>R27801R Base Price: \$2253</p> <p>Back/Arm upcharge: +0 +\$96 +\$171 +\$282 +\$438 +\$504 +\$639 +\$852 +\$1011 +\$1185 +\$1548 +\$1929</p> <p>Seat upcharge: +0 +\$56 +\$100 +\$165 +\$256 +\$294 +\$373 +\$497 +\$590 +\$692 +\$903 +\$1126</p> <p>For power/USB unit, see electrical placement chart. Includes ganging hardware (1 side). Add \$60 for (SSS), \$88 (SBS) Add \$585 for 36 lbs. (CW) Add \$95 for (SP) or \$450 for (BS) Add \$37 for (TP) Add \$117 for (MB)</p>															
		OVERALL DIMENSIONS			SEAT DIMENSIONS			BACK DIMENSIONS								
		W D H			W D H			W H								
		29.5 30 32			26 19 18			26 14								
			RTA 00			1 per carton										
 <p>R27802</p> <p>Lounge Chair - High Back COM Yardage: Back: 2.75; Seat: 1.75 Freight class: 250 Product weight: 71 Cubic feet per carton: 24.75</p>	<p>R27802 Base Price: \$2240</p> <p>Back upcharge: +0 +\$88 +\$157 +\$259 +\$402 +\$462 +\$586 +\$781 +\$927 +\$1087 +\$1419 +\$1769</p> <p>Seat upcharge: +0 +\$56 +\$100 +\$165 +\$256 +\$294 +\$373 +\$497 +\$590 +\$692 +\$903 +\$1126</p> <p>For power/USB unit, see electrical placement chart. Includes ganging hardware (2 sides). Add \$60 for (SSS), \$91 for (SBS) Add \$585 for 36 lbs. (CW) Add \$95 for (SP) or \$450 for (BS) Add \$37 for (TP) Add \$117 for (MB)</p>															
		OVERALL DIMENSIONS			SEAT DIMENSIONS			BACK DIMENSIONS								
		W D H			W D H			W H								
		26 30.5 41.5			26 19 18			26 23.5								
			RTA 00			1 per carton										
 <p>R27802B</p> <p>Lounge Chair - High Back COM Yardage: Back: 4.75; Seat: 1.75 Freight class: 250 Product weight: 88.5 Cubic feet per carton: 31.25</p>	<p>R27802B Base Price: \$2922</p> <p>Back/Arm upcharge: +0 +\$152 +\$271 +\$447 +\$694 +\$798 +\$1012 +\$1349 +\$1601 +\$1877 +\$2451 +\$3055</p> <p>Seat upcharge: +0 +\$56 +\$100 +\$165 +\$256 +\$294 +\$373 +\$497 +\$590 +\$692 +\$903 +\$1126</p> <p>For power/USB unit, see electrical placement chart. Ganging not available. Add \$60 for (SSS), \$139 for (SBS) Add \$585 for 36 lbs. (CW) Add \$95 for (SP) or \$450 for (BS) Add \$37 for (TP) Add \$117 for (MB)</p>															
		OVERALL DIMENSIONS			SEAT DIMENSIONS			BACK DIMENSIONS								
		W D H			W D H			W H								
		33 30.5 41.5			26 19 18			26 23.5								
			RTA 00			1 per carton										

DESCRIPTION MODEL#/ FEATURES STANDARD TEXTILE GRADES



R27802L

R27802R

Lounge Chair - High Back
 COM Yardage: Back: 3.75; Seat: 1.75
 Freight class: 250
 Product weight: 78.5
 Cubic feet per carton: 31.25

R27802L Base Price: **\$2581**
R27802R Base Price: **\$2581**
 Back/Arm upcharge: **+0**
 Seat upcharge: **+0**

For power/USB unit, see electrical placement chart.
 Includes ganging hardware (1 side).
 Add \$60 for (SSS), \$115 (SBS)
 Add \$585 for 36 lbs. (CW)
 Add \$95 for (SP) or \$450 for (BS)
 Add \$37 for (TP)
 Add \$117 for (MB)

1/COM	2	3	4	5	6	7	8	9	10	11	12
OVERALL DIMENSIONS			SEAT DIMENSIONS			BACK DIMENSIONS					
W	D	H	W	D	H	W	H				
29.5	30.5	41.5	26	19	18	26	23.5				
RTA 00			1 per carton								



R27803

Lounge Chair - Extended Back
 COM Yardage: Back: 3; Seat: 1.75
 Freight class: 250
 Product weight: 81
 Cubic feet per carton: 28

R27803 Base Price: **\$2663**
 Back upcharge: **+0**
 Seat upcharge: **+0**

For power/USB unit, see electrical placement chart.
 Includes ganging hardware (2 sides).
 Add \$60 for (SSS), \$97 for (SBS)
 Add \$585 for 36 lbs. (CW)
 Add \$95 for (SP) or \$450 for (BS)
 Add \$37 for (TP)
 Add \$117 for (MB)

1/COM	2	3	4	5	6	7	8	9	10	11	12
OVERALL DIMENSIONS			SEAT DIMENSIONS			BACK DIMENSIONS					
W	D	H	W	D	H	W	H				
26	31	47	26	19	18	26	29				
RTA 00			1 per carton								



R27803B

Lounge Chair - Standard Back
 COM Yardage: Back: 5; Seat: 1.75
 Freight class: 250
 Product weight (lbs.): 101.5
 Cubic feet per carton: 35

R27803B Base Price: **\$3346**
 Back/Arm upcharge: **+0**
 Seat upcharge: **+0**

For power/USB unit, see electrical placement chart.
 Ganging not available.
 Add \$60 for (SSS), \$146 (SBS)
 Add \$585 for 36 lbs. (CW)
 Add \$95 for (SP) or \$450 for (BS)
 Add \$37 for (TP)
 Add \$117 for (MB)

1/COM	2	3	4	5	6	7	8	9	10	11	12
OVERALL DIMENSIONS			SEAT DIMENSIONS			BACK DIMENSIONS					
W	D	H	W	D	H	W	H				
33	31	47	26	19	18	26	29				
RTA 00			1 per carton								



R27803L

R27803R

Lounge Chair - Standard Back
 COM Yardage: Back: 4; Seat: 1.75
 Freight class: 250
 Product weight (lbs.): 91.5
 Cubic feet per carton: 35

R27803L Base Price: **\$3005**
R27803R Base Price: **\$3005**
 Back/Arm upcharge: **+0**
 Seat upcharge: **+0**

For power/USB unit, see electrical placement chart.
 Includes ganging hardware (1 side).
 Add \$60 for (SSS), \$121 (SBS)
 Add \$585 for 36 lbs. (CW)
 Add \$95 for (SP) or \$450 for (BS)
 Add \$37 for (TP)
 Add \$117 for (MB)

1/COM	2	3	4	5	6	7	8	9	10	11	12
OVERALL DIMENSIONS			SEAT DIMENSIONS			BACK DIMENSIONS					
W	D	H	W	D	H	W	H				
29.5	31	47	26	19	18	26	29				
RTA 00			1 per carton								

DESCRIPTION

MODEL#/ FEATURES

STANDARD TEXTILE GRADES

1/COM 2 3 4 5 6 7 8 9 10 11 12



R27804

Two Seater - Standard Back
COM Yardage: Back: 2.75; Seat: 2
Freight class: 250
Product weight: 113 | 133 shelf model
Cubic feet per carton: 37.5 | 51shelf model

R27804 Base Price: **\$2978**
R27804S Base Price: **\$3650**
Back upcharge: **+0**
Seat upcharge: **+0**

For power/USB unit, see electrical placement chart. Includes ganging hardware (2 sides).
Add \$88 for (SSS), \$110 for (SBS)
Add \$1166 for 72 lbs. (CW), (C6)
Add \$181 for (SP) or \$715 for (BS)
Add \$37 for (TP)
Add \$233 for (MB)

Shelf: 52W 10D 1H

OVERALL DIMENSIONS			SEAT DIMENSIONS			BACK DIMENSIONS		
W	D	H	W	D	H	W	H	
52	30	32	52	19	18	52	14	
RTA 00			1 per carton					



R27804B

Two Seater - Standard Back
COM Yardage: Back: 4.75; Seat: 2
Freight class: 250
Product weight: 133 | 154 shelf model
Cubic feet per carton: 42.5 | 57.5 shelf model

R27804B Base Price: **\$3660**
R27804SB Base Price: **\$4332**
Back/Arm upcharge: **+0**
Seat upcharge: **+0**

For power/USB unit, see electrical placement chart. Ganging not available.
Add \$88 for (SSS), \$158 for (SBS)
Add \$1166 for 72 lbs. (CW), (C6)
Add \$181 for (SP) or \$715 for (BS)
Add \$37 for (TP)
Add \$233 for (MB)

Shelf: 52W 10D 1H

OVERALL DIMENSIONS			SEAT DIMENSIONS			BACK DIMENSIONS		
W	D	H	W	D	H	W	H	
59	30	32	52	19	18	52	14	
RTA 00			1 per carton					



R27804L

Two Seater - Standard Back
COM Yardage: Back: 3.75; Seat: 2
Freight class: 250
Product weight: 123
Cubic feet per carton: 42.5

R27804L Base Price: **\$3318**
R27804R Base Price: **\$3318**
Back/Arm upcharge: **+0**
Seat upcharge: **+0**

For power/USB unit, see electrical placement chart. Includes ganging hardware (1 side).
Add \$88 for (SSS), \$134 for (SBS)
Add \$1166 for 72 lbs. (CW), (C6)
Add \$181 for (SP) or \$715 for (BS)
Add \$37 for (TP)
Add \$233 for (MB)

1/COM 2 3 4 5 6 7 8 9 10 11 12

OVERALL DIMENSIONS			SEAT DIMENSIONS			BACK DIMENSIONS		
W	D	H	W	D	H	W	H	
55.5	30	32	52	19	18	52	14	
RTA 00			1 per carton					



R27804SL

Two Seater - Standard Back
COM Yardage: Back: 3.75; Seat: 2
Freight class: 250
Product weight: 144
Cubic feet per carton: 57.5

R27804SL Base Price: **\$3991**
R27804SR Base Price: **\$3991**
Back/Arm upcharge: **+0**
Seat upcharge: **+0**

For power/USB unit, see electrical placement chart. Includes ganging hardware (1 side).
Add \$88 for (SSS), \$134 for (SBS)
Add \$1166 for 72 lbs. (CW), (C6)
Add \$181 for (SP) or \$715 for (BS)
Add \$37 for (TP)
Add \$233 for (MB)

Shelf: 52W 10D 1H

OVERALL DIMENSIONS			SEAT DIMENSIONS			BACK DIMENSIONS		
W	D	H	W	D	H	W	H	
55.5	40.5	32	52	19	18	52	14	
RTA 00			1 per carton					

DESCRIPTION MODEL#/ FEATURES STANDARD TEXTILE GRADES

		STANDARD TEXTILE GRADES												
		1/COM	2	3	4	5	6	7	8	9	10	11	12	
	R27805	Base Price:	\$3624											
	R27805S	Base Price:	\$4294											
		Back upcharge:	+0	+\$112	+\$200	+\$329	+\$511	+\$588	+\$746	+\$994	+\$1180	+\$1383	+\$1806	+\$2251
		Seat upcharge:	+0	+\$64	+\$114	+\$188	+\$292	+\$336	+\$426	+\$568	+\$674	+\$790	+\$1032	+\$1286
		Shelf: 52W 10D 1H												
		OVERALL DIMENSIONS			SEAT DIMENSIONS			BACK DIMENSIONS						
		W	D	H	W	D	H	W	H					
		52	30.5	41.5	52	19	18	52	23.5					
		RTA 00		1 per carton										
R27805	R27805S	For power/USB unit, see electrical placement chart. Includes ganging hardware (1 sides) Add \$88 for (SSS), \$145for (SBS) Add \$1166 for 72 lbs. (CW), (C6) Add \$181 for (SP) or \$715 for (BS) Add \$37 for (TP) Add \$233 for (MB)												
Two Seater - High Back COM Yardage: Back: 3.50; Seat: 2 Freight class: 250 Product weight: 138 139 shelf model Cubic feet per carton: 47.25 64.75 shelf model														

		STANDARD TEXTILE GRADES												
		1/COM	2	3	4	5	6	7	8	9	10	11	12	
	R27805B	Base Price:	\$4306											
	R27805SB	Base Price:	\$4977											
		Back/Arm upcharge:	+0	+\$176	+\$314	+\$517	+\$803	+\$924	+\$1172	+\$1562	+\$1854	+\$2173	+\$2838	+\$3537
		Seat upcharge:	+0	+\$64	+\$114	+\$188	+\$292	+\$336	+\$426	+\$568	+\$674	+\$790	+\$1032	+\$1286
		Shelf: 52W 10D 1H												
		OVERALL DIMENSIONS			SEAT DIMENSIONS			BACK DIMENSIONS						
		W	D	H	W	D	H	W	H					
		59	30.5	41.5	52	19	18	52	23.5					
		RTA 00		1 per carton										
R27805B	R27805SB	For power/USB unit, see electrical placement chart. Ganging not available. Add \$88 for (SSS), \$193 for (SBS) Add \$1166 for 72 lbs. (CW), (C6) Add \$181 for (SP) or \$715 for (BS) Add \$37 for (TP) Add \$233 for (MB)												
Two Seater - High Back COM Yardage: Back: 5.50; Seat: 2 Freight class: 250 Product weight: 138 159 shelf model Cubic feet per carton: 54 73 shelf model														

		STANDARD TEXTILE GRADES												
		1/COM	2	3	4	5	6	7	8	9	10	11	12	
	R27805L	Base Price:	\$3964											
	R27805R	Base Price:	\$3964											
		Back/Arm upcharge:	+0	+\$144	+\$257	+\$423	+\$657	+\$756	+\$959	+\$1278	+\$1517	+\$1778	+\$2322	+\$2894
		Seat upcharge:	+0	+\$64	+\$114	+\$188	+\$292	+\$336	+\$426	+\$568	+\$674	+\$790	+\$1032	+\$1286
		Shelf: 52W 10D 1H												
		OVERALL DIMENSIONS			SEAT DIMENSIONS			BACK DIMENSIONS						
		W	D	H	W	D	H	W	H					
		55.5	30.5	41.5	52	19	18	52	23.5					
		RTA 00		1 per carton										
R27805L	R27805R	For power/USB unit, see electrical placement chart. Includes ganging hardware (1 side). Add \$88 for (SSS), \$193 for (SBS) Add \$1166 for 72 lbs. (CW), (C6) Add \$181 for (SP) or \$715 for (BS) Add \$37 for (TP) Add \$233 for (MB)												
Two Seater - High Back COM Yardage: Back: 4.50; Seat: 2 Freight class: 250 Product weight: 128 Cubic feet per carton: 54														

		STANDARD TEXTILE GRADES												
		1/COM	2	3	4	5	6	7	8	9	10	11	12	
	R27805SL	Base Price:	\$4636											
	R27805SR	Base Price:	\$4636											
		Back/Arm upcharge:	+0	+\$144	+\$257	+\$423	+\$657	+\$756	+\$959	+\$1278	+\$1517	+\$1778	+\$2322	+\$2894
		Seat upcharge:	+0	+\$64	+\$114	+\$188	+\$292	+\$336	+\$426	+\$568	+\$674	+\$790	+\$1032	+\$1286
		Shelf: 52W 10D 1H												
		OVERALL DIMENSIONS			SEAT DIMENSIONS			BACK DIMENSIONS						
		W	D	H	W	D	H	W	H					
		55.5	41	41.5	52	19	18	52	23.5					
		RTA 00		1 per carton										
R27805SL	R27805SR	For power/USB unit, see electrical placement chart. Includes ganging hardware (1 side). Add \$88 for (SSS), \$193 for (SBS) Add \$1166 for 72 lbs. (CW), (C6) Add \$181 for (SP) or \$715 for (BS) Add \$37 for (TP) Add \$233 for (MB)												
Two Seater - High Back COM Yardage: Back: 4.50; Seat: 2 Freight class: 250 Product weight: 149 Cubic feet per carton: 73														

DESCRIPTION MODEL#/ FEATURES STANDARD TEXTILE GRADES

 <p>R27806</p> <p>Two Seater - Extended Back COM Yardage: Back: 3.50; Seat: 2 Freight class: 250 Product weight: 131 152 shelf model Cubic feet per carton: 53.75 72.75 shelf model</p>	<p>R27806S</p> <p>Base Price: \$4125</p> <p>Base Price: \$4798</p> <p>Back upcharge: +0</p> <p>Seat upcharge: +0</p>	1/COM	2	3	4	5	6	7	8	9	10	11	12																								
		<p>Shelf: 52W 10D 1H</p> <table border="1"> <thead> <tr> <th colspan="3">OVERALL DIMENSIONS</th> <th colspan="3">SEAT DIMENSIONS</th> <th colspan="3">BACK DIMENSIONS</th> </tr> <tr> <th>W</th> <th>D</th> <th>H</th> <th>W</th> <th>D</th> <th>H</th> <th>W</th> <th colspan="2">H</th> </tr> </thead> <tbody> <tr> <td>52</td> <td>31</td> <td>47</td> <td>52</td> <td>19</td> <td>18</td> <td>52</td> <td colspan="2">29</td> </tr> </tbody> </table> <p>RTA 00 1 per carton</p>	OVERALL DIMENSIONS			SEAT DIMENSIONS			BACK DIMENSIONS			W	D	H	W	D	H	W	H		52	31	47	52	19	18	52	29									
OVERALL DIMENSIONS			SEAT DIMENSIONS			BACK DIMENSIONS																															
W	D	H	W	D	H	W	H																														
52	31	47	52	19	18	52	29																														

 <p>R27806B</p> <p>Two Seater - Extended Back COM Yardage: Back: 6 Seat: 2 Freight class: 250 Product weight: 151 172 shelf model Cubic feet per carton: 60.5 82 shelf model</p>	<p>R27806B Base Price: \$4808</p> <p>R27806SB Base Price: \$5479</p> <p>Back/Arm upcharge: +0</p> <p>Seat upcharge: +0</p>	1/COM	2	3	4	5	6	7	8	9	10	11	12																								
		<p>Shelf: 52W 10D 1H</p> <table border="1"> <thead> <tr> <th colspan="3">OVERALL DIMENSIONS</th> <th colspan="3">SEAT DIMENSIONS</th> <th colspan="3">BACK DIMENSIONS</th> </tr> <tr> <th>W</th> <th>D</th> <th>H</th> <th>W</th> <th>D</th> <th>H</th> <th>W</th> <th colspan="2">H</th> </tr> </thead> <tbody> <tr> <td>59</td> <td>31</td> <td>47</td> <td>52</td> <td>19</td> <td>18</td> <td>52</td> <td colspan="2">29</td> </tr> </tbody> </table> <p>RTA 00 1 per carton</p>	OVERALL DIMENSIONS			SEAT DIMENSIONS			BACK DIMENSIONS			W	D	H	W	D	H	W	H		59	31	47	52	19	18	52	29									
OVERALL DIMENSIONS			SEAT DIMENSIONS			BACK DIMENSIONS																															
W	D	H	W	D	H	W	H																														
59	31	47	52	19	18	52	29																														

 <p>R27806L</p> <p>Two Seater - Extended Back COM Yardage: Back: 5; Seat: 2 Freight class: 250 Product weight: 141 Cubic feet per carton: 60.5</p>	<p>R27806L Base Price: \$4466</p> <p>R27806SR Base Price: \$5139</p> <p>Back/Arm upcharge: +0</p> <p>Seat upcharge: +0</p>	1/COM	2	3	4	5	6	7	8	9	10	11	12																							
		<p>Shelf: 52W 10D 1H</p> <table border="1"> <thead> <tr> <th colspan="3">OVERALL DIMENSIONS</th> <th colspan="3">SEAT DIMENSIONS</th> <th colspan="3">BACK DIMENSIONS</th> </tr> <tr> <th>W</th> <th>D</th> <th>H</th> <th>W</th> <th>D</th> <th>H</th> <th>W</th> <th colspan="2">H</th> </tr> </thead> <tbody> <tr> <td>55.5</td> <td>31</td> <td>47</td> <td>52</td> <td>19</td> <td>18</td> <td>52</td> <td colspan="2">29</td> </tr> </tbody> </table> <p>RTA 00 1 per carton</p>	OVERALL DIMENSIONS			SEAT DIMENSIONS			BACK DIMENSIONS			W	D	H	W	D	H	W	H		55.5	31	47	52	19	18	52	29								
OVERALL DIMENSIONS			SEAT DIMENSIONS			BACK DIMENSIONS																														
W	D	H	W	D	H	W	H																													
55.5	31	47	52	19	18	52	29																													

 <p>R27806SL</p> <p>Two Seater - Extended Back COM Yardage: Back: 5; Seat: 2 Freight class: 250 Product weight: 162 Cubic feet per carton: 82</p>	<p>R27806SL Base Price: \$5139</p> <p>R27806SR Base Price: \$5139</p> <p>Back/Arm upcharge: +0</p> <p>Seat upcharge: +0</p>	1/COM	2	3	4	5	6	7	8	9	10	11	12																							
		<p>Shelf: 52W 10D 1H</p> <table border="1"> <thead> <tr> <th colspan="3">OVERALL DIMENSIONS</th> <th colspan="3">SEAT DIMENSIONS</th> <th colspan="3">BACK DIMENSIONS</th> </tr> <tr> <th>W</th> <th>D</th> <th>H</th> <th>W</th> <th>D</th> <th>H</th> <th>W</th> <th colspan="2">H</th> </tr> </thead> <tbody> <tr> <td>55.5</td> <td>41.5</td> <td>47</td> <td>52</td> <td>19</td> <td>18</td> <td>52</td> <td colspan="2">29</td> </tr> </tbody> </table> <p>RTA 00 1 per carton</p>	OVERALL DIMENSIONS			SEAT DIMENSIONS			BACK DIMENSIONS			W	D	H	W	D	H	W	H		55.5	41.5	47	52	19	18	52	29								
OVERALL DIMENSIONS			SEAT DIMENSIONS			BACK DIMENSIONS																														
W	D	H	W	D	H	W	H																													
55.5	41.5	47	52	19	18	52	29																													

DESCRIPTION MODEL#/ FEATURES STANDARD TEXTILE GRADES



R27807

R27807S

Three Seater - Standard Back
 COM Yardage: Back: 4.50; Seat: 2.50
 Freight class: 250
 Product weight: 152 | 173 shelf model
 Cubic feet per carton: 55.5 | 173 shelf model

R27807 Base Price: **\$4669**
R27807S Base Price: **\$5557**
 Back upcharge: **+0**
 Seat upcharge: **+0**
 Shelf: 52W 10D 1H
 For power/USB unit, see electrical placement chart. Includes ganging hardware (2 sides).
 Add \$108 for (SSS), \$127 for (SBS)
 Add \$1166 for 72 lbs. (CW), (C6)
 Add \$272 for (SP) or \$984 for (BS)
 Add \$37 for (TP)
 Add \$347 for (MB)

1/COM	2	3	4	5	6	7	8	9	10	11	12
-------	---	---	---	---	---	---	---	---	----	----	----

	+\$144	+\$257	+\$423	+\$657	+\$756	+\$959	+\$1278	+\$1517	+\$1778	+\$2322	+\$2894
	+\$112	+\$200	+\$329	+\$511	+\$588	+\$746	+\$994	+\$1180	+\$1383	+\$1806	+\$2251

OVERALL DIMENSIONS			SEAT DIMENSIONS			BACK DIMENSIONS					
W	D	H	W	D	H	W	H				
78	30	32	78	19	18	78	14				
RTA 00			1 per carton								



R27807B

R27807SB

Three Seater - Standard Back
 COM Yardage: Back: 6.50; Seat: 3.50
 Freight class: 250
 Product weight: 170 | 193 shelf model
 Cubic feet per carton: 60.5 | 79.75 shelf model

R27807B Base Price: **\$5352**
R27807SB Base Price: **\$6240**
 Back/Arm upcharge: **+0**
 Seat upcharge: **+0**
 Shelf: 52W 10D 1H
 For power/USB unit, see electrical placement chart. Ganging not available.
 Add \$108 for (SSS), \$175 for (SBS)
 Add \$1166 for 72 lbs. (CW), (C6)
 Add \$272 for (SP) or \$984 for (BS)
 Add \$37 for (TP)
 Add \$347 for (MB)

1/COM	2	3	4	5	6	7	8	9	10	11	12
-------	---	---	---	---	---	---	---	---	----	----	----

	+\$208	+\$371	+\$611	+\$949	+\$1092	+\$1385	+\$1846	+\$2191	+\$2568	+\$3354	+\$4180
	+\$112	+\$200	+\$329	+\$511	+\$588	+\$746	+\$994	+\$1180	+\$1383	+\$1806	+\$2251

OVERALL DIMENSIONS			SEAT DIMENSIONS			BACK DIMENSIONS					
W	D	H	W	D	H	W	H				
85	30	32	78	19	18	78	14				
RTA 00			1 per carton								



R27807L

R27807R

Three Seater - Standard Back
 COM Yardage: Back: 5.50; Seat: 3.50
 Freight class: 250
 Product weight: 160
 Cubic feet per carton: 60.5

R27807L Base Price: **\$5011**
R27807R Base Price: **\$5412**
 Back/Arm upcharge: **+0**
 Seat upcharge: **+0**
 Shelf: 52W 10D 1H
 For power/USB unit, see electrical placement chart. Includes ganging hardware (2 sides).
 Add \$108 for (SSS), \$151 for (SBS)
 Add \$1166 for 72 lbs. (CW), (C6)
 Add \$272 for (SP) or \$984 for (BS)
 Add \$37 for (TP)
 Add \$347 for (MB)

1/COM	2	3	4	5	6	7	8	9	10	11	12
-------	---	---	---	---	---	---	---	---	----	----	----

	+\$176	+\$314	+\$517	+\$803	+\$924	+\$1172	+\$1562	+\$1854	+\$2173	+\$2838	+\$3537
	+\$112	+\$200	+\$329	+\$511	+\$588	+\$746	+\$994	+\$1180	+\$1383	+\$1806	+\$2251

OVERALL DIMENSIONS			SEAT DIMENSIONS			BACK DIMENSIONS					
W	D	H	W	D	H	W	H				
81.5	30	32	78	19	18	78	14				
RTA 00			1 per carton								



R27807SL

R27807SR

Three Seater - Standard Back
 COM Yardage: Back: 5.50; Seat: 3.50
 Freight class: 250
 Product weight: 183
 Cubic feet per carton: 79.75

R27807SL Base Price: **\$5899**
R27807SR Base Price: **\$5899**
 Back/Arm upcharge: **+0**
 Seat upcharge: **+0**
 Shelf: 52W 10D 1H
 For power/USB unit, see electrical placement chart. Includes ganging hardware (2 sides).
 Add \$108 for (SSS), \$151 for (SBS)
 Add \$1166 for 72 lbs. (CW), (C6)
 Add \$272 for (SP) or \$984 for (BS)
 Add \$37 for (TP)
 Add \$347 for (MB)

1/COM	2	3	4	5	6	7	8	9	10	11	12
-------	---	---	---	---	---	---	---	---	----	----	----

	+\$176	+\$314	+\$517	+\$803	+\$924	+\$1172	+\$1562	+\$1854	+\$2173	+\$2838	+\$3537
	+\$112	+\$200	+\$329	+\$511	+\$588	+\$746	+\$994	+\$1180	+\$1383	+\$1806	+\$2251

OVERALL DIMENSIONS			SEAT DIMENSIONS			BACK DIMENSIONS					
W	D	H	W	D	H	W	H				
81.5	40.5	32	78	19	18	78	14				
RTA 00			1 per carton								

DESCRIPTION MODEL#/ FEATURES STANDARD TEXTILE GRADES



R27808 R27808S

Three Seater - High Back
COM Yardage: Back: 5.75; Seat: 3.50
Freight class: 250
Product weight: 177 | 201 shelf model
Cubic feet per carton: 69.75 | 95.5 shelf model

R27808 Base Price: **\$5446**
R27808S Base Price: **\$6335**
Back upcharge: **+0**
Seat upcharge: **+0**

For power/USB unit, see electrical placement chart.
Includes ganging hardware (2 sides).
Add \$108 for (SSS), \$170 for (SBS)
Add \$1166 for 72 lbs. (CW), (C6)
Add \$272 for (SP) or \$984 for (BS)
Add \$37 for (TP)
Add \$347 for (MB)

1/COM	2	3	4	5	6	7	8	9	10	11	12
-------	---	---	---	---	---	---	---	---	----	----	----

+0	+\$184	+\$328	+\$541	+\$840	+\$966	+\$1225	+\$1633	+\$1938	+\$2272	+\$2967	+\$3698
+0	+\$112	+\$200	+\$329	+\$511	+\$588	+\$746	+\$994	+\$1180	+\$1383	+\$1806	+\$2251

Shelf: 52W 10D 1H

OVERALL DIMENSIONS			SEAT DIMENSIONS			BACK DIMENSIONS					
W	D	H	W	D	H	W	H				
78	30.5	41.5	78	19	18	78	23.5				
RTA 00			1 per carton								



R27808B R27808SB

Three Seater - High Back
COM Yardage: Back: 7.75; Seat: 3.50
Freight class: 250
Product weight: 190.5 | 221.5 shelf model
Cubic feet per carton: 69.75 | 101.5 shelf model

R27808B Base Price: **\$6129**
R27808SB Base Price: **\$7018**
Back/Arm upcharge: **+0**
Seat upcharge: **+0**

For power/USB unit, see electrical placement chart.
Ganging not available.
Add \$108 for (SSS), \$219 for (SBS)
Add \$1166 for 72 lbs. (CW), (C6)
Add \$272 for (SP) or \$984 for (BS)
Add \$37 for (TP)
Add \$347 for (MB)

1/COM	2	3	4	5	6	7	8	9	10	11	12
-------	---	---	---	---	---	---	---	---	----	----	----

+0	+\$248	+\$442	+\$729	+\$1132	+\$1302	+\$1651	+\$2201	+\$2612	+\$3062	+\$3999	+\$4984
+0	+\$112	+\$200	+\$329	+\$511	+\$588	+\$746	+\$994	+\$1180	+\$1383	+\$1806	+\$2251

Shelf: 52W 10D 1H

OVERALL DIMENSIONS			SEAT DIMENSIONS			BACK DIMENSIONS					
W	D	H	W	D	H	W	H				
85	30.5	41.5	78	19	18	78	23.5				
RTA 00			1 per carton								



R27808L R27808R

Three Seater - High Back
COM Yardage: Back: 6.75; Seat: 3.50
Freight class: 250
Product weight: 180.5
Cubic feet per carton: 76.75

R27808L Base Price: **\$5787**
R27808R Base Price: **\$5787**
Back/Arm upcharge: **+0**
Seat upcharge: **+0**

For power/USB unit, see electrical placement chart.
Includes ganging hardware (2 sides).
Add \$108 for (SSS), \$219 for (SBS)
Add \$1166 for 72 lbs. (CW), (C6)
Add \$272 for (SP) or \$984 for (BS)
Add \$37 for (TP)
Add \$347 for (MB)

1/COM	2	3	4	5	6	7	8	9	10	11	12
-------	---	---	---	---	---	---	---	---	----	----	----

+0	+\$216	+\$385	+\$635	+\$986	+\$1134	+\$1438	+\$1917	+\$2275	+\$2667	+\$3483	+\$4341
+0	+\$112	+\$200	+\$329	+\$511	+\$588	+\$746	+\$994	+\$1180	+\$1383	+\$1806	+\$2251

OVERALL DIMENSIONS			SEAT DIMENSIONS			BACK DIMENSIONS					
W	D	H	W	D	H	W	H				
81.5	30.5	41.5	78	19	18	78	23.5				
RTA 00			1 per carton								



R27808SL R27808SR

Three Seater - High Back
COM Yardage: Back: 6.75; Seat: 3.50
Freight class: 250
Product weight: 211.5
Cubic feet per carton: 101.5

R27808SL Base Price: **\$6676**
R27808SR Base Price: **\$6676**
Back/Arm upcharge: **+0**
Seat upcharge: **+0**

For power/USB unit, see electrical placement chart.
Includes ganging hardware (2 sides).
Add \$108 for (SSS), \$219 for (SBS)
Add \$1166 for 72 lbs. (CW), (C6)
Add \$272 for (SP) or \$984 for (BS)
Add \$37 for (TP)
Add \$347 for (MB)

1/COM	2	3	4	5	6	7	8	9	10	11	12
-------	---	---	---	---	---	---	---	---	----	----	----

+0	+\$216	+\$385	+\$635	+\$986	+\$1134	+\$1438	+\$1917	+\$2275	+\$2667	+\$3483	+\$4341
+0	+\$112	+\$200	+\$329	+\$511	+\$588	+\$746	+\$994	+\$1180	+\$1383	+\$1806	+\$2251





Shelf: 52W 10D 1H

OVERALL DIMENSIONS			SEAT DIMENSIONS			BACK DIMENSIONS					
W	D	H	W	D	H	W	H				
81.5	41	41.5	78	19	18	78	23.5				
RTA 00			1 per carton								





LOUNGE

RIVER+ SEATING R

DESCRIPTION	MODEL#/ FEATURES	STANDARD TEXTILE GRADES												
		1/COM	2	3	4	5	6	7	8	9	10	11	12	
 <p>R27809 R27809S</p> <p>Three Seater - Extended Back COM Yardage: Back: 6.50; Seat: 3.50 Freight class: 250 Product weight: 165 198 shelf model Cubic feet per carton: 79.25 108.5 shelf model</p>	<p>R27809 Base Price: \$5908 R27809S Base Price: \$6796</p> <p>Back upcharge: +0 Seat upcharge: +0</p> <p>For power/USB unit, see electrical placement chart. Includes ganging hardware (2 sides). Add \$108 for (SSS), \$181 for (SBS) Add \$1166 for 72 lbs. (CW), (C6) Add \$272 for (SP) or \$984 for (BS) Add \$37 for (TP) Add \$347 for (MB)</p>	<p>\$5908</p> <p>\$6796</p> <p>+0 +\$208 +\$371 +\$611 +\$949 +\$1092+\$1385 +\$1846 +\$2191 +\$2568 +\$3354 +\$4180 +0 +\$112 +\$200 +\$329 +\$511 +\$588 +\$746 +\$994 +\$1180 +\$1383 +\$1806 +\$2251</p>	<p>OVERALL DIMENSIONS</p> <p>W D H</p>			<p>SEAT DIMENSIONS</p> <p>W D H</p>			<p>BACK DIMENSIONS</p> <p>W H</p>					
				78	31	47	78	19	18	78	29			
			RTA 00										1 per carton	
 <p>R27809B R27809SB</p> <p>Three Seater - Extended Back COM Yardage: Back: 7.50; Seat: 3.50 Freight class: 250 Product weight: 190 220 shelf model Cubic feet per carton: 86.25 114 shelf model</p>	<p>R27809B Base Price: \$6589 R27809SB Base Price: \$7477</p> <p>Back/Arm upcharge: +0 Seat upcharge: +0</p> <p>For power/USB unit, see electrical placement chart. Ganging not available. Add \$108 for (SSS), \$229 for (SBS) Add \$1166 for 72 lbs. (CW), (C6) Add \$272 for (SP) or \$984 for (BS) Add \$37 for (TP) Add \$347 for (MB)</p>	<p>\$6589</p> <p>\$7477</p> <p>+0 +\$272 +\$485 +\$799 +\$1241 +\$1428+\$1811 +\$2414 +\$2865 +\$3358 +\$4386 +\$5466 +0 +\$112 +\$200 +\$329 +\$511 +\$588 +\$746 +\$994 +\$1180 +\$1383 +\$1806 +\$2251</p>	<p>OVERALL DIMENSIONS</p> <p>W D H</p>			<p>SEAT DIMENSIONS</p> <p>W D H</p>			<p>BACK DIMENSIONS</p> <p>W H</p>					
				85	31	47	78	19	18	78	29			
			RTA 00										1 per carton	
 <p>R27809L R27809R</p> <p>Three Seater - Extended Back COM Yardage: Back: 7.50; Seat: 3.50 Freight class: 250 Product weight: 180 Cubic feet per carton: 86.25</p>	<p>R27809L Base Price: \$6249 R27809R Base Price: \$6249</p> <p>Back/Arm upcharge: +0 Seat upcharge: +0</p> <p>For power/USB unit, see electrical placement chart. Includes ganging hardware (1 side). Add \$108 for (SSS), \$205 for (SBS) Add \$1166 for 72 lbs. (CW), (C6) Add \$272 for (SP) or \$984 for (BS) Add \$37 for (TP) Add \$347 for (MB)</p>	<p>\$6249</p> <p>\$6249</p> <p>+0 +\$240 +\$428 +\$705 +\$1095 +\$1260+\$1598 +\$2130 +\$2528 +\$2963 +\$3870 +\$4823 +0 +\$112 +\$200 +\$329 +\$511 +\$588 +\$746 +\$994 +\$1180 +\$1383 +\$1806 +\$2251</p>	<p>OVERALL DIMENSIONS</p> <p>W D H</p>			<p>SEAT DIMENSIONS</p> <p>W D H</p>			<p>BACK DIMENSIONS</p> <p>W H</p>					
				81.5	31	47	78	19	18	78	29			
			RTA 00										1 per carton	
 <p>R27809SL R27809SR</p> <p>Three Seater - Extended Back COM Yardage: Back: 7.50; Seat: 3.50 Freight class: 250 Product weight: 210 Cubic feet per carton: 114</p>	<p>R27809SL Base Price: \$7137 R27809SR Base Price: \$7137</p> <p>Back/Arm upcharge: +0 Seat upcharge: +0</p> <p>For power/USB unit, see electrical placement chart. Includes ganging hardware (1 side). Add \$108 for (SSS), \$205 for (SBS) Add \$1166 for 72 lbs. (CW), (C6) Add \$272 for (SP) or \$984 for (BS) Add \$37 for (TP) Add \$347 for (MB)</p>	<p>\$7137</p> <p>\$7137</p> <p>+0 +\$240 +\$428 +\$705 +\$1095 +\$1260+\$1598 +\$2130 +\$2528 +\$2963 +\$3870 +\$4823 +0 +\$112 +\$200 +\$329 +\$511 +\$588 +\$746 +\$994 +\$1180 +\$1383 +\$1806 +\$2251</p>	<p>OVERALL DIMENSIONS</p> <p>W D H</p>			<p>SEAT DIMENSIONS</p> <p>W D H</p>			<p>BACK DIMENSIONS</p> <p>W H</p>					
				81.5	41.5	47	78	19	18	78	29			
			RTA 00										1 per carton	





DESCRIPTION	MODEL#/ FEATURES	STANDARD TEXTILE GRADES											
-------------	------------------	-------------------------	--	--	--	--	--	--	--	--	--	--	--

		1/COM	2	3	4	5	6	7	8	9	10	11	12
 <p>R27810</p> <p>Bariatric Lounge Chair - Standard Back COM Yardage: Back: 2.25; Seat: 2 Freight class: 250 Product weight: 90 Cubic feet per carton: 28.75</p>	<p>R27810 Base Price: \$2916</p> <p>Back upcharge: +0</p> <p>Seat upcharge: +0</p>												
<p>For power/USB unit, see electrical placement chart. Includes ganging hardware (2 sides). Add \$64 for (SSS), \$79 for (SBS) Add \$585 for 36 lbs. (CW) Add \$127 for (SP) or \$627 for (BS) Add \$37 for (TP) Add \$174 for (MB)</p>		<p>OVERALL DIMENSIONS</p> <p>W D H</p>			<p>SEAT DIMENSIONS</p> <p>W D H</p>			<p>BACK DIMENSIONS</p> <p>W H</p>					
		39	30	32		39	19	18		39		14	
		RTA 00		1 per carton									

		1/COM	2	3	4	5	6	7	8	9	10	11	12
 <p>R27810B</p> <p>Bariatric Lounge Chair - Standard Back COM Yardage: Back: 4.25; Seat: 2 Freight class: 250 Product weight: 108 Cubic feet per carton: 33</p>	<p>R27810B Base Price: \$3598</p> <p>Back/Arm upcharge: +0</p> <p>Seat upcharge: +0</p>												
<p>For power/USB unit, see electrical placement chart. Ganging not available. Add \$64 for (SSS), \$128 for (SBS) Add \$585 for 36 lbs. (CW) Add \$127 for (SP) or \$627 for (BS) Add \$37 for (TP) Add \$174 for (MB)</p>		<p>OVERALL DIMENSIONS</p> <p>W D H</p>			<p>SEAT DIMENSIONS</p> <p>W D H</p>			<p>BACK DIMENSIONS</p> <p>W H</p>					
		46	30	32		39	19	18		39		14	
		RTA 00		1 per carton									

		1/COM	2	3	4	5	6	7	8	9	10	11	12
 <p>R27810L</p> <p>R27810R</p> <p>Bariatric Lounge Chair - Standard Back COM Yardage: Back: 3.25; Seat: 2 Freight class: 250 Product weight: 98 Cubic feet per carton: 33</p>	<p>R27810L Base Price: \$3257</p> <p>R27810R Base Price: \$3257</p> <p>Back/Arm upcharge: +0</p> <p>Seat upcharge: +0</p>												
<p>For power/USB unit, see electrical placement chart. Includes ganging hardware (1 side). Add \$64 for (SSS), \$103 for (SBS) Add \$585 for 36 lbs. (CW) Add \$127 for (SP) or \$627 for (BS) Add \$37 for (TP) Add \$174 for (MB)</p>		<p>OVERALL DIMENSIONS</p> <p>W D H</p>			<p>SEAT DIMENSIONS</p> <p>W D H</p>			<p>BACK DIMENSIONS</p> <p>W H</p>					
		42.5	30	32		39	19	18		39		14	
		RTA 00		1 per carton									

		1/COM	2	3	4	5	6	7	8	9	10	11	12
 <p>R27811</p> <p>Bariatric Lounge Chair - High Back COM Yardage: Back: 2.75; Seat: 2 Freight class: 250 Product weight: 98 Cubic feet per carton: 36</p>	<p>R27811 Base Price: \$3244</p> <p>Back upcharge: +0</p> <p>Seat upcharge: +0</p>												
<p>For power/USB unit, see electrical placement chart. Includes ganging hardware (2 sides). Add \$64 for (SSS), \$101 for (SBS) Add \$585 for 36 lbs. (CW), (C6) Add \$127 for (SP) or \$627 for (BS) Add \$37 for (TP) Add \$174 for (MB)</p>		<p>OVERALL DIMENSIONS</p> <p>W D H</p>			<p>SEAT DIMENSIONS</p> <p>W D H</p>			<p>BACK DIMENSIONS</p> <p>W H</p>					
		39	30.5	41.5		39	19	18		39		23.5	
		RTA 00		1 per carton									

DESCRIPTION	MODEL#/ FEATURES	STANDARD TEXTILE GRADES											
		1/COM	2	3	4	5	6	7	8	9	10	11	12
 <p>R27811B</p> <p>Bariatric Lounge Chair - High Back COM Yardage: Back: 4.75; Seat: 2 Freight class: 250 Product weight: 117.5 Cubic feet per carton: 42.25</p>	R27811B Base Price:	\$3925											
	Back/Arm upcharge:	+0	+\$152	+\$271	+\$447	+\$694	+\$798	+\$1012	+\$1349	+\$1601	+\$1877	+\$2451	+\$3055
	Seat upcharge:	+0	+\$64	+\$114	+\$188	+\$292	+\$336	+\$426	+\$568	+\$674	+\$790	+\$1032	+\$1286
	For power/USB unit, see electrical placement chart. Ganging not available.												
	Add \$64 for (SSS), \$150 for (SBS) Add \$585 for 36 lbs. (CW), (C6) Add \$127 for (SP) or \$627 for (BS) Add \$37 for (TP) Add \$174 for (MB)												
		OVERALL DIMENSIONS			SEAT DIMENSIONS			BACK DIMENSIONS					
		W	D	H	W	D	H	W	H				
		46	30.5	41.5	39	19	18	39	23.5				
		RTA 00	1 per carton										
 <p>R27811L</p> <p>Bariatric Lounge Chair - High Back COM Yardage: Back: 3.75; Seat: 2 Freight class: 250 Product weight: 107.5 Cubic feet per carton: 42.25</p>	R27811L Base Price:	\$3585											
	R27811R Base Price:	\$3585											
	Back/Arm upcharge:	+0	+\$120	+\$214	+\$353	+\$548	+\$630	+\$799	+\$1065	+\$1264	+\$1482	+\$1935	+\$2412
	Seat upcharge:	+0	+\$64	+\$114	+\$188	+\$292	+\$336	+\$426	+\$568	+\$674	+\$790	+\$1032	+\$1286
	For power/USB unit, see electrical placement chart. Includes ganging hardware (1 side). Add \$64 for (SSS), \$126 for (SBS) Add \$585 for 36 lbs. (CW), (C6) Add \$127 for (SP) or \$627 for (BS) Add \$37 for (TP) Add \$174 for (MB)												
		OVERALL DIMENSIONS			SEAT DIMENSIONS			BACK DIMENSIONS					
		W	D	H	W	D	H	W	H				
		42.5	30.5	41.5	39	19	18	39	23.5				
		RTA 00	1 per carton										
 <p>R27812</p> <p>Bariatric Lounge Chair - Extended Back COM Yardage: Back: 3.25; Seat: 2 Freight class: 250 Product weight: 115 Cubic feet per carton: 41</p>	R27812 Base Price:	\$3434											
	Back upcharge:	+0	+\$104	+\$186	+\$306	+\$475	+\$546	+\$693	+\$923	+\$1096	+\$1284	+\$1677	+\$2090
	Seat upcharge:	+0	+\$64	+\$114	+\$188	+\$292	+\$336	+\$426	+\$568	+\$674	+\$790	+\$1032	+\$1286
	For power/USB unit, see electrical placement chart. Includes ganging hardware (2 sides). Add \$64 for (SSS), \$110 for (SBS) Add \$585 for 36 lbs. (CW), (C6) Add \$127 for (SP) or \$627 for (BS) Add \$37 for (TP) Add \$174 for (MB)												
			OVERALL DIMENSIONS			SEAT DIMENSIONS			BACK DIMENSIONS				
		W	D	H	W	D	H	W	H				
		39	31	47	39	19	18	39	29				
		RTA 00	1 per carton										
 <p>R27812B</p> <p>Bariatric Lounge Chair - Extended Back COM Yardage: Back: 5.25; Seat: 2 Freight class: 250 Product weight: 132.5 Cubic feet per carton: 47.25</p>	R27812B Base Price:	\$4116											
	Back/Arm upcharge:	+0	+\$168	+\$300	+\$494	+\$767	+\$882	+\$1119	+\$1491	+\$1770	+\$2074	+\$2709	+\$3376
	Seat upcharge:	+0	+\$64	+\$114	+\$188	+\$292	+\$336	+\$426	+\$568	+\$674	+\$790	+\$1032	+\$1286
	For power/USB unit, see electrical placement chart. Ganging not available. Add \$64 for (SSS), \$158 for (SBS) Add \$585 for 36 lbs. (CW), (C6) Add \$127 for (SP) or \$627 for (BS) Add \$37 for (TP) Add \$174 for (MB)												
			OVERALL DIMENSIONS			SEAT DIMENSIONS			BACK DIMENSIONS				
		W	D	H	W	D	H	W	H				
		46	31	47	39	19	18	39	29				
		RTA 00	1 per carton										

DESCRIPTION **MODEL#/ FEATURES** **STANDARD TEXTILE GRADES**



R27812L

Bariatric Lounge Chair - Extended Back
COM Yardage: Back: 4.25; Seat: 2
Freight class: 250
Product weight: 122.5
Cubic feet per carton: 47.25

R27812R

R27812L Base Price: **\$3776**
R27812R Base Price: **\$3776**
Back/Arm upcharge:
Seat upcharge:

For power/USB unit, see electrical placement chart.
Includes ganging hardware (1 side).
Add \$64 for (SSS), \$134 for (SBS)
Add \$585 for 36 lbs. (CW), (C6)
Add \$127 for (SP) or \$627 for (BS)
Add \$37 for (TP)
Add \$174 for (MB)

1/COM	2	3	4	5	6	7	8	9	10	11	12
-------	---	---	---	---	---	---	---	---	----	----	----

OVERALL DIMENSIONS			SEAT DIMENSIONS			BACK DIMENSIONS	
W	D	H	W	D	H	W	H

42.5	31	47	39	19	18	39	29
------	----	----	----	----	----	----	----

RTA 00	1 per carton										
---------------	--------------	--	--	--	--	--	--	--	--	--	--



R27815

Inside Curve Two Seater - Standard Back
COM Yardage: Back: 3; Seat: 2
Freight class: 250
Product weight: 93 | 119 shelf model
Cubic feet per carton: 42.75 | 63.5 shelf model

R27815S

R27815 Base Price: **\$3143**
R27815S Base Price: **\$4117**
Back upcharge:
Seat upcharge:

For power/USB unit, see electrical placement chart.
Includes ganging hardware (2 sides).
Add \$79 for (SSS), \$110 for (SBS)
Add \$1166 for 72 lbs. (CW), (C6)
Add \$161 for (SP) or \$715 for (BS)
Add \$37 for (TP)
Add \$233 for (MB)

1/COM	2	3	4	5	6	7	8	9	10	11	12
-------	---	---	---	---	---	---	---	---	----	----	----

Shelf: 52W 10D 1H

OVERALL DIMENSIONS			SEAT DIMENSIONS			BACK DIMENSIONS	
W	D	H	W	D	H	W	H

50.5	30	32	42	19	18	51	14
------	----	----	----	----	----	----	----

RTA 00	1 per carton										
---------------	--------------	--	--	--	--	--	--	--	--	--	--



R27815L

Inside Curve Two Seater - Standard Back
COM Yardage: Back: 4; Seat: 2
Freight class: 250
Product weight: 102
Cubic feet per carton: 43.5

R27815R

R27815L Base Price: **\$3485**
R27815R Base Price: **\$3485**
Back/Arm upcharge:
Seat upcharge:

For power/USB unit, see electrical placement chart.
Includes ganging hardware (1 side).
Add \$79 for (SSS), \$134 for (SBS)
Add \$1166 for 72 lbs. (CW), (C6)
Add \$161 for (SP) or \$715 for (BS)
Add \$37 for (TP)
Add \$233 for (MB)

1/COM	2	3	4	5	6	7	8	9	10	11	12
-------	---	---	---	---	---	---	---	---	----	----	----

OVERALL DIMENSIONS			SEAT DIMENSIONS			BACK DIMENSIONS	
W	D	H	W	D	H	W	H

54	30	32	42	19	18	51	14
----	----	----	----	----	----	----	----

RTA 00	1 per carton										
---------------	--------------	--	--	--	--	--	--	--	--	--	--



R27815SL

Inside Curve Two Seater - Standard Back
COM Yardage: Back: 4; Seat: 2
Freight class: 250
Product weight: 102 | 128 shelf model
Cubic feet per carton: 43.5 | 65 shelf model

R27815SR

R27815SL Base Price: **\$4459**
R27815SR Base Price: **\$4459**
Back/Arm upcharge:
Seat upcharge:

For power/USB unit, see electrical placement chart.
Includes ganging hardware (1 side).
Add \$79 for (SSS), \$134 for (SBS)
Add \$1166 for 72 lbs. (CW), (C6)
Add \$161 for (SP) or \$715 for (BS)
Add \$37 for (TP)
Add \$233 for (MB)





1/COM	2	3	4	5	6	7	8	9	10	11	12
-------	---	---	---	---	---	---	---	---	----	----	----

Shelf: 52W 10D 1H

OVERALL DIMENSIONS			SEAT DIMENSIONS			BACK DIMENSIONS	
W	D	H	W	D	H	W	H

61.5	40.5	32	42	19	18	51	14
------	------	----	----	----	----	----	----

RTA 00	1 per carton										
---------------	--------------	--	--	--	--	--	--	--	--	--	--

DESCRIPTION		MODEL#/ FEATURES		STANDARD TEXTILE GRADES																										
				1/COM	2	3	4	5	6	7	8	9	10	11	12															
	<p>R27816</p> <p>Inside Curve Two Seater - High Back COM Yardage: Back: 3.50; Seat: 2 Freight class: 300 Product weight: 106 132 shelf model Cubic feet per carton: 53.75 79.75 shelf model</p>	<p>R27816S</p> <p>For power/USB unit, see electrical placement chart. Includes ganging hardware (2 sides). Add \$79 for (SSS), \$145 for (SBS) Add \$1166 for 72 lbs. (CW), (C6) Add \$161 for (SP) or \$715 for (BS) Add \$37 for (TP) Add \$233 for (MB)</p>	<p>Base Price: \$4091</p> <p>Base Price: \$5005</p> <p>Back upcharge: +0</p> <p>Seat upcharge: +0</p>	Shelf: 52W 10D 1H																										
				<table border="1"> <thead> <tr> <th colspan="3">OVERALL DIMENSIONS</th> <th colspan="3">SEAT DIMENSIONS</th> <th colspan="3">BACK DIMENSIONS</th> </tr> <tr> <th>W</th> <th>D</th> <th>H</th> <th>W</th> <th>D</th> <th>H</th> <th>W</th> <th>H</th> </tr> </thead> <tbody> <tr> <td>51</td> <td>30.5</td> <td>41.5</td> <td>42</td> <td>19</td> <td>18</td> <td>51</td> <td>23.5</td> </tr> </tbody> </table>			OVERALL DIMENSIONS			SEAT DIMENSIONS			BACK DIMENSIONS			W	D	H	W	D	H	W	H	51	30.5	41.5	42	19	18	51
OVERALL DIMENSIONS			SEAT DIMENSIONS			BACK DIMENSIONS																								
W	D	H	W	D	H	W	H																							
51	30.5	41.5	42	19	18	51	23.5																							
	<p>R27816L</p> <p>Inside Curve Two Seater - High Back COM Yardage: Back: 4.50; Seat: 2 Freight class: 250 Product weight: 115 Cubic feet per carton: 55.5</p>	<p>R27816SR</p> <p>For power/USB unit, see electrical placement chart. Includes ganging hardware (1 side). Add \$79 for (SSS), \$169 for (SBS) Add \$1166 for 72 lbs. (CW), (C6) Add \$161 for (SP) or \$715 for (BS) Add \$37 for (TP) Add \$233 for (MB)</p>	<p>Base Price: \$4433</p> <p>Base Price: \$4433</p> <p>Back/Arm upcharge: +0</p> <p>Seat upcharge: +0</p>	Shelf: 52W 10D 1H																										
				<table border="1"> <thead> <tr> <th colspan="3">OVERALL DIMENSIONS</th> <th colspan="3">SEAT DIMENSIONS</th> <th colspan="3">BACK DIMENSIONS</th> </tr> <tr> <th>W</th> <th>D</th> <th>H</th> <th>W</th> <th>D</th> <th>H</th> <th>W</th> <th>H</th> </tr> </thead> <tbody> <tr> <td>54.5</td> <td>30.5</td> <td>41.5</td> <td>42</td> <td>19</td> <td>18</td> <td>51</td> <td>23.5</td> </tr> </tbody> </table>			OVERALL DIMENSIONS			SEAT DIMENSIONS			BACK DIMENSIONS			W	D	H	W	D	H	W	H	54.5	30.5	41.5	42	19	18	51
OVERALL DIMENSIONS			SEAT DIMENSIONS			BACK DIMENSIONS																								
W	D	H	W	D	H	W	H																							
54.5	30.5	41.5	42	19	18	51	23.5																							
	<p>R27816SL</p> <p>Inside Curve Two Seater - High Back COM Yardage: Back: 4.50; Seat: 2 Freight class: 250 Product weight: 141.5 Cubic feet per carton: 82.5</p>	<p>R27816SR</p> <p>For power/USB unit, see electrical placement chart. Includes ganging hardware (1 side). Add \$79 for (SSS), \$169 for (SBS) Add \$1166 for 72 lbs. (CW), (C6) Add \$161 for (SP) or \$715 for (BS) Add \$37 for (TP) Add \$233 for (MB)</p>	<p>Base Price: \$5347</p> <p>Base Price: \$5347</p> <p>Back/Arm upcharge: +0</p> <p>Seat upcharge: +0</p>	Shelf: 52W 10D 1H																										
				<table border="1"> <thead> <tr> <th colspan="3">OVERALL DIMENSIONS</th> <th colspan="3">SEAT DIMENSIONS</th> <th colspan="3">BACK DIMENSIONS</th> </tr> <tr> <th>W</th> <th>D</th> <th>H</th> <th>W</th> <th>D</th> <th>H</th> <th>W</th> <th>H</th> </tr> </thead> <tbody> <tr> <td>62</td> <td>41</td> <td>41.5</td> <td>42</td> <td>19</td> <td>18</td> <td>51</td> <td>23.5</td> </tr> </tbody> </table>			OVERALL DIMENSIONS			SEAT DIMENSIONS			BACK DIMENSIONS			W	D	H	W	D	H	W	H	62	41	41.5	42	19	18	51
OVERALL DIMENSIONS			SEAT DIMENSIONS			BACK DIMENSIONS																								
W	D	H	W	D	H	W	H																							
62	41	41.5	42	19	18	51	23.5																							
	<p>R27817</p> <p>Inside Curve Two Seater - Extended Back COM Yardage: Back: 4; Seat: 2 Freight class: 300 Product weight: 118 139 shelf model Cubic feet per carton: 61 90.5 shelf model</p>	<p>R27817S</p> <p>For power/USB unit, see electrical placement chart. Includes ganging hardware (2 sides). Add \$79 for (SSS), \$155 for (SBS) Add \$1166 for 72 lbs. (CW), (C6) Add \$161 for (SP) or \$715 for (BS) Add \$37 for (TP) Add \$233 for (MB)</p>	<p>Base Price: \$4334</p> <p>Base Price: \$5249</p> <p>Back upcharge: +0</p> <p>Seat upcharge: +0</p>	Shelf: 52W 10D 1H																										
				<table border="1"> <thead> <tr> <th colspan="3">OVERALL DIMENSIONS</th> <th colspan="3">SEAT DIMENSIONS</th> <th colspan="3">BACK DIMENSIONS</th> </tr> <tr> <th>W</th> <th>D</th> <th>H</th> <th>W</th> <th>D</th> <th>H</th> <th>W</th> <th>H</th> </tr> </thead> <tbody> <tr> <td>51.5</td> <td>31</td> <td>47</td> <td>42</td> <td>19</td> <td>18</td> <td>51</td> <td>29</td> </tr> </tbody> </table>			OVERALL DIMENSIONS			SEAT DIMENSIONS			BACK DIMENSIONS			W	D	H	W	D	H	W	H	51.5	31	47	42	19	18	51
OVERALL DIMENSIONS			SEAT DIMENSIONS			BACK DIMENSIONS																								
W	D	H	W	D	H	W	H																							
51.5	31	47	42	19	18	51	29																							

DESCRIPTION MODEL#/ FEATURES STANDARD TEXTILE GRADES



R27817L

Inside Curve Two Seater - Extended Back
 COM Yardage: Back: 5; Seat: 2
 Freight class: 300
 Product weight: 122
 Cubic feet per carton: 62.25

R27817R

R27817L Base Price: **\$4675**
R27817R Base Price: **\$4675**
 Back/Arm upcharge: **+0**
 Seat upcharge: **+0**
 For power/USB unit, see electrical placement chart.
 Includes ganging hardware (1 side).
 Add \$79 for (SSS), \$180 for (SBS)
 Add \$1166 for 72 lbs. (CW), (C6)
 Add \$161 for (SP) or \$715 for (BS)
 Add \$37 for (TP)
 Add \$233 for (MB)

1/COM	2	3	4	5	6	7	8	9	10	11	12
-------	---	---	---	---	---	---	---	---	----	----	----

+0	+\$160	+\$285	+\$470	+\$730	+\$840	+\$1065	+\$1420	+\$1685	+\$1975	+\$2580	+\$3215
+0	+\$64	+\$114	+\$188	+\$292	+\$336	+\$426	+\$568	+\$674	+\$790	+\$1032	+\$1286

OVERALL DIMENSIONS			SEAT DIMENSIONS			BACK DIMENSIONS					
W	D	H	W	D	H	W	H				
54	31	47	42	19	18	51	29				
RTA 00			1 per carton								



R27817SL

Inside Curve Two Seater - Extended Back
 COM Yardage: Back: 5; Seat: 2
 Freight class: 300
 Product weight: 149
 Cubic feet per carton: 92.75

R27817SR

R27817SL Base Price: **\$5590**
R27817SR Base Price: **\$5590**
 Back/Arm upcharge: **+0**
 Seat upcharge: **+0**
 For power/USB unit, see electrical placement chart.
 Includes ganging hardware (1 side).
 Add \$79 for (SSS), \$180 for (SBS)
 Add \$1166 for 72 lbs. (CW), (C6)
 Add \$161 for (SP) or \$715 for (BS)
 Add \$37 for (TP)
 Add \$233 for (MB)

1/COM	2	3	4	5	6	7	8	9	10	11	12
-------	---	---	---	---	---	---	---	---	----	----	----

+0	+\$160	+\$285	+\$470	+\$730	+\$840	+\$1065	+\$1420	+\$1685	+\$1975	+\$2580	+\$3215
+0	+\$64	+\$114	+\$188	+\$292	+\$336	+\$426	+\$568	+\$674	+\$790	+\$1032	+\$1286

Shelf: 52W 10D 1H

OVERALL DIMENSIONS			SEAT DIMENSIONS			BACK DIMENSIONS					
W	D	H	W	D	H	W	H				
62.5	41.5	47	42	19	18	51	29				
RTA 00			1 per carton								



R27818

Outside Curve Two Seater - Standard Back
 COM Yardage: Back: 2.25; Seat: 2
 Freight class: 4.25
 Product weight: 93 | 107 shelf model
 Cubic feet per carton: 42.75 | 63.5 shelf model

R27818S

R27818 Base Price: **\$3065**
R27818S Base Price: **\$3981**
 Back upcharge: **+0**
 Seat upcharge: **+0**
 For power/USB unit, see electrical placement chart.
 Includes ganging hardware (2 sides).
 Add \$86 for (SSS), \$96 for (SBS)
 Add \$1166 for 72 lbs. (CW), (C6)
 Add \$161 for (SP) or \$806 for (BS)
 Add \$37 for (TP)
 Add \$233 for (MB)

1/COM	2	3	4	5	6	7	8	9	10	11	12
-------	---	---	---	---	---	---	---	---	----	----	----

+0	+\$72	+\$129	+\$212	+\$329	+\$378	+\$480	+\$639	+\$759	+\$889	+\$1161	+\$1447
+0	+\$64	+\$114	+\$188	+\$292	+\$336	+\$426	+\$568	+\$674	+\$790	+\$1032	+\$1286

Shelf: 52W 10D 1H

OVERALL DIMENSIONS			SEAT DIMENSIONS			BACK DIMENSIONS					
W	D	H	W	D	H	W	H				
50	30	32	50	19	18	36	14				
RTA 00			1 per carton								



R27818L

Outside Curve Two Seater - Standard Back
 COM Yardage: Back: 3.25; Seat: 2
 Freight class: 5.25
 Product weight: 102
 Cubic feet per carton: 43.5

R27818R

R27818L Base Price: **\$3406**
R27818R Base Price: **\$3406**
 Back/Arm upcharge: **+0**
 Seat upcharge: **+0**
 For power/USB unit, see electrical placement chart.
 Includes ganging hardware (1 side).
 Add \$86 for (SSS), \$120 for (SBS)
 Add \$1166 for 72 lbs. (CW), (C6)
 Add \$161 for (SP) or \$806 for (BS)
 Add \$37 for (TP)
 Add \$233 for (MB)

1/COM	2	3	4	5	6	7	8	9	10	11	12
-------	---	---	---	---	---	---	---	---	----	----	----

+0	+\$104	+\$186	+\$306	+\$475	+\$546	+\$693	+\$923	+\$1096	+\$1284	+\$1677	+\$2090
+0	+\$64	+\$114	+\$188	+\$292	+\$336	+\$426	+\$568	+\$674	+\$790	+\$1032	+\$1286

OVERALL DIMENSIONS			SEAT DIMENSIONS			BACK DIMENSIONS					
W	D	H	W	D	H	W	H				
53.5	30	32	50	19	18	36	14				
RTA 00			1 per carton								

DESCRIPTION MODEL#/ FEATURES STANDARD TEXTILE GRADES

	<p>R27818SL Base Price: \$4322 R27818SR Base Price: \$4322</p> <p>Back/Arm upcharge: +0 Seat upcharge: +0</p> <p>Shelf: 52W 10D 1H</p>	1/COM	2	3	4	5	6	7	8	9	10	11	12	
		<p>For power/USB unit, see electrical placement chart. Includes ganging hardware (1 side). Add \$86 for (SSS), \$120 for (SBS) Add \$1166 for 72 lbs. (CW), (C6) Add \$161 for (SP) or \$806 for (BS) Add \$37 for (TP) Add \$233 for (MB)</p>												
<p>R27818SL</p> <p>Outside Curve Two Seater - Standard Back COM Yardage: Back 3.25; Seat: 2 Freight class: 5.25 Product weight: 116 Cubic feet per carton: 65</p>	<p>R27818SR</p>	<p>OVERALL DIMENSIONS</p> <p>W D H</p>			<p>SEAT DIMENSIONS</p> <p>W D H</p>			<p>BACK DIMENSIONS</p> <p>W H</p>						
		53.5	40.5	32	50	19	18	36	14					
		<p>RTA 00 1 per carton</p>												

	<p>R27819 Base Price: \$3650 R27819S Base Price: \$4566</p> <p>Back upcharge: +0 Seat upcharge: +0</p> <p>Shelf: 52W 10D 1H</p>	1/COM	2	3	4	5	6	7	8	9	10	11	12	
		<p>For power/USB unit, see electrical placement chart. Includes ganging hardware (2 sides). Add \$86 for (SSS), \$125 for (SBS) Add \$1166 for 72 lbs. (CW), (C6) Add \$161 for (SP) or \$806 for (BS) Add \$37 for (TP) Add \$233 for (MB)</p>												
<p>R27819</p> <p>Outside Curve Two Seater - High Back COM Yardage: Back 3.25; Seat: 2 Freight class: 300 Product weight: 101 115 shelf model Cubic feet per carton: 53.75 79.75 shelf model</p>	<p>R27819S</p>	<p>OVERALL DIMENSIONS</p> <p>W D H</p>			<p>SEAT DIMENSIONS</p> <p>W D H</p>			<p>BACK DIMENSIONS</p> <p>W H</p>						
		50	30.5	41.5	50	19	18	32	23.5					
		<p>RTA 00 1 per carton</p>												

	<p>R27819L Base Price: \$3991 R27819R Base Price: \$3991</p> <p>Back/Arm upcharge: +0 Seat upcharge: +0</p>	1/COM	2	3	4	5	6	7	8	9	10	11	12	
		<p>For power/USB unit, see electrical placement chart. Includes ganging hardware (1 side). Add \$86 for (SSS), \$149 for (SBS) Add \$1166 for 72 lbs. (CW), (C6) Add \$161 for (SP) or \$806 for (BS) Add \$37 for (TP) Add \$233 for (MB)</p>												
<p>R27819L</p> <p>Outside Curve Two Seater - High Back COM Yardage: Back 4.25; Seat: 2 Freight class: 300 Product weight: 110 Cubic feet per carton: 55.5</p>	<p>R27819R</p>	<p>OVERALL DIMENSIONS</p> <p>W D H</p>			<p>SEAT DIMENSIONS</p> <p>W D H</p>			<p>BACK DIMENSIONS</p> <p>W H</p>						
		53.5	30.5	41.5	50	19	18	32	23.5					
		<p>RTA 00 1 per carton</p>												

	<p>R27819SL Base Price: \$4907 R27819SR Base Price: \$4907</p> <p>Back/Arm upcharge: +0 Seat upcharge: +0</p> <p>Shelf: 52W 10D 1H</p>	1/COM	2	3	4	5	6	7	8	9	10	11	12	
		<p>For power/USB unit, see electrical placement chart. Includes ganging hardware (1 side). Add \$86 for (SSS), \$149 for (SBS) Add \$1166 for 72 lbs. (CW), (C6) Add \$161 for (SP) or \$806 for (BS) Add \$37 for (TP) Add \$233 for (MB)</p>												
<p>R27819SL</p> <p>Outside Curve Two Seater - High Back COM Yardage: Back 4.25; Seat: 2 Freight class: 300 Product weight: 124.5 Cubic feet per carton: 82.5</p>	<p>R27819SR</p>	<p>OVERALL DIMENSIONS</p> <p>W D H</p>			<p>SEAT DIMENSIONS</p> <p>W D H</p>			<p>BACK DIMENSIONS</p> <p>W H</p>						
		53.5	41	41.5	50	19	18	32	23.5					
		<p>RTA 00 1 per carton</p>												

DESCRIPTION MODEL#/ FEATURES STANDARD TEXTILE GRADES



R27820

R27820S

Outside Curve Two Seater - Extended Back
COM Yardage: Back 4.25; Seat: 2
Freight class: 300
Product weight: 109 | 120 shelf
Cubic feet per carton: 61 | 90.5 shelf

R27820 Base Price: **\$4342**
R27820S Base Price: **\$4861**
Back upcharge: **+0**
Seat upcharge: **+0**

1/COM	2	3	4	5	6	7	8	9	10	11	12
-------	---	---	---	---	---	---	---	---	----	----	----

Shelf: 52W 10D 1H

OVERALL DIMENSIONS			SEAT DIMENSIONS			BACK DIMENSIONS		
W	D	H	W	D	H	W	H	
50	31	47	50	19	18	28	29	
RTA 00			1 per carton					

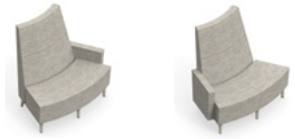

R27820L

R27820R

Outside Curve Two Seater - Extended Back
COM Yardage: Back 5.25; Seat: 2
Freight class: 300
Product weight: 113
Cubic feet per carton: 62.25

R27820L Base Price: **\$4361**
R27820R Base Price: **\$4361**
Back/Arm upcharge: **+0**
Seat upcharge: **+0**

1/COM	2	3	4	5	6	7	8	9	10	11	12
-------	---	---	---	---	---	---	---	---	----	----	----

OVERALL DIMENSIONS			SEAT DIMENSIONS			BACK DIMENSIONS		
W	D	H	W	D	H	W	H	
53.5	31	47	50	19	18	28	29	
RTA 00			1 per carton					



R27820SL

R27820SR

Outside Curve Two Seater - Extended Back
COM Yardage: Back 5.25; Seat: 2
Freight class: 300
Product weight: 113 | 130 shelf
Cubic feet per carton: 62.25 | 92.75 shelf

R27820SL Base Price: **\$5203**
R27820SR Base Price: **\$5203**
Back/Arm upcharge: **+0**
Seat upcharge: **+0**

1/COM	2	3	4	5	6	7	8	9	10	11	12
-------	---	---	---	---	---	---	---	---	----	----	----

Shelf: 52W 10D 1H

OVERALL DIMENSIONS			SEAT DIMENSIONS			BACK DIMENSIONS		
W	D	H	W	D	H	W	H	
53.5	41.5	47	50	19	18	28	29	
RTA 00			1 per carton					



R27821

R27821S





90 Corner - Standard Back
COM Yardage: Back 4; Seat: 2
Freight class: 250
Product weight: 105 | 137 shelf
Cubic feet per carton: 35.5 | 63 shelf



R27821 Base Price: **\$4054**
R27821S Base Price: **\$5338**
Back upcharge: **+0**
Seat upcharge: **+0**

1/COM	2	3	4	5	6	7	8	9	10	11	12
-------	---	---	---	---	---	---	---	---	----	----	----

Shelf: 52W 10D 1H

OVERALL DIMENSIONS			SEAT DIMENSIONS			BACK DIMENSIONS		
W	D	H	W	D	H	W	H	
37.5	37.5	32	24	19	18	24	14	
RTA 00			1 per carton					

DESCRIPTION		MODEL#/ FEATURES		STANDARD TEXTILE GRADES											
				1/COM	2	3	4	5	6	7	8	9	10	11	12
	<p>R27822</p> <p>90 Corner - High Back COM Yardage: Back 5.75; Seat: 2 Freight class: 250 Product weight: 119 154 shelf Cubic feet per carton: 44.5 79.24 shelf</p>	<p>R27822 Base Price: \$4828</p>													
		<p>R27822S Base Price: \$6111</p> <p>Back upcharge: +0</p> <p>Seat upcharge: +0</p>	<p>+\$184</p> <p>+\$64</p>	<p>+\$328</p> <p>+\$114</p>	<p>+\$541</p> <p>+\$188</p>	<p>+\$840</p> <p>+\$292</p>	<p>+\$966</p> <p>+\$336</p>	<p>+\$1225</p> <p>+\$426</p>	<p>+\$1633</p> <p>+\$568</p>	<p>+\$1938</p> <p>+\$674</p>	<p>+\$2272</p> <p>+\$790</p>	<p>+\$2967</p> <p>+\$1032</p>	<p>+\$3698</p> <p>+\$1286</p>		
				Shelf: 52W 10D 1H											
				<p>OVERALL DIMENSIONS</p> <p>W D H</p>			<p>SEAT DIMENSIONS</p> <p>W D H</p>			<p>BACK DIMENSIONS</p> <p>W H</p>					
				38.5 38.5 41.5			24 19 18			24 23.5					
				<p>RTA 00</p>		1 per carton									
	<p>R27823</p> <p>90 Corner - Extended Back COM Yardage: Back 6.25; Seat: 2 Freight class: 250 Product weight: 128 160 shelf Cubic feet per carton: 50.5 90 shelf</p>	<p>R27823 Base Price: \$5310</p>													
		<p>R27823S Base Price: \$6594</p> <p>Back upcharge: +0</p> <p>Seat upcharge: +0</p>	<p>+\$200</p> <p>+\$64</p>	<p>+\$357</p> <p>+\$114</p>	<p>+\$588</p> <p>+\$188</p>	<p>+\$913</p> <p>+\$292</p>	<p>+\$1050</p> <p>+\$336</p>	<p>+\$1332</p> <p>+\$426</p>	<p>+\$1775</p> <p>+\$568</p>	<p>+\$2107</p> <p>+\$674</p>	<p>+\$2469</p> <p>+\$790</p>	<p>+\$3225</p> <p>+\$1032</p>	<p>+\$2733</p> <p>+\$1286</p>		
				Shelf: 52W 10D 1H											
				<p>OVERALL DIMENSIONS</p> <p>W D H</p>			<p>SEAT DIMENSIONS</p> <p>W D H</p>			<p>BACK DIMENSIONS</p> <p>W H</p>					
				39 39 47			24 19 18			24 29					
				<p>RTA 00</p>		1 per carton									
	<p>R27824</p> <p>120 Corner - Standard Back COM Yardage: Back 4; Seat: 2 Freight class: 250 Product weight: 109 138 shelf Cubic feet per carton: 48.25 68.5 shelf</p>	<p>R27824 Base Price: \$4197</p>													
		<p>R27824S Base Price: \$5483</p> <p>Back upcharge: +0</p> <p>Seat upcharge: +0</p>	<p>+\$128</p> <p>+\$64</p>	<p>+\$228</p> <p>+\$114</p>	<p>+\$376</p> <p>+\$188</p>	<p>+\$584</p> <p>+\$292</p>	<p>+\$672</p> <p>+\$336</p>	<p>+\$852</p> <p>+\$426</p>	<p>+\$1136</p> <p>+\$568</p>	<p>+\$1348</p> <p>+\$674</p>	<p>+\$1580</p> <p>+\$790</p>	<p>+\$2064</p> <p>+\$1032</p>	<p>+\$2572</p> <p>+\$1286</p>		
				Shelf: 52W 10D 1H											
				<p>OVERALL DIMENSIONS</p> <p>W D H</p>			<p>SEAT DIMENSIONS</p> <p>W D H</p>			<p>BACK DIMENSIONS</p> <p>W H</p>					
				52.5 30 32			52 19 18			52 14					
				<p>RTA 00</p>		1 per carton									
	<p>R27825</p> <p>120 Corner - High Back COM Yardage: Back 5.75; Seat: 2 Freight class: 300 Product weight: 118 144 shelf Cubic feet per carton: 60.5 86 shelf</p>	<p>R27825 Base Price: \$4911</p>													
		<p>R27825S Base Price: \$6197</p> <p>Back upcharge: +0</p> <p>Seat upcharge: +0</p>	<p>+\$184</p> <p>+\$64</p>	<p>+\$328</p> <p>+\$114</p>	<p>+\$541</p> <p>+\$188</p>	<p>+\$840</p> <p>+\$292</p>	<p>+\$966</p> <p>+\$336</p>	<p>+\$1225</p> <p>+\$426</p>	<p>+\$1633</p> <p>+\$568</p>	<p>+\$1938</p> <p>+\$674</p>	<p>+\$2272</p> <p>+\$790</p>	<p>+\$2967</p> <p>+\$1032</p>	<p>+\$3698</p> <p>+\$1286</p>		
				Shelf: 52W 10D 1H											
				<p>OVERALL DIMENSIONS</p> <p>W D H</p>			<p>SEAT DIMENSIONS</p> <p>W D H</p>			<p>BACK DIMENSIONS</p> <p>W H</p>					
				53.5 30.5 41.5			41 21 18			51 23.5					
				<p>RTA 00</p>		1 per carton									

DESCRIPTION	MODEL#/ FEATURES	STANDARD TEXTILE GRADES											
		1/COM	2	3	4	5	6	7	8	9	10	11	12
 <p>R27826</p> <p>120 Corner - Extended Back COM Yardage: Back 6.25; Seat: 2 Freight class: 300 Product weight: 123 144 shelf Cubic feet per carton: 68.75 97.75 shelf</p>	<p>R27826 Base Price: \$5328</p> <p>R27826S Base Price: \$6612</p> <p>Back upcharge: +0 +\$200 +\$357 +\$588 +\$913 +\$1050+\$1332 +\$1775 +\$2107 +\$2469 +\$3225 +\$4019</p> <p>Seat upcharge: +0 +\$64 +\$114 +\$188 +\$292 +\$336 +\$426 +\$568 +\$674 +\$790 +\$1032 +\$1286</p> <p>Shelf: 52W 10D 1H</p>	<p>OVERALL DIMENSIONS</p> <p>W D H</p>			<p>SEAT DIMENSIONS</p> <p>W D H</p>			<p>BACK DIMENSIONS</p> <p>W H</p>					
		54	31.5	47	41	21	18	51	29	<p>RTA 00 1 per carton</p>			
 <p>Loop Arm COM Yardage: N/A Freight class: 92.5 Product weight (lbs.): 6.3 Cubic feet per carton: 0.6</p>	<p>Attachment hardware included. Polished Aluminum arms sold separately (1 pc).</p> <p>Armcap finish options: (NGT) Night, (FOG) Fog, (LAB) Latte</p>	<p>OVERALL DIMENSIONS</p> <p>W D H</p>			<p>SEAT DIMENSIONS</p> <p>W D H</p>			<p>BACK DIMENSIONS</p> <p>W H</p>					
		2.5	14	19.5	-	-	-	-	-	<p>RTA 1 1 per carton</p>			
 <p>Loop Arm w/Armcap COM Yardage: N/A Freight class: 92.5 Product weight (lbs.): 6.61 Cubic feet per carton: 0.6</p>	<p>Attachment hardware included. Polished Aluminum arms sold separately (1 pc).</p> <p>Armcap finish options: (NGT) Night, (FOG) Fog, (LAB) Latte</p>	<p>OVERALL DIMENSIONS</p> <p>W D H</p>			<p>SEAT DIMENSIONS</p> <p>W D H</p>			<p>BACK DIMENSIONS</p> <p>W H</p>					
		2.5	14	19.5	-	-	-	-	-	<p>RTA 1 1 per carton</p>			

RIVER+ BENCHES



Two Seater Bench
model R27832

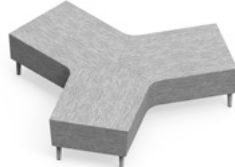

Y Bench
model R27842



42" Round Bench
model R27845

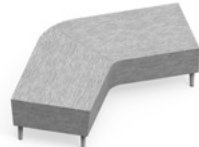

Inside Curve Boomerang Bench
model R27840

River+ Seating, Tables & Media Hearths

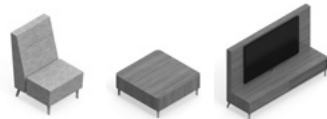

For River+ seating, please see page 330

For River+ tables, please see page 354

For River+ media hearths, please see page 358

EXAMPLE RIVER+ BENCH ORDER CODE:

R27832	-CE90	-S6	-AS	-CH	-	-SP
Model number	Textile	Leg selection	Leg angle	Leg finish	Additional weight	Bottom selection
-	-	-F1	-W			
Sealed Seams	Moisture barrier	Power/USB position	Power finish			

Additional Options specify at end of order code.	SPECIFY CODE
Tamperproof fasteners Upcharges vary, see model.	TP
Moisture barrier Upcharges vary, see model.	MB

*linking hardware is lowered to clear the staple strip.
Units will only gang with other units with sealed bottom.
**cannot be combined with linking hardware or power units

STANDARD FEATURES

- A modular series that is composed of straight, and curved sections, as well as freestanding units.
- Linking units can be used together in any combination to create a wide variety of layouts. Ganging hardware is standard and is factory installed. Ganging hardware swivels out of the way when not in use.
- The standard, 6.5" tapered legs are made of welded steel.
- Legs are straight (vertical) as standard. Linking models are optionally available with angled back legs to match River+ seating units.
- Legs are standard in Chrome with Black non-marking height adjustable glides.
- River+ is rated for an active weight up to 600 lbs. per seat and 24/7 use.
- For 24/7 use and/or heavy duty application use, Global's Heavy Duty warranty is applicable on models specified with performance textiles, rated for 150,000 double rubs.
- Check textile availability prior to specifying upholstery material. Leather not available on River+ series
- All units are shipped fully assembled.

OPTIONAL FEATURES

- Legs are available in 3" and 8" heights with no upcharge. All heights are available with fixed-to-floor option. Please specify. Add \$72. Fastening hardware not included.
- Steel bottom provides tamperproof protection (includes tamperproof screws). Specify **(BS)** - see each model for upcharge.**
- Up to two power units are available on straight, Y, curved and boomerang benches.
- Each power unit includes one AC outlet and two USB-a, 10-watt charging ports.
- Power location options include front or back. See electrical placement diagrams. Electrical units must be factory installed. Add \$612 per unit.
- Power units are available in either Jet Black **(J)** or White **(W)** with 120", three-prong matching cords.
- To add sealed seams to your product, specify **(SLS)** - see each model for upcharge.
- To match leg angles with lounge seating, straight front and angled back 6.5" or 8" legs are available on straight, curved, corner, and boomerang units. Specify **(SA)**. No upcharge.
- Products can be weighted to reduce the ease of movement. For additional weight options, specify **(CW)** - see each model for available additional weight and upcharge.
- The underside of the seat can be finished with PVC (vinyl) and sealed to prevent penetration of liquids. Specify **(SP)** - see each model for upcharge.*

Please add option codes in the following order:

- Model number**
R27831 to R27833 Straight benches
R27834 to R27835 Curved benches
R27836 to R27839 Corner benches
R27840 to R27841 Boomerang benches
R27842 Y bench
R27843 to R27846 Round non-linking benches
R27847 to R27850 Square non-linking benches
- Textile**
Specify textile code.
- Leg selection**
(S6) Standard seat height (17.5"), 6.5" leg w/ adjustable glides. No upcharge.
(S3) Low seat (14"), 3" leg w/adjustable glides. No upcharge.
(S8) High seat (19"), 8" leg w/adjustable glides. No upcharge.
(F6) Standard seat height (17.5"), 6.5" leg, fixed to floor. Add \$92.
(F3) Low seat (14"), 3" leg, fixed to floor. Add \$92.
(F8) High seat (19"), 8" leg, fixed to floor. Add \$92.
- Leg angle**
(AST) Straight legs. No upcharge.
(SA) Straight front legs, angled back legs (available only for 6.5" and 8" high legs on straight, curved, corner and boomerang units). No upcharge.
- Leg finish**
(CHM) Chrome
(TDW) Designer White
(TFR) Frost
(TLA) Latte
(TNE) Nevada
(TSH) Shadow
(TTU) Tungsten
(TBL) Black
(TFO) Fog
(TIV) Cloud
(TMO) Mocha
(TOA) Toast
(TSN) Sand
- Additional weight**
(CW) Additional weight. Upcharges vary, see model.
- Bottom selection**
(SSB) Standard bottom.
(SP) Vinyl sealed bottom w/staple strip. Upcharges vary, see model.*
(BS) Steel bottom. Upcharges vary, see model.**
- Sealed seams**
(SLS) Sealed seams. Upcharges vary, see model.
- Moisture barrier**
(MB) Upcharges vary, see model.
- Power/USB unit position** (straight, curved, boomerang and Y benches only, as shown below). Add \$612 per unit.
(NP) No power (no upcharge)
(F1) Front left
(F2) Front right
(EB1) Back left
(EB2) Back right
- Power unit finish**
(J) Jet Black
(W) White
- Tamperproof fasteners**
(TP) Upcharges vary, see model.

ELECTRICAL PLACEMENT

Straight benches

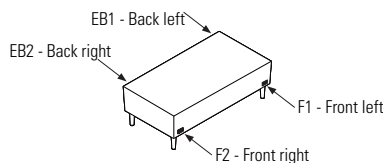

Y bench

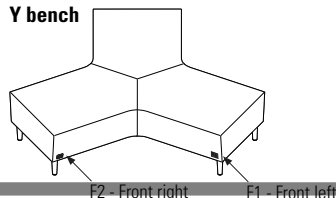

Curved benches

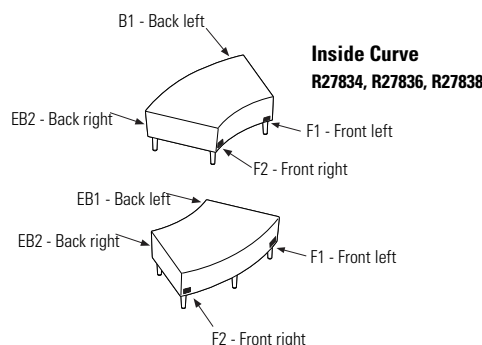

Boomerang benches

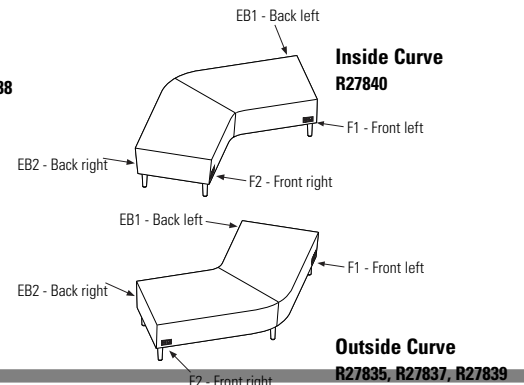

DESCRIPTION FEATURES MODEL# STANDARD TEXTILE GRADES

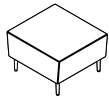

Single Seater Bench
COM Yardage: 1.75
Freight class: 1.75
Product weight: 48
Cubic feet per carton: 10.5

For power/USB unit, see electrical placement chart.
Includes ganging hardware (2 sides).
Add \$63 for **(SLS)**
Add \$92 for **(F6, F3, or F8)**
Add \$585 for 36 lbs. **(CW)**
Add \$74 for **(SP)** or \$339 for **(BS)**
Add \$37 for **(TP)**
Add \$117 for **(MB)**

	1	2	3	4	5	6	7	8	9	10	11	12
R27831	1288	1344	1388	1453	1544	1582	1661	1785	1878	1980	2191	2414

OVERALL DIMENSIONS			SEAT DIMENSIONS			BACK DIMENSIONS		
W	D	H	W	D	H	W	H	

26	28.5	17.5	-	-	-	-	-
----	------	------	---	---	---	---	---

RTA 00 1 per carton

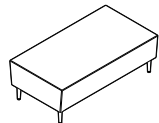

Two Seater Bench
COM Yardage: 2.75
Freight class: 2.50
Product weight: 65
Cubic feet per carton: 20.5

For power/USB unit, see electrical placement chart.
Includes ganging hardware (2 sides).
Add \$77 for **(SLS)**
Add \$92 for **(F6, F3, or F8)**
Add \$1166 for 72 lbs. **(CW)**
Add \$115 for **(SP)** or \$562 for **(BS)**
Add \$37 for **(TP)**
Add \$233 for **(MB)**

	1	2	3	4	5	6	7	8	9	10	11	12
R27832	1885	1973	2042	2144	2287	2347	2471	2666	2812	2972	3304	3654

OVERALL DIMENSIONS			SEAT DIMENSIONS			BACK DIMENSIONS		
W	D	H	W	D	H	W	H	

52	28.5	17.5	-	-	-	-	-
----	------	------	---	---	---	---	---

RTA 00 1 per carton

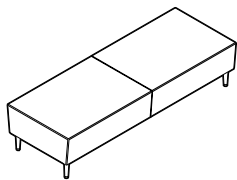

Three Seater Bench
COM Yardage: 4.5
Freight class: 4.5
Product weight: 103
Cubic feet per carton: 30.25

For power/USB unit, see electrical placement chart.
Includes ganging hardware (2 sides).
Add \$113 for **(SLS)**
Add \$92 for **(F6, F3, or F8)**
Add \$1166 for 72 lbs. **(CW)**
Add \$161 for **(SP)** or \$715 for **(BS)**
Add \$37 for **(TP)**
Add \$347 for **(MB)**

	1	2	3	4	5	6	7	8	9	10	11	12
R27833	2964	3108	3221	3387	3621	3720	3923	4242	4481	4742	5286	5858

OVERALL DIMENSIONS			SEAT DIMENSIONS			BACK DIMENSIONS		
W	D	H	W	D	H	W	H	

78	28.5	17.5	-	-	-	-	-
----	------	------	---	---	---	---	---

RTA 00 1 per carton

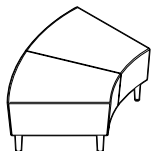

Inside Curve Two Seater Bench
COM Yardage: 3
Freight class: 2.50
Product weight: 60
Cubic feet per carton: 22.75

For power/USB unit, see electrical placement chart.
Includes ganging hardware (2 sides).
Add \$69 for **(SLS)**
Add \$92 for **(F6, F3, or F8)**
Add \$1166 for 72 lbs. **(CW)**
Add \$115 for **(SP)** or \$450 for **(BS)**
Add \$45 for **(TP)**
Add \$233 for **(MB)**

	1	2	3	4	5	6	7	8	9	10	11	12
R27834	2560	2656	2731	2842	2998	3064	3199	3412	3571	3745	4108	4489

OVERALL DIMENSIONS			SEAT DIMENSIONS			BACK DIMENSIONS		
W	D	H	W	D	H	W	H	

50	30.5	17.5	-	-	-	-	-
----	------	------	---	---	---	---	---

RTA 00 1 per carton

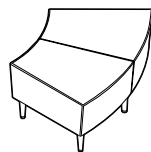

Outside Curve Two Seater Bench
COM Yardage: 3
Freight class: 2.50
Product weight: 60
Cubic feet per carton: 22.75

For power/USB unit, see electrical placement chart.
Includes ganging hardware (2 sides).
Add \$69 for **(SLS)**
Add \$92 for **(F6, F3, or F8)**
Add \$1166 for 72 lbs. **(CW)**
Add \$115 for **(SP)** or \$450 for **(BS)**
Add \$45 for **(TP)**
Add \$233 for **(MB)**

	1	2	3	4	5	6	7	8	9	10	11	12
R27835	2560	2656	2731	2842	2998	3064	3199	3412	3571	3745	4108	4489

OVERALL DIMENSIONS			SEAT DIMENSIONS			BACK DIMENSIONS		
W	D	H	W	D	H	W	H	



50	30.5	17.5	-	-	-	-	-
----	------	------	---	---	---	---	---

RTA 00 1 per carton

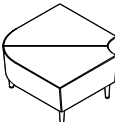
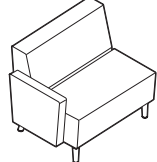
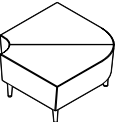
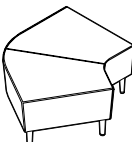
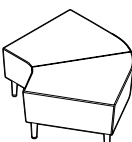
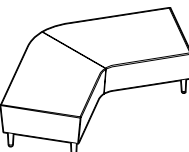
Options: **(SLS)** Sealed seams
(F6, F3, F8) Floor mount legs
(CW) Counterweight
(SP) Vinyl sealed bottom
(BS) Steel bottom
(TP) Tamperproof
(MB) Moisture barrier

DESCRIPTION	FEATURES	MODEL#	STANDARD TEXTILE GRADES													
			1	2	3	4	5	6	7	8	9	10	11	12		
  <p>90° Inside Curve Corner Bench COM Yardage: 3.25 Freight class: 250 Product weight: 60 Cubic feet per carton: 17.25</p>	<p>For power/USB unit, see electrical placement chart.</p> <p>Includes ganging hardware (2 sides).</p> <p>Add \$69 for (SLS) Add \$92 for (F6, F3, or F8) Add \$585 for 36 lbs. (CW) Add \$134 for (SP) or \$523 for (BS) Add \$45 for (TP) Add \$233 for (MB)</p>	R27836	2553	2657	2739	2859	3028	3099	3246	3476	3649	3837	4230	4643		
		OVERALL DIMENSIONS			SEAT DIMENSIONS			BACK DIMENSIONS								
		W	D	H	W	D	H	W	H							
		36.5	36.5	17.5	-	-	-	-	-							
		RTA 00	1 per carton													
 <p>90° Outside Curve Corner Bench COM Yardage: 3.25 Freight class: 250 Product weight: 60 Cubic feet per carton: 17.25</p>	<p>For power/USB unit, see electrical placement chart.</p> <p>Includes ganging hardware (2 sides).</p> <p>Add \$69 for (SLS) Add \$92 for (F6, F3, or F8) Add \$585 for 36 lbs. (CW) Add \$134 for (SP) or \$523 for (BS) Add \$45 for (TP) Add \$233 for (MB)</p>	R27837	2553	2657	2739	2859	3028	3099	3246	3476	3649	3837	4230	4643		
		OVERALL DIMENSIONS			SEAT DIMENSIONS			BACK DIMENSIONS								
		W	D	H	W	D	H	W	H							
		36.5	36.5	17.5	-	-	-	-	-							
		RTA 00	1 per carton													
 <p>120° Inside Curve Corner Bench COM Yardage: 3.5 Freight class: 250 Product weight: 57 Cubic feet per carton: 26.75</p>	<p>For power/USB unit, see electrical placement chart.</p> <p>Includes ganging hardware (2 sides).</p> <p>Add \$73 for (SLS) Add \$92 for (F6, F3, or F8) Add \$585 for 36 lbs. (CW) Add \$127 for (SP) or \$575 for (BS) Add \$45 for (TP) Add \$233 for (MB)</p>	R27838	2553	2665	2753	2882	3064	3141	3299	3547	3733	3936	4359	4804		
		OVERALL DIMENSIONS			SEAT DIMENSIONS			BACK DIMENSIONS								
		W	D	H	W	D	H	W	H							
		36.5	51.5	17.5	-	-	-	-	-							
		RTA 00	1 per carton													
 <p>120° Outside Curve Corner Bench COM Yardage: 3.5 Freight class: 250 Product weight: 57 Cubic feet per carton: 26.75</p>	<p>For power/USB unit, see electrical placement chart.</p> <p>Includes ganging hardware (2 sides).</p> <p>Add \$73 for (SLS) Add \$92 for (F6, F3, or F8) Add \$585 for 36 lbs. (CW) Add \$127 for (SP) or \$575 for (BS) Add \$45 for (TP) Add \$233 for (MB)</p>	R27839	2553	2665	2753	2882	3064	3141	3299	3547	3733	3936	4359	4804		
		OVERALL DIMENSIONS			SEAT DIMENSIONS			BACK DIMENSIONS								
		W	D	H	W	D	H	W	H							
		36.5	51.5	17.5	-	-	-	-	-							
		RTA 00	1 per carton													
 <p>Inside Curve Boomerang Bench COM Yardage: 5.25 Freight class: 250 Product weight: 126 Cubic feet per carton: 47.75</p>	<p>For power/USB unit, see electrical placement chart.</p> <p>Includes ganging hardware (2 sides).</p> <p>Add \$108 for (SLS) Add \$92 for (F6, F3, or F8) Add \$1166 for 72 lbs. (CW) Add \$187 for (SP) or \$1011 for (BS) Add \$45 for (TP) Add \$347 for (MB)</p>	R27840	3950	4118	4250	4444	4717	4832	5069	5441	5720	6024	6659	7326		
		OVERALL DIMENSIONS			SEAT DIMENSIONS			BACK DIMENSIONS								
		W	D	H	W	D	H	W	H							
		82	45	17.5	-	-	-	-	-							
		RTA 00	1 per carton													

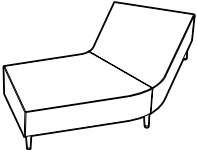
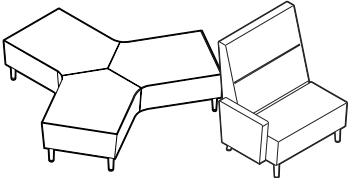
Options: **(SLS)** Sealed seams
(F6, F3, F8) Floor mount legs
(CW) Counterweight
(SP) Vinyl sealed bottom
(BS) Steel bottom
(TP) Tamperproof
(MB) Moisture barrier

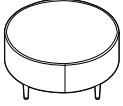
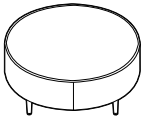
DESCRIPTION	FEATURES	MODEL#	STANDARD TEXTILE GRADES													
			1	2	3	4	5	6	7	8	9	10	11	12		
 <p>Outside Curve Boomerang Bench COM Yardage: 5.25 Freight class: 250 Product weight: 126 Cubic feet per carton: 47.75</p>	<p>For power/USB unit, see electrical placement chart.</p> <p>Includes ganging hardware (2 sides).</p> <p>Add \$108 for (SLS) Add \$92 for (F6, F3, or F8) Add \$1166 for 72 lbs. (CW) Add \$187 for (SP) or \$1011 for (BS) Add \$45 for (TP) Add \$347 for (MB)</p>	<p>R27841</p>	3950	4118	4250	4444	4717	4832	5069	5441	5720	6024	6659	7326		
			OVERALL DIMENSIONS			SEAT DIMENSIONS			BACK DIMENSIONS							
			W	D	H	W	D	H	W	H						
			82	45	17.5	-	-	-	-	-						
			RTA 00	1 per carton												
 <p>Y Bench COM Yardage: 8 Freight class: 250 Product weight: 203 Cubic feet per carton: 101.2</p>	<p>For power/USB unit, see electrical placement chart.</p> <p>Includes ganging hardware (2 sides).</p> <p>Add \$180 for (SLS) Add \$92 for (F6, F3, or F8) Add \$875 for 54 lbs. (CW) Add \$280 for (SP) or \$1253 for (BS) Add \$63 for (TP) Add \$463 for (MB)</p>	<p>R27842</p>	6361	6617	6817	7113	7529	7705	8065	8633	9057	9521	10489	11505		
			OVERALL DIMENSIONS			SEAT DIMENSIONS			BACK DIMENSIONS							
			W	D	H	W	D	H	W	H						
			82	70	17.5	-	-	-	-	-						
			RTA 00	1 per carton												
 <p>18" Dia. Round Bench COM Yardage: 1 Freight class: 150 Product weight: 25 Cubic feet per carton: 4.7</p>	<p>No power/USB unit.</p> <p>Freestanding unit only.</p> <p>Add \$42 for (SLS) Add \$92 for (F6, F3, or F8) Not available (CW) Add \$108 for (SP), (BS) not available Add \$37 for (TP) Add \$117 for (MB)</p>	<p>R27843</p>	789	821	846	883	935	957	1002	1073	1126	1184	1305	1432		
			OVERALL DIMENSIONS			SEAT DIMENSIONS			BACK DIMENSIONS							
			W	D	H	W	D	H	W	H						
			18	18	17.5	-	-	-	-	-						
			RTA 00	1 per carton												
 <p>36" Dia. Round Bench COM Yardage: 3.25 Freight class: 250 Product weight: 50 Cubic feet per carton: 18.25</p>	<p>No power/USB unit.</p> <p>Freestanding unit only.</p> <p>Add \$63 for (SLS) Add \$92 for (F6, F3, or F8) Add \$585 for 36 lbs. (CW) Add \$168 for (SP) or \$575 for (BS) Add \$37 for (TP) Add \$117 for (MB)</p>	<p>R27844</p>	1891	1995	2077	2197	2366	2437	2584	2814	2987	3175	3568	3981		
			OVERALL DIMENSIONS			SEAT DIMENSIONS			BACK DIMENSIONS							
			W	D	H	W	D	H	W	H						
			36	36	17.5	-	-	-	-	-						
			RTA 00	1 per carton												
 <p>42" Dia. Round Bench COM Yardage: 3.5 Freight class: 250 Product weight: 55 Cubic feet per carton: 23</p>	<p>No power/USB unit.</p> <p>Freestanding unit only.</p> <p>Add \$69 for (SLS) Add \$92 for (F6, F3, or F8) Add \$1166 for 72 lbs. (CW) Add \$187 for (SP) or \$635 for (BS) Add \$37 for (TP) Add \$233 for (MB)</p>	<p>R27845</p>	2176	2288	2376	2505	2687	2764	2922	3170	3356	3559	3982	4427		
			OVERALL DIMENSIONS			SEAT DIMENSIONS			BACK DIMENSIONS							
			W	D	H	W	D	H	W	H						
			42	42	17.5	-	-	-	-	-						
			RTA 00	1 per carton												

Options: **(SLS)** Sealed seams
(F6, F3, F8) Floor mount legs
(CW) Counterweight
(SP) Vinyl sealed bottom
(BS) Steel bottom
(TP) Tamperproof
(MB) Moisture barrier

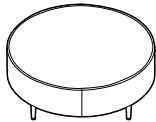
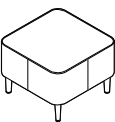
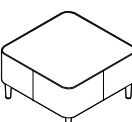
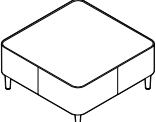
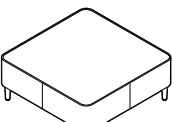
DESCRIPTION	FEATURES	MODEL#	STANDARD TEXTILE GRADES											
			1	2	3	4	5	6	7	8	9	10	11	12
 <p>48" Dia. Round Bench COM Yardage: 3.75 Freight class: 250 Product weight: 65 Cubic feet per carton: 30</p>	<p>No power/USB unit.</p> <p>Freestanding unit only.</p> <p>Add \$77 for (SLS) Add \$92 for (F6, F3, or F8) Add \$1166 for 72 lbs. (CW) Add \$207 for (SP) or \$675 for (BS) Add \$37 for (TP) Add \$347 for (MB)</p>	R27846	2454	2574	2668	2807	3002	3084	3253	3519	3718	3936	4389	4866
			OVERALL DIMENSIONS			SEAT DIMENSIONS			BACK DIMENSIONS					
			W	D	H	W	D	H	W	H				
			48	48	17.5	-	-	-	-	-				
			RTA 00	1 per carton										
 <p>24" Square Bench COM Yardage: 1.5 Freight class: 250 Product weight: 30 Cubic feet per carton: 8</p>	<p>No power/USB unit.</p> <p>Freestanding unit only.</p> <p>Add \$55 for (SLS) Add \$92 for (F6, F3, or F8) Add \$585 for 36 lbs. (CW) Add \$115 for (SP) or \$260 for (BS) Add \$37 for (TP) Add \$117 for (MB)</p>	R27847	1078	1126	1164	1219	1297	1330	1398	1504	1584	1671	1852	2043
			OVERALL DIMENSIONS			SEAT DIMENSIONS			BACK DIMENSIONS					
			W	D	H	W	D	H	W	H				
			24	24	17.5	-	-	-	-	-				
			RTA 00	1 per carton										
 <p>30" Square Bench COM Yardage: 2.75 Freight class: 250 Product weight: 40 Cubic feet per carton: 12.25</p>	<p>No power/USB unit.</p> <p>Freestanding unit only.</p> <p>Add \$63 for (SLS) Add \$92 for (F6, F3, or F8) Add \$585 for 36 lbs. (CW) Add \$161 for (SP) or \$196 for (BS) Add \$37 for (TP) Add \$117 for (MB)</p>	R27848	1424	1512	1581	1683	1826	1886	2010	2205	2351	2511	2843	3193
			OVERALL DIMENSIONS			SEAT DIMENSIONS			BACK DIMENSIONS					
			W	D	H	W	D	H	W	H				
			30	30	17.5	-	-	-	-	-				
			RTA 00	1 per carton										
 <p>36" Square Bench COM Yardage: 3 Freight class: 250 Product weight: 50 Cubic feet per carton: 18.25</p>	<p>No power/USB unit.</p> <p>Freestanding unit only.</p> <p>Add \$69 for (SLS) Add \$92 for (F6, F3, or F8) Add \$1166 for 72 lbs. (CW) Add \$173 for (SP) or \$423 for (BS) Add \$37 for (TP) Add \$233 for (MB)</p>	R27849	1775	1871	1946	2057	2213	2279	2414	2627	2786	2960	3323	3704
			OVERALL DIMENSIONS			SEAT DIMENSIONS			BACK DIMENSIONS					
			W	D	H	W	D	H	W	H				
			36	36	17.5	-	-	-	-	-				
			RTA 00	1 per carton										
 <p>42" Square Bench COM Yardage: 3.25 Freight class: 250 Product weight: 60 Cubic feet per carton: 23</p>	<p>No power/USB unit.</p> <p>Freestanding unit only.</p> <p>Add \$79 for (SLS) Add \$92 for (F6, F3, or F8) Add \$1166 for 72 lbs. (CW) Add \$192 for (SP) or \$589 for (BS) Add \$37 for (TP) Add \$347 for (MB)</p>	R27850	2156	2260	2342	2462	2631	2702	2849	3079	3252	3440	3833	4246
			OVERALL DIMENSIONS			SEAT DIMENSIONS			BACK DIMENSIONS					
			W	D	H	W	D	H	W	H				
			42	42	17.5	-	-	-	-	-				
			RTA 00	1 per carton										

Options: **(SLS)** Sealed seams
(F6, F3, F8) Floor mount legs
(CW) Counterweight
(SP) Vinyl sealed bottom
(BS) Steel bottom
(TP) Tamperproof
(MB) Moisture barrier

RIVER+ TABLES

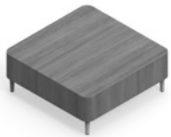

42" Square Coffee Table
model R27858



Outside Curve End Table
model R27864



18" Dia. Round Laptop Table
model 7743

River+ Seating, Benches & Media Hearths



For River+ seating, please see page 330
For River+ benches, please see page 349
For River+ media hearths, please see page 358

STANDARD FEATURES

- A modular series that is composed of straight and curved sections, as well as freestanding units.
- Linking units can be used together in any combination with River+ seating and bench units to create a wide variety of layouts. Ganging hardware is standard and is factory installed. Ganging hardware swivels out of the way when not in use.
- Front and back faces of end (linking) tables angles slightly inwards. This inward slant matches the inward angles of River seating so all units coordinate in visual appearance.
- The standard 6.5", welded steel legs are straight (vertical) as standard. Linking models are optionally available with an angled back leg to visually align with River+ seating units.
- Legs are standard in Chrome with Black, non-marking, height adjustable glides.
- Tables are made with high pressure laminate. Custom high pressure laminate finishes will be considered upon request.
- Laptop tables have 1" thick laminate tops.
- Laptop table painted metal base finishes are available in Black and Tungsten only.

OPTIONAL FEATURES

- Legs of coffee and end (linking) tables are available in 3" (S3) and 8" (S8) heights. All leg heights are available with fixed-to-floor (F3) and (F8) options. Add \$92.
- To match adjacent lounge seating, straight front and angled back 6.5" or 8" legs are available on linking/end tables. Specify (SA). No upcharge.
- Power units are available on all tables except laptop tables. Each unit includes one AC outlet and two USB-a, 10 watt charging ports. Add \$612 upcharge per unit.
- Power location options include top, front or end. See electrical placement diagrams. Electrical units must be factory installed.
- Power units are available in either Jet Black (J) or White (W) with 120", three-prong matching cords.
- Products can be weighted to reduce the ease of movement. For additional weight options, specify (CW). See each model for available additional weight and upcharge.

Please add option codes in the following order:

- **Model number**
R27855 to R27858 Square coffee tables
R27859 Rectangular coffee table
R27860 to R27861 Round coffee tables
R27862 to R27864 Linking/end tables
7443 and 7745 Freestanding tables
- **Laminate finishes**
(ACJ) Absolute Acajou (ASN) Asian Night
(AWC) Avant Cherry (AWH) Avant Honey
(BLK) Black (BRC) Brushed Cobalt
(CMB) Clear Maple (DES) Dark Espresso
(DWT) Designer White (HGT) Hayden Grey
(NBL) Noce Biondo (NGL) Noce Grigio
(NEL) Noce Leggero (NML) Noce Medio
(QTM) Quartered Mahogany
(SOG) Storm Grey (TFW) Tiger Fruitwood
(TWL) Tiger Walnut (WCR) Winter Cherry
(WGY) Willow Grey (WHC) White Chocolate
(WHE) Walnut Heights (colors shown on website)
- **Leg selection**
(S6) Standard height (6.5") w/adjustable glides. No upcharge.
(S3) Low (3") w/adjustable glides. No upcharge.
(S8) High (8") w/adjustable glides. No upcharge.
(F6) Standard height (6.5"), fixed to floor. Add \$92.
(F3) Low (3"), fixed to floor. Add \$92.
(F8) High (8"), fixed to floor. Add \$92.
- **Leg angle** (linking/end tables only)
(AST) Straight legs. No upcharge.
(SA) Straight front legs, angled back legs. No upcharge.
- **Leg finish**
(CHM) Chrome (TBL) Black
(TDW) Designer White (TFO) Fog
(TFR) Frost (TIV) Cloud
(TLA) Latte (TMO) Mocha
(TNE) Nevada (TOA) Toast
(TSH) Shadow (TSN) Sand
(TTU) Tungsten
- **Additional weight**
(CW) Additional weight. Upcharges vary, see model.
- **Power/USB unit position** (coffee and linking/end tables only, as shown below).
Add \$612 per unit.
(NP) No power (no upcharge)
(LE1) Left end (coffee table only)
(LE2) Right end (coffee table only)
(F3) Front center (coffee table only)
(T1) Top
- **Power unit finish**
(J) Jet Black
(W) White
- **(TP) Tamperproof fasteners.** Add \$148.

EXAMPLE RIVER+ TABLE ORDER CODE:

R27858	-ACJ	-S6	-AS	-CM	-	-T1	-W	-
Model number	Laminate	Leg selection	Leg angle	Leg finish	Additional weight	Power/USB	Power finish	Fasteners

ELECTRICAL PLACEMENT

Coffee Tables

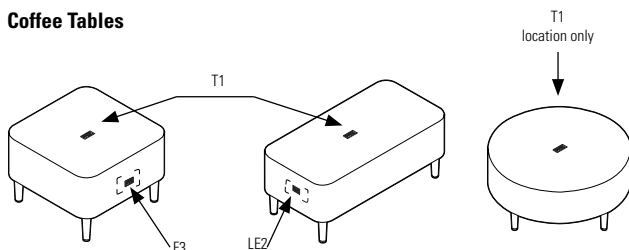

Linking Tables

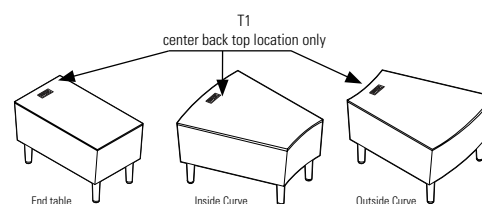

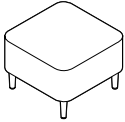
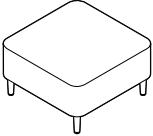
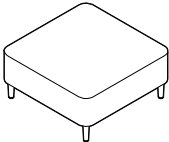
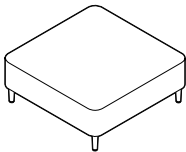
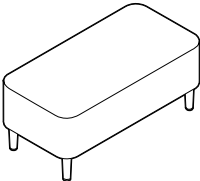
DESCRIPTION	FEATURES	MODEL#	STANDARD TEXTILE GRADES																						
 <p>24" Square Coffee Table COM: N/A Freight class: 250 Product weight: 40 Cubic feet per carton: 10.7</p>	<p>For power/USB unit, see electrical placement chart.</p> <p>Freestanding unit only. Add \$678 for 36 lbs. (CW)</p>	<p>R27855</p>	List price																						
			1374																						
			<table border="1"> <thead> <tr> <th colspan="3">OVERALL DIMENSIONS</th> <th colspan="3">SEAT DIMENSIONS</th> <th colspan="2">BACK DIMENSIONS</th> </tr> <tr> <th>W</th> <th>D</th> <th>H</th> <th>W</th> <th>D</th> <th>H</th> <th>W</th> <th>H</th> </tr> </thead> <tbody> <tr> <td>24</td> <td>24</td> <td>17</td> <td>-</td> <td>-</td> <td>-</td> <td>-</td> <td>-</td> </tr> </tbody> </table>		OVERALL DIMENSIONS			SEAT DIMENSIONS			BACK DIMENSIONS		W	D	H	W	D	H	W	H	24	24	17	-	-
OVERALL DIMENSIONS			SEAT DIMENSIONS			BACK DIMENSIONS																			
W	D	H	W	D	H	W	H																		
24	24	17	-	-	-	-	-																		
<p>RTA 00 1 per carton</p>																									
 <p>30" Square Coffee Table COM: N/A Freight class: 250 Product weight: 53 Cubic feet per carton: 15.3</p>	<p>For power/USB unit, see electrical placement chart.</p> <p>Freestanding unit only. Add \$585 for 36 lbs. (CW)</p>	<p>R27856</p>	List price																						
			1447																						
			<table border="1"> <thead> <tr> <th colspan="3">OVERALL DIMENSIONS</th> <th colspan="3">SEAT DIMENSIONS</th> <th colspan="2">BACK DIMENSIONS</th> </tr> <tr> <th>W</th> <th>D</th> <th>H</th> <th>W</th> <th>D</th> <th>H</th> <th>W</th> <th>H</th> </tr> </thead> <tbody> <tr> <td>30</td> <td>30</td> <td>17</td> <td>-</td> <td>-</td> <td>-</td> <td>-</td> <td>-</td> </tr> </tbody> </table>		OVERALL DIMENSIONS			SEAT DIMENSIONS			BACK DIMENSIONS		W	D	H	W	D	H	W	H	30	30	17	-	-
OVERALL DIMENSIONS			SEAT DIMENSIONS			BACK DIMENSIONS																			
W	D	H	W	D	H	W	H																		
30	30	17	-	-	-	-	-																		
<p>RTA 00 1 per carton</p>																									
 <p>36" Square Coffee Table COM: N/A Freight class: 250 Product weight: 75 Cubic feet per carton: 20.6</p>	<p>For power/USB unit, see electrical placement chart.</p> <p>Freestanding unit only. Add \$1166 for 72 lbs. (CW)</p>	<p>R27857</p>	List price																						
			1658																						
			<table border="1"> <thead> <tr> <th colspan="3">OVERALL DIMENSIONS</th> <th colspan="3">SEAT DIMENSIONS</th> <th colspan="2">BACK DIMENSIONS</th> </tr> <tr> <th>W</th> <th>D</th> <th>H</th> <th>W</th> <th>D</th> <th>H</th> <th>W</th> <th>H</th> </tr> </thead> <tbody> <tr> <td>36</td> <td>36</td> <td>17</td> <td>-</td> <td>-</td> <td>-</td> <td>-</td> <td>-</td> </tr> </tbody> </table>		OVERALL DIMENSIONS			SEAT DIMENSIONS			BACK DIMENSIONS		W	D	H	W	D	H	W	H	36	36	17	-	-
OVERALL DIMENSIONS			SEAT DIMENSIONS			BACK DIMENSIONS																			
W	D	H	W	D	H	W	H																		
36	36	17	-	-	-	-	-																		
<p>RTA 00 1 per carton</p>																									
 <p>42" Square Coffee Table COM: N/A Freight class: 150 Product weight: 115 Cubic feet per carton: 26.7</p>	<p>For power/USB unit, see electrical placement chart.</p> <p>Freestanding unit only. Add \$1166 for 72 lbs. (CW)</p>	<p>R27858</p>	List price																						
			1843																						
			<table border="1"> <thead> <tr> <th colspan="3">OVERALL DIMENSIONS</th> <th colspan="3">SEAT DIMENSIONS</th> <th colspan="2">BACK DIMENSIONS</th> </tr> <tr> <th>W</th> <th>D</th> <th>H</th> <th>W</th> <th>D</th> <th>H</th> <th>W</th> <th>H</th> </tr> </thead> <tbody> <tr> <td>42</td> <td>42</td> <td>17</td> <td>-</td> <td>-</td> <td>-</td> <td>-</td> <td>-</td> </tr> </tbody> </table>		OVERALL DIMENSIONS			SEAT DIMENSIONS			BACK DIMENSIONS		W	D	H	W	D	H	W	H	42	42	17	-	-
OVERALL DIMENSIONS			SEAT DIMENSIONS			BACK DIMENSIONS																			
W	D	H	W	D	H	W	H																		
42	42	17	-	-	-	-	-																		
<p>RTA 00 1 per carton</p>																									
 <p>Rectangular Coffee Table COM: N/A Freight class: 250 Product weight: 55 Cubic feet per carton: 14.2</p>	<p>For power/USB unit, see electrical placement chart.</p> <p>Freestanding unit only. Add \$585 for 36 lbs. (CW)</p>	<p>R27859</p>	List price																						
			1505																						
			<table border="1"> <thead> <tr> <th colspan="3">OVERALL DIMENSIONS</th> <th colspan="3">SEAT DIMENSIONS</th> <th colspan="2">BACK DIMENSIONS</th> </tr> <tr> <th>W</th> <th>D</th> <th>H</th> <th>W</th> <th>D</th> <th>H</th> <th>W</th> <th>H</th> </tr> </thead> <tbody> <tr> <td>40</td> <td>20</td> <td>17</td> <td>-</td> <td>-</td> <td>-</td> <td>-</td> <td>-</td> </tr> </tbody> </table>		OVERALL DIMENSIONS			SEAT DIMENSIONS			BACK DIMENSIONS		W	D	H	W	D	H	W	H	40	20	17	-	-
OVERALL DIMENSIONS			SEAT DIMENSIONS			BACK DIMENSIONS																			
W	D	H	W	D	H	W	H																		
40	20	17	-	-	-	-	-																		
<p>RTA 00 1 per carton</p>																									

Options: **(CW)** Counterweight

DESCRIPTION FEATURES MODEL# STANDARD TEXTILE GRADES

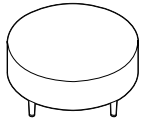

36" Dia. Round Coffee Table
 COM: N/A
 Freight class: 150
 Product weight: 63
 Cubic feet per carton: 15.3

For power/USB unit, see electrical placement chart.
 Freestanding unit only.
 Add \$585 for 36 lbs. (CW)

List price								
R27860		1784						
OVERALL DIMENSIONS			SEAT DIMENSIONS			BACK DIMENSIONS		
W	D	H	W	D	H	W	H	
36	36	17	-	-	-	-	-	
RTA 00		1 per carton						

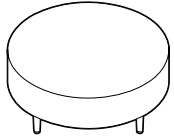

42" Dia. Round Coffee Table
 COM: N/A
 Freight class: 150
 Product weight: 85
 Cubic feet per carton: 20.6

For power/USB unit, see electrical placement chart.
 Freestanding unit only.
 Add \$1166 for 72 lbs. (CW)

List price								
R27861		1956						
OVERALL DIMENSIONS			SEAT DIMENSIONS			BACK DIMENSIONS		
W	D	H	W	D	H	W	H	
42	42	17	-	-	-	-	-	
RTA 00		1 per carton						

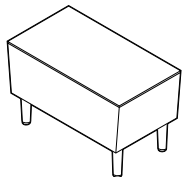

Rectangular End Table
 COM: N/A
 Freight class: 300
 Product weight: 40
 Cubic feet per carton: 20.6

For power/USB unit, see electrical placement chart.
 Includes ganging hardware (2 sides).
 Add \$293 for 18 lbs. (CW)

List price								
R27862		1461						
OVERALL DIMENSIONS			SEAT DIMENSIONS			BACK DIMENSIONS		
W	D	H	W	D	H	W	H	
28	15	17	-	-	-	-	-	
RTA 00		1 per carton						

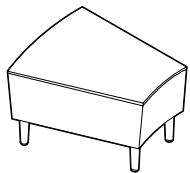

Inside Curve End Table
 COM: N/A
 Freight class: 250
 Product weight: 47
 Cubic feet per carton: 13.3

For power/USB unit, see electrical placement chart.
 Includes ganging hardware (2 sides).
 Add \$293 for 18 lbs. (CW)

List price								
R27863		1919						
OVERALL DIMENSIONS			SEAT DIMENSIONS			BACK DIMENSIONS		
W	D	H	W	D	H	W	H	
28	17	17	-	-	-	-	-	
RTA 00		1 per carton						

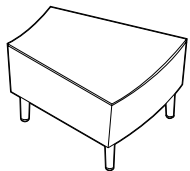

Outside Curve End Table
 COM: N/A
 Freight class: 250
 Product weight: 47
 Cubic feet per carton: 13.3

For power/USB unit, see electrical placement chart.
 Includes ganging hardware (2 sides).
 Add \$293 for 18 lbs. (CW)

List price								
R27864		1919						
OVERALL DIMENSIONS			SEAT DIMENSIONS			BACK DIMENSIONS		
W	D	H	W	D	H	W	H	
28	17	17	-	-	-	-	-	
RTA 00		1 per carton						

Options: (CW) Counterweight

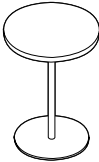
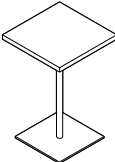
DESCRIPTION	FEATURES	MODEL#	STANDARD TEXTILE GRADES																												
 <p>18" Dia. Round Laptop Table COM: N/A Freight class: 150 Product weight: 32 Cubic feet per carton: 6</p>	<p>No power/USB unit.</p> <p>Base only available in Black or Tungsten finish.</p>	List price																													
		7743	733																												
		<table border="1"> <thead> <tr> <th colspan="3">OVERALL DIMENSIONS</th> <th colspan="3">SEAT DIMENSIONS</th> <th colspan="2">BACK DIMENSIONS</th> </tr> <tr> <th>W</th> <th>D</th> <th>H</th> <th>W</th> <th>D</th> <th>H</th> <th>W</th> <th>H</th> </tr> </thead> <tbody> <tr> <td>18</td> <td>18</td> <td>25.25</td> <td>-</td> <td>-</td> <td>-</td> <td>-</td> <td>-</td> </tr> </tbody> </table>			OVERALL DIMENSIONS			SEAT DIMENSIONS			BACK DIMENSIONS		W	D	H	W	D	H	W	H	18	18	25.25	-	-	-	-	-			
		OVERALL DIMENSIONS			SEAT DIMENSIONS			BACK DIMENSIONS																							
W	D	H	W	D	H	W	H																								
18	18	25.25	-	-	-	-	-																								
RTA 00	1 per carton																														
 <p>16" Square Laptop Table COM: N/A Freight class: 125 Product weight: 36 Cubic feet per carton: 6</p>	<p>No power/USB unit.</p> <p>Base only available in Black or Tungsten finish.</p>	List price																													
		7745	750																												
		<table border="1"> <thead> <tr> <th colspan="3">OVERALL DIMENSIONS</th> <th colspan="3">SEAT DIMENSIONS</th> <th colspan="2">BACK DIMENSIONS</th> </tr> <tr> <th>W</th> <th>D</th> <th>H</th> <th>W</th> <th>D</th> <th>H</th> <th>W</th> <th>H</th> </tr> </thead> <tbody> <tr> <td>16</td> <td>16</td> <td>25.25</td> <td>-</td> <td>-</td> <td>-</td> <td>-</td> <td>-</td> </tr> </tbody> </table>			OVERALL DIMENSIONS			SEAT DIMENSIONS			BACK DIMENSIONS		W	D	H	W	D	H	W	H	16	16	25.25	-	-	-	-	-			
		OVERALL DIMENSIONS			SEAT DIMENSIONS			BACK DIMENSIONS																							
W	D	H	W	D	H	W	H																								
16	16	25.25	-	-	-	-	-																								
RTA 00	1 per carton																														

RIVER+ MEDIA HEARTH



Media Hearth with Sliding Laminate Doors - 84" model R27877

River+ Seating, Tables & Benches

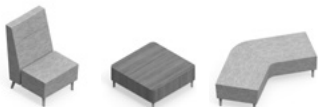

For River+ seating, please see page 330
 For River+ tables, please see page 354.
 For River+ benches, please see page 349

STANDARD FEATURES

- A fully finished media center with features and finishes that coordinate with River+ seating, benches and tables. The fully finished back supports ease of planning.
- The 6.5" legs match River+ tapered legs. Legs are straight on the front and angled on the back.
- Legs are standard in Chrome with Black non-marking height adjustable glides.
- Two hidden grommets are standard on the unit. One grommet is centered on the back panel, behind the monitor location. The other is beneath the unit, allowing cables to route from the monitor, through the unit, to the floor.
- Models are available with open shelving or closed, with sliding laminate or glass doors.
- Monitors, mounts and power are not included.
- See Suggested Maximum Monitor Diagonal Sizes chart for recommended maximum dimensions.
- To mount flatscreen or monitor to media hearth, use fixed mounting hardware only; not for use with articulating or extendable arm mounting hardware. Combined weight of mounting hardware and monitor or flatscreen not to exceed 75 lbs.
- Media hearths are made with thermally fused laminates. Specify from the many finishes listed. Custom, high pressure laminate finishes will be considered upon request.

OPTIONAL FEATURES

- An optional user access grommet is available for the top of the storage shelf, allowing cable routing for user access. Specify center grommet (GP2). Add \$88.
- Optional 6.5" floor mount legs are available. Add \$92. Mounting hardware not included.

Please add option codes in the following order:

- **Model number**
R27870 to R27874 Media hearth with open shelf.
R27875 to R27879 Media hearth with sliding laminate doors.
R27880 to R27884 Media hearth with sliding glass doors.
- **Laminate finishes**
(ACJ) Absolute Acajou **(ASN)** Asian Night
(AWC) Avant Cherry **(AWH)** Avant Honey
(BLK) Black **(BRC)** Brushed Cobalt
(CMB) Clear Maple **(DES)** Dark Espresso
(DWT) Designer White **(HGT)** Hayden Grey
(NBL) Noce Biondo **(NGL)** Noce Grigio
(NEL) Noce Leggero **(NML)** Noce Medio
(QTM) Quartered Mahogany
(SOG) Storm Grey **(TFW)** Tiger Fruitwood
(TWL) Tiger Walnut **(WCR)** Winter Cherry
(WGY) Willow Grey **(WCH)** White Chocolate
(WHE) Walnut Heights
 (colors shown on website)
- **Leg selection**
(S6) Standard height (6.5") w/adjustable glides. No upcharge.
(F6) Standard height (6.5"), floor mount. Add \$92.
- **Leg finish**
(CHM) Chrome **(TBL)** Black
(TDW) Designer White **(TFO)** Fog
(TFR) Frost **(TIV)** Cloud
(TLA) Latte **(TMO)** Mocha
(TNE) Nevada **(TOA)** Toast
(TSH) Shadow **(TSN)** Sand
(TTU) Tungsten
- **Grommet**
(GP2) Center grommet. Add \$88.

EXAMPLE RIVER+ MEDIA HEARTH ORDER CODE:

R27870	-ACJ	-S6	-CH	-
Model number	Laminate finish	Leg selection	Leg finish	Grommet

SUGGESTED MAXIMUM MONITOR DIAGONAL SIZES			
(measurements to be verified by end user)			
Model	Width	Overall usable area	Monitor diagonal dim.
R27870, R27875, R27880	60"	60 W x 37 H	60"
R27871, R27876, R27881	72"	72 W x 37 H	65"
R27872, R27877, R27882	84"	84 W x 37 H	65"
R27873, R27878, R27883	96"	96 W x 37 H	65"
R27874, R27879, R27884	96"	96 W x 37 H	2 x 50"

GROMMET PLACEMENT

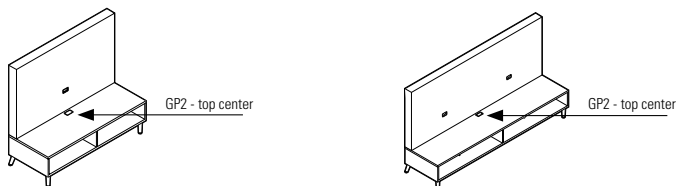

*Optional grommet is always located in the center of the top of the storage shelf (near the vertical surface).

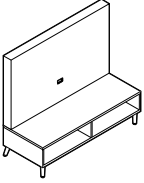
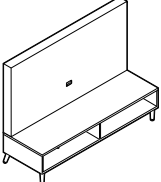
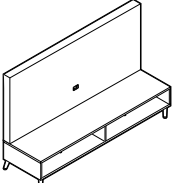
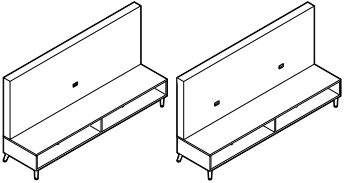
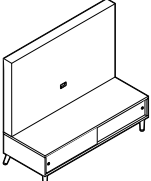
DESCRIPTION	FEATURES	MODEL#	STANDARD TEXTILE GRADES						
 <p>Media Hearth with Open Shelf - 60" COM: N/A Freight class: 150 Product weight: 170.5 Cubic feet per carton: 14.37</p>			List price						
		R27870	3747						
			OVERALL DIMENSIONS		SEAT DIMENSIONS			BACK DIMENSIONS	
			W	D	H	W	D	H	W
		60	24	54	-	-	-	-	-
			RTA 1	2 cartons					
 <p>Media Hearth with Open Shelf - 72" COM: N/A Freight class: 150 Product weight: 189 Cubic feet per carton: 17.15</p>			List price						
		R27871	3867						
			OVERALL DIMENSIONS		SEAT DIMENSIONS			BACK DIMENSIONS	
			W	D	H	W	D	H	W
		72	24	54	-	-	-	-	-
			RTA 1	2 cartons					
 <p>Media Hearth with Open Shelf - 84" COM: N/A Freight class: 150 Product weight: 209 Cubic feet per carton: 19.94</p>			List price						
		R27872	4146						
			OVERALL DIMENSIONS		SEAT DIMENSIONS			BACK DIMENSIONS	
			W	D	H	W	D	H	W
		84	24	54	-	-	-	-	-
			RTA 1	2 cartons					
 <p>Media Hearth with Open Shelf - 96" COM: N/A Freight class: 150 Product weight: 231.5 Cubic feet per carton: 22.72</p>			List price						
		R27873	4329						
		R27874	4408						
			Dual Monitor						
		OVERALL DIMENSIONS		SEAT DIMENSIONS			BACK DIMENSIONS		
		W	D	H	W	D	H	W	H
		96	24	54	-	-	-	-	-
			RTA 1	2 cartons					
 <p>Media Hearth with Sliding Laminate Doors - 60" COM: N/A Freight class: 150 Product weight: 170.5 Cubic feet per carton: 14.37</p>			List price						
		R27875	4858						
			OVERALL DIMENSIONS		SEAT DIMENSIONS			BACK DIMENSIONS	
			W	D	H	W	D	H	W
		60	24	54	-	-	-	-	-
			RTA 1	2 cartons					

DESCRIPTION

FEATURES

MODEL#

STANDARD TEXTILE GRADES

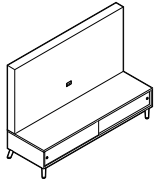
**Media Hearth with Sliding Laminate Doors - 72"**

COM: N/A
 Freight class: 150
 Product weight: 189
 Cubic feet per carton: 17.15

List price

R27876 5118**OVERALL DIMENSIONS**
W D H

72 24 54

SEAT DIMENSIONS
W D H

- - -

BACK DIMENSIONS
W H

- -

RTA 1

2 cartons

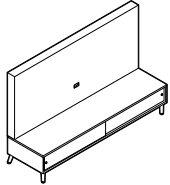
**Media Hearth with Sliding Laminate Doors - 84"**

COM: N/A
 Freight class: 150
 Product weight: 209
 Cubic feet per carton: 19.94

List price

R27877 5405**OVERALL DIMENSIONS**
W D H

84 24 54

SEAT DIMENSIONS
W D H

- - -

BACK DIMENSIONS
W H

- -

RTA 1

2 cartons

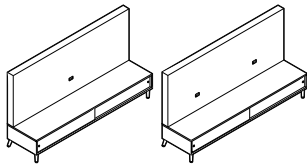
**Media Hearth with Sliding Laminate Doors - 96"**

COM: N/A
 Freight class: 150
 Product weight: 231.5
 Cubic feet per carton: 22.72

List price

R27878 5599**R27879** 5669

Dual Monitor

OVERALL DIMENSIONS
W D H

96 24 54

SEAT DIMENSIONS
W D H

- - -

BACK DIMENSIONS
W H

- -

RTA 1

2 cartons

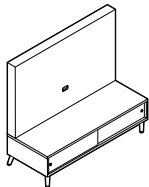
**Media Hearth with Sliding Glass Doors - 60"**

COM: N/A
 Freight class: 150
 Product weight: 170.5
 Cubic feet per carton: 14.37

List price

R27880 5162**OVERALL DIMENSIONS**
W D H

60 24 54

SEAT DIMENSIONS
W D H

- - -

BACK DIMENSIONS
W H

- -

RTA 1

2 cartons

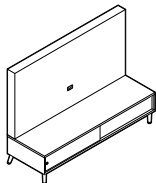
**Media Hearth with Sliding Glass Doors - 72"**

COM: N/A
 Freight class: 150
 Product weight: 189
 Cubic feet per carton: 17.15

List price

R27881 5418**OVERALL DIMENSIONS**
W D H

72 24 54

SEAT DIMENSIONS
W D H

- - -

BACK DIMENSIONS
W H

- -

RTA 1

2 cartons

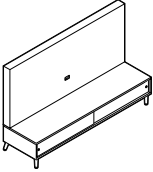
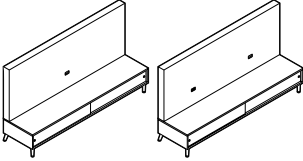
DESCRIPTION	FEATURES	MODEL#	STANDARD TEXTILE GRADES						
 <p>Media Hearth with Sliding Glass Doors - 84" COM: N/A Freight class: 150 Product weight: 209 Cubic feet per carton: 19.94</p>			List price						
		R27882	5727						
			OVERALL DIMENSIONS		SEAT DIMENSIONS			BACK DIMENSIONS	
			W	D	H	W	D	H	W
		84	24	54	-	-	-	-	-
		RTA 1	2 cartons						
 <p>Media Hearth with Sliding Glass Doors - 96" COM: N/A Freight class: 150 Product weight: 231.5 Cubic feet per carton: 22.72</p>			List price						
		R27883	6084						
		R27884	6154						
			Dual Monitor						
			OVERALL DIMENSIONS		SEAT DIMENSIONS			BACK DIMENSIONS	
		W	D	H	W	D	H	W	H
		96	24	54	-	-	-	-	-
		RTA 1	2 cartons						

SIRENA™



models 3371 Lounge Chairs, 3373 Two Seat Sofa, 3400 Coffee Table, and 3402 End Table



model 3371



model 3372CTRL

STANDARD FEATURES

- Modern club style seating includes: lounge chair, two and three seat sofas.
- Complete with Modern tables for reception areas, meeting rooms, and private office use.
- Lounge seating distinctive round style feet are finished in Black Only.
- All models have fixed, non-removable seat cushions with arm height at 25" in the front.
- Casters are available on lounge chairs only. **C1M** casters are standard.
- Please note leather models offer additional stitch details.
- Check textile availability prior to specifying upholstery material.
- When ordering models with tablet, specify for left hand or for right hand tablet. See models below.
- Laminate Tops, are 1.5" thick.
- Table legs are 1.5" steel tubing, tapered toward the bottom to 7/8", equipped with self-leveling, pivoting steel glides.



OPTIONAL FEATURES

- Laminate tables, tablets and bookshelves are offered in the following laminate finishes: Absolute Acajou (**ACJ**), Asian Night (**ASN**), Avant Cherry (**AWC**), Avant Honey (**AWH**), Clear Maple (**CMB**), Dark Espresso (**DES**), Designer White (**DWT**), Hayden Grey (**HGT**), Noce Biondo (**NBL**), Noce Grigio (**NGL**), Noce Leggero (**NEL**), Noce Medio (**NML**), Quartered Mahogany (**QTM**), Tiger Walnut (**TWL**), Walnut Heights (**WHE**), White Chocolate (**WHC**) and Winter Cherry (**WCR**). Please Specify.
- Table legs are available in Tungsten (**TTU**), Charcoal (**TSH**), Black (**TBL**) at no upcharge. Not available in Chrome.

STITCH DETAIL WHEN UPHOLSTERED IN ALL LEATHER - ILLUSTRATIONS BELOW

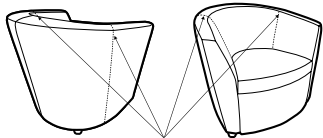

Lounge Chair

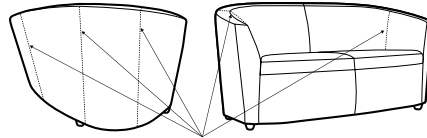

Two and Three Seater Sofas

DESCRIPTION

FEATURES

MODEL#

STANDARD TEXTILE GRADES



Lounge Chair Fabric
COM Yardage: 4.25
Freight Class: 250
Product Weight (lbs.): 52
Cubic Feet Per Carton: 19.25

	1	2	3	4	5	6	7	8	9	10	11	12
3371	-	1601	1712	1875	2108	2196	2399	2782	2973	3328	3821	4432

OVERALL DIMENSIONS			SEAT DIMENSIONS			BACK DIMENSIONS	
W	D	H	W	D	H	W	H
30.5	29.5	28.5	20	20	17.5	19	11.5

RTA 00















Lounge Chair w/Casters
COM Yardage: 4.25
Freight Class: 250
Product Weight (lbs.): 52
Cubic Feet Per Carton: 19.25

	1	2	3	4	5	6	7	8	9	10	11	12
3371C	-	1723	1840	2012	2258	2349	2562	2963	3165	3537	4054	4693

OVERALL DIMENSIONS			SEAT DIMENSIONS			BACK DIMENSIONS	
W	D	H	W	D	H	W	H
30.5	29.5	29.5	20	20	17.5	19	11.5

RTA 00

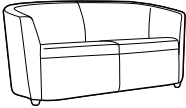
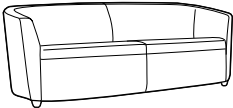
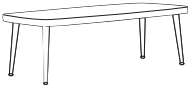
DESCRIPTION	FEATURES	MODEL#	STANDARD TEXTILE GRADES											
			1	2	3	4	5	6	7	8	9	10	11	12
 3371LTL	 3371RTL	3371LTL 3371RTL	-	2312	2427	2600	2844	2935	3148	3551	3753	4122	4643	5282
		OVERALL DIMENSIONS W D H	SEAT DIMENSIONS W D H	BACK DIMENSIONS W H	32.5	29.5	28.5	20	20	17.5	19	11.5		
Lounge Chair w/Laminate Tablet COM Yardage: 4.25 Freight Class: 250 Product Weight (lbs.): 58 Cubic Feet Per Carton: 19.25			RTA 00											
 3371CLTL	 3371CRTL	3371CLTL 3371CRTL	-	2444	2561	2734	2978	3069	3285	3683	3886	4255	4775	5416
		OVERALL DIMENSIONS W D H	SEAT DIMENSIONS W D H	BACK DIMENSIONS W H	32	29.5	29.5	20	20	17.5	19	11.5		
Lounge Chair w/Casters & Laminate Tablet COM Yardage: 4.25 Freight Class: 250 Product Weight (lbs.): 62 Cubic Feet Per Carton: 19.25			RTA 00											
		3372	-	2133	2244	2407	2639	2727	2931	3314	3504	3860	4353	4964
	OVERALL DIMENSIONS W D H	SEAT DIMENSIONS W D H	BACK DIMENSIONS W H	30.5	29.5	28.5	20	20	17.5	19	11.5			
Lounge Chair w/Laminate Book Shelf COM Yardage: 4.25 Freight Class: 250 Product Weight (lbs.): 55 Cubic Feet Per Carton: 19.25			RTA 00											
		3372C	-	2338	2451	2612	2845	2933	3137	3517	3710	4064	4560	5170
	OVERALL DIMENSIONS W D H	SEAT DIMENSIONS W D H	BACK DIMENSIONS W H	30.5	29.5	28.5	20	20	17.5	19	11.5			
Lounge Chair w/Casters & Laminate Book Shelf COM Yardage: 4.25 Freight Class: 250 Product Weight (lbs.): 55 Cubic Feet Per Carton: 19.25			RTA 00											
 3372LTL	 3372RTL	3372LTL 3372RTL	-	2781	2892	3055	3288	3376	3579	3962	4153	4508	5001	5612
		OVERALL DIMENSIONS W D H	SEAT DIMENSIONS W D H	BACK DIMENSIONS W H	32.5	29.5	28.5	20	20	17.5	19	11.5		
Lounge Chair w/Laminate Tablet/Book Shelf COM Yardage: 4.25 Freight Class: 250 Product Weight (lbs.): 66 Cubic Feet Per Carton: 19.25			RTA 00											

DESCRIPTION	FEATURES	MODEL#	STANDARD TEXTILE GRADES											
			1	2	3	4	5	6	7	8	9	10	11	12
 3372CLTL	 3372CRTL	3372CLTL 3372CRTL	-	2918	3031	3192	3425	3513	3716	4099	4290	4646	5138	5749
			OVERALL DIMENSIONS W D H			SEAT DIMENSIONS W D H			BACK DIMENSIONS W H					
Lounge Chair w/ Casters & Laminate Tablet/Book Shelf COM Yardage: 4.25 Freight Class: 250 Product Weight (lbs.): 66 Cubic Feet Per Carton: 19.25			<div style="background-color: black; color: white; padding: 2px; text-align: center;">RTA 00</div>											
		3373	-	3006	3189	3459	3841	3985	4320	4949	5263	5849	6662	7665
			OVERALL DIMENSIONS W D H			SEAT DIMENSIONS W D H			BACK DIMENSIONS W H					
Two Seat Sofa COM Yardage: 7 Freight Class: 300 Product Weight (lbs.): 92 Cubic Feet Per Carton: 48			<div style="background-color: black; color: white; padding: 2px; text-align: center;">RTA 00</div>											
		3374	-	3614	3815	4114	4536	4697	5068	5765	6114	6762	7661	8770
			OVERALL DIMENSIONS W D H			SEAT DIMENSIONS W D H			BACK DIMENSIONS W H					
Three Seat Sofa COM Yardage: 7.75 Freight Class: 300 Product Weight (lbs.): 107 Cubic Feet Per Carton: 55.5			<div style="background-color: black; color: white; padding: 2px; text-align: center;">RTA 00</div>											
		3400	1718	-	-	-	-	-	-	-	-	-	-	-
			OVERALL DIMENSIONS W D H			SEAT DIMENSIONS W D H			BACK DIMENSIONS W H					
Coffee Table - 48" Laminate Top COM Yardage: N/A Freight Class: 250 Product Weight (lbs.): 52 Cubic Feet Per Carton: 17.25			<div style="background-color: black; color: white; padding: 2px; text-align: center;">RTA 00</div>											
		3401	1900	-	-	-	-	-	-	-	-	-	-	-
			OVERALL DIMENSIONS W D H			SEAT DIMENSIONS W D H			BACK DIMENSIONS W H					
Coffee Table - 56" Laminate Top COM Yardage: N/A Freight Class: 175 Product Weight (lbs.): 60 Cubic Feet Per Carton: 19			<div style="background-color: black; color: white; padding: 2px; text-align: center;">RTA 00</div>											

DESCRIPTION	FEATURES	MODEL#	STANDARD TEXTILE GRADES												
			1	2	3	4	5	6	7	8	9	10	11	12	
		3402	1378	-	-	-	-	-	-	-	-	-	-	-	-
 <p>End Table - Laminate Top COM Yardage: N/A Freight Class: 250 Product Weight (lbs.): 26 Cubic Feet Per Carton: 7.75</p>	OVERALL DIMENSIONS			SEAT DIMENSIONS			BACK DIMENSIONS								
	W	D	H	W	D	H	W	H							
	17	22	14.5	-	-	-	-	-							
			RTA 00												

VENTURE



48\"/>



78\"/>



60\"/>

STANDARD FEATURES

- Venture is a solid and durable banquette seating series.
- Banquettes are available with or without fully upholstered backs. Open back banquettes are intended to be placed against walls or in other layouts where the back will not be visible.
- Heavy duty frame has plywood construction suitable for public environments. For 24/7 use environments, must use approved textiles with 100,000 double-rubs and above.
- Cushions are made with highly resilient foam and seats are equipped with a synthetic rubberized webbing suspension system for extra comfort.
- Cushions are fixed and non-removable.
- Ganging bracket kit (8509) gangs single back models 'back to back'. Standard in Black. Contains two brackets
- Legs are metal painted and Chrome with Black glides, suitable for carpet and hard surface flooring.

- Closed back models are fully upholstered for use in open settings and to support reconfiguration.
- Open back models are available for use against walls or for ganging back to back. They and have a Black outer back protective dust cover.
- Check textile availability prior to specifying upholstery material.

Note: Double-sided models (8508-48 to 8508-78) measure 55" deep, 48" high and weigh over 100 lbs. They may require coordination for special handling and accommodation through doorway and elevators.

OPTIONAL FEATURES:

Add option codes in the following order

- **Model Number**
- **Back and seat textile**
Specify textile code.
- **Leg Finish.** No upcharge
(CHM) Chrome
(TBL) Black
(TLA) Latte
(TTU) Tungsten

EXAMPLE VENTURE ORDER CODE:

8506-48	EL58	TBL
Model #	Textile	Leg Finish

DESCRIPTION	FEATURES	MODEL #	STANDARD TEXTILE GRADES											
			1	2	3	4	5	6	7	8	9	10	11	12
<p>48\"/> COM Yardage: 6.75 Freight Class: 300 Product weight (lbs): 104 Cubic Feet Per Carton: 50.75</p>		8506-48	2779	2996	3165	3414	3766	3914	4218	4697	5055	5446	6263	7120
<p>60\"/> COM Yardage: 8 Freight Class: 250 Product weight (lbs): 127 Cubic Feet Per Carton: 62.75</p>		8506-60	3313	3569	3769	4065	4481	4657	5017	5585	6009	6473	7441	8457
<p>72\"/> COM Yardage: 9 Freight Class: 250 Product weight (lbs): 153 Cubic Feet Per Carton: 75</p>		8506-72	3530	3818	4043	4376	4844	5042	5447	6086	6563	7085	8174	9317

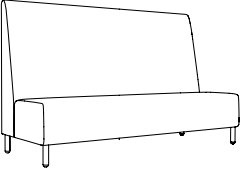
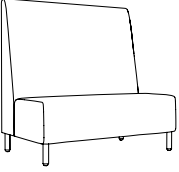
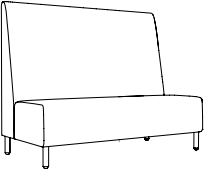
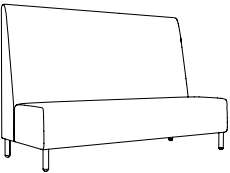
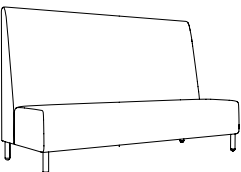
DESCRIPTION	FEATURES	MODEL#	STANDARD TEXTILE GRADES											
			1	2	3	4	5	6	7	8	9	10	11	12
 <p>78"W Three Seater Banquette, Closed Back COM Yardage: 10 Freight Class: 250 Product weight (lbs): 163 Cubic Feet Per Carton: 79.75</p>		8506-78	3872	4192	4442	4812	5332	5552	6002	6712	7242	7822	9032	10302
			OVERALL DIMENSIONS			SEAT DIMENSIONS			BACK DIMENSIONS					
			W	D	H	W	D	H	W	H				
			78	28	48	78	19	18	78	30				
										RTA 00			1 per carton	
 <p>48"W Two Seater Banquette, Open Back COM Yardage: 5 Freight Class: 250 Product weight (lbs): 105 Cubic Feet Per Carton: 50.75</p>		8507-48	2615	2775	2900	3085	3345	3455	3680	4035	4300	4590	5195	5830
			OVERALL DIMENSIONS			SEAT DIMENSIONS			BACK DIMENSIONS					
			W	D	H	W	D	H	W	H				
			48	28	48	48	19	18	48	30				
										RTA 00			1 per carton	
 <p>60"W Two Seater Banquette, Open Back COM Yardage: 6 Freight Class: 250 Product weight (lbs): 127 Cubic Feet Per Carton: 62.75</p>		8507-60	2978	3170	3321	3542	3854	3986	4257	4682	5001	5349	6074	6837
			OVERALL DIMENSIONS			SEAT DIMENSIONS			BACK DIMENSIONS					
			W	D	H	W	D	H	W	H				
			60	28	48	60	19	18	60	30				
										RTA 00			1 per carton	
 <p>72"W Three Seater Banquette, Open Back COM Yardage: 7 Freight Class: 250 Product weight (lbs): 153 Cubic Feet Per Carton: 75</p>		8507-72	3338	3562	3737	3996	4360	4514	4829	5326	5697	6103	6950	7839
			OVERALL DIMENSIONS			SEAT DIMENSIONS			BACK DIMENSIONS					
			W	D	H	W	D	H	W	H				
			72	28	48	72	19	18	72	30				
										RTA 00			1 per carton	
 <p>78"W Three Seater Banquette, Open Back COM Yardage: 8 Freight Class: 250 Product weight (lbs): 163 Cubic Feet Per Carton: 79.75</p>		8507-78	3667	3923	4124	4419	4835	5011	5372	5939	6364	6828	7795	8812
			OVERALL DIMENSIONS			SEAT DIMENSIONS			BACK DIMENSIONS					
			W	D	H	W	D	H	W	H				
			78	28	48	78	19	18	78	30				
										RTA 00			1 per carton	

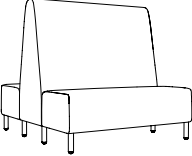
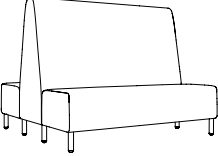
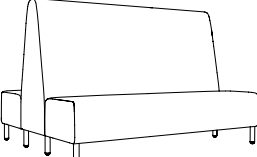
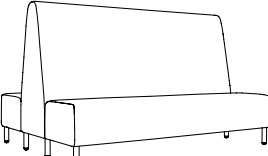
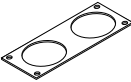
DESCRIPTION	FEATURES	MODEL#	STANDARD TEXTILE GRADES												
			1	2	3	4	5	6	7	8	9	10	11	12	
 <p>48\"W Four Seater Banquette, Double Back COM Yardage: 9 Freight Class: 300 Product weight (lbs): 163 Cubic Feet Per Carton: 89.75</p>		8508-48	5045	5333	5559	5892	6360	6557	6963	7601	8079	8601	9689	10833	
	OVERALL DIMENSIONS			SEAT DIMENSIONS			BACK DIMENSIONS								
	W D H			W D H			W H								
	48 55 48			48 19 18			48 30								
				RTA 00			1 per carton								
 <p>60\"W Four Seater Banquette, Double Back COM Yardage: 10 Freight Class: 300 Product weight (lbs): 198 Cubic Feet Per Carton: 111</p>		8508-60	5845	6165	6415	6785	7305	7525	7975	8685	9215	9795	11005	12275	
	OVERALL DIMENSIONS			SEAT DIMENSIONS			BACK DIMENSIONS								
	W D H			W D H			W H								
	60 55 48			60 19 18			60 30								
				RTA 00			1 per carton								
 <p>72\"W Six Seater Banquette, Double Back COM Yardage: 11 Freight Class: 300 Product weight (lbs): 242 Cubic Feet Per Carton: 132.5</p>		8508-72	6940	7292	7568	7975	8547	8788	9284	10064	10648	11286	12616	14014	
	OVERALL DIMENSIONS			SEAT DIMENSIONS			BACK DIMENSIONS								
	W D H			W D H			W H								
	72 55 48			72 19 18			72 30								
				RTA 00			1 per carton								
 <p>78\"W Six Seater Banquette, Double Back COM Yardage: 12 Freight Class: 300 Product weight (lbs): 255 Cubic Feet Per Carton: 141.7</p>		8508-78	7756	8140	8441	8885	9509	9772	10313	11164	11801	12497	13948	15473	
	OVERALL DIMENSIONS			SEAT DIMENSIONS			BACK DIMENSIONS								
	W D H			W D H			W H								
	78 55 48			78 19 18			78 30								
				RTA 00			1 per carton								
 <p>Ganging Bracket Kit COM Yardage: n/a Freight Class: 70 Product weight (lbs): 0.5 Cubic Feet Per Carton: 0.1</p>			List price												
		8509	85												
	OVERALL DIMENSIONS			SEAT DIMENSIONS			BACK DIMENSIONS								
	W D H			W D H			W H								
	2.5 6 0.25			- - -			- - -								
			RTA 00			1 per carton									

VITROLA



Vitrola is offered in two back heights, standard lounge and high back lounge, along with two and three seat sofa models.



Matching ottoman and accent pillow to complete the offering.

STANDARD FEATURES

- Classic soft seating upholstery design with swooping arms.
- Available in standard Lounge, High Back Lounge along with Two and Three Seat Sofa models.
- Matching Ottoman and Accent Pillow complete the offering.
- Fully upholstered with piping details at the bottom of frame.
- Seat cushions are fixed or sewn tight.
- Standard in tapered maple wood legs. Standard in tapered maple wood legs. Legs are equipped with White non-marking glides as standard. Suitable for both carpet and hard surface flooring.
- Back upholstery is continuous without seams. In the event the textile cannot be railroaded, stitch lines will be required (one for 2 seater and two for 3 seater).
- All models ship fully assembled.
- Check textile availability prior to specifying upholstery material.

OPTION CODES



Please add option codes in the following order:

- **Model number**
8271 Lounge Chair
8272 Two Seat Sofa
8273 Three Seat Sofa
8274 Ottoman
8275 High Back Lounge Chair
8276 Accent Pillow
- **Fabric**
Specify fabric code.
- **Wood Legs**
(AA) Absolute **(AAM)**
(BM) Black **(BKM)**
(CM) Cherry **(ACM)**
(EO) English Oak **(EOM)**
(EC) Espresso Café **(ECM)**
(HG) Grey **(HGM)**
(HO) Honey **(AHM)**
(TM) Mahogany **(TMM)**
(VM) Maple **(AVM)**
(MM) Medium Walnut **(MWM)**
(NL) Natural Walnut **(NLW)**
(SN) Night **(ASM)**
(BI) Noce Biondo **(NBM)**
(GI) Noce Grigio **(NGM)**
(EI) Noce Leggero **(NEM)**
(MI) Noce Medio **(NMM)**
(SK) Shaker Cherry **(SKM)**
(TF) Fruitwood **(TFM)**
(TW) Walnut **(TWM)**
(WC) WC Cream **(WTM)**
(WH) White **(WHM)**
(WE) Winter Cherry **(WCM)**
(colors shown on website).

EXAMPLE OF ORDER CODE:

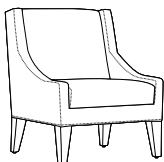
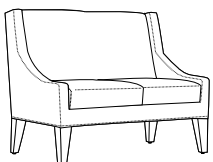
8271	WA50	HG
Model Number	Fabric	Wood Legs

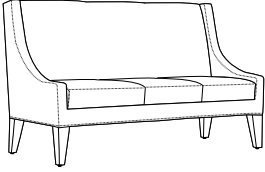
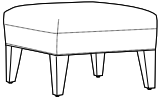
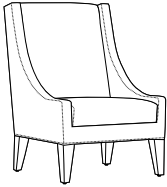
DESCRIPTION	FEATURES	MODEL#	STANDARD TEXTILE GRADES											
			1	2	3	4	5	6	7	8	9	10	11	12
 <p>Lounge Chair COM Yardage: 5.25 Freight Class: 150 Product Weight (lbs.): 90 Cubic Feet Per Carton: 20.25</p>		8271	\$1483	\$1661	\$1800	\$2008	\$2306	\$2447	\$2715	\$3145	\$3475	\$3842	\$4598	\$5407
			OVERALL DIMENSIONS			SEAT DIMENSIONS			BACK DIMENSIONS					
			W	D	H	W	D	H	W	H				
			28	31	34	22	21	17.5	22	18				
			RTA 00											
 <p>Two Seat Sofa COM Yardage: 7.25 Freight Class: 250 Product Weight (lbs.): 107 Cubic Feet Per Carton: 36.5</p>		8272	\$2434	\$2716	\$2938	\$3273	\$3749	\$3973	\$4404	\$5091	\$5619	\$6208	\$7421	\$8711
			OVERALL DIMENSIONS			SEAT DIMENSIONS			BACK DIMENSIONS					
			W	D	H	W	D	H	W	H				
			51	31	34	44	21	17.5	44	18				
			RTA 00											

DESCRIPTION	FEATURES	MODEL#	STANDARD TEXTILE GRADES											
			1	2	3	4	5	6	7	8	9	10	11	12
 <p>Three Seat Sofa COM Yardage: 9.25 Freight Class: 250 Product Weight (lbs.): 140 Cubic Feet Per Carton: 51.75</p>		8273	\$3165	\$3587	\$3923	\$4426	\$5139	\$5472	\$6120	\$7150	\$7942	\$8825	\$10643	\$12579
			OVERALL DIMENSIONS			SEAT DIMENSIONS			BACK DIMENSIONS					
			W	D	H	W	D	H	W	H				
			74.25	31	34	66	21	17.5	66	18				
			RTA 00											
 <p>Ottoman COM Yardage:1.75 Freight Class: 250 Product Weight (lbs.): 20 Cubic Feet Per Carton: 8</p>		8274	\$852	\$943	\$1014	\$1116	\$1266	\$1336	\$1472	\$1686	\$1850	\$2034	\$2412	\$2818
			OVERALL DIMENSIONS			SEAT DIMENSIONS			BACK DIMENSIONS					
			W	D	H	W	D	H	W	H				
			24	24	17	-	-	-	-	-				
			RTA 00											
 <p>High Back Lounge Chair COM Yardage: 6.25 Freight Class: 250 Product Weight (lbs.): 96 Cubic Feet Per Carton:28.25</p>		8275	\$1785	\$1977	\$2132	\$2362	\$2690	\$2841	\$3138	\$3612	\$3977	\$4379	\$5212	\$6101
			OVERALL DIMENSIONS			SEAT DIMENSIONS			BACK DIMENSIONS					
			W	D	H	W	D	H	W	H				
			28	31	42	22	21	17.5	22	26				
			RTA 00											
 <p>Accent Pillow COM Yardage: 0.75 Freight Class: 150 Product Weight (lbs.): 4 Cubic Feet Per Carton: 1</p>		8276	\$176	\$200	\$219	\$245	\$285	\$303	\$338	\$394	\$437	\$485	\$584	\$688
			OVERALL DIMENSIONS			SEAT DIMENSIONS			BACK DIMENSIONS					
			W	D	H	W	D	H	W	H				
			23	6	8	-	-	-	-	-				
			RTA 00 1 per carton											

WIND™



models 3361 Lounge chair & 3362 Two seat sofa, with 3357 Coffee table.

ADDITIONAL STITCH DETAIL - ILLUSTRATIONS BELOW



Standard Detailing - when upholstered in FABRIC or VINYL



Additional Detailing - when upholstered in GENUINE LEATHER

STANDARD FEATURES

- Compact, contemporary design includes a raised modern version of the traditional lounge chair that is scaled down for smaller spaces.
- Chair and table legs is standard in Chrome.
- There are no caster options for the Wind series.
- Wind tables complement the modern decor of many office environments.
- Check textile availability prior to specifying upholstery material.

OPTIONAL FEATURES

- **Seating and Table Frame Finish**
 - (CHM) Chrome
 - (TBZ) Buzz Blue
 - (TCR) Carrot
 - (TDW) Designer White
 - (TFO) Fog
 - (TIN) Ink
 - (TKA) Kalua
 - (TMO) Mocha
 - (TNE) Nevada
 - (TSN) Sand
 - (TTU) Tungsten
 - (ACO) Antique Chrome. Add \$306 for lounge chair. Add \$383 for two seat sofa. Add \$449 for three seat sofa. Add \$150 for tables.
 - (BCH) Brushed Chrome. Add \$144 for lounge chair. Add \$175 for two seat sofa. Add \$196 for three seat sofa. Add \$100 for tables.
 - (SBR) Satin Brass. Add \$306 for lounge chair. Add \$383 for two seat sofa. Add \$449 for three seat
- **Table Tops**
 - (ACJ) Absolute Acajou
 - (AWC) Avant Cherry
 - (BLK) Black
 - (CMB) Clear Maple
 - (DWT) Designer White
 - (NBL) Noce Biondo
 - (NEL) Noce Leggero
 - (QTM) Quartered Mahogany
 - (SOG) Storm Grey
 - (TWL) Tiger Walnut
 - (WHC) White Chocolate
 - (WCR) Winter Cherry
 - (ASN) Asian Night
 - (AWH) Avant Honey
 - (BRC) Brushed Cobalt
 - (DES) Dark Espresso
 - (HGT) Hayden Grey
 - (NGL) Noce Grigio
 - (NML) Noce Medio
 - (OTM) Quartered Mahogany
 - (TFW) Tiger Fruitwood
 - (WHE) Walnut Heights
 - (WGY) Willow Grey

sofa. Add \$150 for tables.

- **Table Tops**
 - Table tops are available in the following high pressure laminate finishes at a 20% upcharge.
 - (ACJ) Absolute Acajou
 - (AWC) Avant Cherry
 - (BLK) Black
 - (CMB) Clear Maple
 - (DWT) Designer White
 - (NBL) Noce Biondo
 - (NEL) Noce Leggero
 - (QTM) Quartered Mahogany
 - (SOG) Storm Grey
 - (TWL) Tiger Walnut
 - (WHC) White Chocolate
 - (WCR) Winter Cherry
 - (ASN) Asian Night
 - (AWH) Avant Honey
 - (BRC) Brushed Cobalt
 - (DES) Dark Espresso
 - (HGT) Hayden Grey
 - (NGL) Noce Grigio
 - (NML) Noce Medio
 - (OTM) Quartered Mahogany
 - (TFW) Tiger Fruitwood
 - (WHE) Walnut Heights
 - (WGY) Willow Grey

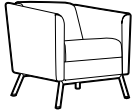
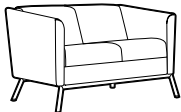
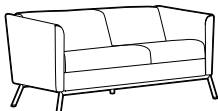
DESCRIPTION	FEATURES	MODEL#	STANDARD TEXTILE GRADES											
			1	2	3	4	5	6	7	8	9	10	11	12
 <p>Lounge Chair COM Yardage: 4.5 Freight Class: 250 Product Weight (lbs.): 62 Cubic Feet Per Carton: 16.5</p>		3361	-	2357	2477	2656	2909	3005	3228	3644	3855	4240	4779	5445
			OVERALL DIMENSIONS			SEAT DIMENSIONS			BACK DIMENSIONS					
			W	D	H	W	D	H	W	H				
			27.5	29	28.5	19.5	19	17	19	12				
			RTA 00											
 <p>Two Seat Sofa COM Yardage: 6.75 Freight Class: 250 Product Weight (lbs.): 102 Cubic Feet Per Carton: 30</p>		3362	-	3132	3315	3580	3959	4106	4436	5063	5375	5956	6765	7760
			OVERALL DIMENSIONS			SEAT DIMENSIONS			BACK DIMENSIONS					
			W	D	H	W	D	H	W	H				
			54.5	29	28.5	46.5	19	17	46.5	12				
			RTA 00											
 <p>Three Seat Sofa COM Yardage: 9 Freight Class: 250 Product Weight (lbs.): 135 Cubic Feet Per Carton: 42.5</p>		3363	-	3904	4138	4486	4976	5162	5593	6403	6807	7558	8603	9893
			OVERALL DIMENSIONS			SEAT DIMENSIONS			BACK DIMENSIONS					
			W	D	H	W	D	H	W	H				
			78	29	28.5	70.5	19	17	70.5	12				
			RTA 00											

DESCRIPTION FEATURES MODEL# STANDARD TEXTILE GRADES



End Table
COM Yardage: N/A
Freight Class: 250
Product Weight (lbs.): 36
Cubic Feet Per Carton: 11.5

MODEL#		STANDARD TEXTILE GRADES											
		1	2	3	4	5	6	7	8	9	10	11	12
3366	863	-	-	-	-	-	-	-	-	-	-	-	-
Laminate Top													
OVERALL DIMENSIONS			SEAT DIMENSIONS			BACK DIMENSIONS							
W	D	H	W	D	H	W	H						
24	24	17	-	-	-	-	-						
RTA 00													



Rectangular Coffee Table
COM Yardage: N/A
Freight Class: 250
Product Weight (lbs.): 52
Cubic Feet Per Carton: 16

MODEL#		STANDARD TEXTILE GRADES											
		1	2	3	4	5	6	7	8	9	10	11	12
3367	1142	-	-	-	-	-	-	-	-	-	-	-	-
Laminate Top													
OVERALL DIMENSIONS			SEAT DIMENSIONS			BACK DIMENSIONS							
W	D	H	W	D	H	W	H						
48	20	15	-	-	-	-	-						
RTA 00													



Square Coffee Table
COM Yardage: N/A
Freight Class: 250
Product Weight (lbs.): 66
Cubic Feet Per Carton: 22

MODEL#		STANDARD TEXTILE GRADES											
		1	2	3	4	5	6	7	8	9	10	11	12
3368	1546	-	-	-	-	-	-	-	-	-	-	-	-
Laminate Top													
OVERALL DIMENSIONS			SEAT DIMENSIONS			BACK DIMENSIONS							
W	D	H	W	D	H	W	H						
36	36	15	-	-	-	-	-						
RTA 00													



Round Table
COM Yardage: N/A
Freight Class: 250
Product Weight (lbs.): 35
Cubic Feet Per Carton: 11.5

MODEL#		STANDARD TEXTILE GRADES											
		1	2	3	4	5	6	7	8	9	10	11	12
3870	944	-	-	-	-	-	-	-	-	-	-	-	-
Laminate Top													
OVERALL DIMENSIONS			SEAT DIMENSIONS			BACK DIMENSIONS							
W	D	H	W	D	H	W	H						
24	24	17	-	-	-	-	-						
RTA 00													



Round Coffee Table
COM Yardage: N/A
Freight Class: 250
Product Weight (lbs.): 57
Cubic Feet Per Carton: 22

MODEL#		STANDARD TEXTILE GRADES											
		1	2	3	4	5	6	7	8	9	10	11	12
3871	1389	-	-	-	-	-	-	-	-	-	-	-	-
Laminate Top													
OVERALL DIMENSIONS			SEAT DIMENSIONS			BACK DIMENSIONS							
W	D	H	W	D	H	W	H						
36	36	15	-	-	-	-	-						
RTA 00													

WIND™ LINEAR



models 3363R and 3363L with 3882 bridge table, 3360 table attaching bracket kit and two 3380 coffee tables

STANDARD FEATURES

- Wind Linear is an extension of the Wind lounge series with an emphasis on expansive, clean lines. Wind Linear tables complement the modern decor of many offices.
- This modular furniture series includes single arm and armless sofas, benches, bridges and tables
- Seating and freestanding tables can be used as stand-alone products. Seating units can be linked together using bridge tables to create infinite configurations. Note: an upholstered seat unit cannot be linked with another upholstered seat unit.
- Chair and table legs are standard in Chrome.
- There are no caster options for the Wind Linear series.
- Table 'bridges' can mount outside or in-between seats to accommodate various work and collaborative settings. Requires table attaching bracket kit (3360).
- Please note Bridge End Table (model 3882) is only to be used with Chairs and/or Sofa models. Not usable with Bench or Ottoman Models.
- Please note Bridge Table (model 3884) is only to be used with Bench models 3361B and/or Ottoman models 3363B.
- Check textile availability prior to specifying upholstery material.

OPTIONAL FEATURES

- Wind linear table models are offered in laminate finishes to coordinate with Global casegoods and wood seating. These tables are not offered in high pressure laminates or epoxy finishes.
- Table tops are available in high pressure laminate at an upcharge. Add 20%.
- **Seating and Table Frame Finish**

(CHM) Chrome	(TBL) Black
(TBZ) Buzz Blue	(TCC) Cactus
(TCR) Carrot	(TDJ) Dijon
(TDW) Designer White	(TEG) Eggplant
(TFO) Fog	(TFR) Frost
(TIN) Ink	(TIV) Cloud
(TKA) Kalua	(TLA) Latte
(TMO) Mocha	(TOA) Toast
(TNE) Nevada	(TSH) Shadow
(TSN) Sand	(TSR) Scarlet
(TTU) Tungsten	
- (ACO) Antique Chrome. Add \$306 for single seater chair and ottoman. Add \$449 for single sofa and bench. Add \$150 for tables.
- (BCH) Brushed Chrome. Add \$144 for single seater chair and ottoman. Add \$225 for single sofa and bench. Add \$75 for tables.
- (SBR) Satin Brass. Add \$306 for single seater chair and ottoman. Add \$449 for single sofa and bench. Add \$150 for tables.

SAMPLE LAYOUTS

Layout A



Qty	Model Number	Description	Dimensions	List Price
1	3361R	Single Seater - Right Arm	39.5 x 29 x 28.5	2495
1	3361L	Single Seater - Left Arm	39.5 x 29 x 28.5	2495
1	3363NA	Single Sofa - Armless	72 x 29 x 28.5	3324
1	3881R	Bridge Corner Table - Right	25 x 25 x 12	1613
1	3881L	Bridge Corner Table - Left	25 x 25 x 12	1613
2	3360	Table Bracket Kit - 1 Kit per table		178 x 2

SAMPLE LAYOUT TOTAL IN STANDARD BLACK FRAME **\$11,896**

Layout B



Qty	Model Number	Description	Dimensions	List Price
1	3361R	Single Seater - Right Arm	39.5 x 29 x 28.5	2495
1	3361L	Single Seater - Left Arm	39.5 x 29 x 28.5	2495
1	3361NA	Single Seater - Armless	36.5 x 29 x 28.5	2205
2	3882	Bridge End Table	25 x 20 x 12	881 x 2
2	3360	Table Bracket Kit - 1 Kit per table		178 x 2

SAMPLE LAYOUT TOTAL IN STANDARD BLACK FRAME **\$9313**

DESCRIPTION

FEATURES

MODEL#

STANDARD TEXTILE GRADES

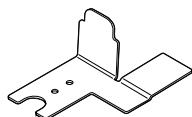

Table Bracket Kit





COM Yardage: N/A
 Freight Class: 70
 Product Weight (lbs.): 1.5
 Cubic Feet Per Carton: 0.03 (1 Kit per carton)

Includes 4 brackets and hardware.
 Use with models 3381R, 3381L, & 3382.

	1	2	3	4	5	6	7	8	9	10	11	12
3360	178	-	-	-	-	-	-	-	-	-	-	-

OVERALL DIMENSIONS			SEAT DIMENSIONS			BACK DIMENSIONS	
W	D	H	W	D	H	W	H
-	-	-	-	-	-	-	-

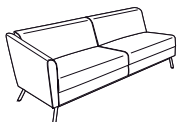

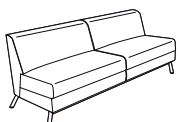
DESCRIPTION	FEATURES	MODEL#	STANDARD TEXTILE GRADES												
			1	2	3	4	5	6	7	8	9	10	11	12	
 3361R	 3361L	3361R 3361L	-	2495	2620	2804	3063	3160	3386	3813	4027	4426	4977	5659	
			OVERALL DIMENSIONS W D H			SEAT DIMENSIONS W D H			BACK DIMENSIONS W H						
			39.5	29	28.5	36	19	17	36	12					
			RTA 00												
 3361NA		3361NA	-	2205	2292	2419	2596	2663	2818	3110	3254	3528	3907	4369	
	OVERALL DIMENSIONS W D H			SEAT DIMENSIONS W D H			BACK DIMENSIONS W H								
			36.5	29	28.5	36.5	19	17.5	36.5	12					
			RTA 00												
 3363R	 3363L	3363R 3363L	-	3736	3938	4238	4660	4821	5191	5888	6237	6885	7784	8898	
			OVERALL DIMENSIONS W D H			SEAT DIMENSIONS W D H			BACK DIMENSIONS W H						
			75	29	28.5	71	19	17	71	12					
			RTA 00												
 3363NA		3363NA	-	3324	3493	3744	4098	4234	4543	5128	5421	5964	6719	7650	
	OVERALL DIMENSIONS W D H			SEAT DIMENSIONS W D H			BACK DIMENSIONS W H								
			72	29	28.5	72	19	17	72	12					
			RTA 00												



Single Seater - w/ Left or Right Arm
 COM Yardage: 4.75
 Freight Class: 250
 Product Weight (lbs.): 72
 Cubic Feet Per Carton: 28.5

Single Seater - Armless
 COM Yardage: 3.25
 Freight Class: 250
 Product Weight (lbs.): 58
 Cubic Feet Per Carton: 28.5

Single Sofa - w/ Left or Right Arm
 COM Yardage: 7.75
 Freight Class: 250
 Product Weight (lbs.): 120
 Cubic Feet Per Carton: 41

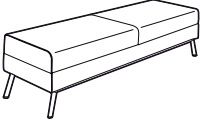
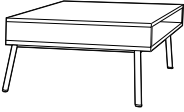
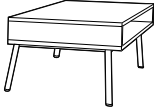
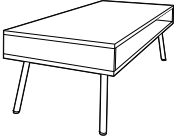
Single Sofa - Armless
 COM Yardage: 6.5
 Freight Class: 250
 Product Weight (lbs.): 111
 Cubic Feet Per Carton: 39.25

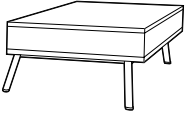
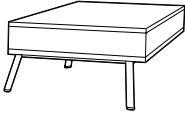
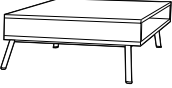
DESCRIPTION	FEATURES	MODEL#	STANDARD TEXTILE GRADES													
			1	2	3	4	5	6	7	8	9	10	11	12		
 <p>Ottoman COM Yardage: 1.75 Freight Class: 150 Product Weight (lbs.): 50 Cubic Feet Per Carton: 12.5</p>		3361B	-	1639	1687	1755	1854	1899	1987	2129	2237	2358	2608	2873		
			OVERALL DIMENSIONS			SEAT DIMENSIONS			BACK DIMENSIONS							
			W	D	H	W	D	H	W	H						
			35.5	20.5	17.5	-	-	-	-	-						
			RTA 00													
 <p>Bench COM Yardage: 3.5 Freight Class: 150 Product Weight (lbs.): 80 Cubic Feet Per Carton: 18.75</p>		3363B	-	2524	2640	2730	2864	3057	3122	3291	3609	3764	4059	4461		
			OVERALL DIMENSIONS			SEAT DIMENSIONS			BACK DIMENSIONS							
			W	D	H	W	D	H	W	H						
			72	20.5	17.5	-	-	-	-	-						
			RTA 00													
 <p>Side Table - Rectangular COM Yardage: N/A Freight Class: 250 Product Weight (lbs.): 38 Cubic Feet Per Carton: 11.5</p>	Freestanding.	3878	1235	-	-	-	-	-	-	-	-	-	-	-		
			OVERALL DIMENSIONS			SEAT DIMENSIONS			BACK DIMENSIONS							
			W	D	H	W	D	H	W	H						
			20	25	16	-	-	-	-	-						
			RTA 00													
 <p>Side Table - 25" Square COM Yardage: N/A Freight Class: 250 Product Weight (lbs.): 40 Cubic Feet Per Carton: 11.5</p>	Freestanding.	3879	1347	-	-	-	-	-	-	-	-	-	-	-		
			OVERALL DIMENSIONS			SEAT DIMENSIONS			BACK DIMENSIONS							
			W	D	H	W	D	H	W	H						
			25	25	16	-	-	-	-	-						
			RTA 00													
 <p>Coffee Table - 54" COM Yardage: N/A Freight Class: 250 Product Weight (lbs.): 52 Cubic Feet Per Carton: 16</p>	Freestanding.	3880	1502	-	-	-	-	-	-	-	-	-	-	-		
			OVERALL DIMENSIONS			SEAT DIMENSIONS			BACK DIMENSIONS							
			W	D	H	W	D	H	W	H						
			20	54	15	-	-	-	-	-						
			RTA 00													

DESCRIPTION	FEATURES	MODEL#	STANDARD TEXTILE GRADES											
			1	2	3	4	5	6	7	8	9	10	11	12
 <p>3881R</p>	 <p>3881L</p>	<p>3881R 1613 3881L</p>	-	-	-	-	-	-	-	-	-	-	-	
			<p>OVERALL DIMENSIONS W D H</p>			<p>SEAT DIMENSIONS W D H</p>			<p>BACK DIMENSIONS W H</p>					
<p>Bridge Corner Table COM Yardage: - Freight Class: 250 Product Weight (lbs.): 33 Cubic Feet Per Carton: 11.5</p>			<p>Require Bracket Kit (3360).</p>											
			<p>RTA 00</p>											
		<p>3882</p>	881	-	-	-	-	-	-	-	-	-	-	
			<p>OVERALL DIMENSIONS W D H</p>			<p>SEAT DIMENSIONS W D H</p>			<p>BACK DIMENSIONS W H</p>					
<p>Bridge End Table COM Yardage: N/A Freight Class: 250 Product Weight (lbs.): 25 Cubic Feet Per Carton: 3.4</p>			<p>Require Bracket Kit (3360). To be used with Chair and Sofa models. Not usable with Bench or Ottoman Models</p>											
			<p>RTA 00</p>											
		<p>3883</p>	1223	-	-	-	-	-	-	-	-	-	-	
			<p>OVERALL DIMENSIONS W D H</p>			<p>SEAT DIMENSIONS W D H</p>			<p>BACK DIMENSIONS W H</p>					
<p>Low Side Table COM Yardage: N/A Freight Class: 250 Product Weight (lbs.): 32 Cubic Feet Per Carton: 11.5</p>			<p>Freestanding.</p>											
			<p>RTA 00</p>											
		<p>3884</p>	820	-	-	-	-	-	-	-	-	-	-	
			<p>OVERALL DIMENSIONS W D H</p>			<p>SEAT DIMENSIONS W D H</p>			<p>BACK DIMENSIONS W H</p>					
<p>Bridge Table - 20" Square COM Yardage: N/A Freight Class: 125 Product Weight (lbs.): 23 Cubic Feet Per Carton: 3.4</p>			<p>Require Bracket Kit (3360). To be used with models 3361B and/or 3363B.</p>											
			<p>RTA 00</p>											
		<p>3885</p>	-	230	256	296	349	373	419	510	553	639	754	897
			<p>OVERALL DIMENSIONS W D H</p>			<p>SEAT DIMENSIONS W D H</p>			<p>BACK DIMENSIONS W H</p>					
<p>Bolster Cushion COM Yardage: 1 Freight Class: 70 Product Weight (lbs.): 1.5 Cubic Feet Per Carton: 1.3</p>			<p>1 Loose Cushion.</p>											
			<p>RTA 00</p>											

heavy duty/24hr

Concorde Executive 24HR	382	Malaga TS	379	Truform TS	381
Granada TS	378	ObusForme Comfort TS	380	Vion TS	387
Granada Deluxe TS	379	Robust	385		
G1 Ergo Select TS	383	Saxon	386		





model TS3140-3 Malaga



model TS5451-3 Truform

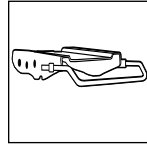

Multi-Depth Mechanism
Standard on all models. Allows seat to move forward and backward over a 2" range with 5 locking positions to provide a more shallow or deeper seat.

STANDARD FEATURES

- The **TS** models are available within standard series. **TS** stands for "Three Shift" and each of the TS models are rated for 24-7 applications as well as weight rated up to 350 pounds.
- Multi-tilter models feature a heavy duty mechanism.
- All models are standard with either Ultracell or molded heavy duty seat foam.
- All models have a heavy duty 3" wide back upright.
- All models, except Truform, have outer back panels retained by trim screws for extra security.
- All models, except Truform have standard clear vinyl bumper guards around their outside backs.
- Multi-tilters standard with Pneumatic seat height and sliding seat depth adjustment. Forward and rearward seat tilt with infinite lock and free floating back angle control. Tilt tension control.
- Heavy duty drafting stools are standard with fixed back. Seat depth and pneumatic seat height adjustments. Swivels with adjustable chrome footring.
- Grade 2 and above textiles (or 100,000+ double rubs) are recommended for 24-7 applications.
- Check textile availability prior to specifying upholstery material.

OPTIONAL FEATURES

- An optional abrasion-resistant outer back fabric (polyester) is available (excludes Truform) (**BKB**). Resistant to impact damage. Available in Black only. Add \$21.

DESCRIPTION FEATURES MODEL# STANDARD TEXTILE GRADES



LB Heavy Duty Multi-Tilter Plain Back Ratchet Back
COM Yardage: 1.50
Freight Class: 150
Product Weight (lbs.): 52
Cubic Feet Per Carton: 9.25

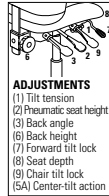

Granada TS

Ergonomic Features:
A, B, C, D, E, F, G, H, M, N, Q, S

	1	2	3	4	5	6	7	8	9	10	11	12
TS3121	1455	1508	1550	1611	1699	1728	1802	1946	2015	2149	2329	2557

OVERALL DIMENSIONS			SEAT DIMENSIONS			BACK DIMENSIONS	
W	D	H	W	D	H	W	H
26	24.5	37.75	20.5	17-19.5	16.5-20.5	19	19-22



HB Heavy Duty Multi-Tilter Plain Back Ratchet Back
COM Yardage: 1.75
Freight Class: 150
Product Weight (lbs.): 55
Cubic Feet Per Carton: 9.25

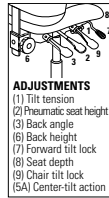

Granada TS

Ergonomic Features:
A, B, C, D, E, F, G, H, M, N, Q, S

	1	2	3	4	5	6	7	8	9	10	11	12
TS3123	1589	1650	1700	1769	1869	1901	1991	2160	2240	2395	2608	2870

OVERALL DIMENSIONS			SEAT DIMENSIONS			BACK DIMENSIONS	
W	D	H	W	D	H	W	H
26	24.5	39.75	20.5	17-19.5	16.5-20.5	19	19-22



LB Heavy Duty Multi-Tilter Plain Back
COM Yardage: 1.50
Freight Class: 125
Product Weight (lbs.): 58
Cubic Feet Per Carton: 9.25

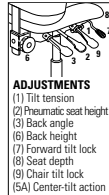









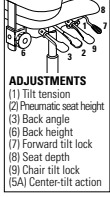

Granada TS

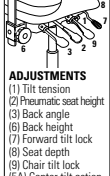

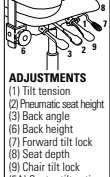

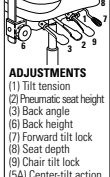

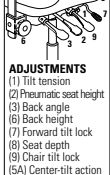



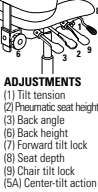



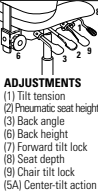

Ergonomic Features:
A, B, C, D, E, F, G, H, M, N, Q, S

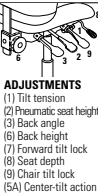



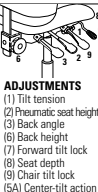

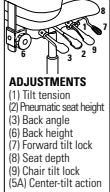

	1	2	3	4	5	6	7	8	9	10	11	12
TS3212	1137	1190	1231	1291	1377	1408	1483	1625	1697	1830	2010	2236

OVERALL DIMENSIONS			SEAT DIMENSIONS			BACK DIMENSIONS	
W	D	H	W	D	H	W	H
26	24	40.	20.5	17-19.5	17.5-21.5	19	21.5-25.5

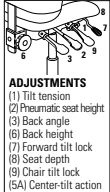

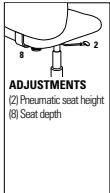
DESCRIPTION	FEATURES	MODEL#	STANDARD TEXTILE GRADES																									
			1	2	3	4	5	6	7	8	9	10	11	12														
 <p>HB Heavy Duty Multi-Tilter Plain Back COM Yardage: 1.75 Freight Class: 150 Product Weight (lbs.): 57 Cubic Feet Per Carton: 10.50</p>	 <p>ADJUSTMENTS (1) Tilt tension (2) Pneumatic seat height (3) Back angle (6) Back height (7) Forward tilt lock (8) Seat depth (9) Chair tilt lock (5A) Center-tilt action</p>	Granada TS	Ergonomic Features: A, B, C, D, E, F, G, H, M, N, Q, S	<table border="1"> <tr> <td>TS3217</td> <td>1251</td> <td>1314</td> <td>1360</td> <td>1431</td> <td>1531</td> <td>1566</td> <td>1654</td> <td>1824</td> <td>1900</td> <td>2057</td> <td>2271</td> <td>2531</td> </tr> </table>												TS3217	1251	1314	1360	1431	1531	1566	1654	1824	1900	2057	2271	2531
				TS3217	1251	1314	1360	1431	1531	1566	1654	1824	1900	2057	2271	2531												
				OVERALL DIMENSIONS			SEAT DIMENSIONS			BACK DIMENSIONS																		
				W	D	H	W	D	H	W		H																
26	24.5	43	20.5	17-19.5	17.5-21.5	19		21.5-25.5																				
			RTA 2																									
 <p>HB Heavy Duty Multi-Tilter COM Yardage: 2 Freight Class: 125 Product Weight (lbs.): 65 Cubic Feet Per Carton: 9.25</p>	 <p>ADJUSTMENTS (1) Tilt tension (2) Pneumatic seat height (3) Back angle (6) Back height (7) Forward tilt lock (8) Seat depth (9) Chair tilt lock (5A) Center-tilt action</p>	Granada Deluxe TS	Ergonomic Features: A, B, C, E, F, H, M, N, Q, S	<table border="1"> <tr> <td>TS1170-3</td> <td>1281</td> <td>1343</td> <td>1390</td> <td>1459</td> <td>1562</td> <td>1596</td> <td>1683</td> <td>1851</td> <td>1931</td> <td>2089</td> <td>2300</td> <td>2561</td> </tr> </table>												TS1170-3	1281	1343	1390	1459	1562	1596	1683	1851	1931	2089	2300	2561
				TS1170-3	1281	1343	1390	1459	1562	1596	1683	1851	1931	2089	2300	2561												
				OVERALL DIMENSIONS			SEAT DIMENSIONS			BACK DIMENSIONS																		
				W	D	H	W	D	H	W		H																
26	23.5	45	21	18-20.5	17.5-21.5	20		23-28.25																				
			RTA 2																									
 <p>MB Heavy Duty Multi-Tilter COM Yardage: 1.75 Freight Class: 125 Product Weight (lbs.): 63 Cubic Feet Per Carton: 9.25</p>	 <p>ADJUSTMENTS (1) Tilt tension (2) Pneumatic seat height (3) Back angle (6) Back height (7) Forward tilt lock (8) Seat depth (9) Chair tilt lock (5A) Center-tilt action</p>	Granada Deluxe TS	Ergonomic Features: A, B, C, E, F, H, M, N, Q, S	<table border="1"> <tr> <td>TS1171-3</td> <td>\$1165</td> <td>\$1223</td> <td>\$1260</td> <td>\$1320</td> <td>\$1407</td> <td>\$1437</td> <td>\$1511</td> <td>\$1657</td> <td>\$1725</td> <td>\$1858</td> <td>\$2039</td> <td>\$2265</td> </tr> </table>												TS1171-3	\$1165	\$1223	\$1260	\$1320	\$1407	\$1437	\$1511	\$1657	\$1725	\$1858	\$2039	\$2265
				TS1171-3	\$1165	\$1223	\$1260	\$1320	\$1407	\$1437	\$1511	\$1657	\$1725	\$1858	\$2039	\$2265												
				OVERALL DIMENSIONS			SEAT DIMENSIONS			BACK DIMENSIONS																		
				W	D	H	W	D	H	W		H																
26	23.5	41	21	18-20.5	17.5-21.5	20		19-24.25																				
			RTA 2																									
 <p>HB Heavy Duty Multi-Tilter COM Yardage: 1.75 Freight Class: 125 Product Weight (lbs.): 63 Cubic Feet Per Carton: 9.25</p>	 <p>ADJUSTMENTS (1) Tilt tension (2) Pneumatic seat height (3) Back angle (6) Back height (7) Forward tilt lock (8) Seat depth (9) Chair tilt lock (5A) Center-tilt action</p>	Malaga TS	Ergonomic Features: A, B, C, D, E, F, G, H, M, N, Q, S	<table border="1"> <tr> <td>TS3140-3</td> <td>\$1496</td> <td>\$1556</td> <td>\$1606</td> <td>\$1674</td> <td>\$1776</td> <td>\$1808</td> <td>\$1897</td> <td>\$2067</td> <td>\$2147</td> <td>\$2304</td> <td>\$2515</td> <td>\$2776</td> </tr> </table>												TS3140-3	\$1496	\$1556	\$1606	\$1674	\$1776	\$1808	\$1897	\$2067	\$2147	\$2304	\$2515	\$2776
				TS3140-3	\$1496	\$1556	\$1606	\$1674	\$1776	\$1808	\$1897	\$2067	\$2147	\$2304	\$2515	\$2776												
				OVERALL DIMENSIONS			SEAT DIMENSIONS			BACK DIMENSIONS																		
				W	D	H	W	D	H	W		H																
26	25	44	20	17.5-20	16.5-20.5	18.5		25-27.25																				
			RTA 2																									
 <p>LB Heavy Duty Multi-Tilter COM Yardage: 60 Freight Class: 125 Product Weight (lbs.): 60 Cubic Feet Per Carton: 9.25</p>	 <p>ADJUSTMENTS (1) Tilt tension (2) Pneumatic seat height (3) Back angle (6) Back height (7) Forward tilt lock (8) Seat depth (9) Chair tilt lock (5A) Center-tilt action</p>	Malaga TS	Ergonomic Features: A, B, C, D, E, F, G, H, M, N, Q, S	<table border="1"> <tr> <td>TS3141-3</td> <td>\$1378</td> <td>\$1429</td> <td>\$1470</td> <td>\$1530</td> <td>\$1617</td> <td>\$1648</td> <td>\$1724</td> <td>\$1866</td> <td>\$1936</td> <td>\$2069</td> <td>\$2251</td> <td>\$2479</td> </tr> </table>												TS3141-3	\$1378	\$1429	\$1470	\$1530	\$1617	\$1648	\$1724	\$1866	\$1936	\$2069	\$2251	\$2479
				TS3141-3	\$1378	\$1429	\$1470	\$1530	\$1617	\$1648	\$1724	\$1866	\$1936	\$2069	\$2251	\$2479												
				OVERALL DIMENSIONS			SEAT DIMENSIONS			BACK DIMENSIONS																		
				W	D	H	W	D	H	W		H																
25	24.5	39.75	20	17.5-20	16.5-20.5	18.5		20.5-22.75																				
			RTA 1																									

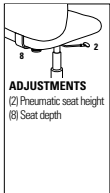
DESCRIPTION	FEATURES	MODEL#	STANDARD TEXTILE GRADES																																																														
			1	2	3	4	5	6	7	8	9	10	11	12																																																			
 <p>HB Heavy Duty Multi -Tilter COM Yardage: 2.25 Freight Class: 125 Product Weight (lbs.): 74 Cubic Feet Per Carton: 11</p>	 <p>ADJUSTMENTS (1) Tilt tension (2) Pneumatic seat height (3) Back angle (6) Back height (7) Forward tilt lock (8) Seat depth (9) Chair tilt lock (5A) Center-tilt action</p>	<p>ObusForme Comfort TS</p> <p>Ergonomic Features: A, C, E, F, H, M, N, S</p>	<table border="1"> <tr> <td>RTA 2</td> <td></td> <td colspan="10"></td> </tr> </table>												RTA 2																																																		
			RTA 2																																																														
			<table border="1"> <thead> <tr> <th colspan="3">OVERALL DIMENSIONS</th> <th colspan="3">SEAT DIMENSIONS</th> <th colspan="2">BACK DIMENSIONS</th> </tr> <tr> <th>W</th> <th>D</th> <th>H</th> <th>W</th> <th>D</th> <th>H</th> <th>W</th> <th>H</th> </tr> </thead> <tbody> <tr> <td>26</td> <td>25</td> <td>48</td> <td>21</td> <td>17.5-20</td> <td>16-20</td> <td>19</td> <td>27</td> </tr> </tbody> </table>			OVERALL DIMENSIONS			SEAT DIMENSIONS			BACK DIMENSIONS		W	D	H	W	D	H	W	H	26	25	48	21	17.5-20	16-20	19	27	<table border="1"> <tr> <td>1</td><td>2</td><td>3</td><td>4</td><td>5</td><td>6</td><td>7</td><td>8</td><td>9</td><td>10</td><td>11</td><td>12</td> </tr> <tr> <td>1369</td><td>1451</td><td>1512</td><td>1608</td><td>1740</td><td>1804</td><td>1924</td><td>2118</td><td>2266</td><td>2434</td><td>2773</td><td>3135</td> </tr> </table>												1	2	3	4	5	6	7	8	9	10	11	12	1369	1451	1512	1608	1740	1804	1924	2118	2266	2434	2773	3135
			OVERALL DIMENSIONS			SEAT DIMENSIONS			BACK DIMENSIONS																																																								
W	D	H	W	D	H	W	H																																																										
26	25	48	21	17.5-20	16-20	19	27																																																										
1	2	3	4	5	6	7	8	9	10	11	12																																																						
1369	1451	1512	1608	1740	1804	1924	2118	2266	2434	2773	3135																																																						
 <p>MB Heavy Duty Multi -Tilter COM Yardage: 2 Freight Class: 125 Product Weight (lbs.): 71 Cubic Feet Per Carton: 10.50</p>	 <p>ADJUSTMENTS (1) Tilt tension (2) Pneumatic seat height (3) Back angle (6) Back height (7) Forward tilt lock (8) Seat depth (9) Chair tilt lock (5A) Center-tilt action</p>	<p>ObusForme Comfort TS</p> <p>Ergonomic Features: A, C, E, F, H, M, N, S</p>	<table border="1"> <tr> <td>RTA 2</td> <td></td> <td colspan="10"></td> </tr> </table>												RTA 2																																																		
			RTA 2																																																														
			<table border="1"> <thead> <tr> <th colspan="3">OVERALL DIMENSIONS</th> <th colspan="3">SEAT DIMENSIONS</th> <th colspan="2">BACK DIMENSIONS</th> </tr> <tr> <th>W</th> <th>D</th> <th>H</th> <th>W</th> <th>D</th> <th>H</th> <th>W</th> <th>H</th> </tr> </thead> <tbody> <tr> <td>26</td> <td>25</td> <td>44</td> <td>21</td> <td>17.5-20</td> <td>16-20</td> <td>19.5</td> <td>22-27.25</td> </tr> </tbody> </table>			OVERALL DIMENSIONS			SEAT DIMENSIONS			BACK DIMENSIONS		W	D	H	W	D	H	W	H	26	25	44	21	17.5-20	16-20	19.5	22-27.25	<table border="1"> <tr> <td>1</td><td>2</td><td>3</td><td>4</td><td>5</td><td>6</td><td>7</td><td>8</td><td>9</td><td>10</td><td>11</td><td>12</td> </tr> <tr> <td>1306</td><td>1380</td><td>1439</td><td>1525</td><td>1649</td><td>1692</td><td>1799</td><td>2004</td><td>2103</td><td>2295</td><td>2553</td><td>2875</td> </tr> </table>												1	2	3	4	5	6	7	8	9	10	11	12	1306	1380	1439	1525	1649	1692	1799	2004	2103	2295	2553	2875
			OVERALL DIMENSIONS			SEAT DIMENSIONS			BACK DIMENSIONS																																																								
W	D	H	W	D	H	W	H																																																										
26	25	44	21	17.5-20	16-20	19.5	22-27.25																																																										
1	2	3	4	5	6	7	8	9	10	11	12																																																						
1306	1380	1439	1525	1649	1692	1799	2004	2103	2295	2553	2875																																																						
 <p>HB Heavy Duty Multi -Tilter with Schukra COM Yardage: 2.25 Freight Class: 125 Product Weight (lbs.): 74 Cubic Feet Per Carton: 11</p>	 <p>ADJUSTMENTS (1) Tilt tension (2) Pneumatic seat height (3) Back angle (6) Back height (7) Forward tilt lock (8) Seat depth (9) Chair tilt lock (5A) Center-tilt action</p>	<p>ObusForme Comfort TS</p> <p>Ergonomic Features: A, C, E, F, H, M, N, S</p>	<table border="1"> <tr> <td>RTA 2</td> <td></td> <td colspan="10"></td> </tr> </table>												RTA 2																																																		
			RTA 2																																																														
			<table border="1"> <thead> <tr> <th colspan="3">OVERALL DIMENSIONS</th> <th colspan="3">SEAT DIMENSIONS</th> <th colspan="2">BACK DIMENSIONS</th> </tr> <tr> <th>W</th> <th>D</th> <th>H</th> <th>W</th> <th>D</th> <th>H</th> <th>W</th> <th>H</th> </tr> </thead> <tbody> <tr> <td>26</td> <td>25</td> <td>48</td> <td>21</td> <td>17.5-20</td> <td>16-20</td> <td>19.5</td> <td>27-32.25</td> </tr> </tbody> </table>			OVERALL DIMENSIONS			SEAT DIMENSIONS			BACK DIMENSIONS		W	D	H	W	D	H	W	H	26	25	48	21	17.5-20	16-20	19.5	27-32.25	<table border="1"> <tr> <td>1</td><td>2</td><td>3</td><td>4</td><td>5</td><td>6</td><td>7</td><td>8</td><td>9</td><td>10</td><td>11</td><td>12</td> </tr> <tr> <td>1516</td><td>1598</td><td>1663</td><td>1760</td><td>1899</td><td>1949</td><td>2069</td><td>2302</td><td>2412</td><td>2626</td><td>2917</td><td>3280</td> </tr> </table>												1	2	3	4	5	6	7	8	9	10	11	12	1516	1598	1663	1760	1899	1949	2069	2302	2412	2626	2917	3280
			OVERALL DIMENSIONS			SEAT DIMENSIONS			BACK DIMENSIONS																																																								
W	D	H	W	D	H	W	H																																																										
26	25	48	21	17.5-20	16-20	19.5	27-32.25																																																										
1	2	3	4	5	6	7	8	9	10	11	12																																																						
1516	1598	1663	1760	1899	1949	2069	2302	2412	2626	2917	3280																																																						
 <p>MB Heavy Duty Multi -Tilter with Schukra COM Yardage: 2 Freight Class: 125 Product Weight (lbs.): 69 Cubic Feet Per Carton: 10.50</p>	 <p>ADJUSTMENTS (1) Tilt tension (2) Pneumatic seat height (3) Back angle (6) Back height (7) Forward tilt lock (8) Seat depth (9) Chair tilt lock (5A) Center-tilt action</p>	<p>ObusForme Comfort TS</p> <p>Ergonomic Features: A, C, E, F, H, M, N, S</p>	<table border="1"> <tr> <td>RTA 2</td> <td></td> <td colspan="10"></td> </tr> </table>												RTA 2																																																		
			RTA 2																																																														
			<table border="1"> <thead> <tr> <th colspan="3">OVERALL DIMENSIONS</th> <th colspan="3">SEAT DIMENSIONS</th> <th colspan="2">BACK DIMENSIONS</th> </tr> <tr> <th>W</th> <th>D</th> <th>H</th> <th>W</th> <th>D</th> <th>H</th> <th>W</th> <th>H</th> </tr> </thead> <tbody> <tr> <td>26</td> <td>25</td> <td>44</td> <td>21</td> <td>17.5-20</td> <td>16-20</td> <td>19.5</td> <td>22</td> </tr> </tbody> </table>			OVERALL DIMENSIONS			SEAT DIMENSIONS			BACK DIMENSIONS		W	D	H	W	D	H	W	H	26	25	44	21	17.5-20	16-20	19.5	22	<table border="1"> <tr> <td>1</td><td>2</td><td>3</td><td>4</td><td>5</td><td>6</td><td>7</td><td>8</td><td>9</td><td>10</td><td>11</td><td>12</td> </tr> <tr> <td>1458</td><td>1532</td><td>1591</td><td>1677</td><td>1801</td><td>1844</td><td>1952</td><td>2156</td><td>2256</td><td>2446</td><td>2704</td><td>3028</td> </tr> </table>												1	2	3	4	5	6	7	8	9	10	11	12	1458	1532	1591	1677	1801	1844	1952	2156	2256	2446	2704	3028
			OVERALL DIMENSIONS			SEAT DIMENSIONS			BACK DIMENSIONS																																																								
W	D	H	W	D	H	W	H																																																										
26	25	44	21	17.5-20	16-20	19.5	22																																																										
1	2	3	4	5	6	7	8	9	10	11	12																																																						
1458	1532	1591	1677	1801	1844	1952	2156	2256	2446	2704	3028																																																						

DESCRIPTION	FEATURES	MODEL#	STANDARD TEXTILE GRADES														
			1	2	3	4	5	6	7	8	9	10	11	12			
 <p>HB Heavy Duty Multi - Tilter COM Yardage: 2 Freight Class: 125 Product Weight (lbs.): 63 Cubic Feet Per Carton: 10.50</p>	 <p>ADJUSTMENTS (1) Tilt tension (2) Pneumatic seat height (3) Back angle (6) Back height (7) Forward tilt lock (8) Seat depth (9) Chair tilt lock (5A) Center-tilt action</p>	TS5450-3	1048	1116	1166	1246	1359	1398	1496	1681	1771	1944	2177	2472			
			OVERALL DIMENSIONS			SEAT DIMENSIONS			BACK DIMENSIONS								
			W	D	H	W	D	H	W	H							
			26	25	42	20	18-20.5	16.5-20.5	20	23.5-26							
<p>Truform TS Ergonomic Features: A, B, C, D, F, G, H, M, N, Q, S</p>			RTA 2														
			 <p>MB Heavy Duty Multi - Tilter COM Yardage: 1.75 Freight Class: 150 Product Weight (lbs.): 60 Cubic Feet Per Carton: 10.50</p>	 <p>ADJUSTMENTS (1) Tilt tension (2) Pneumatic seat height (3) Back angle (6) Back height (7) Forward tilt lock (8) Seat depth (9) Chair tilt lock (5A) Center-tilt action</p>	TS5451-3	1012	1073	1120	1187	1285	1321	1406	1570	1647	1799	2004	2259
						OVERALL DIMENSIONS			SEAT DIMENSIONS			BACK DIMENSIONS					
						W	D	H	W	D	H	W	H				
26	25	38.5				20	18-20.5	16.5-20.5	20	20-22.5							
<p>Truform TS Ergonomic Features: A, B, C, D, F, G, H, M, N, Q, S</p>			RTA 2														
			 <p>MB Heavy Duty Drafting Stool Armless COM Yardage: 1.75 Freight Class: 250 Product Weight (lbs.): 35 Cubic Feet Per Carton: 10.75</p>	 <p>ADJUSTMENTS (2) Pneumatic seat height (8) Seat depth</p>	S5457-6	1072	1134	1180	1245	1346	1380	1464	1627	1706	1858	2063	2319
						OVERALL DIMENSIONS			SEAT DIMENSIONS			BACK DIMENSIONS					
						W	D	H	W	D	H	W	H				
20	25	43				20	17.5-19	22-30	20	20							
<p>Truform S Ergonomic Features: A, B, C, J, M, N</p>			RTA 2														
			 <p>MB Heavy Duty Drafting Stool COM Yardage: 1.75 Freight Class: 150 Product Weight (lbs.): 45 Cubic Feet Per Carton: 10.75</p>	 <p>ADJUSTMENTS (2) Pneumatic seat height (8) Seat depth</p>	S5458-6	1243	1304	1351	1417	1517	1551	1637	1800	1876	2029	2234	2489
						OVERALL DIMENSIONS			SEAT DIMENSIONS			BACK DIMENSIONS					
						W	D	H	W	D	H	W	H				
26	25	43				20	17.5-19	22-30	20	20							
<p>Truform S Ergonomic Features: A, B, C, J, M, N</p>			RTA 2														

CONCORDE™ EXECUTIVE 24HR



model 2424



Push Button

Location within reach increases your adjustment. Promotes good posture as you move to various positions.



STANDARD FEATURES

- All adjustments are made with button controls that are conveniently located in full view, for easy use.
- Compound curved molded foam seat and back cushions.
- Seat cushion with Velcro attachment is easily removed and replaced.
- Rated for Multi-Shift use for persons up to 350 pounds.
- Standard with Allen-bolted width adjustable arms (Allen key included). Arms adjust 1 1/4" wider on each side, a total of 2 1/2" extra width.
- Pneumatic seat height adjustment and 5 - position tilt lock. Tilt tension control.

- Ratchet style back height adjustment.
- All models are standard with a reinforced five-legged, injection molded base with **C10** casters, Black (**BK**) Only.
- Check textile availability prior to specifying upholstery material.

OPTIONAL FEATURES

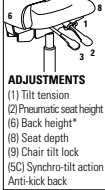
- Models are not available with **C7** glides.

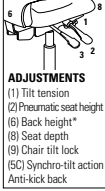
DESCRIPTION	FEATURES	MODEL#	STANDARD TEXTILE GRADES																																																
			1	2	3	4	5	6	7	8	9	10	11	12																																					
 <p>HB Synchro - Tilter Concorde Executive 24HR COM Yardage: 2.50 Freight Class: 250 Product Weight (lbs.): 78 Cubic Feet Per Carton: 23.50</p>	 <p>ADJUSTMENTS (1) Tilt tension (2) Pneumatic seat height (6) Back height* (8) Seat depth (9) Chair tilt lock (5C) Synchro-tilt action Anti-kick back</p>	<p>Seat depth Adjust: 16" to 18"</p> <p>Ergonomic Features: A, B, C, D, E, L, M, N, Q, T</p> <p>RTA 00</p>	<table border="1"> <thead> <tr> <th colspan="3">OVERALL DIMENSIONS</th> <th colspan="3">SEAT DIMENSIONS</th> <th colspan="3">BACK DIMENSIONS</th> </tr> <tr> <th>W</th> <th>D</th> <th>H</th> <th>W</th> <th>D</th> <th>H</th> <th>W</th> <th>H</th> </tr> </thead> <tbody> <tr> <td>28.5</td> <td>27</td> <td>50</td> <td>21</td> <td>17.5-19</td> <td>18-22</td> <td>21</td> <td>28-31</td> </tr> </tbody> </table>												OVERALL DIMENSIONS			SEAT DIMENSIONS			BACK DIMENSIONS			W	D	H	W	D	H	W	H	28.5	27	50	21	17.5-19	18-22	21	28-31												
			OVERALL DIMENSIONS			SEAT DIMENSIONS			BACK DIMENSIONS																																										
			W	D	H	W	D	H	W	H																																									
28.5	27	50	21	17.5-19	18-22	21	28-31																																												
<table border="1"> <thead> <tr> <th colspan="12">STANDARD TEXTILE GRADES</th> </tr> <tr> <th>1</th> <th>2</th> <th>3</th> <th>4</th> <th>5</th> <th>6</th> <th>7</th> <th>8</th> <th>9</th> <th>10</th> <th>11</th> <th>12</th> </tr> </thead> <tbody> <tr> <td>2424</td> <td>-</td> <td>2962</td> <td>3030</td> <td>3128</td> <td>3272</td> <td>3325</td> <td>3446</td> <td>3679</td> <td>3791</td> <td>4008</td> <td>4306</td> <td>4678</td> </tr> </tbody> </table>												STANDARD TEXTILE GRADES												1	2	3	4	5	6	7	8	9	10	11	12	2424	-	2962	3030	3128	3272	3325	3446	3679	3791	4008	4306	4678			
STANDARD TEXTILE GRADES																																																			
1	2	3	4	5	6	7	8	9	10	11	12																																								
2424	-	2962	3030	3128	3272	3325	3446	3679	3791	4008	4306	4678																																							
 <p>HB Synchro - Tilter Concorde Executive 24HR COM Yardage: 2.50 Freight Class: 250 Product Weight (lbs.): 78 Cubic Feet Per Carton: 23.50</p>	 <p>ADJUSTMENTS (1) Tilt tension (2) Pneumatic seat height (6) Back height* (8) Seat depth (9) Chair tilt lock (5C) Synchro-tilt action Anti-kick back</p>	<p>Additional seat depth: 1"</p> <p>Ergonomic Features: A, B, C, D, E, L, M, N, Q, T</p> <p>RTA 00</p>	<table border="1"> <thead> <tr> <th colspan="12">STANDARD TEXTILE GRADES</th> </tr> <tr> <th>1</th> <th>2</th> <th>3</th> <th>4</th> <th>5</th> <th>6</th> <th>7</th> <th>8</th> <th>9</th> <th>10</th> <th>11</th> <th>12</th> </tr> </thead> <tbody> <tr> <td>2424-18</td> <td>-</td> <td>3010</td> <td>3082</td> <td>3180</td> <td>3318</td> <td>3374</td> <td>3497</td> <td>3728</td> <td>3845</td> <td>4060</td> <td>4360</td> <td>4730</td> </tr> </tbody> </table>												STANDARD TEXTILE GRADES												1	2	3	4	5	6	7	8	9	10	11	12	2424-18	-	3010	3082	3180	3318	3374	3497	3728	3845	4060	4360	4730
			STANDARD TEXTILE GRADES																																																
			1	2	3	4	5	6	7	8	9	10	11	12																																					
2424-18	-	3010	3082	3180	3318	3374	3497	3728	3845	4060	4360	4730																																							
<table border="1"> <thead> <tr> <th colspan="3">OVERALL DIMENSIONS</th> <th colspan="3">SEAT DIMENSIONS</th> <th colspan="3">BACK DIMENSIONS</th> </tr> <tr> <th>W</th> <th>D</th> <th>H</th> <th>W</th> <th>D</th> <th>H</th> <th>W</th> <th>H</th> </tr> </thead> <tbody> <tr> <td>28.5</td> <td>27</td> <td>50</td> <td>21</td> <td>17.5-19</td> <td>18-22</td> <td>21</td> <td>28-31</td> </tr> </tbody> </table>												OVERALL DIMENSIONS			SEAT DIMENSIONS			BACK DIMENSIONS			W	D	H	W	D	H	W	H	28.5	27	50	21	17.5-19	18-22	21	28-31															
OVERALL DIMENSIONS			SEAT DIMENSIONS			BACK DIMENSIONS																																													
W	D	H	W	D	H	W	H																																												
28.5	27	50	21	17.5-19	18-22	21	28-31																																												

G1 ERGO SELECT™ TS



model TS7333

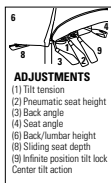

Ergonomic Features:
 A, B, C, D, E, F, G, H, M, N,
 O, R, S, U

MECHANISM:
 Multi-tilter mechanism (-3)

STANDARD FEATURES

- TS models are available within the standard G1 Ergo Select series. TS stands for “three shift” and each TS model is rated for 24/7 applications as well as weight rated up to 350 lbs.
- Models feature a heavy duty multi-tilter mechanism, cylinder and molded heavy duty seat foam.
- Standard with pneumatic seat height, forward and rearward seat tilt with infinite lock, free floating back angle control, tilt tension control and side activated sliding seat depth.
- Available in three back heights and two seat sizes (standard or generous).
- Stitch detail on edges of seat and back is discrete, using matched thread as standard.
- Standard with height and width adjustable (G5) arms with sliding armcaps. Armcaps also articulate inwards and outwards to aim toward the keyboard or mouse area.
- Five prong, injection molded, fiberglass reinforced nylon Black base with (C82) dual wheel carpet casters.
- G1 Ergo Select is fully compliant with latest BIFMA G1, GSA, and CGSB specifications.
- For 24 hour applications, Global’s Lifetime Warranty is applicable only on fabrics that are rated for 100,000 double rubs.
- Check textile availability prior to specifying upholstery material.

OPTIONAL FEATURES

- Upholstery is available with exaggerated top stitch detail (heavier thread). Fourteen coordinating or contrasting colors may be selected. Please specify.
- Optional Ergo Select arms are height (4”) and width adjustable with sliding armcaps. Armcaps also articulate inwards (25°) and outwards (25°) to aim toward the keyboard or mouse area.



Please add option codes in the following order:

- **Model number**
TS7331 Medium back
TS7332 High back
TS7333 Extended high back
- **Textile**
 Specify textile codes for back and seat
- **Mechanism**
 (-3) Multi-tilter mechanism
- **Seat Size**
(STAN) Standard seat
(GS) Generous seat
- **Arms**
(G5) G5 arms..... **Standard**
(H1) Ergo Select arms..... **Add \$83**
(H2) Ergo Select arms
 w/wide armcaps..... **Add \$114**
- **Base**
(B7) Black nylon B7B base **Standard**
(A7) Polished aluminum B7A base..... **Add \$154**
- **Casters**
(C82) Dual wheel carpet casters..... **Standard**
(C82R) Dual wheel
 hard floor casters..... **Add \$87**
- **Stitch detail**
(MS) Color matched stitching.
 Decorative top stitch..... **No upcharge**
(XP) Black **(XB)** Beige
(XG) Copen **(XA)** Graphite
(XK) Mahogany **(XJ)** Natural
(XH) Navy #3 **(XD)** New Grey
(XF) Nickel **(XN)** Off-White
(XL) Rubytone **(XI)** Scarlett
(XC) Smoke **(XE)** Taupe
 (colors shown on website)

EXAMPLE G1 ERGO SELECT TS ORDER CODE:

TS7332	-WA53	-WA53	-3	-STAN	-H1	-B7	-C82	-MS
Model #	Back fabric	Seat fabric	Mechanism	Seat size	Arms	Base	Casters	Stitch detail

G1 Ergo Select TS dimensional information: based on measurements with heavy duty multi-tilter mechanism				
	Distance between arms	Standard arm height	Seat depth range	Standard seat height
Standard seat (STAN) Heavy duty 4" lift & (H1) arms	16.0" - 21.5" = 5.5" adjustment	7.3" - 11.4"	16.5" - 18.75"	17.5" - 21.5"
Generous seat (GS) Heavy duty 4" lift & (H1) arms	17.25" - 22.75" = 5.5" adjustment		17.25" - 19.5"	

DESCRIPTION	FEATURES	MODEL#	STANDARD TEXTILE GRADES													
			1	2	3	4	5	6	7	8	9	10	11	12		
 <p>Medium Back</p> <p>COM Yardage: 1.65 Freight Class: 125 Product Weight (lbs.): 66 Cubic Feet Per Carton: 10.50</p>	See series notes for mechanism options.	TS7331	1330	1388	1427	1492	1581	1622	1704	1832	1932	2044	2270	2513		
		OVERALL DIMENSIONS			SEAT DIMENSIONS			BACK DIMENSIONS								
		W D H			W D H			W H								
		24 21.5 42			19.75 15.5-18.5 17.5-21.5			19 22								
		RTA 1			1 per carton											
 <p>High Back</p> <p>COM Yardage: 1.75 Freight Class: 125 Product Weight (lbs.): 68 Cubic Feet Per Carton: 10.50</p>	See series notes for mechanism options.	TS7332	1395	1455	1499	1566	1662	1707	1793	1932	2038	2156	2398	2659		
		OVERALL DIMENSIONS			SEAT DIMENSIONS			BACK DIMENSIONS								
		W D H			W D H			W H								
		24.5 23 45.5			16.5-18.75 15.5-18.5 17.5-21.5			19 24.5								
		RTA 1			1 per carton											
 <p>Extended High Back</p> <p>COM Yardage: 2 Freight Class: 125 Product Weight (lbs.): 70 Cubic Feet Per Carton: 11</p>	See series notes for mechanism options.	TS7333	1459	1527	1578	1657	1766	1817	1917	2074	2198	2332	2613	2912		
		OVERALL DIMENSIONS			SEAT DIMENSIONS			BACK DIMENSIONS								
		W D H			W D H			W H								
		26 24 51			16.5-18.75 15.5-18.5 17.5-21.5			19 27								
		RTA 1			1 per carton											

ROBUST





model 2527

STANDARD FEATURES

- Heavy duty chair rated for multi shift users up to 500 pounds.
- Standard with a six prong, oval tubular steel base (32" in diameter) in Black (BK) Only.
- Standard with a solid steel loop style arm. The arm is vinyl dipped to be warm to the touch and impact absorbent.
- Arms are width adjustable for an extra 2" on each side, providing additional room and comfort for users.
- There are no arm options for this series.
- Side tension adjustment can be reached from a seated position.
- Standard with Ultracell high density, high resilient foam on seat and back.
- Large diameter 3" black casters, providing easier mobility.
- Casters are suitable for hard surface flooring or carpet. There are no caster options for this series.
- Standard pneumatic seat height adjustment. Forward and rearward seat tilt with infinite lock and free floating back angle control. Tilt tension control.
- This series has a two-tone fabric combination as standard. Trim is always Silhouette fabric, SL20 Asphalt.

OPTIONAL FEATURES

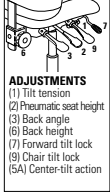
- Upholstered in fabric only. Check textile availability prior to specifying.
- An optional abrasion-resistant outer back fabric (polyester) is available (BKB). Resistant to impact damage. Available in Black only. Add \$21.

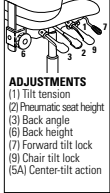
DESCRIPTION	FEATURES	MODEL#	STANDARD TEXTILE GRADES											
			1	2	3	4	5	6	7	8	9	10	11	12
 <p>HB Heavy Duty Multi-Tilter COM Yardage: 3.25 Freight Class: 250 Product Weight (lbs.): 118 Cubic Feet Per Carton: 33.50</p>	 <p>ADJUSTMENTS (1) Tilt tension (2) Pneumatic seat height (3) Back angle (6) Back height (7) Forward tilt lock (9) Chair tilt lock (5A) Center-tilt action</p> <p>Ergonomic Features: A, B, C, F, G, M, N, S</p>	2526	-	2523	2608	2734	2913	2979	3134	3426	3572	3843	4222	4686
		OVERALL DIMENSIONS			SEAT DIMENSIONS			BACK DIMENSIONS						
		W	D	H	W	D	H	W	H					
29	27.5	50.5	25.5	20	16.5-20.5	22	30							
 <p>MB Heavy Duty Multi-Tilter COM Yardage: 3 Freight Class: 250 Product Weight (lbs.): 114 Cubic Feet Per Carton: 29.50</p>	 <p>ADJUSTMENTS (1) Tilt tension (2) Pneumatic seat height (3) Back angle (6) Back height (7) Forward tilt lock (9) Chair tilt lock (5A) Center-tilt action</p> <p>Ergonomic Features: A, B, C, F, G, M, N, S</p>	2527	-	2353	2432	2546	2711	2772	2917	3187	3322	3572	3921	4351
		OVERALL DIMENSIONS			SEAT DIMENSIONS			BACK DIMENSIONS						
		W	D	H	W	D	H	W	H					
29	26.5	42.5	25.5	20	16.5-20.5	22	24							

SAXON



model 2512-3



Back

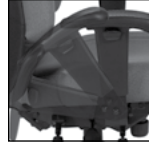

Arm Feature

Arms are designed to flip up and accommodate people wearing equipment belts.

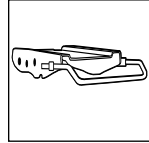

Multi-Depth Mechanism

Standard on all models. Allows seat to move forward and backward over a 2" range with 5 locking positions to provide a more shallow or deeper seat.

STANDARD FEATURES

- A contoured molded, Dual cushion Ultracell® foam seat and heavily padded back provides exceptional comfort.
- Rated for multi shift use by persons up to 350 pounds.
- Standard with a five-legged, injection molded base in Black (BK) Only.
- Standard with VL "fold up" arms. Arms fold up to accommodate users that wear equipment belts, such as Policemen and 911 Operators.
- Standard with Vari-Width Adapter Plate (WA).
- Standard with ratchet back height adjustment.
- Check textile availability prior to specifying upholstery material.

OPTIONAL FEATURES

- An abrasion-resistant outer back fabric (polyester) is standard and resistant to impact damage (BKB). Available in Black only. Add \$21
- C10 casters are standard. Please see page 389 for additional caster options. Optional caster may be priced higher than the standard casters and will incur and upcharge. Lower priced optional casters will not be credited.

DESCRIPTION



HB Heavy Duty Multi-Tilter

COM Yardage: 2.25
 Freight Class: 150
 Product Weight (lbs.): 60
 Cubic Feet Per Carton: 13

FEATURES

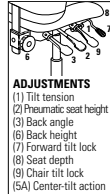

- ADJUSTMENTS**
- (1) Tilt tension
 - (2) Pneumatic seat height
 - (3) Back angle
 - (5) Back height
 - (7) Forward tilt lock
 - (8) Seat depth
 - (9) Chair tilt lock
 - (5A) Center-tilt action

Ergonomic Features:
 A, B, C, M, N, S

MODEL#

	1	2	3	4	5	6	7	8	9	10	11	12
2512-3	-	1685	1749	1839	1970	2019	2131	2344	2450	2648	2923	3260

STANDARD TEXTILE GRADES

OVERALL DIMENSIONS

W	D	H
27.5	25	39.5

SEAT DIMENSIONS

W	D	H
22.5	19-21.5	18-22

BACK DIMENSIONS

W	H
20	19.5-22



VION



model TS6321-3



model TS6331-3

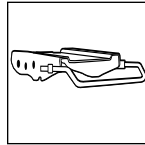

Multi-Depth Mechanism
Allows seat to move forward and backward over a 2" range with 5 locking positions to provide a more shallow or deeper seat.

VION FINISHES - TASK SEATING				
Back Frame	Base	Specify Code	Arm Option	Specify Code
Black	Black	BLK no upcharge	Adj. "T" arm (Black) Adj. "T" arm, fixed armcap (Black) Adj. "T" arm (Black , Chrome accent) Adj. "T" arm, fixed armcap (Black , Chrome accent)	AS AF AC A
Black	Polished Aluminum	BAU Add \$154	Fixed "C" arm (Black) Fixed "C" arm (Polished Aluminum)	C CA - Add \$187
Shadow	Shadow	SHW Add \$70	Adj. "T" arm (Shadow) Adj. "T" arm, fixed armcap (Shadow) Adj. "T" arm (Shadow , Chrome accent)	SHA SHF SHR
Shadow	Polished Aluminum	SAU Add \$223	Adj. "T" arm, fixed armcap (Shadow , Chrome accent) Fixed "C" arm (Shadow) Fixed "C" arm (Polished Aluminum)	SHD SHC CA - Add \$187
Fog	Fog	FOG Add \$70	Adj. "T" arm (Fog) Adj. "T" arm, fixed armcap (Fog) Adj. "T" arm (Fog , Chrome accent)	FA FF FC
Fog	Polished Aluminum	FAU Add \$223	Adj. "T" arm, fixed armcap (Fog , Chrome accent) Fixed "C" arm (Fog) Fixed "C" arm (Polished Aluminum)	CF CC CA - Add \$187





* All arms have Black SSU Armcaps.





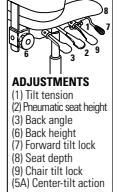

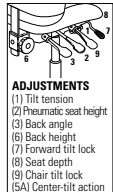



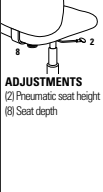



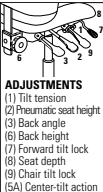



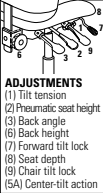



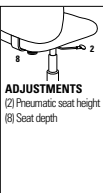



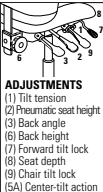



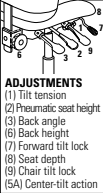



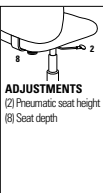

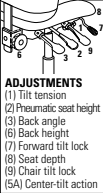

STANDARD FEATURES

- The TS models are available within standard Vion series. TS stands for "Three Shift" and each of the TS models are rated for 24-7 applications as well as weight rated up to 350 pounds.
- Multi-Tilter models, feature a heavy duty mechanism.
- Multi-Tilters are standard with Pneumatic seat height and sliding seat depth adjustment. Forward and rearward seat tilt with infinite lock and free floating back angle control. Tilt tension control.
- Side activated sliding seat depth adjustment (MD) is standard on Multi-Tilter. Provides 2" of seat depth adjustment.
- Heavy duty drafting stools are standard with fixed back. Seat depth and pneumatic seat height adjustments. Swivels with adjustable chrome footring.
- All models are standard with either Ultracell or molded heavy duty seat foam.
- All models have a heavy duty 3" wide back upright.
- All models are standard with height and width adjustable arms (**AS**) that feature a front to back sliding armcap.
- Mesh back models are available in 10 standard Vion colors: Aqua (**MS75**), Black (**MS69**), Black Cherry (**MS76**), Blue (**MS72**), Dust (**MS77**), Ivory (**MS78**), Natural (**MS74**), Paprika (**MS79**), Rope (**MS73**) and Stone (**MS71**).
- Mesh back models will always feature black fabric (Jenny **JN02**) on the back side.
- Check textile availability prior to specifying upholstery material. Materials must meet or exceed 100,000 double rubs to comply with Globals Heavy Duty seating textile warranty.

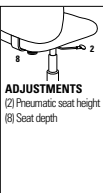
OPTIONAL FEATURES

- Vion back frames, arms and bases are available in three colors: Black, Shadow and Fog. See Vion finishes chart for options and upcharges. Armcaps are always Black.
- Mesh back models are also available in 10 Dimension Mesh colors: Black (**DBK**), Fog (**DST**), Chalk (**DCL**), Shadow (**DGM**), Charcoal (**DCH**), Sand (**DSD**), Cobalt (**DCO**), Pool Blue (**DPB**), Citrus (**DCT**) and Berry (**DBE**). Add \$25
- Upholstered back models offer a Matching Outer (**MO**) upholstery option. Due to the additional material needed, these models are listed separately and are priced differently than the standard upholstered back models.
- Two featured "T" arm options that include height and width adjusting arms, one with sliding arm caps (**AS**) and one without sliding arm caps (**AF**). Also, available is a stylish fixed urethane arm (**C**) for conference/management environments.
- Optional Lumbar Pad can be added at the time of order. Please specify **LP**. Add \$37. Lumbar Pad can also be order after sale as a kit, specify model 6339 at \$39 list. The Lumbar Pad is adjustable up to 3".
- Optional Memory Foam available on Vion Seats. Please specify **MF**. Add \$108.
- B7A** Polished aluminum base and matching chrome arm accent on either **AS** or **AF** arms. Please specify **ALU** and **AC**. Add \$154.

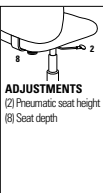
DESCRIPTION	FEATURES	MODEL#	STANDARD TEXTILE GRADES																														
			1	2	3	4	5	6	7	8	9	10	11	12																			
 <p>HB Heavy Duty Multi - Tilter - Mesh Back COM Yardage: 1.75 Freight Class: 150 Product Weight (lbs.): 49 Cubic Feet Per Carton: 9.75</p>	 <p>ADJUSTMENTS (1) Tilt tension (2) Pneumatic seat height (3) Back angle (6) Back height (7) Forward tilt lock (8) Seat depth (9) Chair tilt lock (5A) Center-tilt action</p>	<p>Vion TS</p> <p>Ergonomic Features: A, B, C, E, F, G, H, M, N, Q, U, S</p>	<table border="1"> <tr> <td>TS6321-3</td> <td>1197</td> <td>1231</td> <td>1257</td> <td>1295</td> <td>1349</td> <td>1369</td> <td>1416</td> <td>1508</td> <td>1553</td> <td>1636</td> <td>1752</td> <td>1894</td> </tr> </table>												TS6321-3	1197	1231	1257	1295	1349	1369	1416	1508	1553	1636	1752	1894						
			TS6321-3	1197	1231	1257	1295	1349	1369	1416	1508	1553	1636	1752	1894																		
			<table border="1"> <thead> <tr> <th colspan="3">OVERALL DIMENSIONS</th> <th colspan="3">SEAT DIMENSIONS</th> <th colspan="3">BACK DIMENSIONS</th> </tr> <tr> <th>W</th> <th>D</th> <th>H</th> <th>W</th> <th>D</th> <th>H</th> <th>W</th> <th>H</th> </tr> </thead> <tbody> <tr> <td>25.5</td> <td>24</td> <td>41</td> <td>20</td> <td>17-19.5</td> <td>17.5-21.5</td> <td>19</td> <td>21.5-24</td> </tr> </tbody> </table>			OVERALL DIMENSIONS			SEAT DIMENSIONS			BACK DIMENSIONS			W	D	H	W	D	H	W	H	25.5	24	41	20	17-19.5	17.5-21.5	19	21.5-24	<p>RTA 2 </p>		
OVERALL DIMENSIONS			SEAT DIMENSIONS			BACK DIMENSIONS																											
W	D	H	W	D	H	W	H																										
25.5	24	41	20	17-19.5	17.5-21.5	19	21.5-24																										
<p>MB Heavy Duty Multi - Tilter - Mesh Back COM Yardage: 1.75 Freight Class: 150 Product Weight (lbs.): 49 Cubic Feet Per Carton: 9.75</p>			 <p>ADJUSTMENTS (1) Tilt tension (2) Pneumatic seat height (3) Back angle (6) Back height (7) Forward tilt lock (8) Seat depth (9) Chair tilt lock (5A) Center-tilt action</p>			<p>Vion TS</p> <p>Ergonomic Features: A, B, C, E, F, G, H, M, N, Q, U, S</p>			<table border="1"> <tr> <td>TS6322-3</td> <td>1150</td> <td>1185</td> <td>1211</td> <td>1249</td> <td>1304</td> <td>1323</td> <td>1370</td> <td>1462</td> <td>1507</td> <td>1590</td> <td>1707</td> <td>1849</td> </tr> </table>												TS6322-3	1150	1185	1211	1249	1304	1323	1370	1462	1507	1590	1707	1849
TS6322-3	1150	1185	1211	1249	1304	1323	1370	1462	1507	1590	1707	1849																					
<table border="1"> <thead> <tr> <th colspan="3">OVERALL DIMENSIONS</th> <th colspan="3">SEAT DIMENSIONS</th> <th colspan="3">BACK DIMENSIONS</th> </tr> <tr> <th>W</th> <th>D</th> <th>H</th> <th>W</th> <th>D</th> <th>H</th> <th>W</th> <th>H</th> </tr> </thead> <tbody> <tr> <td>25.5</td> <td>24</td> <td>39</td> <td>20</td> <td>17-19.5</td> <td>17.5-21.5</td> <td>19</td> <td>21.5-24</td> </tr> </tbody> </table>			OVERALL DIMENSIONS			SEAT DIMENSIONS			BACK DIMENSIONS			W	D	H	W	D	H	W	H	25.5	24	39	20	17-19.5	17.5-21.5	19	21.5-24	<p>RTA 2 </p>					
OVERALL DIMENSIONS			SEAT DIMENSIONS			BACK DIMENSIONS																											
W	D	H	W	D	H	W	H																										
25.5	24	39	20	17-19.5	17.5-21.5	19	21.5-24																										

DESCRIPTION	FEATURES	MODEL#	STANDARD TEXTILE GRADES																																																																																																																																																																																	
			1	2	3	4	5	6	7	8	9	10	11	12																																																																																																																																																																						
 <p>MB Heavy Duty Stool - Mesh Back COM Yardage: 1.75 Freight Class: 150 Product Weight (lbs.): 49 Cubic Feet Per Carton: 9.75</p>	 <p>ADJUSTMENTS (2) Pneumatic seat height (8) Seat depth</p>	S6328-6	925	964	992	1034	1096	1117	1171	1274	1324	1418	1548	1711																																																																																																																																																																						
			OVERALL DIMENSIONS			SEAT DIMENSIONS			BACK DIMENSIONS																																																																																																																																																																											
			W	D	H	W	D	H	W	H																																																																																																																																																																										
			25.5	24	48	20	17.5	23.5-33.5	19	21.5-24																																																																																																																																																																										
<p>Vion S</p> <p>Ergonomic Features: C, E, H, M, N, Q, U</p>	 	 <p>HB Heavy Duty Multi - Tilter - Upholstered Back COM Yardage: 1.75 Freight Class: 150 Product Weight (lbs.): 49 Cubic Feet Per Carton: 9.75</p>	 <p>ADJUSTMENTS (1) Tilt tension (2) Pneumatic seat height (3) Back angle (6) Back height (7) Forward tilt lock (8) Seat depth (9) Chair tilt lock (SA) Center-tilt action</p>	TS6331-3	1321	1365	1397	1444	1512	1539	1596	1712	1766	1872	2016	2194	TS6331-3MO	1373	1440	1491	1569	1679	1730	1829	1986	2108	2244	2523	2819	OVERALL DIMENSIONS			SEAT DIMENSIONS			BACK DIMENSIONS						W	D	H	W	D	H	W	H				25.5	24	41	20	17-19.5	17.5-21.5	19	21.5-24				<p>Vion TS</p> <p>Ergonomic Features: A, B, C, E, F, G, H, M, N, Q, U, S</p>	 	 <p>MB Heavy Duty Multi - Tilter - Upholstered Back COM Yardage: 1.75 Freight Class: 150 Product Weight (lbs.): 49 Cubic Feet Per Carton: 9.75</p>	 <p>ADJUSTMENTS (1) Tilt tension (2) Pneumatic seat height (3) Back angle (6) Back height (7) Forward tilt lock (8) Seat depth (9) Chair tilt lock (SA) Center-tilt action</p>	TS6332-3	1274	1317	1348	1396	1464	1490	1548	1664	1717	1824	1968	2146	TS6332-3MO	1329	1402	1458	1543	1660	1715	1825	1996	2128	2275	2578	2901	OVERALL DIMENSIONS			SEAT DIMENSIONS			BACK DIMENSIONS						W	D	H	W	D	H	W	H				25.5	24	41	20	17-19.5	17.5-21.5	19	21.5-24				<p>Vion TS</p> <p>Ergonomic Features: A, B, C, E, F, G, H, M, N, Q, U, S</p>	 	 <p>MB Heavy Duty Drafting Stool - Upholstered Back COM Yardage: 1 Freight Class: 150 Product Weight (lbs.): 47 Cubic Feet Per Carton: 10.50</p>	 <p>ADJUSTMENTS (2) Pneumatic seat height (8) Seat depth</p>	S6338-6	1038	1086	1121	1176	1253	1280	1348	1476	1536	1658	1819	2020	OVERALL DIMENSIONS			SEAT DIMENSIONS			BACK DIMENSIONS						W	D	H	W	D	H	W	H				25.5	24	48	20	17.5	23.5-33.5	18.5	21				<p>Vion S</p> <p>Ergonomic Features: C, E, M, N</p>	 
					 <p>HB Heavy Duty Multi - Tilter - Upholstered Back COM Yardage: 1.75 Freight Class: 150 Product Weight (lbs.): 49 Cubic Feet Per Carton: 9.75</p>	 <p>ADJUSTMENTS (1) Tilt tension (2) Pneumatic seat height (3) Back angle (6) Back height (7) Forward tilt lock (8) Seat depth (9) Chair tilt lock (SA) Center-tilt action</p>	TS6331-3	1321	1365	1397	1444	1512	1539	1596	1712	1766	1872	2016	2194																																																																																																																																																																	
								TS6331-3MO	1373	1440	1491	1569	1679	1730	1829	1986	2108	2244	2523	2819																																																																																																																																																																
								OVERALL DIMENSIONS			SEAT DIMENSIONS			BACK DIMENSIONS																																																																																																																																																																						
W	D	H	W	D				H	W	H																																																																																																																																																																										
25.5	24	41	20	17-19.5	17.5-21.5	19	21.5-24																																																																																																																																																																													
<p>Vion TS</p> <p>Ergonomic Features: A, B, C, E, F, G, H, M, N, Q, U, S</p>	 	 <p>MB Heavy Duty Multi - Tilter - Upholstered Back COM Yardage: 1.75 Freight Class: 150 Product Weight (lbs.): 49 Cubic Feet Per Carton: 9.75</p>	 <p>ADJUSTMENTS (1) Tilt tension (2) Pneumatic seat height (3) Back angle (6) Back height (7) Forward tilt lock (8) Seat depth (9) Chair tilt lock (SA) Center-tilt action</p>	TS6332-3	1274	1317	1348	1396	1464	1490	1548	1664	1717	1824	1968	2146	TS6332-3MO	1329	1402	1458	1543	1660	1715	1825	1996	2128	2275	2578	2901	OVERALL DIMENSIONS			SEAT DIMENSIONS			BACK DIMENSIONS						W	D	H	W	D	H	W	H				25.5	24	41	20	17-19.5	17.5-21.5	19	21.5-24				<p>Vion TS</p> <p>Ergonomic Features: A, B, C, E, F, G, H, M, N, Q, U, S</p>	 	 <p>MB Heavy Duty Drafting Stool - Upholstered Back COM Yardage: 1 Freight Class: 150 Product Weight (lbs.): 47 Cubic Feet Per Carton: 10.50</p>	 <p>ADJUSTMENTS (2) Pneumatic seat height (8) Seat depth</p>	S6338-6	1038	1086	1121	1176	1253	1280	1348	1476	1536	1658	1819	2020	OVERALL DIMENSIONS			SEAT DIMENSIONS			BACK DIMENSIONS						W	D	H	W	D	H	W	H				25.5	24	48	20	17.5	23.5-33.5	18.5	21				<p>Vion S</p> <p>Ergonomic Features: C, E, M, N</p>	 																																																																
					 <p>MB Heavy Duty Multi - Tilter - Upholstered Back COM Yardage: 1.75 Freight Class: 150 Product Weight (lbs.): 49 Cubic Feet Per Carton: 9.75</p>	 <p>ADJUSTMENTS (1) Tilt tension (2) Pneumatic seat height (3) Back angle (6) Back height (7) Forward tilt lock (8) Seat depth (9) Chair tilt lock (SA) Center-tilt action</p>	TS6332-3	1274	1317	1348	1396	1464	1490	1548	1664	1717	1824	1968	2146																																																																																																																																																																	
								TS6332-3MO	1329	1402	1458	1543	1660	1715	1825	1996	2128	2275	2578	2901																																																																																																																																																																
								OVERALL DIMENSIONS			SEAT DIMENSIONS			BACK DIMENSIONS																																																																																																																																																																						
W	D	H	W	D				H	W	H																																																																																																																																																																										
25.5	24	41	20	17-19.5	17.5-21.5	19	21.5-24																																																																																																																																																																													
<p>Vion TS</p> <p>Ergonomic Features: A, B, C, E, F, G, H, M, N, Q, U, S</p>	 	 <p>MB Heavy Duty Drafting Stool - Upholstered Back COM Yardage: 1 Freight Class: 150 Product Weight (lbs.): 47 Cubic Feet Per Carton: 10.50</p>	 <p>ADJUSTMENTS (2) Pneumatic seat height (8) Seat depth</p>	S6338-6	1038	1086	1121	1176	1253	1280	1348	1476	1536	1658	1819	2020	OVERALL DIMENSIONS			SEAT DIMENSIONS			BACK DIMENSIONS						W	D	H	W	D	H	W	H				25.5	24	48	20	17.5	23.5-33.5	18.5	21				<p>Vion S</p> <p>Ergonomic Features: C, E, M, N</p>	 																																																																																																																																
					 <p>MB Heavy Duty Drafting Stool - Upholstered Back COM Yardage: 1 Freight Class: 150 Product Weight (lbs.): 47 Cubic Feet Per Carton: 10.50</p>	 <p>ADJUSTMENTS (2) Pneumatic seat height (8) Seat depth</p>	S6338-6	1038	1086	1121	1176	1253	1280	1348	1476	1536	1658	1819	2020																																																																																																																																																																	
								OVERALL DIMENSIONS			SEAT DIMENSIONS			BACK DIMENSIONS																																																																																																																																																																						
								W	D	H	W	D	H	W	H																																																																																																																																																																					
25.5	24	48	20	17.5				23.5-33.5	18.5	21																																																																																																																																																																										
<p>Vion S</p> <p>Ergonomic Features: C, E, M, N</p>	 																																																																																																																																																																																			

arm and caster options



HOW TO SELECT ARMRESTS

Global has a wide selection of armrest to suit almost every work task. Armrest are an important feature of a chair. They reduce stress an tension on the spine, neck and shoulder muscles by supporting the weight of your arms. This makes you more comfortable and ultimately more productive. Height, width and angle adjustable armrests enable you to position your arms at a comfortable working position, based on the task at hand.

COMFORT TIPS

- Wrists should be in a straight or neutral position - avoid bending your wrists
- When mousing, use whole arm movements instead of flexing your wrist.
- Rest your palm on the mouse pad for support.

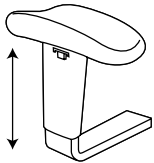

HEIGHT ADJUSTABLE ARMS

- A full range of arms is available with armcaps in self-skinned urethane (SSU).
- Use the features available on Global's adjustable arms to accommodate your ergonomic requirements.

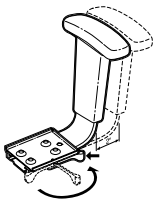

VARI-WIDTH ARM

- Features maximum comfort while enabling you to maintain top productivity levels.
- Easy to use levers enable you to adjust the distance between armrests quickly and simply. An ergonomic feature, Vari-Width maximizes shoulder support as it accommodates the specific width requirements of each user.
- Metal adapter plates provide width adjustability. One adapter plate is attached under each side of the seat. Arms are inserted into the adapter plates.
- Arms extend outward up to 2" on each side. A lever locks each arm in any position.
- Vari-Width is available only with Global's height adjustable arms. The arm chart (on the following pages) specifies all arm options available for the Vari-Width series. Vari-Width is standard on many chairs; they can also be retroactively installed on chairs.
- When ordering, please specify series, arm and **(WA)** ie. Loover 2660-0 **(G5)** and **(WA)**. When ordering as retrofit, please specify **2660-0-WA**.

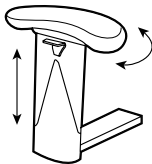

ROTATING ARMCAPS

Rotating armcaps articulate inward and/or outward. This positions the arm to support mousing or keyboarding activities. Rotating armcaps can also be used to narrow the space between the arms for slender people seeking arm support while keyboarding.

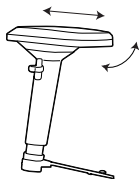

SLIDING ARMCAPS

Select arms have sliding armcaps. They can slide over top of the seat to narrow the space between the arms for smaller users. Sliding armcaps also slide forward for arm support for larger users or slide to the rear allowing slender users to sit closer to their worksurface.

OPTIONAL ARMS

Purchased separately from the chair. Cost listed below arm descriptions. Refer to chart for series compatibility.



AS

Height and width adjustable forward and backward sliding armcaps.
\$252

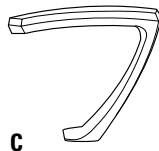

C

Fixed height and stylish "C" arm. Self-skinned urethane. Black only.
\$252

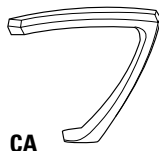

CA

Fixed height and stylish "C" arm. Polished Aluminum.
\$398

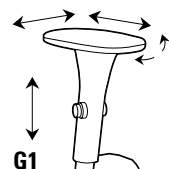

G1

Height and width adjustable forward and backward sliding armcaps. Self-skinned urethane pad rotates inward.
\$252



G2

Special low rise version of G3 arm, positions 1" lower but retains all G3 functions.
\$252

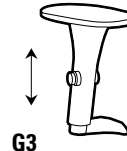

G3

Height and width adjustable forward and backward sliding armcaps. Self-skinned urethane pad rotates inward 30 degrees.
\$252



G4

Height adjustable "T" style Graphic arm. Self-Skinned Urethane (SSU) armcap. Slides forward and back.
\$252



G5

Lockable, highly adjustable armcap slides forward and backward, cap slides over seat 3/4" each side, cap rotates inward & outward. Soft (SSU) arm pad.
\$252



G6

Special low rise version of G5 arm, positions 1" lower but retains all G5 arm functions.
\$252

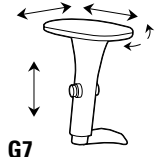

G7

Wider highly adjustable armcap slides forward and backward, cap slides over seat 3/4" each side. Cap rotates inward. Soft SSU arm pad. Curved corners and sides.
\$252

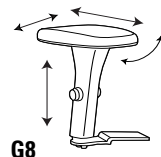

G8

Special low rise version of G7 arm, positions 1" lower but retains all G7 functions.
\$252

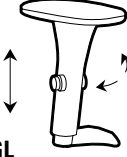

GL

Width adjustable forward and backward sliding armcaps.
\$252

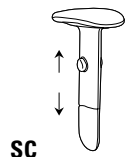

SC

Height adjustable forward swept arms with kidney shaped armcaps. Self-skinned urethane.
\$220

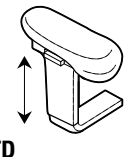

TD

Height adjustable "T" arms with teardrop shaped armcaps. Self-skinned urethane.
\$220

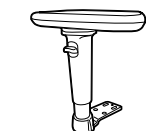

T6

Height adj. T arm. Rotates 360. Self-skinned urethane.
\$294

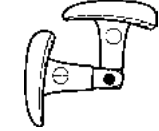

ZT

Height adjustable "T" arms, teardrop shaped. Swings away and folds. Self-skinned urethane.
\$268



3B

Height Adjustable "T" arm with soft touch Self-Skinned Urethane (SSU) armcap.
\$220

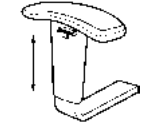

3N

Height adjustable "T" arms with curved shaped armcaps. Self-skinned urethane. Available in Black only.
\$180

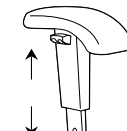

3P

Height adjustable "waterfall edge" arms. Self-skinned urethane. Available in Black Only.
\$280



3R

Hard durometer. Height Adjustable "T" arm with Concave Oval soft touch Self-Skinned Urethane (SSU) armcap.
\$220

ARM SELECTIONS

SERIES \ ARM	STD	AS	C	CA	G1	G2	G3	G4	G5	G6	G7	G8
ASPEN	AS		NA	NA	0	NA	0	0	0	NA	0	0
ENTERPRISE	TD	36	NA	NA	36	36	36	36	36	36	NA	NA
GOAL	3N	NR	77	NA	NR	NR	NR	NR	NR	NR	NR	NR
GRAHAM	3N	83	NA	NA	77	77	77	77	77	77	NA	NA
GRANADA	3N	83	NA	NA	77	77	77	77	77	77	NR	NR
GRANADA DELUXE	3B	83	NA	NA	36	36	36	36	36	36	NA	NA
GRAPHIC	G4	0	0	NA	0	NA	0		0	NA	0	0
LOOVER	G5	0	0	176	0	0	0	0	STD	0	0	0
MALAGA	TD	36	NA	NA	36	36	36	36	36	36	NA	NA
OBUSFORME COMFORT	G3	0	NA	NA	0	0	STD	0	0	0	0	0
SAXON	VL	0	NA	NA	0	0	0	0	0	0	0	0
SUPRA X	SC	83	36	NA	36	36	36	36	36	36	NA	NA
SYNOPSIS	3B	83	36	NA	36	36	36	36	36	36	NA	NA
TRIUMPH	G1	0	NA	NA	STD	NA	0	0	0	NA	NA	NA
TRUFORM	SC	83	36	NA	36	36	36	36	36	36	36	NA
TYE	3N	83	NA	NA	77	77	77	77	77	77	77	NA
VION	AS/C	STD	STD	176	0	0	0	0	0	0	0	0
WEEV	GL	0	0	NA	0	0	0	0	0	0	0	0

NOTE: ARMCHAIRS HAVE FIXED ARMS WHICH ARE NOT INTERCHANGEABLE WITH ADJUSTABLE ARMS LISTED ABOVE.
 * INDICATES THAT ARMS CANNOT BE USED WITH "WA" ARM WIDTH ADAPTER.

\$0 = AVAILABLE AT NO ADDITIONAL CHARGE

NA = NOT AVAILABLE

NR = OPTION NOT RECOMMENDED

SERIES \ ARMS	STD	GL	SC	TD	T6	ZT	3B	3N	3P	3R	WA
ASPEN	AS	0	NR	NR	NA	NA	NR	NR	NR	NR	STD
ENTERPRISE	G1	36	0	0	100	46	0	0	0	0	STD
GOAL	3N	NR	42	42	NR	93	42	STD	42	42	NA
GRAHAM	3N	77	42	42	141	93	42	STD	42	42	NA
GRANADA	3N	77	42	42	141	93	42	STD	42	42	STD
GRANADA DELUXE	3B	36	0	0	100	46	STD	0	0	0	STD
GRAPHIC	G4	0	0	NR	65	15	NR	NR	NR	NR	STD
LOOVER	G5	0	0	0	0	NA	0	0	0	0	0
MALAGA	TD	36	0	STD	100	46	0	0	0	0	STD
OBUSFORME COMFORT	G3	0	0	0	65	14	0	0	0	0	STD
SAXON	VL	0	0	NR	48	NR	0	0	0	0	NA
SUPRA X	SC	36	STD	0	100	46	0	0	0	0	STD
SYNOPSIS	3B	36	0	0	100	46	STD	0	0	0	STD
TRIUMPH	G1	0	NA	NA	NA	NA	NA	NA	NA	NA	NA
TRUFORM	SC	36	STD	0	100	46	0	0	0	0	NA
TYE	3N	77	42	42	141	93	42	STD	42	42	NA
VION	AS/C	0	0	0	65	NA	0	0	0	0	0
WEEV	GL	STD	0	0	65	15	0	0	0	0	STD

NOTE: ARMCHAIRS HAVE FIXED ARMS WHICH ARE NOT INTERCHANGEABLE WITH ADJUSTABLE ARMS LISTED ABOVE.
 * INDICATES THAT ARMS CANNOT BE USED WITH "WA" ARM WIDTH ADAPTER.

\$0 = AVAILABLE AT NO ADDITIONAL CHARGE

NA = NOT AVAILABLE

NR = OPTION NOT RECOMMENDED

CASTER SELECTIONS

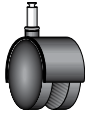

C1	2" Dual Wheel Caster	Black	Carpeted Floor	1 each set of 5	\$17 \$76
----	----------------------	-------	----------------	--------------------	----------------------------

Available on: Softcurve and Traditional bases.



C7	Slipper Glide (allows chair to remain at caster height)	Black	Any surface	1 each set of 5	\$17 \$76
----	---	-------	-------------	--------------------	----------------------------

Available on: All bases



C9R	2 1/2" Dual Wheel Rubber Coated Caster	Black	Vinyl, Marble, Hardwood Floor	1 each set of 5	\$31 \$140
-----	---	-------	----------------------------------	--------------------	-----------------------------

Available on: All bases



C10	2" Integrated Dual Wheel Caster	Black	Carpeted Floor	1 each set of 5	\$28 \$125
-----	------------------------------------	-------	----------------	--------------------	-----------------------------

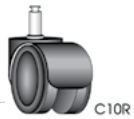

C10R	Integrated Dual Wheel Rubber Coated Caster	Black	Vinyl, Marble, Hardwood Floor	1 each set of 5	\$40 \$183
------	---	-------	----------------------------------	--------------------	-----------------------------

Available on: Concorde, Graham, Malaga, and Tamiri bases only.



C14R	Automatic Locking Rubber Caster (while sitting)	Black	Any surface*	1 each set of 5	\$81 \$327
------	---	-------	--------------	--------------------	-----------------------------

Available on: All bases



C15	Manual Locking Caster (individual)	Black	Carpeted Floor	1 each set of 5	\$37 \$169
-----	---------------------------------------	-------	----------------	--------------------	-----------------------------

Available on: All bases

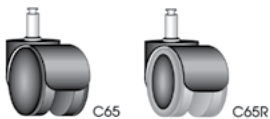











C65	2" Dual Wheel Caster	Black	Carpeted Floor	1 each set of 5	\$24 \$76
-----	----------------------	-------	----------------	--------------------	----------------------------

C65R	2" Dual Wheel Rubber Coated Caster	Black	Vinyl, Marble, Hardwood Floor	1 each set of 5	\$34 \$140
------	---------------------------------------	-------	----------------------------------	--------------------	-----------------------------

Available on: All bases (except wood base chairs).

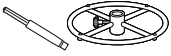
CASTER NOTES:

- The casters shown above are sold in sets for replacement purposes. This price list can also be used to calculate the upcharge to change casters at time of ordering a chair. Optional casters may be priced higher than the standard casters for your chair and the difference will be charged. Lower priced casters will not be credited.
- All casters are not appropriate for all flooring surfaces. Please consult with your sales representative or Global Customer Service representative for special situations that can be verified with the caster manufacturer. Alternative casters, if needed, may require an upcharge.
- *Recommended for use on hard surface floors.

	MODEL #	MODEL NAME
	3G	3" cylinder Soft Descent™ pneumatic lift cylinder with 3 inch travel range. This lift cannot be used on synchro-tilter (-0) and multi-tilter (-3) mechanisms due to operational interference with controls.
	4F	Fixed height swivel spindle #4 Fixed height, swivel only. Seat height is determined by the spindle length which is preset at the factory and cannot be changed.
	4L	4" cylinder, low rise Soft Descent™ low rise, pneumatic lift cylinder with 4 inch travel range.
	5F	Fixed height swivel spindle #5 Fixed height, swivel only. Seat height is determined by the spindle length which is preset at the factory and cannot be changed.
	5L	5" cylinder, low rise Soft Descent™ low rise, pneumatic lift cylinder with 5 inch travel range.
	7G	7" cylinder Soft Descent™ pneumatic lift cylinder with 7 inch travel range. Lift allows most users to sit at both desk and counter heights. Seats may be too tall for shorter users at desk height.
	7R	7" cylinder with 20" Chrome footrest Soft Descent™ pneumatic lift cylinder with 7 inch travel range and adjustable footrest. Lift allows most users to sit at both desk and counter heights. Seats may be too tall for shorter users at desk height (refer to cylinder chart on page 396).
	SC	Self-centering, height auto-return Center and height return pneumatic lift cylinder with 2 inch travel range. Chair always swivels back to face the original direction so groups of chairs remain aligned. The seat height may be lowered by occupant, but chairs return to the maximum seat height when user exits the chair.
	SH	Height auto-return, swivel Height return pneumatic lift cylinder with 2 inch travel range. The seat height may be lowered by occupant, but chairs return to the maximum seat height when user exits the chair.
	SN	Height auto-return, non-swivel Height return pneumatic lift cylinder with 2 inch travel range. The seat height may be lowered by occupant, but chairs return to the maximum seat height when user exits the chair. Lift does not swivel.

CYLINDER NOTES:

- All cylinders are not appropriate for all mechanisms. Please refer to the following chart for compatibility and effect on minimum seat height.
- For cylinder upcharges and replacement costs, please contact Customer Service.

CYLINDER SELECTIONS





SERIES	CYLINDER	STD	3G	4L	4F	5L	5F	7G	7R	SC	SH	SN
	Mechanism											
ACCORD	-2	4L	NA	STD	NA	+1.5	NA	+1.0	NA	NA	NA	NA
	-4	4G*	NA	NA	+0.5	NA	+1.0	+1.0	NA	+1.5	+1.5	+1.5
ASPEN	-3	4L	-0.75	STD	NA	+1.5	NA	+2.0	NA	NA	NA	NA
G1 ERGO SELECT	-0	4L	N/A	STD	NA	+1.5	NA	NA	NA	NA	NA	NA
	-3	4L	N/A	STD	NA	+1.5	NA	+2.0	NA	NA	NA	NA
	-8	4L	N/A	STD	NA	+1.5	NA	+2.0	NA	NA	NA	NA
G20		5L	-2.25	-1.5	NA	STD	NA	+1.0	NA	NA	NA	NA
GRANADA DELUXE	-2,-3	4L	NA	STD	NA	+1.5	NA	+2.0	NA	NA	NA	NA
	-5	4L	-0.75	STD	NA	+1.5	NA	+2.0	NA	NA	NA	NA
LOOVER	-3	4L	-0.75	STD	NA	+1.5	NA	+2.0	NA	NA	NA	NA
	-4	5L	-2.25	-1.5	NA	STD	+1.0	+1.0	+1.0	+1.75	+1.75	+1.75
	-8	5L	-2.25	-1.5	NA	STD	+1.0	+1.0	+1.0	+2.0	+2.0	+2.0
LURAY	-2	4L	NA	STD	NA	+1.5	NA	NA	NA	NA	NA	NA
	-4	5L	NA	-1.5	+0.5	STD	+1.0	+1.0	NA	+1.5	+1.5	+1.5
MALAGA	-1,-4	5L	-2.25	-1.5	NA	STD	NA	+1.0	NA	NA	NA	NA
	-2,-3	5L	NA	-1.5	NA	STD	NA	+1.0	NA	NA	NA	NA
NOVELLO		5L	-2.25	-1.5	NA	STD	NA	+1.0	NA	NA	NA	NA
OBUSFORME COMFORT	-2,-3	4L	NA	STD	NA	+1.5	NA	+2.0	NA	NA	NA	NA
	-5	4L	-0.75	STD	NA	+1.5	NA	NA	NA	NA	NA	NA
PREFER		4G*	-1.75	-1.25	+0	+0.25	+1.0	+0.75	+0.75	NA	NA	NA
ROMA		4L*	-0.75	STD	NA	+1.5	+2.5	+2.0	NA	+2.0	+2.0	+2.0
SOFTCURVE LM	-1	5L	NA	-1.5	NA	STD	NA	NA	NA	NA	NA	NA
	-2,-3	4L	NA	STD	NA	+1.5	NA	NA	NA	NA	NA	NA
	-4	5L	NA	-1.5	NA	STD	+0.5	NA	NA	+2.0	+2.0	+2.0
SOLAR		4L*	NA	NA	+0.0	NA	+1.0	NA	NA	NA	NA	NA
SORA	-8	4L	-0.75	STD	NA	+1.5	NA	+2.0	+2.0	NA	NA	NA
SPREE		5L	-2.25	-1.5	NA	STD	NA	+1.0	NA	NA	NA	NA
SUPRA-X	-1,-4,-5	5L	-2.25	-1.5	NA	STD	NA	+1.0	NA	NA	NA	NA
	-3	5L	NA	-1.5	NA	STD	NA	+1.0	NA	NA	NA	NA
SYNOPSIS	-3	5L	NA	-1.5	NA	STD	NA	+1.0	NA	NA	NA	NA
	-4	5L	-2.25	-1.5	NA	STD	+1.0	+1.0	NA	+2.25	+2.25	+2.25
TRIUMPH	-3,-8	4L*	-0.75	STD	NA	+1.5	NA	+2.0	NA	NA	NA	NA
TRUFORM	-0	5L	NA	-1.5	NA	STD	NA	NA	NA	NA	NA	NA
	-3	5L	NA	-1.5	NA	STD	NA	+1.0	NA	NA	NA	NA
	-1,-4,-5	5L	NA	-1.5	NA	STD	NA	+1.0	NA	NA	NA	NA
VION	-8	5L	-2.25	-1.5	NA	STD	NA	+1.0	NA	NA	NA	NA
	-3	5L	-2.25	-1.5	NA	STD	NA	+1.0	+1.0	+1.75	+1.75	+1.5
	-4	5L	-2.25	-1.5	NA	STD	+1.0	+1.0	+1.0	+1.0	+1.0	+1.5
WEEV	-8	5L	-2.25	-1.5	NA	STD	+0.5	+1.0	NA	NA	NA	+1.5
	-3,-4,-8	5L	-2.25	-1.5	NA	STD	NA	+1.0	NA	NA	NA	NA

NOTE: CHART VALUES INDICATE CHANGE FROM STANDARD MINIMUM SEAT HEIGHT (IN INCHES).

3G AND 7G CYLINDERS ARE NOT AVAILABLE FOR USE WITH -0 SYNCHRO-TILT MECHANISM.

*SPECIAL CYLINDER

DUET AND POPCORN GLIDE SELECTIONS

GLIDES	SURFACE	CARPET	VINYL SHEET	LVT	VCT	RUBBER	CORK	HARDWOOD	LAMINATE	CERAMIC TILE, STONE	MARBLE, GRANITE	CONCRETE
NO GLIDE (XG): The plain Chrome sled based frame slides easily and silently over carpeted surfaces. Note: do not use in damp areas.												
		●	NR	NR	NR	●	NR	NR	NR	NR	NR	NR
CLEAR POLYCARBONATE GLIDE (CG): The polycarbonate glide is easy to move over most flooring. It does not leave marks and it reduces noise on hard surfaces.												
		●	NR	NR	NR	●	NR	NR	NR	NR	NR	●
STAINLESS STEEL PAD ON POLYCARBONATE GLIDE (SG): The stainless steel bottomed glide slides easily. It is extremely durable, reduces floor contact and noise on hard surfaces.												
		●	NR	NR	NR	●	NR	NR	NR	NR	NR	NR
FELT PAD ON POLY CARBONATE GLIDE (FG): The felt bottomed glide moves silently and smoothly on hard surface flooring. Helps to prevent floor damage.												
		NR	●	●	●	NR	●	NR	●	NR	NR	NR
RUBBER NO SLIP PAD ON POLY CARBONATE GLIDE (RG): The rubber bottomed glide is slip-resistant. It grips flooring, reduces movement, scratching and eliminates noise.												
		NR	●	●	●	NR	NR	●	●	●	●	NR

NOTE: THE ABOVE IS ONLY A GUIDELINE BASED ON CLEAN AND PROPERLY FINISHED FLOORS. GLIDES THAT ARE NOT RECOMMENDED FOR USE WILL NOT BE COVERED BY GLOBAL'S LIFETIME WARRANTY. SITE CONDITIONS CAN DRAMATICALLY AFFECT HOW APPROPRIATE A GLIDE IS FOR ANY APPLICATION. REGULAR INSPECTION OF GLIDES IS CRITICAL TO PREVENTING FLOOR DAMAGE. SEE DESCRIPTIONS BELOW.

● = BEST FOR APPLICATION

NR = OPTION NOT RECOMMENDED

NO GLIDE (XG): The plain Chrome sled based frame slides easily and silently over carpeted surfaces. Note: do not use in damp areas.
CLEAR POLYCARBONATE GLIDE (CG): The polycarbonate glide is easy to move over most flooring. It does not leave marks and it reduces noise on hard surfaces.
STAINLESS STEEL PAD ON POLYCARBONATE GLIDE (SG): The stainless steel bottomed glide slides easily. It is extremely durable, reduces floor contact and noise on hard surfaces.
FELT PAD ON POLYCARBONATE GLIDE (FG): The felt bottomed glide moves silently and smoothly on hard surface flooring. Helps to prevent floor damage.
RUBBER NO SLIP PAD ON POLYCARBONATE GLIDE (RG): The rubber bottomed glide is slip-resistant. It grips flooring, reduces movement, scratching and eliminates noise.

specialty

Academic Task 399

Industrial Clean Room 410

Academic Arms + Casters 421

Industrial Seating 401

Industrial Anti-Microbial 415

Industrial ESD 406

Industrial Wipe Down 418

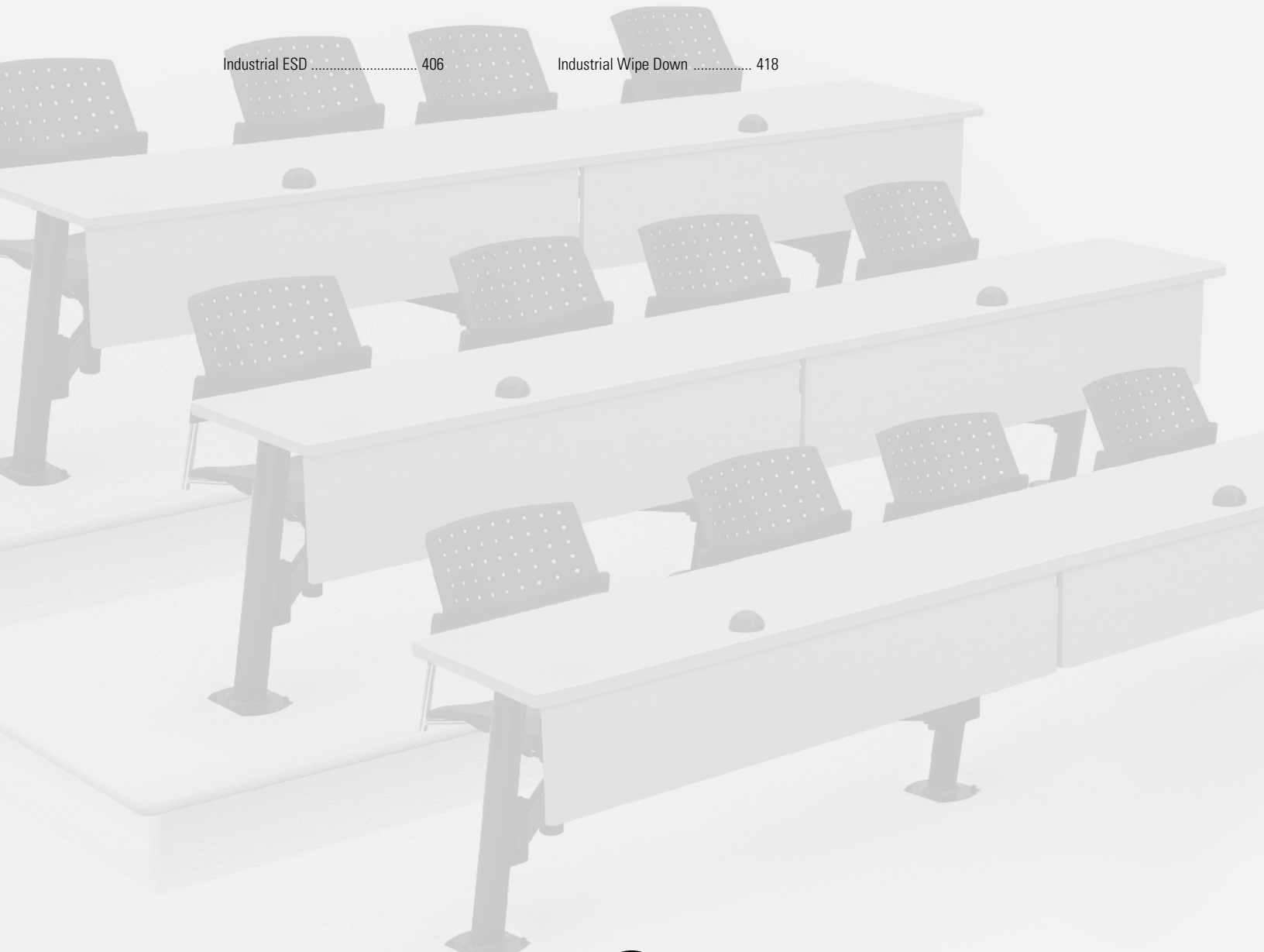

ACADEMIC TASK SEATING







model S2237-6 (3N) Goal

STANDARD FEATURES

- Durable task seating designed to sustain years of use in educational and training room applications.
- The back bar is welded to the chair mechanism and the backrest is permanently fixed in height and angle.
- Standard with adjustable height T-arms with curved urethane armcaps (3N) in Black Only.
- All models are standard with a five-legged, injection molded base.
- Base and frame available in Black (BK) Only.
- C65 casters are standard.
- Vari-Width Adapter Plate (WA) (This is a Standard Feature for Granada models. An Option for Goal models. Add \$80. Available when chair is ordered with adjustable height arms. Allows each arm to move outward an additional 2" (for a total of 4" extra seat width) and locks with the use of an easy to maneuver lever.
- Check textile availability prior to specifying upholstery material.

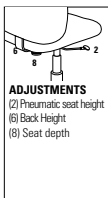
OPTIONAL FEATURES

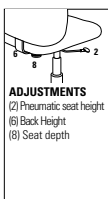
- See next page for additional arm options.
- Please see page 394 for additional caster options. Optional casters may be priced higher than the standard casters for your chair and the difference will be charged. Lower priced optional casters will not be credited.
- Vinyl Bumper Guard: This is a standard feature for Granada, Malaga, & Goal. As an option on ObusForme & Supra X. Add \$22. Available with back edge vinyl bumper guard option (VBG).
- Granada Models Only: Black base with chrome footring. Specify "B3". Add \$113.

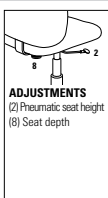
DESCRIPTION	FEATURES	MODEL#	STANDARD TEXTILE GRADES											
			1	2	3	4	5	6	7	8	9	10	11	12
 <p>LB Task w/3N Arms COM Yardage: 1.5 Freight Class: 250 Product Weight (lbs.): 41 Cubic Feet Per Carton: 10.75</p>	 <p>ADJUSTMENTS (2) Pneumatic seat height (6) Back Height (8) Seat depth</p> <p>Goal</p> <p>Ergonomic Features: C, H, N</p>	<p>S2237-6</p>	590	643	682	744	824	855	931	1072	1139	1267	1445	1667
			OVERALL DIMENSIONS			SEAT DIMENSIONS			BACK DIMENSIONS					
			W	D	H	W	D	H	W	H				
	24	23.5	37.5	20.5	17	16-21	18.5	19						
				RTA 2	ups									
 <p>LB Task Armless COM Yardage: 1.50 Freight Class: 250 Product Weight (lbs.): 35 Cubic Feet Per Carton: 9</p>	 <p>ADJUSTMENTS (2) Pneumatic seat height (6) Back Height (8) Seat depth</p> <p>Goal</p> <p>Ergonomic Features: C, H, N</p>	<p>S2239-6</p>	468	521	560	619	705	732	809	950	1015	1146	1323	1547
			OVERALL DIMENSIONS			SEAT DIMENSIONS			BACK DIMENSIONS					
			W	D	H	W	D	H	W	H				
	20	23.5	37.5	20.5	17	16-21	18.5	19						
				RTA 2	ups									
 <p>LB Task Chair Armless/Plain Back COM Yardage: 1.5 Freight Class: 250 Product Weight (lbs.): 34 Cubic Feet Per Carton: 9.75</p>	 <p>ADJUSTMENTS (2) Pneumatic seat height (8) Seat depth</p> <p>Granada</p> <p>Ergonomic Features: C, M, N</p>	<p>S3254</p>	686	744	780	840	923	953	1029	1169	1235	1365	1546	1765
			OVERALL DIMENSIONS			SEAT DIMENSIONS			BACK DIMENSIONS					
			W	D	H	W	D	H	W	H				
	20.5	24.5	38	20.5	18.5	16.5-21.5	19	18.5						
				RTA 2	ups									

EXPLANATION OF VARIOUS INDUSTRIAL APPLICATIONS

This section presents only some of the possibilities that are available. Please contact your Sales Representative for additional information.



50 - INDUSTRIAL

Designed for heavier duty intensive environments such as those found in factories, assembly lines and dispatch offices. Seating features durable components including heavy gauge steel construction, chromed chip/corrosion/humidity resistant pneumatic lift cylinders and frames, heavy duty bases, weight activated interval safety casters for hard floors or encased levelling glides, wear resistant fabric or easy clean vinyl upholstery.



52 - ELECTROSTATIC DISCHARGE (ESD)

ESD seating is designed to assist in the protection of delicate electronic equipment from the discharge of static electricity. All components of these chairs are designed and manufactured using conductive materials including: special fabric, bases, "lightning bolt" casters, mechanisms, pneumatic lifts and footings. ESD seating is designed to be used in conjunction with personal wrist straps and ESD controlled floorings or ESD mats. All ESD seating products are tested to and meet the requirements of the ESD Association Standard Test Method ESD STM 12.1 - 1997 Section 5.3.



56 - CLEAN ROOM (CLASS UL #1000)

Class 1000 is the least intensive Clean Room classification used by hospital equipment suppliers and photo finishing/film companies. Workers here usually wear shop coats and gloves. Vinyl applied to the underside of the seat and vinyl or fabric upholstery are designed to prevent dust and other contaminants from entering the environment.



62 - ANTI-MICROBIAL

For hospital areas and labs that require furniture that minimizes bacterial and fungal growth and wipes up easily. Anti-microbial seating inhibits micro organism invasion and growth. Integrated filters allow fabric/vinyl to breathe. A Class 1000 cleanroom would not contain more than 1000 particles bigger than half a micron in a cubic foot of air.



64 - WIPE DOWN

Furniture designed for dry food manufacturers, hospitals and forensic labs requiring regular and immediate clean up of dust,dirt or powder. Upholstery of any kind is unacceptable here. Features include comfortable Black self-skinned polyurethane seats and backs, chip/corroionn/humidity resistant pneumatic lift cylinders and frames,safety casters or glides. Some "Wipe Down" products may also be available with ESD.

FABRIC APPLICATION GRID

APPLICATION	FABRIC/VINYL
50 - Industrial	Grade 1 (fabric): Terrace, Waterfall Grade 2 (fabric): Imprint Grade 2 (vinyl): Allante FRee, Luxhide, MorCare™ Collection (Abbey, Arc, Aristo, Cinema, Nomad, Verve, Vitality)
52 - Electrostatic Discharge (ESD)	
56 - Clean Room (Class UL #1000)	Grade 2 (vinyl): Allante FRee, Luxhide, MorCare™ Collection (Abbey, Arc, Aristo, Cinema, Nomad, Verve, Vitality)
62 - Anti-Microbial with Global UltraSeal™	Grade 2 (vinyl): MorCare™ Collection (Abbey, Arc, Aristo, Cinema, Nomad, Verve, Vitality)
Wipe Down - 64	No upholstery required, seats are molded self-skinned urethane (SSU) foam.

INDUSTRIAL SEATING



model 3212-50 (3N)

model 3288-50 (3N)



50 - Industrial
Designed for heavy duty environments found in factories, assembly lines and dispatch offices. See page 416 for available fabrics.

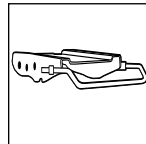

Multi-Depth Mechanism
Standard on Granada models. Allows seat to move forward and backward over a 2" range with 5 locking positions to provide a more shallow or deeper seat.





* Images shown are for illustration purposes only.





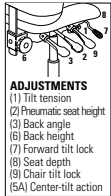

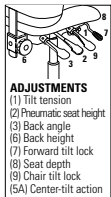

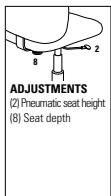
STANDARD FEATURES

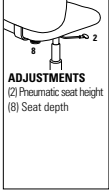

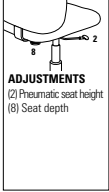

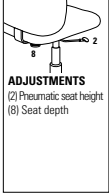
- *Industrial models have a chrome back upright.
- Granada models feature a molded seat and contoured back with enhanced lumbar support.
- Standard with adjustable height T-arms with curved urethane armcaps (3N) in Black Only.
- Chrome chip/corrosion/humidity resistant pneumatic lift cylinders and frames.
- Chairs have a 5" chrome pneumatic cylinder, stools have a 10" chrome pneumatic cylinder.
- All chairs and stools have chrome back uprights.
- Clear protective back bumper (full surround) is standard on all models.
- Standard with a five-legged, heavy duty molded base in Black.
- **C10R** casters are standard on Granada models and Minotaur stools.
- Minotaur models are standard with a five-legged, heavy duty base with metal hub and **C7R** casters.
- Heavy Duty Bench Stools are standard with non-slip rubber glides.
- Check textile availability prior to specifying upholstery material.

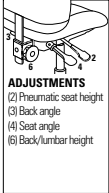

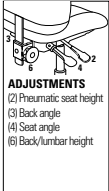
OPTIONAL FEATURES

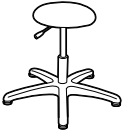
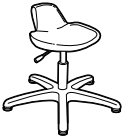
- See back of this section for additional arm or caster options.
- Optional casters may be priced higher than the standard casters for your chair and the difference will be charged. Lower priced optional casters will not be credited.

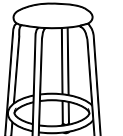
DESCRIPTION	FEATURES	MODEL#	STANDARD TEXTILE GRADES												
			1	2	3	4	5	6	7	8	9	10	11	12	
 <p>LB Multi-Tilter COM Yardage: 1.5 Freight Class: 150 Product Weight (lbs.): 52 Cubic Feet Per Carton: 13</p>	 <p>ADJUSTMENTS (1) Tilt tension (2) Pneumatic seat height (3) Back angle (6) Back height (7) Forward tilt lock (8) Seat depth (9) Chair tilt lock (5A) Center-tilt action</p>	<p>3212-50</p>	-	1675	1716	1774	1862	-	-	-	-	-	-		
			OVERALL DIMENSIONS			SEAT DIMENSIONS			BACK DIMENSIONS						
			W	D	H	W	D	H	W	H					
	25.5	24	40	20.5	17-19.5	18-23	19	17.5-21.5							
				RTA 2											
 <p>HB Multi-Tilter COM Yardage: 1.75 Freight Class: 250 Product Weight (lbs.): 55 Cubic Feet Per Carton: 15.5</p>	 <p>ADJUSTMENTS (1) Tilt tension (2) Pneumatic seat height (3) Back angle (6) Back height (7) Forward tilt lock (8) Seat depth (9) Chair tilt lock (5A) Center-tilt action</p>	<p>3217-50</p>	-	1728	1786	1864	1975	-	-	-	-	-	-		
			OVERALL DIMENSIONS			SEAT DIMENSIONS			BACK DIMENSIONS						
			W	D	H	W	D	H	W	H					
	25.5	24.5	43	20.5	17-19.5	18-23	19	21.5-25.5							
				RTA 2											
 <p>LB Task - Armless COM Yardage: 1.5 Freight Class: 250 Product Weight (lbs.): 32 Cubic Feet Per Carton: 13</p>	 <p>ADJUSTMENTS (2) Pneumatic seat height (8) Seat depth</p>	<p>3254-50</p>	-	1163	1205	1264	1352	-	-	-	-	-	-		
			OVERALL DIMENSIONS			SEAT DIMENSIONS			BACK DIMENSIONS						
			W	D	H	W	D	H	W	H					
	20.5	24	38	20.5	17-19.5	17-22	19	19							
				RTA 2											

DESCRIPTION	FEATURES	MODEL#	STANDARD TEXTILE GRADES																														
			1	2	3	4	5	6	7	8	9	10	11	12																			
 <p>LB Task - w/3N Arms COM Yardage: 1.5 Freight Class: 250 Product Weight (lbs.): 40 Cubic Feet Per Carton: 13</p>	 <p>ADJUSTMENTS (2) Pneumatic seat height (8) Seat depth</p>	<p>Granada</p> <p>Ergonomic Features: C, E, M, N</p>	<table border="1"> <tr> <td>3255-50</td> <td>-</td> <td>1332</td> <td>1373</td> <td>1433</td> <td>1519</td> <td>-</td> <td>-</td> <td>-</td> <td>-</td> <td>-</td> <td>-</td> <td>-</td> <td>-</td> </tr> </table>												3255-50	-	1332	1373	1433	1519	-	-	-	-	-	-	-	-					
			3255-50	-	1332	1373	1433	1519	-	-	-	-	-	-	-	-																	
			<table border="1"> <tr> <th colspan="3">OVERALL DIMENSIONS</th> <th colspan="3">SEAT DIMENSIONS</th> <th colspan="3">BACK DIMENSIONS</th> </tr> <tr> <th>W</th> <th>D</th> <th>H</th> <th>W</th> <th>D</th> <th>H</th> <th>W</th> <th>H</th> </tr> <tr> <td>25.5</td> <td>24</td> <td>38</td> <td>20.5</td> <td>17-19.5</td> <td>17-22</td> <td>19</td> <td>19</td> </tr> </table>			OVERALL DIMENSIONS			SEAT DIMENSIONS			BACK DIMENSIONS			W	D	H	W	D	H	W	H	25.5	24	38	20.5	17-19.5	17-22	19	19	<p>RTA 2</p>		
			OVERALL DIMENSIONS			SEAT DIMENSIONS			BACK DIMENSIONS																								
W	D	H	W	D	H	W	H																										
25.5	24	38	20.5	17-19.5	17-22	19	19																										
 <p>Stool Task - Armless COM Yardage: 1.5 Freight Class: 250 Product Weight (lbs.): 37 Cubic Feet Per Carton: 13</p>	 <p>ADJUSTMENTS (2) Pneumatic seat height (8) Seat depth</p>	<p>Granada</p> <p>Ergonomic Features: C, E, M, N</p>	<table border="1"> <tr> <td>3256-50</td> <td>-</td> <td>1339</td> <td>1382</td> <td>1439</td> <td>1526</td> <td>-</td> <td>-</td> <td>-</td> <td>-</td> <td>-</td> <td>-</td> <td>-</td> <td>-</td> </tr> </table>												3256-50	-	1339	1382	1439	1526	-	-	-	-	-	-	-	-					
			3256-50	-	1339	1382	1439	1526	-	-	-	-	-	-	-	-																	
			<table border="1"> <tr> <th colspan="3">OVERALL DIMENSIONS</th> <th colspan="3">SEAT DIMENSIONS</th> <th colspan="3">BACK DIMENSIONS</th> </tr> <tr> <th>W</th> <th>D</th> <th>H</th> <th>W</th> <th>D</th> <th>H</th> <th>W</th> <th>H</th> </tr> <tr> <td>20.5</td> <td>24</td> <td>48</td> <td>20.5</td> <td>17.5-19</td> <td>24-34</td> <td>19</td> <td>19</td> </tr> </table>			OVERALL DIMENSIONS			SEAT DIMENSIONS			BACK DIMENSIONS			W	D	H	W	D	H	W	H	20.5	24	48	20.5	17.5-19	24-34	19	19	<p>RTA 2</p>		
			OVERALL DIMENSIONS			SEAT DIMENSIONS			BACK DIMENSIONS																								
W	D	H	W	D	H	W	H																										
20.5	24	48	20.5	17.5-19	24-34	19	19																										
 <p>Stool Task - w/3N Arms COM Yardage: 1.5 Freight Class: 250 Product Weight (lbs.): 43 Cubic Feet Per Carton: 15.75</p>	 <p>ADJUSTMENTS (2) Pneumatic seat height (8) Seat depth</p>	<p>Granada</p> <p>Ergonomic Features: C, E, H, M, N, Q</p>	<table border="1"> <tr> <td>3257-50</td> <td>-</td> <td>1506</td> <td>1548</td> <td>1610</td> <td>1692</td> <td>-</td> <td>-</td> <td>-</td> <td>-</td> <td>-</td> <td>-</td> <td>-</td> <td>-</td> </tr> </table>												3257-50	-	1506	1548	1610	1692	-	-	-	-	-	-	-	-					
			3257-50	-	1506	1548	1610	1692	-	-	-	-	-	-	-	-																	
			<table border="1"> <tr> <th colspan="3">OVERALL DIMENSIONS</th> <th colspan="3">SEAT DIMENSIONS</th> <th colspan="3">BACK DIMENSIONS</th> </tr> <tr> <th>W</th> <th>D</th> <th>H</th> <th>W</th> <th>D</th> <th>H</th> <th>W</th> <th>H</th> </tr> <tr> <td>25.5</td> <td>24</td> <td>48</td> <td>20.5</td> <td>17.5-19</td> <td>24-34</td> <td>19</td> <td>19</td> </tr> </table>			OVERALL DIMENSIONS			SEAT DIMENSIONS			BACK DIMENSIONS			W	D	H	W	D	H	W	H	25.5	24	48	20.5	17.5-19	24-34	19	19	<p>RTA 2</p>		
			OVERALL DIMENSIONS			SEAT DIMENSIONS			BACK DIMENSIONS																								
W	D	H	W	D	H	W	H																										
25.5	24	48	20.5	17.5-19	24-34	19	19																										
 <p>Stool Operator - Armless COM Yardage: 1.5 Freight Class: 250 Product Weight (lbs.): 44 Cubic Feet Per Carton: 13</p>	 <p>ADJUSTMENTS (2) Pneumatic seat height (3) Back angle (4) Seat angle (6) Back/lumbar height</p>	<p>Granada</p> <p>Ergonomic Features: C, D, F, G, M, N</p>	<table border="1"> <tr> <td>3278-50</td> <td>-</td> <td>1607</td> <td>1647</td> <td>1705</td> <td>1794</td> <td>-</td> <td>-</td> <td>-</td> <td>-</td> <td>-</td> <td>-</td> <td>-</td> <td>-</td> </tr> </table>												3278-50	-	1607	1647	1705	1794	-	-	-	-	-	-	-	-					
			3278-50	-	1607	1647	1705	1794	-	-	-	-	-	-	-	-																	
			<table border="1"> <tr> <th colspan="3">OVERALL DIMENSIONS</th> <th colspan="3">SEAT DIMENSIONS</th> <th colspan="3">BACK DIMENSIONS</th> </tr> <tr> <th>W</th> <th>D</th> <th>H</th> <th>W</th> <th>D</th> <th>H</th> <th>W</th> <th>H</th> </tr> <tr> <td>20.5</td> <td>23.5</td> <td>48</td> <td>20.5</td> <td>17.5</td> <td>24-34</td> <td>19</td> <td>17.5-21</td> </tr> </table>			OVERALL DIMENSIONS			SEAT DIMENSIONS			BACK DIMENSIONS			W	D	H	W	D	H	W	H	20.5	23.5	48	20.5	17.5	24-34	19	17.5-21	<p>RTA 2</p>		
			OVERALL DIMENSIONS			SEAT DIMENSIONS			BACK DIMENSIONS																								
W	D	H	W	D	H	W	H																										
20.5	23.5	48	20.5	17.5	24-34	19	17.5-21																										
 <p>Stool Operator - w/3N Arms COM Yardage: 1.5 Freight Class: 250 Product Weight (lbs.): 52 Cubic Feet Per Carton: 15.75</p>	 <p>ADJUSTMENTS (2) Pneumatic seat height (3) Back angle (4) Seat angle (6) Back/lumbar height</p>	<p>Granada</p> <p>Ergonomic Features: C, D, F, G, H, M, N, Q</p>	<table border="1"> <tr> <td>3288-50</td> <td>-</td> <td>1772</td> <td>1814</td> <td>1872</td> <td>1959</td> <td>-</td> <td>-</td> <td>-</td> <td>-</td> <td>-</td> <td>-</td> <td>-</td> <td>-</td> </tr> </table>												3288-50	-	1772	1814	1872	1959	-	-	-	-	-	-	-	-					
			3288-50	-	1772	1814	1872	1959	-	-	-	-	-	-	-	-																	
			<table border="1"> <tr> <th colspan="3">OVERALL DIMENSIONS</th> <th colspan="3">SEAT DIMENSIONS</th> <th colspan="3">BACK DIMENSIONS</th> </tr> <tr> <th>W</th> <th>D</th> <th>H</th> <th>W</th> <th>D</th> <th>H</th> <th>W</th> <th>H</th> </tr> <tr> <td>25.5</td> <td>23.5</td> <td>48</td> <td>20.5</td> <td>17.5</td> <td>24-34</td> <td>19</td> <td>17.5-21</td> </tr> </table>			OVERALL DIMENSIONS			SEAT DIMENSIONS			BACK DIMENSIONS			W	D	H	W	D	H	W	H	25.5	23.5	48	20.5	17.5	24-34	19	17.5-21	<p>RTA 2</p>		
			OVERALL DIMENSIONS			SEAT DIMENSIONS			BACK DIMENSIONS																								
W	D	H	W	D	H	W	H																										
25.5	23.5	48	20.5	17.5	24-34	19	17.5-21																										

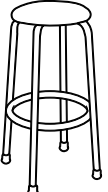
DESCRIPTION	FEATURES	MODEL#	STANDARD TEXTILE GRADES											
			1	2	3	4	5	6	7	8	9	10	11	12
 <p>Minotaur - Work Stool COM Yardage: 0.75 Freight Class: 300 Product Weight (lbs.): 14 Cubic Feet Per Carton: 9.75</p>	5" Pneumatic Ergonomic Features: C	9602-50	-	614	636	664	705	-	-	-	-	-	-	
		OVERALL DIMENSIONS W D H			SEAT DIMENSIONS W D H			BACK DIMENSIONS W H						
		14	14	17.5	14	-	15-20	-	-					
		RTA 00												
 <p>Minotaur - Work Stool COM Yardage: 0.75 Freight Class: 300 Product Weight (lbs.): 16 Cubic Feet Per Carton: 13</p>	10" Pneumatic Ergonomic Features: C	9604-50	-	700	722	750	791	-	-	-	-	-	-	
		OVERALL DIMENSIONS W D H			SEAT DIMENSIONS W D H			BACK DIMENSIONS W H						
		14	14	26.5	14	-	21.5-31.5	-	-					
		RTA 00												
 <p>Minotaur - Work Stool COM Yardage: N/A Freight Class: 300 Product Weight (lbs.): 16 Cubic Feet Per Carton: 13</p>	5" Pneumatic Ergonomic Features: C	9611-50	878	-	-	-	-	-	-	-	-	-	-	
		OVERALL DIMENSIONS W D H			SEAT DIMENSIONS W D H			BACK DIMENSIONS W H						
		14	14	24.5	14	-	15-20	-	-					
		RTA 00												
 <p>Minotaur - Work Stool COM Yardage: N/A Freight Class: 300 Product Weight (lbs.): 18 Cubic Feet Per Carton: 13</p>	10" Pneumatic Ergonomic Features: C	9612-50	940	-	-	-	-	-	-	-	-	-	-	
		OVERALL DIMENSIONS W D H			SEAT DIMENSIONS W D H			BACK DIMENSIONS W H						
		14	14	31	14	-	21.5-31.5	-	-					
		RTA 00												
 <p>Minotaur - Heavy Duty Work Stool COM Yardage: N/A Freight Class: 300 Product Weight (lbs.): 18 Cubic Feet Per Carton: 13</p>		9624-50	-	482	504	533	573	-	-	-	-	-	-	
		OVERALL DIMENSIONS W D H			SEAT DIMENSIONS W D H			BACK DIMENSIONS W H						
		14	14	27.5	14	-	27.5	-	-					
		RTA 00												

DESCRIPTION	FEATURES	MODEL#	STANDARD TEXTILE GRADES											
			1	2	3	4	5	6	7	8	9	10	11	12
 <p>Minotaur - Heavy Duty Work Stool COM Yardage: 0.75 Freight Class: 250 Product Weight (lbs.): 19 Cubic Feet Per Carton: 5.5</p>		9632-50	-	520	543	571	612	-	-	-	-	-	-	-
			OVERALL DIMENSIONS			SEAT DIMENSIONS			BACK DIMENSIONS					
			W	D	H	W	D	H	W	H				
		16	16	32.5	14	-	32.5	-	-					
		RTA 00												

DESCRIPTION	FEATURES	MODEL#	STANDARD TEXTILE GRADES											
			1	2	3	4	5	6	7	8	9	10	11	12
 <p>Minotaur - Work Stool Task COM Yardage: N/A Freight Class: 250 Product Weight (lbs.): 26 Cubic Feet Per Carton: 13</p>		9662-50	1004	-	-	-	-	-	-	-	-	-	-	-
			OVERALL DIMENSIONS			SEAT DIMENSIONS			BACK DIMENSIONS					
			W	D	H	W	D	H	W	H				
	5" Pneumatic	18	21	32	18	16.5-19	14-19	16.5	16					
	Ergonomic Features: C, E	RTA 2												

DESCRIPTION	FEATURES	MODEL#	STANDARD TEXTILE GRADES											
			1	2	3	4	5	6	7	8	9	10	11	12
 <p>Minotaur - Work Stool Task COM Yardage: N/A Freight Class: 250 Product Weight (lbs.): 33 Cubic Feet Per Carton: 13</p>		9663-50	1195	-	-	-	-	-	-	-	-	-	-	-
			OVERALL DIMENSIONS			SEAT DIMENSIONS			BACK DIMENSIONS					
			W	D	H	W	D	H	W	H				
	10" Pneumatic	18	20.5	42	18	16.5-19	20-30	16.5	16.5					
	Ergonomic Features: C, E	RTA 2												

DESCRIPTION	FEATURES	MODEL#	STANDARD TEXTILE GRADES											
			1	2	3	4	5	6	7	8	9	10	11	12
 <p>Minotaur - Stool Posture Task COM Yardage: N/A Freight Class: 250 Product Weight (lbs.): 30 Cubic Feet Per Carton: 13</p>		9664-50	1132	-	-	-	-	-	-	-	-	-	-	-
			OVERALL DIMENSIONS			SEAT DIMENSIONS			BACK DIMENSIONS					
			W	D	H	W	D	H	W	H				
	5" Pneumatic	18	20	32	18	16	14-19	16.5	12.5-19					
	Ergonomic Features: C, D	RTA 2												

DESCRIPTION	FEATURES	MODEL#	STANDARD TEXTILE GRADES											
			1	2	3	4	5	6	7	8	9	10	11	12
 <p>Minotaur - Stool Posture Task COM Yardage: N/A Freight Class: 250 Product Weight (lbs.): 33 Cubic Feet Per Carton: 13</p>		9665-50	1321	-	-	-	-	-	-	-	-	-	-	-
			OVERALL DIMENSIONS			SEAT DIMENSIONS			BACK DIMENSIONS					
			W	D	H	W	D	H	W	H				
	10" Pneumatic	18	20	42	39	16	20.5-30.5	16.5	12.5-19					
	Ergonomic Features: C, D	RTA 2												

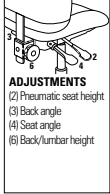
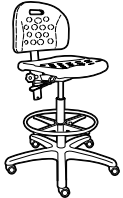
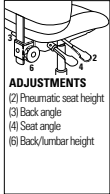
DESCRIPTION	FEATURES	MODEL#	STANDARD TEXTILE GRADES													
			1	2	3	4	5	6	7	8	9	10	11	12		
 <p>Minotaur - Stool Operator COM Yardage: N/A Freight Class: 250 Product Weight (lbs.): 34 Cubic Feet Per Carton: 13</p>	 <p>ADJUSTMENTS (2) Pneumatic seat height (3) Back angle (4) Seat angle (6) Back/lumbar height</p>	9666-50	1306	-	-	-	-	-	-	-	-	-	-	-		
			OVERALL DIMENSIONS			SEAT DIMENSIONS			BACK DIMENSIONS							
			W	D	H	W	D	H	W	H						
			18	20.5	32	18	17	15-20	16.5	12.5-19						
			RTA 2													
 <p>Minotaur - Stool Operator COM Yardage: N/A Freight Class: 250 Product Weight (lbs.): 35 Cubic Feet Per Carton: 13</p>	 <p>ADJUSTMENTS (2) Pneumatic seat height (3) Back angle (4) Seat angle (6) Back/lumbar height</p>	9667-50	1498	-	-	-	-	-	-	-	-	-	-	-		
			OVERALL DIMENSIONS			SEAT DIMENSIONS			BACK DIMENSIONS							
			W	D	H	W	D	H	W	H						
			18	20.5	42	18	17	21-31	16.5	12.5-19						
			RTA 2													

ESD SEATING



model 3256-52

model 9667-52 (C42)



52 - Electrostatic Discharge (ESD)
Designed to direct static electricity away from delicate equipment, electronic components or volatile chemicals.

* Images shown are for illustration purposes only.





STANDARD FEATURES





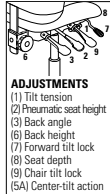

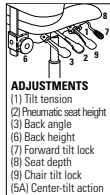

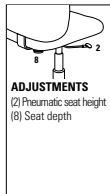
- *ESD models have a polished aluminum base.
- Use of an ESD chair does not guarantee the dissipation of static electricity. Other products (that may include an ESD chair mat, etc.) as part of an ESD design or system may be necessary depending on the specific situation.
- Granada models feature a molded seat and contoured back with enhanced lumbar support.
- Granada models are standard with fixed height T-arms with upholstered kidney shaped armcaps **(Z2)**, in Chrome.
- No other conductive arms are available.
- Chrome chip/corrosion/humidity resistant pneumatic lift cylinders and frames.
- Chairs have a 5" chrome pneumatic cylinder, stools have a 10" chrome pneumatic cylinder.
- All chairs and stools have chrome back uprights and frames.
- Clear protective back bumper (full surround) is standard on all models.
- Check textile availability prior to specifying upholstery material.

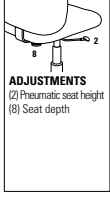

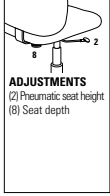

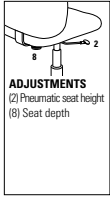
- Standard with a five-legged, polished aluminum base.
- **C38R** casters are standard. These casters are suitable for hard surface flooring. Not Available on models 9601-52 and 9604-52.
- For models 9601-52 and 9604-52 a polished aluminum base with **C42 ESD** Glides are standard.
- All Work Stools and Heavy Duty Bench Stools have chrome frames.
- Work stools are shipped fully set-up.

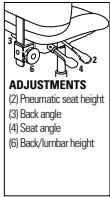

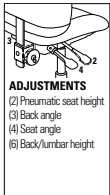

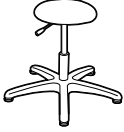
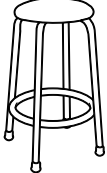

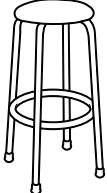
OPTIONAL FEATURES

- See back of this section for additional arm or caster options.
- Optional casters may be priced higher than the standard casters for your chair and the difference will be charged. Lower priced optional casters will not be credited.

DESCRIPTION	FEATURES	MODEL#	STANDARD TEXTILE GRADES																									
			1	2	3	4	5	6	7	8	9	10	11	12														
 <p>LB Multi-Tilter COM Yardage: 1.5 Freight Class: 250 Product Weight (lbs.): 250 Cubic Feet Per Carton: 13</p>	 <p>ADJUSTMENTS (1) Tilt tension (2) Pneumatic seat height (3) Back angle (6) Back height (7) Forward tilt lock (8) Seat depth (9) Chair tilt lock (5A) Center-tilt action</p>	<p>Granada</p> <p>Ergonomic Features: A, B, C, D, E, F, G, H, M, N, Q, S</p>	<table border="1"> <tr> <td>3212-52</td> <td>-</td> <td>-</td> <td>1929</td> <td>-</td> <td>2074</td> <td>-</td> <td>-</td> <td>-</td> <td>-</td> <td>-</td> <td>-</td> <td>-</td> <td>-</td> </tr> </table>												3212-52	-	-	1929	-	2074	-	-	-	-	-	-	-	-
			3212-52	-	-	1929	-	2074	-	-	-	-	-	-	-	-												
			<p>OVERALL DIMENSIONS</p> <table border="1"> <tr> <th>W</th> <th>D</th> <th>H</th> </tr> <tr> <td>26.5</td> <td>24</td> <td>40</td> </tr> </table>			W	D	H	26.5	24	40	<p>SEAT DIMENSIONS</p> <table border="1"> <tr> <th>W</th> <th>D</th> <th>H</th> </tr> <tr> <td>20.5</td> <td>17-19.5</td> <td>18-23</td> </tr> </table>			W	D	H	20.5	17-19.5	18-23	<p>BACK DIMENSIONS</p> <table border="1"> <tr> <th>W</th> <th>H</th> </tr> <tr> <td>19</td> <td>17.5-21.5</td> </tr> </table>						W	H
W	D	H																										
26.5	24	40																										
W	D	H																										
20.5	17-19.5	18-23																										
W	H																											
19	17.5-21.5																											
<p>RTA 2</p>																												
 <p>HB Multi-Tilter COM Yardage: 1.75 Freight Class: 150 Product Weight (lbs.): 57 Cubic Feet Per Carton: 13</p>	 <p>ADJUSTMENTS (1) Tilt tension (2) Pneumatic seat height (3) Back angle (6) Back height (7) Forward tilt lock (8) Seat depth (9) Chair tilt lock (5A) Center-tilt action</p>	<p>Granada</p> <p>Ergonomic Features: A, B, C, D, E, F, G, H, M, N, Q, S</p>	<table border="1"> <tr> <td>3217-52</td> <td>-</td> <td>-</td> <td>1984</td> <td>-</td> <td>2177</td> <td>-</td> <td>-</td> <td>-</td> <td>-</td> <td>-</td> <td>-</td> <td>-</td> <td>-</td> </tr> </table>												3217-52	-	-	1984	-	2177	-	-	-	-	-	-	-	-
			3217-52	-	-	1984	-	2177	-	-	-	-	-	-	-	-												
			<p>OVERALL DIMENSIONS</p> <table border="1"> <tr> <th>W</th> <th>D</th> <th>H</th> </tr> <tr> <td>26.5</td> <td>24.5</td> <td>43</td> </tr> </table>			W	D	H	26.5	24.5	43	<p>SEAT DIMENSIONS</p> <table border="1"> <tr> <th>W</th> <th>D</th> <th>H</th> </tr> <tr> <td>20.5</td> <td>17-19.5</td> <td>18-23</td> </tr> </table>			W	D	H	20.5	17-19.5	18-23	<p>BACK DIMENSIONS</p> <table border="1"> <tr> <th>W</th> <th>H</th> </tr> <tr> <td>19</td> <td>21.5-25.5</td> </tr> </table>						W	H
W	D	H																										
26.5	24.5	43																										
W	D	H																										
20.5	17-19.5	18-23																										
W	H																											
19	21.5-25.5																											
<p>RTA 2</p>																												
 <p>LB Task - Armless COM Yardage: 1.5 Freight Class: 250 Product Weight (lbs.): 34 Cubic Feet Per Carton: 13</p>	 <p>ADJUSTMENTS (2) Pneumatic seat height (8) Seat depth</p>	<p>Granada</p> <p>Ergonomic Features: C, E, M, N</p>	<table border="1"> <tr> <td>3254-52</td> <td>-</td> <td>-</td> <td>1416</td> <td>-</td> <td>1564</td> <td>-</td> <td>-</td> <td>-</td> <td>-</td> <td>-</td> <td>-</td> <td>-</td> <td>-</td> </tr> </table>												3254-52	-	-	1416	-	1564	-	-	-	-	-	-	-	-
			3254-52	-	-	1416	-	1564	-	-	-	-	-	-	-	-												
			<p>OVERALL DIMENSIONS</p> <table border="1"> <tr> <th>W</th> <th>D</th> <th>H</th> </tr> <tr> <td>20.5</td> <td>24</td> <td>38</td> </tr> </table>			W	D	H	20.5	24	38	<p>SEAT DIMENSIONS</p> <table border="1"> <tr> <th>W</th> <th>D</th> <th>H</th> </tr> <tr> <td>20.5</td> <td>17.5-19</td> <td>17-22</td> </tr> </table>			W	D	H	20.5	17.5-19	17-22	<p>BACK DIMENSIONS</p> <table border="1"> <tr> <th>W</th> <th>H</th> </tr> <tr> <td>19</td> <td>19</td> </tr> </table>						W	H
W	D	H																										
20.5	24	38																										
W	D	H																										
20.5	17.5-19	17-22																										
W	H																											
19	19																											
<p>RTA 2</p>																												

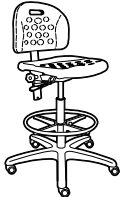
DESCRIPTION	FEATURES	MODEL#	STANDARD TEXTILE GRADES											
			1	2	3	4	5	6	7	8	9	10	11	12
 <p>LB Task - w/ZZ Arms COM Yardage: 1.5 Freight Class: 250 Product Weight (lbs.): 42 Cubic Feet Per Carton: 13</p>	 <p>ADJUSTMENTS (2) Pneumatic seat height (8) Seat depth</p>	<p>3255-52</p>	-	-	\$1584	-	\$1734	-	-	-	-	-	-	
			OVERALL DIMENSIONS			SEAT DIMENSIONS			BACK DIMENSIONS					
			W	D	H	W	D	H	W	H				
			26.5	24	38	20.5	17.5-19	17-22	19	19				
<p>Granada</p> <p>Ergonomic Features: C, E, M, N</p>			RTA 2											
 <p>Stool Task - Armless COM Yardage: 1.5 Freight Class: 250 Product Weight (lbs.): 39 Cubic Feet Per Carton: 13</p>	 <p>ADJUSTMENTS (2) Pneumatic seat height (8) Seat depth</p>	<p>3256-52</p>	-	-	\$1592	-	\$1739	-	-	-	-	-	-	
			OVERALL DIMENSIONS			SEAT DIMENSIONS			BACK DIMENSIONS					
			W	D	H	W	D	H	W	H				
			20.5	24	48	20.5	17.5-19	24-34	19	19				
<p>Granada</p> <p>Ergonomic Features: C, E, M, N</p>			RTA 2											
 <p>Stool Task COM Yardage: 1.50 Freight Class: 250 Product Weight (lbs.): 45 Cubic Feet Per Carton: 15.50</p>	 <p>ADJUSTMENTS (2) Pneumatic seat height (8) Seat depth</p>	<p>3257-52</p>	-	-	\$1836	-	\$1983	-	-	-	-	-	-	
			OVERALL DIMENSIONS			SEAT DIMENSIONS			BACK DIMENSIONS					
			W	D	H	W	D	H	W	H				
			25.5	24	48	20.5	17.5-19	24-34	19	19				
<p>Granada</p> <p>Ergonomic Features: C, E, H, M, N, Q</p>			RTA 2											
 <p>Stool Operator - Armless COM Yardage: 1.5 Freight Class: 250 Product Weight (lbs.): 46 Cubic Feet Per Carton: 13</p>	 <p>ADJUSTMENTS (2) Pneumatic seat height (3) Back angle (4) Seat angle (6) Back/lumbar height</p>	<p>3278-52</p>	-	-	\$1860	-	\$2006	-	-	-	-	-	-	
			OVERALL DIMENSIONS			SEAT DIMENSIONS			BACK DIMENSIONS					
			W	D	H	W	D	H	W	H				
			20.5	23.5	48	20.5	17.5	24-34	19	17.5-21.5				
<p>Granada</p> <p>Ergonomic Features: C, D, F, G, M, N</p>			RTA 2											
 <p>Stool Operator COM Yardage: 1.5 Freight Class: 250 Product Weight (lbs.): 54 Cubic Feet Per Carton: 15.75</p>	 <p>ADJUSTMENTS (2) Pneumatic seat height (3) Back angle (4) Seat angle (6) Back/lumbar height</p>	<p>3288-52</p>	-	-	\$2025	-	\$2170	-	-	-	-	-	-	
			OVERALL DIMENSIONS			SEAT DIMENSIONS			BACK DIMENSIONS					
			W	D	H	W	D	H	W	H				
			26.5	23.5	48	20.5	17.5	24-34	19	17.5-21.5				
<p>Granada</p> <p>Ergonomic Features: C, D, F, G, H, M, N, Q</p>			RTA 2											

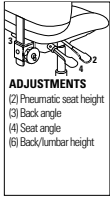
DESCRIPTION	FEATURES	MODEL#	STANDARD TEXTILE GRADES											
			1	2	3	4	5	6	7	8	9	10	11	12
 Minotaur - Work Stool COM Yardage: 0.75 Freight Class: 250 Product Weight (lbs.): 14 Cubic Feet Per Carton: 6.75	5" Pneumatic Ergonomic Features: C	9602-52	\$815	-	-	-	-	-	-	-	-	-	-	-
		OVERALL DIMENSIONS			SEAT DIMENSIONS			BACK DIMENSIONS						
		W	D	H	W	D	H	W	H					
		14	14	17.5	14	-	15-20	-	-					
						RTA 00								
 Minotaur - Work Stool COM Yardage: 0.75 Freight Class: 300 Product Weight (lbs.): 16 Cubic Feet Per Carton: 13	10" Pneumatic Ergonomic Features: C	9604-52	\$878	-	-	-	-	-	-	-	-	-	-	
		OVERALL DIMENSIONS			SEAT DIMENSIONS			BACK DIMENSIONS						
		W	D	H	W	D	H	W	H					
		14	14	26.5	14	-	21.5-31.5	-	-					
						RTA 00								
 Minotaur - Heavy Duty Work Stool COM Yardage: 0.75 Freight Class: 250 Product Weight (lbs.): 17 Cubic Feet Per Carton: 5.5	Ergonomic Features: C	9624-52	\$709	-	-	-	-	-	-	-	-	-	-	
		OVERALL DIMENSIONS			SEAT DIMENSIONS			BACK DIMENSIONS						
		W	D	H	W	D	H	W	H					
		16	16	27.5	14	-	27.5	-	-					
						RTA 00								
 Minotaur - Heavy Duty Work Stool COM Yardage: 0.75 Freight Class: 250 Product Weight (lbs.): 19 Cubic Feet Per Carton: 5.5	Ergonomic Features: C	9632-52		-	\$731	-	-\$803	-	-	-	-	-	-	
		OVERALL DIMENSIONS			SEAT DIMENSIONS			BACK DIMENSIONS						
		W	D	H	W	D	H	W	H					
		16	16	32.5	14	-	32.5	-	-					
						RTA 00								
 Minotaur - Work Stool Task COM Yardage: N/A Freight Class: 250 Product Weight (lbs.): 26 Cubic Feet Per Carton: 13	5" Pneumatic Ergonomic Features: C, E	9662-52	\$1230	-	-	-	-	-	-	-	-	-	-	
		OVERALL DIMENSIONS			SEAT DIMENSIONS			BACK DIMENSIONS						
		W	D	H	W	D	H	W	H					
		18	21	32	18	16.5-19	14-19	16.5	16					
						RTA 2								

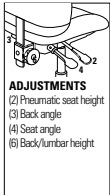
DESCRIPTION	FEATURES	MODEL#	STANDARD TEXTILE GRADES											
			1	2	3	4	5	6	7	8	9	10	11	12
 <p>Minotaur - Work Stool Task COM Yardage: N/A Freight Class: 250 Product Weight (lbs.): 33 Cubic Feet Per Carton: 13</p>	<p>10" Pneumatic</p> <p>Ergonomic Features: C, E</p>	<p>9663-52</p>	\$1423	-	-	-	-	-	-	-	-	-	-	-
			<p>OVERALL DIMENSIONS</p> <p>W D H</p>			<p>SEAT DIMENSIONS</p> <p>W D H</p>			<p>BACK DIMENSIONS</p> <p>W H</p>					
			18	20.5	42	18	16.5-19	20-30	16.5	16.5				
			RTA 2											
 <p>Minotaur - Stool Posture Task COM Yardage: N/A Freight Class: 250 Product Weight (lbs.): 30 Cubic Feet Per Carton: 13</p>	<p>5" Pneumatic</p> <p>Ergonomic Features: C, D</p>	<p>9664-52</p>	\$1358	-	-	-	-	-	-	-	-	-	-	
			<p>OVERALL DIMENSIONS</p> <p>W D H</p>			<p>SEAT DIMENSIONS</p> <p>W D H</p>			<p>BACK DIMENSIONS</p> <p>W H</p>					
			18	20	32	18	16	14-19	16.5	12.5-19				
			RTA 2											
 <p>Minotaur - Stool Posture Task COM Yardage: N/A Freight Class: 250 Product Weight (lbs.): 33 Cubic Feet Per Carton: 13</p>	<p>10" Pneumatic</p> <p>Ergonomic Features: C, D</p>	<p>9665-52</p>	\$1548	-	-	-	-	-	-	-	-	-	-	
			<p>OVERALL DIMENSIONS</p> <p>W D H</p>			<p>SEAT DIMENSIONS</p> <p>W D H</p>			<p>BACK DIMENSIONS</p> <p>W H</p>					
			18	20	42	39	16	20.5-30.5	16.5	12.5-19				
			RTA 2											
 <p>Minotaur - Stool Operator COM Yardage: N/A Freight Class: 250 Product Weight (lbs.): 34 Cubic Feet Per Carton: 13</p>	 <p>ADJUSTMENTS (2) Pneumatic seat height (3) Back angle (4) Seat angle (6) Back/lumbar height</p>	<p>9666-52</p>	\$1537	-	-	-	-	-	-	-	-	-	-	
			<p>OVERALL DIMENSIONS</p> <p>W D H</p>			<p>SEAT DIMENSIONS</p> <p>W D H</p>			<p>BACK DIMENSIONS</p> <p>W H</p>					
			18	20.5	32	18	17	15-20	16.5	12.5-19				
			RTA 2											
 <p>Minotaur - Stool Operator COM Yardage: N/A Freight Class: 250 Product Weight (lbs.): 35 Cubic Feet Per Carton: 13</p>	 <p>ADJUSTMENTS (2) Pneumatic seat height (3) Back angle (4) Seat angle (6) Back/lumbar height</p>	<p>9667-52</p>	\$1727	-	-	-	-	-	-	-	-	-	-	
			<p>OVERALL DIMENSIONS</p> <p>W D H</p>			<p>SEAT DIMENSIONS</p> <p>W D H</p>			<p>BACK DIMENSIONS</p> <p>W H</p>					
			18	20.5	42	18	17	21-31	16.5	12.5-19				
			RTA 2											

CLEAN ROOM CLASS #1000 - SEATING



model 3212-56 (3N)



model 9666-56



56 - Clean Room Class #1000

Vinyl applied to the underside of the seat and vinyl or fabric upholstery are designed to prevent dust and other contaminants from entering the environment.

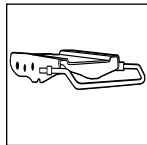

Multi-Depth Mechanism

Standard on Granada models. Allows seat to move forward and backward over a 2" range with 5 locking positions to provide a more shallow or deeper seat.





* Images shown are for illustration purposes only.





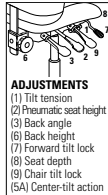

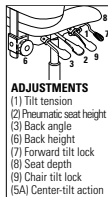

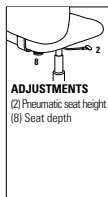
STANDARD FEATURES

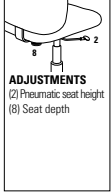

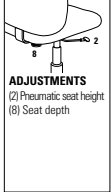

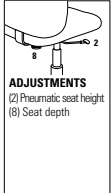
- *Clean Room Class #1000 models have a black cylinder.
- Granada models feature a molded seat and contoured back with enhanced lumbar support.
- Granada models are standard with adjustable height T-arms with curved urethane armcaps (3N) in Black Only. See page 346 for additional arm options.
- Chairs have a 5" black pneumatic cylinder, stools have a 10" black pneumatic cylinder.
- All chairs and stools have black back uprights and frames.
- Clear protective back bumper (full surround) is standard on all models.
- Standard with a five-legged, injection molded base in Black.
- **C10R** casters are standard on Granada and Minotaur Stools.
- **C65R** casters are standard on Minotaur Work Stools.
- All Bench Stools have chrome frames.
- Work Stools are shipped fully set-up.
- All Clean Room models are only available in grade 2 vinyls.
- Check textile availability prior to specifying upholstery material.

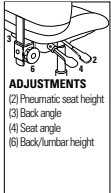

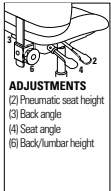

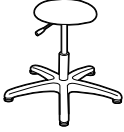
OPTIONAL FEATURES

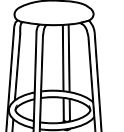

- See back of this section for additional arm or caster options.
- Optional casters may be priced higher than the standard casters for your chair and the difference will be charged. Lower priced optional casters will not be credited.

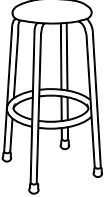
DESCRIPTION	FEATURES	MODEL#	STANDARD TEXTILE GRADES													
			1	2	3	4	5	6	7	8	9	10	11	12		
 <p>LB Multi-Tilter COM Yardage: 1.5 Freight Class: 150 Product Weight (lbs.): 52 Cubic Feet Per Carton: 13</p>	 <p>ADJUSTMENTS (1) Tilt tension (2) Pneumatic seat height (3) Back angle (6) Back height (7) Forward tilt lock (8) Seat depth (9) Chair tilt lock (5A) Center-tilt action</p>	<p>Granada</p> <p>Ergonomic Features: A, B, C, D, E, F, G, H, M, N, Q, S</p> <p>RTA 2</p>	-	1574	-	-	-	-	-	-	-	-	-	-		
			OVERALL DIMENSIONS			SEAT DIMENSIONS			BACK DIMENSIONS							
			W	D	H	W	D	H	W	H						
			52	24	40	20.5	17-19.5	18-23	19	17.5-21.5						
 <p>HB Multi-Tilter COM Yardage: 1.75 Freight Class: 250 Product Weight (lbs.): 55 Cubic Feet Per Carton: 15.5</p>	 <p>ADJUSTMENTS (1) Tilt tension (2) Pneumatic seat height (3) Back angle (6) Back height (7) Forward tilt lock (8) Seat depth (9) Chair tilt lock (5A) Center-tilt action</p>	<p>Granada</p> <p>Ergonomic Features: A, B, C, D, E, F, G, H, M, N, Q, S</p> <p>RTA 2</p>	-	\$1625	-	-	-	-	-	-	-	-	-	-		
			OVERALL DIMENSIONS			SEAT DIMENSIONS			BACK DIMENSIONS							
			W	D	H	W	D	H	W	H						
			25.5	24.5	43	20.5	17-19.5	18-23	19	21.5-25.5						
 <p>LB Task - Armless COM Yardage: 1.5 Freight Class: 250 Product Weight (lbs.): 40 Cubic Feet Per Carton: 13</p>	 <p>ADJUSTMENTS (2) Pneumatic seat height (8) Seat depth</p>	<p>Granada</p> <p>Ergonomic Features: C, E, M, N</p> <p>RTA 2</p>	-	\$1065	-	-	-	-	-	-	-	-	-	-		
			OVERALL DIMENSIONS			SEAT DIMENSIONS			BACK DIMENSIONS							
			W	D	H	W	D	H	W	H						
			20.5	24	38	20.5	17.5-19	17-22	19	19						

DESCRIPTION	FEATURES	MODEL#	STANDARD TEXTILE GRADES											
			1	2	3	4	5	6	7	8	9	10	11	12
 LB Task - w/3N Arms COM Yardage: 1.5 Freight Class: 250 Product Weight (lbs.): 40 Cubic Feet Per Carton: 13	 ADJUSTMENTS (2) Pneumatic seat height (8) Seat depth	3255-56 - \$1118 - - - - - - - - - - - -	OVERALL DIMENSIONS			SEAT DIMENSIONS			BACK DIMENSIONS					
			W	D	H	W	D	H	W	H				
			25.5	24	38	20.5	17.5-19	17-22	19	19				
						RTA 2								
 Stool Task - Armless COM Yardage: 1.5 Freight Class: 250 Product Weight (lbs.): 37 Cubic Feet Per Carton: 13	 ADJUSTMENTS (2) Pneumatic seat height (8) Seat depth	3256-56 - \$1236 - - - - - - - - - - - -	OVERALL DIMENSIONS			SEAT DIMENSIONS			BACK DIMENSIONS					
			W	D	H	W	D	H	W	H				
			20.5	24	48	20.5	17.5-19	24-34	19	19				
						RTA 2								
 Stool Task - w/3N Arms COM Yardage: 1.5 Freight Class: 250 Product Weight (lbs.): 43 Cubic Feet Per Carton: 15.75	 ADJUSTMENTS (2) Pneumatic seat height (8) Seat depth	3257-56 - \$1404 - - - - - - - - - - - -	OVERALL DIMENSIONS			SEAT DIMENSIONS			BACK DIMENSIONS					
			W	D	H	W	D	H	W	H				
			25.5	24	48	20.5	17.5-19	24-34	19	19				
						RTA 2								
 Stool Operator - Armless COM Yardage: 1.5 Freight Class: 250 Product Weight (lbs.): 44 Cubic Feet Per Carton: 13	 ADJUSTMENTS (2) Pneumatic seat height (3) Back angle (4) Seat angle (6) Back/lumbar height	3278-56 - \$1505 - - - - - - - - - - - -	OVERALL DIMENSIONS			SEAT DIMENSIONS			BACK DIMENSIONS					
			W	D	H	W	D	H	W	H				
			20.5	23.5	48	20.5	17.5	24-34	19	17.5-21.5				
						RTA 2								
 Stool Operator - w/3N Arms COM Yardage: 1.5 Freight Class: 250 Product Weight (lbs.): 52 Cubic Feet Per Carton: 15.75	 ADJUSTMENTS (2) Pneumatic seat height (3) Back angle (4) Seat angle (6) Back/lumbar height	3288-56 - \$1670 - - - - - - - - - - - -	OVERALL DIMENSIONS			SEAT DIMENSIONS			BACK DIMENSIONS					
			W	D	H	W	D	H	W	H				
			25.5	23.5	48	20.5	17.5	24-34	19	17.5-21.5				
						RTA 2								

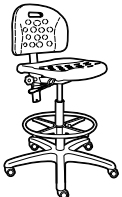
DESCRIPTION	FEATURES	MODEL#	STANDARD TEXTILE GRADES											
			1	2	3	4	5	6	7	8	9	10	11	12
 <p>Minotaur - Work Stool COM Yardage: 0.75 Freight Class: 250 Product Weight (lbs.): 14 Cubic Feet Per Carton: 6.5</p>	5" Pneumatic Ergonomic Features: C	9602-56	-	\$723	-	-	-	-	-	-	-	-	-	
		OVERALL DIMENSIONS			SEAT DIMENSIONS			BACK DIMENSIONS						
		W	D	H	W	D	H	W	H					
		14	14	17.5	14	-	15-20	-	-					
			RTA 00											
 <p>Minotaur - Work Stool COM Yardage: 0.75 Freight Class: 250 Product Weight (lbs.): 16 Cubic Feet Per Carton: 6.5</p>	10" Pneumatic Ergonomic Features: C	9604-56	-	\$788	-	-	-	-	-	-	-	-	-	
		OVERALL DIMENSIONS			SEAT DIMENSIONS			BACK DIMENSIONS						
		W	D	H	W	D	H	W	H					
		14	14	26.5	14	-	21.5-31.5	-	-					
			RTA 00											
 <p>Minotaur - Work Stool COM Yardage: N/A Freight Class: 250 Product Weight (lbs.): 16 Cubic Feet Per Carton: 6.5</p>	5" Pneumatic Ergonomic Features: C	9611-56	\$763	-	-	-	-	-	-	-	-	-	-	
		OVERALL DIMENSIONS			SEAT DIMENSIONS			BACK DIMENSIONS						
		W	D	H	W	D	H	W	H					
		14	14	24.5	14	-	15-20	-	-					
			RTA 00											
 <p>Minotaur - Work Stool COM Yardage: N/A Freight Class: 250 Product Weight (lbs.): 18 Cubic Feet Per Carton: 8.25</p>	10" Pneumatic Ergonomic Features: C	9612-56	\$825	-	-	-	-	-	-	-	-	-	-	
		OVERALL DIMENSIONS			SEAT DIMENSIONS			BACK DIMENSIONS						
		W	D	H	W	D	H	W	H					
		14	14	31	14	-	21.5-31.5	-	-					
			RTA 00											
 <p>Minotaur - Heavy Duty Work Stool COM Yardage: 0.75 Freight Class: 250 Product Weight (lbs.): 17 Cubic Feet Per Carton: 5.5</p>		9624-56	-	\$634	-	-	-	-	-	-	-	-	-	
		OVERALL DIMENSIONS			SEAT DIMENSIONS			BACK DIMENSIONS						
		W	D	H	W	D	H	W	H					
		16	16	27.5	14	-	27.5	-	-					
			RTA 00 											

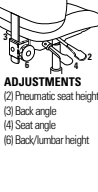
DESCRIPTION	FEATURES	MODEL#	STANDARD TEXTILE GRADES													
			1	2	3	4	5	6	7	8	9	10	11	12		
 <p>Minotaur - Heavy Duty Work Stool COM Yardage: 0.75 Freight Class: 250 Product Weight (lbs.): 19 Cubic Feet Per Carton: 5.5</p>		9632-56	-	\$662	-	-	-	-	-	-	-	-	-	-		
			OVERALL DIMENSIONS			SEAT DIMENSIONS			BACK DIMENSIONS							
			W	D	H	W	D	H	W	H						
			16	16	32.5	14	-	32.5	-	-						
			RTA 00													
 <p>Minotaur - Work Stool Task COM Yardage: N/A Freight Class: 250 Product Weight (lbs.): 26 Cubic Feet Per Carton: 13</p>	5" Pneumatic Ergonomic Features: C, E	9662-56	\$890	-	-	-	-	-	-	-	-	-	-	-		
			OVERALL DIMENSIONS			SEAT DIMENSIONS			BACK DIMENSIONS							
			W	D	H	W	D	H	W	H						
			18	21	32	18	16.5-19	14-19	16.5	16						
			RTA 2													
 <p>Minotaur - Work Stool Task COM Yardage: N/A Freight Class: 250 Product Weight (lbs.): 33 Cubic Feet Per Carton: 13</p>	10" Pneumatic Ergonomic Features: C, E	9663-56	\$1079	-	-	-	-	-	-	-	-	-	-	-		
			OVERALL DIMENSIONS			SEAT DIMENSIONS			BACK DIMENSIONS							
			W	D	H	W	D	H	W	H						
			18	20.5	42	18	16.5-19	20-30	16.5	16.5						
			RTA 2													
 <p>Minotaur - Stool Posture Task COM Yardage: N/A Freight Class: 250 Product Weight (lbs.): 30 Cubic Feet Per Carton: 13</p>	5" Pneumatic Ergonomic Features: C, D	9664-56	\$1016	-	-	-	-	-	-	-	-	-	-	-		
			OVERALL DIMENSIONS			SEAT DIMENSIONS			BACK DIMENSIONS							
			W	D	H	W	D	H	W	H						
			18	20	32	18	16	14-19	16.5	12.5-19						
			RTA 2													
 <p>Minotaur - Stool Posture Task COM Yardage: N/A Freight Class: 250 Product Weight (lbs.): 33 Cubic Feet Per Carton: 13</p>	10" Pneumatic Ergonomic Features: C, D	9665-56	\$1205	-	-	-	-	-	-	-	-	-	-	-		
			OVERALL DIMENSIONS			SEAT DIMENSIONS			BACK DIMENSIONS							
			W	D	H	W	D	H	W	H						
			18	20	42	39	16	20.5-30.5	16.5	12.5-19						
			RTA 2													

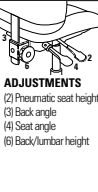
DESCRIPTION	FEATURES	MODEL#	STANDARD TEXTILE GRADES											
			1	2	3	4	5	6	7	8	9	10	11	12
 <p>Minotaur - Stool Operator COM Yardage: N/A Freight Class: 250 Product Weight (lbs.): 34 Cubic Feet Per Carton: 13</p>	 <p>ADJUSTMENTS (2) Pneumatic seat height (3) Back angle (4) Seat angle (6) Back/lumbar height</p>	9666-56 \$1195 - - - - - - - - - -	OVERALL DIMENSIONS			SEAT DIMENSIONS			BACK DIMENSIONS					
			W	D	H	W	D	H	W	H				
			18	20.5	18	18	17	15-20	16.5	12.5-19				
			RTA 2											
 <p>Minotaur - Stool Operator COM Yardage: N/A Freight Class: 250 Product Weight (lbs.): 35 Cubic Feet Per Carton: 13</p>	 <p>ADJUSTMENTS (2) Pneumatic seat height (3) Back angle (4) Seat angle (6) Back/lumbar height</p>	9667-56 \$1385 - - - - - - - - - -	OVERALL DIMENSIONS			SEAT DIMENSIONS			BACK DIMENSIONS					
			W	D	H	W	D	H	W	H				
			18	20.5	42	18	17	21-31	16.5	12.5-19				
			RTA 2											

ANTI-MICROBIAL - SEATING



model 3212-62 (3N)

* Images shown are for illustration purposes only.



62 - Anti-Microbial
Upholstered chairs have vinyl and an integrated filter applied to the underside of the seat to prevent dust and other contaminants from entering the environment

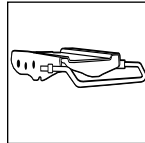





Multi-Depth Mechanism
Standard on Granada models. Allows seat to move forward and backward over a 2" range with 5 locking positions to provide a more shallow or deeper seat.





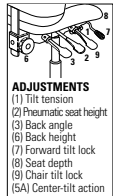

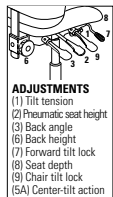

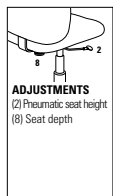
STANDARD FEATURES

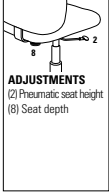

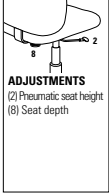

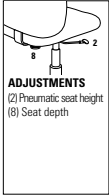
- *Anti-Microbial models have a chrome back upright and polished aluminum base.
- Select models feature a molded seat and contoured back with enhanced lumbar support.
- Granada models are standard with height adjustable T-arms with curved urethane armcaps (3N) in Black Only.
- Chrome chip/corrosion/humidity resistant pneumatic lift cylinders and frames.
- Chairs have a 5" Chrome pneumatic cylinder
- Stools have a 10" chrome pneumatic cylinder.
- All chairs and stools have Chrome back uprights and frames.
- Clear protective back bumper (full surround) is standard on all models.
- Standard with a five-legged, polished aluminum base.
- C10R casters are standard.
- All bench stools have chrome frames.
- Work stools are shipped fully set-up.
- Check textile availability prior to specifying upholstery material.

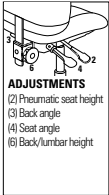
OPTIONAL FEATURES

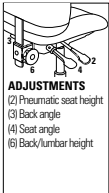
- See back of this section for additional arm or caster options.
- Optional casters may be priced higher than the standard casters for your chair and the difference will be charged. Lower priced optional casters will not be credited.
- All Anti-Microbial models are only available in MorCare™ Collection vinyl (grade 2).

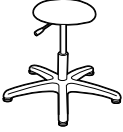
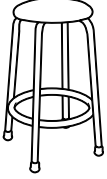
DESCRIPTION	FEATURES	MODEL#	STANDARD TEXTILE GRADES													
			1	2	3	4	5	6	7	8	9	10	11	12		
 LB Multi-Tilter COM Yardage: 1.5 Freight Class: 150 Product Weight (lbs.): 54 Cubic Feet Per Carton: 13	 ADJUSTMENTS (1) Tilt tension (2) Pneumatic seat height (3) Back angle (6) Back height (7) Forward tilt lock (8) Seat depth (9) Chair tilt lock (5A) Center-tilt action	3212-62	-	\$1977	-	-	-	-	-	-	-	-	-			
			OVERALL DIMENSIONS			SEAT DIMENSIONS			BACK DIMENSIONS							
			W	D	H	W	D	H	W	H						
			25.5	24	40	20.5	17-19.5	18-23	19	17.5-21.5						
			RTA 2													
 HB Multi-Tilter COM Yardage: 1.75 Freight Class: 250 Product Weight (lbs.): 57 Cubic Feet Per Carton: 15.5	 ADJUSTMENTS (1) Tilt tension (2) Pneumatic seat height (3) Back angle (6) Back height (7) Forward tilt lock (8) Seat depth (9) Chair tilt lock (5A) Center-tilt action	3217-62	-	\$2034	-	-	-	-	-	-	-	-	-			
			OVERALL DIMENSIONS			SEAT DIMENSIONS			BACK DIMENSIONS							
			W	D	H	W	D	H	W	H						
			25.5	24.5	43	20.5	17-19.5	18-23	19	21.5-25.5						
			RTA 2													
 LB Task - Armless COM Yardage: 1.5 Freight Class: 250 Product Weight (lbs.): 42 Cubic Feet Per Carton: 13	 ADJUSTMENTS (2) Pneumatic seat height (8) Seat depth	3254-62	-	\$1469	-	-	-	-	-	-	-	-				
			OVERALL DIMENSIONS			SEAT DIMENSIONS			BACK DIMENSIONS							
			W	D	H	W	D	H	W	H						
			20.5	24	38	20.5	17.5-19	17-22	19	19						
			RTA 2													

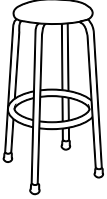
DESCRIPTION	FEATURES	MODEL#	STANDARD TEXTILE GRADES													
			1	2	3	4	5	6	7	8	9	10	11	12		
 LB Task - w/3N Arms COM Yardage: 1.5 Freight Class: 250 Product Weight (lbs.): 42 Cubic Feet Per Carton: 13	 ADJUSTMENTS (2) Pneumatic seat height (8) Seat depth	3255-62 - \$1636 - - - - - - - - - - - -	OVERALL DIMENSIONS			SEAT DIMENSIONS			BACK DIMENSIONS							
			W	D	H	W	D	H	W	H						
			25.5	24	38	20.5	17.5-19	17-22	19	19						
			Granada Ergonomic Features: C, E, M, N			RTA 2										
 Stool Task - Armless COM Yardage: 1.5 Freight Class: 250 Product Weight (lbs.): 41 Cubic Feet Per Carton: 13	 ADJUSTMENTS (2) Pneumatic seat height (8) Seat depth	3256-62 - \$1645 - - - - - - - - - - - -	OVERALL DIMENSIONS			SEAT DIMENSIONS			BACK DIMENSIONS							
			W	D	H	W	D	H	W	H						
			20.5	24	48	20.5	17.5-19	24-34	19	19						
			Granada Ergonomic Features: C, E, M, N			RTA 2										
 Stool Task - w/3N Arms COM Yardage: 1.5 Freight Class: 250 Product Weight (lbs.): 45 Cubic Feet Per Carton: 15.75	 ADJUSTMENTS (2) Pneumatic seat height (8) Seat depth	3257-62 - \$1809 - - - - - - - - - - - -	OVERALL DIMENSIONS			SEAT DIMENSIONS			BACK DIMENSIONS							
			W	D	H	W	D	H	W	H						
			25.5	24	48	20.5	17.5-19	24-34	19	19						
			Granada Ergonomic Features: C, E, H, M, N, Q			RTA 2										
 Stool Operator - Armless COM Yardage: 1.5 Freight Class: 250 Product Weight (lbs.): 48 Cubic Feet Per Carton: 13	 ADJUSTMENTS (2) Pneumatic seat height (3) Back angle (4) Seat angle (6) Back/lumbar height	3278-62 - \$1911 - - - - - - - - - - - -	OVERALL DIMENSIONS			SEAT DIMENSIONS			BACK DIMENSIONS							
			W	D	H	W	D	H	W	H						
			20.5	23.5	48	20.5	17.5	24-34	19	17.5-21.5						
			Granada Ergonomic Features: C, D, F, G, M, N			RTA 2										
 Stool Operator - w/3N Arms COM Yardage: 1.5 Freight Class: 250 Product Weight (lbs.): 54 Cubic Feet Per Carton: 15.75	 ADJUSTMENTS (2) Pneumatic seat height (3) Back angle (4) Seat angle (6) Back/lumbar height	3288-62 - \$2078 - - - - - - - - - - - -	OVERALL DIMENSIONS			SEAT DIMENSIONS			BACK DIMENSIONS							
			W	D	H	W	D	H	W	H						
			25.5	23.5	48	20.5	17.5	24-34	19	17.5-21.5						
			Granada Ergonomic Features: C, D, F, G, H, M, N, Q			RTA 2										

DESCRIPTION	FEATURES	MODEL#	STANDARD TEXTILE GRADES											
			1	2	3	4	5	6	7	8	9	10	11	12
 <p>Minotaur - Work Stool COM Yardage: 00.75 Freight Class: 300 Product Weight (lbs.): 14 Cubic Feet Per Carton: 9.75</p>	5" Pneumatic Ergonomic Features: C	9602-62	-	\$815	-	-	-	-	-	-	-	-	-	-
		OVERALL DIMENSIONS W D H			SEAT DIMENSIONS W D H			BACK DIMENSIONS W H						
		14	14	17.5	14	-	15-20	-	-					
		RTA 00												
 <p>Minotaur - Work Stool COM Yardage: 00.75 Freight Class: 300 Product Weight (lbs.): 16 Cubic Feet Per Carton: 13</p>	10" Pneumatic Ergonomic Features: C	9604-62	-	\$878	-	-	-	-	-	-	-	-	-	
		OVERALL DIMENSIONS W D H			SEAT DIMENSIONS W D H			BACK DIMENSIONS W H						
		14	14	26.5	14	-	21.5-31.5	-	-					
		RTA 00												
 <p>Minotaur - Heavy Duty Work Stool COM Yardage: 00.75 Freight Class: 250 Product Weight (lbs.): 17 Cubic Feet Per Carton: 5.5</p>		9624-62	-	\$863	-	-	-	-	-	-	-	-		
		OVERALL DIMENSIONS W D H			SEAT DIMENSIONS W D H			BACK DIMENSIONS W H						
		16	16	27.5	14	-	27.5	-	-					
		RTA 00 												
 <p>Minotaur - Heavy Duty Work Stool COM Yardage: 00.75 Freight Class: 250 Product Weight (lbs.): 19 Cubic Feet Per Carton: 5.5</p>		9632-62	-	\$892	-	-	-	-	-	-	-	-		
		OVERALL DIMENSIONS W D H			SEAT DIMENSIONS W D H			BACK DIMENSIONS W H						
		16	16	16	14	-	32.5	-	-					
		RTA 00 												

WIPE DOWN - SEATING



model 9632-64



model 9667-64



64 - Wipe Down
Furniture designed for dry food manufacturers, hospitals and forensic labs requiring regular and immediate clean up of dust, dirt or powder.



* Images shown are for illustration purposes only.





STANDARD FEATURES

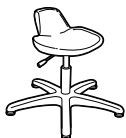

- *Wipe Down models have a black pneumatic cylinder.
- Minotaur Wipe Down models have comfortable Black, self-skinned polyurethane seats and backs.
- Chip/corrosion/humidity resistant pneumatic lift cylinders and frames.
- Stools have a 5" or 10" black pneumatic cylinder.
- All chairs have a chrome back upright.
- Standard with a five-legged, heavy duty molded base in Black.
- No arms are available for any work stools.
- All Bench Stools have chrome frames.
- Work Stools are shipped fully set-up.

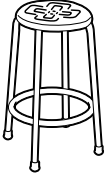
OPTIONAL FEATURES

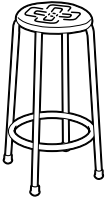
- Work stools are available with optional **C5** casters at no charge. Please Specify.
- See back of this section for additional arm or caster options.
- Optional casters may be priced higher than the standard casters for your chair and the difference will be charged. Lower priced optional casters will not be credited

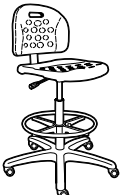
DESCRIPTION	FEATURES	MODEL#	STANDARD TEXTILE GRADES												
			1	2	3	4	5	6	7	8	9	10	11	12	
 <p>Minotaur - Work Stool COM Yardage: N/A Freight Class: 250 Product Weight (lbs.): 14 Cubic Feet Per Carton: 6.5</p>	5" Pneumatic Ergonomic Features: C	9602-64	\$634	-	-	-	-	-	-	-	-	-	-	-	
		OVERALL DIMENSIONS			SEAT DIMENSIONS			BACK DIMENSIONS							
		W	D	H	W	D	H	W	H						
	14	14	17.5	14	-	15-20	-	-							
				RTA 00											
 <p>Minotaur - Work Stool COM Yardage: N/A Freight Class: 250 Product Weight (lbs.): 16 Cubic Feet Per Carton: 6.5</p>	10" Pneumatic Ergonomic Features: C	9604-64	\$700	-	-	-	-	-	-	-	-	-	-	-	
		OVERALL DIMENSIONS			SEAT DIMENSIONS			BACK DIMENSIONS							
		W	D	H	W	D	H	W	H						
	14	14	26.5	14	-	21.5-31.5	-	-							
				RTA 00											
 <p>Minotaur - Work Stool COM Yardage: N/A Freight Class: 250 Product Weight (lbs.): 16 Cubic Feet Per Carton: 6.5</p>	5" Pneumatic Ergonomic Features: C	9611-64	\$763	-	-	-	-	-	-	-	-	-	-	-	
		OVERALL DIMENSIONS			SEAT DIMENSIONS			BACK DIMENSIONS							
		W	D	H	W	D	H	W	H						
	14	14	24.5	14	-	15-20	-	-							
				RTA 00											

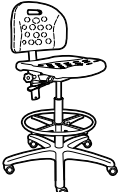
DESCRIPTION	FEATURES	MODEL#	STANDARD TEXTILE GRADES													
			1	2	3	4	5	6	7	8	9	10	11	12		
 <p>Minotaur - Work Stool COM Yardage: N/A Freight Class: 250 Product Weight (lbs.): 18 Cubic Feet Per Carton: 8.25</p>	<p>10" Pneumatic</p> <p>Ergonomic Features: C</p>	9612-64	\$825	-	-	-	-	-	-	-	-	-	-	-	-	
			OVERALL DIMENSIONS			SEAT DIMENSIONS			BACK DIMENSIONS							
			W	D	H	W	D	H	W	H						
			14	14	31	14	-	21.5-31.5	-	-						
			RTA 00													
 <p>Minotaur - Heavy Duty Work Stool COM Yardage: N/A Freight Class: 250 Product Weight (lbs.): 17 Cubic Feet Per Carton: 5.5</p>		9624-64	\$634	-	-	-	-	-	-	-	-	-	-	-	-	
			OVERALL DIMENSIONS			SEAT DIMENSIONS			BACK DIMENSIONS							
			W	D	H	W	D	H	W	H						
			16	16	27.5	14	-	27.5	-	-						
			RTA 00 													
 <p>Minotaur - Heavy Duty Work Stool COM Yardage: N/A Freight Class: 250 Product Weight (lbs.): 19 Cubic Feet Per Carton: 5.5</p>		9632-64	\$662	-	-	-	-	-	-	-	-	-	-	-	-	
			OVERALL DIMENSIONS			SEAT DIMENSIONS			BACK DIMENSIONS							
			W	D	H	W	D	H	W	H						
			16	16	32.5	14	-	32.5	-	-						
			RTA 00 													
 <p>Minotaur - Work Stool Task COM Yardage: N/A Freight Class: 250 Product Weight (lbs.): 26 Cubic Feet Per Carton: 13</p>	<p>5" Pneumatic</p> <p>Ergonomic Features: C, E</p>	9662-64	\$890	-	-	-	-	-	-	-	-	-	-	-	-	
			OVERALL DIMENSIONS			SEAT DIMENSIONS			BACK DIMENSIONS							
			W	D	H	W	D	H	W	H						
			18	21	32	18	16.5-19	14-19	16.5	16						
			RTA 00													
 <p>Minotaur - Work Stool Task COM Yardage: N/A Freight Class: 250 Product Weight (lbs.): 33 Cubic Feet Per Carton: 13</p>	<p>10" Pneumatic</p> <p>Ergonomic Features: C, E</p>	9663-64	\$1079	-	-	-	-	-	-	-	-	-	-	-	-	
			OVERALL DIMENSIONS			SEAT DIMENSIONS			BACK DIMENSIONS							
			W	D	H	W	D	H	W	H						
			18	20.5	42	18	16.5-19	20-30	16.5	16.5						
			RTA 00													

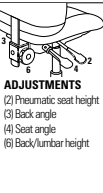
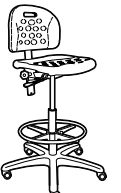
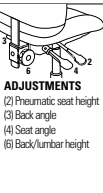
DESCRIPTION	FEATURES	MODEL#	STANDARD TEXTILE GRADES											
			1	2	3	4	5	6	7	8	9	10	11	12
 Minotaur - Stool Posture Task COM Yardage: N/A Freight Class: 250 Product Weight (lbs.): 30 Cubic Feet Per Carton: 13	5" Pneumatic Ergonomic Features: C, D	9664-64 \$1016	-	-	-	-	-	-	-	-	-	-	-	
			OVERALL DIMENSIONS			SEAT DIMENSIONS			BACK DIMENSIONS					
			W	D	H	W	D	H	W	H				
			18	20	32	18	16	14-19	16.5	12.5-19				
			RTA 2											
 Minotaur - Stool Posture Task COM Yardage: N/A Freight Class: 250 Product Weight (lbs.): 33 Cubic Feet Per Carton: 13	10" Pneumatic Ergonomic Features: C, D	9665-64 \$1205	-	-	-	-	-	-	-	-	-	-	-	
			OVERALL DIMENSIONS			SEAT DIMENSIONS			BACK DIMENSIONS					
			W	D	H	W	D	H	W	H				
			18	20	42	18	16	20.5-30.5	16.5	12.5-19				
			RTA 2											
 Minotaur - Stool Operator COM Yardage: N/A Freight Class: 250 Product Weight (lbs.): 34 Cubic Feet Per Carton: 13	 ADJUSTMENTS (2) Pneumatic seat height (3) Back angle (4) Seat angle (6) Back/lumbar height	9666-64 \$1195	-	-	-	-	-	-	-	-	-	-	-	
			OVERALL DIMENSIONS			SEAT DIMENSIONS			BACK DIMENSIONS					
			W	D	H	W	D	H	W	H				
			18	20.5	32	18	17	15-20	16.5	12.5-19				
			RTA 2											
 Minotaur - Stool Operator COM Yardage: N/A Freight Class: 250 Product Weight (lbs.): 35 Cubic Feet Per Carton: 13	 ADJUSTMENTS (2) Pneumatic seat height (3) Back angle (4) Seat angle (6) Back/lumbar height	9667-64 \$1385	-	-	-	-	-	-	-	-	-	-	-	
			OVERALL DIMENSIONS			SEAT DIMENSIONS			BACK DIMENSIONS					
			W	D	H	W	D	H	W	H				
			18	20.5	42	18	17	21-31	16.5	12.5-19				
			RTA 2											

ACADEMIC REPLACEMENT ARMS

(For Task Seating models ONLY)
 Arms other than those provided as standard on your chair.
 Refer to chart below for availability by series.



	STD	AL	F	O	OJ	TD	ZH	3N	4J	4M	4T	GL	9B	9S
GOAL	3N	NR	NR	42	106	42	NR	STD	139	77	77	NR	201	NR
GRANADA	3N	83	201	42	106	42	0	STD	139	77	77	77	201	106

SO = AVAILABLE AT NO ADDITIONAL CHARGE

NR = OPTION NOT RECOMMENDED

INDUSTRIAL REPLACEMENT ARMS

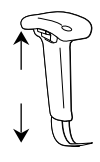
Optional arms for INDUSTRIAL and ESD seating ONLY.

 <p>3N</p>	Industrial Seating Series	Options	*Replacement Arm Price	**Optional Arm Price
	Adjustable height T-arm, Curved	urethane	STD	\$211
 <p>2Z</p>	Industrial Seating Series	Options	*Replacement Arm Price	**Optional Arm Price
	Fixed height T-arm, Kidney Shaped	upholstered	STD (ESD Models)	\$106

Notes:

* Use this column to select another arm other than the one provided on your chair.

** Use this column to select arms for a chair that doesn't come with arms.



C5	Large Ball Caster	Chrome Hood/ Black Ball	Hard Floor	1 each	\$21
-----------	-------------------	----------------------------	------------	--------	-------------

Available as a substitute for C56 glides on Wipe Down Work stools at no charge.



C7R	Slipper Glide		All surface except ESD	1 each	\$23
------------	---------------	--	---------------------------	--------	-------------

Standard on Industrial, Anti-Microbial and Wipe Down Minotaur Work stools.

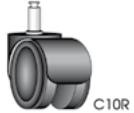

C10R	Integrated Dual Wheel Rubber Coated Caster	Black	Vinyl, Marble, Hardwood Floor	1 each	\$40
-------------	---	-------	----------------------------------	--------	-------------

Standard on Industrial , Clean Room #1000 and Wipe Down Minotaur stools and Clean Room #1000 and Anti-Microbial Granada models.



C38R	Non-Braking, Dual Wheel, Caster w/ESD	Die Cast Zinc Chrome Plated Hood Wheels - First Grade Polyamide w/ Soft polyurethane tread.	Hard Floor Surfaces	1 each	\$64
-------------	--	---	---------------------	--------	-------------

Standard on ESD chairs and stools.



C39R	Dual Wheel, Hard Floor Safety Caster w/Interval Brake	Galvanized Steel Axle w/Chrome Plated Hood Zinc die cast frame)	Hard Floor Surfaces	1 each	\$62
-------------	---	--	---------------------	--------	-------------

Standard on Industrial chairs and stools. Weight activated release brake helps to prevent chair from moving when not in use.



C40	Dual Wheel Safety Caster w/ESD, Interval Brake	Galvanized Steel Axle w/Chrome Plated Hood (Zinc die cast frame)	Carpeted Surfaces	1 each	\$62
------------	--	---	-------------------	--------	-------------

Available as a substitute on ESD chairs and stools only. Weight activated release brake helps to prevent chair from moving when not in use.



C40R	Dual Wheel, Hard Floor Safety Caster w/ESD, Interval Brake	Galvanized Steel Axle w/Chrome Plated Hood (Zinc die cast frame)	Tiled Surfaces	1 each	\$69
-------------	--	---	----------------	--------	-------------

Available as a substitute on ESD chairs and stools only. Weight activated release brake helps to prevent chair from moving when not in use.



C42	High Profile Steel Glide w/ESD w/Impact Resistant Polymer Glide	Steel Stem and Shell (Zinc plated steel stem)	All Surfaces	1 each	\$23
------------	--	--	--------------	--------	-------------

Standard on Minotaur Heavy Duty Bench stools and Work stools with ESD



C65R	2" Dual Wheel Rubber Coated Caster	Black	All surfaces except ESD	1 each	\$34
-------------	---------------------------------------	-------	----------------------------	--------	-------------

Standard on Clean Room #1000 Minotaur work stools.

INDUSTRIAL CASTERS NOTES:

- Prices listed for Industrial Casters are upcharges when substituted on Industrial chair orders.
- Industrial Casters are not suitable for use on standard Global seating products.
- All casters are not appropriate for all flooring surfaces. Please consult with your Sales Representative or Global Customer Care for special situations that can be verified with the caster manufacturer. Alternate casters, if needed, may require an upcharge.

PLEASE SPECIFY ALL SUBSTITUTIONS AND OPTIONS.

textiles and finishes

Care and Cleaning

TEXTILES

Fabrics: To extend the life of your seating upholstered in fabric, regularly dust the chair to prevent airborne particles from penetrating the fabric surface.

For light soiling, use a damp cloth and blot the spot with very slight pressure, taking care never to soak the fabric. Dry with a clean cloth by blotting - never rub fabric. More intense stains can be treated the same way, but with a mild detergent. Always test fabric first in an unseen area before using any cleaning method.

Leather: For regular cleaning, simply use a soft damp cloth, taking care not to soak the leather. For more thorough treatment, soak a soft cloth in mild soap solution and wipe surface in a light circular motion. Repeat with clean water. Allow to dry and polish with a soft dry cloth. Do not use detergents, aerosol sprays or other polishes.

Various Care and Cleaning Methods

- **Water-Based Cleaner:** Spot clean, using the foam only from a water-based cleaning agent, such as a mild detergent or non-solvent upholstery shampoo product. Apply foam with a soft brush in a circular motion. Vacuum when dry. Pretest small area before proceeding.
- **Solvent Cleaner:** Spot clean, using a mild water-free solvent or dry cleaning product. Clean only in a well-ventilated room and avoid any product containing carbon tetrachloride or other toxic materials. Pre-test a small area before proceeding.
- **Water/Solvent Cleaner:** Spot clean with amid solvent, an upholstery shampoo, or the foam from a mild detergent. When using a solvent or dry cleaning product, follow instructions carefully and clean only in a well-ventilated room. Avoid any product that contains carbon tetrachloride or other toxic materials. With either method, pretest a small area before proceeding.
- **Vacuum Only:** Clean this fabric only by vacuuming or light brushing to prevent accumulation of dust and grime. Water-based foam cleaning agents of any kind may cause excessive shrinking, staining, or distortion of the surface pile and therefore, should not be used.
- **Crypton Cleaning:** Generally stains are removed with plain water and powdered enzyme detergent. Upholstery foam shampoo, water-based cleaning products and germicidal detergents can be used. Be sure to remove all residue from cleaning products with clean water. Do not use solvent-based cleaners or dry cleaning products.

HARD SURFACES

Wood Veneer Finishes: Waxing or polishing catalyzed finishes is not recommended because this will give a greasy, cloudy or uneven appearance to the product and could void your warranty. Global's conversion varnish is best cleaned by wiping the surface with a damp cloth, followed by a soft dry cloth in the direction of the grain. If the surfaces are heavily soiled, a gentle product like "Windex" can be used, following the same instructions as above.

Laminate & Painted Metal Finishes: Using a soft cloth, simply wipe the surface with a mild soap solution or glass cleaner. Always use a dry cloth and circular motion to prevent streaks.

TEXTILES & FINISHES

Textile Price Grades - Global Textiles

Grade 1	Carrera, Dobby, Fusion, Illusion, Jenny, Quilt, Terrace, Trak, Urban, Waterfall, Wavelength
Grade 2	Allante FRee, Elevate, Etch, GC Linen, Imprint, Luxhide, Release,
Grade 3	Non standard GLOBAL textiles
Grade 4	Non standard GLOBAL textiles
Grade 6	Novaro Genuine Leather, non standard GLOBAL textiles
Grade 7	Non standard GLOBAL textiles
Grade 8	Non standard GLOBAL textiles
Grade 9	Non standard GLOBAL textiles
Grade 11	Non standard GLOBAL textiles
Grade 10	Non standard GLOBAL textiles
Grade 12	Non standard GLOBAL textiles

Please refer to individual seating series for availability of a particular textile.

The charts above do not include Textiles offered by Alliance Partners: Architex, Arc-Com Fabrics, Designtex, Green Hides, LDI Interiors, Luum Textiles, Maharam, Mayer Fabrics, Momentum, and Ultrafabrics.

Blend Seating Textiles

The grid below outlines the grade structure for using multiple textiles on select seating series. Blended textiles occur when one textile is chosen for one part of the chair and a different textile is selected for another part of the chair, resulting in a revised "blended grade".

NOT FOR USE with Calidon, Collingwood, Erin, Oakville or River+. See series price list pages for applicable pricing.

For specification and pricing for more than two different textiles, please contact Global CustomerCare for approval process and pricing.

FIRST TEXTILE SELECTED

		FIRST TEXTILE SELECTED																	
		1	2	3	4	5	6	7	8	9	10	11	12	13	14	15	16	17	18
SECOND TEXTILE SELECTED	1	1																	
	2	2	2																
	3	3	3	3															
	4	3	4	4	4														
	5	4	4	5	5	5													
	6	5	5	5	6	6	6												
	7	5	6	6	6	7	7	7											
	8	6	6	7	7	7	8	8	8										
	9	7	7	7	8	8	8	9	9	9									
	10	8	8	8	8	9	9	9	10	10	10								
	11	9	9	9	9	9	10	10	10	11	11	11							
	12	10	10	10	10	10	10	11	11	11	12	12	12						
	13	11	11	11	11	11	11	12	12	12	12	13	13	13					
	14	11	12	12	12	12	12	12	13	13	13	13	14	14	14				
	15	12	12	13	13	13	13	13	13	14	14	14	14	15	15	15			
	16	13	13	13	14	14	14	14	14	14	15	15	15	15	16	16	16		
	17	14	14	14	14	15	15	15	15	15	15	16	16	16	16	17	17	17	
	18	15	15	15	15	15	16	16	16	16	16	16	17	17	17	17	18	18	18

Textile and Color Listings

Grade 1

Carrera 100% Polyester

CE84 Zest	CE85 Savannah	CE86 Slate	CE87 Rainforest	CE88 Aspen	CE89 Dune	CE90 Flannel
CE91 Azure	CE92 Chili	CE93 Jute	CE95 Ink	CE96 Sangria	CE97 Java	CE98 Charcoal

Dobby 96% Recycled Polyester / 4% Virgin Polyester

DB30 Snowcap	DB31 Bonsai	DB32 Cloud	DB33 Sand	DB34 Pewter	DB35 Santa Fe	DB36 Corfu
DB37 Medium Taupe	DB38 Charcoal	DB39 Berry	DB40 Royal	DB41 Titanium	DB42 Black	

Fusion 90% Virgin Polyester / 10% Post-Consumer Recycled Polyester

FU71 Tangerine	FU72 Fresh	FU73 Moss	FU74 Tomato	FU75 Aqua	FU76 Sandstone	FU77 Granite
FU78 Poppy	FU79 Cadet	FU80 Oasis	FU81 Graphite	FU82 Viola	FU83 Cobalt	FU84 Flax
FU85 Carbon						

Illusion 100% Virgin Polyester

II01 Cappuccino	II02 Paprika	II03 Tropic	II04 Wicker	II05 Hemp	II06 Cayenne	II07 Maui
II08 Dusk	II09 Smoke	II10 Currant	II11 Fiji	II12 Ozone	II13 Ebony	

Jenny 100% Polyester

JN01 Midnite	JN02 Ebony	JN03 Slate	JN07 Vermilion	JN08 Admiral	JN11 Charcoal	JN25 Silver Lining
JN26 Oatmeal	JN27 Sunflower	JN28 Cascade	JN29 Harvest	JN30 Melon	JN31 Berry	JN32 Green Grass
JN33 Roast						

Quilt 100% Polyester

QL10 Black	QL11 Charcoal Grey	QL14 Navy	QL16 Wine	QL19 Silver	QL20 Feather	QL21 Dune
QL22 Meadow	QL23 Cadet	QL24 Geranium	QL25 Daisy	QL26 Quest	QL27 Punch	QL28 Tangerine
QL29 Cocoa						

Terrace 70% Virgin Polyester / 30% Post-Consumer Recycled Polyester

TC61 Tigerlily	TC62 Shadow	TC63 Cobble	TC64 Cherry Blossom	TC65 Bluebell	TC66 Apple	TC67 Haze
TC68 Cerise	TC69 Twilight	TC70 Wintergreen	TC71 Ironwork	TC72 Pine Cone	TC73 Flirt	TC74 Echo
TC75 Glacier						

Trak 100% Recycled Polyester

TK40 Taupe	TK41 Mustard	TK42 Latte	TK43 Cement	TK44 Silver	TK45 Copper	TK46 Teal
TK47 Apple	TK48 Steel	TK49 Merlot	TK50 Midnight Sky	TK51 Mocha	TK52 Carbon	

Urban 62% Recycled Polyester / 32% Polyester

UR10 Red Rose	UR11 Ocean Blue	UR12 Blue Bayou	UR13 Green Grass	UR14 Sandcastle	UR15 Beach Day	UR16 Boardwalk
UR17 Earth	UR18 Brown Ridge	UR19 White Sand	UR20 Granite Rock	UR21 Gravel Road	UR22 Black Coal	

Waterfall 60% Virgin Polyester / 40% Post-Consumer Recycled Polyester

WA40 Trance	WA41 Tryst	WA42 Splash	WA43 Victoria	WA44 Imagine	WA45 Sky	WA46 Rainforest
WA47 Rumble	WA48 Prism	WA49 Tranquility	WA50 Grand	WA51 Rushing	WA52 Magestic	WA53 Pacific
WA54 Dance						

Wavelength 100% Virgin Polyester

WV01 Lime	WV02 Mint	WV03 Stone	WV04 Flame	WV05 Mykonos	WV06 Savannah	WV07 Mesa
WV08 Plasma	WV09 Cancun	WV10 Quartz	WV11 Moonrock	WV12 Rubine	WV13 Corfu	WV14 Bluejay
WV14 Panther						

Grade 2

Elevate 80% Post-Consumer Recycled Polyester / 20% Rayon

EL51 Halo	EL52 Dove	EL53 Safari	EL54 Sunglow	EL55 Margarita	EL56 Fiji	EL57 Mist
EL58 Blaze	EL59 Wasabi	EL60 Mystic	EL61 Mica	EL62 Cherry	EL63 Scuba	EL64 Lapis
EL65 Onyx						

Etch 80% Post-Consumer Recycled Polyester / 20% Rayon

ET81 Drift	ET82 Citron	ET83 Calypso	ET84 Mandarin	ET85 Crisp	ET86 Iris	ET87 Nickel
ET88 Paprika	ET89 Nutmeg	ET90 Marine	ET91 Magnet	ET92 Infrared	ET93 Espresso	ET94 Indigo
ET95 Anthracite						

Imprint 100% Post-Consumer Polyester

IM70 Almond	IM71 Cork	IM72 Sand	IM73 Currie	IM74 Candy Apple	IM75 Ocean	IM76 Navy
IM77 Green Tea	IM78 Celery	IM79 Oregon	IM80 Walnut	IM81 Paprika	IM82 Graphite	IM83 Slate
IM84 Licorice						

TEXTILES & FINISHES

Grade 2 (Vinyl) For availability of chair series in Vinyl, please contact a Global Sales Representative.

Allante FFree 100% Vinyl Face / 100% Polyester Backing

A01F Illusion	A02F Bright White	A03F White Crush	A04F Ivory	A05F Ice	A06F Bleached Sand	A07F Taupe Fawn
A08F Warm Smoke	A09F Autumn Rain	A10F Cookie	A11F Sierra Brick	A12F Gibraltar	A13F Chateau Grey	A14F Garden Green
A15F Oasis Green	A16F Ink Black	A17F Purple Impulse	A18F Italian Rose	A19F Mountain Sky	A20F Old Navy	A21F Galaxy
A22F Red Truffle	A23F Chocolate Sundae	A24F Province Blue	A25F Eclipse			

GC Linen 100% Vinyl Face

LE50 Potters Clay	LE51 Pearl	LE52 Tan	LE53 Storm	LE54 Butter	LE55 Haystack	LE56 Ganache
LE57 Sunset	LE58 Burnt Orange	LE59 Cayenne	LE60 Navy	LE61 Bamboo	LE62 Gray	LE63 Charcoal
LE64 Moss						

Luxhide 100% Vinyl Face / Bonded Leather Backing

BL20 Black	BL22 Parchment	BL23 Saddle	BL24 Dark Brown	BL26 Burgundy	BL27 Charcoal	BL28 White
BL34 Light Grey						

Release 100% Vinyl Face

RL11 White	RL12 Chalk	RL13 Stone	RL14 Taupe	RL15 Orange	RL16 Country	RL17 Tuscan
RL18 Cottage	RL19 Yellow	RL21 Red Barn	RL22 Brave Red	RL23 Gypsy Red	RL24 Cajun	RL25 Vineyard
RL26 Olive	RL27 Bonsai	RL28 Summer's Dream	RL29 Calico	RL31 Green	RL32 Blue	RL33 Black
RL34 Cool Grey	RL35 Thunder Grey	RL36 Navy	RL37 Dark Chocolate	RL38 Espresso		

Grade 6

Novaro Genuine Leather 100% Leather

N050 Ash	N051 Asphalt	N052 Bison	N053 Blueberry	N054 Cloud	N055 Clove	N056 Cordovan
N057 Doe	N058 Linen	N059 Marina	N060 Phantom	N061 Pigeon	N062 Scarlet	N063 Turtle
N064 Wheat						

PANEL FABRICS

GRADE 2

Lola 100% Polyester.

LL11 Medium Taupe LL12 Caramel Cream LL14 Blue Mist LL35 Spray LL36 Granite LL37 Cinder LL38 Sandstone

GRADE 3

Anchorage 65% Pre-consumer Polyester / 35% Post-consumer Polyester

AN40 Birch AN41 Green Apple AN42 Lapis AN43 Straw AN44 Wolf AN45 Goose AN46 Angora
 AN47 Cumin AN48 Asteroid AN49 Geranium AN50 Thistle AN51 Graphite AN52 Slate AN53 Quarry Blue
 AN54 Onyx AN55 Pumpkin AN56 Red Delicious AN57 Sunshine AN59 Waterfall AN61 Vanilla AN62 Cobalt
 AN64 Cloud

Merge 100% Polyester / 75% Post-consumer Recycled Polyester

MG20 Fawn MG21 Marshmallow MG22 Driftwood MG23 Dove MG24 Graphite MG25 Slate MG26 Eucalyptus
 MG27 Fire Engine MG28 Mediterranean MG29 Midnight

FINISHES

Seating Finishes - Metal: Please consult each Seating Series for finish availability.

Antique Copper (ACO) Black (TBL) Brushed Chrome (BCH) Buzz Blue (TBZ) Cactus (TCC) Carrot (TCR) Cloud (TIV)
 Chrome (CHM) Designer White (TDW) Dijon (TDJ) Eggplant (TEG) Fog (TFO) Frost (TFR) Ink (TIN)
 Kalua (TKA) Latte (TLA) Mocha (TMO) Nevada (TNE) Sand (TSN) Satin Brass (SBR) Scarlet (TSR)
 Shadow (TSH) Toast (TOA) Tungsten (TTU)

Seating Finishes - Plastic (Duet, Popcorn, and Sonic)

Buzz Blue (BZB) Cactus (CCT) Carrot (CRO) Cloud (IVC) Dijon (DJN) Eggplant (EGP) Fog (FOG)
 Frost (FRO) Ink (INK) Latte (LAB) Night (BLK) Sand (SND) Scarlet (SAR) Shadow (SHW)

Seating Finishes - Wood Seating finishes will not necessarily match Casegoods finishes. This is due to the fact that Seating and Casegoods finishes use different wood species and are manufactured at multiple locations.

Absolute (AAM) Black (BKM) Cherry (ACM) Espresso Cafe (ECM) English Oak (EOM) Fruitwood (TFM) Gray (HGM)
 Honey (AHM) Mahogany (TMM) Maple (AVM) Medium Walnut (MWM) Natural Walnut (NLW) Night (ASM) Noce Biondo (NBM)
 Noce Grigio (NGM) Noce Leggero (NEM) Noce Medio (NMM) Shaker Cherry (SKM) Walnut (TWM) WC Cream (WTM) White (WHM)
 Winter Cherry (WCM)

Desks, Workstations, Tables and Accessories - Laminate

Absolute Acajou (ACJ) Asian Night (ASN) Avant Cherry (AWC) Avant Honey (AWH) Black (BLK) Brushed Cobalt (BRC) Clear Maple (CMB)
 Dark Espresso (DES) Designer White (DWT) Hayden Grey (HGT) Noce Biondo (NBL) Noce Grigio (NGL) Noce Leggero (NEL) Noce Medio (NML)
 Quartered Mahogany (QTM) Storm Grey (SOG) Tiger Fruitwood (TFW) Tiger Walnut (TWL) Walnut Heights (WHE) White Chocolate (WHC) Willow Grey (WGY)
 Winter Cherry (WCR)

Desks, Workstations, Tables and Accessories - Wood Veneer

Almond Cherry (AMW) Cocoa Walnut (CAW) Coral (CRW) Dark Cherry (DCW) Espresso Walnut (EWW) Evening Oak (EVW) Grey on Oak (GRW)
 Hazelnut (HAW) Honey Maple (SMW) Java (JAW) Latte Walnut (LTW) Milestone (MTW) Mocha (MCW) Natural Maple (MPW)
 Red Cherry (RCW) Vintage Cherry (VNW) Walnut (WLW) Warm Cherry (WCW) White Maple (WMW)

Metal File + Storage Finishes

Business Grey (BGR) Black Coffee Textured (BKC) Black (BLK) Bone (BNE) Blizzard Textured (BZD) Charcoal (CHR)
 Claret (CLT) Dark Chocolate Textured (DCH) Desert Putty (DPT) Designer White (DWT) Fog (FOG) Grey (GRY)
 Light Grey (LGR) Ice (ICE) Ivory (IVR) Mocha Textured (MCH) Metro (MET) Moss (MOS)
 Nevada (NEV) Navy (NVY) Oyster (OYS) Stonedust Textured (SDT) Storm Grey (SGR) Silver (SIL)
 Sky (SKY) Stone (STN) Taupe (TPE) Tahiti Sand (TSA) Tungsten (TUN) Willow (WIL)

TEXTILES & FINISHES

Solid Wood and Laminate Coordinating Colors

Solid Wood Colors

Absolute (AAM)
 Black (BKM)
 Cherry (ACM)
 Espresso Cafe (ECM)
 Fruitwood (TFM)
 Gray (HGM)
 Honey (AHM)
 Mahogany (TMM)
 Maple (AVM)
 Medium Walnut (MWM)
 Night (ASM)
 Noce Biondo (NBM)
 Noce Grigio (NGM)
 Noce Leggero (NEM)
 Noce Medio (NMM)
 Walnut (TWM)
 WC Cream (WTM)
 White (WHM)
 Winter Cherry (WCM)

Laminate Colors

Absolute Acajou (ACJ)
 Black (BLK)
 Avant Cherry (AWC)
 Dark Espresso (DES)
 Tiger Fruitwood (TFW)
 Hayden Grey (HGT)
 Avant Honey (AWH)
 Quartered Mahogany (QTM)
 Clear Maple (CMB)
 Tiger Walnut (TWL)
 Asian Night (ASN)
 Noce Biondo (NBL)
 Noce Leggero (NEL)
 Noce Leggero (NEL)
 Noce Medio (NML)
 Tiger Walnut (TWL)
 White Chocolate (WHC)
 Designer White (DWT)
 Winter Cherry (WCR)

DRIFT TABLE FINISHES COORDINATION CHART			
HPL TOP FINISH		COORDINATING WOOD BASE FINISH	
ACJ**	Absolute Acajou	AAM	Absolute
ASN**	Asian Night	ASM	Night
AWC**	Avant Cherry	ACM	Cherry
AWH**	Avant Honey	AHM	Honey
BLK**	Black	BKM	Black
CMB**	Clear Maple	AVM*	Maple
DES**	Dark Espresso	ECM	Espresso Cafe
DWT**	Designer White	WHM	White
HGT	Hayden Grey	HGM	Grey
NBL**	Noce Biondo	NBM	Noce Biondo
NEL**	Noce Leggero	NEM	Noce Leggero
NGL**	Noce Grigio	NGM	Noce Grigio
NML**	Noce Medio	NMM	Noce Medio
QTM**	Quartered Mahogany	TMM	Mahogany
TFW**	Tiger Fruitwood	TFM	Fruitwood
TWL**	Tiger Walnut	TWM	Walnut
WCR**	Winter Cherry	WCM	Winter Cherry
WHC**	White Chocolate	WTM	WC Cream
WHE**	Walnut Heights	MWM	Medium Walnut
HPL TOP FINISHES WITH NO COORDINATING WOOD BASE FINISHES		WOOD BASE FINISHES WITH NO COORDINATING HPL TOP FINISHES	
BRC**	Brushed Cobalt	EOM	English Oak
SOG**	Storm Grey	NLW	Natural Walnut
WGY**	Willow Grey	SKM	Shaker Cherry
**Chrome base models are available for all HPL Top Finishes			

Please note that these finishes are coordinating and not exact matches. Please reach out to your Global Sales Representative for physical samples of finishes prior to ordering.

COM and Graded-In Textiles:

Global will evaluate the textile to determine its possible use on our furniture. An approved COM or Graded-In textile does not warrant or guarantee the performance of the textile. Any warranty claims for this upholstery material will fall to the original vendor of the fabric, Global will not be responsible for costs associated with recovering or replacement.

COM Approval and Ordering Instructions

All COM requests must be submitted to Global for preliminary approval prior to acceptance of an order. Approval signifies only such material can be applied to the products they are intended. Approval does not constitute any responsibility nor any warranty on behalf of Global as to the appearance, behavior or durability of the COM or COL.

To confirm a COM textile is applicable for a Global seating product

1. Reference the [Global Textile Search](#) tool to verify if your COM has already been evaluated for application.
2. Fill out the COM Authorization form and send it to comrequest@globalfurnituregroup.com
3. If the manufacturer of the textile is **NOT** part of our Alliance Textile Partnership, send a fabric sample (minimum 3" x 3") and copy of the authorization form for evaluation to:

Ship 3x3	Global Furniture Group
Sample to:	COM Sample Review Department
	17 West Stow Road
	Marlton, NJ 08053

Global Alliance partners include ArcCom, Architex, CF Stinson, CTL Prescott Leather, DesignTex, EnviroLeather, Green Hides, Knoll Textiles, LUUM, Maharam, Momentum Textiles, Mayer, Morbern and Ultrafabrics

4. An approved COM email will be sent indicating the textile approval, the required yardage and the Global orderable number.
5. To order, submit furniture order with noted orderable textile number to Global Furniture Group.
6. Order required textile yardage from textile manufacturer:

Ship Fabric	See textile approval	Include on PO to Mill:	<ul style="list-style-type: none"> • Request Global orderable textile number be included on shipping slip • Attach Approved COM form
Yardage to:	form for factory address		

COM orders will be scheduled for production only upon receipt of production yardage.

COM Application

In the absence of any application instructions, Global will apply the textile in what it determines to be the best manner and cannot be held responsible after upholstering. Excess COM materials will be discarded at the discretion of Global unless otherwise instructed by the customer at the time the order is placed.

COM Yardage Requirements

Upon approval of the submitted COM, Global will provide yardage requirements for the product model submitted. Yardage requirements shown in the List Price Book are based on plain, non-directional, 54" wide textile that is being cut up the roll. If the COM is to be railroaded, please note on the COM Authorization form.

The following chart is provided as a budgeting tool for our customers to estimate costs associated with yardage purchase. Final yardage requirement is evaluated and provided by Global on the final approval form. Global is not responsible where additional materials must be ordered.

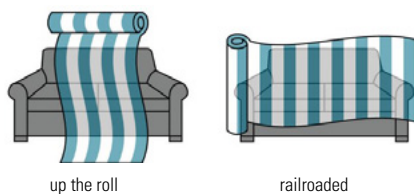

up the roll

railroaded

For 2-way repeats, ranges are calculate by using the higher repeat . (i.e if the repeat is 13v x 15h you would use 15h to calculate the extra yardage needed).

Repeat	Horizontal repeat	Vertical repeat	2-Way repeat in 2 directions
1/4" - 5"	Add 10%	Add 15%	Add 15%
6" - 9"	Add 15%	Add 18%	Add 20%
10" - 13"	Add 30%	Add 35%	Add 40%
14" - 19"	Add 45%	Add 55%	Add 60%

Sealed Seams (Vinyl textile only):

This process increases the strength and integrity of the seam for Vinyl textiles, providing additional protection against moisture penetration through the seam and can prevent insects from entering the interior of the upholstered piece through the seams.

Testing must be conducted on every Vinyl textile and approval must be confirmed prior to acceptance of an order requesting sealed seams. When sealed seams are requested on the COM form, and if the vinyl textile is not an alliance partner, please contact Customer Care on where to submit the 1 yard of material needed for evaluation.

Note: Moisture barrier is not an option in conjunction with sealed seams.

C.O.M. AUTHORIZATION FORM

CUSTOMER INFORMATION

To be completed by the dealer/design firm. Please review COM instructions. Incomplete information may delay or prevent approval.

A+D/Dealer/Company Name:			Contact:		
Billing Address:			Phone:		
City:	State:	Zip:	Email:		
End-User/Project Name:			End-User/Project Registered? YES NO If YES, The Global Quote#:		
Local Global Distribution Center:			Date:		

TEXTILE APPLICATION INFORMATION - ONE TEXTILE PER FORM

SEATING MODEL NUMBER	QUANTITY	FULL CHAIR	SEAT ONLY	BACK, ARMS ONLY	SPECIAL INSTRUCTIONS (PLEASE INCLUDE DRAWING)

Textile Name (Series/Style #):		
Textile Color Name and Description:		
Mill or Manufacturer's Name:		
Textile Content (% Cotton, % Poly, % Wool, etc.):		
Textile Width:	Pattern Repeat: VERTICAL:	HORIZONTAL:
Rail Roaded? YES NO	Sealed Seams? (Vinyl only-may req. add'l yardage + testing) YES NO	

TEXTILE DIRECTION



STAPLE FABRIC TO THIS FORM IN THE DIRECTION IN WHICH THE FABRIC IS TO BE UPHOLSTERED WITH THE TOP OF THIS PAGE BEING THE SAME AS THE TOP OF THE CHAIR.

NEW TEXTILE

Attached textile sample
(Minimum 5" x 5" Max 12" x 12")
In correct DIRECTION and SIDE.

PREVIOUSLY APPROVED TEXTILE

Please email completed form to:
ComRequest@globalfurnituregroup.com

MAIL FORM AND TEXTILE SAMPLE ONLY TO:

GLOBAL - COM Department
17 West Stow Road
Marlton, NJ 08053 | 856.596.3390

Please contact your local GLOBAL Distribution Center for status of all COM requests. When textile is approved and an authorization number issued, a set of shipping instructions will be faxed or emailed to you.

Approved textiles are to be shipped to the address that will be included with instructions. Do not ship textiles to the address on this form. Dealer is responsible for the shipping expenses. Brokerage fees will be paid for by Global. However, duties imposed by North American Governments related to textile materials, content and Country of Origin, additional fees may apply and will be billed separately.

Please Note: C.O.M Textiles may not be shipped without shipping documents. GLOBAL is not responsible for any material shipped without the authorization number.

Please be advised that Global has phased out the use of textiles that contain certain Phthalates, including but not limited to: DEHP (di (2-ethylhexyl) phthalate), DBP (di-n-butyl phthalate), BBP (butyl benzyl phthalate) and DINP (di-isononyl phthalate) (collectively the "Listed Chemicals"). The Listed Chemicals are used in certain types of vinyls. Global cannot accept orders for textiles that contain the Listed Chemicals, if such orders are to be shipped to the U.S.A. or are intended for customer in the U.S.A. If you are not sure if the C.O.M you have selected contains the Listed Chemicals, please contact the manufacturer or supplier of the fabric to verify.

GLOBAL AUTHORIZATION FORM (TO BE COMPLETED BY GLOBAL)

CAN#: _____	TEXTILE YARDAGE (REQUIRED FOR THE ORDER): _____	GU CODE: _____
-------------	---	----------------

THINK GLOBAL / THINK GREEN



LEVEL 3 CERTIFIED
Many programs in various categories



LEED PARTNERSHIP PROGRAM
Products can help you earn credits



GREENGUARD CERTIFIED
Gold

THE ENVIRONMENT We believe now more than ever, that it is our responsibility to protect the environment and our precious natural resources for future generations. The growing importance of energy and environmental concerns continues to challenge us in this ever changing marketplace.

As an industry leader, Global continues to take proactive steps towards reducing the negative impacts on the environment. We are building "healthier" offices; investing in Research & Development and new technologies; reducing waste and the consumption of energy; and improving the quality of the air we breathe, all which can have a significant impact on our quality of life.



Epoxy Powder coating process is solvent free. No harmful VOC's or lead. No toxins are released into the atmosphere.

Global's recycled fabrics offer affordable, environmentally responsible alternatives to commercial textiles. We recycle 35,000 lbs of fabric offcuts weekly.



powder paint process:
98% paint recovery and reuse

more recycled fabric
less to the landfill

talk to us about our
leed partnership program

we've diverted
90% of our wood waste from landfill in four years



Global has the products and resources to help your projects achieve LEED certification.

New technology allows us to reduce glue usage by 50%. In addition, our polyurethane glue reduces emissions and requires less energy to apply.



TERMS & CONDITIONS

This illustrated price list has been designed to facilitate fast reference and easy use. All products are categorized into "seating", "desks", "files", "panels", "tables" and "modular furniture", and are listed numerically within their categories. The line drawings match actual photographs (where possible) to aid in instant recognition of the total range within a series.

Sales of Global-The Total Office ("Global") products are made only on Global's standard terms and conditions of sale which are contained in this Price Book. These standard terms and conditions may be modified or supplemented only by a separately written document signed by Global's authorized personnel at its head office in Marlton, NJ. Any term or condition contained in any purchase order or other form used by dealer/purchaser to order goods (including standard, printed language) which is different from, in addition to, or in any way inconsistent with Global's standard terms and conditions shall be of no force or effect whatsoever.

All illustrations, specifications and prices in this book are based on the latest product information available at the time of publication. Global reserves the right to make changes, at any time and without prior notice, to prices, colors, materials, specifications and models offered.

Description

Each product shown or described in this price list is standard Global product. Variations are noted at the beginning of each series. Any variations from what is standard may require additional delivery time and cost and may affect the warranty given. Sizes and weights shown are approximate and are subject to slight changes from time to time.

Prices and Payment

The prices shown in this book, as well as those quoted by Global, are in United States dollars for orders shipped to destinations in the U.S. and Mexico.

If shipping date requested is more than 90 days from date of order, Global shall have the right to use published list prices effective at the time of shipment.

Orders are invoiced at the time of shipment. Terms of payment are net 30 days from date of invoice (1% 15 days) unless otherwise stated. The customer agrees that Global shall have the right to enforce a charge amounting to 1.5% per month (18% per year) on invoices outstanding more than 30 days.

If dealer/purchaser's most recent annual net volume is less than \$5,000.00, payment must be made in advance.

Any products sold by Global shall remain the personal property of Global until fully paid.

Prices are suggested list prices only and are subject to change without notice. Global will, however, attempt to keep dealer/purchasers up-to-date on all developments including price changes.

Taxes

All prices shown in this book are exclusive of sales, use, excise and other applicable taxes and are the dealer/purchaser's responsibility as per the invoice issued by Global. If dealer/purchaser claims an exemption from such taxes, it shall be the dealer/purchaser's responsibility to furnish Global with an appropriate exemption certificate at time of order.

Ordering Information

To avoid errors and/or duplication Global requires that all orders be submitted in writing. All orders submitted to Global in writing will be acknowledged on Global's acknowledgement forms governing the transaction. The details appearing

on this acknowledgement will describe the items to be shipped and the approximate shipping date. It is the dealer/purchaser's responsibility to determine that the information in the acknowledgement is correct. In the event of an error, the dealer/purchaser must notify Global immediately by telephone followed by written confirmation. Shipping dates are assigned to orders based on the item having the longest manufacturing lead time.

When ordering, please provide the following information:

- 1) Account number (if possible)
- 2) P.O. number
- 3) "Bill to" and "ship to" name and address
- 4) Complete model number
- 5) Description
- 6) Options:
 - a. Upholstery fabric type and color (specify by name and number)
 - b. Color of paint finish, laminate or wood (if applicable)
 - c. Trim options (frame)
 - d. Arms
 - e. Base, Casters
 - f. Mechanism
 - g. Accessories

Dealer/purchaser is responsible for providing correct information when placing an order. Orders with incorrect information (finish, etc.) will be scheduled for manufacturing upon receipt of complete information.

All phone orders must be confirmed in writing by the customer within 7 days.

To prevent a delay in processing orders, please specify delivery routing.

Changes and Cancellations

After the date of Global's acknowledgement of a dealer/purchaser's order, the order may not be changed or cancelled by dealer/purchaser without the written consent of Global. Special order items, C.O.M. and fabric-covered items already in production are not subject to change or cancellation under any circumstances. Fabric-covered items are considered to be in production once the fabric is scheduled for cutting. Other standard items already in production are subject to a minimum 35% cancellation charge.

Errors and Omissions

All quotations, acknowledgements and invoices are subject to corrections for any errors and omissions.

FINISHES

Seating Finishes

Where painted frames are not a standard color, there is a one time charge of \$613 list price per-order for custom wood staining/color matching. Restrictions may apply. The customer must provide a 3" x 3" color chip/sample. Non-standard finishes must be approved by Global prior to acceptance of order.

File Finishes

All non-standard finishes must be approved by Global prior to acceptance of order and may be subject to an upcharge.

Laminated Tops - Pricing for all non-standard finishes and sizes must be provided by Global Customer Service and may be subject to an upcharge.

Desk Finishes

Because the distinctive characteristics and the nature of wood products cause variations, exact matches are not always possible.

Global has launched a finishes program between marketing companies within the Global Group to match products as best as possible when same finishes are specified.

C.O.M. (Customers Own Material)

Use of Customer's Own Material must be approved by Global prior to acceptance of order. Please refer to page 431 of the Price Book and fill out the Authorization Request Form. Photocopy and use this form as often as necessary. The customer must provide a 12" x 12" fabric sample and advise how the fabric is to be applied. **Fabric yardage requirement will be advised by the factory, and additional yardage may be required if pattern requires matching.** Yardage shown in the List Price Book does not allow for pattern repeat/matching. Send to the address provided on shipping document upon approval from Global. If C.O.M. is difficult to apply or if product shall be modified, extra charges shall be made. Global reserves the right to cancel an order at any time if C.O.M. is inadequate for any reason. Customer's Own Material must be shipped freight and duties paid to our factory. Such shipment must be fully identified with purchaser's order number, RGA # provided by Global, and the item for which material is intended. Performance of C.O.M. when applied to product is the sole responsibility of the purchaser. Global's standard product warranty shall not apply to C.O.M. Use of C.O.M. will not reduce the published list price.

Textile Grading

All products are priced according to their standard fabric and fabric grade. Lower grade fabrics are available (unless otherwise specified) at same price as standard.

The listing of prices for each model indicates the prices for higher upholstery grades. Prices are based on yardage in imperial measurements.

TEXTILE PRICE GRADES - GLOBAL TEXTILES

Grade	Upholstery (Seating Fabrics)
1	Carrera, Fusion, Hudson, Jenny, Quilt, Terrace, Urban, Waterfall
2	Allante FRee, Elevate, Etch, GC Linen, Imprint, Luxhide, Match, Release, Replay, Silhouette
3	Couture
6	Novaro Genuine Leather
Grade	Upholstery (Panel Fabrics)
2	Lola
3	Anchorage, Merge

The charts above do not include Textiles offered by Alliance Partners: Arc-Com Fabrics, CF Stinson, Designtex, Knoll Textiles, Green Hides, LDI Interiors, Luum Textiles, Maharam, Mayer Fabrics, Momentum, and Ultrafabrics.

Upholstery Coverings

Slight variations in color may occur between dye lots. Although Global attempts to minimize these variances, they do occur and must be accepted as normal and will not be considered defects.

Yardage

Required yardage (ydg) is based on unmatched materials with widths of 54" for seating, 63" for GPS panels. Yardage calculations are based on imperial measurements.

Arms

A wide selection of arms are available for some series. See Arm Charts for details.

Delays

Global's shipping confirmation will state a shipping date which is Global's best estimate at the time the order is acknowledged. However, Global shall not incur any obligation or liability to Purchaser for failure to ship by specified date unless Global has agreed to an unequivocal shipping date in a separately signed written document executed by its authorized personnel at its head office. In addition, Global shall not be liable for any loss or damage resulting from any delay or failure in shipment or other failure to perform all or any part of the agreement between the parties with respect to the goods shown on the face of the order acknowledgement where such delay, failure, loss or damage is the proximate result of any act of any governmental authority or political subdivision thereof, revolution, riot, civil disorder or disturbance, delay or default in transportation, strike disputes among or between labor unions or other labor disputes, delay or inability in obtaining materials and facilities, fire, flood, act of God or any cause not within the reasonable control of the company, whether of the class of causes enumerated or otherwise.

F.O.B.

F.O.B. point is Global's Factory, Downsview, Ontario, Canada, or any Global Regional Distribution Center.

UPS Shipments

Seating products marked with a UPS symbol are packaged for UPS-able shipments.

Handling

A \$25. net handling charge per shipment will be applied for non UPS-able orders of less than \$2000. list.

Special Delivery Requirements

Global's delivered pricing provides for dock delivery during normal business hours (considered to be 8 am to 4 pm Monday through Friday) to customer/end user only. Additional delivery requirements such as inside delivery, lift gate, limited access sites, installations and weekend deliveries will incur an additional expense and will be the responsibility of the dealer.

Service

Service requests are normally the responsibility of Global's authorized dealers. Where this cannot be accomplished on a local level, service problems should be referred to Global's Customer Service Department in the nearest distribution center.

Returns

No returns of goods will be accepted without written consent and shipping instruction of Global. A minimum re-stocking charge of 35% is made on all authorized returns for credit or refund, provided goods are received by Global in the condition in which they left the factory. This may increase depending on the type of product. Global's Return Goods Authorization (R.G.A.) numbers must appear prominently on all authorized returns. Global will not be responsible for freight costs. No

credit will be given if goods cannot be reused as new. Special order items, non-stock items and C.O.M. products are in no event subject to return. All returns must be approved and authorized in writing by Global Customer Service. Global reserves the right to refuse delivery of any unauthorized returns.

Claims

All goods are sold F.O.B. plant or Global Distribution Center. Global is not responsible for damage which occurs in transit (or in storage). The carrier signs for all goods received in apparently good order. It is the dealer/purchaser's responsibility to examine goods upon receipt and to file any claims with the carrier for losses or damage to the product occurring during transit, including concealed damage.

Any claims made against Global for apparent defects, errors or shortages must be made by the dealer/purchaser, in writing, within 15 working days after any delivery. Failure by the dealer/purchaser to make any claim against Global within 15 days shall constitute acceptance of the goods and a waiver of any apparent defects, errors or shortages.

Suspension

In the event that the dealer/purchaser defaults in the payment of any sum due to Global, or in the event the dealer/purchaser's financial condition becomes unsatisfactory to Global, Global shall have the right to defer or discontinue shipment of any goods until such time as the default is cured or the dealer/purchaser provides assurance of payment to Global.

Copyright

All catalogs, photographs, drawings, price lists and other printed material are protected by copyright. All rights reserved.

Trademarks

All trademarks are owned by GlobalFurniture Group other than OBUSFORME™ which is owned by OBUSFORME LTD. and are used under license. OBUSFORME® and the distinctive backrest design are registered trademarks of OBUSFORME LTD.

Designs and Patents

Many of the products produced by Global are protected by design registrations, design patents and/or patents. Design and specifications are subject to change, discontinuance or additions without notice.

Cubic Measure

The stated cubage is an approximate cubic foot measure to calculate freight costs. The figure shown is the volume for one carton and is subject to change without notice. It is most economical to purchase the specified number per carton.

Combined Shipments

Global will make every effort to combine shipments and orders on written request. However, Global cannot be held responsible where such request is not complied with.

Offer of Sale

Possession of this price list or any other literature shall not imply the company's willingness to sell to the holder and shall not be construed as a direct offer of sale.

If a conflict arises between: (i) prices found in software support packages furnished to the customer by Global or by any other source on behalf of Global; and (ii) Global's current printed price lists, then the most current shall prevail.

Disclaimer

All dimensions are in inches. Prices shown are current manufacturer's suggested list prices at the time of printing. All applicable taxes are extra. Descriptions, specifications and prices are subject to change without notice. Errors and omissions are subject to correction.

Flammability

The foam used in Global chairs meets the requirements of California TB117. In addition to the foam, upholstery materials must also meet the California TB117 smolder resistant requirements. Please contact Customer Care to determine if a selected textile meets the California TB117 requirement.

This list price book is effective as of January 1, 2022.

For periodic updates, please check the PDF at www.globalfurnituregroup.com/resources. Global warrants that all commercial products are free from defects in material and workmanship, for the life of the product, to the original purchaser.

LIFETIME WARRANTY

Global will repair or replace, at Global's option, as the sole remedy for any defect covered by the warranty. The warranty applies to products manufactured after March 22, 2016.

Global makes no warranty that any of its products are suitable for any particular purpose and makes no other warranties, express or implied, other than those set out here. As codes and standards vary from one jurisdiction to another, references to compliance are solely for convenience and without any representation as to accuracy or suitability. Users must verify the suitability of such information or product for their specific application. In no event shall Global be liable in either tort or contract for any loss or direct, special, incidental, consequential, or exemplary damages. The warranty applies to single shift, standard commercial usage, defined as a standard eight (8) hour day, forty (40) hour week for users weighing up to 300 pounds.

General Commercial Seating

Global's warranty for general commercial seating covers all chair components including pneumatic cylinders, bases, casters, glides, frames, arms, plastic seats, backs and other structural components.

Exceptions to the warranty for general commercial seating are as follows:

- Foam, textiles (as sampled on Global branded and textile program cards), mesh material and electrical devices, are warranted for five (5) Years
- Control mechanisms are warranted for twelve (12) Years
- Heavy duty seating and Indoor/Outdoor Furniture are not defined as General commercial seating (see below for warranty exceptions)

Heavy Duty Seating

Global offers products designed for multiple shift applications (24 hours a day / 7 days a week) and larger individuals weighing up to 400, 500 and/or 600 pounds (depending on series and/or model). Global warrants these products for twelve (12) years to the original purchaser. All components (including control mechanisms, pneumatic cylinders, bases, casters, glides, frames, arms, plastic seats/backs, etc.) are covered for 24/7 applications under the warranty. The exceptions are foam, upholstery and textiles, which are covered for five (5) years. Fabric or upholstery material on these products must exceed 100,000 double rubs for the textile portion of the warranty to apply. Heavy Duty product series that apply under this warranty can be found in the Heavy Duty section of this list price book.

Outdoor Furniture

Global offers products designed for use indoors or outdoors. Global warrants these products for three (3) years to the original purchaser. This warranty applies to single shift (eight (8) hour day, forty (40) hour week) for users weighing up to 275 pounds, unless noted otherwise. Outdoor furniture must be stored indoors during inclement or extreme weather such as extreme cold, extreme heat, or excessive wind.

Exceptions to the warranty for indoor/outdoor furniture is as follows:

- Only Global branded textiles and Alliance Partner carded textile program materials expressly identified for outdoor application are covered for three (3) years when used outdoors.

Global's Warranty does not apply (for any product category) to the following:

- Products not purchased directly from authorized Global resellers
- Nominal or normal amount of wear and tear that can occur over time
- Failures which result from negligence, abuse, accident or misuse
- Failure to apply, install or maintain products according to Global's written instructions and warnings
- Modifications, attachments or repair methods not approved by Global
- Damage caused by a carrier in transit, or delivery/installation contractors
- The matching of colors, grains or textures (wood, leather, etc.) of natural materials
- Products exposed to extreme hot or cold temperatures or excessively dry or humid environments
- Colorfastness or the matching of color of textiles, dye lots of textile can vary
- Damage by markings or staining; damage by sharp objects or imprinting from instruments
- Damage to textiles or laminate and wood surfaces/edges from exposure to sunlight (including UV rays)
- Products used for rental purposes
- Purchased parts are warranted for one (1) year
- Failure to follow specific cleaning and disinfecting instructions posted on globalfurnituregroup.com

Seating Warranty Summary

Seating Type	Components Warranty For Original Purchaser	Use Time For Warranty Coverage	Exceptions
General Commercial Seating	Lifetime	8 Hours/5 Days Per Week	Foam/Upholstery/Textiles/Mesh/Electrical Devices - 5 Years Control Mechanisms - 12 Years
Heavy Duty Seating	12 Years	24 Hours/7 Days Per Week	Foam/Upholstery/Textiles - 5 Years
Indoor/Outdoor Furniture	3 Years	8 Hours/5 Days Per Week	Outdoor Use Textiles – 3 Years

Textiles

Global warrants Global branded textiles and Alliance Partner carded textile programs inclusive of fabrics, vinyls and leather products for five (5) years. Global does not warrant COM (Customer Own Materials) or graded-in materials (non-carded) and purchased by Global for a customer. For graded-in or COM products, please contact the textile supplier for performance information and warranty details. Please refer to our website at globalfurnituregroup.com for detailed information on cleaning and disinfecting procedures. Improper usage of disinfecting/cleaning products may void the warranty.

Global textiles and finishes are updated periodically to meet the demand and trends of the market. As a result, some textiles and finishes may be discontinued by Global or the manufacturer. In the event that a textile or finish is discontinued, Global will make every reasonable effort to provide an alternative product(s) of comparable function.

Files, Desks, Modular Furniture, Tables, Panels & Accessories

Global warrants all components of metal storage and filing, laminate and wood veneer desks, laminate and wood veneer tables, metal leg components and panels for the lifetime of the product to the original purchaser.

The warranty applies to single shift, standard commercial usage, defined as a standard eight (8) hour day, forty (40) hour week. Load restrictions apply, refer to individual product descriptions.

Exceptions to the warranty for files/desks/tables and panels are as follows:

- Electrical devices, panel and tackboard textiles, adjustable keyboard mechanisms, non-electrical table mechanisms, monitor arms, lecterns, coat trees and task lights - five (5) years
- Laminate folding tables - one (1) year
- Motorized electrical components - two (2) years

Files, Desks, Modular Furniture, Tables, Panels & Accessories Warranty Summary

Product Type	Components Warranty For Original Purchaser	Exceptions
Metal storage and filing	Lifetime	none
Laminate/wood veneer desks and modular furniture	Lifetime	tackboard textiles, electrical devices, task lights - 5 years
Boardroom, conference and training tables	Lifetime	electrical devices - 5 years moving parts - 5 years
Panels	Lifetime	panel textiles, electrical devices, task lights - 5 years
Coat racks and lecterns	5 years	none
Folding tables (laminate & molded)	1 year	none
Height adjustable tables	5 years	motorized parts (on electrical tables) - 2 years

Global's Warranty does not apply (for any product category) to the following:

- Products not purchased directly from authorized Global resellers
- Nominal or normal amount of wear and tear that can occur over time
- Failures which result from negligence, abuse, accident or misuse
- Failure to apply, install or maintain products according to Global's written instructions and warnings
- Modifications, attachments or repair methods not approved by Global
- Damage caused by a carrier in transit, or delivery/installation contractors
- The matching of colors, grains or textures (wood, leather, etc.) of natural materials
- Products exposed to extreme hot or cold temperatures or excessively dry or humid environments
- Colorfastness or the matching of color of textiles, dye lots of textile can vary
- Damage by markings or staining; damage by sharp objects or imprinting from instruments
- Damage to textiles or laminate and wood surfaces/edges from exposure to sunlight (including UV rays)
- Products used for rental purposes
- Purchased parts are warranted for one (1) year
- Failure to follow specific cleaning and disinfecting instructions posted on globalfurnituregroup.com

Global's warranty does not cover the costs of transportation or labor. Repair or replacement will be at Global's option.

Global makes no warranty that any of its products are suitable for any particular purpose and makes no other warranties, express or implied, other than those set out here. As codes and standards vary from one jurisdiction to another, references to compliance are solely for convenience and without any representation as to accuracy or suitability. Users must verify the suitability of such information or product for their specific application. In no event shall Global be liable in either tort or contract for any loss or direct, special, incidental, consequential, or exemplary damages.

Global's warranty applies to products sold within the United States of America, Mexico, the Commonwealth of Puerto Rico and Canada.

Global US Headquarters/Distribution Center

17 West Stow Road, P.O. Box 562
 Marlton, New Jersey U.S.A. 08053
 T (856) 596-3390
 T (800) 220-1900

A \$25 net handling charge per shipment
 will be applied for non-UPSable orders of
 less than \$2,000 list.

Showrooms**Atlanta**

10 10th Street
 Suite 150
 Atlanta, GA 30309
 T (404) 879-0998

Boston

One Harbor Street
 Suite 104
 Boston, MA 02210
 T (617) 406-5435

Chicago

222 Merchandise
 Mart Plaza
 10th Floor, Suite 1035
 Chicago, IL 60654
 T (312) 755-0843

Miami

112 NE 41st Street
 6th floor
 Miami, FL 33137

New York City

386 Park Avenue South
 7th floor
 New York, NY 10016
 T (212) 545-9900

Philadelphia

1735 Market Street
 38th Floor
 Philadelphia PA, 19103
 T (215) 861-0963

New Jersey (Southern)

119 West Greentree Road
 Marlton, NJ 08053
 T (856) 596-3390

Phoenix

4675 E Cotton Center Blvd.
 Suite 165
 Phoenix, AZ 85040
 T (602) 426-0666
 T (602) 426-0777

Washington, DC

1130 Connecticut Avenue
 10th Floor, Suite 1000
 Washington, DC 20036
 T (202) 659-0230
 T (202) 659-0236

Distribution Centers**Atlanta Area**

6715 Maple Ave.
 Suite 100
 Buford, GA 30518
 T (678) 602-4130

Baltimore Area

Troy Hill
 Corporate Center
 7030 Troy Hill Drive
 Elkridge, MD 21075
 T (410) 379-8021

Boston Area

19 Connector Road
 Unit 1
 Andover, MA 01810
 T (978) 470-8463

Chicago Area

27W501 North Ave.
 Suite 300
 West Chicago, IL 60185
 T (630) 681-2818

Cincinnati Area

8712 LeSaint Drive
 Fairfield, OH 45014
 T (513) 777-0009

Dallas Area

2025 West Beltline Road
 #100
 Carrollton, TX 75006
 T (972) 236-1366

Denver Area

16401 East 33rd Drive
 Suite 50
 Aurora, CO 80011
 T (303) 340-1617

Ft. Lauderdale Area

560 Sawgrass
 Corporate Pkwy
 Sunrise, FL 33325
 T (954) 846-8888

Houston Area

7865 Northcourt Road
 Suite 200
 Houston, TX 77040
 T (713) 695-5777

Los Angeles Area

3629 Workman Mill Road
 Whittier, CA 90670
 T (562) 484-9686

Seattle Area

Oakesdale Commerce Ctr.
 820 Southwest 34th Street
 Building W7, Suite A
 Renton, WA 98057
 T (425) 291-9282

Kansas City Area

11617 West 81st Street
 Lenexa, KS 66214
 T (913) 310-9963

Tampa Area

10351 Windhorst Road
 Tampa, FL 33619
 T (813) 621-6272

