



# evolve systems



**ISO 14001:2004 Registered**  
CGSB #006b



**level**™  
the BIFMA sustainability standard  
SCS-SCF0245-4  
SCS-SCF0245-4

## PROTECTING THE ENVIRONMENT FOR FUTURE GENERATIONS

Our environmental success story began with the challenge to create an office system that would meet today's business requirements while maintaining a firm commitment to save and protect the environment.

Sustainability became a part of the creative focus and development of Evolve that incorporates the latest technology and design features to provide excellent performance at a competitive price.

As government and industry environment ratings such as LEEDS & Greenguard become more prevalent, Evolve offers designers and architects functional, attractive, and economical office designs that meet these standards.

Evolve is a leader in reducing waste in the manufacturing of its products as well as utilizing recycled materials wherever possible. We make extensive use of recycled plastic and wood waste from other Global factories.

Evolve is committed to the continuous improvement of our environmental systems, the prevention of pollution, and to comply with both the spirit and the letter of all relevant environmental legislation.

Evolve Panels are 100% recyclable at the end of their lifespan. Nothing from an Evolve Panel needs to end up in a landfill.

## PRODUCT INFORMATION

Evolve offers fabrics that are made from 100% recycled polyester, which means less waste going to landfills. These fabrics also reduced the demand for petroleum products, and decrease the environmental impacts of processing those petroleum products into polyester.

Evolve has developed a Panel interior made from 100% recycled wood and polypropylene. Through innovative design and technology, Evolve utilizes waste that would have normally been sent to landfill.

Evolve Panels are insulated with Roxul, a mineral wool insulation made from slag, an inert steel by-product, and basalt rock. Roxul is a high density product that provides maximum sound absorption to reduce noise in the work environment. Roxul insulation is fire resistant, water repellent and will not support the growth of fungi or mildew.

Evolve's epoxy powder coating process involves no liquids and is solvent free. It contains no harmful VOC's or lead. Up to 99% of over sprayed powdered is reclaimed, mixed with virgin powder and reused.

**BEAM**

**Power Beam**

- All metal components are painted with environmentally friendly epoxy powder.
- Raceway Interiors are coated with recycled epoxy powder.
- The entire Evolve Power Beam and the processes used to manufacture it are designed to save and protect the environment. Evolve panels are made from recycled materials and are 100% recyclable.
- Components conform to CGSB and ANSI/BIFMA Standards
- The quality and performance level of these panels have been tested to equal or exceed the requirements of the U.S. Government.
- Power Beam has a steel frame and is 2 7/8" thick. Corner posts create a panel creep of 3 1/4".
- Leveling Glides extend 1 1/2" high.

**Power Beam Options**

- Power Beams are available in the following heights: 24", 30", and 36".
- Module widths come in seven (7) sizes: 36", 42", 48", 54", 60", 66" and 72"
- Straight, 90 Degree & 120 Degree

**Extension Module Options**

- Acoustic Fabric (Tackable), Glazed, Open, Laminate, Whiteboard,, Air Flow.
- Attaches to the top of the Power Beam or another extension module (not to exceed 42"h above finished floor).
- Offered in 6", 12", and 18" heights
- Can be stacked up to 42" high above the finished floor (A.F.F.)

**Beam Reconfiguration**

- Extension Modules can be modified on site by replacing fabric modules with Glazed, Open, Laminate, Whiteboard or Air Flow at any time after the initial installation.
- Fabric can be replaced easily; using pre-cut segments of fabric, a drawstring (C-Jex) is sewn in around the edges. Then a rubber spline is used to 'screen' the fabric in place.

**VOICE/DATA AND ELECTRICAL POWER**

- NOTE: Panels and Electric components are CSA/UL approved. Tools are not required to install electrical in the Power Beam.

**Electric Information**

- Electric can be run in all three Power Beam heights (24"h, 30"h or 36"h)
  - 8-Wire, 4-Circuit Capability
  - 2 Utility + 2 Dedicated Circuits
  - 10 Gauge (oversized) Neutrals
- All circuits can support up to 20 amps (15 CSA)
- Contact Evolve customer care for additional wiring options.

**Raceway Information**

- Raceway knockouts sizes conform to the ANSI/TIA/EIA Furniture Opening Standard of 1.38" x 2.71".
- Power Beam raceway is available at 36"- 72" wide.
- 36"- 60" - 2 electric / 1 data on each side.
- 66" & 72" - 4 electric / 1 data on each side. (When specifying 4 duplexes on one side 2 i-connectors are required per side.)
- Standard data face mount plates can be used without the need of adapter plates (supplied by others).
- **Cabling Capacities** (calculations below are based on .25" diameter communication cables.)
- **Power Modules**
  - Without Electric – 65 Cables
  - With Electric – 54 Cables
- **Panel Connectors - 90 Degree Connector Posts**
  - Without Electric – 45 cables
  - With Electric – 25 Cables

**WORK TABLES**

**Freestanding Tables**

- Foli height adjustable (23" or 29"d)
- Bungee (20", 24" or 30"d)
- Junction (20", 24" or 30"d)
- 2gether (18" or 24"d)

- **Power Beam is a freestanding beam system and does not support attachment of an Evolve brackets or overhead storage including cantilevers or other support brackets.**

**WARRANTIES AND PERFORMANCE**

- A Lifetime Warranty
- Non Obsolescence Warranty
- Reduced cost of assembly and reconfiguration
- ISO9001:2000 Registered
- ISO14001:2004 Registered
- GreenGuard Certified
- ANSI/BIFMA CGSB testing on all products
- For piece of mind over the long term, we cover you with a comprehensive warranty that is supported by our dealer network.
- Some installation companies claim that the Evolve Panels System can be installed in half the time it takes to install most of our competitor's segmented panels. This cost saving can amount to thousands of dollars over the lifetime of our furniture.
- Your assurance of consistent quality to an international standard. Evolve Systems is committed to design, manufacture and distribute superior quality office furniture, which meets or exceeds the requirements of our customers.
- Confirmation that Evolve is committed (1) to providing product that, through their entire life cycle, minimize negative environmental impacts on the environment, (2) to continuous improvement to our environmental systems and programs and (3) to comply to all relevant environmental legislation and regulations.
- Evolve Systems can help a company meet LEED requirements for office furniture.
- Evolve components are tested to the highest standard in the industry. This is your assurance of quality and longevity.



**TECHNICAL FEATURES OF POWER BEAM:**

- Evolve Power Beam is 2 7/8" thick.
- An aluminum low profile top cap is included with Power Beams.
- Power Beam will accommodate 65 .25" diameter communication cables without electrical or 54 .25" diameter communication cables with electrical.
- 90-degree post extension accommodates 45 .25" diameter communication cables without electrical and 25 .25" diameter communication cables with electric.
- Raceway knockout openings are 1.38" x 2.71".

**BASIC FEATURES OF POWER BEAM:**

- Power Beam is available in three (3) heights: 24"h, 30"h and 36"h; and seven (7) widths: 36"w, 42"w, 48"w, 54"w, 60"w, 66"w and 72"w.
- There is no panel creep in a straight Beam-to-Beam configuration; however, a corner post (2, 3, 4 way) will add 3.25" inches to a beam run.

**BASIC FEATURES OF EXTENSION MODULES:**

- Extension modules stack on the top of a Power Beam or another extension module (maximum height - 42"h, above finished floor).
- Fabric extension modules may have different fabrics on opposite sides within the same grade with no up-charge.
- If different grades of fabric are used on one module, the entire modules will be priced utilizing the fabric with the highest grade.

**GENERAL WARRANTY INFORMATION:**

- Panel and tackboard textiles, adjustable keyboard mechanisms, tasklights and electrical devices = ten (10) Years
- Other parts = Lifetime Warranty

# POWER BEAM

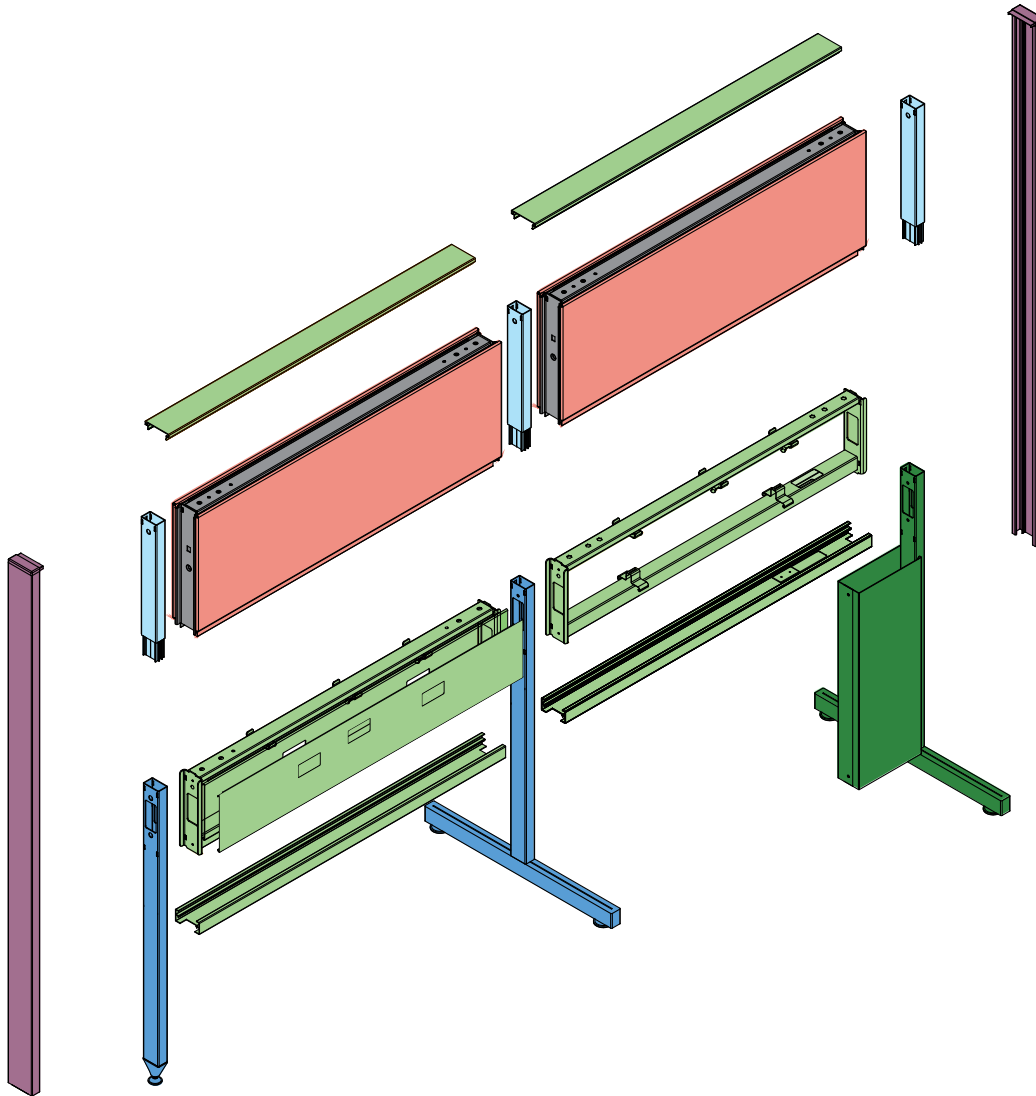

**POWER BEAM  
RACEWAY**



**VERTICAL  
BASE INFEED  
COVER**



**LEGS**



**EXTENSION  
MODULE  
CONNECTOR**



**EXTENSION  
MODULE**



**END OF RUN  
TRIM**

## EXTENSION MODULE MATERIALS

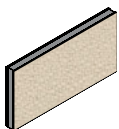

**FABRIC**



**LAMINATE**

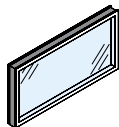

**GLASS**



**WRITE BOARD**

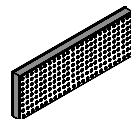

**AIRFLOW**

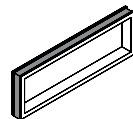

**OPEN**

**EVPBE - 6" HIGH POWER BEAM KIT WITH ELECTRICAL CUTOUT FOR BASE INFEED (36"W TO 60"W)**

- Power beam with bottom cut out (on one end) for base infeed
- Aluminum top trim and bottom trim included
- Bottom trim has a cut out on one side for electrical access and a bracket to connect to the vertical base infeed cover (ordered separately)
- Vertical base infeed cover with support leg ordered separately

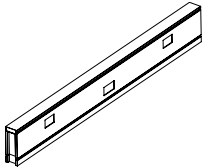
DESCRIPTION	PRODUCT CODE	LIST PRICE LP	DIMENSIONS/INCHES		
			H	W	D
	EVPBE36	272	6	36	2 7/8
	EVPBE42	295	6	42	2 7/8
	EVPBE48	321	6	48	2 7/8
	EVPBE54	350	6	54	2 7/8
	EVPBE60	363	6	60	2 7/8

**EVPBE - 6" HIGH POWER BEAM KIT WITH ELECTRICAL CUT OUT FOR BASE INFEED (66"W AND 72"W)**

- Power beam with bottom cut out (on one end) for base infeed
- Aluminum top trim and bottom trim included
- Bottom trim has a cut out on one side for electrical access and a bracket to connect to the vertical base infeed cover (ordered separately)
- Vertical base infeed cover with support leg ordered separately

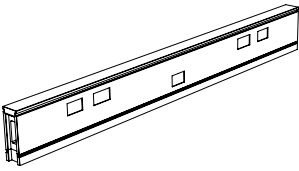
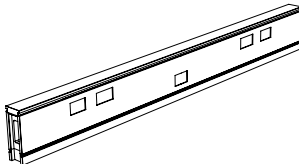
DESCRIPTION	PRODUCT CODE	LIST PRICE LP	DIMENSIONS/INCHES		
			H	W	D
 	EVPBE66	583	6	66	2 7/8
	EVPBE72	607	6	72	2 7/8

**EVPB - 6" HIGH POWER BEAM RACEWAY (36"W TO 60"W)**

- Aluminum top trim and bottom trim included
- No access for base infeed
- Support legs ordered separately

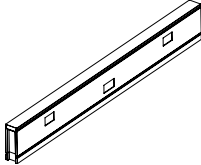
DESCRIPTION	PRODUCT CODE	LIST PRICE LP	DIMENSIONS/INCHES		
			H	W	D
	EVPB36	260	6	36	2 7/8
	EVPB42	277	6	42	2 7/8
	EVPB48	302	6	48	2 7/8
	EVPB54	329	6	54	2 7/8
	EVPB60	344	6	60	2 7/8

**EVPB - 6" HIGH POWER BEAM RACEWAY (66"W AND 72"W)**

- 66" Power Beam Kit consists of (1) 30" Power Beam and (1) 36" Power Beam Inline connector and hardware included
- 72" Power Beam Kit consists of (1) 36" Power Beam and (1) 36" Power Beam with bottom cut out for a base feed. Inline connector and hardware included
- One piece aluminum top trim and one piece aluminum bottom trim included
- No access for base infeed
- Support legs ordered separately

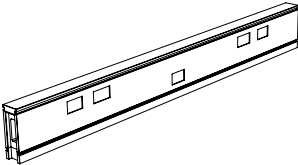
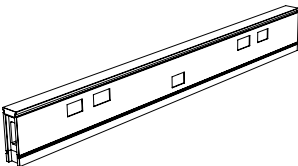
DESCRIPTION	PRODUCT CODE	LIST PRICE LP	DIMENSIONS/INCHES		
			H	W	D
	EVPB66	553	6	66	2 7/8
	EVPB72	574	6	72	2 7/8

**EVPBEP - POWER BEAM WITH ELECTRICAL CUT OUT FOR PASS THROUGH CABINET**

- Power beam with electrical cut out for base feed from pass though cabinet
- Aluminum top trim included
- 60" Power beam kit includes two 30" power distribution housing (EVE8PD30) and jumper cable (EVE8CP17)
- 72" Power beam kit includes two 36" power distribution housing (EVE8PD36) and jumper cable (EVE8CP17)
- Provides two duplex receptacle per panel side
- Power beam base feed to be ordered separately
- Power Beam Storage cabinet with pass through needs to be ordered separately (EVPBSCGDP or EVPBSCP) See page 34

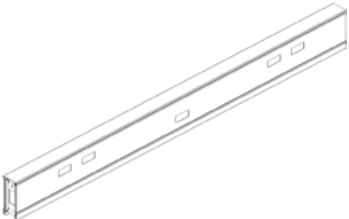
DESCRIPTION	PRODUCT CODE	LIST PRICE LP	DIMENSIONS/INCHES		
			H	W	D
	EVPBEP60KIT	898	6	60	2 7/8
	EVPBEP72KIT	1191	6	72	2 7/8

**NOTE: To be used with cable pass through cabinet**

**EVPBEP - POWER BEAM WITH ELECTRICAL CUT OUT FOR PASS THROUGH CABINET**

- Power beam with electrical cut out for base feed from pass through cabinet
- Aluminum top trim included
- 60" Power beam kit includes two 30" raceway covers per side
- 72" Power beam kit includes two 36" raceway covers per side
- 60" Power beam kit includes two 30" power distribution housing (EVE8PD30) and jumper cable (EVE8CP17)
- 72" Power beam kit includes two 36" power distribution housing (EVE8PD36) and jumper cable (EVE8CP17)
- Provides four duplex receptacle per panel side
- Power beam base feed to be ordered separately
- Power Beam Storage cabinet with pass through be ordered separately (EVPBSCGDP or EVPBSCP)

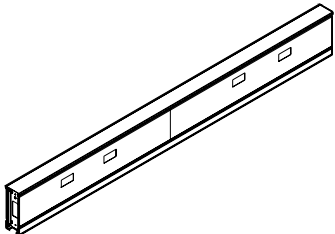
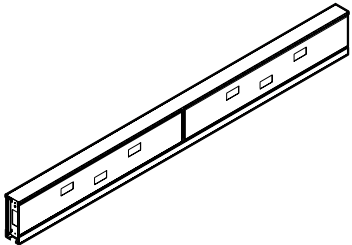
DESCRIPTION	PRODUCT CODE	LIST PRICE LP	DIMENSIONS/INCHES		
			H	W	D
	EVPBEP60KIT01	921	6	60	2 7/8
	EVPBEP72KIT01	1191	6	72	2 7/8

**NOTE: To be used with cable pass through cabinet**

**EVPBFCL - VERTICAL BASE INFEEED COVER INCLUDING SUPPORT LEG WITH FOOT**

- Connects to Power Beam Kit with electrical cut out
- Includes vertical cover and slotted connector support leg with foot
- Power Beam kit with electrical cut out ordered separately
- Base infeed ordered separately

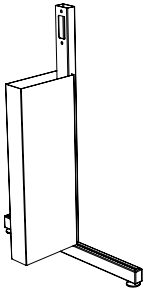
DESCRIPTION	PRODUCT CODE	LIST PRICE LP	DIMENSIONS/INCHES		
			H	W	D
	EVPBFCL24	220	24	6	18
	EVPBFCL30	247	30	6	18
	EVPBFCL36	271	36	6	18





# VERTICAL BASE INFEED COVER W/LEG FOR NY POWER BOX ENTRY / SUPPORT LEGS

## EVPBFBGXXNY - VERTICAL COVER WITH GLIDE FOR NY BOX POWER ENTRY

- Connects to Power Beam Kit with electrical cut out.
- Includes vertical covers and slotted connector with glide base.
- End of run trim below power beam included.
- Power Beam with electrical cut out to be ordered separately.



DESCRIPTION	PRODUCT CODE	LIST PRICE LP	DIMENSIONS/INCHES		
			H	W	D
	EVPBFCG24NY	185	24	6	2 7/8
	EVPBFCG30NY	211	30	6	2 7/8
	EVPBFCG36NY	237	36	6	2 7/8

## EVPBL - POWER BEAM CONNECTOR SUPPORT LEG WITH FOOT

- Connects two Power Beams in a straight run.
- 24" h -- 18" open to floor
- 30" h -- 24" open to floor
- 36" h -- 30" open to floor

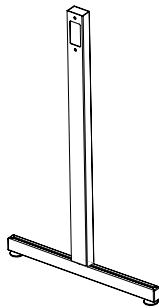

DESCRIPTION	PRODUCT CODE	LIST PRICE LP	DIMENSIONS/INCHES		
			H	W	D
	EVPBL24	109	24	18	
	EVPBL30	115	30	18	
	EVPBL36	120	36	18	

## EVPBLFF - POWER BEAM LEG WITH FLAT FOOT

- Connects two Power Beams on equal height.
- Includes connector with flat foot, connecting hardware.
- Note: Leg has to be used next to Post legs with glides. When specifying please keep sequence post leg with glide, leg with flat foot, post leg with glide. Only post legs with glide provides adjustment for leveling power beams run.

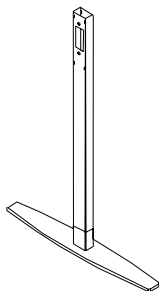

DESCRIPTION	PRODUCT CODE	LIST PRICE LP	DIMENSIONS/INCHES		
			H	W	D
	EVPBLFF24	129	24	21	
	EVPBLFF30	136	30	21	
	EVPBLFF36	145	36	21	

# SUPPORT LEGS

## EVPBSL - POWER BEAM SINGLE LEG

- Connects two Power Beams in a straight run.
- Includes non slotted connector with leg, glides and connecting hardware
- For one sided Power beam application
- Laminate end panels must be attached to single leg at end of power beam run for stability
- Laminate end panels to be ordered separately

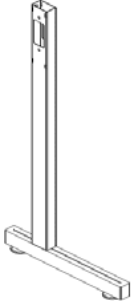
DESCRIPTION	PRODUCT CODE	LIST PRICE LP	DIMENSIONS/INCHES		
			H	W	D
	EVPBSL24	109	24	15	
	EVPBSL30	115	30	15	
	EVPBSL36	120	36	15	

## EVPBCB - POWER BEAM CONNECTOR SUPPORT LEG WITH GLIDE

- Connects two Power Beams in a straight run.
- 24" h -- 18" open to floor
- 30" h -- 24" open to floor
- 36" h -- 30" open to floor

DESCRIPTION	PRODUCT CODE	LIST PRICE LP	DIMENSIONS/INCHES		
			H	W	D
	EVPBGICB24	73	24	2	
	EVPBGICB30	80	30	2	
	EVPBGICB36	85	36	2	

## EVPB24CPA - ONE WAY POST WITH T LEG FOR 24" H POWER BEAM

- One way post attaches to end of power beam run
- Post and connecting hardware add 3.25" to power beam run
- Includes post, power beam T leg, post with trim all around, levelling glide, hardware and trim kit
- Includes two floor mount plates to secure post to floor

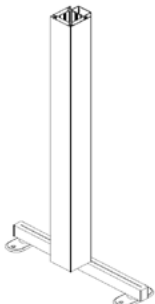
DESCRIPTION	PRODUCT CODE	LIST PRICE LP	DIMENSIONS/INCHES		
			H	W	D
	EVPB24CPA124	341	24	3	2 7/8
	EVPB24CPA130	361	30	3	2 7/8
	EVPB24CPA136	374	36	3	2 7/8
	EVPB24CPA142	424	42	3	2 7/8

**EVPB30CPA - ONE WAY POST WITH T LEG FOR 30" H POWER BEAM**

- One way post attaches to end of power beam run
- Post and connecting hardware add 3.25" to power beam run
- Includes post, power beam T leg, post with trim all around, levelling glide, hardware and trim kit
- Includes two floor mount plates to secure post to floor

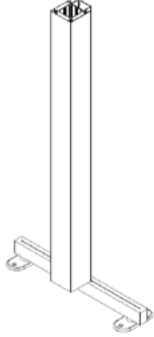
DESCRIPTION	PRODUCT CODE	LIST PRICE LP	DIMENSIONS/INCHES		
			H	W	D
	EVPB30CPA130	361	30	3	2 7/8
	EVPB30CPA136	374	36	3	2 7/8
	EVPB30CPA142	424	42	3	2 7/8

**EVPB36CPA - ONE WAY POST WITH T LEG FOR 36" H POWER BEAM**

- One way post attaches to end of power beam run
- Post and connecting hardware add 3.25" to power beam run
- Includes post, power beam T leg, post with trim all around, levelling glide, hardware and trim kit
- Includes two floor mount plates to secure post to floor

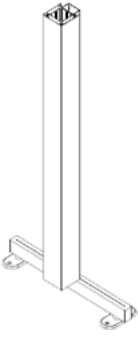
DESCRIPTION	PRODUCT CODE	LIST PRICE LP	DIMENSIONS/INCHES		
			H	W	D
	EVPB36CPA136	374	36	3	2 7/8
	EVPB36CPA142	424	42	3	2 7/8

**EVPBCEPLA - POWER BEAM 2 WAY CORNER POST**

- Connects two power beams of equal height in 90 degree configuration
- Post and connecting hardware add 3.25" to power beam run
- Includes one post, two nonslotted power beam connectors, post with trim all around, levelling glide, hardware and trim kit

DESCRIPTION	PRODUCT CODE	LIST PRICE	DIMENSIONS/INCHES		
			H	W	D
	EVPBCEPLA224	175	24	3	3
	EVPBCEPLA230	181	30	3	3
	EVPBCEPLA236	190	36	3	3

**EVPBCEPLA - POWER BEAM 3 WAY CORNER POST**

- Connects three power beams of equal height in 90 degree configuration
- Post and connecting hardware add 3.25" to power beam run
- Includes one post, three nonslotted power beam connectors, post with trim all around, levelling glide, hardware and trim kit

DESCRIPTION	PRODUCT CODE	LIST PRICE	DIMENSIONS/INCHES		
			H	W	D
	EVPBCEPLA324	192	24	3	3
	EVPBCEPLA330	200	30	3	3
	EVPBCEPLA336	209	36	3	3

**EVPBCEPLA - POWER BEAM 4 WAY CORNER POST**

- Includes one post, four nonslotted power beam connectors, post with trim all around, levelling glide, hardware and trim kit
- Connects four power beams of equal height in 90 degree configuration
- Post and connecting hardware add 3.25" to power beam run

DESCRIPTION	PRODUCT CODE	LIST PRICE	DIMENSIONS/INCHES		
			H	W	D
	EVPBCEPLA424	229	24	3	3
	EVPBCEPLA430	246	30	3	3
	EVPBCEPLA436	252	36	3	3

**EVPBCIPLA - POWER BEAM INLINE 2 WAY CORNER POST**

- Connects two power beams of equal height in inline configuration
- Post and connecting hardware add 3.25" to power beam run
- Includes one post, two nonslotted power beam connectors, post with trim all around, levelling glide, hardware and trim kit

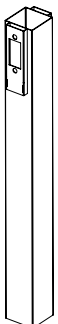
DESCRIPTION	PRODUCT CODE	LIST PRICE	DIMENSIONS/INCHES		
			H	W	D
	EVPBCIPLA224	175	24	3	3
	EVPBCIPLA230	181	30	3	3
	EVPBCIPLA236	190	36	3	3

**EVPB24CPA - PANEL TO 24" H POWER BEAM 2 WAY CORNER POST**

- Connects one panel and one 24" H power beam in 90 degree configuration
- Includes post, panel connectors and power beam connectors, post with trim all around, levelling glide, hardware and trim kit
- Post and connecting hardware add 3.25" to power beam run
- Pass thru only for power beam

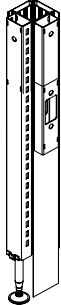
DESCRIPTION	PRODUCT CODE	LIST PRICE LP	DIMENSIONS/INCHES		
			H	W	D
	EVPB24CPA230	178	30	3	3
	EVPB24CPA236	219	36	3	3
	EVPB24CPA242	219	42	3	3

**EVPB30CPA - PANEL TO 30" H POWER BEAM 2 WAY CORNER POST**

- Connects one panel and one 30" H power beam in 90 degree configuration
- Includes post, panel connectors and power beam connectors, post with trim all around, levelling glide, hardware and trim kit
- Post and connecting hardware add 3.25" to power beam run
- Pass thru only for power beam

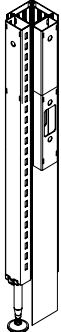
DESCRIPTION	PRODUCT CODE	LIST PRICE	DIMENSIONS/INCHES		
			H	W	D
	EVPB30CPA230	178	30	3	3
	EVPB30CPA236	219	36	3	3
	EVPB30CPA242	219	42	3	3

**EVPB36CPA - PANEL TO 36" H POWER BEAM 2 WAY CORNER POST**

- Connects one panel and one 36" H power beam in 90 degree configuration
- Includes post, panel connectors and power beam connectors, post with trim all around, levelling glide, hardware and trim kit
- Post and connecting hardware add 3.25" to power beam run
- Pass thru only for power beam

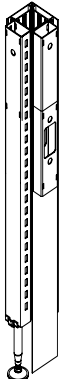
DESCRIPTION	PRODUCT CODE	LIST PRICE	DIMENSIONS/INCHES		
			H	W	D
	EVPB36CPA236	219	36	3	3
	EVPB36CPA242	219	42	3	3

# CORNER POST - 90-DEGREE

## EVPB24CPA - PANEL TO 24" H POWER BEAM 3 WAY CORNER POST

- Connects two panels and one 24" H power beam in 90 degree configuration
- Includes post, panel connectors and power beam connectors, post with trim all around, levelling glide, hardware and trim kit
- Post and connecting hardware add 3.25" to power beam run
- Pass thru only for power beam

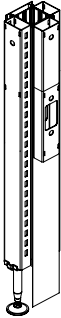
DESCRIPTION	PRODUCT CODE	LIST PRICE LP	DIMENSIONS/INCHES		
			H	W	D
	EVPB24CPA330	218	30	3	3
	EVPB24CPA336	283	36	3	3
	EVPB24CPA342	283	42	3	3

## EVPB30CPA - PANEL TO 30" H POWER BEAM 3 WAY CORNER POST

- Connects two panels and one 30" H power beam in T degree configuration
- Includes post, panel connectors and power beam connectors, post with trim all around, levelling glide, hardware and trim kit
- Post and connecting hardware add 3.25" to power beam run
- Pass thru only for power beam

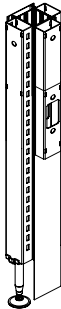
DESCRIPTION	PRODUCT CODE	LIST PRICE	DIMENSIONS/INCHES		
			H	W	D
	EVPB30CPA330	218	30	3	3
	EVPB30CPA336	291	36	3	3
	EVPB30CPA342	291	42	3	3

## EVPB36CPA - PANEL TO 36" H POWER BEAM 3 WAY CORNER POST

- Connects two panels and one 36" H power beams in T degree configuration
- Includes post, panel connectors and power beam connectors, post with trim all around, levelling glide, hardware and trim kit
- Post and connecting hardware add 3.25" to power beam run
- Pass thru only for power beam

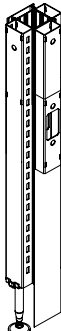
DESCRIPTION	PRODUCT CODE	LIST PRICE	DIMENSIONS/INCHES		
			H	W	D
	EVPB36CPA336	291	36	3	3
	EVPB36CPA342	291	42	3	3

**EVPB24CPA - PANEL TO 24" H POWER BEAM 3 WAY CORNER POST**

- Connects two 24" H power beams with panel in T configuration
- Includes post, panel connectors and power beam connectors, post with trim all around, levelling glide, hardware and trim kit
- Post and connecting hardware add 3.25" to power beam run
- Pass thru only for power beam

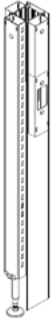
DESCRIPTION	PRODUCT CODE	LIST PRICE LP	DIMENSIONS/INCHES		
			H	W	D
	EVPB24CPA330P	218	30	3	3
	EVPB24CPA336P	291	36	3	3
	EVPB24CPA342P	291	42	3	3

**EVPB30CPA - PANEL TO 30" H POWER BEAM 3 WAY CORNER POST**

- Connects two 30" H power beams with panel in T configuration
- Includes post, panel connectors and power beam connectors, post with trim all around, levelling glide, hardware and trim kit
- Post and connecting hardware add 3.25" to power beam run
- Pass thru only for power beam

DESCRIPTION	PRODUCT CODE	LIST PRICE	DIMENSIONS/INCHES		
			H	W	D
	EVPB30CPA330P	218	30	3	3
	EVPB30CPA336P	291	36	3	3
	EVPB30CPA342P	291	42	3	3

**EVPB36CPA - PANEL TO 36" H POWER BEAM 3 WAY CORNER POST**

- Connects two panels and two 36" H power beams in T configuration
- Includes post, panel connectors and power beam connectors, post with trim all around, levelling glide, hardware and trim kit
- Post and connecting hardware add 3.25" to power beam run
- Pass thru only for power beam

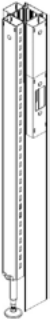
DESCRIPTION	PRODUCT CODE	LIST PRICE	DIMENSIONS/INCHES		
			H	W	D
	EVPB36CPA336P	291	24	3	3
	EVPB36CPA342P	291	30	3	3



**EVPB24CPA - PANEL TO 24" H POWER BEAM 4 WAY CORNER POST**

- Connects two panels and two 24" H power beams in X configuration
- Includes post, panel connectors and power beam connectors, post with trim all around, levelling glide, hardware and trim kit
- Post and connecting hardware add 3.25" to power beam run
- Pass thru only for power beam

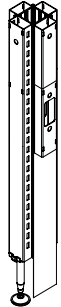
DESCRIPTION	PRODUCT CODE	LIST PRICE LP	DIMENSIONS/INCHES		
			H	W	D
	EVPB24CPA430	268	30	3	3
	EVPB24CPA436	341	36	3	3
	EVPB24CPA442	341	42	3	3

**EVPB30CPA - PANEL TO 30" H POWER BEAM 4 WAY CORNER POST**

- Connects two panels and two 30" H power beams in X configuration
- Includes post, panel connectors and power beam connectors, post with trim all around, levelling glide, hardware and trim kit
- Post and connecting hardware add 3.25" to power beam run
- Pass thru only for power beam

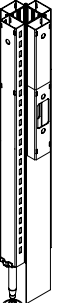
DESCRIPTION	PRODUCT CODE	LIST PRICE	DIMENSIONS/INCHES		
			H	W	D
	EVPB30CPA430	268	30	3	3
	EVPB30CPA436	341	36	3	3
	EVPB30CPA442	341	42	3	3

**EVPB36CPA - PANEL TO 36" H POWER BEAM 4 WAY CORNER POST**

- Connects two panels and two 36" H power beams in X configuration
- Includes post, panel connectors and power beam connectors, post with trim all around, levelling glide, hardware and trim kit
- Post and connecting hardware add 3.25" to power beam run
- Pass thru only for power beam

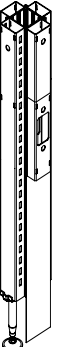
DESCRIPTION	PRODUCT CODE	LIST PRICE	DIMENSIONS/INCHES		
			H	W	D
	EVPB36CPA436	341	24	3	3
	EVPB36CPA442	341	30	3	3

**EVPB6CEPLA - POWER BEAM 2-WAY 120-DEGREE CORNER POST**

- Connects two power beams of equal height in 120 degree configuration
- Includes one post, two nonslotted power beam connectors, post with trim all around, levelling glide, hardware and trim kit

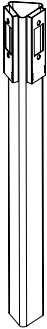
DESCRIPTION	PRODUCT CODE	LIST PRICE	DIMENSIONS/INCHES		
			H	W	D
	EVPB6CEPLA224	203	24	3	3
	EVPB6CEPLA230	209	30	3	3
	EVPB6CEPLA236	219	36	3	3

**EVPB6CEPLA - POWER BEAM 3-WAY 120-DEGREE CORNER POST**

- Connects three power beams of equal height in 120 degree configuration
- Includes one post, three nonslotted power beam connectors, post with trim all around, levelling glide, hardware and trim kit

DESCRIPTION	PRODUCT CODE	LIST PRICE	DIMENSIONS/INCHES		
			H	W	D
	EVPB6CEPLA324	220	24	3	3
	EVPB6CEPLA330	227	30	3	3
	EVPB6CEPLA336	237	36	3	3

**EVPBIEC - EXTENSION CONNECTOR FOR POWER BEAM**

- Attaches to power beam connector
- Includes non slotted extension connector and connecting hardware
- Must be attached to power beam connector with provided screw before installing power beam

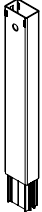
DESCRIPTION	PRODUCT CODE	LIST PRICE	DIMENSIONS/INCHES		
			H	W	D
	EVPBIEC06	49	6	2 7/8	
	EVPBIEC12	49	12	2 7/8	
	EVPBIEC18	58	18	2 7/8	
	EVPBIEC24	58	24	2 7/8	

**EVPBCEPA1 - POWER BEAM CORNER EXTENSION POST 1 WAY**

- Connects at end of a run of extension modules
- Post and connecting hardware add 3.25" to power beam run
- Includes one extension post, one non slotted extension connectors for power beam, connecting hardware and trim kit
- Power Beam Corner Extension Post are not stackable

DESCRIPTION	PRODUCT CODE	LIST PRICE	DIMENSIONS/INCHES		
			H	W	D
	EVPBCEPA106	90	6	3	3
	EVPBCEPA112	90	12	3	3
	EVPBCEPA118	114	18	3	3
	EVPBCEPA124	114	24	3	3

**EVPBCEIPA2 - POWER BEAM INLINE 2 WAY CORNER EXTENSION POST**

- Connects two extension modules in inline configuration
- Post and connecting hardware add 3.25" to power beam run
- Includes one extension post, two non slotted extension connectors for power beam, connecting hardware and trim kit
- Power Beam Corner Extension Post are not stackable

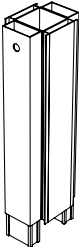
DESCRIPTION	PRODUCT CODE	LIST PRICE	DIMENSIONS/INCHES		
			H	W	D
	EVPBCEIPA206	97	6	3	3
	EVPBCEIPA212	97	12	3	3
	EVPBCEIPA218	158	18	3	3
	EVPBCEIPA224	158	24	3	3

**EVPBCEPA2 - POWER BEAM CORNER EXTENSION POST 2 WAY**

- Connects two extension modules in 90 degree configuration
- Post and connecting hardware add 3.25" to power beam run
- Includes one extension post, two non slotted extension connectors for power beam , connecting hardware and trim kit
- Power Beam Corner Extension Post are not stackable

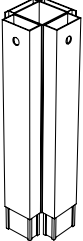
DESCRIPTION	PRODUCT CODE	LIST PRICE	DIMENSIONS/INCHES		
			H	W	D
	EVPBCEPA206	92	6	3	3
	EVPBCEPA212	92	12	3	3
	EVPBCEPA218	145	18	3	3
	EVPBCEPA224	145	24	3	3

**EVPBCEPA3 - POWER BEAM CORNER EXTENSION POST 3 WAY**

- Connects three extension modules in 90 degree configuration
- Post and connecting hardware add 3.25" to power beam run
- Includes one extension post, three non slotted extension connectors for power beam , connecting hardware and trim kit
- Power Beam Corner Extension Post are not stackable

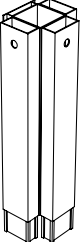
DESCRIPTION	PRODUCT CODE	LIST PRICE	DIMENSIONS/INCHES		
			H	W	D
	EVPBCEPA306	110	6	3	3
	EVPBCEPA312	110	12	3	3
	EVPBCEPA318	170	18	3	3
	EVPBCEPA324	170	24	3	3

**EVPBCEP4 - POWER BEAM CORNER EXTENSION POST 4 WAY**

- Connects four extension modules in 90 degree configuration
- Post and connecting hardware add 3.25" to power beam run
- Includes one extension post, four non slotted extension connectors for power beam connecting hardware and trim kit
- Power Beam Corner Extension Post are not stackable

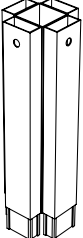
DESCRIPTION	PRODUCT CODE	LIST PRICE	DIMENSIONS/INCHES		
			H	W	D
	EVPBCEP406	127	6	3	3
	EVPBCEP412	127	12	3	3
	EVPBCEP418	187	18	3	3
	EVPBCEP424	187	24	3	3

**EVPB6CEPA1 - POWER BEAM 120 DEGREE CORNER EXTENSION POST 1 WAY**

- Connects one extension module in 120 degree configuration
- Includes one extension post, three non slotted extension connectors for power beam , connecting hardware and trim kit
- Power Beam Corner Extension Post are not stackable

DESCRIPTION	PRODUCT CODE	LIST PRICE	DIMENSIONS/INCHES		
			H	W	D
	EVPB6CEPA124	148	24	3	3

**EVPB6CEPA2 - POWER BEAM 120-DEGREE CORNER EXTENSION POST 2 WAY**

- Connects two extension modules in 120 degree configuration
- Includes one extension post, two non slotted extension connectors for power beam , connecting hardware and trim kit
- Power Beam Corner Extension Post are not stackable

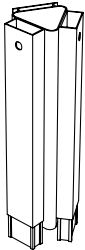
DESCRIPTION	PRODUCT CODE	LIST PRICE	DIMENSIONS/INCHES		
			H	W	D
	EVPB6CEPA206	92	6	3	3
	EVPB6CEPA212	92	12	3	3
	EVPB6CEPA218	142	18	3	3
	EVPB6CEPA224	142	24	3	3

**EVPB6CEP3 - POWER BEAM 120 DEGREE CORNER EXTENSION POST 3 WAY**

- Connects three extension modules in 120 degree configuration
- Includes one extension post, three non slotted extension connectors for power beam , connecting hardware and trim kit
- Power Beam Corner Extension Post are not stackable

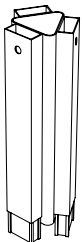
DESCRIPTION	PRODUCT CODE	LIST PRICE	DIMENSIONS/INCHES		
			H	W	D
	EVPB6CEP306	109	6	3	3
	EVPB6CEP312	109	12	3	3
	EVPB6CEP318	170	18	3	3
	EVPB6CEP324	170	24	3	3

**EVPB24CPSANR - NR PANEL TO 24"H POWER BEAM 4 WAY CORNER POST**

- Connects two NR panels and two 24"H power beams in 90 degree configuration
- Post and connecting hardware ad 3.25" to power beam run
- Includes post, panel connectors and power beam connectors, post with trim all around, levelling glide, hardware and trim kit. Pass through only for power beam, power beam leg slotted

DESCRIPTION	PRODUCT CODE	LIST PRICE	DIMENSIONS/INCHES		
			H	W	D
	EVPB24CPSA430NR	267	30	3	3
	EVPB24CPSA436NR	341	36	3	3
	EVPB24CPSA442NR	341	42	3	3

**EVPB30CPSANR - NR PANEL TO 30"H POWER BEAM 4 WAY CORNER POST**

- Connects two NR panels and two 30"H power beams in 90 degree configuration
- Post and connecting hardware ad 3.25" to power beam run
- Includes post, panel connectors and power beam connectors, post with trim all around, levelling glide, hardware and trim kit. Pass through only for power beam, power beam leg slotted

DESCRIPTION	PRODUCT CODE	LIST PRICE	DIMENSIONS/INCHES		
			H	W	D
	EVPB30CPSA430NR	267	30	3	3
	EVPB30CPSA436NR	341	36	3	3
	EVPB30CPSA442NR	341	42	3	3

**EVPB36CPSANR - NR PANEL TO 36"H POWER BEAM 4 WAY CORNER POST**

- Connects two NR panels and two 36"H power beams in 90 degree configuration
- Post and connecting hardware ad 3.25" to power beam run
- Includes post, panel connectors and power beam connectors, post with trim all around, levelling glide, hardware and trim kit. Pass through only for power beam, power beam leg slotted

DESCRIPTION	PRODUCT CODE	LIST PRICE	DIMENSIONS/INCHES		
			H	W	D
	EVPB36CPSA436NR	341	36	3	3
	EVPB36CPSA442NR	341	42	3	3

NOT ON CONTRACT

**EVPB24CPSANR - NR PANEL TO 24"H POWER BEAM 3 WAY CORNER POST**

- Connects NR panels and 24"H power beams in 90 degree configuration
- Post and connecting hardware ad 3.25" to power beam run
- Includes post, panel connectors and power beam connectors, post with trim all around, levelling glide, hardware and trim kit. Pass through only for power beam, power beam leg slotted

DESCRIPTION	PRODUCT CODE	LIST PRICE	DIMENSIONS/INCHES		
			H	W	D
	EVPB24CPSA330NR	217	30	3	3
	EVPB24CPSA336NR	290	36	3	3
	EVPB24CPSA342NR	290	42	3	3

**EVPB24CPSANR - NR PANEL TO 30"H POWER BEAM 3 WAY CORNER POST**

- Connects NR panels and 30"H power beams in 90 degree configuration
- Post and connecting hardware ad 3.25" to power beam run
- Includes post, panel connectors and power beam connectors, post with trim all around, levelling glide, hardware and trim kit. Pass through only for power beam, power beam leg slotted

DESCRIPTION	PRODUCT CODE	LIST PRICE	DIMENSIONS/INCHES		
			H	W	D
	EVPB30CPSA330NR	217	30	3	3
	EVPB30CPSA336NR	290	36	3	3
	EVPB30CPSA342NR	290	42	3	3

**EVPB24CPSANR - NR PANEL TO 36"H POWER BEAM 3 WAY CORNER POST**

- Connects NR panels and 36"H power beams in 90 degree configuration
- Post and connecting hardware ad 3.25" to power beam run
- Includes post, panel connectors and power beam connectors, post with trim all around, levelling glide, hardware and trim kit. Pass through only for power beam, power beam leg slotted

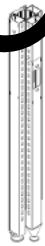
DESCRIPTION	PRODUCT CODE	LIST PRICE	DIMENSIONS/INCHES		
			H	W	D
	EVPB36CPSA336NR	290	36	3	3
	EVPB36CPSA342NR	290	42	3	3

NOT ON CONTRACT

**EVPB24CPSANR - NR PANEL TO 24"H POWER BEAM 2 WAY CORNER POST**

- Connects one NR panel and one 24"H power beam in 90 degree configuration
- Post and connecting hardware ad 3.25" to power beam run
- Includes post, panel connectors and power beam connectors, post with trim all around, levelling glide, hardware and trim kit. Pass through only for power beam, power beam leg slotted



DESCRIPTION	PRODUCT CODE	LIST PRICE	DIMENSIONS/INCHES		
			H	W	D
	EVPB24CPSA230NR	175	30	3	3
	EVPB24CPSA236NR	218	36	3	3
	EVPB24CPSA242NR	218	42	3	3

**EVPB24CPSANR - NR PANEL TO 30"H POWER BEAM 2 WAY CORNER POST**

- Connects one NR panel and one 30"H power beam in 90 degree configuration
- Post and connecting hardware ad 3.25" to power beam run
- Includes post, panel connectors and power beam connectors, post with trim all around, levelling glide, hardware and trim kit. Pass through only for power beam, power beam leg slotted



DESCRIPTION	PRODUCT CODE	LIST PRICE	DIMENSIONS/INCHES		
			H	W	D
	EVPB30CPSA230NR	175	30	3	3
	EVPB30CPSA236NR	218	36	3	3
	EVPB30CPSA242NR	218	42	3	3

**EVPB24CPSANR - NR PANEL TO 36"H POWER BEAM 2 WAY CORNER POST**

- Connects one NR panel and one 36"H power beam in 90 degree configuration
- Post and connecting hardware ad 3.25" to power beam run
- Includes post, panel connectors and power beam connectors, post with trim all around, levelling glide, hardware and trim kit. Pass through only for power beam, power beam leg slotted



DESCRIPTION	PRODUCT CODE	LIST PRICE	DIMENSIONS/INCHES		
			H	W	D
	EVPB36CPSA236NR	218	30	3	3
	EVPB36CPSA242NR	218	36	3	3

NOT ON CONTRACT



**EVPB24CPSANR - NR PANEL TO 24"H POWER BEAM 3 WAY CORNER POST**

- Connects two 24"H power beams with NR panel in "T" configuration
- Post and connecting hardware ad 3.25" to power beam run
- Includes post, panel connectors and power beam connectors, post with trim all around, levelling glide, hardware and trim kit. Pass through only for power beam, power beam leg slotted

DESCRIPTION	PRODUCT CODE	LIST PRICE	DIMENSIONS/INCHES		
			H	W	D
	EVPB24CPSA330PNR	217	30	3	3
	EVPB24CPSA336PNR	290	36	3	3
	EVPB24CPSA342PNR	290	42	3	3

**EVPB30CPSANR - NR PANEL TO 30"H POWER BEAM 3 WAY CORNER POST**

- Connects two 30"H power beams with NR panel in "T" configuration
- Post and connecting hardware ad 3.25" to power beam run
- Includes post, panel connectors and power beam connectors, post with trim all around, levelling glide, hardware and trim kit. Pass through only for power beam, power beam leg slotted

DESCRIPTION	PRODUCT CODE	LIST PRICE	DIMENSIONS/INCHES		
			H	W	D
	EVPB30CPSA330PNR	217	30	3	3
	EVPB30CPSA336PNR	290	36	3	3
	EVPB30CPSA342PNR	290	42	3	3

**EVPB36CPSANR - NR PANEL TO 36"H POWER BEAM 3 WAY CORNER POST**

- Connects two 36"H power beams with NR panel in "T" configuration
- Post and connecting hardware ad 3.25" to power beam run
- Includes post, panel connectors and power beam connectors, post with trim all around, levelling glide, hardware and trim kit. Pass through only for power beam, power beam leg slotted

DESCRIPTION	PRODUCT CODE	LIST PRICE	DIMENSIONS/INCHES		
			H	W	D
	EVPB36CPSA336PNR	290	36	3	3
	EVPB36CPSA342PNR	290	42	3	3

NOT ON CONTRACT

**EVPBGICBS - POWER BEAM SLOTTED CONNECTOR WITH BASE FOR GLIDE**

- Slotted connector allows to attached brackets for worksurfaces
- Connects two power beams on equal height
- Includes slotted connector with glide and connecting hardware

DESCRIPTION	PRODUCT CODE	LIST PRICE	DIMENSIONS/INCHES	
			H	W
	EVPBGICBS24	71	24	2
	EVPBGICBS30	77	30	2
	EVPBGICBS36	84	36	2

Note: Power Beam to be installed in stable configuration using two way posts, three way posts, four way posts to provide support for worksurfaces.

**EVPBLS - POWER BEAM SLOTTED CONNECTOR WITH LEG**

- Slotted connector allows to attached brackets for worksurfaces
- Connects two power beams on equal height
- Includes slotted connector with leg, glides and connecting hardware

DESCRIPTION	PRODUCT CODE	LIST PRICE	DIMENSIONS/INCHES		
			H	W	D
	EVPBLS24	108	24	18	
	EVPBLS30	114	30	18	
	EVPBLS36	119	36	18	

Note: Power Beam to be installed in stable configuration using two way posts, three way posts, four way posts to provide support for worksurfaces.

**EVPBFCGS - VERTICAL BASE POWER BEAM COVER WITH GLIDE**

- Slotted connector allows to attached brackets for worksurfaces
- Connects to electrical cut out power beam
- Includes vertical covers and slotted connector with glide base, end-of-run trim below power beam. Power Beam with electrical cut out to be ordered separately.

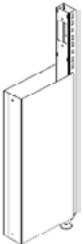
DESCRIPTION	PRODUCT CODE	LIST PRICE	DIMENSIONS/INCHES		
			H	W	D
	EVPBFCGS24	185	24	6	3
	EVPBFCGS30	209	30	6	3
	EVPBFCGS36	238	36	6	3

Note: Power Beam to be installed in stable configuration using two way posts, three way posts, four way posts to provide support for worksurfaces.

NOT ON CONTRACT

**EVPBFCLS - VERTICAL BASE POWER FEED COVER WITH SLOTTED LEG**

- Slotted connector allows to attached brackets for worksurfaces
- Connects to electrical cut out power beam
- Includes vertical covers and slotted connector with leg, end-of-run trim below power beam. Power Beam with electrical cut out to be ordered separately

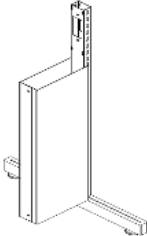
DESCRIPTION	PRODUCT CODE	LIST PRICE	DIMENSIONS/INCHES		
			H	W	D
	EVPBFCLS24	219	24	6	21
	EVPBFCLS30	246	30	6	21
	EVPBFCLS36	271	36	6	21

Note: Power Beam to be installed in stable configuration using two way posts, three way posts, four way posts to provide support for worksurfaces.

**EVPBIEC - EXTENSION CONNECTOR SLOTTED FOR POWER**

- Attaches to power beam connector
- Includes slotted extension connector and connecting hardware
- Must be attached to power beam connector with provided screw before installing power beam

DESCRIPTION	PRODUCT CODE	LIST PRICE	DIMENSIONS/INCHES		
			H	W	D
	EVPBIEC06	49	6	2.875	
	EVPBIEC12	49	12	2.875	
	EVPBIEC18	58	18	2.875	
	EVPBIEC24	58	24	2.875	

**EVPBLERT - END OF RUN TRIM FOR CONNECTOR**

- Finishes exposed connector at the end of a run of Power Beam
- Power Beam connector not included

DESCRIPTION	PRODUCT CODE	LIST PRICE	DIMENSIONS/INCHES		
			H	W	D
	EVPBLERT48	85	45.4	2.875	
	EVPBLERT54	90	51.4	2.875	
	EVPBLERT66	95	63.4	2.875	

Note: Power Beam to be installed in stable configuration using two way posts, three way posts, four way posts to provide support for worksurfaces.

**EVPBGICBM - POWER BEAM CONNECTOR WITH BASE AND CASTOR**

- Connects two power beams on equal height
- Includes connector with castor and connecting hardware
- Castors are lockable
- Laminate end panel with castors must be used at end with T leg for stability

DESCRIPTION	PRODUCT CODE	LIST PRICE	DIMENSIONS/INCHES		
			H	W	D
	EVPBGICB24M	88	25	2	
	EVPBGICB30M	95	31	2	
	EVPBGICB36M	101	37	2	



**NOT ON CONTRACT**

Note: Castors to be locked when power feed is connected to wall outlet. Disconnect power feed from power before moving power beam.

**EVPBLM - POWER BEAM CONNECTOR WITH LEG AND CASTORS**

- Connects two power beams on equal height
- Includes connector with leg, castors and connecting hardware
- Castors are lockable
- Laminate end panel with castors must be used at end for stability

DESCRIPTION	PRODUCT CODE	LIST PRICE	DIMENSIONS/INCHES		
			H	W	D
	EVPBL24M	142	25	18	
	EVPBL30M	147	31	18	
	EVPBL36M	152	37	18	

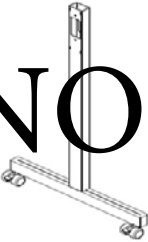

**NOT ON CONTRACT**

Note: Castors to be locked when power feed is connected to wall outlet. Disconnect power feed from power before moving power beam.

**EVPBFCGM - VERTICAL BASE POWER FEED COVER WITH CASTOR**

- Connects to electrical cut out power beam
- Includes vertical covers and connector with castor
- Castors are lockable
- End of run trim below power beam included
- Power beam with electrical cut out to be ordered separately
- Power beam base feed with plug to be used, to be ordered separately
- Laminate end panel with castors must be used at end with T leg for stability

DESCRIPTION	PRODUCT CODE	LIST PRICE	DIMENSIONS/INCHES		
			H	W	D
	EVPBFCG24M	201	25	6	3
	EVPBFCG30M	227	31	6	3
	EVPBFCG36M	255	37	6	3



**NOT ON CONTRACT**

Note: Castors to be locked when power feed is connected to wall outlet. Disconnect power feed from power before moving power beam.

**EVPBFCLM - VERTICAL BASE POWER FEED COVER WITH LEG AND CASTORS**

- Connects to electrical cut out power beam
- Includes vertical covers and connector with leg with castors
- Castors are lockable
- End of run trim below power beam included
- Power beam with electrical cut out to be ordered separately
- Power beam base feed with plug to be used, to be ordered separately
- Laminate end panel with castors must be used at end with T leg for stability

DESCRIPTION	PRODUCT CODE	LIST PRICE	DIMENSIONS/INCHES		
			H	W	D

EVPBFCL24M	255	25	6	21
EVPBFCL30M	279	31	6	21
EVPBFCL36M	306	37	6	21

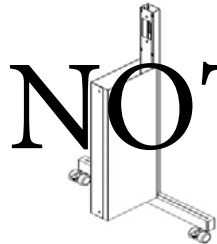

**NOT ON CONTRACT**

Note: Castors to be locked when power feed is connected to wall outlet. Disconnect power feed from power before moving power beam.

**EVPBLEPM - POWER BEAM LAMINATE END PANEL WITH CASTORS**

- Attaches to power beam connector with leg
- Includes brackets to attached to leg
- Finished in thermally fused laminate, if wood grain is selected, grain runs horizontally
- Laminate End Panel height is inclusive of castors

DESCRIPTION	PRODUCT CODE	LIST PRICE	DIMENSIONS/INCHES		
			H	W	D

EVPBLEP2451M	417	25	51	1
EVPBLEP3051M	512	31	51	1
EVPBLEP3651M	613	37	51	1
EVPBLEP4251M	889	43	51	1
EVPBLEP463M	501	25	63	1
EVPBLEP3063M	613	31	63	1
EVPBLEP3663M	728	37	63	1
EVPBLEP4263M	979	43	63	1

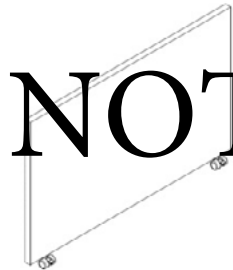

**NOT ON CONTRACT**

Note: Castors to be locked when power feed is connected to wall outlet. Disconnect power feed from power before moving power beam.

**EVE8FR3PBP - POWER ENTRY FOR POWER BEAM WITH PLUG FOR WALL PLATE INFEEED**

- Snaps in to power distribution housing
- Includes 48" long flexible vinyl conduit with Dekko plug
- Includes bracket to attach to Vertical raceway panel
- Power beam with electrical cut out must be ordered
- 71" long base feed will work with 24" and 36" H Power beam
- Power beam base feed with Dekko plug will fit only into wall plate infeed
- Wall plate infeed must be hardwired to source by licensed electrician

DESCRIPTION	PRODUCT CODE	LIST PRICE	DIMENSIONS/INCHES		
			H	W	D

EVE8FR3PBP	344	71		
------------	-----	----	--	--

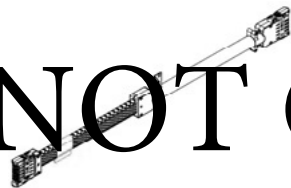

**NOT ON CONTRACT**

Note: Only compatible with wall plate infeed EVE8FR3PBP

**EVE8WPIPB - WALL PLATE INFEEED FOR POWER BEAM WITH DEKKO PLUG**

- Wall plate infeed must be installed and hardwired to source by licensed electrician
- Power beam base feed with Dekko plug to be ordered separately
- Only Power beam base feed with Dekko plug will fit into Wall plate infeed

DESCRIPTION	PRODUCT CODE	LIST PRICE	DIMENSIONS/INCHES		
			H	W	D
	EVE8WPIPB	560	5.25	5.25	1.75

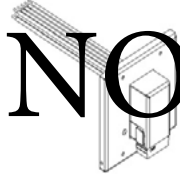

**NOT ON CONTRACT**

Note: Only compatible with power beam base feed with Dekko plug EVE8FR3PBP

**EVE8CP-H - CEILING PASS THRU CABLES WITH WIRE MESH**

- Pass thru cable to connect from ceiling to power beam
- In ceiling connects thru "I" connector to hardwired standard ceiling feed laying in ceiling
- Pass thru cables with wire mesh allows to connect thru ceiling post to Panels, Beltline and Power beam
- "I" connector and standard ceiling feed to be ordered separately

DESCRIPTION	PRODUCT CODE	LIST PRICE	DIMENSIONS/INCHES		
			H	W	D
	EVE8CP120-H	336		120	
	EVE8CP180-H	446		180	
	EVE8CP240-H	554		240	

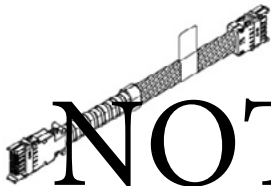

**NOT ON CONTRACT**

Note: Only compatible with wall plate infeed EVE8WPIPB

**EXTENSION MODULES BY MATERIALS**

**Fabric Panel Extension Module**

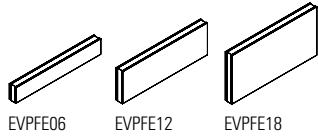

**Tempered Glass Panel Extension Module**

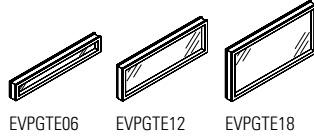

**Write Board Extension Module - Single Sided**



**Write Board Extension Module - Double Sided**



**Laminate Extension Module - Single Sided**

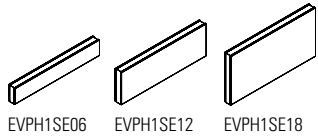

**Laminate Extension Module - Double Sided**

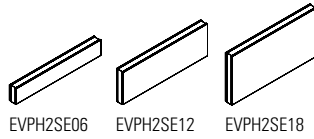

**Air Flow Extension Module**

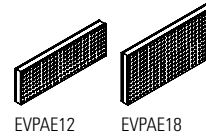

**Privacy Glass**

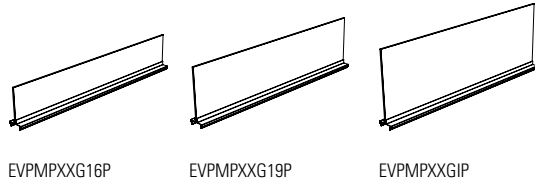

**PET Felt**





When ordering Beam Extension Modules, Inline Extension Connectors (EVPIEC) must be ordered separately. Please see EVPBIEC for details.

Inline Extension Connectors for Power Beam connect two Beam Extension Modules of equal height in a straight run.

Extension connectors do **not** provide support for hang-on storage components.

**EVPFE - FABRIC PANEL EXTENSION MODULE**

- Attaches on top of a panel.
- Modules can be stacked to add privacy or divide space.
- Each side of the fabric module may have a different fabric within the same grade at no charge.
- Panel Extension Modules cannot install higher than 42" high above finished floor.
- If different grades of fabric are used on one module, the entire module must be priced at highest grade.
- When ordering Panel Extension Modules, additional connectors are required.
- Fabric on 66" and 72" wide fabric panel extension modules is applied railroaded. Any connecting beams in other widths should be specified with railroaded fabric as well to match.
- \*Top Trims are not included with Extension Modules.

	DESCRIPTION	PRODUCT CODE	LIST PRICE		DIMENSIONS/INCHES		
			Gr1	Gr2	H	W	D
	Fabric Panel Extension Module - 6" High	EVPFE0636	228	246	6	36	2 7/8
		EVPFE0642	258	273	6	42	2 7/8
		EVPFE0648	277	298	6	48	2 7/8
		EVPFE0654	299	320	6	54	2 7/8
		EVPFE0660	321	348	6	60	2 7/8
		EVPFE0666	341	370	6	66	2 7/8
	Fabric Panel Extension Module - 12" High	EVPFE1236	228	246	12	36	2 7/8
		EVPFE1242	258	273	12	42	2 7/8
		EVPFE1248	277	298	12	48	2 7/8
		EVPFE1254	299	320	12	54	2 7/8
		EVPFE1260	321	348	12	60	2 7/8
		EVPFE1266	341	370	12	66	2 7/8
	Fabric Panel Extension Module - 18" High	EVPFE1836	291	318	18	36	2 7/8
		EVPFE1842	319	354	18	42	2 7/8
		EVPFE1848	349	385	18	48	2 7/8
		EVPFE1854	378	419	18	54	2 7/8
		EVPFE1860	411	455	18	60	2 7/8
		EVPFE1866	443	490	18	66	2 7/8
	Fabric Panel Extension Module - 24" High	EVPFE2436	291	318	24	36	2 7/8
		EVPFE2442	319	354	24	42	2 7/8
		EVPFE2448	349	385	24	48	2 7/8
		EVPFE2454	378	419	24	54	2 7/8
		EVPFE2460	411	455	24	60	2 7/8
		EVPFE2466	443	490	24	66	2 7/8
		EVPFE2472	472	525	24	72	2 7/8



**EVPGTE - TEMPERED GLASS PANEL EXTENSION MODULE**

- Attaches on top of beam.
- Modules can be stacked to add privacy or to divide space.
- Panel Extension Modules cannot install higher than 42”h above finished floor
- Standard in clear (CLR) or smoked glass (SMK) as an option.
- Frosted Glass (FRST) 20% upcharge. Contact EVOLVE Customer Support for details.
- When ordering Panel Extension Modules, additional connectors are required.
- \*Top Trims are not included with Extension Modules.

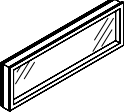
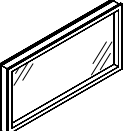
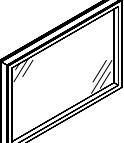
	DESCRIPTION	PRODUCT CODE	LIST PRICE	DIMENSIONS/INCHES		
				H	W	D
	Tempered Glass Panel Extension Module - 6" High	EVPGTE0636	481	6	36	2.78
		EVPGTE0642	588	6	42	2.78
		EVPGTE0648	656	6	48	2.78
		EVPGTE0654	717	6	54	2.78
		EVPGTE0660	773	6	60	2.78
		EVPGTE0666	828	6	66	2.78
		EVPGTE0672	887	6	72	2.78
	Tempered Glass Panel Extension Module - 12" High	EVPGTE1236	481	12	36	2.78
		EVPGTE1242	588	12	42	2.78
		EVPGTE1248	656	12	48	2.78
		EVPGTE1254	717	12	54	2.78
		EVPGTE1260	773	12	60	2.78
		EVPGTE1266	828	12	66	2.78
		EVPGTE1272	887	12	72	2.78
	Tempered Glass Panel Extension Module - 18" High	EVPGTE1836	641	18	36	2.78
		EVPGTE1842	726	18	42	2.78
		EVPGTE1848	813	18	48	2.78
		EVPGTE1854	882	18	54	2.78
		EVPGTE1860	946	18	60	2.78
		EVPGTE1866	1009	18	66	2.78
		EVPGTE1872	1077	18	72	2.78
	Tempered Glass Panel Extension Module - 24" High	EVPGTE2436	641	24	36	2.78
		EVPGTE2442	726	24	42	2.78
		EVPGTE2448	813	24	48	2.78
		EVPGTE2454	882	24	54	2.78
		EVPGTE2460	946	24	60	2.78
		EVPGTE2466	1009	24	66	2.78
		EVPGTE2472	1077	24	72	2.78

**EVPW1SE - WRITE BOARD EXTENSION MODULE - SINGLE SIDED**

- Attaches on top of a beam.
- Provides writing surface on one side and fabric on the other side.
- Modules can be stacked to add privacy or to divide space.
- Panel Extension Modules cannot install higher than 42" high above finished floor.
- When ordering Beam Extension Modules, additional connectors are required.
- \*Top Trims are not included with Extension Modules.

	DESCRIPTION	PRODUCT CODE	LIST PRICE		DIMENSIONS/INCHES		
			Gr1	Gr2	H	W	D
	Write Board Extension Module - Single Sided 6" High	EVPW1SE0636	371	381	6	36	2 7/8
		EVPW1SE0642	420	425	6	42	2 7/8
		EVPW1SE0648	457	469	6	48	2 7/8
		EVPW1SE0654	515	527	6	54	2 7/8
		EVPW1SE0660	542	554	6	60	2 7/8
		EVPW1SE0666	567	578	6	66	2 7/8
		EVPW1SE0672	627	636	6	72	2 7/8
	Write Board Extension Module - Single Sided 12" High	EVPW1SE1236	371	381	12	36	2 7/8
		EVPW1SE1242	420	425	12	42	2 7/8
		EVPW1SE1248	457	469	12	48	2 7/8
		EVPW1SE1254	515	527	12	54	2 7/8
		EVPW1SE1260	542	554	12	60	2 7/8
		EVPW1SE1266	567	578	12	66	2 7/8
		EVPW1SE1272	627	636	12	72	2 7/8
	Write Board Extension Module - Single Sided 18" High	EVPW1SE1836	404	418	18	36	2 7/8
		EVPW1SE1842	453	469	18	42	2 7/8
		EVPW1SE1848	497	514	18	48	2 7/8
		EVPW1SE1854	541	558	18	54	2 7/8
		EVPW1SE1860	582	602	18	60	2 7/8
		EVPW1SE1866	625	647	18	66	2 7/8
		EVPW1SE1872	668	690	18	72	2 7/8
	Write Board Extension Module - Single Sided 24" High	EVPW1SE2436	404	419	24	36	2 7/8
		EVPW1SE2442	453	471	24	42	2 7/8
		EVPW1SE2448	497	516	24	48	2 7/8
		EVPW1SE2454	541	558	24	54	2 7/8
		EVPW1SE2460	582	603	24	60	2 7/8
		EVPW1SE2466	625	651	24	66	2 7/8
		EVPW1SE2472	668	693	24	72	2 7/8

**EVPW2SE - WRITE BOARD EXTENSION MODULE - DOUBLE SIDED**

- Attaches on top of a panel.
- Provides writing surface on two sides.
- Modules can be stacked to add privacy or to divide space.
- Panel Extension Modules cannot install higher than 42" above finished floor
- When ordering Panel Extension Modules, additional connectors are required.
- \*Top Trims are not included with Extension Modules.

DESCRIPTION	PRODUCT CODE	LIST PRICE	DIMENSIONS/INCHES		
			H	W	D
 Write Board Extension Module - Double Sided - 6"High	EVPW2SE0636	422	6	36	2 7/8
	EVPW2SE0642	479	6	42	2 7/8
	EVPW2SE0648	534	6	48	2 7/8
	EVPW2SE0654	616	6	54	2 7/8
	EVPW2SE0660	632	6	60	2 7/8
	EVPW2SE0666	646	6	66	2 7/8
	EVPW2SE0672	730	6	72	2 7/8
Write Board Extension Module - Double Sided - 12"High	EVPW2SE1236	422	12	36	2 7/8
	EVPW2SE1242	479	12	42	2 7/8
	EVPW2SE1248	534	12	48	2 7/8
	EVPW2SE1254	616	12	54	2 7/8
	EVPW2SE1260	632	12	60	2 7/8
	EVPW2SE1266	646	12	66	2 7/8
	EVPW2SE1272	730	12	72	2 7/8
Write Board Extension Module - Double Sided - 18"High	EVPW2SE1836	515	18	36	2 7/8
	EVPW2SE1842	582	18	42	2 7/8
	EVPW2SE1848	649	18	48	2 7/8
	EVPW2SE1854	718	18	54	2 7/8
	EVPW2SE1860	784	18	60	2 7/8
	EVPW2SE1866	849	18	66	2 7/8
	EVPW2SE1872	918	18	72	2 7/8
Write Board Extension Module - Double Sided - 24"High	EVPW2SE2436	515	24	36	2 7/8
	EVPW2SE2442	582	24	42	2 7/8
	EVPW2SE2448	649	24	48	2 7/8
	EVPW2SE2454	718	24	54	2 7/8
	EVPW2SE2460	784	24	60	2 7/8
	EVPW2SE2466	849	24	66	2 7/8
	EVPW2SE2472	918	24	72	2 7/8

**EVPH1SE - LAMINATE EXTENSION MODULE - SINGLE SIDED**

- Attaches on top of a beam.
- Laminate module provides a durable, washable surface on one side and fabric on the other side.
- Modules can be stacked to add privacy or to divide space.
- Panel Extension Modules cannot install higher than 42”h above finished floor.
- When ordering Panel Extension Modules, additional connectors are required.
- Available in high pressure laminate finishes only.
- \*Top Trims are not included with Extension Modules.

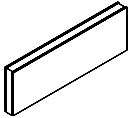
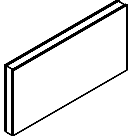
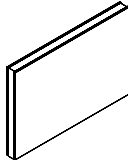
	DESCRIPTION	PRODUCT CODE	LIST PRICE		DIMENSIONS/INCHES		
			Gr1	Gr2	H	W	D
	Laminate Extension Module - Single Sided	EVPH1SE0636	371	376	6	36	2 7/8
		EVPH1SE0642	420	422	6	42	2 7/8
		EVPH1SE0648	457	470	6	48	2 7/8
		EVPH1SE0654	515	527	6	54	2 7/8
		EVPH1SE0660	542	547	6	60	2 7/8
		EVPH1SE0666	567	578	6	66	2 7/8
		EVPH1SE0672	627	636	6	72	2 7/8
	Laminate Extension Module - Single Sided	EVPH1SE1236	371	384	12	36	2 7/8
		EVPH1SE1242	420	429	12	42	2 7/8
		EVPH1SE1248	457	471	12	48	2 7/8
		EVPH1SE1254	515	529	12	54	2 7/8
		EVPH1SE1260	542	556	12	60	2 7/8
		EVPH1SE1266	567	578	12	66	2 7/8
		EVPH1SE1272	627	636	12	72	2 7/8
	Laminate Extension Module - Single Sided	EVPH1SE1836	520	534	18	36	2 7/8
		EVPH1SE1842	587	601	18	42	2 7/8
		EVPH1SE1848	644	659	18	48	2 7/8
		EVPH1SE1854	697	717	18	54	2 7/8
		EVPH1SE1860	767	788	18	60	2 7/8
		EVPH1SE1866	834	861	18	66	2 7/8
		EVPH1SE1872	657	667	18	72	2 7/8
	Laminate Extension Module - Single Sided	EVPH1SE2436	520	537	24	36	2 7/8
		EVPH1SE2442	587	604	24	42	2 7/8
		EVPH1SE2448	644	662	24	48	2 7/8
		EVPH1SE2454	697	721	24	54	2 7/8
		EVPH1SE2460	767	792	24	60	2 7/8
		EVPH1SE2466	834	862	24	66	2 7/8
		EVPH1SE2472	902	918	24	72	2 7/8

**EVPH2SE - LAMINATE EXTENSION MODULE - DOUBLE SIDED**

- Attaches on top of a beam.
- Laminate faces on both sides of the module provide durable, washable surfaces.
- Modules can be stacked to add privacy or to divide space.
- Panel Extension Modules cannot install higher than 42”h above finished floor.
- When ordering Panel Extension Modules, additional connectors are required.
- Available in high pressure laminate finishes only.
- \*Top Trims are not included with Extension Modules.

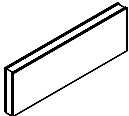
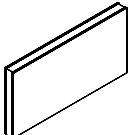
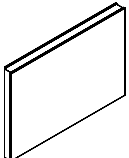
	DESCRIPTION	PRODUCT CODE	LIST PRICE	DIMENSIONS/INCHES		
				H	W	D
	Laminate Extension Module - Double Sided	EVPH2SE0636	422	6	36	2 7/8
		EVPH2SE0642	479	6	42	2 7/8
		EVPH2SE0648	534	6	48	2 7/8
		EVPH2SE0654	616	6	54	2 7/8
		EVPH2SE0660	646	6	60	2 7/8
		EVPH2SE0666	632	6	66	2 7/8
		EVPH2SE0672	730	6	72	2 7/8
	Laminate Extension Module - Double Sided	EVPH2SE1236	422	12	36	2 7/8
		EVPH2SE1242	479	12	42	2 7/8
		EVPH2SE1248	534	12	48	2 7/8
		EVPH2SE1254	616	12	54	2 7/8
		EVPH2SE1260	632	12	60	2 7/8
		EVPH2SE1266	632	12	66	2 7/8
		EVPH2SE1272	730	12	72	2 7/8
	Laminate Extension Module - Double Sided	EVPH2SE1836	629	18	36	2 7/8
		EVPH2SE1842	710	18	42	2 7/8
		EVPH2SE1848	805	18	48	2 7/8
		EVPH2SE1854	882	18	54	2 7/8
		EVPH2SE1860	950	18	60	2 7/8
		EVPH2SE1866	1018	18	66	2 7/8
		EVPH2SE1872	1097	18	72	2 7/8
	Laminate Extension Module - Double Sided	EVPH2SE2436	629	24	36	2 7/8
		EVPH2SE2442	710	24	42	2 7/8
		EVPH2SE2448	805	24	48	2 7/8
		EVPH2SE2454	882	24	54	2 7/8
		EVPH2SE2460	950	24	60	2 7/8
		EVPH2SE2466	1018	24	66	2 7/8
		EVPH2SE2472	1097	24	72	2 7/8

**EVPAE - AIR FLOW EXTENSION MODULE**

- Metal air flow panel extension.
- Attaches to top of beam.
- Modules can be stacked to add privacy or to divide space.
- Panel Extension Modules cannot install higher than 42”h above finished floor.
- When ordering Panel Extension Modules, additional connectors are required.
- \*Top Trims are not included with Extension Modules.

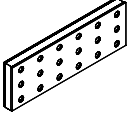
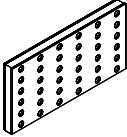
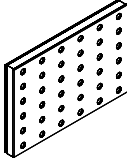
	DESCRIPTION	PRODUCT CODE	LIST PRICE	DIMENSIONS/INCHES		
				H	W	D
	Air Flow Extension Module - 12" High	EVPAE1236	439	12	36	2 7/8
		EVPAE1242	484	12	42	2 7/8
		EVPAE1248	548	12	48	2 7/8
		EVPAE1254	633	12	54	2 7/8
		EVPAE1260	721	12	60	2 7/8
		EVPAE1266	810	12	66	2 7/8
		EVPAE1272	891	12	72	2 7/8
	Air Flow Extension Module - 18" High	EVPAE1836	528	18	36	2 7/8
		EVPAE1842	578	18	42	2 7/8
		EVPAE1848	665	18	48	2 7/8
		EVPAE1854	764	18	54	2 7/8
		EVPAE1860	858	18	60	2 7/8
		EVPAE1866	954	18	66	2 7/8
		EVPAE1872	1053	18	72	2 7/8
	Air Flow Extension Module - 24" High	EVPAE2436	528	24	24	2 7/8
		EVPAE2442	578	24	42	2 7/8
		EVPAE2448	665	24	48	2 7/8
		EVPAE2454	757	24	54	2 7/8
		EVPAE2460	858	24	60	2 7/8
		EVPAE2466	954	24	66	2 7/8
		EVPAE2472	1053	24	72	2 7/8

**EVPOE - OPEN PANEL EXTENSION MODULE**

- Attaches to top portion of a beam.
- Modules can be stacked to add privacy or to divide space
- Panel Extension Modules cannot install higher than 42" above finished floor.
- When ordering Panel Extension Modules, additional connectors are required.
- \*Top Trims are not included with Extension Modules.

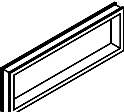
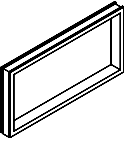
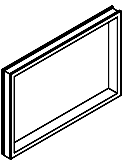
	DESCRIPTION	PRODUCT CODE	LIST PRICE	DIMENSIONS/INCHES		
				H	W	D
	Open Panel Extension Module - 6" High	EVPOE0636	376	6	36	2 7/8
		EVPOE0642	456	6	42	2 7/8
		EVPOE0648	512	6	48	2 7/8
		EVPOE0654	558	6	54	2 7/8
		EVPOE0660	602	6	60	2 7/8
		EVPOE0666	648	6	66	2 7/8
		EVPOE0672	695	6	72	2 7/8
	Open Panel Extension Module - 12" High	EVPOE1236	376	12	36	2 7/8
		EVPOE1242	456	12	42	2 7/8
		EVPOE1248	513	12	48	2 7/8
		EVPOE1254	558	12	54	2 7/8
		EVPOE1260	604	12	60	2 7/8
		EVPOE1266	648	12	66	2 7/8
		EVPOE1272	695	12	72	2 7/8
	Open Panel Extension Module - 18" High	EVPOE1836	499	18	36	2 7/8
		EVPOE1842	561	18	42	2 7/8
		EVPOE1848	633	18	48	2 7/8
		EVPOE1854	686	18	54	2 7/8
		EVPOE1860	739	18	60	2 7/8
		EVPOE1866	794	18	66	2 7/8
		EVPOE1872	846	18	72	2 7/8
	Open Panel Extension Module - 24" High	EVPOE2436	499	24	36	2 7/8
		EVPOE2442	561	24	42	2 7/8
		EVPOE2448	633	24	48	2 7/8
		EVPOE2454	686	24	54	2 7/8
		EVPOE2460	739	24	60	2 7/8
		EVPOE2466	794	24	66	2 7/8
		EVPOE2472	846	24	72	2 7/8

**EVMPMPXXGI6P - 6" H BEAM MOUNT PRIVACY GLASS W/ ALUMINUM TRIM**

- Attaches on top of Power Beam or extension modules to add privacy or divide space.
- Privacy Glass is integrated into the aluminum top trim.
- Includes aluminum trim with channel and glass tile.
- Glass and attachment hardware ship separately.
- Standard in clear (CLR) or frosted (FRST) glass.
- Privacy glass modules may stack on top of Power Beam or extension modules at 42" high to achieve a height up to 54"h above finished floor.
- \*Top Trims are not included with Extension Modules.

	DESCRIPTION	PRODUCT CODE	LIST PRICE		DIMENSIONS/INCHES		
			Clear	Frosted	H	W	D
 36"W Shown	6" H Panel Mount Privacy Glass w/ Aluminum Trim - 36" Wide	EVMPMP36GI6P	335	367	6	36	2 7/8
	6" H Panel Mount Privacy Glass w/ Aluminum Trim - 42" Wide	EVMPMP42GI6P	350	404	6	42	2 7/8
	6" H Panel Mount Privacy Glass w/ Aluminum Trim - 48" Wide	EVMPMP48GI6P	359	442			2 7/8
	6" H Panel Mount Privacy Glass w/ Aluminum Trim - 54" Wide	EVMPMP54GI6P	372	476	6	54	2 7/8
	6" H Panel Mount Privacy Glass w/ Aluminum Trim - 60" Wide	EVMPMP60GI6P	393	510	6	60	2 7/8
	6" H Panel Mount Privacy Glass w/ Aluminum Trim - 66" Wide	EVMPMP66GI6P	443	587	6	66	2 7/8
	6" H Panel Mount Privacy Glass w/ Aluminum Trim - 72" Wide	EVMPMP72GI6P	493	588	6	72	2 7/8

**EVMPMPXXGI9P - 9" H BEAM MOUNT PRIVACY GLASS W/ ALUMINUM TRIM**

- Attaches on top of Power Beam or extension modules to add privacy or divide space.
- Privacy Glass is integrated into the aluminum top trim.
- Includes aluminum trim with channel and glass tile.
- Glass and attachment hardware ship separately.
- Standard in clear (CLR) or frosted (FRST) glass.
- Privacy glass modules may stack on top of Power Beam or extension modules at 42" high to achieve a height up to 54"h above finished floor.
- \*Top Trims are not included with Extension Modules.

	DESCRIPTION	PRODUCT CODE	LIST PRICE		DIMENSIONS/INCHES		
			Clear	Frosted	H	W	D
 36"W Shown	9" H Panel Mount Privacy Glass w/ Aluminum Trim - 36" Wide	EVMPMP36GI9P	335	367	9	36	2 7/8
	9" H Panel Mount Privacy Glass w/ Aluminum Trim - 42" Wide	EVMPMP42GI9P	350	407	9	42	2 7/8
	9" H Panel Mount Privacy Glass w/ Aluminum Trim - 48" Wide	EVMPMP48GI9P	359	421	9	48	2 7/8
	9" H Panel Mount Privacy Glass w/ Aluminum Trim - 54" Wide	EVMPMP54GI9P	372	455	9	54	2 7/8
	9" H Panel Mount Privacy Glass w/ Aluminum Trim - 60" Wide	EVMPMP60GI9P	383	492	9	60	2 7/8
	9" H Panel Mount Privacy Glass w/ Aluminum Trim - 66" Wide	EVMPMP66GI9P	443	588	9	66	2 7/8
	9" H Panel Mount Privacy Glass w/ Aluminum Trim - 72" Wide	EVMPMP72GI9P	456	612	9	72	2 7/8

NOT A CONTRACT



**EVPMPXXGIP - 12" PANEL MOUNT PRIVACY GLASS W/ ALUMINUM TRIM**

- Attaches on top of Evolve Panels to add privacy or divide space.
- Privacy Glass is integrated into the aluminum top trim.
- Includes aluminum trim with channel and glass tile.
- Standard in clear (CLR), frosted (FRST) or writeable (WRW) glass.

DESCRIPTION	PRODUCT CODE	LIST PRICE			DIMENSIONS/INCHES		
		CLR	FRST	WRW	H	W	D
Panel Mount Privacy Glass w/ Aluminum Trim - 36" Wide	EVPMP36GIP	335	367	492	12	36	2 7/8
Panel Mount Privacy Glass w/ Aluminum Trim - 42" Wide	EVPMP42GIP	350	404	542	12	42	2 7/8
Panel Mount Privacy Glass w/ Aluminum Trim - 48" Wide	EVPMP48GIP	369	442	592	12	48	2 7/8
Panel Mount Privacy Glass w/ Aluminum Trim - 54" Wide	EVPMP54GIP	384	477	638	12	54	2 7/8
Panel Mount Privacy Glass w/ Aluminum Trim - 60" Wide	EVPMP60GIP	395	514	688	12	60	2 7/8
Panel Mount Privacy Glass w/ Aluminum Trim - 66" Wide	EVPMP66GIP	443	587	785	12	66	2 7/8
Panel Mount Privacy Glass w/ Aluminum Trim - 72" Wide	EVPMP72GIP	470	641	820	12	72	2 7/8

**EVPMPXXGI18P - 18" H PANEL MOUNT PRIVACY GLASS**

- Privacy Glass integrated with aluminum top trim.
- Attaches on top of panels to add privacy or divide space.
- Includes aluminum trim with channel and glass tile.
- Aluminum trim must be specified for entire station when ordering panel mount privacy glass.
- Glass and attachment hardware to ship separately.

DESCRIPTION	PRODUCT CODE	LIST PRICE			DIMENSIONS/INCHES		
		Clear	Frosted		H	W	D
18" H Panel Mount Privacy Glass w/ Aluminum Trim - 36" Wide	EVPMP36G118P	501	548		18	36	2 7/8
18" H Panel Mount Privacy Glass w/ Aluminum Trim - 42" Wide	EVPMP42G118P	523	604		18	42	2 7/8
18" H Panel Mount Privacy Glass w/ Aluminum Trim - 48" Wide	EVPMP48G118P	554	659		18	48	2 7/8
18" H Panel Mount Privacy Glass w/ Aluminum Trim - 54" Wide	EVPMP54G118P	574	714		18	54	2 7/8
18" H Panel Mount Privacy Glass w/ Aluminum Trim - 60" Wide	EVPMP60G118P	593	773		18	60	2 7/8
18" H Panel Mount Privacy Glass w/ Aluminum Trim - 66" Wide	EVPMP66G118P	665	877		18	66	2 7/8
18" H Panel Mount Privacy Glass w/ Aluminum Trim - 72" Wide	EVPMP72G118P	703	917		18	72	2 7/8

NOT A CONTRACT

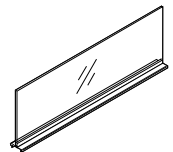

NOT A CONTRACT

**EVMPNXXGI18P - 18" H PANEL MOUNT PRIVACY GLASS WITH NOTCHED TOP TRIM FOR VARIABLE HEIGHT CONNECTOR**

- Privacy Glass integrated with aluminum top trim.
- Attaches on top of panels to add privacy or divide space.
- Includes aluminum trim with channel and glass tile.
- Standard in clear (CLR) or frosted (FRST) glass.
- Aluminium trim must be specified for entire station when ordering panel mount privacy glass.
- Glass and attachment hardware to ship separately.

DESCRIPTION	PRODUCT CODE	LIST PRICE		DIMENSIONS/INCH		
		Clear	Frosted	H	W	
18" H Panel Mount Privacy Glass w/ Aluminum Trim - 36" Wide	EVMPN36GI18P	501	548	18	36	2 7/8
18" H Panel Mount Privacy Glass w/ Aluminum Trim - 42" Wide	EVMPN42GI18P	523	604	18	42	2 7/8
18" H Panel Mount Privacy Glass w/ Aluminum Trim - 48" Wide	EVMPN48GI18P	554	659	18	48	2 7/8
18" H Panel Mount Privacy Glass w/ Aluminum Trim - 54" Wide	EVMPN54GI18P	574	714	18	54	2 7/8
18" H Panel Mount Privacy Glass w/ Aluminum Trim - 60" Wide	EVMPN60GI18P	594	773	18	60	2 7/8
18" H Panel Mount Privacy Glass w/ Aluminum Trim - 66" Wide	EVMPN66GI18P	665	877	18	66	2 7/8
18" H Panel Mount Privacy Glass w/ Aluminum Trim - 72" Wide	EVMPN72GI18P	703	917	18	72	2 7/8

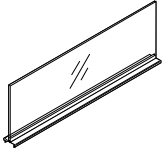

NOT ON CONTRACT

**EVPMPDNXXGI18P-18"H PANEL MOUNT PRIVACY GLASS WITH DOUBLE NOTCHED TOP TRIM FOR VARIABLE HEIGHT CONNECTOR**

- Privacy Glass integrated with aluminum top trim.
- Attaches on top of panels to add privacy or divide space.
- Includes aluminum trim with channel and glass tile.
- Standard in clear (CLR) or frosted (FRST) glass.
- Aluminium trim must be specified for entire station when ordering panel mount privacy glass.
- Glass and attachment hardware to ship separately.

DESCRIPTION	PRODUCT CODE	LIST PRICE		DIMENSIONS/INCHES		
		Clear	Frosted	H	W	
18" H Panel Mount Privacy Glass w/ Aluminum Trim - 36" Wide	EVPMPDN36GI18P	501	548	18	36	2 7/8
18" H Panel Mount Privacy Glass w/ Aluminum Trim - 42" Wide	EVPMPDN42GI18P	523	604	18	42	2 7/8
18" H Panel Mount Privacy Glass w/ Aluminum Trim - 48" Wide	EVPMPDN48GI18P	554	659	18	48	2 7/8
18" H Panel Mount Privacy Glass w/ Aluminum Trim - 54" Wide	EVPMPDN54GI18P	574	719	18	54	2 7/8
18" H Panel Mount Privacy Glass w/ Aluminum Trim - 60" Wide	EVPMPDN60GI18P	594	773	18	60	2 7/8
18" H Panel Mount Privacy Glass w/ Aluminum Trim - 66" Wide	EVPMPDN66GI18P	665	877	18	66	2 7/8
18" H Panel Mount Privacy Glass w/ Aluminum Trim - 72" Wide	EVPMPDN72GI18P	693	917	18	72	2 7/8

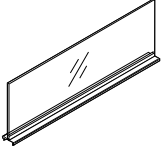

NOT ON CONTRACT

**EVMPMPXXGI6W - 6" H PRIVACY GLASS W/ ALUMINUM TRIM FOR 1" LAMINATE PANEL**

- Attaches on top of Evolve 1" Laminate Panels to add privacy or divide space.
- Privacy Glass is integrated into the aluminum top trim.
- Aluminum trim has rail for accessories.
- Includes aluminum trim with end caps and glass tile
- Glass and attachment hardware ship separately.
- Standard in clear (CLR) or frosted (FRST) glass.
- \*Top Trims are not included with Extension Modules.

	DESCRIPTION	PRODUCT CODE	LIST PRICE		DIMENSIONS/INCHES		
			Clear	Frosted	H	W	D
 36"W Shown	6" H Privacy Glass w/ Aluminum Trim for 1" Laminate Panel - 24" Wide	EVMPMP24GI6W	290	356	6		1
	6" H Privacy Glass w/ Aluminum Trim for 1" Laminate Panel- 30" Wide	EVMPMP30GI6W	315	361	6	30	1
	6" H Privacy Glass w/ Aluminum Trim for 1" Laminate Panel - 36" Wide	EVMPMP36GI6W	335	368	6	36	1
	6" H Privacy Glass w/ Aluminum Trim for 1" Laminate Panel- 42" Wide	EVMPMP42GI6W	350	405	6	42	1
	6" H Privacy Glass w/ Aluminum Trim for 1" Laminate Panel- 48" Wide	EVMPMP48GI6W	365	440	6	48	1

**EVMPMPXXGI9W - 9" H PRIVACY GLASS W/ ALUMINUM TRIM FOR 1" LAMINATE PANEL**

- Attaches on top of Evolve 1" Laminate Panels to add privacy or divide space.
- Privacy Glass is integrated into the aluminum top trim.
- Aluminum trim has rail for accessories.
- Includes aluminum trim with end caps and glass tile.
- Glass and attachment hardware ship separately.
- Standard in clear (CLR) or frosted (FRST) glass.
- \*Top Trims are not included with Extension Modules.

	DESCRIPTION	PRODUCT CODE	LIST PRICE		DIMENSIONS/INCHES		
			Clear	Frosted	H	W	D
 36"W Shown	9" H Privacy Glass w/ Aluminum Trim for 1" Laminate Panel - 24" Wide	EVMPMP24GI9W	290	356	9	24	1
	9" H Privacy Glass w/ Aluminum Trim for 1" Laminate Panel- 30" Wide	EVMPMP30GI9W	315	361	9	30	1
	9" H Privacy Glass w/ Aluminum Trim for 1" Laminate Panel - 36" Wide	EVMPMP36GI9W	335	368	9	36	1
	9" H Privacy Glass w/ Aluminum Trim for 1" Laminate Panel- 42" Wide	EVMPMP42GI9W	350	405	9	42	1
	9" H Privacy Glass w/ Aluminum Trim for 1" Laminate Panel- 48" Wide	EVMPMP48GI9W	369	440	9	48	1

NOT A CONTRACT

**EVPMPXXGIW - 12" H PRIVACY GLASS W/ ALUMINUM TRIM FOR 1" LAMINATE PANEL**

- Attaches on top of Evolve 1" Laminate Panels to add privacy or divide space.
- Privacy Glass is integrated into the aluminum top trim.
- Aluminum trim has rail for accessories.
- Includes aluminum trim with end caps and glass tile
- Glass and attachment hardware ship separately.
- Standard in clear (CLR), frosted (FRST) or writeable (WRW) glass.

DESCRIPTION	PRODUCT CODE	LIST PRICE			DIMENSIONS/INCHES		
		CLR	FRST	WRW	H	W	D
12" H Privacy Glass w/ Aluminum Trim for 1" Laminate Panel - 24" Wide	EVPMP24GIW	290	356	472	12	24	1
12" H Privacy Glass w/ Aluminum Trim for 1" Laminate Panel - 30" Wide	EVPMP30GIW	315	361	481	12	30	1
12" H Privacy Glass w/ Aluminum Trim for 1" Laminate Panel - 36" Wide	EVPMP36GIW	335	368	491	12	36	1
12" H Privacy Glass w/ Aluminum Trim for 1" Laminate Panel - 42" Wide	EVPMP42GIW	350	405	512	12	42	1
12" H Privacy Glass w/ Aluminum Trim for 1" Laminate Panel - 48" Wide	EVPMP48GIW	369	446	591	12	48	1

**EVPFDW - 6" H FELT DIVIDER W/ ALUMINUM TRIM FOR 1" LAMINATE PANEL**

- Privacy Felt Divider integrated with aluminum top trim.
- Attaches on top of laminate panels to add privacy or divide space.
- Includes aluminum trim with channel and felt tile.
- Felt and attachment hardware to ship separately.
- 9 mm felt material is tackable and comes in 9 different colors. Please specify color.
- Aluminum top trim available in standard paint finishes.

DESCRIPTION	PRODUCT CODE	LIST PRICE	DIMENSIONS/INCHES		
			H	W	D
6" H Felt Divider w/ Aluminum Trim for 1" Laminate Panel	EVPFD0624W	116	6	24	1
	EVPFD0630W	135	6	30	1
	EVPFD0636W	160	6	36	1
	EVPFD0642W	180	6	42	1
	EVPFD0648W	264	6	48	1
	EVPFD0654W	289	6	54	1
	EVPFD0660W	310	6	60	1
	EVPFD0666W	327	6	66	1
	EVPFD0672W	369	6	72	1

**EVPFDW - 9" H FELT DIVIDER W/ ALUMINUM TRIM FOR 1" LAMINATE PANEL**

- Privacy Felt Divider integrated with aluminum top trim.
- Attaches on top of laminate panels to add privacy or divide space.
- Includes aluminum trim with channel and felt tile.
- Felt and attachment hardware to ship separately.
- 9 mm felt material is tackable and comes in 9 different colors. Please specify color.
- Aluminum top trim available in standard paint finishes.

DESCRIPTION	PRODUCT CODE	LIST PRICE	DIMENSIONS/INCHES		
			H	W	D
9" H Felt Divider w/ Aluminum Trim for 1" Laminate Panel	EVPFD0924W	116	9	24	1
	EVPFD0930W	135	9	30	1
	EVPFD0936W	160	9	36	1
	EVPFD0942W	180	9	42	1
	EVPFD0948W	264	9	48	1
	EVPFD0954W	289	9	54	1
	EVPFD0960W	310	9	60	1
	EVPFD0966W	327	9	66	1
	EVPFD0972W	369	9	72	1

**EVFPDW - 12" H FELT DIVIDER W/ ALUMINUM TRIM FOR 1" LAMINATE PANEL**

- Privacy Felt Divider integrated with aluminum top trim.
- Attaches on top of laminate panels to add privacy or divide space.
- Includes aluminum trim with channel and felt tile.
- Felt and attachment hardware to ship separately.
- 9 mm felt material is tackable and comes in 9 different colors. Please specify color.
- Aluminum top trim available in standard paint finishes.

DESCRIPTION	PRODUCT CODE	LIST PRICE	DIMENSIONS/INCHES		
			H	W	D
 <p>12" H Felt Divider w/ Aluminum Trim for 1" Laminate Panel</p>	EVFPD1224W	116	12	24	1
	EVFPD1230W	135	12	30	1
	EVFPD1236W	160	12	36	1
	EVFPD1242W	180	12	42	1
	EVFPD1248W	264	12	48	1
	EVFPD1254W	289	12	54	1
	EVFPD1260W	310	12	60	1
	EVFPD1266W	327	12	66	1
	EVFPD1272W	369	12	72	1

**EVFPDW - 18" H FELT DIVIDER W/ ALUMINUM TRIM FOR 1" LAMINATE PANEL**

- Privacy Felt Divider integrated with aluminum top trim.
- Attaches on top of laminate panels to add privacy or divide space.
- Includes aluminum trim with channel and felt tile.
- Felt and attachment hardware to ship separately.
- 9 mm felt material is tackable and comes in 9 different colors. Please specify color.
- Aluminum top trim available in standard paint finishes.

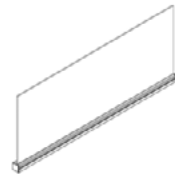
DESCRIPTION	PRODUCT CODE	LIST PRICE	DIMENSIONS/INCHES		
			H	W	D
 <p>18" H Felt Divider w/ Aluminum Trim for 1" Laminate Panel</p>	EVFPD1824W	145	18	24	1
	EVFPD1830W	169	18	30	1
	EVFPD1836W	200	18	36	1
	EVFPD1842W	223	18	42	1
	EVFPD1848W	329	18	48	1
	EVFPD1854W	359	18	54	1
	EVFPD1860W	388	18	60	1
	EVFPD1866W	407	18	66	1
	EVFPD1872W	462	18	72	1

# PET FELT DIVIDER

## EVFDK06P - 6" PANEL MOUNTED FELT DIVIDER

- Privacy felt panel integrated with aluminum top trim.
- Attaches on top of panels to add privacy or divide space. Includes aluminum trim with channel and felt tile.
- Aluminum trim must be specified for entire station when ordering panel mount privacy felt.
- Felt and attachment hardware to ship separately.
- 9mm thick Felt material is tackable and comes in 9 different colors. Please specify color: Graphite (GPH), Mist (MTS), Pewter (PWT), Harvest (HVT), Shamrock (SHR), Brick (BRI), Denim (DEN), Black (BLK) or White (WHT).

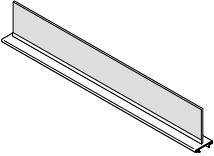
DESCRIPTION	PRODUCT CODE	LIST PRICE Gr1	DIMENSIONS/INCHES		
			H	W	D
 <p>6" Privacy felt panel integrated with aluminum top trim</p>	EVFDK0624P	116	6	24	2 7/8
	EVFDK0630P	135	6	30	2 7/8
	EVFDK0636P	160	6	36	2 7/8
	EVFDK0642P	180	6	42	2 7/8
	EVFDK0648P	264	6	48	2 7/8
	EVFDK0654P	289	6	54	2 7/8
	EVFDK0660P	310	6	60	2 7/8
	EVFDK0666P	327	6	66	2 7/8
	EVFDK0672P	369	6	72	2 7/8

## EVFDK09P - 9" PANEL MOUNTED FELT DIVIDER

- Privacy felt panel integrated with aluminum top trim.
- Attaches on top of panels to add privacy or divide space. Includes aluminum trim with channel and felt tile.
- Aluminum trim must be specified for entire station when ordering panel mount privacy felt.
- Felt and attachment hardware to ship separately.
- 9mm thick Felt material is tackable and comes in 9 different colors. Please specify color: Graphite (GPH), Mist (MTS), Pewter (PWT), Harvest (HVT), Shamrock (SHR), Brick (BRI), Denim (DEN), Black (BLK) or White (WHT).

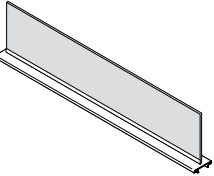
DESCRIPTION	PRODUCT CODE	LIST PRICE Gr1	DIMENSIONS/INCHES		
			H	W	D
 <p>9" Privacy felt panel integrated with aluminum top trim</p>	EVFDK0924P	116	9	24	2 7/8
	EVFDK0930P	135	9	30	2 7/8
	EVFDK0936P	160	9	36	2 7/8
	EVFDK0942P	180	9	42	2 7/8
	EVFDK0948P	264	9	48	2 7/8
	EVFDK0954P	289	9	54	2 7/8
	EVFDK0960P	310	9	60	2 7/8
	EVFDK0966P	327	9	66	2 7/8
	EVFDK0972P	369	9	72	2 7/8

## EVFDK12P - 12" PANEL MOUNTED FELT DIVIDER

- Privacy felt panel integrated with aluminum top trim.
- Attaches on top of panels to add privacy or divide space. Includes aluminum trim with channel and felt tile.
- Aluminum trim must be specified for entire station when ordering panel mount privacy felt.
- Felt and attachment hardware to ship separately.
- 9mm thick Felt material is tackable and comes in 9 different colors. Please specify color: Graphite (GPH), Mist (MTS), Pewter (PWT), Harvest (HVT), Shamrock (SHR), Brick (BRI), Denim (DEN), Black (BLK) or White (WHT).

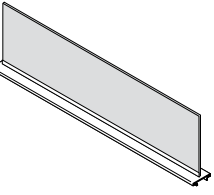
DESCRIPTION	PRODUCT CODE	LIST PRICE Gr1	DIMENSIONS/INCHES		
			H	W	D
 <p>12" Privacy felt panel integrated with aluminum top trim</p>	EVFDK1224P	116	12	24	2 7/8
	EVFDK1230P	135	12	30	2 7/8
	EVFDK1236P	160	12	36	2 7/8
	EVFDK1242P	180	12	42	2 7/8
	EVFDK1248P	264	12	48	2 7/8
	EVFDK1254P	289	12	54	2 7/8
	EVFDK1260P	310	12	60	2 7/8
	EVFDK1266P	327	12	66	2 7/8
	EVFDK1272P	369	12	72	2 7/8

**EVFDK12PN - 12" PANEL MOUNTED FELT DIVIDER, 1 NOTCH**

- Privacy felt panel integrated with aluminum top trim.
- Attaches on top of panels to add privacy or divide space. Includes aluminum trim with channel and felt tile.
- Aluminum trim must be specified for entire station when ordering panel mount privacy felt.
- Felt and attachment hardware to ship separately.
- 9mm thick Felt material is tackable and comes in 9 different colors. Please specify color: Graphite (GPH), Mist (MTS), Pewter (PWT), Harvest (HVT), Shamrock (SHR), Brick (BRI), Denim (DEN), Black (BLK) or White (WHT).

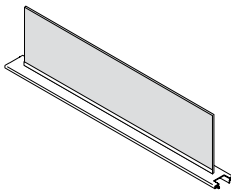
DESCRIPTION	PRODUCT CODE	LIST PRICE Gr1	DIMENSIONS/INCHES		
			H	W	D
 <p>12" Privacy felt panel integrated with aluminum top trim with 1 Notch</p>	EVFDK1224PN	116	12	22.68	2 7/8
	EVFDK1230PN	135	12	28.68	2 7/8
	EVFDK1236PN	160	12	34.68	2 7/8
	EVFDK1242PN	180	12	40.68	2 7/8
	EVFDK1248PN	264	12	46.68	2 7/8
	EVFDK1254PN	289	12	52.68	2 7/8
	EVFDK1260PN	310	12	58.68	2 7/8

**EVFDK12PDN - 12" PANEL MOUNTED FELT DIVIDER, 2 NOTCHES**

- Privacy felt panel integrated with aluminum top trim.
- Attaches on top of panels to add privacy or divide space. Includes aluminum trim with channel and felt tile.
- Aluminum trim must be specified for entire station when ordering panel mount privacy felt.
- Felt and attachment hardware to ship separately.
- 9mm thick Felt material is tackable and comes in 9 different colors. Please specify color: Graphite (GPH), Mist (MTS), Pewter (PWT), Harvest (HVT), Shamrock (SHR), Brick (BRI), Denim (DEN), Black (BLK) or White (WHT).

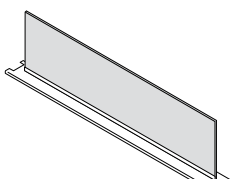
DESCRIPTION	PRODUCT CODE	LIST PRICE Gr1	DIMENSIONS/INCHES		
			H	W	D
 <p>12" Privacy felt panel integrated with aluminum top trim with 2 Notches</p>	EVFDK1224PDN	116	12	21.44	2 7/8
	EVFDK1230PDN	135	12	27.44	2 7/8
	EVFDK1236PDN	160	12	33.44	2 7/8
	EVFDK1242PDN	180	12	39.44	2 7/8
	EVFDK1248PDN	264	12	45.44	2 7/8
	EVFDK1254PDN	289	12	51.44	2 7/8
	EVFDK1260PDN	310	12	57.44	2 7/8

**EVFDK18P - 18" PANEL MOUNTED FELT DIVIDER**

- Privacy felt panel integrated with aluminum top trim.
- Attaches on top of panels to add privacy or divide space. Includes aluminum trim with channel and felt tile.
- Aluminum trim must be specified for entire station when ordering panel mount privacy felt.
- Felt and attachment hardware to ship separately.
- 9mm thick Felt material is tackable and comes in 9 different colors. Please specify color: Graphite (GPH), Mist (MTS), Pewter (PWT), Harvest (HVT), Shamrock (SHR), Brick (BRI), Denim (DEN), Black (BLK) or White (WHT).

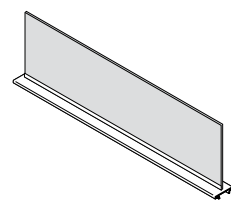
DESCRIPTION	PRODUCT CODE	LIST PRICE Gr1	DIMENSIONS/INCHES		
			H	W	D
 <p>18" Privacy felt panel integrated with aluminum top trim</p>	EVFDK1824P	145	18	24	2 7/8
	EVFDK1830P	169	18	30	2 7/8
	EVFDK1836P	200	18	36	2 7/8
	EVFDK1842P	223	18	42	2 7/8
	EVFDK1848P	329	18	48	2 7/8
	EVFDK1854P	359	18	54	2 7/8
	EVFDK1860P	388	18	60	2 7/8
	EVFDK1866P	407	18	66	2 7/8
	EVFDK1872P	462	18	72	2 7/8



**EVPPGT - GLAZED PRIVACY PANEL**

- Includes panel with two connectors with T legs with glides and end of run trims
- 3" thick mobile or freestanding panels.
- 22" deep T-legs for stability (9.5" on each side)
- 66" high. Additional widths, heights and configurations available.
- All Modules are Tempered Glass.
- Includes end of run trim.

DESCRIPTION	PRODUCT CODE	LIST PRICE		DIMENSIONS/INCHES		
		Clear	Frosted	H	W	D
Freestanding Glazed Privacy Panel	EVPPGT6660	2030	2671	66	60	27/8
Mobile Glazed Privacy Panel	EVPPGT6660M	2098	2743	66	60	27/8

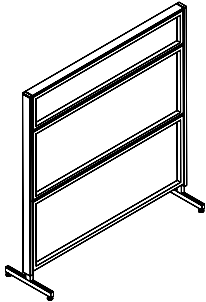

**EVPPHGT - LAMINATE GLAZED PRIVACY PANEL**

- Includes panel with two connectors with T legs with glides and end of run trims
- 3" thick mobile or freestanding panels.
- 22" deep T-legs for stability (9.5" on each side)
- 66" high. Additional widths, heights and configurations available.
- Laminate Base Module w/36" Tempered Glass above.
- Includes end of run trim.

DESCRIPTION	PRODUCT CODE	LIST PRICE		DIMENSIONS/INCHES		
		Clear	Frosted	H	W	D
Freestanding Laminate Glazed Privacy Panel	EVPPHGT6660	2149	2494	66	60	27/8
Mobile Laminate Glazed Privacy Panel	EVPPHGT6660M	2220	2565	66	60	27/8

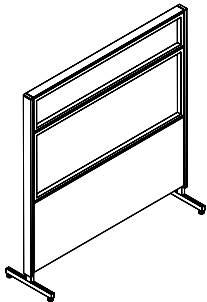

**EVPPHGTU - LAMINATE GLAZED PRIVACY PANEL**

- Includes panel with two connectors with T legs with glides and end of run trims
- 3" thick mobile or freestanding panels.
- 22" deep T-legs for stability (9.5" on each side)
- 66" high. Additional widths, heights and configurations available.
- Bottom Two Modules are Laminate w/12" Tempered Glass on top.
- Includes end of run trim.

DESCRIPTION	PRODUCT CODE	LIST PRICE		DIMENSIONS/INCHES		
		Clear	Frosted	H	W	D
Freestanding Laminate Glazed Privacy Panel	EVPPHGTU6660	2271	2642	66	60	27/8
Mobile Laminate Glazed Privacy Panel	EVPPHGTU6660M	2341	2712	66	60	27/8

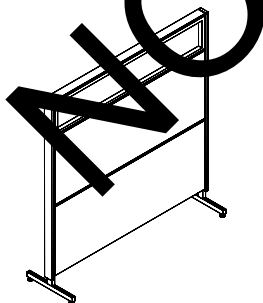

**EVPPH2S - LAMINATE PRIVACY PANEL**

- Includes panel with two connectors with T legs with glides and end of run trims
- 3" thick mobile or freestanding panels.
- 22" deep T-legs for stability (9.5" on each side)
- 66" high. Additional widths, heights and configurations available.
- All Modules are Laminate.
- Includes end of run trim.

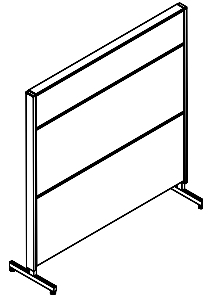

DESCRIPTION	PRODUCT CODE	LIST PRICE	DIMENSIONS/INCHES		
			H	W	D
Freestanding Laminate Privacy Panel	EVPPH2S6660	2301	66	60	27/8
Mobile Laminate Privacy Panel	EVPPH2S6660M	2371	66	60	27/8

**EVPPF2W - WRITE BOARD PRIVACY PANEL**

- Includes panel with two connectors with T legs with glides and end of run trims
- 3" thick mobile or freestanding panels.
- 22" deep T-legs for stability (9.5" on each side)
- 66" high. Additional widths, heights and configurations available.
- Fabric Base Module w/36" Writeboard.
- Includes end of run trim.

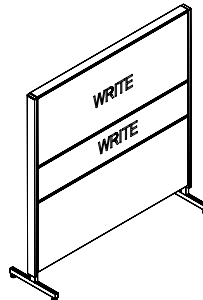

DESCRIPTION	PRODUCT CODE	LIST PRICE		DIMENSIONS/INCHES		
		Gr1	Gr2	H	W	D
Freestanding Write Board Privacy Panel	EVPPF2W6660	2370	2412	66	60	27/8
Mobile Write Board Privacy Panel	EVPPF2W6660M	2440	2481	66	60	27/8

**EVPPH2W - WRITE BOARD PRIVACY PANEL**

- Includes panel with two connectors with T legs with glides and end of run trims
- 3" thick mobile or freestanding panels.
- 22" deep T-legs for stability (9.5" on each side)
- 66" high. Additional widths, heights and configurations available.
- Laminate Base Module w/36" Writeboard.
- Includes end of run trim.

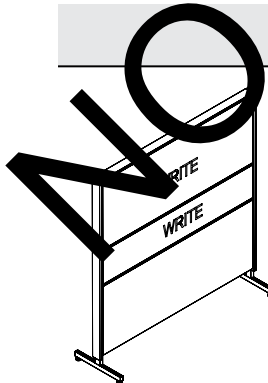

DESCRIPTION	PRODUCT CODE	LIST PRICE	DIMENSIONS/INCHES		
			H	W	D
Freestanding Write Board Privacy Panel	EVPPH2W6660	2546	66	60	27/8
Mobile Write Board Privacy Panel	EVPPH2W6660M	2615	66	60	27/8

# GALLERY PANELS

## EVPP - FREESTANDING GLAZED PRIVACY PANEL

- Includes panel with two connectors with T legs.
- 3" thick freestanding panels with leveling glides.
- 22" deep T-legs for stability (9.5" on each side)
- All Modules are Tempered Glass.
- Includes end of run trim.

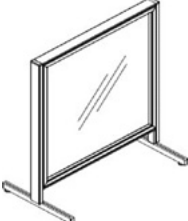
DESCRIPTION	PRODUCT CODE	LIST PRICE		DIMENSIONS/INCHES		
		CLR	FRST	H	W	D
 Freestanding Glazed Monolithic Privacy Panel	EVPPXGT4218	715	862	42	18	27/8
	EVPPXGT4224	787	963	42	24	27/8
	EVPPXGT4230	855	1058	42	30	27/8
	EVPPXGT4236	920	1149	42	36	27/8
	EVPPXGT4242	994	1252	42	42	27/8

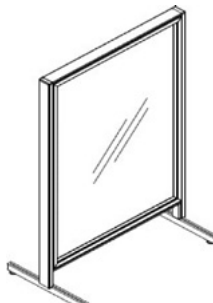
DESCRIPTION	PRODUCT CODE	LIST PRICE		DIMENSIONS/INCHES		
		CLR	FRST	H	W	D
 Freestanding Glazed Monolithic Privacy Panel	EVPPXGT5418	838	1010	54	18	27/8
	EVPPXGT5424	919	1102	54	24	27/8
	EVPPXGT5430	997	1242	54	30	27/8
	EVPPXGT5436	1079	1351	54	36	27/8
	EVPPXGT5442	1172	1472	54	42	27/8

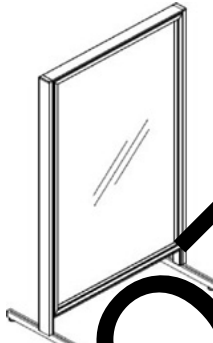
DESCRIPTION	PRODUCT CODE	LIST PRICE		DIMENSIONS/INCHES		
		CLR	FRST	H	W	D
 Freestanding Glazed Monolithic Privacy Panel	EVPPXGT6618	960	1175	66	18	27/8
	EVPPXGT6624	1054	1307	66	24	27/8
	EVPPXGT6630	1150	1437	66	30	27/8
	EVPPXGT6636	1237	1561	66	36	27/8
	EVPPXGT6642	1340	1707	66	42	27/8

NOT ON CONTRACT

**EVPP - GLAZED MOBILE PRIVACY PANEL**

- Includes panel with two connectors with T legs.
- 3" thick freestanding panels with 1" locking casters.
- 22" deep T-legs for stability (9.5" on each side)
- All Modules are Tempered Glass.
- Includes end of run trim.
- 

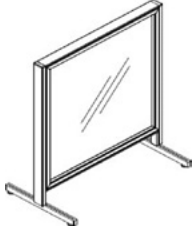
DESCRIPTION	PRODUCT CODE	LIST PRICE		DIMENSIONS/INCHES		
		CLR	FRST	H	W	D
 Monolithic Mobile Glazed Privacy Panel	EVPPXGT4218M	786	931	42	18	2 7/8
	EVPPXGT4224M	858	1033	42	24	2 7/8
	EVPPXGT4230M	926	1127	42	30	2 7/8
	EVPPXGT4236M	989	1217	42	36	2 7/8
	EVPPXGT4242M	1063	1324	42	42	2 7/8

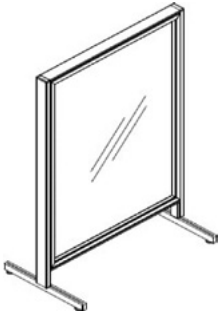
DESCRIPTION	PRODUCT CODE	LIST PRICE			DIMENSIONS/INCHES		
		CLR	FRST	WRW	H	W	D
 Mobile Glazed Monolithic Privacy Panel	EVPPXGT5418M	905	1081	1374	54	18	2 7/8
	EVPPXGT5424M	988	1201	1582	54	24	2 7/8
	EVPPXGT5430M	1069	1313	1783	54	30	2 7/8
	EVPPXGT5436M	1146	1423	1984	54	36	2 7/8
	EVPPXGT5442M	1232	1542	2195	54	42	2 7/8

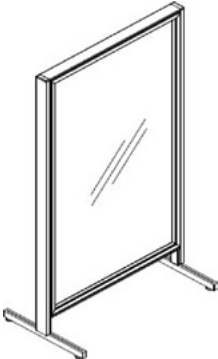
DESCRIPTION	PRODUCT CODE	LIST PRICE			DIMENSIONS/INCHES		
		CLR	FRST	WRW	H	W	D
 Mobile Glazed Monolithic Privacy Panel	EVPPXGT6618M	1029	1247	1615	66	18	2 7/8
	EVPPXGT6624M	1124	1378	1860	66	24	2 7/8
	EVPPXGT6630M	1219	1509	2105	66	30	2 7/8
	EVPPXGT6636M	1307	1631	2341	66	36	2 7/8
	EVPPXGT6642M	1410	1777	2598	66	42	2 7/8

## EVPBLERT - END OF RUN TRIM

- Specify to match height of beam or total height with extension modules

DESCRIPTION	PRODUCT CODE	LIST PRICE	DIMENSIONS/INCHES		
			H	W	D
	EVPBLERT24	54	21.4	2 7/8	
	EVPBLERT30	73	27.4	2 7/8	
	EVPBLERT36	77	33.4	2 7/8	
	EVPBLERT42	82	39.4	2 7/8	

**EVPBLEPDSNC - POWER BEAM LAMINATE DOUBLE SIDED GALLERY PANEL, FINISHED ENDS**

- Attaches to power beam channel.
- To be installed at end of power beam run.
- Finished in thermally fused laminate.
- No connection both sides.
- Laminate Gallery Panel height is inclusive of panel glides extended to their full height.
- If wood grain is selected, grain runs horizontally.
- Power beam channel and bottom connecting bracket to be ordered separately.

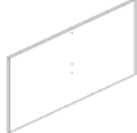
	DESCRIPTION	PRODUCT CODE	LIST PRICE LP	DIMENSIONS/INCHES		
				H	W	D
	Laminate Double Sided Connecting Gallery Panel - Finished Ends - 42" High	EVPBLEPDS4251NC	692	42	51	1
		EVPBLEPDS4263NC	900	42	63	1
		EVPBLEPDS4275NC	1110	42	75	1
	Laminate Double Sided Connecting Gallery Panel - Finished Ends - 48" High	EVPBLEPDS4851NC	754	48	51	1
		EVPBLEPDS4863NC	999	48	63	1
		EVPBLEPDS4875NC	1214	48	75	1
	Laminate Double Sided Connecting Gallery Panel - Finished Ends - 54" High	EVPBLEPDS5451NC	875	54	51	1
		EVPBLEPDS5463NC	1143	54	63	1
		EVPBLEPDS5475NC	1322	54	75	1

**EVPBLEPDS - POWER BEAM LAMINATE DOUBLE SIDED CONNECTING GALLERY PANEL, CONNECTOR ENDS**







- Attaches to power beam channel.
- To be installed at end of power beam run.
- Finished in thermally fused laminate.
- No connection both sides.
- Locking connection both sides.
- Laminate Gallery Panel height is inclusive of panel glides extended to their full height.
- If wood grain is selected, grain runs horizontally.
- Power beam channel and bottom connecting bracket to be ordered separately.

	DESCRIPTION	PRODUCT CODE	LIST PRICE LP	DIMENSIONS/INCHES		
				H	W	D
	Laminate Double Sided Connecting Gallery Panel - Finished Ends - 42" High	EVPBLEPDS4251	692	42	51	1
		EVPBLEPDS4263	900	42	63	1
		EVPBLEPDS4275	1110	42	75	1
	Laminate Double Sided Connecting Gallery Panel - Finished Ends - 48" High	EVPBLEPDS4851	754	48	51	1
		EVPBLEPDS4863	999	48	63	1
		EVPBLEPDS4875	1214	48	75	1
	Laminate Double Sided Connecting Gallery Panel - Finished Ends - 52" High	EVPBLEPDS5451	875	54	51	1
		EVPBLEPDS5463	1143	54	63	1
		EVPBLEPDS5475	1322	54	75	1

# GALLERY PANELS



## EVPBLEPSSNC- POWER BEAM LAMINATE SINGLE SIDED GALLERY PANEL, FINISHED ENDS

- Attaches to power beam channel.
- To be installed at end of power beam run on one side.
- Finished in thermally fused laminate.
- No connection both sides.
- Laminate Gallery Panel height is inclusive of panel glides extended to their full height.
- If wood grain is selected, grain runs horizontally.
- Power beam channel and bottom connecting bracket to be ordered separately.

	DESCRIPTION	PRODUCT CODE	LIST PRICE LP	DIMENSIONS/INCHES		
				H	W	D
	Laminate Single Sided Connecting Gallery Panel - Finished Ends - Left - 42" High	EVPBLEPSSL4227NC	450	42	27	1
		EVPBLEPSSL4233NC	502	42	33	1
		EVPBLEPSSL4239NC	564	42	39	1
		EVPBLEPSSL4245NC	646	42	45	1
		EVPBLEPSSL4251NC	692	42	51	1
	Laminate Single Sided Connecting Gallery Panel - Finished Ends - Left - 48" High	EVPBLEPSSL4827NC	492	48	27	1
		EVPBLEPSSL4833NC	558	48	33	1
		EVPBLEPSSL4839NC	625	48	39	1
		EVPBLEPSSL4845NC	692	48	45	1
		EVPBLEPSSL4851NC	784	48	51	1
	Laminate Single Sided Connecting Gallery Panel - Finished Ends - Left - 54" High	EVPBLEPSSL5427NC	541	54	27	1
		EVPBLEPSSL5433NC	618	54	33	1
		EVPBLEPSSL5439NC	704	54	39	1
		EVPBLEPSSL5445NC	824	54	45	1
		EVPBLEPSSL5451NC	875	54	51	1
	Laminate Single Sided Connecting Gallery Panel - Finished Ends -Right - 42" High	EVPBLEPSSR4227NC	450	42	27	1
		EVPBLEPSSR4233NC	502	42	33	1
		EVPBLEPSSR4239NC	564	42	39	1
		EVPBLEPSSR4245NC	646	42	45	1
		EVPBLEPSSR4251NC	692	42	51	1
	Laminate Single Sided Connecting Gallery Panel - Finished Ends -Right - 48" High	EVPBLEPSSR4827NC	492	48	27	1
		EVPBLEPSSR4833NC	558	48	33	1
		EVPBLEPSSR4839NC	625	48	39	1
		EVPBLEPSSR4845NC	692	48	45	1
		EVPBLEPSSR4851NC	784	48	51	1
	Laminate Single Sided Connecting Gallery Panel - Finished Ends - Right - 54" High	EVPBLEPSSR5427NC	541	54	27	1
		EVPBLEPSSR5433NC	618	54	33	1
		EVPBLEPSSR5439NC	704	54	39	1
		EVPBLEPSSR5445NC	824	54	45	1
		EVPBLEPSSR5451NC	875	54	51	1

**EVPBLEPSS - POWER BEAM LAMINATE SINGLE SIDED GALLERY PANEL, CONNECTOR ENDS**

- Attaches to power beam channel.
- To be installed at end of power beam run on one side.
- Finished in thermally fused laminate.
- Locking connection both sides.
- Laminate Gallery Panel height is inclusive of panel glides extended to their full height.
- If wood grain is selected, grain runs horizontally.
- Power beam channel and bottom connecting bracket to be ordered separately.

	DESCRIPTION	PRODUCT CODE	LIST PRICE	DIMENSIONS/INCHES		
			LP	H	W	D
	Laminate Single Sided Connecting Gallery Panel Connector Ends - Left - 42" High	EVPBLEPSSL4227	450	42	27	1
		EVPBLEPSSL4233	502	42	33	1
		EVPBLEPSSL4239	564	42	39	1
		EVPBLEPSSL4245	646	42	45	1
		EVPBLEPSSL4251	692	42	51	1
	Laminate Single Sided Connecting Gallery Panel Connector Ends - Left - 48" High	EVPBLEPSSL4827	492	48	27	1
		EVPBLEPSSL4833	558	48	33	1
		EVPBLEPSSL4839	625	48	39	1
		EVPBLEPSSL4845	692	48	45	1
		EVPBLEPSSL4851	784	48	51	1
	Laminate Single Sided Connecting Gallery Panel Connector Ends - Left - 54" High	EVPBLEPSSL5427	541	54	27	1
		EVPBLEPSSL5433	618	54	33	1
		EVPBLEPSSL5439	704	54	39	1
		EVPBLEPSSL5445	824	54	45	1
		EVPBLEPSSL5451	875	54	51	1
	Laminate Single Sided Connecting Gallery Panel Connector Ends -Right - 42" High	EVPBLEPSSR4227	450	42	27	1
		EVPBLEPSSR4233	502	42	33	1
		EVPBLEPSSR4239	564	42	39	1
		EVPBLEPSSR4245	646	42	45	1
		EVPBLEPSSR4251	692	42	51	1
	Laminate Single Sided Connecting Gallery Panel Connector Ends -Right - 48" High	EVPBLEPSSR4827	492	48	27	1
		EVPBLEPSSR4833	692	48	33	1
		EVPBLEPSSR4839	625	48	39	1
		EVPBLEPSSR4845	692	48	45	1
		EVPBLEPSSR4851	784	48	51	1
	Laminate Single Sided Connecting Gallery Panel Connector Ends - Right - 54" High	EVPBLEPSSR5427	541	54	27	1
		EVPBLEPSSR5433	618	54	33	1
		EVPBLEPSSR5439	704	54	39	1
		EVPBLEPSSR5445	824	54	45	1
		EVPBLEPSSR5451	875	54	51	1



**EVPBLEPDCNC - POWER BEAM LAMINATE DOUBLE SIDED MIDDLE GALLERY PANEL, 24" ELECTRICAL CUTOUT, FINISHED ENDS**

- Attaches to power beam channel.
- To be installed in middle between two power beam in straight run.
- Cut out for electric at 24" power beam height
- Finished in thermally fused laminate.
- No connection both sides.
- Laminate Gallery Panel height is inclusive of panel glides extended to their full height.
- If wood grain is selected, grain runs horizontally.
- Power beam channel and bottom connecting bracket to be ordered separately.

DESCRIPTION	PRODUCT CODE	LIST PRICE LP	DIMENSIONS/INCHES		
			H	W	D
 Laminate Double Sided Middle Gallery Panel - 24" Electrical Cutout - 42" High	EVPBLEPDC4251NC	692	42	51	1
	EVPBLEPDC4263NC	900	42	63	1
	EVPBLEPDC4275NC	1110	42	75	1
Laminate Double Sided Middle Gallery Panel - 24" Electrical Cutout - 48" High	EVPBLEPDC4851NC	754	48	51	1
	EVPBLEPDC4863NC	999	48	63	1
	EVPBLEPDC4875NC	1214	48	75	1
Laminate Double Sided Middle Gallery Panel - 24" Electrical Cutout - 54" High	EVPBLEPDC5451NC	875	54	51	1
	EVPBLEPDC5463NC	1143	54	63	1
	EVPBLEPDC5475NC	1322	54	75	1

**EVPBLEPDBNC - POWER BEAM LAMINATE DOUBLE SIDED MIDDLE GALLERY PANEL, 30" ELECTRICAL CUTOUT, FINISHED ENDS**

- Attaches to power beam channel.
- To be installed in middle between two power beam in straight run.
- Cut out for electric at 30" power beam height
- Finished in thermally fused laminate.
- No connection both sides.
- Laminate Gallery Panel height is inclusive of panel glides extended to their full height.
- If wood grain is selected, grain runs horizontally.
- Power beam channel and bottom connecting bracket to be ordered separately.

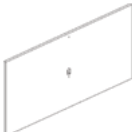
DESCRIPTION	PRODUCT CODE	LIST PRICE LP	DIMENSIONS/INCHES		
			H	W	D
 Laminate Double Sided Middle Gallery Panel - 30" Electrical Cutout - 42" High	EVPBLEPDC4251BNC	692	42	51	1
	EVPBLEPDC4263BNC	900	42	63	1
	EVPBLEPDC4275BNC	1110	42	75	1
Laminate Double Sided Middle Gallery Panel - 30" Electrical Cutout - 48" High	EVPBLEPDC4851BNC	754	48	51	1
	EVPBLEPDC4863BNC	999	48	63	1
	EVPBLEPDC4875BNC	1214	48	75	1
Laminate Double Sided Middle Gallery Panel - 30" Electrical Cutout - 54" High	EVPBLEPDC5451BNC	875	54	51	1
	EVPBLEPDC5463BNC	1143	54	63	1
	EVPBLEPDC5475BNC	1322	54	75	1

**EVPBLEPDCNC - POWER BEAM LAMINATE DOUBLE SIDED MIDDLE GALLERY PANEL, 36" ELECTRICAL CUTOUT, FINISHED ENDS**

- Attaches to power beam channel.
- To be installed in middle between two power beam in straight run.
- Cut out for electric at 36" power beam height
- Finished in thermally fused laminate.
- No connection both sides.
- Laminate Gallery Panel height is inclusive of panel glides extended to their full height.
- If wood grain is selected, grain runs horizontally.
- Power beam channel and bottom connecting bracket to be ordered separately.

	DESCRIPTION	PRODUCT CODE	LIST PRICE LP	DIMENSIONS/INCHES		
				H	W	D
	Laminate Double Sided Middle Gallery Panel - 36" Electrical Cutout - 42" High	EVPBLEPDC4251CNC	692	42	51	1
		EVPBLEPDC4263CNC	900	42	63	1
		EVPBLEPDC4275CNC	1110	42	75	1
	Laminate Double Sided Middle Gallery Panel - 36" Electrical Cutout - 48" High	EVPBLEPDC4851CNC	754	48	51	1
		EVPBLEPDC4863CNC	999	48	63	1
		EVPBLEPDC4875CNC	1214	48	75	1
	Laminate Double Sided Middle Gallery Panel - 36" Electrical Cutout - 54" High	EVPBLEPDC5451CNC	875	54	51	1
		EVPBLEPDC5463CNC	1143	54	63	1
		EVPBLEPDC5475CNC	1322	54	75	1

## EVPBLEPDC - POWER BEAM LAMINATE DOUBLE SIDED MIDDLE CONNECTING GALLERY PANEL, 24"H ELECTRICAL CUTOUT

- Attaches to power beam channel.
- To be installed in middle between two power beams in straight run.
- Cut out for electric at 24" power beam height.
- Finished in thermally fused laminate.
- No connection both sides.
- Laminate Gallery Panel height is inclusive of panel glides extended to their full height.
- If wood grain is selected, grain runs horizontally.
- Power beam channel and bottom connecting bracket to be ordered separately.

	DESCRIPTION	PRODUCT CODE	LIST PRICE LP	DIMENSIONS/INCHES		
				H	W	D
	Laminate Double Sided Middle Connecting Gallery Panel - Electrical Cutout - 42" High	EVPBLEPDC4251	692	42	51	1
		EVPBLEPDC4263	900	42	63	1
		EVPBLEPDC4275	1110	42	75	1
	Laminate Double Sided Middle Connecting Gallery Panel - Electrical Cutout - 48" High	EVPBLEPDC4851	754	48	51	1
		EVPBLEPDC4863	999	48	63	1
		EVPBLEPDC4875	1214	48	75	1
	Laminate Double Sided Middle Connecting Gallery Panel - Electrical Cutout - 54" High	EVPBLEPDC5451	875	54	51	1
		EVPBLEPDC5463	1143	54	63	1
		EVPBLEPDC5475	1322	54	75	1

## EVPBLEPDC - POWER BEAM LAMINATE DOUBLE SIDED MIDDLE CONNECTING GALLERY PANEL, 30"H ELECTRICAL CUTOUT

- Attaches to power beam channel.
- To be installed in middle between two power beams in straight run.
- Cut out for electric at 30" power beam height
- Finished in thermally fused laminate.
- Locking connection both sides.
- Laminate Gallery Panel height is inclusive of panel glides extended to their full height.
- If wood grain is selected, grain runs horizontally.
- Power beam channel and bottom connecting bracket to be ordered separately.

	DESCRIPTION	PRODUCT CODE	LIST PRICE LP	DIMENSIONS/INCHES		
				H	W	D
	Laminate Double Sided Middle Connecting Gallery Panel - 30" Electrical Cutout - 42" High	EVPBLEPDC4251B	692	42	51	1
		EVPBLEPDC4263B	900	42	63	1
		EVPBLEPDC4275B	1110	42	75	1
	Laminate Double Sided Middle Connecting Gallery Panel - 30" Electrical Cutout - 48" High	EVPBLEPDC4851B	754	48	51	1
		EVPBLEPDC4863B	999	48	63	1
		EVPBLEPDC4875B	1214	48	75	1
	Laminate Double Sided Middle Connecting Gallery Panel - 30" Electrical Cutout - 54" High	EVPBLEPDC5451B	875	54	51	1
		EVPBLEPDC5463B	1143	54	63	1
		EVPBLEPDC5475B	1322	54	75	1

**EVPBLEPDC - POWER BEAM LAMINATE DOUBLE SIDED MIDDLE CONNECTING GALLERY PANEL, 36"H ELECTRICAL CUTOUT**

- Attaches to power beam channel.
- To be installed in middle between two power beams in straight run.
- Cut out for electric at 36" power beam height
- Finished in thermally fused laminate.
- Locking connection both sides.
- Laminate Gallery Panel height is inclusive of panel glides extended to their full height.
- If wood grain is selected, grain runs horizontally.
- Power beam channel and bottom connecting bracket to be ordered separately.

	DESCRIPTION	PRODUCT CODE	LIST PRICE LP	DIMENSIONS/INCHES		
				H	W	D
	Laminate Double Sided Middle Connecting Gallery Panel - 30" Electrical Cutout - 42" High	EVPBLEPDC4251C	692	42	51	1
		EVPBLEPDC4263C	900	42	63	1
		EVPBLEPDC4275C	1110	42	75	1
	Laminate Double Sided Middle Connecting Gallery Panel - 30" Electrical Cutout - 48" High	EVPBLEPDC4851C	754	48	51	1
		EVPBLEPDC4863C	999	48	63	1
		EVPBLEPDC4875C	1214	48	75	1
	Laminate Double Sided Middle Connecting Gallery Panel - 30" Electrical Cutout - 54" High	EVPBLEPDC5451C	875	54	51	1
		EVPBLEPDC5463C	1143	54	63	1
		EVPBLEPDC5475C	1322	54	75	1

**EVPBLEPSCNC - POWER BEAM LAMINATE SINGLE SIDED MIDDLE GALLERY PANEL, FINISHED ENDS, 24"H ELECTRICAL CUTOUT**

- Attaches to power beam channel.
- To be installed in middle between two power beam in straight run on one side.
- Cut out for electric at 24" power beam height.
- Finished in thermally fused laminate.
- No connection both sides.
- Laminate Gallery Panel height is inclusive of panel glides extended to their full height.
- If wood grain is selected, grain runs horizontally.
- Power beam channel and bottom connecting bracket to be ordered separately.

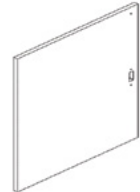
	DESCRIPTION	PRODUCT CODE	LIST PRICE LP	DIMENSIONS/INCHES		
				H	W	D
	Laminate Single Sided Middle Gallery Panel - Finished Ends - 42" High	EVPBLEPSC4227NC	450	42	27	1
		EVPBLEPSC4233NC	502	42	33	1
		EVPBLEPSC4239NC	564	42	39	1
		EVPBLEPSC4245NC	646	42	45	1
		EVPBLEPSC4251NC	692	42	51	1
	Laminate Single Sided Middle Gallery Panel - Finished Ends - 48" High	EVPBLEPSC4827NC	492	48	27	1
		EVPBLEPSC4833NC	558	48	33	1
		EVPBLEPSC4839NC	625	48	39	1
		EVPBLEPSC4845NC	692	48	45	1
		EVPBLEPSC4851NC	784	48	51	1
	Laminate Single Sided Middle Gallery Panel - Finished Ends - 54" High	EVPBLEPSC5427NC	541	54	27	1
		EVPBLEPSC5433NC	618	54	33	1
		EVPBLEPSC5439NC	704	54	39	1
		EVPBLEPSC5445NC	692	54	45	1
		EVPBLEPSC5451NC	875	54	51	1

**EEVPBLEPSCNC - POWER BEAM LAMINATE SINGLE SIDED MIDDLE GALLERY PANEL, FINISHED ENDS, 30”H ELECTRICAL CUTOUT**

- Attaches to power beam channel.
- To be installed in middle between two power beam in straight run on one side.
- Cut out for electric at 30” power beam height
- Finished in thermally fused laminate.
- No connection both sides.
- Laminate Gallery Panel height is inclusive of panel glides extended to their full height.
- If wood grain is selected, grain runs horizontally.
- Power beam channel and bottom connecting bracket to be ordered separately.

	DESCRIPTION	PRODUCT CODE	LIST PRICE LP	DIMENSIONS/INCHES		
				H	W	D
	Laminate Single Sided Middle Gallery Panel - Finished Ends - 42” High	EVPBLEPSC4227BNC	450	42	27	1
		EVPBLEPSC4233BNC	502	42	33	1
		EVPBLEPSC4239BNC	564	42	39	1
		EVPBLEPSC4245BNC	646	42	45	1
		EVPBLEPSC4251BNC	692	42	51	1
	Laminate Single Sided Middle Gallery Panel - Finished Ends - 48” High	EVPBLEPSC4827BNC	492	48	27	1
		EVPBLEPSC4833BNC	558	48	33	1
		EVPBLEPSC4839BNC	625	48	39	1
		EVPBLEPSC4845BNC	692	48	45	1
		EVPBLEPSC4851BNC	784	48	51	1
	Laminate Single Sided Middle Gallery Panel - Finished Ends - 54” High	EVPBLEPSC5427BNC	541	54	27	1
		EVPBLEPSC5433BNC	618	54	33	1
		EVPBLEPSC5439BNC	704	54	39	1
		EVPBLEPSC5445BNC	824	54	45	1
		EVPBLEPSC5451BNC	875	54	51	1

**EVPBLEPSCNC - POWER BEAM LAMINATE SINGLE SIDED MIDDLE GALLERY PANEL, FINISHED ENDS, 36"H ELECTRICAL CUTOUT**

- Attaches to power beam channel.
- To be installed in middle between two power beam in straight run on one side.
- Cut out for electric at 36" power beam height
- Finished in thermally fused laminate.
- No connection both sides.
- Laminate Gallery Panel height is inclusive of panel glides extended to their full height.
- If wood grain is selected, grain runs horizontally.
- Power beam channel and bottom connecting bracket to be ordered separately.

	DESCRIPTION	PRODUCT CODE	LIST PRICE LP	DIMENSIONS/INCHES		
				H	W	D
	Laminate Single Sided Middle Gallery Panel - Finished Ends - 42" High	EVPBLEPSC4227CNC	450	42	27	1
		EVPBLEPSC4233CNC	502	42	33	1
		EVPBLEPSC4239CNC	564	42	39	1
		EVPBLEPSC4245CNC	646	42	45	1
		EVPBLEPSC4251CNC	692	42	51	1
	Laminate Single Sided Middle Gallery Panel - Finished Ends - 48" High	EVPBLEPSC4827CNC	492	48	27	1
		EVPBLEPSC4833CNC	558	48	33	1
		EVPBLEPSC4839CNC	625	48	39	1
		EVPBLEPSC4845CNC	692	48	45	1
		EVPBLEPSC4851CNC	784	48	51	1
	Laminate Single Sided Middle Gallery Panel - Finished Ends - 54" High	EVPBLEPSC5427CNC	541	54	27	1
		EVPBLEPSC5433CNC	618	54	33	1
		EVPBLEPSC5439CNC	704	54	39	1
		EVPBLEPSC5445CNC	824	54	45	1
		EVPBLEPSC5451CNC	875	54	51	1

# GALLERY PANELS

## EVPBLEPSC - POWER BEAM LAMINATE SINGLE SIDED MIDDLE CONNECTING GALLERY PANEL, 24"H ELECTRICAL CUTOUT

- Attaches to power beam channel.
- To be installed in middle between two power beam in straight run on one side.
- Cut out for electrics at 24" power beam height
- Finished in thermally fused laminate.
- Locking connection one side.
- Laminate Gallery Panel height is inclusive of panel glides extended to their full height.
- If wood grain is selected, grain runs horizontally.
- Power beam channel and bottom connecting bracket to be ordered separately.

	DESCRIPTION	PRODUCT CODE	LIST PRICE LP	DIMENSIONS/INCHES		
				H	W	D
	Laminate Single Sided Connecting Gallery Panel - 24" Electrical Cutout - 42" High	EVPBLEPSC4227	450	42	27	1
		EVPBLEPSC4233	502	42	33	1
		EVPBLEPSC4239	564	42	39	1
		EVPBLEPSC4245	646	42	45	1
		EVPBLEPSC4251	692	42	51	1
	Laminate Single Sided Connecting Gallery Panel - 24" Electrical Cutout - 48" High	EVPBLEPSC4827	492	48	27	1
		EVPBLEPSC4833	558	48	33	1
		EVPBLEPSC4839	625	48	39	1
		EVPBLEPSC4845	692	48	45	1
		EVPBLEPSC4851	784	48	51	1
	Laminate Single Sided Connecting Gallery Panel - 24" Electrical Cutout - 54" High	EVPBLEPSC5427	541	54	27	1
		EVPBLEPSC5433	618	54	33	1
		EVPBLEPSC5439	704	54	39	1
		EVPBLEPSC5445	824	54	45	1
		EVPBLEPSC5451	875	54	51	1

## EVPBLEPSC - POWER BEAM LAMINATE SINGLE SIDED MIDDLE CONNECTING GALLERY PANEL, 30"H ELECTRICAL CUTOUT

- Attaches to power beam channel.
- To be installed in middle between two power beam in straight run on one side.
- Cut out for electrics at 30" power beam height.
- Finished in thermally fused laminate.
- Locking connection on one side.
- Laminate Gallery Panel height is inclusive of panel glides extended to their full height.
- If wood grain is selected, grain runs horizontally.
- Power beam channel and bottom connecting bracket to be ordered separately.

	DESCRIPTION	PRODUCT CODE	LIST PRICE LP	DIMENSIONS/INCHES		
				H	W	D
	Laminate Single Sided Connecting Gallery Panel - 30" Electrical Cutout - 42" High	EVPBLEPSC4227B	450	42	27	1
		EVPBLEPSC4233B	502	42	33	1
		EVPBLEPSC4239B	564	42	39	1
		EVPBLEPSC4245B	646	42	45	1
		EVPBLEPSC4251B	692	42	51	1
	Laminate Single Sided Connecting Gallery Panel - 30" Electrical Cutout - 48" High	EVPBLEPSC4827B	492	48	27	1
		EVPBLEPSC4833B	558	48	33	1
		EVPBLEPSC4839B	625	48	39	1
		EVPBLEPSC4845B	692	48	45	1
		EVPBLEPSC4851B	784	48	51	1
	Laminate Single Sided Connecting Gallery Panel - 30" Electrical Cutout - 54" High	EVPBLEPSC5427B	541	54	27	1
		EVPBLEPSC5433B	618	54	33	1
		EVPBLEPSC5439B	704	54	39	1
		EVPBLEPSC5445B	824	54	45	1
		EVPBLEPSC5451B	875	54	51	1

**EVPBLEPSC - POWER BEAM LAMINATE SINGLE SIDED MIDDLE CONNECTING GALLERY PANEL, 36" H ELECTRICAL CUTOUT**

- Attaches to power beam channel.
- To be installed in middle between two power beam in straight run on one side.
- Cut out for electric at 36" power beam height
- Finished in thermally fused laminate.
- Locking connection on one side.
- Laminate Gallery Panel height is inclusive of panel glides extended to their full height.
- If wood grain is selected, grain runs horizontally.
- Power beam channel and bottom connecting bracket to be ordered separately.







	DESCRIPTION	PRODUCT CODE	LIST PRICE LP	DIMENSIONS/INCHES		
				H	W	D
	Laminate Single Sided Connecting Gallery Panel - 36" Electrical Cutout - 42" High	EVPBLEPSC4227C	450	42	27	1
		EVPBLEPSC4233C	502	42	33	1
		EVPBLEPSC4239C	564	42	39	1
		EVPBLEPSC4245C	646	42	45	1
		EVPBLEPSC4251C	692	42	51	1
	Laminate Single Sided Connecting Gallery Panel - 36" Electrical Cutout - 48" High	EVPBLEPSC4827C	492	48	27	1
		EVPBLEPSC4833C	558	48	33	1
		EVPBLEPSC4839C	625	48	39	1
		EVPBLEPSC4845C	692	48	45	1
		EVPBLEPSC4851C	784	48	51	1
	Laminate Single Sided Connecting Gallery Panel - 36" Electrical Cutout - 54" High	EVPBLEPSC5427C	541	54	27	1
		EVPBLEPSC5433C	618	54	33	1
		EVPBLEPSC5439C	704	54	39	1
		EVPBLEPSC5445C	824	54	45	1
		EVPBLEPSC5451C	875	54	51	1



# GALLERY PANELS



## EVLXPMNC - LAMINATE GALLERY EXTENSION PANEL, FINISHED END

- Locking connection on one side, no connection at end.
- Finished in thermally fused laminate.
- Laminate Gallery Extension Panel height is inclusive of panel glides extended to their full height.
- If wood grain is selected, grain runs horizontally.
- Bottom connecting brackets to be ordered separately.

	DESCRIPTION	PRODUCT CODE	LIST PRICE LP	DIMENSIONS/INCHES		
				H	W	D
	Laminate Gallery Extension Panel	EVLPML4224NC	369	42	24	1
	Finished End - 42" High	EVLPML4230NC	450	42	30	1
		EVLPML4236NC	502	42	36	1
		EVLPML4242NC	563	42	42	1
		EVLPML4248NC	645	42	48	1
	Laminate Gallery Extension Panel	EVLPML4824NC	424	48	24	1
	Finished End - 48" High	EVLPML4830NC	492	48	30	1
		EVLPML4836NC	558	48	36	1
		EVLPML4842NC	625	48	42	1
		EVLPML4848NC	692	48	48	1
	Laminate Gallery Extension Panel	EVLPML5424NC	462	54	24	1
	Finished End - 54" High	EVLPML5430NC	541	54	30	1
		EVLPML5436NC	618	54	36	1
		EVLPML5442NC	704	54	42	1
		EVLPML5448NC	824	54	48	1
	Laminate Gallery Extension Panel	EVLPMR4224NC	369	42	24	1
	Finished End - 42" High	EVLPMR4230NC	450	42	30	1
		EVLPMR4236NC	502	42	36	1
		EVLPMR4242NC	563	42	42	1
		EVLPMR4248NC	645	42	48	1
	Laminate Gallery Extension Panel	EVLPMR4824NC	424	48	24	1
	Finished End - 48" High	EVLPMR4830NC	492	48	30	1
		EVLPMR4836NC	558	48	36	1
		EVLPMR4842NC	625	48	42	1
		EVLPMR4848NC	692	48	48	1
	Laminate Gallery Extension Panel	EVLPMR5424NC	462	54	24	1
	Finished End - 54" High	EVLPMR5430NC	541	54	30	1
		EVLPMR5436NC	618	54	36	1
		EVLPMR5442NC	704	54	42	1
		EVLPMR5448NC	824	54	48	1

**EVLXPM - LAMINATE GALLERY STRAIGHT EXTENSION PANEL, CONNECTOR ENDS**



- Locking connection both sides.
- Finished in thermally fused laminate.
- Laminate Gallery Panel height is inclusive of panel glides extended to their full height.
- If wood grain is selected, grain runs horizontally.
- Bottom connecting brackets to be ordered separately.

	DESCRIPTION	PRODUCT CODE	LIST PRICE LP	DIMENSIONS/INCHES		
				H	W	D
	Laminate Gallery Straight Extension	EVLXPML4224	369	42	24	1
	Panel - Connector Ends - Left - 42" High	EVLXPML4230	450	42	30	1
		EVLXPML4236	502	42	36	1
		EVLXPML4242	563	42	42	1
		EVLXPML4248	645	42	48	1
	Laminate Gallery Straight Extension	EVLXPML4824	424	48	24	1
	Panel - Connector Ends - Left - 48" High	EVLXPML4830	492	48	30	1
		EVLXPML4836	692	48	36	1
		EVLXPML4842	625	48	42	1
		EVLXPML4848	692	48	48	1
	Laminate Gallery Straight Extension	EVLXPML5424	462	54	24	1
	Panel - Connector Ends - Left - 54" High	EVLXPML5430	541	54	30	1
		EVLXPML5436	618	54	36	1
		EVLXPML5442	704	54	42	1
		EVLXPML5448	824	54	48	1
	Laminate Gallery Straight Extension	EVLXPMR4224	369	42	24	1
	Panel - Connector Ends - Right - 42" High	EVLXPMR4230	450	42	30	1
		EVLXPMR4236	502	42	36	1
		EVLXPMR4242	563	42	42	1
		EVLXPMR4248	645	42	48	1
	Laminate Gallery Straight Extension	EVLXPMR4824	424	48	24	1
	Panel - Connector Ends - Right - 48" High	EVLXPMR4830	492	48	30	1
		EVLXPMR4836	558	48	36	1
		EVLXPMR4842	625	48	42	1
		EVLXPMR4848	692	48	48	1
	Laminate Gallery Straight Extension	EVLXPMR5424	462	54	24	1
	Panel - Connector Ends - Right - 54" High	EVLXPMR5430	541	54	30	1
		EVLXPMR5436	618	54	36	1
		EVLXPMR5442	704	54	42	1
		EVLXPMR5448	824	54	48	1

# GALLERY PANELS

## EV2LXP - LAMINATE GALLERY TWO-WAY EXTENSION PANEL, FINISHED ENDS

- Panel connects at 90 degree with extension panel.
- Finished in thermally fused laminate.
- Laminate Gallery Extension Panel height is inclusive of panel glides extended to their full height.
- If wood grain is selected, grain runs horizontally.
- Corner connecting brackets to be ordered separately.

	DESCRIPTION	PRODUCT CODE	LIST PRICE LP	DIMENSIONS/INCHES		
				H	W	D
	Laminate Gallery Two-Way Extension Panel - Finished Ends - Left - 42" High	EV2LXP4225	371	42	25	1
		EV2LXP4231	450	42	31	1
		EV2LXP4237	502	42	37	1
		EV2LXP4243	564	42	43	1
		EV2LXP4249	646	42	49	1
	Laminate Gallery Two-Way Extension Panel - Finished Ends - Left - 48" High	EV2LXP4825	424	48	25	1
		EV2LXP4831	492	48	31	1
		EV2LXP4837	558	48	37	1
		EV2LXP4843	625	48	43	1
		EV2LXP4849	692	48	49	1
	Laminate Gallery Two-Way Extension Panel - Finished Ends - Left - 54" High	EV2LXP5425	497	54	25	1
		EV2LXP5431	568	54	31	1
		EV2LXP5437	638	54	37	1
		EV2LXP5443	776	54	43	1
		EV2LXP5449	875	54	49	1
	Laminate Gallery Two-Way Extension Panel - Finished Ends - Right - 42" High	EV2LXPR4225	371	42	25	1
		EV2LXPR4231	450	42	33	1
		EV2LXPR4237	502	42	37	1
		EV2LXPR4243	564	42	43	1
		EV2LXPR4249	646	42	49	1
	Laminate Gallery Two-Way Extension Panel - Finished Ends - Right - 48" High	EV2LXPR4825	424	48	25	1
		EV2LXPR4831	492	48	33	1
		EV2LXPR4837	558	48	37	1
		EV2LXPR4843	625	48	43	1
		EV2LXPR4849	692	48	49	1
	Laminate Gallery Two-Way Extension Panel - Finished Ends - Right - 54" High	EV2LXPR5425	497	54	25	1
		EV2LXPR5431	568	54	31	1
		EV2LXPR5437	638	54	37	1
		EV2LXPR5443	776	54	43	1
		EV2LXPR5449	875	54	49	1

**EV3LXP - LAMINATE GALLERY THREE-WAY EXTENSION PANEL, FINISHED ENDS**

- Panel connects "T" configuration with extension panel.
- Finished in thermally fused laminate.
- Laminate Gallery Extension Panel height is inclusive of panel glides extended to their full height.
- If wood grain is selected, grain runs horizontally.
- Corner connecting brackets to be ordered separately.

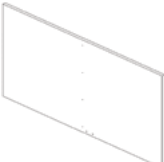
	DESCRIPTION	PRODUCT CODE	LIST PRICE LP	DIMENSIONS/INCHES		
				H	W	D
	Laminate Gallery Three-Way Extension Panel - Finished Ends - Left - 42" High	EV3LXPL4249	692	42	49	1
		EV3LXPL4261	824	42	61	1
		EV3LXPL4273	959	42	73	1
	Laminate Gallery Three-Way Extension Panel - Finished Ends - Left - 48" High	EV3LXPL4849	784	48	49	1
		EV3LXPL4861	963	48	61	1
		EV3LXPL4873	1143	48	73	1
	Laminate Gallery Three-Way Extension Panel - Finished Ends - Left - 54" High	EV3LXPL5449	875	54	49	1
		EV3LXPL5461	1143	54	61	1
		EV3LXPL5473	1322	54	73	1
	Laminate Gallery Three-Way Extension Panel - Finished Ends - Left - 42" High	EV3LXPR4249	692	42	49	1
		EV3LXPR4261	824	42	61	1
		EV3LXPR4273	959	42	73	1
	Laminate Gallery Three-Way Extension Panel - Finished Ends - Left - 48" High	EV3LXPR4849	784	48	49	1
		EV3LXPR4861	963	48	61	1
		EV3LXPR4873	1143	48	73	1
	Laminate Gallery Three-Way Extension Panel - Finished Ends - Left - 54" High	EV3LXPR5449	875	54	49	1
		EV3LXPR5461	1143	54	61	1
		EV3LXPR5473	1322	54	73	1

## EV4LXP - LAMINATE DOUBLE GALLERY PANEL FOR FOUR-WAY, FINISHED ENDS

- Panel connects "+" configuration with extension panel.
- Finished in thermally fused laminate.
- Laminate Gallery Extension Panel height is inclusive of panel glides extended to their full height.
- If wood grain is selected, grain runs horizontally.
- Corner connecting brackets to be ordered separately

	DESCRIPTION	PRODUCT CODE	LIST PRICE LP	DIMENSIONS/INCHES		
				H	W	D
	Laminate Double Gallery Panel	EV4LXP4249	692	42	49	1
	Four-Way - Finished Ends - 42" High	EV4LXP4261	901	42	61	1
		EV4LXP4273	1110	42	73	1
	Laminate Double Gallery Panel	EV4LXP4849	754	48	49	1
	Four-Way - Finished Ends - 48" High	EV4LXP4861	999	48	61	1
		EV4LXP4873	1214	48	73	1
	Laminate Double Gallery Panel	EV4LXP5449	875	54	49	1
	Four-Way - Finished Ends - 48" High	EV4LXP5461	1143	54	61	1
		EV4LXP5473	1322	54	73	1

## EV4LXPM - LAMINATE GALLERY EXTENSION PANEL FOR FOUR-WAY CONFIGURATION, FINISHED ENDS

- Locking connection on one side only for four way panel.
- Finished in thermally fused laminate.
- Universal to be used on both sides of four way laminate panel.
- Laminate Gallery Extension Panel height is inclusive of panel glides extended to their full height.
- If wood grain is selected, grain runs horizontally.
- Bottom connecting brackets to be ordered separately.

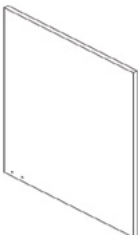
	DESCRIPTION	PRODUCT CODE	LIST PRICE LP	DIMENSIONS/INCHES		
				H	W	D
	Laminate Gallery Extension Panel	EV4LXPM4224	369	42	24	1
	Four-Way - Finished Ends - 42" High	EV4LXPM4230	450	42	30	1
		EV4LXPM4236	502	42	36	1
		EV4LXPM4242	563	42	42	1
		EV4LXPM4248	645	42	58	1
	Laminate Gallery Extension Panel	EV4LXPM4824	424	48	24	1
	Four-Way - Finished Ends - 42" High	EV4LXPM4830	492	48	30	1
		EV4LXPM4836	558	48	36	1
		EV4LXPM4842	625	48	42	1
		EV4LXPM4848	692	48	48	1
	Laminate Gallery Extension Panel	EV4LXPM5424	462	54	24	1
	Four-Way - Finished Ends - 42" High	EV4LXPM5430	541	54	30	1
		EV4LXPM5436	618	54	36	1
		EV4LXPM5442	704	54	42	1
		EV4LXPM5448	824	54	48	1

**EVPBIECH - POWER BEAM CONNECTOR CHANNEL**

- One piece channel for power beam and extension module above, attaches to laminate panels with screws.
- Power beam attaches to channel with clamps and extension module attaches above.
- Channel has cut out for power beam electric to run thru laminate panel.
- Note: not stackable. Channel has cut out for power beam electric to run thru laminate panel.

DESCRIPTION	PRODUCT CODE	LIST PRICE LP	DIMENSIONS/INCHES		
			H	W	D
 Connector Channel	EVPBIECH12	51	12	2.875	
	EVPBIECH18	58	18	2.875	
	EVPBIECH24	69	24	2.875	
	EVPBIECH30	75	30	2.875	
	EVPBIECH36	81	36	2.875	

**EVHLPBB01 - LAMINATE GALLERY PANEL BOTTOM BRACKET**

- Laminate panel bottom bracket connects two laminate end panels at bottom with screws.
- Available in standard paint colors.
- Bracket and screws included.

DESCRIPTION	PRODUCT CODE	LIST PRICE LP	DIMENSIONS/INCHES		
			H	W	D
 Bottom Bracket	EVHLPBB01	47	1.5	8	1

**EVHLPCB01 - LAMINATE GALLERY PANEL CORNER BRACKET**

- Laminate panel corner bottom bracket connects two laminate panels at 90 degree.
- Available in standard paint colors.
- Bracket and screws included.

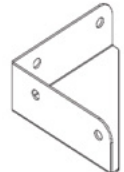
DESCRIPTION	PRODUCT CODE	LIST PRICE LP	DIMENSIONS/INCHES		
			H	W	D
 Corner Bracket	EVHLPCB01	46	1.5	4	4

**EVPBGFC - GALLERY PANEL BASE FEED COVER**

- Connects to gallery panels, underneath power beam with electrical cutout.
- Includes vertical covers and slotted connector.
- Power beam with electrical cut out to be ordered separately.

	DESCRIPTION	PRODUCT CODE	LIST PRICE	DIMENSIONS/INCHES		
			LP	H	W	D
	Gallery Panel Base Feed Cover	EVPBGFC24	185	24	6	3
		EVPBGFC30	211	30	6	3
		EVPBGFC36	237	36	6	3

**EVPBGDP - GALLERY PANEL POWER DATA POST / COMM LAY-IN**

- Attaches to Power beam gallery end panel to bring power and/or data cables from ceiling to power beam.
- Three-sided power pole with snap-on fourth side.
- Made of aluminum and can be field cut.
- Accommodates up to 25 CAT 5 cables with electric.
- Accommodates up to 45 CAT 5 cables without electric.
- Standard data post extension used above.
- Standard data post extension to be ordered separately.

	DESCRIPTION	PRODUCT CODE	LIST PRICE	DIMENSIONS/INCHES		
			LP	H	W	D
	Gallery Panel Power Data Post 24" High	EVPBGDP42	161	42	2	
		EVPBGDP48	182	48	2	
		EVPBGDP54	220	54	2	
	Gallery Panel Power Data Post 30" High	EVPBGDP42B	161	42	2	
		EVPBGDP48B	182	48	2	
		EVPBGDP54B	220	54	2	
	Gallery Panel Power Data Post 36" High	EVPBGDP42C	161	42	2	
		EVPBGDP48C	182	48	2	
		EVPBGDP54C	220	54	2	

**EVPBLEP - LAMINATE END PANEL FOR POWER BEAM**

- Connects to a power beam support leg with foot at the end of a run
- Includes brackets to attach to support leg with foot
- Finished in thermally fused laminate. If wood grain is selected, grain runs horizontally
- Laminate End Panel height is inclusive of panel glides extended to their full height
- Laminate end panel must connect to a support leg with foot and will not connect to a support leg with glide
- Must be used with Connectors with T-Leg

DESCRIPTION	PRODUCT CODE	LIST PRICE	DIMENSIONS/INCHES		
			H	W	D
 Laminate End Panel for Power Beam	EVPBLEP2451	384	24	51	1
	EVPBLEP3051	479	30	51	1
	EVPBLEP3651	578	36	51	1
	EVPBLEP4251	847	42	51	1
	EVPBLEP2463	469	24	63	1
	EVPBLEP3063	583	30	63	1
	EVPBLEP3663	693	36	63	1
	EVPBLEP4263	946	42	63	1

**EVPBLEP - LAMINATE END PANEL FOR POWER BEAM, SINGLE LEG**

- Attaches to power beam connector with single leg
- For one sided Power beam application
- Includes brackets to attached to leg
- Finished in thermally fused laminate, if wood grain is selected, grain runs horizontally
- Laminate End Panel height is inclusive of panel glides extended to their full height
- EVPBLEPxx30 to be used for 24" deep worksurface
- EVPBLEPxx36 to be used for 30" deep worksurface

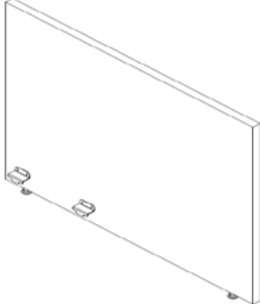
DESCRIPTION	PRODUCT CODE	LIST PRICE	DIMENSIONS/INCHES		
			H	W	D
	EVPBLEP2430	347	24	30	1
	EVPBLEP3030	374	30	30	1
	EVPBLEP3630	401	36	30	1
	EVPBLEP4230	470	42	30	1
	EVPBLEP2436	404	24	36	1
	EVPBLEP3036	418	30	36	1
	EVPBLEP3636	470	36	36	1
	EVPBLEP4236	563	42	36	1



**EVE8PD - POWER DISTRIBUTION HOUSING**

- Power housing is specified per beam size (e.g. EVE8PD36 is for use in a 36" beam).
- 8 wire, 4 circuits (2+2 configuration).
- Accommodates two duplex receptacles per panel side.

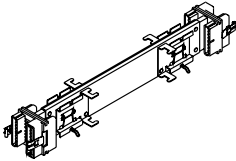
DESCRIPTION	PRODUCT CODE	LIST PRICE	DIMENSIONS/INCHES		
			H	L	D
 Power Distribution Housing	EVE8PD36	231		17 1/2	
	EVE8PD42	237		23 1/2	
	EVE8PD48	257		29 1/2	
	EVE8PD54	258		39 1/4	
	EVE8PD60	259		41 1/2	
	EVE8PD66	269		41 1/2	
	EVE8PD72	284		41 1/2	

**EVE8CP - FLEXIBLE MESH JUMPER CABLE**

- Used to connect two power distribution housings in a straight run, 90-degree or 120-degree connections.
- 18.5" flexible mesh jumper replaces EVE8CP20 jumper for corner post applications.

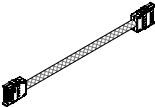
DESCRIPTION	PRODUCT CODE	LIST PRICE	DIMENSIONS/INCHES		
			H	L	D
 Flexible Mesh Jumper Cable	EVE8CP17	126		17 1/2	
	EVE8CP18	156		18 1/2	

**EVE8CPXX-H - PASS-THROUGH CABLE**

- Flexible metal conduit with wire mesh distributes electrical power through non-powered beams.
- To calculate the length of a Pass-Through Cable, add the widths of the non-powered beam separating the powered panels (panels with distribution housing attached). To this, add 16" (distance from the edge of the panel to the distribution housing x 2).
- Add additional 3" when passing through a post. See the Tips at the beginning of the section for more details.
- Hybrid pass-through cables with wire mesh allows connection at 90 degree post at one end for Evolve panels including Beltline and Power Beam.

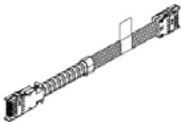
DESCRIPTION	PRODUCT CODE	LIST PRICE	DIMENSIONS/INCHES		
			H	L	D
 Pass-Through Cable	EVE8CP40-H	211		40	
	EVE8CP46-H	218		46	
	EVE8CP52-H	224		52	
	EVE8CP58-H	238		58	
	EVE8CP64-H	248		64	
	EVE8CP70-H	256		70	
	EVE8CP76-H	258		76	
	EVE8CP82-H	269		82	
	EVE8CP88-H	278		88	
	EVE8CP94-H	285		88	
	EVE8CP100-H	294		100	
	EVE8CP106-H	308		106	
	EVE8CP118-H	323		118	
	EVE8CP130-H	355		130	
	EVE8CP142-H	371		142	
	EVE8CP154-H	388		154	
	EVE8CP172-H	417		172	
	EVE8CP190-H	437		190	
	EVE8CP208-H	454		208	

**EVE8CP50-H - JUMPER CABLE PANEL TO POWER BEAM**

- Jumper cable to connect panel power distribution housing to power beam
- Hybrid jumper cable with metal conduit and with 24" long wire mesh end to be able to plug into power beam
- Panel to Power beam Post with vertical base feed covers to be ordered separately
- Power beam with electrical cut out must be ordered
- 50" long Jumper cable will work with 24", 30" and 36" H Power beam

DESCRIPTION	PRODUCT CODE	LIST PRICE	DIMENSIONS/INCHES		
			H	L	D
Jumper cable Panel to Power Beam	EVE8CP50-H	24		50	



**NOT ON CONTRACT**

**EVE8CI-1 - "I" CONNECTOR**

- Female - Female connector used to connect two Pass-Through Cables
- Connects receptacles for 66" w and 72" w modules when two are required on one end

DESCRIPTION	PRODUCT CODE	LIST PRICE	DIMENSIONS/INCHES		
			H	W	D

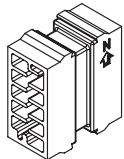

"I" Connector	EVE8CI-1	94			
---------------	----------	----	--	--	--

**EVE8RD - DUPLEX RECEPTACLE**

- Duplex receptacles are rated for 15 Amps.
- EVE8RD1 = Circuit #1 (utility circuit)
- EVE8RD2 = Circuit #2 (utility circuit)
- EVE8RDA = Circuit A (dedicated)
- EVE8RDB = Circuit B (dedicated)

**NOTE:**

- EVE8RD1 and EVE8RD2 (#1 and #2 share common ground)
- EVE8RDA and EVE8RDB (A and B share common ground)
- Up to 8 receptacles on average per circuit (24 per infeed), not to exceed total of 15 Amps per circuit.
- Actual quantity of receptacles is determined by individual electrical requirements as determined by the customer.
- Standard in black. Available in White or Nevada with upcharge, add \$3.00.

DESCRIPTION	PRODUCT CODE	LIST PRICE	DIMENSIONS/INCHES		
			H	W	D

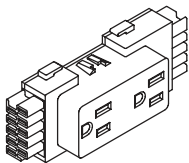

Duplex Receptacle	EVE8RD1	36	2	4 5/8	1 1/4
	EVE8RD2	36	2	4 5/8	1 1/4
	EVE8RDA	36	2	4 5/8	1 1/4
	EVE8RDB	36	2	4 5/8	1 1/4

**EVE8RD1CA - CALIFORNIA CONTROLLED DUPLEX RECEPTACLE**

- California Title 24 meets federal and LEED certification guidelines
- Allows circuit to be controlled or switched off when utility is not in use.
- Duplex receptacles are rated for 15 Amps.
- EVE8RD1CA = Circuit #1 (utility circuit)
- EVE8RD2CA = Circuit #2 (utility circuit)
- EVE8RDACA = Circuit A (dedicated)
- EVE8RDBCA = Circuit B (dedicated)

**NOTE:**

- EVE8RD1CA and EVE8RD2CA (#1 and #2 share common ground)
- EVE8RDACA and EVE8RDBCA (A and B share common ground)
- Up to 6 receptacles per circuit (24 per infeed), not to exceed total of 15 Amps per circuit.
- Available in BLK finish only.

DESCRIPTION	PRODUCT CODE	LIST PRICE	DIMENSIONS/INCHES		
			H	W	D
Duplex Receptacle	EVE8RD1CA	39	2	4.58	1 1/4
	EVE8RD2CA	39	2	4.58	1 1/4
	EVE8RDACA	39	2	4.58	1 1/4
	EVE8RDBCA	39	2	4.58	1 1/4

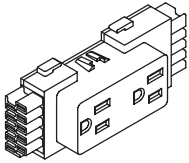

**EVEUSB01 - USB MODULE**

- Includes two USB ports.
- Available in White and Black.

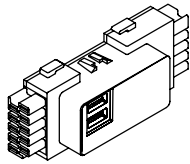

DESCRIPTION	PRODUCT CODE	LIST PRICE	DIMENSIONS/INCHES		
			H	L	D
USB Module - White	EVEUSB01WHT	226	2	4 5/8	1 1/4
USB Module - Black	EVEUSB01BLK	226	2	4 5/8	1 1/4

**EVE8FR3PB - POWER ENTRY FOR POWER BEAM**

- Snaps in to power distribution housing
- Includes 84" long flexible vinyl conduit
- Includes bracket to attach within vertical infeed cover
- Must be hardwired to source by licensed electrician

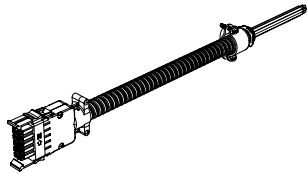

DESCRIPTION	PRODUCT CODE	LIST PRICE	DIMENSIONS/INCHES		
			H	W	D
	EVE8FR3PB	484		84	

**EVE8FR3PBD - DOUBLE POWER ENTRY FOR POWER BEAM**

- Each power feed entry snaps into separate power distribution housing
- Includes two 84" long flexible vinyl conduit
- Includes double bracket to attach to Vertical base power feed cover leg
- Must be installed in middle between two power beams, one base feed plugs to power beam on opposite side of leg than attached bracket
- Vertical base power feed cover with leg to be ordered separately
- Must be hardwired to source by licensed electrician

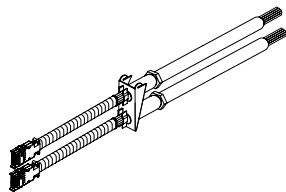

DESCRIPTION	PRODUCT CODE	LIST PRICE	DIMENSIONS/INCHES		
			H	W	D
	EVE8FR3PBD	808		84	

**NOTE: Always determine that each individual harness is electrically connected to only one power supply.**

**EVE8EC - CEILING POWER ENTRY**

- Must specify at a 90 or 120 Degree Post
- Post extension specified separate
- Floor plate must be separate on post with ceiling infeed

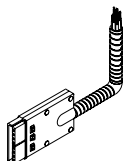

DESCRIPTION	PRODUCT CODE	LIST PRICE	DIMENSIONS/INCHES		
			H	L	D
Ceiling Power Entry	EVE8EC1	284		132	
	EVE8EC2	497		144	
	EVE8EC3	560		180	

**EVEENY-2PB - HARDWARE POWER ENTRY BOX - NEW YORK FOR POWER BEAM**

- A licensed electrician must provide hard wire connection within the junction box.
- Box attaches vertically with screws to leg between Vertical base feed covers
- Vertical base power feed cover with leg to be ordered separately
- Must be installed in middle between two power beams, plugs to power beam on opposite side of leg than attached box
- For use with Power Beam only

DESCRIPTION	PRODUCT CODE	LIST PRICE	DIMENSIONS/INCHES		
			H	W	D

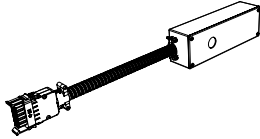

Hardware Power Entry Box - New York	EVEENY2PB	470	3	28	2 1/5
-------------------------------------	-----------	-----	---	----	-------

**EVEJBC-1PB - HARDWARE JUNCTION BOX - CHICAGO FOR POWER BEAM**

- Can be retrofitted in any size of power beam at the receptacle location.
- Gives access from one side only at each location.
- Customer to supply conduit, wiring, receptacle, and face plate.
- A licensed electrician must provide hardware connection with the junction box.
- 2 per power beam
- For use with Power Beam only

DESCRIPTION	PRODUCT CODE	LIST PRICE	DIMENSIONS/INCHES		
			H	W	D

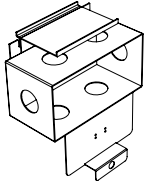

Hardware Junction Box - Chicago	EVEJBC-1PB	108			
---------------------------------	------------	-----	--	--	--

**EVDPE - POST EXTENSION DATA/ COMM LAY-IN**

- Attaches to the top of post to bring power and/or data cables from ceiling to panel power way
- Three-sided power pole with snap-on fourth side
- Post extension can be open on one side for lay-in or power and/or data cables
- Made of aluminum and can be field cut
- Accommodates up to 25 CAT 5 cables with electric. Accommodates up to 45 CAT 5 cables without electric
- Ceiling infeed installed on one way post with T Leg requires securing post with two Floor mount plates
- Post extension bigger then 82"H is made from two parts

DESCRIPTION	PRODUCT CODE	LIST PRICE	DIMENSIONS/INCHES		
			H	W	D

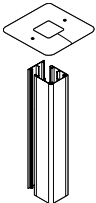

Post Extension Data/Comm Lay-in	EVDPE64	182	64	2	
	EVDPE82	220	84	2	
	EVDPE88	327	88	2	
	EVDPE94	350	94	2	
	EVDPE100	372	100	2	

**EVAFMB01 - FLOOR MOUNT PLATE**

- Attaches to floor.
- Secures beam to floor.
- Attachment screws are not included.
- Care should be taken to use correct fastners for type of floor.
- Available in chrome finish only.

DESCRIPTION	PRODUCT CODE	LIST PRICE	DIMENSIONS/INCHES		
			H	W	D
Floor Mount Plate	EVAFMB01	91	0.25	5	2.5



**EVPBECH34 - E-CHAIN WITH BRACKET**

- E-Chain provides cable management from the Power Beam to a height adjustable table
- Includes bracket to attach to bottom of Power Beam
- E-chain provides wire management for all height adjustable table heights
- Available in black only

DESCRIPTION	PRODUCT CODE	LIST PRICE	DIMENSIONS/INCHES		
			H	W	D
E-Chain with Bracket	EVPBECH34	418	41	1	2

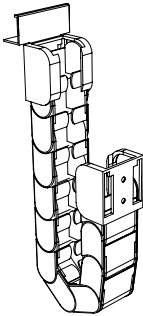

**EVPBT01 - POWER BEAM TRAY**

- Power beam tray provides support for wires
- Can be used with power beam only
- Available in standard and premium paint finishes

DESCRIPTION	PRODUCT CODE	LIST PRICE	DIMENSIONS/INCHES		
			H	W	D
Power Beam Tray	EVPBT01	44	12	1.25	3.5

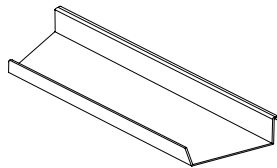

**EVAFWMXXP - WIRE MANAGER**

- PET Wire manager installed under worksurface
- Including attachment brackets
- Available in standard felt colors

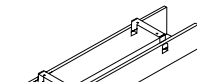
DESCRIPTION	PRODUCT CODE	LIST PRICE	DIMENSIONS/INCHES		
			H	W	D
 PET Wire Manager	EVAFWM22P	128	3.375	22	
	EVAFWM28P	147	3.375	28	4
	EVAFWM34P	162	3.375	34	4

**EVAFWMXXPL - WIRE MANAGER FOR 90 DEGREE CORNER-LEFT**

- PET Wire manager installed under worksurface
- Including attachment brackets
- Available in standard felt colors

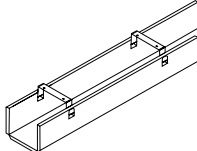
DESCRIPTION	PRODUCT CODE	LIST PRICE	DIMENSIONS/INCHES		
			H	W	D
 PET Wire Manager 90 Degree Corner - Left	EVAFWM26PL	141	3.375	26	4
	EVAFWM32PL	158	3.375	32	4
	EVAFWM38PL	172	3.375	38	4

**EVAFWMXXPR - FELT WIRE MANAGER FOR 90 DEGREE CORNER-RIGHT**

- Felt Wire manager installed under worksurface
- Including attachment brackets
- Available in standard felt colors

DESCRIPTION	PRODUCT CODE	LIST PRICE	DIMENSIONS/INCHES		
			H	W	D
 PET Wire Manager 90 Degree Corner - Right	EVAFWM26PR	141	3.375	26	4
	EVAFWM32PR	158	3.375	32	4
	EVAFWM38PR	172	3.375	38	4

NOT ON CONTRACT

**EVSDAOH - POWER BEAM DUAL ACCESS OVERHEAD**

- Inside dimensions 6.500"high x 13"deep
- Laminate Overhead
- Available in standard Evolve laminate finishes
- Top mount on power beam
- Dual Access Overhead Support Brackets to be ordered separately
- Horizontal tube with trim and power beam legs for storage to be ordered separately
- Power Beam shared storage cabinet must be installed at bottom for stability
- Power beam legs for storage must be used

DESCRIPTION	PRODUCT CODE	LIST PRICE	DIMENSIONS/INCHES		
			H	W	D
Dual Access Overhead	EVSDAOH60	1336	8.5	60	16
	EVSDAOH72	1357	8.6	72	16

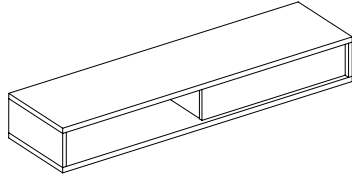

**EVPBSCGD - POWER BEAM SHARED STORAGE CABINET WITH SLIDING GLASS DOOR**

- Inside dimensions 13"high x 13"deep
- Laminate storage cabinet, available in standard Evolve laminate finishes
- Available in Temperete Frosted Glass only, glass with hole to pull
- Tracks for sliding glass available in Tungsten only
- To be used with 24" H Power beam only
- To be installed under power beam between T legs
- Power Beam Storage cabinet attaches to bottom of power beam with brackets
- For ease of installation, levelers in middle included

DESCRIPTION	PRODUCT CODE	LIST PRICE	DIMENSIONS/INCHES		
			H	W	D
Storage Cabinet with Sliding Glass Right	EVPBSCGDR60	2008	15	58.75	16
	EVPBSCGDR72	2240	15	70.75	16
Storage Cabinet with Sliding Glass Left	EVPBSCGDL60	2008	15	58.75	16
	EVPBSCGDL72	2240	15	70.75	16

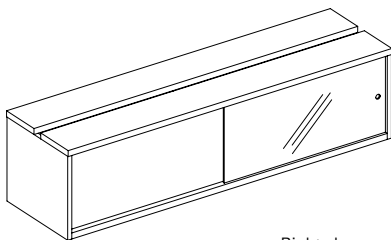

Right shown  
(opening on right)



**EVPBSCP - POWER BEAM STORAGE CABINET AND CABLE PASS THROUGH**

- Inside dimensions 13”high x 13”deep
- Laminate storage cabinet, available in standard Evolve laminate finishes
- **To be used with 24” H Power beam only and 60” and 72” widths only**
- To be installed under power beam between two T legs
- Power Beam Storage cabinet attaches to bottom of power beam with brackets
- For ease of installation, levelers in middle included
- Cabinet with cable pass through in middle to bring power to power beam above
- Includes metal cover for easy access to wires
- Electrics not included
- Power beam base feed to be ordered separately
- Power beam kit with electrical cut out in middle to be ordered separately (EVPBEPxxKIT) See page 7

DESCRIPTION	PRODUCT CODE	LIST PRICE	DIMENSIONS/INCHES		
			H	W	D
Storage Cabinet Right	EVPBSCP60	1798	15	58.75	16
	EVPBSCP72	1901	15	70.75	16
Storage Cabinet Left	EVPBSCPL60	1798	15	58.75	16
	EVPBSCPL72	1901	15	70.75	16

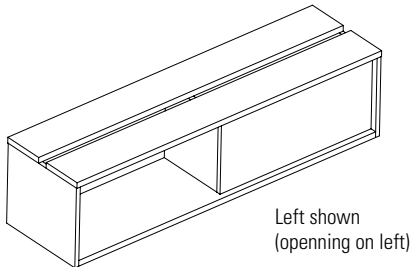

Left shown  
(opening on left)

**NOTE: Can not be converted to cabinet with glass door.  
To be used with 24” H Power Beam only**

**EVPBSCGDP - POWER BEAM STORAGE CABINET WITH SLIDING GLASS DOOR AND CABLE PASS THROUGH**

- Inside dimensions 13”high x 13”deep
- Laminate storage cabinet, available in standard Evolve laminate finishes
- Available in Tempered Frosted Glass only, with handle
- Tracks for sliding glass available in Tungsten only
- **To be used with 24” H Power beam only and 60” and 72” widths only**
- To be installed under power beam between two T legs
- Power Beam Storage cabinet attaches to bottom of power beam with brackets
- For ease of installation, levelers in middle included
- Cabinet with cable pass through in middle to bring power to power beam above
- Includes metal cover for easy access to wires
- Electrics not included
- Power beam base feed to be ordered separately
- Power beam kit with electrical cut out in middle to be ordered separately (EVPBEPxxKIT) See page 7

DESCRIPTION	PRODUCT CODE	LIST PRICE	DIMENSIONS/INCHES		
			H	W	D
Storage Cabinet with Sliding Glass Right	EVPBSCGDPR60	3043	15	58.75	16
	EVPBSCGDPR72	3217	15	70.75	16
Storage Cabinet with Sliding Glass Left	EVPBSCGDPL60	3043	15	58.75	16
	EVPBSCGDPL72	3217	15	70.75	16

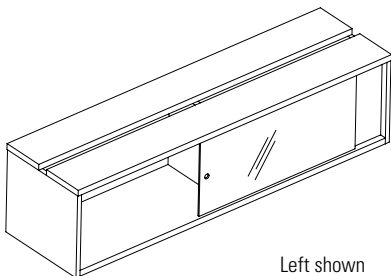

Left shown  
(opening on left)

**NOTE: To be used with 24” H Power Beam only**

**VPBL - 36" H POWER BEAM CONNECTOR WITH LEG FOR STORAGE**

- Connects 24" H power beams on equal height
- Includes non slotted connector with leg, glides and connecting hardware
- Horizontal tube to be ordered separately
- Must be used with overhead

DESCRIPTION	PRODUCT CODE	LIST PRICE	DIMENSIONS/INCHES		
			H	W	D
Connector with Leg for Storage	EVPBL36S	120	36	18	16

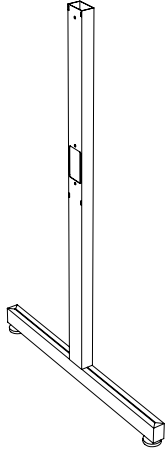



# textiles and finishes

## Care and Cleaning

The following guide encompasses the Power Beam System line.

The guide was compiled using information from our "raw" material suppliers and is relevant only to our standard offering finishes and textiles.

---

### FABRICS

To extend the life of your upholstered panels, regularly dust the panel to prevent airborne particles from penetrating the fabric surface.

For light soiling, use a damp cloth and blot the spot with very slight pressure, taking care never to soak the fabric. Dry with a clean cloth by blotting - never rub fabric. More intense stains can be treated the same way, but with a mild detergent. Always test fabric first in an unseen area before using any cleaning method.

### PANEL FRAMES

The panel frames are manufactured out of sturdy aluminum with a powder coated enamel paint finish. To clean the frames of the panels, and all hardware associated with the Evolve line, simply utilize a clean, damp cloth. For stubborn stains on the panel frames, you may consider adding a mild detergent.

### GLAZED PANELS

Cleaning of the glazing in panels should only be done with a damp lint-free cloth. A mild detergent can be used if necessary. Do not use paper towels in combination with a window cleaner-this may cause scratches to the glazing.

### WORKSURFACES

The worksurfaces are manufactured using primarily Nevamar Brand laminates as the exposed surface. To properly clean these areas, it is best to use a clean, damp cloth and circular motion to prevent streaks. For stubborn stains, you are able to add a mild detergent to the water. Be certain not to use an ammonia-based solution. It will react with the PVC, or wood edge trim, causing permanent damage to the contacted areas.

### ACCESSORIES

The accessories sold with the Evolve product line can be simply cleaned with a clean, damp cloth. If they are really dirty, a mild, non-abrasive solution may be added. Wipe with a damp cloth after the solution, and finally, a dry cloth.

**LAMINATES – THERMALLY FUSED & HIGH PRESSURE**

Absolute Acajou*	<b>ACJ</b>
Asian Night*	<b>ASN</b>
Avant Cherry*	<b>AWC</b>
Avant Honey*	<b>AWH</b>
Black*	<b>BLK</b>
Blizzard*	<b>BZD</b>
Blizzard Matrix	<b>BMX</b>
Brushed Cobalt*	<b>BRC</b>
Clear Maple*	<b>CMB</b>
Custom Grey	<b>CGY</b>
Dark Espresso*	<b>DES</b>
Designer White*	<b>DWT</b>
Grey Matrix	<b>GRX</b>
Hayden Grey	<b>HGT</b>
Hayden Linen	<b>HLN</b>
Noce Biondo	<b>(NBL)</b>
Noce Grigio	<b>(NGL)</b>
Noce Leggero	<b>(NEL)</b>
Noce Medio	<b>(NML)</b>
Quartered Mahogany*	<b>QTM</b>
Stone Dust	<b>SDT</b>
Stone Linen	<b>SLN</b>
Storm Grey	<b>SOG</b>
Studio White Matrix	<b>SWX</b>
String	<b>STG</b>
Tiger Fruitwood*	<b>TFW</b>
Tiger Walnut*	<b>TWL</b>
Walnut Heights*	<b>WHE</b>
Willow Grey	<b>WGY</b>
Winter Cherry*	<b>WCR</b>
White Chocolate*	<b>WHC</b>

Additional paint and laminates may be available. Contact Evolve Customer Support for details.

\* Matching Wood Grain PVC edge available.

\* PVC panel and connector trims are discontinued. Effective 12/2014

\* 1 1/8" Worksurfaces are discontinued. Effective December 2014

**PVC EDGE TRIM**

Absolute Acajou	<b>AAE</b>
Asian Night	<b>ASE</b>
Avant Cherry	<b>ACE</b>
Avant Honey	<b>AHE</b>
Black	<b>BLK</b>
Blizzard	<b>BZD</b>
Brushed Cobalt	<b>BRC</b>
Charcoal	<b>CHR</b>
Clear Maple	<b>CME</b>
Dark Espresso*	<b>DES</b>
Designer White	<b>DWE</b>
Nevada	<b>NEV</b>
Quartered Mahogany*	<b>QTM</b>
Shaker Cherry*	<b>SKE</b>
Silver	<b>SIL</b>
Taupe	<b>TPE</b>
Tiger Fruitwood*	<b>TFW</b>
Tiger Maple*	<b>TMP</b>
Tiger Walnut*	<b>TWL</b>
Tungsten	<b>TUN</b>
Walnut Heights	<b>WHE</b>
Winter Cherry*	<b>WCR</b>
White Chocolate*	<b>CBE</b>

\* 1 7/16" HPW PVC Trim for Worksurfaces is not available in Dark Espresso (DES), Tiger Fruitwood (TFW), Tiger Maple (TMP) and Tiger Walnut (TWL).

**WOOD VENEER WORKSURFACES\***

Almond Cherry	<b>AMW</b>
Cocoa Walnut	<b>CAW</b>
Coral	<b>CRW</b>
Dark Cherry	<b>DCW</b>
Espresso Walnut	<b>EWV</b>
Evening Oak	<b>EVV</b>
Grey on Oak	<b>GRW</b>
Hazlenut	<b>HAW</b>
Honey Maple	<b>SMW</b>
Java	<b>JAW</b>
Latte Walnut	<b>LTW</b>
Milestone	<b>MTW</b>
Mocha	<b>MCW</b>
Natural Maple	<b>MPW</b>
Red Cherry	<b>RCW</b>
Vintage Cherry	<b>VNW</b>
Walnut	<b>WLW</b>
Warm Cherry	<b>WCW</b>
White Maple	<b>WMW</b>

All wood veneer worksurfaces are 1.38" thick.

\*Note: Wood veneer options for worksurfaces are available at an up charge and with an extended lead time. Contact Evolve Customer Support for details.

**ACCENT PAINTED FINISHES**

Crystal Blue	<b>CYB</b>
Lime Green	<b>LMG</b>
Orange Flame	<b>ORF</b>
Steel Blue	<b>STB</b>
Vermilion Red	<b>VLR</b>

Accessory painted finishes are subject to 10% upcharge and minimum order of 50 pieces, orders under 50 pieces subject to \$500 net fee

**STANDARD PAINT & FRAME COLORS**

(for application to trim, steel components, PVC, vertical and horizontal members)

Black	<b>BLK</b>
Blizzard (Textured)	<b>BZD</b>
Charcoal	<b>CHR</b>
Designer White	<b>DWT</b>
Fog	<b>FOG</b>
Nevada	<b>NEV</b>
Silver	<b>SIL</b>
Stone Dust (Textured)	<b>SDT</b>
Taupe	<b>TPE</b>
Tungsten <sup>o</sup>	<b>TUN</b>

Additional paint and laminates may be available. Contact Evolve Customer Support for details.

<sup>o</sup>Tungsten paint is subject to 10% upcharge EXCEPT on Worksurfaces, PVC items, or when PVC trim components are ordered separately.

**PREMIUM PAINT & FRAME COLORS**

Black Coffee*	<b>BKC</b>
Bone*	<b>BNE</b>
Business Grey*	<b>BGR</b>
Claret*	<b>CLT</b>
Dark Chocolate*	<b>DCH</b>
Desert Putty*	<b>DPT</b>
Grey*	<b>GRY</b>
Ice*	<b>ICE</b>
Ivory*	<b>IVR</b>
Light Grey*	<b>LGR</b>
Metro*	<b>MET</b>
Mocha*	<b>MCH</b>
Moss*	<b>MOS</b>
Navy*	<b>NAV</b>
Oyster*	<b>OYS</b>
Sky*	<b>SKY</b>
Stone*	<b>STN</b>
Storm Grey	<b>SGR</b>
Tahiti Sand*	<b>TSA</b>
Willow*	<b>WIL</b>

\*Premium paint selections are available on the following components: Panels (top trim and frame), Hardware, End-of run/Post Kits, and Accessories at a 22% upcharge. Storage with no upcharge.

\*Please note all Double Wall Storage units must be ordered in a minimum quantity of 50 when ordering in a premium paint finish. Different model types can be combined to achieve the minimum quantity required. See pages 192-193 for affected models.

All special and premium paint match orders of 50 panels or less will incur a \$500 net setup fee. Panels, hardware, accessories and storage may be combined on orders to achieve minimum of 50 pieces or more and will not be subject to \$500 net set up fee. Add on orders will not have that charge for 90 days after the original order has shipped and must have the original PO# quoted otherwise they will not qualify for the program.

Global matte paint finishes are available on most Evolve Storage pieces without an up charge regardless of quantities.

All Mica and Metallic paint finishes will incur a minimum up charge of 10%.

All non-standard paint finishes must be approved by Evolve prior to placing an order.

ADA Overheads are not available in Evolve premium color paints. ADA Overheads are available in Evolve standard paint colors only.

Frames for all Open Panel models, all panel retainers, PVC components for panels and connectors are unavailable in premium or special/custom paint colors. They are available in standard Evolve paint colors only.

**PANEL FABRICS – GRADE 1**

**Anchorage** - 35% Post - consumer Recycled Polyester and 65% Pre -consumer Recycled Polyester

Birch .....	<b>AN40</b>
Green Apple .....	<b>AN41</b>
Lapis .....	<b>AN42</b>
Straw .....	<b>AN43</b>
Wolf .....	<b>AN44</b>
Goose .....	<b>AN45</b>
Angora .....	<b>AN46</b>
Cumin .....	<b>AN47</b>
Asteriod .....	<b>AN48</b>
Geranium .....	<b>AN49</b>
Thistle .....	<b>AN50</b>
Graphite .....	<b>AN51</b>
Slate .....	<b>AN52</b>
Quarry Blue .....	<b>AN53</b>
Onyx .....	<b>AN54</b>
Pumpkin .....	<b>AN55</b>
Red Delicious .....	<b>AN56</b>
Sunshine .....	<b>AN57</b>
Waterfall .....	<b>AN59</b>
Vanilla .....	<b>AN61</b>
Cobalt .....	<b>AN62</b>
Cloud .....	<b>AN64</b>

**Aurora** - 100% Polyester, 80% minimum Post-Consumer Recycled Polyester

Cloud .....	<b>AU20</b>
Seal .....	<b>AU21</b>
Fog .....	<b>AU22</b>
Pewter .....	<b>AU23</b>
Granite .....	<b>AU24</b>
Oat .....	<b>AU25</b>
Coconut .....	<b>AU26</b>
Latte .....	<b>AU27</b>
Lake .....	<b>AU28</b>
Frost .....	<b>AU29</b>

**Chance** - 63% Virgin Polyester, 37% Post-Consumer Recycled Polyester

Mist .....	<b>CN51</b>
Dill .....	<b>CN52</b>
Island .....	<b>CN53</b>
Plaza .....	<b>CN54</b>
Tranquil .....	<b>CN55</b>
Malt .....	<b>CN56</b>
Navajo .....	<b>CN57</b>
Prairie .....	<b>CN58</b>
Cinder .....	<b>CN59</b>
Oasis .....	<b>CN66</b>

**Linea** - 100% Post Consumer Recycled Polyester

Queue .....	<b>LN41</b>
Cord .....	<b>LN42</b>
Twine .....	<b>LN43</b>
Thread .....	<b>LN44</b>
Contour .....	<b>LN45</b>
Silhouette .....	<b>LN46</b>
Cable .....	<b>LN47</b>
Route .....	<b>LN48</b>

**Lisbon** - 80% Polyester, 20% Post-Consumer Recycled Polyester

Gesso .....	<b>LS11</b>
Dusk .....	<b>LS12</b>
Grey .....	<b>LS13</b>
Ivory .....	<b>LS14</b>
Henna .....	<b>LS15</b>
Nocturnal .....	<b>LS16</b>
Moss .....	<b>LS17</b>
Navy .....	<b>LS18</b>
Buff .....	<b>LA19</b>
Spa .....	<b>LS20</b>

**Loopy** - 100% Recycled Polyester

Oyster .....	<b>LP60</b>
Putty .....	<b>LP61</b>
Marble .....	<b>LP62</b>
Hazelnut .....	<b>LP63</b>
Latte .....	<b>LP64</b>
Bay .....	<b>LP65</b>
Wild Rice .....	<b>LP66</b>
Harbor .....	<b>LP67</b>

**Melody** - 100% Recycled Polyester

Spray .....	<b>ME40</b>
Pond .....	<b>ME41</b>
Sand Bar .....	<b>ME42</b>
Silt .....	<b>ME43</b>
Pebble .....	<b>ME44</b>
Lake .....	<b>ME45</b>
Gravel .....	<b>ME46</b>
Boulder .....	<b>ME47</b>

**Merge** - 100% Polyester, 75% minimum Post-Consumer Recycled Polyester

Fawn .....	<b>MG20</b>
Marshmallow .....	<b>MG21</b>
Driftwood .....	<b>MG22</b>
Dove .....	<b>MG23</b>
Graphite .....	<b>MG24</b>
Slate .....	<b>MG25</b>
Eucalyptus .....	<b>MG26</b>
Fire Engine .....	<b>MG27</b>
Mediterranean .....	<b>MG28</b>
Midnight .....	<b>MG29</b>

**Pinpoint** - 100% Post-Consumer Recycled Polyester

Bliss .....	<b>PN11</b>
Delight .....	<b>PN12</b>
Dune .....	<b>PN13</b>
Infusion .....	<b>PN14</b>
Ebony .....	<b>PN15</b>
Fresh .....	<b>PN16</b>
Carrot .....	<b>PN17</b>
Splash .....	<b>PN18</b>
Vibe .....	<b>PN19</b>
Gala .....	<b>PN20</b>

**Streak** - 100% Recycled Polyester

Beach .....	<b>SR81</b>
Shade .....	<b>SR86</b>
Stretch .....	<b>SR88</b>
Sprint .....	<b>SR89</b>
Roll .....	<b>SR91</b>
Dart .....	<b>SR92</b>
Zoom .....	<b>SR93</b>
Splash .....	<b>SR94</b>
Whiz .....	<b>SR95</b>
Flash .....	<b>SR96</b>

**Tek** - 100% Recycled Polyester

Finesse .....	<b>TX60</b>
Grain .....	<b>TX61</b>
Essence .....	<b>TX62</b>
Warp .....	<b>TX64</b>
Mesh .....	<b>TX67</b>
Form .....	<b>TX69</b>
Spice .....	<b>TX71</b>
Glacier .....	<b>TX72</b>
Spring .....	<b>TX73</b>
Harmony .....	<b>TX74</b>
Smoke .....	<b>TX75</b>
Pebble .....	<b>TX76</b>

**Terrace** - 100% Post-Consumer Recycled Polyester

Lotus .....	<b>TC60</b>
Tigerlily .....	<b>TC61</b>
Shadow .....	<b>TC62</b>
Cobble .....	<b>TC63</b>
Cherry Blossom .....	<b>TC64</b>
Bluebell .....	<b>TC65</b>
Apple .....	<b>TC66</b>
Haze .....	<b>TC67</b>
Cerise .....	<b>TC68</b>
Twilight .....	<b>TC69</b>
Wintergreen .....	<b>TC70</b>
Ironwork .....	<b>TC71</b>
Flirt .....	<b>TC73</b>
Echo .....	<b>TC74</b>
Glacier .....	<b>TC75</b>

**PANEL FABRICS— GRADE 2**

**Cyclone** - 56% post-consumer recycled polyester and 44% polyester.

Stove Pipe .....	<b>IM37</b>
Stainless.....	<b>IM40</b>
Polished Pewter .....	<b>IM41</b>
Welded Steel .....	<b>IM43</b>
Etched Bronze.....	<b>IM44</b>
Fired Titanium.....	<b>IM46</b>
Chrome.....	<b>IM49</b>
Dark Annealed.....	<b>IM50</b>
Karat.....	<b>IM54</b>
Red Metal.....	<b>IM55</b>
Oxidized Bronze.....	<b>IM56</b>
Bright Ray.....	<b>IM57</b>
Bismuth Crystal .....	<b>IM58</b>
Gallium Blue.....	<b>IM59</b>

**Dashing** -100% Post-Consumer Recycled Polyester

Classic Silver.....	<b>DS21</b>
Refined Marble.....	<b>DS22</b>
Antique Sage.....	<b>DS23</b>
Polished Slate .....	<b>DS24</b>
Genteel Beige .....	<b>DS25</b>
Bespoke Tan .....	<b>DS26</b>
Dapper Grey.....	<b>DS27</b>

**Mesh** - 100% Recycled Polyester

Canyon.....	<b>B33A</b>
Napa Valley.....	<b>B34A</b>
Huntington.....	<b>B36A</b>
Huron.....	<b>B37A</b>
Heartland.....	<b>B39A</b>
Oat.....	<b>B81A</b>
Pepper .....	<b>B82A</b>
Limestone.....	<b>B84A</b>
Zinc.....	<b>B86A</b>

**Quadrille** - 52.5% Polyester / 47.5% Recycled Polyester  
\*Maximum panel width is 48'

Escapade.....	<b>QU30</b>
Shenanigan .....	<b>QU31</b>
Revelry .....	<b>QU32</b>
Spring.....	<b>QU33</b>
Regalia .....	<b>QU34</b>
Soiree.....	<b>QU35</b>
Zest.....	<b>QU36</b>
Gambol.....	<b>QU37</b>
Leisure .....	<b>QU38</b>
Fair .....	<b>QU39</b>
Fiesta.....	<b>QU40</b>
Carnival .....	<b>QU41</b>
Spree.....	<b>QU42</b>
Opus .....	<b>QU43</b>
Jubilee.....	<b>QU44</b>
Masquerade .....	<b>QU45</b>
Cabarets .....	<b>QU46</b>

**PET PANEL FABRICS**

Graphite.....	<b>GPH</b>
Mist .....	<b>MTS</b>
Pewter .....	<b>PWT</b>
Harvest.....	<b>HVT</b>
Shamrock.....	<b>SHR</b>
Brick.....	<b>BRI</b>
Denim.....	<b>DEN</b>
Black.....	<b>BLK</b>
White.....	<b>WHT</b>



**GRADE 1**

**Dobby** - 96% Recycled Polyester / 4% Virgin Polyester

Snowcap.....	<b>DB30</b>
Bonsai.....	<b>DB31</b>
Cloud.....	<b>DB32</b>
Sand.....	<b>DB33</b>
Pewter.....	<b>DB34</b>
Sante Fe.....	<b>DB35</b>
Corfu.....	<b>DB36</b>
Medium Taupe.....	<b>DB37</b>
Charcoal.....	<b>DB38</b>
Berry.....	<b>DB39</b>
Royal.....	<b>DB40</b>
Titanium.....	<b>DB41</b>
Black.....	<b>DB42</b>

**Fusion** - 90% Virgin Polyester/ 10% Post-Consumer Recycled Polyester

Tangerine.....	<b>FU71</b>
Fresh.....	<b>FU72</b>
Moss.....	<b>FU73</b>
TomatoF.....	<b>FU74</b>
Aqua.....	<b>FU75</b>
Sandstone.....	<b>FU76</b>
Granite.....	<b>FU77</b>
Poppy.....	<b>FU78</b>
Cadet.....	<b>FU79</b>
Oasis.....	<b>FU80</b>
Graphite.....	<b>FU81</b>
Viola.....	<b>FU82</b>
Cobalt.....	<b>FU83</b>
Flax.....	<b>FU84</b>
Carbon.....	<b>FU85</b>

**Illusion** - 100% Virgin Polyester

Cappuccino.....	<b>I101</b>
Paprika.....	<b>I102</b>
Tropic.....	<b>I103</b>
Wicker.....	<b>I104</b>
Hemp.....	<b>I105</b>
Cayenne.....	<b>I106</b>
Maui.....	<b>I107</b>
Dusk.....	<b>I108</b>
Smoke.....	<b>I109</b>
Currant.....	<b>I110</b>
Fiji.....	<b>I111</b>
Ozone.....	<b>I112</b>
Ebony.....	<b>I113</b>

**Jenny** - 100% Polyester

Midnite.....	<b>JN01</b>
Ebony.....	<b>JN02</b>
Slate.....	<b>JN03</b>
Vermilion.....	<b>JN07</b>
Admiral.....	<b>JN08</b>
Charcoal.....	<b>JN11</b>
Silver Lining.....	<b>JN25</b>
Oatmeal.....	<b>JN26</b>
Sunflower.....	<b>JN27</b>
Cascade.....	<b>JN28</b>
Harvest.....	<b>JN29</b>
Mellon.....	<b>JN30</b>
Berry.....	<b>JN31</b>
Green Grass.....	<b>JN32</b>
Roast.....	<b>JN33</b>

**Quilt** - 100% Polyester

Black.....	<b>QL10</b>
Charcoal Grey.....	<b>QL11</b>
Navy.....	<b>QL14</b>
Wine.....	<b>QL16</b>
Silver.....	<b>QL19</b>
Feather.....	<b>QL20</b>
Dune.....	<b>QL21</b>
Meadow.....	<b>QL22</b>
Cadet.....	<b>QL23</b>
Geranium.....	<b>QL24</b>
Daisy.....	<b>QL25</b>
Quest.....	<b>QL26</b>
Punch.....	<b>QL27</b>
Tangerine.....	<b>QL28</b>
Cocoa.....	<b>QL29</b>

**Terrace** - 100% Post-Consumer Recycled Polyester

Lotus.....	<b>TC60</b>
Tigerlily.....	<b>TC61</b>
Shadow.....	<b>TC62</b>
Cobble.....	<b>TC63</b>
Cherry Blossom.....	<b>TC64</b>
Bluebell.....	<b>TC65</b>
Apple.....	<b>TC66</b>
Haze.....	<b>TC67</b>
Cerise.....	<b>TC68</b>
Twilight.....	<b>TC69</b>
Wintergreen.....	<b>TC70</b>
Ironwork.....	<b>TC71</b>
Pine Cone.....	<b>TC72</b>
Flirt.....	<b>TC73</b>
Echo.....	<b>TC74</b>

**Trak** - 100% Recycled Polyester

Taupe.....	<b>TK40</b>
Mustard.....	<b>TK41</b>
Latte.....	<b>TK42</b>
Cement.....	<b>TK43</b>
Silver.....	<b>TK44</b>
Copper.....	<b>TK45</b>
Teal.....	<b>TK46</b>
Apple.....	<b>TK47</b>
Steel.....	<b>TK48</b>
Merlot.....	<b>TK49</b>
Midnight Sky.....	<b>TK50</b>
Mocha.....	<b>TK51</b>
Carbon.....	<b>TK52</b>

**Urban** - 62% Recycled Polyester / 32% Polyester

Red Rose.....	<b>UR10</b>
Ocean Blue.....	<b>UR11</b>
Blue Bayou.....	<b>UR12</b>
Green Grass.....	<b>UR13</b>
Sandcastle.....	<b>UR14</b>
Beach Day.....	<b>UR15</b>
Boardwalk.....	<b>UR16</b>
Earth.....	<b>UR17</b>
Brown Ridge.....	<b>UR18</b>
White Sand.....	<b>UR19</b>
Granite Rock.....	<b>UR20</b>
Gravel Road.....	<b>UR21</b>
Black Coal.....	<b>UR22</b>

**Waterfall** - 60% Virgin Polyester /40% Post - Consumer Recycled Polyester

Trance.....	<b>WA40</b>
Tryst.....	<b>WA41</b>
Splash.....	<b>WA42</b>
Victoria.....	<b>WA43</b>
Imagine.....	<b>WA44</b>
Sky.....	<b>WA45</b>
Rainforest.....	<b>WA46</b>
Rumble.....	<b>WA47</b>
Prism.....	<b>WA48</b>
Tranquility.....	<b>WA49</b>
Grand.....	<b>WA50</b>
Rushing.....	<b>WA51</b>
Majestic.....	<b>WA52</b>
Pacific.....	<b>WA53</b>
Dance.....	<b>WA54</b>

**Waterfall** - 60% Virgin Polyester /40% Post - Consumer Recycled Polyester

Lime.....	<b>WV01</b>
Mint.....	<b>WV02</b>
Stone.....	<b>WV03</b>
Flame.....	<b>WV04</b>
Mykonos.....	<b>WV05</b>
Savannah.....	<b>WV06</b>
Mesa.....	<b>WV07</b>
Plasma.....	<b>WV08</b>
Cancun.....	<b>WV09</b>
Quartz.....	<b>WV10</b>
Moonrock.....	<b>WV11</b>
Rubine.....	<b>WV12</b>
Corfu.....	<b>WV13</b>
Bluejay.....	<b>WV14</b>

**GRADE 2 (FABRIC)**

**Imprint** - 100% Post-Consumer Polyester

Almond.....	<b>IM70</b>
Cork.....	<b>IM71</b>
Sand.....	<b>IM72</b>
Currie.....	<b>IM73</b>
Candy Apple.....	<b>IM74</b>
Ocean.....	<b>IM75</b>
Navy.....	<b>IM76</b>
Green Tea.....	<b>IM77</b>
Celery.....	<b>IM78</b>
Oregano.....	<b>IM79</b>
Walnut.....	<b>IM80</b>
Paprika.....	<b>IM81</b>
Graphite.....	<b>IM82</b>
Slate.....	<b>IM83</b>
Licorice.....	<b>IM84</b>



**GRADE 2 (VINYL)**

For availability of chair series in Vinyl, please contact a Global Sales Representative.

**Allante FRee** - 100% Vinyl Face / 100% Polyester Backing

Illusion .....	<b>A01F</b>
Bright White .....	<b>A02F</b>
White Crush .....	<b>A03F</b>
Ivory .....	<b>A04F</b>
Ice .....	<b>A05F</b>
Bleached Sand .....	<b>A06F</b>
Taupe Fawn .....	<b>A07F</b>
Warm Smoke .....	<b>A08F</b>
Autumn Rain .....	<b>A09F</b>
Cookie .....	<b>A10F</b>
Sierra Brick .....	<b>A11F</b>
Gibraltar .....	<b>A12F</b>
Chateau Grey .....	<b>A13F</b>
Golden Green .....	<b>A14F</b>
Oasis Green .....	<b>A15F</b>
Ink Black .....	<b>A16F</b>
Purple impulse .....	<b>A17F</b>
Italian Rose .....	<b>A18F</b>
Mountain Sky .....	<b>A19F</b>
Old Navy .....	<b>A20F</b>
Galaxy .....	<b>A21F</b>
Red Truffle .....	<b>A22F</b>
Chocolate Sundae .....	<b>A23F</b>
Province Blue .....	<b>A24F</b>
Eclipse .....	<b>A25F</b>

**GRADE 3 (RECYCLED)**

**Couture** - 100% Post-Consumer

Polyester	
Mocha .....	<b>CE71</b>
Sapphire .....	<b>CE74</b>
Neptune .....	<b>CE75</b>
Lake .....	<b>CE76</b>
Willow .....	<b>CE77</b>
Sassy .....	<b>CE78</b>
Persimmon .....	<b>CE80</b>
Carbon .....	<b>CE81</b>
Sterling .....	<b>CE82</b>

**SEND COMPLETED FORM AND FABRIC TO:**

Evolve Furniture Group  
 555 Petrolia Road  
 Toronto, Ontario M3J2X8  
 Attn: Eliza Porres

Requested By: \_\_\_\_\_

Phone #: \_\_\_\_\_

Fax #: \_\_\_\_\_

Product Name \_\_\_\_\_

Dealer/Specifier \_\_\_\_\_

Dealer Contact: \_\_\_\_\_

Evolve CSR: \_\_\_\_\_

Phone #: \_\_\_\_\_

Fax #: \_\_\_\_\_

**FABRIC INFORMATION**

Fabric Manufacturer: \_\_\_\_\_

Color Name: \_\_\_\_\_

Color #: \_\_\_\_\_

Pattern Name: \_\_\_\_\_

Pattern #: \_\_\_\_\_

Content: \_\_\_\_\_

Weight: \_\_\_\_\_

Width: \_\_\_\_\_

Repeat Horizontal: \_\_\_\_\_

Repeat Vertical: \_\_\_\_\_

Other Comments: \_\_\_\_\_

**REQUEST FOR APPLICATION TEST (THIS REQUIRES 2 YARDS OF FABRIC)**

\_\_\_\_\_ Evolve Panel

\_\_\_\_\_ Evolve Tackboard

\_\_\_\_\_ OH Doors

Total Number of yards for testing: \_\_\_\_\_

Please Note:

Evolve is not responsible for the duty and brokerage fees for C.O.M. Fabric to clear customs. These charges will be billed to the dealer on a separate invoice.

# PANEL FABRIC SPECIFICATION SHEET

**SEND COMPLETED FORM TO:**

EVOLVE Furniture Group  
 555 Petrolia Road  
 Toronto, Ontario M3J2X8  
 Attn: Eliza Porres

<b>SUPPLIER</b>  <b>PATTERN</b>  <b>WIDTH</b>  <b>CONTENT</b>	<b>REMARKS:</b> _____ _____ _____ _____	
<b>LIGHT FASTNESS</b>  <b>FLAMMABILITY</b>  <b>TUNNER TEST</b>	<b>REMARKS:</b> _____ _____ _____ _____	
<b>CUT PRICE</b>  <b>1 - 3 ROLLS</b>  <b>4 ROLLS</b>	<b>REMARKS:</b> _____ _____ _____ _____	
<b>DIRECTIONAL</b>  <b>PANELS CORNERS</b>  <b>RACEWAY COVER</b>  <b>RACEWAY CORNERS</b>  <b>STRETCH</b>	<b>REMARKS:</b> _____ _____ _____ _____	<b>EASY</b> <b>HARD</b> <b>X-HARD</b>
<b>APPROVED</b> <input type="checkbox"/> <b>NOT APPROVED</b> <input type="checkbox"/> <b>CONDITIONAL APPROVAL</b> <input type="checkbox"/>		
<b>REMARKS:</b> _____ _____ _____		
* This fabric is approved for upholster-ability only. The approval does not account for the durability of the fabric at the time of, and after installation of the product		
<b>SIGNATURE:</b> _____ <b>PRINT NAME:</b> _____ <b>DATE:</b> _____		

# C.O.M AUTHORIZATION FORM FOR EVOLVE PEDESTAL AND LATERAL CUSHIONS

## CUSTOMER INFORMATION

To be completed by the dealer/design firm. Use one form per textile. Incomplete information may delay or prevent approval.

A+D/Dealer/Company Name:	Contact:	Date:
Billing Address:	Phone:	
City: State: Zip:	Fax:	
End-User/Project Name:	End-User/Project Registered? YES NO	If YES, The Evolve Quote#:

## TEXTILE APPLICATION INFORMATION

MODEL NUMBER	QUANTITY	SPECIAL INSTRUCTIONS

Textile Name (Series/Style #):

Textile Color Name and Description:

Country of Origin:

Mill or Manufacturer's Name:

Textile Content (% Cotton, % Poly, % Wool, etc.):

Textile Width: Pattern Repeat: VERTICAL HORIZONTAL Rail Roaded? YES NO

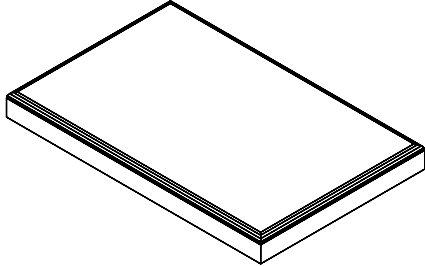
TEXTILE DIRECTION	NEW TEXTILE	PREVIOUSLY APPROVED TEXTILE
 <p><b>STAPLE FABRIC TO THIS FORM IN THE DIRECTION IN WHICH THE FABRIC IS TO BE UPHOLSTERED WITH THE LEFT SIDE OF THIS PAGE BEING THE SAME LEFT AS THE CUSHION.</b></p>	Attached textile sample (Minimum 5" x 5" Max 12" x 12") In correct DIRECTION and SIDE.	Fax completed form to: 856.596.5684
	<b>MAIL FORM AND TEXTILE SAMPLE ONLY TO:</b> GLOBAL - COM Department 17 West Stow Road Marlton, NJ 08053   856.596.3390	
	Please contact your local EVOLVE CustomeCare representative for status of all COM requests. When textile is approved and an authorization number issued, a set of shipping instructions will be faxed or e-mailed to you.  Approved textiles are to be shipped to the address that will be included with instructions. Do not ship textiles to the address on this form. Dealer is responsible for the shipping expenses. Brokerage fees will be paid for by Global. However, duties imposed by North American Governments related to textile materials, content and Country of Origin, additional fees may apply and will be billed separately.  Please Note: C.O.M Textiles may not be shipped without shipping documents. GLOBAL is not responsible for any material shipped without the authorization number.	
<p><b>Please be advised that Global has phased out the use of textiles that contain certain Phthalates, including but not limited to: DEHP ( di (2-ethylhexyl) phthalate), DBP (di-n-butyl phthalate), BBP (butyl benzyl phthalate) and DINP (di-isononyl phthalate) (collectively the "Listed Chemicals"). The Listed Chemicals are used in certain types of vinyls. Global cannot accept orders for textiles that contain the Listed Chemicals, if such orders are to be shipped to the U.S.A. or are intended for customer in the U.S.A. If you are not sure if the C.O.M you have selected contains the Listed Chemicals, please contact the manufacturer or supplier of the fabric to verify.</b></p>		

## EVOLVE AUTHORIZATION FORM (TO BE COMPLETED BY CUSTOMERCARE REP.)

CAN#:	TEXTILE YARDAGE (REQUIRED FOR THE ORDER):	GU CODE:
SIGNATURE: _____	PRINT NAME: _____	DATE: _____

**TOP**

**STAPLE  
MINIMUM 6" X 6"  
FABRIC SAMPLE HERE  
IN THE DIRECTION IT IS TO BE  
APPLIED TO THE PRODUCT**

**BOTTOM**

The Evolve Furniture Group has partnered with the software vendors listed below to provide you with an online source for viewing the 2014 Evolve Electronic Catalog. Please visit their websites for additional information and download details.

**2020 Technologies**

www.2020technologies.com  
5503 Mile Road NW  
Grand Rapids, MI 49544  
Phone: 800-638-6002

**Ice Edge Business Solutions**

www.ice-edge.com  
4001 S 700 East, Suite 450  
Salt Lake City, UT 84107  
Phone: 801-747-0373

**KISP**

www.kisp.com  
Customer Support: 416-499-2457  
Cad Services Team: 416-499-2457 x3  
Customer Service e-mail: tellmemore@kisp.com  
CAD Services requests CadServices@kispstech.com

**Project Matrix**

www.projectmatrix.com  
11655 Lebanon Rd.  
Cincinnati, OH 45241  
Tech Support Instant Messenger: projectmatrixtech@yahoo.com  
Phone: 513.554.1665  
Fax: 513.554.1255

**Quintero-Smith Incorporated/Midnight Oil**

www.midnight-oil.com  
10469 Kinnard Avenue  
Los Angeles, CA 90024  
voice: 800-350-7434 (US Only)  
international: 310-478-5140  
fax: 310-478-4572  
e-mail: jimrs@q-si.com

**APPLICATION OF STANDARD TERMS**

Sales of Evolve products are made only on Evolve standard terms and conditions of sale which are contained in the Price Book and in Evolve's order acknowledgments. These standard terms and conditions may be modified or supplemented only by a separately written document signed by Evolve's authorized personnel at its head office in Marlton, New Jersey. An offer by Purchaser of said terms and conditions shall not be binding until accepted by Evolve in writing.

All illustrations, specifications and prices in this Price List are based on the latest product information available at the time of publication. Evolve reserves the right to make changes, at any time and without prior notice, to prices, colors, materials, specifications and models offered.

**PRICES AND PAYMENT**

The prices shown in this Price List, as well as those quoted by Evolve, shall be in US dollars for orders shipped to destinations within the continental United States.

Prices listed herein are for standard product. Quotations for special product are available through Evolve Customer Support Department in Marlton, New Jersey.

If shipping date requested is more than 90 days from date of order Evolve shall use published list prices effective at the time of shipment.

Not included in the list price are special or export packing, unpacking and installation. Orders are invoiced at the time of shipment. The Customer agrees to pay a charge of 2% per month of invoices outstanding more than 30 days.

**FOR PAYMENTS ONLY, MAIL TO:**

Evolve Furniture Group, a division of:  
Global Industries, Inc.  
17 West Stow Road  
P.O. Box 562  
Marlton, New Jersey 08053

Any products sold shall remain the property of Evolve until fully paid for in cash. The Purchaser agrees to perform all acts which may be necessary to perfect and assure retention of title to such products to Evolve until such time as the goods have been paid for in full.

Freight charges will be prepaid by Evolve to destinations within the contiguous United States on shipments of \$10,000 list and greater. For shipments less than \$10,000 list, the freight charge will be 5% of the total list price.

Please note exception below:

**All showroom and mock-up orders will be subject to actual freight charges.**

Evolve shall, in its sole discretion, determine the most appropriate method of shipment routing and carrier. Shipments of less than a full trailer load (LTL) shall ship via common carrier. **These LTL shipments are not subject to specific delivery days or times.** Full trailer loads will provide for dedicated delivery time and schedule. Purchaser may request special packaging or method of shipment at Purchaser's sole expense.

**TAXES**

All sales, use, excise and other applicable taxes and the collection and reporting thereof (excluding only taxes on the net income of Evolve) are the Purchaser's responsibility and will be invoiced to the Purchaser. If Purchaser claims an exemption from such taxes, it shall be the Purchaser's responsibility to furnish an appropriate exemption certificate to Evolve.

**ORDER INFORMATION**

Evolve requires that **all orders be submitted in writing** to avoid errors and/or duplication. Orders will be acknowledged with Evolve's acknowledgement forms governing the transaction. The details appearing on the acknowledgement will describe the items to be shipped to Purchaser who must ascertain that they are correct. If not correct, Purchaser should notify Evolve immediately by telephone or fax followed by written confirmation. Acknowledgment shows approximate shipping date of items ordered. **Shipping dates are assigned to orders based on the item having the longest manufacturing lead time.** Orders with Customer's Own Material (C.O.M.), or missing or incorrect information (finish selections, fabric selections, etc.) will be scheduled for manufacturing upon receipt of COM or correct complete information. Purchaser must indicate if multiple shipping schedules are required including noting if the shipping date requested is longer than standard posted lead time. Each shipment will be invoiced at time of shipping and will be subject to payment terms described herein.

**C.O.M. CUSTOMER'S OWN MATERIAL**

Should Purchaser request a fabric, not standard to the Evolve upholstery line, Purchaser shall submit a sample of not less than two yards for approval. Evolve will determine whether fabric is suitable to manufacturing process and applicable UL or code requirements. Should Evolve be required to test such fabric, it shall so advise Purchaser, and Purchaser shall be responsible for all costs associated therewith. This includes all duty and brokerage fees.

Fabric yardage requirement will be determined by Evolve. An additional charge may be made to cover the cost of cutting, matching or sewing unusual or directional patterns. Evolve shall have no responsibility for condition, quality, performance, physical properties or any other aspect of C.O.M. For panels, price as if grade 1 fabric is used.

Evolve reserves the right to reject any C.O.M. deemed unsuitable.

Evolve reserves the right to cancel an order at any time if C.O.M. is, in the sole judgement of Evolve, inadequate for any reason.

**CHANGES AND CANCELLATION**

The order may not be changed or cancelled by Purchaser without the written consent of Evolve. This charge can be as much as 100% based upon proximity to scheduled shipment date. Special order items and fabric-covered items already in production are not subject to change or cancellation under any circumstances. Fabric-covered items are considered to be in production once the fabric has been cut.

**DEPOSIT ON SPECIAL ORDERS**

Orders for nonstandard products may, at Evolve's discretion, require deposit prior to scheduling of production, the amount of the deposit being credited against the total price of the project.

**SUSPENSION**

In the event that the Purchaser defaults in the payment of any sum due Evolve, or in the event the Purchaser's financial condition becomes unsatisfactory to Evolve, Evolve shall have the right at its option, upon written notice to the Purchaser, to cancel shipment of any goods, unless within ten (10) days of Purchaser's receipt of such notice Purchaser provides assurance of payment to Evolve in such form, content and/or amounts as Evolve, in its sole discretion, deems adequate.

**COMBINED SHIPMENTS**

Evolve will make every effort to combine shipments and orders on written request. However, acceptance of such request shall be with Evolve's sole discretion.

**CODE RESTRICTIONS**

Evolve portable furniture may be subject to local fire, electrical and/or building codes applicable to portable furniture. It shall be Purchaser's sole responsibility for the proper application of Evolve items within the limitations of such local codes, which may be different from area to area.

**SERVICE**

Service problems shall be handled by the authorized Evolve dealer. Where this cannot be accomplished on a local level, service problems should be referred to:

Evolve Furniture Group  
Customer Support  
17 West Stow Road  
Marlton, New Jersey USA 08053  
856-552-4000 888-827-2500  
Attention: Evolve Operations Manager

### STORAGE

In the event Purchaser requests postponement of delivery beyond the acknowledged shipping date, Evolve may transfer the goods to storage on Purchaser's account and at Purchaser's risk and expense subject to a daily storage rate. Such transfer to storage shall be deemed shipment to Purchaser for all purposes, including invoicing and payment.

### DELAYS

Evolve's order acknowledgement will state a shipping date which is Evolve's best estimate at the time the order is acknowledged. However, Evolve shall not incur any obligation or liability to Purchaser for failure to ship by a specified date. In addition, Evolve shall not be liable for any loss or damage resulting from any delay or failure in shipment or other failure to perform all or any part of the agreement between the parties with respect to the goods shown on the face of the order acknowledgement where such delay, failure, loss or damage is the proximate result of any act of any governmental authority or political subdivision thereof, revolution, riot, civil disorder or disturbance, act of enemies, delay or default in transportation, strike disputes among or between unions or other labor disputes, delay or inability in obtaining materials and facilities, fire, flood, act of God or any cause not within the reasonable control of Evolve, whether of the class of causes enumerated or otherwise. Without limiting the generality of the foregoing, Evolve may, without causing any breach or incurring liability, allocate goods which are in short supply, regardless of the reasons therefore, among purchasers, in any manner which Evolve, in its sole discretion, deems advisable.

### BACK CHARGES

Evolve will not accept charges for expense incurred by the Purchaser in expediting shipments or otherwise. Evolve will not accept charges for the repair of damage by others.

### CLAIMS

All goods are sold F.O.B. Toronto, Canada, unless otherwise agreed to in writing by Evolve. Evolve is not responsible for damage which occurs in transit or in storage. The carrier signs for all goods received in good order. It is the Purchaser's responsibility to examine goods upon receipt and to file any claims with the carrier. Any claims made against Evolve for apparent defects, errors or shortages must be made by the Purchaser in writing, within fifteen (15) working days after any delivery. Failure by the Purchaser to make any claim against Evolve within the above-described fifteen days shall constitute acceptance of the goods and a waiver of any apparent defects, errors or shortages.

### RETURNS

No returns of goods will be accepted without written consent and shipping instructions, including Evolve's Return Goods Authorization (R.G.A.) numbers, to Evolve. A minimum restocking charge of 35% is made on all authorized returns for credit or refund, provided goods are received by Evolve in the condition in which they left the factory. No credit will be given if goods cannot be reused. Special order items and fabric-covered items are in no event subject to return. All returns must be approved and authorized in writing by Evolve Customer Support, Marlton, New Jersey.

### LIFETIME WARRANTY

Evolve warrants that all commercial products are free from defects in material and workmanship, for the life of the product, to the original purchaser. This warranty is made by Evolve only to original customers acquiring the product directly from Evolve's authorized dealers. The customer's sole remedy pursuant to this warranty is limited to repair or replacement of parts or product at Evolve's option. Consent from Evolve must be obtained before any warranty work is performed. This warranty shall not apply to any products which must be replaced because of normal wear and tear, negligence, abuse or "accident", shipping damage, or product use and installation other than in accordance with written instructions or warnings. It shall also not apply when product has been modified or altered, repaired or refurbished by someone other than Evolve or an authorized dealer or because of natural variations over which Evolve has no control. In the event of repair and/or replacement of any defective product, Evolve does not warrant matching color, grain, texture or dye lots. Evolve's warranty does not cover the cost of transportation or labor. Repair or replacement will be at Evolve's option. Evolve makes no warranty that any of its products are suitable for any particular purpose and makes no other warranties, expressed or implied, other than those set forth in this Price List. As codes and standards vary from one jurisdiction to another, references to compliance are solely for convenience and without any representation as to accuracy or suitability. Users must verify the suitability of such information or product for their specific application. In no event shall Evolve be liable in either tort or contract for any loss or direct, special, incidental, consequential, or exemplary damages.

This Lifetime Warranty is NOT applicable to customers who use Evolve products for rental purposes and is effective only for products, parts or components manufactured after January 1, 2011.

Exceptions to this warranty include:

- Global fabrics and wood veneers, which are warranted for five years from date of delivery.
- Electrical components, which are warranted for ten years from the date of delivery.
- Moving parts such as glides, slides, casters, user-adjustable worksurface mechanisms, which are warranted for five years from date of delivery.

- Fading on fabric and wood veneers can be caused by exposure to U.V. rays/sunlight. Natural wood veneer, being a natural material, will have shade differences between veneer sheers, the difference will be more apparent between dye lots.

Evolve does not warrant color fastness on Customer's Own Material.

Because of natural variations over which Evolve has no control, this warranty does not extend to color, grain or texture of wood, and Evolve does not warrant matching of color, grain or texture.

Evolve makes no warranties, including implied warranties of merchantability and fitness for a particular purpose, other than the express warranties contained herein.

### LIMITATION OF REMEDY

Purchaser's sole and exclusive remedy (excluding the repair or replacement of goods for breach of the express warranty above) for any matter or claim arising under or relating to these terms and conditions, the goods covered hereby and any transaction involving or relating to such goods, whether in contract, tort (including negligence) or otherwise, shall be payment of the lesser of the cost to repair or replace said product or the purchase price for the goods to which the claim relates. In no event shall Evolve be liable for any special, indirect, consequential, or incidental damages, including without limitation, damages for loss of business profits, business interruptions, or loss of information.

### EVOLVE'S WARRANTY DOES NOT APPLY (FOR ANY PRODUCT CATEGORY) TO THE FOLLOWING:

- Failures due to wear and tear
- Failures which result from negligence, abuse, accident or misuse
- Failure to apply, install or maintain products according to Evolve's written instructions and warnings
- Modifications, attachments or repair methods not approved by Evolve
- Damage caused by a carrier in transit, or delivery/installation contractors
- The matching of colors, grains or textures (wood, leather, etc.) of natural materials and color matching of textiles
- Products exposed to extreme hot or cold temperatures or excessively dry or humid environments
- Colorfastness or the matching of color of textiles
- Damage by markings or staining; damage by sharp objects or imprinting from instruments
- Damage to textiles or laminate and wood surfaces/edges from exposure to sunlight (including UV rays)
- Products used for rental purposes

Evolve's warranty applies to products sold within the United States of America, Mexico, the Commonwealth of Puerto Rico and Canada.



showrooms and distribution centers throughout the united states

SHOWROOMS

<b>Atlanta</b> 10 10th Street, Suite 150 Atlanta, GA 30309 T 404.879.0998	<b>Chicago</b> The Merchandise Mart 10th Floor, Suite 1035 Chicago, IL 60654 T 312.755.0843	<b>New Jersey (Southern)</b> 119 Greentree Road Marlton, NJ 08053 T 856.596.3390	<b>Philadelphia</b> 1735 Market Street 38th Floor Philadelphia PA, 19103 215.861.0963	<b>Washington, DC</b> 1130 Connecticut Avenue Washington, DC 20036 T 202.659.0230
<b>Boston</b> One Harbor Street, Suite 104 Boston, MA 02210 T 617.406.5435	<b>Miami</b> 112 NE 41st Street 6th floor Miami, FL 33137	<b>New York City</b> 386 Park Avenue South, 7th floor New York, NY 10016 T 212.545.9900	<b>Phoenix</b> 4675 East Cotton Center Boulevard, Suite 165 Phoenix, AZ 85040 T 602.426.0666	

SHOWROOMS + DISTRIBUTION CENTERS

<b>Atlanta Area</b> 6715 Maple Ave. Suite 100 Buford, GA 30518 T 678.602.4130	<b>Cincinnati Area</b> 8712 LeSaint Drive Fairfield, OH 45014 T 513.777.0009	<b>Ft. Lauderdale Area</b> 560 Sawgrass Corporate Parkway Sunrise, FL 33325 T 954.846.8888	<b>Los Angeles Area</b> 12320 Bloomfield Avenue, Unit A Santa Fe Springs, CA 90670 T 562.484.9686
<b>Baltimore Area</b> Troy Hill Corporate Center 7030 Troy Hill Drive Elkridge, MD 21075 T 410.379.8021	<b>Dallas Area</b> 2025 W. Beltline Rd., #100 Carrollton, TX 75006 T 972.236.1366	<b>Houston</b> 7865 Northcourt Road, Building D, Suite 200 Houston, TX 77040 T 713.695.5777	<b>Seattle Area</b> Oakesdale Commerce Center 820 Southwest 34th St. Building W7, Suite A Renton, WA 98057 T 425.291.9282
<b>Chicago Area</b> 27W501 North Avenue West Chicago, IL 60185 T 630.681.2818	<b>Denver Area</b> 16401 E. 33rd Dr., Ste. 50 Aurora, CO 80011 T 303.340.1617	<b>Kansas Area</b> 11617 West 81st Street Lenexa, KS 66214 T 913.310.9963	<b>Tampa Area</b> 10351 Windhorst Road Tampa, FL 33619 T 813.621.6272

Global - USA Headquarters

17 West Stow Road P.O. Box 562  
Marlton, New Jersey U.S.A. 08053  
Tel (856) 596-3390 (800) 220-1900  
Fax (856) 596-5684

Global - Canada Headquarters

1350 Flint Road  
Downsview, ON Canada M3J 2J7  
Sales & Marketing: Tel (1-877) 446-2251  
Customer Service: Fax (800) 361-3182  
Government Customer Service: Fax (416) 739-6319

