



List Price Book  
Effective July 14, 2025

Furniture & Accessories #ESCNJ 22/23-08

evolve systems



Bid Term: 7/2/2022 - 7/1/2024  
Extended to 7/1/2025  
Extended to 1/1/2026

# evolve systems



ISO 14001:2004 Registered  
CGSB #006b



the BIFMA sustainability standard  
SCS-SCF0245-4

## PROTECTING THE ENVIRONMENT FOR FUTURE GENERATIONS

Our environmental success story began with the challenge to create an office system that would meet today's business requirements while maintaining a firm commitment to save and protect the environment.

Sustainability became a part of the creative focus and development of Evolve that incorporates the latest technology and design features to provide excellent performance at a competitive price.

As government and industry environment ratings such as LEEDS & Greenguard become more prevalent, Evolve offers designers and architects functional, attractive, and economical office designs that meet these standards.

Evolve is a leader in reducing waste in the manufacturing of its products as well as utilizing recycled materials wherever possible. We make extensive use of recycled plastic and wood waste from other Global factories.

Evolve is committed to the continuous improvement of our environmental systems, the prevention of pollution, and to comply with both the spirit and the letter of all relevant environmental legislation.

Evolve Panels are 100% recyclable at the end of their lifespan. Nothing from an Evolve Panel needs to end up in a landfill.

## PRODUCT INFORMATION

Evolve offers fabrics that are made from 100% recycled polyester, which means less waste going to landfills. These fabrics also reduced the demand for petroleum products, and decrease the environmental impacts of processing those petroleum products into polyester.

Evolve has developed a Panel interior made from 100% recycled wood and polypropylene. Through innovative design and technology, Evolve utilizes waste that would have normally been sent to landfill.

Evolve Panels are insulated with Roxul, a mineral wood insulation made from slag, an inert steel by-product, and basalt rock. Roxul is a high density product that provides maximum sound absorption to reduce noise in the work environment. Roxul insulation is fire resistant, water repellent and will not support the growth of fungi or mildew.

Evolve's epoxy powder coating process involves no liquids and is solvent free. It contains no harmful VOC's or lead. Up to 99% of over sprayed powdered is reclaimed, mixed with virgin powder and reused.



# INTRODUCTION

# TABLE OF CONTENTS

## REFERENCES

Features, Benefits & General Information .....	4-5
Coding an Order .....	6-8
Textiles & Finishes .....	320-324
Panel COM Form .....	325
Panel Fabric Specification Sheet .....	326
Panel Fabric Sample.....	328
Appendix .....	329
Terms & Conditions.....	330-331

## PANELS

Panels – Technical Information.....	10
Panel – Types .....	11-19
Panel – Configurations.....	20-21
Graphic Panels .....	22-26
Monolithic.....	27-31
Segmented .....	33-38
Partly Glazed .....	39-48
Fully Glazed .....	49-52
Reception .....	53-54
Pass-thru Sliding door.....	55-56
Slatwall .....	57-63
Write Board.....	64-65
Laminate.....	66-69
Airflow.....	70-70
Metal Skin.....	73-76
Open.....	77-82
No Raceway.....	83-95
Gallery.....	96-109
1” Laminate.....	110-111
Double Inline Connector.....	112-113
Door.....	114-116
Acoustic Grid.....	117-119

## EXTENSION MODULES

Extension Modules – Technical Information .....	120
Extension Modules – Types .....	120
Fabric.....	121
Tempered Glass.....	122
Reception Panel .....	123
Write Board.....	124-125
Laminate.....	126-127
Airflow.....	128
Open.....	129
Bridge Panel.....	130-132
Bridge Module.....	133-138
Privacy Glass.....	139-148

Felt Divider.....	149-152
Ceiling Filler .....	153-155
Privacy Panels .....	156-172

## PANELS - CONNECTORS

Panels – Technical Information.....	175
Inline Connector.....	176-178
End-of-Run.....	179
Two-Way Post .....	180-183
Three-Way Post.....	184-188
Four-Way Post.....	189-192
One Way Post.....	193-194
Inline Two-Way Post .....	195-196
60 Degree.....	197-199
45 Degree.....	199-200
Upmount End of Run .....	200-201
Extension.....	202-205
Trims.....	206-209

## ELECTRICAL

Electrical – Technical Information .....	214
Electrical – Wire Schematic .....	212
Electrical – Configurations.....	213-214
Power Distribution Housing.....	215
Cables.....	216
Power Entry.....	219-218
Post Extension.....	218-220
Task Lights.....	220
LED Lights .....	220-222
Accessories .....	222-225

## WORKSURFACES

Worksurfaces – Technical Information.....	227
Worksurfaces – Configuration .....	228
Worksurfaces – Grain Direction .....	229
Straight Worksurface.....	231-232
Curvilinear Worksurface .....	233
Corner Worksurface .....	234-238
“L” Worksurface.....	239
Transition Worksurface.....	239
Hatchet Worksurfaces .....	240
“D” Worksurface.....	240
“P” Top .....	240
Straight Wedge Worksurfaces .....	241
Piano Top.....	242
Quarter Round Panel Worksurface .....	243
Radius Worksurface.....	244

Transaction Worksurfaces .....	244-247
Height Adjustable .....	248-251
Accessories .....	252-258

## FREESTANDING DESKING

Freestanding Worksurface with Corner Legs ..	261-262
--	---------

## STORAGE

Storage – Technical Information .....	265-267
Overhead Storage .....	268-286
Pedestals.....	277-282
Cube Storage.....	283-287
Lateral Files.....	288-295
Storage Cabinet .....	296
Accessories .....	297-298
Storage Towers .....	299-302
Credenza.....	303
Key Alike Form .....	304

## ACCESSORIES

Tack Board.....	307
White Marker Board .....	308
Load Bars.....	308
Rail Accessories.....	311-313
Keyboard Supports .....	314
Mouse Supports .....	315
Keyboard Combination Chart .....	316
Monitor Arms .....	315-318
Laptop Support.....	319
Desktop Document Holder.....	329
Touch-up Paint Kit .....	320

## INTRODUCTION

## FEATURES, BENEFITS & GENERAL INFORMATION

### PANELS

- NOTE: Panels consist of module frames, module interiors and a variety of skins.

#### Panel Information

- All metal components are painted with environmentally friendly epoxy powder.
- Raceway Interiors are coated with recycled epoxy powder.
- The entire Evolve Panel and the processes used to manufacture it are designed to save and protect the environment. Evolve panels are made from recycled materials and are 100% recyclable.
- Panels conform to CGSB and ANSI/BIFMA Standards
- The quality and performance level of these panels have been tested to equal or exceed the requirements of the U.S. Government.
- Classified as Acoustic, these panels meet the acoustical requirements of the U.S. Government with the following ratings:
  - .65 NRC
  - 23 STC
- Panel has a steel frame and is 2 7/8" thick. Corner posts create a panel creep of 3 1/4".
- Leveling Glides extend 2 1/2" high. (Carpet grippers are available, contact Evolve Customer Support).

#### Panel Options

- Standard, Beltline and Light\* Segmented Panels are available in the following heights: 30", 42", 54" and 66".
- Standard, Beltline and Light\* Monolithic Panels are available in the following heights: 42", 48", 54" and 66"
  - \* Light panels do not contain a base raceway, therefore the listed heights consider the 6" open space that would have contained a raceway.
- Standard and Light Panel widths come in (8) sizes: 18", 24", 30", 36", 42", 48" 54" and 60"
- Beltline Panel widths come in (7) sizes: 24", 30", 36", 42", 48", 54" and 60". The 6" Power Belt Module is metal with knockouts on both sides.
- Beltline Panel with Chimney widths come in (2) sizes: 36" and 42".

#### Panel Skin Options

- Acoustic Fabric (Tackable), Glazed, Open, Laminate, Whiteboard, Metal, Air Flow, Slot

#### Panel Extension Modules

- Attaches to the top of Standard, Beltline or Light panels.
- Offered in 6", 12", 18" and 24" heights
- Can be stacked in an excess of 14'-0". (Contact the Evolve Specification Department regarding additional support required.)

### Extension Module Options

- Fabric, Glazed, Open, Laminate, Whiteboard and Airflow. Laminate and Whiteboard available in single and double sided.

### Panel Reconfiguration

- Panels can be modified on site by replacing fabric modules with Glazed, Open, Laminate, Whiteboard or Air Flow at any time after the initial installation\*.
- All panel types existing on site can have their height altered by replacing the vertical liners (on each side of the panel) and adding or subtracting modules\* as required.
- Fabric can be replaced easily; using pre-cut segments of fabric, a drawstring (C-Jex) is sewn in around the edges. Then a rubber spline is used to 'screen' the fabric in place.
- Panels can be removed from the workstation, without having to remove an overhead or worksurface.
- Corner connectors can be converted from 2-way to 3-way, etc., by attaching an in-line connector with one screw.
- The Power Belt Module for the Beltline Panels cannot be relocated.
  - \*Contact Evolve Customer Support for information on field installed modules (they are available in heights of 6", 12" and 24")

### VOICE/DATA AND ELECTRICAL POWER

- NOTE: Panels and Electric components are CSA/UL approved. Tools are not required to install electrical in the Evolve Panel System.

#### Voice and Data can be run at the following levels:

- Standard Panels – Base of the panel.
- Beltline Panels – Base, Beltline of the panel.
- Beltline Light Panels – Beltline of the panel.

#### Electric can be run at the following levels:

- Standard Panels – Base raceway
- Beltline Panels – Base and/or Beltline raceway
- Light Panels – Do not contain a raceway for electric.
- Beltline Light Panels – Beltline raceway

#### Additional Data and Electric Options

- A panel mounted power bar can be mounted on-module at any level and contains a 14' cord.
- Desktop modules are available to install in the worksurface scoop for electric and data.
- 6" Vertical Panel provides electric and data above the worksurface and electric just below the worksurface.

### Electric Information

- Electric can be run in any raceway whether it is at the base or Beltline.
  - 8-Wire, 4-Circuit Capability
  - 2 Utility + 2 Dedicated Circuits
  - 10 Gauge (oversized) Neutrals.
- All circuits can support up to 20 amps (15 CSA).

### Raceway Information

- Raceway knockouts sizes conform to the ANSI/TIA/EIA Furniture Opening Standard of 1.38" x 2.71" at the base and Beltline.
- Panels 24" wide include raceway covers with one knockout.
- Panels 30" wide include raceway covers with two knockouts.
- Panels 36"-60" wide include raceway covers with three knockouts.
- Standard data face mount plates can be used without the need of adapter plates (supplied by others).
- Cabling Capacities**  
(calculations below are based on CAT5 cables)
- Base Raceway – for Standard and Beltline Panels**
  - Without Electric – 140 Cables
  - With Electric – 48 Cables
- Beltline Raceway – for Beltline and Light Beltline Panels**
  - Without Electric – 65 Cables
  - With Electric – 54 Cables
- Panel Connectors - 45 Degree Connectors Posts**
  - Without Electric – 20 Cables
  - With Electric – 6 Cables
- Panel Connectors - 60 Degree Connector Posts**
  - Without Electric – 20 cables
  - With Electric – 6 Cables
- Post Extension - 90 Degree Post**
  - Without Electric - 45 Cables
  - With Electric - 25 Cables
- Post Extension - 45 Degree Post**
  - Without Electric - 20 Cables
  - With Electric - 6 Cables
- Post Extension - 60 Degree Post**
  - Without Electric - 20 Cables
  - With Electric - 6 Cables

### WORKSURFACES

- NOTE: Worksurfaces come in a variety of shapes and sizes.

#### Worksurface Options

- Standard worksurface depths are 18"d, 24"d and 30"d.
- Standard worksurface widths range from 24"w – 84"w standard depending on the shape.

## INTRODUCTION

## FEATURES, BENEFITS & GENERAL INFORMATION

### Worksurface Laminate Options

- Thermally Fused – 1" thick
- High Pressure – 1-1/16" thick
- High Pressure – 1-7/16" thick
- Wood Veneer – Contact Customer Support for Quotes

### Worksurface Information

- Cable scoops are located in the back of each worksurface to route power and data cables
- Depth from center of scoop to panel is 1-1/8".
- Once installed there is a 3/8" gap between the worksurface and the panels for additional cabling needs.
- Custom sizes are available, contact Customer Support for Quotes.
- Metal inserts are standard for a metal to metal connection between the worksurface and the supporting hardware. This will allow product to be reconfigured many times and still perform.
- All worksurfaces utilize balanced construction.

### STORAGE

#### Pedestals

- Available as Worksurface Supporting, Freestanding and Mobile.
- Mobile pedestals are available with or without a cushion. Mobile pedestals with a cushion can have an upholstery fabric applied to them.
- Standard Pedestal Depths are 18"d, 19"d, 23"d, 24"d, 29"d and 30"d
- Pedestal widths are 15"w. Please note maximum extension of pedestal glide is 1".

#### File Drawers

- 150 lb Full Extension Slides
- Full height drawer sides are standard on all File drawers which enables the hanging of files from the drawer side so no extra hardware is necessary. File drawers accept legal, letter and metric sized files.

#### Box Drawers

- 75 lb Single Action Slides

### Drawer Information

- Steel construction guarantees the performance of the product over the long term.
- Welded joints with a full top, back and base ensure that the pedestal will sit square and adequately support the worksurface where necessary.
- Double wall drawer face
- 20 gauge steel
- Metal roller ball bearing slides
- Adjustable glides are accessible from the inside of the pedestal.
- Standard positive and secure locking system.
- Epoxy powder coated.
- Locks can be keyed alike or master keyed\*. Please note Key list(s) required to key alike.
- \*Master Key must be ordered separate.
- Standard recessed handle offers uncluttered aesthetic.

### Lateral Files

- All lateral files are 18" deep
- Standard widths are 30"w, 36"w and 42"w.
- Standard EV12 Heights are 27.75"h, 40.5"h, 54"h and 65.88"h.
- Available with fixed front drawers, receding doors with roll-out shelf, and half height drawers (See page 184 for more information Lateral File)

### Lateral File Information

- Drawer anti-locking system
- Three Stage, anti-bounceback suspension
- Receding door features 16 gauge, spring loaded hinges
- Premium drawer slides with black zinc coating for smoother, quieter motion.
- Pre-Installed file bars
- 18-20 gauge steel
- Adjustable glides are accessible from the inside of the lateral file. Please note maximum extension for lateral glide is 5/8"

### Storage Towers

- Features all metal construction and a choice of 20 different configurations.
- Heights include 50"h, 54"h and 65.875"h. 42"h and 48"h available upon request.
- 24"w x 24"d
- Side shelving available.

### Bookcases and Storage Cabinets

- Features all metal construction.
- Available in widths of 30"w, 36"w and 42"w.
- Heights include 27.75"h, 40.5"h, 54"h and 65.88"h.

### Overhead Storage

- Standard widths include 24"w (not available on all units), 30"w, 36"w, 42"w, 48"w, 54"w and 60"w. Please note ADA and Double Wall Overheads are not available in 24"
- Standard heights range from 12"h to 17.5"h.
- Overhead Options
- Flat Front 12" Flipper Door
- Full Pull 13" Flipper Door
- Full Pull Double Wall Flipper Door (also available with shelf option)
- Full Pull 16" Flipper Door (door retracts inside cabinet)
- Sliding glass doors
- ADA Compliant Overhead with soft close mechanism
- High and Low Profile Shelf
- A magnetic whiteboard is available for metal front overheads.

### WARRANTIES AND PERFORMANCE

- A Lifetime Warranty
- Non Obsolescence Warranty
- Reduced cost of assembly and reconfiguration
- ISO9001:2000 Registered
- ISO14001:2004 Registered
- GreenGuard Certified
- ANSI/BIFMA CGSB testing on all products
- For piece of mind over the long term, we cover you with a comprehensive warranty that is supported by our dealer network.
- Some installation companies claim that the Evolve Panels System can be installed in half the time it takes to install most of our competitor's segmented panels. This cost saving can amount to thousands of dollars over the lifetime of our furniture.
- Your assurance of consistent quality to an international standard. Evolve Systems is committed to design, manufacture and distribute superior quality office furniture, which meets or exceeds the requirements of our customers.
- Confirmation that Evolve is committed (1) to providing product that, through their entire life cycle, minimize negative environmental impacts on the environment, (2) to continuous improvement to our environmental systems and programs and (3) to comply to all relevant environmental legislation and regulations.
- Evolve Systems can help a company meet LEED requirements for office furniture.
- Evolve components are tested to the highest standard in the industry. This is your assurance of quality and longevity.

# INTRODUCTION

# CODING AN ORDER

Evolve products have been coded using alphas that correspond with the product name. This creates an easy-to-remember code. The following breaks down the coding logic and highlights the required code components needed to order within each product category.

## PANELS

**Example:**

**Product:**

**Segmented Panel**

Specify

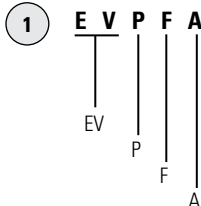

Base Code found on the product page to the left of the product name and a simple product illustration.

**EV**olve product line

**P**anel category

**F**abric-covered or partly fabric-covered Panel

**A**coustic Panel

(EVPF P – represents Premium Acoustic)

2 EVPFA**6648**

Panel size offering. Listed on every product page with price listing.

Note: Additional dimensions are provided for most products on the far right hand side of each page. These dimensions are not required in the ordering code.

3 EVPFA6648 –**BLK**

Finish code for frame. See Textiles & Finishes pages 251-252.

To specify fabric for an Evolve Panel, please note:

4 EVPFA6648-BLK–**B84A**

Fabric code for all modules on both sides of the Panel\*. See Textiles & Finishes pages 251-252.

\* **NOTE:** If different fabrics are to be included on an Evolve Panel, please use the following ordering format. **Start at the bottom** of one side of a Panel and work to the top module of that Panel. Then start the process over on the other side of the Panel. As an example:

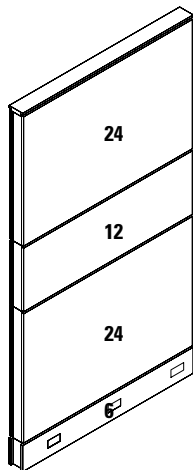

= 66

Position 3

Position 2

Position 1

11	B86A	I = Inside
12	B84A	O = Outside
13	B86A	
01	B86A	
02	B86A	
03	B86A	

# INTRODUCTION

# CODING AN ORDER

## ELECTRICAL

**Example:**      **Product:**      **Pass-Through Cables**

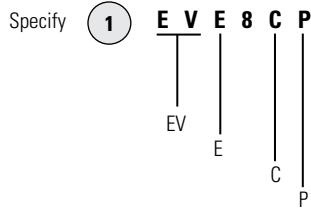

Base Code found on the product page to the left of the product name and a simple product illustration.

**EV**olve product line

**E**lectrical category

**C**able Panel.

**P**ass-Through.

(2) **EVE8CP40**

Product size offering – length. Listed on every product page with price listing. Note: Additional dimensions are provided for most products on the far right hand side of each page. These dimensions are not required in the ordering code.

## WORKSURFACES

**Example:**      **Product:**      **Curvilinear Worksurface - Left**

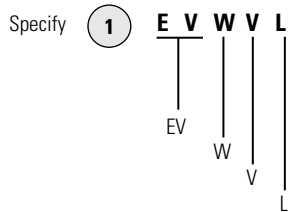

Base Code found on the product page to the left of the product name and a simple product illustration.

**EV**olve product line

**W**orksurface category

Cur**V**ilinear shape

**L**eft hand configuration

(2) **EWWWL3042**

Worksurface size offering. Listed on every product page with price listing. Note: Additional dimensions are provided for most products on the far right hand side of each page. These dimensions are not required in the ordering code.

(3) **EWWWL3042-T431**

Laminate code for surface. See Textiles & Finishes pages 251-252.

(4) **EWWWL3042-T431-CHR**

PVC code for trim. See Textiles & Finishes pages 240-241.

# INTRODUCTION

# CODING AN ORDER

## WORKSURFACES - HARDWARE

Example:

Product:

End Panel

Specify

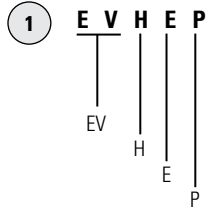

Base Code found on the product page to the left of the product name and a simple product illustration.

**EV**olve product line

**H**ardware category

**E**nd Panel.

End **P**anel.

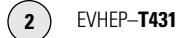

Laminate code for End Panel. See Textiles & Finishes pages 251-252.

## STORAGE

Example:

Product:

Box, Box, File Pedestal

Specify

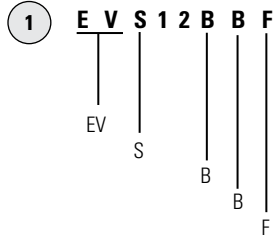

Base Code found on the product page to the left of the product name and a simple product illustration.

**EV**olve product line

**S**torage category

**B**ox drawer

**B**ox drawer

**F**ile drawer

## ACCESSORIES

Example:

Product:

White Board

Specify

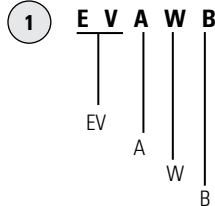

Base Code found on the product page to the left of the product name and a simple product illustration.

**EV**olve product line

**A**ccessories category

**W**hite Board

**B**hite Board

# panels

**TECHNICAL FEATURES OF EVOLVE PANELS:**

- Evolve Panels are 2 7/8" thick.
- An aluminum low profile top cap is included with the panel.
- Base Raceway will allow for 140 data cables without electrical, or 48 data cables with electrical.
- Beltline Raceway will allow for 65 data cables without electrical or 54 data cables with electrical.
- 90 degree post extension will allow for 45 data cables without electric and 25 data cables with electric.
- Raceway knockout openings are 1.38" x 2.71".
- Acoustic Rating: .65 = NRC - Noise Reduction Coefficient
- STC: 23 = Sound Transmission Coefficient

**BASIC FEATURES OF EVOLVE PANELS:**

- Evolve Segmented Panels are available in four (4) basic heights: 30", 42", 54" and 66"; and eight (8) widths: 18", 24", 30" 36", 42", 48", 54" High and 60".
- Evolve Monolithic Panels are available in four (4) basic heights: 42", 48", 54" and 66"; and eight (8) widths: 18", 24", 30" 36", 42", 48", 54" and 60".
- Evolve Panels must include the same segmentation on both sides of the panel. Cannot be Monolithic on one side and Segmented on the other.
- Opposite sides of each Fabric Module may have a different fabric within the same grade at no upcharge.
- If different grades of fabric are used on one panel, the entire panel must be priced at the highest grade.
- There is no panel creep in a straight Panel-to-Panel configuration; however, a corner post (2, 3, 4 way) will add 3.25" inches to a panel run.
- All Fabric Acoustic Panels (EVPFA) are composed of a 6" raceway module and a 24" base-height module which create the EVPFA30. Subsequent heights are created by adding either a 12" high module to create an EVPFA42 or a 24" high module to create an EVPFA54. The addition of both 12" and 24" modules creates a EVPFA66.
- In contrast, a Premium Panel (EVFPF) is composed of a 6" raceway module, a 24" base-height module and either two (2) or three (3) 12" modules which make up the two premium heights: EVFPF54 and EVFPF66.
- All Panels available with Aluminum trim as a standard option.
- Individual fabric covered acoustic modules incorporated into a rigid steel frame.
- Raceway covers included with panels
- Beltline Panels contain a 6" Power Belt Module that is metal with knockouts on both sides.

**BASIC FEATURES OF EXTENSION MODULES:**

- Stackability: Evolve Panels can be increased in height in 6", 12", 18" or 24" increments. See Extension Module (pages 82-90) for part numbers.
- Panel Extension Modules stack on the top of a Panel.
- Modules can be stacked to add privacy or divide space.
- Opposite sides of a fabric module may have a different fabric within the same grade at no upcharge.
- If different grades of fabric are used on one Panel, the entire Module must be priced at highest grade.

**GENERAL WARRANTY INFORMATION:**

- Panel and tackboard textiles, adjustable keyboard mechanisms, tasklights and electrical devices = ten (10) Years
- Other parts = Lifetime Warranty

PANELS

TYPES

MONOLITHIC PANELS - PAGES 22-27

Monolithic Panel

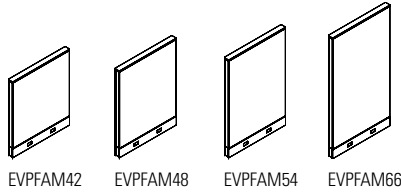

Monolithic Light Panel

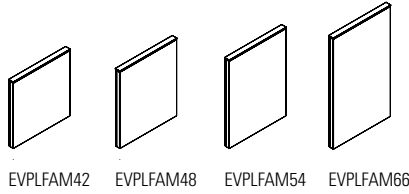

Monolithic Beltline Powered Panel

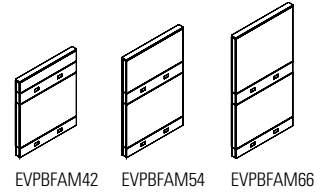

Monolithic Beltline Powered Light Panel

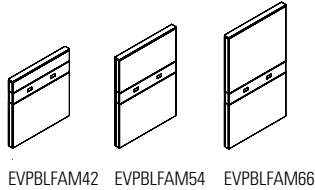

Monolithic Beltline Powered Chimney Panel

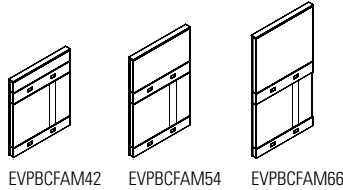

Chimney Jumper Cable Kit

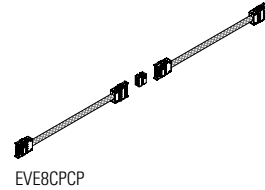

Monolithic Beltline Non-Powered Panel

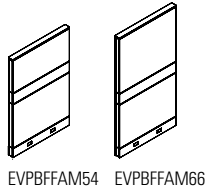

Monolithic Beltline Non-Powered Light Panel

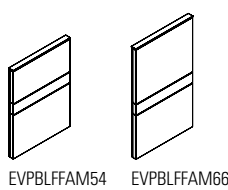

SEGMENTED PANELS - PAGES 28-33

Segmented Panel

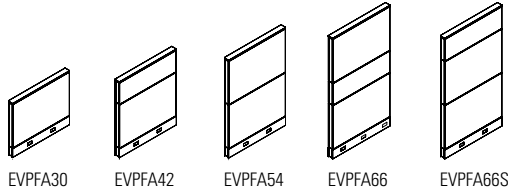

Segmented Light Panel

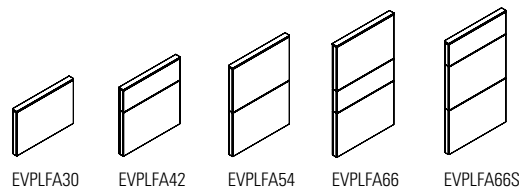

Segmented Premium Panel

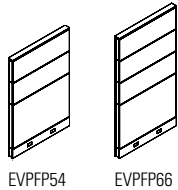

Segmented Premium Light Panel

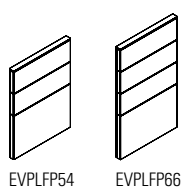

Segmented Beltline Powered Panel

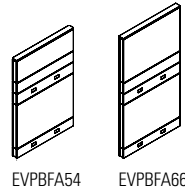

Segmented Beltline Powered Light Panel

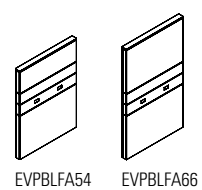

Segmented Beltline Powered Chimney Panel

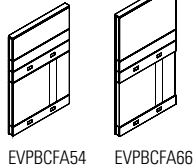

Chimney Jumper Cable Kit

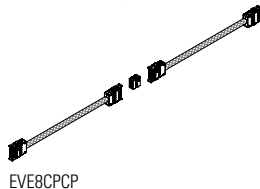

Segmented Beltline Non-Powered Panel

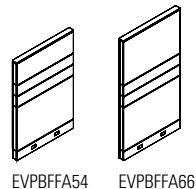

Segmented Beltline Non-Powered Light Panel

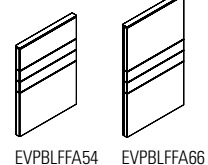

PARTLY GLAZED - TEMPERED GLASS PANELS - PAGES 34-43

Monolithic 12"H Glazed Panel

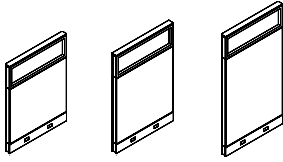

EVPMGTU48 EVPMGTU54 EVPMGTU66

Monolithic 12"H Glazed Light Panel

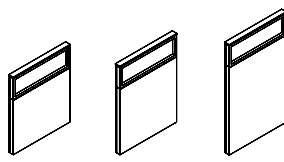

EVPLMGTU48 EVPLMGTU54 EVPLMGTU66

Segmented 12"H Glazed Panel

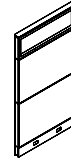

EVPPFGTU66

Segmented 12"H Glazed Light Panel

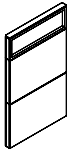

EVPLFGTU66

Segmented 12"H Glazed Premium Panel

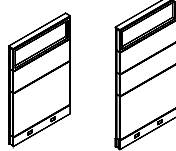

EVPPFGTU54 EVPPFGTU66

Segmented 12"H Glazed Premium Light Panel

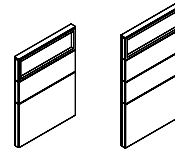

EVPLFGTU54 EVPLFGTU66

Partly Glazed Panel

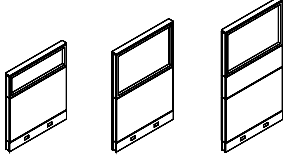

EVPPFGT42 EVPPFGT54 EVPPFGT66

Partly Glazed Light Panel

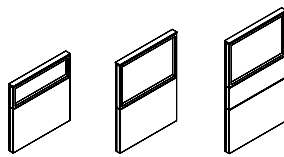

EVPLFGT42 EVPLFGT54 EVPLFGT66

Partly Glazed Panel - 36"H



EVPPFGTX66

Partly Glazed Light Panel - 36"H

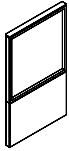

EVPLFGTX66

Partly Glazed Beltline Powered Panel

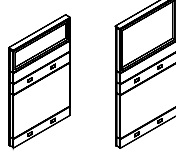

EVPPBFGT54 EVPPBFGT66

Partly Glazed Beltline Powered Light Panel

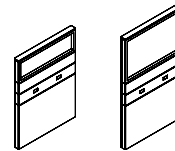

EVPLBFGT54 EVPLBFGT66

Partly Glazed Beltline Powered Chimney Panel

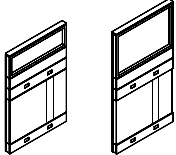

EVPPBCFGT54 EVPPBCFGT66

Chimney Jumper Cable Kit

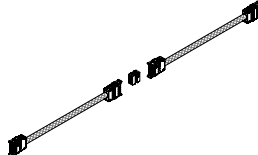

EVE8CPCP

Partly Glazed Premium Panel

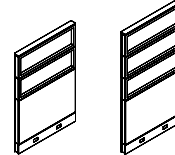

EVPPFGT54 EVPPFGT66

Partly Glazed Premium Light Panel

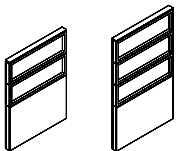

EVPLFGT54 EVPLFGT66

FULLY GLAZED - TEMPERED GLASS PANELS - PAGES 44-47

Fully Monolithic Panel

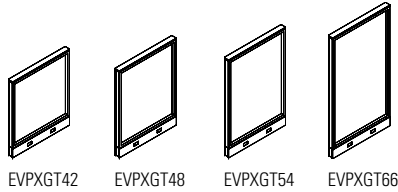

Fully Monolithic Light Panel

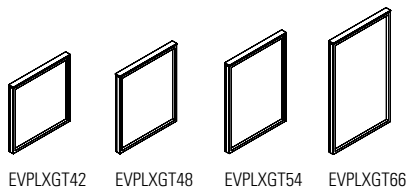

Fully Glazed Segmented Panel

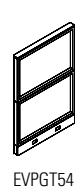

Fully Glazed Segmented Light Panel

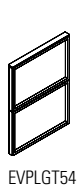

Fully Glazed Premium Panel

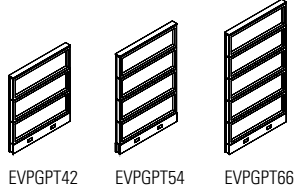

Fully Glazed Premium Light Panel

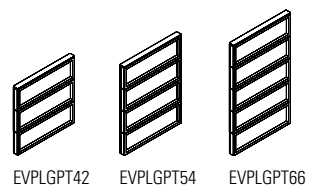

PASS-THRU SLIDING DOOR - PAGES 50-51

Pass-Thru Sliding Door Glazed Panel

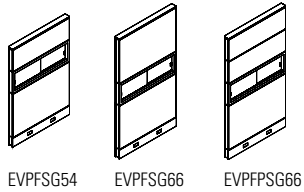

Fabric Glazed Pass-Thru Sliding Door Panel

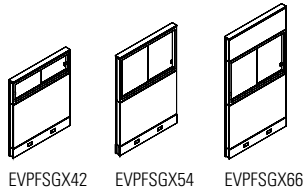

PANELS

TYPES

SLATWALL PANELS - PAGES 52-58

Slatwall Panel - Single Sided

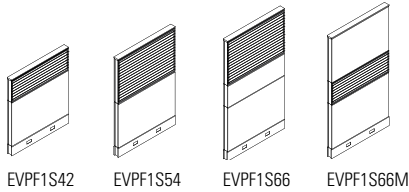

Slatwall Light Panel - Single Sided

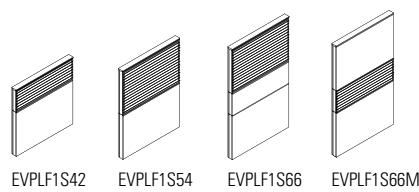

Slatwall Panel - Double Sided

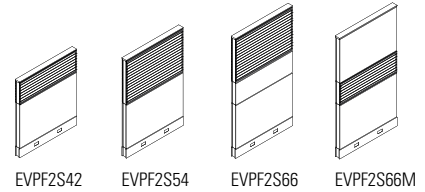

Slatwall Light Panel - Double Sided

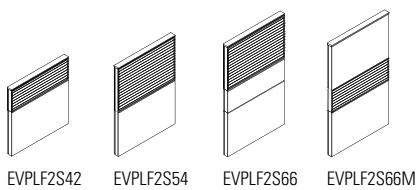

Frameless Slatwall Panel - Double Sided

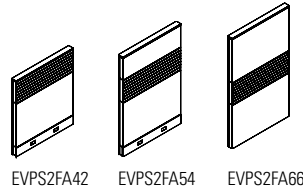

Frameless Slatwall Beltline Powered Panel - DS

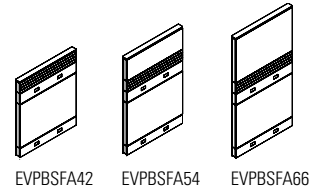

Frameless Slatwall Beltline Powered Light Panel - DS

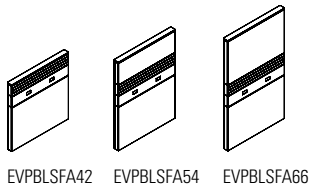

Frameless Slatwall Beltline Powered Chimney Panel - Double Sided

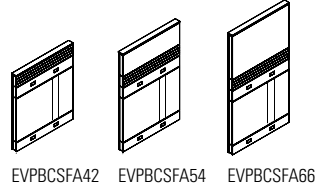

Chimney Jumper Cable Kit

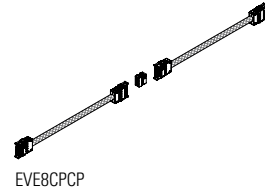

WRITE BOARD PANELS - PAGES 59-60

Write Board Panel - Single Sided

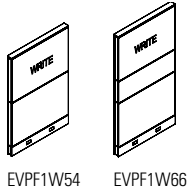

Write Board Light Panel - Single Sided

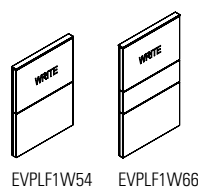

Write Board Panel - Double Sided

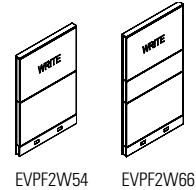

Write Board Light Panel - Double Sided

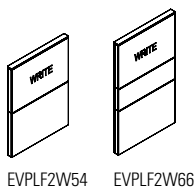

PANELS

TYPES

LAMINATE PANELS - PAGES 61-64

Laminate Panel - Single Sided

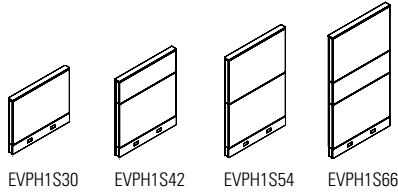

Laminate Light Panel - Single Sided

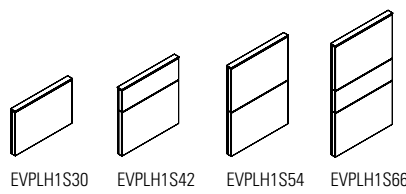

Laminate Panel - Double Sided

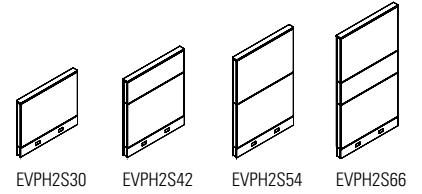

Laminate Light Panel - Double Sided

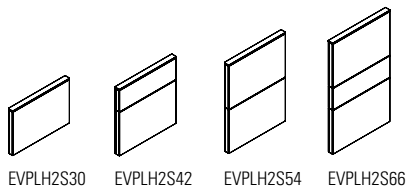

AIRFLOW PANELS - PAGES 65-68

Airflow Panel

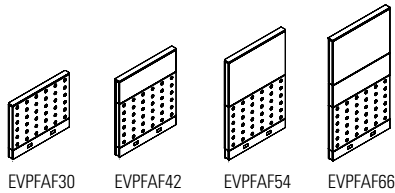

Airflow Light Panel

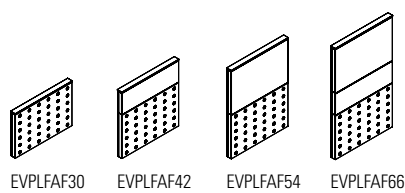

Airflow Premium Panel

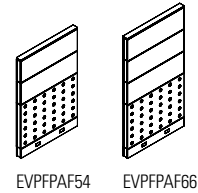

Airflow Premium Light Panel

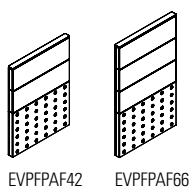

Airflow Middle Premium Light Panel

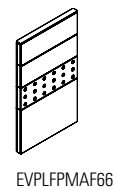

METAL SKIN PANELS - PAGES 69-72

Metal Skin Panel - Single Sided

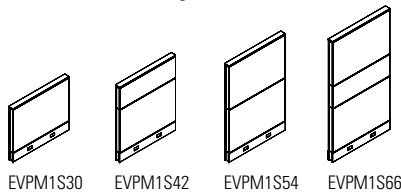

Metal Skin Light Panel - Single Sided

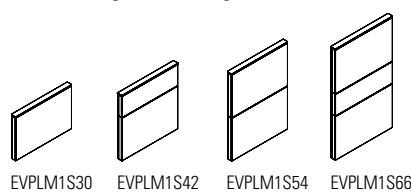

Metal Skin Panel - Double Sided

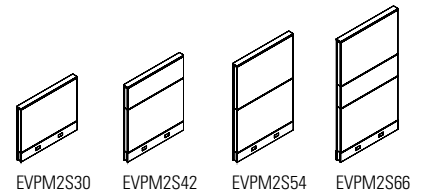

Metal Skin Light Panel - Double Sided

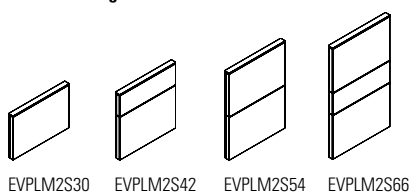

OPEN PANELS - PAGES 73-78

Open Bottom Panel

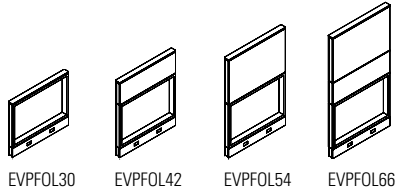

Open Bottom Light Panel

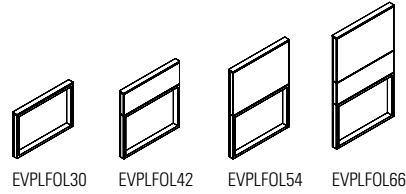

Open Bottom Premium Panel

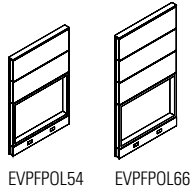

Open Bottom Premium Light Panel

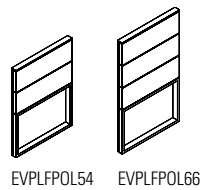

Open Middle Panel - 12"H Opening

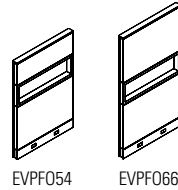

Open Middle Light Panel - 12"H Opening

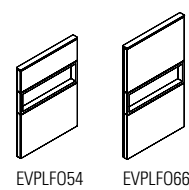

Open Middle Premium Panel - 12"H Opening

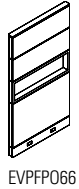

Open Middle Premium Light Panel - 12"H Opening

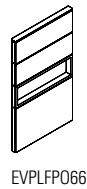

Open Middle Panel - 24"H Opening

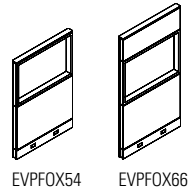

Open Middle Light Panel - 24"H Opening

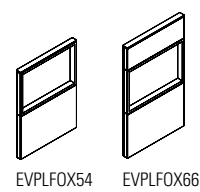

NO RACEWAY PANELS - PAGES 79-91

Segmented

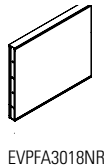

Monolithic



Laminate - Single Sided

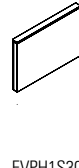

Laminate - Double Sided

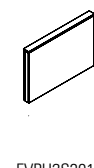

Fully Glazed Monolithic

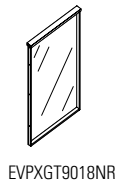

Inline Connector

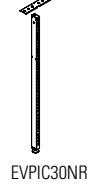

End of Run

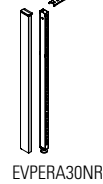

Corner Post - One Way

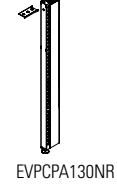

Inline Corner Post - Two Way

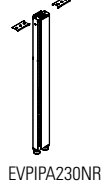

Corner Post - Two Way

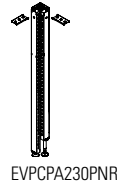

Corner Post - Three Way

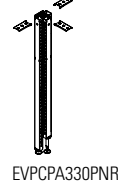

Corner Post - Four Way

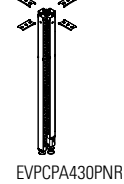

GALLERY PANELS - PAGES 92-105

**Laminate Double Sided  
Finished Ends**



EVLEPDS4251NC

**Laminate Double Sided  
Connector Ends**



EVLEPDS4251

**Laminate Single Sided  
Finished Ends**



EVLEPSSL4227NC

**Laminate Double Sided  
Connector Ends**



EVLEPSSL4227

**Laminate Double Sided Middle  
Base Power, Finished Ends**



EVLEPDC4251NC

**Laminate Double Sided Middle  
Beltline Power, Finished Ends**



EVICLXP4251NC

**Laminate Double Sided  
Base Power, Connector Ends**



EVLEPDC4251

**Laminate Double Sided Middle  
Beltline Power, Connector Ends**



EVICLXP4251

**Laminate Single Sided Middle  
Base Power, Finished Ends**



EVLEPSC4227NC

**Laminate Single Sided Middle  
Base Power, Connector End**



EVLEPSC4227

**Laminate Single Sided Middle  
Beltline Power, Finished Ends**



EVLEPSCB4227NC

**Laminate Single Sided Middle  
Beltline Power, Connector End**



EVLEPSCB4227

**Laminate Gallery Extension  
Finished End**



EVLXPML4224NC

**Laminate Gallery Straight  
Extension, Connector Ends**



EVLXPML4224

**Laminate Gallery Two-Way  
Extension, Finished Ends**



EV2LXPL4225

**Laminate Gallery Three-Way  
Extension, Finished Ends**



EV3LXPL4249

**Laminate Double Gallery for  
Four-Way, Finished Ends**



EV4LXP4249

**Laminate Extension Panel for  
Four-Way, Finished Ends**



EV4LXPM4224

**Panel Connector with  
U Channel**

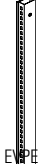

EVPERCH42

**Panel Connector w/U Channel  
For Beltline Panels**



EVPPERCH42

**Laminate Gallery Panel Bottom  
Bracket**



EVHLPBB01

**Laminate Gallery Panel  
Corner Bracket**



EVHLPBB01

**Connector w/U Channel  
Top Trim Aluminum**



EVPTTAU24

PANELS

TYPES

1" LAMINATE PANELS - PAGES 106-108

1" Laminate End Panel

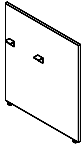

EVLEPR42

1" Laminate Middle Panel



EVLMP42

1" Laminate End Panel w/ Accessory Rail

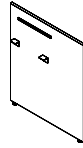

EVLEPR42A

1" Laminate Middle Panel w/ Accessory Rail

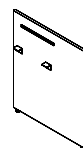

EVLMP42A

Double Inline Panel Connector

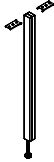

EVPDIC42

Beltline DoubleInline Panel Connector

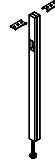

EVBDIC42

Double Inline Connector Trim

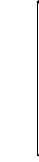

EVPDVTF42

Double Inline Panel Connector  
 Top Trim - Aluminum

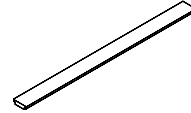

EVPTTA25

DOOR PANELS - PAGES 110-112

Door Panel - Solid

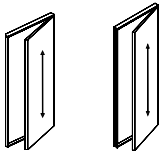

EVPS84

EVPS90

Knob Lock Set

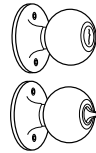

EVPSL01

Lever Lock Set



EVPSL02

Sliding Door Lock

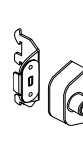

EVPSLOCK

Sliding Privacy Door

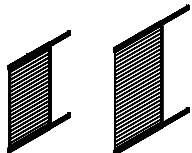

EVPSL66

EVPSL81

Mini Panel Kit

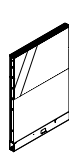

EVMPK02

Low Profile Foot

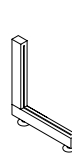

EVHLPF01

PRIVACY PANELS - PAGES 149-164

Glazed Monolithic Privacy Panel



EVPPXGTF4218

Ribbed Monolithic Privacy Panel



EVPPXGR4218 EVPPXGR4218M EVPPXGRF4218

78" Glazed Monolithic Privacy Panel



EVPPXGT7824 EVPPXGT7824M EVPPXGTF7824

Glazed Privacy Panel



EVPPGT5424 EVPPGT5424M

Glazed Privacy Panel

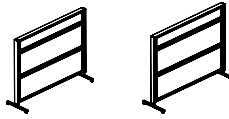

EVPPGT6624 EVPPGT6624M

Laminate Glazed Privacy Panel



EVPPHGTU5424 EVPPHGTU5424M

Laminate Glazed Privacy Panel

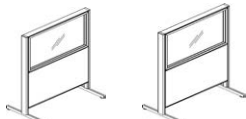

EVPPHGT5424 EVPPHGT6624M

Laminate Privacy Panel

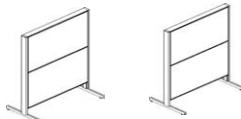

EVPPH2S5424 EVPPH2S5424M

Write Board Glazed Privacy Panel

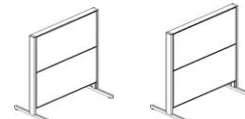

EVPPF2W5424 EVPPF2W5424M

Write Board Laminate Privacy Panel

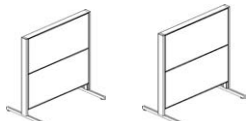

EVPPH2W5424 EVPPH2W5424M

# PANELS

# CONFIGURATION

This page provides an exploded view of a sample configuration highlighting each **Panel** component required when specifying this configuration.

### Components

- |   |  |
|---|--|
| <p><b>A.</b> EVPERA66      End-of-Run Kit (Wall mount)<br/>                 Note: adds 1" to the width of a Panel Run.</p> <p><b>B.</b> EVPFA6636      Segmented Panel</p> <p><b>C.</b> EVPIC66      Inline Panel Connector</p> <p><b>D.</b> EVPCPA266      Two-Way Corner Post<br/>                 Note: Trim kit included.<br/>                 Post Connectors can be custom manufactured with or without slots. Contact your Evolve Customer Support Representative for a special quote.</p> | <p><b>E.</b> EVPVC66      Variable-Height Connector<br/>                 Note: Connector height must reference taller Panel.</p> <p><b>F.</b> EVPTVA24      Panel Trim Variable-Height</p> <p><b>G.</b> EVPFA4236      Segmented Panel</p> |
|---|--|

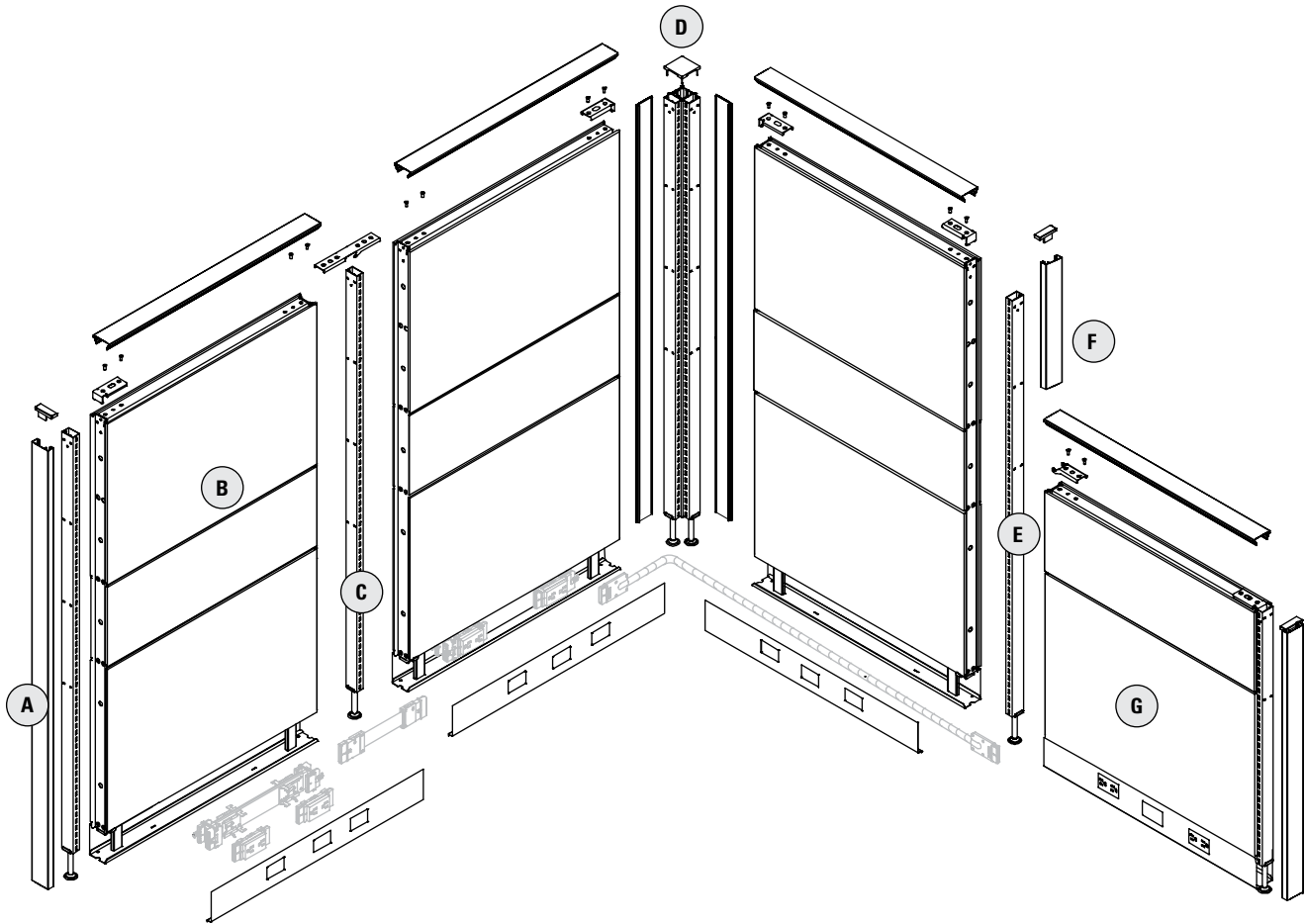

This page provides an exploded view of a sample configuration highlighting each **Beltline Power Panel** component required when specifying this configuration.

**Components**

- |  |  |
|--|--|
| <p><b>A.</b> EVPERA66 End-of-Run Kit (Wall mount)<br/>                 Note: adds 1" to the width of a Panel Run.</p> <p><b>B.</b> EVPBCFAM6636 Monolithic Beltline Powered Chimney Panel</p> <p><b>C.</b> EVPBIC66 Inline Panel Connector for Beltline Electric Panels</p> <p><b>D.</b> EVPBIPA266 Two-Way Corner Post for Beltline Electric Panels<br/><br/>                 Note: Trim kit included.<br/>                 Post Connectors can be custom manufactured with or without slots. Contact your Evolve Customer Support Representative for a special quote.<br/>                 Note: All beltline post connectors come with PVC covers to install at beltline height on all sides.</p> | <p><b>E.</b> EVPVC66 Variable-Height Connector for Beltline Electric Panels<br/>                 Note: Connector height must reference taller Panel.</p> <p><b>F.</b> EVPTEA24 Panel Extension Trim</p> <p><b>G.</b> EVPBFAM4236 Monolithic Beltline Powered Panel</p> |
|--|--|

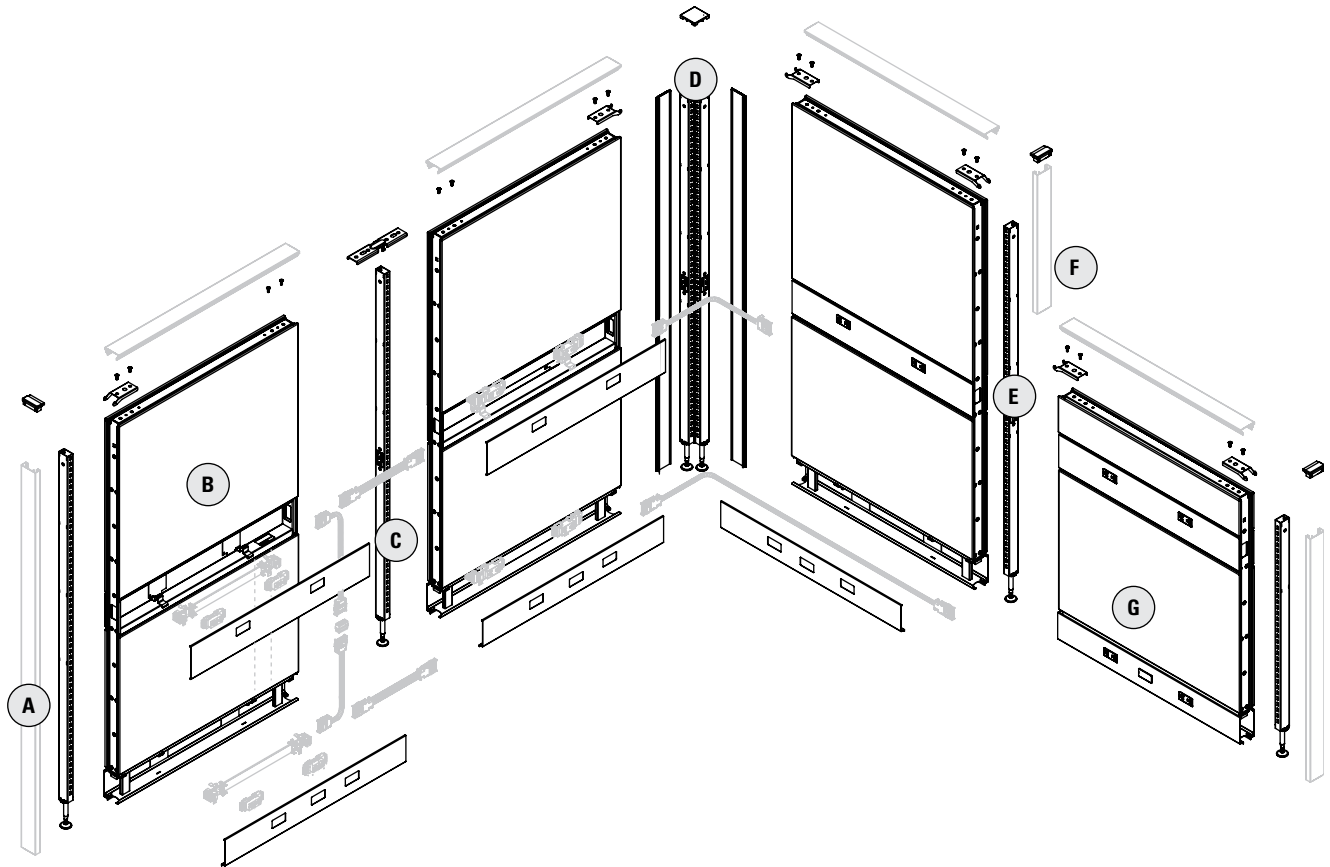

**EACH ORDER MUST INCLUDE:**

- Purchase Order
- Layout showing where the image(s) appear in the run of panels.
- A completed Price Chart, showing the location of the image(s) on each appropriate panel.
- Artwork must be submitted in accordance with the following artwork specifications.
- NOTE: Final artwork specification approval must be given before order can be processed.

**TRANSFER DEVICES**

- Email up to 10MB to your Evolve Customer Service Representative.
- Courier CD/DVD/USB drive to your Evolve Customer Service Representative.

**ARTWORK SPECIFICATIONS**

- Non-Photographic artwork should be vector art. Saved in Adobe Illustrator (.ai) or as an EPS (.eps)
- All bitmap or photographic artwork has to be at a minimum of 100 dpi at the full size of the panel to be printed.
- We accept Adobe CS5 files.
- Any linked files must be included or imbedded.
- Leave any PSD files un-flattened
- All fonts must be converted to outlines.
- Do not convert to CMYK, leave all images as RGB if possible
- No Word, Powerpoint, Publisher or other Microsoft files can be used.
- Include a PDF or .jpg for reference when sending native Photoshop or Illustrator format files.

**COLOR MATCHING**

- A Pantone color reference must be supplied or we cannot accept responsibility for correct color or color correction.
- When it is not possible to refer to Pantone colors, we will do our best to meet your requirements.

**IMAGE CLARITY**

- We will advise should the selected image not lend itself to the element size requested.

**NOTE:**

- We reserve the right to put an order on hold when the files are found to be incomplete or when documents have been either incorrectly saved, fonts have not been converted to curves or the job appears not to be commercially acceptable.

**IMAGE BLEED:**

- To facilitate placement on the panel. Extension of the image past the finished visible area of the panel (bleed) is required.
- Evolve Panels need a 3.5" bleed on all sides

**EXAMPLE OF IMAGE RESOLUTION:**

- The resolution required for a 36 wide x 24 high Evolve panel at 100dpi (minimum resolution)

The resolution required for a 36 wide x 24 high Evolve panel at 300dpi (higher quality)

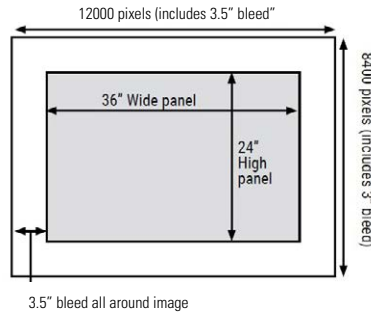
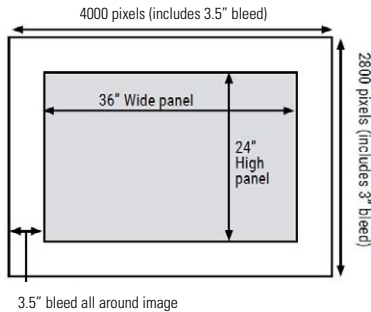

**EVOLVE SYSTEMS - GRAPHIC PANEL EXAMPLE PROCEDURE**

**STEP 1:** Customer orders the following EVPFA6636 panel with;

- Bottom module inside face (24/36 size fabric) with image 01.
- Middle module inside face (12/36 size fabric) with image 02.
- All other fabric material is regular fabric - top module inside face and all outside module faces.

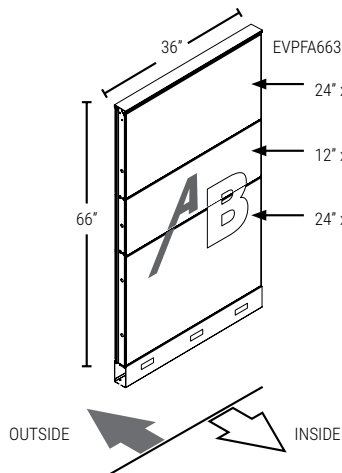

**Note: To order, please use graphic codes below**

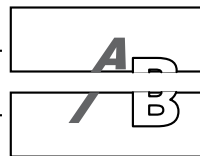

- (A)  
EVPGRP1236
- (B)  
EVPGRP2436

**STEP 2:** On the regular panel - replace fabric pieces with corresponding graphic pieces.

**STEP 3:** On the regular panel - replace fabric pieces with corresponding graphic pieces.

- EVPGRP1236 for the middle module inside face
- EVPGRP2436 for the bottom module inside face

**EVGGRP - 6"H GRAPHIC FABRIC FACTORY INSTALLED**

- Graphic fabric for one side of 6" module.
- Graphic fabric to be installed at factory at specified 6" H module of fabric panel
- Fabric panel not included. Prices shown are an upcharge to the applicable panel price. Please add the upcharge to the list price of the panel on which you are specifying a graphic.
- Applies to the following panels: EVPFA, EVFPF, EVPF1W, EVPF2W, EVPF1S, EVPF2S, EVPFGT, EVFPFGTU, EVPFOL, EVFPOL, EVPFO, EVFPFO, EVPFE, EVFPFE
- Note: initial set up charge is \$250 net per image

	DESCRIPTION	PRODUCT CODE	LIST PRICE	DIMENSIONS/INCHES		
				H	W	D
	Graphic fabric for 6" Module	EVGGRP0624	171	6	24	
		EVGGRP0630	214	6	30	
		EVGGRP0636	257	6	36	
		EVGGRP0642	299	6	42	
		EVGGRP0648	342	6	48	
		EVGGRP0654	388	6	54	
		EVGGRP0660	432	6	60	

**EVGGRP - 12"H GRAPHIC FABRIC FACTORY INSTALLED**

- Graphic fabric for one side of 12" module.
- Graphic fabric to be installed at factory at specified 12" H module of fabric panel
- Fabric panel not included. Prices shown are an upcharge to the applicable panel price. Please add the upcharge to the list price of the panel on which you are specifying a graphic.
- Applies to the following panels: EVPFA, EVFPF, EVPF1W, EVPF2W, EVPF1S, EVPF2S, EVPFGT, EVFPFGTU, EVPFOL, EVFPOL, EVPFO, EVFPFO, EVPFE, EVFPFE
- Note: initial set up charge is \$250 net per image

	DESCRIPTION	PRODUCT CODE	LIST PRICE	DIMENSIONS/INCHES		
				H	W	D
	Graphic fabric for 12" Module	EVGGRP1224	171	12	24	
		EVGGRP1230	214	12	30	
		EVGGRP1236	257	12	36	
		EVGGRP1242	299	12	42	
		EVGGRP1248	342	12	48	
		EVGGRP1254	388	12	54	
		EVGGRP1260	432	12	60	

**EVGGRP - 18"H GRAPHIC FABRIC FACTORY INSTALLED**

- Graphic fabric for one side of 18" module.
- Graphic fabric to be installed at factory at specified 18" H module of fabric panel
- Fabric panel not included. Prices shown are an upcharge to the applicable panel price. Please add the upcharge to the list price of the panel on which you are specifying a graphic.
- Applies to the following panels: EVPFA, EVFPF, EVPF1W, EVPF2W, EVPF1S, EVPF2S, EVPFGT, EVFPFGTU, EVPFOL, EVFPOL, EVPFO, EVFPFO, EVPFE, EVFPFE
- Note: initial set up charge is \$250 net per image

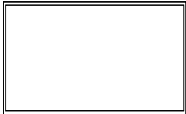
	DESCRIPTION	PRODUCT CODE	LIST PRICE	DIMENSIONS/INCHES		
				H	W	D
	Graphic fabric for 18" Module	EVGGRP1824	336	18	24	
		EVGGRP1830	422	18	30	
		EVGGRP1836	510	18	36	
		EVGGRP1842	598	18	42	
		EVGGRP1848	683	18	48	
		EVGGRP1854	769	18	54	
		EVGGRP1860	858	18	60	

**EVPGRP - 24"H GRAPHIC FABRIC FACTORY INSTALLED**

- Graphic fabric for one side of 24" module.
- Graphic fabric to be installed at factory at specified 24" H module of fabric panel
- Fabric panel not included. Prices shown are an upcharge to the applicable panel price. Please add the upcharge to the list price of the panel on which you are specifying a graphic.
- Applies to the following panels: EVPFA, EVFPF, EVPF1W, EVPF2W, EVPF1S, EVPF2S, EVPFGT, EVFPFGTU, EVPFOL, EVFPFOL, EVPFO, EVFPFO, EVPFE, EVFPFE
- Note: initial set up charge is \$250 net per image

DESCRIPTION	PRODUCT CODE	LIST PRICE	DIMENSIONS/INCHES		
			H	W	D
 Graphic fabric for 24" Module	EVPGRP2424	336	24	24	
	EVPGRP2430	422	24	30	
	EVPGRP2436	510	24	36	
	EVPGRP2442	598	24	42	
	EVPGRP2448	683	24	48	
	EVPGRP2454	769	24	54	
	EVPGRP2460	858	24	60	

**EVPGRP - 36"H GRAPHIC FABRIC FACTORY INSTALLED**

- Graphic fabric for one side of 36" module (42" panel)
- Graphic fabric to be installed at factory on monolithic module
- Fabric panel not included. Prices shown are an upcharge to the applicable panel price. Please add the upcharge to the list price of the panel on which you are specifying a graphic.
- Applies to the following panels: EVPFAM
- Note: initial set up charge is \$250 net per image

DESCRIPTION	PRODUCT CODE	LIST PRICE	DIMENSIONS/INCHES		
			H	W	D
 Graphic fabric for 36" Monolithic Module	EVPGRP3624	510	36	24	
	EVPGRP3630	656	36	30	
	EVPGRP3636	785	36	36	
	EVPGRP3642	914	36	42	
	EVPGRP3648	1044	36	48	
	EVPGRP3654	1176	36	54	
	EVPGRP3660	1306	36	60	

**EVPGRP - 42"H GRAPHIC FABRIC FACTORY INSTALLED**

- Graphic fabric for one side of 42" module (48" panel)
- Graphic fabric to be installed at factory on monolithic module
- Fabric panel not included. Prices shown are an upcharge to the applicable panel price. Please add the upcharge to the list price of the panel on which you are specifying a graphic.
- Applies to the following panels: EVPFAM
- Note: initial set up charge is \$250 net per image

DESCRIPTION	PRODUCT CODE	LIST PRICE	DIMENSIONS/INCHES		
			H	W	D
 Graphic fabric for 42" Monolithic Module	EVPGRP4224	599	42	24	
	EVPGRP4230	762	42	30	
	EVPGRP4236	914	42	36	
	EVPGRP4242	1067	42	42	
	EVPGRP4248	1221	42	48	
	EVPGRP4254	1371	42	54	
	EVPGRP4260	1524	42	60	

# PANELS

# GRAPHIC PANELS

## EVPGRP - 48"H GRAPHIC FABRIC FACTORY INSTALLED

- Graphic fabric for one side of 48" module (54" panel).
- Graphic fabric to be installed at factory on monolithic module
- Fabric panel not included. Prices shown are an upcharge to the applicable panel price. Please add the upcharge to the list price of the panel on which you are specifying a graphic.
- Applies to the following panels: EVPFAM
- Note: initial set up charge is \$250 net per image

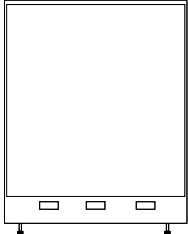
	DESCRIPTION	PRODUCT CODE	LIST PRICE	DIMENSIONS/INCHES		
				H	W	D
	Graphic fabric for 48" Monolithic Module	EVPGRP4824	681	48	24	
		EVPGRP4830	870	48	30	
		EVPGRP4836	975	48	36	
		EVPGRP4842	1221	48	42	
		EVPGRP4848	1394	48	48	
		EVPGRP4854	1569	48	54	
		EVPGRP4860	1741	48	60	

## EVPGRP - 60"H GRAPHIC FABRIC FACTORY INSTALLED

- Graphic fabric for one side of 60" module (66" panel).
- Graphic fabric to be installed at factory on monolithic module
- Fabric panel not included. Prices shown are an upcharge to the applicable panel price. Please add the upcharge to the list price of the panel on which you are specifying a graphic.
- Applies to the following panels: EVPFAM
- Note: initial set up charge is \$250 net per image

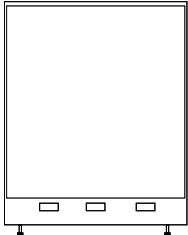

	DESCRIPTION	PRODUCT CODE	LIST PRICE	DIMENSIONS/INCHES		
				H	W	D
	Graphic fabric for 60" Monolithic Module	EVPGRP6024	858	60	24	
		EVPGRP6030	1090	60	30	
		EVPGRP6036	1306	60	36	
		EVPGRP6042	1524	60	42	
		EVPGRP6048	1741	60	48	
		EVPGRP6054	1958	60	54	
		EVPGRP6060	2176	60	60	

# PANELS

# MONOLITHIC

## EVPFAM - MONOLITHIC PANEL

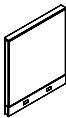
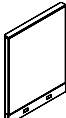
- Monolithic Panel incorporates fabric modules within a solid steel frame.
- Fabric covered modules are tackable and acoustical.
- Opposite sides of each panel may have a different fabric within the same grade at no upcharge.
- If different grades of fabric are used on one panel, the entire panel must be priced at highest grade.
- An aluminum low profile top cap is included.
- Stackability: Evolve panels can be increased in height in 6"H, 12"H, 18"H or 24"H increments. See Extension Modules for part numbers.

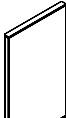

	DESCRIPTION	PRODUCT CODE	LIST PRICE		DIMENSIONS/INCHES		
			Gr1	Gr2	H	W	D
	Monolithic Panel - 42" High	EVPFAM4218	389	427	42	18	2 7/8
		EVPFAM4224	417	464	42	24	2 7/8
		EVPFAM4230	477	532	42	30	2 7/8
		EVPFAM4236	509	572	42	36	2 7/8
		EVPFAM4242	562	636	42	42	2 7/8
		EVPFAM4248	613	694	42	48	2 7/8
		EVPFAM4254	674	764	42	54	2 7/8
	Monolithic Panel - 48" High	EVPFAM4818	394	432	48	18	2 7/8
		EVPFAM4824	434	482	48	24	2 7/8
		EVPFAM4830	502	559	48	30	2 7/8
		EVPFAM4836	547	610	48	36	2 7/8
		EVPFAM4842	610	683	48	42	2 7/8
		EVPFAM4848	662	742	48	48	2 7/8
		EVPFAM4854	732	823	48	54	2 7/8
	Monolithic Panel - 54" High	EVPFAM5418	400	438	54	18	2 7/8
		EVPFAM5424	440	487	54	24	2 7/8
		EVPFAM5430	511	566	54	30	2 7/8
		EVPFAM5436	569	635	54	36	2 7/8
		EVPFAM5442	634	707	54	42	2 7/8
		EVPFAM5448	690	771	54	48	2 7/8
		EVPFAM5454	756	850	54	54	2 7/8
	Monolithic Panel - 66" High	EVPFAM6618	493	531	66	18	2 7/8
		EVPFAM6624	540	588	66	24	2 7/8
		EVPFAM6630	610	668	66	30	2 7/8
		EVPFAM6636	711	774	66	36	2 7/8
		EVPFAM6642	796	869	66	42	2 7/8
		EVPFAM6648	863	942	66	48	2 7/8
		EVPFAM6654	959	1047	66	54	2 7/8
		EVPFAM6660	1052	1149	66	60	2 7/8

# PANELS

# MONOLITHIC

## EVPLFAM - MONOLITHIC LIGHT PANEL

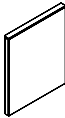
- Monolithic Light Panel incorporates fabric modules within a solid steel frame.
- There is no base raceway in Light Panels to accommodate electrical.
- Light Panel Connectors must be used in conjunction with Light Panels.
- Fabric covered modules are tackable and acoustical.
- Opposite sides of each panel may have a different fabric within the same grade at no upcharge.
- If different grades of fabric are used on one panel, the entire panel must be priced at highest grade.
- An aluminum low profile top cap is included.
- Stackability: Evolve Light panels can be increased in height in 6"H, 12"H, 18"H or 24"H increments. See Extension Modules for part numbers.

	DESCRIPTION	PRODUCT CODE	LIST PRICE		DIMENSIONS/INCHES		
			Gr1	Gr2	H	W	D
	Monolithic Light Panel - 42" High	EVPLFAM4218	374	410	42	18	2 7/8
		EVPLFAM4224	393	440	42	24	2 7/8
		EVPLFAM4230	452	507	42	30	2 7/8
		EVPLFAM4236	483	546	42	36	2 7/8
		EVPLFAM4242	537	606	42	42	2 7/8
		EVPLFAM4248	582	661	42	48	2 7/8
		EVPLFAM4254	640	722	42	54	2 7/8
		EVPLFAM4260	693	786	42	60	2 7/8
	Monolithic Light Panel - 48" High	EVPLFAM4818	379	415	48	18	2 7/8
		EVPLFAM4824	412	459	48	24	2 7/8
		EVPLFAM4830	477	530	48	30	2 7/8
		EVPLFAM4836	518	577	48	36	2 7/8
		EVPLFAM4842	579	649	48	42	2 7/8
		EVPLFAM4848	630	705	48	48	2 7/8
		EVPLFAM4854	695	782	48	54	2 7/8
		EVPLFAM4860	756	851	48	60	2 7/8
	Monolithic Light Panel - 54" High	EVPLFAM5418	380	416	54	18	2 7/8
		EVPLFAM5424	419	463	54	24	2 7/8
		EVPLFAM5430	486	541	54	30	2 7/8
		EVPLFAM5436	540	601	54	36	2 7/8
		EVPLFAM5442	601	671	54	42	2 7/8
		EVPLFAM5448	654	733	54	48	2 7/8
		EVPLFAM5454	718	808	54	54	2 7/8
		EVPLFAM5460	786	880	54	60	2 7/8
	Monolithic Light Panel - 66" High	EVPLFAM6618	471	507	66	18	2 7/8
		EVPLFAM6624	513	560	66	24	2 7/8
		EVPLFAM6630	579	636	66	30	2 7/8
		EVPLFAM6636	674	737	66	36	2 7/8
		EVPLFAM6642	756	826	66	42	2 7/8
		EVPLFAM6648	820	895	66	48	2 7/8
		EVPLFAM6654	909	997	66	54	2 7/8
		EVPLFAM6660	998	1093	66	60	2 7/8

# PANELS

# MONOLITHIC

## EVPBFAM - MONOLITHIC BELTLINE POWERED PANEL

- Monolithic Beltline Powered Panel incorporates fabric modules with a power beltline raceway, within a solid steel frame.
- 6"H power beltline raceway, to accommodate electrical, is metal with knockouts on both side.
- A Chimney Panel is required to run electric and data from the base to belt.
- Beltline Connectors must be used in conjunction with beltline panels.
- Fabric covered modules are tackable and acoustical.
- Opposite sides of each panel may have a different fabric within the same grade at no upcharge.
- If different grades of fabric are used on one panel, the entire panel must be priced at highest grade.
- An aluminum low profile top cap is included.
- Stackability: Evolve panels can be increased in height in 6"H, 12"H, 18"H or 24"H increments. See Extension Modules for part numbers.

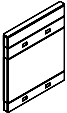
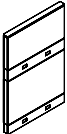
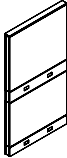
	DESCRIPTION	PRODUCT CODE	LIST PRICE		DIMENSIONS/INCHES		
			Gr1	Gr2	H	W	D
	Monolithic Beltline Powered Panel - 42" High 24" Fabric /6" Power Belt /6" Fabric	EVPBFAM4224	514	543	42	24	2 7/8
		EVPBFAM4230	607	641	42	30	2 7/8
		EVPBFAM4236	692	733	42	36	2 7/8
		EVPBFAM4242	779	826	42	42	2 7/8
		EVPBFAM4248	863	915	42	48	2 7/8
		EVPBFAM4254	944	1002	42	54	2 7/8
	Monolithic Beltline Powered Panel - 54" High 24" Fabric /6" Power Belt /18" Fabric	EVPBFAM5424	617	656	54	24	2 7/8
		EVPBFAM5430	724	771	54	30	2 7/8
		EVPBFAM5436	818	873	54	36	2 7/8
		EVPBFAM5442	917	978	54	42	2 7/8
		EVPBFAM5448	1007	1077	54	48	2 7/8
		EVPBFAM5454	1106	1181	54	54	2 7/8
	Monolithic Beltline Powered Panel - 66" High 24" Fabric /6" Power Belt /30" Fabric	EVPBFAM6624	730	800	66	24	2 7/8
		EVPBFAM6630	852	932	66	30	2 7/8
		EVPBFAM6636	963	1056	66	36	2 7/8
		EVPBFAM6642	1085	1191	66	42	2 7/8
		EVPBFAM6648	1198	1318	66	48	2 7/8
		EVPBFAM6654	1313	1445	66	54	2 7/8
		EVPBFAM6660	1429	1574	66	60	2 7/8

# PANELS

# MONOLITHIC

## EVPBLFAM - MONOLITHIC BELTLINE POWERED LIGHT PANEL

- Monolithic Beltline Powered Light Panel incorporates fabric modules with a power beltline raceway within a solid steel frame
- 6”H power beltline raceway, to accommodate electrical, is metal with knockouts on both sides.
- There is no base raceway in Light Panels to accommodate electrical
- Light Beltline Panel Connectors must be used in conjunction with Light Beltline Panels.
- Fabric covered modules are tackable and acoustical.
- Opposite sides of each panel may have a different fabric within the same grade at no upcharge.
- If different grades of fabric are used on one panel, the entire panel must be priced at highest grade.
- An aluminum low profile top cap is included.
- Stackability: Evolve Light panels can be increased in height in 6”H, 12”H, 18”H or 24”H increments. See Extension Modules for part numbers.

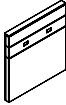
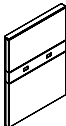
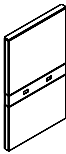
	DESCRIPTION	PRODUCT CODE	LIST PRICE		DIMENSIONS/INCHES		
			Gr1	Gr2	H	W	D
	Monolithic Beltline Powered Light Panel - 42” High	EVPBLFAM4224	488	517	42	24	2 7/8
	24” Fabric /6” Power Belt /6” Fabric	EVPBLFAM4230	577	611	42	30	2 7/8
		EVPBLFAM4236	656	697	42	36	2 7/8
		EVPBLFAM4242	739	786	42	42	2 7/8
		EVPBLFAM4248	820	870	42	48	2 7/8
		EVPBLFAM4254	898	956	42	54	2 7/8
		EVPBLFAM4260	976	1039	42	60	2 7/8
	Monolithic Beltline Powered Light Panel - 54” High	EVPBLFAM5424	569	610	54	24	2 7/8
	24” Fabric /6” Power Belt /18” Fabric	EVPBLFAM5430	666	714	54	30	2 7/8
		EVPBLFAM5436	752	807	54	36	2 7/8
		EVPBLFAM5442	840	903	54	42	2 7/8
		EVPBLFAM5448	928	998	54	48	2 7/8
		EVPBLFAM5454	1019	1094	54	54	2 7/8
		EVPBLFAM5460	1102	1184	54	60	2 7/8
	Monolithic Beltline Powered Light Panel - 66” High	EVPBLFAM6624	679	748	66	24	2 7/8
	24” Fabric /6” Power Belt /30” Fabric	EVPBLFAM6630	789	869	66	30	2 7/8
		EVPBLFAM6636	894	988	66	36	2 7/8
		EVPBLFAM6642	1007	1113	66	42	2 7/8
		EVPBLFAM6648	1113	1235	66	48	2 7/8
		EVPBLFAM6654	1221	1351	66	54	2 7/8
		EVPBLFAM6660	1328	1473	66	60	2 7/8

# PANELS

# MONOLITHIC

## EVPBCFAM - MONOLITHIC BELTLINE POWERED CHIMNEY PANEL

- Monolithic Chimney Beltline Powered Panel incorporates fabric modules with a power beltline raceway within a solid steel frame.
- A Chimney Panel is required to run electric and data from the base to belt.
- Separate electric harness required to go from base to belt (see EVE8CPCP).
- 6"H power beltline raceway, to accommodate electrical, is metal with knockouts on both sides.
- Beltline Connectors must be used in conjunction with beltline panels.
- Fabric covered modules are tackable and acoustical.
- Opposite sides of each panel may have a different fabric within the same grade at no upcharge.
- If different grades of fabric are used on one panel, the entire panel must be priced at highest grade.
- An aluminum low profile top cap is included.
- Stackability: Evolve panels can be increased in height in 6"H, 12"H, 18"H or 24"H increments. See Extension Module listings for part numbers

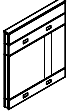
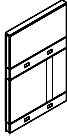
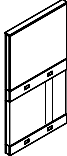
	DESCRIPTION	PRODUCT CODE	LIST PRICE		DIMENSIONS/INCHES		
			Gr1	Gr2	H	W	D
	Monolithic Beltline Powered Chimney Panel - 42" High 24" Fabric Chimney /6" Power Belt /6" Fabric	EVPBCFAM4236	777	818	42	36	2 7/8
		EVPBCFAM4242	865	912	42	42	2 7/8
	Monolithic Beltline Powered Chimney Panel - 54" High 24" Fabric Chimney /6" Power Belt /18" Fabric	EVPBCFAM5436	899	956	54	36	2 7/8
		EVPBCFAM5442	1001	1064	54	42	2 7/8
	Monolithic Beltline Powered Chimney Panel - 66" High 24" Fabric Chimney /6" Power Belt /30" Fabric	EVPBCFAM6636	1047	1141	66	36	2 7/8
		EVPBCFAM6642	1170	1276	66	42	2 7/8

## EVE8CPCP - CHIMNEY PANEL JUMPER CABLE KIT

- Contains two (2) 17" flexible harnesses and one (1) "I" connector.
- Used to connect electric from the base to the beltline raceway in Beltline Powered Chimney panel.
- Must use in conjunction with base power distribution harness and beltline power distribution harness (sold separately)

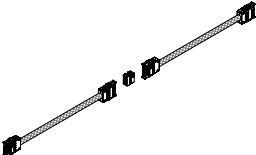
	DESCRIPTION	PRODUCT CODE	LIST PRICE	DIMENSIONS/INCHES		
				H	W	D
	Chimney Panel Jumper Cable Kit	EVE8CPCP	365			

**EVPBFFAM - MONOLITHIC BELTLINE NON-POWERED PANEL**

- Monolithic Beltline Non-Powered Panel incorporates fabric modules within a solid steel frame.
- Electrical cannot pass through panel at the beltline level.
- Fabric covered modules are tackable and acoustical.
- Opposite sides of each panel may have a different fabric within the same grade at no upcharge.
- If different grades of fabric are used on one panel, the entire panel must be priced at highest grade.
- An aluminum low profile top cap is included.
- Stackability: Evolve panels can be increased in height in 6"H, 12"H, 18"H or 24"H increments. See Extension Modules for part numbers.

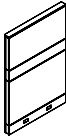
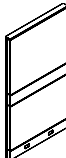
	DESCRIPTION	PRODUCT CODE	LIST PRICE		DIMENSIONS/INCHES		
			Gr1	Gr2	H	W	D
	Monolithic Beltline Non-Powered Panel - 54" High	EVPBFFAM5424	617	661	54	24	2 7/8
	24" Fabric /6" Fabric /18" Fabric	EVPBFFAM5430	724	777	54	30	2 7/8
		EVPBFFAM5436	818	879	54	36	2 7/8
		EVPBFFAM5442	917	987	54	42	2 7/8
		EVPBFFAM5448	1007	1087	54	48	2 7/8
		EVPBFFAM5454	1106	1196	54	54	2 7/8
		EVPBFFAM5460	1199	1296	54	60	2 7/8
	Monolithic Beltline Non-Powered Panel - 66" High	EVPBFFAM6624	730	801	66	24	2 7/8
	24" Fabric /6" Fabric /30" Fabric	EVPBFFAM6630	852	939	66	30	2 7/8
		EVPBFFAM6636	963	1062	66	36	2 7/8
		EVPBFFAM6642	1085	1201	66	42	2 7/8
		EVPBFFAM6648	1198	1326	66	48	2 7/8
		EVPBFFAM6654	1313	1453	66	54	2 7/8
		EVPBFFAM6660	1429	1587	66	60	2 7/8

**EVPBLFFAM - MONOLITHIC BELTLINE NON-POWERED LIGHT PANEL**

- Monolithic Beltline Non-Powered Light Panel incorporates all fabric modules within a solid steel frame.
- There is no base raceway in Light Panels to accommodate electrical.
- Electrical cannot pass through panel at the beltline level.
- Fabric covered modules are tackable and acoustical.
- Opposite sides of each panel may have a different fabric within the same grade at no upcharge.
- If different grades of fabric are used on one panel, the entire panel must be priced at highest grade.
- An aluminum low profile top cap is included.
- Stackability: Evolve panels can be increased in height in 6"H, 12"H, 18"H or 24"H increments. See Extension Modules for part numbers.

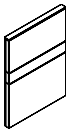
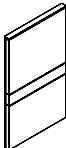

	DESCRIPTION	PRODUCT CODE	LIST PRICE		DIMENSIONS/INCHES		
			Gr1	Gr2	H	W	D
	Monolithic Beltline Non-Powered Light Panel - 54" High	EVPBLFFAM5424	569	616	54	24	2 7/8
	24" Fabric /6" Fabric /18" Fabric	EVPBLFFAM5430	669	724	54	30	2 7/8
		EVPBLFFAM5436	752	813	54	36	2 7/8
		EVPBLFFAM5442	840	910	54	42	2 7/8
		EVPBLFFAM5448	928	1007	54	48	2 7/8
		EVPBLFFAM5454	1019	1107	54	54	2 7/8
		EVPBLFFAM5460	1102	1199	54	60	2 7/8
	Monolithic Beltline Non-Powered Light Panel - 66" High	EVPBLFFAM6624	679	750	66	24	2 7/8
	24" Fabric /6" Fabric /30" Fabric	EVPBLFFAM6630	789	876	66	30	2 7/8
		EVPBLFFAM6636	894	993	66	36	2 7/8
		EVPBLFFAM6642	1007	1124	66	42	2 7/8
		EVPBLFFAM6648	1113	1242	66	48	2 7/8
		EVPBLFFAM6654	1221	1361	66	54	2 7/8
		EVPBLFFAM6660	1328	1486	66	60	2 7/8

# PANELS

# SEGMENTED

## EVPFA - SEGMENTED PANEL

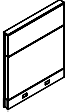
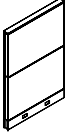
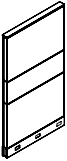
- Segmented Panel incorporates fabric modules within a solid steel frame.
- Fabric covered modules are tackable and acoustical.
- Opposite sides of each panel may have a different fabric within the same grade at no upcharge.
- If different grades of fabric are used on one panel, the entire panel must be priced at highest grade.
- An aluminum low profile top cap is included.
- Stackability: Evolve panels can be increased in height in 6"H, 12"H, 18"H or 24"H increments. See Extension Modules or part numbers.

	DESCRIPTION	PRODUCT CODE	LIST PRICE		DIMENSIONS/INCHES		
			Gr1	Gr2	H	W	D
	Segmented Panel - 30" High	EVPPFA3018	380	398	30	18	2 7/8
		EVPPFA3024	393	420	30	24	2 7/8
		EVPPFA3030	440	467	30	30	2 7/8
		EVPPFA3036	476	506	30	36	2 7/8
		EVPPFA3042	509	547	30	42	2 7/8
		EVPPFA3048	561	602	30	48	2 7/8
		EVPPFA3054	606	650	30	54	2 7/8
		EVPPFA3060	650	700	30	60	2 7/8
	Segmented Panel - 42" High	EVPPFA4218	420	448	42	18	2 7/8
		EVPPFA4224	445	479	42	24	2 7/8
		EVPPFA4230	515	556	42	30	2 7/8
		EVPPFA4236	552	599	42	36	2 7/8
		EVPPFA4242	633	686	42	42	2 7/8
		EVPPFA4248	679	740	42	48	2 7/8
		EVPPFA4254	753	820	42	54	2 7/8
		EVPPFA4260	824	897	42	60	2 7/8
	Segmented Panel - 54" High	EVPPFA5418	451	487	54	18	2 7/8
		EVPPFA5424	492	534	54	24	2 7/8
		EVPPFA5430	562	617	54	30	2 7/8
		EVPPFA5436	629	690	54	36	2 7/8
		EVPPFA5442	711	781	54	42	2 7/8
		EVPPFA5448	788	867	54	48	2 7/8
		EVPPFA5454	855	942	54	54	2 7/8
		EVPPFA5460	919	1013	54	60	2 7/8
	Segmented Panel - 66" High	EVPPFA6618	569	613	66	18	2 7/8
		EVPPFA6624	610	667	66	24	2 7/8
		EVPPFA6630	677	741	66	30	2 7/8
		EVPPFA6636	791	870	66	36	2 7/8
		EVPPFA6642	892	979	66	42	2 7/8
		EVPPFA6648	959	1056	66	48	2 7/8
		EVPPFA6654	1039	1148	66	54	2 7/8
		EVPPFA6660	1126	1244	66	60	2 7/8
	Segmented Panel - 66" High	EVPPFA6618S	569	613	66	18	2 7/8
		EVPPFA6624S	610	667	66	24	2 7/8
		EVPPFA6630S	677	741	66	30	2 7/8
		EVPPFA6636S	791	870	66	36	2 7/8
		EVPPFA6642S	892	979	66	42	2 7/8
		EVPPFA6648S	959	1056	66	48	2 7/8
		EVPPFA6654S	1039	1148	66	54	2 7/8
		EVPPFA6660S	1126	1244	66	60	2 7/8

# PANELS

# SEGMENTED

## EVPLFA - SEGMENTED LIGHT PANEL

- Segmented Light Panel incorporates fabric modules within a solid steel frame.
- There is no base raceway in Light Panels to accommodate electrical.
- Light Panel Connectors must be used in conjunction with Light Panels.
- Fabric covered modules are tackable and acoustical.
- Opposite sides of each panel may have a different fabric within the same grade at no upcharge.
- If different grades of fabric are used on one panel, the entire panel must be priced at highest grade.
- An aluminum low profile top cap is included.
- Stackability: Evolve Light panels can be increased in height in 6"H, 12"H, 18"H or 24"H increments. See Extension Modules for part numbers.

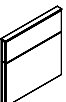
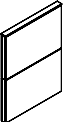
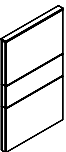
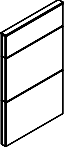

	DESCRIPTION	PRODUCT CODE	LIST PRICE		DIMENSIONS/INCHES		
			Gr1	Gr2	H	W	D
	Segmented Light Panel - 30" High	EVPLFA3018	361	381	30	18	2 7/8
		EVPLFA3024	377	398	30	24	2 7/8
		EVPLFA3030	419	447	30	30	2 7/8
		EVPLFA3036	451	480	30	36	2 7/8
		EVPLFA3042	483	519	30	42	2 7/8
		EVPLFA3048	534	575	30	48	2 7/8
		EVPLFA3054	575	617	30	54	2 7/8
EVPLFA3060	617	665	30	60	2 7/8		
	Segmented Light Panel - 42" High	EVPLFA4218	397	423	42	18	2 7/8
		EVPLFA4224	422	455	42	24	2 7/8
		EVPLFA4230	489	528	42	30	2 7/8
		EVPLFA4236	528	572	42	36	2 7/8
		EVPLFA4242	600	650	42	42	2 7/8
		EVPLFA4248	645	704	42	48	2 7/8
		EVPLFA4254	714	777	42	54	2 7/8
EVPLFA4260	785	855	42	60	2 7/8		
	Segmented Light Panel - 54" High	EVPLFA5418	428	462	54	18	2 7/8
		EVPLFA5424	470	511	54	24	2 7/8
		EVPLFA5430	537	587	54	30	2 7/8
		EVPLFA5436	596	654	54	36	2 7/8
		EVPLFA5442	674	741	54	42	2 7/8
		EVPLFA5448	752	826	54	48	2 7/8
		EVPLFA5454	815	896	54	54	2 7/8
EVPLFA5460	870	963	54	60	2 7/8		
	Segmented Light Panel - 66" High	EVPLFA6618	540	579	66	18	2 7/8
		EVPLFA6624	577	634	66	24	2 7/8
		EVPLFA6630	642	705	66	30	2 7/8
		EVPLFA6636	754	827	66	36	2 7/8
		EVPLFA6642	850	931	66	42	2 7/8
		EVPLFA6648	909	1003	66	48	2 7/8
		EVPLFA6654	987	1089	66	54	2 7/8
EVPLFA6660	1070	1183	66	60	2 7/8		
	Segmented Light Panel - 66" High	EVPLFA6618S	540	579	66	18	2 7/8
		EVPLFA6624S	577	634	66	24	2 7/8
		EVPLFA6630S	642	705	66	30	2 7/8
		EVPLFA6636S	754	827	66	36	2 7/8
		EVPLFA6642S	850	931	66	42	2 7/8
		EVPLFA6648S	909	1003	66	48	2 7/8
		EVPLFA6654S	987	1089	66	54	2 7/8
EVPLFA6660S	1070	1183	66	60	2 7/8		

# PANELS

# SEGMENTED

## EVFPF - SEGMENTED PREMIUM PANEL

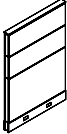
- Segmented Premium Panel incorporates fabric modules within a solid steel frame.
- Segmented Premium panels incorporate 12" H acoustic modules above 24" base module , plus 6" H base raceway.
- Fabric covered modules are tackable and acoustical.
- Opposite sides of each panel may have a different fabric within the same grade at no upcharge.
- If different grades of fabric are used on one panel, the entire panel must be priced at highest grade.
- An aluminum low profile top cap is included.
- Stackability: Evolve panels can be increased in height in 6"H, 12"H, 18"H or 24"H increments. See Extension Modules for part numbers.

	DESCRIPTION	PRODUCT CODE	LIST PRICE		DIMENSIONS/INCHES		
			Gr1	Gr2	H	W	D
	Segmented Premium Panel - 54" High	EVFPF5418	529	565	54	18	2 7/8
		EVFPF5424	561	605	54	24	2 7/8
		EVFPF5430	618	670	54	30	2 7/8
		EVFPF5436	727	788	54	36	2 7/8
		EVFPF5442	822	892	54	42	2 7/8
		EVFPF5448	879	958	54	48	2 7/8
		EVFPF5454	932	1022	54	54	2 7/8
		EVFPF5460	986	1081	54	60	2 7/8
	Segmented Premium Panel - 66" High	EVFPF6618	665	707	66	18	2 7/8
		EVFPF6624	692	747	66	24	2 7/8
		EVFPF6630	753	820	66	30	2 7/8
		EVFPF6636	797	876	66	36	2 7/8
		EVFPF6642	949	1037	66	42	2 7/8
		EVFPF6648	1038	1136	66	48	2 7/8
		EVFPF6654	1106	1207	66	54	2 7/8
		EVFPF6660	1175	1295	66	60	2 7/8

## EVPLFP - SEGMENTED LIGHT PANEL - PREMIUM

- Segmented Premium Light Panel incorporates fabric modules within a solid steel frame.
- Segmented Premium panels incorporate 12" H acoustic modules above 24" base module , plus 6" H open base.
- There is no base raceway in Light Panels to accommodate electrical.
- Light Panel Connectors must be used in conjunction with Light Panels.
- Fabric covered modules are tackable and acoustical.
- Opposite sides of each panel may have a different fabric within the same grade at no upcharge.
- If different grades of fabric are used on one panel, the entire panel must be priced at highest grade.
- An aluminum low profile top cap is included.
- Stackability: Evolve Light panels can be increased in height in 6"H, 12"H, 18"H or 24"H increments. See Extension Modules for part numbers.

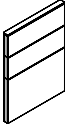
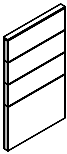
	DESCRIPTION	PRODUCT CODE	LIST PRICE		DIMENSIONS/INCHES		
			Gr1	Gr2	H	W	D
	Segmented Premium Light Panel - Premium - 54" High	EVPLFP5418	503	536	54	18	2 7/8
		EVPLFP5424	534	578	54	24	2 7/8
		EVPLFP5430	587	637	54	30	2 7/8
		EVPLFP5436	693	751	54	36	2 7/8
		EVPLFP5442	782	849	54	42	2 7/8
		EVPLFP5448	834	907	54	48	2 7/8
		EVPLFP5454	888	969	54	54	2 7/8
		EVPLFP5460	936	1030	54	60	2 7/8
	Segmented Premium Light Panel - Premium - 66" High	EVPLFP6618	633	674	66	18	2 7/8
		EVPLFP6624	656	708	66	24	2 7/8
		EVPLFP6630	714	777	66	30	2 7/8
		EVPLFP6636	757	831	66	36	2 7/8
		EVPLFP6642	899	986	66	42	2 7/8
		EVPLFP6648	986	1079	66	48	2 7/8
		EVPLFP6654	1051	1150	66	54	2 7/8
		EVPLFP6660	1115	1231	66	60	2 1/4

# PANELS

# SEGMENTED

## EVPBFA - SEGMENTED BELTLINE POWERED PANEL

- Segmented Beltline Powered Panel incorporates fabric modules with a power beltline raceway, within a solid steel frame.
- A Chimney Panel is required to run electric and data from the base to belt.
- 6"H power beltline raceway, to accommodate electrical, is metal with knockouts on both sides.
- Beltline connectors must be used in conjunction with beltline panels.
- Fabric covered modules are tackable and acoustical.
- Opposite sides of each panel may have a different fabric within the same grade at no upcharge.
- If different grades of fabric are used on one panel, the entire panel must be priced at highest grade.
- An aluminum low profile top cap is included.
- Stackability: Evolve panels can be increased in height in 6"H, 12"H, 18"H or 24"H increments. See Extension Modules for part numbers.

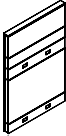
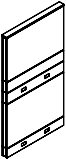
	DESCRIPTION	PRODUCT CODE	LIST PRICE		DIMENSIONS/INCHES		
			Gr1	Gr2	H	W	D
	Segmented Beltline Powered Panel - 54" High 24" Fabric /6" Power /6" Fabric /12" Fabric	EVPBFA5424	616	655	54	24	2 7/8
		EVPBFA5430	722	769	54	30	2 7/8
		EVPBFA5436	830	887	54	36	2 7/8
		EVPBFA5442	930	993	54	42	2 7/8
		EVPBFA5448	1018	1088	54	48	2 7/8
		EVPBFA5454	1115	1194	54	54	2 7/8
		EVPBFA5460	1216	1303	54	60	2 7/8
	Segmented Beltline Powered Panel - 66" High 24" Fabric /6" Power /6" Fabric /24" Fabric	EVPBFA6624	736	788	66	24	2 7/8
		EVPBFA6630	863	922	66	30	2 7/8
		EVPBFA6636	976	1046	66	36	2 7/8
		EVPBFA6642	1099	1178	66	42	2 7/8
		EVPBFA6648	1215	1305	66	48	2 7/8
		EVPBFA6654	1334	1432	66	54	2 7/8
		EVPBFA6660	1450	1559	66	60	2 7/8

## EVPBLFA - SEGMENTED BELTLINE POWERED LIGHT PANEL

- Segmented Beltline Powered Light Panel incorporates fabric modules with a power beltline raceway, within a solid steel frame.
- There is no base raceway in Light Panels to accommodate electrical.
- 6"H power beltline raceway, to accommodate electrical, is metal with knockouts on both sides.
- Beltline Light Panel Connectors must be used in conjunction with Beltline Light Panels.
- Fabric covered modules are tackable and acoustical.
- Opposite sides of each panel may have a different fabric within the same grade at no upcharge.
- If different grades of fabric are used on one panel, the entire panel must be priced at highest grade.
- An aluminum low profile top cap is included.
- Stackability: Evolve Light panels can be increased in height in 6"H, 12"H, 18"H or 24"H increments. See Extension Modules for part numbers.

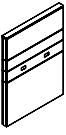
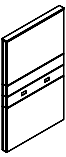
	DESCRIPTION	PRODUCT CODE	LIST PRICE		DIMENSIONS/INCHES		
			Gr1	Gr2	H	W	D
	Segmented Beltline Powered Light Panel - 54" High 24" Fabric /6" Power /6" Fabric /12" Fabric	EVPBLFA5424	565	604	54	24	2 7/8
		EVPBLFA5430	662	709	54	30	2 7/8
		EVPBLFA5436	764	821	54	36	2 7/8
		EVPBLFA5442	858	921	54	42	2 7/8
		EVPBLFA5448	936	1006	54	48	2 7/8
		EVPBLFA5454	1028	1103	54	54	2 7/8
		EVPBLFA5460	1122	1204	54	60	2 7/8
	Segmented Beltline Powered Light Panel - 66" High 24" Fabric /6" Power /6" Fabric /24 Fabric	EVPBLFA6624	679	729	66	24	2 7/8
		EVPBLFA6630	791	850	66	30	2 7/8
		EVPBLFA6636	899	969	66	36	2 7/8
		EVPBLFA6642	1013	1093	66	42	2 7/8
		EVPBLFA6648	1115	1205	66	48	2 7/8
		EVPBLFA6654	1227	1324	66	54	2 7/8
		EVPBLFA6660	1335	1444	66	60	2 7/8

# PANELS

# SEGMENTED

## EVPBCFA - SEGMENTED BELTLINE POWERED CHIMNEY PANEL

- Segmented Chimney Beltline Powered Panel incorporates fabric modules with a power beltline raceway, within a solid steel frame.
- A Chimney Panel is required to run electric and data from the base to belt.
- Separate electric harness required to go from base to belt (see EVE8CPCP).
- 6"H power beltline raceway, to accommodate electrical, is metal with knockouts on both sides.
- Beltline Connectors must be used in conjunction with beltline panels.
- Fabric covered modules are tackable and acoustical.
- Opposite sides of each panel may have a different fabric within the same grade at no upcharge.
- If different grades of fabric are used on one panel, the entire panel must be priced at highest grade.
- An aluminum low profile top cap is included.
- Stackability: Evolve panels can be increased in height in 6"H, 12"H, 18"H or 24"H increments. See Extension Modules for part numbers.

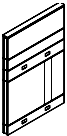
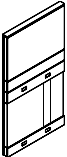
	DESCRIPTION	PRODUCT CODE	LIST PRICE		DIMENSIONS/INCHES		
			Gr1	Gr2	H	W	D
	Segmented Beltline Powered Chimney Panel - 54" High	EVPBCFA5436	917	972	54	36	2 7/8
	24" Fabric Chimney /6" Power / 6" Fabric /12" Fabric	EVPBCFA5442	1018	1079	54	42	2 7/8
	Segmented Beltline Powered Chimney Panel - 66" High	EVPBCFA6636	1062	1132	66	36	2 7/8
	24" Fabric Chimney /6" Power / 6" Fabric /24" Fabric	EVPBCFA6642	1185	1265	66	42	2 7/8

## EVE8CPCP - CHIMNEY PANEL JUMPER CABLE KIT

- Contains two (2) 17" flexible harnesses and one (1) "I" connector.
- Used to connect electric from the base to the beltline raceway in Beltline Powered Chimney panel.
- Must use in conjunction with base power distribution harness and beltline power distribution harness (sold separately)

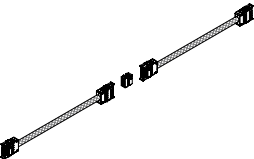
	DESCRIPTION	PRODUCT CODE	LIST PRICE		DIMENSIONS/INCHES		
			Gr1	Gr2	H	W	D
	Chimney Panel Jumper Cable Kit	EVE8CPCP	365				

# PANELS

# SEGMENTED

## EVPBFFA - SEGMENTED BELTLINE NON-POWERED PANEL

- Double Beltline Non-Powered Panel incorporates all fabric modules within a solid steel frame.
- Electrical cannot pass through panel at the beltline level.
- Fabric covered modules are tackable and acoustical.
- Opposite sides of each panel may have a different fabric within the same grade at no upcharge.
- If different grades of fabric are used on one panel, the entire panel must be priced at highest grade.
- An aluminum low profile top cap is included.
- Stackability: Evolve panels can be increased in height in 6"H, 12"H, 18"H or 24"H increments. See Extension Modules for part numbers.

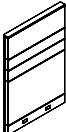
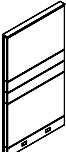
	DESCRIPTION	PRODUCT CODE	LIST PRICE		DIMENSIONS/INCHES		
			Gr1	Gr2	H	W	D
	Segmented Beltline Non-Powered Panel - 54" High	EVPBFFA5424	594	632	54	24	2 7/8
		EVPBFFA5430	650	703	54	30	2 7/8
	24" Fabric /6" Fabric /6" Fabric /12" Fabric	EVPBFFA5436	764	827	54	36	2 7/8
		EVPBFFA5442	863	933	54	42	2 7/8
		EVPBFFA5448	925	1004	54	48	2 7/8
		EVPBFFA5454	975	1065	54	54	2 7/8
		EVPBFFA5460	1023	1118	54	60	2 7/8
	Segmented Beltline Non-Powered Panel - 66" High	EVPBFFA6624	644	699	66	24	2 7/8
		EVPBFFA6630	756	822	66	30	2 7/8
	24" Fabric /6" Fabric /6" Fabric /24" Fabric	EVPBFFA6636	871	945	66	36	2 7/8
		EVPBFFA6642	981	1071	66	42	2 7/8
		EVPBFFA6648	1072	1170	66	48	2 7/8
		EVPBFFA6654	1177	1286	66	54	2 7/8
		EVPBFFA6660	1280	1400	66	60	2 7/8

## EVPBLFFA - SEGMENTED BELTLINE NON-POWERED LIGHT PANEL

- Double Beltline Non-Powered Panel incorporates all fabric modules within a solid steel frame.
- Electrical cannot pass through panel at the beltline level.
- There is no base raceway in Light Panels to accommodate electrical.
- Fabric covered modules are tackable and acoustical.
- Opposite sides of each panel may have a different fabric within the same grade at no upcharge.
- If different grades of fabric are used on one panel, the entire panel must be priced at highest grade.
- An aluminum low profile top cap is included.
- Stackability: Evolve panels can be increased in height in 6"H, 12"H, 18"H or 24"H increments.
- See Extension Modules for part numbers.

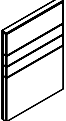
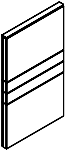
	DESCRIPTION	PRODUCT CODE	LIST PRICE		DIMENSIONS/INCHES		
			Gr1	Gr2	H	W	D
	Segmented Beltline Non-Powered Light Panel - 54" High	EVPBLFFA5424	489	533	54	24	2 7/8
		EVPBLFFA5430	577	630	54	30	2 7/8
	24" Fabric /6" Fabric /6" Fabric /12" Fabric	EVPBLFFA5436	655	718	54	36	2 7/8
		EVPBLFFA5442	733	803	54	42	2 7/8
		EVPBLFFA5448	815	894	54	48	2 7/8
		EVPBLFFA5454	927	1015	54	54	2 7/8
		EVPBLFFA5460	972	1069	54	60	2 7/8
	Segmented Beltline Non-Powered Light Panel - 66" High	EVPBLFFA6624	610	665	66	24	2 7/8
		EVPBLFFA6630	677	741	66	30	2 7/8
	24" Fabric /6" Fabric /6" Fabric /24" Fabric	EVPBLFFA6636	791	865	66	36	2 7/8
		EVPBLFFA6642	892	980	66	42	2 7/8
		EVPBLFFA6648	959	1057	66	48	2 7/8
		EVPBLFFA6654	1039	1148	66	54	2 7/8
		EVPBLFFA6660	1126	1244	66	60	2 7/8

# PANELS

# PARTLY GLAZED

## EVPMTU - MONOLITHIC 12"H GLAZED PANEL - TEMPERED GLASS

- Monolithic 12"H Glazed Panel incorporates a lower fabric module with a 12"H top position glazed module, into a solid steel frame.
- Fabric covered modules are tackable and acoustical.
- Opposite sides of each panel may have a different fabric within the same grade at no upcharge.
- If different grades of fabric are used on one panel, the entire panel must be priced at highest grade.
- An aluminum low profile top cap is included.
- Stackability: Evolve panels can be increased in height in 6"H, 12"H, 18"H or 24"H increments. See Extension Modules for part numbers.
- Standard in clear (CLR) glass.
- Frosted glass (FRST) 20% upcharge.

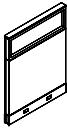
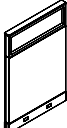
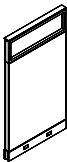
	DESCRIPTION	PRODUCT CODE	LIST PRICE		DIMENSIONS/INCHES		
			Gr1	Gr2	H	W	D
	Monolithic 12"H Glazed Panel - Tempered Glass - 48" High	EVPMTU4818	577	611	48	18	2 7/8
		EVPMTU4824	676	723	48	24	2 7/8
		EVPMTU4830	784	841	48	30	2 7/8
		EVPMTU4836	894	960	48	36	2 7/8
		EVPMTU4842	992	1063	48	42	2 7/8
		EVPMTU4848	1079	1166	48	48	2 7/8
		EVPMTU4854	1198	1285	48	54	2 7/8
		EVPMTU4860	1313	1414	48	60	2 7/8
	Monolithic 12"H Glazed Panel - Tempered Glass - 54" High	EVPMTU5418	595	634	54	18	2 7/8
		EVPMTU5424	692	739	54	24	2 7/8
		EVPMTU5430	788	847	54	30	2 7/8
		EVPMTU5436	879	940	54	36	2 7/8
		EVPMTU5442	975	1048	54	42	2 7/8
		EVPMTU5448	1079	1166	54	48	2 7/8
		EVPMTU5454	1181	1274	54	54	2 7/8
		EVPMTU5460	1279	1380	54	60	2 7/8
	Monolithic 12"H Glazed Panel - Tempered Glass - 66" High	EVPMTU6618	635	673	66	18	2 7/8
		EVPMTU6624	760	810	66	24	2 7/8
		EVPMTU6630	866	925	66	30	2 7/8
		EVPMTU6636	970	1036	66	36	2 7/8
		EVPMTU6642	1078	1151	66	42	2 7/8
		EVPMTU6648	1189	1271	66	48	2 7/8
		EVPMTU6654	1301	1392	66	54	2 7/8
		EVPMTU6660	1417	1515	66	60	2 7/8

# PANELS

# PARTLY GLAZED

## EVPLMGU - MONOLITHIC 12"H GLAZED LIGHT PANEL - TEMPERED GLASS

- Monolithic 12"H Glazed Light Panel incorporates a lower fabric module with a 12"H top position glazed module, into a solid steel frame.
- There is no base raceway in Light Panels to accommodate electrical.
- Light Panel Connectors must be used in conjunction with Light Panels.
- Fabric covered modules are tackable and acoustical.
- Opposite sides of each panel may have a different fabric within the same grade at no upcharge.
- If different grades of fabric are used on one panel, the entire panel must be priced at highest grade.
- An aluminum low profile top cap is included.
- Stackability: Evolve panels can be increased in height in 6"H, 12"H, 18"H or 24"H increments. See Extension Modules for part numbers.
- Standard in clear (CLR) glass.
- Frosted glass (FRST) 20% upcharge.

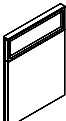
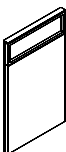
	DESCRIPTION	PRODUCT CODE	LIST PRICE		DIMENSIONS/INCHES		
			Gr1	Gr2	H	W	D
	Monolithic 12"H Glazed Light Panel - Tempered Glass - 48" High	EVPLMGU4818	564	600	48	18	2 7/8
		EVPLMGU4824	660	707	48	24	2 7/8
		EVPLMGU4830	766	823	48	30	2 7/8
		EVPLMGU4836	879	942	48	36	2 7/8
		EVPLMGU4842	973	1044	48	42	2 7/8
		EVPLMGU4848	1056	1138	48	48	2 7/8
		EVPLMGU4854	1172	1254	48	54	2 7/8
		EVPLMGU4860	1289	1388	48	60	2 7/8
	Monolithic 12"H Glazed Light Panel - Tempered Glass - 54" High	EVPLMGU5418	583	622	54	18	2 7/8
		EVPLMGU5424	678	722	54	24	2 7/8
		EVPLMGU5430	772	830	54	30	2 7/8
		EVPLMGU5436	863	924	54	36	2 7/8
		EVPLMGU5442	959	1030	54	42	2 7/8
		EVPLMGU5448	1056	1138	54	48	2 7/8
		EVPLMGU5454	1156	1246	54	54	2 7/8
		EVPLMGU5460	1257	1355	54	60	2 7/8
	Monolithic 12"H Glazed Light Panel - Tempered Glass - 66" High	EVPLMGU6618	622	658	66	18	2 7/8
		EVPLMGU6624	745	795	66	24	2 7/8
		EVPLMGU6630	851	908	66	30	2 7/8
		EVPLMGU6636	950	1013	66	36	2 7/8
		EVPLMGU6642	1053	1126	66	42	2 7/8
		EVPLMGU6648	1165	1246	66	48	2 7/8
		EVPLMGU6654	1275	1368	66	54	2 7/8
		EVPLMGU6660	1386	1481	66	60	2 7/8

# PANELS

# PARTLY GLAZED

## EVPFGTU - FABRIC 12"H GLAZED PANEL - TEMPERED GLASS

- Segmented 12"H Glazed Panel incorporates a lower fabric module with a 12"H top position glazed module, into a solid steel frame.
- Panels incorporate 12"H acoustic modules above 30"H base section with a 12"H glazed module at the top.
- Fabric covered modules are tackable and acoustical.
- Opposite sides of each panel may have a different fabric within the same grade at no upcharge.
- If different grades of fabric are used on one panel, the entire panel must be priced at highest grade.
- An aluminum low profile top cap is included.
- Stackability: Evolve panels can be increased in height in 6"H, 12"H, 18"H or 24"H increments. See Extension Modules for part numbers.
- Standard in clear (CLR) glass.
- Frosted glass (FRST) 20% upcharge.

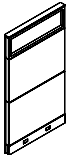
	DESCRIPTION	PRODUCT CODE	LIST PRICE		DIMENSIONS/INCHES		
			Gr1	Gr2	H	W	D
	Fabric 12" Glazed Panel - Tempered Glass 66" High	EVPFGTU6618	712	748	66	18	2 7/8
		EVPFGTU6624	830	877	66	24	2 7/8
		EVPFGTU6630	947	1000	66	30	2 7/8
		EVPFGTU6636	1059	1122	66	36	2 7/8
		EVPFGTU6642	1197	1266	66	42	2 7/8
		EVPFGTU6648	1298	1377	66	48	2 7/8
		EVPFGTU6654	1450	1538	66	54	2 7/8
		EVPFGTU6660	1598	1692	66	60	2 7/8

## EVPLFGTU - FABRIC 12"H GLAZED LIGHT PANEL

- Segmented 12"H Glazed Light Panel incorporates a lower fabric module with a 12"H top position glazed module, into a solid steel frame.
- Panels incorporate 12"H acoustic modules above 30"H base section with a 12"H glazed module at the top.
- There is no base raceway in Light Panels to accommodate electrical.
- Light Panel Connectors must be used in conjunction with Light Panels.
- Opposite sides of each panel may have a different fabric within the same grade at no upcharge.
- If different grades of fabric are used on one panel, the entire panel must be priced at highest grade.
- An aluminum low profile top cap is included.
- Stackability: Evolve panels can be increased in height in 6"H, 12"H, 18"H or 24"H increments.
- See Extension Modules for part numbers.
- Standard in clear (CLR) glass.
- Frosted glass (FRST) 20% upcharge.

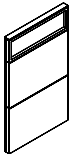

	DESCRIPTION	PRODUCT CODE	LIST PRICE		DIMENSIONS/INCHES		
			Gr1	Gr2	H	W	D
	Fabric 12"H Glazed Light Panel - 66" High	EVPLFGTU6618	695	729	66	18	2 7/8
		EVPLFGTU6624	817	864	66	24	2 7/8
		EVPLFGTU6630	928	980	66	30	2 7/8
		EVPLFGTU6636	1041	1102	66	36	2 7/8
		EVPLFGTU6642	1171	1238	66	42	2 7/8
		EVPLFGTU6648	1271	1346	66	48	2 7/8
		EVPLFGTU6654	1420	1507	66	54	2 7/8
		EVPLFGTU6660	1568	1661	66	60	2 7/8

# PANELS

# PARTLY GLAZED



## EVPFPGTU - SEGMENTED 12”H GLAZED PANEL - PREMIUM - TEMPERED GLASS

- Segmented 12”H Glazed Premium Panel incorporates a lower fabric module with a 12”H top position glazed module, into a solid steel frame.
- Premium panels incorporate a 6”H base raceway, 24”H base module, 12”H acoustic module and a 12”H glazed module at the top.
- Fabric covered modules are tackable and acoustical.
- Opposite sides of each panel may have a different fabric within the same grade at no upcharge.
- If different grades of fabric are used on one panel, the entire panel must be priced at highest grade.
- An aluminum low profile top cap is included.
- Stackability: Evolve panels can be increased in height in 6”H, 12”H, 18”H or 24”H increments. See Extension Modules for part numbers.
- Standard in clear (CLR) glass.
- Frosted glass (FRST) 20% upcharge.

	DESCRIPTION	PRODUCT CODE	LIST PRICE		DIMENSIONS/INCHES		
			Gr1	Gr2	H	W	D
	Segmented 12”H Glazed Premium Panel - Tempered Glass - 54” High	EVPFPGTU5418	655	682	54	18	2 7/8
		EVPFPGTU5424	768	802	54	24	2 7/8
		EVPFPGTU5430	867	909	54	30	2 7/8
		EVPFPGTU5436	975	1025	54	36	2 7/8
		EVPFPGTU5442	1094	1149	54	42	2 7/8
		EVPFPGTU5448	1189	1248	54	48	2 7/8
		EVPFPGTU5454	1334	1400	54	54	2 7/8
	Segmented 12”H Glazed Premium Panel - Tempered Glass - 66” High	EVPFPGTU6618	801	834	66	18	2 7/8
		EVPFPGTU6624	940	988	66	24	2 7/8
		EVPFPGTU6630	1070	1122	66	30	2 7/8
		EVPFPGTU6636	1201	1264	66	36	2 7/8
		EVPFPGTU6642	1356	1426	66	42	2 7/8
		EVPFPGTU6648	1467	1546	66	48	2 7/8
		EVPFPGTU6654	1641	1729	66	54	2 7/8
EVPFPGTU6660	1822	1919	66	60	2 7/8		

## EVPLFPGTU - SEGMENTED 12”H GLAZED PREMIUM LIGHT PANEL – TEMPERED GLASS

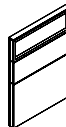
- Segmented 12”H Glazed Premium Light Panel incorporates a lower fabric module with a 12”H top position glazed module, into a solid steel frame.
- Premium panels incorporate a 30”H base section, 12”H acoustic module and a 12”H glazed module at the top.
- There is no base raceway in Light Panels to accommodate electrical.
- Light Panel Connectors must be used in conjunction with Light Panels.
- Opposite sides of each panel may have a different fabric within the same grade at no upcharge.
- If different grades of fabric are used on one panel, the entire panel must be priced at highest grade.
- An aluminum low profile top cap is included.
- Stackability: Evolve panels can be increased in height in 6”H, 12”H, 18”H or 24”H increments.
- See Extension Modules for part numbers.
- Standard in clear (CLR) glass.
- Frosted glass (FRST) 20% upcharge.

	DESCRIPTION	PRODUCT CODE	LIST PRICE		DIMENSIONS/INCHES		
			Gr1	Gr2	H	W	D
	Segmented 12”H Glazed Premium Panel - Premium - Tempered Glass - 54” High	EVPLFPGTU5418	642	668	54	18	2 7/8
		EVPLFPGTU5424	754	788	54	24	2 7/8
		EVPLFPGTU5430	852	893	54	30	2 7/8
		EVPLFPGTU5436	959	1006	54	36	2 7/8
		EVPLFPGTU5442	1075	1132	54	42	2 7/8
		EVPLFPGTU5448	1165	1226	54	48	2 7/8
		EVPLFPGTU5454	1306	1370	54	54	2 7/8
	Segmented 12”H Glazed Premium Panel - Premium - Tempered Glass - 66” High	EVPLFPGTU6618	787	819	66	18	2 7/8
		EVPLFPGTU6624	923	970	66	24	2 7/8
		EVPLFPGTU6630	1047	1099	66	30	2 7/8
		EVPLFPGTU6636	1180	1241	66	36	2 7/8
		EVPLFPGTU6642	1329	1398	66	42	2 7/8
		EVPLFPGTU6648	1439	1514	66	48	2 7/8
		EVPLFPGTU6654	1607	1694	66	54	2 7/8
EVPLFPGTU6660	1786	1881	66	60	2 7/8		

# PANELS

# PARTLY GLAZED

## EVPPFGT - PARTLY GLAZED PANEL - TEMPERED GLASS

- Partly Glazed Panel incorporates a lower fabric module with a 12"H or 24"H top position glazed module, into a solid steel frame.
- Opposite sides of each panel may have a different fabric within the same grade at no upcharge.
- If different grades of fabric are used on one panel, the entire panel must be priced at highest grade.
- An aluminum low profile top cap is included.
- Stackability: Evolve panels can be increased in height in 6"H, 12"H, 18"H or 24"H increments. See Extension Modules for part numbers.
- Standard in clear (CLR) glass.
- Frosted glass (FRST) 20% upcharge.

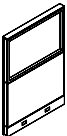
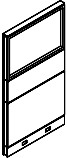

	DESCRIPTION	PRODUCT CODE	LIST PRICE		DIMENSIONS/INCHES		
			Gr1	Gr2	H	W	D
	Partly Glazed Panel - Tempered Glass - 42" High	EVPPFGT4218	504	524	42	18	2 7/8
		EVPPFGT4224	595	621	42	24	2 7/8
		EVPPFGT4230	674	702	42	30	2 7/8
		EVPPFGT4236	752	786	42	36	2 7/8
		EVPPFGT4242	835	873	42	42	2 7/8
		EVPPFGT4248	914	955	42	48	2 7/8
		EVPPFGT4254	1021	1065	42	54	2 7/8
		EVPPFGT4260	1127	1177	42	60	2 7/8
	Partly Glazed Panel - Tempered Glass - 54" High	EVPPFGT5418	557	578	54	18	2 7/8
		EVPPFGT5424	647	673	54	24	2 7/8
		EVPPFGT5430	752	781	54	30	2 7/8
		EVPPFGT5436	852	886	54	36	2 7/8
		EVPPFGT5442	952	988	54	42	2 7/8
		EVPPFGT5448	1038	1079	54	48	2 7/8
		EVPPFGT5454	1203	1247	54	54	2 7/8
		EVPPFGT5460	1366	1419	54	60	2 7/8
	Partly Glazed Panel - Tempered Glass - 66" High	EVPPFGT6618	706	734	66	18	2 7/8
		EVPPFGT6624	821	857	66	24	2 7/8
		EVPPFGT6630	947	988	66	30	2 7/8
		EVPPFGT6636	1078	1126	66	36	2 7/8
		EVPPFGT6642	1211	1268	66	42	2 7/8
		EVPPFGT6648	1316	1377	66	48	2 7/8
		EVPPFGT6654	1513	1580	66	54	2 7/8
		EVPPFGT6660	1712	1783	66	60	2 7/8

# PANELS

# PARTLY GLAZED

## EVPLFGT - PARTLY GLAZED LIGHT PANEL - TEMPERED GLASS

- Partly Glazed Light Panel incorporates a lower fabric module with a 12"H or 24"H top position glazed module, into a solid steel frame.
- There is no base raceway in Light Panels to accommodate electrical.
- Light Panel Connectors must be used in conjunction with Light Panels.
- Opposite sides of each panel may have a different fabric within the same grade at no upcharge.
- If different grades of fabric are used on one panel, the entire panel must be priced at highest grade.
- An aluminum low profile top cap is included.
- Stackability: Evolve panels can be increased in height in 6"H, 12"H, 18"H or 24"H increments. See Extension Modules for part numbers.
- Standard in clear (CLR) glass.
- Frosted glass (FRST) 20% upcharge.

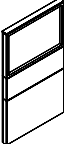
	DESCRIPTION	PRODUCT CODE	LIST PRICE		DIMENSIONS/INCHES		
			Gr1	Gr2	H	W	D
	Partly Glazed Light Panel - Tempered Glass - 42" High	EVPLFGT4218	493	514	42	18	2 7/8
		EVPLFGT4224	583	609	42	24	2 7/8
		EVPLFGT4230	659	688	42	30	2 7/8
		EVPLFGT4236	733	767	42	36	2 7/8
		EVPLFGT4242	821	859	42	42	2 7/8
		EVPLFGT4248	893	934	42	48	2 7/8
		EVPLFGT4254	998	1042	42	54	2 7/8
		EVPLFGT4260	1105	1153	42	60	2 7/8
	Partly Glazed Light Panel - Tempered Glass - 54" High	EVPLFGT5418	547	565	54	18	2 7/8
		EVPLFGT5424	635	661	54	24	2 7/8
		EVPLFGT5430	733	762	54	30	2 7/8
		EVPLFGT5436	832	866	54	36	2 7/8
		EVPLFGT5442	934	970	54	42	2 7/8
		EVPLFGT5448	1018	1059	54	48	2 7/8
		EVPLFGT5454	1181	1228	54	54	2 7/8
		EVPLFGT5460	1339	1392	54	60	2 7/8
	Partly Glazed Light Panel - Tempered Glass - 66" High	EVPLFGT6618	693	722	66	18	2 7/8
		EVPLFGT6624	801	837	66	24	2 7/8
		EVPLFGT6630	928	969	66	30	2 7/8
		EVPLFGT6636	1053	1100	66	36	2 7/8
		EVPLFGT6642	1189	1242	66	42	2 7/8
		EVPLFGT6648	1292	1350	66	48	2 7/8
		EVPLFGT6654	1482	1549	66	54	2 7/8
		EVPLFGT6660	1679	1749	66	60	2 7/8

# PANELS

# PARTLY GLAZED

## EVPPFGTX - PARTLY GLAZED PANEL - 36"H TEMPERED GLASS

- Partly Glazed Panel incorporates a lower fabric module with 36"H top position glazed module, into a solid steel frame.
- Opposite sides of each panel may have a different fabric within the same grade at no upcharge.
- If different grades of fabric are used on one panel, the entire panel must be priced at highest grade.
- An aluminum low profile top cap is included.
- Stackability: Evolve panels can be increased in height in 6"H, 12"H, 18"H or 24"H increments. See Extension Modules for part numbers.
- Standard in clear (CLR) glass.
- Frosted glass (FRST) 40% upcharge.

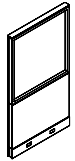
	DESCRIPTION	PRODUCT CODE	LIST PRICE		DIMENSIONS/INCHES		
			Gr1	Gr2	H	W	D
	Fabric 36" Glazed Panel -	EVPPFGTX6618	818	836	66	18	2 7/8
	Tempered Glass - 66" High	EVPPFGTX6624	901	928	66	24	2 7/8
		EVPPFGTX6630	1045	1074	66	30	2 7/8
		EVPPFGTX6636	1188	1221	66	36	2 7/8
		EVPPFGTX6642	1328	1366	66	42	2 7/8
		EVPPFGTX6648	1454	1495	66	48	2 7/8
		EVPPFGTX6654	1598	1642	66	54	2 7/8
		EVPPFGTX6660	1742	1794	66	60	2 7/8

## EVPLFGTX - PARTLY GLAZED LIGHT PANEL - 36"H TEMPERED GLASS

- Partly Glazed Light Panel incorporates a lower fabric module with 36"H top position glazed module, into a solid steel frame.
- There is no base raceway in Light Panels to accommodate electrical.
- Light Panel Connectors must be used in conjunction with Light Panels.
- Opposite sides of each panel may have a different fabric within the same grade at no upcharge.
- If different grades of fabric are used on one panel, the entire panel must be priced at highest grade.
- An aluminum low profile top cap is included.
- Stackability: Evolve panels can be increased in height in 6"H, 12"H, 18"H or 24"H increments. See Extension Modules for part numbers.
- Standard in clear (CLR) glass.
- Frosted glass (FRST) 40% upcharge.

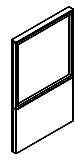
	DESCRIPTION	PRODUCT CODE	LIST PRICE		DIMENSIONS/INCHES		
			Gr1	Gr2	H	W	D
	Partly Glazed Light Panel -	EVPLFGTX6618	789	807	66	18	2 7/8
	36"H Tempered Glass - 66" High	EVPLFGTX6624	874	901	66	24	2 7/8
		EVPLFGTX6630	1015	1043	66	30	2 7/8
		EVPLFGTX6636	1150	1184	66	36	2 7/8
		EVPLFGTX6642	1289	1325	66	42	2 7/8
		EVPLFGTX6648	1410	1449	66	48	2 7/8
		EVPLFGTX6654	1550	1592	66	54	2 7/8
		EVPLFGTX6660	1691	1743	66	60	2 7/8

# PANELS

# PARTLY GLAZED

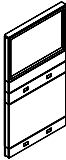

## EVPBFGT - PARTLY GLAZED BELTLINE POWERED PANEL

- Partly Glazed Beltline Powered Panel incorporates fabric modules with a power beltline raceway and a 12"H or 24"H glazed module, within a solid steel frame.
- A Chimney Panel is required to run electric and data from the base to belt.
- 6"H power beltline raceway, to accommodate electrical, is metal with knockouts on both sides.
- Beltline Connectors must be used in conjunction with beltline panels.
- Opposite sides of each panel may have a different fabric within the same grade at no upcharge.
- If different grades of fabric are used on one panel, the entire panel must be priced at highest grade.
- An aluminum low profile top cap is included.
- Stackability: Evolve panels can be increased in height in 6"H, 12"H, 18"H or 24"H increments. See Extension Modules for part numbers.
- Standard in clear (CLR) glass.
- Frosted glass (FRST) 20% upcharge.

	DESCRIPTION	PRODUCT CODE	LIST PRICE		DIMENSIONS/INCHES		
			Gr1	Gr2	H	W	D
	Partly Glazed Beltline Powered Panel - 54" High	EVPBFGT5424	824	853	54	24	2 7/8
	24" Fabric /6" Power Belt/ 6" Fabric /12" Glass	EVPBFGT5430	966	1000	54	30	2 7/8
		EVPBFGT5436	1098	1139	54	36	2 7/8
		EVPBFGT5442	1236	1283	54	42	2 7/8
		EVPBFGT5448	1370	1422	54	48	2 7/8
		EVPBFGT5454	1503	1560	54	54	2 7/8
		EVPBFGT5460	1639	1700	54	60	2 7/8
	Partly Glazed Beltline Powered Panel - 66" High	EVPBFGT6624	936	965	66	24	2 7/8
	24" Fabric /6" Power Belt/ 6" Fabric /24" Glass	EVPBFGT6630	1091	1125	66	30	2 7/8
		EVPBFGT6636	1241	1282	66	36	2 7/8
		EVPBFGT6642	1394	1441	66	42	2 7/8
		EVPBFGT6648	1537	1589	66	48	2 7/8
		EVPBFGT6654	1691	1730	66	54	2 7/8
		EVPBFGT6660	1841	1902	66	60	2 7/8

## EVPBLFGT - PARTLY GLAZED BELTLINE POWER LIGHT PANEL

- Partly Glazed Beltline Powered Light Panel incorporates fabric modules with a power beltline raceway and a 12"H or 24"H glazed module, within a solid steel frame.
- 6"H power beltline raceway, to accommodate electrical, is metal with knockouts on both sides.
- There is no base raceway in Light Panels to accommodate electrical.
- Light Beltline Panel Connectors must be used in conjunction with Light Beltline Panels.
- Opposite sides of each panel may have a different fabric within the same grade at no upcharge.
- If different grades of fabric are used on one panel, the entire panel must be priced at highest grade.
- An aluminum low profile top cap is included.
- Stackability: Evolve Light panels can be increased in height in 6"H, 12"H, 18"H or 24"H increments. See Extension Modules for part numbers.
- Standard in clear (CLR) glass.
- Frosted glass (FRST) 20% upcharge.

	DESCRIPTION	PRODUCT CODE	LIST PRICE		DIMENSIONS/INCHES		
			Gr1	Gr2	H	W	D
	Partly Glazed Beltline Powered Light Panel - 54" High	EVPBLFGT5424	785	814	54	24	2 7/8
	24" Fabric /6" Power Belt/ 6" Fabric /12" Glass	EVPBLFGT5430	919	953	54	30	2 7/8
		EVPBLFGT5436	1043	1084	54	36	2 7/8
		EVPBLFGT5442	1175	1222	54	42	2 7/8
		EVPBLFGT5448	1301	1353	54	48	2 7/8
		EVPBLFGT5454	1429	1486	54	54	2 7/8
		EVPBLFGT5460	1556	1619	54	60	2 7/8
	Partly Glazed Beltline Powered Light Panel - 66" High	EVPBLFGT6624	889	918	66	24	2 7/8
	24" Fabric /6" Power Belt/ 6" Fabric /24" Glass	EVPBLFGT6630	1036	1070	66	30	2 7/8
		EVPBLFGT6636	1180	1221	66	36	2 7/8
		EVPBLFGT6642	1322	1370	66	42	2 7/8
		EVPBLFGT6648	1464	1516	66	48	2 7/8
		EVPBLFGT6654	1607	1664	66	54	2 7/8
		EVPBLFGT6660	1747	1810	66	60	2 7/8

# PANELS

# PARTLY GLAZED

## EVPBCFGT - PARTLY GLAZED BELTLINE POWERED CHIMNEY PANEL - TEMPERED GLASS

- Partly Glazed Beltline Powered Chimney Panel incorporates fabric modules with a power beltline raceway and a 12"H or 24"H glazed module, within a solid steel frame.
- A Chimney Panel is required to run electric and data from the base to belt.
- Separate electric harness required to go from base to belt (see EVE8CPCP).
- 6"H power beltline raceway, to accommodate electrical, is metal with knockouts on both sides.
- Beltline Connectors must be used in conjunction with beltline panels.
- Opposite sides of each panel may have a different fabric within the same grade at no upcharge.
- If different grades of fabric are used on one panel, the entire panel must be priced at highest grade.
- An aluminum low profile top cap is included.
- Stackability: Evolve panels can be increased in height in 6"H, 12"H, 18"H or 24"H increments. See Extension Modules for part numbers.
- Standard in clear (CLR) glass.
- Frosted glass (FRST) 20% upcharge.

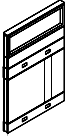
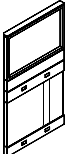
	DESCRIPTION	PRODUCT CODE	LIST PRICE		DIMENSIONS/INCHES		
			Gr1	Gr2	H	W	D
	Partly Glazed Beltline Powered Chimney Panel - Tempered Glass - 54" High	EVPBCFGT5436	1183	1225	54	36	2 7/8
	24" Fabric Chimney /6" Power Belt / 6" Fabric /12" Glass	EVPBCFGT5442	1322	1370	54	42	2 7/8
	Partly Glazed Beltline Powered Chimney Panel - Tempered Glass - 66" High	EVPBCFGT6636	1342	1383	66	36	2 7/8
	24" Fabric Chimney /6" Power Belt / 6" Fabric /24" Glass	EVPBCFGT6642	1480	1527	66	42	2 7/8

## EVE8CPCP - CHIMNEY PANEL JUMPER CABLE KIT

- Contains two (2) 17" flexible harnesses and one (1) "I" connector.
- Used to connect electric from the base to the beltline raceway in Beltline Powered Chimney panel.
- Must use in conjunction with base power distribution harness and beltline power distribution harness (sold separately)

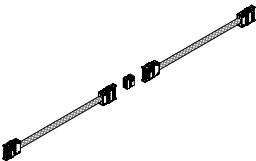
	DESCRIPTION	PRODUCT CODE	LIST PRICE	DIMENSIONS/INCHES		
				H	W	D
	Chimney Panel Jumper Cable Kit	EVE8CPCP	365			

# PANELS

# PARTLY GLAZED

## EVFPFGT - PARTLY GLAZED PREMIUM PANEL - TEMPERED GLASS

- Partly Glazed Premium Panel incorporates 12"H glazed modules above 30"H fabric base section.
- Opposite sides of each panel may have a different fabric within the same grade at no upcharge.
- If different grades of fabric are used on one panel, the entire panel must be priced at highest grade.
- An aluminum low profile top cap is included.
- Stackability: Evolve panels can be increased in height in 6"H, 12"H, 18"H or 24"H increments. See Extension Modules for part numbers.
- Standard in clear (CLR) glass.
- Frosted glass (FRST) 20% upcharge.

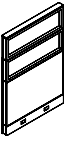
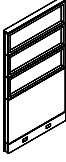
	DESCRIPTION	PRODUCT CODE	LIST PRICE		DIMENSIONS/INCHES		
			Gr1	Gr2	H	W	D
	Partly Glazed Premium Panel - Tempered Glass - 54" High	EVFPFGT5418	674	695	54	18	2 7/8
		EVFPFGT5424	801	824	54	24	2 7/8
		EVFPFGT5430	898	927	54	30	2 7/8
		EVFPFGT5436	998	1032	54	36	2 7/8
		EVFPFGT5442	1113	1151	54	42	2 7/8
		EVFPFGT5448	1225	1266	54	48	2 7/8
		EVFPFGT5454	1370	1418	54	54	2 7/8
		EVFPFGT5460	1511	1564	54	60	2 7/8
	Partly Glazed Premium Panel - Tempered Glass - 66" High	EVFPFGT6618	839	859	66	18	2 7/8
		EVFPFGT6624	1008	1036	66	24	2 7/8
		EVFPFGT6630	1133	1162	66	30	2 7/8
		EVFPFGT6636	1245	1279	66	36	2 7/8
		EVFPFGT6642	1388	1426	66	42	2 7/8
		EVFPFGT6648	1534	1576	66	48	2 7/8
		EVFPFGT6654	1734	1784	66	54	2 7/8
		EVFPFGT6660	1930	1983	66	60	2 7/8

## EVPLFPGT - PARTLY GLAZED PREMIUM LIGHT PANEL – TEMPERED GLASS

- Partly Glazed Premium Panel incorporates 12"H glazed modules above 30"H fabric base section.
- There is no base raceway in Light Panels to accommodate electrical.
- Light Panel Connectors must be used in conjunction with Light Panels.
- Opposite sides of each panel may have a different fabric within the same grade at no upcharge.
- If different grades of fabric are used on one panel, the entire panel must be priced at highest grade.
- An aluminum low profile top cap is included.
- Stackability: Evolve panels can be increased in height in 6"H, 12"H, 18"H or 24"H increments.
- See Extension Modules for part numbers.
- Standard in clear (CLR) glass.
- Frosted glass (FRST) 20% upcharge.

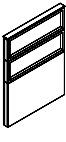
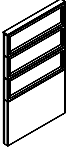
	DESCRIPTION	PRODUCT CODE	LIST PRICE		DIMENSIONS/INCHES		
			Gr1	Gr2	H	W	D
	Partly Glazed Premium Light Panel - Tempered Glass - 54" High	EVPLFPGT5418	651	672	54	18	2 7/8
		EVPLFPGT5424	779	800	54	24	2 7/8
		EVPLFPGT5430	870	899	54	30	2 7/8
		EVPLFPGT5436	972	1005	54	36	2 7/8
		EVPLFPGT5442	1080	1116	54	42	2 7/8
		EVPLFPGT5448	1189	1228	54	48	2 7/8
		EVPLFPGT5454	1328	1375	54	54	2 7/8
		EVPLFPGT5460	1465	1517	54	60	2 7/8
	Partly Glazed Premium Light Panel - Tempered Glass - 66" High	EVPLFPGT6618	818	836	66	18	2 7/8
		EVPLFPGT6624	981	1009	66	24	2 7/8
		EVPLFPGT6630	1094	1123	66	30	2 7/8
		EVPLFPGT6636	1209	1243	66	36	2 7/8
		EVPLFPGT6642	1349	1385	66	42	2 7/8
		EVPLFPGT6648	1487	1529	66	48	2 7/8
		EVPLFPGT6654	1680	1727	66	54	2 7/8
		EVPLFPGT6660	1875	1925	66	60	2 7/8

# PANELS

# FULLY GLAZED

## EVPXGT - FULLY GLAZED MONOLITHIC PANEL - TEMPERED GLASS

- Fully Glazed Monolithic Panels are incorporated into a solid steel frame.
- An aluminum low profile top cap is included.
- Stackability: Evolve panels can be increased in height in 6"H, 12"H, 18"H or 24"H increments. See Extension Modules for part numbers.
- Standard in clear (CLR) glass.
- Frosted glass (FRST) 40% upcharge.

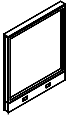
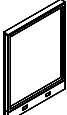
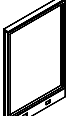
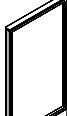



	DESCRIPTION	PRODUCT CODE	LIST PRICE	DIMENSIONS/INCHES		
				H	W	D
	Fully Glazed Monolithic Panel - Tempered Glass - 42" High	EVPXGT4218	540	42	18	2 7/8
		EVPXGT4224	595	42	24	2 7/8
		EVPXGT4230	692	42	30	2 7/8
		EVPXGT4236	777	42	36	2 7/8
		EVPXGT4242	865	42	42	2 7/8
	Fully Glazed Monolithic Panel - Tempered Glass - 48" High	EVPXGT4818	482	48	18	2 7/8
		EVPXGT4824	616	48	24	2 7/8
		EVPXGT4830	680	48	30	2 7/8
		EVPXGT4836	839	48	36	2 7/8
		EVPXGT4842	885	48	42	2 7/8
	Fully Glazed Monolithic Panel - Tempered Glass - 54" High	EVPXGT5418	598	54	18	2 7/8
		EVPXGT5424	702	54	24	2 7/8
		EVPXGT5430	817	54	30	2 7/8
		EVPXGT5436	919	54	36	2 7/8
		EVPXGT5442	1018	54	42	2 7/8
	Fully Glazed Monolithic Panel - Tempered Glass - 66" High	EVPXGT6618	701	66	18	2 7/8
		EVPXGT6624	810	66	24	2 7/8
		EVPXGT6630	936	66	30	2 7/8
		EVPXGT6636	1052	66	36	2 7/8
		EVPXGT6642	1171	66	42	2 7/8

# PANELS

# FULLY GLAZED

## EVPLXGT - FULLY GLAZED MONOLITHIC LIGHT PANEL - TEMPERED GLASS

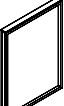
- Fully Glazed Monolithic Light Panels are incorporated into a solid steel frame.
- There is no base raceway in Light Panels to accommodate electrical.
- Light Panel Connectors must be used in conjunction with Light Panels.
- An aluminum low profile top cap is included.
- Stackability: Evolve panels can be increased in height in 6"H, 12"H, 18"H or 24"H increments. See Extension Modules for part numbers.
- Standard in clear (CLR) glass.
- Frosted glass (FRST) 40% upcharge.

	DESCRIPTION	PRODUCT CODE	LIST PRICE	DIMENSIONS/INCHES		
				H	W	D
	Fully Glazed Monolithic Light Panel - Tempered Glass - 42" High	EVPLXGT4218	513	42	18	2 7/8
		EVPLXGT4224	565	42	24	2 7/8
		EVPLXGT4230	656	42	30	2 7/8
		EVPLXGT4236	736	42	36	2 7/8
		EVPLXGT4242	822	42	42	2 7/8
	Fully Glazed Monolithic Light Panel - Tempered Glass - 48" High	EVPLXGT4818	454	48	18	2 7/8
		EVPLXGT4824	585	48	24	2 7/8
		EVPLXGT4830	647	48	30	2 7/8
		EVPLXGT4836	799	48	36	2 7/8
		EVPLXGT4842	836	48	42	2 7/8
	Fully Glazed Monolithic Light Panel - Tempered Glass - 54"	EVPLXGT5418	571	54	18	2 7/8
		EVPLXGT5424	669	54	24	2 7/8
		EVPLXGT5430	770	54	30	2 7/8
		EVPLXGT5436	870	54	36	2 7/8
		EVPLXGT5442	966	54	42	2 7/8
	Fully Glazed Monolithic Light Panel - Tempered Glass - 66" High	EVPLXGT6618	668	66	18	2 7/8
		EVPLXGT6624	769	66	24	2 7/8
		EVPLXGT6630	890	66	30	2 7/8
		EVPLXGT6636	998	66	36	2 7/8
		EVPLXGT6642	1113	66	42	2 7/8

## EVPGT - FULLY GLAZED SEGMENTED PANEL - TEMPERED GLASS

- Fully Glazed Segmented Panel incorporates (2) 24"H Glazed modules into a solid steel frame.
- An aluminum low profile top cap is included.
- Stackability: Evolve panels can be increased in height in 6"H, 12"H, 18"H or 24"H increments. See Extension Modules for part numbers.
- Standard in clear (CLR) glass.
- Frosted glass (FRST) 40% upcharge.

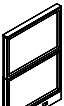
	DESCRIPTION	PRODUCT CODE	LIST PRICE	DIMENSIONS/INCHES		
				H	W	D
	Fully Glazed Segmented Panel - Tempered Glass - 54" High	EVPGT5418	764	54	18	2 7/8
		EVPGT5424	937	54	24	2 7/8
		EVPGT5430	1036	54	30	2 7/8
		EVPGT5436	1133	54	36	2 7/8
		EVPGT5442	1253	54	42	2 7/8
		EVPGT5448	1398	54	48	2 7/8
		EVPGT5454	1537	54	54	2 7/8
		EVPGT5460	1679	54	60	2 7/8

# PANELS

# FULLY GLAZED

## EVPLGT - FULLY GLAZED SEGMENTED LIGHT PANEL - TEMPERED GLASS

- Fully Glazed Segmented Light Panel incorporates (2) 24"H Glazed modules into a solid steel frame.
- There is no base raceway in Light Panels to accommodate electrical.
- Light Panel Connectors must be used in conjunction with Light Panels.
- An aluminum low profile top cap is included.
- Stackability: Evolve panels can be increased in height in 6"H, 12"H, 18"H or 24"H increments. See Extension Modules for part numbers.
- Standard in clear (CLR) glass.
- Frosted glass (FRST) 40% upcharge.

	DESCRIPTION	PRODUCT CODE	LIST PRICE	DIMENSIONS/INCHES		
				H	W	D
	Fully Glazed Segmented Light Panel	EVPLGT5418	726	54	18	2 7/8
	Tempered Glass - 54" High	EVPLGT5424	892	54	24	2 7/8
		EVPLGT5430	985	54	30	2 7/8
		EVPLGT5436	1075	54	36	2 7/8
		EVPLGT5442	1194	54	42	2 7/8
		EVPLGT5448	1327	54	48	2 7/8
		EVPLGT5454	1462	54	54	2 7/8
		EVPLGT5460	1594	54	60	2 7/8

## EVPGPT - FULLY GLAZED PREMIUM PANEL - TEMPERED GLASS

- Fully Glazed Premium Panel incorporates 12"H Glazed Modules into a solid steel frame.
- An aluminum low profile top cap is included.
- Stackability: Evolve panels can be increased in height in 6"H, 12"H, 18"H or 24"H increments. See Extension Modules for part numbers.
- Standard in clear (CLR) glass.
- Frosted glass (FRST) 40% upcharge.

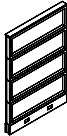
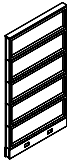
	DESCRIPTION	PRODUCT CODE	LIST PRICE	DIMENSIONS/INCHES		
				H	W	D
	Fully Glazed Premium Panel -	EVPGPT4218	754	42	18	2 7/8
	Tempered Glass - 42" High	EVPGPT4224	923	42	24	2 7/8
		EVPGPT4230	1021	42	30	2 7/8
		EVPGPT4236	1113	42	36	2 7/8
		EVPGPT4242	1235	42	42	2 7/8
		EVPGPT4248	1372	42	48	2 7/8
		EVPGPT4254	1512	42	54	2 7/8
		EVPGPT4260	1647	42	60	2 7/8
	Fully Glazed Premium Panel -	EVPGPT5418	953	54	18	2 7/8
	Tempered Glass - 54" High	EVPGPT5424	1171	54	24	2 7/8
		EVPGPT5430	1295	54	30	2 7/8
		EVPGPT5436	1410	54	36	2 7/8
		EVPGPT5442	1568	54	42	2 7/8
		EVPGPT5448	1745	54	48	2 7/8
		EVPGPT5454	1924	54	54	2 7/8
		EVPGPT5460	2098	54	60	2 7/8
	Fully Glazed Premium Panel -	EVPGPT6618	1154	66	18	2 7/8
	Tempered Glass - 66" High	EVPGPT6624	1419	66	24	2 7/8
		EVPGPT6630	1570	66	30	2 7/8
		EVPGPT6636	1707	66	36	2 7/8
		EVPGPT6642	1895	66	42	2 7/8
		EVPGPT6648	2111	66	48	2 7/8
		EVPGPT6654	2329	66	54	2 7/8
		EVPGPT6660	2546	66	60	2 7/8

# PANELS

# FULLY GLAZED

## EVPLGPT - FULLY GLAZED PREMIUM LIGHT PANEL - TEMPERED GLASS

- Fully Glazed Premium Light Panel incorporates 12"H Glazed Modules into a solid steel frame.
- There is no base raceway in Light Panels to accommodate electrical.
- Light Panel Connectors must be used in conjunction with Light Panels.
- An aluminum low profile top cap is included.
- Stackability: Evolve panels can be increased in height in 6"H, 12"H, 18"H or 24"H increments. See Extension Modules for part numbers.
- Standard in clear (CLR) glass.
- Frosted glass (FRST) 40% upcharge.

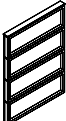
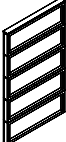
	DESCRIPTION	PRODUCT CODE	LIST PRICE	DIMENSIONS/INCHES		
				H	W	D
	Fully Glazed Premium Light Panel - Tempered Glass - 42" High	EVPLGPT4218	730	42	18	2 7/8
		EVPLGPT4224	893	42	24	2 7/8
		EVPLGPT4230	988	42	30	2 7/8
		EVPLGPT4236	1080	42	36	2 7/8
		EVPLGPT4242	1198	42	42	2 7/8
		EVPLGPT4248	1331	42	48	2 7/8
		EVPLGPT4254	1467	42	54	2 7/8
EVPLGPT4260	1598	42	60	2 7/8		
	Fully Glazed Premium Light Panel - Tempered Glass - 54" High	EVPLGPT5418	927	54	18	2 7/8
		EVPLGPT5424	1137	54	24	2 7/8
		EVPLGPT5430	1253	54	30	2 7/8
		EVPLGPT5436	1370	54	36	2 7/8
		EVPLGPT5442	1522	54	42	2 7/8
		EVPLGPT5448	1692	54	48	2 7/8
		EVPLGPT5454	1863	54	54	2 7/8
EVPLGPT5460	2033	54	60	2 7/8		
	Fully Glazed Premium Light Panel - Tempered Glass - 66" High	EVPLGPT6618	1122	66	18	2 7/8
		EVPLGPT6624	1375	66	24	2 7/8
		EVPLGPT6630	1524	66	30	2 7/8
		EVPLGPT6636	1655	66	36	2 7/8
		EVPLGPT6642	1841	66	42	2 7/8
		EVPLGPT6648	2048	66	48	2 7/8
		EVPLGPT6654	2257	66	54	2 7/8
EVPLGPT6660	2469	66	60	2 7/8		

**EVPHSG - RECEPTION PANEL LAMINATE**

- Reception panel incorporates glazed module and pass thru module within steel frame. Glazing is clear only.
- 6" H or 12" H pass thru with sliding glass door module.
- 24" H Laminate bottom module.
- Aluminum low profile top is included.
- Stackability: Evolve panels can be increased in height in 6", 12", 24" increments. See module listing for part numbers.

	DESCRIPTION	PRODUCT CODE	LIST PRICE	DIMENSIONS/INCHES		
				H	W	D
	Reception Panel with 12" H Pass Thru	EVPHSG2M6636	1546	66	36	2 7/8
		EVPHSG2M6642	1671	66	42	2 7/8
		EVPHSG2M6648	1807	66	48	2 7/8

**EVPHSG - RECEPTION PANEL LAMINATE**

- Reception panel incorporates glazed module and pass thru module within steel frame. Glazing is clear only.
- 6" H pass thru with sliding glass door module.
- 30" H Laminate bottom module.
- Aluminum low profile top is included.
- Stackability: Evolve panels can be increased in height in 6", 12", 24" increments. See module listing for part numbers.

	DESCRIPTION	PRODUCT CODE	LIST PRICE	DIMENSIONS/INCHES		
				H	W	D
	Reception Panel with 6" H Pass Thru	EVPHSG3M6636	1604	66	36	2 7/8
		EVPHSG3M6642	1724	66	42	2 7/8
		EVPHSG3M6648	1888	66	48	2 7/8

**EVPHSG - RECEPTION PANEL LAMINATE**

- Reception panel incorporates glazed module and pass thru module within steel frame. Glazing is clear only.
- 6" H or 12" H pass thru with sliding glass door module.
- 24" H Laminate bottom module.
- Aluminum low profile top is included.
- Stackability: Evolve panels can be increased in height in 6", 12", 24" increments. See module listing for part numbers.

	DESCRIPTION	PRODUCT CODE	LIST PRICE	DIMENSIONS/INCHES		
				H	W	D
	Reception Panel with 6" H Pass Thru	EVPHSG5M6636	1581	66	36	2 7/8
		EVPHSG5M6642	1707	66	42	2 7/8
		EVPHSG5M6648	1843	66	48	2 7/8

# PANELS

# RECEPTION

## EVPHSG - RECEPTION PANEL FABRIC

- Reception panel incorporates glazed module and pass thru module within steel frame. Glazing is clear only.
- 6" H or 12" H pass thru with sliding glass door module.
- 24" H Fabric bottom module.
- Aluminum low profile top is included.
- Stackability: Evolve panels can be increased in height in 6", 12", 24" increments. See module listing for part numbers.

	DESCRIPTION	PRODUCT CODE	LIST PRICE		DIMENSIONS/INCHES		
			Gr1	Gr2	H	W	D
	Reception Panel with 12" H Pass Thru	EVPHSG2M6636	1382	1412	66	36	2 7/8
		EVPHSG2M6642	1522	1560	66	42	2 7/8
		EVPHSG2M6648	1676	1714	66	48	2 7/8

## EVPHSG - RECEPTION PANEL FABRIC

- Reception panel incorporates glazed module and pass thru module within steel frame. Glazing is clear only.
- 6" H pass thru with sliding glass door module.
- 30" H Fabric bottom module.
- Aluminum low profile top is included.
- Stackability: Evolve panels can be increased in height in 6", 12", 24" increments. See module listing for part numbers.

	DESCRIPTION	PRODUCT CODE	LIST PRICE		DIMENSIONS/INCHES		
			Gr1	Gr2	H	W	D
	Reception Panel with 6" H Pass Thru	EVPHSG3M6636	1458	1490	66	36	2 7/8
		EVPHSG3M6642	1589	1627	66	42	2 7/8
		EVPHSG3M6648	1724	1762	66	48	2 7/8

## EVPHSG - RECEPTION PANEL FABRIC

- Reception panel incorporates glazed module and pass thru module within steel frame. Glazing is clear only.
- 6" H or 12" H pass thru with sliding glass door module.
- 24" H Fabric bottom module.
- Aluminum low profile top is included.
- Stackability: Evolve panels can be increased in height in 6", 12", 24" increments. See module listing for part numbers.

	DESCRIPTION	PRODUCT CODE	LIST PRICE		DIMENSIONS/INCHES		
			Gr1	Gr2	H	W	D
	Reception Panel with 6" H Pass Thru	EVPHSG5M6636	1405	1437	66	36	2 7/8
		EVPHSG5M6642	1565	1601	66	42	2 7/8
		EVPHSG5M6648	1722	1760	66	48	2 7/8

## EVSL - LAMINATED SHELF FOR RECEPTION PANEL

- Laminated Wood Shelf Panel Mounted.
- Shelf thickness 1".
- Available in LP.
- Includes attachment hardware.

	DESCRIPTION	PRODUCT CODE	LIST PRICE	DIMENSIONS/INCHES		
				H	W	D
	Reception Panel Shelf	EVSL1218	277	1.125	18	12
		EVSL1224	297	1.125	24	12
		EVSL1230	315	1.125	30	12
		EVSL1236	335	1.125	36	12
		EVSL1242	354	1.125	42	12
		EVSL1248	374	1.125	48	12

# PANELS

# PASS - THRU

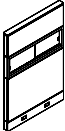
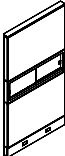
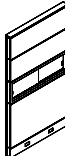

## EVPFSG - PASS-THRU SLIDING DOOR GLAZED PANEL - TEMPERED GLASS

- Pass-Thru Sliding Door Glazed Panel incorporates fabric modules on upper and lower positions, with Middle 12"H Pass-Thru Sliding Door module, into a solid steel frame.
- Tracks for Sliding glass door available in Tungsten only.
- Opposite sides of each panel may have a different fabric within the same grade at no upcharge.
- If different grades of fabric are used on one panel, the entire panel must be priced at highest grade.
- An aluminum low profile top cap is included.
- Stackability: Evolve panels can be increased in height in 6"H, 12"H, 18"H or 24"H increments. See Extension Modules for part numbers.
- Standard in clear (CLR) glass.
- Frosted glass (FRST) 20% upcharge.

	DESCRIPTION	PRODUCT CODE	LIST PRICE		DIMENSIONS/INCHES		
			Gr1	Gr2	H	W	D
	Pass-Thru Sliding Door Glazed Panel - Tempered Glass - 54" High	EVPFSG5424	768	802	54	24	2 7/8
		EVPFSG5430	867	909	54	30	2 7/8
		EVPFSG5436	975	1025	54	36	2 7/8
		EVPFSG5442	1094	1149	54	42	2 7/8
		EVPFSG5448	1189	1248	54	48	2 7/8
		EVPFSG5454	1334	1401	54	54	2 7/8
		EVPFSG5460	1474	1547	54	60	2 7/8
	Pass-Thru Sliding Door Glazed Panel - Tempered Glass - 66" High	EVPFSG6624	830	877	66	24	2 7/8
		EVPFSG6630	947	1000	66	30	2 7/8
		EVPFSG6636	1059	1123	66	36	2 7/8
		EVPFSG6642	1197	1266	66	42	2 7/8
		EVPFSG6648	1298	1377	66	48	2 7/8
		EVPFSG6654	1450	1537	66	54	2 7/8
		EVPFSG6660	1632	1693	66	60	2 7/8
	Pass-Thru Sliding Door Glazed Panel - Tempered Glass - 66" High	EVPPFSG6624	830	877	66	24	2 7/8
		EVPPFSG6630	947	1000	66	30	2 7/8
		EVPPFSG6636	1059	1123	66	36	2 7/8
		EVPPFSG6642	1197	1266	66	42	2 7/8
		EVPPFSG6648	1298	1377	66	48	2 7/8
		EVPPFSG6654	1450	1537	66	54	2 7/8
		EVPPFSG6660	1632	1693	66	60	2 7/8

**EVPFSGX - FABRIC GLAZED PASS-THRU SLIDING DOOR PANEL - TEMPERED GLASS**

- Pass-Thru Sliding Door Glazed Panel incorporates fabric modules with 12”H or 24”H Pass-Thru Sliding Door module, into a solid steel frame.
- Tracks for Sliding glass door available in Tungsten only.
- Opposite sides of each panel may have a different fabric within the same grade at no upcharge.
- If different grades of fabric are used on one panel, the entire panel must be priced at highest grade.
- An aluminum low profile top cap is included.
- Stackability: Evolve panels can be increased in height in 6”H, 12”H, 18”H or 24”H increments. See Extension Modules for part numbers.
- Standard in clear (CLR) glass.
- Frosted glass (FRST) 20% upcharge.

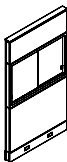

	DESCRIPTION	PRODUCT CODE	LIST PRICE		DIMENSIONS/INCHES		
			Gr1	Gr2	H	W	D
	Fabric Glazed Pass-Thru Sliding Door Panel - Tempered Glass - 42” High	EVPFSGX4224	595	621	42	24	2 7/8
		EVPFSGX4230	674	702	42	30	2 7/8
		EVPFSGX4236	752	786	42	36	2 7/8
		EVPFSGX4242	835	873	42	42	2 7/8
		EVPFSGX4248	914	955	42	48	2 7/8
		EVPFSGX4254	1021	1065	42	54	2 7/8
		EVPFSGX4260	1127	1177	42	60	2 7/8
	Fabric Glazed Pass-Thru Sliding Door Panel - Tempered Glass - 54” High	EVPFSGX5424	647	673	54	24	2 7/8
		EVPFSGX5430	752	781	54	30	2 7/8
		EVPFSGX5436	852	886	54	36	2 7/8
		EVPFSGX5442	952	988	54	42	2 7/8
		EVPFSGX5448	1038	1079	54	48	2 7/8
		EVPFSGX5454	1203	1247	54	54	2 7/8
		EVPFSGX5460	1366	1419	54	60	2 7/8
	Fabric Glazed Pass-Thru Sliding Door Panel - Tempered Glass - 66” High	EVPFSGX6624	821	857	66	24	2 7/8
		EVPFSGX6630	947	988	66	30	2 7/8
		EVPFSGX6636	1078	1126	66	36	2 7/8
		EVPFSGX6642	1211	1268	66	42	2 7/8
		EVPFSGX6648	1316	1377	66	48	2 7/8
		EVPFSGX6654	1513	1580	66	54	2 7/8
		EVPFSGX6660	1712	1783	66	60	2 7/8

# PANELS

# SLATWALL

## EVPF1S - SLATWALL PANEL - SINGLE SIDED

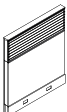
- Slatwall Panel incorporates fabric modules with a single 12”H or 24”H top position slatwall module, into a solid steel frame.
- 66”H panel can be configured with either a 24”H slatwall module at the top or a 12”H slatwall at the middle Position (EVPF1S66xxM)
- Opposite side is fabric covered.
- Slatwall is made of aluminum.
- Accessories can be used on slatwall modules. Please see accessory section for additional details.
- Opposite sides of each panel may have a different fabric within the same grade at no upcharge.
- If different grades of fabric are used on one panel, the entire panel must be priced at highest grade.
- An aluminum low profile top cap is included.
- Stackability: Evolve panels can be increased in height in 6”H, 12”H, 18”H or 24”H increments. See Extension Modules for part numbers.

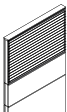
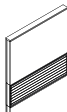
	DESCRIPTION	PRODUCT CODE	LIST PRICE		DIMENSIONS/INCHES		
			Gr1	Gr2	H	W	D
	Slatwall Panel - Single Sided - 42” High	EVPF1S4218	562	588	42	18	2 7/8
		EVPF1S4224	670	702	42	24	2 7/8
		EVPF1S4230	786	820	42	30	2 7/8
		EVPF1S4236	898	937	42	36	2 7/8
		EVPF1S4242	1021	1065	42	42	2 7/8
		EVPF1S4248	1110	1162	42	48	2 7/8
		EVPF1S4254	1233	1288	42	54	2 7/8
		EVPF1S4260	1349	1412	42	60	2 7/8
	Slatwall Panel - Single Sided - 54” High	EVPF1S5418	662	689	54	18	2 7/8
		EVPF1S5424	797	831	54	24	2 7/8
		EVPF1S5430	930	971	54	30	2 7/8
		EVPF1S5436	1070	1117	54	36	2 7/8
		EVPF1S5442	1209	1266	54	42	2 7/8
		EVPF1S5448	1318	1381	54	48	2 7/8
		EVPF1S5454	1469	1536	54	54	2 7/8
		EVPF1S5460	1615	1682	54	60	2 7/8
	Slatwall Panel - Single Sided - 66” High	EVPF1S6618	840	869	66	18	2 7/8
		EVPF1S6624	1008	1056	66	24	2 7/8
		EVPF1S6630	1182	1237	66	30	2 7/8
		EVPF1S6636	1362	1419	66	36	2 7/8
		EVPF1S6642	1548	1618	66	42	2 7/8
		EVPF1S6648	1684	1754	66	48	2 7/8
		EVPF1S6654	1875	1950	66	54	2 7/8
		EVPF1S6660	2066	2148	66	60	2 7/8
	Slat Wall Panel - Single Sided - Middle Module - 66” High	EVPF1S6618M	819	858	66	18	2 7/8
		EVPF1S6624M	985	1035	66	24	2 7/8
		EVPF1S6630M	1149	1208	66	30	2 7/8
		EVPF1S6636M	1322	1392	66	36	2 7/8
		EVPF1S6642M	1505	1584	66	42	2 7/8
		EVPF1S6648M	1639	1727	66	48	2 7/8
		EVPF1S6654M	1822	1920	66	54	2 7/8
		EVPF1S6660M	2005	2114	66	60	2 7/8

# PANELS

# SLATWALL

## EVPLF1S - SLATWALL LIGHT PANEL - SINGLE SIDED

- Slatwall Light Panel incorporates fabric modules with a single 12”H or 24”H top position slatwall module, into a solid steel frame.
- 66”H panel can be configured with either a 24”H slatwall module at the top or a 12”H slatwall at the middle Position (EVPLF1S66xxM)
- Opposite side is fabric covered
- Slatwall is made of aluminum.
- Accessories can be used on slatwall modules. Please see accessory section for additional details.
- There is no base raceway in Light Panels to accommodate electrical.
- Light Panel Connectors must be used in conjunction with Light Panels.
- Opposite sides of each panel may have a different fabric within the same grade at no upcharge.
- If different grades of fabric are used on one panel, the entire panel must be priced at highest grade.
- An aluminum low profile top cap is included.
- Stackability: Evolve panels can be increased in height in 6”H, 12”H, 18”H or 24”H increments. See Extension Modules for part numbers.

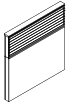
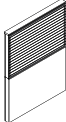
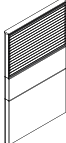
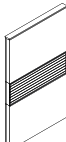
	DESCRIPTION	PRODUCT CODE	LIST PRICE		DIMENSIONS/INCHES		
			Gr1	Gr2	H	W	D
	Slatwall Light Panel - Single Sided- 42” High	EVPLF1S4218	549	575	42	18	2 7/8
		EVPLF1S4224	656	688	42	24	2 7/8
		EVPLF1S4230	769	803	42	30	2 7/8
		EVPLF1S4236	882	920	42	36	2 7/8
		EVPLF1S4242	998	1042	42	42	2 7/8
		EVPLF1S4248	1089	1139	42	48	2 7/8
		EVPLF1S4254	1206	1261	42	54	2 7/8
	EVPLF1S4260	1322	1385	42	60	2 7/8	
	Slatwall Light Panel - Single Sided - 54” High	EVPLF1S5418	648	674	54	18	2 7/8
		EVPLF1S5424	782	815	54	24	2 7/8
		EVPLF1S5430	914	955	54	30	2 7/8
		EVPLF1S5436	1047	1094	54	36	2 7/8
		EVPLF1S5442	1185	1240	54	42	2 7/8
		EVPLF1S5448	1295	1356	54	48	2 7/8
		EVPLF1S5454	1440	1506	54	54	2 7/8
	EVPLF1S5460	1583	1649	54	60	2 7/8	
	Slatwall Light Panel - Single Sided - 66” High	EVPLF1S6618	824	853	66	18	2 7/8
		EVPLF1S6624	988	1035	66	24	2 7/8
		EVPLF1S6630	1157	1210	66	30	2 7/8
		EVPLF1S6636	1334	1391	66	36	2 7/8
		EVPLF1S6642	1517	1586	66	42	2 7/8
		EVPLF1S6648	1648	1718	66	48	2 7/8
		EVPLF1S6654	1834	1909	66	54	2 7/8
	EVPLF1S6660	2025	2106	66	60	2 7/8	
	Slatwall Light Panel - Single Sided - Middle Module - 66” High	EVPLF1S6618M	800	838	66	18	2 7/8
		EVPLF1S6624M	966	1014	66	24	2 7/8
		EVPLF1S6630M	1127	1184	66	30	2 7/8
		EVPLF1S6636M	1298	1367	66	36	2 7/8
		EVPLF1S6642M	1475	1554	66	42	2 7/8
		EVPLF1S6648M	1605	1692	66	48	2 7/8
		EVPLF1S6654M	1786	1883	66	54	2 7/8
	EVPLF1S6660M	1964	2068	66	60	2 7/8	

# PANELS

# SLATWALL

## EVPF2S - SLATWALL PANEL - DOUBLE SIDED

- Slatwall Panel incorporates fabric modules with a single 12"H or 24"H top position slatwall module, into a solid steel frame.
- 66"H panel can be configured with either a 24"H slatwall module at the top or a 12"H slatwall at the middle Position (EVPF2S66xxM)
- Slatwall module has slatwall on both sides.
- Slatwall is made of aluminum.
- Accessories can be used on slatwall modules. Please see accessory section for additional details.
- Opposite sides of each panel may have a different fabric within the same grade at no upcharge.
- If different grades of fabric are used on one panel, the entire panel must be priced at highest grade.
- An aluminum low profile top cap is included.
- Stackability: Evolve panels can be increased in height in 6"H, 12"H, 18"H or 24"H increments. See Extension Modules for part numbers.

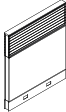
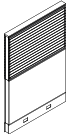
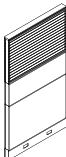
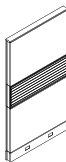

	DESCRIPTION	PRODUCT CODE	LIST PRICE		DIMENSIONS/INCHES		
			Gr1	Gr2	H	W	D
	Slatwall Panel - Double Sided - 42" High	EVPF2S4218	630	650	42	18	2 7/8
		EVPF2S4224	760	787	42	24	2 7/8
		EVPF2S4230	894	923	42	30	2 7/8
		EVPF2S4236	1043	1077	42	36	2 7/8
		EVPF2S4242	1189	1227	42	42	2 7/8
		EVPF2S4248	1331	1372	42	48	2 7/8
		EVPF2S4254	1465	1509	42	54	2 7/8
		EVPF2S4260	1593	1646	42	60	2 7/8
	Slatwall Panel - Double Sided - 54" High	EVPF2S5418	735	755	54	18	2 7/8
		EVPF2S5424	899	926	54	24	2 7/8
		EVPF2S5430	1062	1091	54	30	2 7/8
		EVPF2S5436	1240	1274	54	36	2 7/8
		EVPF2S5442	1418	1456	54	42	2 7/8
		EVPF2S5448	1592	1633	54	48	2 7/8
		EVPF2S5454	1751	1795	54	54	2 7/8
		EVPF2S5460	1906	1958	54	60	2 7/8
	Slatwall Panel - Double Sided - 66" High	EVPF2S6618	952	978	66	18	2 7/8
		EVPF2S6624	1171	1207	66	24	2 7/8
		EVPF2S6630	1386	1427	66	30	2 7/8
		EVPF2S6636	1609	1656	66	36	2 7/8
		EVPF2S6642	1842	1897	66	42	2 7/8
		EVPF2S6648	2066	2125	66	48	2 7/8
		EVPF2S6654	2281	2345	66	54	2 7/8
		EVPF2S6660	2488	2562	66	60	2 7/8
	Slatwall Panel - Double Sided - Middle Module - 66" High	EVPF2S6618M	927	963	66	18	2 7/8
		EVPF2S6624M	1138	1185	66	24	2 7/8
		EVPF2S6630M	1349	1402	66	30	2 7/8
		EVPF2S6636M	1566	1625	66	36	2 7/8
		EVPF2S6642M	1788	1857	66	42	2 7/8
		EVPF2S6648M	2005	2085	66	48	2 7/8
		EVPF2S6654M	2218	2305	66	54	2 7/8
		EVPF2S6660M	2422	2517	66	60	2 7/8

# PANELS

# SLATWALL

## EVPLF2S - SLATWALL LIGHT PANEL - DOUBLE SIDED

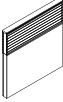
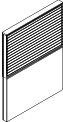
- Slatwall Light Panel incorporates fabric modules with a single 12"H or 24"H top position slatwall module, into a solid steel frame.
- 66"H panel can be configured with either a 24"H slatwall module at the top or a 12"H slatwall at the middle Position (EVPLF2S66xxM)
- Slatwall module has slatwall on both sides.
- Slatwall is made of aluminum.
- Accessories can be used on slatwall modules. Please see accessory section for additional details.
- There is no base raceway in Light Panels to accommodate electrical.
- Light Panel Connectors must be used in conjunction with Light Panels.
- Opposite sides of each panel may have a different fabric within the same grade at no upcharge.
- If different grades of fabric are used on one panel, the entire panel must be priced at highest grade.
- An aluminum low profile top cap is included.
- Stackability: Evolve panels can be increased in height in 6"H, 12"H, 18"H or 24"H increments.
- See Extension Modules for part numbers.

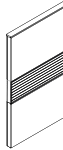
	DESCRIPTION	PRODUCT CODE	LIST PRICE		DIMENSIONS/INCHES		
			Gr1	Gr2	H	W	D
	Slatwall Light Panel - Double Sided - 42" High	EVPLF2S4218	617	635	42	18	2 7/8
		EVPLF2S4224	745	771	42	24	2 7/8
		EVPLF2S4230	879	906	42	30	2 7/8
		EVPLF2S4236	1023	1057	42	36	2 7/8
		EVPLF2S4242	1165	1203	42	42	2 7/8
		EVPLF2S4248	1305	1344	42	48	2 7/8
		EVPLF2S4254	1435	1477	42	54	2 7/8
		EVPLF2S4260	1559	1612	42	60	2 7/8
	Slatwall Light Panel - Double Sided - 54" High	EVPLF2S5418	722	740	54	18	2 7/8
		EVPLF2S5424	885	908	54	24	2 7/8
		EVPLF2S5430	1043	1071	54	30	2 7/8
		EVPLF2S5436	1215	1248	54	36	2 7/8
		EVPLF2S5442	1387	1423	54	42	2 7/8
		EVPLF2S5448	1558	1599	54	48	2 7/8
		EVPLF2S5454	1717	1759	54	54	2 7/8
		EVPLF2S5460	1869	1921	54	60	2 7/8
	Slatwall Light Panel - Double Sided - 66" High	EVPLF2S6618	934	961	66	18	2 7/8
		EVPLF2S6624	1148	1184	66	24	2 7/8
		EVPLF2S6630	1362	1401	66	30	2 7/8
		EVPLF2S6636	1577	1624	66	36	2 7/8
		EVPLF2S6642	1806	1859	66	42	2 7/8
		EVPLF2S6648	2025	2082	66	48	2 7/8
		EVPLF2S6654	2233	2297	66	54	2 7/8
		EVPLF2S6660	2440	2511	66	60	2 7/8
	Slatwall Light Panel - Double Sided - 66" High	EVPLF2S6618M	899	941	66	18	2 7/8
		EVPLF2S6624M	1115	1162	66	24	2 7/8
		EVPLF2S6630M	1322	1375	66	30	2 7/8
		EVPLF2S6636M	1534	1592	66	36	2 7/8
		EVPLF2S6642M	1753	1820	66	42	2 7/8
		EVPLF2S6648M	1964	2039	66	48	2 7/8
		EVPLF2S6654M	2173	2260	66	54	2 7/8
		EVPLF2S6660M	2375	2470	66	60	2 7/8

# PANELS

# SLATWALL

## EVPBSFA - FRAMELESS SLATWALL BELTLINE POWERED PANEL - DOUBLE SIDED ONLY

- Frameless Slatwall Beltline Powered Panel incorporates fabric modules with a single 6”H slatwall module above a power beltline raceway, into a solid steel frame.
- Slatwall module has slatwall on both sides only, and is not available Single Sided.
- Slatwall is made of aluminum.
- Slatwall is not encompassed within a frame.
- A Chimney Panel is required to run electric and data from the base to belt
- 6”H power beltline raceway, to accommodate electrical, is metal with knockouts on both sides.
- Beltline Connectors must be used in conjunction with beltline panels.
- Accessories can be used on slatwall modules. Please see accessory section for additional details.
- Opposite sides of each panel may have a different fabric within the same grade at no upcharge.
- If different grades of fabric are used on one panel, the entire panel must be priced at highest grade.
- An aluminum low profile top cap is included.
- Stackability: Evolve panels can be increased in height in 6”H, 12”H, 18”H or 24”H increments. See Extension Modules for part numbers.

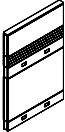
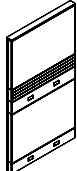

	DESCRIPTION	PRODUCT CODE	LIST PRICE		DIMENSIONS/INCHES		
			Gr1	Gr2	H	W	D
	Frameless Slatwall Beltline Powered Panel - Double Sided Only - 42” High	EVPBSFA4224	557	583	42	24	2 7/8
		EVPBSFA4230	648	675	42	30	2 7/8
		EVPBSFA4236	756	788	42	36	2 7/8
		EVPBSFA4242	850	888	42	42	2 7/8
		EVPBSFA4248	936	977	42	48	2 7/8
		EVPBSFA4254	1029	1073	42	54	2 7/8
		EVPBSFA4260	1118	1168	42	60	2 7/8
	Frameless Slatwall Beltline Powered Panel - Double Sided Only - 54” High	EVPBSFA5424	703	737	54	24	2 7/8
		EVPBSFA5430	819	860	54	30	2 7/8
		EVPBSFA5436	966	1013	54	36	2 7/8
		EVPBSFA5442	1080	1133	54	42	2 7/8
		EVPBSFA5448	1189	1250	54	48	2 7/8
		EVPBSFA5454	1292	1359	54	54	2 7/8
		EVPBSFA5460	1406	1479	54	60	2 7/8
	Frameless Slatwall Beltline Powered Panel - Double Sided Only - 66” High	EVPBSFA6624	785	827	66	24	2 7/8
		EVPBSFA6630	909	964	66	30	2 7/8
		EVPBSFA6636	1050	1111	66	36	2 7/8
		EVPBSFA6642	1180	1250	66	42	2 7/8
		EVPBSFA6648	1302	1381	66	48	2 7/8
		EVPBSFA6654	1427	1514	66	54	2 7/8
		EVPBSFA6660	1550	1644	66	60	2 7/8

# PANELS

# SLATWALL

## EVPBLSFA - FRAMELESS SLATWALL BELTLINE POWERED LIGHT PANEL - DOUBLE SIDED ONLY

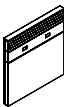
- Frameless Slatwall Beltline Powered Light Panel incorporates fabric modules with a single 6”H slatwall module above a power beltline raceway, into a solid steel frame.
- Slatwall module has slatwall on both sides only, and is not available Single Sided.
- Slatwall is made of aluminum.
- Slatwall is not encompassed within a frame.
- 6”H power beltline raceway, to accommodate electrical, is metal with knockouts on both sides.
- There is no base raceway in Light Panels to accommodate electrical.
- Light Beltline Panel Connectors must be used in conjunction with Light Beltline Panels.
- Accessories can be used on slatwall modules. Please see accessory section for additional details.
- Opposite sides of each panel may have a different fabric within the same grade at no upcharge.
- If different grades of fabric are used on one panel, the entire panel must be priced at highest grade.
- An aluminum low profile top cap is included.
- Stackability: Evolve panels can be increased in height in 6”H, 12”H, 18”H or 24”H increments. See Extension Modules for part numbers.

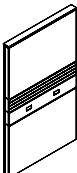
	DESCRIPTION	PRODUCT CODE	LIST PRICE		DIMENSIONS/INCHES		
			Gr1	Gr2	H	W	D
	Frameless Slatwall Beltline Powered Light Panel - Double Sided Only- 42” High	EVPBLSFA4224	532	558	42	24	2 7/8
		EVPBLSFA4230	617	645	42	30	2 7/8
		EVPBLSFA4236	722	754	42	36	2 7/8
		EVPBLSFA4242	806	842	42	42	2 7/8
		EVPBLSFA4248	893	934	42	48	2 7/8
		EVPBLSFA4254	984	1028	42	54	2 7/8
		EVPBLSFA4260	1069	1117	42	60	2 7/8
	Frameless Slatwall Beltline Powered Light Panel - Double Sided Only- 54” High	EVPBLSFA5424	654	688	54	24	2 7/8
		EVPBLSFA5430	714	801	54	30	2 7/8
		EVPBLSFA5436	852	946	54	36	2 7/8
		EVPBLSFA5442	1006	1059	54	42	2 7/8
		EVPBLSFA5448	1107	1168	54	48	2 7/8
		EVPBLSFA5454	1201	1267	54	54	2 7/8
		EVPBLSFA5460	1310	1381	54	60	2 7/8
	Frameless Slatwall Beltline Powered Light Panel - Double Sided Only - 66” High	EVPBLSFA6624	726	767	66	24	2 7/8
		EVPBLSFA6630	839	894	66	30	2 7/8
		EVPBLSFA6636	974	1035	66	36	2 7/8
		EVPBLSFA6642	1090	1161	66	42	2 7/8
		EVPBLSFA6648	1203	1282	66	48	2 7/8
		EVPBLSFA6654	1321	1407	66	54	2 7/8
		EVPBLSFA6660	1435	1529	66	60	2 7/8

# PANELS

# SLATWALL

## EVPBCSFA - FRAMELESS SLATWALL BELTLINE POWERED CHIMNEY PANEL - DOUBLE SIDED ONLY

- Frameless Slatwall Beltline Powered Chimney Panel incorporates fabric modules with a single 6”H slatwall module above a power beltline raceway, into a solid steel frame.
- Slatwall module has slatwall on both sides only, and is not available Single Sided.
- Slatwall is made of aluminum.
- Slatwall is not encompassed within a frame.
- A Chimney Panel is required to run electric and data from the base to belt.
- Separate electric harness required to go from base to belt (see EVE8CPCP).
- 6”H power beltline raceway, to accommodate electrical, is metal with knockouts on both sides.
- Beltline Connectors must be used in conjunction with beltline panels.
- Accessories can be used on slatwall modules. Please see accessory section for additional details.
- Opposite sides of each panel may have a different fabric within the same grade at no upcharge.
- If different grades of fabric are used on one panel, the entire panel must be priced at highest grade.
- An aluminum low profile top cap is included.
- Stackability: Evolve panels can be increased in height in 6”H, 12”H, 18”H or 24”H increments. See Extension Modules for part numbers.

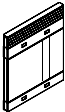
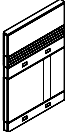
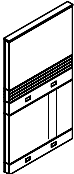
	DESCRIPTION	PRODUCT CODE	LIST PRICE		DIMENSIONS/INCHES		
			Gr1	Gr2	H	W	D
	Frameless Slatwall Beltline Powered -	EVPBCSFA4236	835	867	42	36	2 7/8
	Chimney Panel - Double Sided Only - 42” High	EVPBCSFA4242	929	967	42	42	2 7/8
	Frameless Slatwall Beltline Powered -	EVPBCSFA5436	1047	1094	54	36	2 7/8
	Chimney Panel - Double Sided Only - 54” High	EVPBCSFA5442	1161	1214	54	42	2 7/8
	Frameless Slatwall Beltline Powered -	EVPBCSFA6636	1134	1195	66	36	2 7/8
	Chimney Panel - Double Sided Only - 66” High	EVPBCSFA6642	1259	1329	66	42	2 7/8

## EVE8CPCP - CHIMNEY PANEL JUMPER CABLE KIT

- Contains two (2) 17” flexible harnesses and one (1) “I” connector.
- Used to connect electric from the base to the beltline raceway in Beltline Powered Chimney panel.
- Must use in conjunction with base power distribution harness and beltline power distribution harness (sold separately)

	DESCRIPTION	PRODUCT CODE	LIST PRICE	DIMENSIONS/INCHES		
				H	W	D

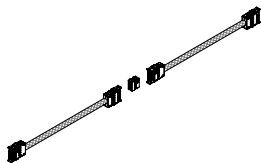



Chimney Panel Jumper Cable Kit	EVE8CPCP	365
--------------------------------	----------	-----

# PANELS

# WRITE BOARD



## EVPF1W - WRITE BOARD PANEL - SINGLE SIDED

- Write Board Panel incorporates fabric modules with a single 24"H top position write board module, into a solid steel frame.
- Use erasable writeboard markers only.
- Fabric covered modules are tackable and acoustical.
- Opposite sides of each panel may have a different fabric within the same grade at no upcharge.
- If different grades of fabric are used on one panel, the entire panel must be priced at highest grade.
- An aluminum low profile top cap is included.
- Stackability: Evolve panels can be increased in height in 6"H, 12"H, 18"H or 24"H increments. See Extension Modules for part numbers.

	DESCRIPTION	PRODUCT CODE	LIST PRICE		DIMENSIONS/INCHES		
			Gr1	Gr2	H	W	D
	Write Board Panel - Single Sided - 54" High	EVPF1W5418	548	568	54	18	2 7/8
		EVPF1W5424	679	713	54	24	2 7/8
		EVPF1W5430	820	861	54	30	2 7/8
		EVPF1W5436	907	955	54	36	2 7/8
		EVPF1W5442	1021	1076	54	42	2 7/8
		EVPF1W5448	1150	1211	54	48	2 7/8
		EVPF1W5454	1278	1322	54	54	2 7/8
		EVPF1W5460	1408	1479	54	60	2 7/8
	Write Board Panel - Single Sided - 66" High	EVPF1W6618	695	724	66	18	2 7/8
		EVPF1W6624	856	900	66	24	2 7/8
		EVPF1W6630	1017	1069	66	30	2 7/8
		EVPF1W6636	1133	1196	66	36	2 7/8
		EVPF1W6642	1279	1349	66	42	2 7/8
		EVPF1W6648	1429	1508	66	48	2 7/8
		EVPF1W6654	1588	1679	66	54	2 7/8
		EVPF1W6660	1752	1849	66	60	2 7/8

## EVPLF1W - WRITE BOARD LIGHT PANEL - SINGLE SIDED

- Write Board Panel incorporates fabric modules with a single 24"H top position write board module, into a solid steel frame.
- Use erasable writeboard markers only.
- Fabric covered modules are tackable and acoustical.
- Opposite sides of each panel may have a different fabric within the same grade at no upcharge.
- If different grades of fabric are used on one panel, the entire panel must be priced at highest grade.
- Light panel connectors must be used for Light Panels.
- There is no base raceway in Light Panels to accommodate electrical.
- An aluminum low profile top cap is included.
- Stackability: Evolve panels can be increased in height in 6"H, 12"H, 18"H or 24"H increments. See Extension Modules for part numbers.



	DESCRIPTION	PRODUCT CODE	LIST PRICE		DIMENSIONS/INCHES		
			Gr1	Gr2	H	W	D
	Write Board Light Panel - Single Sided - 54" High	EVPLF1W5418	532	553	54	18	2 7/8
		EVPLF1W5424	659	693	54	18	2 7/8
		EVPLF1W5430	796	835	54	18	2 7/8
		EVPLF1W5436	880	924	54	18	2 7/8
		EVPLF1W5442	988	1041	54	18	2 7/8
		EVPLF1W5448	1115	1174	54	18	2 7/8
		EVPLF1W5454	1242	1283	54	18	2 7/8
		EVPLF1W5460	1366	1436	54	18	2 7/8
	Write Board Light Panel - Single Sided - 66" High	EVPLF1W6618	677	704	66	18	2 7/8
		EVPLF1W6624	830	872	66	24	2 7/8
		EVPLF1W6630	985	1035	66	30	2 7/8
		EVPLF1W6636	1094	1155	66	36	2 7/8
		EVPLF1W6642	1243	1310	66	42	2 7/8
		EVPLF1W6648	1385	1460	66	48	2 7/8
		EVPLF1W6654	1538	1626	66	54	2 7/8
		EVPLF1W6660	1699	1794	66	60	2 7/8

# PANELS

# WRITE BOARD



## EVPF2W - WRITE BOARD PANEL - DOUBLE SIDED

- Write Board Panel incorporates fabric modules with a single 24”H top position write board module, into a solid steel frame.
- Use erasable writeboard markers only.
- Opposite sides of each panel may have a different fabric within the same grade at no upcharge.
- If different grades of fabric are used on one panel, the entire panel must be priced at highest grade.
- An aluminum low profile top cap is included.
- Stackability: Evolve panels can be increased in height in 6”H, 12”H, 18”H or 24”H increments. See Extension Modules for part numbers.

	DESCRIPTION	PRODUCT CODE	LIST PRICE		DIMENSIONS/INCHES		
			Gr1	Gr2	H	W	D
	Write Board Panel - Double Sided - 54” High	EVPF2W5418	593	613	54	18	2 7/8
		EVPF2W5424	742	763	54	24	2 7/8
		EVPF2W5430	925	953	54	30	2 7/8
		EVPF2W5436	998	1032	54	36	2 7/8
		EVPF2W5442	1134	1172	54	42	2 7/8
		EVPF2W5448	1326	1367	54	48	2 7/8
		EVPF2W5454	1472	1516	54	54	2 7/8
		EVPF2W5460	1622	1675	54	60	2 7/8
	Write Board Panel - Double Sided - 66” High	EVPF2W6618	736	763	66	18	2 7/8
		EVPF2W6624	917	951	66	24	2 7/8
		EVPF2W6630	1122	1164	66	30	2 7/8
		EVPF2W6636	1227	1275	66	36	2 7/8
		EVPF2W6642	1388	1443	66	42	2 7/8
		EVPF2W6648	1598	1656	66	48	2 7/8
		EVPF2W6654	1783	1850	66	54	2 7/8
		EVPF2W6660	1964	2037	66	60	2 7/8

## EVPLF2W - WRITE BOARD LIGHT PANEL - DOUBLE SIDED

- Write Board Light Panel incorporates fabric modules with a single 24”H top position write board module, into a solid steel frame.
- Use erasable writeboard markers only.
- There is no base raceway in Light Panels to accommodate electrical.
- Light Panel Connectors must be used in conjunction with Light Panels.
- Opposite sides of each panel may have a different fabric within the same grade at no upcharge.
- If different grades of fabric are used on one panel, the entire panel must be priced at highest grade.
- An aluminum low profile top cap is included.
- Stackability: Evolve panels can be increased in height in 6”H, 12”H, 18”H or 24”H increments. See Extension Modules for part numbers.

	DESCRIPTION	PRODUCT CODE	LIST PRICE		DIMENSIONS/INCHES		
			Gr1	Gr2	H	W	D
	Write Board Light Panel - Double Sided - 54” High	EVPLF2W5418	575	592	54	18	2 7/8
		EVPLF2W5424	721	742	54	18	2 7/8
		EVPLF2W5430	894	922	54	18	2 7/8
		EVPLF2W5436	972	1005	54	18	2 7/8
		EVPLF2W5442	1098	1136	54	18	2 7/8
		EVPLF2W5448	1283	1322	54	18	2 7/8
		EVPLF2W5454	1428	1472	54	18	2 7/8
		EVPLF2W5460	1573	1623	54	18	2 7/8
	Write Board Light Panel - Double Sided - 66” High	EVPLF2W6618	715	741	66	18	2 7/8
		EVPLF2W6624	889	923	66	24	2 7/8
		EVPLF2W6630	1087	1129	66	30	2 7/8
		EVPLF2W6636	1191	1238	66	36	2 7/8
		EVPLF2W6642	1349	1402	66	42	2 7/8
		EVPLF2W6648	1550	1608	66	48	2 7/8
		EVPLF2W6654	1730	1796	66	54	2 7/8
		EVPLF2W6660	1975	1975	66	60	2 7/8

# PANELS

# LAMINATE

## EVPH1S - LAMINATE PANEL - SINGLE SIDED

- Laminate Panel incorporates single sided laminate modules, into a solid steel frame.
- Opposite side is fabric covered.
- Laminate faces on all modules provide durable, washable surfaces on Single Sided of the panel.
- Available in high pressure laminate only.
- If wood grain is selected, grain runs horizontally.
- If different grades of fabric are used on one panel, the entire panel must be priced at highest grade.
- An aluminum low profile top cap is included.
- Stackability: Evolve panels can be increased in height in 6"H, 12"H, 18"H or 24"H increments. See Extension Modules for part numbers.

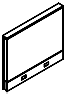
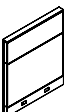
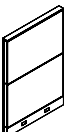
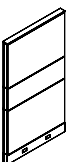

	DESCRIPTION	PRODUCT CODE	LIST PRICE		DIMENSIONS/INCHES		
			Gr1	Gr2	H	W	D
	Laminate Panel - Single Sided - 30" High	EVPH1S3018	452	463	30	18	2 7/8
		EVPH1S3024	540	554	30	24	2 7/8
		EVPH1S3030	629	646	30	30	2 7/8
		EVPH1S3036	715	734	30	36	2 7/8
		EVPH1S3042	815	832	30	42	2 7/8
		EVPH1S3048	885	903	30	48	2 7/8
		EVPH1S3054	974	997	30	54	2 7/8
		EVPH1S3060	1070	1093	30	60	2 7/8
	Laminate Panel - Single Sided - 42" High	EVPH1S4218	538	553	42	18	2 7/8
		EVPH1S4224	639	659	42	24	2 7/8
		EVPH1S4230	748	771	42	30	2 7/8
		EVPH1S4236	856	884	42	36	2 7/8
		EVPH1S4242	972	1001	42	42	2 7/8
		EVPH1S4248	1056	1088	42	48	2 7/8
		EVPH1S4254	1171	1207	42	54	2 7/8
		EVPH1S4260	1283	1322	42	60	2 7/8
	Laminate Panel - Single Sided - 54" High	EVPH1S5418	630	645	54	18	2 7/8
		EVPH1S5424	758	785	54	24	2 7/8
		EVPH1S5430	889	917	54	30	2 7/8
		EVPH1S5436	1018	1050	54	36	2 7/8
		EVPH1S5442	1153	1191	54	42	2 7/8
		EVPH1S5448	1258	1299	54	48	2 7/8
		EVPH1S5454	1399	1443	54	54	2 7/8
		EVPH1S5460	1536	1586	54	60	2 7/8
	Laminate Panel - Single Sided - 66" High	EVPH1S6618	779	802	66	18	2 7/8
		EVPH1S6624	936	968	66	24	2 7/8
		EVPH1S6630	1093	1129	66	30	2 7/8
		EVPH1S6636	1262	1303	66	36	2 7/8
		EVPH1S6642	1434	1478	66	42	2 7/8
		EVPH1S6648	1559	1611	66	48	2 7/8
		EVPH1S6654	1738	1795	66	54	2 7/8
		EVPH1S6660	1912	1973	66	60	2 7/8

# PANELS

# LAMINATE

## EVPLH1S - LAMINATE LIGHT PANEL - SINGLE SIDED

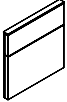
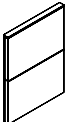
- Laminate Panel incorporates single sided laminate modules, into a solid steel frame.
- Opposite side is fabric covered.
- Laminate faces on all modules provide durable, washable surfaces on Single Sided of the panel.
- Available in high pressure laminate only.
- If wood grain is selected, grain runs horizontally.
- There is no base raceway in Light Panels to accommodate electrical.
- Light Panel Connectors must be used in conjunction with Light Panels.
- If different grades of fabric are used on one panel, the entire panel must be priced at highest grade.
- An aluminum low profile top cap is included.
- Stackability: Evolve panels can be increased in height in 6"H, 12"H, 18"H or 24"H increments. See Extension Modules for part numbers.





	DESCRIPTION	PRODUCT CODE	LIST PRICE		DIMENSIONS/INCHES		
			Gr1	Gr2	H	W	D
	Laminate Light Panel - Single Sided - 30" High	EVPLH1S3018	440	448	30	18	2 7/8
		EVPLH1S3024	526	537	30	24	2 7/8
		EVPLH1S3030	610	619	30	30	2 7/8
		EVPLH1S3036	694	713	30	36	2 7/8
		EVPLH1S3042	787	801	30	42	2 7/8
		EVPLH1S3048	858	872	30	48	2 7/8
		EVPLH1S3054	944	969	30	54	2 7/8
		EVPLH1S3060	1036	1057	30	60	2 7/8
	Laminate Light Panel - Single Sided - 42" High	EVPLH1S4218	523	537	42	18	2 7/8
		EVPLH1S4224	618	638	42	24	2 7/8
		EVPLH1S4230	725	751	42	30	2 7/8
		EVPLH1S4236	830	858	42	36	2 7/8
		EVPLH1S4242	941	970	42	42	2 7/8
		EVPLH1S4248	1027	1056	42	48	2 7/8
		EVPLH1S4254	1137	1171	42	54	2 7/8
		EVPLH1S4260	1245	1283	42	60	2 7/8
	Laminate Light Panel - Single Sided - 54" High	EVPLH1S5418	611	625	54	18	2 7/8
		EVPLH1S5424	735	761	54	24	2 7/8
		EVPLH1S5430	864	891	54	30	2 7/8
		EVPLH1S5436	986	1019	54	36	2 7/8
		EVPLH1S5442	1118	1152	54	42	2 7/8
		EVPLH1S5448	1219	1260	54	48	2 7/8
		EVPLH1S5454	1356	1400	54	54	2 7/8
		EVPLH1S5460	1490	1540	54	60	2 7/8
	Laminate Light Panel - Single Sided - 66" High	EVPLH1S6618	756	782	66	18	2 7/8
		EVPLH1S6624	909	938	66	24	2 7/8
		EVPLH1S6630	1059	1093	66	30	2 7/8
		EVPLH1S6636	1222	1261	66	36	2 7/8
		EVPLH1S6642	1388	1432	66	42	2 7/8
		EVPLH1S6648	1516	1564	66	48	2 7/8
		EVPLH1S6654	1684	1741	66	54	2 7/8
		EVPLH1S6660	1854	1915	66	60	2 7/8

# PANELS

# LAMINATE

## EVPH2S - LAMINATE PANEL - DOUBLE SIDED

- Laminate Panel incorporates double sided laminate modules, into a solid steel frame.
- Laminate faces on all modules provide durable, washable surfaces on Single Sided of the panel.
- Available in high pressure laminate only.
- If wood grain is selected, grain runs horizontally.
- If different grades of fabric are used on one panel, the entire panel must be priced at highest grade.
- An aluminum low profile top cap is included.
- Stackability: Evolve panels can be increased in height in 6"H, 12"H, 18"H or 24"H increments. See Extension Modules for part numbers.



	DESCRIPTION	PRODUCT CODE	LIST PRICE	DIMENSIONS/INCHES		
				H	W	D
	Laminate Panel - Double Sided - 30" High	EVPH2S3018	616	30	18	2 7/8
		EVPH2S3024	616	30	24	2 7/8
		EVPH2S3030	726	30	30	2 7/8
		EVPH2S3036	830	30	36	2 7/8
		EVPH2S3042	944	30	42	2 7/8
		EVPH2S3048	1053	30	48	2 7/8
		EVPH2S3054	1169	30	54	2 7/8
	EVPH2S3060	1262	30	60	2 7/8	
	Laminate Panel - Double Sided - 42" High	EVPH2S4218	598	42	18	2 7/8
		EVPH2S4224	726	42	24	2 7/8
		EVPH2S4230	855	42	30	2 7/8
		EVPH2S4236	995	42	36	2 7/8
		EVPH2S4242	1134	42	42	2 7/8
		EVPH2S4248	1268	42	48	2 7/8
		EVPH2S4254	1396	42	54	2 7/8
	EVPH2S4260	1517	42	60	2 7/8	
	Laminate Panel - Double Sided - 54" High	EVPH2S5418	701	54	18	2 7/8
		EVPH2S5424	858	54	24	2 7/8
		EVPH2S5430	1017	54	30	2 7/8
		EVPH2S5436	1181	54	36	2 7/8
		EVPH2S5442	1348	54	42	2 7/8
		EVPH2S5448	1516	54	48	2 7/8
		EVPH2S5454	1670	54	54	2 7/8
	EVPH2S5460	1816	54	60	2 7/8	
	Laminate Panel - Double Sided - 66" High	EVPH2S6618	885	66	18	2 7/8
		EVPH2S6624	1085	66	24	2 7/8
		EVPH2S6630	1283	66	30	2 7/8
		EVPH2S6636	1490	66	36	2 7/8
		EVPH2S6642	1705	66	42	2 7/8
		EVPH2S6648	1912	66	48	2 7/8
		EVPH2S6654	2109	66	54	2 7/8
	EVPH2S6660	2304	66	60	2 7/8	

# PANELS

# LAMINATE

## EVPLH2S - LAMINATE LIGHT PANEL - DOUBLE SIDED

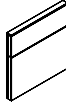
- Laminate Panel incorporates double sided laminate modules, into a solid steel frame.
- Laminate faces on all modules provide durable, washable surfaces on Single Sided of the panel.
- Available in high pressure laminate only
- If wood grain is selected, grain runs horizontally.
- There is no base raceway in Light Panels to accommodate electrical.
- Light Panel Connectors must be used in conjunction with Light Panels.
- If different grades of fabric are used on one panel, the entire panel must be priced at highest grade.
- An aluminum low profile top cap is included.
- Stackability: Evolve panels can be increased in height in 6"H, 12"H, 18"H or 24"H increments. See Extension Modules for part numbers.

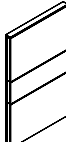
	DESCRIPTION	PRODUCT CODE	LIST PRICE	DIMENSIONS/INCHES		
				H	W	D
	Laminate Light Panel - Double Sided - 30" High	EVPLH2S3018	596	30	18	2 7/8
		EVPLH2S3024	596	30	24	2 7/8
		EVPLH2S3030	703	30	30	2 7/8
		EVPLH2S3036	804	30	36	2 7/8
		EVPLH2S3042	919	30	42	2 7/8
		EVPLH2S3048	1024	30	48	2 7/8
		EVPLH2S3054	1135	30	54	2 7/8
		EVPLH2S3060	1222	30	60	2 7/8
	Laminate Light Panel - Double Sided - 42" High	EVPLH2S4218	582	42	18	2 7/8
		EVPLH2S4224	703	42	24	2 7/8
		EVPLH2S4230	829	42	30	2 7/8
		EVPLH2S4236	966	42	36	2 7/8
		EVPLH2S4242	1098	42	42	2 7/8
		EVPLH2S4248	1233	42	48	2 7/8
		EVPLH2S4254	1352	42	54	2 7/8
		EVPLH2S4260	1472	42	60	2 7/8
	Laminate Light Panel - Double Sided - 54" High	EVPLH2S5418	680	54	18	2 7/8
		EVPLH2S5424	831	54	24	2 7/8
		EVPLH2S5430	985	54	30	2 7/8
		EVPLH2S5436	1144	54	36	2 7/8
		EVPLH2S5442	1306	54	42	2 7/8
		EVPLH2S5448	1471	54	48	2 7/8
		EVPLH2S5454	1619	54	54	2 7/8
		EVPLH2S5460	1759	54	60	2 7/8
	Laminate Light Panel - Double Sided - 66" High	EVPLH2S6618	756	66	18	2 7/8
		EVPLH2S6624	1051	66	24	2 7/8
		EVPLH2S6630	1245	66	30	2 7/8
		EVPLH2S6636	1444	66	36	2 7/8
		EVPLH2S6642	1653	66	42	2 7/8
		EVPLH2S6648	1854	66	48	2 7/8
		EVPLH2S6654	2046	66	54	2 7/8
		EVPLH2S6660	2235	66	60	2 7/8

# PANELS

# AIR FLOW

## EVPFAF - AIRFLOW PANEL

- Airflow Panel incorporates bottom 24"H airflow module with individual fabric modules, within a steel frame.
- The 24"H Metal airflow module is positioned in the base section to provide air circulation.
- Opposite sides of each panel may have a different fabric within the same grade at no upcharge.
- If different grades of fabric are used on one panel, the entire panel must be priced at highest grade.
- An aluminum low profile top cap is included.
- Stackability: Evolve panels can be increased in height in 6"H, 12"H, 18"H or 24"H increments. See Extension Modules for part numbers.

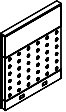
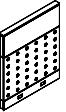
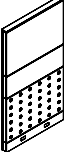
	DESCRIPTION	PRODUCT CODE	LIST PRICE		DIMENSIONS/INCHES		
			Gr1	Gr2	H	W	D
	Airflow Panel - 30" High	EVPFAF3024	517		30	24	2 7/8
		EVPFAF3030	615		30	30	2 7/8
		EVPFAF3036	680		30	36	2 7/8
		EVPFAF3042	756		30	42	2 7/8
		EVPFAF3048	852		30	48	2 7/8
		EVPFAF3054	976		30	54	2 7/8
		EVPFAF3060	1102		30	60	2 7/8
	Airflow Panel - 42" High	EVPFAF4224	659	673	42	24	2 7/8
		EVPFAF4230	779	796	42	30	2 7/8
		EVPFAF4236	867	887	42	36	2 7/8
		EVPFAF4242	963	983	42	42	2 7/8
		EVPFAF4248	1089	1110	42	48	2 7/8
		EVPFAF4254	1240	1266	42	54	2 7/8
		EVPFAF4260	1258	1285	42	60	2 7/8
	Airflow Panel - 54" High	EVPFAF5424	739	765	54	24	2 7/8
		EVPFAF5430	851	879	54	30	2 7/8
		EVPFAF5436	951	984	54	36	2 7/8
		EVPFAF5442	1059	1097	54	42	2 7/8
		EVPFAF5448	1191	1232	54	48	2 7/8
		EVPFAF5454	1386	1434	54	54	2 7/8
		EVPFAF5460	1512	1562	54	60	2 7/8
	Airflow Panel - 66" High	EVPFAF6624	863	897	66	24	2 7/8
		EVPFAF6630	1017	1058	66	30	2 7/8
		EVPFAF6636	1138	1186	66	36	2 7/8
		EVPFAF6642	1268	1321	66	42	2 7/8
		EVPFAF6648	1429	1488	66	48	2 7/8
		EVPFAF6654	1615	1682	66	54	2 7/8
		EVPFAF6660	1797	1870	66	60	2 7/8

# PANELS

# AIR FLOW

## EVPLFAF - AIRFLOW LIGHT PANEL

- Airflow Light Panel incorporates bottom 24"H airflow module with individual fabric modules, within a steel frame.
- The 24"H Metal airflow module is positioned in the base section to provide air circulation.
- There is no base raceway in Light Panels to accommodate electrical.
- Light Panel Connectors must be used in conjunction with Light Panels.
- Opposite sides of each panel may have a different fabric within the same grade at no upcharge.
- If different grades of fabric are used on one panel, the entire panel must be priced at highest grade.
- An aluminum low profile top cap is included.
- Stackability: Evolve panels can be increased in height in 6"H, 12"H, 18"H or 24"H increments. See Extension Module listings for part numbers

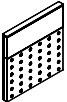
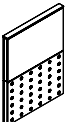
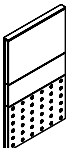
	DESCRIPTION	PRODUCT CODE	LIST PRICE		DIMENSIONS/INCHES		
			Gr1	Gr2	H	W	D
	Airflow Light Panel - 30" High	EVPLFAF3024	503		30	18	2 7/8
		EVPLFAF3030	595		30	30	2 7/8
		EVPLFAF3036	660		30	36	2 7/8
		EVPLFAF3042	732		30	42	2 7/8
		EVPLFAF3048	824		30	48	2 7/8
		EVPLFAF3054	949		30	54	2 7/8
		EVPLFAF3060	1072		30	60	2 7/8
	Airflow Light Panel - 42" High	EVPLFAF4224	640	651	42	18	2 7/8
		EVPLFAF4230	756	774	42	30	2 7/8
		EVPLFAF4236	840	860	42	36	2 7/8
		EVPLFAF4242	932	953	42	42	2 7/8
		EVPLFAF4248	1053	1074	42	48	2 7/8
		EVPLFAF4254	1200	1226	42	54	2 7/8
		EVPLFAF4260	1219	1247	42	60	2 7/8
	Airflow Light Panel - 54" High	EVPLFAF5424	718	741	54	18	2 7/8
		EVPLFAF5430	823	852	54	30	2 7/8
		EVPLFAF5436	925	958	54	36	2 7/8
		EVPLFAF5442	1029	1067	54	42	2 7/8
		EVPLFAF5448	1154	1195	54	48	2 7/8
		EVPLFAF5454	1345	1386	54	54	2 7/8
		EVPLFAF5460	1467	1515	54	60	2 7/8
	Airflow Light Panel - 66" High	EVPLFAF6624	834	867	66	18	2 7/8
		EVPLFAF6630	985	1026	66	30	2 7/8
		EVPLFAF6636	1105	1152	66	36	2 7/8
		EVPLFAF6642	1233	1285	66	42	2 7/8
		EVPLFAF6648	1385	1443	66	48	2 7/8
		EVPLFAF6654	1568	1629	66	54	2 7/8
		EVPLFAF6660	1745	1815	30	60	2 7/8

# PANELS

# AIR FLOW

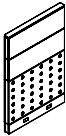
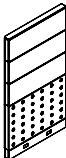

## EVPPPAF - AIRFLOW PREMIUM PANEL

- Airflow Premium Panel incorporates bottom 24"H airflow module with individual fabric modules, within a steel frame.
- The 24"H Metal airflow module is positioned in the base section to provide air circulation.
- Premium panels incorporate 12"H acoustic modules above 30"H base section.
- Opposite sides of each panel may have a different fabric within the same grade at no upcharge.
- If different grades of fabric are used on one panel, the entire panel must be priced at highest grade.
- An aluminum low profile top cap is included.
- Stackability: Evolve panels can be increased in height in 6"H, 12"H, 18"H or 24"H increments. See Extension Modules for part numbers.

	DESCRIPTION	PRODUCT CODE	LIST PRICE		DIMENSIONS/INCHES		
			Gr1	Gr2	H	W	D
	Airflow Premium Panel - 54" High	EVPPPAF5424	821	844	54	24	2 7/8
		EVPPPAF5430	940	969	54	30	2 7/8
		EVPPPAF5436	1051	1083	54	36	2 7/8
		EVPPPAF5442	1168	1206	54	42	2 7/8
		EVPPPAF5448	1322	1364	54	48	2 7/8
		EVPPPAF5454	1494	1541	54	54	2 7/8
	Airflow Premium Panel - 66" High	EVPPPAF6624	941	975	66	24	2 7/8
		EVPPPAF6630	1105	1146	66	30	2 7/8
		EVPPPAF6636	1236	1284	66	36	2 7/8
		EVPPPAF6642	1372	1425	66	42	2 7/8
		EVPPPAF6648	1558	1619	66	48	2 7/8
		EVPPPAF6654	1754	1821	66	54	2 7/8
EVPPPAF6660	1958	2029	66	60	2 7/8		

## EVPLPPAF - AIRFLOW PREMIUM LIGHT PANEL

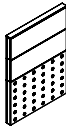
- Airflow Premium Light Panel incorporates bottom 24"H airflow module with individual 12"H fabric modules, within a steel frame.
- The 24"H Metal airflow module is positioned in the base section to provide air circulation.
- Premium panels incorporate 12"H acoustic modules above 30"H base section.
- There is no base raceway in Light Panels to accommodate electrical.
- Light Panel Connectors must be used in conjunction with Light Panels.
- Opposite sides of each panel may have a different fabric within the same grade at no upcharge.
- If different grades of fabric are used on one panel, the entire panel must be priced at highest grade.
- An aluminum low profile top cap is included.
- Stackability: Evolve panels can be increased in height in 6"H, 12"H, 18"H or 24"H increments. See Extension Modules for part numbers.





	DESCRIPTION	PRODUCT CODE	LIST PRICE		DIMENSIONS/INCHES		
			Gr1	Gr2	H	W	D
	Airflow Premium Light Panel - 54" High	EVPLPPAF5424	797	820	54	18	2 7/8
		EVPLPPAF5430	914	941	54	30	2 7/8
		EVPLPPAF5436	1021	1050	54	36	2 7/8
		EVPLPPAF5442	1134	1170	54	42	2 7/8
		EVPLPPAF5448	1280	1319	54	48	2 7/8
		EVPLPPAF5454	1451	1492	54	54	2 7/8
	Airflow Premium Light Panel - 66" High	EVPLPPAF6624	915	947	66	18	2 7/8
		EVPLPPAF6630	1074	1113	66	30	2 7/8
		EVPLPPAF6636	1199	1247	66	36	2 7/8
		EVPLPPAF6642	1331	1383	66	42	2 7/8
		EVPLPPAF6648	1513	1572	66	48	2 7/8
		EVPLPPAF6654	1703	1764	66	54	2 7/8
EVPLPPAF6660	1898	1968	66	60	2 7/8		

# PANELS

# METAL

## EVPM1S - METAL SKIN PANEL - SINGLE SIDED

- Metal Skin Panel incorporates single sided metal skin modules, into a solid steel frame.
- Opposite side is fabric covered.
- Metal faces on all modules provide durable, washable and magnetic surfaces on Single Sided of the panel.
- If different grades of fabric are used on one panel, the entire panel must be priced at highest grade.
- An aluminum low profile top cap is included.
- Stackability: Evolve panels can be increased in height in 6"H, 12"H, 18"H or 24"H increments. See Extension Modules for part numbers.



	DESCRIPTION	PRODUCT CODE	LIST PRICE		DIMENSIONS/INCHES		
			Gr1	Gr2	H	W	D
	Metal Skin Panel - Single Sided 30" High	EVPM1S3018	586	597	30	18	2 7/8
		EVPM1S3024	701	716	30	24	2 7/8
		EVPM1S3030	817	831	30	30	2 7/8
		EVPM1S3036	928	946	30	36	2 7/8
		EVPM1S3042	1052	1073	30	42	2 7/8
		EVPM1S3048	1146	1167	30	48	2 7/8
		EVPM1S3054	1266	1287	30	54	2 7/8
		EVPM1S3060	1386	1412	30	60	2 7/8
	Metal Skin Panel - Single Sided 42" High	EVPM1S4218	695	710	42	18	2 7/8
		EVPM1S4224	828	846	42	24	2 7/8
		EVPM1S4230	972	995	42	30	2 7/8
		EVPM1S4236	1111	1139	42	36	2 7/8
		EVPM1S4242	1262	1290	42	42	2 7/8
		EVPM1S4248	1371	1404	42	48	2 7/8
		EVPM1S4254	1523	1557	42	54	2 7/8
		EVPM1S4260	1671	1710	42	60	2 7/8
	Metal Skin Panel - Single Sided 54" High	EVPM1S5418	819	837	54	18	2 7/8
		EVPM1S5424	985	1008	54	24	2 7/8
		EVPM1S5430	1153	1180	54	30	2 7/8
		EVPM1S5436	1318	1352	54	36	2 7/8
		EVPM1S5442	1495	1533	54	42	2 7/8
		EVPM1S5448	1633	1674	54	48	2 7/8
		EVPM1S5454	1816	1863	54	54	2 7/8
		EVPM1S5460	1996	2046	54	60	2 7/8
	Metal Skin Panel - Single Sided 66" High	EVPM1S6618	1008	1034	66	18	2 7/8
		EVPM1S6624	1216	1245	66	24	2 7/8
		EVPM1S6630	1420	1456	66	30	2 7/8
		EVPM1S6636	1639	1680	66	36	2 7/8
		EVPM1S6642	1862	1906	66	42	2 7/8
		EVPM1S6648	2027	2079	66	48	2 7/8
		EVPM1S6654	2254	2311	66	54	2 7/8
		EVPM1S6660	2483	2546	66	60	2 7/8

# PANELS

# METAL

## EVPLM1S - METAL SKIN LIGHT PANEL - SINGLE SIDED

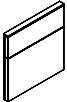
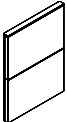
- Metal Skin Light Panel incorporates single sided metal skin modules, into a solid steel frame.
- Opposite side is fabric covered.
- Metal faces on all modules provide durable, washable and magnetic surfaces on Single Sided of the panel.
- There is no base raceway in Light Panels to accommodate electrical.
- Light Panel Connectors must be used in conjunction with Light Panels.
- If different grades of fabric are used on one panel, the entire panel must be priced at highest grade.
- An aluminum low profile top cap is included.
- Stackability: Evolve panels can be increased in height in 6"H, 12"H, 18"H or 24"H increments. See Extension Modules for part numbers.





	DESCRIPTION	PRODUCT CODE	LIST PRICE		DIMENSIONS/INCHES		
			Gr1	Gr2	H	W	D
	Metal Skin Light Panel - Single Sided - 30" High	EVPLM1S3018	571	580	30	18	2 7/8
		EVPLM1S3024	680	692	30	24	2 7/8
		EVPLM1S3030	788	800	30	30	2 7/8
		EVPLM1S3036	899	918	30	36	2 7/8
		EVPLM1S3042	1023	1038	30	42	2 7/8
		EVPLM1S3048	1111	1130	30	48	2 7/8
		EVPLM1S3054	1231	1246	30	54	2 7/8
		EVPLM1S3060	1345	1368	30	60	2 7/8
	Metal Skin Light Panel - Single Sided - 42" High	EVPLM1S4218	677	691	42	18	2 7/8
		EVPLM1S4224	801	819	42	24	2 7/8
		EVPLM1S4230	941	964	42	30	2 7/8
		EVPLM1S4236	1079	1106	42	36	2 7/8
		EVPLM1S4242	1222	1250	42	42	2 7/8
		EVPLM1S4248	1329	1362	42	48	2 7/8
		EVPLM1S4254	1475	1509	42	54	2 7/8
		EVPLM1S4260	1620	1658	42	60	2 7/8
	Metal Skin Light Panel - Single Sided - 54" High	EVPLM1S5418	791	809	54	18	2 7/8
		EVPLM1S5424	953	974	54	24	2 7/8
		EVPLM1S5430	1118	1144	54	30	2 7/8
		EVPLM1S5436	1278	1311	54	36	2 7/8
		EVPLM1S5442	1452	1488	54	42	2 7/8
		EVPLM1S5448	1585	1624	54	48	2 7/8
		EVPLM1S5454	1759	1807	54	54	2 7/8
		EVPLM1S5460	1935	1985	54	60	2 7/8
	Metal Skin Light Panel - Single Sided - 66" High	EVPLM1S6618	981	1007	66	18	2 7/8
		EVPLM1S6624	1181	1209	66	24	2 7/8
		EVPLM1S6630	1377	1413	66	30	2 7/8
		EVPLM1S6636	1588	1629	66	36	2 7/8
		EVPLM1S6642	1807	1851	66	42	2 7/8
		EVPLM1S6648	1964	2016	66	48	2 7/8
		EVPLM1S6654	2188	2243	66	54	2 7/8
		EVPLM1S6660	2408	2469	66	60	2 7/8

# PANELS

# METAL

## EVPM2S - METAL SKIN PANEL - DOUBLE SIDED

- Metal Skin Panel incorporates double sided metal skin modules, into a solid steel frame.
- Metal faces on all modules provide durable, washable and magnetic surfaces on Single Sided of the panel.
- If different grades of fabric are used on one panel, the entire panel must be priced at highest grade.
- An aluminum low profile top cap is included.
- Stackability: Evolve panels can be increased in height in 6"H, 12"H, 18"H or 24"H increments. See Extension Modules for part numbers.



	DESCRIPTION	PRODUCT CODE	LIST PRICE	DIMENSIONS/INCHES		
				H	W	D
	Metal Skin Panel - Double Sided - 30" High	EVPM2S3018	863	30	18	2 7/8
		EVPM2S3024	863	30	24	2 7/8
		EVPM2S3030	1015	30	30	2 7/8
		EVPM2S3036	1161	30	36	2 7/8
		EVPM2S3042	1161	30	42	2 7/8
		EVPM2S3048	1318	30	48	2 7/8
		EVPM2S3054	1474	30	54	2 7/8
		EVPM2S3060	1761	30	60	2 7/8
	Metal Skin Panel - Double Sided - 42" High	EVPM2S4218	834	42	18	2 7/8
		EVPM2S4224	1015	42	24	2 7/8
		EVPM2S4230	1195	42	30	2 7/8
		EVPM2S4236	1388	42	36	2 7/8
		EVPM2S4242	1583	42	42	2 7/8
		EVPM2S4248	1776	42	48	2 7/8
		EVPM2S4254	1950	42	54	2 7/8
		EVPM2S4260	2122	42	60	2 7/8
	Metal Skin Panel - Double Sided - 54" High	EVPM2S5418	981	54	18	2 7/8
		EVPM2S5424	1199	54	24	2 7/8
		EVPM2S5430	1419	54	30	2 7/8
		EVPM2S5436	1648	54	36	2 7/8
		EVPM2S5442	1886	54	42	2 7/8
		EVPM2S5448	2119	54	48	2 7/8
		EVPM2S5454	2331	54	54	2 7/8
		EVPM2S5460	2542	54	60	2 7/8
	Metal Skin Panel - Double Sided - 66" High	EVPM2S6618	1234	66	18	2 7/8
		EVPM2S6624	1517	66	24	2 7/8
		EVPM2S6630	1796	66	30	2 7/8
		EVPM2S6636	2086	66	36	2 7/8
		EVPM2S6642	2383	66	42	2 7/8
		EVPM2S6648	2674	66	48	2 7/8
		EVPM2S6654	2949	66	54	2 7/8
		EVPM2S6660	3228	66	60	2 7/8

# PANELS

# METAL

## EVPLM2S - METAL SKIN LIGHT PANEL - DOUBLE SIDED

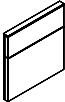
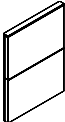
- Metal Skin Light Panel incorporates double sided metal skin modules, into a solid steel frame.
- Metal faces on all modules provide durable, washable and magnetic surfaces on Single Sided of the panel.
- There is no base raceway in Light Panels to accommodate electrical.
- Light Panel Connectors must be used in conjunction with Light Panels.
- If different grades of fabric are used on one panel, the entire panel must be priced at highest grade.
- An aluminum low profile top cap is included.
- Stackability: Evolve panels can be increased in height in 6”H, 12”H, 18”H or 24”H increments. See Extension Modules for part numbers.

	DESCRIPTION	PRODUCT CODE	LIST PRICE	DIMENSIONS/INCHES		
				H	W	D
	Metal Skin Light Panel - Double Sided - 30" High	EVPLM2S3018	834	30	18	2 7/8
		EVPLM2S3024	834	30	24	2 7/8
		EVPLM2S3030	984	30	30	2 7/8
		EVPLM2S3036	1127	30	36	2 7/8
		EVPLM2S3042	1127	30	42	2 7/8
		EVPLM2S3048	1278	30	48	2 7/8
		EVPLM2S3054	1429	30	54	2 7/8
		EVPLM2S3060	1710	30	60	2 7/8
	Metal Skin Light Panel - Double Sided - 42" High	EVPLM2S4218	810	42	18	2 7/8
		EVPLM2S4224	984	42	24	2 7/8
		EVPLM2S4230	1157	42	30	2 7/8
		EVPLM2S4236	1349	42	36	2 7/8
		EVPLM2S4242	1534	42	42	2 7/8
		EVPLM2S4248	1721	42	48	2 7/8
		EVPLM2S4254	1892	42	54	2 7/8
		EVPLM2S4260	2058	42	60	2 7/8
	Metal Skin Light Panel - Double Sided - 54" High	EVPLM2S5418	950	54	18	2 7/8
		EVPLM2S5424	1164	54	24	2 7/8
		EVPLM2S5430	1375	54	30	2 7/8
		EVPLM2S5436	1599	54	36	2 7/8
		EVPLM2S5442	1829	54	42	2 7/8
		EVPLM2S5448	2055	54	48	2 7/8
		EVPLM2S5454	2259	54	54	2 7/8
		EVPLM2S5460	2466	54	60	2 7/8
	Metal Skin Light Panel - Double Sided - 66" High	EVPLM2S6618	1197	66	18	2 7/8
		EVPLM2S6624	1472	66	24	2 7/8
		EVPLM2S6630	1742	66	30	2 7/8
		EVPLM2S6636	2024	66	36	2 7/8
		EVPLM2S6642	2310	66	42	2 7/8
		EVPLM2S6648	2595	66	48	2 7/8
		EVPLM2S6654	2858	66	54	2 7/8
		EVPLM2S6660	3160	66	60	2 7/8

# PANELS

OPEN

## EVPFOL - OPEN BOTTOM PANEL

- Open Bottom Panel incorporates bottom 24"H open module with individual fabric modules, within a steel frame.
- The 24"H open bottom module in the base section is to provide air circulation and access to electrical or data.
- Opposite sides of each panel may have a different fabric within the same grade at no upcharge.
- If different grades of fabric are used on one panel, the entire panel must be priced at highest grade.
- An aluminum low profile top cap is included.
- Stackability: Evolve panels can be increased in height in 6"H, 12"H, 18"H or 24"H increments. See Extension Modules for part numbers.

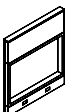
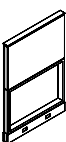
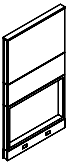

	DESCRIPTION	PRODUCT CODE	LIST PRICE		DIMENSIONS/INCHES		
			Gr1	Gr2	H	W	D
	Open Bottom Panel - 30" High	EVPFOL3018	299		30	18	2 7/8
		EVPFOL3024	340		30	24	2 7/8
		EVPFOL3030	384		30	30	2 7/8
		EVPFOL3036	421		30	36	2 7/8
		EVPFOL3042	462		30	42	2 7/8
		EVPFOL3048	498		30	48	2 7/8
		EVPFOL3054	539		30	54	2 7/8
EVPFOL3060	577		30	60	2 7/8		
	Open Bottom Panel - 42" High	EVPFOL4218	445	455	42	18	2 7/8
		EVPFOL4224	511	525	42	24	2 7/8
		EVPFOL4230	577	594	42	30	2 7/8
		EVPFOL4236	647	667	42	36	2 7/8
		EVPFOL4242	718	739	42	42	2 7/8
		EVPFOL4248	772	793	42	48	2 7/8
		EVPFOL4254	851	872	42	54	2 7/8
EVPFOL4260	923	949	42	60	2 7/8		
	Open Bottom Panel - 54" High	EVPFOL5418	502	522	54	18	2 7/8
		EVPFOL5424	572	598	54	24	2 7/8
		EVPFOL5430	655	682	54	30	2 7/8
		EVPFOL5436	733	767	54	36	2 7/8
		EVPFOL5442	818	856	54	42	2 7/8
		EVPFOL5448	885	926	54	48	2 7/8
		EVPFOL5454	969	1013	54	54	2 7/8
EVPFOL5460	1047	1100	54	60	2 7/8		
	Open Bottom Panel - 66" High	EVPFOL6618	651	679	66	18	2 7/8
		EVPFOL6624	748	784	66	24	2 7/8
		EVPFOL6630	855	896	66	30	2 7/8
		EVPFOL6636	960	1007	66	36	2 7/8
		EVPFOL6642	1078	1135	66	42	2 7/8
		EVPFOL6648	1154	1213	66	48	2 7/8
		EVPFOL6654	1275	1341	66	54	2 7/8
EVPFOL6660	1388	1462	66	60	2 7/8		

# PANELS

OPEN

## EVPLFOL - OPEN BOTTOM LIGHT PANEL

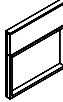
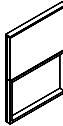
- Open Bottom Light Panel incorporates bottom 24"H open module with individual fabric modules, within a steel frame.
- The 24"H open bottom module in the base section is to provide air circulation and access to electrical or data.
- There is no base raceway in Light Panels to accommodate electrical.
- Light Panel Connectors must be used in conjunction with Light Panels.
- Opposite sides of each panel may have a different fabric within the same grade at no upcharge.
- If different grades of fabric are used on one panel, the entire panel must be priced at highest grade.
- An aluminum low profile top cap is included.
- Stackability: Evolve panels can be increased in height in 6"H, 12"H, 18"H or 24"H increments. See Extension Modules for part numbers.



	DESCRIPTION	PRODUCT CODE	LIST PRICE		DIMENSIONS/INCHES		
			Gr1	Gr2	H	W	D
	Open Bottom Light Panel - 30" High	EVPLFOL3018	288		30	18	2 7/8
		EVPLFOL3024	326		30	24	2 7/8
		EVPLFOL3030	373		30	30	2 7/8
		EVPLFOL3036	409		30	36	2 7/8
		EVPLFOL3042	448		30	42	2 7/8
		EVPLFOL3048	477		30	48	2 7/8
		EVPLFOL3054	525		30	54	2 7/8
		EVPLFOL3060	560		30	60	2 7/8
	Open Bottom Light Panel - 42" High	EVPLFOL4218	430	441	42	18	2 7/8
		EVPLFOL4224	495	510	42	24	2 7/8
		EVPLFOL4230	560	578	42	30	2 7/8
		EVPLFOL4236	629	649	42	36	2 7/8
		EVPLFOL4242	695	716	42	42	2 7/8
		EVPLFOL4248	753	771	42	48	2 7/8
		EVPLFOL4254	823	844	42	54	2 7/8
		EVPLFOL4260	893	920	42	60	2 7/8
	Open Bottom Light Panel - 54" High	EVPLFOL5418	482	502	54	18	2 7/8
		EVPLFOL5424	548	574	54	24	2 7/8
		EVPLFOL5430	630	656	54	30	2 7/8
		EVPLFOL5436	703	736	54	36	2 7/8
		EVPLFOL5442	784	820	54	42	2 7/8
		EVPLFOL5448	850	891	54	48	2 7/8
		EVPLFOL5454	929	971	54	54	2 7/8
		EVPLFOL5460	1006	1058	54	60	2 7/8
	Open Bottom Premium Panel - 66" High	EVPLFOL6618	624	651	60	18	2 7/8
		EVPLFOL6624	721	755	60	24	2 7/8
		EVPLFOL6630	821	860	60	30	2 7/8
		EVPLFOL6636	923	967	60	36	2 7/8
		EVPLFOL6642	1035	1090	60	42	2 7/8
		EVPLFOL6648	1107	1166	60	48	2 7/8
		EVPLFOL6654	1222	1285	60	54	2 7/8
		EVPLFOL6660	1336	1406	60	60	2 7/8

# PANELS

OPEN

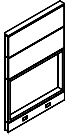

## EVFPOL - OPEN BOTTOM PREMIUM PANEL

- Open Bottom Premium Panel incorporates bottom 24”H open module with individual fabric modules, within a steel frame.
- The 24”H open bottom module in the base section is to provide air circulation and access to electrical or data.
- Premium panels incorporate 12”H fabric modules above 30”H base section.
- Opposite sides of each panel may have a different fabric within the same grade at no upcharge.
- If different grades of fabric are used on one panel, the entire panel must be priced at highest grade.
- An aluminum low profile top cap is included.
- Stackability: Evolve panels can be increased in height in 6”H, 12”H, 18”H or 24”H increments. See Extension Modules for part numbers.

	DESCRIPTION	PRODUCT CODE	LIST PRICE		DIMENSIONS/INCHES		
			Gr1	Gr2	H	W	D
	Open Bottom Premium Panel - 54” High	EVFPOL5418	593	613	54	18	2 7/8
		EVFPOL5424	679	705	54	24	2 7/8
		EVFPOL5430	776	803	54	30	2 7/8
		EVFPOL5436	870	903	54	36	2 7/8
		EVFPOL5442	981	1017	54	42	2 7/8
		EVFPOL5448	1051	1092	54	48	2 7/8
		EVFPOL5454	1156	1203	54	54	2 7/8
	Open Bottom Premium Panel - 66” High	EVFPOL6618	742	770	66	18	2 7/8
		EVFPOL6624	856	892	66	24	2 7/8
		EVFPOL6630	973	1014	66	30	2 7/8
		EVFPOL6636	1098	1146	66	36	2 7/8
		EVFPOL6642	1240	1293	66	42	2 7/8
		EVFPOL6648	1327	1388	66	48	2 7/8
		EVFPOL6654	1471	1538	66	54	2 7/8
		EVFPOL6660	1612	1685	66	60	2 7/8

## EVPLPOL - OPEN BOTTOM PREMIUM LIGHT PANEL

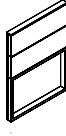
- Open Bottom Premium Light Panel incorporates bottom 24”H open module with individual fabric modules, within a steel frame.
- The 24”H open bottom module in the base section is to provide air circulation and access to electrical or data.
- Premium panels incorporate 12”H fabric modules above 30”H base section.
- There is no base raceway in Light Panels to accommodate electrical.
- Light Panel Connectors must be used in conjunction with Light Panels.
- Opposite sides of each panel may have a different fabric within the same grade at no upcharge.
- If different grades of fabric are used on one panel, the entire panel must be priced at highest grade.
- An aluminum low profile top cap is included.
- Stackability: Evolve panels can be increased in height in 6”H, 12”H, 18”H or 24”H increments. See Extension Modules for part numbers.

	DESCRIPTION	PRODUCT CODE	LIST PRICE		DIMENSIONS/INCHES		
			Gr1	Gr2	H	W	D
	Open Bottom Premium Light Panel - 54” High	EVPLPOL5418	569	589	54	18	2 7/8
		EVPLPOL5424	651	678	54	24	2 7/8
		EVPLPOL5430	745	771	54	30	2 7/8
		EVPLPOL5436	835	867	54	36	2 7/8
		EVPLPOL5442	940	974	54	42	2 7/8
		EVPLPOL5448	1008	1047	54	48	2 7/8
		EVPLPOL5454	1110	1154	54	54	2 7/8
	Open Bottom Premium Light Panel - 66” High	EVPLPOL6618	713	740	60	18	2 7/8
		EVPLPOL6624	822	856	60	24	2 7/8
		EVPLPOL6630	932	973	60	30	2 7/8
		EVPLPOL6636	1052	1099	60	36	2 7/8
		EVPLPOL6642	1189	1241	60	42	2 7/8
		EVPLPOL6648	1274	1335	60	48	2 7/8
		EVPLPOL6654	1410	1474	60	54	2 7/8
		EVPLPOL6660	1548	1619	60	60	2 7/8

# PANELS

# OPEN

## EVVFO - OPEN MIDDLE PANEL - 12"H OPENING

- Open Middle Panel incorporates a 12"H middle position open module with fabric modules, within a steel frame.
- Open Middle Panel Incorporates a 12"H opening above 30"H base module to provide pass-through convenience.
- Opposite sides of each panel may have a different fabric within the same grade at no upcharge.
- If different grades of fabric are used on one panel, the entire panel must be priced at highest grade.
- An aluminum low profile top cap is included.
- Stackability: Evolve panels can be increased in height in 6"H, 12"H, 18"H or 24"H increments. See Extension Modules or part numbers.

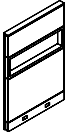
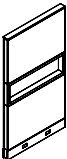
	DESCRIPTION	PRODUCT CODE	LIST PRICE		DIMENSIONS/INCHES		
			Gr1	Gr2	H	W	D
	Open Middle Panel - 12"H Opening - 54" High	EVVFO5418	600	629	54	18	2 7/8
		EVVFO5424	698	734	54	24	2 7/8
		EVVFO5430	803	844	54	30	2 7/8
		EVVFO5436	914	962	54	36	2 7/8
		EVVFO5442	1029	1082	54	42	2 7/8
		EVVFO5448	1110	1171	54	48	2 7/8
		EVVFO5454	1231	1297	54	54	2 7/8
	Open Middle Panel - 12"H Opening - 66" High	EVVFO6618	662	698	66	18	2 7/8
		EVVFO6624	764	812	66	24	2 7/8
		EVVFO6630	880	932	66	30	2 7/8
		EVVFO6636	998	1061	66	36	2 7/8
		EVVFO6642	1126	1195	66	42	2 7/8
		EVVFO6648	1215	1295	66	48	2 7/8
		EVVFO6654	1348	1436	66	54	2 7/8
	EVVFO6660	1472	1570	66	60	2 7/8	

## EVPLFO - OPEN MIDDLE LIGHT PANEL - 12"H OPENING

- Open Middle Light Panel incorporates a 12"H middle position open module with fabric modules, within a steel frame.
- Open Middle Light Panel Incorporates a 12"H opening above 30"H base module to provide pass-through convenience.
- There is no base raceway in Light Panels to accommodate electrical.
- Light Panel Connectors must be used in conjunction with Light Panels.
- Opposite sides of each panel may have a different fabric within the same grade at no upcharge.
- If different grades of fabric are used on one panel, the entire panel must be priced at highest grade.
- An aluminum low profile top cap is included.
- Stackability: Evolve panels can be increased in height in 6"H, 12"H, 18"H or 24"H increments. See Extension Modules for part numbers.

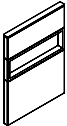
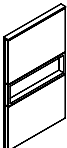
	DESCRIPTION	PRODUCT CODE	LIST PRICE		DIMENSIONS/INCHES		
			Gr1	Gr2	H	W	D
	Open Middle Light Panel - 12"H Opening - 54" High	EVPLFO5418	572	599	54	18	2 7/8
		EVPLFO5424	665	699	54	24	2 7/8
		EVPLFO5430	764	803	54	30	2 7/8
		EVPLFO5436	867	911	54	36	2 7/8
		EVPLFO5442	976	1029	54	42	2 7/8
		EVPLFO5448	1053	1110	54	48	2 7/8
		EVPLFO5454	1168	1232	54	54	2 7/8
	Open Middle Light Panel - 12"H Opening - 66" High	EVPLFO6618	630	664	60	18	2 7/8
		EVPLFO6624	726	768	60	24	2 7/8
		EVPLFO6630	834	886	60	30	2 7/8
		EVPLFO6636	950	1008	60	36	2 7/8
		EVPLFO6642	1070	1136	60	42	2 7/8
		EVPLFO6648	1154	1228	60	48	2 7/8
		EVPLFO6654	1279	1360	60	54	2 7/8
	EVPLFO6660	1399	1492	60	60	2 7/8	

# PANELS

OPEN

## EVFPFO - OPEN MIDDLE PREMIUM PANEL - 12"H OPENING

- Open Middle Premium Panel incorporates a 12"H middle position open module with fabric modules, within a steel frame.
- Open Middle Premium Panel Incorporates a 12"H opening above 30"H base module to provide pass-through convenience.
- Premium panels incorporate 12"H modules above 30"H base section.
- Opposite sides of each panel may have a different fabric within the same grade at no upcharge.
- If different grades of fabric are used on one panel, the entire panel must be priced at highest grade.
- An aluminum low profile top cap is included.
- Stackability: Evolve panels can be increased in height in 6"H, 12"H, 18"H or 24"H increments. See Extension Modules for part numbers.

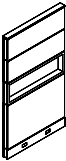
	DESCRIPTION	PRODUCT CODE	LIST PRICE		DIMENSIONS/INCHES		
			Gr1	Gr2	H	W	D
	Open Middle Premium Panel - 12"H Opening - 66" High	EVFPFO6618	753	789	66	18	2 7/8
		EVFPFO6624	870	917	66	24	2 7/8
		EVFPFO6630	1001	1056	66	30	2 7/8
		EVFPFO6636	1134	1195	66	36	2 7/8
		EVFPFO6642	1289	1359	66	42	2 7/8
		EVFPFO6648	1385	1465	66	48	2 7/8
		EVFPFO6654	1536	1623	66	54	2 7/8
		EVFPFO6660	1691	1789	66	60	2 7/8

## EVPLFPO - OPEN MIDDLE PREMIUM LIGHT PANEL - 12" OPENING

- Open Middle Premium Light Panel incorporates a 12"H middle position open module with fabric modules, within a steel frame.
- Open Middle Premium Light Panel Incorporates a 12"H opening above 30"H base module to provide pass-through convenience.
- Premium panels incorporate 12"H modules above 30"H base section.
- There is no base raceway in Light Panels to accommodate electrical.
- Light Panel Connectors must be used in conjunction with Light Panels.
- Opposite sides of each panel may have a different fabric within the same grade at no upcharge.
- If different grades of fabric are used on one panel, the entire panel must be priced at highest grade.
- An aluminum low profile top cap is included.
- Stackability: Evolve panels can be increased in height in 6"H, 12"H, 18"H or 24"H increments. See Extension Modules for part numbers.

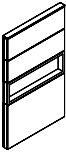
	DESCRIPTION	PRODUCT CODE	LIST PRICE		DIMENSIONS/INCHES		
			Gr1	Gr2	H	W	D
	Open Middle Premium Light Panel - 12"H Opening - 66" High	EVPLFPO6618	714	748	66	18	2 7/8
		EVPLFPO6624	829	871	66	24	2 7/8
		EVPLFPO6630	951	1001	66	30	2 7/8
		EVPLFPO6636	1077	1135	66	36	2 7/8
		EVPLFPO6642	1225	1291	66	42	2 7/8
		EVPLFPO6648	1317	1391	66	48	2 7/8
		EVPLFPO6654	1459	1541	66	54	2 7/8
		EVPLFPO6660	1607	1700	66	60	2 7/8

# PANELS

# OPEN

## EVFFOX - OPEN MIDDLE PANEL - 24"H OPENING

- Open Middle Panel incorporates a 24"H middle position open module with fabric modules, within a steel frame.
- Open Middle Panel Incorporates a 24"H opening above 30"H base module to provide pass-through convenience.
- Opposite sides of each panel may have a different fabric within the same grade at no upcharge.
- If different grades of fabric are used on one panel, the entire panel must be priced at highest grade.
- An aluminum low profile top cap is included.
- Stackability: Evolve panels can be increased in height in 6"H, 12"H, 18"H or 24"H increments. See Extension Modules for part numbers.

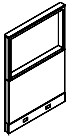
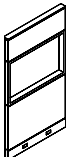
	DESCRIPTION	PRODUCT CODE	LIST PRICE		DIMENSIONS/INCHES		
			Gr1	Gr2	H	W	D
	Open Middle Panel - 24"H Opening - 54" High	EVFFOX5418	502	522	54	18	2 7/8
		EVFFOX5424	572	598	54	24	2 7/8
		EVFFOX5430	655	682	54	30	2 7/8
		EVFFOX5436	733	767	54	36	2 7/8
		EVFFOX5442	817	855	54	42	2 7/8
		EVFFOX5448	880	921	54	48	2 7/8
		EVFFOX5454	966	1010	54	54	2 7/8
	Open Middle Panel - 24"H Opening - 66" High	EVFFOX6618	651	679	66	18	2 7/8
		EVFFOX6624	748	784	66	24	2 7/8
		EVFFOX6630	880	921	66	30	2 7/8
		EVFFOX6636	960	1007	66	36	2 7/8
		EVFFOX6642	1078	1135	66	42	2 7/8
		EVFFOX6648	1154	1213	66	48	2 7/8
		EVFFOX6654	1275	1341	66	54	2 7/8
		EVFFOX6660	1388	1462	66	60	2 7/8

## EVPLFOX - OPEN MIDDLE LIGHT PANEL - 24"H OPENING

- Open Middle Panel incorporates a 24"H middle position open module with fabric modules, within a steel frame.
- Open Middle Panel Incorporates a 24"H opening above 30"H base module to provide pass-through convenience.
- There is no base raceway in Light Panels to accommodate electrical.
- Light Panel Connectors must be used in conjunction with Light Panels.
- Opposite sides of each panel may have a different fabric within the same grade at no upcharge.
- If different grades of fabric are used on one panel, the entire panel must be priced at highest grade.
- An aluminum low profile top cap is included.
- Stackability: Evolve panels can be increased in height in 6"H, 12"H, 18"H or 24"H increments. See Extension Modules for part numbers.

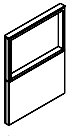
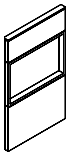

	DESCRIPTION	PRODUCT CODE	LIST PRICE		DIMENSIONS/INCHES		
			Gr1	Gr2	H	W	D
	Open Middle Light Panel - 24"H Opening - 54" High	EVPLFOX5418	477	495	54	18	2 7/8
		EVPLFOX5424	541	567	54	24	2 7/8
		EVPLFOX5430	622	648	54	30	2 7/8
		EVPLFOX5436	698	731	54	36	2 7/8
		EVPLFOX5442	770	806	54	42	2 7/8
		EVPLFOX5448	834	873	54	48	2 7/8
		EVPLFOX5454	919	961	54	54	2 7/8
	Open Middle Light Panel - 24"H Opening - 66" High	EVPLFOX6618	618	645	66	18	2 7/8
		EVPLFOX6624	712	746	66	24	2 7/8
		EVPLFOX6630	834	873	66	30	2 7/8
		EVPLFOX6636	911	958	66	36	2 7/8
		EVPLFOX6642	1024	1076	66	42	2 7/8
		EVPLFOX6648	1094	1152	66	48	2 7/8
		EVPLFOX6654	1210	1273	66	54	2 7/8
		EVPLFOX6660	1322	1392	66	60	2 7/8

# PANELS

# SEGMENTED - NO RACEWAY

## EVPFANR - SEGMENTED NO RACEWAY PANEL

- Segmented No Raceway panel incorporates fabric modules within steel frame.
- There is no base raceway in No Raceway Panels to accommodate electric.
- No Raceway connectors to be used.
- Fabric covered modules are tackable and acoustical.
- Each side of fabric module may have different fabric within the same grade at no charge.
- If different grades of fabric are used, the entire module must be price at highest grade.
- Aluminum low profile top and bottom cap is included.
- Stackability: Evolve panels can be increased in height in 6"H, 12"H, 18"H, 24"H increments. See module listing for part numbers See Extension Modules for part numbers.

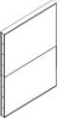
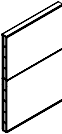
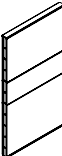
	DESCRIPTION	PRODUCT CODE	LIST PRICE		DIMENSIONS/INCHES		
			Gr1	Gr2	H	W	D
	Segmented NR Panel - 30" High	EVPPFA3018NR	397	416	30	18	2 7/8
		EVPPFA3024NR	412	439	30	24	2 7/8
		EVPPFA3030NR	463	489	30	30	2 7/8
		EVPPFA3036NR	499	531	30	36	2 7/8
		EVPPFA3042NR	534	573	30	42	2 7/8
		EVPPFA3048NR	587	631	30	48	2 7/8
		EVPPFA3054NR	636	683	30	54	2 7/8
	Segmented NR Panel - 42" High	EVPPFA4218NR	440	469	42	18	2 7/8
		EVPPFA4224NR	467	501	42	24	2 7/8
		EVPPFA4230NR	540	582	42	30	2 7/8
		EVPPFA4236NR	580	631	42	36	2 7/8
		EVPPFA4242NR	665	717	42	42	2 7/8
		EVPPFA4248NR	713	776	42	48	2 7/8
		EVPPFA4254NR	789	858	42	54	2 7/8
	Segmented NR Panel - 48" High	EVPPFA4818NR	473	502	48	18	2 7/8
		EVPPFA4824NR	515	544	48	24	2 7/8
		EVPPFA4830NR	592	621	48	30	2 7/8
		EVPPFA4836NR	659	688	48	36	2 7/8
		EVPPFA4842NR	744	773	48	42	2 7/8
		EVPPFA4848NR	829	858	48	48	2 7/8
		EVPPFA4854NR	898	927	48	54	2 7/8
	Segmented NR Panel - 54" High	EVPPFA5418NR	473	511	54	18	2 7/8
		EVPPFA5424NR	515	563	54	24	2 7/8
		EVPPFA5430NR	592	646	54	30	2 7/8
		EVPPFA5436NR	659	723	54	36	2 7/8
		EVPPFA5442NR	744	818	54	42	2 7/8
		EVPPFA5448NR	829	911	54	48	2 7/8
		EVPPFA5454NR	898	986	54	54	2 7/8
	Segmented NR Panel - 66" High	EVPPFA6618NR	595	642	66	18	2 7/8
		EVPPFA6624NR	639	697	66	24	2 7/8
		EVPPFA6630NR	711	777	66	30	2 7/8
		EVPPFA6636NR	831	912	66	36	2 7/8
		EVPPFA6642NR	936	1027	66	42	2 7/8
		EVPPFA6648NR	1006	1107	66	48	2 7/8
		EVPPFA6654NR	1091	1204	66	54	2 7/8
EVPPFA6660NR	1182	1306	66	60	2 7/8		

# PANELS

# MONOLITHIC - NO RACEWAY

## EVPFAMNR - MONOLITHIC NO RACEWAY PANEL

- Monolithic No Raceway panel incorporates fabric modules within steel frame.
- There is no base raceway in No Raceway Panels to accommodate electric.
- No Raceway connectors to be used.
- Fabric covered modules are tackable and acoustical.
- Each side of fabric module may have different fabric within the same grade at no charge.
- If different grades of fabric are used, the entire module must be price at highest grade.
- Aluminum low profile top and bottom cap is included.
- Stackability: Evolve panels can be increased in height in 6"H, 12"H, 18"H, 24"H increments. See module listing for part numbers See Extension Modules for part numbers.

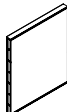
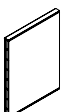
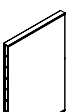
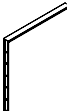
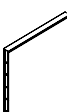



	DESCRIPTION	PRODUCT CODE	LIST PRICE		DIMENSIONS/INCHES		
			Gr1	Gr2	H	W	D
	Monolithic NR Panel 42" High	EVPFAM4218NR	410	448	42	18	2 7/8
		EVPFAM4224NR	436	483	42	24	2 7/8
		EVPFAM4230NR	502	601	42	30	2 7/8
		EVPFAM4236NR	534	598	42	36	2 7/8
		EVPFAM4242NR	592	671	42	42	2 7/8
		EVPFAM4248NR	642	730	42	48	2 7/8
		EVPFAM4254NR	705	799	42	54	2 7/8
	Monolithic NR Panel - 48" High	EVPFAM4818NR	416	454	48	18	2 7/8
		EVPFAM4824NR	455	506	48	24	2 7/8
		EVPFAM4830NR	528	583	48	30	2 7/8
		EVPFAM4836NR	574	638	48	36	2 7/8
		EVPFAM4842NR	639	714	48	42	2 7/8
		EVPFAM4848NR	694	777	48	48	2 7/8
		EVPFAM4854NR	768	863	48	54	2 7/8
	Monolithic NR Panel - 54" High	EVPFAM5418NR	421	459	54	18	2 7/8
		EVPFAM5424NR	463	511	54	24	2 7/8
		EVPFAM5430NR	537	594	54	30	2 7/8
		EVPFAM5436NR	595	664	54	36	2 7/8
		EVPFAM5442NR	666	740	54	42	2 7/8
		EVPFAM5448NR	724	806	54	48	2 7/8
		EVPFAM5454NR	789	888	54	54	2 7/8
	Monolithic NR Panel - 66" High	EVPFAM6618NR	517	556	66	18	2 7/8
		EVPFAM6624NR	570	620	66	24	2 7/8
		EVPFAM6630NR	639	698	66	30	2 7/8
		EVPFAM6636NR	744	810	66	36	2 7/8
		EVPFAM6642NR	834	909	66	42	2 7/8
		EVPFAM6648NR	904	987	66	48	2 7/8
		EVPFAM6654NR	1006	1097	66	54	2 7/8
	Monolithic NR Panel - 90" High	EVPFAM9018NR	909	976	90	18	2 7/8
		EVPFAM9024NR	984	1065	90	24	2 7/8
		EVPFAM9030NR	1094	1197	90	30	2 7/8
		EVPFAM9036NR	1274	1387	90	36	2 7/8

# PANELS

# LAMINATE - NO RACEWAY

## EVPH1SNR - LAMINATE NO RACEWAY - PANEL SINGLE SIDED

- Laminated No Raceway panel incorporates single sided laminate modules within steel frame.
- Opposite side is fabric covered.
- Laminated faces on all modules provide durable, washable surfaces on One Side of the panel.
- Available in high pressure laminate only.
- If wood grain is selected, grain runs horizontally.
- There is no base raceway in No Raceway Panels to accommodate electric.
- No Raceway connectors to be used.
- If different grades of fabric are used, the entire module must be priced at highest grade.
- An aluminum low profile top and bottom cap is included.
- Stackability: Evolve panels can be increased in height in 6"H, 12"H, 18"H, 24"H increments. See module listing for part numbers.



	DESCRIPTION	PRODUCT CODE	LIST PRICE		DIMENSIONS/INCHES		
			Gr1	Gr2	H	W	D
	Laminated NR Panel - Single Sided - 30" High	EVPH1S3018NR	488	497	30	18	2 7/8
		EVPH1S3024NR	585	597	30	24	2 7/8
		EVPH1S3030NR	679	692	30	30	2 7/8
		EVPH1S3036NR	772	790	30	36	2 7/8
		EVPH1S3042NR	879	893	30	42	2 7/8
		EVPH1S3048NR	954	973	30	48	2 7/8
		EVPH1S3054NR	1052	1078	30	54	2 7/8
	EVPH1S3060NR	1157	1181	30	60	2 7/8	
	Laminated NR Panel - Single Sided - 42" High	EVPH1S4218NR	582	596	42	18	2 7/8
		EVPH1S4224NR	691	712	42	24	2 7/8
		EVPH1S4230NR	810	831	42	30	2 7/8
		EVPH1S4236NR	927	955	42	36	2 7/8
		EVPH1S4242NR	1050	1080	42	42	2 7/8
		EVPH1S4248NR	1142	1175	42	48	2 7/8
		EVPH1S4254NR	1266	1304	42	54	2 7/8
	EVPH1S4260NR	1387	1429	42	60	2 7/8	
	Laminated NR Panel - Single Sided - 54" High	EVPH1S5418NR	680	695	54	18	2 7/8
		EVPH1S5424NR	821	848	54	24	2 7/8
		EVPH1S5430NR	962	991	54	30	2 7/8
		EVPH1S5436NR	1100	1132	54	36	2 7/8
		EVPH1S5442NR	1245	1286	54	42	2 7/8
		EVPH1S5448NR	1362	1406	54	48	2 7/8
		EVPH1S5454NR	1512	1559	54	54	2 7/8
	EVPH1S5460NR	1662	1715	54	60	2 7/8	
	Laminated NR Panel - Single Sided - 66" High	EVPH1S6618NR	842	869	66	18	2 7/8
		EVPH1S6624NR	1012	1045	66	24	2 7/8
		EVPH1S6630NR	1183	1222	66	30	2 7/8
		EVPH1S6636NR	1365	1407	66	36	2 7/8
		EVPH1S6642NR	1550	1598	66	42	2 7/8
		EVPH1S6648NR	1550	1598	66	48	2 7/8
		EVPH1S6654NR	1880	1937	66	54	2 7/8
	EVPH1S6660NR	2067	2133	66	60	2 7/8	

# PANELS

# LAMINATE - NO RACEWAY

## EVPH2SNR - LAMINATE NO RACEWAY - PANEL DOUBLE SIDED

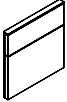
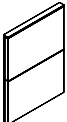
- Laminate No Raceway panel incorporates double sided laminate modules, within steel frame.
- Laminate faces on all modules provide durable, washable surfaces on both sides of the panel.
- Available in high pressure laminate only.
- If wood grain is selected, grain runs horizontally.
- There is no base raceway in No Raceway Panels to accommodate electric.
- No Raceway connectors to be used.
- If different grades of fabric are used, the entire module must be priced at highest grade.
- An aluminum low profile top and bottom cap is included.
- Stackability: Evolve panels can be increased in height in 6"H, 12"H, 18"H, 24"H increments. See module listing for part numbers.

	DESCRIPTION	PRODUCT CODE	LIST PRICE	DIMENSIONS/INCHES		
				H	W	D
	Laminate NR Panel - Double Sided - 30" High	EVPH2S3018NR	666	30	18	2 7/8
		EVPH2S3024NR	666	30	24	2 7/8
		EVPH2S3030NR	786	30	30	2 7/8
		EVPH2S3036NR	898	30	36	2 7/8
		EVPH2S3042NR	1021	30	42	2 7/8
		EVPH2S3048NR	1141	30	48	2 7/8
		EVPH2S3054NR	1264	30	54	2 7/8
	EVPH2S3060NR	1365	30	60	2 7/8	
	Laminate NR Panel - Double Sided - 42" High	EVPH2S4218NR	647	42	18	2 7/8
		EVPH2S4224NR	786	42	24	2 7/8
		EVPH2S4230NR	926	42	30	2 7/8
		EVPH2S4236NR	1075	42	36	2 7/8
		EVPH2S4242NR	1225	42	42	2 7/8
		EVPH2S4248NR	1372	42	48	2 7/8
		EVPH2S4254NR	1509	42	54	2 7/8
	EVPH2S4260NR	1641	42	60	2 7/8	
	Laminate NR Panel - Double Sided - 54" High	EVPH2S5418NR	758	54	18	2 7/8
		EVPH2S5424NR	928	54	24	2 7/8
		EVPH2S5430NR	1099	54	30	2 7/8
		EVPH2S5436NR	1276	54	36	2 7/8
		EVPH2S5442NR	1458	54	42	2 7/8
		EVPH2S5448NR	1639	54	48	2 7/8
		EVPH2S5454NR	1806	54	54	2 7/8
	EVPH2S5460NR	1963	54	60	2 7/8	
	Laminate NR Panel - Double Sided - 66" High	EVPH2S6618NR	954	66	18	2 7/8
		EVPH2S6624NR	1172	66	24	2 7/8
		EVPH2S6630NR	1387	66	30	2 7/8
		EVPH2S6636NR	1610	66	36	2 7/8
		EVPH2S6642NR	1844	66	42	2 7/8
		EVPH2S6648NR	2067	66	48	2 7/8
		EVPH2S6654NR	2282	66	54	2 7/8
	EVPH2S6660NR	2491	66	60	2 7/8	

# PANELS

## FULLY GLAZED MONOLITHIC - NO RACEWAY

### EVPGTNR - FULLY GLAZED SEGMENTED NO RACEWAY PANEL

- Fully Glazed Segmented No Raceway Panels are incorporated in solid steel frame
- There is no base raceway in No Raceway Panels to accommodate electric
- No Raceway connectors to be used
- Standard in clear (CLR) glass.
- Frosted glass (FRST) 40% upcharge
- Aluminum low profile top and bottom cap is included
- Stackability: Evolve panels can be increased in height in 6"H, 12"H, 18"H, 24"H increments. See module listing for part numbers.

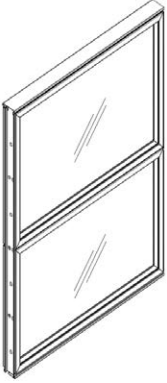
DESCRIPTION	PRODUCT CODE	LIST PRICE	DIMENSIONS/INCHES		
			H	W	D
 Glazed Segmented NR Panel 48" H	EVPGT4818NR	801	48	18	2 7/8
	EVPGT4824NR	984	48	24	2 7/8
	EVPGT4830NR	1089	48	30	2 7/8
	EVPGT4836NR	1188	48	36	2 7/8
	EVPGT4842NR	1316	48	42	2 7/8
	EVPGT4848NR	1467	48	48	2 7/8
	EVPGT4854NR	1615	48	54	2 7/8
	EVPGT4860NR	1762	48	60	2 7/8

### EVPXGTNR - FULLY GLAZED MONOLITHIC NO RACEWAY PANEL

- Fully Glazed Monolithic No Raceway Panels are incorporated in solid steel frame.
- There is no base raceway in No Raceway Panels to accommodate electric.
- No Raceway connectors to be used.
- Standard in clear (CLR) glass.
- Frosted glass (FRST) 40% upcharge.
- Size 90"x36"W is maximum size allowed.
- Panel height to align with standard door height.
- Aluminum low profile top and bottom cap is included.
- Stackability: Evolve panels can be increased in height in 6"H, 12"H, 18"H, 24"H increments. See module listing for part numbers.

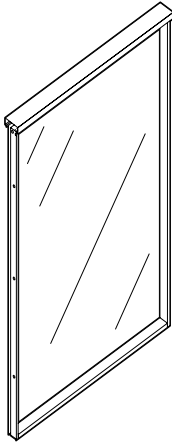
DESCRIPTION	PRODUCT CODE	LIST PRICE	DIMENSIONS/INCHES		
			H	W	D
 Glazed Monolithic NR Panel 90" High	EVPXGT9018NR	1018	90	18	2 7/8
	EVPXGT9024NR	1161	90	24	2 7/8
	EVPXGT9030NR	1317	90	30	2 7/8
	EVPXGT9036NR	1424	90	36	2 7/8

# PANELS

# INLINE CONNECTOR - NO RACEWAY

## EVPICNR - INLINE CONNECTOR NO RACEWAY PANEL

- Connects two No Raceway Panels in a straight run.
- Provides slotted support for worksurfaces and hang on components.
- Includes one slotted connector with leveling glide and connecting hardware.
- Connectors are available without slots, as a special at no extra charge. Contact Customer Support.

	DESCRIPTION	PRODUCT CODE	LIST PRICE	DIMENSIONS/INCHES		
				H	W	D
	Inline Connector No Raceway Panel	EVPIC30NR	83	30	2	
	To be used only with 90" H NR Glazed Panels	EVPIC42NR	97	42	2	
		EVPIC48NR	101	48	2	
		EVPIC54NR	104	54	2	
		EVPIC66NR	116	66	2	

## EVPICPNR - INLINE CONNECTOR PANEL - NO RACEWAY PANEL

- Connects Panel to No Raceway panel in straight run.
- Provides slotted support for worksurfaces and hang on components.
- Includes one slotted connector with leveling glide and connecting hardware.
- Connectors are available without slots, as a special at no extra charge. Contact Customer Support.
- Note: Allows to connect panel to NR panel in straight run.

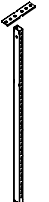
	DESCRIPTION	PRODUCT CODE	LIST PRICE	DIMENSIONS/INCHES		
				H	W	D
	Inline Connector Panel - No Raceway Panel	EVPIC30PNR	80	30	2	
		EVPIC42PNR	93	42	2	
		EVPIC48PNR	97	48	2	
		EVPIC54PNR	99	54	2	
		EVPIC66PNR	110	66	2	

## EVPIC90NR - INLINE CONNECTOR NO RACEWAY PANEL

- Connects two 90" H No Raceway panel in straight run.
- Includes one slotted connector with leveling glide and connecting hardware.
- Connectors are without slots
- To be used only with 90" H NR Glazed Panels.

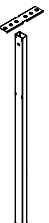
	DESCRIPTION	PRODUCT CODE	LIST PRICE	DIMENSIONS/INCHES		
				H	W	D
	Inline Connector No Raceway Panel	EVPIC90NR	174	90	2	

# PANELS

# INLINE CONNECTOR - NO RACEWAY

## EVVIC90PNR - INLINE CONNECTOR PANEL - NO RACEWAY PANEL

- Connects 90" H No Raceway panel to 90" H door in straight run.
- Includes one non slotted connector with leveling glide and connecting hardware
- Connectors are without slots.
- Note: To be used only with 90" H NR Glazed Panels and 90" H door

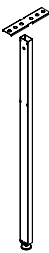
	DESCRIPTION	PRODUCT CODE	LIST PRICE	DIMENSIONS/INCHES		
				H	W	D
	Inline Connector Panel - No Raceway Panel	EVVIC90PNR	174	90	2	

## EVVICNR - INLINE VARIABLE HEIGHT CONNECTOR NO RACEWAY PANEL

- Connects two No Raceway panels of differing height in straight run.
- Connector must reference taller panel.
- Can be used for any variation of panel height.
- Variable height trim must be ordered separately (see EVPTVA).
- Provides slotted support for worksurfaces and hang on components.
- Includes one slotted connector with leveling glide and connecting hardware.
- Connectors are available without slots, as a special at no extra charge. Contact customer support..

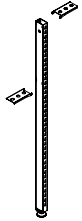
	DESCRIPTION	PRODUCT CODE	LIST PRICE	DIMENSIONS/INCHES		
				H	W	D
	Inline Variable Height Connector	EVVIC42NR	104	42	2	
	No Raceway Panel	EVVIC48NR	106	48	2	
		EVVIC54NR	109	54	2	
		EVVIC66NR	117	66	2	

## EVVICPNR - INLINE VARIABLE HEIGHT CONNECTOR PANEL - NO RACEWAY PANEL

- Connects Panel to No Raceway panels of differing height in straight run.
- Connector must reference taller panel.
- Can be used for any variation of panel height.
- Variable height trim must be ordered separately (see EVPTVA).
- Provides slotted support for worksurfaces and hang on components.
- Includes one slotted connector with leveling glide and connecting hardware.
- Connectors are available without slots, as a special at no extra charge. Contact customer support.
- Note: Allows to connect panel to NR panel in straight run

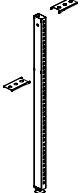
	DESCRIPTION	PRODUCT CODE	LIST PRICE	DIMENSIONS/INCHES		
				H	W	D
	Inline Variable Height Connector	EVVIC42PNR	110	42	2	
	Panel - No Raceway Panel	EVVIC48PNR	117	48	2	
		EVVIC54PNR	132	54	2	
		EVVIC66PNR	146	66	2	

# PANELS

# END OF RUN - NO RACEWAY

## EVPERANR - END OF RUN POST KIT FOR NO RACEWAY PANEL

- Connects at end of No Raceway panel and can attach to a panel to fixed wall.
- Adds 1" to width of panel run.
- Provides slotted support for worksurfaces and hang on components.
- Includes one slotted connector with leveling glide and connecting hardware and glide and connecting hardware and trim kit.
- Can be attached to face of another panel to provide off modular connection.
- Connectors are available without slots, as a special at no extra charge. Contact customer support.

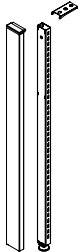
DESCRIPTION	PRODUCT CODE	LIST PRICE	DIMENSIONS/INCHES		
			H	W	D
 End End of Run Post Kit No Raceway Panel	EVPERA30NR	101	30	2	
	EVPERA42NR	116	42	2	
	EVPERA48NR	122	48	2	
	EVPERA54NR	137	54	2	
	EVPERA66NR	152	66	2	

## EVPERA90NR - END OF RUN POST KIT FOR NO RACEWAY PANEL

- Connects two 90" H No Raceway panel and can attach to a panel to fixed wall.
- Adds 1" to width of panel run.
- Includes Non-Slotted connector with leveling glide and connecting hardware and trim kit.
- Can be attached to face of another panel to provide off modular connection.
- Connectors are without slots.
- To be used only with 90" H NR Glazed Panels.

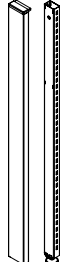
DESCRIPTION	PRODUCT CODE	LIST PRICE	DIMENSIONS/INCHES		
			H	W	D
 End End of Run Post Kit To be used only with 90" H NR Glazed Panels	EVPERA90NR	218	66	2	

# PANELS

# CORNER POST - NO RACEWAY

## EVPCPA1NR - ONE WAY CORNER POST NO RACEWAY PANEL

- Connects at end of No Raceway panel run in place of EVPERA- End of run post kit.
- Should not be used to attach panel to fixed wall.
- Post and connecting hardware add 3.25" to power beam run.
- Provides slotted support for worksurfaces and hang on components.
- Includes post, panel connectors and power beam connectors, post with trim all around, levelling glide, hardware and trim kit.
- Connectors are available without slots, as a special at no extra charge. Contact customer support.

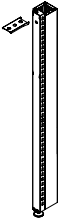
DESCRIPTION	PRODUCT CODE	LIST PRICE	DIMENSIONS/INCHES		
			H	W	D
 One Way Corner Post No Raceway Panel	EVPCPA130NR	134	30	2 7/8	
	EVPCPA142NR	152	42	2 7/8	
	EVPCPA148NR	179	48	2 7/8	
	EVPCPA154NR	204	54	2 7/8	
	EVPCPA166NR	250	66	2 7/8	

## EVPCPA190NR - ONE WAY CORNER POST NO RACEWAY PANEL

- Connects at end of 90" H No Raceway panel run in place of EVPERA - End of run post kit.
- Should not be used to attach panel to fixed wall.
- Post and connecting hardware add 3.25" to power beam run.
- Includes post, panel connectors and power beam connectors, post with trim all around, levelling glide, hardware and trim kit.
- Connectors are without slots.
- To be used only with 90" H NR Glazed Panels.

DESCRIPTION	PRODUCT CODE	LIST PRICE	DIMENSIONS/INCHES		
			H	W	D
 One Way Corner Post No Raceway Panel To be used only with 90" H NR Glazed Panels	EVPCPA190NR	369	90	2 7/8	

# PANELS

# CORNER POST - NO RACEWAY

## EVPIPA2NR - INLINE TWO WAY CORNER POST NO RACEWAY PANEL

- Connects two No Raceway panel of equal height in straight run.
- Post and connecting hardware add 3.25" to power beam run.
- Provides slotted support for worksurfaces and hang on components.
- Includes post, panel connectors and power beam connectors, post with trim all around, levelling glide, hardware and trim kit.
- Connectors are available without slots, as a special at no extra charge. Contact customer support.

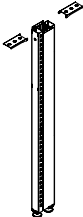
	DESCRIPTION	PRODUCT CODE	LIST PRICE	DIMENSIONS/INCHES		
				H	W	D
	Inline Two Way Corner Post	EVPIPA230NR	183	30	2 7/8	
	No Raceway Panel	EVPIPA242NR	232	42	2 7/8	
		EVPIPA248NR	253	48	2 7/8	
		EVPIPA254NR	277	54	2 7/8	
		EVPIPA266NR	328	66	2 7/8	

## EVPIPA290NR - INLINE TWO WAY CORNER POST NO RACEWAY PANEL

- Connects two No Raceway panel of equal height in a straight run.
- Post and connecting hardware add 3.25" to power beam run.
- Includes post, panel connectors and power beam connectors, post with trim all around, levelling glide, hardware and trim kit.
- Connectors are without slots.
- To be used only with 90" H NR Glazed Panels.

	DESCRIPTION	PRODUCT CODE	LIST PRICE	DIMENSIONS/INCHES		
				H	W	D
	Inline Two Way Corner Post No Raceway Panel To be used only with 90" H NR Glazed Panels	EVPIPA290NR	493	90	2 7/8	

# PANELS

# CORNER POST - NO RACEWAY

## EVPCPA2PNR - TWO WAY CORNER POST NO RACEWAY PANEL-PANEL

- Connects No Raceway panel and Raceway Panel of equal height in 90 degree configuration.
- Post and connecting hardware add 3.25" to power beam run.
- Provides slotted support for worksurfaces and hang on components.
- Includes post, panel connectors and power beam connectors, post with trim all around, levelling glide, hardware and trim kit.
- Connectors are available without slots, as a special at no extra charge. Contact customer support.

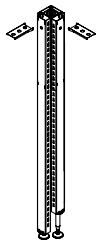
DESCRIPTION	PRODUCT CODE	LIST PRICE	DIMENSIONS/INCHES		
			H	W	D
 <p>Two Way Corner Post No Raceway Panel</p>	EVPCPA230PNR	188	30	2 7/8	
	EVPCPA242PNR	235	42	2 7/8	
	EVPCPA248PNR	250	48	2 7/8	
	EVPCPA254PNR	289	54	2 7/8	
	EVPCPA266PNR	344	66	2 7/8	

## EVPCPA290NR - TWO WAY CORNER POST NO RACEWAY PANEL

- Connects two 90" H No Raceway panels of equal height in "T" configuration.
- Post and connecting hardware add 3.25" to power beam run.
- Includes post, panel connectors and power beam connectors, post with trim all around, levelling glide, hardware and trim kit.
- Connectors are without slots.
- To be used only with 90" H NR Glazed Panels.

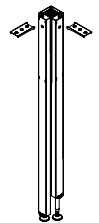
DESCRIPTION	PRODUCT CODE	LIST PRICE	DIMENSIONS/INCHES		
			H	W	D
 <p>Two Way Corner Post No Raceway Panel To be used only with 90" H NR Glazed Panels</p>	EVPCPA290NR	494	90	2 7/8	

# PANELS

# CORNER POST - NO RACEWAY

## EVPCPA3PNR - THREE WAY CORNER POST NO RACEWAY PANEL-PANEL-NO RACEWAY PANEL

- Connects two No Raceway panels and Raceway Panels of equal height in "T" configuration.
- Post and connecting hardware add 3.25" to power beam run.
- Provides slotted support for worksurfaces and hang on components.
- Includes post, panel connectors and power beam connectors, post with trim all around, levelling glide, hardware and trim kit.
- Connectors are available without slots, as a special at no extra charge. Contact customer support.

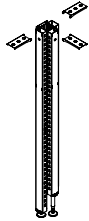

DESCRIPTION	PRODUCT CODE	LIST PRICE	DIMENSIONS/INCHES		
			H	W	D
Three Way Corner Post	EVPCPA330PNR	234	30	2 7/8	
No Raceway Panel	EVPCPA342PNR	312	42	2 7/8	
	EVPCPA348PNR	344	48	2 7/8	
	EVPCPA354PNR	377	54	2 7/8	
	EVPCPA366PNR	445	66	2 7/8	

## EVPCPA3PNRP - THREE WAY CORNER POST PANEL-NO RACEWAY PANEL-PANEL

- Connects two panels and No raceway Panel of equal height in "T" configuration.
- Post and connecting hardware add 3.25" to power beam run.
- Provides slotted support for worksurfaces and hang on components.
- Includes post, panel connectors and power beam connectors, post with trim all around, levelling glide, hardware and trim kit.
- Connectors available without slots, as a special at no extra charge. Contact CustomerCare

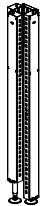

DESCRIPTION	PRODUCT CODE	LIST PRICE	DIMENSIONS/INCHES		
			H	W	D
Three Way Corner Post	EVPCPA330PNRP	234	30	2 7/8	
No Raceway Panel	EVPCPA342PNRP	312	42	2 7/8	
	EVPCPA348PNRP	344	48	2 7/8	
	EVPCPA354PNRP	377	54	2 7/8	
	EVPCPA366PNRP	445	66	2 7/8	

## EVPCPA390NR - THREE WAY CORNER POST NO RACEWAY PANEL

- Connects two 90" H No Raceway panels of equal height in "T" configuration.
- Post and connecting hardware add 3.25" to power beam run.
- Includes post, panel connectors and power beam connectors, post with trim all around, levelling glide, hardware and trim kit.
- Connectors are without slots.
- To be used only with 90" H NR Glazed Panels.

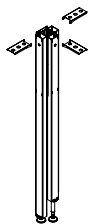

DESCRIPTION	PRODUCT CODE	LIST PRICE	DIMENSIONS/INCHES		
			H	W	D
Three Way Corner Post	EVPCPA390NR	623	90	2 7/8	
No Raceway Panel					
To be used only with 90" H NR Glazed Panels					

# PANELS

# CORNER POST - NO RACEWAY

## EVPCPA4PNR - FOUR WAY CORNER POST NO RACEWAY PANEL-PANEL-NO RACEWAY PANEL-PANEL

- Connects two No Raceway panels and two Raceway panels of equal height in "+" configuration.
- Post and connecting hardware add 3.25" to power beam run.
- Provides slotted support for worksurfaces and hang on components.
- Includes post, panel connectors and power beam connectors, post with trim all around, levelling glide, hardware and trim kit.
- Connectors are available without slots, as a special at no extra charge. Contact customer support.

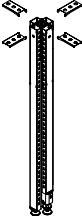
DESCRIPTION	PRODUCT CODE	LIST PRICE	DIMENSIONS/INCHES		
			H	W	D
 <p>Four Way Corner Post No Raceway Panel</p>	EVPCPA430PNR	286	30	2 7/8	
	EVPCPA442PNR	365	42	2 7/8	
	EVPCPA448PNR	405	48	2 7/8	
	EVPCPA454PNR	441	54	2 7/8	
	EVPCPA466PNR	517	66	2 7/8	

## EVPCPA490NR - FOUR WAY CORNER POST NO RACEWAY PANEL

- Connects four 90" H No Raceway panels of equal height in "+" configuration.
- Post and connecting hardware add 3.25" to power beam run.
- Includes post, panel connectors and power beam connectors, post with trim all around, levelling glide, hardware and trim kit.
- Connectors are without slots.
- To be used only with 90" H NR Glazed Panels.

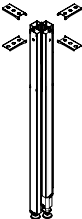
DESCRIPTION	PRODUCT CODE	LIST PRICE	DIMENSIONS/INCHES		
			H	W	D
 <p>Four Way Corner Post No Raceway Panel To be used only with 90" H NR Glazed Panels</p>	EVPCPA490NR	715	90	2 7/8	

# PANELS

# GALLERY

## EVLEPDSNC - LAMINATE DOUBLE SIDED GALLERY PANEL, FINISHED ENDS

- Attaches to end of run connector with "U" channel.
- To be installed at end of panel run.
- Finished in thermally fused laminate.
- No connection on both sides.
- Laminate Gallery Panel height is inclusive of panel glides extended to their full height.
- If wood grain is selected, grain runs horizontally.
- End of run connector with "U" channel and bottom connecting brackets to be ordered separately.

	DESCRIPTION	PRODUCT CODE	LIST PRICE	DIMENSIONS/INCHES		
			LP	H	W	D
	Laminate Double Sided Gallery Panel	EVLEPDS4251NC	741	42	51	1
	Finished Ends - 42" High	EVLEPDS4263NC	965	42	63	1
		EVLEPDS4275NC	1188	42	75	1
	Laminate Double Sided Gallery Panel	EVLEPDS4851NC	807	48	51	1
	Finished Ends - 48" High	EVLEPDS4863NC	1069	48	63	1
		EVLEPDS4875NC	1299	48	75	1
	Laminate Double Sided Gallery Panel	EVLEPDS5451NC	937	54	51	1
	Finished Ends - 54" High	EVLEPDS5463NC	1224	54	63	1
		EVLEPDS5475NC	1415	54	75	1

## EVLEPDS - LAMINATE DOUBLE SIDED GALLERY PANEL, CONNECTOR ENDS

- Attaches to end of run connector with "U" channel.
- To be installed at end of panel run.
- Finished in thermally fused laminate.
- Locking connection both sides.
- Laminate Gallery Extension Panel height is inclusive of panel glides extended to their full height.
- If wood grain is selected, grain runs horizontally.
- End of run connector with "U" channel and bottom connecting brackets to be ordered separately.





	DESCRIPTION	PRODUCT CODE	LIST PRICE	DIMENSIONS/INCHES		
			LP	H	W	D
	Laminate Double Sided Gallery	EVLEPDS4251	741	42	51	1
	Panel - Connector Ends - 42" High	EVLEPDS4263	965	42	63	1
		EVLEPDS4275	1188	42	75	1
	Laminate Double Sided Gallery	EVLEPDS4851	807	48	51	1
	Panel - Connector Ends - 48" High	EVLEPDS4863	1069	48	63	1
		EVLEPDS4875	1299	48	75	1
	Laminate Double Sided Gallery	EVLEPDS5451	937	54	51	1
	Panel - Connector Ends - 54" High	EVLEPDS5463	1224	54	63	1
		EVLEPDS5475	1415	54	75	1

# PANELS

# GALLERY

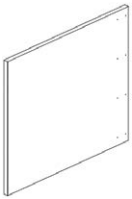
## EVLEPSSNC - LAMINATE SINGLE SIDED GALLERY PANEL, FINISHED ENDS

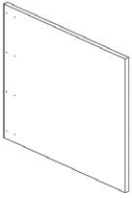
- Attaches to end of run connector with "U" channel.
- To be installed at end of panel run on one side.
- Finished in thermally fused laminate.
- No connection both sides.
- Laminate Gallery Extension Panel height is inclusive of panel glides extended to their full height.
- If wood grain is selected, grain runs horizontally.
- End of run connector with "U" channel and bottom connecting brackets to be ordered separately.





	DESCRIPTION	PRODUCT CODE	LIST PRICE LP	DIMENSIONS/INCHES		
				H	W	D
	Laminate Single Sided Gallery Panel - Finished Ends - 42" High	EVLEPSSL4227NC	482	42	27	1
		EVLEPSSL4233NC	538	42	33	1
		EVLEPSSL4239NC	604	42	39	1
		EVLEPSSL4245NC	692	42	45	1
		EVLEPSSL4251NC	741	42	51	1
	Laminate Single Sided Gallery Panel - Finished Ends - 48" High	EVLEPSSL4827NC	527	48	27	1
		EVLEPSSL4833NC	598	48	33	1
		EVLEPSSL4839NC	669	48	39	1
		EVLEPSSL4845NC	741	48	45	1
		EVLEPSSL4851NC	839	48	51	1
	Laminate Single Sided Gallery Panel - Finished Ends - 54" High	EVLEPSSL5427NC	579	54	27	1
		EVLEPSSL5433NC	662	54	33	1
		EVLEPSSL5439NC	754	54	39	1
		EVLEPSSL5445NC	882	54	45	1
		EVLEPSSL5451NC	937	54	51	1
	Laminate Single Sided Gallery Panel - Finished Ends - 42" High	EVLEPSSR4227NC	482	42	27	1
		EVLEPSSR4233NC	538	42	33	1
		EVLEPSSR4239NC	604	42	39	1
		EVLEPSSR4245NC	692	42	45	1
		EVLEPSSR4251NC	741	42	51	1
	Laminate Single Sided Gallery Panel - Finished Ends - 48" High	EVLEPSSR4827NC	527	48	27	1
		EVLEPSSR4833NC	598	48	33	1
		EVLEPSSR4839NC	669	48	39	1
		EVLEPSSR4845NC	741	48	45	1
		EVLEPSSR4851NC	839	48	51	1
	Laminate Single Sided Gallery Panel - Finished Ends - 54" High	EVLEPSSR5427NC	807	54	27	1
		EVLEPSSR5433NC	662	54	33	1
		EVLEPSSR5439NC	754	54	39	1
		EVLEPSSR5445NC	882	54	45	1
		EVLEPSSR5451NC	937	54	51	1

# PANELS

# GALLERY

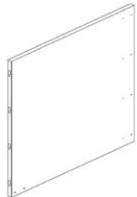
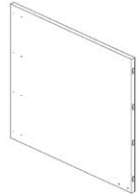
## EVLEPSS - LAMINATE SINGLE SIDED GALLERY PANEL, CONNECTOR END

- Attaches to end of run connector with "U" channel.
- To be installed at end of panel run on one side.
- Finished in thermally fused laminate.
- Locking connection on one side.
- Laminate Gallery Extension Panel height is inclusive of panel glides extended to their full height.
- If wood grain is selected, grain runs horizontally.
- End of run connector with "U" channel and bottom connecting brackets to be ordered separately

	DESCRIPTION	PRODUCT CODE	LIST PRICE	DIMENSIONS/INCHES		
			LP	H	W	D
	Laminate Single Sided Gallery Panel - Connector Ends - 42" High	EVLEPSSL4227	482	42	27	1
		EVLEPSSL4233	538	42	33	1
		EVLEPSSL4239	604	42	39	1
		EVLEPSSL4245	692	42	45	1
		EVLEPSSL4251	741	42	51	1
	Laminate Single Sided Gallery Pannel - Connector Ends - 48" High	EVLEPSSL4827	527	48	27	1
		EVLEPSSL4833	598	48	33	1
		EVLEPSSL4839	669	48	39	1
		EVLEPSSL4845	741	42	45	1
		EVLEPSSL4851	839	42	51	1
	Laminate Single Sided Gallery Pannel - Connector Ends - 54" High	EVLEPSSL5427	579	54	27	1
		EVLEPSSL5433	662	54	33	1
		EVLEPSSL5439	754	42	39	1
		EVLEPSSL5445	882	54	45	1
		EVLEPSSL5451	937	42	51	1
	Laminate Single Sided Gallery Pannel - Connector Ends - 42" High	EVLEPSSR4227	482	42	27	1
		EVLEPSSR4233	538	42	33	1
		EVLEPSSR4239	604	42	39	1
		EVLEPSSR4245	692	42	45	1
		EVLEPSSR4251	741	42	51	1
	Laminate Single Sided Gallery Pannel - Connector Ends - 48" High	EVLEPSSR4827	527	48	27	1
		EVLEPSSR4833	598	48	33	1
		EVLEPSSR4839	669	48	39	1
		EVLEPSSR4845	741	42	45	1
		EVLEPSSR4851	839	42	51	1
	Laminate Single Sided Gallery Pannel - Connector Ends - 54" High	EVLEPSSR5427	579	54	27	1
		EVLEPSSR5433	662	54	33	1
		EVLEPSSR5439	754	54	39	1
		EVLEPSSR5445	882	42	45	1
		EVLEPSSR5451	937	42	51	1

# PANELS

# GALLERY

## EVLEPDCNC - LAMINATE DOUBLE SIDED MIDDLE GALLERY PANEL, BASE POWER, FINISHED ENDS

- Attaches in middle of panel run with connector with "U" channel.
- To be installed in middle between two panels in straight run.
- Finished in thermally fused laminate.
- Locking connection on both side.
- Laminate Gallery Panel height is inclusive of panel glides extended to their full height.
- If wood grain is selected, grain runs horizontally.
- End of run connector with "U" channel and bottom connecting brackets to be ordered separately.

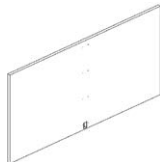

DESCRIPTION	PRODUCT CODE	LIST PRICE LP	DIMENSIONS/INCHES		
			H	W	D
Laminate Double Sided Gallery Panel Finished Ends - 42" High	EVLEPDC4251NC	937	42	51	1
	EVLEPDC4263NC	965	42	63	1
	EVLEPDC4275NC	1188	42	75	1
Laminate Double Sided Gallery Panel Finished Ends - 48" High	EVLEPDC4851NC	807	48	51	1
	EVLEPDC4863NC	1069	48	63	1
	EVLEPDC4875NC	1299	48	75	1
Laminate Double Sided Gallery Panel Finished Ends - 54" High	EVLEPDC4851NC	807	54	51	1
	EVLEPDC4863NC	1069	54	63	1
	EVLEPDC4875NC	1299	54	75	1

## EVICLXPNC - LAMINATE DOUBLE SIDED MIDDLE GALLERY PANEL, BELTLINE POWER, FINISHED ENDS

- Attaches in middle of panel run with connector with "U" channel
- To be installed in middle between two beltline panels in straight run .
- Finished in thermally fused laminate.
- No connection both sides.
- Laminate Gallery Panel height is inclusive of panel glides extended to their full height.
- If wood grain is selected, grain runs horizontally.
- End of run connector with "U" channel and bottom connecting brackets to be ordered separately.



DESCRIPTION	PRODUCT CODE	LIST PRICE LP	DIMENSIONS/INCHES		
			H	W	D
Laminate Double Sided Middle Gallery Panel - Finished Ends - 42" High	EVICLXP4251NC	741	42	51	1
	EVICLXP4263NC	965	42	63	1
	EVICLXP4275NC	1188	42	75	1
Laminate Double Sided Middle Gallery Panel - Finished Ends - 48" High	EVICLXP4851NC	807	48	51	1
	EVICLXP4863NC	1069	48	63	1
	EVICLXP4875NC	1299	48	75	1
Laminate Double Sided Middle Gallery Panel - Finished Ends - 54" High	EVICLXP5451NC	937	54	51	1
	EVICLXP5463NC	1224	54	63	1
	EVICLXP5475NC	1415	54	75	1

**EVLEPDC - LAMINATE DOUBLE SIDED MIDDLE GALLERY PANEL, BASE POWER, CONNECTOR ENDS**

- Attaches to end of run connector with "U" channel.
- To be installed in middle between two panels in straight run.
- Finished in thermally fused laminate.
- Locking connection both sides.
- Laminate Gallery Extension Panel height is inclusive of panel glides extended to their full height.
- If wood grain is selected, grain runs horizontally.
- End of run connector with "U" channel and bottom connecting brackets to be ordered separately.

	DESCRIPTION	PRODUCT CODE	LIST PRICE	DIMENSIONS/INCHES		
			LP	H	W	D
	Laminate Double Sided Middle Gallery Panel - Connector End - 42" High	EVLEPDC4251	741	42	51	1
		EVLEPDC4263	965	42	63	1
		EVLEPDC4275	1188	42	75	1
	Laminate Single Sided Middle Gallery Panel - Connector End - 48" High	EVLEPDC4851	807	48	51	1
		EVLEPDC4863	1069	48	63	1
		EVLEPDC4875	1299	48	75	1
	Laminate Single Sided Middle Gallery Panel - Connector End - 54" High	EVLEPDC5451	937	54	51	1
		EVLEPDC5463	1224	54	63	1
		EVLEPDC5475	1415	54	75	1

**EVICLXP - LAMINATE DOUBLE SIDED MIDDLE GALLERY PANEL, BELTLINE POWER, CONNECTOR ENDS**

- Attaches in middle of panel run with connector with "U" channel.
- To be installed in middle between two panels in straight run on one side.
- Finished in thermally fused laminate.
- Locking connection on both sides.
- Laminate Gallery Panel height is inclusive of panel glides extended to their full height.
- If wood grain is selected, grain runs horizontally.
- End of run connector with "U" channel and bottom connecting brackets to be ordered separately.

	DESCRIPTION	PRODUCT CODE	LIST PRICE	DIMENSIONS/INCHES		
			LP	H	W	D
	Laminate Double Sided Gallery Panel Connector Ends - 42" High	EVICLXP4251	741	42	51	1
		EVICLXP4263	965	42	63	1
		EVICLXP4275	1188	42	75	1
	Laminate Double Sided Gallery Panel Connector Ends - 42" High	EVICLXP4851	807	48	51	1
		EVICLXP4863	1069	48	63	1
		EVICLXP4875	1299	48	75	1
	Laminate Double Sided Gallery Panel Connector Ends - 42" High	EVICLXP5451	937	54	51	1
		EVICLXP5463	1224	54	63	1
		EVICLXP5475	1415	42	75	1

# PANELS

# GALLERY

## EVLEPSCNC - LAMINATE SINGLE SIDED MIDDLE GALLERY PANEL, BASE POWER, FINISHED ENDS

- Attaches in middle of panel run with connector with "U" channel.
- To be installed in middle between two panels in straight run on one side.
- Cut out for electrics at base height.
- Finished in thermally fused laminate.
- No connection both sides.
- Laminate Gallery Panel height is inclusive of panel glides extended to their full height.
- If wood grain is selected, grain runs horizontally.
- End of run connector with "U" channel and bottom connecting brackets to be ordered separately.

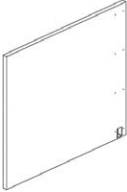
DESCRIPTION	PRODUCT CODE	LIST PRICE LP	DIMENSIONS/INCHES		
			H	W	D
 Laminate Single Sided Gallery Panel - Finished End - 42" High	EVLEPSC4227NC	482	42	27	1
	EVLEPSC4233NC	538	42	33	1
	EVLEPSC4239NC	604	42	39	1
	EVLEPSC4245NC	692	42	45	1
	EVLEPSC4251NC	741	42	51	1
 Laminate Single Sided Gallery Panel - Finished End - 48" High	EVLEPSC4827NC	527	48	27	1
	EVLEPSC4833NC	598	48	33	1
	EVLEPSC4839NC	669	48	39	1
	EVLEPSC4845NC	741	48	45	1
	EVLEPSC4851NC	839	48	51	1
 Laminate Single Sided Gallery Panel - Finished End - 54" High	EVLEPSC5427NC	579	54	27	1
	EVLEPSC5433NC	662	54	33	1
	EVLEPSC5439NC	754	54	39	1
	EVLEPSC5445NC	882	54	45	1
	EVLEPSC5451NC	937	54	51	1

## EVLEPSC - LAMINATE SINGLE SIDED MIDDLE GALLERY PANEL, BASE POWER, CONNECTOR END

- Attaches in middle of panel run with connector with "U" channel.
- To be installed in middle between two panels in straight run on one side.
- Finished in thermally fused laminate.
- Locking connection on one side.
- Laminate Gallery Panel height is inclusive of panel glides extended to their full height.
- If wood grain is selected, grain runs horizontally.
- End of run connector with "U" channel and bottom connecting brackets to be ordered separately.

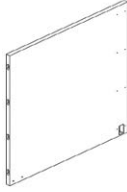
DESCRIPTION	PRODUCT CODE	LIST PRICE LP	DIMENSIONS/INCHES		
			H	W	D
 Laminate Single Sided Middle Gallery Panel - Connector Ends - 42" High	EVLEPSC4227	482	42	27	1
	EVLEPSC4233	538	42	33	1
	EVLEPSC4239	604	42	39	1
	EVLEPSC4245	692	42	45	1
	EVLEPSC4251	741	42	51	1
 Laminate Single Sided Middle Gallery Panel - Connector Ends - 48" High	EVLEPSC4827	527	48	27	1
	EVLEPSC4833	598	48	33	1
	EVLEPSC4839	669	48	39	1
	EVLEPSC4845	741	42	45	1
	EVLEPSC4851	839	42	51	1
 Laminate Single Sided Middle Gallery Panel - Connector Ends - 54" High	EVLEPSC5427	579	54	27	1
	EVLEPSC5433	662	54	33	1
	EVLEPSC5439	754	42	39	1
	EVLEPSC5445	882	54	45	1
	EVLEPSC5451	937	42	51	1

# PANELS

# GALLERY

## EVLEPSCNC - LAMINATE SINGLE SIDED MIDDLE GALLERY PANEL, BELTLINE POWER, FINISHED ENDS

- Attaches in middle of panel run with connector with "U" channel.
- To be installed in middle between two beltline panels in straight run.
- Cut out for electrics at beltline height.
- Finished in thermally fused laminate.
- No connection both sides.
- Laminate Gallery Panel height is inclusive of panel glides extended to their full height.
- If wood grain is selected, grain runs horizontally.
- End of run connector with "U" channel and bottom connecting brackets to be ordered separately.

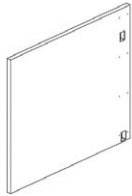
DESCRIPTION	PRODUCT CODE	LIST PRICE LP	DIMENSIONS/INCHES		
			H	W	D
 Laminate Single Sided Gallery Panel Finished Ends - 42" High	EVLEPSCB4227NC	482	42	27	1
	EVLEPSCB4233NC	538	42	33	1
	EVLEPSCB4239NC	604	42	39	1
	EVLEPSCB4245NC	741	42	45	1
	EVLEPSCB4251NC	741	42	51	1
Laminate Single Sided Gallery Panel Finished Ends - 48" High	EVLEPSCB4827NC	527	48	27	1
	EVLEPSCB4833NC	598	48	33	1
	EVLEPSCB4839NC	669	48	39	1
	EVLEPSCB4845NC	741	48	45	1
	EVLEPSCB4851NC	839	48	51	1
Laminate Single Sided Gallery Panel Finished Ends - 54" High	EVLEPSCB5427NC	579	54	27	1
	EVLEPSCB5433NC	662	54	33	1
	EVLEPSCB5439NC	754	54	39	1
	EVLEPSCB5445NC	882	54	45	1
	EVLEPSCB5451NC	937	54	51	1

## EVLEPSC - LAMINATE SINGLE SIDED MIDDLE GALLERY PANEL, BELTLINE POWER, CONNECTOR END

- Attaches in middle of panel run with connector with "U" channel.
- To be installed in middle between two panels in straight run on one side.
- Finished in thermally fused laminate.
- Locking connection on one side.
- Laminate Gallery Panel height is inclusive of panel glides extended to their full height.
- If wood grain is selected, grain runs horizontally.
- End of run connector with "U" channel and bottom connecting brackets to be ordered separately.

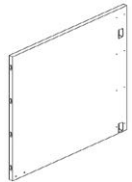



DESCRIPTION	PRODUCT CODE	LIST PRICE LP	DIMENSIONS/INCHES		
			H	W	D
 Laminate Single Sided Middle Gallery Panel - Connector Ends - 42" High	EVLEPSCB4227	482	42	27	1
	EVLEPSCB4233	538	42	33	1
	EVLEPSCB4239	604	42	39	1
	EVLEPSCB4245	692	42	45	1
	EVLEPSCB4251	741	42	51	1
Laminate Single Sided Middle Gallery Panel - Connector Ends - 48" High	EVLEPSCB4827	527	48	27	1
	EVLEPSCB4833	598	48	33	1
	EVLEPSCB4839	669	48	39	1
	EVLEPSCB4845	741	48	45	1
	EVLEPSCB4851	839	48	51	1
Laminate Single Sided Middle Gallery Panel - Connector Ends - 54" High	EVLEPSCB5427	579	54	27	1
	EVLEPSCB5433	662	54	33	1
	EVLEPSCB5439	754	54	39	1
	EVLEPSCB5445	882	54	45	1
	EVLEPSCB5451	937	42	51	1

# PANELS

# GALLERY

## EVLXPMMC - LAMINATE GALLERY EXTENSION PANEL, FINISHED END

- Locking connection on one side, no connection at end.
- Finished in thermally fused laminate.
- Laminate Gallery Extension Panel height is inclusive of panel glides extended to their full height.
- If wood grain is selected, grain runs horizontally.
- Bottom connecting brackets to be ordered separately.



	DESCRIPTION	PRODUCT CODE	LIST PRICE LP	DIMENSIONS/INCHES		
				H	W	D
	Laminate Gallery Extension Panel	EVLPML4224NC	395	42	24	1
	Finished End - 42" High	EVLPML4230NC	482	42	30	1
		EVLPML4236NC	538	42	36	1
		EVLPML4242NC	603	42	42	1
		EVLPML4248NC	691	42	48	1
	Laminate Gallery Extension Panel	EVLPML4824NC	454	48	24	1
	Finished End - 48" High	EVLPML4830NC	527	48	30	1
		EVLPML4836NC	598	48	36	1
		EVLPML4842NC	669	48	42	1
		EVLPML4848NC	741	48	48	1
	Laminate Gallery Extension Panel	EVLPML5424NC	807	54	24	1
	Finished End - 54" High	EVLPML5430NC	579	54	30	1
		EVLPML5436NC	662	54	36	1
		EVLPML5442NC	754	54	42	1
		EVLPML5448NC	882	54	48	1
	Laminate Gallery Extension Panel	EVLXPMR4224NC	395	42	24	1
	Finished End - 42" High	EVLXPMR4230NC	482	42	30	1
		EVLXPMR4236NC	538	42	36	1
		EVLXPMR4242NC	603	42	42	1
		EVLXPMR4248NC	691	42	48	1
	Laminate Gallery Extension Panel	EVLXPMR4824NC	454	48	24	1
	Finished End - 48" High	EVLXPMR4830NC	527	48	30	1
		EVLXPMR4836NC	598	48	36	1
		EVLXPMR4842NC	669	48	42	1
		EVLXPMR4848NC	741	48	48	1
	Laminate Gallery Extension Panel	EVLXPMR5424NC	495	54	24	1
	Finished End - 54" High	EVLXPMR5430NC	579	54	30	1
		EVLXPMR5436NC	662	54	36	1
		EVLXPMR5442NC	754	54	42	1
		EVLXPMR5448NC	882	54	48	1

# PANELS

# GALLERY

## EVLXPM - LAMINATE GALLERY STRAIGHT EXTENSION PANEL, CONNECTOR ENDS

- Locking connection both sides.
- Finished in thermally fused laminate.
- Laminate Gallery Panel height is inclusive of panel glides extended to their full height.
- If wood grain is selected, grain runs horizontally.
- Bottom connecting brackets to be ordered separately.



	DESCRIPTION	PRODUCT CODE	LIST PRICE LP	DIMENSIONS/INCHES		
				H	W	D
	Laminate Gallery Straight Extension	EVLXPML4224	741	42	24	1
	Panel - Connector Ends - Left - 42" High	EVLXPML4230	482	42	30	1
		EVLXPML4236	538	42	36	1
		EVLXPML4242	603	42	42	1
		EVLXPML4248	691	42	48	1
	Laminate Gallery Straight Extension	EVLXPML4824	454	48	24	1
	Panel - Connector Ends - Left - 48" High	EVLXPML4830	527	48	30	1
		EVLXPML4836	598	48	36	1
		EVLXPML4842	669	48	42	1
		EVLXPML4848	741	48	48	1
	Laminate Gallery Straight Extension	EVLXPML5424	495	54	24	1
	Panel - Connector Ends - Left - 54" High	EVLXPML5430	579	54	30	1
		EVLXPML5436	662	54	36	1
		EVLXPML5442	754	54	42	1
		EVLXPML5448	882	54	48	1
	Laminate Gallery Straight Extension	EVLXPMR4224	395	42	24	1
	Panel - Connector Ends - Right - 42" High	EVLXPMR4230	482	42	30	1
		EVLXPMR4236	538	42	36	1
		EVLXPMR4242	603	42	42	1
		EVLXPMR4248	691	42	48	1
	Laminate Gallery Straight Extension	EVLXPMR4824	454	48	24	1
	Panel - Connector Ends - Right - 48" High	EVLXPMR4830	527	48	30	1
		EVLXPMR4836	598	48	36	1
		EVLXPMR4842	669	48	42	1
		EVLXPMR4848	741	48	48	1
	Laminate Gallery Straight Extension	EVLXPMR5424	495	54	24	1
	Panel - Connector Ends - Right - 54" High	EVLXPMR5430	579	54	30	1
		EVLXPMR5436	662	54	36	1
		EVLXPMR5442	754	54	42	1
		EVLXPMR5448	882	54	48	1

# PANELS

# GALLERY

## EV2LXP - LAMINATE GALLERY TWO-WAY EXTENSION PANEL, FINISHED ENDS

- Panel connects at 90 degree with extension panel.
- Finished in thermally fused laminate.
- Laminate Gallery Extension Panel height is inclusive of panel glides extended to their full height.
- If wood grain is selected, grain runs horizontally.
- Corner connecting brackets to be ordered separately.



	DESCRIPTION	PRODUCT CODE	LIST PRICE LP	DIMENSIONS/INCHES		
				H	W	D
	Laminate Gallery Two-Way Extension	EV2LXPL4225	397	42	25	1
	Panel - Finished Ends - Left - 42" High	EV2LXPL4231	482	42	31	1
		EV2LXPL4237	538	42	37	1
		EV2LXPL4243	604	42	43	1
		EV2LXPL4249	692	42	49	1
	Laminate Gallery Two-Way Extension	EV2LXPL4825	454	48	25	1
	Panel - Finished Ends - Left - 48" High	EV2LXPL4831	527	48	31	1
		EV2LXPL4837	598	48	37	1
		EV2LXPL4843	669	48	43	1
		EV2LXPL4849	741	48	49	1
	Laminate Gallery Two-Way Extension	EV2LXPL5425	532	54	25	1
	Panel - Finished Ends - Left - 54" High	EV2LXPL5431	608	54	31	1
		EV2LXPL5437	683	54	37	1
		EV2LXPL5443	831	54	43	1
		EV2LXPL5449	937	54	49	1
	Laminate Gallery Two-Way Extension	EV2LXPR4225	397	42	25	1
	Panel - Finished Ends - Right - 42" High	EV2LXPR4231	482	42	33	1
		EV2LXPR4237	538	42	37	1
		EV2LXPR4243	604	42	43	1
		EV2LXPR4249	692	42	49	1
	Laminate Gallery Two-Way Extension	EV2LXPR4825	454	48	25	1
	Panel - Finished Ends - Right - 48" High	EV2LXPR4831	527	48	33	1
		EV2LXPR4837	598	48	37	1
		EV2LXPR4843	669	48	43	1
		EV2LXPR4849	741	48	49	1
	Laminate Gallery Two-Way Extension	EV2LXPR5425	532	54	25	1
	Panel - Finished Ends - Right - 54" High	EV2LXPR5431	608	54	31	1
		EV2LXPR5437	683	54	37	1
		EV2LXPR5443	831	54	43	1
		EV2LXPR5449	937	54	49	1

# PANELS

# GALLERY

## EV3LXP - LAMINATE GALLERY THREE-WAY EXTENSION PANEL, FINISHED ENDS

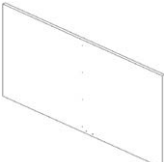
- Panel connects "T" configuration with extension panel.
- Finished in thermally fused laminate.
- Laminate Gallery Extension Panel height is inclusive of panel glides extended to their full height.
- If wood grain is selected, grain runs horizontally.
- Corner connecting brackets to be ordered separately.

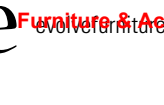
	DESCRIPTION	PRODUCT CODE	LIST PRICE LP	DIMENSIONS/INCHES		
				H	W	D
	Laminate Gallery Three-Way Extension Panel - Finished Ends - Left - 42" High	EV3LXPL4249	741	42	49	1
		EV3LXPL4261	882	42	61	1
		EV3LXPL4273	1027	42	73	1
	Laminate Gallery Three-Way Extension Panel - Finished Ends - Left - 48" High	EV3LXPL4849	839	48	49	1
		EV3LXPL4861	1031	48	61	1
		EV3LXPL4873	1224	48	73	1
	Laminate Gallery Three-Way Extension Panel - Finished Ends - Left - 54" High	EV3LXPL5449	937	54	49	1
		EV3LXPL5461	1224	54	61	1
		EV3LXPL5473	1415	54	73	1
	Laminate Gallery Three-Way Extension Panel - Finished Ends - Left - 42" High	EV3LXPR4249	741	42	49	1
		EV3LXPR4261	882	42	61	1
		EV3LXPR4273	1027	42	73	1
	Laminate Gallery Three-Way Extension Panel - Finished Ends - Left - 48" High	EV3LXPR4849	839	48	49	1
		EV3LXPR4861	1031	48	61	1
		EV3LXPR4873	1224	48	73	1
	Laminate Gallery Three-Way Extension Panel - Finished Ends - Left - 54" High	EV3LXPR5449	937	54	49	1
		EV3LXPR5461	1224	54	61	1
		EV3LXPR5473	1415	54	73	1

**EV4LXP - LAMINATE DOUBLE GALLERY PANEL FOR FOUR-WAY, FINISHED ENDS**

- Panel connects "+" configuration with extension panel.
- Finished in thermally fused laminate.
- Laminate Gallery Extension Panel height is inclusive of panel glides extended to their full height.
- If wood grain is selected, grain runs horizontally.
- Corner connecting brackets to be ordered separately

	DESCRIPTION	PRODUCT CODE	LIST PRICE LP	DIMENSIONS/INCHES		
				H	W	D
	Laminate Double Gallery Panel	EV4LXP4249	741	42	49	1
	Four-Way - Finished Ends - 42" High	EV4LXP4261	965	42	61	1
		EV4LXP4273	1188	42	73	1
	Laminate Double Gallery Panel	EV4LXP4849	807	48	49	1
	Four-Way - Finished Ends - 48" High	EV4LXP4861	1069	48	61	1
		EV4LXP4873	1299	48	73	1
	Laminate Double Gallery Panel	EV4LXP5449	937	54	49	1
	Four-Way - Finished Ends - 48" High	EV4LXP5461	1224	54	61	1
		EV4LXP5473	1415	54	73	1

**EV4LXPM - LAMINATE GALLERY EXTENSION PANEL FOR FOUR-WAY CONFIGURATION, FINISHED ENDS**

- Locking connection on one side only for four way panel.
- Finished in thermally fused laminate.
- Universal to be used on both sides of four way laminate panel.
- Laminate Gallery Extension Panel height is inclusive of panel glides extended to their full height.
- If wood grain is selected, grain runs horizontally.
- Bottom connecting brackets to be ordered separately.

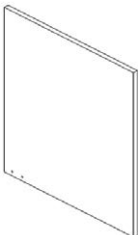
	DESCRIPTION	PRODUCT CODE	LIST PRICE LP	DIMENSIONS/INCHES		
				H	W	D
	Laminate Gallery Extension Panel	EV4LXPM4224	395	42	24	1
	Four-Way - Finished Ends - 42" High	EV4LXPM4230	482	42	30	1
		EV4LXPM4236	538	42	36	1
		EV4LXPM4242	603	42	42	1
		EV4LXPM4248	691	42	58	1
	Laminate Gallery Extension Panel	EV4LXPM4824	454	48	24	1
	Four-Way - Finished Ends - 42" High	EV4LXPM4830	527	48	30	1
		EV4LXPM4836	598	48	36	1
		EV4LXPM4842	669	48	42	1
		EV4LXPM4848	741	48	48	1
	Laminate Gallery Extension Panel	EV4LXPM5424	495	54	24	1
	Four-Way - Finished Ends - 42" High	EV4LXPM5430	579	54	30	1
		EV4LXPM5436	662	54	36	1
		EV4LXPM5442	754	54	42	1
		EV4LXPM5448	882	54	48	1

**EVERCH - EVOLVE PANEL CONNECTOR WITH U CHANNEL**

- U channel attaches with screws to laminate end panel or laminate middle panel.
- Evolve panels attaches to connector.
- Pass thru at bottom and beltline location for power/data.
- U channel is welded to connector.
- Includes connector with U channel and hardware.

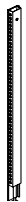
DESCRIPTION	PRODUCT CODE	LIST PRICE LP	DIMENSIONS/INCHES		
			H	W	D
 Panel Connector U Channel	EVERCH42	185	42	2.875	1
	EVERCH48	198	48	2.875	1
	EVERCH54	214	54	2.875	1

**EVPBERCH - EVOLVE PANEL CONNECTOR WITH U CHANNEL FOR BELTLINE PANELS**

- U channel attaches with screws to laminate middle panel.
- Evolve panels attaches to connector.
- Pass thru at bottom and beltline location for power/data.
- U channel is welded to connector.
- Includes connector with U channel and hardware.

DESCRIPTION	PRODUCT CODE	LIST PRICE LP	DIMENSIONS/INCHES		
			H	W	D
 Panel Connector U Channel	EVPBERCH42	185	42	2.875	1
	EVPBERCH48	198	48	2.875	1
	EVPBERCH54	214	54	2.875	1

**EVERCHNR - NO RACEWAY PANEL CONNECTOR WITH U CHANNEL**

- U channel attaches with screws to laminate end panel or laminate middle panel
- Evolve NR panels attaches to connector
- U channel is welded to NR connector
- Includes NR connector with U channel and hardware

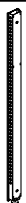
DESCRIPTION	PRODUCT CODE	LIST PRICE LP	DIMENSIONS/INCHES		
			H	W	D
 No Raceway Connector with U Channel	EVERCH42NR	185	42	2.875	1
	EVERCH48NR	198	48	2.875	1
	EVERCH54NR	214	54	2.875	1

**EVPGDCP - GALLERY PANEL DATA POST / COMM LAY-IN**

- One way post attaches to Gallery Panel at the end to bring power and/or data cables from ceiling to Evolve panels.
- Accommodates up to 25 CAT 5 cables with electric. Accommodates up to 45 CAT 5 cables without electric.
- Middle Gallery panel with bottom cut out for electric must be ordered.
- Standard data post extension used above.
- Standard data post extension to be ordered separately.

DESCRIPTION	PRODUCT CODE	LIST PRICE LP	DIMENSIONS/INCHES		
			H	W	D
 Data Post	EVPGDCP42	247	42	3	
	EVPGDCP48	289	48	3	
	EVPGDCP54	316	54	3	

**EVHLPBB01 - LAMINATE GALLERY PANEL BOTTOM BRACKET**

- Laminate panel bottom bracket connects two laminate end panels at bottom with screws. • Bracket and screws included
- Available in standard paint colors.

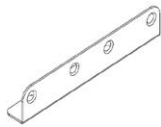

DESCRIPTION	PRODUCT CODE	LIST PRICE LP	DIMENSIONS/INCHES		
			H	W	D
Bottom Bracket	EVHLPBB01	51	1.5	8	1

**EVHLPB01 - LAMINATE GALLERY PANEL CORNER BRACKET**

- Laminate panel corner bottom bracket connects two laminate panels at 90 degree. • Bracket and screws included.
- Available in standard paint colors.

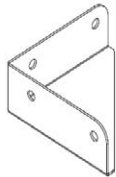

DESCRIPTION	PRODUCT CODE	LIST PRICE LP	DIMENSIONS/INCHES		
			H	W	D
Corner Bracket	EVHLPB01	50	1.5	4	4

**EVPTTAU - EVOLVE CONNECTOR WITH U CHANNEL TOP TRIM ALUMINUM**

- Aluminum top trim longer by 0.625" to cover width of connector with U channel. • Available in standard paint colors.
- Trim can not span a post.



DESCRIPTION	PRODUCT CODE	LIST PRICE LP	DIMENSIONS/INCHES		
			H	W	D
Top Trim Aluminum	EVPTTAU24	27	1	24.625	1
	EVPTTAU30	29	1	30.625	1
	EVPTTAU36	33	1	36.625	1
	EVPTTAU42	38	1	42.625	1
	EVPTTAU48	52	1	48.625	1
	EVPTTAU54	58	1	54.625	1
	EVPTTAU60	64	1	60.625	1
	EVPTTAU66	70	1	66.625	1
	EVPTTAU72	79	1	72.625	1
	EVPTTAU78	87	1	78.625	1
EVPTTAU84	93	1	84.625	1	

# PANELS

# 1" LAMINATE

## EVLEP - 1" LAMINATE END PANEL

- 1" Laminate End Panel attaches to an end of run connector.
- Left Hand or Right Hand available.
- Finished in thermally Fused Laminate.
- Includes threaded metal inserts and support brackets to attach a worksurface on one side.
- 1" Laminate end panel have panel leveling glides.
- If wood grain is selected, grain runs vertically.

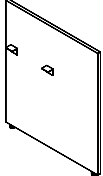
	DESCRIPTION	PRODUCT CODE	LIST PRICE		DIMENSIONS/INCHES		
			LP		H	W	D
	1" Laminate End Panel - Right - 42" High	EVLEPR4224	403		42	24	1
		EVLEPR4230	503		42	30	1
		EVLEPR4236	603		42	36	1
		EVLEPR4242	702		42	42	1
		EVLEPR4248	803		42	48	1
	1" Laminate End Panel - Left - 42" High	EVLEPL4224	403		42	24	1
		EVLEPL4230	503		42	30	1
		EVLEPL4236	603		42	36	1
		EVLEPL4242	702		42	42	1
		EVLEPL4248	803		42	48	1
	1" Laminate End Panel - Right - 48" High	EVLEPR4824	454		48	24	1
		EVLEPR4830	575		48	30	1
		EVLEPR4836	690		48	36	1
		EVLEPR4842	800		48	42	1
		EVLEPR4848	917		48	48	1
	1" Laminate End Panel - Left - 48" High	EVLEPL4824	454		48	24	1
		EVLEPL4830	575		48	30	1
		EVLEPL4836	690		48	36	1
		EVLEPL4842	800		48	42	1
		EVLEPL4848	917		48	48	1

## EVLMP - 1" LAMINATE MIDDLE PANEL

- 1" Laminate Middle Panel attaches to a double inline connector.
- Finished in thermally Fused Laminate.
- Includes threaded metal inserts and support brackets to attach worksurfaces on both sides.
- 1" Laminate middle panel has panel leveling glides.
- If wood grain is selected, grain runs vertically.

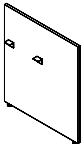
	DESCRIPTION	PRODUCT CODE	LIST PRICE		DIMENSIONS/INCHES		
			LP		H	W	D
	1" Laminate Middle Panel - 42" High	EVLMP4224	450		42	24	1
		EVLMP4230	547		42	30	1
		EVLMP4236	648		42	36	1
		EVLMP4242	753		42	42	1
		EVLMP4248	905		42	48	1
	1" Laminate Middle Panel - 48" High	EVLMP4824	502		48	24	1
		EVLMP4830	619		48	30	1
		EVLMP4836	733		48	36	1
		EVLMP4842	850		48	42	1
		EVLMP4848	965		48	48	1

# PANELS

# 1" LAMINATE

## EVLEPXXYYA - 1" LAMINATE END PANEL WITH ACCESSORY RAIL

- 1" Laminate End Panel attaches to an end of run connector.
- Includes accessory rail.
- Accessories can be used on accessory rail. Please see accessory section for additional details.
- Finished in thermally Fused Laminate.
- Includes threaded metal inserts and support brackets to attach a worksurface on one side.
- 1" Laminate end panel have panel leveling glides.
- If wood grain is selected, grain runs vertically.

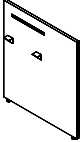
DESCRIPTION	PRODUCT CODE	LIST PRICE LP	DIMENSIONS/INCHES		
			H	W	D
 1" Laminate End Panel with Accessory Rail - Right - 42" High	EVLEPR4224A	455	42	24	1
	EVLEPR4230A	554	42	30	1
	EVLEPR4236A	656	42	36	1
	EVLEPR4242A	760	42	42	1
	EVLEPR4248A	865	42	48	1
 1" Laminate End Panel with Accessory Rail - Left - 42" High	EVLEPL4224A	455	42	24	1
	EVLEPL4230A	554	42	30	1
	EVLEPL4236A	656	42	36	1
	EVLEPL4242A	760	42	42	1
	EVLEPL4248A	865	42	48	1
 1" Laminate End Panel with Accessory Rail - Right - 48" High	EVLEPR4824A	510	48	24	1
	EVLEPR4830A	617	48	30	1
	EVLEPR4836A	695	48	36	1
	EVLEPR4842A	797	48	42	1
	EVLEPR4848A	974	48	48	1
 1" Laminate End Panel with Accessory Rail - Left - 48" High	EVLEPL4824A	510	48	24	1
	EVLEPL4830A	617	48	30	1
	EVLEPL4836A	695	48	36	1
	EVLEPL4842A	797	48	42	1
	EVLEPL4848A	974	48	48	1

## EVLMPXXYYA - 1" LAMINATE MIDDLE PANEL WITH ACCESSORY RAIL

- 1" Laminate Middle Panel attaches to a double inline connector.
- Includes accessory rail.
- Accessories can be used on accessory rail. Please see accessory section for additional details.
- Finished in thermally Fused Laminate.
- Includes threaded metal inserts and support brackets to attach a worksurface on one side.
- 1" Laminate middle panel has panel leveling glides.
- If wood grain is selected, grain runs vertically.

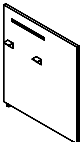
DESCRIPTION	PRODUCT CODE	LIST PRICE LP	DIMENSIONS/INCHES		
			H	W	D
 1" Laminate Middle Panel with Accessory Rail - 42" High	EVLMP4224A	513	42	24	1
	EVLMP4230A	615	42	30	1
	EVLMP4236A	722	42	36	1
	EVLMP4242A	820	42	42	1
	EVLMP4248A	926	42	48	1
 1" Laminate Middle Panel with Accessory Rail - 48" High	EVLMP4824A	565	48	24	1
	EVLMP4830A	690	48	30	1
	EVLMP4836A	800	48	36	1
	EVLMP4842A	917	48	42	1
	EVLMP4848A	1033	48	48	1

# PANELS

# DOUBLE INLINE CONNECTOR

### EVPDIC - DOUBLE INLINE PANEL CONNECTOR

- Used to connect 1" laminate middle panel to panels of equal height in a straight run.
- Aluminum top trim for double inline connector must be used.
- Provides slotted support for worksurfaces and hardware support.
- Includes two slotted posts with leveling glides and connection hardware.
- Use 17" flexible mesh jumper cable to pass-through panels.

DESCRIPTION	PRODUCT CODE	LIST PRICE	DIMENSIONS/INCHES		
			H	W	D
Double Inline Panel Connector	EVPDIC42	180	42	2	
	EVPDIC48	191	48	2	

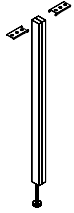

### EVPBIC - BELTLINE DOUBLE INLINE PANEL CONNECTOR

- Used to connect 1" laminate middle panel to panels of equal height in a straight run.
- Use in-between beltline panels.
- Aluminum top trim for double inline connector must be used.
- Provides slotted support for worksurfaces and hardware support.
- Includes two slotted posts with leveling glides and connection hardware.
- Use 17" flexible mesh jumper cable to pass-through panels.

DESCRIPTION	PRODUCT CODE	LIST PRICE	DIMENSIONS/INCHES		
			H	W	D
Beltline Double Inline Panel Connector	EVPBIC42	180	42	2	
	EVPBIC48	191	48	2	

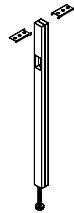

# PANELS

# DOUBLE INLINE CONNECTOR

## EVPDVTF - DOUBLE INLINE CONNECTOR TRIM

- Attaches to exposed side of double inline connector.

DESCRIPTION	PRODUCT CODE	LIST PRICE	DIMENSIONS/INCHES		
			H	W	D
 Double Inline Connector Trim	EVPDVTF42	23	42		
	EVPDVTF48	29	48		

## EVPTTA - DOUBLE INLINE PANEL CONNECTOR TOP TRIM - ALUMINUM

- Aluminum top trim is longer by 1.125" to cover width of panel and double inline connector.
- Trim cannot span a post connector.
- Available in standard and premium paint colors.

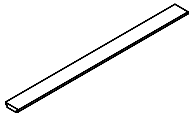
DESCRIPTION	PRODUCT CODE	LIST PRICE	DIMENSIONS/INCHES		
			H	W	D
 Double Inline Connector Trim - Aluminum	EVPTTA25	27		25	
	EVPTTA31	29		31	
	EVPTTA37	23		37	
	EVPTTA43	38		43	
	EVPTTA49	52		49	
	EVPTTA55	58		55	
	EVPTTA61	64		61	
	EVPTTA67	70		67	
	EVPTTA73	79		73	
	EVPTTA79	87		79	
EVPTTA85	93		83		

# PANELS

# DOORS

## EVPDS - DOOR PANEL - SOLID

- All door surfaces are high pressure laminate.
- HP Laminate finish available in all standard Evolve colors.
- Two panel widths: 36" or 42" High.
- 84" Door Panel height = 66"H panel plus one 18"H Panel Extension Module.
- 90" Door Panel height = 66" H panel plus one 24"H or two 12"H Panel Extension Modules.
- Door and door trim can be specified left- or right-handed (see diagram).
- Handedness of Door Panel can be changed in the field.
- Select door frame color from standard trim colors.
- Door Sizes:
  - 36"W Door is 33.63"W without frame (This door is not ADA compliant)
  - 42"W Door is 39.63"W without frame
  - 84"H Door is 81.5"H without frame
  - 90"H Door is 87.5"H without frame
- If laminate is selected in a wood grain, the grain runs vertical.
- Customer is responsible to confirm and meet all city, county or any other municipality codes in relation to door clearances.
- Knob or lever to be ordered separately

DESCRIPTION	PRODUCT CODE	LIST PRICE	DIMENSIONS/INCHES		
			H	W	D
Door Panel - Solid - 84" High x 36" Wide	EVPDS8436L	3060	84	36	2 7/8
	EVPDS8436R	3060	84	36	2 7/8
Door Panel - Solid - 84" High x 42" Wide	EVPDS8442L	3541	84	42	2 7/8
	EVPDS8442R	3541	84	42	2 7/8
Door Panel - Solid - 90" High x 36" Wide	EVPDS9036L	3060	90	36	2 7/8
	EVPDS9036R	3060	90	36	2 7/8
Door Panel - Solid - 90" High x 42" Wide	EVPDS9042L	3541	90	42	2 7/8
	EVPDS9042R	3541	90	42	2 7/8

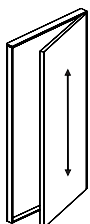

## EVPDG- FULL GLAZED DOOR PANEL

- All door surfaces are high pressure laminate with window.
- HP laminate finish available in all standard Evolve colors.
- Two panels width 36" or 42"
- 84" Door panel height = 66"H panel and 18" H Panel Extension Modules.
- 90" Door panel height = 66"H panel and 24" H or two 12" H Panel extension modules.
- Door and door trim can be specified left or right handed (see diagram).
- Handedness of Door can be changed in field.
- Select frame color from standard trim colors.
- Door Sizes:
  - 36"W Door is 33.63"W without frame (This door is not ADA compliant)
  - 42"W Door is 39.63"W without frame
  - 84"H Door is 81.5"H without frame
  - 90"H Door is 87.5"H without frame
- If laminate is selected in wood grain, the grain runs vertical.
- Customer is responsible to confirm and meet, city, county or any other municipality codes in relation to door clearances
- Knob or lever to be ordered separately

DESCRIPTION	PRODUCT CODE	PRICE		DIMENSIONS/INCHES		
		CLR	FRST ADD	H	W	D
Door Panel - Glazed - 84" High x 36" Wide	EVPDG8436L	3437	137	84	36	2 7/8
	EVPDG8436R	3437	137	84	36	2 7/8
Door Panel - Glazed - 84" High x 42" Wide	EVPDG8442L	3918	139	84	42	2 7/8
	EVPDG8442R	3918	139	84	42	2 7/8
Door Panel - Glazed - 90" High x 36" Wide	EVPDG9036L	3437	137	90	36	2 7/8
	EVPDG9036R	3437	137	90	36	2 7/8
Door Panel - Glazed - 90" High x 42" Wide	EVPDG9042L	3918	139	90	42	2 7/8
	EVPDG9042R	3918	139	90	42	2 7/8



# PANELS

# DOORS

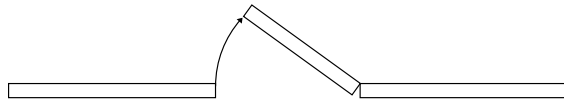

Right Hand Hung Door

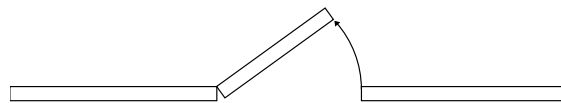

Left Hand Hung Door

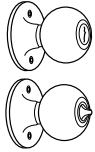

Knob Lock Set  
 (Knob Lock Set is not ADA compliant)  
 Lock set sold separately from doors.  
 Specific core #'s and Master Key not available

EVPSL01

128



Lever Lock Set  
 Lock set sold separately from doors.  
 Specific core #'s and Master Key not available

EVPSL02

175

### EVHLPF01 - LOW PROFILE FOOT

- Used to provide additional support to panel run without adding panels
- Connects to inline connector or end of run at base of panels

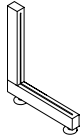
DESCRIPTION	PRODUCT CODE	LIST PRICE	DIMENSIONS/INCHES		
			H	W	D
 Low Profile Foot	EVHLPF01	139	11	1	11

### EVPSL/R - SLIDING PRIVACY DOOR

- Sliding Privacy Door attaches to Evolve Panels using standard connectors to add privacy. Brackets that attach to Connectors are included.
- This door must mount on panels of equal width. It is also intended to be used for openings of equal width.
- Left (L) or right-handedness (R) is determined by the direction of door movement (from compressed to expanded position), while facing the door on the panel mounted side.
- Painted frame may match any Evolve Standard Paint Finish. The door interior is standard with a louvered acrylic finish.
- Telescoping arms eliminate the need for thresholds, wheels or casters.
- 81" H door must connect to panels 84" or higher.
- Thickness of louvered acrylic is 6 mm.

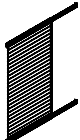
DESCRIPTION	PRODUCT CODE	LIST PRICE	DIMENSIONS/INCHES			
			H	W	D	
	Sliding Privacy Door - 66" High	EVPSL6636R	3443	66	36	3
		EVPSL6636L	3443	66	36	3
		EVPSL6642R	3531	66	42	3
		EVPSL6642L	3531	66	42	3
	Sliding Privacy Door - 81" High	EVPSL8136R	3635	81	36	3
		EVPSL8136L	3635	81	36	3
		EVPSL8142R	3903	81	42	3
		EVPSL8142L	3903	81	42	3

**PANELS**

**DOORS**

**EVPSLLOCK - SLIDING DOOR LOCK**

- Lock bracket attaches to sliding door with screws.
- Includes strike plate bracket which attaches to slots in connector.
- Lock included.
- Lock sets sold separately from sliding doors.
- Available in Tungsten only.

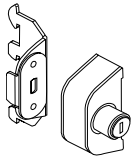
	DESCRIPTION	PRODUCT CODE	LIST PRICE	DIMENSIONS/INCHES		
				H	W	D
	Sliding Door Lock - Right	EVPSLLOCKR	316	2.65	1.2	0.9
	Sliding Door Lock - Left	EVPSLLOCKL	316	2.65	1.2	0.9

**EVMPK02 - MINI PANEL KIT**

- Evolve's Mini Panel Kits are available to our dealers and their sales staff.
- All Mini Panel Kit orders receive standard freight terms (Free freight applies to orders dock delivered to one commercial business location in the contiguous United States during normal business hours. Residential deliveries will incur additional delivery charges.)
- The Evolve mini panel is an excellent sales tool featuring a cut away of a module and samples of various hardware and electrical components and consists of the following:
  - 1 EVFP3024 30 x 24 Premium with cut-away
  - 1 EVPCP232 Two-way corner post
  - 1 EVPER30 End of run trim kit
  - 1 EVDHPT24 High Profile Top Cap
  - 1 EVDCPHP2 Two-way High Profile Top Cap
  - 1 EVDPE4 Post Extension Lay in
  - 1 EVE8PD24 Power distribution housing
  - 1 EVE8CP16 Jumper Cable
  - 1 EVE8RDA/B Duplex Receptacle
  - 1 Pizza cutter spline tool
  - 1 Replacement fabric
  - 1 Panel Bag with Evolve Logo
  - 1 Parts Bag with Evolve Logo

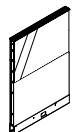
	DESCRIPTION	PRODUCT CODE	LIST PRICE	DIMENSIONS/INCHES		
				H	W	D
	Mini Panel Kit	EVMPK02	2945	30	24	2 7/8

# PANELS

# ACOUSTIC GRID

## EVPRGLAXXY - ACOUSTIC GRID 5FT WIDE

- PET acoustic grid installed on top of panels
- Acoustic grid kit includes PET pieces, aluminum channel, hardware
- Panels configuration in back 30-30 , aluminum channel runs depth wise
- PET slats run from side to side
- PET pieces available in standard PET colors
- Separate PET colors available for outer skirt and inner structure
- Top trim with channel to be ordered separately
- Shipped KD , to be assembled on job site
- Additional sizes available up to 10' x 12'

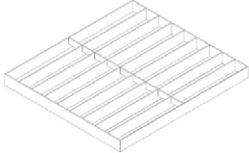
DESCRIPTION	PRODUCT CODE	LIST PRICE	DIMENSIONS/INCHES		
			H	W	D
	EVPRGLA4860D	2731	5.5	60	48
	EVPRGLA6060D	3236	5.5	60	60
	EVPRGLA7260D	3741	5.5	60	72
	EVPRGLA8460D	4246	5.5	60	84
	EVPRGLA9060D	4499	5.5	60	90
	EVPRGLA9660D	4789	5.5	60	96

## EVPRGLAXXY - ACOUSTIC GRID 6FT WIDE

- PET acoustic grid installed on top of panels
- Acoustic grid kit includes PET pieces, aluminum channel, hardware
- Panels configuration in back 24-24-24 , aluminum channel runs depth wise
- PET slats run from side to side
- PET pieces available in standard PET colors
- Separate PET colors available for outer skirt and inner structure
- Top trim with channel to be ordered separately
- Shipped KD , to be assembled on job site
- Additional sizes available up to 10' x 12'

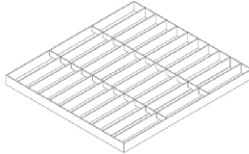
DESCRIPTION	PRODUCT CODE	LIST PRICE	DIMENSIONS/INCHES		
			H	W	D
	EVPRGLA4872D	3283	5.5	72	48
	EVPRGLA6072D	3896	5.5	72	60
	EVPRGLA7272D	4507	5.5	72	72
	EVPRGLA8472D	5118	5.5	72	84
	EVPRGLA9072D	5422	5.5	72	90
	EVPRGLA9672D	5766	5.5	72	96

## EVPRGLAXXY - ACOUSTIC GRID 7FT WIDE

- PET acoustic grid installed on top of panels
- Acoustic grid kit includes PET pieces, aluminum channel, hardware
- Panels configuration in back 24-36-24 , aluminum channel runs depth wise
- PET slats run from side to side
- PET pieces available in standard PET colors
- Separate PET colors available for outer skirt and inner structure
- Top trim with channel to be ordered separately
- Shipped KD , to be assembled on job site
- Additional sizes available up to 10' x 12'

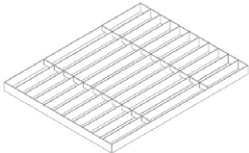
DESCRIPTION	PRODUCT CODE	LIST PRICE	DIMENSIONS/INCHES		
			H	W	D
	EVPRGLA4884D	3671	5.5	84	48
	EVPRGLA6084D	4346	5.5	84	60
	EVPRGLA7284D	5021	5.5	84	72
	EVPRGLA8484D	5696	5.5	84	84
	EVPRGLA9084D	6034	5.5	84	90
	EVPRGLA9684D	6409	5.5	84	96

# PANELS

# ACOUSTIC GRID

## EVPRGLAXXY - ACOUSTIC GRID 7-1/2 FT WIDE

- PET acoustic grid installed on top of panels
- Acoustic grid kit includes PET pieces, aluminum channel, hardware
- Panels configuration in back 30-30-30 , aluminum channel runs depth wise
- PET slats run from side to side
- PET pieces available in standard PET colors
- Separate PET colors available for outer skirt and inner structure
- Top trim with channel to be ordered separately
- Shipped KD, to be assembled on job site
- Additional sizes available up to 10' x 12'

DESCRIPTION	PRODUCT CODE	LIST PRICE	DIMENSIONS/INCHES		
			H	W	D
	EVPRGLA4890D	3812	5.5	90	48
	EVPRGLA6090D	4518	5.5	90	60
	EVPRGLA7290D	5225	5.5	90	72
	EVPRGLA8490D	5933	5.5	90	84
	EVPRGLA9090D	6288	5.5	90	90
	EVPRGLA9690D	6678	5.5	90	96

## EVPRGLAXXY - ACOUSTIC GRID 8FT WIDE

- PET acoustic grid installed on top of panels
- Acoustic grid kit includes PET pieces, aluminum channel, hardware
- Panels configuration in back 30-36-30 , aluminum channel runs depth wise
- PET slats run from side to side
- PET pieces available in standard PET colors
- Separate PET colors available for outer skirt and inner structure
- Top trim with channel to be ordered separately
- Shipped KD, to be assembled on job site
- Additional sizes available up to 10' x 12'

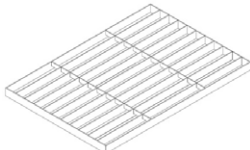
DESCRIPTION	PRODUCT CODE	LIST PRICE	DIMENSIONS/INCHES		
			H	W	D
	EVPRGLA4896D	4094	5.5	96	48
	EVPRGLA6096D	4834	5.5	96	60
	EVPRGLA7296D	5572	5.5	96	72
	EVPRGLA8496D	6312	5.5	96	84
	EVPRGLA9096D	6684	5.5	96	90
	EVPRGLA9696D	7089	5.5	96	96

## EVPRGLAXXY - ACOUSTIC GRID 12FT WIDE

- PET acoustic grid installed on top of panels
- Acoustic grid kit includes PET pieces, aluminum channel, hardware
- Panels configuration in back 24-30--36-30-24 , aluminum channel runs depth wise
- PET slats run from side to side
- PET pieces available in standard PET colors
- Top trim with channel to be ordered separately
- Beam kit above opening for acoustic grid to be ordered separately
- Shipped KD, to be assembled on job site

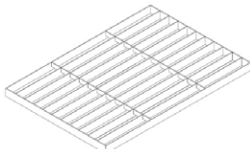
DESCRIPTION	PRODUCT CODE	LIST PRICE	DIMENSIONS/INCHES		
			H	W	D
	EVPRGLA120144D	9422	5.5	144	120

**EVPTTCA - ALUMINUM TOP TRIM WITH CHANNEL**

- Top trim with channel
- Available in standard paint colors
- Note: Trim can span inline connector, but not a Post

DESCRIPTION	PRODUCT CODE	LIST PRICE	DIMENSIONS/INCHES		
			H	W	D
	EVPTTCA18	20	18	2.875	
	EVPTTCA24	28	24	2.875	
	EVPTTCA30	36	30	2.875	
	EVPTTCA36	39	36	2.875	
	EVPTTCA42	47	42	2.875	
	EVPTTCA48	57	48	2.875	
	EVPTTCA54	67	54	2.875	
	EVPTTCA60	74	60	2.875	
	EVPTTCA66	81	66	2.875	
	EVPTTCA72	90	72	2.875	
	EVPTTCA78	98	78	2.875	
	EVPTTCA84	109	84	2.875	
	EVPTTCA90	115	90	2.875	
	EVPTTCA96	125	96	2.875	

# PANELS

# TECHNICAL INFORMATION/ TYPES



When ordering Panel Extension Modules, Inline Panel Extension Connectors (EVPIEC) must be ordered separately. Please see EVPIEC for details.

Inline Panel Extension Connectors connect two panel extension modules of equal height in a straight run.

Extension connectors do **not** provide support for hang-on storage components above 66" H.

When specifying stacking panels up to 66" H and using a single full height connector additional single clamps (EVCLVAR) are recommended. Order 2 clamps per extension module.

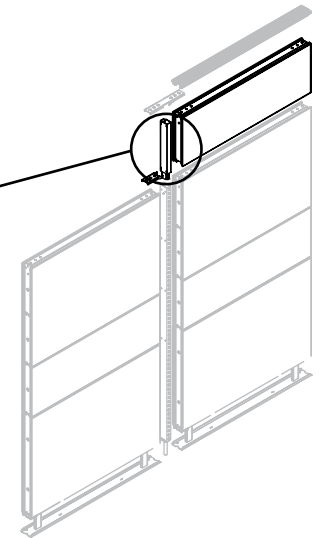
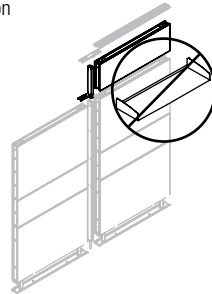

## EXTENSION MODULES BY TYPE

### Fabric Panel Extension Module

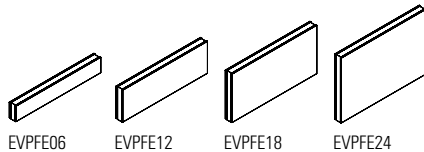

### Fabric Panel Extension Module - Premium

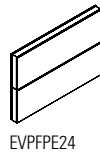

### Tempered Glass Panel Extension Module

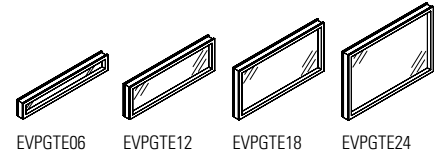

### Tempered Glass Panel Extension Module - Premium

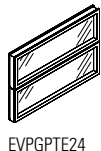

### Write Board Extension Module - Single Sided

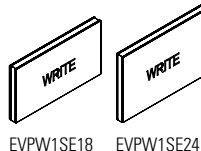

### Write Board Extension Module - Double Sided

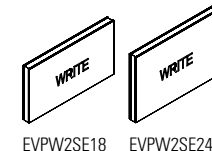

### Laminate Extension Module - Single Sided

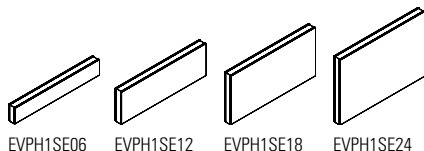

### Laminate Extension Module - Double Sided

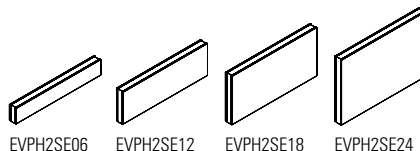

### Air Flow Extension Module

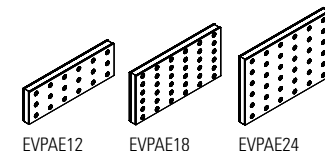

### Open Panel Extension Module

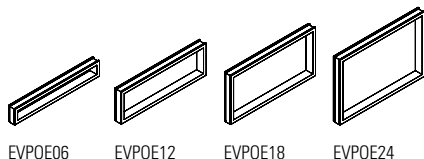

### Panel Mount Privacy Glass

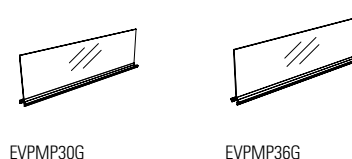

### Panel Mount PET Felt Divider

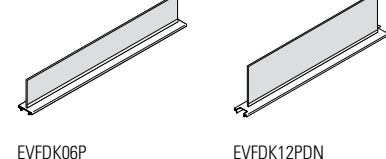

# PANELS

# FABRIC PANEL - EXTENSION MODULE

## EVPFE - FABRIC PANEL EXTENSION MODULE

- Attaches on top of a panel.
- Modules can be stacked to add privacy or divide space.
- Panel Extension Modules are not load bearing if installed higher than 66" High.
- Each side of the fabric module may have a different fabric within the same grade at no charge.
- If different grades of fabric are used on one module, the entire module must be priced at highest grade.
- When ordering Panel Extension Modules, additional connectors are required.
- \*Top Trims are not included with Extension Modules.

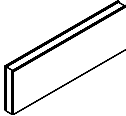
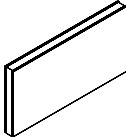
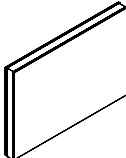
	DESCRIPTION	PRODUCT CODE	LIST PRICE		DIMENSIONS/INCHES		
			Gr1	Gr2	H	W	D
	Fabric Panel Extension Module - 6" High	EVPFE0618	198	208	6	18	2 7/8
		EVPFE0624	201	215	6	24	2 7/8
		EVPFE0630	220	240	6	30	2 7/8
		EVPFE0636	244	265	6	36	2 7/8
		EVPFE0642	277	295	6	42	2 7/8
		EVPFE0648	297	320	6	48	2 7/8
		EVPFE0654	320	346	6	54	2 7/8
		EVPFE0660	344	373	6	60	2 7/8
	Fabric Panel Extension Module - 12" High	EVPFE1218	198	208	12	18	2 7/8
		EVPFE1224	201	215	12	24	2 7/8
		EVPFE1230	220	240	12	30	2 7/8
		EVPFE1236	244	265	12	36	2 7/8
		EVPFE1242	277	295	12	42	2 7/8
		EVPFE1248	297	320	12	48	2 7/8
		EVPFE1254	320	346	12	54	2 7/8
		EVPFE1260	344	373	12	60	2 7/8
	Fabric Panel Extension Module - 18" High	EVPFE1818	239	257	18	18	2 7/8
		EVPFE1824	248	274	18	24	2 7/8
		EVPFE1830	269	298	18	30	2 7/8
		EVPFE1836	312	342	18	36	2 7/8
		EVPFE1842	342	380	18	42	2 7/8
		EVPFE1848	374	413	18	48	2 7/8
		EVPFE1854	405	449	18	54	2 7/8
		EVPFE1860	440	488	18	60	2 7/8
	Fabric Panel Extension Module - 24" High	EVPFE2418	239	257	24	18	2 7/8
		EVPFE2424	248	274	24	24	2 7/8
		EVPFE2430	269	298	24	30	2 7/8
		EVPFE2436	312	342	24	36	2 7/8
		EVPFE2442	342	380	24	42	2 7/8
		EVPFE2448	374	413	24	48	2 7/8
		EVPFE2454	405	449	24	54	2 7/8
		EVPFE2460	440	488	24	60	2 7/8

## EVPFPE - FABRIC PANEL EXTENSION MODULE - PREMIUM

- Attaches on top of a panel.
- Modules can be stacked to add privacy or to divide space.
- Panel Extension Modules are not load bearing above 66" High.
- Each side of each module may have a different fabric within the same grade at no charge.
- If different grades of fabric are used on the Panel Extension Module, the module must be priced at highest grade.
- When ordering Panel Extension Modules, additional connectors are required.
- \*Top Trims are not included with Extension Modules.

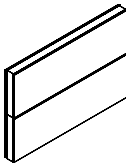
	DESCRIPTION	PRODUCT CODE	LIST PRICE		DIMENSIONS/INCHES		
			Gr1	Gr2	H	W	D
	Fabric Panel Extension Module - Premium - 24" High	EVPFPE2418	323	343	24	18	2 7/8
		EVPFPE2424	344	371	24	24	2 7/8
		EVPFPE2430	386	414	24	30	2 7/8
		EVPFPE2436	434	464	24	36	2 7/8
		EVPFPE2442	487	525	24	42	2 7/8
		EVPFPE2448	523	562	24	48	2 7/8
		EVPFPE2454	577	621	24	54	2 7/8
		EVPFPE2460	630	680	24	60	2 7/8

# PANELS

# FABRIC PANEL - EXTENSION MODULE

## EVPGTE - TEMPERED GLASS PANEL EXTENSION MODULE

- Attaches on top of panel.
- Modules can be stacked to add privacy or to divide space.
- Panel Extension Modules are not load bearing above 66" H.
- Standard in clear (CLR) glass.
- Frosted Glass (FRST) 40% upcharge. Contact EVOLVE Customer Support for details.
- When ordering Panel Extension Modules, additional connectors are required.
- \*Top Trims are not included with Extension Modules.

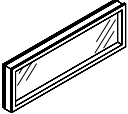
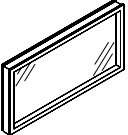
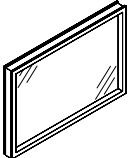
	DESCRIPTION	PRODUCT CODE	LIST PRICE	DIMENSIONS/INCHES		
				H	W	D
	Tempered Glass Panel Extension Module - 6" High	EVPGTE0618	380	6	18	2 7/8
		EVPGTE0624	410	6	24	2 7/8
		EVPGTE0630	492	6	30	2 7/8
		EVPGTE0636	515	6	36	2 7/8
		EVPGTE0642	630	6	42	2 7/8
		EVPGTE0648	702	6	48	2 7/8
		EVPGTE0654	768	6	54	2 7/8
EVPGTE0660	828	6	60	2 7/8		
	Tempered Glass Panel Extension Module - 12" High	EVPGTE1218	380	12	18	2 7/8
		EVPGTE1224	410	12	24	2 7/8
		EVPGTE1230	492	12	30	2 7/8
		EVPGTE1236	515	12	36	2 7/8
		EVPGTE1242	630	12	42	2 7/8
		EVPGTE1248	702	12	48	2 7/8
		EVPGTE1254	768	12	54	2 7/8
EVPGTE1260	828	12	60	2 7/8		
	Tempered Glass Panel Extension Module - 18" High	EVPGTE1818	571	18	18	2 7/8
		EVPGTE1824	587	18	24	2 7/8
		EVPGTE1830	629	18	30	2 7/8
		EVPGTE1836	686	18	36	2 7/8
		EVPGTE1842	777	18	42	2 7/8
		EVPGTE1848	870	18	48	2 7/8
		EVPGTE1854	944	18	54	2 7/8
EVPGTE1860	1013	18	60	2 7/8		
	Tempered Glass Panel Extension Module - 24" High	EVPGTE2418	571	24	18	2 7/8
		EVPGTE2424	587	24	24	2 7/8
		EVPGTE2430	629	24	30	2 7/8
		EVPGTE2436	686	24	36	2 7/8
		EVPGTE2442	777	24	42	2 7/8
		EVPGTE2448	870	24	48	2 7/8
		EVPGTE2454	944	24	54	2 7/8
EVPGTE2460	1013	24	60	2 7/8		

## EVPGPTE - TEMPERED GLASS PREMIUM PANEL EXTENSION MODULE

- Attaches to top of a panel.
- Modules can be stacked to add privacy or to divide space.
- Panel Extension Modules are not load bearing above 66" H.
- Standard in clear (CLR) glass.
- Frosted Glass (FRST) 40% upcharge. Contact EVOLVE Customer Support for details.
- When ordering Panel Extension Modules, additional connectors are required.
- \*Top Trims are not included with Extension Modules.

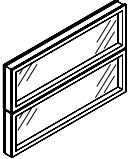
	DESCRIPTION	PRODUCT CODE	LIST PRICE	DIMENSIONS/INCHES		
				H	W	D
	Tempered Glass Premium Panel Extension Module - 24" High	EVPGPTE2418	562	24	18	2 7/8
		EVPGPTE2424	623	24	24	2 7/8
		EVPGPTE2430	712	24	30	2 7/8
		EVPGPTE2436	810	24	36	2 7/8
		EVPGPTE2442	898	24	42	2 7/8
		EVPGPTE2448	1007	24	48	2 7/8
		EVPGPTE2454	1098	24	54	2 7/8
EVPGPTE2460	1189	224	60	2 7/8		

# PANELS

# TEMPERED GLASS - EXTENSION MODULE

## EVPSG - PASS THRU SLIDING GLASS EXTENSION MODULE

- Pass thru with sliding glass door module.
- Attaches on top of a panel.
- Module can be stacked to add privacy or divide space.
- Panel extension module is not load bearing if installed higher than 66" High.
- When ordering panel extension modules , additional connectors are required.
- \*Top Trims are not included with Extension Modules.

	DESCRIPTION	PRODUCT CODE	PRICE		DIMENSIONS/INCHES		
			CLR	FRS ADD	H	W	D
	Reception Panel Extension Module - 6" High	EVPSGE0636	411	86	6	36	2 7/8
		EVPSGE0642	440	93	6	42	2 7/8
		EVPSGE0648	535	109	6	48	2 7/8

## EVPSG - PASS THRU SLIDING GLASS EXTENSION MODULE

- Pass thru with sliding glass door module.
- Attaches on top of a panel.
- Module can be stacked to add privacy or divide space.
- Panel extension module is not load bearing if installed higher than 66" High.
- When ordering panel extension modules , additional connectors are required.
- \*Top Trims are not included with Extension Modules.

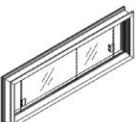
	DESCRIPTION	PRODUCT CODE	PRICE		DIMENSIONS/INCHES		
			CLR	FRS ADD	H	W	D
	Reception Panel Extension Module - 12" High	EVPSGE1236	498	102	12	36	2 7/8
		EVPSGE1242	527	109	12	42	2 7/8
		EVPSGE1248	552	115	12	48	2 7/8

## EVPSGX - TALK THRU GLASS EXTENSION MODULE

- Talk thru glass module.
- Attaches on top of a panel.
- Module can be stacked to add privacy or divide space.
- Panel extension module is not load bearing if installed higher than 66" High.
- When ordering panel extension modules , additional connectors are required.
- \*Top Trims are not included with Extension Modules.

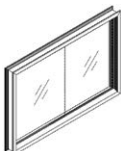
	DESCRIPTION	PRODUCT CODE	PRICE		DIMENSIONS/INCHES		
			CLR	FRS ADD	H	W	D
	Reception Panel Extension Module - 24" High	EVPSGXE2436	640	130	24	36	2 7/8
		EVPSGXE2442	705	141	24	42	2 7/8
		EVPSGXE2448	768	158	24	48	2 7/8

## EVPSGX - TALK THRU GLASS EXTENSION MODULE

- Talk thru glass module.
- Attaches on top of a panel.
- Module can be stacked to add privacy or divide space.
- Panel extension module is not load bearing if installed higher than 66" High.
- When ordering panel extension modules , additional connectors are required.
- \*Top Trims are not included with Extension Modules.

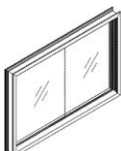
	DESCRIPTION	PRODUCT CODE	PRICE		DIMENSIONS/INCHES		
			CLR	FRS ADD	H	W	D
	Reception Panel Extension Module - 30" High	EVPSGXE3036	698	158	30	36	2 7/8
		EVPSGXE3042	785	160	30	42	2 7/8
		EVPSGXE3048	850	173	30	48	2 7/8

# PANELS

# WRITE BOARD - EXTENSION MODULE

## EVPW1SE - WRITE BOARD EXTENSION MODULE - SINGLE SIDED

- Attaches on top of a panel.
- Provides writing surface on a Single Side.
- Modules can be stacked to add privacy or to divide space.
- Panel Extension Modules are not load bearing above 66" H.
- When ordering Panel Extension Modules, additional connectors are required.
- High pressure only
- Use erasable Write Board markers only.
- \*Top Trims are not included with Extension Modules.

DESCRIPTION	PRODUCT CODE	LIST PRICE		DIMENSIONS/INCHES		
		Gr1	Gr2	H	W	D
 Write Board Extension Module - Single Sided 6"High	EVPW1SE0618	269	278	6	36	7/8
	EVPW1SE0624	313	323	6	36	2 7/8
	EVPW1SE0636	397	408	6	36	2 7/8
	EVPW1SE0642	450	456	6	42	2 7/8
	EVPW1SE0648	489	502	6	48	2 7/8
	EVPW1SE0654	552	565	6	54	2 7/8
EVPW1SE0660	580	593	6	60	2 7/8	
Write Board Extension Module - Single Sided 12"High	EVPW1SE1218	269	278	12	36	2 7/8
	EVPW1SE1224	313	323	12	36	2 7/8
	EVPW1SE1236	397	408	12	36	2 7/8
	EVPW1SE1242	450	456	12	42	2 7/8
	EVPW1SE1248	489	502	12	48	2 7/8
	EVPW1SE1254	552	565	12	54	2 7/8
EVPW1SE1260	580	593	12	60	2 7/8	
Write Board Extension Module - Single Sided 18"High	EVPW1SE1818	288	299	18	18	2 7/8
	EVPW1SE1824	330	342	18	24	2 7/8
	EVPW1SE1830	372	382	18	30	2 7/8
	EVPW1SE1836	433	448	18	36	2 7/8
	EVPW1SE1842	485	503	18	42	2 7/8
	EVPW1SE1848	532	551	18	48	2 7/8
EVPW1SE1854	579	598	18	54	2 7/8	
EVPW1SE1860	623	645	18	60	2 7/8	
Write Board Extension Module - Single Sided 24"High	EVPW1SE2418	288	299	24	18	2 7/8
	EVPW1SE2424	330	344	24	24	2 7/8
	EVPW1SE2430	372	386	24	30	2 7/8
	EVPW1SE2436	433	450	24	36	2 7/8
	EVPW1SE2442	485	505	24	42	2 7/8
	EVPW1SE2448	532	553	24	48	2 7/8
EVPW1SE2454	579	598	24	54	2 7/8	
EVPW1SE2460	623	646	24	60	2 7/8	

**PANELS**

**WRITE BOARD - EXTENSION MODULE**

**EVPW2SE - WRITE BOARD EXTENSION MODULE - DOUBLE SIDED**

- Attaches on top of a panel.
- Provides writing surface on two sides.
- Modules can be stacked to add privacy or to divide space.
- Panel Extension Modules are not load bearing above 66" H.
- When ordering Panel Extension Modules, additional connectors are required.
- High pressure only
- Use erasable Write Board markers only.
- \*Top Trims are not included with Extension Modules.

DESCRIPTION	PRODUCT CODE	LIST PRICE	DIMENSIONS/INCHES		
			H	W	D
 Write Board Extension Module - Double Sided - 6"High	EVPW2SE0618	289	6	18	2 7/8
	EVPW2SE0624	342	6	24	2 7/8
	EVPW2SE0630	394	6	30	2 7/8
	EVPW2SE0636	452	6	36	2 7/8
	EVPW2SE0642	513	6	42	2 7/8
	EVPW2SE0648	572	6	48	2 7/8
	EVPW2SE0654	660	6	54	2 7/8
	EVPW2SE0660	677	6	60	2 7/8
	Write Board Extension Module - Double Sided - 12"High	EVPW2SE1218	289	12	18
EVPW2SE1224		342	12	24	2 7/8
EVPW2SE1230		394	12	30	2 7/8
EVPW2SE1236		452	12	36	2 7/8
EVPW2SE1242		513	12	42	2 7/8
EVPW2SE1248		572	12	48	2 7/8
EVPW2SE1254		660	12	54	2 7/8
EVPW2SE1260		677	12	60	2 7/8
Write Board Extension Module - Double Sided - 18"High	EVPW2SE1818	348	18	18	2 7/8
	EVPW2SE1824	410	18	24	2 7/8
	EVPW2SE1830	471	18	30	2 7/8
	EVPW2SE1836	552	18	36	2 7/8
	EVPW2SE1842	623	18	42	2 7/8
	EVPW2SE1848	695	18	48	2 7/8
	EVPW2SE1854	769	18	54	2 7/8
EVPW2SE1860	839	18	60	2 7/8	
Write Board Extension Module - Double Sided - 24"High	EVPW2SE2418	348	24	18	2 7/8
	EVPW2SE2424	410	24	24	2 7/8
	EVPW2SE2430	471	24	30	2 7/8
	EVPW2SE2436	552	24	36	2 7/8
	EVPW2SE2442	623	24	42	2 7/8
	EVPW2SE2448	695	24	48	2 7/8
	EVPW2SE2454	769	24	54	2 7/8
	EVPW2SE2460	839	24	60	2 7/8

# PANELS

# LAMINATE - EXTENSION MODULE

## EVPH1SE - LAMINATE EXTENSION MODULE - SINGLE SIDED

- Attaches on top of a panel.
- Laminate face on the module provides a durable, washable surface on Single Side of the panel.
- Modules can be stacked to add privacy or to divide space.
- Panel Extension Modules are not load bearing above 66" H.
- When ordering Panel Extension Modules, additional connectors are required.
- Available in high pressure only.
- \*Top Trims are not included with Extension Modules.

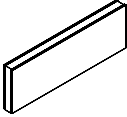
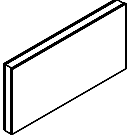
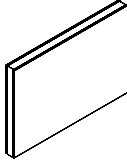
	DESCRIPTION	PRODUCT CODE	LIST PRICE		DIMENSIONS/INCHES		
			Gr1	Gr2	H	W	D
	Laminate Extension Module - Single Sided 6" High	EVPH1SE0618	269	278	6	18	2 7/8
		EVPH1SE0624	313	317	6	24	2 7/8
		EVPH1SE0630	350	353	6	30	2 7/8
		EVPH1SE0636	397	403	6	36	2 7/8
		EVPH1SE0642	450	453	6	42	2 7/8
		EVPH1SE0648	489	503	6	48	2 7/8
		EVPH1SE0654	552	565	6	54	2 7/8
		EVPH1SE0660	580	586	6	60	2 7/8
	Laminate Extension Module - Single Sided 12" High	EVPH1SE1218	269	278	12	18	2 7/8
		EVPH1SE1224	313	324	12	24	2 7/8
		EVPH1SE1230	350	358	12	30	2 7/8
		EVPH1SE1236	397	411	12	36	2 7/8
		EVPH1SE1242	450	460	12	42	2 7/8
		EVPH1SE1248	489	504	12	48	2 7/8
		EVPH1SE1254	552	567	12	54	2 7/8
		EVPH1SE1260	580	595	12	60	2 7/8
	Laminate Extension Module - Single Sided 18" High	EVPH1SE1818	359	369	18	18	2 7/8
		EVPH1SE1824	423	434	18	24	2 7/8
		EVPH1SE1830	487	502	18	30	2 7/8
		EVPH1SE1836	557	572	18	36	2 7/8
		EVPH1SE1842	629	644	18	42	2 7/8
		EVPH1SE1848	690	707	18	48	2 7/8
		EVPH1SE1854	746	768	18	54	2 7/8
		EVPH1SE1860	821	844	18	60	2 7/8
	Laminate Extension Module - Single Sided 24" High	EVPH1SE2418	359	373	24	18	2 7/8
		EVPH1SE2424	423	438	24	24	2 7/8
		EVPH1SE2430	487	505	24	30	2 7/8
		EVPH1SE2436	557	576	24	36	2 7/8
		EVPH1SE2442	629	648	24	42	2 7/8
		EVPH1SE2448	690	710	24	48	2 7/8
		EVPH1SE2454	746	772	24	54	2 7/8
		EVPH1SE2460	821	848	24	60	2 7/8

# PANELS

# LAMINATE - EXTENSION MODULE

## EVPH2SE - LAMINATE EXTENSION MODULE - DOUBLE SIDED

- Attaches on top of a panel.
- Laminate faces on both sides of the module provide durable, washable surfaces.
- Modules can be stacked to add privacy or to divide space.
- Panel Extension Modules are not load bearing above 66" H
- When ordering Panel Extension Modules, additional connectors are required.
- Available in high pressure only.
- \*Top Trims are not included with Extension Modules.

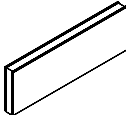
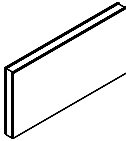
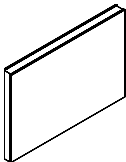
	DESCRIPTION	PRODUCT CODE	LIST PRICE	DIMENSIONS/INCHES		
				H	W	D
	Laminate Extension Module - Double Sided 6" High	EVPH2SE0618	289	6	18	2 7/8
		EVPH2SE0624	342	6	24	2 7/8
		EVPH2SE0630	394	6	30	2 7/8
		EVPH2SE0636	452	6	36	2 7/8
		EVPH2SE0642	513	6	42	2 7/8
		EVPH2SE0648	572	6	48	2 7/8
		EVPH2SE0654	660	6	54	2 7/8
EVPH2SE0660	677	6	60	2 7/8		
	Laminate Extension Module - Double Sided 12" High	EVPH2SE1218	289	12	18	2 7/8
		EVPH2SE1224	342	12	24	2 7/8
		EVPH2SE1230	394	12	30	2 7/8
		EVPH2SE1236	452	12	36	2 7/8
		EVPH2SE1242	513	12	42	2 7/8
		EVPH2SE1248	572	12	48	2 7/8
		EVPH2SE1254	660	12	54	2 7/8
EVPH2SE1260	677	12	60	2 7/8		
	Laminate Extension Module - Double Sided 18" High	EVPH2SE1818	416	18	18	2 7/8
		EVPH2SE1824	502	18	24	2 7/8
		EVPH2SE1830	580	18	30	2 7/8
		EVPH2SE1836	674	18	36	2 7/8
		EVPH2SE1842	760	18	42	2 7/8
		EVPH2SE1848	862	18	48	2 7/8
		EVPH2SE1854	944	18	54	2 7/8
EVPH2SE1860	1017	18	60	2 7/8		
	Laminate Extension Module - Double Sided 24" High	EVPH2SE2418	416	24	18	2 7/8
		EVPH2SE2424	502	24	24	2 7/8
		EVPH2SE2430	580	24	30	2 7/8
		EVPH2SE2436	674	24	36	2 7/8
		EVPH2SE2442	760	24	42	2 7/8
		EVPH2SE2448	862	24	48	2 7/8
		EVPH2SE2454	944	24	54	2 7/8
EVPH2SE2460	1017	24	60	2 7/8		

# PANELS

# AIR FLOW - EXTENSION MODULE

## EVPAE - AIR FLOW EXTENSION MODULE

- Metal air flow panel extension
- Attaches to top of panel
- Modules can be stacked to add privacy or to divide space.
- Panel Extension Modules are not load bearing above 66" H.
- When ordering Panel Extension Modules, additional connectors are required.
- \*Top Trims are not included with Extension Modules.

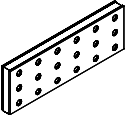
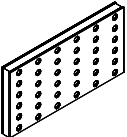
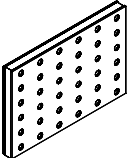
	DESCRIPTION	PRODUCT CODE	LIST PRICE	DIMENSIONS/INCHES		
				H	W	D
	Air Flow Extension Module - 12" High	EVPAE1224	348	12	24	2 7/8
		EVPAE1230	416	12	30	2 7/8
		EVPAE1236	470	12	36	2 7/8
		EVPAE1242	518	12	42	2 7/8
		EVPAE1248	587	12	48	2 7/8
		EVPAE1254	678	18	54	2 7/8
	Air Flow Extension Module - 18" High	EVPAE1824	438	18	24	2 7/8
		EVPAE1830	511	18	30	2 7/8
		EVPAE1836	565	18	36	2 7/8
		EVPAE1842	619	18	42	2 7/8
		EVPAE1848	712	18	48	2 7/8
		EVPAE1854	818	18	54	2 7/8
	Air Flow Extension Module - 24" High	EVPAE2424	438	24	24	2 7/8
		EVPAE2430	511	24	30	2 7/8
		EVPAE2436	565	24	36	2 7/8
		EVPAE2442	619	24	42	2 7/8
		EVPAE2448	712	24	48	2 7/8
		EVPAE2454	810	18	54	2 7/8
		EVPAE2460	919	24	60	2 7/8

# PANELS

# OPEN - EXTENSION MODULE

## EVPOE - OPEN PANEL EXTENSION MODULE

- Attaches to top portion of a panel.
- Modules can be stacked to add privacy or to divide space
- Panel Extension Modules are not load bearing above 66" H.
- When ordering Panel Extension Modules, additional connectors are required.
- \*Top Trims are not included with Extension Modules.

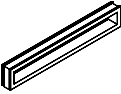
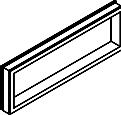
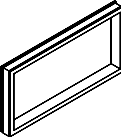
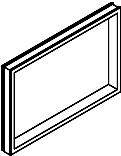
	DESCRIPTION	PRODUCT CODE	LIST PRICE	DIMENSIONS/INCHES		
				H	W	D
	Open Panel Extension Module - 6" High	EVPOE0618	310	6	18	2 7/8
		EVPOE0624	316	6	24	2 7/8
		EVPOE0630	386	6	30	2 7/8
		EVPOE0636	403	6	36	2 7/8
		EVPOE0642	488	6	42	2 7/8
		EVPOE0648	548	6	48	2 7/8
		EVPOE0654	598	6	54	2 7/8
	EVPOE0660	645	6	60	2 7/8	
	Open Panel Extension Module - 12" High	EVPOE1218	312	12	18	2 7/8
		EVPOE1224	318	12	24	2 7/8
		EVPOE1230	386	12	30	2 7/8
		EVPOE1236	403	12	36	2 7/8
		EVPOE1242	488	12	42	2 7/8
		EVPOE1248	549	12	48	2 7/8
		EVPOE1254	598	12	54	2 7/8
	EVPOE1260	647	12	60	2 7/8	
	Open Panel Extension Module - 18" High	EVPOE1818	454	18	18	2 7/8
		EVPOE1824	462	18	24	2 7/8
		EVPOE1830	488	18	30	2 7/8
		EVPOE1836	534	18	36	2 7/8
		EVPOE1842	601	18	42	2 7/8
		EVPOE1848	678	18	48	2 7/8
		EVPOE1854	735	18	54	2 7/8
	EVPOE1860	791	18	60	2 7/8	
	Open Panel Extension Module - 24" High	EVPOE2418	462	24	18	2 7/8
		EVPOE2424	454	24	24	2 7/8
		EVPOE2430	488	24	30	2 7/8
		EVPOE2436	534	24	36	2 7/8
		EVPOE2442	601	24	42	2 7/8
		EVPOE2448	678	24	48	2 7/8
		EVPOE2454	735	24	54	2 7/8
	EVPOE2460	791	24	60	2 7/8	

# PANELS

# INLINE EXTENSION - BRIDGE PANEL

## EVPIECBS - BRIDGE PANEL INLINE EXTENSION CONNECTOR

- Connects bridge panel to inline extension connector.
- Includes one bridge extension connector and connecting hardware.

DESCRIPTION	PRODUCT CODE	LIST PRICE	DIMENSIONS/INCHES		
			H	W	D
 Bridge Panel Inline Extension Connector	EVPIECBS06	53	6	3	3
	EVPIECBS12	53	12	3	3
	EVPIECBS18	63	18	3	3
	EVPIECBS24	63	24	3	3

## EVPEERBSA - BRIDGE PANEL END OF RUN EXTENSION CONNECTOR - ALUMINUM TRIM

- Connects at end of run of bridge panel and can attach panel to fixed wall.
- Adds 1" to width of panel run.
- Provides slotted support for worksurfaces and hang on components up to 66"H.
- Includes one slotted bridge extension connector and connecting hardware and trim kit.

DESCRIPTION	PRODUCT CODE	LIST PRICE	DIMENSIONS/INCHES		
			H	W	D
 Bridge Panel End of Run Extension Connector Aluminum Trim	EVPEERBSA06	57	6	3	3
	EVPEERBSA12	57	12	3	3
	EVPEERBSA18	69	18	3	3
	EVPEERBSA24	69	24	3	3

## EVPICBS - BRIDGE PANEL INLINE CONNECTOR WITHOUT ALUMINUM INSERT

- Connects two bridge panels to inline connector.
- Inline connector in middle between two bridge panels, above opening, using double clamp at bottom.
- Includes one bridge extension connector without aluminum insert, includes connecting hardware.

DESCRIPTION	PRODUCT CODE	LIST PRICE	DIMENSIONS/INCHES		
			H	W	D
 Bridge Panel Inline Connector without Aluminum Insert	EVPICBS06	53	6	3	3
	EVPICBS12	53	12	3	3
	EVPICBS18	63	18	3	3
	EVPICBS24	63	24	3	3

# PANELS

# EXTENSION POST - BRIDGE PANEL

## EVPCEPB1 - BRIDGE PANEL CORNER EXTENSION POST 1 WAY

- Connects at end of a run of extension modules.
- Post and connecting hardware add 3.25" to power beam run.
- Includes one extension post, one slotted extension connectors for bridge panel, connecting hardware and trim kit.



DESCRIPTION	PRODUCT CODE	LIST PRICE	DIMENSIONS/INCHES		
			H	W	D
Bridge Panel Inline Extension Connector	EVPCEPBSA106	97	6	3	3
	EVPCEPBSA112	97	12	3	3
	EVPCEPBSA118	122	18	3	3
	EVPCEPBSA124	122	24	3	3

## EVPCEPB2 - BRIDGE PANEL CORNER EXTENSION POST 2 WAY

- Connects two bridge panels in 90 degree configuration.
- Post and connecting hardware add 3.25" to power beam run.
- Includes one extension post, two one slotted extension connectors for bridge panel, connecting hardware and trim kit.



DESCRIPTION	PRODUCT CODE	LIST PRICE	DIMENSIONS/INCHES		
			H	W	D
Bridge Panel Corner Extension Post 2 way	EVPCEPBSA206	99	6	3	3
	EVPCEPBSA212	99	12	3	3
	EVPCEPBSA218	156	18	3	3
	EVPCEPBSA224	156	24	3	3

## EVPCEPB3 - BRIDGE PANEL CORNER EXTENSION POST 3 WAY

- Connects three bridge panels in T degree configuration.
- Post and connecting hardware add 3.25" to power beam run.
- Includes one extension post, three one slotted extension connectors for bridge panel, connecting hardware and trim kit.



DESCRIPTION	PRODUCT CODE	LIST PRICE	DIMENSIONS/INCHES		
			H	W	D
Bridge Panel Corner Extension Post 3 way	EVPCEPBSA306	118	6	3	3
	EVPCEPBSA312	118	12	3	3
	EVPCEPBSA318	182	18	3	3
	EVPCEPBSA324	182	24	3	3

# PANELS

# EXTENSION POST - BRIDGE PANEL

## EVPCEPB4 - BRIDGE PANEL CORNER EXTENSION POST 4 WAY

- Connects four bridge panels in X degree configuration.
- Post and connecting hardware add 3.25" to power beam run.
- Includes one extension post, four one slotted extension connectors for bridge panel, connecting hardware and trim kit.

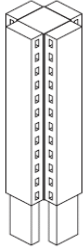

DESCRIPTION	PRODUCT CODE	LIST PRICE	DIMENSIONS/INCHES		
			H	W	D
Bridge Panel Corner Extension Post 4 way	EVPCEPBS406	136	6	3	3
	EVPCEPBS412	136	12	3	3
	EVPCEPBS418	201	18	3	3
	EVPCEPBS424	201	24	3	3

## EVPCEIPBSA2 - BRIDGE PANEL INLINE TWO WAY POST EXTENSION

- Connects two bridge panels in straight run.
- Post and connecting hardware add 3.25" to power beam run.
- Includes one extension post, two slotted extension connectors for bridge panel, connecting hardware and trim kit.



DESCRIPTION	PRODUCT CODE	LIST PRICE	DIMENSIONS/INCHES		
			H	W	D
Bridge Panel Inline Extension Post 2 way	EVPCEIPBSA206	104	6	3	3
	EVPCEIPBSA212	104	12	3	3
	EVPCEIPBSA218	170	18	3	3
	EVPCEIPBSA224	170	24	3	3

# PANELS

# FABRIC PANEL - BRIDGE MODULE

## EVPFEB - FABRIC PANEL BRIDGE MODULE

- Bridge modules connects two panels above opening.
- Requires bridge extension connectors, connects with clamps on top and at bottom.
- Each side of fabric module may have different fabric within the same grade at no charge.
- If different grades of fabric are used, the entire module must be price at highest grade.
- When ordering bridge modules , additional bridge connectors are required.
- Aluminum trim for bottom to be ordered separately.

	DESCRIPTION	PRODUCT CODE	LIST PRICE		DIMENSIONS/INCHES			
			Gr1	Gr2	H	W	D	
	Fabric Panel Bridge Module - 6" High	EVPFEB0618	198	207	6	18	3	
		EVPFEB0624	201	215	6	24	3	
		EVPFEB0630	220	238	6	30	3	
		EVPFEB0636	244	263	6	36	3	
		EVPFEB0642	277	294	6	42	3	
		EVPFEB0648	297	318	6	48	3	
		EVPFEB0654	320	343	6	54	3	
		EVPFEB0660	344	373	6	60	3	
		Fabric Panel Bridge Module - 12" High	EVPFEB1218	198	207	12	18	3
			EVPFEB1224	201	215	12	24	3
EVPFEB1230	220		238	12	30	3		
EVPFEB1236	244		263	12	36	3		
EVPFEB1242	277		294	12	42	3		
EVPFEB1248	297		318	12	48	3		
EVPFEB1254	320		343	12	54	3		
EVPFEB1260	344		373	12	60	3		
Fabric Panel Bridge Module - 18" High	EVPFEB1818	239	257	18	18	3		
	EVPFEB1824	248	269	18	24	3		
	EVPFEB1830	269	298	18	30	3		
	EVPFEB1836	312	342	18	36	3		
	EVPFEB1842	342	380	18	42	3		
	EVPFEB1848	374	413	18	48	3		
	EVPFEB1854	405	449	18	54	3		
	EVPFEB1860	440	488	18	60	3		
Fabric Panel Bridge Module - 24" High	EVPFEB2418	239	257	24	18	3		
	EVPFEB2424	248	269	24	24	3		
	EVPFEB2430	269	298	24	30	3		
	EVPFEB2436	312	342	24	36	3		
	EVPFEB2442	342	380	24	42	3		
	EVPFEB2448	374	413	24	48	3		
	EVPFEB2454	405	449	24	54	3		
	EVPFEB2460	440	488	24	60	3		

## EVPFPEB - FABRIC PANEL BRIDGE MODULE - PREMIUM

- Bridge modules connects two panels above opening.
- Requires bridge extension connectors, connects with clamps on top and at bottom.
- Each side of fabric module may have different fabric within the same grade at no charge.
- If different grades of fabric are used, the entire module must be price at highest grade.
- When ordering bridge modules , additional bridge connectors are required.
- Aluminum trim for bottom to be ordered separately.

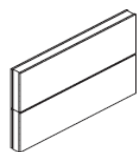
	DESCRIPTION	PRODUCT CODE	LIST PRICE		DIMENSIONS/INCHES		
			Gr1	Gr2	H	W	D
	Fabric Panel Bridge Module - Premium	EVPFPEB2418	323	342	24	18	3
		EVPFPEB2424	344	367	24	24	3
		EVPFPEB2430	386	413	24	30	3
		EVPFPEB2436	434	463	24	36	3
		EVPFPEB2442	487	525	24	42	3
		EVPFPEB2448	523	564	24	48	3
		EVPFPEB2454	577	621	24	54	3
		EVPFPEB2460	630	680	24	60	3

# PANELS

# TEMPERED GLASS - BRIDGE MODULE

## EVPGTEB - TEMPERED GLASS BRIDGE MODULE

- Bridge modules connects two panels above opening.
- Requires bridge extension connectors, connects with clamps on top and at bottom.
- Standard in clear (CLR) glass.
- Frosted glass (FRST) 40% upcharge. Contact Evolve Customer support for details.
- When ordering bridge modules, additional bridge connectors are required.
- Aluminum trim for bottom to be ordered separately.

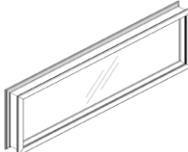
	DESCRIPTION	PRODUCT CODE	LIST PRICE	DIMENSIONS/INCHES			
				H	W	D	
	Tempered Glass Bridge Module - 6" High	EVPGTEB0618	380	6	18	3	
		EVPGTEB0624	410	6	24	3	
		EVPGTEB0630	492	6	30	3	
		EVPGTEB0636	515	6	36	3	
		EVPGTEB0642	630	6	42	3	
		EVPGTEB0648	702	6	48	3	
		EVPGTEB0654	768	6	54	3	
		EVPGTEB0660	828	6	60	3	
		Tempered Glass Bridge Module - 12" High	EVPGTEB1218	380	12	18	3
			EVPGTEB1224	410	12	24	3
EVPGTEB1230	492		12	30	3		
EVPGTEB1236	515		12	36	3		
EVPGTEB1242	630		12	42	3		
EVPGTEB1248	702		12	48	3		
EVPGTEB1254	768		12	54	3		
EVPGTEB1260	828		12	60	3		
Tempered Glass Bridge Module - 18" High	EVPGTEB1818		571	18	18	3	
	EVPGTEB1824		587	18	24	3	
	EVPGTEB1830	629	18	30	3		
	EVPGTEB1836	686	18	36	3		
	EVPGTEB1842	777	18	42	3		
	EVPGTEB1848	870	18	48	3		
	EVPGTEB1854	944	18	54	3		
	EVPGTEB1860	1013	18	60	3		
	Tempered Glass Bridge Module - 24" High	EVPGTEB2418	571	24	18	3	
		EVPGTEB2424	587	24	24	3	
EVPGTEB2430		629	24	30	3		
EVPGTEB2436		686	24	36	3		
EVPGTEB2442		777	24	42	3		
EVPGTEB2448		870	24	48	3		
EVPGTEB2454		944	24	54	3		
EVPGTEB2460		1013	24	60	3		

## EVPGPTEB - TEMPERED GLASS BRIDGE MODULE - PREMIUM

- Bridge modules connects two panels above opening.
- Requires bridge extension connectors, connects with clamps at bottom.
- Standard in clear (CLR) glass.
- Frosted glass (FRST) 40% upcharge. Contact Evolve Customer support for details.
- When ordering bridge modules, additional bridge connectors are required.
- Aluminum trim for bottom to be ordered separately.

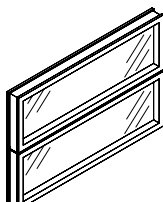
	DESCRIPTION	PRODUCT CODE	LIST PRICE	DIMENSIONS/INCHES		
				H	W	D
	Tempered Glass Bridge Module - Premium	EVPGPTEB2418	562	24	18	3
		EVPGPTEB2424	623	24	24	3
		EVPGPTEB2430	712	24	30	3
		EVPGPTEB2436	810	24	36	3
		EVPGPTEB2442	898	24	42	3
		EVPGPTEB2448	1007	24	48	3
		EVPGPTEB2454	1098	24	54	3
		EVPGPTEB2460	1189	24	60	3

# PANELS

# WRITE BOARD - BRIDGE MODULE

## EVPW1SEB - WRITE BOARD BRIDGE MODULE - SINGLE SIDED

- Bridge modules connects two panels above opening.
- Requires bridge extension connectors, connects with clamps at bottom.
- Provides writing surface on Single side.
- Panel extension module is not load bearing if installed higher than 66" High.
- Use erasable Write Board markers only.
- When ordering bridge modules, additional bridge connectors are required.
- Aluminum trim for bottom to be ordered separately.

DESCRIPTION	PRODUCT CODE	LIST PRICE		DIMENSIONS/INCHES		
		Gr1	Gr2	H	W	D
 Write Board Bridge Module - 6" High Single Sided	EVPW1SEB0618	269	278	6	18	3
	EVPW1SEB0624	313	324	6	24	3
	EVPW1SEB0630	350	358	6	30	3
	EVPW1SEB0636	397	411	6	36	3
	EVPW1SEB0642	450	460	6	42	3
	EVPW1SEB0648	489	567	6	48	3
	EVPW1SEB0654	552	567	6	54	3
	EVPW1SEB0660	580	595	6	60	3
Write Board Bridge Module - 12" High Single Sided	EVPW1SEB1218	269	278	12	18	3
	EVPW1SEB1224	313	324	12	24	3
	EVPW1SEB1230	350	358	12	30	3
	EVPW1SEB1236	397	411	12	36	3
	EVPW1SEB1242	450	460	12	42	3
	EVPW1SEB1248	489	504	12	48	3
	EVPW1SEB1254	552	567	12	54	3
	EVPW1SEB1260	580	595	12	60	3
Write Board Bridge Module - 18" High Single Sided	EVPW1SEB1818	359	373	18	18	3
	EVPW1SEB1824	423	438	18	24	3
	EVPW1SEB1830	487	505	18	30	3
	EVPW1SEB1836	557	576	18	36	3
	EVPW1SEB1842	629	648	18	42	3
	EVPW1SEB1848	690	710	18	48	3
	EVPW1SEB1854	746	772	18	54	3
	EVPW1SEB1860	821	848	18	60	3
Write Board Bridge Module - 24" High Single Sided	EVPW1SEB2418	359	373	24	18	3
	EVPW1SEB2424	423	438	24	24	3
	EVPW1SEB2430	487	505	24	30	3
	EVPW1SEB2436	557	576	24	36	3
	EVPW1SEB2442	629	648	24	42	3
	EVPW1SEB2448	690	710	24	48	3
	EVPW1SEB2454	746	772	24	54	3
	EVPW1SEB2460	821	848	24	60	3

# PANELS

# WRITE BOARD - BRIDGE MODULE

## EVPW2SEB - WRITE BOARD BRIDGE MODULE - DOUBLE SIDED

- Bridge modules connects two panels above opening.
- Requires bridge extension connectors, connects with clamps at bottom.
- Provides writing surface on Single side.
- Panel extension module is not load bearing if installed higher than 66" High.
- Available in high pressure only.
- Use erasable Write Board markers only.
- When ordering bridge modules, additional bridge connectors are required.
- Aluminum trim for bottom to be ordered separately.

DESCRIPTION	PRODUCT CODE	LIST PRICE	DIMENSIONS/INCHES		
			H	W	D
 Write Board Bridge Module - 6" High Double Sided	EVPW2SEB0618	289	6	18	3
	EVPW2SEB0624	342	6	24	3
	EVPW2SEB0630	394	6	30	3
	EVPW2SEB0636	452	6	36	3
	EVPW2SEB0642	513	6	42	3
	EVPW2SEB0648	572	6	48	3
	EVPW2SEB0654	660	6	54	3
	EVPW2SEB0660	677	6	60	3
Tempered Glass Bridge Module - 12" High Double Sided	EVPW2SEB1218	289	12	18	3
	EVPW2SEB1224	342	12	24	3
	EVPW2SEB1230	394	12	30	3
	EVPW2SEB1236	452	12	36	3
	EVPW2SEB1242	513	12	42	3
	EVPW2SEB1248	572	12	48	3
	EVPW2SEB1254	660	12	54	3
	EVPW2SEB1260	677	12	60	3
Tempered Glass Bridge Module - 18" High Double Sided	EVPW2SEB1818	416	18	18	3
	EVPW2SEB1824	502	18	24	3
	EVPW2SEB1830	580	18	30	3
	EVPW2SEB1836	674	18	36	3
	EVPW2SEB1842	760	18	42	3
	EVPW2SEB1848	862	18	48	3
	EVPW2SEB1854	944	18	54	3
	EVPW2SEB1860	1017	18	60	3
Tempered Glass Bridge Module - 24" High Double Sided	EVPW2SEB2418	416	24	18	3
	EVPW2SEB2424	502	24	24	3
	EVPW2SEB2430	580	24	30	3
	EVPW2SEB2436	674	24	36	3
	EVPW2SEB2442	760	24	42	3
	EVPW2SEB2448	862	24	48	3
	EVPW2SEB2454	944	24	54	3
	EVPW2SEB2460	1017	24	60	3

# PANELS

# LAMINATE - BRIDGE MODULE

## EVPH1SEB - LAMINATE BRIDGE MODULE - SINGLE SIDED

- Bridge modules connects two panels above opening.
- Requires bridge extension connectors, connects with clamps at bottom.
- Laminate face on module provides durable, washable surface on Single side of panel.
- Panel extension module is not load bearing if installed higher than 66" High.
- Available in high pressure only.
- When ordering bridge modules , additional bridge connectors are required.
- Aluminum trim for bottom to be ordered separately.

	DESCRIPTION	PRODUCT CODE	LIST PRICE		DIMENSIONS/INCHES		
			Gr1	Gr2	H	W	D
	Laminate Bridge Module - 6" High Single Sided	EVPH1SEB0618	269	278	6	18	3
		EVPH1SEB0624	313	324	6	24	3
		EVPH1SEB0630	350	358	6	30	3
		EVPH1SEB0636	397	411	6	36	3
		EVPH1SEB0642	450	460	6	42	3
		EVPH1SEB0648	489	504	6	48	3
		EVPH1SEB0654	552	567	6	54	3
		EVPH1SEB0660	580	595	6	60	3
	Laminate Bridge Module - 12" High Single Sided	EVPH1SEB1218	269	278	12	18	3
		EVPH1SEB1224	313	324	12	24	3
		EVPH1SEB1230	350	358	12	30	3
		EVPH1SEB1236	397	411	12	36	3
		EVPH1SEB1242	450	460	12	42	3
		EVPH1SEB1248	489	504	12	48	3
		EVPH1SEB1254	552	567	12	54	3
		EVPH1SEB1260	580	595	12	60	3
	Laminate Bridge Module - 18" High Single Sided	EVPH1SEB1818	359	373	18	18	3
		EVPH1SEB1824	423	438	18	24	3
		EVPH1SEB1830	487	505	18	30	3
		EVPH1SEB1836	557	576	18	36	3
		EVPH1SEB1842	629	648	18	42	3
		EVPH1SEB1848	690	710	18	48	3
		EVPH1SEB1854	746	772	18	54	3
		EVPH1SEB1860	821	848	18	60	3
	Laminate Bridge Module - 24" High Single Sided	EVPH1SEB2418	359	373	24	18	3
		EVPH1SEB2424	423	438	24	24	3
		EVPH1SEB2430	487	505	24	30	3
		EVPH1SEB2436	557	576	24	36	3
		EVPH1SEB2442	629	648	24	42	3
		EVPH1SEB2448	690	710	24	48	3
		EVPH1SEB2454	746	772	24	54	3
		EVPH1SEB2460	821	848	24	60	3

# PANELS

# LAMINATE - BRIDGE MODULE

## EVPH2SEB - LAMINATE BRIDGE MODULE - DOUBLE SIDED

- Bridge modules connects two panels above opening.
- Requires bridge extension connectors, connects with clamps at bottom.
- Laminate face on both sides of the module provides durable, washable surface.
- Panel extension module is not load bearing if installed higher than 66" High.
- When ordering panel extension modules, additional connectors are required.
- Available in high pressure only.
- When ordering bridge modules , additional bridge connectors are required.
- Aluminum trim for bottom to be ordered separately.

DESCRIPTION	PRODUCT CODE	LIST PRICE	DIMENSIONS/INCHES		
			H	W	D
 Laminate Bridge Module - 6" High Double Sided	EVPH2SEB0618	289	6	18	3
	EVPH2SEB0624	342	6	24	3
	EVPH2SEB0630	394	6	30	3
	EVPH2SEB0636	452	6	36	3
	EVPH2SEB0642	513	6	42	3
	EVPH2SEB0648	572	6	48	3
	EVPH2SEB0654	660	6	54	3
	EVPH2SEB0660	677	6	60	3
	Laminate Bridge Module - 12" High Double Sided	EVPH2SEB1218	289	12	18
EVPH2SEB1224		342	12	24	3
EVPH2SEB1230		394	12	30	3
EVPH2SEB1236		452	12	36	3
EVPH2SEB1242		513	12	42	3
EVPH2SEB1248		572	12	48	3
EVPH2SEB1254		660	12	54	3
EVPH2SEB1260		677	12	60	3
Laminate Bridge Module - 18" High Double Sided	EVPH2SEB1818	416	18	18	3
	EVPH2SEB1824	502	18	24	3
	EVPH2SEB1830	580	18	30	3
	EVPH2SEB1836	674	18	36	3
	EVPH2SEB1842	760	18	42	3
	EVPH2SEB1848	862	18	48	3
	EVPH2SEB1854	944	18	54	3
	EVPH2SEB1860	1017	18	60	3
Laminate Bridge Module - 24" High Double Sided	EVPH2SEB2418	416	24	18	3
	EVPH2SEB2424	502	24	24	3
	EVPH2SEB2430	580	24	30	3
	EVPH2SEB2436	674	24	36	3
	EVPH2SEB2442	760	24	42	3
	EVPH2SEB2448	862	24	48	3
	EVPH2SEB2454	944	24	54	3
	EVPH2SEB2460	1017	24	60	3

# PANELS

# PRIVACY GLASS - EXTENSION MODULE

## EVPMPXXGI6P - 6" H PANEL MOUNT PRIVACY GLASS W/ ALUMINUM TRIM

- Attaches on top of Evolve Panels to add privacy or divide space.
- Privacy Glass is integrated into the aluminum top trim.
- Aluminum trim must be specified for entire station when ordering panel mount privacy glass.
- Includes aluminum trim with channel and glass tile
- Glass and attachment hardware ship separately.
- Standard in clear (CLR) or frosted (FRST) glass.

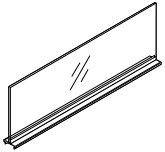
	DESCRIPTION	PRODUCT CODE	LIST PRICE		DIMENSIONS/INCHES		
			Clear	Frosted	H	W	D
	6" H Panel Mount Privacy Glass w/ Aluminum Trim - 24" Wide	EVPMP24GI6P	301	73	6	24	2 7/8
	6" H Panel Mount Privacy Glass w/ Aluminum Trim - 30" Wide	EVPMP30GI6P	326	53	6	30	2 7/8
	6" H Panel Mount Privacy Glass w/ Aluminum Trim - 36" Wide	EVPMP36GI6P	359	38	6	36	2 7/8
	6" H Panel Mount Privacy Glass w/ Aluminum Trim - 42" Wide	EVPMP42GI6P	375	63	6	42	2 7/8
	6" H Panel Mount Privacy Glass w/ Aluminum Trim - 48" Wide	EVPMP48GI6P	385	80	6	48	2 7/8
	6" H Panel Mount Privacy Glass w/ Aluminum Trim - 54" Wide	EVPMP54GI6P	399	100	6	54	2 7/8
	6" H Panel Mount Privacy Glass w/ Aluminum Trim - 60" Wide	EVPMP60GI6P	410	132	6	60	2 7/8
	6" H Panel Mount Privacy Glass w/ Aluminum Trim - 66" Wide	EVPMP66GI6P	475	158	6	66	2 7/8
	6" H Panel Mount Privacy Glass w/ Aluminum Trim - 72" Wide	EVPMP72GI6P	488	158	6	72	2 7/8

# PANELS

# PRIVACY GLASS - EXTENSION MODULE

## EVPMPXXGI9P - 9"H PANEL MOUNT PRIVACY GLASS W/ ALUMINUM TRIM

- Attaches on top of Evolve Panels to add privacy or divide space.
- Privacy Glass is integrated into the aluminum top trim.
- Aluminum trim must be specified for entire station when ordering panel mount privacy glass.
- Includes aluminum trim with channel and glass tile
- Glass and attachment hardware ship separately.
- Standard in clear (CLR) or frosted (FRST) glass.

	DESCRIPTION	PRODUCT CODE	LIST PRICE		DIMENSIONS/INCHES		
			Clear	Frosted	H	W	D
	9" H Panel Mount Privacy Glass w/ Aluminum Trim - 24" Wide	EVPMP24GI9P	301	73	9	24	2 7/8
	9" H Panel Mount Privacy Glass w/ Aluminum Trim - 30" Wide	EVPMP30GI9P	326	53	9	30	2 7/8
	9" H Panel Mount Privacy Glass w/ Aluminum Trim - 36" Wide	EVPMP36GI9P	359	38	9	36	2 7/8
	9" H Panel Mount Privacy Glass w/ Aluminum Trim - 42" Wide	EVPMP42GI9P	375	63	9	42	2 7/8
	9" H Panel Mount Privacy Glass w/ Aluminum Trim - 48" Wide	EVPMP48GI9P	385	80	9	48	2 7/8
	9" H Panel Mount Privacy Glass w/ Aluminum Trim - 54" Wide	EVPMP54GI9P	399	100	9	54	2 7/8
	9" H Panel Mount Privacy Glass w/ Aluminum Trim - 60" Wide	EVPMP60GI9P	410	132	9	60	2 7/8
	9" H Panel Mount Privacy Glass w/ Aluminum Trim - 66" Wide	EVPMP66GI9P	475	158	9	66	2 7/8
9" H Panel Mount Privacy Glass w/ Aluminum Trim - 72" Wide	EVPMP72GI9P	488	158	9	72	2 7/8	

# PANELS

# PRIVACY GLASS - EXTENSION MODULE

### EVPMPXXGIP - 12" PANEL MOUNT PRIVACY GLASS W/ ALUMINUM TRIM

- Attaches on top of Evolve Panels to add privacy or divide space.
- Privacy Glass is integrated into the aluminum top trim.
- Includes aluminum trim with channel and glass tile.
- Standard in clear (CLR), frosted (FRST) or writeable (WRW) glass.

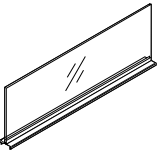
	DESCRIPTION	PRODUCT CODE	LIST PRICE			DIMENSIONS/INCHES		
			CLR	FRST ADD	WRW ADD	H	W	D
	Panel Mount Privacy Glass w/ Aluminum Trim - 24" Wide	EVPMP24GIP	311	73	196	12	24	2 7/8
	Panel Mount Privacy Glass w/ Aluminum Trim - 30" Wide	EVPMP30GIP	338	53	180	12	30	2 7/8
	Panel Mount Privacy Glass w/ Aluminum Trim - 36" Wide	EVPMP36GIP	359	38	171	12	36	2 7/8
	Panel Mount Privacy Glass w/ Aluminum Trim - 42" Wide	EVPMP42GIP	375	63	206	12	42	2 7/8
	Panel Mount Privacy Glass w/ Aluminum Trim - 48" Wide	EVPMP48GIP	395	80	240	12	48	2 7/8
	Panel Mount Privacy Glass w/ Aluminum Trim - 54" Wide	EVPMP54GIP	411	102	275	12	54	2 7/8
	Panel Mount Privacy Glass w/ Aluminum Trim - 60" Wide	EVPMP60GIP	423	132	316	12	60	2 7/8
	Panel Mount Privacy Glass w/ Aluminum Trim - 66" Wide	EVPMP66GIP	475	158	368	12	66	2 7/8
Panel Mount Privacy Glass w/ Aluminum Trim - 72" Wide	EVPMP72GIP	503	158	377	12	72	2 7/8	

### EVPMPNXXGIP - 12" H PANEL MOUNT PRIVACY GLASS W/ NOTCHED TOP TRIM FOR INLINE VARIABLE HEIGHT CONNECTOR

- Privacy Glass integrated with aluminum top trim.
- Attaches on top of panels to add privacy or divide space.
- Includes aluminum top trim with channel with notched end and glass tile.
- Standard in clear (CLR) or frosted (FRST) glass.
- Aluminium trim must be specified for entire station when ordering panel mount privacy glass.
- Glass and attachment hardware to ship separately

	DESCRIPTION	PRODUCT CODE	LIST PRICE		DIMENSIONS/INCHES		
			Clear	FRST ADD	H	W	D
	Panel Mount Privacy Glass w/ Notched Top Trim for Variable Height Connector - 12" High	EVPMPN24GIP	311	73	12	24	2 7/8
		EVPMPN30GIP	338	53	12	30	2 7/8
		EVPMPN36GIP	359	38	12	36	2 7/8
		EVPMPN42GIP	375	63	12	42	2 7/8
		EVPMPN48GIP	395	80	12	48	2 7/8
		EVPMPN54GIP	411	100	12	54	2 7/8
	EVPMPN60GIP	423	132	12	60	2 7/8	

# PANELS

# PRIVACY GLASS - EXTENSION MODULE

## EVPMPDNXXGIP - 12" H PANEL MOUNT PRIVACY GLASS W/ DOUBLE NOTCHED TOP TRIM FOR INLINE VARIABLE HEIGHT CONNECTOR

- Privacy Glass integrated with aluminum top trim.
- Attaches on top of panels to add privacy or divide space.
- Includes aluminum top trim with channel with notched ends and glass tile.
- Standard in clear (CLR) or frosted (FRST) glass.
- Aluminium trim must be specified for entire station when ordering panel mount privacy glass.
- Glass and attachment hardware to ship separately.

DESCRIPTION	PRODUCT CODE	LIST PRICE		DIMENSIONS/INCHES		
		Clear	FRST ADD	H	W	D
 Panel Mount Privacy Glass w/ double notched top trim for variable height connector - 12" High	EVPMPDN24GIP	311	73	12	24	2 7/8
	EVPMPDN30GIP	338	53	12	30	2 7/8
	EVPMPDN36GIP	359	38	12	36	2 7/8
	EVPMPDN42GIP	375	63	12	42	2 7/8
	EVPMPDN48GIP	395	80	12	48	2 7/8
	EVPMPDN54GIP	411	100	12	54	2 7/8
	EVPMPDN60GIP	423	132	12	60	2 7/8

## EVPMPXXGI18P - 18" H PANEL MOUNT PRIVACY GLASS

- Privacy Glass integrated with aluminum top trim.
- Attaches on top of panels to add privacy or divide space.
- Includes aluminum trim with channel and glass tile.
- Aluminium trim must be specified for entire station when ordering panel mount privacy glass.
- Glass and attachment hardware to ship separately.

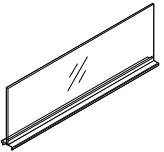
DESCRIPTION	PRODUCT CODE	LIST PRICE		DIMENSIONS/INCHES		
		Clear	FRST ADD	H	W	D
 18" H Panel Mount Privacy Glass w/ Aluminum Trim - 24" Wide	EVPMP24G118P	464	104	18	24	2 7/8
	EVPMP30G118P	503	79	18	30	2 7/8
	EVPMP36G118P	537	54	18	36	2 7/8
	EVPMP42G118P	560	90	18	42	2 7/8
	EVPMP48G118P	593	117	18	48	2 7/8
	EVPMP54G118P	615	156	18	54	2 7/8
	EVPMP60G118P	635	195	18	60	2 7/8
	EVPMP66G118P	712	232	18	66	2 7/8
	EVPMP72G118P	753	233	18	72	2 7/8

# PANELS

# PRIVACY GLASS - EXTENSION MODULE

## EVPMPNXXG118P - 18" H PANEL MOUNT PRIVACY GLASS WITH NOTCHED TOP TRIM FOR VARIABLE HEIGHT CONNECTOR

- Privacy Glass integrated with aluminum top trim.
- Attaches on top of panels to add privacy or divide space.
- Includes aluminum trim with channel and glass tile.
- Standard in clear (CLR) or frosted (FRST) glass.
- Aluminium trim must be specified for entire station when ordering panel mount privacy glass.
- Glass and attachment hardware to ship separately.

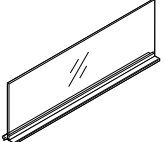
	DESCRIPTION	PRODUCT CODE	LIST PRICE		DIMENSIONS/INCHES		
			Clear	FRST ADD	H	W	D
	18" H Panel Mount Privacy Glass w/ Aluminum Trim - 24" Wide	EVPMPN24G118P	464	104	18	24	2 7/8
	18" H Panel Mount Privacy Glass w/ Aluminum Trim - 30" Wide	EVPMPN30G118P	503	79	18	30	2 7/8
	18" H Panel Mount Privacy Glass w/ Aluminum Trim - 36" Wide	EVPMPN36G118P	537	54	18	36	2 7/8
	18" H Panel Mount Privacy Glass w/ Aluminum Trim - 42" Wide	EVPMPN42G118P	560	90	18	42	2 7/8
	18" H Panel Mount Privacy Glass w/ Aluminum Trim - 48" Wide	EVPMPN48G118P	593	117	18	48	2 7/8
	18" H Panel Mount Privacy Glass w/ Aluminum Trim - 54" Wide	EVPMPN54G118P	615	156	18	54	2 7/8
	18" H Panel Mount Privacy Glass w/ Aluminum Trim - 60" Wide	EVPMPN60G118P	635	195	18	60	2 7/8
	18" H Panel Mount Privacy Glass w/ Aluminum Trim - 66" Wide	EVPMPN66G118P	712	232	18	66	2 7/8
18" H Panel Mount Privacy Glass w/ Aluminum Trim - 72" Wide	EVPMPN72G118P	753	233	18	72	2 7/8	

# PANELS

# PRIVACY GLASS - EXTENSION MODULE

## EVPMPDNXXGI18P-18"H PANEL MOUNT PRIVACY GLASS WITH DOUBLE NOTCHED TOP TRIM FOR VARIABLE HEIGHT CONNECTOR

- Privacy Glass integrated with aluminum top trim.
- Attaches on top of panels to add privacy or divide space.
- Includes aluminum trim with channel and glass tile.
- Standard in clear (CLR) or frosted (FRST) glass.
- Aluminium trim must be specified for entire station when ordering panel mount privacy glass.
- Glass and attachment hardware to ship separately.

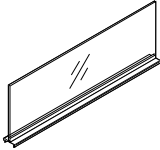
	DESCRIPTION	PRODUCT CODE	LIST PRICE		DIMENSIONS/INCHES		
			Clear	FRST ADD	H	W	D
	18" H Panel Mount Privacy Glass w/ Aluminum Trim - 24" Wide	EVPMPDN24GI18P	464	104	18	24	2 7/8
	18" H Panel Mount Privacy Glass w/ Aluminum Trim - 30" Wide	EVPMPDN30GI18P	503	79	18	30	2 7/8
	18" H Panel Mount Privacy Glass w/ Aluminum Trim - 36" Wide	EVPMPDN36GI18P	537	54	18	36	2 7/8
	18" H Panel Mount Privacy Glass w/ Aluminum Trim - 42" Wide	EVPMPDN42GI18P	560	90	18	42	2 7/8
	18" H Panel Mount Privacy Glass w/ Aluminum Trim - 48" Wide	EVPMPDN48GI18P	593	117	18	48	2 7/8
	18" H Panel Mount Privacy Glass w/ Aluminum Trim - 54" Wide	EVPMPDN54GI18P	615	156	18	54	2 7/8
	18" H Panel Mount Privacy Glass w/ Aluminum Trim - 60" Wide	EVPMPDN60GI18P	635	195	18	60	2 7/8
	18" H Panel Mount Privacy Glass w/ Aluminum Trim - 66" Wide	EVPMPDN66GI18P	712	232	18	66	2 7/8
18" H Panel Mount Privacy Glass w/ Aluminum Trim - 72" Wide	EVPMPDN72GI18P	753	233	18	72	2 7/8	

# PANELS

# PRIVACY GLASS - EXTENSION MODULE

## EVPMPXXGI6PU - 6" H PANEL MOUNT PRIVACY GLASS FOR U CHANNEL FOR GALLERY PANEL ON ONE END

- Privacy Glass integrated with aluminum top trim to be used with U channel with connector for Gallery Panels.
- Attaches on top of panels to add privacy or divide space.
- Includes aluminum trim with channel and glass tile.
- Standard in clear (CLR) or frosted (FRST) glass.
- Aluminium trim must be specified for entire station when ordering panel mount privacy glass.
- Glass and attachment hardware to ship separately.
- Trim and glass extended for U channel from one end.

DESCRIPTION	PRODUCT CODE	LIST PRICE		DIMENSIONS/INCHES		
		Clear	FRST ADD	H	W	D
 6" H Panel Mount Privacy Glass U Channel for Gallery Panel	EVPMP24GI6PU	347	52	6	24	5/8
	EVPMP30GI6PU	372	80	6	30	5/8
	EVPMP36GI6PU	386	449	6	36	5/8
	EVPMP42GI6PU	409	80	6	42	5/8
	EVPMP48GI6PU	423	104	6	48	5/8
	EVPMP54GI6PU	436	135	6	54	5/8
	EVPMP60GI6PU	475	157	6	60	5/8
	EVPMP66GI6PU	503	156	6	66	5/8
	EVPMP72GI6PU	532	152	6	72	5/8

## EVPMPXXGI9PU - 9" H PANEL MOUNT PRIVACY GLASS FOR U CHANNEL FOR GALLERY PANEL ON ONE END

- Privacy Glass integrated with aluminum top trim to be used with U channel with connector for Gallery Panels.
- Attaches on top of panels to add privacy or divide space.
- Includes aluminum trim with channel and glass tile.
- Standard in clear (CLR) or frosted (FRST) glass.
- Aluminium trim must be specified for entire station when ordering panel mount privacy glass.
- Glass and attachment hardware to ship separately.
- Trim and glass extended for U channel from one end.

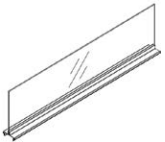
DESCRIPTION	PRODUCT CODE	LIST PRICE		DIMENSIONS/INCHES		
		Clear	FRST ADD	H	W	D
 9" H Panel Mount Privacy Glass U Channel for Gallery Panel	EVPMP24GI9PU	347	52	9	24	5/8
	EVPMP30GI9PU	406	80	9	30	5/8
	EVPMP36GI9PU	446	449	9	36	5/8
	EVPMP42GI9PU	488	80	9	42	5/8
	EVPMP48GI9PU	527	104	9	48	5/8
	EVPMP54GI9PU	570	135	9	54	5/8
	EVPMP60GI9PU	475	157	9	60	5/8
	EVPMP66GI9PU	503	156	9	66	5/8
	EVPMP72GI9PU	532	152	9	72	5/8

## EVPMPXXGI12PU - 12" H PANEL MOUNT PRIVACY GLASS FOR U CHANNEL FOR GALLERY PANEL ON ONE END

- Privacy Glass integrated with aluminum top trim to be used with U channel with connector for Gallery Panels.
- Attaches on top of panels to add privacy or divide space.
- Includes aluminum trim with channel and glass tile.
- Standard in clear (CLR) or frosted (FRST) glass.
- Aluminium trim must be specified for entire station when ordering panel mount privacy glass.
- Glass and attachment hardware to ship separately.
- Trim and glass extended for U channel from one end.

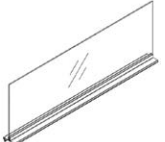
DESCRIPTION	PRODUCT CODE	LIST PRICE		DIMENSIONS/INCHES		
		Clear	FRST ADD	H	W	D
 12" H Panel Mount Privacy Glass U Channel for Gallery Panel	EVPMP24GI12PU	347	52	12	24	5/8
	EVPMP30GI12PU	372	80	12	30	5/8
	EVPMP36GI12PU	386	449	12	36	5/8
	EVPMP42GI12PU	409	80	12	42	5/8
	EVPMP48GI12PU	423	104	12	48	5/8
	EVPMP54GI12PU	436	135	12	54	5/8
	EVPMP60GI12PU	475	157	12	60	5/8
	EVPMP66GI12PU	503	156	12	66	5/8
	EVPMP72GI12PU	532	152	12	72	5/8

# PANELS

# PRIVACY GLASS - EXTENSION MODULE

## EVPMPXXGI18PU - 18" H PANEL MOUNT PRIVACY GLASS FOR U CHANNEL FOR GALLERY PANEL ON ONE END

- Privacy Glass integrated with aluminum top trim to be used with U channel with connector for Gallery Panels.
- Attaches on top of panels to add privacy or divide space.
- Includes aluminum trim with channel and glass tile.
- Standard in clear (CLR) or frosted (FRST) glass.
- Aluminium trim must be specified for entire station when ordering panel mount privacy glass.
- Glass and attachment hardware to ship separately.
- Trim and glass extended for U channel from one end.

DESCRIPTION	PRODUCT CODE	LIST PRICE		DIMENSIONS/INCHES		
		Clear	FRST ADD	H	W	D
 18" H Panel Mount Privacy Glass U Channel for Gallery Panel	EVPMP24GI18PU	503	76	18	24	5/8
	EVPMP30GI18PU	537	53	18	30	5/8
	EVPMP36GI18PU	560	613	18	36	5/8
	EVPMP42GI18PU	593	116	18	42	5/8
	EVPMP48GI18PU	615	151	18	48	5/8
	EVPMP54GI18PU	635	193	18	54	5/8
	EVPMP60GI18PU	712	228	18	60	5/8
	EVPMP66GI18PU	753	232	18	66	5/8
	EVPMP72GI18PU	796	233	18	72	5/8

## EVPMPXXGI6PDU - 6" H PANEL MOUNT PRIVACY GLASS FOR U CHANNEL FOR GALLERY PANELS ON BOTH ENDS

- Privacy Glass integrated with aluminum top trim to be used with U channel with connector for Gallery Panels.
- Attaches on top of panels to add privacy or divide space.
- Includes aluminum trim with channel and glass tile.
- Standard in clear (CLR) or frosted (FRST) glass.
- Aluminium trim must be specified for entire station when ordering panel mount privacy glass.
- Glass and attachment hardware to ship separately.
- Trim and glass extended for U channel from both ends.

DESCRIPTION	PRODUCT CODE	LIST PRICE		DIMENSIONS/INCHES		
		Clear	FRST ADD	H	W	D
 6" H Panel Mount Privacy Glass U Channel for Gallery Panel	EVPMP24GI6PDU	347	52	6	25	1/4
	EVPMP30GI6PDU	369	38	6	31	1/4
	EVPMP36GI6PDU	386	449	6	37	1/4
	EVPMP42GI6PDU	408	81	6	43	1/4
	EVPMP48GI6PDU	423	104	6	49	1/4
	EVPMP54GI6PDU	436	135	6	55	1/4
	EVPMP60GI6PDU	475	157	6	61	1/4
	EVPMP66GI6PDU	503	156	6	67	1/4
	EVPMP72GI6PDU	532	152	6	73	1/4

## EVPMPXXGI9PDU - 9" H PANEL MOUNT PRIVACY GLASS FOR U CHANNEL FOR GALLERY PANELS ON BOTH ENDS

- Privacy Glass integrated with aluminum top trim to be used with U channel with connector for Gallery Panels.
- Attaches on top of panels to add privacy or divide space.
- Includes aluminum trim with channel and glass tile.
- Standard in clear (CLR) or frosted (FRST) glass.
- Aluminium trim must be specified for entire station when ordering panel mount privacy glass.
- Glass and attachment hardware to ship separately.
- Trim and glass extended for U channel from both ends.

DESCRIPTION	PRODUCT CODE	LIST PRICE		DIMENSIONS/INCHES		
		Clear	FRST ADD	H	W	D
 9" H Panel Mount Privacy Glass U Channel for Gallery Panel	EVPMP24GI9PDU	347	52	9	25	1/4
	EVPMP30GI9PDU	369	38	9	31	1/4
	EVPMP36GI9PDU	386	449	9	37	1/4
	EVPMP42GI9PDU	408	81	9	43	1/4
	EVPMP48GI9PDU	423	104	9	49	1/4
	EVPMP54GI9PDU	436	135	9	55	1/4
	EVPMP60GI9PDU	475	157	9	61	1/4
	EVPMP66GI9PDU	503	156	9	67	1/4
	EVPMP72GI9PDU	532	152	9	73	1/4

# PANELS

# PRIVACY GLASS - EXTENSION MODULE

## EVPMPXXGIPDU - 12" H PANEL MOUNT PRIVACY GLASS FOR U CHANNEL FOR GALLERY PANELS ON BOTH ENDS

- Privacy Glass integrated with aluminum top trim to be used with U channel with connector for Gallery Panels.
- Attaches on top of panels to add privacy or divide space.
- Includes aluminum trim with channel and glass tile.
- Standard in clear (CLR) or frosted (FRST) glass.
- Aluminium trim must be specified for entire station when ordering panel mount privacy glass.
- Glass and attachment hardware to ship separately.
- Trim and glass extended for U channel from both ends.

DESCRIPTION	PRODUCT CODE	LIST PRICE		DIMENSIONS/INCHES		
		Clear	FRST ADD	H	W	D
 12" H Panel Mount Privacy Glass U Channel for Gallery Panel	EVPMP24GIPDU	347	52	12	25 1/4	
	EVPMP30GIPDU	369	38	12	31 1/4	
	EVPMP36GIPDU	386	449	12	37 1/4	
	EVPMP42GIPDU	408	81	12	43 1/4	
	EVPMP48GIPDU	423	104	12	49 1/4	
	EVPMP54GIPDU	436	135	12	55 1/4	
	EVPMP60GIPDU	475	157	12	61 1/4	
	EVPMP66GIPDU	503	156	12	67 1/4	
	EVPMP72GIPDU	532	152	12	73 1/4	

## EVPMPXXGI18PDU - 18" H PANEL MOUNT PRIVACY GLASS FOR U CHANNEL FOR GALLERY PANELS ON BOTH ENDS

- Privacy Glass integrated with aluminum top trim to be used with U channel with connector for Gallery Panels.
- Attaches on top of panels to add privacy or divide space.
- Includes aluminum trim with channel and glass tile.
- Standard in clear (CLR) or frosted (FRST) glass.
- Aluminium trim must be specified for entire station when ordering panel mount privacy glass.
- Glass and attachment hardware to ship separately.
- Trim and glass extended for U channel from both ends.

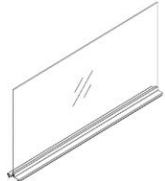
DESCRIPTION	PRODUCT CODE	LIST PRICE		DIMENSIONS/INCHES		
		Clear	FRST ADD	H	W	D
 18" H Panel Mount Privacy Glass U Channel for Gallery Panel	EVPMP24G118PDU	504	74	18	25 1/4	
	EVPMP30G118PDU	537	53	18	31 1/4	
	EVPMP36G118PDU	559	650	18	37 1/4	
	EVPMP42G118PDU	593	116	18	43 1/4	
	EVPMP48G118PDU	615	151	18	49 1/4	
	EVPMP54G118PDU	635	193	18	55 1/4	
	EVPMP60G118PDU	711	232	18	61 1/4	
	EVPMP66G118PDU	754	228	18	67 1/4	
	EVPMP72G118PDU	796	80	18	73 1/4	

# PANELS

# PRIVACY GLASS - EXTENSION MODULE

### EVPMPXXGI6W - 6" H PRIVACY GLASS W/ ALUMINUM TRIM FOR 1" LAMINATE PANEL

- Attaches on top of Evolve 1" Laminate Panels to add privacy or divide space.
- Privacy Glass is integrated into the aluminum top trim.
- Aluminum trim has rail for accessories.
- Includes aluminum trim with end caps and glass tile
- Glass and attachment hardware ship separately.
- Standard in clear (CLR) or frosted (FRST) glass.

	DESCRIPTION	PRODUCT CODE	LIST PRICE		DIMENSIONS/INCHES		
			Clear	FRST ADD	H	W	D
	6" H Privacy Glass w/ Aluminum Trim for 1" Laminate Panel - 24" Wide	EVPMP24GI6W	311	73	6	24	1
	6" H Privacy Glass w/ Aluminum Trim for 1" Laminate Panel- 30" Wide	EVPMP30GI6W	338	53	6	30	1
	6" H Privacy Glass w/ Aluminum Trim for 1" Laminate Panel - 36" Wide	EVPMP36GI6W	359	38	6	36	1
	6" H Privacy Glass w/ Aluminum Trim for 1" Laminate Panel- 42" Wide	EVPMP42GI6W	375	63	6	42	1
	6" H Privacy Glass w/ Aluminum Trim for 1" Laminate Panel- 48" Wide	EVPMP48GI6W	395	80	6	48	1

### EVPMPXXGI9W - 9" H PRIVACY GLASS W/ ALUMINUM TRIM FOR 1" LAMINATE PANEL

- Attaches on top of Evolve 1" Laminate Panels to add privacy or divide space.
- Privacy Glass is integrated into the aluminum top trim.
- Aluminum trim has rail for accessories.
- Includes aluminum trim with end caps and glass tile
- Glass and attachment hardware ship separately.
- Standard in clear (CLR) or frosted (FRST) glass.

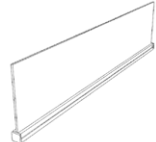
	DESCRIPTION	PRODUCT CODE	LIST PRICE		DIMENSIONS/INCHES		
			Clear	FRST ADD	H	W	D
	9" H Privacy Glass w/ Aluminum Trim for 1" Laminate Panel - 24" Wide	EVPMP24GI9W	311	73	9	24	1
	9" H Privacy Glass w/ Aluminum Trim for 1" Laminate Panel- 30" Wide	EVPMP30GI9W	338	53	9	30	1
	9" H Privacy Glass w/ Aluminum Trim for 1" Laminate Panel - 36" Wide	EVPMP36GI9W	359	38	9	36	1
	9" H Privacy Glass w/ Aluminum Trim for 1" Laminate Panel- 42" Wide	EVPMP42GI9W	375	63	9	42	1
	9" H Privacy Glass w/ Aluminum Trim for 1" Laminate Panel- 48" Wide	EVPMP48GI9W	395	80	9	48	1

# PANELS

# PRIVACY GLASS / FELT DIVIDER - EXTENSION MODULE

## EVPMPXXGIW - 12" H PRIVACY GLASS W/ ALUMINUM TRIM FOR 1" LAMINATE PANEL

- Attaches on top of Evolve 1" Laminate Panels to add privacy or divide space.
- Privacy Glass is integrated into the aluminum top trim.
- Aluminum trim has rail for accessories.
- Includes aluminum trim with end caps and glass tile
- Glass and attachment hardware ship separately.
- Standard in clear (CLR), frosted (FRST) or writeable (WRW) glass.

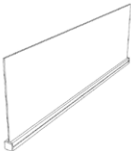
DESCRIPTION	PRODUCT CODE	LIST PRICE			DIMENSIONS/INCHES			
		CLR	FRST ADD	WRW ADD	H	W	D	
	12" H Privacy Glass w/ Aluminum Trim for 1" Laminate Panel - 24" Wide	EVMPMP24GIW	311	73	196	12	24	1
	12" H Privacy Glass w/ Aluminum Trim for 1" Laminate Panel - 30" Wide	EVMPMP30GIW	338	53	180	12	30	1
	12" H Privacy Glass w/ Aluminum Trim for 1" Laminate Panel - 36" Wide	EVMPMP36GIW	359	38	170	12	36	1
	12" H Privacy Glass w/ Aluminum Trim for 1" Laminate Panel - 42" Wide	EVMPMP42GIW	375	63	206	12	42	1
	12" H Privacy Glass w/ Aluminum Trim for 1" Laminate Panel - 48" Wide	EVMPMP48GIW	395	80	239	12	48	1

## EVFPFDW - 6" H FELT DIVIDER W/ ALUMINUM TRIM FOR 1" LAMINATE PANEL

- Privacy Felt Divider integrated with aluminum top trim.
- Attaches on top of laminate panels to add privacy or divide space.
- Includes aluminum trim with channel and felt tile.
- Felt and attachment hardware to ship separately.
- 9 mm felt material is tackable and comes in 9 different colors. Please specify color.
- Aluminum top trim available in standard paint finishes.

DESCRIPTION	PRODUCT CODE	LIST PRICE	DIMENSIONS/INCHES			
			H	W	D	
	6" H Felt Divider w/ Aluminum Trim for 1" Laminate Panel	EVFPFD0624W	125	6	24	1
		EVFPFD0630W	145	6	30	1
		EVFPFD0636W	172	6	36	1
		EVFPFD0642W	193	6	42	1
		EVFPFD0648W	283	6	48	1
		EVFPFD0654W	310	6	54	1
		EVFPFD0660W	332	6	60	1
		EVFPFD0666W	350	6	66	1
		EVFPFD0672W	395	6	72	1

## EVFPFDW - 9" H FELT DIVIDER W/ ALUMINUM TRIM FOR 1" LAMINATE PANEL

- Privacy Felt Divider integrated with aluminum top trim.
- Attaches on top of laminate panels to add privacy or divide space.
- Includes aluminum trim with channel and felt tile.
- Felt and attachment hardware to ship separately.
- 9 mm felt material is tackable and comes in 9 different colors. Please specify color.
- Aluminum top trim available in standard paint finishes.

DESCRIPTION	PRODUCT CODE	LIST PRICE	DIMENSIONS/INCHES			
			H	W	D	
	9" H Felt Divider w/ Aluminum Trim for 1" Laminate Panel	EVFPFD0924W	125	9	24	1
		EVFPFD0930W	145	9	30	1
		EVFPFD0936W	172	9	36	1
		EVFPFD0942W	193	9	42	1
		EVFPFD0948W	283	9	48	1
		EVFPFD0954W	310	9	54	1
		EVFPFD0960W	332	9	60	1
		EVFPFD0966W	350	9	66	1
		EVFPFD0972W	395	9	72	1

# PANELS

# PET FELT DIVIDER - EXTENSION MODULE

## EVFPDW - 12" H FELT DIVIDER W/ ALUMINUM TRIM FOR 1" LAMINATE PANEL

- Privacy Felt Divider integrated with aluminum top trim.
- Attaches on top of laminate panels to add privacy or divide space.
- Includes aluminum trim with channel and felt tile.
- Felt and attachment hardware to ship separately.
- 9 mm felt material is tackable and is available in standard PET colors. Please specify.
- Aluminum top trim available in standard paint finishes.

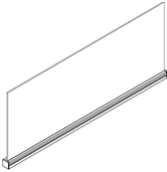
DESCRIPTION	PRODUCT CODE	LIST PRICE	DIMENSIONS/INCHES		
			H	W	D
 12" H Felt Divider w/ Aluminum Trim for 1" Laminate Panel	EVFPD1224W	125	12	24	1
	EVFPD1230W	145	12	30	1
	EVFPD1236W	172	12	36	1
	EVFPD1242W	193	12	42	1
	EVFPD1248W	283	12	48	1
	EVFPD1254W	310	12	54	1
	EVFPD1260W	332	12	60	1
	EVFPD1266W	350	12	66	1
	EVFPD1272W	395	12	72	1

## EVFPDW - 18" H FELT DIVIDER W/ ALUMINUM TRIM FOR 1" LAMINATE PANEL

- Privacy Felt Divider integrated with aluminum top trim.
- Attaches on top of laminate panels to add privacy or divide space.
- Includes aluminum trim with channel and felt tile.
- Felt and attachment hardware to ship separately.
- 9 mm felt material is tackable and is available in standard PET colors. Please specify..
- Aluminum top trim available in standard paint finishes.

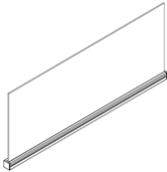
DESCRIPTION	PRODUCT CODE	LIST PRICE	DIMENSIONS/INCHES		
			H	W	D
 18" H Felt Divider w/ Aluminum Trim for 1" Laminate Panel	EVFPD1824W	156	18	24	1
	EVFPD1830W	181	18	30	1
	EVFPD1836W	214	18	36	1
	EVFPD1842W	239	18	42	1
	EVFPD1848W	353	18	48	1
	EVFPD1854W	385	18	54	1
	EVFPD1860W	416	18	60	1
	EVFPD1866W	436	18	66	1
	EVFPD1872W	495	18	72	1

# PANELS

# PET FELT DIVIDER - EXTENSION MODULE

## EVFDK06P - 6" PANEL MOUNTED FELT DIVIDER

- Privacy felt panel integrated with aluminum top trim.
- Attaches on top of panels to add privacy or divide space. Includes aluminum trim with channel and felt tile.
- Aluminum trim must be specified for entire station when ordering panel mount privacy felt.
- Felt and attachment hardware to ship separately.
- 9 mm felt material is tackable and is available in standard PET colors. Please specify.

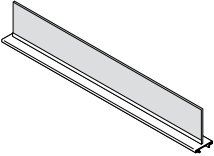
DESCRIPTION	PRODUCT CODE	LIST PRICE Gr1	DIMENSIONS/INCHES		
			H	W	D
 <p>6" Privacy felt panel integrated with aluminum top trim</p>	EVFDK0624P	125	6	24	2 7/8
	EVFDK0630P	145	6	30	2 7/8
	EVFDK0636P	172	6	36	2 7/8
	EVFDK0642P	193	6	42	2 7/8
	EVFDK0648P	283	6	48	2 7/8
	EVFDK0654P	310	6	54	2 7/8
	EVFDK0660P	332	6	60	2 7/8
	EVFDK0666P	350	6	66	2 7/8
	EVFDK0672P	395	6	72	2 7/8

## EVFDK09P - 9" PANEL MOUNTED FELT DIVIDER

- Privacy felt panel integrated with aluminum top trim.
- Attaches on top of panels to add privacy or divide space. Includes aluminum trim with channel and felt tile.
- Aluminum trim must be specified for entire station when ordering panel mount privacy felt.
- Felt and attachment hardware to ship separately.
- 9 mm felt material is tackable and is available in standard PET colors. Please specify.

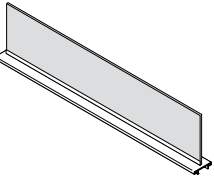
DESCRIPTION	PRODUCT CODE	LIST PRICE Gr1	DIMENSIONS/INCHES		
			H	W	D
 <p>9" Privacy felt panel integrated with aluminum top trim</p>	EVFDK0924P	125	9	24	2 7/8
	EVFDK0930P	145	9	30	2 7/8
	EVFDK0936P	172	9	36	2 7/8
	EVFDK0942P	193	9	42	2 7/8
	EVFDK0948P	283	9	48	2 7/8
	EVFDK0954P	310	9	54	2 7/8
	EVFDK0960P	332	9	60	2 7/8
	EVFDK0966P	350	9	66	2 7/8
	EVFDK0972P	395	9	72	2 7/8

## EVFDK12P - 12" PANEL MOUNTED FELT DIVIDER

- Privacy felt panel integrated with aluminum top trim.
- Attaches on top of panels to add privacy or divide space. Includes aluminum trim with channel and felt tile.
- Aluminum trim must be specified for entire station when ordering panel mount privacy felt.
- Felt and attachment hardware to ship separately.
- 9 mm felt material is tackable and is available in standard PET colors. Please specify.

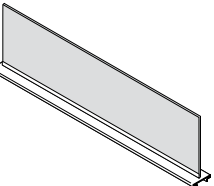
DESCRIPTION	PRODUCT CODE	LIST PRICE Gr1	DIMENSIONS/INCHES		
			H	W	D
 <p>12" Privacy felt panel integrated with aluminum top trim</p>	EVFDK1224P	125	12	24	2 7/8
	EVFDK1230P	145	12	30	2 7/8
	EVFDK1236P	172	12	36	2 7/8
	EVFDK1242P	193	12	42	2 7/8
	EVFDK1248P	283	12	48	2 7/8
	EVFDK1254P	310	12	54	2 7/8
	EVFDK1260P	332	12	60	2 7/8

# PANELS

# PET FELT DIVIDER - EXTENSION MODULE

## EVFDK12PN - 12" PANEL MOUNTED FELT DIVIDER, 1 NOTCH

- Privacy felt panel integrated with aluminum top trim.
- Attaches on top of panels to add privacy or divide space. Includes aluminum trim with channel and felt tile.
- Aluminum trim must be specified for entire station when ordering panel mount privacy felt.
- Felt and attachment hardware to ship separately.
- 9 mm felt material is tackable and is available in standard PET colors. Please specify.

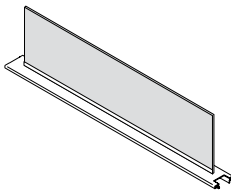
DESCRIPTION	PRODUCT CODE	LIST PRICE Gr1	DIMENSIONS/INCHES		
			H	W	D
 <p>12" Privacy felt panel integrated with aluminum top trim with 1 Notch</p>	EVFDK1224PN	125	12	22.68	2 7/8
	EVFDK1230PN	145	12	28.68	2 7/8
	EVFDK1236PN	172	12	34.68	2 7/8
	EVFDK1242PN	193	12	40.68	2 7/8
	EVFDK1248PN	283	12	46.68	2 7/8
	EVFDK1254PN	310	12	52.68	2 7/8
	EVFDK1260PN	332	12	58.68	2 7/8

## EVFDK12PDN - 12" PANEL MOUNTED FELT DIVIDER, 2 NOTCHES

- Privacy felt panel integrated with aluminum top trim.
- Attaches on top of panels to add privacy or divide space. Includes aluminum trim with channel and felt tile.
- Aluminum trim must be specified for entire station when ordering panel mount privacy felt.
- Felt and attachment hardware to ship separately.
- 9 mm felt material is tackable and is available in standard PET colors. Please specify.

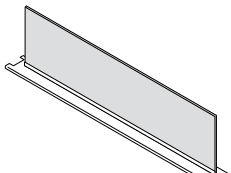
DESCRIPTION	PRODUCT CODE	LIST PRICE Gr1	DIMENSIONS/INCHES		
			H	W	D
 <p>12" Privacy felt panel integrated with aluminum top trim with 2 Notches</p>	EVFDK1224PDN	125	12	21.44	2 7/8
	EVFDK1230PDN	145	12	27.44	2 7/8
	EVFDK1236PDN	172	12	33.44	2 7/8
	EVFDK1242PDN	193	12	39.44	2 7/8
	EVFDK1248PDN	283	12	45.44	2 7/8
	EVFDK1254PDN	310	12	51.44	2 7/8
	EVFDK1260PDN	332	12	57.44	2 7/8

# PANELS

# CEILING FILLER - PRIVACY DIVIDER

## EVFPDK06XXPCF - 6" H PANEL MOUNT PRIVACY DIVIDER CEILING FILLER KIT

- Privacy Felt Divder integrated with aluminum top trim.
- Aluminum top trim available in standard paint finishes.
- Attaches on top of panels to add privacy or divide space.
- Includes aluminum trim with channel and Felt tile.
- Felt tile and attachment hardware to ship separately.
- 9 mm felt material is tackable and is available in standard PET colors. Please specify.
- PVC cap for closing gap at ceiling included.
- PVC cap available in white only.

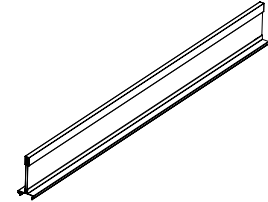

DESCRIPTION	PRODUCT CODE	LIST PRICE	DIMENSIONS/INCHES		
			H	W	D
Panel Mount Felt Divider Ceiling Filler Kit	EVFDK0618PCF	118	6	18	
	EVFDK0624PCF	141	6	24	
	EVFDK0630PCF	167	6	30	
	EVFDK0636PCF	196	6	36	
	EVFDK0642PCF	221	6	42	
	EVFDK0648PCF	326	6	48	
	EVFDK0654PCF	353	6	54	
	EVFDK0660PCF	384	6	60	
	EVFDK0666PCF	403	6	66	
	EVFDK0672PCF	454	6	72	

## EVFPDK06XXPCFP - 6" H PANEL MOUNT PRIVACY DIVIDER CEILING FILLER KIT

- Privacy Felt Divder integrated with aluminum top trim.
- Aluminum top trim available in standard paint finishes.
- Aluminum trim is width of panel.
- Attaches on top of panels to add privacy or divide space.
- Includes aluminum trim with channel and Felt tile.
- Felt tile and attachment hardware to ship separately.
- 9 mm felt material is tackable and is available in standard PET colors. Please specify.
- Felt tile is longer and overhangs half of width of post.
- PVC cap for closing gap at ceiling included.
- PVC cap available in white only.

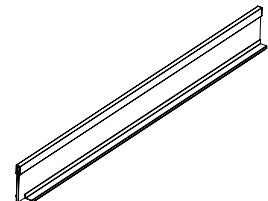

DESCRIPTION	PRODUCT CODE	LIST PRICE	DIMENSIONS/INCHES		
			H	W	D
Panel Mount Felt Divider Ceiling Filler at Post Kit	EVFDK0619PCF	141	6	19 3/4	
	EVFDK0625PCF	167	6	25 3/4	
	EVFDK0631PCF	196	6	31 3/4	
	EVFDK0637PCF	221	6	37 3/4	
	EVFDK0643PCF	326	6	43 3/4	
	EVFDK0649PCF	353	6	49 3/4	
	EVFDK0655PCF	384	6	55 3/4	
	EVFDK0661PCF	403	6	61 3/4	
	EVFDK0667PCF	454	6	67 3/4	
	EVFDK0673PCF	509	6	73 3/4	

## EVFPDK09XXPCF - 9" H PANEL MOUNT PRIVACY DIVIDER CEILING FILLER KIT

- Privacy Felt Divder integrated with aluminum top trim.
- Aluminum top trim available in standard paint finishes.
- Attaches on top of panels to add privacy or divide space.
- Includes aluminum trim with channel and Felt tile.
- Felt tile and attachment hardware to ship separately.
- 9 mm felt material is tackable and is available in standard PET colors. Please specify.
- PVC cap for closing gap at ceiling included.
- PVC cap available in white only.

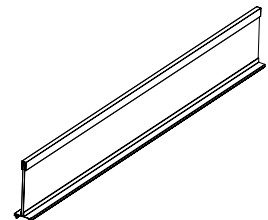

DESCRIPTION	PRODUCT CODE	LIST PRICE	DIMENSIONS/INCHES		
			H	W	D
Panel Mount Felt Divider Ceiling Filler Kit	EVFDK0918PCF	118	9	18	
	EVFDK0924PCF	141	9	24	
	EVFDK0930PCF	167	9	30	
	EVFDK0936PCF	196	9	36	
	EVFDK0942PCF	221	9	42	
	EVFDK0948PCF	326	9	48	
	EVFDK0954PCF	353	9	54	
	EVFDK0960PCF	384	9	60	
	EVFDK0966PCF	403	9	66	
	EVFDK0972PCF	454	9	72	

# PANELS

# CEILING FILLER - FELT DIVIDER

## EVFPDK09XXPCFP - 9" H PANEL MOUNT PRIVACY DIVIDER CEILING FILLER KIT

- Privacy Felt Divider integrated with aluminum top trim.
- Aluminum trim is width of panel.
- Aluminum top trim available in standard paint finishes.
- Attaches on top of panels to add privacy or divide space.
- Includes aluminum trim with channel and Felt tile.
- Felt tile and attachment hardware to ship separately.
- 9 mm felt material is tackable and is available in standard PET colors. Please specify.
- Felt tile is longer and overhangs half of width of post.
- PVC cap for closing gap at ceiling included.
- PVC cap available in white only.

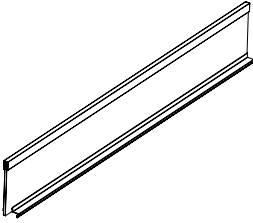
DESCRIPTION	PRODUCT CODE	LIST PRICE	DIMENSIONS/INCHES		
			H	W	D
 Panel Mount Felt Divider Ceiling Filler at Post Kit	EVFDK0919PCF	141	9	19 3/4	
	EVFDK0925PCF	167	9	25 3/4	
	EVFDK0931PCF	196	9	31 3/4	
	EVFDK0937PCF	221	9	37 3/4	
	EVFDK0943PCF	326	9	43 3/4	
	EVFDK0949PCF	353	9	49 3/4	
	EVFDK0955PCF	384	9	55 3/4	
	EVFDK0961PCF	403	9	61 3/4	
	EVFDK0967PCF	454	9	67 3/4	
	EVFDK0973PCF	509	9	73 3/4	

## EVPTFC - CEILING FILLER PVC CAP FOR FELT DIVIDER

- To be installed on top on felt divider when used as ceiling filler.
- Field installed on top of felt divider to close gap at ceiling.
- Available in 18"-96" lengths.
- Available in white only.
- Felt divider with top trim kit to be ordered separately.

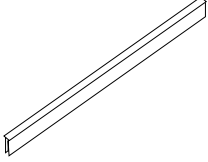
DESCRIPTION	PRODUCT CODE	LIST PRICE	DIMENSIONS/INCHES		
			H	W	D
 PVC Cap for Felt Divider	EVPTFC18	19	1 3/8	18	3/4
	EVPTFC24	21	1 3/8	24	3/4
	EVPTFC30	26	1 3/8	30	3/4
	EVPTFC36	29	1 3/8	36	3/4
	EVPTFC42	32	1 3/8	42	3/4
	EVPTFC48	47	1 3/8	48	3/4
	EVPTFC54	51	1 3/8	54	3/4
	EVPTFC60	53	1 3/8	60	3/4
	EVPTFC66	57	1 3/8	66	3/4
	EVPTFC72	63	1 3/8	72	3/4
	EVPTFC78	69	1 3/8	78	3/4
	EVPTFC84	74	1 3/8	84	3/4
	EVPTFC90	81	1 3/8	90	3/4
	EVPTFC96	87	1 3/8	96	3/4

## EVFELTPXXHWR - ALUMINUM TOP TRIM WITH CHANNEL

- Top trim with channel.
- Available in standard paint colors.
- Note: Trim can span inline connector, but not a Post

DESCRIPTION	PRODUCT CODE	LIST PRICE	DIMENSIONS/INCHES		
			H	W	D
 Aluminum Top Trim	EVFELTP18HWR	47		18	2.875
	EVFELTP24HWR	48		24	2.875
	EVFELTP30HWR	55		30	2.875
	EVFELTP36HWR	61		36	2.875
	EVFELTP42HWR	69		42	2.875
	EVFELTP48HWR	75		48	2.875
	EVFELTP54HWR	82		54	2.875
	EVFELTP60HWR	90		60	2.875
	EVFELTP66HWR	99		66	2.875
	EVFELTP72HWR	112		72	2.875

# PANELS

# CEILING FILLER - FELT DIVIDER

## EVFELTXXYP - FELT TILE

- Felt tile.
- Available in standard felt colors.
- Top trim with channel and PVC cap to be ordered separately.

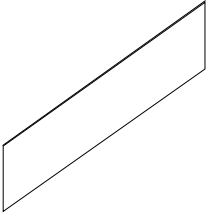
DESCRIPTION	PRODUCT CODE	LIST PRICE	DIMENSIONS/INCHES		
			H	W	D
 Felt Tile - 6" High	EVFELT0618P	34	6	18	
	EVFELT0624P	42	6	24	
	EVFELT0630P	58	6	30	
	EVFELT0636P	74	6	36	
	EVFELT0642P	91	6	42	
	EVFELT0648P	113	6	48	
	EVFELT0654P	128	6	54	
	EVFELT0660P	142	6	60	
	EVFELT0666P	160	6	66	
	EVFELT0672P	175	6	72	
Felt Tile - 9" High	EVFELT0918P	57	9	18	
	EVFELT0924P	69	9	24	
	EVFELT0930P	81	9	30	
	EVFELT0936P	98	9	36	
	EVFELT0942P	110	9	42	
	EVFELT0948P	181	9	48	
	EVFELT0954P	198	9	54	
	EVFELT0960P	217	9	60	
	EVFELT0966P	234	9	66	
	EVFELT0972P	248	9	72	

**PANELS**

**PRIVACY PANELS**

**EVPP - GLAZED FREESTANDING PRIVACY PANEL**

- Includes panel with two connectors with T legs.
- 3" thick freestanding panels with leveling glides.
- 22" deep T-legs for stability (9.5" on each side)
- All Modules are Tempered Glass.
- Includes end of run trim.

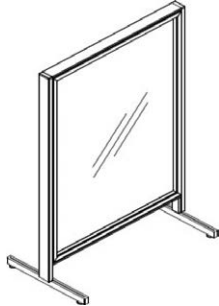
	DESCRIPTION	PRODUCT CODE	LIST PRICE		DIMENSIONS/INCHES		
			CLR	FRST ADD	H	W	D
	Glazed Monolithic Freestanding Privacy Panel	EVPPXGT5418	892	194	54	18	27/8
		EVPPXGT5424	984	228	54	24	27/8
		EVPPXGT5430	1069	265	54	30	27/8
		EVPPXGT5436	1151	299	54	36	27/8
		EVPPXGT5442	1243	336	54	42	27/8

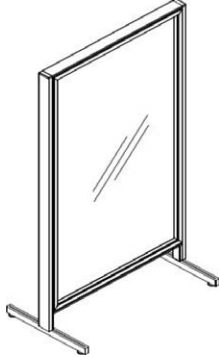
	DESCRIPTION	PRODUCT CODE	LIST PRICE		DIMENSIONS/INCHES		
			CLR	FRST ADD	H	W	D
	Glazed Monolithic Freestanding Privacy Panel	EVPPXGT6618	1028	234	66	18	27/8
		EVPPXGT6624	1128	273	66	24	27/8
		EVPPXGT6630	1231	312	66	30	27/8
		EVPPXGT6636	1324	350	66	36	27/8
		EVPPXGT6642	1434	395	66	42	27/8

# PANELS

# PRIVACY PANELS

## EVPP - GLAZED MOBILE PRIVACY PANEL

- Includes panel with two connectors with T legs.
- 3" thick freestanding panels with 1" locking casters.
- 22" deep T-legs for stability (9.5" on each side)
- All Modules are Tempered Glass.
- Includes end of run trim.

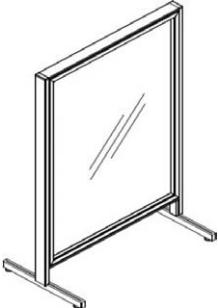
DESCRIPTION	PRODUCT CODE	LIST PRICE			DIMENSIONS/INCHES		
		CLR	FRST ADD	WRW ADD	H	W	D
 Mobile Glazed Monolithic Privacy Panel	EVPPXGT5418M	969	194	651	54	18	2 7/8
	EVPPXGT5424M	1058	232	806	54	24	2 7/8
	EVPPXGT5430M	1144	265	957	54	30	2 7/8
	EVPPXGT5436M	1227	299	1111	54	36	2 7/8
	EVPPXGT5442M	1319	335	1266	54	42	2 7/8

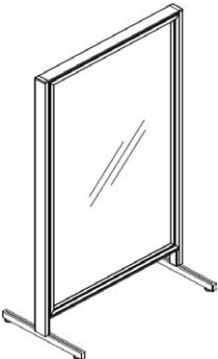
DESCRIPTION	PRODUCT CODE	LIST PRICE			DIMENSIONS/INCHES		
		CLR	FRST ADD	WRW ADD	H	W	D
 Mobile Glazed Monolithic Privacy Panel	EVPPXGT6618M	1102	234	801	66	18	2 7/8
	EVPPXGT6624M	1203	273	988	66	24	2 7/8
	EVPPXGT6630M	1305	313	1174	66	30	2 7/8
	EVPPXGT6636M	1399	351	1358	66	36	2 7/8
	EVPPXGT6642M	1509	395	1551	66	42	2 7/8

# PANELS

# PRIVACY PANELS

## EVPP - MONOLITHIC PRIVACY PANEL - RIBBED POLYCARBONATE

- Includes panel with two connectors with T legs.
- 3" thick freestanding panels with leveling glides
- 22" deep T-legs for stability (9.5" on each side)
- Ribbed Panels are semi-private translucent polycarbonate.
- Includes end of run trim.

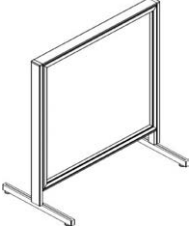
DESCRIPTION	PRODUCT CODE	LIST PRICE	DIMENSIONS/INCHES			
			H	W	D	
	Freestanding Ribbed Monolithic Privacy Panel	EVPPXGR4218	815	42	18	2 7/8
		EVPPXGR4224	853	42	24	2 7/8
		EVPPXGR4230	929	42	30	2 7/8
		EVPPXGR4236	1005	42	36	2 7/8
		EVPPXGR4242	1083	42	42	2 7/8

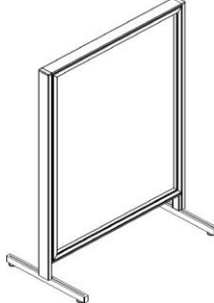
DESCRIPTION	PRODUCT CODE	LIST PRICE	DIMENSIONS/INCHES			
			H	W	D	
	Freestanding Ribbed Monolithic Privacy Panel	EVPPXGR5418	954	54	18	2 7/8
		EVPPXGR5424	1013	54	24	2 7/8
		EVPPXGR5430	1100	54	30	2 7/8
		EVPPXGR5436	1189	54	36	2 7/8
		EVPPXGR5442	1286	54	42	2 7/8

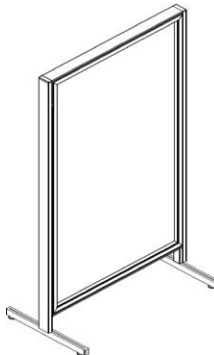
DESCRIPTION	PRODUCT CODE	LIST PRICE	DIMENSIONS/INCHES			
			H	W	D	
	Freestanding Ribbed Monolithic Privacy Panel	EVPPXGR6618	1045	66	18	2 7/8
		EVPPXGR6624	1154	66	24	2 7/8
		EVPPXGR6630	1256	66	30	2 7/8
		EVPPXGR6636	1356	66	36	2 7/8
		EVPPXGR6642	1465	66	42	2 7/8

# PANELS

# PRIVACY PANELS

## EVPP - MONOLITHIC PRIVACY PANEL - RIBBED POLYCARBONATE

- Includes panel with two connectors with T legs.
- 3" thick freestanding panels with 1" locking casters.
- 22" deep T-legs for stability (9.5" on each side)
- Ribbed Panels are semi-private translucent polycarbonate.
- Includes end of run trim.

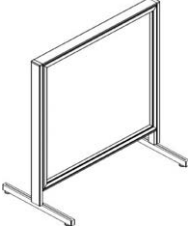
	DESCRIPTION	PRODUCT CODE	LIST PRICE	DIMENSIONS/INCHES		
				H	W	D
	Mobile Ribbed Monolithic Privacy Panel	EVPPXGR4218M	889	42	18	27/8
		EVPPXGR4224M	929	42	24	27/8
		EVPPXGR4230M	1005	42	30	27/8
		EVPPXGR4236M	1080	42	36	27/8
		EVPPXGR4242M	1158	42	42	27/8

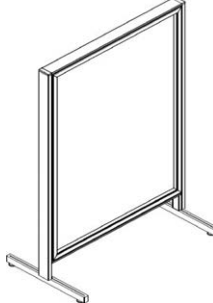
	DESCRIPTION	PRODUCT CODE	LIST PRICE	DIMENSIONS/INCHES		
				H	W	D
	Mobile Ribbed Monolithic Privacy Panel	EVPPXGR5418M	1033	54	18	27/8
		EVPPXGR5424M	1089	54	24	27/8
		EVPPXGR5430M	1177	54	30	27/8
		EVPPXGR5436M	1265	54	36	27/8
		EVPPXGR5442M	1362	54	42	27/8

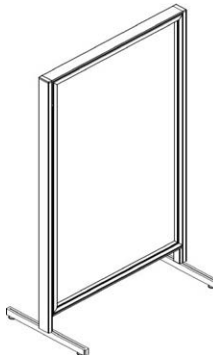
	DESCRIPTION	PRODUCT CODE	LIST PRICE	DIMENSIONS/INCHES		
				H	W	D
	Mobile Ribbed Monolithic Privacy Panel	EVPPXGR6618M	1121	66	18	27/8
		EVPPXGR6624M	1231	66	24	27/8
		EVPPXGR6630M	1256	66	30	27/8
		EVPPXGR6636M	1431	66	36	27/8
		EVPPXGR6642M	1539	66	42	27/8

# PANELS

# PRIVACY PANELS

### EVPP - MONOLITHIC PRIVACY PANEL - GLAZED

- Includes panel with two connectors with T legs
- 3" thick freestanding panels with flat foot
- 22" deep T-legs for stability (9.5" on each side)
- Glazed Panels are available in tempered Clear glass (CLR) and Frosted glass (FRST)
- Includes end of run trim

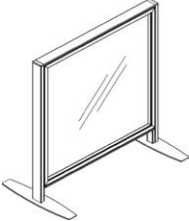
DESCRIPTION	PRODUCT CODE	LIST PRICE		DIMENSIONS/INCHES		
		CLR	FRST ADD	H	W	D
 Freestanding Glazed Monolithic Privacy Panel	EVPPXGTF4218	766	159	42	18	27/8
	EVPPXGTF4224	843	192	42	24	27/8
	EVPPXGTF4230	915	218	42	30	27/8
	EVPPXGTF4236	985	246	42	36	27/8
	EVPPXGTF4242	1064	279	42	42	27/8

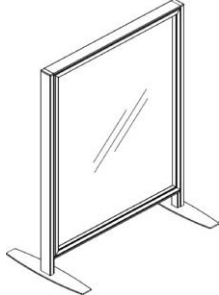
DESCRIPTION	PRODUCT CODE	LIST PRICE		DIMENSIONS/INCHES		
		CLR	FRST ADD	H	W	D
 Freestanding Glazed Monolithic Privacy Panel	EVPPXGTF5418	892	194	54	18	27/8
	EVPPXGTF5424	984	228	54	24	27/8
	EVPPXGTF5430	1069	265	54	30	27/8
	EVPPXGTF5436	1151	299	54	36	27/8
	EVPPXGTF5442	1243	299	54	42	27/8

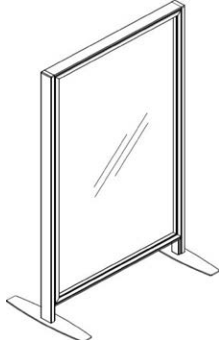
DESCRIPTION	PRODUCT CODE	LIST PRICE		DIMENSIONS/INCHES		
		CLR	FRST ADD	H	W	D
 Freestanding Glazed Monolithic Privacy Panel	EVPPXGTF6618	1028	234	66	18	27/8
	EVPPXGTF6624	1128	273	66	24	27/8
	EVPPXGTF6630	1231	312	66	30	27/8
	EVPPXGTF6636	1324	350	66	36	27/8
	EVPPXGTF6642	1434	394	66	42	27/8

# PANELS

# PRIVACY PANELS

## EVPP - MONOLITHIC PRIVACY PANEL - RIBBED POLYCARBONATE

- Includes panel with two connectors with T legs
- 3" thick freestanding panels with flat foot
- 22" deep T-legs for stability (9.5" on each side)
- Ribbed Panels are semi-private translucent polycarbonate.
- Includes end of run trim.

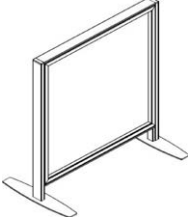
	DESCRIPTION	PRODUCT CODE	LIST PRICE	DIMENSIONS/INCHES		
				H	W	D
	Freestanding Ribbed Monolithic Privacy Panel	EVPPXGRF4218	815	42	18	2 7/8
		EVPPXGRF4224	853	42	24	2 7/8
		EVPPXGRF4230	929	42	30	2 7/8
		EVPPXGRF4236	1005	42	36	2 7/8
		EVPPXGRF4242	1083	42	42	2 7/8

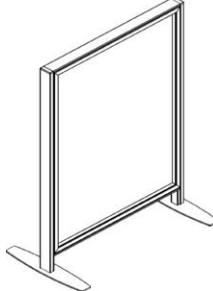
	DESCRIPTION	PRODUCT CODE	LIST PRICE	DIMENSIONS/INCHES		
				H	W	D
	Freestanding Ribbed Monolithic Privacy Panel	EVPPXGRF5418	954	54	18	2 7/8
		EVPPXGRF5424	1013	54	24	2 7/8
		EVPPXGRF5430	1100	54	30	2 7/8
		EVPPXGRF5436	1189	54	36	2 7/8
		EVPPXGRF5442	1286	54	42	2 7/8

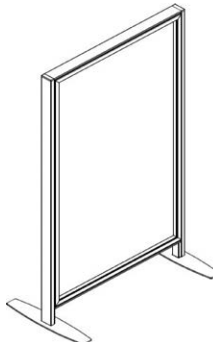
	DESCRIPTION	PRODUCT CODE	LIST PRICE	DIMENSIONS/INCHES		
				H	W	D
	Freestanding Ribbed Monolithic Privacy Panel	EVPPXGRF6618	1045	66	18	2 7/8
		EVPPXGRF6624	1154	66	24	2 7/8
		EVPPXGRF6630	1256	66	30	2 7/8
		EVPPXGRF6636	1356	66	36	2 7/8
		EVPPXGRF6642	1465	66	42	2 7/8

**EVPP - MONOLITHIC PRIVACY PANEL - 78" HIGH**

- Includes panel with two connectors with T legs.
- 3" thick freestanding panels with leveling glides
- 22" deep T-legs for stability (9.5" on each side)
- Glazed Panels are available in tempered Clear glass (CLR) and Frosted glass (FRST)
- Ribbed Panels are semi-private translucent polycarbonate.
- Includes end of run trim.
- Includes 48"H Glazed module and 29"H legs

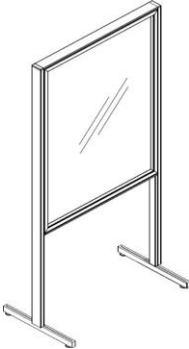
DESCRIPTION	PRODUCT CODE	LIST PRICE		DIMENSIONS/INCHES		
		CLR	FRST ADD	H	W	D
 Freestanding Glazed Monolithic Privacy Panel	EVPPXGT7824	1053	232	78	24	2 7/8
	EVPPXGT7830	1138	265	78	30	2 7/8
	EVPPXGT7836	1222	299	78	36	2 7/8
	EVPPXGT7842	1316	335	78	42	2 7/8

**EVPP - MONOLITHIC PRIVACY PANEL - 78" HIGH**

- Includes panel with two connectors with T legs.
- 3" thick freestanding panels with leveling glides
- 22" deep T-legs for stability (9.5" on each side)
- Glazed Panels are available in tempered Clear glass (CLR) and Frosted glass (FRST)
- Ribbed Panels are semi-private translucent polycarbonate.
- Includes end of run trim.
- Includes 48"H Ribbled module and 29"H legs

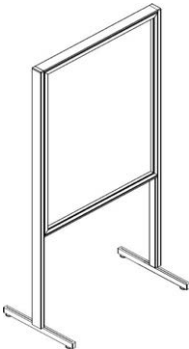
DESCRIPTION	PRODUCT CODE	LIST PRICE	DIMENSIONS/INCHES		
			H	W	D
 Freestanding Ribbed Monolithic Privacy Panel	EVPPXGR7824	1092	78	24	2 7/8
	EVPPXGR7830	1182	78	30	2 7/8
	EVPPXGR7836	1092	78	36	2 7/8
	EVPPXGR7842	1366	78	42	2 7/8

# PANELS

# PRIVACY PANELS

## EVPP - MONOLITHIC PRIVACY PANEL - 78" HIGH

- Includes panel with two connectors with T legs.
- 3" thick freestanding panels with 1" locking casters
- 22" deep T-legs for stability (9.5" on each side)
- Glazed Panels are available in tempered Clear glass (CLR) and Frosted glass (FRST)
- Ribbed Panels are semi-private translucent polycarbonate.
- Includes end of run trim.
- Includes 48"H Glazed module and 29"H legs

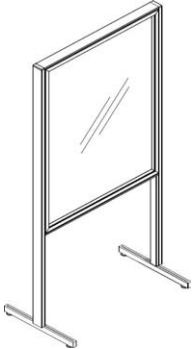
	DESCRIPTION	PRODUCT CODE	LIST PRICE		DIMENSIONS/INCHES		
			CLR	FRST ADD	H	W	D
	Mobile Glazed Monolithic Privacy Panel	EVPPXGT7824M	1129	228	78	24	2 7/8
		EVPPXGT7830M	1216	265	78	30	2 7/8
		EVPPXGT7836M	1298	299	78	36	2 7/8
		EVPPXGT7842M	1388	336	78	42	2 7/8

## EVPP - MONOLITHIC PRIVACY PANEL - 78" HIGH

- Includes panel with two connectors with T legs.
- 3" thick freestanding panels with 1" locking casters
- 22" deep T-legs for stability (9.5" on each side)
- Glazed Panels are available in tempered Clear glass (CLR) and Frosted glass (FRST)
- Ribbed Panels are semi-private translucent polycarbonate.
- Includes end of run trim.
- Includes 48"H Ribbed module and 29"H legs

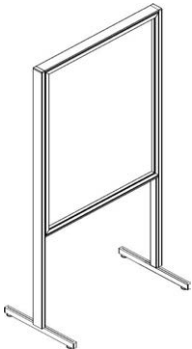
	DESCRIPTION	PRODUCT CODE	LIST PRICE		DIMENSIONS/INCHES		
			CLR	FRST ADD	H	W	D
	Mobile Ribbed Monolithic Privacy Panel	EVPPXGR7824M	1169		78	24	2 7/8
		EVPPXGR7830M	1257		78	30	2 7/8
		EVPPXGR7836M	1169		78	36	2 7/8
		EVPPXGR7842M	1442		78	42	2 7/8

**EVPP - MONOLITHIC PRIVACY PANEL - 78" HIGH**

- Includes panel with two connectors with T legs
- 3" thick freestanding panels with flat foot
- 22" deep T-legs for stability (9.5" on each side)
- Glazed Panels are available in tempered Clear glass (CLR) and Frosted glass (FRST)
- Ribbed Panels are semi-private translucent polycarbonate.
- Includes end of run trim.
- Includes 48"H Glazed module and 29"H legs

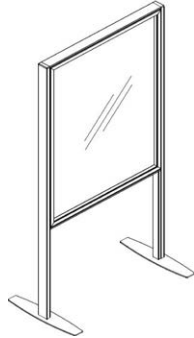

DESCRIPTION	PRODUCT CODE	LIST PRICE		DIMENSIONS/INCHES		
		CLR	FRST ADD	H	W	D
Freestanding Glazed Monolithic Privacy Panel	EVPPXGTF7824	1053	232	78	24	27/8
	EVPPXGTF7830	1138	265	78	30	27/8
	EVPPXGTF7836	1222	299	78	36	27/8
	EVPPXGTF7842	1316	335	78	42	27/8

**EVPP - MONOLITHIC PRIVACY PANEL - 78" HIGH**

- Includes panel with two connectors with T legs
- 3" thick freestanding panels with flat foot
- 22" deep T-legs for stability (9.5" on each side)
- Glazed Panels are available in tempered Clear glass (CLR) and Frosted glass (FRST)
- Ribbed Panels are semi-private translucent polycarbonate.
- Includes end of run trim.
- Includes 48"H Ribbed module and 29"H legs

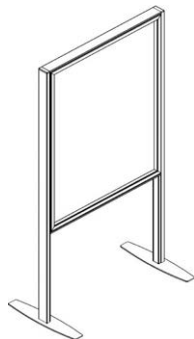

DESCRIPTION	PRODUCT CODE	LIST PRICE	DIMENSIONS/INCHES		
			H	W	D
Freestanding Ribbed Monolithic Privacy Panel	EVPPXGRF7824	1092	78	24	27/8
	EVPPXGRF7830	1182	78	30	27/8
	EVPPXGRF7836	1092	78	36	27/8
	EVPPXGRF7842	1366	78	42	27/8

# PANELS

# PRIVACY PANELS

## EVPP - GLAZED PRIVACY PANEL

- Includes panel with two connectors with T legs.
- 3" thick freestanding panels with leveling glides
- 22" deep T-legs for stability (9.5" on each side)
- All Modules are Tempered Glass.
- Available in clear glass (CLR) and frosted glass (FRST)
- Includes end of run trim.

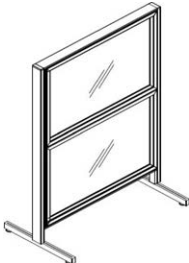
DESCRIPTION	PRODUCT CODE	LIST PRICE		DIMENSIONS/INCHES		
		CLR	FRST ADD	H	W	D
 Freestanding Glazed Privacy Panel	EVPPGT5424	1016	244	54	24	27/8
	EVPPGT5430	286	286	54	30	27/8
	EVPPGT5436	325	325	54	36	27/8
	EVPPGT5442	368	368	54	42	27/8
	EVPPGT5448	410	410	54	48	27/8
	EVPPGT5454	455	455	54	54	27/8
	EVPPGT5460	493	493	54	60	27/8

## EVPP - GLAZED PRIVACY PANEL

- Includes panel with two connectors with T legs.
- 3" thick freestanding panels with leveling glides
- 22" deep T-legs for stability (9.5" on each side)
- All Modules are Tempered Glass.
- Available in clear glass (CLR) and frosted glass (FRST)
- Includes end of run trim.

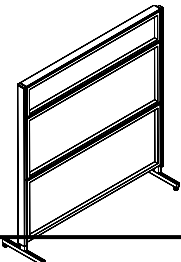
DESCRIPTION	PRODUCT CODE	LIST PRICE		DIMENSIONS/INCHES		
		CLR	FRST ADD	H	W	D
 Freestanding Glazed Privacy Panel	EVPPGT6624	1268	330	66	24	27/8
	EVPPGT6630	1391	384	66	30	27/8
	EVPPGT6636	1585	456	66	36	27/8
	EVPPGT6642	1719	511	66	42	27/8
	EVPPGT6648	1855	569	66	48	27/8
	EVPPGT6654	2007	629	66	54	27/8
	EVPPGT6660	2173	691	66	60	27/8

## EVPP - MOBILE GLAZED PRIVACY PANEL

- Includes panel with two connectors with T legs.
- 3" thick freestanding panels with 1" locking casters.
- 22" deep T-legs for stability (9.5" on each side)
- All Modules are Tempered Glass.
- Available in clear glass (CLR) and frosted glass (FRST)
- Includes end of run trim.

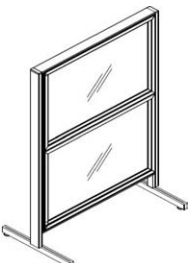
DESCRIPTION	PRODUCT CODE	LIST PRICE		DIMENSIONS/INCHES		
		CLR	FRST ADD	H	W	D
 Mobile Glazed Privacy Panel	EVPPGT5424M	1091	246	54	24	27/8
	EVPPGT5430M	1191	287	54	30	27/8
	EVPPGT5436M	1289	325	54	36	27/8
	EVPPGT5442M	1396	368	54	42	27/8
	EVPPGT5448M	1501	410	54	48	27/8
	EVPPGT5454M	1611	455	54	54	27/8
	EVPPGT5460M	1707	493	54	60	27/8

# PANELS

# PRIVACY PANELS

## EVPP - MOBILE GLAZED PRIVACY PANEL

- Includes panel with two connectors with T legs.
- 3" thick freestanding panels with 1" locking casters.
- 22" deep T-legs for stability (9.5" on each side)
- All Modules are Tempered Glass.
- Available in clear glass (CLR) and frosted glass (FRST)
- Includes end of run trim.

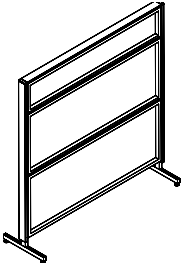
DESCRIPTION	PRODUCT CODE	LIST PRICE		DIMENSIONS/INCHES		
		CLR	FRST ADD	H	W	D
 <p>Mobile Glazed Privacy Panel</p>	EVPPGT6624M	1344	332	66	24	27/8
	EVPPGT6630M	1467	381	66	30	27/8
	EVPPGT6636M	1659	456	66	36	27/8
	EVPPGT6642M	1795	511	66	42	27/8
	EVPPGT6648M	1930	569	66	48	27/8
	EVPPGT6654M	2083	624	66	54	27/8
	EVPPGT6660M	2245	692	66	60	27/8

## EVPP - LAMINATE GLAZED PRIVACY PANEL

- Includes panel with two connectors with T legs.
- 3" thick freestanding panels with leveling glides
- 22" deep T-legs for stability (9.5" on each side)
- All Modules are Tempered Glass.
- Bottom Two Modules are Laminate w/12" Tempered Glass on top.
- Includes end of run trim.

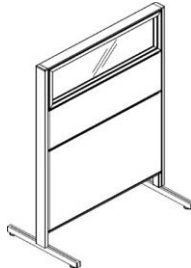
DESCRIPTION	PRODUCT CODE	LIST PRICE		DIMENSIONS/INCHES		
		CLR	FRST ADD	H	W	D
 <p>Freestanding Laminate Glazed Privacy Panel</p>	EVPPHGTU5424	1240	170	54	24	27/8
	EVPPHGTU5430	1375	196	54	30	27/8
	EVPPHGTU5436	1513	226	54	36	27/8
	EVPPHGTU5442	1650	253	54	42	27/8
	EVPPHGTU5448	1787	279	54	48	27/8
	EVPPHGTU5454	1938	310	54	54	27/8
	EVPPHGTU5460	2077	336	54	60	27/8

## EVPP - LAMINATE GLAZED PRIVACY PANEL

- Includes panel with two connectors with T legs.
- 3" thick freestanding panels with leveling glides
- 22" deep T-legs for stability (9.5" on each side)
- Bottom Two Modules are Laminate w/12" Tempered Glass on top.
- Includes end of run trim.

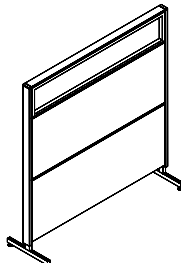
DESCRIPTION	PRODUCT CODE	LIST PRICE		DIMENSIONS/INCHES		
		CLR	FRST ADD	H	W	D
 <p>Freestanding Laminate Glazed Privacy Panel</p>	EVPPHGTU6624	1386	193	66	24	27/8
	EVPPHGTU6630	1548	224	66	30	27/8
	EVPPHGTU6636	1740	264	66	36	27/8
	EVPPHGTU6642	1899	292	66	42	27/8
	EVPPHGTU6648	2055	326	66	48	27/8
	EVPPHGTU6654	2235	361	66	54	27/8
	EVPPHGTU6660	2430	399	66	60	27/8

# PANELS

# PRIVACY PANELS

### EVPP - MOBILE LAMINATE GLAZED PRIVACY PANEL

- Includes panel with two connectors with T legs.
- 3" thick freestanding panels with 1" locking casters.
- 22" deep T-legs for stability (9.5" on each side)
- Bottom Two Modules are Laminate w/12" Tempered Glass on top.
- Includes end of run trim.

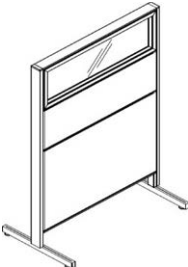
DESCRIPTION	PRODUCT CODE	LIST PRICE		DIMENSIONS/INCHES		
		CLR	FRST ADD	H	W	D
 Mobile Laminate Glazed Privacy Panel	EVPPHGTU5424M	1316	170	54	24	27/8
	EVPPHGTU5430M	1450	196	54	30	27/8
	EVPPHGTU5436M	1589	224	54	36	27/8
	EVPPHGTU5442M	1729	253	54	42	27/8
	EVPPHGTU5448M	1863	280	54	48	27/8
	EVPPHGTU5454M	2012	311	54	54	27/8
	EVPPHGTU5460M	2152	338	54	60	27/8

### EVPP - MOBILE LAMINATE GLAZED PRIVACY PANEL

- Includes panel with two connectors with T legs.
- 3" thick freestanding panels with 1" locking casters.
- 22" deep T-legs for stability (9.5" on each side)
- Bottom Two Modules are Laminate w/12" Tempered Glass on top.
- Includes end of run trim.

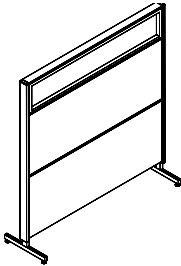
DESCRIPTION	PRODUCT CODE	LIST PRICE		DIMENSIONS/INCHES		
		CLR	FRST ADD	H	W	D
 Mobile Laminate Glazed Privacy Panel	EVPPHGTU6624M	1462	193	66	24	27/8
	EVPPHGTU6630M	1623	222	66	30	27/8
	EVPPHGTU6636M	1816	265	66	36	27/8
	EVPPHGTU6642M	1974	290	66	42	27/8
	EVPPHGTU6648M	2133	325	66	48	27/8
	EVPPHGTU6654M	2310	361	66	54	27/8
	EVPPHGTU6660M	2505	399	66	60	27/8

### EVPP - LAMINATE GLAZED PRIVACY PANEL

- Includes panel with two connectors with T legs.
- 3" thick freestanding panels with leveling glides
- 22" deep T-legs for stability (9.5" on each side)
- All Modules are Tempered Glass.
- Laminate Base Module w/24" Tempered Glass above.
- Includes end of run trim.

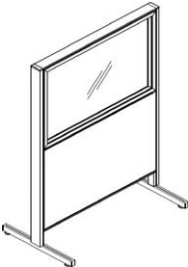
DESCRIPTION	PRODUCT CODE	LIST PRICE		DIMENSIONS/INCHES		
		CLR	FRST ADD	H	W	D
 Freestanding Laminate Glazed Privacy Panel	EVPPHGT5424	1074	136	54	24	27/8
	EVPPHGT5430	1192	161	54	30	27/8
	EVPPHGT5436	1316	182	54	36	27/8
	EVPPHGT5442	1435	207	54	42	27/8
	EVPPHGT5448	1552	234	54	48	27/8
	EVPPHGT5454	1680	257	54	54	27/8
	EVPPHGT5460	1794	281	54	60	27/8

# PANELS

# PRIVACY PANELS

### EVPP - LAMINATE GLAZED PRIVACY PANEL

- Includes panel with two connectors with T legs.
- 3" thick freestanding panels with leveling glides
- 22" deep T-legs for stability (9.5" on each side)
- Laminate Base Module w/36" Tempered Glass above.
- Includes end of run trim.

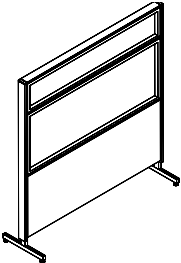
DESCRIPTION	PRODUCT CODE	LIST PRICE		DIMENSIONS/INCHES		
		CLR	FRST ADD	H	W	D
 Freestanding Laminate Glazed Privacy Panel	EVPPHGT6624	1328	179	66	24	27/8
	EVPPHGT6630	1471	207	66	30	27/8
	EVPPHGT6636	1656	246	66	36	27/8
	EVPPHGT6642	1796	273	66	42	27/8
	EVPPHGT6648	1941	302	66	48	27/8
	EVPPHGT6654	2107	336	66	54	27/8
	EVPPHGT6660	2300	373	66	60	27/8

### EVPP - MOBILE LAMINATE GLAZED PRIVACY PANEL

- Includes panel with two connectors with T legs.
- 3" thick freestanding panels with 1" locking casters.
- 22" deep T-legs for stability (9.5" on each side)
- Laminate Base Module w/36" Tempered Glass above.
- Includes end of run trim.

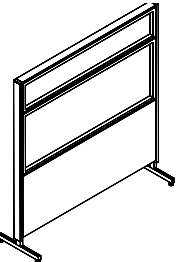
DESCRIPTION	PRODUCT CODE	LIST PRICE		DIMENSIONS/INCHES		
		CLR	FRST ADD	H	W	D
 Mobile Laminate Glazed Privacy Panel	EVPPHGT6624M	1404	180	66	24	27/8
	EVPPHGT6630M	1547	206	66	30	27/8
	EVPPHGT6636M	1733	246	66	36	27/8
	EVPPHGT6642M	1871	273	66	42	27/8
	EVPPHGT6648M	2017	301	66	48	27/8
	EVPPHGT6654M	2183	335	66	54	27/8
	EVPPHGT6660M	2376	373	66	60	27/8

### EVPP - MOBILE LAMINATE GLAZED PRIVACY PANEL

- Includes panel with two connectors with T legs.
- 3" thick freestanding panels with 1" locking casters.
- 22" deep T-legs for stability (9.5" on each side)
- Laminate Base Module w/24" Tempered Glass above.
- Includes end of run trim.

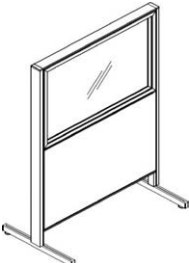
DESCRIPTION	PRODUCT CODE	LIST PRICE		DIMENSIONS/INCHES		
		CLR	FRST ADD	H	W	D
 Mobile Laminate Glazed Privacy Panel	EVPPHGT5424M	1149	137	54	24	27/8
	EVPPHGT5430M	1267	161	54	30	27/8
	EVPPHGT5436M	1388	183	54	36	27/8
	EVPPHGT5442M	1511	210	54	42	27/8
	EVPPHGT5448M	1630	233	54	48	27/8
	EVPPHGT5454M	1756	257	54	54	27/8
	EVPPHGT5460M	1869	280	54	60	27/8

# PANELS

# PRIVACY PANELS

## EVPP - LAMINATE PRIVACY PANEL

- Includes panel with two connectors with T legs.
- 3" thick freestanding panels with leveling glides
- 22" deep T-legs for stability (9.5" on each side)
- All Modules are Laminate.
- Includes end of run trim.

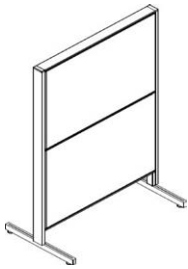
DESCRIPTION	PRODUCT CODE	LIST PRICE	DIMENSIONS/INCHES		
			H	W	D
 Freestanding Laminate Privacy Panel	EVPPH2S5424	1133	54	24	27/8
	EVPPH2S5430	1271	54	30	27/8
	EVPPH2S5436	1417	54	36	27/8
	EVPPH2S5442	1550	54	42	27/8
	EVPPH2S5448	1680	54	48	27/8
	EVPPH2S5454	1825	54	54	27/8
	EVPPH2S5460	1954	54	60	27/8

## EVPP - LAMINATE PRIVACY PANEL

- Includes panel with two connectors with T legs.
- 3" thick freestanding panels with leveling glides
- 22" deep T-legs for stability (9.5" on each side)
- All Modules are Laminate.
- Includes end of run trim.

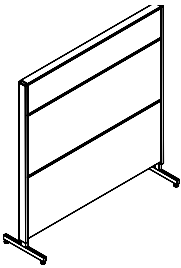
DESCRIPTION	PRODUCT CODE	LIST PRICE	DIMENSIONS/INCHES		
			H	W	D
 Freestanding Laminate Privacy Panel	EVPPH2S6624	1371	66	24	27/8
	EVPPH2S6630	1549	66	30	27/8
	EVPPH2S6636	1752	66	36	27/8
	EVPPH2S6642	1928	66	42	27/8
	EVPPH2S6648	2098	66	48	27/8
	EVPPH2S6654	2275	66	54	27/8
	EVPPH2S6660	2463	66	60	27/8

## EVPP - MOBILE LAMINATE PRIVACY PANEL

- Includes panel with two connectors with T legs.
- 3" thick freestanding panels with 1" locking casters.
- 22" deep T-legs for stability (9.5" on each side)
- All Modules are Laminate.
- Available in clear glass (CLR) and frosted glass (FRST)
- Includes end of run trim.

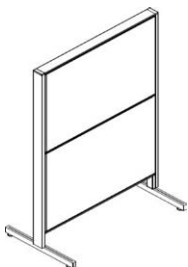
DESCRIPTION	PRODUCT CODE	LIST PRICE	DIMENSIONS/INCHES		
			H	W	D
 Mobile Laminate Privacy Panel	EVPPH2S5424M	1206	54	24	27/8
	EVPPH2S5430M	1345	54	30	27/8
	EVPPH2S5436M	1491	54	36	27/8
	EVPPH2S5442M	1627	54	42	27/8
	EVPPH2S5448M	1756	54	48	27/8
	EVPPH2S5454M	1900	54	54	27/8
	EVPPH2S5460M	2031	54	60	27/8

# PANELS

# PRIVACY PANELS

## EVPP - MOBILE LAMINATE PRIVACY PANEL

- Includes panel with two connectors with T legs.
- 3" thick freestanding panels with 1" locking casters.
- 22" deep T-legs for stability (9.5" on each side)
- All Modules are Laminate.
- Includes end of run trim.

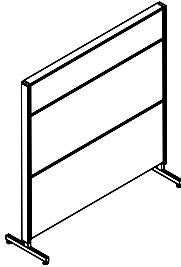
DESCRIPTION	PRODUCT CODE	LIST PRICE	DIMENSIONS/INCHES			
			H	W	D	
	Mobile Laminate Privacy Panel	EVPPH2S6624M	1446	66	24	27/8
		EVPPH2S6630M	1625	66	30	27/8
		EVPPH2S6636M	1828	66	36	27/8
		EVPPH2S6642M	2004	66	42	27/8
		EVPPH2S6648M	2174	66	48	27/8
		EVPPH2S6654M	2350	66	54	27/8
		EVPPH2S6660M	2537	66	60	27/8

## EVPP - FABRIC WRITE BOARD PRIVACY PANEL

- Includes panel with two connectors with T legs.
- 3" thick freestanding panels with leveling glides
- 22" deep T-legs for stability (9.5" on each side)
- Fabric Base Module with Write Board above.
- Includes end of run trim.

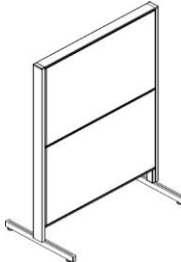
DESCRIPTION	PRODUCT CODE	LIST PRICE		DIMENSIONS/INCHES			
		GR 1	GR 2	H	W	D	
	Freestanding Write Board Privacy Panel	EVPPF2W5424	1093	1114	54	24	27/8
		EVPPF2W5430	1224	1251	54	30	27/8
		EVPPF2W5436	1354	1388	54	36	27/8
		EVPPF2W5442	1486	1519	54	42	27/8
		EVPPF2W5448	1634	1675	54	48	27/8
		EVPPF2W5454	1776	1823	54	54	27/8
		EVPPF2W5460	1902	1955	54	60	27/8

## EVPP - MOBILE FABRIC WRITE BOARD PRIVACY PANEL

- Includes panel with two connectors with T legs.
- 3" thick freestanding panels with 1" locking casters.
- 22" deep T-legs for stability (9.5" on each side)
- Fabric Base Module with Write Board above.
- Includes end of run trim.

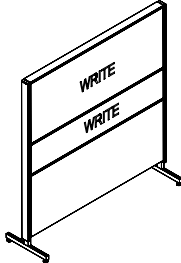
DESCRIPTION	PRODUCT CODE	LIST PRICE		DIMENSIONS/INCHES			
		GR 1	GR 2	H	W	D	
	Mobile Write Board Glazed Privacy Panel	EVPPF2W6624M	1396	1419	66	24	27/8
		EVPPF2W6630M	1623	1651	66	30	27/8
		EVPPF2W6636M	1821	1850	66	36	27/8
		EVPPF2W6642M	2000	2038	66	42	27/8
		EVPPF2W6648M	2198	2237	66	48	27/8
		EVPPF2W6654M	2382	2435	66	54	27/8
		EVPPF2W6660M	2611	2659	66	60	27/8

# PANELS

# PRIVACY PANELS

## EVPP - MOBILE FABRIC WRITE BOARD PRIVACY PANEL

- Includes panel with two connectors with T legs.
- 3" thick freestanding panels with 1" locking casters.
- 22" deep T-legs for stability (9.5" on each side)
- Fabric Base Module with Write Board above.
- Includes end of run trim.

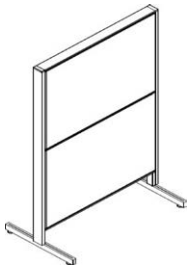
DESCRIPTION	PRODUCT CODE	LIST PRICE		DIMENSIONS/INCHES		
		GR 1	GR 2	H	W	D
 Mobile Write Board Privacy Panel	EVPPF2W5424M	1170	1190	54	24	27/8
	EVPPF2W5430M	1299	1327	54	30	27/8
	EVPPF2W5436M	1430	1463	54	36	27/8
	EVPPF2W5442M	1559	1594	54	42	27/8
	EVPPF2W5448M	1710	1751	54	48	27/8
	EVPPF2W5454M	1851	1898	54	54	27/8
	EVPPF2W5460M	1978	2031	54	60	27/8

## EVPP - MOBILE LAMINATE WRITE BOARD PRIVACY PANEL

- Includes panel with two connectors with T legs.
- 3" thick freestanding panels with 1" locking casters.
- 22" deep T-legs for stability (9.5" on each side)
- Laminate Base Module with Write Board above.
- Includes end of run trim.

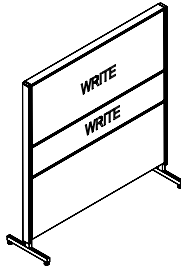
DESCRIPTION	PRODUCT CODE	LIST PRICE	DIMENSIONS/INCHES		
			H	W	D
 Mobile Write Board Laminated Privacy Panel	EVPPH2W6624M	1493	66	24	27/8
	EVPPH2W6630M	1754	66	30	27/8
	EVPPH2W6636M	1993	66	36	27/8
	EVPPH2W6642M	2188	66	42	27/8
	EVPPH2W6648M	2384	66	48	27/8
	EVPPH2W6654M	2590	66	54	27/8
	EVPPH2W6660M	2799	66	60	27/8

## EVPP - LAMINATE WRITE BOARD PRIVACY PANEL

- Includes panel with two connectors with T legs.
- 3" thick freestanding panels with leveling glides
- 22" deep T-legs for stability (9.5" on each side)
- Laminate Base Module with Write Board above.
- Includes end of run trim.

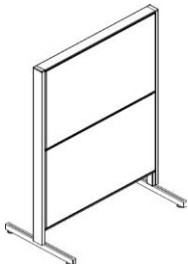
DESCRIPTION	PRODUCT CODE	LIST PRICE	DIMENSIONS/INCHES		
			H	W	D
 Freestanding Write Board Privacy Panel	EVPPH2W5424	1200	54	24	27/8
	EVPPH2W5430	1357	54	30	27/8
	EVPPH2W5436	1522	54	36	27/8
	EVPPH2W5442	1674	54	42	27/8
	EVPPH2W5448	1821	54	48	27/8
	EVPPH2W5454	1982	54	54	27/8
	EVPPH2W5460	2129	54	60	27/8

# PANELS

# PRIVACY PANELS

### EVPP - LAMINATE WRITE BOARD PRIVACY PANEL

- Includes panel with two connectors with T legs.
- 3" thick freestanding panels with leveling glides
- 22" deep T-legs for stability (9.5" on each side)
- Laminated Base Module with Write Board above
- Includes end of run trim.

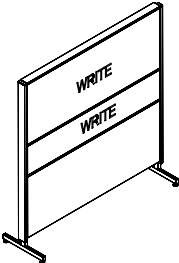
DESCRIPTION	PRODUCT CODE	LIST PRICE	DIMENSIONS/INCHES		
			H	W	D
 Freestanding Write Board Laminated Privacy Panel	EVPPH2W6624	1419	66	24	27/8
	EVPPH2W6630	1679	66	30	27/8
	EVPPH2W6636	1918	66	36	27/8
	EVPPH2W6642	2112	66	42	27/8
	EVPPH2W6648	2307	66	48	27/8
	EVPPH2W6654	2514	66	54	27/8
	EVPPH2W6660	2725	66	60	27/8

### EVPP - MOBILE LAMINATE WRITE BOARD PRIVACY PANEL

- Includes panel with two connectors with T legs.
- 3" thick freestanding panels with 1" locking casters.
- 22" deep T-legs for stability (9.5" on each side)
- Laminated Base Module with Write Board above.
- Includes end of run trim.

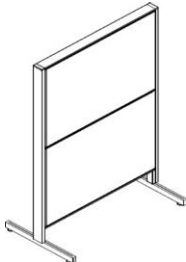
DESCRIPTION	PRODUCT CODE	LIST PRICE	DIMENSIONS/INCHES		
			H	W	D
 Mobile Write Board Privacy Panel	EVPPH2W5424M	1277	54	24	27/8
	EVPPH2W5430M	1434	54	30	27/8
	EVPPH2W5436M	1595	54	36	27/8
	EVPPH2W5442M	1747	54	42	27/8
	EVPPH2W5448M	1895	54	48	27/8
	EVPPH2W5454M	2057	54	54	27/8
	EVPPH2W5460M	2205	54	60	27/8

### EVPP - FABRIC WRITE BOARD PRIVACY PANEL

- Includes panel with two connectors with T legs.
- 3" thick freestanding panels with leveling glides
- 22" deep T-legs for stability (9.5" on each side)
- Fabric Base Module with Write Board above
- Includes end of run trim.

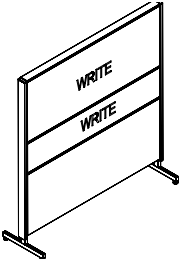
DESCRIPTION	PRODUCT CODE	LIST PRICE		DIMENSIONS/INCHES		
		GR 1	GR 2	H	W	D
 Freestanding Write Board Glazed Privacy Panel	EVPPF2W6624	1321	1342	66	24	27/8
	EVPPF2W6630	1548	1577	66	30	27/8
	EVPPF2W6636	1745	1775	66	36	27/8
	EVPPF2W6642	1925	1960	66	42	27/8
	EVPPF2W6648	2124	2159	66	48	27/8
	EVPPF2W6654	2305	2358	66	54	27/8
	EVPPF2W6660	2536	2584	66	60	27/8



# panel connectors

# PANEL CONNECTORS

# TECHNICAL INFORMATION



Slotted posts are included with each Variable-Height Corner Post. The height of each slotted post must be specified when ordering a Variable-Height Corner Post. Slotted post height is determined by the height of the connecting panel run.

### Example

Step 1 Specify base code listed on pricing page.

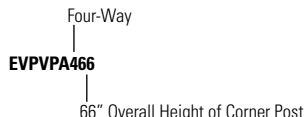

### Segmented Panel

Step 2 Specify slotted post heights.

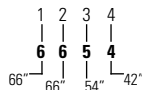

**Note:** To specify height, use the first number of the connecting panel run height dimension.

### Slotted Post Positions

As illustrated in the example below, start with position 1 and continue clockwise specifying the height of each slotted post.

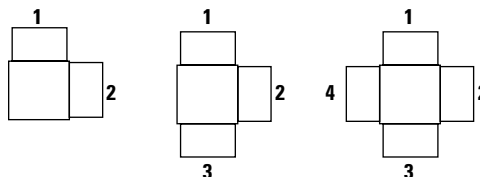

### Sample Configuration - EVPVPA466-6654

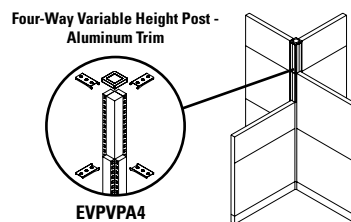

## PANEL CONNECTORS BY TYPE

### Inline Connector ..... 121-123

- Inline Connector
- Inline Connector for Light Panels
- Inline Connector for Beltline Powered Panels
- Inline Connector for Beltline Powered Light Panels
- Inline Variable - Height Connector
- Inline Variable - Height Connector for Light Panels
- Inline Variable - Height Connector for Beltline Powered Panels
- Inline Variable - Height Connector for Beltline Powered Light Panels

### End-of-Run ..... 124

- End-of-Run Post Kit (Wall Mountable) - Aluminum Trim
- End-of-Run Post Kit for Light Panels (Wall Mountable) - Aluminum Trim

### Two-Way Post ..... 125-128

- Two-Way Post - Aluminum Trim
- Two-Way Post for Light Panels - Aluminum Trim
- Two-Way Post for Beltline Powered Panels - Aluminum Trim
- Two-Way Post for Beltline Powered Light Panels - Aluminum Trim
- Two-Way Variable - Height Post - Aluminum Trim
- Two-Way Variable - Height Post for Light Panels - Aluminum Trim
- Two-Way Variable - Height Post for Beltline Powered Panels - Aluminum Trim
- Two-Way Variable - Height Post for Beltline Powered Light Panels - Aluminum Trim

### Three-Way Post ..... 129-132

- Three-Way Post - Aluminum Trim
- Three-Way Post for Light Panels - Aluminum Trim
- Three-Way Post for Beltline Powered Panels - Aluminum Trim
- Three-Way Post for Beltline Powered Light Panels - Aluminum Trim
- Three-Way Variable - Height Post - Aluminum Trim
- Three-Way Variable - Height Post for Light Panels - Aluminum Trim
- Three-Way Variable - Height Post for Beltline Powered Panels - Aluminum Trim
- Three-Way Variable - Height Post for Beltline Powered Light Panels - Aluminum Trim

### Four-Way Post ..... 133-136

- Four-Way Post
- Four-Way Post for Light Panels
- Four-Way Post for Beltline Powered Panels
- Four-Way Post for Beltline Powered Light Panels
- Four-Way Variable - Height Post - Aluminum Trim
- Four-Way Variable - Height Post for Light Panels - Aluminum Trim
- Four-Way Variable - Height Post for Beltline Powered Panels - Aluminum Trim
- Four-Way Variable - Height Post for Beltline Powered Light Panels - Aluminum Trim

### One-Way Post ..... 137-138

- One-Way Post - Aluminum Trim
- One-Way Post for Light Panels - Aluminum Trim
- One-Way Post for Beltline Powered Panels - Aluminum Trim
- One-Way Post for Beltline Powered Light Panels - Aluminum Trim

### Inline Two-Way Post ..... 139-140

- Inline Two-Way Post - Aluminum Trim
- Inline Two-Way Post for Light Panels - Aluminum Trim
- Inline Two-Way Post for Beltline Powered Panels - Aluminum Trim
- Inline Two-Way Post for Beltline Powered Light Panels - Aluminum Trim

### 60 Degree ..... 141-143

- Two-Way 60 Degree Post - Aluminum Trim
- Two-Way 60 Degree Post for Beltline Powered Panels - Aluminum Trim
- Two-Way 60 Degree Variable - Height Post - Aluminum Trim
- Two-Way 60 Degree Variable - Height Post for Beltline Powered Panels - Aluminum Trim
- Three-Way 60 Degree Post for Beltline Powered Panels
- Three-Way 60 Degree Post for Beltline Powered Panels - Aluminum Trim
- Three-Way 60 Degree Variable - Height Post - Aluminum Trim
- Three-Way 60 Degree Variable - Height Post for Beltline Powered Panels - Aluminum Trim

### 45 Degree ..... 143-144

- Two-Way 45 Degree Post
- Two-Way 45 Degree Variable - Height Post

### Upmount End of Run ..... 144-145

- Upmount End-of-Run Post Kit (Wall Mountable) - Aluminum
- Upmount End-of-Run Post Kit for Light Panels (Wall Mountable) - Aluminum
- Upmount End-of-Run Trim - Aluminum
- Upmount End-of-Run Trim for Light Panels - Aluminum

### Extension ..... 146-149

- Inline Extension Connector - Slotted
- End-of-Run Extension Connector - Slotted - Aluminum
- Two-Way Post Extension - Slotted - Aluminum
- Three-Way Post Extension - Slotted - Aluminum
- Four-Way Post Extension - Slotted - Aluminum
- One-Way Post Extension - Slotted - Aluminum
- Inline Two-Way Post Extension - Slotted - Aluminum
- Two-Way 60 Degree Post Extension - Slotted - Aluminum
- Three Way 60 Degree Post Extension - Slotted - Aluminum
- One-Way 60 Degree Post Extension - Slotted - Aluminum
- Two-Way 45 Degree Post Extension - Slotted - Aluminum
- One-Way 45 Degree Post Extension - Slotted - Aluminum

### Trims ..... 150-153

- Upmount Extension Trim - Aluminum
- End-of-Run Trim - Aluminum
- End-of-Run Trim for Light Panels - Aluminum
- Panel Trim Variable Height - Aluminum
- Panel Extension Trim - Aluminum
- Flat Trim - Aluminum
- Flat Trim for Light Panels - Aluminum
- Flat Extension Trim - Aluminum
- Panel Top Trim - Aluminum
- Panel Top Single Notched Trim - Aluminum
- Panel Top Double Notched Trim - Aluminum
- Slot Cover

# PANEL CONNECTORS

INLINE

## EVPIC - INLINE CONNECTOR

- Connects two panels of equal height in a straight run.
- Provides slotted support for worksurfaces and hang-on storage components.
- Includes one slotted connector with leveling glide and connecting hardware.
- Connectors available without slots, as a special at no upcharge. Contact Customer Support.

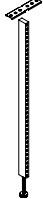
DESCRIPTION	PRODUCT CODE	LIST PRICE	DIMENSIONS/INCHES		
			H	W	D
 Inline Connector	EVPIC30	80	30	2	
	EVPIC42	93	42	2	
	EVPIC48	97	48	2	
	EVPIC54	99	54	2	
	EVPIC66	110	60	2	

## EVPLTIC - LIGHT PANEL INLINE CONNECTOR LEG WITH TRIMS

- Connects two Light panel in straight run.
- Provides slotted support for worksurfaces and hang on components.
- Includes one slotted connector with leveling glide with leg and trims and connecting hardware.
- Connectors available without slots, as a special at no extra charge. Contact customer support.

DESCRIPTION	PRODUCT CODE	LIST PRICE	DIMENSIONS/INCHES		
			H	W	D
 Light Panel Inline Connector Leg with Trims	EVPLTIC30	80	30	2	
	EVPLTIC42	93	42	2	
	EVPLTIC48	97	48	2	
	EVPLTIC54	99	54	2	
	EVPLTIC66	110	66	2	

## EVPBIC - INLINE CONNECTOR FOR BELTLINE POWERED PANELS

- Connects two Beltline Powered panels of equal height in a straight run.
- Provides slotted support for worksurfaces and hang-on storage components.
- Includes one slotted connector with leveling glide and connecting hardware.
- Connectors available without slots, as a special at no upcharge. Contact Customer Support.

DESCRIPTION	PRODUCT CODE	LIST PRICE	DIMENSIONS/INCHES		
			H	W	D
 Inline Connector for Beltline Powered Panels	EVPBIC42	93	42	2	
	EVPBIC54	99	54	2	
	EVPBIC66	110	66	2	

# PANEL CONNECTORS

# INLINE

## EVPBLTIC - BELTLINE LIGHT PANEL INLINE CONNECTOR LEG WITH TRIMS

- Connects two Light panel in straight run.
- Provides slotted support for worksurfaces and hang on components.
- Includes one slotted connector with leveling glide with leg and trims and connecting hardware.
- Connectors available without slots, as a special at no extra charge. Contact customer support.

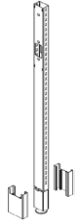
DESCRIPTION	PRODUCT CODE	LIST PRICE	DIMENSIONS/INCHES		
			H	W	D
 Beltline Light Panel Inline Connector Leg with trims	EVPBLTIC42	93	42	2	
	EVPBLTIC54	99	54	2	
	EVPBLTIC66	110	66	2	

## EVPVC - INLINE VARIABLE - HEIGHT CONNECTOR

- Connects two panels of differing height in a straight run.
- Connector must reference taller panel.
- Can be used for any variation of panel heights.
- Variable-height trim must be ordered separately (see EVPTVAXX)
- Provides slotted support for worksurfaces and hang-on storage components.
- Includes one slotted connector with leveling glide and connecting hardware.
- Connectors available without slots, as a special at no upcharge. Contact Customer Support.
- Please see page 92 on how to specify.

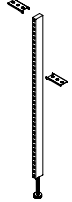
DESCRIPTION	PRODUCT CODE	LIST PRICE	DIMENSIONS/INCHES		
			H	W	D
 Inline Variable - Height Connector	EVPVC42	99	42	2	
	EVPVC48	101	48	2	
	EVPVC54	102	54	2	
	EVPVC66	112	66	2	

## EVPLTVC - INLINE VARIABLE HEIGHT CONNECTOR WITH LEG WITH TRIMS

- Connects two Light panels of differing height in straight run.
- Connector must reference taller panel.
- Can be used for any variation of panel height.
- Variable height trim must be ordered separately (see EVPTVAXx).
- Provides slotted support for worksurfaces and hang on components.
- Includes one slotted connector with leveling glide with leg and trims and connecting hardware.
- Connectors available without slots, as a special at no extra charge. Contact customer support.

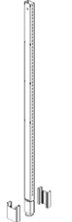
DESCRIPTION	PRODUCT CODE	LIST PRICE	DIMENSIONS/INCHES		
			H	W	D
 Inline Variable Height Connector with Leg with Trims	EVPLTVC42	99	42	2	
	EVPLTVC48	101	48	2	
	EVPLTVC54	102	54	2	
	EVPLTVC66	112	66	2	

# PANEL CONNECTORS

INLINE

## EVPBVC - INLINE VARIABLE - HEIGHT CONNECTOR FOR BELTLINE POWERED PANELS

- Connects two Beltline Powered panels of differing height in a straight run.
- Connector must reference taller panel.
- Can be used for any variation of panel heights.
- Variable-height trim must be ordered separately (see EVPTVAXX)
- Provides slotted support for worksurfaces and hang-on storage components.
- Includes one slotted connector with leveling glide and connecting hardware.
- Connectors available without slots, as a special at no upcharge. Contact Customer Support.
- Please see page 92 on how to specify.

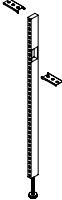
	DESCRIPTION	PRODUCT CODE	LIST PRICE	DIMENSIONS/INCHES		
				H	W	D
	Inline Variable - Height Connector for Beltline Powered Panels	EVPBVC54	102	54	2	
		EVPBVC66	112	66	2	

## EVPBTVVC - INLINE VARIABLE HEIGHT CONNECTOR FOR BELTLINE LIGHT PANEL

- Connects two Light panels of differing height in straight run.
- Connector must reference taller panel.
- Can be used for any variation of panel height.
- Variable height trim must be ordered separately (see EVPTVAXX)
- Provides slotted support for worksurfaces and hang on components.
- Includes one slotted connector with leveling glide with leg and trims and connecting hardware.
- Includes one slotted connector with leveling glide with leg and trims and connecting hardware.

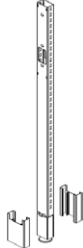
	DESCRIPTION	PRODUCT CODE	LIST PRICE	DIMENSIONS/INCHES		
				H	W	D
	Inline Variable Height Connector	EVPBTVVC54	102	54	2	
		EVPBTVVC66	112	60	2	

# PANEL CONNECTORS

END OF RUN

## EVPERA - END-OF-RUN POST KIT (WALL MOUNTABLE) - ALUMINUM TRIM

- Connects at the end of a panel run and can be used to attach a panel to a fixed wall.
- Adds 1" to the width of the panel run.
- Provides slotted support for worksurfaces and hang-on storage components.
- Includes one slotted connector with leveling glide, connecting hardware and trim kit.
- Can be attached to face of another panel to provide off-modular panel connection.
- Connectors available without slots, as a special at no upcharge. Contact Customer Support.

	DESCRIPTION	PRODUCT CODE	LIST PRICE	DIMENSIONS/INCHES		
				H	W	D
	End-of-Run Post Kit (Wall Mountable) -	EVPERA30	97	30	2 7/8	
	Aluminum Trim	EVPERA42	110	42	2 7/8	
		EVPERA48	117	48	2 7/8	
		EVPERA54	132	54	2 7/8	
		EVPERA66	146	66	2 7/8	

## EVPLTERA - END OF RUN POST KIT FOR LIGHT PANEL

- Connects at end of Light panel and can attach to a panel to fixed wall.
- Adds 1" to width of panel run.
- Provides slotted support for worksurfaces and hang on components.
- Includes one slotted connector with leveling glide with leg and trims and connecting hardware.
- Can be attached to face of another panel to provide off modular connection.
- Connectors available without slots, as a special at no extra charge. Contact customer support.

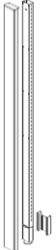
	DESCRIPTION	PRODUCT CODE	LIST PRICE	DIMENSIONS/INCHES		
				H	W	D
	End of run post kit for Light Panel	EVPLTERA30	97	30	2	
		EVPLTERA42	110	42	2	
		EVPLTERA48	117	48	2	
		EVPLTERA54	132	54	2	
		EVPLTERA66	146	66	2	

# PANEL CONNECTORS

2 - WAY

## EVPCPA2 - TWO-WAY POST - ALUMINUM TRIM

- Connects two panels of equal height in a 90 degree configuration.
- Post and connecting hardware adds 3.25" to the panel run.
- Provides slotted support for worksurfaces and hang-on storage components.
- Includes one post, two slotted connectors with leveling glides, connecting hardware and trim kit.
- Connectors available without slots, as a special at no upcharge. Contact Customer Support.

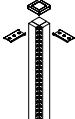
DESCRIPTION	PRODUCT CODE	LIST PRICE	DIMENSIONS/INCHES		
			H	W	D
 <p>Two-Way Post - Aluminum Trim</p>	EVPCPA230	180	30	2 7/8	
	EVPCPA242	224	42	2 7/8	
	EVPCPA248	239	48	2 7/8	
	EVPCPA254	278	54	2 7/8	
	EVPCPA266	326	66	2 7/8	

## EVPLTCPA2 - TWO WAY CORNER POST FOR LIGHT PANEL

- Connects two Light panel of equal height in 90 degree configuration.
- Post and connecting hardware add 3.25" to power beam run.
- Provides slotted support for worksurfaces and hang on components.
- Includes post, panel connectors and power beam connectors, post with trim all around, levelling glide, hardware and trim kit.
- Leg trim matches selected trim color.
- Connectors available without slots, as a special at no extra charge. Contact customer support.

DESCRIPTION	PRODUCT CODE	LIST PRICE	DIMENSIONS/INCHES		
			H	W	D
 <p>Two Way Corner Post for Light Panel</p>	EVPLTCPA230	180	30	2 7/8	
	EVPLTCPA242	224	42	2 7/8	
	EVPLTCPA248	239	48	2 7/8	
	EVPLTCPA254	278	54	2 7/8	
	EVPLTCPA266	326	66	2 7/8	

## EVPLTCPA2P- TWO WAY CORNER POST FOR LIGHT PANEL

- Connects Light panel and Panel of equal height in 90 degree configuration.
- Post and connecting hardware add 3.25" to power beam run.
- Provides slotted support for worksurfaces and hang on components.
- Includes post, panel connectors and power beam connectors, post with trim all around, levelling glide, hardware and trim kit.
- Leg trim matches selected trim color.
- Connectors are available without slots, as a special at no extra charge. Contact customer support.

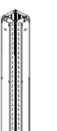
DESCRIPTION	PRODUCT CODE	LIST PRICE	DIMENSIONS/INCHES		
			H	W	D
 <p>Two Way Corner Post for Light Panel</p>	EVPLTCPA230P	180	30	2 7/8	
	EVPLTCPA242P	224	42	2 7/8	
	EVPLTCPA248P	239	48	2 7/8	
	EVPLTCPA254P	278	54	2 7/8	
	EVPLTCPA266P	326	66	2 7/8	

# PANEL CONNECTORS

2 - WAY

## EVPBCPA2 - TWO-WAY POST FOR BELTLINE POWERED PANELS - ALUMINUM TRIM

- Connects two Beltline Powered panels of equal height in a 90 degree configuration.
- Post and connecting hardware adds 3.25" to the panel run.
- Provides slotted support for worksurfaces and hang-on storage components.
- Includes one post, two slotted connectors with leveling glides, connecting hardware and trim kit.
- Connectors available without slots, as a special at no upcharge. Contact Customer Support.

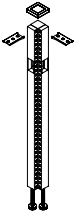
DESCRIPTION	PRODUCT CODE	LIST PRICE	DIMENSIONS/INCHES		
			H	W	D
 <p>Two-Way Post for Beltline Powered Panels - Aluminum Trim</p>	EVPBCPA242	224	42	2 7/8	
	EVPBCPA254	278	54	2 7/8	
	EVPBCPA266	326	66	2 7/8	

## EVPBLTCPA2 - TWO WAY CORNER POST FOR BELTLINE LIGHT PANEL

- Connects two Light panel of equal height in 90 degree configuration.
- Post and connecting hardware add 3.25" to power beam run.
- Provides slotted support for worksurfaces and hang on components.
- Includes post, panel connectors and power beam connectors, post with trim all around, levelling glide, hardware and trim kit.
- Leg trim matches selected trim color.
- Connectors available without slots, as a special at no extra charge. Contact customer support.

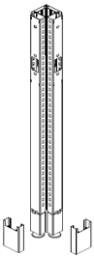
DESCRIPTION	PRODUCT CODE	LIST PRICE	DIMENSIONS/INCHES		
			H	W	D
 <p>Two Way Corner Post for Beltline Light Panel</p>	EVPBLTCPA242	224	42	2	
	EVPBLTCPA248	239	48	2	
	EVPBLTCPA254	278	54	2	
	EVPBLTCPA266	326	66	2	

## EVPBLTCPA2P - TWO WAY CORNER POST FOR BELTLINE LIGHT PANEL

- Connects Beltline Light panel and Beltline Panel of equal height in 90 degree configuration.
- Post and connecting hardware add 3.25" to power beam run.
- Provides slotted support for worksurfaces and hang on components.
- Includes post, panel connectors and power beam connectors, post with trim all around, levelling glide, hardware and trim kit.
- Leg trim matches selected trim color.
- Connectors are available without slots, as a special at no extra charge. Contact customer support.

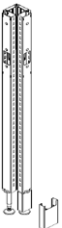
DESCRIPTION	PRODUCT CODE	LIST PRICE	DIMENSIONS/INCHES		
			H	W	D
 <p>Two Way Corner Post for Beltline Light Panel</p>	EVPBLTCPA242P	224	42	2 7/8	
	EVPBLTCPA248P	239	48	2 7/8	
	EVPBLTCPA254P	278	54	2 7/8	
	EVPBLTCPA266P	326	66	2 7/8	

# PANEL CONNECTORS

2 - WAY

## EVPVPA2 - TWO-WAY VARIABLE - HEIGHT POST - ALUMINIM TRIM

- Connects two panels of differing height in a 90 degree configuration.
- Connector must reference taller panel.
- Post and connecting hardware adds 3.25" to the panel run.
- Provides slotted support for worksurfaces and hang-on storage components.
- Includes one post, two slotted connectors with leveling glides, connecting hardware and trim kit.
- Connectors available without slots as a special at no upcharge. Contact Customer Support
- Please see page 92 on how to specify.

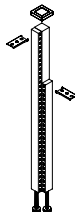
DESCRIPTION	PRODUCT CODE	LIST PRICE	DIMENSIONS/INCHES		
			H	W	D
 Two-Way Variable - Height Post - Aluminum Trim	EVPVPA242	224	42	2 7/8	
	EVPVPA248	250	48	2 7/8	
	EVPVPA254	278	54	2 7/8	
	EVPVPA266	326	66	2 7/8	

## EVPLTVPA2 - TWO WAY VARIABLE HEIGHT CORNER POST FOR LIGHT PANEL

- Connects two Light panel of differing height in 90 degree configuration.
- Connector must reference taller panel.
- Post and connecting hardware add 3.25" to power beam run.
- Provides slotted support for worksurfaces and hang on components.
- Includes post, panel connectors and power beam connectors, post with trim all around, levelling glide, hardware and trim kit.
- Leg trim matches selected trim color.
- Connectors available without slots, as a special at no extra charge. Contact customer support.

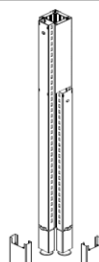
DESCRIPTION	PRODUCT CODE	LIST PRICE	DIMENSIONS/INCHES		
			H	W	D
 Two Way Variable Height Corner Post for Beltline Light Panel	EVPLTVPA242	224	42	2 7/8	
	EVPLTVPA248	239	48	2 7/8	
	EVPLTVPA254	278	54	2 7/8	
	EVPLTVPA266	326	66	2 7/8	

## EVPLTVPA2P- TWO WAY VARIABLE HEIGHT CORNER POST FOR LIGHT PANEL - PANEL

- Connects Light panel and Panel of differing height in 90 degree configuration.
- Connector must reference taller panel.
- Post and connecting hardware add 3.25" to power beam run.
- Provides slotted support for worksurfaces and hang on components.
- Includes post, panel connectors and power beam connectors, post with trim all around, levelling glide, hardware and trim kit.
- Leg trim matches selected trim color.
- Connectors are available without slots, as a special at no extra charge. Contact customer support.

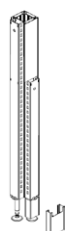
DESCRIPTION	PRODUCT CODE	LIST PRICE	DIMENSIONS/INCHES		
			H	W	D
 Two Way Variable Height Corner Post for Light Panel-Panel	EVPLTVPA242P	224	42	2 7/8	
	EVPLTVPA248P	239	48	2 7/8	
	EVPLTVPA254P	278	54	2 7/8	
	EVPLTVPA266P	326	66	2 7/8	

# PANEL CONNECTORS

2 - WAY

## EVPBVPA2 - TWO-WAY VARIABLE - HEIGHT POST FOR BELTLINE POWERED PANELS - ALUMINIM TRIM

- Connects two Beltline Powered panels of differing height in a 90 degree configuration.
- Connector must reference taller panel.
- Post and connecting hardware adds 3.25" to the panel run.
- Provides slotted support for worksurfaces and hang-on storage components.
- Includes one post, two slotted connectors with leveling glides, connecting hardware and trim kit.
- Connectors available without slots, as a special at no upcharge. Contact Customer Support.

DESCRIPTION	PRODUCT CODE	LIST PRICE	DIMENSIONS/INCHES		
			H	W	D

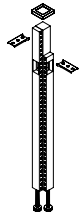

Two-Way Variable - Height Post for Beltline Powered Panels - Aluminum Trim	EVPBVPA254	278	54	2 7/8	
	EVPBVPA266	326	66	2 7/8	

## EVPBLTVA2 - TWO WAY VARIABLE HEIGHT CORNER POST FOR BELTLINE LIGHT PANEL

- Connects two Light panel of differing height in 90 degree configuration.
- Connector must reference taller panel.
- Post and connecting hardware add 3.25" to power beam run.
- Provides slotted support for worksurfaces and hang on components.
- Leg trim matches selected trim color.
- Includes post, panel connectors and power beam connectors, post with trim all around, levelling glide, hardware and trim kit.
- Connectors available without slots, as a special at no extra charge. Contact customer support.

DESCRIPTION	PRODUCT CODE	LIST PRICE	DIMENSIONS/INCHES		
			H	W	D



Two Way Variable Height Corner Post for Beltline Light Panel	EVPBLTVA254	278	54	2 7/8	
	EVPBLTVA266	326	66	2 7/8	

## EVPBLTVA2P - TWO WAY VARIABLE HEIGHT CORNER POST FOR BELTLINE LIGHT PANEL

- Connects Beltline Light panel and Beltline Panel of differing height in 90 degree configuration.
- Connector must reference taller panel.
- Post and connecting hardware add 3.25" to power beam run.
- Provides slotted support for worksurfaces and hang on components.
- Includes post, panel connectors and power beam connectors, post with trim all around, levelling glide, hardware and trim kit.
- Leg trim matches selected trim color.
- Connectors are available without slots, as a special at no extra charge. Contact customer support.

DESCRIPTION	PRODUCT CODE	LIST PRICE	DIMENSIONS/INCHES		
			H	W	D

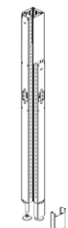

Two Way Variable Height Corner Post for Beltline Light Panel	EVPBLTVA254P	359	54	2 7/8	
	EVPBLTVA266P	326	66	2 7/8	

# PANEL CONNECTORS

3 - WAY

## EVPCPA3 - THREE-WAY POST - ALUMINUM TRIM

- Connects three panels of equal height in a "T" configuration.
- Post and connecting hardware adds 3.25" to the panel run.
- Provides slotted support for worksurfaces and hang-on storage components.
- Includes one post, three slotted connectors with leveling glides, connecting hardware and trim kit.
- Connectors available without slots, as a special at no upcharge. Contact Customer Support.

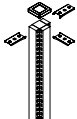
DESCRIPTION	PRODUCT CODE	LIST PRICE	DIMENSIONS/INCHES		
			H	W	D
 <p>Three-Way Post - Aluminum Trim</p>	EVPCPA330	222	30	2 7/8	
	EVPCPA342	297	42	2 7/8	
	EVPCPA348	326	48	2 7/8	
	EVPCPA354	359	54	2 7/8	
	EVPCPA366	423	66	2 7/8	

## EVPLTCPA3 - THREE WAY CORNER POST FOR LIGHT PANEL

- Connects three Light panel of equal height in "T" configuration.
- Post and connecting hardware add 3.25" to power beam run.
- Provides slotted support for worksurfaces and hang on components.
- Includes post, panel connectors and power beam connectors, post with trim all around, levelling glide, hardware and trim kit.
- Leg trim matches selected trim color.
- Connectors available without slots, as a special at no extra charge. Contact customer support.

DESCRIPTION	PRODUCT CODE	LIST PRICE	DIMENSIONS/INCHES		
			H	W	D
 <p>Three Way Corner Post for Light Panel</p>	EVPLTCPA330	222	30	2 7/8	
	EVPLTCPA342	297	42	2 7/8	
	EVPLTCPA348	326	48	2 7/8	
	EVPLTCPA354	359	54	2 7/8	
	EVPLTCPA366	423	66	2 7/8	

## EVPLTCPA3P - THREE WAY CORNER POST FOR PANEL - LIGHT PANEL

- Connects one Light panel and two Panels of equal height in "T" configuration, Panel-Light Panel-Panel.
- Post and connecting hardware add 3.25" to power beam run.
- Provides slotted support for worksurfaces and hang on components.
- Includes post, panel connectors and power beam connectors, post with trim all around, levelling glide, hardware and trim kit.
- Leg trim matches selected trim color.
- Connectors are available without slots, as a special at no extra charge. Contact customer support.

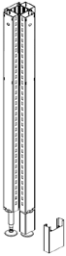
DESCRIPTION	PRODUCT CODE	LIST PRICE	DIMENSIONS/INCHES		
			H	W	D
 <p>Three Way Corner Post for Panel-Light Panel</p>	EVPLTCPA330P	222	30	2 7/8	
	EVPLTCPA342P	297	42	2 7/8	
	EVPLTCPA348P	326	48	2 7/8	
	EVPLTCPA354P	359	54	2 7/8	
	EVPLTCPA366P	423	66	2 7/8	

# PANEL CONNECTORS

3 - WAY

## EVPLTCPA3PT - THREE WAY CORNER POST FOR LIGHT PANEL -PANEL-LIGHT PANEL

- Connects one Light panel and two Panels of equal height in "T" configuration , Light Panel-Panel-Light Panel.
- Post and connecting hardware add 3.25" to Power Beam run.
- Provides slotted support for worksurfaces and hang on components.
- Includes post, panel connectors and power beam connectors, post with trim all around, leveling glide, hardware and trim kit.
- Leg trim matches selected trim color.
- Connectors available without slots, as a special at no upcharge. Contact Customer Support.

DESCRIPTION	PRODUCT CODE	LIST PRICE	DIMENSIONS/INCHES		
			H	W	D
 Three-Way Corner Post Light Panel-Panel-Light Panel	EVPLTCPA330PT	222	30	2 7/8	
	EVPLTCPA342PT	297	42	2 7/8	
	EVPLTCPA348PT	326	48	2 7/8	
	EVPLTCPA354PT	359	54	2 7/8	
	EVPLTCPA366PT	423	66	2 7/8	

## EVPBCPA3 - THREE-WAY POST FOR BELTLINE POWERED PANELS - ALUMINUM TRIM

- Connects three Beltline Powered panels of equal height in a "T" configuration.
- Post and connecting hardware adds 3.25" to the panel run.
- Provides slotted support for worksurfaces and hang-on storage components.
- Includes one post, three slotted connectors with leveling glides, connecting hardware and trim kit.
- Connectors available without slots, as a special at no upcharge. Contact Customer Support.

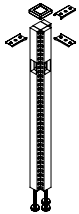
DESCRIPTION	PRODUCT CODE	LIST PRICE	DIMENSIONS/INCHES		
			H	W	D
 Three-Way Post for Beltline Powered Panels - Aluminum Trim	EVPBCPA342	297	42	2 7/8	
	EVPBCPA354	359	54	2 7/8	
	EVPBCPA366	423	66	2 7/8	

## EVPLTCPA3 - THREE WAY CORNER POST FOR BELTLINE LIGHT PANEL

- Connects three Light panel of equal height in "T" configuration.
- Post and connecting hardware add 3.25" to power beam run.
- Provides slotted support for worksurfaces and hang on components.
- Includes post, panel connectors and power beam connectors, post with trim all around, levelling glide, hardware and trim kit.
- Leg trim matches selected trim color.
- Connectors available without slots, as a special at no extra charge. Contact customer support.

DESCRIPTION	PRODUCT CODE	LIST PRICE	DIMENSIONS/INCHES		
			H	W	D
 Three Way Corner Post for Beltline Light Panel	EVPLTCPA342	297	42	2	
	EVPLTCPA348	326	48	2	
	EVPLTCPA354	359	54	2	
	EVPLTCPA366	423	66	2	

# PANEL CONNECTORS

3 - WAY

## EVPBLTCPA3P - THREE WAY CORNER POST FOR BELTLINE LIGHT PANEL

- Connects one Beltline Light panel and two Beltline panels of equal height in "T" configuration.
- Post and connecting hardware add 3.25" to power beam run.
- Provides slotted support for worksurfaces and hang on components.
- Includes post, panel connectors and power beam connectors, post with trim all around, levelling glide, hardware and trim kit.
- Leg trim matches selected trim color.
- Connectors are available without slots, as a special at no extra charge. Contact customer support.

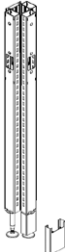
DESCRIPTION	PRODUCT CODE	LIST PRICE	DIMENSIONS/INCHES		
			H	W	D
 Three way Corner Post Light Panel	EVPBLTCPA342P	297	42	2 7/8	
	EVPBLTCPA348P	326	48	2 7/8	
	EVPBLTCPA354P	359	54	2 7/8	
	EVPBLTCPA366P	423	66	2 7/8	

## EVPVPA3 - THREE-WAY VARIABLE - HEIGHT POST - ALUMINUM TRIM

- Connects three panels of differing height in a "T" configuration.
- Connector must reference taller panel.
- Post and connecting hardware adds 3.25" to the panel run.
- Provides slotted support for worksurfaces and hang-on storage components.
- Includes one post, three slotted connectors with leveling glides, connecting hardware and trim kit.
- Connectors available without slots, as a special at no upcharge. Contact Customer Support.
- Please see page 92 on how to specify.

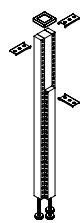
DESCRIPTION	PRODUCT CODE	LIST PRICE	DIMENSIONS/INCHES		
			H	W	D
 Three-Way Variable - Height Post - Aluminum Trim	EVPVPA342	297	42	2 7/8	
	EVPVPA348	326	48	2 7/8	
	EVPVPA354	359	54	2 7/8	
	EVPVPA366	423	66	2 7/8	

## EVPLTVPA3 - THREE WAY VARIABLE HEIGHT CORNER POST FOR LIGHT PANEL

- Connects three Light panel of differing height in "T" configuration.
- Connector must reference taller panel.
- Post and connecting hardware add 3.25" to power beam run.
- Provides slotted support for worksurfaces and hang on components.
- Includes post, panel connectors and power beam connectors, post with trim all around, levelling glide, hardware and trim kit.
- Leg trim matches selected trim color.
- Connectors available without slots, as a special at no extra charge. Contact customer support.

DESCRIPTION	PRODUCT CODE	LIST PRICE	DIMENSIONS/INCHES		
			H	W	D
 Three Way Variable Height Corner Post for Light Panel	EVPLTVPA342	297	42	2 7/8	
	EVPLTVPA348	326	48	2 7/8	
	EVPLTVPA354	359	54	2 7/8	
	EVPLTVPA366	423	66	2 7/8	

# PANEL CONNECTORS

3 - WAY

## EVPLTVA3P- THREE WAY VARIABLE HEIGHT CORNER POST FOR LIGHT PANEL - PANEL

- Connects one Light panel and two Panels of differing height in "T" configuration, Panel-Light Panel-Panel.
- Connector must reference taller panel.
- Post and connecting hardware add 3.25" to power beam run.
- Provides slotted support for worksurfaces and hang on components.
- Includes post, panel connectors and power beam connectors, post with trim all around, levelling glide, hardware and trim kit.
- Leg trim matches selected trim color.
- Connectors are available without slots, as a special at no extra charge. Contact customer support.

DESCRIPTION	PRODUCT CODE	LIST PRICE	DIMENSIONS/INCHES		
			H	W	D

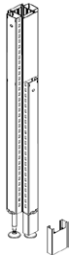

Three Way Variable Height Corner Post for Panel-Light Panel-Panel	EVPLTVA342P	297	42	2 7/8	
	EVPLTVA348P	326	48	2 7/8	
	EVPLTVA354P	359	54	2 7/8	
	EVPLTVA366P	423	66	2 7/8	

## EVPBVPA3 - THREE-WAY VARIABLE - HEIGHT POST FOR BELTLINE POWERED PANELS - ALUMINUM TRIM

- Connects three Beltline Powered panels of differing height in a "T" configuration.
- Connector must reference taller panel.
- Post and connecting hardware adds 3.25" to the panel run.
- Provides slotted support for worksurfaces and hang-on storage components.
- Includes one post, three slotted connectors with leveling glides, connecting hardware and trim kit.
- Connectors available without slots, as a special at no upcharge. Contact Customer Support.
- Please see page 92 on how to specify.

DESCRIPTION	PRODUCT CODE	LIST PRICE	DIMENSIONS/INCHES		
			H	W	D

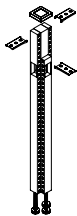

Three-Way Variable - Height Post for Beltline Powered Panels - Aluminum Trim	EVPBVPA354	359	54	2 7/8	
	EVPBVPA366	423	66	2 7/8	

# PANEL CONNECTORS

3 - WAY

## EVPBLTVPA3 - THREE WAY VARIABLE HEIGHT CORNER POST FOR BELTLINE LIGHT PANEL

- Connects one Beltline Light panel and two beltline Panels of differing height in "T" configuration.
- Connector must reference taller panel.
- Post and connecting hardware add 3.25" to power beam run.
- Provides slotted support for worksurfaces and hang on components.
- Includes post, panel connectors and power beam connectors, post with trim all around, levelling glide, hardware and trim kit.
- Leg trim matches selected trim color.
- Connectors available without slots, as a special at no extra charge. Contact customer support.

DESCRIPTION	PRODUCT CODE	LIST PRICE	DIMENSIONS/INCHES		
			H	W	D
Three Way Variable Height Corner Post for Beltline Light Panel	EVPBLTVPA354	359	54	2 7/8	
	EVPBLTVPA366	423	66	2 7/8	



## EVPBLTVPA3P - THREE WAY VARIABLE HEIGHT CORNER POST FOR BELTLINE LIGHT PANEL

- Connects one Beltline Light panel and two Beltline panels of equal height in "T" configuration.
- Connector must reference taller panel.
- Post and connecting hardware add 3.25" to power beam run.
- Provides slotted support for worksurfaces and hang on components.
- Includes post, panel connectors and power beam connectors, post with trim all around, levelling glide, hardware and trim kit.
- Leg trim matches selected trim color.
- Connectors are available without slots, as a special at no extra charge. Contact customer support.

DESCRIPTION	PRODUCT CODE	LIST PRICE	DIMENSIONS/INCHES		
			H	W	D
Three Way Variable Height Corner Post for Beltline Light Panel	EVPBLTVPA354P	359	54	2 7/8	
	EVPBLTVPA366P	423	66	2 7/8	

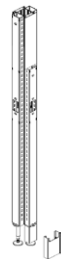

# PANEL CONNECTORS

4 - WAY

## EVPCP4 - FOUR-WAY POST

- Connects four panels of equal height in a "+" configuration.
- Post and connecting hardware adds 3.25" to the panel run.
- Provides slotted support for worksurfaces and hang-on storage components.
- Includes one post, four slotted connectors with leveling glides and connecting hardware.
- Connectors available without slots, as a special at no upcharge. Contact Customer Support.

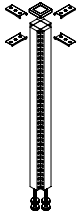
DESCRIPTION	PRODUCT CODE	LIST PRICE	DIMENSIONS/INCHES		
			H	W	D
 <p>Four-Way Post</p>	EVPCP430	275	30	2 7/8	
	EVPCP442	348	42	2 7/8	
	EVPCP448	386	48	2 7/8	
	EVPCP454	421	54	2 7/8	
	EVPCP466	492	66	2 7/8	

## EVPLTCPA4 - FOUR WAY CORNER POST FOR LIGHT PANEL

- Connects three Light panel of equal height in "+" configuration.
- Post and connecting hardware add 3.25" to power beam run.
- Provides slotted support for worksurfaces and hang on components.
- Includes post, panel connectors and power beam connectors, post with trim all around, levelling glide, hardware and trim kit.
- Leg trim matches selected trim color.
- Connectors available without slots, as a special at no extra charge. Contact customer support.

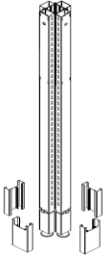
DESCRIPTION	PRODUCT CODE	LIST PRICE	DIMENSIONS/INCHES		
			H	W	D
 <p>Four Way Corner Post for Light Panel</p>	EVPLTCPA430	275	30	2 7/8	
	EVPLTCPA442	348	42	2 7/8	
	EVPLTCPA448	386	48	2 7/8	
	EVPLTCPA454	421	54	2 7/8	
	EVPLTCPA466	492	66	2 7/8	

## EVPLTCPA4P- FOUR WAY CORNER POST FOR LIGHT PANEL - PANEL

- Connects two Beltline Light panel and two Beltline Panels of equal height in "+" configuration.
- Post and connecting hardware add 3.25" to power beam run.
- Provides slotted support for worksurfaces and hang on components.
- Includes post, panel connectors and power beam connectors, post with trim all around, levelling glide, hardware and trim kit.
- Leg trim matches selected trim color.
- Connectors are available without slots, as a special at no extra charge. Contact customer support.

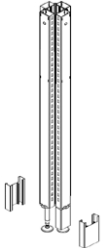
DESCRIPTION	PRODUCT CODE	LIST PRICE	DIMENSIONS/INCHES		
			H	W	D
 <p>Four Way Corner Post for Light Panel-Panel</p>	EVPLTCPA430P	275	30	2 7/8	
	EVPLTCPA442P	348	42	2 7/8	
	EVPLTCPA448P	386	48	2 7/8	
	EVPLTCPA454P	421	54	2 7/8	
	EVPLTCPA466P	492	66	2 7/8	

# PANEL CONNECTORS

4 - WAY

## EVPBCP4 - FOUR-WAY POST FOR BELTLINE POWERED PANELS

- Connects four Beltline Powered panels of equal height in a "+" configuration.
- Post and connecting hardware adds 3.25" to the panel run.
- Provides slotted support for worksurfaces and hang-on storage components.
- Includes one post, four slotted connectors with leveling glides and connecting hardware.
- Connectors available without slots, as a special at no upcharge. Contact Customer Support.

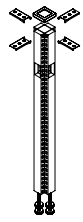
DESCRIPTION	PRODUCT CODE	LIST PRICE	DIMENSIONS/INCHES		
			H	W	D
 <p>Four-Way Post for Beltline Powered Panels</p>	EVPBCP442	348	42	2 7/8	
	EVPBCP454	421	54	2 7/8	
	EVPBCP466	492	66	2 7/8	

## EVBLTCA4 - FOUR WAY CORNER POST FOR BELTLINE LIGHT PANEL

- Connects four Light panel of equal height in "+" configuration.
- Post and connecting hardware add 3.25" to power beam run.
- Provides slotted support for worksurfaces and hang on components.
- Includes post, panel connectors and power beam connectors, post with trim all around, levelling glide, hardware and trim kit.
- Leg trim matches selected trim color.
- Connectors available without slots, as a special at no extra charge. Contact customer support.

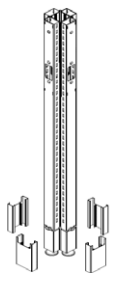
DESCRIPTION	PRODUCT CODE	LIST PRICE	DIMENSIONS/INCHES		
			H	W	D
 <p>Four Way Corner Post for Beltline Light Panel</p>	EVBLTCA442	348	42	2	
	EVBLTCA448	386	48	2	
	EVBLTCA454	421	54	2	
	EVBLTCA466	492	66	2	

## EVPLTVA4P- FOUR WAY VARIABLE HEIGHT CORNER POST FOR LIGHT PANEL - PANEL

- Connects two Light panels and two Panels of differing height in "+" configuration, Panel-Light Panel-Panel-Light Panel.
- Connector must reference taller panel.
- Post and connecting hardware add 3.25" to power beam run.
- Provides slotted support for worksurfaces and hang on components.
- Includes post, panel connectors and power beam connectors, post with trim all around, levelling glide, hardware and trim kit.
- Leg trim matches selected trim color.
- Connectors are available without slots, as a special at no extra charge. Contact customer support.

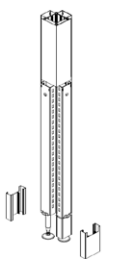
DESCRIPTION	PRODUCT CODE	LIST PRICE	DIMENSIONS/INCHES		
			H	W	D
 <p>Three Way Variable Height Corner Post for Panel-Light Panel-Panel-Light Panel</p>	EVPLTVA442P	348	42	2 7/8	
	EVPLTVA448P	386	48	2 7/8	
	EVPLTVA454P	421	54	2 7/8	
	EVPLTVA466P	492	66	2 7/8	

# PANEL CONNECTORS

4 - WAY

## EVPVPA4 - FOUR-WAY VARIABLE - HEIGHT POST - ALUMINUM TRIM

- Connects four panels of differing heights in a "+" configuration.
- Connector must reference taller panel.
- Post and connecting hardware adds 3.25" to the panel run.
- Provides slotted support for worksurfaces and hang-on storage components.
- Includes one post, four slotted connectors with leveling glides, connecting hardware and trim kit.
- Connectors available without slots, as a special at no upcharge. Contact Customer Support.
- Please see page 92 on how to specify.

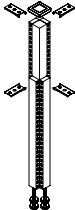
DESCRIPTION	PRODUCT CODE	LIST PRICE	DIMENSIONS/INCHES		
			H	W	D
 <p>Four-Way Variable - Height Corner Post - Aluminum Trim</p>	EVPVPA442	348	42	2 7/8	
	EVPVPA448	386	48	2 7/8	
	EVPVPA454	421	54	2 7/8	
	EVPVPA466	492	66	2 7/8	

## EVPLTVPA4 - FOUR WAY VARIABLE HEIGHT CORNER POST FOR LIGHT PANEL

- Connects four Light panel of differing height in "+" configuration.
- Connector must reference taller panel.
- Post and connecting hardware add 3.25" to power beam run.
- Provides slotted support for worksurfaces and hang on components.
- Includes post, panel connectors and power beam connectors, post with trim all around, levelling glide, hardware and trim kit.
- Leg trim matches selected trim color.
- Connectors available without slots, as a special at no extra charge. Contact customer support.

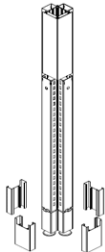
DESCRIPTION	PRODUCT CODE	LIST PRICE	DIMENSIONS/INCHES		
			H	W	D
 <p>Four Way Variable Height Corner Post for Light Panel</p>	EVPLTVPA442	348	42	2 7/8	
	EVPLTVPA448	386	48	2 7/8	
	EVPLTVPA454	421	54	2 7/8	
	EVPLTVPA466	492	66	2 7/8	

## EVPBLTCPA4P - FOUR WAY CORNER POST FOR BELTLINE LIGHT PANEL

- Connects two Beltline Light panel and two Beltline Panels of equal height in "+" configuration.
- Post and connecting hardware add 3.25" to power beam run.
- Provides slotted support for worksurfaces and hang on components.
- Leg trim matches selected trim color.
- Includes post, panel connectors and power beam connectors, post with trim all around, levelling glide, hardware and trim kit.
- Connectors are available without slots, as a special at no extra charge. Contact customer support.

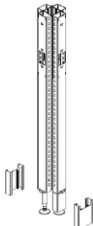
DESCRIPTION	PRODUCT CODE	LIST PRICE	DIMENSIONS/INCHES		
			H	W	D
 <p>Four Way Corner Post Beltline Light Panel</p>	EVPBLTCPA442P	275	42	2 7/8	
	EVPBLTCPA448P	348	48	2 7/8	
	EVPBLTCPA454P	386	54	2 7/8	
	EVPBLTCPA466P	492	66	2 7/8	

# PANEL CONNECTORS

4 - WAY

## EVPBVPA4 - FOUR-WAY VARIABLE - HEIGHT POST FOR BELTLINE POWERED PANELS - ALUMINUM TRIM

- Connects four Beltline Powered panels of differing heights in an "+" configuration.
- Connector must reference taller panel.
- Post and connecting hardware adds 3.25" to the panel run.
- Provides slotted support for worksurfaces and hang-on storage components.
- Includes one post, four slotted connectors with leveling glides, connecting hardware and trim kit.
- Connectors available without slots, as a special at no upcharge. Contact Customer Support.
- Please see page 92 on how to specify.

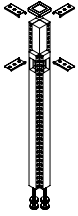
DESCRIPTION	PRODUCT CODE	LIST PRICE	DIMENSIONS/INCHES		
			H	W	D
 Four-Way Variable - Height Post for Beltline Powered Panels - Aluminum Trim	EVPBVPA454	421	54	2 7/8	
	EVPBVPA466	492	66	2 7/8	

## EVPBLTVPA4 - FOUR WAY VARIABLE HEIGHT CORNER POST FOR BELTLINE LIGHT PANEL

- Connects four Light panel of differing height in "+" configuration.
- Connector must reference taller panel.
- Post and connecting hardware add 3.25" to power beam run.
- Provides slotted support for worksurfaces and hang on components.
- Includes post, panel connectors and power beam connectors, post with trim all around, levelling glide, hardware and trim kit.
- Leg trim matches selected trim color.
- Connectors available without slots, as a special at no extra charge. Contact customer support.

DESCRIPTION	PRODUCT CODE	LIST PRICE	DIMENSIONS/INCHES		
			H	W	D
 Four Way Variable Height Corner Post for Beltline Light Panel Aluminum Trim	EVPBLTVPA454	421	54	2 7/8	
	EVPBLTVPA466	492	66	2 7/8	

## EVPBLTVPA4P- FOUR WAY VARIABLE HEIGHT CORNER POST FOR BELTLINE LIGHT PANEL

- Connects two Beltline Light panel and two Beltline Panels of differing height in "+" configuration.
- Connector must reference taller panel.
- Post and connecting hardware add 3.25" to power beam run.
- Provides slotted support for worksurfaces and hang on components.
- Includes post, panel connectors and power beam connectors, post with trim all around, levelling glide, hardware and trim kit.
- Leg trim matches selected trim color.
- Connectors are available without slots, as a special at no extra charge. Contact customer support.

DESCRIPTION	PRODUCT CODE	LIST PRICE	DIMENSIONS/INCHES		
			H	W	D
 Four Way Variable Height Corner Post for Beltline Light Panel	EVPBLTVPA454P	421	54	2 7/8	
	EVPBLTVPA466P	492	66	2 7/8	

# PANEL CONNECTORS

1 - WAY

## EVPCPA1 - ONE-WAY POST - ALUMINUM TRIM

- Connects at the end of a panel run in place of an EVPERA – End-of-Run Post Kit.
- Should not be used to attach a panel to a fixed wall.
- Post and connecting hardware adds 3.25" to the panel run.
- Provides slotted support for worksurfaces and hang-on storage components.
- Includes one post and one slotted connector with a leveling glide, connecting hardware and trim kit.
- Connectors available without slots, as a special at no upcharge. Contact Customer Support.

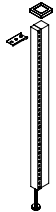
DESCRIPTION	PRODUCT CODE	LIST PRICE	DIMENSIONS/INCHES		
			H	W	D
 One-Way Post - Aluminum Trim	EVPCPA130	128	30	2 7/8	
	EVPCPA142	146	42	2 7/8	
	EVPCPA148	171	48	2 7/8	
	EVPCPA154	195	54	2 7/8	
	EVPCPA166	239	66	2 7/8	

## EVPLTCPA1 - ONE WAY CORNER POST FOR LIGHT PANEL

- Connects at end of Light panel run in place of EVPERA- End of run post kit..
- Should not be used to attach panel to fixed wall.
- Post and connecting hardware add 3.25" to power beam run.
- Provides slotted support to worksurfaces and hang on components.
- Includes post, panel connectors and power beam connectors, post with trim all around, levelling glide, hardware and trim kit.
- Connectors are available without slots, as a special at no extra charge. Contact customer support

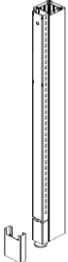
DESCRIPTION	PRODUCT CODE	LIST PRICE	DIMENSIONS/INCHES		
			H	W	D
 One Way Corner Post for Light Panel	EVPLTCPA130	128	30	2 7/8	
	EVPLTCPA142	146	30	2 7/8	
	EVPLTCPA148	171	30	2 7/8	
	EVPLTCPA154	195	30	2 7/8	
	EVPLTCPA166	239	30	2 7/8	

# PANEL CONNECTORS

1 - WAY

## EVPBCPA1 - ONE-WAY POST FOR BELTLINE POWERED PANELS - ALUMINUM TRIM

- Connects at the end of a Beltline Powered panel run in place of an EVPERA – End-of-Run Post Kit.
- Should not be used to attach a panel to a fixed wall.
- Post and connecting hardware adds 3.25" to the panel run.
- Provides slotted support for worksurfaces and hang-on storage components.
- Includes one post and one slotted connector with a leveling glide, connecting hardware and trim kit.
- Connectors available without slots, as a special at no upcharge. Contact Customer Support.

DESCRIPTION	PRODUCT CODE	LIST PRICE	DIMENSIONS/INCHES		
			H	W	D
 One-Way Post for Beltline Powered Panels - Aluminum Trim	EVPBCPA142	146	42	2 7/8	
	EVPBCPA154	195	54	2 7/8	
	EVPBCPA166	239	66	2 7/8	

## EVPBLTCPA1 - ONE WAY CORNER POST FOR BELTLINE LIGHT PANEL

- Connects at end of Light panel run in place of EVPERA- End of run post kit.
- Should not be used to attach pane to fixed wall.
- Post and connecting hardware add 3.25" to power beam run.
- Provides slotted support for worksurfaces and hang on components.
- Includes post, panel connectors and power beam connectors, post with trim all around, levelling glide, hardware and trim kit.
- Connectors are available without slots, as a special at no extra charge. Contact customer support.

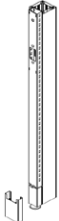
DESCRIPTION	PRODUCT CODE	LIST PRICE	DIMENSIONS/INCHES		
			H	W	D
 One Way Corner Post for Beltline Light Panel	EVPBLTCPA142	146	42	2	
	EVPBLTCPA148	171	48	2	
	EVPBLTCPA154	195	54	2	
	EVPBLTCPA166	239	66	2	

# PANEL CONNECTORS

## INLINE 2 - WAY

### EVPIPA2 - INLINE TWO-WAY POST - ALUMINUM TRIM

- Connects two panels of equal height in a straight line in place of EVPIC – In-Line Connector.
- Post and connecting hardware adds 3.25" to the panel run.
- Provides slotted support for worksurfaces and hang-on storage components.
- Includes one post, two slotted connectors with leveling glides, connecting hardware and trim kit.
- Connectors available without slots, as a special at no upcharge. Contact Customer Support.

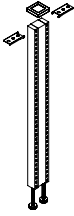
	DESCRIPTION	PRODUCT CODE	LIST PRICE	DIMENSIONS/INCHES		
				H	W	D
	Inline Two-Way Post - Aluminum Trim	EVPIPA230	175	30	2 7/8	
		EVPIPA242	220	42	2 7/8	
		EVPIPA248	242	48	2 7/8	
		EVPIPA254	264	54	2 7/8	
		EVPIPA266	313	66	2 7/8	

### EVLTPIPA2 - INLINE TWO WAY CORNER POST LIGHT PANEL

- Connects two Light panel of equal height in straight run.
- Post and connecting hardware add 3.25" to power beam run.
- Provides slotted support for worksurfaces and hang on components.
- Includes post, panel connectors and power beam connectors, post with trim all around, levelling glide, hardware and trim kit.
- Leg trim matches selected trim color.
- Connectors are available without slots, as a special at no extra charge. Contact customer support.

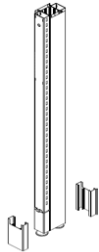
	DESCRIPTION	PRODUCT CODE	LIST PRICE	DIMENSIONS/INCHES		
				H	W	D
	Inline Two way Corner Post Light Panel	EVPLTPIPA230	175	30	2 7/8	
		EVPLTPIPA242	220	42	2 7/8	
		EVPLTPIPA248	242	48	2 7/8	
		EVPLTPIPA254	264	54	2 7/8	
		EVPLTPIPA266	313	66	2 7/8	

# PANEL CONNECTORS

# INLINE 2 - WAY

## EVPBIPA2 - INLINE TWO-WAY POST FOR BELTLINE POWERED PANELS - ALUMINUM TRIM

- Connects two Beltline Powered panels of equal height in between a post in a straight line in place of EVPIC – In-Line Connector.
- Post and connecting hardware adds 3.25" to the panel run.
- Provides slotted support for worksurfaces and hang-on storage components.
- Includes one post, two slotted connectors with leveling glides, connecting hardware and trim kit.
- Connectors available without slots, as a special at no upcharge. Contact Customer Support.

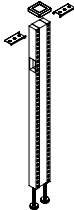
DESCRIPTION	PRODUCT CODE	LIST PRICE	DIMENSIONS/INCHES		
			H	W	D
 Inline Two-Way Post for Beltline Powered Panels - Aluminum Trim	EVPBIPA242	220	42	2 7/8	
	EVPBIPA254	264	54	2 7/8	
	EVPBIPA266	313	66	2 7/8	

## EVPBLTPIPA2 - INLINE TWO WAY CORNER POST BELTLINE LIGHT PANEL

- Connects two Light panel of equal height in straight run.
- Post and connecting hardware add 3.25" to power beam run.
- Provides slotted support for worksurfaces and hang on components.
- Leg trim matches selected trim color.
- Includes post, panel connectors and power beam connectors, post with trim all around, levelling glide, hardware and trim kit.
- Connectors are available without slots, as a special at no extra charge. Contact customer support.

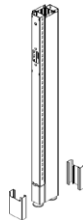
DESCRIPTION	PRODUCT CODE	LIST PRICE	DIMENSIONS/INCHES		
			H	W	D
 Inline Two Way Corner Post Beltline Light Panel	EVPBLTPIPA242	220	42	2 7/8	
	EVPBLTPIPA248	242	48	2 7/8	
	EVPBLTPIPA254	264	54	2 7/8	
	EVPBLTPIPA266	313	66	2 7/8	

# PANEL CONNECTORS

60 DEGREE

## EVP6PA2 - TWO-WAY 60 DEGREE POST - ALUMINUM TRIM

- Connects two panels of equal height in a 120 degree configuration.
- Provides slotted support for worksurfaces and hang-on storage components.
- Includes one 60 degree post, two slotted connectors with leveling glides, connecting hardware and trim kit.
- Connectors available without slots as a special at no upcharge. Contact Customer Service.

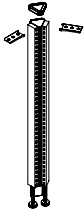
	DESCRIPTION	PRODUCT CODE	LIST PRICE	DIMENSIONS/INCHES		
				H	W	D
	Two-Way 60 Degree Post - Aluminum	EVP6PA230	180	30	3.65	
		EVP6PA242	222	42	3.65	
		EVP6PA248	239	48	3.65	
		EVP6PA254	278	54	3.65	
		EVP6PA266	326	66	3.65	

## EVPB6PA2 - TWO-WAY 60 DEGREE POST FOR BELTLINE POWERED PANELS - ALUMINUM TRIM

- Connects two Beltline Powered panels of equal height in a 120 degree configuration.
- Provides slotted support for worksurfaces and hang-on storage components.
- Includes one 60 degree post, two slotted connectors with leveling glides, connecting hardware and trim kit.
- Connectors available without slots, as a special at no upcharge. Contact Customer Support.

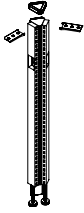
	DESCRIPTION	PRODUCT CODE	LIST PRICE	DIMENSIONS/INCHES		
				H	W	D
	Two-Way 60 Degree Post for Beltline Powered Panels - Aluminum Trim	EVPB6PA242	256	42	3.65	
		EVPB6PA254	278	54	3.65	
		EVPB6PA266	326	66	3.65	

## EVP6VPA2 - TWO-WAY 60 DEGREE VARIABLE - HEIGHT POST - ALUMINUM TRIM

- Connects two panels of differing height in a 120 degree configuration.
- Connector must reference taller panel.
- Provides slotted support for worksurfaces and hang-on storage components.
- Includes one 60 degree post, two slotted connectors with leveling glides, connecting hardware and trim kit.
- Connectors available without slots, as a special at no upcharge. Contact Customer Support.
- Please see page 92 on how to specify.

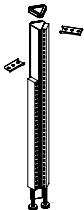
	DESCRIPTION	PRODUCT CODE	LIST PRICE	DIMENSIONS/INCHES		
				H	W	D
	Two-Way 60 Degree Variable - Height Post - Aluminum Trim	EVP6VPA242	222	42	3.65	
		EVP6VPA248	250	48	3.65	
		EVP6VPA254	278	54	3.65	
		EVP6VPA266	328	66	3.65	

# PANEL CONNECTORS

60 DEGREE

## EVPB6VPA2 - TWO-WAY 60 DEGREE VARIABLE - HEIGHT POST FOR BELTLINE POWERED PANELS - ALUMINUM TRIM

- Connects two Beltline Powered panels of differing height in a 120 degree configuration.
- Connector must reference taller panel.
- Provides slotted support for worksurfaces and hang-on storage components.
- Includes one 60 degree post, two slotted connectors with leveling glides, connecting hardware and trim kit.
- Connectors available without slots, as a special at no upcharge. Contact Customer Support.
- Please see page 92 on how to specify.

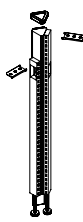
DESCRIPTION	PRODUCT CODE	LIST PRICE	DIMENSIONS/INCHES		
			H	W	D
 Two-Way 60 Degree Variable - Height Post for Beltline Powered Panels - Aluminum Trim	EVPB6VPA242	222	42	3.65	
	EVPB6VPA254	278	54	3.65	
	EVPB6VPA266	328	66	3.65	

## EVP6P3 - THREE-WAY 60 DEGREE POST

- Connects three panels of equal height in a 120 degree configuration.
- Provides slotted support for worksurfaces and hang-on storage components.
- Includes one 60 degree post, three slotted connectors with leveling glides and connecting hardware.
- Connectors available without slots, as a special at no upcharge. Contact Customer Support.

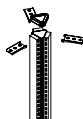
DESCRIPTION	PRODUCT CODE	LIST PRICE	DIMENSIONS/INCHES		
			H	W	D
 Three-Way 60 Degree Post	EVP6P330	221	30	3.65	
	EVP6P342	294	42	3.65	
	EVP6P348	326	48	3.65	
	EVP6P354	359	54	3.65	
	EVP6P366	423	66	3.65	

## EVPB6P3 - THREE-WAY 60 DEGREE POST FOR BELTLINE POWERED PANELS

- Connects three Beltline Powered panels of equal height in a 120 degree configuration.
- Provides slotted support for worksurfaces and hang-on storage components.
- Includes one 60 degree post, three slotted connectors with leveling glides and connecting hardware.
- Connectors available without slots, as a special at no upcharge. Contact Customer Support.

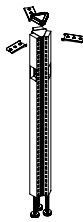
DESCRIPTION	PRODUCT CODE	LIST PRICE	DIMENSIONS/INCHES		
			H	W	D
 Three-Way 60 Degree Post for Beltline Powered Panels	EVPB6P342	281	42	3.65	
	EVPB6P354	342	54	3.65	
	EVPB6P366	403	66	3.65	

# PANEL CONNECTORS

60 DEGREE/45 DEGREE

## EVP6VPA3 - THREE-WAY 60 DEGREE VARIABLE - HEIGHT POST - ALUMINUM TRIM

- Connects three panels of differing height in a 120 degree configuration.
- Connector must reference taller panel.
- Provides slotted support for worksurfaces and hang-on storage components.
- Includes one 60 degree post, three slotted connectors with leveling glides, connecting hardware and trim kit.
- Connectors available without slots, as a special at no upcharge. Contact Customer Support.
- Please see page 92 on how to specify.

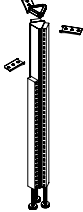
DESCRIPTION	PRODUCT CODE	LIST PRICE	DIMENSIONS/INCHES		
			H	W	D
 Three-Way 60 Degree Variable - Height Post - Aluminum Trim	EVP6VPA342	294	42	3.65	
	EVP6VPA348	326	48	3.65	
	EVP6VPA354	359	54	3.65	
	EVP6VPA366	423	66	3.65	

## EVPB6VPA3 - THREE-WAY 60 DEGREE VARIABLE - HEIGHT POST FOR BELTLINE POWERED PANELS - ALUMINUM TRIM

- Connects three Beltline Powered panels of differing height in a 120 degree configuration.
- Connector must reference taller panel.
- Provides slotted support for worksurfaces and hang-on storage components.
- Includes one 60 degree post, three slotted connectors with leveling glides, connecting hardware and trim kit.
- Connectors available without slots, as a special at no upcharge. Contact Customer Support.
- Please see page 92 on how to specify.

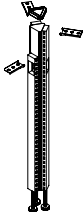
DESCRIPTION	PRODUCT CODE	LIST PRICE	DIMENSIONS/INCHES		
			H	W	D
 Three-Way for 60 Degree Variable - Height Post for Beltline Powered Panels - Aluminum Trim	EVPB6VPA342	323	42	3.65	
	EVPB6VPA354	359	54	3.65	
	EVPB6VPA366	423	66	3.65	

## EVP4P2 - TWO-WAY 45 DEGREE POST - ALUMINUM TRIM

- Connects two panels of equal height in a 135 degree configuration.
- Provides slotted support for worksurfaces and hang-on storage components.
- Includes one 45 degree post, two slotted connectors with leveling glides, connecting hardware and trim kit.
- Connectors available without slots, as a special at no upcharge. Contact Customer Support.

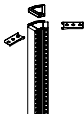
DESCRIPTION	PRODUCT CODE	LIST PRICE	DIMENSIONS/INCHES		
			H	W	D
 Two-Way 45 Degree Post Aluminum Trim	EVP4P230	180	30	3.65	
	EVP4P242	222	42	3.65	
	EVP4P248	239	48	3.65	
	EVP4P254	278	54	3.65	
	EVP4P266	326	66	3.65	

# PANEL CONNECTORS

# 45 DEGREE / UPMOUNT END OF RUN

## EVP4VPA2 - TWO-WAY 45 DEGREE VARIABLE - HEIGHT POST - ALUMINUM TRIM

- Connects two panels of differing height in a 135 degree configuration.
- Connector must reference taller panel.
- Provides slotted support for worksurfaces and hang-on storage components.
- Includes one 45 degree post, two slotted connectors with leveling glides, connecting hardware and trim kit.
- Connectors available without slots, as a special at no upcharge. Contact Customer Support.
- Please see page 92 on how to specify.

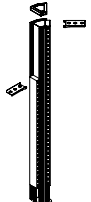
DESCRIPTION	PRODUCT CODE	LIST PRICE	DIMENSIONS/INCHES		
			H	W	D
 Two-Way 45 Degree Variable - Height Post Aluminum Trim	EVP4VPA242	294	42	3.65	
	EVP4VPA248	326	48	3.65	
	EVP4VPA254	359	54	3.65	
	EVP4VPA266	423	66	3.65	

## EVPUERA - UPMOUNT END-OF-RUN POST KIT - ALUMINUM TRIM

- Used at the end of Panel run to support Worksurfaces and Upmount Overhead Storage.
- Can attach to a Panel run to fixed wall.
- Adds 1" to the width of Light Panel run.
- 10% upcharge for Tungsten trim/paint.
- Aluminum trim must be specified when using premium color paints. Premium color paints are not available on PVC trim.

DESCRIPTION	PRODUCT CODE	LIST PRICE	DIMENSIONS/INCHES		
			H	W	D
 Upmount End-of-Run Post Kit - Aluminum Trim.	EVPUERA66	163	66	2 7/8	

## EVPLUERA - UPMOUNT END-OF-RUN POST KIT FOR LIGHT PANELS (WALL MOUNTABLE) - ALUMINUM

- Used at the end of Panel run to support Worksurfaces and Upmount Overhead Storage.
- Can attach to a Panel run to fixed wall.
- Adds 1" to the width of Light Panel run.
- Includes slotted Connector with leveling glide, connecting hardware, decorative sleeve and trim kit.

DESCRIPTION	PRODUCT CODE	LIST PRICE	DIMENSIONS/INCHES		
			H	W	D
 Upmount End-of-Run Post Kit - for Light Panels - Wall Mountable - Aluminum	EVPLUERA66	163	66	2 7/8	

# PANEL CONNECTORS

# UPMOUNT END OF RUN

## EVPUETA - UPMOUNT END-OF-RUN TRIM - ALUMINUM

- Replaces existing 66”h End-of-Run Trim Only
- Comes with one Upmount Extension Trim EVPUET12 and one Upmount End-of-Run Trim.
- Must be used in conjunction with slotted connectors.

	DESCRIPTION	PRODUCT CODE	LIST PRICE	DIMENSIONS/INCHES		
				H	W	D
	Upmount End-of-Run Trim - Aluminum	EVPUETA66	116		2 7/8	

## EVPLUETA - UPMOUNT END-OF-RUN TRIM FOR LIGHT PANELS - ALUMINUM

- Includes one Upmount Extension Trim EVPUETA12 and one Upmount End-of-Run Trim.
- Must be used in conjunction with Slotted Connector.

	DESCRIPTION	PRODUCT CODE	LIST PRICE	DIMENSIONS/INCHES		
				H	W	D
	Upmount End-of-Run Trim for Light Panels - Aluminum	EVPLUETA66	116	63	2 7/8	

## EVAFMB01 - FLOOR MOUNT PLATE

- Attaches to floor.
- Secures panel to floor.
- Attachement screws are not included.
- Care should be taken to use correct fastners for type of floor.
- Available in chrome finish only.

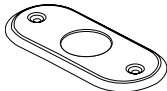
	DESCRIPTION	PRODUCT CODE	LIST PRICE	DIMENSIONS/INCHES		
				H	W	D
	Floor Mount Plate	EVAFMB01	98	0.25	5	2.5

# PANEL CONNECTORS

# EXTENSION

## EVPIECS - INLINE EXTENSION CONNECTOR - SLOTTED

- Connects two extension modules in a straight run.
- Includes one slotted inline extension connector and connecting hardware.
- Provides slotted support for worksurfaces and hang-on storage, up to 66"H.

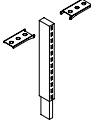
DESCRIPTION	PRODUCT CODE	LIST PRICE	DIMENSIONS/INCHES		
			H	W	D
 Inline Extension Connector - Slotted	EVPIECS06	53	6	2 7/8	
	EVPIECS12	53	12	2 7/8	
	EVPIECS18	63	18	2 7/8	
	EVPIECS24	63	24	2 7/8	

## EVPEERSA - END-OF-RUN EXTENSION CONNECTOR - SLOTTED - ALUMINUM TRIM

- Connects at the end of a run of extension modules, and can be used to attach a panel to a fixed wall.
- Adds 1" to the width of panel run.
- Includes one slotted inline extension connector, connecting hardware and trim kit.
- Provides slotted support for worksurfaces and hang-on storage, up to 66"H.

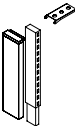
DESCRIPTION	PRODUCT CODE	LIST PRICE	DIMENSIONS/INCHES		
			H	W	D
 End-of-Run Extension Connector - Slotted - Aluminum Trim	EVPEERSA06	57	6	2 7/8	
	EVPEERSA12	57	12	2 7/8	
	EVPEERSA18	69	18	2 7/8	
	EVPEERSA24	69	24	2 7/8	

## EVPCEPSA2 - TWO-WAY POST EXTENSION - SLOTTED - ALUMINUM TRIM

- Connects two extension modules in a 90 degree configuration.
- Post and connecting hardware adds 3.25" to the panel run.
- Includes one post, two slotted inline extension connectors, connecting hardware and trim kit.
- Provides slotted support for worksurfaces and hang-on storage, up to 66"H.

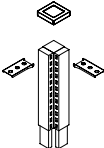
DESCRIPTION	PRODUCT CODE	LIST PRICE	DIMENSIONS/INCHES		
			H	W	D
 Two-Way Post Extension - Slotted Aluminum Trim	EVPCEPSA206	99	6	2 7/8	
	EVPCEPSA212	99	12	2 7/8	
	EVPCEPSA218	156	18	2 7/8	
	EVPCEPSA224	156	24	2 7/8	

## EVPCEPSA3 - THREE-WAY POST EXTENSION - SLOTTED - ALUMINUM TRIM

- Connects three extension modules in a "T" configuration.
- Post and connecting hardware adds 3.25" to the panel run.
- Includes one post, three slotted inline extension connectors, connecting hardware and trim kit.
- Provides slotted support for worksurfaces and hang-on storage, up to 66"H.

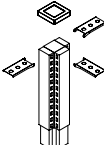
DESCRIPTION	PRODUCT CODE	LIST PRICE	DIMENSIONS/INCHES		
			H	W	D
 Three-Way Post Extension - Slotted Aluminum Trim	EVPCEPSA306	118	6	2 7/8	
	EVPCEPSA312	118	12	2 7/8	
	EVPCEPSA318	182	18	2 7/8	
	EVPCEPSA324	182	24	2 7/8	

# PANEL CONNECTORS

# EXTENSION

## EVPCEPS4 - FOUR-WAY POST EXTENSION - SLOTTED

- Connects four extension modules in a “+” configuration.
- Post and connecting hardware adds 3.25” to the panel run.
- Includes one post, four slotted inline extension connectors, connecting hardware and trim kit.
- Provides slotted support for worksurfaces and hang-on storage, up to 66”H.

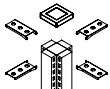
DESCRIPTION	PRODUCT CODE	LIST PRICE	DIMENSIONS/INCHES		
			H	W	D
 Four-Way Post Extension - Slotted	EVPCEPS406	136	6	2 7/8	
	EVPCEPS412	136	12	2 7/8	
	EVPCEPS418	201	18	2 7/8	
	EVPCEPS424	201	24	2 7/8	

## EVPCEPSA1 - ONE-WAY POST EXTENSION - SLOTTED - ALUMINUM TRIM

- Connects at the end of a run of extension modules in place of an EVPEERSA – End-of-Run Extension Connector.
- Should not be used to attach a panel to a fixed wall.
- Post and connecting hardware adds 3.25” to the panel run.
- Includes one post, one slotted inline extension connector, connecting hardware and trim kit.
- Provides slotted support for worksurfaces and hang-on storage, up to 66”H.

DESCRIPTION	PRODUCT CODE	LIST PRICE	DIMENSIONS/INCHES		
			H	W	D
 One-Way Post Extension - Slotted Aluminum Trim	EVPCEPSA106	97	6	2 7/8	
	EVPCEPSA112	97	12	2 7/8	
	EVPCEPSA118	122	18	2 7/8	
	EVPCEPSA124	122	24	2 7/8	

## EVPCEPSA2 – INLINE TWO-WAY POST EXTENSION - SLOTTED - ALUMINUM TRIM

- Connects two extension modules in a straight line in place of EVPIECS – In-Line Extension Connector.
- Post and connecting hardware adds 3.25” to the panel run.
- Includes one post, two slotted inline extension connectors, connecting hardware and trim kit.
- Provides slotted support for worksurfaces and hang-on storage, up to 66”H.

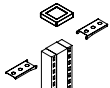
DESCRIPTION	PRODUCT CODE	LIST PRICE	DIMENSIONS/INCHES		
			H	W	D
 Inline Two-Way Post Extension - Slotted Aluminum Trim	EVPCEPSA206	104	6	2 7/8	
	EVPCEPSA212	104	12	2 7/8	
	EVPCEPSA218	170	18	2 7/8	
	EVPCEPSA224	170	24	2 7/8	

# PANEL CONNECTORS

# 60 DEGREE EXTENSION

## EVP6CEPSA2 - TWO-WAY 60 DEGREE POST EXTENSION - SLOTTED - ALUMINUM TRIM

- Connects two extension modules in a 120 degree configuration.
- Includes one post, two slotted inline extension connectors, connecting hardware and trim kit.
- Provides slotted support for worksurfaces and hang-on storage, up to 66"H.

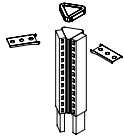

DESCRIPTION	PRODUCT CODE	LIST PRICE	DIMENSIONS/INCHES		
			H	W	D
Two-Way 60 Degree Post Extension - Slotted - Aluminum Trim	EVP6CEPSA206	99	6	3.65	
	EVP6CEPSA212	99	12	3.65	
	EVP6CEPSA218	152	18	3.65	
	EVP6CEPSA224	152	24	3.65	

## EVP6CEPS3 - THREE-WAY 60 DEGREE POST EXTENSION - SLOTTED

- Connects three extension modules in a 120 degree configuration.
- Includes one post, three slotted inline extension connectors and connecting hardware.
- Provides slotted support for worksurfaces and hang-on storage, up to 66"H.

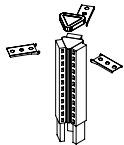

DESCRIPTION	PRODUCT CODE	LIST PRICE	DIMENSIONS/INCHES		
			H	W	D
Three-Way 60 Degree Post Extension - Slotted	EVP6CEPS306	117	6	3.65	
	EVP6CEPS312	117	12	3.65	
	EVP6CEPS318	182	18	3.65	
	EVP6CEPS324	182	24	3.65	

## EVP6CEPSA1 - ONE-WAY 60 DEGREE POST EXTENSION - SLOTTED - ALUMINUM TRIM

- Connects at the end of a run of extension modules in a 120 degree configuration.
- Should not be used to attach a panel to a fixed wall.
- Includes one post, one slotted inline extension connector, connecting hardware and trim kit.
- Provides slotted support for worksurfaces and hang-on storage, up to 66"H.

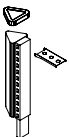

DESCRIPTION	PRODUCT CODE	LIST PRICE	DIMENSIONS/INCHES		
			H	W	D
One-Way 60 Degree Post Extension - Slotted - Aluminum Trim	EVP6CEPSA106	97	6	3.65	
	EVP6CEPSA112	97	12	3.65	
	EVP6CEPSA118	120	18	3.65	
	EVP6CEPSA124	120	24	3.65	

# PANEL CONNECTORS

# 45 DEGREE EXTENSION / CEILING BRACKET

## EVP4CEPS2 - TWO-WAY 45 DEGREE POST EXTENSION - SLOTTED - ALUMINUM TRIM

- Connects two extension modules in a 135 degree configuration.
- Provides slotted support for worksurfaces and hang-on storage, up to 66"H.
- Includes one post, two slotted inline extension connectors, connecting hardware and trim kit.

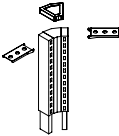
	DESCRIPTION	PRODUCT CODE	LIST PRICE	DIMENSIONS/INCHES		
				H	W	D
	Two-Way 45 Degree Post Extension -	EVP4CEPS206	99	6	3.65	
	Slotted - Aluminum Trim	EVP4CEPS212	99	12	3.65	
		EVP4CEPS218	152	18	3.65	
		EVP4CEPS224	152	24	3.65	

## EVP4CEPSA1 - ONE-WAY 45 DEGREE POST EXTENSION - SLOTTED - ALUMINUM TRIM

- Connects at the end of a run of extension modules in a 135 degree configuration.
- Provides slotted support for worksurfaces and hang-on storage, up to 66"H.
- Should not be used to attach a panel to a fixed wall.
- Includes one post, one slotted inline extension connector, connecting hardware and trim kit.

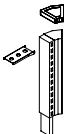
	DESCRIPTION	PRODUCT CODE	LIST PRICE	DIMENSIONS/INCHES		
				H	W	D
	One-Way 45 Degree Post Extension -	EVP4CEPSA106	97	6	3.65	
	Slotted - Aluminum Trim	EVP4CEPSA112	97	12	3.65	
		EVP4CEPSA118	120	18	3.65	
		EVP4CEPSA124	120	24	3.65	

## EVHCBP01 - CEILING BRACKET FOR POST

- Used to secure corner post to ceiling deck (not ceiling grid).
- Note: Care should be taken to attach ceiling brackets to secure ceiling using correct fasteners. Failure to do so may result in collapse of unit and subsequent possible injury.
- 4.8" x 4.8" top plate with 1.5 x 1.5 square tube 12" H , square tube fits inside aluminum Corner Post.
- Square tube can slide in post , bracket pushed to ceiling to be secured.

	DESCRIPTION	PRODUCT CODE	LIST PRICE	DIMENSIONS/INCHES		
				H	W	D
	Ceiling Bracket for Post	EVHCBP01	79	12	4.8	4.8

## EVHCBIC01 - CEILING BRACKET FOR INLINE CONNECTOR

- Used to secure corner post to ceiling deck (not ceiling grid).
- Note: Care should be taken to attach ceiling brackets to secure ceiling using correct fasteners. Failure to do so may result in collapse of unit and subsequent possible injury.
- 4.8" x 4.8" top plate with 7.5"H insert in middle of plate, insert fits inside Inline Connector.
- 7.5" H insert can slide in connector , bracket pushed to ceiling to secure.

	DESCRIPTION	PRODUCT CODE	LIST PRICE	DIMENSIONS/INCHES		
				H	W	D
	Ceiling Bracket for Inline Connector	EVHCBP01	79	7.5	4.8	4.8

# PANEL CONNECTORS

# CEILING BRACKET / TRIMS

## EVHCBER01 - CEILING BRACKET FOR END OF RUN CONNECTOR

- Used to secure corner post to ceiling deck (not ceiling grid).
- 4.8" x 4.8" top plate with 7.5"H insert offset from center of plate, insert fits inside End-of-Run or Inline Connector.
- 7.5" H insert can slide in connector, bracket pushed to ceiling to secure.
- Note: Care should be taken to attach ceiling brackets to secure ceiling using correct fasteners. Failure to do so may result in collapse of unit and subsequent possible injury

DESCRIPTION	PRODUCT CODE	LIST PRICE	DIMENSIONS/INCHES		
			H	W	D
Ceiling Bracket for Inline Connector	EVHCBER01	79	7.5	4.8	4.8

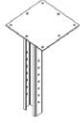

## EVPUETA - UPMOUNT EXTENSION TRIM - ALUMINUM

- Finishes the exposed connector above a shorter panel.
- Slotted connector not included.

DESCRIPTION	PRODUCT CODE	LIST PRICE	DIMENSIONS/INCHES		
			H	W	D
Upmount Extension Trim - Aluminum	EVPUETA12	53	12	2 7/8	

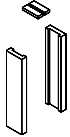

## EVPERTA - END-OF-RUN TRIM - ALUMINUM

- Finishes the exposed Connector at the end of a run.
- Slotted Connector not included.
- Please note that actual cut sizes are nominally smaller than quoted

DESCRIPTION	PRODUCT CODE	LIST PRICE	DIMENSIONS/INCHES		
			H	W	D
End-of-Run Trim - Aluminum	EVPERTA30	58	30	2 7/8	
	EVPERTA42	79	42	2 7/8	
	EVPERTA48	83	48	2 7/8	
	EVPERTA54	88	54	2 7/8	
	EVPERTA66	98	66	2 7/8	
	EVPERTA72	103	72	2 7/8	
	EVPERTA78	109	78	2 7/8	
	EVPERTA84	112	84	2 7/8	
	EVPERTA90	112	90	2 7/8	



## EVPLERTA - END-OF-RUN TRIM FOR LIGHT PANELS - ALUMINUM

- Finishes the exposed Connector at the end of a run of the Light Panels.
- Slotted Connector not included.
- Please note that actual cut sizes are nominally smaller than quoted

DESCRIPTION	PRODUCT CODE	LIST PRICE	DIMENSIONS/INCHES		
			H	W	D
End-of-Run Trim for Light Panels - Aluminum	EVPLERTA30	59	26 1/4	2 7/8	
	EVPLERTA42	69	38 1/4	2 7/8	
	EVPLERTA48	79	44 1/4	2 7/8	
	EVPLERTA54	91	50 1/4	2 7/8	
	EVPLERTA66	98	62 1/4	2 7/8	
	EVPLERTA72	101	68 1/4	2 7/8	
	EVPLERTA78	104	74 1/4	2 7/8	
	EVPLERTA84	110	80 1/4	2 7/8	
	EVPLERTA90	116	86 1/4	2 7/8	

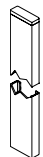

# PANEL CONNECTORS

# TRIMS

## EVPTVA - PANEL TRIM - VARIABLE HEIGHT - ALUMINUM

- Attaches to the exposed end of the taller panel when 2 panels of different height meet in straight run.
- Slotted Connector not included.
- Please note that actual cut sizes are nominally smaller than quoted

DESCRIPTION	PRODUCT CODE	LIST PRICE	DIMENSIONS/INCHES		
			H	W	D
 Panel Trim - Variable Height - Aluminum	EVPTVA06	23	6	2 7/8	
	EVPTVA12	32	12	2 7/8	
	EVPTVA18	39	18	2 7/8	
	EVPTVA24	52	24	2 7/8	
	EVPTVA30	59	30	2 7/8	
	EVPTVA36	69	36	2 7/8	

## EVPTVA - PANEL TRIM - VARIABLE HEIGHT - ALUMINUM

- Attaches to bottom of exposed end of panel to provide extension for End-of-Run post trim kit when using panel extensions.
- Does not include slotted connector nor connecting hardware.
- Please note that actual cut sizes are nominally smaller than quoted

DESCRIPTION	PRODUCT CODE	LIST PRICE	DIMENSIONS/INCHES		
			H	W	D
 Panel Extension Trim - Aluminum	EVPTVA12	29	12	2 7/8	
	EVPTVA18	39	18	2 7/8	
	EVPTVA24	50	24	2 7/8	

## EVPTVA - PANEL TRIM - VARIABLE HEIGHT - ALUMINUM

- To be used with 30"H posts as a replacement trim.
- For "U" trim configuration use three flat trim according to height specifications.
- For "L" trim configuration use two flat trim according to height configurations.
- Please note that actual cut sizes are nominally smaller than quoted

DESCRIPTION	PRODUCT CODE	LIST PRICE	DIMENSIONS/INCHES		
			H	W	D
 Flat Trim - Aluminum	EVPTVA30	19	29 1/8	2 7/8	
	EVPTVA36	20	34 1/8	2 7/8	
	EVPTVA42	23	41 1/8	2 7/8	
	EVPTVA48	29	47 1/8	2 7/8	
	EVPTVA54	29	53 1/8	2 7/8	
	EVPTVA66	32	65 1/8	2 7/8	
	EVPTVA72	45	72 1/8	2 7/8	
	EVPTVA78	33	77 1/8	2 7/8	
	EVPTVA84	36	83 1/8	2 7/8	
	EVPTVA90	34	89 1/8	2 7/8	
	EVPTVA96	38	95 1/8	2 7/8	

# PANEL CONNECTORS

# TRIMS

## EVPVTFEA - FLAT EXTENSION TRIM - ALUMINUM

- Finishes exposed faces of One-Way, Two-Way, Three-Way and Inline Panels.
- For reconfiguration and replacement use only.
- For "U" trim configuration use three flat trim according to height specification.
- For "L" trim configuration use two flat trim according to height specification.
- Aluminum Trim must be specified when using premium color paints.
- Please note that actual cut sizes are nominally smaller than quoted

DESCRIPTION	PRODUCT CODE	LIST PRICE	DIMENSIONS/INCHES		
			H	W	D
 Flat Extension Trim - Aluminum	EVPVTFEA06	16	12 3/8	2 7/8	
	EVPVTFEA12	18	12 3/8	2 7/8	
	EVPVTFEA18	20	18 3/8	2 7/8	
	EVPVTFEA24	20	24 3/8	2 7/8	
	EVPVTFEA30	23	30 3/8	2 7/8	
	EVPVTFEA36	29	36 3/8	2 7/8	
	EVPVTFEA42	30	42 3/8	2 7/8	
	EVPVTFEA48	32	48 3/8	2 7/8	
	EVPVTFEA54	33	54 3/8	2 7/8	
	EVPVTFEA66	36	66 3/8	2 7/8	
	EVPVTFEA72	38	72 3/8	2 7/8	
	EVPVTFEA78	38	78 3/8	2 7/8	
	EVPVTFEA84	48	84 3/8	2 7/8	
	EVPVTFEA90	50	90 3/8	2 7/8	
	EVPVTFEA96	52	96 3/8	2 7/8	

## EVPLVTFA - FLAT TRIM FOR LIGHT PANELS - ALUMINUM

- Finishes exposed faces of One-Way, Two-Way, Three-Way and Inline Panels.
- For reconfiguration and replacement use only.
- For "U" trim configuration use three flat trim according to height specification.
- For "L" trim configuration use two flat trim according to height specification.
- Aluminum Trim must be specified when using premium color paints.
- Please note that actual cut sizes are nominally smaller than quoted

DESCRIPTION	PRODUCT CODE	LIST PRICE	DIMENSIONS/INCHES		
			H	W	D
 Flat Trim for Light Panels - Aluminum	EVPLVTFA30	19	26 1/4	2 7/8	
	EVPLVTFA42	23	38 1/4	2 7/8	
	EVPLVTFA48	29	44 1/4	2 7/8	
	EVPLVTFA54	29	50 1/4	2 7/8	
	EVPLVTFA66	32	62 1/4	2 7/8	
	EVPLVTFA72	32	68 1/4	2 7/8	
	EVPLVTFA78	33	74 1/4	2 7/8	
	EVPLVTFA84	33	80 1/4	2 7/8	
	EVPLVTFA90	34	86 1/4	2 7/8	

## EVPTTA - PANEL TOP TRIM - ALUMINUM - FIELD INSTALLED

- This trim can span an Inline Connector, but not a Post Connector.
- Please note that actual cut sizes are nominally smaller than quoted

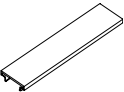
DESCRIPTION	PRODUCT CODE	LIST PRICE	DIMENSIONS/INCHES		
			H	W	D
 Panel Top Trim - Aluminum	EVPTTA18F	18	18	2 7/8	
	EVPTTA24F	23	24	2 7/8	
	EVPTTA30F	30	30	2 7/8	
	EVPTTA36F	33	36	2 7/8	
	EVPTTA42F	39	42	2 7/8	
	EVPTTA48F	50	48	2 7/8	
	EVPTTA54F	57	54	2 7/8	
	EVPTTA60F	63	60	2 7/8	
	EVPTTA66F	69	66	2 7/8	
	EVPTTA72F	75	72	2 7/8	
	EVPTTA78F	83	78	2 7/8	
	EVPTTA84F	91	84	2 7/8	
	EVPTTA90F	97	90	2 7/8	

# PANEL CONNECTORS

# TRIMS

EVPTTA96F 104 96 2 7/8

## EVPTNTA - PANEL TOP SINGLE NOTCHED TRIM - ALUMINUM - FIELD INSTALLED

- Used when connecting a lower Panel to a higher Panel
- This trim can span an Inline Connector, but not a Post Connector.
- Please note that actual cut sizes are nominally smaller than quoted

DESCRIPTION	PRODUCT CODE	LIST PRICE	DIMENSIONS/INCHES		
			H	W	D
 Panel Top Singled Notched Trim - Aluminum	EVPTNTA18F	20	18	2 7/8	
	EVPTNTA24F	27	24	2 7/8	
	EVPTNTA30F	30	30	2 7/8	
	EVPTNTA36F	33	36	2 7/8	
	EVPTNTA42F	38	42	2 7/8	
	EVPTNTA48F	52	48	2 7/8	
	EVPTNTA54F	58	54	2 7/8	
	EVPTNTA60F	66	60	2 7/8	
	EVPTNTA66F	70	66	2 7/8	
	EVPTNTA72F	75	72	2 7/8	
	EVPTNTA78F	81	78	2 7/8	
	EVPTNTA84F	88	84	2 7/8	
	EVPTNTA90F	93	90	2 7/8	
	EVPTNTA96F	97	96	2 7/8	

## EVPTDNTA - PANEL TOP DOUBLE NOTCHED TRIM - ALUMINUM - FIELD INSTALLED

- Used when connecting a lower Panel to a higher Panel
- This trim can span an Inline Connector, but not a Post Connector.
- Please note that actual cut sizes are nominally smaller than quoted

DESCRIPTION	PRODUCT CODE	LIST PRICE	DIMENSIONS/INCHES		
			H	W	D
 Panel Top Double Notched Trim - Aluminum	EVPTDNTA18F	23	18	2 7/8	
	EVPTDNTA24F	30	24	2 7/8	
	EVPTDNTA30F	33	30	2 7/8	
	EVPTDNTA36F	36	36	2 7/8	
	EVPTDNTA42F	39	42	2 7/8	
	EVPTDNTA48F	53	48	2 7/8	
	EVPTDNTA54F	59	54	2 7/8	
	EVPTDNTA60F	69	60	2 7/8	
	EVPTDNTA66F	74	66	2 7/8	
	EVPTDNTA72F	80	72	2 7/8	
	EVPTDNTA78F	87	78	2 7/8	
	EVPTDNTA84F	60	87	2 7/8	
	EVPTDNTA90F	95	90	2 7/8	
	EVPTDNTA96F	99	96	2 7/8	

## EVSC12 - SLOT COVER

- Covers the slots of a slotted connector between modules as well as corner post situation.
- Available in all standard colors (Black, Charcoal Silver, Taupe, Tungsten, White and Nevada)
- Sold per foot. The desired quantity of the slot covers is the required length in feet.
- An easy way to calculate the required length is to sum the length of all inline connectors used in a project (including the posts) and multiply by 2.
- Should be field cut to required length.

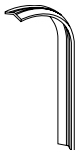
DESCRIPTION	PRODUCT CODE	LIST PRICE	DIMENSIONS/INCHES		
			H	W	D
 Slot Cover	EVSC12	10			

# electrical

**STEP-BY-STEP SPECIFICATION – 8-WIRE ELECTRICAL SYSTEM**

**Step 1 Determine the location of the source power entering the Panel Run.**

1. At the base of the Panel.
  - (a) Use EVE8FR1 Reversible Floor Power Entry (default to EVE8FR1).
  - (b) Select the Panel to which the Floor Power Entry will be attached. This Panel requires an EVEPD Power Distribution Housing.
  - (c) Select the side of the Panel and the receptacle outlet to which the Floor Power Entry is to be attached.
2. From the ceiling.
  - (a) Use EVE8EC1 Ceiling Power Entry.
  - (b) Select the post through which to feed the Ceiling Power Entry.
  - (c) One Panel adjacent to the selected post requires an EVEPD Power Distribution Housing.
  - (d) Attach Ceiling Power entry to the nearest end of the Power Distribution Housing.

**Step 2 Determine which Panels are to be powered.**

1. Use EVE8PD Power Distribution Housing that corresponds with the width of the Panel.

**Step 3 Connect power to the powered Panels.**

1. Use EVE8CP16 Jumper Cable between two adjacent powered Panels, separated by an Inline Connector.
2. Use EVE8CP18 Jumper Cable between two adjacent powered Panels separated by a post.
3. Use EVE8CP Pass-Through Cables to connect powered Panels that are separated by one or more non-powered Panels (maximum distance between the powered Panels is 16 feet).
  - (a) The length of the Pass-Through Cable is calculated by adding together the widths of the non-powered Panels (that separate the two powered Panels) and applying an additional 16" to the total. (EVE8PD Power Distribution Housing is positioned 8" in from the ends of the powered Panel.)
  - (b) An additional 3" must be added to the Pass-Through Cable for each post that the cable passes through.
4. From the price list, select the EVE8CP Pass-Through Cable that matches the calculated length. If the length is between listed sizes, use the next size up.

**Step 4 Determine the location and circuitry of the receptacles.**

1. Each powered Panel has four (4) potential locations for EVE8RD Duplex Receptacles – 2 per side. (Exception: 24" wide Panel has only two potential locations – 1 per side, 18" wide Panel has no locations for receptacles.)
2. At each receptacle location there is a choice of four circuit options. Select a circuit option for each location. Circuits one & two are utility circuits; circuits A & B are dedicated circuits.

**BELTLINE TIPS:**

**DO** - use a 17" long Mesh Beltline Jumper when making 90 degree turns in the Beltline raceways only.

**DO NOT** - use a 20" long Metal Flex Jumper when attempting to make 90 degree turns in the Beltline Raceways. The end connector is too long to make the turn.

**DO** - use a 20" long Metal Flex Jumper when traveling through a Beltline Post, in a straight line only.

**DO NOT** - use a 17" long Mesh Beltline Jumper Traveling through a Beltline Post, in a straight line only. The Jumper is too short to make the connection.

**EVOLVE'S MODIFIED 8-WIRE ELECTRICAL SYSTEM**

Evolve has modified its 8-Wire Electrical System to stay abreast of changing industry standards.

Evolve's electrical system allows for the integration of the commonly required "2+2" configuration (2 utility circuits, 2 dedicated circuits) found in the source power of most of today's North American buildings.

**This system is rated for connection to:**

1. A grounded 120/240V, single phase, 20 A, 60Hz
2. A 120/208V, 3 phase, 20 A, 60Hz branch circuit

**EQUIPMENT AMPERAGE**

Calculator .....	0.25
Electric Eraser .....	0.50
Pencil Sharpener .....	1.00
Radio .....	0.05
Paper Shredder.....	4.40 - 13.00
Electric Typewriter .....	1.20
Personal Computer.....	2.00 - 4.00
Video Display Terminal .....	0.08
Draft / Letter Quality Printer.....	1.20 - 3.00

**Data/Comm**

Evolve's duplex receptacle openings will now conform to the ANSI/TIA/EIA Furniture Opening Standard of 1.38 +/- .035 x 2.71 +/- .04. There will no longer be the need to use adapter plates to reduce the size of Evolve's raceway opening, or to use Evolve dedicated data plates for data/comm terminations.

**Transition**

A transition cable is available to connect the previous electrical system prior to April 1, 2005 to the current system when adding Panels to an existing installation. Also, new raceway covers with the smaller openings can be provided and applied to existing Panels when retrofitted with new electrics.

Fan.....	1.00
Heater.....	8.50 - 12.50
Coffee Pot.....	15.00
Task Light .....	1.00
Slide Projector.....	2.00 - 6.00
Laser Printer .....	5.00 - 8.00
Processor / Disk Unit .....	1.00 - 10.00
Desk Top Plotter.....	1.50

Some equipment, such as large copiers, printers, plotters, heaters and coffee makers may occupy most of the circuit capacity. It is recommended that such devices be supplied with the power directly from the wall or building receptacle.

WIRING SCHEMATIC

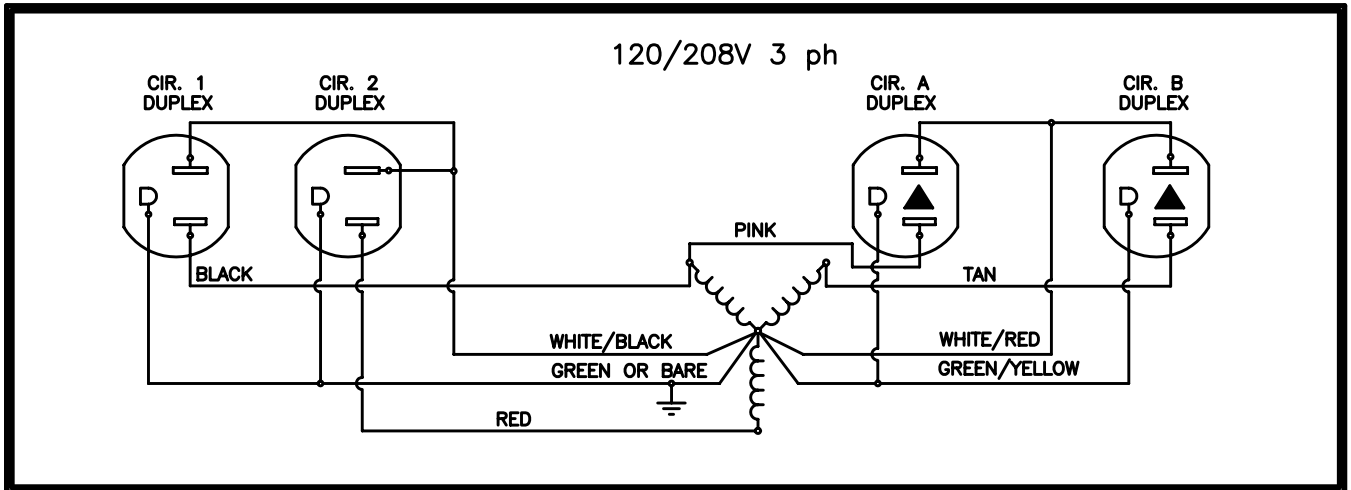
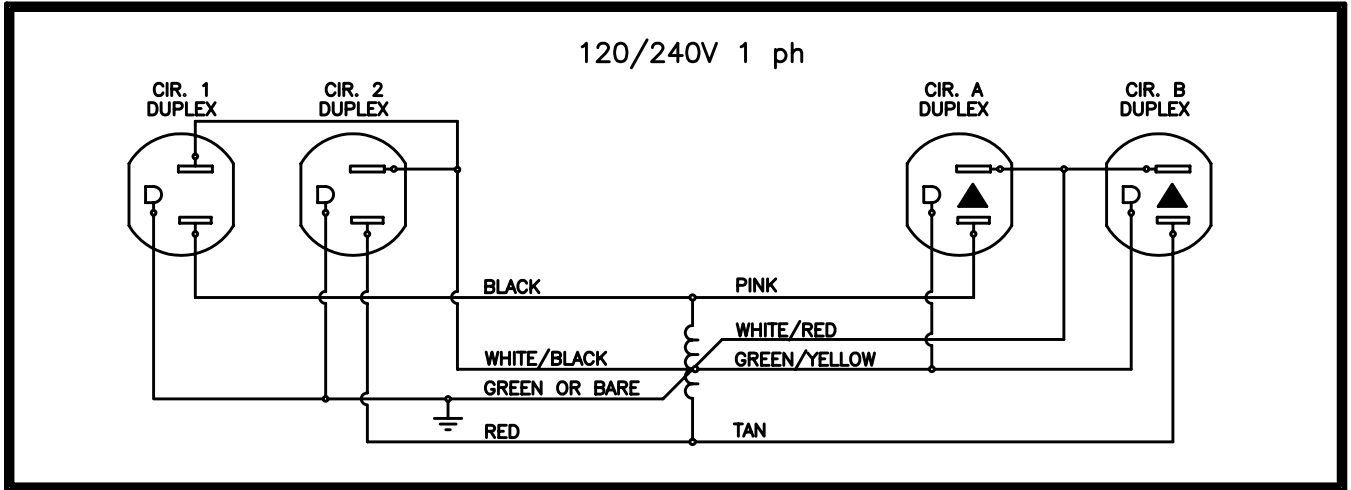

**DEFINING "2 + 2" WIRING CONFIGURATIONS**

**2 + 2 Configuration (8 wire, 4 circuit)**

Two Utility Circuits [Evolve's #1 & #2 circuits] share one neutral wire and one ground wire.  
 (2 hot [circuit] wires + 1 neutral wire\*\*\* + 1 green ground wire\* = 4 wires)

Two Dedicated Circuits [Evolve's "A" & "B" circuits] share one neutral wire and one ground wire.  
 (2 hot [circuit] wires + 1 neutral wire \*\*\* + 1 green/yellow ground wire\*\* = 4 wires)

**NOTE:**

It is the ground wire that makes the difference between "Utility" and "Dedicated" circuits. Refer to Wiring Schematics found in the Price List.

\* A Green ground wire is a "system" ground. This means it could be grounded to any piece of metal, including the Panel.

\*\* A Green/Yellow ground wire is isolated, within the wiring conduit, all the way back to the box at the source (building ground).

\*\*\* All Neutral Wires are 10 gauge rather than 12 gauge meaning they are larger than normal, allowing greater protection against "noise" or interference on the circuit.

# ELECTRICAL

# CONFIGURATION

This page provides an exploded view of a sample configuration highlighting each **Electrical** component required when specifying this configuration.

## Components

- A.** EVE8PD42 Power Distribution Housing  
Note: 8 wire, 4 circuits (3rd/4th circuits dedicated) labeled A or B.
- B.** EVE8CP16 Jumper Cable  
Note: EVE8CP16 connects two powered panels positioned side by side, separated by an Inline Connector  
EVE8CP18 connects two powered panels separated by a post.
- C.** EVE8RD Duplex Receptacle
- D.** EVE8CP Pass-Through Cable  
Note: Pass-Through Extension Cable (EVE8CPF154) available – extends power capability beyond 208".

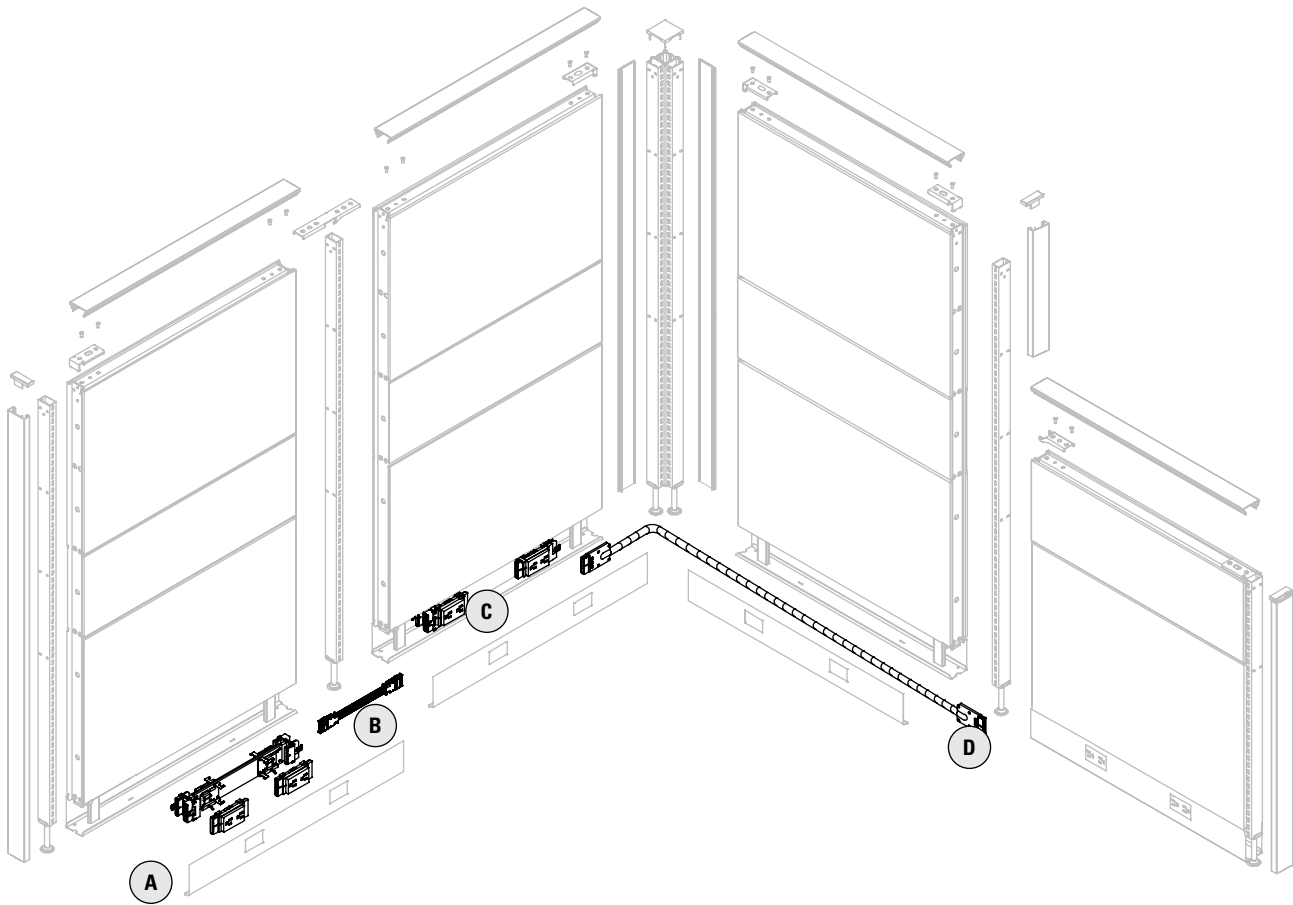

**ELECTRICAL**

**CONFIGURATION**

This page provides an exploded view of a sample configuration highlighting each **Beltline Power Panel** component required when specifying this configuration.

- |  |  |
|--|--|
| <p><b>A.</b> EVE8PD36 Power Distribution Housing<br/>                 Note: 8 wire, 4 circuits (3rd/4th circuits dedicated) labeled A or B.</p> <p><b>B.</b> EVE8CP17 Jumper Cable<br/>                 Note: EVE8CP17 connects two powered panels positioned side by side, separated by an Inline Connector</p> <p><b>C.</b> EVE8RD Duplex Receptacle</p> <p><b>D.</b> EVE8CP Pass-Through Cable<br/>                 Note: Pass-Through Extension Cable (EVE8CPF154) available – extends power capability beyond 208".</p> | <p><b>E.</b> EVE8CP18 Jumper Cable<br/>                 Note: EVE8CP18 connects two powered panels separated by a post, in a straight line.</p> <p><b>F.</b> EVE8CP17 Jumper Cable<br/>                 Note: EVE8CP17 connects two powered panels separated by a post, for turns through post.</p> <p><b>G.</b> EVE8CPCP Base to Belt Pass Through Kit<br/>                 Note: For use in Chimney Panels only.</p> |
|--|--|

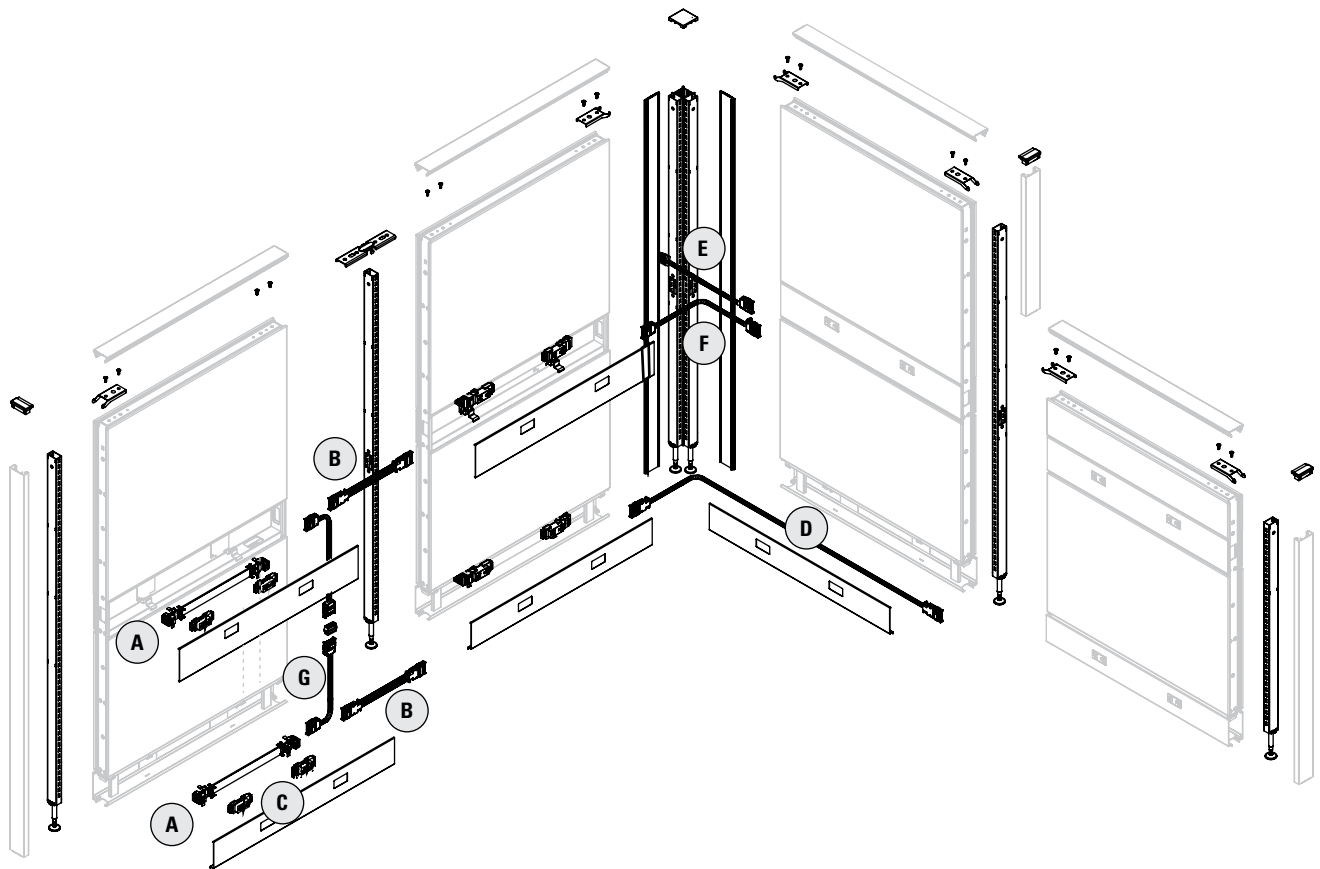

# ELECTRICAL

## EVE8PD - POWER DISTRIBUTION HOUSING

- Power housing is specified per panel size (e.g. EVE8PD36 is for use in a 36" panel).
- 8 wire, 4 circuits (2+2 configuration).
- Provides two duplex receptacles per panel side on all panel widths except the 24" wide panel.
- 24" wide panel allows for only one (1) duplex receptacle per panel side.
- Each power distribution housing supports 15-20 amps.

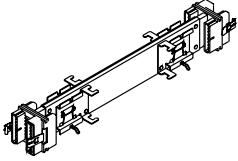
DESCRIPTION	PRODUCT CODE	LIST PRICE	DIMENSIONS/INCHES		
			H	L	D
 Power Distribution Housing	EVE8PD24	175		6 1/4	
	EVE8PD30	236		11 1/2	
	EVE8PD36	248		17 1/2	
	EVE8PD42	254		23 1/2	
	EVE8PD48	275		29 1/2	
	EVE8PD54	277		39 1/4	
	EVE8PD60	278		41 1/2	

## EVE8CP16 - JUMPER CABLE

- The EVE8CP16 electrically connects two powered panels positioned side by side, separated by an Inline connector.

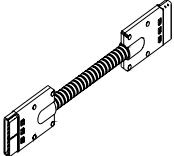
DESCRIPTION	PRODUCT CODE	LIST PRICE	DIMENSIONS/INCHES		
			H	L	D
 Jumper Cable	EVE8CP16	146		16	

## EVE8CP - FLEXIBLE MESH JUMPER CABLE

- Used to connect two power distribution housings at the beltline level at 90 degrees.
- 18.5" flexible mesh jumper replaces EVE8CP20 jumper for corner post applications.

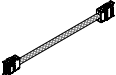
DESCRIPTION	PRODUCT CODE	LIST PRICE	DIMENSIONS/INCHES		
			H	L	D
 Flexible Mesh Jumper Cable	EVE8CP17	135		17 1/2	
	EVE8CP18	167		18 1/2	

## EVE8PCP - CHIMNEY PANEL JUMPER CABLE KIT

- Contains two (2) 17" flexible harnesses and one (1) "I" connector.
- Used to connect electric from the base to the beltline raceway in Beltline Powered Chimney panel.
- Must use in conjunction with base power distribution harness and beltline power distribution harness (sold separately).

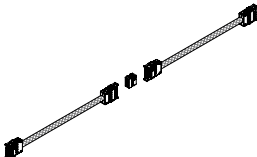
DESCRIPTION	PRODUCT CODE	LIST PRICE	DIMENSIONS/INCHES		
			H	L	D
 Chimney Panel Jumper Cable Kit	EVE8PCP	365			

EVE8RD1

# ELECTRICAL

## EVE8CPXX-H - PASS-THROUGH CABLE

- Flexible metal conduit with wire mesh distributes electrical power through non-powered beams.
- To calculate the length of a Pass-Through Cable, add the widths of the non-powered panels separating the powered panels (panels with distribution housing attached). To this, add 16" (distance from the edge of the panel to the distribution housing x 2).
- Add additional 3" when passing through a post. See the Tips at the beginning of the section for more details.
- Hybrid pass-through cables with wire mesh allows connection at 90 degree post at one end for Evolve panels including Beltline and Power Beam

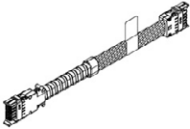
	DESCRIPTION	PRODUCT CODE	LIST PRICE	DIMENSIONS/INCHES		
				H	L	D
	Pass-Through Cable	EVE8CP40-H	226		40	
		EVE8CP46-H	234		46	
		EVE8CP52-H	240		52	
		EVE8CP58-H	255		58	
		EVE8CP64-H	266		64	
		EVE8CP70-H	274		70	
		EVE8CP76-H	277		76	
		EVE8CP82-H	288		82	
		EVE8CP88-H	298		88	
		EVE8CP94-H	305		88	
		EVE8CP100-H	315		100	
		EVE8CP106-H	330		106	
		EVE8CP118-H	346		118	
		EVE8CP130-H	380		130	
		EVE8CP142-H	397		142	
		EVE8CP154-H	416		154	
		EVE8CP172-H	447		172	
		EVE8CP190-H	468		190	
	EVE8CP208-H	486		208		

## EVE8CI-1 - "I" CONNECTOR

- Female - Female connector used to connect two Pass-Through Cables

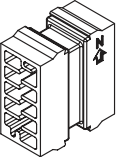
	DESCRIPTION	PRODUCT CODE	LIST PRICE	DIMENSIONS/INCHES		
				H	W	D
	"I" Connector	EVE8CI-1	101			

# ELECTRICAL

## EVE8RD - DUPLEX RECEPTACLE - 15 AMPS

- Duplex receptacles are rated for 15 Amps.
- EVE8RD1 = Circuit #1 (utility circuit)
- EVE8RD2 = Circuit #2 (utility circuit)
- EVE8RDA = Circuit A (dedicated)
- EVE8RDB = Circuit B (dedicated)

### NOTE:

- EVE8RD1 and EVE8RD2 (#1 and #2 share common ground)
- EVE8RDA and EVE8RDB (A and B share common ground)
- Up to 6 receptacles per circuit (24 per infeed), not to exceed total of 15 Amps per circuit.
- Standard in black. Available in White or Nevada with upcharge.

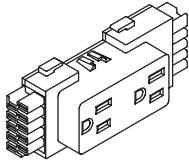
DESCRIPTION	PRODUCT CODE	LIST PRICE	DIMENSIONS/INCHES		
			H	W	D
 Duplex Receptacle	EVE8RD1	66	2	4 5/8	1 1/4
	EVE8RD2	66	2	4 5/8	1 1/4
	EVE8RDA	66	2	4 5/8	1 1/4
	EVE8RDB	66	2	4 5/8	1 1/4
	EVE8RD1SND	44	2	4 5/8	1 1/4
	EVE8RD2SND	44	2	4 5/8	1 1/4
	EVE8RDASND	44	2	4 5/8	1 1/4
	EVE8RDBSND	44	2	4 5/8	1 1/4
	EVE8RD1WHT	44	2	4 5/8	1 1/4
	EVE8RD2WHT	44	2	4 5/8	1 1/4
	EVE8DAWHT	44	2	4 5/8	1 1/4
	EVE8RDBWHT	44	2	4 5/8	1 1/4

## EVE8RD - DUPLEX RECEPTACLE - 20 AMPS

- Duplex receptacles are rated for 20 Amps.
- EVE8RD1-20 = Circuit #1 (utility circuit)
- EVE8RD2-20 = Circuit #2 (utility circuit)
- EVE8RDA-20 = Circuit #A (dedicated)
- EVE8RDB-20 = Circuit #B (dedicated)

### NOTE:

- EVE8RD1-20 and EVE8RD2-20 (#1 and #2 share common ground)
- EVE8RDA-20 and EVE8RDB-20 (A and B share common ground)
- Up to 6 receptacles per circuit (24 per infeed) not to exceed total 20 Amps per circuit
- Standard in black. Available in White or Nevada with upcharge.

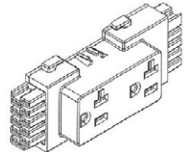
DESCRIPTION	PRODUCT CODE	LIST PRICE	DIMENSIONS/INCHES		
			H	W	D
 Duplex Receptacle 20 amps	EVE8RD1-20	66	2	4 5/8	1 1/4
	EVE8RD2-20	66	2	4 5/8	1 1/4
	EVE8RDA-20	66	2	4 5/8	1 1/4
	EVE8RDB-20	66	2	4 5/8	1 1/4
	EVE8RD1-20SND	66	2	4 5/8	1 1/4
	EVE8RD2-20SND	66	2	4 5/8	1 1/4
	EVE8RDA-20SND	66	2	4 5/8	1 1/4
	EVE8RDB-20SND	66	2	4 5/8	1 1/4
	EVE8RD1-20WHT	66	2	4 5/8	1 1/4
	EVE8RD2-20WHT	66	2	4 5/8	1 1/4
	EVE8RDA-20WHT	66	2	4 5/8	1 1/4
	EVE8RDB-20WHT	66	2	4 5/8	1 1/4

# ELECTRICAL

## EVE8RDxca - CALIFORNIA CONTROLLED DUPLEX RECEPTACLE

- California Title 24 meets federal and LEED certification guidelines
- Allows circuit to be controlled or switched off when utility is not in use.
- Duplex receptacles are rated for 15 Amps.
- EVE8RD1CA = Circuit #1 (utility circuit)
- EVE8RD2CA = Circuit #2 (utility circuit)
- EVE8RDACA = Circuit A (dedicated)
- EVE8RDBCA = Circuit B (dedicated)

### NOTE:

- EVE8RD1CA and EVE8RD2CA (#1 and #2 share common ground)
- EVE8RDACA and EVE8RDBCA (A and B share common ground)
- Up to 6 receptacles per circuit (24 per infeed), not to exceed total of 15 Amps per circuit.
- Available in BLK finish only.

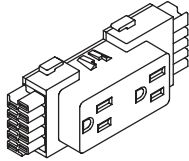

DESCRIPTION	PRODUCT CODE	LIST PRICE	DIMENSIONS/INCHES		
			H	W	D
Duplex Receptacle	EVE8RD1CA	42	2	4 5/8	1 1/4
	EVE8RD2CA	42	2	4 5/8	1 1/4
	EVE8RDACA	42	2	4 5/8	1 1/4
	EVE8RDBCA	42	2	4 5/8	1 1/4

## EVE8RD - DUPLEX RECEPTACLE TO CONVERT STANDARD 2 + 2 SYSTEM TO 3 + 1

- Duplex receptacle are rated for 15 Amps
- EVE8RDA-4 = Duplex receptacle A without triangle to be utility circuit
- EVE8RDB-4 = Duplex receptacle B without triangle to be utility circuit
- Up to 6 receptacles per circuit (24 per infeed) not to exude total 15 Amps per circuit
- Standard in black. Available in White or Nevada with upcharge.

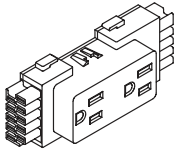

DESCRIPTION	PRODUCT CODE	LIST PRICE	DIMENSIONS/INCHES		
			H	L	D
Duplex Receptacle	EVE8RDA-4	39	2	4 5/8	1 1/4
	EVE8RDB-4	39	2	4 5/8	1 1/4
	EVE8RDA-4SND	42	2	4 5/8	1 1/4
	EVE8RDB-4WHT	42	2	4 5/8	1 1/4
	EVE8RDA-4SND	42	2	4 5/8	1 1/4
	EVE8RDA-4WHT	42	2	4 5/8	1 1/4

## EVEUSB01 - USB MODULE

- Includes two USB ports.
- Available in White and Black.

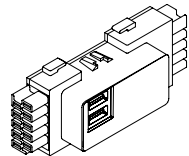

DESCRIPTION	PRODUCT CODE	LIST PRICE	DIMENSIONS/INCHES		
			H	L	D
USB Module - White	EVEUSB01WHT	242	2	4 5/8	1 1/4
USB Module - Black	EVEUSB01BLK	242	2	4 5/8	1 1/4

# ELECTRICAL

## EVE8FR1 - REVERSIBLE FLOOR POWER ENTRY

- Takes the place of a duplex receptacle by snapping into the base power way or Beltline power way.
- Includes 72" long flexible vinyl conduit.
- Must be hard wired to source power by a licensed electrician.
- Diameter is 0.85"

## EVE8FR2 - REVERSIBLE FLOOR POWER ENTRY

- Takes the place of a duplex receptacle by snapping into the base power way or Beltline power way.
- Includes 144" long flexible vinyl conduit.
- Must be hard wired to source power by a licensed electrician.
- Diameter is 0.85"

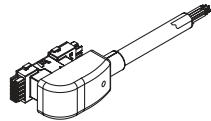

DESCRIPTION	PRODUCT CODE	LIST PRICE	DIMENSIONS/INCHES		
			H	L	D
Reversible Floor Power Entry	EVE8FR1	393		72	
	EVE8FR2	509		144	

## EVE8F - FLOOR POWER ENTRY

- Snaps in end of power distribution housing.
- Includes flexible vinyl conduit.

- Must be hard wired to source power by a licensed electrician.
- Diameter is 0.85"

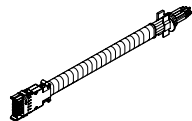

DESCRIPTION	PRODUCT CODE	LIST PRICE	DIMENSIONS/INCHES		
			H	L	D
Floor Power Entry	EVE8F1P	381		72	
	EVE8F2P	493		144	

## VE8EC - CEILING POWER ENTRY

- Snaps into the end of a Power Distribution Housing.
- Flexible metal conduit extends into the ceiling through a corner post and post extension.
- Must be hard wired to source power by a licensed electrician.
- 4" junction box included.

- Post extension ordered separately
- Can feed directly into beltline power when Beltline Post Connectors are specified.
- Cannot feed through Inline or End-of-run Connectors.

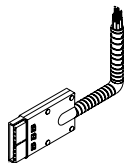

DESCRIPTION	PRODUCT CODE	LIST PRICE	DIMENSIONS/INCHES		
			H	L	D
Ceiling Power Entry	EVE8EC1	304		132	
	EVE8EC2	532		144	
	EVE8EC3	600		180	

## EVEENY-2 - HARDWARE POWER ENTRY BOX - NEW YORK

- A licensed electrician must provide hard wire connection within the junction box.
- Not for use in panels less than 36"W.

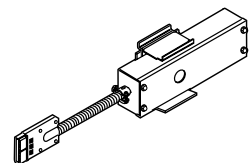

DESCRIPTION	PRODUCT CODE	LIST PRICE	DIMENSIONS/INCHES		
			H	W	D
Hardware Power Entry Box - New York	EVEENY2	503	3	28	2 1/5

# ELECTRICAL

## EVEJBC-1 - HARDWARE JUNCTION BOX - CHICAGO

- Can be retrofitted in any size of panel at the receptacle location.
- Gives access from one side only at each location.
- Customer to supply conduit, wiring, receptacle, and face plate.
- 2 per panel, except 24" panels only one is needed.
- A licensed electrician must provide hardware connection with the junction box.

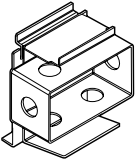
DESCRIPTION	PRODUCT CODE	LIST PRICE	DIMENSIONS/INCHES		
			H	W	D
 <p>Hardware Junction Box - Chicago</p>	EVEJBC-1	116			

## EVDPE - POST EXTENSION DATA/COMM LAY-IN

- Attaches to the top of a post to bring power and/or data cables from the ceiling to the panel power way
- Three-sided power pole with snap-on fourth side.
- Post extension can be opened on one side for lay-in or power and/or data cables.
- Made of aluminum and can be field cut.
- Accommodates up to 25CAT 5 Cables with electric. Accommodates up to 45 CAT 5 Cables without electric.
- Actual size interior dimension of post, 1.80" x 1.80"

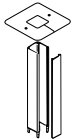
DESCRIPTION	PRODUCT CODE	LIST PRICE	DIMENSIONS/INCHES		
			H	W	D
 <p>Post Extension Data/Comm Lay-in</p>	EVDPE64	195	64	2	
	EVDPE82	236	82	2	

## EVDPE6E - 60° POST EXTENSION DATA/COMM LAY-IN

- Attaches to the top of a 60° corner post to bring power and/or data cables from the ceiling to the panel power way.
- Two-sided power pole with snap-on third side.
- Post extension can be opened on one side for lay-in or power and/or data cables.
- Made of aluminum and can be field cut.
- Accommodates up to 6 CAT 5 Cables with electric. Accommodates up to 20 CAT 5 Cables without electric.

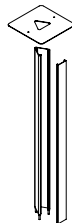
DESCRIPTION	PRODUCT CODE	LIST PRICE	DIMENSIONS/INCHES		
			H	W	D
 <p>60° Post Extension Data/Comm Lay-in</p>	EVDPE64	195	64	2	
	EVDPE82	236	82	2	

# ELECTRICAL

## EVDP4E - 45° POST EXTENSION DATA/COMM LAY-IN

- Attaches to the top of a 45° corner post to bring power and/or data cables from the ceiling to the panel power way.
- Two-sided power pole with snap-on third side.
- Post extension can be opened on one side for lay-in or power and/or data cables.
- Made of aluminum and can be field cut.
- Accommodates up to 6 CAT 5 Cables with electric. Accommodates up to 20 CAT 5 Cables without electric.

DESCRIPTION	PRODUCT CODE	LIST PRICE	DIMENSIONS/INCHES		
			H	W	D
45° Post Extension Data/Comm Lay-in	EVDP4E64	204	64	3.65	
	EVDP4E84	204	84	3.65	

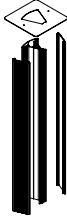

## EVLEDES - STARTER LED TASK LIGHT

- Undercabinet slim profile LED linear light fixture with lens and On/Off switch.
- May be used as stand-alone or extended with add-on section below (EVLEDES\_DSC).
- Plug-in power supply with 72" cord length plus 78" DC cable.
- Includes magnet mounting bracket with optional adhesive metal plate.
- Light enclosure in clear anodizing finish. Color temperature cool white 4000K.
- Lifespan rated 30,000 hours.

DESCRIPTION	PRODUCT CODE	LIST PRICE	DIMENSIONS/INCHES		
			H	W	D
Led Task Light	EVLEDES24	297	1	22.9	1
	EVLEDES36	341	1	33.5	1
	EVLEDES48	379	1	45.5	1

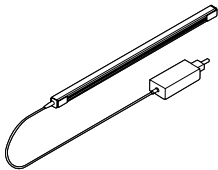

## EVLEDES - ADD-ON LED TASK LIGHT

- Undercabinet slim profile LED linear add-on light fixture with lens.
- Daisy chain unit with 39" linking cable, no power supply.
- Add-on units can only be linked up to a total of 48 watts per power supply; this is equivalent to 10 feet of nominal length of light per power supply.
- Includes magnet mounting bracket with optional adhesive metal plate. Light enclosure in clear anodizing finish. Color temperature cool white 4000K. Lifespan rated 30,000 hours.

DESCRIPTION	PRODUCT CODE	LIST PRICE	DIMENSIONS/INCHES		
			H	W	D
Led Task Light	EVLEDES24DSC	243	1	24	39
	EVLEDES36DSC	286	1	36	39
	EVLEDES48DSC	325	1	48	39

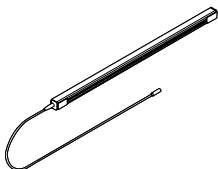

# ELECTRICAL

## EVELEDESOS - OCCUPANCY SENSOR

- Inline add-on controller for dimming and occupancy sensor.
- Sensor bypass switch.

DESCRIPTION	PRODUCT CODE	LIST PRICE	DIMENSIONS/INCHES		
			H	W	D

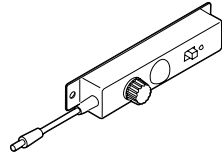

Occupancy Sensor	EVELEDESOS	122	6	2.4	2
------------------	------------	-----	---	-----	---

## EVELEDVS - VOYAGE LED SINGLE LIGHT FIXTURE

- Single arm option with 6 ft. cord.
- Touch & hold dimming capability.
- Brightness adjustment from 100% to 15%.
- Available in Designer White (WHT), Black (BLK) or Silver (SIL).
- Mercury free LEDs and 94% post consumer recyclability by weight.
- Mounting accessories sold separately.

DESCRIPTION	PRODUCT CODE	LIST PRICE	DIMENSIONS/INCHES		
			H	W	D



Voyage LED Single Light Fixture	EVELEDVS	817			
Voyage LED Single Light Fixture w/Occupancy Sensor	EVELEDVSO	1210			

## EVELEDVD - VOYAGE LED DOUBLE LIGHT FIXTURE

- Double arm option with 6 ft. cord.
- Touch & hold dimming capability.
- Brightness adjustment from 100% to 15%.
- Available in Designer White (WHT), Black (BLK) or Silver (SIL).
- Mercury free LEDs and 94% post consumer recyclability by weight.
- Mounting accessories sold separately.

DESCRIPTION	PRODUCT CODE	LIST PRICE	DIMENSIONS/INCHES		
			H	W	D



Voyage LED Double Light Fixture	EVELEDVD	830			
Voyage LED Double Light Fixture w/Occupancy Sensor	EVELEDVDO	1227			

## EVELEDRS - REVO LED SINGLE LIGHT FIXTURE

- Single arm option with 9 ft. cord.
- Touch & hold dimming capability.
- Brightness adjustment from 100% to 15%.
- Available in Designer White (WHT), Black (BLK) or Silver (SIL).
- Mercury free LEDs and 94% post consumer recyclability by weight.
- Mounting accessories sold separately.

DESCRIPTION	PRODUCT CODE	LIST PRICE	DIMENSIONS/INCHES		
			H	W	D



Revo LED Single Light Fixture	EVELEDRS	817			
Revo LED Single Light Fixture w/Occupancy Sensor	EVELEDRSO	1210			

# ELECTRICAL

## EVELEDRD - REVO LED DOUBLE LIGHT FIXTURE

- Double arm option with 9 ft. cord.
- Touch & hold dimming capability.
- Brightness adjustment from 100% to 15%.
- Available in Designer White (WHT), Black (BLK) or Silver (SIL).
- Mercury free LEDs and 94% post consumer recyclability by weight.
- Mounting accessories sold separately.

	DESCRIPTION	PRODUCT CODE	LIST PRICE	DIMENSIONS/INCHES		
				H	W	D
	Revo LED Double Light Fixture	EVELEDRD	830			
	Revo LED Double Light Fixture w/Occupancy Sensor	EVELEDRDO	1227			

## EVELEDAFS - FREESTANDING BASE

	DESCRIPTION	PRODUCT CODE	LIST PRICE	DIMENSIONS/INCHES		
				H	W	D
	Freestanding Base	EVELEDAFS	232			

## EVELEDACM - CLAMP MOUNT

	DESCRIPTION	PRODUCT CODE	LIST PRICE	DIMENSIONS/INCHES		
				H	W	D
	Clamp Mount	EVELEDACM	207			

## EVELEDASW - SLATWALL MOUNT

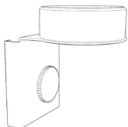
	DESCRIPTION	PRODUCT CODE	LIST PRICE	DIMENSIONS/INCHES		
				H	W	D
	Slatwall Mount	EVELEDASW	207			

# ELECTRICAL

## EVELEDAPM - PANEL MOUNT

	DESCRIPTION	PRODUCT CODE	LIST PRICE	DIMENSIONS/INCHES		
				H	W	D
	Panel Mount	EVELEDAPM	207			

## EVELEDASM - SURFACE MOUNT

	DESCRIPTION	PRODUCT CODE	LIST PRICE	DIMENSIONS/INCHES		
				H	W	D
	Surface Mount	EVELEDASM	207			

## EVECC - CORD COVER

- Attaches to panels vertically between modules to provide enclosures for power or data cords.
- Available in 21" and 36" lengths, 6 per pack.
- Can be field cut to required length.

	DESCRIPTION	PRODUCT CODE	LIST PRICE	DIMENSIONS/INCHES		
				H	W	D
	Inline Cord Cover	EVECC121	38	21		
	For use at panel Inline connections	EVECC136	57	36		
	Corner Cord Cover	EVECC221	38	21		
	For use at panel Inline connections	EVECC236	57	36		

## EVH8RC - RACEWAY COVERS

- Raceway Cover with 1.38" x 2.71" duplex receptacle openings.
- Raceway Covers are sold individually.
- Includes up to three receptacle opening shields depending on width of raceway cover.

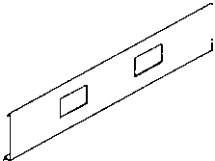
	DESCRIPTION	PRODUCT CODE	LIST PRICE	DIMENSIONS/INCHES		
				H	W	D
	Raceway Covers	EVH8RC18	27	6	18	
		EVH8RC24	39	6	24	
		EVH8RC30	53	6	30	
		EVH8RC36	59	6	36	
		EVH8RC42	66	6	42	
		EVH8RC48	71	6	48	
		EVH8RC54	83	6	54	
		EVH8RC60	91	6	60	

# ELECTRICAL

## EVEMAE - MINI-ADAPT POWER MODULE

- Attaches to scoop at the back of the worksurface.
- Includes two Simplex outlets.
- 6' black cord
- Available in black only.
- Note: Height (H) is measured above the worksurface.

	DESCRIPTION	PRODUCT CODE	LIST PRICE	DIMENSIONS/INCHES		
				H	W	D
	Mini-Adapt Power Module	EVEMAE1	250	2	3.58	3

## EVEMAD - MINI-ADAPT POWER MODULE

- Attaches to scoop at the back of the worksurface.
- Includes two Voice/Data Port, Voice/Data Adapter Kit.
- Accepts Cat3, Cat 5, Cat 5e, Cat 6 jacks.
- Available in black only.
- Note: Height (H) is measured above the worksurface.

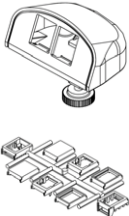
	DESCRIPTION	PRODUCT CODE	LIST PRICE	DIMENSIONS/INCHES		
				H	W	D
	Mini-Adapt Power Module	EVEMAD1	203	2	3.58	3

## EVED50AC - CLAMP MOUNT 2 POWER/USB-A&C

- Ashley Duo clamp mount power module with two 15 amp 120 Volt AC receptacles
- 2.4 amp USB-A port and 60 watt USB-C power delivery port
- 10' power cord with molded plug
- UL listed: UL 962A.
- Clamp accommodates worksurfaces 0.5" to 1.5" thick
- Fastened with thumb screws.

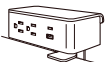
	DESCRIPTION	PRODUCT CODE	LIST PRICE	DIMENSIONS/INCHES		
				H	W	D
	White Module, Silver Bracket	EVED50ACW	525	1.8	5.5	2.8
	Black Module, Silver Bracket	EVED50ACB	525	1.8	5.5	2.8

## EVEDU51AC - UNDER MOUNT 2 POWER/USB-A&C

- Ashley Duo under mount power module with two 15 amp 120 Volt AC receptacles.
- 2.4 amp USB-A port and 60 watt USB-C power delivery port.
- 10' power cord with molded plug.
- UL listed: UL 962A.
- Mountable under most worksurfaces.
- Installation template provided.

	DESCRIPTION	PRODUCT CODE	LIST PRICE	DIMENSIONS/INCHES		
				H	W	D
	White Module, Silver Bracket	EVEDU51ACW	525	3	5.5	3.2
	Black Module, Silver Bracket	EVEDU51ACB	525	3	5.5	3.2

# worksurfaces

**THE INFORMATION LISTED BELOW PROVIDES YOU WITH BASIC FEATURES OF EVOLVE WORKSURFACES.**

- Evolve thermally fused worksurfaces are 1" thick, high pressure is 1 1/16" and 1 7/16" thick. These are finished with 3 mm PVC edging on all sides.
- Standard laminate offerings are available in thermally-fused (TF) and most high pressure laminates (HP). See laminate listings for details.
- Wood grain laminates on corner worksurfaces up to 42" available in laminate run diagonally for an upcharge. Otherwise, standard horizontal application of laminate will be used.
- To avoid unsatisfactory results in laminate application when attaching two corner surfaces side by side, select "WG" surfaces for matching grain.
- Some wood grain laminate worksurfaces will have matching wood grain PVC trim unless specified otherwise.
- The depth of the worksurface scoops are 1 1/8" when measured from the panel the worksurface is attached to.

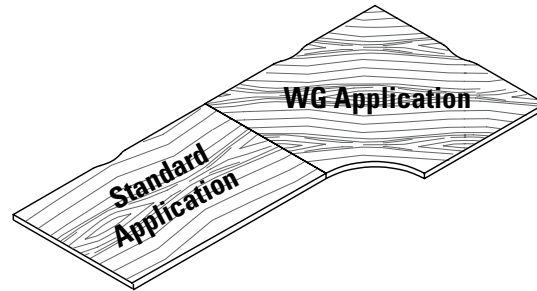

- All worksurfaces have threaded inserts for metal-to-metal connection for support hardware.
- All worksurfaces require support hardware. These are priced separately within this section.
- Communication and electrical wires are routed through a cable scoop located at the back of the worksurface. Depending on the specific surface, note that the number of cable scoops depends upon the width of the worksurface. All worksurface shapes have at least one scoop on the Panel edge.
- A 3/8" separation between the back of the worksurfaces and panels allows for cables to be moved to the panel seams and concealed by wire managers.
- Note: Wood veneer options for worksurfaces are available at an upcharge and with an extended lead time. Contact Evolve Customer Support for details.
- Tungsten (TUN) and Designer White (DWT) trim available at no charge.

• Note the following abbreviations:

**TF = Thermally-Fused Laminate; (1") HP = High-Pressure Laminate (1 1/16"); HPW = High-Pressure Laminate (1 7/16"); WG = Wood Grain**

**One Scoop EVWS 24" - 48"**

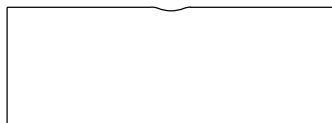

**Two Scoops EVWS 54" - 72"**

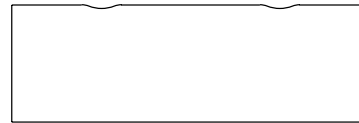

**One Scoop EVWL 24" - 48"**

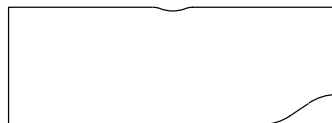

**Two Scoops EVWL 54" - 72"**



This page provides a three dimensional view of a sample configuration highlighting each **Worksurface** component required when specifying this configuration.

### Components

- A. EVWL2436 Curvilinear Worksurface – Left  
Note: When deepest end equals 24", opposite depth is 18"  
When deepest end equals 30", opposite depth is 24"
- B. EVWCC3618 Corner Curved Worksurface
- C. EVWR2436 Curvilinear Worksurface – Right
- D. EVWTEV1536 End Transaction Surface with Cut-out

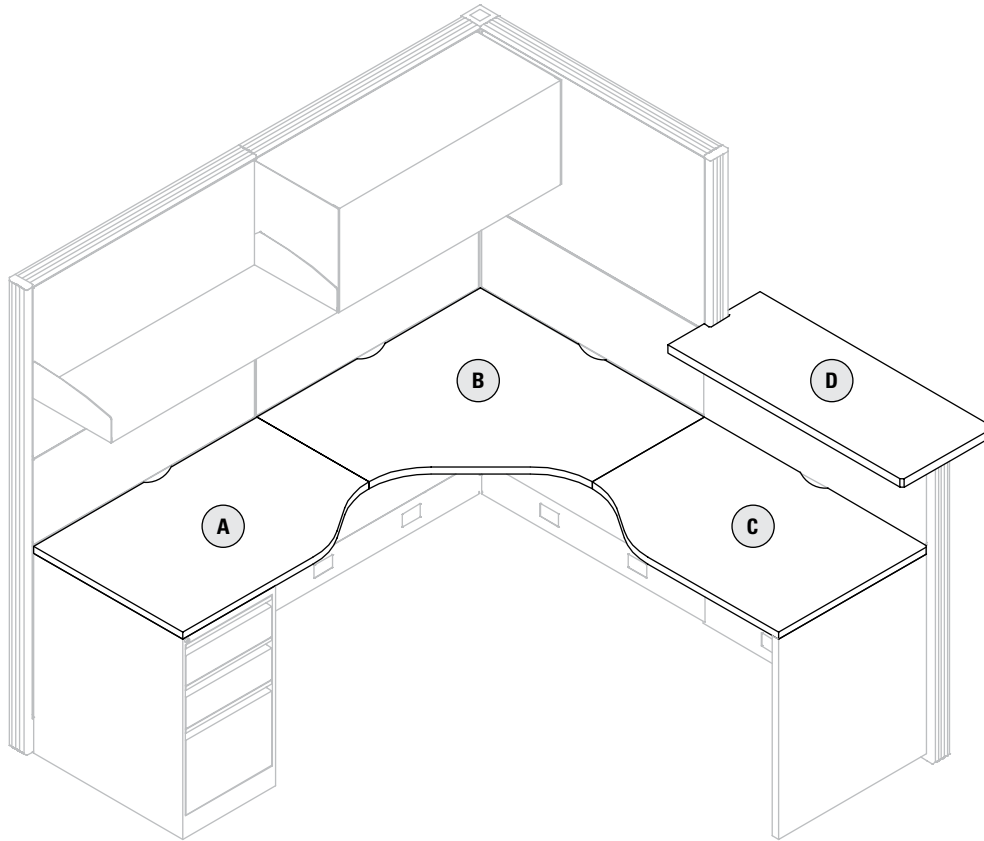

# WORKSURFACES

# GRAIN DIRECTION

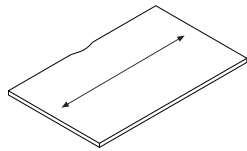

EVWS Worksurfaces

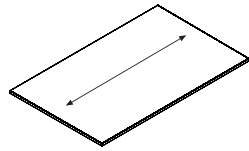

EVWSNS Worksurfaces

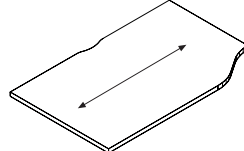

EVWVR Worksurfaces

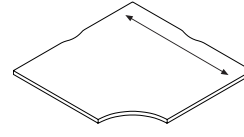

EVWCC Worksurfaces

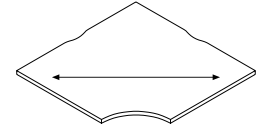

EVWCCxxxWG Worksurfaces

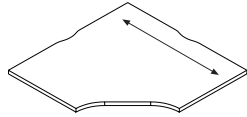

EVWCK Worksurfaces

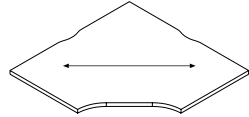

EVWCKxxxWG Worksurfaces

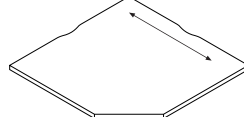

EVWCF Worksurfaces

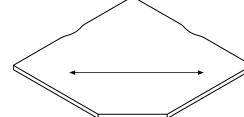

EVWCFxxxWG Worksurfaces

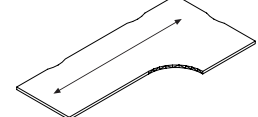

EVWCE Worksurfaces

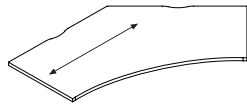

EVWC4C Worksurfaces

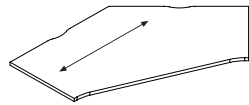

EVWC4K Worksurfaces

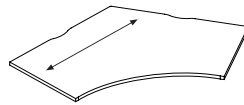

EVWC6C Worksurfaces

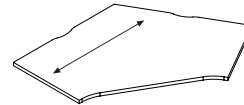

EVWC6K Worksurfaces

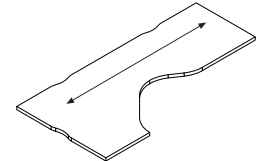

EVWL Worksurfaces

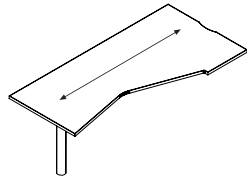

EVWHL Worksurfaces

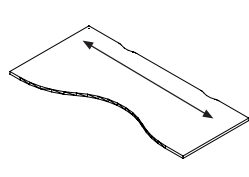

EVWBTL/R Worksurfaces

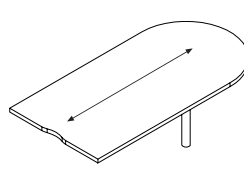

EVWD Worksurfaces

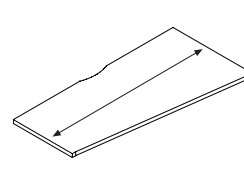

EVWSWL/R Worksurfaces

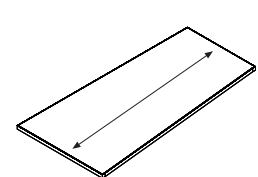

EVWSWNSL/R Worksurfaces

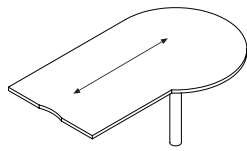

EVWP Worksurfaces

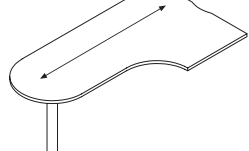

EVWPL/R Worksurfaces

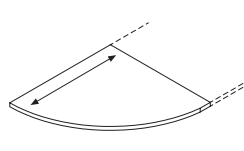

EVWQR and EVWQRC Worksurfaces

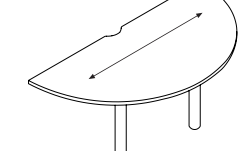

EVWR Worksurfaces

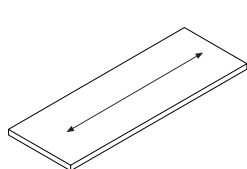

EVWT, EVWTV, EVWTW, EWTEV, EVWTD, EVWTDV, EVWTTD Worksurfaces

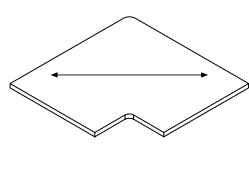

EVWTCLxxxWG Worksurfaces

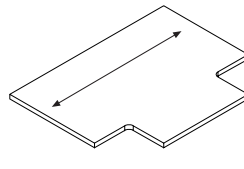

EVWTC Worksurfaces

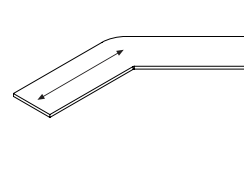

EVW4T Worksurface

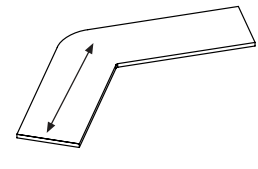

EVW6T Worksurfaces

# WORKSURFACES

# STRAIGHT

## EVWS - STRAIGHT WORKSURFACE

- Support hardware must be ordered separately. See listing in this section of the price book.
- Worksurfaces greater than 48" wide require additional structural support.
- Please choose from Designer White (DWT), Silver (SIL) or Black (BLK) for scoop covers.

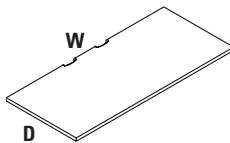
DESCRIPTION	PRODUCT CODE	TF	PRICE		DIMENSIONS/INCHES	
			HP ADD	HPW ADD	D	W
 Straight Worksurface - 18" Deep	EWWS1824P	158	61	165	18	24
	EWWS1830P	165	64	180	18	30
	EWWS1836P	188	71	198	18	36
	EWWS1842P	243	98	267	18	42
	EWWS1848P	290	113	316	18	48
	EWWS1854P	342	137	375	18	54
	EWWS1860P	384	151	417	18	60
	EWWS1866P	401	158	432	18	66
	EWWS1872P	419	163	450	18	72
	EWWS1878P	593	309	753	18	78
	EWWS1884P	636	330	815	18	84
	EWWS1890P	681	353	868	18	90
	EWWS1896P	726	379	927	18	96
 Straight Worksurface - 24" Deep	EWWS2424P	160	61	167	24	24
	EWWS2430P	171	66	180	24	30
	EWWS2436P	193	73	200	24	36
	EWWS2442P	246	98	268	24	42
	EWWS2448P	294	118	323	24	48
	EWWS2454P	346	136	375	24	54
	EWWS2460P	387	149	417	24	60
	EWWS2466P	405	159	434	24	66
	EWWS2472P	422	162	450	24	72
	EWWS2478P	678	194	629	24	78
	EWWS2484P	682	200	638	24	84
	EWWS2490P	681	353	868	24	90
	EWWS2496P	726	379	927	24	96
 Straight Worksurface - 30" Deep	EWWS3024P	188	70	195	30	24
	EWWS3030P	198	81	220	30	30
	EWWS3036P	235	90	248	30	36
	EWWS3042P	328	126	350	30	42
	EWWS3048P	346	136	375	30	48
	EWWS3054P	380	145	405	30	54
	EWWS3060P	405	159	434	30	60
	EWWS3066P	421	163	451	30	66
	EWWS3072P	445	174	483	30	72
	EWWS3078P	842	248	789	30	78
	EWWS3084P	855	244	791	30	84
	EWWS3090P	851	445	1089	30	90
	EWWS3096P	907	471	1157	30	96

# WORKSURFACES

# STRAIGHT

## EVWSNSC - STRAIGHT WORKSURFACE NO SCOOP

- There is no scoop on this work surface.
- Support hardware must be ordered separately. See listing in this section of the price book.
- Surfaces not available in HPW.
- Worksurfaces greater than 48" wide require additional structural support.

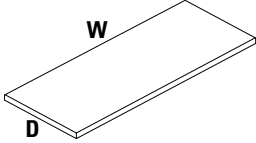
DESCRIPTION	PRODUCT CODE	PRICE		DIMENSIONS/INCHES	
		TF	HP ADD	D	W
 Straight Work surface No Scoops - 24" Deep	EVWSNSC2424	160	61	24	24
	EVWSNSC2430	171	234	24	30
	EVWSNSC2436	193	73	24	36
	EVWSNSC2442	246	98	24	42
	EVWSNSC2448	294	118	24	48
	EVWSNSC2454	346	136	24	54
	EVWSNSC2460	387	149	24	60
	EVWSNSC2466	405	159	24	66
	EVWSNSC2472	422	162	24	72
	EVWSNSC2478	678	194	24	78
	EVWSNSC2484	682	200	24	84
	EVWSNSC2490	681	353	24	90
	EVWSNSC2496	726	379	24	96
	 Straight Work surface No Scoops - 30" Deep	EVWSNSC3024	188	70	30
EVWSNSC3030		198	81	30	30
EVWSNSC3036		235	90	30	30
EVWSNSC3042		328	126	30	42
EVWSNSC3048		346	136	30	48
EVWSNSC3054		380	145	30	54
EVWSNSC3060		405	159	30	60
EVWSNSC3066		421	163	30	66
EVWSNSC3072		445	174	30	72
EVWSNSC3078		842	248	30	78
EVWSNSC3084		855	244	30	84
EVWSNSC3090		851	445	30	90
EVWSNSC3096		907	471	30	96

## EVWSWNSC - WEDGE WORKSURFACE NO SCOOP

- There is no scoop on this work surface.

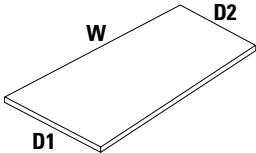
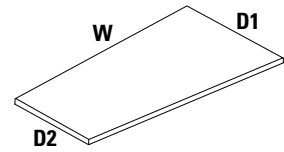
DIMENSIONS/INCHES	PRODUCT CODE	PRICE		DIMENSIONS/INCHES			
		TF	HP ADD	D1	D2	W	
 Straight Wedge Work surface No Scoops - Left	EVWSWNSC241848	412	120	24	18	48	
	EVWSWNSC241854	465	596	24	18	54	
	EVWSWNSC241860	513	152	24	18	60	
	EVWSWNSC241866	569	163	24	18	66	
	EVWSWNSC241872	616	182	24	18	72	
	EVWSWNSC302448	513	152	30	24	48	
	EVWSWNSC302454	577	744	30	24	54	
	EVWSWNSC302460	642	824	30	24	60	
	EVWSWNSC302466	705	908	30	24	66	
	EVWSWNSC302472	770	989	30	24	72	
	 Straight Wedge Work surface No Scoops - Right	EVWSWNSC182448	412	120	24	18	48
		EVWSWNSC182454	465	596	24	18	54
		EVWSWNSC182460	513	152	24	18	60
		EVWSWNSC182466	569	163	24	18	66
EVWSWNSC182472		616	182	24	18	72	
EVWSWNSC243048		513	152	30	24	48	
EVWSWNSC243054		577	744	30	24	54	
EVWSWNSC243060		642	824	30	24	60	
EVWSWNSC243066		705	908	30	24	66	
EVWSWNSC243072		770	989	30	24	72	

# WORKSURFACES

# STRAIGHT

### EWSP - STRAIGHT WORKSURFACE TO SPAN-A-POST

- Support hardware must be ordered separately. See listing in this section of the price book.
- Worksurfaces greater than 48" wide require additional structural support.
- Please choose from Designer White (DWT), Silver (SIL) or Black (BLK) for scoop covers.

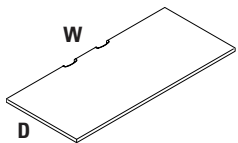
DESCRIPTION	PRODUCT CODE	TF	PRICE		DIMENSIONS/INCHES	
			HP ADD	HPW ADD	D	W
	Straight Worksurface to Span-a-Post - 18" Deep	183	97	235	18	27
	EWWS1827P	165	110	266	18	33
	EWWS1833P	242	128	310	18	39
	EWWS1839P	290	128	332	18	45
	EWWS1845P	344	136	374	18	51
	EWWS1851P	384	151	416	18	57
	EWWS1857P	401	158	432	18	63
	EWWS1863P	419	163	451	18	69
	EWWS1869P	445	233	569	18	75
	EWWS1875P	583	170	540	18	81
	EWWS1881P	595	171	548	18	87
	Straight Worksurface to Span-a-Post - 24" Deep	232	120	289	24	27
	EWWS2427P	277	142	350	24	33
	EWWS2433P	321	167	409	24	39
	EWWS2439P	364	192	466	24	42
	EWWS2445P	411	214	523	24	48
	EWWS2451P	454	238	582	24	57
	EWWS2457P	502	262	638	24	63
	EWWS2463P	546	283	695	24	69
	EWWS2469P	678	221	668	24	75
	EWWS2475P	682	283	764	24	81
	EWWS2481P	694	342	856	24	84
	Straight Worksurface to Span-a-Post - 30" Deep	286	151	365	30	27
	EWWS3027P	344	179	434	30	33
	EWWS3033P	397	210	511	30	39
	EWWS3039P	454	238	582	30	45
	EWWS3045P	513	267	652	30	48
	EWWS3051P	570	297	726	30	57
	EWWS3057P	624	325	798	30	63
	EWWS3063P	681	353	868	30	69
	EWWS3069P	842	280	836	30	75
	EWWS3075P	855	289	862	30	81
	EWWS3081P	898	395	1041	30	87

# WORKSURFACES

# CURVILINEAR

## EVWVL - CURVILINEAR WORKSURFACE - LEFT

- When deepest end equals 24", the opposite depth is 18". When deepest end equals 30", the opposite depth is 24".
- Support hardware must be ordered separately. See listing in this section of the price book.
- Worksurfaces greater than 48" wide require additional structural support.
- Please choose from Designer White (DWT), Silver (SIL) or Black (BLK) for scoop covers.

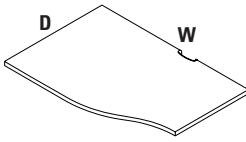
DESCRIPTION	PRODUCT CODE	TF	PRICE		DIMENSIONS/INCHES	
			HP ADD	HPW ADD	D	W
 Curvilinear Worksurface - 24" Deep	EVWVL2424P	204	80	220	24	24
	EVWVL2430P	214	81	227	24	30
	EVWVL2436P	254	99	278	24	36
	EVWVL2442P	294	118	323	24	42
	EVWVL2448P	340	134	363	24	48
	EVWVL2454P	380	145	405	24	54
	EVWVL2460P	411	173	462	24	60
	EVWVL2466P	453	185	503	24	66
	EVWVL2472P	487	214	560	24	72
	EVWVL2478P	678	194	629	24	78
	EVWVL2484P	682	200	638	24	84
Curvilinear Worksurface - 30" Deep	EVWVL3024P	214	81	227	30	24
	EVWVL3030P	224	86	234	30	30
	EVWVL3036P	267	112	294	30	36
	EVWVL3042P	363	140	389	30	42
	EVWVL3048P	380	145	405	30	48
	EVWVL3054P	421	163	451	30	54
	EVWVL3060P	453	185	503	30	60
	EVWVL3066P	487	214	560	30	66
	EVWVL3072P	517	238	613	30	72
	EVWVL3078P	842	248	789	30	78
	EVWVL3084P	855	244	791	30	84

## EVWVR - CURVILINEAR WORKSURFACE - RIGHT

- When deepest end equals 24", the opposite depth is 18". When deepest end equals 30", the opposite depth is 24".
- Support hardware must be ordered separately. See listing in this section of the price book.
- Please choose from Designer White (DWT), Silver (SIL) or Black (BLK) for scoop covers.

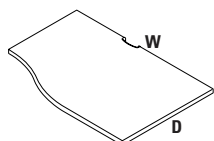
DESCRIPTION	PRODUCT CODE	TF	PRICE		DIMENSIONS/INCHES	
			HP ADD	HPW ADD	D	W
 Curvilinear Worksurface - 24" Deep	EVWVR2424P	204	80	220	24	24
	EVWVR2430P	214	81	227	24	30
	EVWVR2436P	254	99	278	24	36
	EVWVR2442P	294	118	323	24	42
	EVWVR2448P	340	134	363	24	48
	EVWVR2454P	380	145	405	24	54
	EVWVR2460P	411	173	462	24	60
	EVWVR2466P	453	185	503	24	66
	EVWVR2472P	487	214	560	24	72
	EVWVR2478P	678	194	629	24	78
	EVWVR2484P	682	200	638	24	84
Curvilinear Worksurface - 30" Deep	EVWVR3024P	214	81	227	30	24
	EVWVR3030P	224	86	234	30	30
	EVWVR3036P	267	112	294	30	36
	EVWVR3042P	363	140	389	30	42
	EVWVR3048P	380	145	405	30	48
	EVWVR3054P	421	163	451	30	54
	EVWVR3060P	453	185	503	30	60
	EVWVR3066P	487	214	560	30	66
	EVWVR3072P	517	238	613	30	72
	EVWVR3078P	842	248	789	30	78
	EVWVR3084P	855	244	791	30	84

# WORKSURFACES

# CORNER

## EVWCC - CORNER CURVED WORKSURFACE

- When specifying woodgrain laminate (WG) for corner worksurfaces 42" wide or less, choose from a diagonally run grain for an upcharge or standard application at no upcharge.
- Support hardware must be ordered separately. See listings in this section.
- Worksurfaces greater than 48" wide require additional structural support.
- Please choose from Designer White (DWT), Silver (SIL) or Black (BLK) for scoop covers.

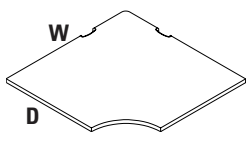
	DESCRIPTION	PRODUCT CODE	PRICE			DIMENSIONS/INCHES	
			TF	HP ADD	HPW ADD	D	W
	Corner Curved Worksurface - 36"	EWCC3618P	534	173	525	18	36
		EWCC3624P	583	193	579	24	36
		EWCC3618WGP	595	194	585	18	36
		EWCC3624WGP	655	214	644	24	36
	Corner Curved Worksurface - 42"	EWCC4224P	789	257	781	24	42
		EWCC4230P	858	278	839	30	42
		EWCC4224WGP	885	340	949	24	42
		EWCC4230WGP	962	310	940	30	42
	Corner Curved Worksurface - 48"	EWCC4824P	923	279	874	24	48
		EWCC4830P	966	417	1105	30	48

## EVWCC - CORNER ASYMMETRICAL WORKSURFACE

- When specifying woodgrain laminate (WG) for corner worksurfaces 42" wide or less, choose from a diagonally run grain for an upcharge or standard application at no upcharge.
- Support hardware must be ordered separately. See listings in this section.
- Please choose from Designer White (DWT), Silver (SIL) or Black (BLK) for scoop covers.

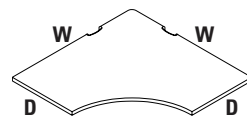
	DESCRIPTION	PRODUCT CODE	PRICE			DIMENSIONS/INCHES		
			TF	HP ADD	HPW ADD	D1	D2	W
	Corner Worksurface - 36" x 36" x 18" x 24"	EWCC36361824P	593	139	504	18	24	36
		EWCC36362418P	593	139	504	24	18	36
		EWCC36361824WGP	662	159	564	18	24	36
		EWCC36362418WGP	662	159	564	24	18	36
	Corner Worksurface - 36" x 36" x 24" x 30"	EWCC36362430P	639	134	518	24	30	36
		EWCC36363024P	639	134	518	30	24	36
		EWCC36362430WGP	715	149	579	24	30	36
		EWCC36363024WGP	715	149	579	30	24	36
	Corner Worksurface - 42" x 42" x 18" x 24"	EWCC42421824P	806	278	818	18	24	42
		EWCC42422418P	806	278	818	24	18	42
		EWCC42421824WGP	904	311	914	18	24	42
		EWCC42422418WGP	904	311	914	24	18	42
	Corner Worksurface - 42" x 42" x 24" x 30"	EWCC42422430P	871	477	1150	24	30	42
		EWCC42423024P	871	477	1150	30	24	42
		EWCC42422430WGP	976	534	1282	24	30	42
		EWCC42423024WGP	976	534	1282	30	24	42
	Corner Worksurface - 48" x 48" x 24" x 30"	EWCC48482430P	1115	420	1182	24	30	42
		EWCC48483024P	1115	420	1182	30	24	42

# WORKSURFACES

# CORNER

## EVWCK - CORNER KEYBOARD WORKSURFACE

- When specifying woodgrain laminate (WG) for corner worksurfaces 42" wide or less, choose from a diagonally run grain for an upcharge or standard application at no upcharge.
- Support hardware must be ordered separately. See listings in this section.
- Worksurfaces greater than 48" wide require additional structural support.
- Please choose from Designer White (DWT), Silver (SIL) or Black (BLK) for scoop covers.

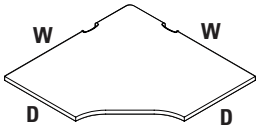
	DESCRIPTION	PRODUCT CODE	PRICE			DIMENSIONS/INCHES	
			TF	HP ADD	HPW ADD	D	W
	Corner Keyboard Worksurface - 36"	EWWCK3618P	541	174	530	18	36
		EWWCK3624P	695	195	638	24	36
		EWWCK3618WGP	607	195	594	18	36
		EWWCK3624WGP	782	218	713	24	36
	Corner Keyboard Worksurface - 42"	EWWCK4224P	798	265	791	24	42
		EWWCK4230P	909	345	970	30	42
		EWWCK4224WGP	893	292	886	24	42
		EWWCK4230WGP	1017	387	1083	30	42
	Corner Keyboard Worksurface - 48"	EWWCK4824P	973	421	1117	24	48
		EWWCK4830P	1081	446	1209	30	48

## EVWCF - FIVE-SIDED WORKSURFACE

- When specifying woodgrain laminate (WG) for corner worksurfaces 42" wide or less, choose from a diagonally run grain for an upcharge or standard application at no upcharge.
- Support hardware must be ordered separately. See listings in this section.
- Please choose from Designer White (DWT), Silver (SIL) or Black (BLK) for scoop covers.

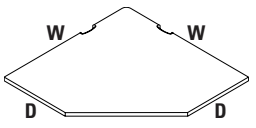
	DESCRIPTION	PRODUCT CODE	PRICE			DIMENSIONS/INCHES	
			TF	HP ADD	HPW ADD	D	W
	Five-Sided Keyboard Worksurface - 30"	EWWCF3012P	372	126	681	12	30
		EWWCF3612P	492	162	561	12	30
	Five-Sided Keyboard Worksurface - 36"	EWWCF3618P	534	173	525	18	36
		EWWCF3624P	583	193	579	24	36
		EWWCF3618WGP	595	195	587	18	36
		EWWCF3624WGP	655	214	644	24	36
	Five-Sided Keyboard Worksurface - 42"	EWWCF4224P	789	257	781	24	42
		EWWCF4230P	858	278	839	30	42
		EWWCF4224WGP	882	288	871	24	42
		EWWCF4230WGP	962	309	937	30	42
	Five-Sided Keyboard Worksurface - 48"	EWWCF4824P	923	279	874	24	48
		EWWCF4830P	966	417	1105	30	48

# WORKSURFACES

# CORNER

## EVWCCEL - EXTENDED CURVED CORNER - LEFT

- There are three cable scoops on this worksurface.
- Support hardware must be ordered separately. See listing in this section of the price book.
- Wood Grain Laminates do not run diagonally on Extended Curved Corners.
- Worksurfaces greater than 48" wide require additional structural support.
- Please choose from Designer White (DWT), Silver (SIL) or Black (BLK) for scoop covers.

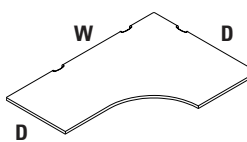
	DESCRIPTION	PRODUCT CODE	PRICE			DIMENSIONS/INCHES		
			TF	HP ADD	HPW ADD	D1	D2	W
	Extended Curved Corner - 36" x 24"	EVWCCEL362448P	723	203	662	36	24	48
		EVWCCEL362460P	787	224	727	36	24	60
		EVWCCEL362466P	865	247	800	36	24	66
		EVWCCEL362472P	954	278	889	36	24	72
		EVWCCEL362478P	1021	292	949	36	24	78
		EVWCCEL362484P	1099	318	1023	36	24	84
	Extended Curved Corner - 42" x 24"	EVWCCEL422460P	829	235	763	42	24	60
		EVWCCEL422466P	909	265	847	42	24	66
		EVWCCEL422472P	1006	288	929	42	24	72
		EVWCCEL422478P	1075	310	996	42	24	78
		EVWCCEL422484P	1157	330	1077	42	24	84
	Extended Curved Corner - 42" x 30"	EVWCCEL423060P	930	270	868	42	30	60
		EVWCCEL423066P	1021	292	949	42	30	66
		EVWCCEL423072P	1115	321	1036	42	30	72
		EVWCCEL423078P	1197	344	1110	42	30	78
		EVWCCEL423084P	1275	365	1182	42	30	84
	Extended Curved Corner - 48" x 24"	EVWCCEL482460P	982	235	840	48	24	60
		EVWCCEL482466P	1058	292	969	48	24	66
		EVWCCEL482472P	1137	341	1077	48	24	72
		EVWCCEL482478P	1247	326	1113	48	24	78
		EVWCCEL482484P	1301	373	1201	48	24	84
	Extended Curved Corner - 48" x 30"	EVWCCEL483060P	1036	300	966	48	30	60
		EVWCCEL483066P	1127	329	1053	48	30	66
		EVWCCEL483072P	1225	353	1138	48	30	72
		EVWCCEL483078P	1316	381	1230	48	30	78
		EVWCCEL483084P	1387	403	1295	48	30	84

# WORKSURFACES

# CORNER

## EVWCER - EXTENDED CURVED CORNER - RIGHT

- There are three cable scoops on this worksurface.
- Support hardware must be ordered separately. See listing in this section of the price list.
- Wood Grain Laminates do not run diagonally on Extended Curved Corners.
- Worksurfaces greater than 48" wide require additional structural support.
- Please choose from Designer White (DWT), Silver (SIL) or Black (BLK) for scoop covers.

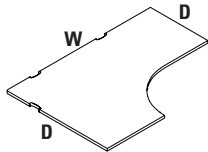
DESCRIPTION	PRODUCT CODE	TF	PRICE		DIMENSIONS/INCHES		
			HP ADD	HPW ADD	D1	D2	W
 Extended Curved Corner - 36" x 24"	EWWCER362448P	723	203	662	36	24	48
	EWWCER362460P	787	224	727	36	24	60
	EWWCER362466P	865	247	800	36	24	66
	EWWCER362472P	954	278	889	36	24	72
	EWWCER362478P	1021	292	949	36	24	78
	EWWCER362484P	1099	318	1023	36	24	84
Extended Curved Corner - 42" x 24"	EWWCER422460P	829	235	763	42	24	60
	EWWCER422466P	909	265	847	42	24	66
	EWWCER422472P	1006	288	929	42	24	72
	EWWCER422478P	1075	310	996	42	24	78
	EWWCER422484P	1157	330	1077	42	24	84
Extended Curved Corner - 42" x 30"	EWWCER423060P	930	270	868	42	30	60
	EWWCER423066P	1021	292	949	42	30	66
	EWWCER423072P	1115	321	1036	42	30	72
	EWWCER423078P	1197	344	1110	42	30	78
	EWWCER423084P	1275	365	1182	42	30	84
Extended Curved Corner - 48" x 24"	EWWCER482460P	982	235	840	48	24	60
	EWWCER482466P	1058	292	969	48	24	66
	EWWCER482472P	1137	341	1077	48	24	72
	EWWCER482478P	1247	326	1113	48	24	78
	EWWCER482484P	1301	373	1201	48	24	84
Extended Curved Corner - 48" x 30"	EWWCER483060P	1036	300	966	48	30	60
	EWWCER483066P	1127	329	1053	48	30	66
	EWWCER483072P	1225	353	1138	48	30	72
	EWWCER483078P	1316	381	1230	48	30	78
	EWWCER483084P	1387	403	1295	48	30	84

## EVWC4C - CURVED CORNER SURFACE FOR 45° POST

- Support hardware must be ordered separately. See the listing in this section.
- Please choose from Designer White (DWT), Silver (SIL) or Black (BLK) for scoop covers.

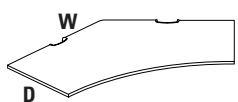
DESCRIPTION	PRODUCT CODE	TF	PRICE		DIMENSIONS/INCHES	
			HP ADD	HPW ADD	D	W
 Corner Curved Surface for 45° Post - 18"	EWWC4C1824P	510	149	476	18	24
	EWWC4C1830P	785	227	732	18	30
	EWWC4C1836P	1115	324	1041	18	36
	EWWC4C1842P	1391	403	1297	18	42
	EWWC4C1848P	1623	469	1511	18	48
Corner Curved Surface for 45° Post - 24"	EWWC4C2424P	611	179	571	24	24
	EWWC4C2430P	914	267	852	24	30
	EWWC4C2436P	1276	372	1189	24	36
	EWWC4C2442P	1391	403	1297	24	42
	EWWC4C2448P	1825	526	1701	24	48
Corner Curved Surface for 45° Post - 30"	EWWC4C3024P	712	210	666	30	24
	EWWC4C3030P	1127	220	890	30	30
	EWWC4C3036P	1276	372	1189	30	36
	EWWC4C3042P	1563	453	1458	30	42
	EWWC4C3048P	2028	585	1888	30	48

# WORKSURFACES

# CORNER

### EVWC4K - KEYBOARD CORNER SURFACE FOR 45° POST

- Support hardware must be ordered separately. See the listing in this section.
- Worksurfaces greater than 48" wide require additional structural support.
- Please choose from Designer White (DWT), Silver (SIL) or Black (BLK) for scoop covers.

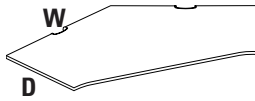
	DESCRIPTION	PRODUCT CODE	PRICE			DIMENSIONS/INCHES	
			TF	HP ADD	HPW ADD	D	W
	Keyboard Curved Surface for 45° Post - 18"	EVWC4K1824P	510	149	476	18	24
		EVWC4K1830P	785	227	732	18	30
		EVWC4K1836P	1115	324	1041	18	36
	Keyboard Curved Surface for 45° Post - 24"	EVWC4K1842P	1391	403	1297	18	42
		EVWC4K1848P	1623	469	1511	18	48
		EVWC4K2424P	611	179	571	24	24
		EVWC4K2430P	914	267	852	24	30
		EVWC4K2436P	1276	372	1189	24	36
		EVWC4K2442P	1391	403	1297	24	42
	Keyboard Curved Surface for 45° Post - 30"	EVWC4K2448P	1825	526	1701	24	48
		EVWC4K3024P	712	210	666	30	24
		EVWC4K3030P	1045	220	890	30	30
EVWC4K3036P		1276	372	1189	30	36	
EVWC4K3042P		1563	453	1458	30	42	
EVWC4K3048P		2028	585	1888	30	48	

### EVWC6C - CURVED CORNER SURFACE FOR 60° POST

- Support hardware must be ordered separately. See the listing in this section.
- Please choose from Designer White (DWT), Silver (SIL) or Black (BLK) for scoop covers.

	DESCRIPTION	PRODUCT CODE	LIST PRICE			DIMENSIONS/INCHES	
			TF	HP ADD	HPW ADD	ADD	W
	Curved Curved Surface for 60° Post - 18"	EVWC6C1824P	409	137	409	18	24
		EVWC6C1830P	638	88	448	18	30
		EVWC6C1836P	954	129	670	18	36
	Curved Curved Surface for 60° Post - 24"	EVWC6C1842P	1169	159	820	18	42
		EVWC6C1848P	1592	216	1117	18	48
		EVWC6C2424P	478	69	341	24	24
		EVWC6C2430P	850	118	596	24	30
		EVWC6C2436P	954	129	670	24	36
		EVWC6C2442P	1459	195	1019	24	42
	Curved Curved Surface for 60° Post - 30"	EVWC6C2448P	1592	216	1117	24	48
		EVWC6C3024P	478	69	341	30	24
		EVWC6C3030P	850	118	596	30	30
EVWC6C3036P		954	129	670	30	36	
EVWC6C3042P		1459	195	1019	30	42	
EVWC6C3048P		1592	216	1117	30	48	

### EVWC6K - CURVED CORNER SURFACE FOR 60° POST

- Support hardware must be ordered separately. See the listing in this section.
- Please choose from Designer White (DWT), Silver (SIL) or Black (BLK) for scoop covers.

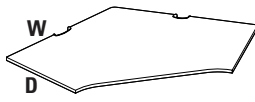
	DESCRIPTION	PRODUCT CODE	PRICE			DIMENSIONS/INCHES	
			TF	HP ADD	HPW ADD	D	W
	Keyboard Curved Surface for 60° Post - 18"	EVWC6K1824P	400	145	417	18	24
		EVWC6K1830P	638	88	448	18	30
		EVWC6K1836P	954	129	670	18	36
	Keyboard Curved Surface for 60° Post - 24"	EVWC6K1842P	1169	159	820	18	42
		EVWC6K1848P	1592	216	1117	18	48
		EVWC6K2430P	850	118	596	24	30
		EVWC6K2436P	954	129	670	24	36
		EVWC6K2442P	1459	195	1019	24	42
		EVWC6K2448P	1592	216	1117	24	48
	Keyboard Curved Surface for 60° Post - 30"	EVWC6K3030P	850	118	596	30	30
		EVWC6K3036P	952	318	950	30	36
		EVWC6K3042P	1302	438	1303	30	42
EVWC6K3048P		1577	540	1594	30	48	

# WORKSURFACES

## EVWL - "L" WORKSURFACE

- There are three cable scoops on this worksurface.
- Support hardware must be ordered separately. See listing in this section of the price list.
- Must be specified either left or right handed.
- Wood Grain Laminates do not run diagonally on Extended Curved Corners.
- Worksurfaces greater than 48" wide require additional structural support.
- Please choose from Designer White (DWT), Silver (SIL) or Black (BLK) for scoop covers.

DESCRIPTION	PRODUCT CODE	TF	PRICE		DIMENSIONS/INCHES	
			HP ADD	HPW ADD	D	W
"L" Worksurface	EWLL2472P	819	310	866	24	72
	EWLWR2472P	819	310	866	24	72

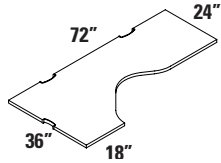

Right shown

## EVWBT - 30" TRANSITION WORKSURFACE

- Support hardware must be ordered separately. See the listing in this section of the price list.
- Opposing side of 30" deep (D1) Transition Worksurface has depth of 24" (D2).
- Scoops located on back edge only.
- Must be specified as right or left handed.
- Please choose from Designer White (DWT), Silver (SIL) or Black (BLK) for scoop covers.

DESCRIPTION	PRODUCT CODE	TF	PRICE		DIMENSIONS/INCHES		
			HP ADD	HPW ADD	D1	D2	W
Transition Worksurface - Left - 30"	EVWBTL3060P	644	188	601	30	24	60
	EVWBTL3066P	711	204	659	30	24	66
	EVWBTL3072P	772	226	723	30	24	72
Transition Worksurface - Right - 30"	EVWBTR3060P	644	188	601	30	24	60
	EVWBTR3066P	711	204	659	30	24	66
	EVWBTR3072P	772	226	723	30	24	72

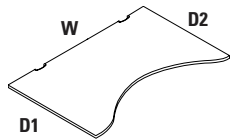

Left shown

## EVWBT - 36" TRANSITION WORKSURFACE

- Support hardware must be ordered separately. See the listing in this section of the price list.
- Opposing side of 36" deep (D1) Transition Worksurface has depth of 30" (D2).
- Scoops located on back edge only.
- Must be specified as right or left handed.
- Please choose from Designer White (DWT), Silver (SIL) or Black (BLK) for scoop covers.

DESCRIPTION	PRODUCT CODE	TF	PRICE		DIMENSIONS/INCHES		
			HP ADD	HPW ADD	D1	D2	W
Transition Worksurface - Left - 36"	EVWBTL3660P	772	226	723	36	30	60
	EVWBTL3666P	850	247	793	36	30	66
	EVWBTL3672P	927	269	865	36	30	72
Transition Worksurface - Right - 36"	EVWBTR3660P	772	226	723	36	30	60
	EVWBTR3666P	850	247	793	36	30	66
	EVWBTR3672P	927	269	865	36	30	72

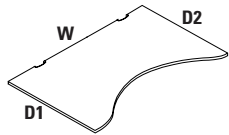

Left shown

# WORKSURFACES

## EVWSH - STRAIGHT EDGE HATCHET WORKSURFACE (LEFT SHOWN)

- Cable scoop is in the center of the 36" wide edge.
- Support hardware must be ordered separately. See listing in this section of the price list
- Monoleg is included
- Must be specified either left or right handed.
- Wood Grain Laminates do not run diagonally on Hatchet Corners
- Please choose from Designer White (DWT), Silver (SIL) or Black (BLK) for scoop covers.

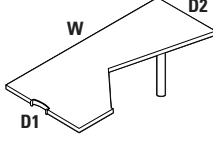
	DESCRIPTION	PRODUCT CODE	PRICE	DIMENSIONS/INCHES		
				D1	D2	W
	Straight Edge Hatchet Worksurface - Left	EVWSHL3672P	1245	36	30	72
	Straight Edge Hatchet Worksurface - Right	EVWSHR3672P	1245	36	30	72

Left Shown

## EVWD - "D" WORKSURFACE

- Support hardware must be ordered separately. See listing in this section of the price list.
- Monoleg is included
- Worksurfaces greater than 48" wide require additional structural support.
- Please choose from Designer White (DWT), Silver (SIL) or Black (BLK) for scoop covers.

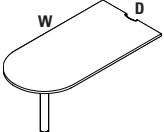
	DESCRIPTION	PRODUCT CODE	TF	PRICE		DIMENSIONS/INCHES	
				HP ADD	HPW ADD	D	W
	"D" Worksurface - 24"	EVWD2442P	583	233	635	24	42
		EVWD2448P	603	232	644	24	48
		EVWD2460P	633	243	678	24	60
		EVWD2472P	678	265	733	24	72
	"D" Worksurface - 30"	EVWD3048P	642	257	705	30	48
		EVWD3060P	678	265	733	30	60
		EVWD3072P	748	290	810	30	72

## EVWPTR - "P" TOP

- There is one scoop on this worksurface.
- Support hardware must be ordered separately. See listing in this section of the price book.
- Must be specified either left or right handed.
- Monoleg is included.
- Please choose from Designer White (DWT), Silver (SIL) or Black (BLK) for scoop covers.

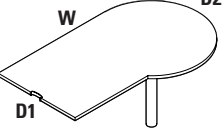
	DESCRIPTION	PRODUCT CODE	TF	PRICE		DIMENSIONS/INCHES		
				HP ADD	HPW ADD	D1	D2	W
	"P" Top Worksurface - 24" Right	EVWPTR245430P	893	262	835	24	30	54
		EVWPTR246030P	959	257	864	24	30	60
		EVWPTR246630P	1004	278	914	24	30	66
		EVWPTR247230P	1057	286	952	24	30	72
	"P" Top Worksurface - 30" Right	EVWPTR306036P	1057	278	941	30	36	60
		EVWPTR306636P	1142	268	970	30	36	66
		EVWPTR307236P	1221	257	992	30	36	72
	"P" Top Worksurface - 24" Left	EVWPTL245430P	893	262	835	24	30	54
		EVWPTL246030P	959	257	864	24	30	60
		EVWPTL246630P	1004	278	914	24	30	66
		EVWPTL247230P	1057	286	952	24	30	72
	"P" Top Worksurface - 30" Left	EVWPTL306036P	1057	278	941	30	36	60
		EVWPTL306636P	1142	268	970	30	36	66
		EVWPTL307236P	1221	257	992	30	36	72

Left Hand Shown

# WORKSURFACES

# STRAIGHT WEDGE

## EVWSW - STRAIGHT WEDGE WORKSURFACES

- There is one scoop on this worksurface.
- Must be specified either left or right handed.
- Support hardware must be ordered separately. See listing in this section of the price book.
- Worksurfaces greater than 48" wide require additional structural support.
- Please choose from Designer White (DWT), Silver (SIL) or Black (BLK) for scoop covers.

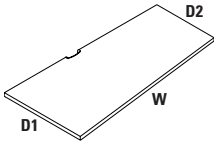
	DESCRIPTION	PRODUCT CODE	PRICE			DIMENSIONS/INCHES			
			TF	HP	HPW	D1	D2	W	
	Straight Wedge Worksurface - Left	EVWSW241848P	412	120	381	24	18	48	
		EVWSW241854P	465	135	432	24	18	54	
		EVWSW241860P	513	152	483	24	18	60	
		EVWSW241866P	569	163	527	24	18	66	
	EVWSW241872P	616	182	579	24	18	72		
			EVWSW302448P	513	152	483	30	24	48
			EVWSW302454P	577	171	538	30	24	54
			EVWSW302460P	642	185	598	30	24	60
			EVWSW302466P	705	204	659	30	24	66
			EVWSW302472P	770	222	715	30	24	72
			Straight Wedge Worksurface - Right	EVWSW182448P	412	120	381	18	24
	EVWSW182454P	465		135	432	18	24	54	
	EVWSW182460P	513		152	483	18	24	60	
	EVWSW182466P	569		163	527	18	24	66	
	EVWSW182472P	616		182	579	18	24	72	
	EVWSW243048P	513		152	483	24	30	48	
EVWSW243054P	577	171	538	24	30	54			
EVWSW243060P	642	185	598	24	30	60			
EVWSW243066P	705	204	659	24	30	66			
EVWSW243072P	770	222	715	24	30	72			

## EVWSWNSC - STRAIGHT WEDGE WORKSURFACES NO SCOOPS

- There is no scoop on this worksurface.
- Support hardware must be ordered separately. See listing in this section of the price book.
- Must be specified either left or right handed.
- Surfaces not available in HPW.

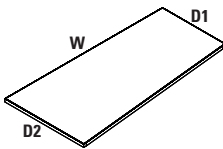
	DESCRIPTION	PRODUCT CODE	PRICE		DIMENSIONS/INCHES		
			TF	HP ADD	D1	D2	W
	Straight Wedge Worksurface No Scoops - Left	EVWSWNSC241848	412	120	24	18	48
		EVWSWNSC241854	465	135	24	18	54
		EVWSWNSC241860	513	152	24	18	60
		EVWSWNSC241866	569	163	24	18	66
		EVWSWNSC241872	616	182	24	18	72
		EVWSWNSC302448	513	152	30	24	48
	EVWSWNSC302454	577	171	30	24	54	
	EVWSWNSC302460	642	185	30	24	60	
	EVWSWNSC302466	705	204	30	24	66	
	EVWSWNSC302472	770	222	30	24	72	
	Straight Wedge Worksurface No Scoops - Right	EVWSWNSC182448	412	120	18	24	48
		EVWSWNSC182454	465	135	18	24	54
EVWSWNSC182460		513	152	18	24	60	
EVWSWNSC182466		569	163	18	24	66	
EVWSWNSC182472		616	182	18	24	72	
EVWSWNSC243048		513	152	24	30	48	
EVWSWNSC243054	577	171	24	30	54		
EVWSWNSC243060	642	185	24	30	60		
EVWSWNSC243066	705	204	24	30	66		
EVWSWNSC243072	770	222	24	30	72		

# WORKSURFACES

# PIANO TOP

## EVWPL - PIANO TOP - LEFT

- There is one scoop on this worksurface.
- Monoleg is included.
- Wood Grain Laminates do not run diagonally on Extended Curved Corners.
- Support hardware must be ordered separately. See listing in this section of the price book.
- Worksurfaces greater than 48" wide require additional structural support. Please choose from Designer White (DWT), Silver (SIL) or Black (BLK) for scoop covers.

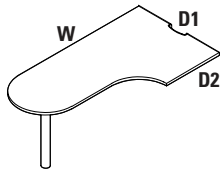
DESCRIPTION	PRODUCT CODE	TF	PRICE		DIMENSIONS/INCHES		
			HP ADD	HPW ADD	D1	D2	W
 Piano Top - Left - 36" x 18"	EVWPL361848P	810	262	791	36	18	48
	EVWPL361854P	888	247	810	36	18	54
	EVWPL361860P	954	244	840	36	18	60
	EVWPL361866P	1029	235	865	36	18	66
	EVWPL361872P	1098	232	890	36	18	72
Piano Top - Left - 36" x 24"	EVWPL362448P	819	262	796	36	24	48
	EVWPL362454P	893	247	818	36	24	54
	EVWPL362460P	965	242	840	36	24	60
	EVWPL362466P	1038	235	867	36	24	66
	EVWPL362472P	1105	232	894	36	24	72
Piano Top - Left - 42" x 24"	EVWPL422454P	1098	132	745	42	24	54
	EVWPL422460P	1165	136	785	42	24	60
	EVWPL422466P	1289	91	777	42	24	66
Piano Top - Left - 42" x 30"	EVWPL422472P	1368	80	800	42	24	72
	EVWPL423060P	1191	137	799	42	30	60
	EVWPL423066P	1317	90	788	42	30	66
Piano Top - Left - 48" x 24"	EVWPL423072P	1394	87	823	42	30	72
	EVWPL482460P	1233	257	1001	48	24	60
	EVWPL482466P	1366	214	997	48	24	66
Piano Top - Left - 48" x 30"	EVWPL482472P	1447	222	1053	48	24	72
	EVWPL483066P	1372	212	998	48	30	66
	EVWPL483072P	1454	222	1056	48	30	72

## EVWPR - PIANO TOP - RIGHT

- There is one scoop on this worksurface.
- Monoleg is included.
- Support hardware must be ordered separately. See listing in this section of the price book.
- Please choose from Designer White (DWT), Silver (SIL) or Black (BLK) for scoop covers.

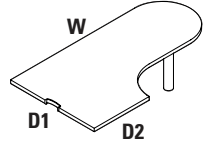
DESCRIPTION	PRODUCT CODE	TF	PRICE		DIMENSIONS/INCHES		
			HP ADD	HPW ADD	D1	D2	W
 Piano Top - Right - 36" x 18"	EVWPR361848P	810	262	791	36	18	48
	EVWPR361854P	888	247	810	36	18	54
	EVWPR361860P	954	244	840	36	18	60
	EVWPR361866P	1029	235	865	36	18	66
	EVWPR361872P	1098	232	890	36	18	72
Piano Top - Right - 36" x 24"	EVWPR362448P	819	262	796	36	24	48
	EVWPR362454P	893	247	818	36	24	54
	EVWPR362460P	965	242	840	36	24	60
	EVWPR362466P	1038	235	867	36	24	66
	EVWPR362472P	1105	232	894	36	24	72
Piano Top - Right - 42" x 24"	EVWPR422454P	1098	132	745	42	24	54
	EVWPR422460P	1165	136	785	42	24	60
	EVWPR422466P	1289	91	777	42	24	66
Piano Top - Right - 42" x 30"	EVWPR422472P	1368	80	800	42	24	72
	EVWPR423060P	1191	137	799	42	30	60
	EVWPR423066P	1317	90	788	42	30	66
Piano Top - Right - 48" x 24"	EVWPR423072P	1394	87	823	42	30	72
	EVWPR482460P	1233	257	1001	48	24	60
	EVWPR482466P	1366	214	997	48	24	66
Piano Top - Right - 48" x 30"	EVWPR482472P	1447	222	1053	48	24	72
	EVWPR483066P	1372	212	998	48	30	66
	EVWPR483072P	1454	222	1056	48	30	72

# WORKSURFACES

# QUARTER ROUND / RADIUS

## EVWQR - QUARTER ROUND PANEL WORKSURFACE

- The worksurface edge running along the panel is a slightly different length than that of the worksurface end, causing the surface to be handed.
- Left hand surface shown.
- The user edge abutting the adjacent worksurface runs straight for 3" before starting to curve.
- Support hardware must be ordered separately. See listing in this section of the price book.
- Worksurfaces greater than 48" wide require additional structural support.

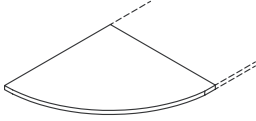
DESCRIPTION	PRODUCT CODE	TF	PRICE		DIMENSIONS/INCHES	
			HP ADD	HPW ADD	D	W
 Quarter Round Panel Worksurface - Left	EWQRL1818	175	59	173	18	18
	EWQRL2424	246	86	247	24	24
	EWQRL3030	324	99	310	30	30
Quarter Round Panel Worksurface - Right	EWQRR1818	175	59	173	18	18
	EWQRR2424	246	86	247	24	24
	EWQRR3030	324	99	310	30	30

## EVWQRC - QUARTER ROUND PANEL CORNER WORKSURFACE

- Wraps around a 90° corner post.
- The user edge abutting the adjacent worksurface runs straight for 3" before starting to curve.
- Support hardware must be ordered separately. See the listing in this section.

DESCRIPTION	PRODUCT CODE	TF	PRICE		DIMENSIONS/INCHES	
			HP ADD	HPW ADD	D	W
 Quarter Round Panel Corner Worksurface	EVWQRC1818	204	69	201	18	18
	EVWQRC2424	292	95	288	24	24
	EVWQRC3030	362	120	354	30	30

## EVWR - RADIUS WORKSURFACE

- Support hardware must be ordered separately. See listing in this section of the price book.
- Monoleg is included.
- Notched end is not finished.
- 18" and 24" come with one monoleg.
- 30" comes with two monolegs.
- Worksurfaces greater than 48" wide require additional structural support.
- Please choose from Designer White (DWT), Silver (SIL) or Black (BLK) for scoop covers.

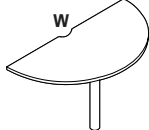
DESCRIPTION	PRODUCT CODE	TF	LIST PRICE		DIMENSIONS/INCHES	
			HP	HPW	D	W
 Radius Worksurface	EVWR18	503	196	541	18	39
	EVWR24	582	228	633	24	51
	EVWR30	1046	408	1127	30	63

# WORKSURFACES

# TRANSACTION

## EVWT - STRAIGHT TRANSACTION WORKSURFACE

- Support hardware must be ordered separately. See listing in this section of the price book.

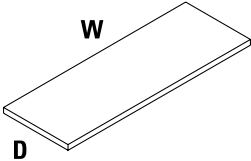
	DESCRIPTION	PRODUCT CODE	PRICE			DIMENSIONS/INCHES	
			TF	HP ADD	HPW ADD	D	W
	Straight Transaction Worksurface	EVWT1512	71	32	80	15	12
		EVWT1518	94	36	97	15	18
		EVWT1524	112	47	124	15	24
		EVWT1530	134	52	140	15	30
		EVWT1536	151	61	163	15	36
		EVWT1542	172	69	183	15	42
		EVWT1548	194	73	201	15	48
		EVWT1554	211	82	228	15	54
		EVWT1560	234	90	247	15	60
		EVWT1566	250	99	277	15	66
		EVWT1572	270	106	289	15	72
		EVWT1578	290	112	311	15	78
EVWT1584	311	124	336	15	84		

## EVWTV - STRAIGHT TRANSACTION WORKSURFACE WITH CUT-OUT

- Used when mounted to a panel that has a taller panel against it in a straight run at an inline.
- Support hardware must be ordered separately. See listing in this section of the price book.

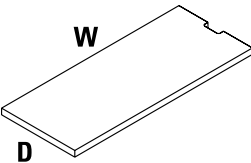
	DESCRIPTION	PRODUCT CODE	PRICE			DIMENSIONS/INCHES	
			TF	HP ADD	HPW ADD	W	D
	Straight Transaction Worksurface with Cut-Out	EVWTV1524	128	41	122	15	24
		EVWTV1530	141	57	149	15	30
		EVWTV1536	163	59	167	15	36
		EVWTV1542	183	69	193	15	42
		EVWTV1548	204	75	216	15	48
		EVWTV1554	224	81	232	15	54
		EVWTV1560	243	82	243	15	60
		EVWTV1566	267	380	565	15	66
		EVWTV1572	281	109	301	15	72

# WORKSURFACES

# TRANSACTION

## EVWTCL - "L" CORNER TRANSACTION SURFACE

- When specifying this item along with a straight surface, deduct 12" from each return side.
- Support hardware must be ordered separately. See listing in this section of the price book.
- Worksurfaces greater than 48" wide require additional structural support.

DESCRIPTION	PRODUCT CODE	TF	PRICE		DIMENSIONS/INCHES	
			HP ADD	HPW ADD	D	W

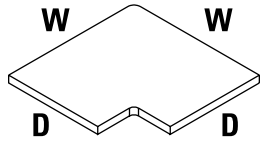

"L" Corner Transaction Surface	EVWTCL90	206	70	204	15	21
--------------------------------	----------	-----	----	-----	----	----

## EVWTCT - "T" CORNER TRANSACTION SURFACE

- When specifying this item along with a straight surface, deduct 12" from each return side.
- Support hardware must be ordered separately. See listing in this section of the price book.

DESCRIPTION	PRODUCT CODE	TF	PRICE		DIMENSIONS/INCHES	
			HP ADD	HPW ADD	D	W

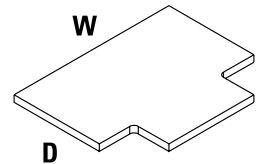

"T" Corner Transaction Surface	EVWTCT90	182	70	194	15	27
--------------------------------	----------	-----	----	-----	----	----

## EVWTE - END TRANSACTION SURFACE

- Extends 1" past end of run.
- Support hardware must be ordered separately. See listing in this section of the price book.

DESCRIPTION	PRODUCT CODE	TF	PRICE		DIMENSIONS/INCHES	
			HP ADD	HPW ADD	D	W

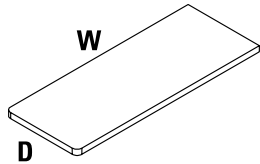

End Transaction Surface	EWWTE1512	94	36	97	15	14
	EWWTE1518	112	47	124	15	20
	EWWTE1524	134	52	140	15	26
	EWWTE1530	151	61	163	15	32
	EWWTE1536	172	69	183	15	38
	EWWTE1542	194	73	201	15	44
	EWWTE1548	211	82	228	15	50
	EWWTE1554	234	90	247	15	56
	EWWTE1560	250	99	277	15	62
	EWWTE1566	270	106	289	15	68
	EWWTE1572	290	112	311	15	74

## EVWTEV - END TRANSACTION SURFACE WITH CUT-OUT

- Used when mounted to a panel that has a taller panel against it in a straight run at an inline.
- Support hardware must be ordered separately. See listing in this section of the price book.
- Notched end is not finished.
- Extends 1" past end of run.

DESCRIPTION	PRODUCT CODE	TF	PRICE		DIMENSIONS/INCHES	
			HP ADD	HPW ADD	D	W

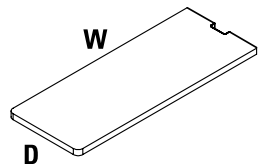

End Transaction Surface with Cut-Out	EVWTEV1524	141	57	149	15	26
	EVWTEV1530	163	59	167	15	32
	EVWTEV1536	183	69	193	15	38
	EVWTEV1542	204	75	216	15	44
	EVWTEV1548	224	81	232	15	50
	EVWTEV1554	243	94	257	15	56
	EVWTEV1560	267	95	277	15	62
	EVWTEV1566	281	110	302	15	68
	EVWTEV1572	302	117	321	15	74

# WORKSURFACES

# TRANSACTION

## EVWTD - "D" TRANSACTION SURFACE

- Support hardware must be ordered separately. See listing in this section of the price book.
- Worksurfaces greater than 48" wide require additional structural support.

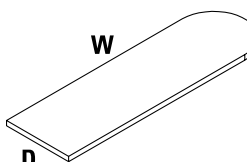
DESCRIPTION	PRODUCT CODE	TF	PRICE		DIMENSIONS/INCHES	
			HP ADD	HPW ADD	D	W
 "D" Transaction Surface	EVWTD1530	171	66	180	15	37
	EVWTD1536	182	71	195	15	43
	EVWTD1542	201	80	218	15	49
	EVWTD1548	224	86	234	15	55
	EVWTD1554	242	97	265	15	61
	EVWTD1560	267	101	281	15	67
	EVWTD1566	282	113	311	15	73
	EVWTD1572	310	124	336	15	79

## EVWTDV - END "D" TRANSACTION SURFACE WITH CUT-OUT

- Notched end is not finished.
- Used when mounted to a panel that has a taller panel against it in a straight run at an inline.
- Support hardware must be ordered separately. See listing in this section of the price book.

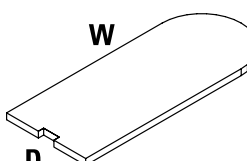
DESCRIPTION	PRODUCT CODE	TF	PRICE		DIMENSIONS/INCHES	
			HP ADD	HPW ADD	D	W
 End "D" Transaction Surface with Cut-Out	EVWTDV1530	182	64	185	15	37
	EVWTDV1536	194	71	198	15	43
	EVWTDV1542	214	79	221	15	49
	EVWTDV1548	235	87	244	15	55
	EVWTDV1554	250	95	266	15	61
	EVWTDV1560	277	104	289	15	67

## EVWTD - DOUBLE "D" TRANSACTION SURFACE

- Support hardware must be ordered separately. See listing in this section of the price book.

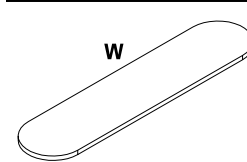
DESCRIPTION	PRODUCT CODE	TF	PRICE		DIMENSIONS/INCHES	
			HP ADD	HPW ADD	D	W
 Double "D" Transaction Surface	EVWTD1548	250	99	277	15	48
	EVWTD1560	290	112	311	15	60
	EVWTD1572	340	134	363	15	72

## EVW4T - CORNER TRANSACTION SURFACE FOR 45° POST

- Support hardware must be ordered separately. See listing in this section of the price book.

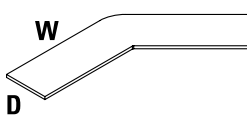
DESCRIPTION	PRODUCT CODE	TF	PRICE		DIMENSIONS/INCHES	
			HP ADD	HPW ADD	W	D
 Corner Transaction Surface for 45° Post	EWW4T1524	698	201	650	15	24
	EWW4T1530	870	254	815	15	30
	EWW4T1536	1218	353	1135	15	36
	EWW4T1542	1623	469	1511	15	42
	EWW4T1548	1739	502	1620	15	48

# WORKSURFACES

# TRANSACTION

## EVW6T - CORNER TRANSACTION SURFACE FOR 60° POST

- Support hardware must be ordered separately. See listing in this section of the price book.
- Worksurfaces greater than 48" wide require additional structural support.

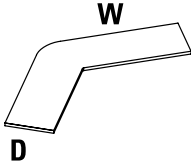
DESCRIPTION	PRODUCT CODE	TF	PRICE		DIMENSIONS/INCHES	
			HP ADD	HPW ADD	D	W
 Corner Transaction Surface for 60° Post	EWV6T1518	409	135	401	15	18
	EWV6T1524	639	217	638	15	24
	EWV6T1530	832	280	832	15	30
	EWV6T1536	1156	388	1157	15	36
	EWV6T1542	1259	423	1262	15	42
	EWV6T1548	1646	552	1650	15	48

## EVW9T - CORNER TRANSACTION SURFACE FOR 90° POST

- Support hardware must be ordered separately. See listing in this section of the price book.

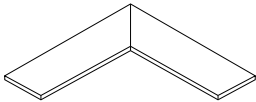
DESCRIPTION	PRODUCT CODE	TF	PRICE		DIMENSIONS/INCHES	
			HP ADD	HPW ADD	D	W
 Corner Transaction Surface for 90° Post - Left	EWV9TL1524	397	210	511	15	24
	EWV9TL1530	477	256	618	15	30
	EWV9TL1536	557	289	712	15	36
	EWV9TL1542	636	330	815	15	42
	EWV9TL1548	715	374	914	15	48
 Corner Transaction Surface for 90° Post - Right	EWV9TR1524	397	210	511	15	24
	EWV9TR1530	477	256	618	15	30
	EWV9TR1536	557	289	712	15	36
	EWV9TR1542	636	330	815	15	42
	EWV9TR1548	715	374	914	15	48

## EVWMP - WORKSURFACE MODESTY PANEL

- Modesty panel fastens to the worksurface and monoleg to provide additional privacy and support
- Made of cold rolled steel
- Metal finish is durable epoxy powder coated.

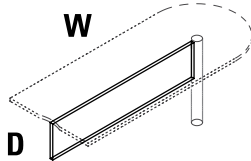
DESCRIPTION	PRODUCT CODE	LIST PRICE	DIMENSIONS/INCHES	
			D	W
 Worksurface Modesty Panel	EWVMP1242	136	12	26
	EWVMP1248	136	12	32
	EWVMP1260	162	12	44
	EWVMP1272	182	12	56

## EVHEP - END PANEL

- Supports the worksurface and enhances the stability of connected panels.
- Provides solid support at the end of a run of worksurfaces.
- Finished in thermally-fused laminate.
- Includes flat brackets and hardware.
- End panel height is inclusive of panel glides extended to their fullest height.
- If wood grains is selected, grain runs vertically.

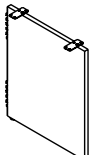
DESCRIPTION	PRODUCT CODE	LIST PRICE	DIMENSIONS/INCHES	
			D	H
 End Panel - 29" High	EVHEP2918	204	18	28
	EVHEP2924	300	24	28
	EVHEP2930	350	30	28

# WORKSURFACES

HEIGHT ADJUSTABLE

## EVWS - STRAIGHT WORKSURFACE - HEIGHT ADJUSTABLE

- Support hardware must be ordered separately. See listing in this section of the price book.
- There is no scoop in this worksurface.

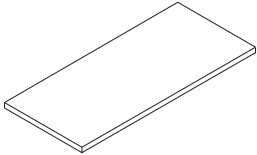
DESCRIPTION	PRODUCT CODE	LP	PRICE		DIMENSIONS/INCHES	
			HP ADD	HPW ADD	D	W
	EVWS2346	294	64	179	23	46
	EVWS2352	346	136	375	23	52
	EVWS2358	387	149	416	23	58
	EVWS2364	405	159	433	23	64
	EVWS2370	422	161	450	23	70
	EVWS2376	678	194	624	23	76
	EVWS2382	682	201	638	23	82
	EVWS2946	346	136	375	29	46
	EVWS2952	380	145	405	29	52
	EVWS2958	405	159	433	29	58
	EVWS2964	421	162	451	29	64
	EVWS2970	445	174	483	29	70
	EVWS2976	842	248	789	29	76
	EVWS2982	855	243	791	29	82

## EVWS - STRAIGHT WORKSURFACE - HEIGHT ADJUSTABLE RETURNS

- Support hardware must be ordered separately. See listing in this section of the price book.
- There is no scoop in this worksurface.

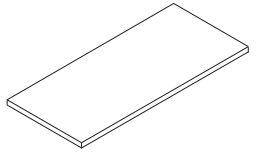
DESCRIPTION	PRODUCT CODE	LP	PRICE		DIMENSIONS/INCHES	
			HP ADD	HPW ADD	D	W
	EVWS2329	171	64	179	23	29
	EVWS2335	193	73	200	23	35
	EVWS2341	246	98	268	23	41
	EVWS2347	294	118	323	23	47
	EVWS2353	346	136	375	23	53
	EVWS2359	387	149	416	23	59
	EVWS2929	198	82	220	29	29
	EVWS2935	235	90	248	29	35
	EVWS2941	328	125	350	29	41
	EVWS2947	346	136	375	29	47
	EVWS2953	380	145	405	29	53
	EVWS2959	405	159	433	29	59

## EVWCC - CORNER SURVED WORKSURFACE - HEIGHT ADJUSTABLE

- Support hardware must be ordered separately. See listing in this section of the price book.
- There is no scoop in this worksurface.

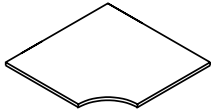
DESCRIPTION	PRODUCT CODE	LP	PRICE		DIMENSIONS/INCHES	
			HP ADD	HPW ADD	D	W
	EVWCC5223	1047	460	1051	23	52
	EVWCC5823	1394	565	1112	23	58
	EVWCC4629	966	416	1102	29	46
	EVWCC5229	1047	460	1051	29	52
	EVWCC5829	1394	565	1112	29	58

# WORKSURFACES

HEIGHT ADJUSTABLE

## EVWCCEL - EXTENDED CORNER WORKSURFACE - HEIGHT ADJUSTABLE

- Support hardware must be ordered separately. See listing in this section of the price book.
- There is no scoop in this worksurface.

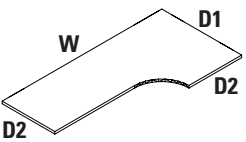
DESCRIPTION	PRODUCT CODE	LP	PRICE		DIMENSIONS/INCHES		
			HP ADD	HPW ADD	D1	D2	W
 <p>Extended Corner Worksurface</p>	EWWCCEL462358	982	234	840	46	23	58
	EWWCCEL462364	1058	292	970	46	23	64
	EWWCCEL462370	1137	340	1075	46	23	70
	EWWCCEL462376	1247	328	1112	46	23	76
	EWWCCEL462382	1301	373	1201	46	23	82
	EWWCCEL522358	1148	523	1027	52	23	58
	EWWCCEL522364	1234	574	1128	52	23	64
	EWWCCEL522370	1322	624	1232	52	23	70
	EWWCCEL522376	1497	730	1439	52	23	76
	EWWCCEL522382	1676	834	1641	52	23	82
	EWWCCEL582364	1262	573	1128	58	23	64
	EWWCCEL582370	1357	631	1242	58	23	70
	EWWCCEL582376	1573	746	1467	58	23	76
	EWWCCEL582382	1785	868	1711	58	23	82
	EWWCCEL462958	1036	300	965	46	29	58
	EWWCCEL462964	1127	329	1056	46	29	64
EWWCCEL462970	1225	353	1136	46	29	70	
EWWCCEL462976	1316	380	1227	46	29	76	
EWWCCEL462982	1387	401	1294	46	29	82	
EWWCCEL522958	1192	541	1068	52	29	58	
EWWCCEL522964	1282	598	1174	52	29	64	
EWWCCEL522970	1375	651	1279	52	29	70	
EWWCCEL522976	1558	759	1493	52	29	76	
EWWCCEL522982	1741	867	1707	52	29	82	
EWWCCEL582964	1349	621	1222	58	29	64	
EWWCCEL582970	1444	679	1335	58	29	70	
EWWCCEL582976	1635	791	1556	58	29	76	
EWWCCEL582982	1829	904	1777	58	29	82	

# WORKSURFACES

HEIGHT ADJUSTABLE

## EWCER - EXTENDED CORNER WORKSURFACE - HEIGHT ADJUSTABLE

- Support hardware must be ordered separately. See listing in this section of the price book.
- There is no scoop in this worksurface.

	DESCRIPTION	PRODUCT CODE	PRICE			DIMENSIONS/INCHES		
			LP	HP ADD	HPW ADD	D1	D2	W
	Extended Corner Worksurface	EWCER462358	982	234	840	46	23	58
		EWCER462364	1058	292	970	46	23	64
		EWCER462370	1137	340	1075	46	23	70
		EWCER462376	1247	328	1112	46	23	76
		EWCER462382	1301	373	1201	46	23	82
		EWCER522358	1148	523	1027	52	23	58
		EWCER522364	1234	574	1128	52	23	64
		EWCER522370	1322	624	1232	52	23	70
		EWCER522376	1497	730	1439	52	23	76
		EWCER522382	1676	834	1641	52	23	82
		EWCER582364	1262	573	1128	58	23	64
		EWCER582370	1357	631	1242	58	23	70
		EWCER582376	1573	746	1467	58	23	76
		EWCER582382	1785	868	1711	58	23	82
		EWCER462958	1036	300	965	46	29	58
		EWCER462964	1127	329	1056	46	29	64
		EWCER462970	1225	353	1136	46	29	70
		EWCER462976	1316	380	1227	46	29	76
		EWCER462982	1387	401	1294	46	29	82
		EWCER522958	1192	541	1068	52	29	58
		EWCER522964	1282	598	1174	52	29	64
		EWCER522970	1375	651	1279	52	29	70
		EWCER522976	1558	759	1493	52	29	76
		EWCER522982	1741	867	1707	52	29	82
		EWCER582964	1349	621	1222	58	29	64
		EWCER582970	1444	679	1335	58	29	70
		EWCER582976	1635	791	1556	58	29	76
		EWCER582982	1829	2730	3606	58	29	82

# WORKSURFACES

# HEIGHT ADJUSTABLE

## EVWS - EXTENDED CURVED CORNER RETURN - HEIGHT ADJUSTABLE

- Support hardware must be ordered separately. See listing in this section of the price book.
- There is no scoop in this worksurface.

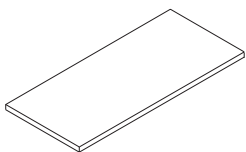
DESCRIPTION	PRODUCT CODE	LP	PRICE		DIMENSIONS/INCHES D W
			HP ADD	HPW ADD	
 Extended Corner Worksurface	EWWS2324	160	59	165	23 24
	EWWS2336	171	64	179	23 36
	EWWS2348	193	73	200	23 38
	EWWS2924	188	69	195	23 24
	EWWS2936	198	82	220	23 36
	EWWS2948	235	90	248	23 48

## EVWC6C - 60 DEGREE CURVED CORNER WORKSURFACE - HEIGHT ADJUSTABLE

- Support hardware must be ordered separately. See listing in this section of the price book.
- There is no scoop in this worksurface.

DESCRIPTION	PRODUCT CODE	LP	LIST PRICE		DIMENSIONS/INCHES D W
			HP ADD	HPW ADD	
 Curved Corner Worksurface	EWWC6C2346	1592	214	1115	23 46
	EWWC6C2352	1700	832	1641	23 52
	EWWC6C2946	1592	214	1115	29 46
	EWWC6C2952	1700	832	1641	29 52

# WORKSURFACES

# ACCESSORIES

### EVTHLEG - EVOLVE BRIDGES LEG

- Leg assembly attaches to panel for application which requires functionality of panels with environment of bridges tables.
- One leg with horizontal member connection to 1" increment slots in connector. Provides support to panel and panel connected worksurface at end of run- design coordinated with Bridges freestanding tables.
- Supports 24" and 30" deep worksurface
- One leg can support 2 adjoining worksurfaces by specifying 2 flat brackets.
- Leveling glides is standard
- No worksurface supporting beams, use panel cantilever and storage for worksurface support.
- One aluminum leg with steel structure - specify left or right and 24" or 30" deep for corresponding worksurface depth.
- Panel bracket, dislodgment clip and worksurface hardware included.
- Anodized aluminum upcharge \$32.00.
- Please specify paint finish.

	DESCRIPTION	PRODUCT CODE	LIST PRICE	DIMENSIONS/INCHES		
				H	D	W
	Evolve Bridges Leg	EVTHLEG24LL	470	29	2.5	24
		EVTHLEG24RL	470	29	2.5	24
		EVTHLEG30LL	493	29	2.5	30
		EVTHLEG30RL	493	29	2.5	30

### EVHPL - EVOLVE PRINCETON LEG

- Princeton leg supports Evolve worksurfaces
- Includes leveling glides
- Legs must used with exact depth worksurfaces only
- Available in standard paint finishes

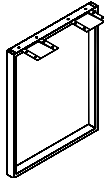
	DESCRIPTION	PRODUCT CODE	LIST PRICE	DIMENSIONS/INCHES		
				H	D	W
	Evolve Princeton Leg	EVHPL24	448	27.5	6.75	24
		EVHPL30	465	27.5	6.75	30

### EVHPL - EVOLVE PRINCETON LEG WITH BRACKET

- Bracket attaches to back of Princeton leg and connects Princeton leg to panel connector
- Supports the worksurface and enhance stability of connected panels
- Includes levelling glides
- Available in standard paint finishes

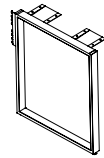
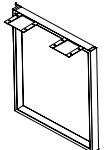
	DESCRIPTION	PRODUCT CODE	LIST PRICE	DIMENSIONS/INCHES		
				H	D	W
	Evolve Princeton Leg with Left Bracket	EVHPL24L	493	27.5	6.75	24
		EVHPL30L	509	27.5	6.75	30
	Evolve Princeton Leg with Right Bracket	EVHPL24R	493	27.5	6.75	24
		EVHPL30R	509	27.5	6.75	30

# WORKSURFACES

# ACCESSORIES

### EVHMEGR - METAL END GABLE ROUND LEG - NO HANDED

- Support the worksurface and enhances the stability of connected panels.
- Includes a leveling glide and decorative PVC sleeve to cover the glide.
- Attaches to Evolve Panels connectors.
- Available in standard paint colors.
- Mounting bracket is universal (LH or RH), attached with screws to back of leg.
- Note: No sharing, please use EVHMSSL12 for sharing

DESCRIPTION	PRODUCT CODE	LIST PRICE	DIMENSIONS/INCHES		
			H	W	D
Metal End Gable Round Leg No Handed	EVHMEGR24	313	29	2	23
	EVHMEGR30	329	29	2	29



### EVHMEGS - METAL END GABLE SQUARE LEG - NO HANDED

- Support the worksurface and enhances the stability of connected panels.
- Includes a leveling glide and decorative PVC sleeve to cover the glide.
- Attaches to Evolve Panels connectors.
- Available in standard paint colors.
- Mounting bracket is universal attached with screws to back of leg.

DESCRIPTION	PRODUCT CODE	LIST PRICE	DIMENSIONS/INCHES		
			H	W	D
Metal End Gable Round Leg No Handed	EVHMEGS24	277	29	2	23
	EVHMEGS30	294	29	2	29

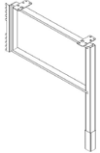

### EVHMSSL - METAL SUPPORT LEG

- Supports two adjoining worksurfaces and enhances the stability of connected panels.
- Includes a levelling glide and decorative PVC sleeve to cover the glide.
- Leveling glide may be extended up to 1 1/2" maximum.
- Flat brackets recommended to ensure alignment of neighboring surface.
- Available in standard paint colors.
- Not designed for use at the end of a worksurface.
- Handedness of support leg cannot be changed.
- Not designed to be used with radius worksurfaces.

DESCRIPTION	PRODUCT CODE	LIST PRICE	DIMENSIONS/INCHES		
			H	W	D
Metal Support Leg	EVHMSSL12	264	28	11	4

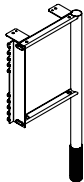

### EVHMSSL - METAL SUPPORT SQUARE LEG

- Support two adjoining worksurfaces and enhances the stability of connected panels.
- Includes a leveling glide and decorative PVC sleeve to cover the glide.
- Attaches to Evolve Panels.
- Available in standard paint colors.

DESCRIPTION	PRODUCT CODE	LIST PRICE	DIMENSIONS/INCHES		
			H	W	D
Metal Support Square Leg	EVHMSSL12	238	29	2	11



# WORKSURFACES

# ACCESSORIES

## EVHC - CANTILEVER FOR KEYBOARD WORKSURFACES

- Attaches a worksurface to a panel connector.
- Used to support two convergent worksurfaces.
- 2 flat brackets are included.
- Priced individually
- Specify handedness of each cantilever
- Available in standard paint colors.

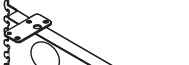
	DESCRIPTION	PRODUCT CODE	LIST PRICE	DIMENSIONS/INCHES	
				D	W
	Cantilever for Keyboard Worksurfaces	EVHC12L/R	118	12	6
		EVHC18L/R	118	18	6
		EVHC24L/R	135	24	6

## EVHS - SUPPORT LEG

- Used in conjunction with a EVHC cantilever.
- Provides extra support where needed.
- Used to help support two convergent worksurfaces.
- Available in standard paint colors.

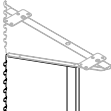
	DESCRIPTION	PRODUCT CODE	LIST PRICE	DIMENSIONS/INCHES		
				H	W	D
	Support Leg - Left	EVHSL2918	110	23.38	0.75	12.5
		EVHSL2924	110	23.38	0.75	12.5
	Support Leg - Right	EVHSR2918	110	23.38	0.75	12.5
		EVHSR2924	110	23.38	0.75	12.5

## EVHCL - CORNER LEG WITH LEVELER

- Provides support for a worksurface.
- Includes leveling glide, PVC Sleeve and attachment plate.
- Leveling glide may be extended up to 1 1/2" maximum.
- 1.5" diameter
- Available in standard paint colors.
- Legs can be used in the corner of a single worksurface or be rotated 45 degrees to support the corners of two worksurfaces.

	DESCRIPTION	PRODUCT CODE	LIST PRICE	DIMENSIONS/INCHES
				H
	Corner Leg Round	EVHCL1	140	28
	Corner Leg Square	EVHCL2	140	28

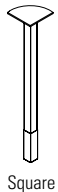

## EVHMSL - MID SUPPORT LEG

- Provides support for a worksurface.
- Includes leveling glide, PVC Sleeve and 4.8" x 4.8" attachment plate.
- Leveling glide may be extended up to 1 1/2" maximum.
- 1.5" diameter.
- Available in standard paint colors.

	DESCRIPTION	PRODUCT CODE	LIST PRICE	DIMENSIONS/INCHES
				H
	Mid Support Leg - Round	EVHMSL1	101	28
	Mid Support Leg - Square	EVHMSL2	101	28

# WORKSURFACES

# ACCESSORIES

## EVHMSL - MID SUPPORT LEG

- Provides additional support for worksurface.
- Includes leveling glide, PVC Sleeve and 4.8" x 4.8" attachment plate.
- 1.5" square tube.
- Available in standard paint colors.

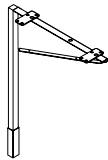
	DESCRIPTION	PRODUCT CODE	LIST PRICE	DIMENSIONS/INCHES		
				H	W	D
	Mid Support Leg - Cantilever Bracket	EVHMSCL18	162	28	18	1.5

## EVWS - 5" SURFACE TO STORAGE SUPPORT LEG

- Provides support for a worksurface.
- Includes leveling glide, PVC Sleeve and 4.8" x 4.8" attachment plate.
- 1.5" diameter.
- Available in standard paint colors.

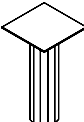
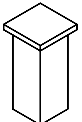
	DESCRIPTION	PRODUCT CODE	LIST PRICE	DIMENSIONS/INCHES		
				H	W	D
	5" Surface to Storage Support Leg - Round	EVWSRL01	63	4.5		
	5" Surface to Storage Support Leg - Square	EVWSSL01	63	4.5		

Round                      Square

## EVHCB - CORNER BRACKETS

- Attaches the corner of any worksurface to a panel connector.
- Priced and shipped in pairs.

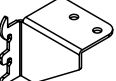
	DESCRIPTION	PRODUCT CODE	LIST PRICE	DIMENSIONS/INCHES	
				D	W
	Corner Brackets	EVHCB2	34	2.5	3.5

## EVHTB - TRANSACTION BRACKETS

- Securely attaches a transaction surface to the top of a panel.
- One pair must be on each side of transaction surface.
- Priced and shipped in pairs.
- Available in standard paint colors.

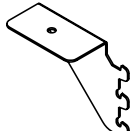
	DESCRIPTION	PRODUCT CODE	LIST PRICE	DIMENSIONS/INCHES	
				D	W
	Transaction Brackets	EVHTB2	34	2.5	3.5

# WORKSURFACES

# ACCESSORIES

### EVHFB - FLAT BRACKET

- Must be used in conjunction with cantilevers or transaction brackets to ensure alignment of neighboring surfaces.
- Available in Black only.
- Priced individually

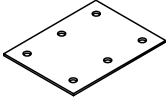
	DESCRIPTION	PRODUCT CODE	LIST PRICE	DIMENSIONS/INCHES	
				D	W
	Flat Bracket	EVHFB1	23	3	4

### EVHCFB1- TIE PLATE

- Must be used in conjunction with cantilever or transaction brackets to ensure alignment of neighboring surfaces.
- Available in black only.
- Aligns with threaded metal inserts in worksurfaces.
- Priced individually.

	DESCRIPTION	PRODUCT CODE	LIST PRICE	DIMENSIONS/INCHES	
				D	W
	Tie Plate	EVHCFB1	23	1.5	3.36

### EVHPB - PEDESTAL BRACKET

- Attaches to back edge of a pedestal and connects a pedestal to panel connector.
- Available in standard paint colors.

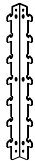
	DESCRIPTION	PRODUCT CODE	LIST PRICE	DIMENSIONS/INCHES	
				H	
	Pedestal Bracket	EVHPB1	39	11	

### EVHWSC - WORKSURFACE SUPPORT CHANNEL

- Support channel attaches to underside of worksurface with screws
- Support channel should be 14" shorter than top length.
- Screws are included.
- Only available in Black.
- Tops with post legs should be specified with support channel for structural reinforcement.

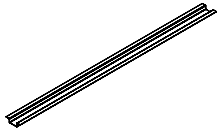
	DESCRIPTION	PRODUCT CODE	LIST PRICE	DIMENSIONS/INCHES	
				L	D
	Worksurface Support Channel	EVHWSC40 - for 54" wide table	86	40	5
		EVHWSC46 - for 60" wide table	93	46	5
		EVHWSC52 - for 66" wide table	99	52	5
		EVHWSC58 - for 72" wide table	112	58	5
		EVHWSC64 - for 78" wide table	125	64	5
		EVHWSC70 - for 84" wide table	136	70	5

# WORKSURFACES

# ACCESSORIES

### EVHWCB1 - WORKSURFACE TO STORAGE BRACKETS

- Bracket connects Worksurface to Storage Towers as additional support.
- Bracket EVHWCB1 cannot fully support a Worksurface. It is to be used in conjunction with a Cantilever.
- Available in standard paint colors.

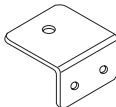
	DESCRIPTION	PRODUCT CODE	LIST PRICE	DIMENSIONS/INCHES		
				H	D	W
	Worksurface to Storage Brackets	EVHWCB1	14	1.25	2	2

### EVHV - SINGLE SLOTTED WALL ADAPTER

- To attach system components to a fixed wall. The vertical wall adapter is a “U” shaped channel with a vertical row of 1” slots in center.
  - Mounting hardware not included. Mounting hardware selection to be based on wall material.
  - Use of wall rack requires lower tooth of top hook on cantilever or shelf to be notched in the field.
  - Available in standard paint colors.
  - Shipped & priced per pair.
- NOTE:**
- Care should be taken to mount adapters only to wall studs using correct fasteners. Failure to do this may result in collapse of the unit and subsequent possible personal injury.

	DESCRIPTION	PRODUCT CODE	LIST PRICE	DIMENSIONS/INCHES	
				H	D
	Single Slotted Wall Track	EVHV01	99	60	.5

### EVDCP - CENTRAL SUPPORT PANEL

- Supports and connects 2 worksurfaces
- Includes two end panel brackets, two levelling glides and modesty inter connect bracket (EVDECCR)
- Attaches to modesty panel
- End panel height is inclusive of panel glides extended to their fullest height
- All Freestanding products are available in thermally fused thickness only.

	DESCRIPTION	PRODUCT CODE	LIST PRICE	DIMENSIONS/INCHES	
				W	H
	Central Support Panel	EVDCP2910	193	10	28
		EVDCP2914	243	14	28
		EVDCP2610	172	10	28
		EVDCP2614	228	14	28

# WORKSURFACES

# ACCESSORIES

### EVDHMSB - MID SUPPORT BRACKET

- Provides mid support for worksurfaces
- Recommended for any lengths over 42"
- Available in black only.

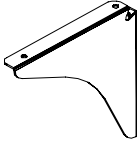
	DESCRIPTION	PRODUCT CODE	LIST PRICE	DIMENSIONS/INCHES		
				D	W	H
	Mid Support Bracket	EVDHMSB	59	7 1/2	7 1/2	1/2

### EVDECCR - MODESTY INTER-CONNECT BRACKET

- Attaches two modesty panels to a mid support panel

	DESCRIPTION	PRODUCT CODE	LIST PRICE	DIMENSIONS/INCHES	
				W	H
	Modesty Inter-Connect Bracket	EVDECCR	33	12 1/2	4

### EVDHLB - END PANEL "L" BRACKET

- Attaches a modesty panel to an end panel
- Available in black only.

	DESCRIPTION	PRODUCT CODE	LIST PRICE	DIMENSIONS/INCHES		
				D	W	H
	End Panel "L" Bracket	EVDHLB	34	1 1/2	12	1 1/2



# freestanding

# FREESTANDING DESKING

# CHASSIS

## EVWFR - RECTANGULAR FREESTANDING WORKSURFACE WITH CORNER LEGS

- Worksurface include 6 threaded-metal inserts in corners, to allow for metal-to-metal connections.
- Worksurface is available in 1-1/16" thick High Pressure laminate only.
- Legs are 1.5" diameter and include leveling glide, PVC sleeve and attachment plate. PVC sleeve available in Evolve standard colors only.
- Legs can be used in the corner of a single worksurface, or rotated 45 degrees to support the corners of two worksurfaces.
- Ships Knocked Down.
- All Freestanding products are available in thermally fused thickness only.

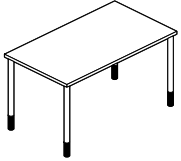
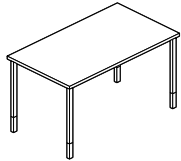
	DESCRIPTION	PRODUCT CODE	LIST PRICE	DIMENSIONS/INCHES		
				D	W	H
	Rectangular Freestanding Worksurface with Round Corner Legs	EWWFR2448HP	951	24	48	29
		EWWFR2460HP	1102	24	60	29
		EWWFR3048HP	1035	30	48	29
		EWWFR3060HP	1133	30	60	29
	Rectangular Freestanding Worksurface with Square Corner Legs	EWWFRS2448HP	951	24	48	29
		EWWFRS2460HP	1102	24	60	29
		EWWFRS3048HP	1035	30	48	29
		EWWFRS3060HP	1133	30	60	29

## EVWFS - SQUARE FREESTANDING WORKSURFACE WITH CORNER LEGS

- Worksurface include 6 threaded-metal inserts in corners, to allow for metal-to-metal connections.
- Worksurface is available in 1-1/16" thick High Pressure laminate only.
- Legs are 1.5" diameter and include leveling glide, PVC sleeve and attachment plate. PVC sleeve available in Evolve standard colors only.
- Legs can be used in the corner of a single worksurface, or rotated 45 degrees to support the corners of two worksurfaces.
- Ships Knocked Down.
- All Freestanding products are available in thermally fused thickness only.

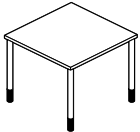
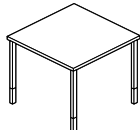

	DESCRIPTION	PRODUCT CODE	LIST PRICE	DIMENSIONS/INCHES		
				D	W	H
	Square Freestanding Worksurface with Round Corner Legs	EWWFS36HP	1005	36	36	29
		EWWFS42HP	1153	42	42	29
		EWWFS48HP	1362	48	48	29
	Square Freestanding Worksurface with Square Corner Legs	EWWFSS36HP	1005	36	36	29
		EWWFSS42HP	1153	42	42	29
		EWWFSS48HP	1362	48	48	29

# FREESTANDING DESKING

# CHASSIS

## EVWFC - ROUND FREESTANDING WORKSURFACE WITH CORNER LEGS

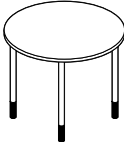
- Worksurface include 6 threaded-metal inserts in corners, to allow for metal-to-metal connections.
- Worksurface is available in 1-1/16" thick High Pressure laminate only.
- Legs are 1.5" diameter and include leveling glide, PVC sleeve and attachment plate.
- Legs can be used in the corner of a single worksurface, or rotated 45 degrees to support the corners of two worksurfaces.
- Ships Knocked Down.
- All Freestanding products are available in thermally fused thickness only.

	DESCRIPTION	PRODUCT CODE	LIST PRICE	DIMENSIONS/INCHES	
				W	H
	Round Freestanding Worksurface with Corner Legs	EWWFC36HP	1072	36	29
		EWWFC42HP	1289	42	29
		EWWFC48HP	1537	48	29
	Round Freestanding Worksurface with Square Corner Legs	EWWFCS36HP	1072	36	29
		EWWFCS42HP	1289	42	29
		EWWFCS48HP	1537	48	29



# storage

# STORAGE

# TECHNICAL INFORMATION

## PRIME FILE FEATURES

- **THE LETTER "P" IN THE MODEL NUMBER DESIGNATES FULL PULL MODELS.**
- An earth friendly electrostatically applied coating protects the environment and provides a durable finish.
- Master keys and core keys are available; please contact your Global customer care representative.
- Five lateral file drawer configurations are available: two-high, three-high, four-high, five-high and six-high, all available in three height options (with the exception of the six-high cabinet which is available in letter-height only).
- STANDARD LOCK BARS ARE ON BOTH SIDES OF CABINET PROVIDING INCREASED SECURITY.
- A patented interlocking system prevents more than one drawer opening at a time to guard against tipping.
- An optional, fully-retractable posting shelf is available for five- and six-high lateral file cabinets to provide a convenient ledge.
- All drawer heights are based on a 1.6" module (the size of the posting shelf), then 3.2", 4.8", 6.4" to up to 16".
- The interior construction of the case permits drawer reconfiguration or retrofit at any time.
- Full extension ball bearing suspension with built-in feature to prevent drawer bounce back and creepage.
- 14.4"H Openings (with receding doors) will accommodate letter, legal and A4 hanging folders, plus STANDARD THREE RING BINDERS.
- 13.6"H Openings (with fixed drawer fronts) will accommodate letter, legal and A4 hanging folders, plus EDP SUSPENDED DATA BINDERS.
- 11.2"H Openings (with receding doors or fixed drawer fronts) will accommodate letter, legal or A4 hanging file folders.
- **DRAWER FRONTS HAVE A WELDED REINFORCEMENT CHANNEL FOR ADDITIONAL STRENGTH.**
- Four adjustable leveling glides are easily accessible from inside the cabinet to assist in quick and proper installation, with 1" adjustment.
- Label holders are included with full pull fronts to clearly identify the contents of each drawer.
- All lateral file accessories are Grey, except for the divider plates and EDP adapters are Black.
- Side-to-side hanging file bars permit hanging letter-, legal- or metric-size files in side-to-side arrangements
- Front-to-back file bars permit hanging letter-, legal- or metric-size files in a front-to-back arrangement. They are shipped in packages of two.
- **Counterweights are required for all cabinets with pull-out drawers and cabinets not located directly under a worksurface.**
- For environmental certifications, please visit [globalfurnituregroup.com](http://globalfurnituregroup.com)
- Lifetime Warranty. (See Terms and Conditions)

## STANDARD PAINT COLORS

Black (BLK)	Blizzard (BZD)	Charcoal (CHR)
Designer White (DWT)	Fog (FOG)	Nevada (NEV)
Silver (SIL)	Stone Dust (SDT)	Taupe (TPE)
Tungsten (TUN)*		

\*10% upcharge applies.

## PREMIUM PAINT COLORS\*\*

Black Coffee (BKC)	Bone (BNE)	Business Grey (BGR)
Claret (CLT)	Dark Chocolate (DCH)	Desert Putty (DPT)
Grey (GRY)	Ice (ICE)	Ivory (IVR)
Light Grey (LGR)	Metro (ME)	Mocha (MCH)
Moss (MOS)	Navy (NVY)	Oyster (OYS)
Sky (SKY)	Stone (STN)	Storm Grey (SGR)
Tahiti Sand (TSA)	Willow (WIL)	

- \*\*Extended lead times for premium paints apply. Contact Evolve Customer Support for details.
- Global matte paint finishes are available on most Evolve Storage pieces without an up charge regardless of quantities.
- All Mica and Metallic paint finishes will incur a minimum up charge of 10%.
- All non-standard paint finishes must be approved by Evolve prior to placing an order.

## GENERAL WARRANTY INFORMATION

- Evolve warrants all components of metal storage and filing for the lifetime of the product to the original purchaser.

This page provides a three dimensional view of a sample configuration highlighting each storage component required when specifying this configuration.

**Components**

- A. UUPFSBG Box, Box, File Pedestal
- B. UUKSS Low-Profile Shelf
- C. UULSF Overhead Flipper Door Storage Unit

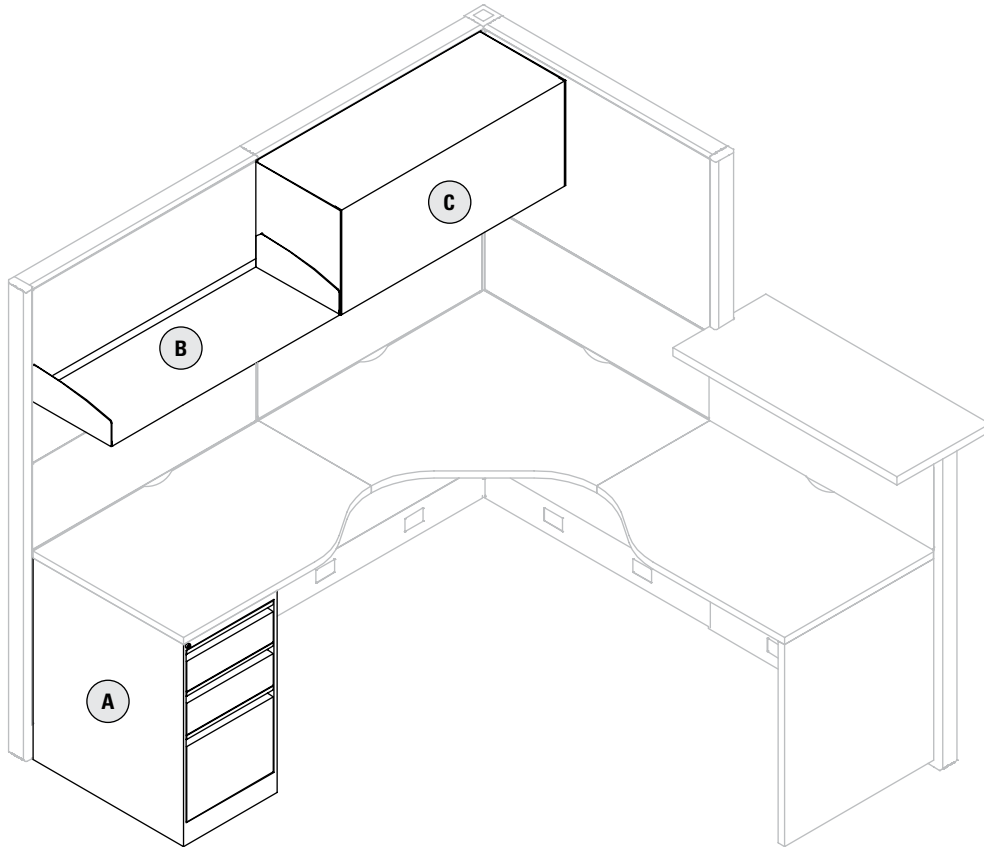

# STORAGE

# TECHNICAL INFORMATION

## INTERIOR CLEAR OPENING WIDTH DIMENSIONS AND FILING CAPACITY

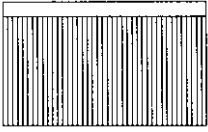
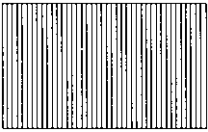
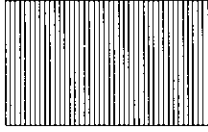
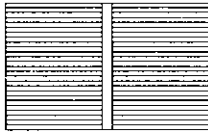
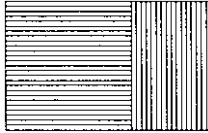
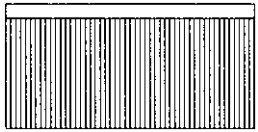
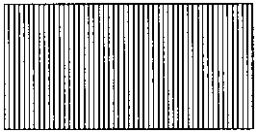
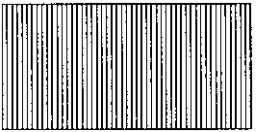
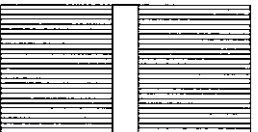
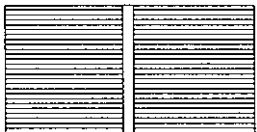
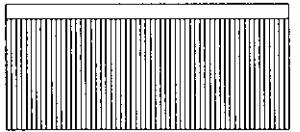
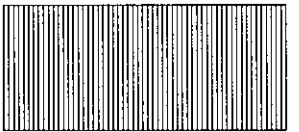
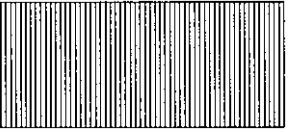
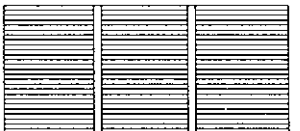
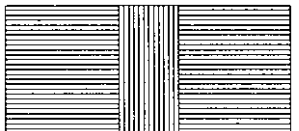
	Letter	Legal	EDP
<p><b>30" Wide Units</b> side-to-side</p> <p>UULFA01 side-to-side file bars are included in standard product.</p>	 Capacity - 26 5/8"	 Capacity - 26 5/8"	 Capacity - 26 5/8" <b>Need ONE pair of EDPs.</b>
	<p><b>30" Wide Units</b> front-to-back</p> <p><b>Not Standard</b> See chart to order the correct number of UULFA0718 per drawer.</p>  Prime - 30 1/2" <b>Need ONE pair of UULFA01 &amp; UULFA0718</b>	 Prime - 15 1/4" + 10" side space <b>Need ONE pair of UULFA01 &amp; UULFA0718</b>	NOT AVAILABLE
<p><b>36" Wide Units</b> side-to-side</p> <p>UULFA02 side-to-side file bars are included in standard product.</p>	 Capacity - 32 5/8"	 Capacity - 32 5/8"	 Capacity - 32 5/8" <b>Need ONE pair EDPs.</b>
	<p><b>36" Wide Units</b> front-to-back</p> <p><b>Not Standard</b> See chart to order the correct number of UULFA0718 per drawer.</p>  Prime - 30 1/2" + 6 1/2" side space <b>Need ONE pair of UULFA02 &amp; UULFA0718</b>	 Prime - 30 1/2" <b>Need ONE pair of UULFA02 &amp; UULFA0718</b>	NOT AVAILABLE
<p><b>42" Wide Units</b> side-to-side</p> <p>UULFA03 side-to-side file bars are included in standard product.</p>	 Capacity - 38 5/8"	 Capacity - 38 5/8"	 Capacity - 38 5/8" <b>Need ONE pair EDPs.</b>
	<p><b>42" Wide Units</b> front-to-back</p> <p><b>Not Standard</b> See chart to order the correct number of UULFA0718 per drawer.</p>  Prime - 45 3/4" <b>Need TWO pairs of UULFA03 &amp; UULFA0718</b>	 Prime - 30 1/2" + 6 1/2" side space 16 <b>Need TWO pairs of UULFA03 &amp; UULFA0718</b>	NOT AVAILABLE

# STORAGE

# PRIME OVERHEAD STORAGE

## UULSF - OVERHEAD FLIPPER DOOR STORAGE UNIT

- Door retracts inside of cabinet.
- Ships fully assembled.
- Inside depth: 12.7".
- 54" and 60" wide models have two doors and two locks.
- Lock is included.

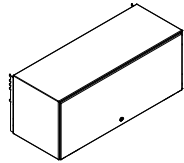

DESCRIPTION	PRODUCT CODE	LIST PRICE	DIMENSIONS/INCHES		
			H	D	W
Overhead Flipper Door Storage Unit	UULSF1324	742	14.6	13.5	24
	UULSF1330	753	14.6	13.5	30
	UULSF1336	776	14.6	13.5	36
	UULSF1342	817	14.6	13.5	42
	UULSF1348	870	14.6	13.5	48
	UULSF1354	921	14.6	13.5	54
	UULSF1360	971	14.6	13.5	60

## UULSF - OVERHEAD FLIPPER DOOR STORAGE UNIT

- Inside depth: 15.7".
- Ships fully assembled.
- Door retracts inside storage unit.
- 54" and 60" wide models have two doors and two locks.
- Lock is included.

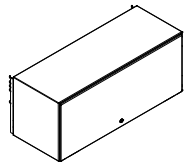

DESCRIPTION	PRODUCT CODE	LIST PRICE	DIMENSIONS/INCHES		
			H	D	W
Overhead Flipper Door Storage Unit - Fully Assembled	UULSF1624	983	14.6	16.5	24
	UULSF1630	1007	14.6	16.5	30
	UULSF1636	1058	14.6	16.5	36
	UULSF1642	1125	14.6	16.5	42
	UULSF1648	1198	14.6	16.5	48
	UULSF1654	1266	14.6	16.5	54
	UULSF1660	1319	14.6	16.5	60

# STORAGE

# LAMINATE OVERHEAD STORAGE

## EVS4DOH - LAMINATE OVERHEAD WITH HINGED DOOR

- Inside height - 13".
- Inside depth - 14".
- Laminate storage cabinet, available in standard Evolve laminate finishes.
- Hardware included to mount unit on the panels.
- Can be panel mounted or wall mounted.

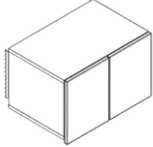
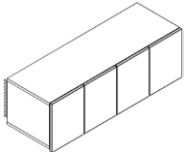
	DESCRIPTION	PRODUCT CODE	LIST PRICE	DIMENSIONS/INCHES		
				H	D	W
	Laminate Overhead with Two Hinged Doors	EVS4DOH24	1283	14.5	16.5	24
		EVS4DOH30	1460	14.5	16.5	30
		EVS4DOH36	1550	14.5	16.5	36
		EVS4DOH42	1746	14.5	16.5	42
	Laminate Overhead with Four Hinged Doors	EVS4DOH48	1946	14.5	16.5	48
		EVS4DOH54	2428	14.5	16.5	54
		EVS4DOH60	2518	14.5	16.5	60
		EVS4DOH66	2639	14.5	16.5	66
		EVS4DOH72	2699	14.5	16.5	72

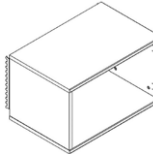
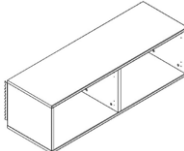

## EVSOPOH - LAMINATE OVERHEAD OPEN

- Inside height - 13".
- Inside depth - 14".
- Laminate storage cabinet, available in standard Evolve laminate finishes.
- Hardware included to mount unit on the panels.
- Can be panel mounted or wall mounted.

	DESCRIPTION	PRODUCT CODE	LIST PRICE	DIMENSIONS/INCHES		
				H	D	W
	Laminate Overhead without Divider	EVSOPOH24	885	14.5	16.5	24
		EVSOPOH30	980	14.5	16.5	30
		EVSOPOH36	1069	14.5	16.5	36
		EVSOPOH42	1160	14.5	16.5	42
	Laminate Overhead with Divider	EVSOPOH48	1374	14.5	16.5	48
		EVSOPOH54	1415	14.5	16.5	54
		EVSOPOH60	1505	14.5	16.5	60
		EVSOPOH66	1596	14.5	16.5	66
		EVSOPOH72	1686	14.5	16.5	72

## EVSGDH - LAMINATE OVERHEAD WITH SLIDING GLASS DOOR

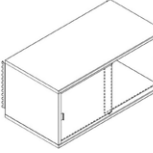
- Inside height - 13".
- Inside depth - 12.5".
- Laminate storage cabinet, available in standard Evolve laminate finishes.
- Available in Tempered Frosted Glass only, with handle.
- Tracks for sliding glass available in Tungsten only.
- Hardware included to mount unit on the panels.
- Can be panel mounted or wall mounted.

	DESCRIPTION	PRODUCT CODE	LIST PRICE	DIMENSIONS/INCHES		
				H	D	W
	Laminate Overhead without Divider	EVSGDH24	2558	14.5	16.5	24
		EVSGDH30	2771	14.5	16.5	30
		EVSGDH36	2956	14.5	16.5	36
		EVSGDH42	3154	14.5	16.5	42
	Laminate Overhead with Divider	EVSGDH48	3414	14.5	16.5	48
		EVSGDH54	3617	14.5	16.5	54
		EVSGDH60	3809	14.5	16.5	60
		EVSGDH66	4093	14.5	16.5	66
		EVSGDH72	4334	14.5	16.5	72

# STORAGE

# LDOUBLE WALL OVERHEAD STORAGE

## EVSDAOH - DUAL ACCESS OVERHEAD

- Inside dimensions 13"high x 13"deep.
- Laminate Overhead. Available in standard Evolve laminate finishes
- Top mount on panels.
- Dual Access Overhead Support Brackets to be ordered separately.

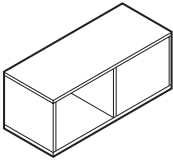
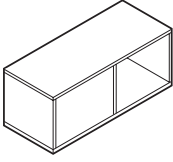
	DESCRIPTION	PRODUCT CODE	LIST PRICE	DIMENSIONS/INCHES		
				H	D	W
	Dual Access Overhead - Left	EVSDAOHL36	1127	15	14.125	36
		EVSDAOHL42	1224	15	14.125	42
		EVSDAOHL48	1279	15	14.125	48
		EVSDAOHL54	1377	15	14.125	54
		EVSDAOHL60	1430	15	14.125	60
	Dual Access Overhead - Right	EVSDAOHR36	1127	15	14.125	36
		EVSDAOHR42	1224	15	14.125	42
		EVSDAOHR48	1279	15	14.125	48
		EVSDAOHR54	1377	15	14.125	54
		EVSDAOHR60	1430	15	14.125	60

## EVSDAOHOS - DUAL ACCESS OVERHEAD WITH OPENING TO ONE SIDE

- Inside dimensions 13"high x 13"deep
- Laminate Overhead
- Available in standard Evolve laminate finishes
- Top mount on panels
- Dual Access Overhead with both opening to one side
- Dual Access Overhead Support Brackets to be ordered separately

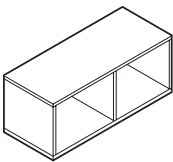
	DESCRIPTION	PRODUCT CODE	LIST PRICE	DIMENSIONS/INCHES		
				H	D	W
	Dual Access Overhead	EVSDAOHOS36	1182	15	14.125	36
		EVSDAOHOS42	1283	15	14.125	42
		EVSDAOHOS48	1341	15	14.125	48
		EVSDAOHOS54	1443	15	14.125	54
		EVSDAOHOS60	1502	15	14.125	60

## EVSDAOHBKTE - END OF RUN BRACKET

- Bracket supports dual access overhead on one side only
- Includes one bracket, aluminum insert and end of run plastic cap
- End of run plastic cap attaches to end of run trim
- Bracket available in standard Evolve paint finishes

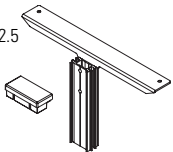
	DESCRIPTION	PRODUCT CODE	LIST PRICE	DIMENSIONS/INCHES		
				H	D	W
	End of Run Single Bracket	EVSDAOHBKTE	101		6.5	12

## EVSDAOHCBKTER/L - END OF RUN CANTILEVER BRACKET

- Bracket supports dual access overhead on one side only
- Includes one bracket, aluminum insert and end of run plastic cap
- End of run plastic cap attaches to end of run trim
- Bracket available in standard Evolve paint finishes
- Bracket overhang to one side

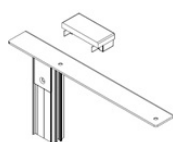
	DESCRIPTION	PRODUCT CODE	LIST PRICE	DIMENSIONS/INCHES		
				H	D	W
	End of Run Single Bracket Right	EVSDAOHCBKTER	101	6.5	12	2.5
	End of Run Single Bracket Left	EVSDAOHCBKTEL	101	6.5	12	2.5

# STORAGE

# LAMINATE OVERHEAD STORAGE

## EVSDAOHBKTS - INLINE SINGLE BRACKET

- Bracket supports dual access overhead on one side only
- Includes one bracket , aluminum insert and inline plastic cap
- Inline plastic cap and top trim align
- Bracket available in standard Evolve paint finishes
- Single clamps must be used when inline single bracket is used

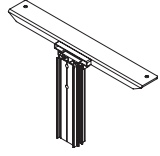
DESCRIPTION	PRODUCT CODE	LIST PRICE	DIMENSIONS/INCHES		
			H	D	W
 Inline Single Bracket	EVSDAOHBKTS	101	6.5	12	2.5

## EVSDAOHCBKTSR/L - INLINE SINGLE CANTILEVER BRACKET

- Bracket supports dual access overhead on one side only
- Includes one bracket , aluminum insert and inline plastic cap
- Inline plastic cap and top trim align
- Bracket available in standard Evolve paint finishes
- Bracket overhang to one side
- Note: Single clamps must be used when inline single bracket is used

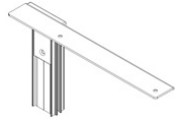
DESCRIPTION	PRODUCT CODE	LIST PRICE	DIMENSIONS/INCHES		
			H	D	W
 Inline Single Bracket Right Inline Single Bracket Left	EVSDAOHCBKTSR EVSDAOHCBKTSL	101 101	6.5 6.5	12 12	2.5 2.5

## EVSDAOHBKTD - DOUBLE BRACKET

- Double Bracket supports sides of dual access overheads when overhead are side by side.
- Includes two brackets, aluminum insert and plastic caps.
- Plastic caps installed between brackets
- Brackets available in standard Evolve paint finishes.
- Single clamps must be used when double bracket is used.

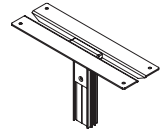
DESCRIPTION	PRODUCT CODE	LIST PRICE	DIMENSIONS/INCHES		
			H	D	W
 Double Bracket	EVSDAOHBKTD	200	6.5	12	4

## EVSDAOHCBKTD - DOUBLE CANTILEVER BRACKET

- Double Bracket supports sides of dual access overheads when overhead are side by side
- Includes two brackets, aluminum insert and plastic caps
- Plastic caps installed between brackets
- Brackets available in standard Evolve paint finishes
- Bracket overhang to one side
- Note: Single clamps must be used when double bracket is used

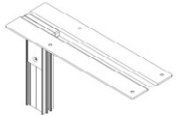
DESCRIPTION	PRODUCT CODE	LIST PRICE	DIMENSIONS/INCHES		
			H	D	W
 Double Bracket	EVSDAOHCBKTD	200	6.5	12	4

# STORAGE

# OVERHEAD STORAGE

## EVSSOH - TOP MOUNT KD OVERHEAD WITH SLIDING GLASS DOOR LEFT

- Inside dimensions 13"high x 13"deep.
- Laminate Side Walls and Divider, available in standard laminate finishes
- Metal Shelves and Back Wall, available in standard paint finishes
- Available in Temperate Frosted Glass only
- Tracks for sliding glass available in Tungsten only
- Top mount on panels
- Ready for quick assembly on site
- Top Mount Overhead Support Brackets to be ordered separately

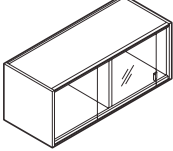
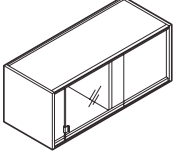
	DESCRIPTION	PRODUCT CODE	LIST PRICE	DIMENSIONS/INCHES		
				H	D	W
	Top Mount KD Overhead - Left	EVSSOHL30	1234	15	15	30
		EVSSOHL36	1365	15	15	36
		EVSSOHL42	1502	15	15	42
		EVSSOHL48	1597	15	15	48
		EVSSOHL54	1693	15	15	54
		EVSSOHL60	1847	15	15	60
	Top Mount KD Overhead - Right	EVSSOHR30	1234	15	15	30
		EVSSOHR36	1365	15	15	36
		EVSSOHR42	1502	15	15	42
		EVSSOHR48	1597	15	15	48
		EVSSOHR54	1693	15	15	54
		EVSSOHR60	1847	15	15	60

## EVSSOHBKTEE - END OF RUN BRACKET

- Bracket supports Top mount KD overhead on one side only
- Includes one bracket , aluminum insert and end of run plastic cap
- End of run plastic cap attaches to end of run trim
- Bracket available in standard Evolve paint finishes

	DESCRIPTION	PRODUCT CODE	LIST PRICE	DIMENSIONS/INCHES		
				H	D	W
	End of Run Single Bracket	EVSSOHBKTE	101	7.5	12	1.5

## EVSSOHBKTS - INLINE SINGLE BRACKET

- Bracket supports Top mount KD overhead on one side only
- Includes one bracket , aluminum insert and inline plastic cap
- Inline plastic cap and top trim align
- Bracket available in standard Evolve paint finishes
- Single clamps must be used when inline single bracket is used

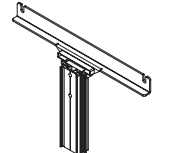
	DESCRIPTION	PRODUCT CODE	LIST PRICE	DIMENSIONS/INCHES		
				H	D	W
	Inline Single Bracket	EVSSOHBKTS	101	7.5	12	1.5

# STORAGE

# OVERHEAD STORAGE

## EVSSOHBKTD - DOUBLE BRACKET

- Double Bracket supports sides of Top Mount KD overheads when overhead are side by side
- Includes two brackets, aluminum insert and plastic caps
- Plastic caps installed between brackets
- Brackets available in standard Evolve paint finishes
- Single clamps must be used when double bracket is used

DESCRIPTION	PRODUCT CODE	LIST PRICE	DIMENSIONS/INCHES		
			H	D	W
Double Bracket	EVSSOHBKTD	200	7.5	12	2

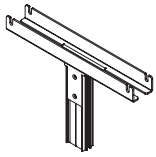

## EVPIECH - 12 "H CHANNEL

- 12" channel to attach panel to side of center mount overhead
- Attaches with wood screws to side of installed center mount overhead with laminate sides
- Includes 12 "H channel and connecting hardware

DESCRIPTION	PRODUCT CODE	LIST PRICE	DIMENSIONS/INCHES		
			H	D	W
12" Channel	EVPIECH12	53	12	3	



## EVADA-PM - EASY-UP OVERHEAD STORAGE UNIT

- Panel Mounted Overhead Storage with metal sides and opaque door that retracts on top of the unit
- Meets CSA B651 Barrier Free Design & ADA (American Disabilities Act).
- 16" high units accept standard and A4 binders.
- All shelves are reinforced for proper weight distribution.
- Inside dimensions: 14.25" high x 12" deep.
- Unit includes attachment hardware, lock and mounting brackets. Back not included.
- Not recommended for use with wall adapter.
- Unit can be converted into an upmount unit in the field by using EVADAxxKIT.
- Shipped partially assembled.
- Available in standard Evolve paint colors only. Door made of opaque plastic. \*\*add 10% upcharge for Tungsten

DESCRIPTION	PRODUCT CODE	LIST PRICE	DIMENSIONS/INCHES		
			H	D	W
Easy-Up Overhead Storage Unit	EVADA30PM	1317	16	14.2	30
	EVADA36PM	1420	16	14.2	36
	EVADA42PM	1516	16	14.2	42
	EVADA48PM	1618	16	14.2	48
	EVADA54PM	1721	16	14.2	54
	EVADA60PM	1819	16	14.2	60

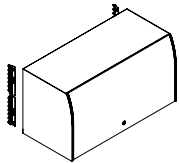

# STORAGE

# OVERHEAD STORAGE

## EVADA-UM - EASY-UP UPMOUNT OVERHEAD STORAGE UNIT

- Meets CSA B651 Barrier Free Design & ADA (American Disabilities Act).
- 16" high units accept standard and A4 binders.
- All shelves are reinforced for proper weight distribution.
- Inside dimensions: 14.25" high x 12" deep.
- Unit includes attachment hardware, lock, mounting cantilevers and has a complete back.
- Shipped partially assembled.
- Available in standard Evolve paint colors only. Door made of opaque plastic.

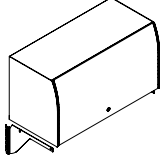
DESCRIPTION	PRODUCT CODE	LIST PRICE	DIMENSIONS/INCHES		
			H	D	W
 Easy-Up Upmount Overhead Storage Unit	EVADA30UM	1561	16	14.2	30
	EVADA36UM	1634	16	14.2	36
	EVADA42UM	1725	16	14.2	42
	EVADA48UM	1815	16	14.2	48
	EVADA54UM	1910	16	14.2	54
	EVADA60UM	2016	16	14.2	60

## UUKSS - LOW-PROFILE SHELF

- 12" deep panel-mounted storage shelf with back lip.
- Includes attachment hardware.
- Ships ready to assemble.

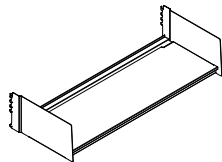
DESCRIPTION	PRODUCT CODE	LIST PRICE	DIMENSIONS/INCHES		
			H	D	W
 Low Profile Shelf	UUKSS24	151	7.5	14.7	24
	UUKSS30	162	7.5	14.7	30
	UUKSS36	179	7.5	14.7	36
	UUKSS42	185	7.5	14.7	42
	UUKSS48	193	7.5	14.7	48
	UUKSS54	201	7.5	14.7	54
	UUKSS60	210	7.5	14.7	60

## EVSLs - LAMINATED SHELF

- Laminated panel mounted wood shelf
- Shelf thickness is 1".
- Available in LP only.
- Includes attachment hardware.

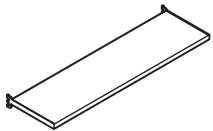
DESCRIPTION	PRODUCT CODE	LIST PRICE	DIMENSIONS/INCHES		
			H	W	D
 Laminated Shelf	EVSLs0818	232	1.125	18	8.5
	EVSLs0824	250	1.125	24	8.5
	EVSLs0830	269	1.125	30	8.5
	EVSLs0836	288	1.125	36	8.5
	EVSLs0842	311	1.125	42	8.5
	EVSLs0848	328	1.125	48	8.5

# STORAGE

# OVERHEAD STORAGE

## EVHV - SINGLE SLOTTED WALL ADAPTER

- To attach system components to a fixed wall. The vertical wall adapter is a "U" shaped channel with a vertical row of 1" slots on center.
- Mounting hardware not included. Mounting hardware selection to be based on wall material.
- Use of wall rack requires lower tooth of top hook on cantilever or shelf to be notched in the field.

- Available in standard paint colors.
- Shipped & priced per pair.

**NOTE:**

- Care should be taken to mount adapters only to wall studs using correct fasteners. Failure to do this may result in collapse of the unit and subsequent possible personal injury.

DESCRIPTION	PRODUCT CODE	LIST PRICE	DIMENSIONS/INCHES	
			D	H



Single Slotted Wall Track

EVHV01

99

60

.5

## EVADA-KIT - UPMOUNT CONVERSION KIT

- Converts an existing panel overhead storage unit EVADA-PM to an upmounted unit (EVADA-UM).
- When used on a 54" high panel, the top of the overhead will match the height of 66" high panels.

- Kit includes a back panel for the overhead and cantilevers.

DESCRIPTION	PRODUCT CODE	LIST PRICE	DIMENSIONS/INCHES		
			H	D	W

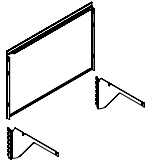

Upmount Conversion Kit

EVADA30KIT

279

16

30

2

EVADA36KIT

294

16

36

2

EVADA42KIT

310

16

42

2

EVADA48KIT

325

16

48

2

EVADA54KIT

339

16

54

2

EVADA60KIT

356

16

60

2

## EVADAPMKIT - PANEL MOUNT CONVERSION KIT

- Converts an existing up mount overhead storage unit EVADA-UM to a panel mounted overhead storage unit EVADA-PM.
- Kit includes panel mounted brackets.

DESCRIPTION	PRODUCT CODE	LIST PRICE	DIMENSIONS/INCHES		
			H	D	W



Panel Mount Conversion Kit

EVADAPMKIT

66

16

2

.5



# STORAGE

# COMPILE PEDESTAL

## CS19XXBBF - WORKSURFACE SUPPORTING BOX/BOX/FILE 15" PEDESTAL

- Worksurface supporting, with predrilled holes in the top.
- Also available as freestanding with finished top.
- All drawer fronts feature a recessed, angled full pull.
- Pedestal height shown includes glide.
- Pencil tray and Lock included.
- File Bars are not included with Compile pedestals. To order file bars, use product code CSPEDHFB at \$15.00 each list.

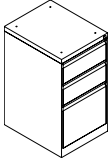
	DESCRIPTION	PRODUCT CODE	LIST PRICE	DIMENSIONS/INCHES		
				H	D	W
	Worksurface Supporting Box/Box/File 15" Pedestal	CS1919BBF	588	27 5/8	18 5/8	15
		CS1923BBF	605	27 5/8	22 5/8	15
		CS1929BBF	686	27 5/8	29 5/8	15

## CS19XXFF - WORKSURFACE SUPPORTING FILE/FILE 15" PEDESTAL

- Worksurface supporting, with predrilled holes in the top.
- Also available as freestanding with finished top.
- All drawer fronts feature a recessed, angled full pull.
- Pedestal height shown includes glide.
- Lock included.
- File Bars are not included with Compile pedestals. To order file bars, use product code CSPEDHFB at \$15.00 each list.

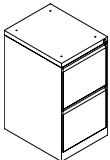
	DESCRIPTION	PRODUCT CODE	LIST PRICE	DIMENSIONS/INCHES		
				H	D	W
	Worksurface Supporting File/File 15" Pedestal	CS1919FF	588	27 5/8	18 5/8	15
		CS1923FF	605	27 5/8	22 5/8	15
		CS1929FF	686	27 5/8	29 5/8	15

## CS19FXXBBF - FREESTANDING BOX/BOX/FILE 15" PEDESTAL

- All drawer fronts feature a recessed, angled full pull.
- Pedestal height shown includes glide.
- Finished top.
- Counterweight, Pencil tray and Lock included.
- File Bars are not included with Compile pedestals. To order file bars, use product code CSPEDHFB at \$15.00 each list.

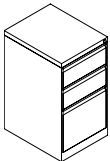
	DESCRIPTION	PRODUCT CODE	LIST PRICE	DIMENSIONS/INCHES		
				H	D	W
	Freestanding Box/Box/File 15" Pedestal	CS19F19BBF	605	27 5/8	18 5/8	15
		CS19F23BBF	623	27 5/8	22 5/8	15
		CS19F29BBF	701	27 5/8	29 5/8	15

## CS19FXXFF - FREESTANDING FILE/FILE 15" PEDESTAL

- All drawer fronts feature a recessed, angled full pull.
- Pedestal height shown includes glide.
- Finished top.
- Counterweight and Lock included.
- File Bars are not included with Compile pedestals. To order file bars, use product code CSPEDHFB at \$15.00 each list.

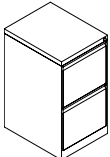
	DESCRIPTION	PRODUCT CODE	LIST PRICE	DIMENSIONS/INCHES		
				H	D	W
	Freestanding File/File 15" Pedestal	CS19F19FF	605	27 5/8	18 5/8	15
		CS19F23FF	623	27 5/8	22 5/8	15
		CS19F29FF	701	27 5/8	29 5/8	15

# STORAGE

# COMPILE PEDESTAL

## CS19MPXXBBF - MOBILE BOX/BOX/FILE PEDESTAL

- All drawer fronts feature a recessed, angled full pull.
- Pedestal height shown includes glide.
- Finished top.
- Counterweight, Pencil tray, and Lock included.
- File Bars are not included with Compile pedestals. To order file bars, use product code CSPEDHFB at \$15.00 each list.

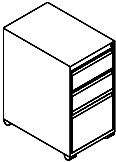
	DESCRIPTION	PRODUCT CODE	LIST PRICE	DIMENSIONS/INCHES		
				H	D	W
	Mobile Box/Box/File Pedestal	CS19MP19BBF	801	27 7/8	18 5/8	15
		CS19MP23BBF	843	27 7/8	22 5/8	15

## CS19MPXXFF - MOBILE FILE/FILE PEDESTAL

- All drawer fronts feature a recessed, angled full pull.
- Pedestal height shown includes glide.
- Finished top.
- Counterweight and Lock included.
- File Bars are not included with Compile pedestals. To order file bars, use product code CSPEDHFB at \$15.00 each list.

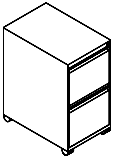
	DESCRIPTION	PRODUCT CODE	LIST PRICE	DIMENSIONS/INCHES		
				H	D	W
	Mobile File/File Pedestal	CS19MP19FF	801	27 7/8	18 5/8	15
		CS19MP23FF	843	27 7/8	22 5/8	15

## CSMCPXXBFNC - MOBILE BOX/FILE PEDESTAL WITH 60MM CASTERS

- Mobile pedestal that includes one pencil tray.
- Includes factory installed counterweight.
- Lock is standard.
- 60mm high castors.
- For use with pedestal seat cushion. See model below.
- Castors do not lock.

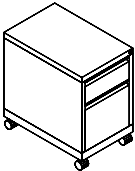
	DESCRIPTION	PRODUCT CODE	LIST PRICE	DIMENSIONS/INCHES		
				H	D	W
	Mobile Box/File Pedestal with 60mm Castors	CSMCP19BFNC	870	23.7/8	18.5/8	15
		CSMCP23BFNC	888	23.7/8	22.5/8	15

## CSCUSH15 - PEDESTAL SEAT CUSHIONS

- Cushions will have single stitching at the seams.
- Velcro included for quick attachment to pedestal file.
- 1" Cushion will have a rectilinear design on all sides.
- 2" Cushion will have waterfall edges Front and Back.
- Cushions are for use on CSMCPXXBFNC Mobile Pedestals.
- Please choose a fabric from the standard cushion textiles on pages 94-96

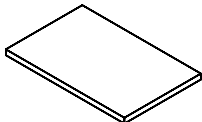
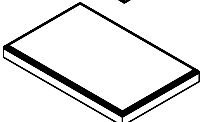
	DESCRIPTION	PRODUCT CODE	LIST PRICE/GRADES														DIM./INCH			YRDS			
			1	2	3	4	5	6	7	8	9	10	11	12	13	14	15	16	17		H	D	W
	Pedestal Seat Cushions - 1" Thick	CSCUSH15X18-5/8X1	220	256	283	319	374	397	445	524	583	650	785	932	1037	1180	1367	1633	1901	1	18.625	15	1
		CSCUSH15X22-5/8X1	246	282	309	345	400	423	471	550	609	676	811	958	1060	1202	1389	1655	1924	1	22.625	15	1
	Pedestal Seat Cushions - 2" Thick	CSCUSH15X18-5/8X2	243	278	303	341	397	420	468	545	605	671	805	955	1334	1523	1777	2131	2490	2	18.625	15	2
		CSCUSH15X22-5/8X2	273	309	340	389	456	489	552	651	726	812	988	1174	1361	1551	1802	2158	2514	2	22.625	15	2

# STORAGE

# PRIME PEDESTAL

## UUPFSBGXXP - PRIME SERIES BOX/BOX/FILE PEDESTAL - WORKSURFACE SUPPORTING

- Two box + one file drawer, locking pedestal.
- Top box drawer 4.8"H; middle box drawer 6.4"H; bottom file drawer 13.6"H (interior 12.5"H) -
- When selected in options, "1" makes the pedestal worksurface supporting, includes pre-drilled top holes for attaching to a worksurface.
- When selected in options, "2" includes a flush top for freestanding applications.
- Worksurface supporting peds can be specified without (NN) or with (W2) a counterweight.
- Freestanding pedestals can be specified without (NN), with concealed casters + counterweight (W1. Add (\$285) or with counterweight only (W2. Add \$240).
- To use as a worksurface supporting pedestal, please specify EVHPB5 separately.
- Pencil tray included top box drawer.
- Ships assembled one carton.

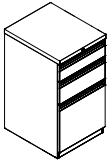
	DESCRIPTION	PRODUCT CODE	LIST PRICE	DIMENSIONS/INCHES		
				H	D	W
	Prime Series Box/Box/File Pedestal - Worksurface Supporting	UUPFSBG18P	771	28.2	18	15
		UUPFSBG22P	779	28.2	22	15
		UUPFSBG28P	862	28.2	28	15

## UUPFOFGXXP - PRIME SERIES FILE/FILE PEDESTAL

- Two file drawer, locking pedestal.
- Top file drawer 11.2"H (interior 10.6"H); bottom file drawer 13.6"H (interior 12.5"H).
- When selected in options, "1" makes the pedestal worksurface supporting, includes pre-drilled top holes for attaching to a worksurface.
- When selected in options, "2" includes a flush top for freestanding applications.
- Worksurface supporting peds can be specified without (NN) or with (W2) a counterweight.
- Freestanding pedestals can be specified without (NN), with concealed casters + counterweight (W1. Add \$285) or with counterweight only (W2. Add \$240).
- To use as a worksurface supporting pedestal, please specify EVHPB5 separately.
- Ships assembled one carton.

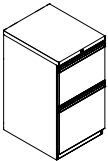
	DESCRIPTION	PRODUCT CODE	LIST PRICE	DIMENSIONS/INCHES		
				H	D	W
	Prime Series File/File Pedestal - Worksurface Supporting	UUPFOFG18P	771	28.2	18	15
		UUPFOFG22P	779	28.2	22	15
		UUPFOFG28P	862	28.2	28	15

## UUPF0BFXXP - PRIME SERIES BOX/FILE PEDESTAL

- One box and one file drawer, locking pedestal.
- Freestanding pedestals can be specified without (NN) or with (W2) a counterweight.
- Freestanding pedestals can be specified without (NN), with concealed casters + counterweight (W1. Add \$285) or with counterweight only (W2. Add \$240).
- Pencil tray included in box drawer.
- Ships assembled one carton.

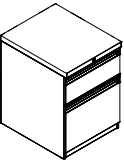
	DESCRIPTION	PRODUCT CODE	LIST PRICE	DIMENSIONS/INCHES		
				H	D	W
	Prime Series Box/File Pedestal	UUPF0BF18P	771	20.8	18	15
		UUPF0BF22P	779	20.8	22	15
		UUPF0BF28P	862	20.8	28	15

# STORAGE

# PRIME PEDESTAL

## UUPW0BFXXP - MOBILE BOX/FILE PEDESTAL WITH 60MM CASTERS

- One box and one file drawer; locking mobile pedestal.
- Pencil tray included in box drawer.
- 60mm casters, two locking/two non-locking.
- Ships assembled one carton.

	DESCRIPTION	PRODUCT CODE	LIST PRICE	DIMENSIONS/INCHES		
				H	D	W
	Mobile Box/File Pedestal with 60mm Casters	UUPW0BF18P	932	18	23.3	15
		UUPW0BF22P	939	22	23.3	15
		UUPW0BF28P	1112	28	23.3	15

## EVCUSHION15 - PEDESTAL SEAT CUSHIONS

- Cushions will have single stitching at the seams.
- Velcro included for quick attachment to pedestal file.
- 1" Cushion will have a rectilinear design on all sides.
- 2" Cushion will have waterfall edges Front and Back,
- Cushions are for use on Prime Mobile Pedestals.
- Please choose a fabric from the standard cushion textiles offering.

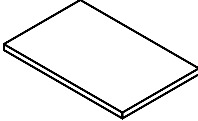
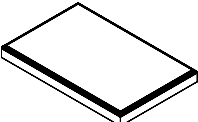
	DESCRIPTION	PRODUCT CODE	LIST PRICE/GRADES																	DIM./INCH			YRDS
			1	2	3	4	5	6	7	8	9	10	11	12	13	14	15	16	17	H	D	W	
	Pedestal Seat Cushions - 1" Thick	EVCUSHION15X18X1	220	259	287	329	387	415	468	553	620	691	841	1002	926	1051	1220	1457	1692	1	18	15	1
		EVCUSHION15X19X1	220	259	287	329	387	415	468	553	620	691	841	1002	926	1051	1220	1457	1692	1	19	15	1
		EVCUSHION15X22X1	246	286	315	355	416	441	494	581	646	719	867	1030	947	1074	1241	1476	1712	1	22	15	1
		EVCUSHION15X23X1	246	286	315	355	416	441	494	581	646	719	867	1030	947	1074	1241	1476	1712	1	23	15	1
		EVCUSHION15X28X1	325	376	408	467	545	582	651	767	854	954	1153	1368	1259	1427	1649	1963	2279	1	28	15	1
		EVCUSHION15X29X1	325	376	408	467	545	582	651	767	854	954	1153	1368	1259	1427	1649	1963	2279	1	29	15	1
	Pedestal Seat Cushions - 2" Thick	EVCUSHION15X18X2	243	282	309	349	408	437	490	576	642	713	861	1027	944	1071	1236	1474	1236	2	18	15	2
		EVCUSHION15X19X2	243	282	309	349	408	437	490	576	642	713	879	1027	944	1071	1236	1474	1236	2	19	15	2
		EVCUSHION15X22X2	273	312	340	382	440	468	523	606	673	744	894	1055	968	1095	1261	1497	1734	2	22	15	2
		EVCUSHION15X23X2	273	312	340	382	440	468	523	606	673	744	894	1055	968	1095	1261	1497	1734	2	23	15	2
		EVCUSHION15X28X2	362	410	445	502	582	619	688	803	890	990	1186	1400	1289	1455	1676	1990	2309	2	28	15	2
		EVCUSHION15X29X2	362	410	445	502	582	619	688	803	890	990	1186	1400	1289	1455	1676	1990	2309	2	29	15	2

## EVHPB5 - PEDESTAL BRACKET

- Attaches to back edge of a pedestal and connects a pedestal to panel connector.
- Available in standard paint colors.

	DESCRIPTION	PRODUCT CODE	LIST PRICE	DIMENSIONS/INCHES		
				H		
	Pedestal Bracket	EVHPB5	39	11		

# STORAGE

# LAMINATE PEDESTAL

## ALL PEDESTALS FEATURE

- Worksurface supporting pedestals are 28" h
- Pencil tray included with B/B/F pedestal
- Box drawer and file drawers mounted on full extension ball bearing slides
- All file drawers come with adjustable rails for legal or letter size hanging folders
- 1-Door pedestal comes handed left or right (handedness is determined by hinge side)
- 1-Door Pedestal includes one adjustable shelf
- Locks are standard on all units and match pull finish

## EVL2PBBF - BOX/BOX/FILE WORKSURFACE SUPPORTING PEDESTAL

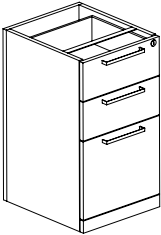
DESCRIPTION	PRODUCT CODE	LIST PRICE	DIMENSIONS/INCHES		
			H	D	W
 Box/Box/File Worksurface Supporting Pedestal	EVL2PBBF18	1113	28	15.5	18
	EVL2PBBF23	1231	28	15.5	23
	EVL2PBBF29	1289	28	15.5	29

## EVL2PFF - FILE/FILE WORKSURFACE SUPPORTING PEDESTAL

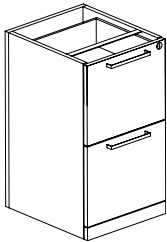
DESCRIPTION	PRODUCT CODE	LIST PRICE	DIMENSIONS/INCHES		
			H	D	W
 File/File Worksurface Supporting Pedestal	EVL2PFF18	1010	28	15.5	18
	EVL2PFF23	1150	28	15.5	23
	EVL2PFF29	1209	28	15.5	29

## EVL2P1D - 1-DOOR WORKSURFACE SUPPORTING PEDESTAL

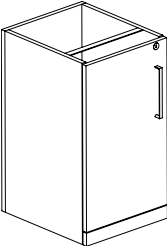
DESCRIPTION	PRODUCT CODE	LIST PRICE	DIMENSIONS/INCHES		
			H	D	W
 1-Door Worksurface Supporting Pedestal	EVL2P1D18(L/R)	847	28	15.5	18
	EVL2P1D23(L/R)	936	28	15.5	23
	EVL2P1D29(L/R)	1033	28	15.5	29

# STORAGE

# LAMINATE PEDESTAL

### ALL MOBILE PEDESTALS FEATURE

- Mobile pedestals with inset top are designed for use with cushion
- Pencil tray included with box drawer
- Box drawer and file drawers mounted on full extension ball bearing slides
- If file drawers come with adjustable rails for legal or letter size hanging folders

### EVL2PBF - BOX/FILE MOBILE PEDESTAL W/STANDARD TOP

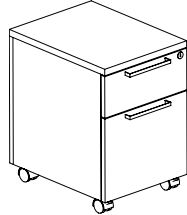

DESCRIPTION	PRODUCT CODE	LIST PRICE	DIMENSIONS/INCHES		
			H	D	W
Box/File Mobile Pedestal w/Standard Top	EVL2PBF20M	1420	22.69	15.5	20
	EVL2PBF24M	1420	22.69	15.5	24

### EVL2PBF-MIT - BOX/FILE MOBILE PEDESTAL W/INSET TOP

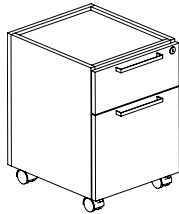

DESCRIPTION	PRODUCT CODE	LIST PRICE	DIMENSIONS/INCHES		
			H	D	W
Box/File Mobile Pedestal w/Inset Top	EVL2PBF18MIT	1331	22	15.5	18
	EVL2PBF24MIT	1411	22	15.5	24

### EVLPTC - MOBILE PEDESTAL CUSHION (FOR USE WITH INSET TOP MOBILE PEDESTALS)

DESCRIPTION	PRODUCT CODE	LIST PRICE/GRADES																	DIM./INCH			YRDS
		1	2	3	4	5	6	7	8	9	10	11	12	13	14	15	16	17	H	D	W	
Mobile Pedestal Cushion	EVLPTC1518	326	365	384	420	466	487	536	605	661	721	844	977	1143	1285	1456	1717	1979	1	15.5	18	1
	EVLPTC1524	377	406	434	468	517	538	580	656	710	772	890	1027	1193	1329	1503	1758	2019	1	15.5	24	1

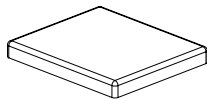

# STORAGE

# CUBE STORAGE

## EVSSP12BFM - CUBE STORAGE BF MOBILE PEDESTAL

- Mobile pedestal with door and shelf
- Includes four locking casters
- File interior dimensions: 11 7/8"H x 11 13/16"W x 10 7/16"D
- Metal wire divider file is 3-7/16" from side, can be installed either on the left or right side
- Includes lock
- Shipped KD

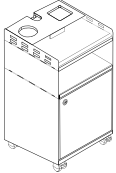
DESCRIPTION	PRODUCT CODE	LIST PRICE	DIMENSIONS/INCHES		
			H	D	W
	EVSSP12BFMKL	877	22	12	12
	EVSSP12BFMKR	877	22	12	12

## EVSSP12BBFM - CUBE STORAGE BBF MOBILE PEDESTAL

- Mobile pedestal with door and shelf
- Includes four locking casters
- File interior dimensions: 11 7/8"H x 11 13/16"W x 10 7/16"D
- Metal wire divider in file is 3-7/16" from side, can be installed either on the left or right side
- Includes lock
- Shipped KD

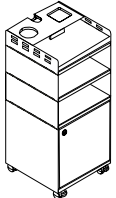
DESCRIPTION	PRODUCT CODE	LIST PRICE	DIMENSIONS/INCHES		
			H	D	W
	EVSSP12BBFMKL	1093	28	12	12
	EVSSP12BBFMKR	1093	28	12	12

## EVSSP12SFM - CUBE STORAGE SF MOBILE PEDESTAL

- Mobile pedestal with doors
- Includes four locking casters
- File interior dimensions: 11 7/8"H x 11 13/16"W x 10 7/16"D
- Metal wire divider in storage and file is 3-7/16" from side, can be installed either on the left or right side
- Storage interior dimension: 10 1/2"H x 11 13/16"W x 10 7/16"D
- Includes lock
- Shipped KD

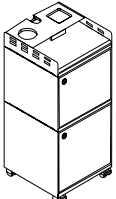
DESCRIPTION	PRODUCT CODE	LIST PRICE	DIMENSIONS/INCHES		
			H	D	W
	EVSSP12SFMKL	1145	28	12	12
	EVSSP12SFMKR	1145	28	12	12

# STORAGE

# CUBE STORAGE

## EVSSP12BFM - CUBE STORAGE BF MOBILE PEDESTAL

- Mobile pedestal with door and shelf
  - Includes four locking casters
  - File interior dimensions: 11 7/8"H x 11 13/16"W x 10 7/16"D
  - Metal wire divider in file is 3-7/16" from side, can be installed either on the left or right side
- Shipped KD

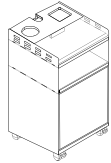

DESCRIPTION	PRODUCT CODE	LIST PRICE	DIMENSIONS/INCHES		
			H	D	W
	EVSSP12BFML	787	22	12	12
	EVSSP12BFMR	787	22	12	12

## EVSSP12BBFM - CUBE STORAGE BBF MOBILE PEDESTAL

- Mobile pedestal with door and shelf
  - Includes four locking casters
  - File interior dimensions: 11 7/8"H x 11 13/16"W x 10 7/16"D
  - Metal wire divider in file is 3-7/16" from side, can be installed either on the left or right side
- Shipped KD

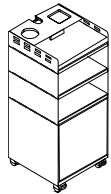

DESCRIPTION	PRODUCT CODE	LIST PRICE	DIMENSIONS/INCHES		
			H	D	W
	EVSSP12BBFML	1004	28	12	12
	EVSSP12BBFMR	1004	28	12	12

## EVSSP12SFM - CUBE STORAGE SF MOBILE PEDESTAL

- Mobile pedestal with doors
  - Includes four locking casters
  - File interior dimensions: 11 7/8"H x 11 13/16"W x 10 7/16"D
  - Metal wire divider in storage and file is 3-7/16" from side, can be installed either on the left or right side
- Storage interior dimension: 10 1/2"H x 11 13/16"W x 10 7/16"D
  - Shipped KD

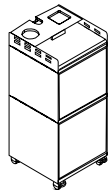

DESCRIPTION	PRODUCT CODE	LIST PRICE	DIMENSIONS/INCHES		
			H	D	W
	EVSSP12SFML	914	28	12	12
	EVSSP12SFMR	914	28	12	12

# STORAGE

# CUBE STORAGE

## EVFELT03BC-PET PIECE FOR SHELF FOR PEDESTAL WITH CLOSED BACK

- PET piece for shelf for pedestal with closed back
- Front edge at 45 degree

DESCRIPTION	PRODUCT CODE	LIST PRICE	DIMENSIONS/INCHES		
			H	D	W

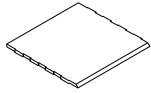

EVFELT03BC	45	12	12	.038
------------	----	----	----	------

## EVSSPH12BF - CUBE STORAGE BF

- Hanging storage
- Attaches to underside of worksurface
- File interior dimensions: 11 7/8"H x 11 13/16"W x 10 7/16"D
- Metal wire divider in file is 3-7/16" from side, can be installed either on the left or right side
- Configuration box/file with door
- Includes lock
- Shipped KD

DESCRIPTION	PRODUCT CODE	LIST PRICE	DIMENSIONS/INCHES		
			H	D	W

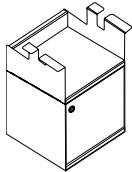

EVSSPH12BFKL	653	18.5	12	12
EVSSPH12BFKR	653	18.5	12	12

## EVSSPH12BFB - CUBE STORAGE BFB

- Hanging storage
- Attaches to underside of worksurface
- File interior dimensions: 11 7/8"H x 11 13/16"W x 10 7/16"D
- Metal wire divider in file is 3-7/16" from side, can be installed either on the left or right side
- Configuration box/file with door/box
- Includes lock
- Shipped KD

DESCRIPTION	PRODUCT CODE	LIST PRICE	DIMENSIONS/INCHES		
			H	D	W

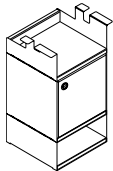

EVSSPH12BFBKL	869	24	12	12
EVSSPH12BFBKR	869	24	12	12

# STORAGE

# CUBE STORAGE

## EVSSPH12BF - CUBE STORAGE BF

- Hanging storage
- Attaches to underside of worksurface
- File interior dimensions: 11 7/8"H x 11 13/16"W x 10 7/16"D
- Metal wire divider in file is 3-7/16" from side, can be installed either on the left or right side
- Configuration box/file with door
- Shipped KD

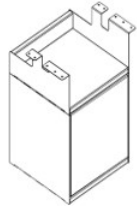

DESCRIPTION	PRODUCT CODE	LIST PRICE	DIMENSIONS/INCHES		
			H	D	W
	EVSSPH12BFL	563	18.5	12	12
	EVSSPH12BFR	563	18.5	12	12

## EVSSPH12BFB - CUBE STORAGE BFB

- Hanging storage
- Attaches to underside of worksurface
- File interior dimensions: 11 7/8"H x 11 13/16"W x 10 7/16"D
- Metal wire divider in file is 3-7/16" from side, can be installed either on the left or right side
- Configuration box/file with door/box
- Shipped KD

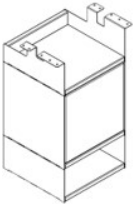

DESCRIPTION	PRODUCT CODE	LIST PRICE	DIMENSIONS/INCHES		
			H	D	W
	EVSSPH12BFBFL	781	24	12	12
	EVSSPH12BFBFR	781	24	12	12

## EVSSPH12B - CUBE STORAGE B

- Hanging storage
- Attaches to underside of worksurface
- Configuration box
- Shipped KD

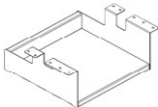

DESCRIPTION	PRODUCT CODE	LIST PRICE	DIMENSIONS/INCHES		
			H	D	W
	EVSSPH12B	219	11.5	12	12

# STORAGE

# CUBE STORAGE

## EVSSPH12BB - CUBE STORAGE BB

- Hanging storage
- Attaches to underside of worksurface
- Configuration box/box
- Shipped KD

DESCRIPTION	PRODUCT CODE	LIST PRICE	DIMENSIONS/INCHES		
			H	D	W
	EVSSPH12BB	435	17	12	12

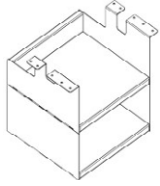

# STORAGE

# COMPILE LATERAL FILE

## CS19XX-1X1FH - ONE 1/2 HEIGHT FIXED FRONT & ONE 12" FIXED FRONT LATERAL FILE

- 1/2 Height Box Drawer.
- 1 Fixed Drawer Front.
- Includes Lock.
- Lateral File Top is required when not installed under a worksurface.
- Counterweights must be specified on lateral files with pull out drawers, unless worksurface supporting, ganged together or anchored to the floor or wall.

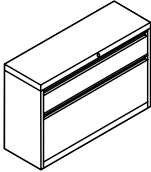
	DESCRIPTION	PRODUCT CODE	LIST PRICE	DIMENSIONS/INCHES		
				H	D	W
	One 1/2 Height Fixed Front &	CS1930P-1X1FH	1328	21.1875	19.25	30
	One 12" Fixed Front Lateral File	CS1936P-1X1FH	1418	21.1875	19.25	36
		CS1942P-1X1FH	1506	21.1875	19.25	42

## CS19XX-1XSND - ONE 1/2 HEIGHT OPEN SHELF & ONE 12" OPEN SHELF LATERAL CABINET

- 1/2 Height Open Shelf.
- Bottom Open Shelf.

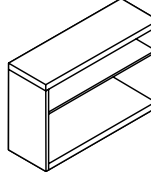
	DESCRIPTION	PRODUCT CODE	LIST PRICE	DIMENSIONS/INCHES		
				H	D	W
	One 1/2 Height Open Shelf &	CS1930-1XSND	666	21.1875	19.25	30
	One 12" Open Shelf Lateral Cabinet	CS1936-1XSND	757	21.1875	19.25	36
		CS1942-1XSND	843	21.1875	19.25	42

## CSCUSH19 - LATERAL SEAT CUSHIONS

- Cushions will have single stitching at the seams,
- Velcro included for quick attachment to lateral file.
- 1" Cushion will have a rectilinear design on all sides.
- 2" Cushion will have waterfall edges Front and Back.
- Please choose a fabric from the standard cushion textiles offering.

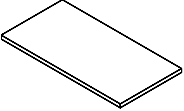
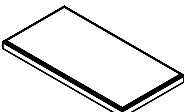
	DESCRIPTION	PRODUCT CODE	LIST PRICE/GRADES														DIM./INCH			YRDS			
			1	2	3	4	5	6	7	8	9	10	11	12	13	14	15	16	17		H	D	W
	Lateral Seat	CSCUSH19-25X30X1	401	446	481	530	605	638	705	809	889	979	1163	1358	1518	1710	1951	2306	2661	1	19	30	1
	Cushions - 1" Thick	CSCUSH19-25X36X1	416	461	496	547	620	653	720	824	904	994	1178	1372	1529	1720	1962	2317	2675	1	19	36	1
		CSCUSH19-25X42X1	431	475	511	560	634	667	733	836	917	1008	1191	1387	1466	1657	1902	2257	2613	1	19	42	1
	Lateral Seat	CSCUSH19-25X30X2	445	490	525	574	649	682	747	850	931	1022	1205	1401	1478	1669	1914	2268	2626	2	19	30	2
	Cushions - 2" Thick	CSCUSH19-25X36X2	456	501	536	585	659	693	758	861	942	1033	1216	1412	1489	1678	1924	2277	2634	2	19	36	2
		CSCUSH19-25X42X2	473	518	553	604	677	710	775	881	959	1050	1233	1429	1500	1691	1933	2290	2645	2	18	42	2

# STORAGE

# PRIME LATERAL FILE

### UULPS0F18XXP - ONE 1/2 HEIGHT FIXED FRONT & ONE 12" FIXED FRONT LATERAL FILE

- Fixed front drawers, top box drawer front 6.4"H (interior 5.2"H) bottom file drawer front 11.2"H (interior 10.8"H).
- Locking.
- Side to side hanging bars included.
- Ships assembled one carton

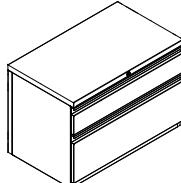
	DESCRIPTION	PRODUCT CODE	LIST PRICE	DIMENSIONS/INCHES		
				H	D	W
	One 1/2 Height Fixed Front & One 12" Fixed Front Lateral File	UULPS0BF1830P	1797	21	18	30
		UULPS0BF1836P	1871	21	18	36
		UULPS0BF1842P	1935	21	18	42

### EVCUSHION18 - LATERAL SEAT CUSHIONS

- Cushions will have single stitching at the seams.
- Velcro included for quick attachment to lateral file.
- 1" Cushion will have a rectilinear design on all sides.
- 2" Cushion will have waterfall edges Front and Back.
- Please choose a fabric from the standard cushion textile offering.

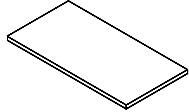
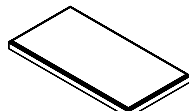
	DESCRIPTION	PRODUCT CODE	LIST PRICE/GRADES														DIM./INCH			YRDS			
			1	2	3	4	5	6	7	8	9	10	11	12	13	14	15	16	17		H	D	W
	Lateral Seat	EVCUSHION18X30X1	341	392	427	482	561	597	669	783	871	806	1169	1382	1270	1441	1659	1976	2292	1	18	30	1
	Cushions - 1" Thick	EVCUSHION18X36X1	379	430	467	521	601	637	709	822	908	1008	1207	1422	1636	1849	2127	2528	2925	1	18	36	1
		EVCUSHION18X42X1	405	456	492	547	627	662	735	848	935	1035	1234	1450	1324	1495	1711	2026	2341	1	18	42	1
	Lateral Seat	EVCUSHION18X30X2	1416	425	458	515	595	632	701	816	904	1003	1203	1416	1300	1467	1686	2002	2316	2	18	30	2
	Cushions - 2" Thick	EVCUSHION18X36X2	420	471	506	560	641	677	748	861	948	1049	1249	1461	1675	1890	2163	2564	2964	2	18	36	2
		EVCUSHION18X42X2	420	471	506	560	641	677	748	861	948	1049	1249	1461	1357	1525	1740	2057	2371	2	18	42	2

### EVT - LATERAL FILE TOPS

- Note the following abbreviations:  
T = Thermally-Fused Laminate and H = High Pressure Laminate.
- Available in standard Evolve finishes.

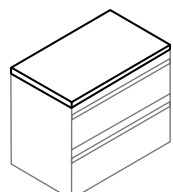
	DESCRIPTION	PRODUCT CODE	LIST PRICE		DIMENSIONS/INCHES		
			LP	HP ADD	H	D	W
	Lateral File Tops	EVT1830	175	71	1	18	30
		EVT1836	198	83	1	18	36
		EVT1842	239	129	1	18	42
		EVT1860	323	234	1	18	60
		EVT1872	380	247	1	18	72
		EVT1884	530	183	1	18	84
		EVT1890	572	206	1	18	90
		EVT18108	691	267	1	18	108

# STORAGE

# COMPILE LATERAL FILE

### CS19XXP - 2F12 - LATERAL FILES - 2 DRAWERS WITH COUNTERWEIGHT

- Counterweight is standard. Two fixed front drawers.
- Side-to-side hanging file bars included.
- Drawers are 12.25" high.
- File cannot be used to store standard three ring binders.
- Lock included.

	DESCRIPTION	PRODUCT CODE	LIST PRICE	DIMENSIONS/INCHES		
				H	D	W
	Lateral Files - 2 Drawers with Counterweight	CS1930P-2F12	1054	27.14	19.25	30
		CS1936P-2F12	1136	27.14	19.25	36
		CS1942P-2F12	1181	27.14	19.25	42

### CS19XXP - 3F12 - LATERAL FILES - 3 DRAWERS WITH COUNTERWEIGHT

- Counterweight is standard. Three fixed front drawers.
- Side-to-side hanging file bars included.
- Drawers are 12.25" high.
- File cannot be used to store standard three ring binders.
- Lock included.

	DESCRIPTION	PRODUCT CODE	LIST PRICE	DIMENSIONS/INCHES		
				H	D	W
	Lateral Files - 3 Drawers with Counterweight	CS1930P-3F12	1312	39.52	19.25	30
		CS1936P-3F12	1383	39.52	19.25	36
		CS1942P-3F12	1444	39.52	19.25	42

### CS19XXP - 4F12 - LATERAL FILES - 4 DRAWERS WITH COUNTERWEIGHT

- Counterweight is standard. Four fixed front drawers.
- Side-to-side hanging file bars included.
- Drawers are 12.25" high.
- File cannot be used to store standard three ring binders.
- Posting shelf option NOT available.
- Lock included.

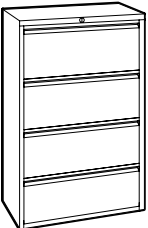
	DESCRIPTION	PRODUCT CODE	LIST PRICE	DIMENSIONS/INCHES		
				H	D	W
	Lateral Files - 4 Drawers with Counterweight	CS1930P-4F12	1675	51.89	19.25	30
		CS1936P-4F12	1754	51.89	19.25	36
		CS1942P-4F12	1888	51.89	19.25	42

# STORAGE

# COMPILE LATERAL FILE

### CS19XXP - 5F12 - LATERAL FILES - 5 DRAWERS

- Four fixed front drawers plus top drawer with receding door and roll-out shelf.
- Side-to-side hanging file bars included.
- Drawers are 12.25" high.
- File cannot be used to store standard three ring binders.
- Posting shelf option NOT available.
- Lock included.

DESCRIPTION	PRODUCT CODE	LIST PRICE	DIMENSIONS/INCHES		
			H	D	W
Lateral Files - 5 Drawers	CS1930P-5F12	1994	66.39	19.25	30
	CS1936P-5F12	2082	66.39	19.25	36
	CS1942P-5F12	2196	66.39	19.25	42

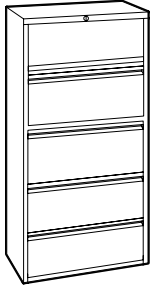

# STORAGE

# PRIME LATERAL FILE

## UULF18P - 12" OPENING LATERAL FILE FIXED FRONT DRAWERS

- Fixed front file drawers, top drawer front 11.2"H (interior 10.6"H) bottom drawer front 13.6"H (interior 12.5"H).
- Locking.
- Side to side hanging bars included.
- Ships assembled one carton
- Counterweight (W2) available. Upcharge applies.
- Individually locking drawers (KID) available. Upcharge applies.

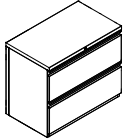
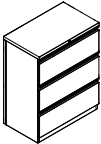
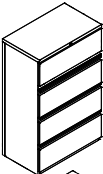
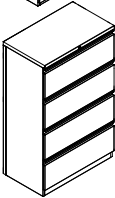
	DESCRIPTION	PRODUCT CODE	LIST PRICE	DIMENSIONS/INCHES		
				H	D	W
	Lateral File - 2 High	UULF20G1830P	1531	28	18	30
		UULF20G1836P	1600	28	18	36
		UULF20G1842P	1689	28	18	42
	Add \$497 for counterweight (W2). Add \$408 for individually locking drawers (KID)					
	Lateral File - 3 High	UULF30G1830P	2006	39.2	18	30
		UULF30G1836P	2107	39.2	18	36
		UULF30G1842P	2230	39.2	18	42
	Add \$480 for counterweight (W2). Add \$822 for individually locking drawers (KID)					
	Lateral File - 4 High	UULF40H1830P	2546	53.6	18	30
		UULF40H1836P	2679	53.6	18	36
		UULF40H1842P	2839	53.6	18	42
	Add \$292 for counterweight (W2). Add \$1229 for individually locking drawers (KID)					
	Lateral File - 5 High	UULF50P1830P	3147	65.6	18	30
		UULF50P1836P	3279	65.6	18	36
		UULF50P1842P	3456	65.6	18	42
	Add \$292 for counterweight (W2). Add \$1643 for individually locking drawers (KID)					

# STORAGE

# LATERAL FILE TOPS

## EVT - LATERAL FILE TOPS

- Note the following abbreviations:
- T = Thermally-Fused Laminate
- H = High Pressure Laminate
- Available in standard Evolve finishes.

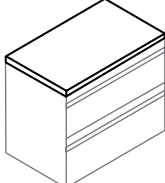
DESCRIPTION	PRODUCT CODE	LIST PRICE		DIMENSIONS/INCHES		
		LP	HP	H	D	W
 Lateral File Tops	EVT1830	175	71	1	18	30
	EVT1836	198	83	1	18	36
	EVT1842	239	129	1	18	42
	EVT1860	323	234	1	18	60
	EVT1872	380	247	1	18	72
	EVT1884	530	183	1	18	84
	EVT1890	572	206	1	18	90
	EVT18108	691	267	1	18	108

# STORAGE

# LAMINATE LATERAL FILE

## LATERAL FILES FEATURES

- Worksurface supporting lateral files ship without a top
- All lateral files feature drawer interlocking system
- All file drawers come with adjustable rails for legal or letter size hanging folders
- "C" combo lateral includes a pencil tray with one box drawer.
- "C" combo lateral only locks on one side
- Lateral files with doors include one adjustable shelf
- Locks are standard on all units and match pull finish
- File drawers are mounted on full extension ball bearing slides

### EVL2L2H - FILE/FILE WORKSURFACE SUPPORTING LATERAL FILE, 18"D & 22"D

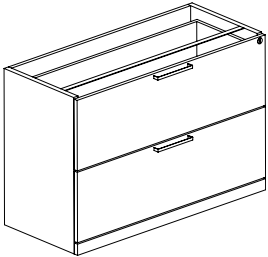
DESCRIPTION	PRODUCT CODE	LIST PRICE	DIMENSIONS/INCHES		
			H	D	W
	File/File Worksurface Supporting Pedestal				
	EVL2L2H1830	1809	28	30	18
	EVL2L2H1836	1926	28	36	18
	EVL2L2H1842	2001	28	42	18
	EVL2L2H2230	1862	28	30	22
	EVL2L2H2236	1980	28	36	22
EVL2L2H2242	2118	28	42	22	

### EVL2L2D - 2-DOOR WORKSURFACE SUPPORTING LATERAL FILE, 18"D & 22"D

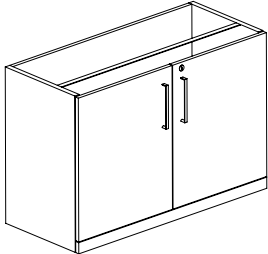
DESCRIPTION	PRODUCT CODE	LIST PRICE	DIMENSIONS/INCHES		
			H	D	W
	2-Door Worksurface Supporting Lateral File				
	EVL2L2D1830	1266	28	30	18
	EVL2L2D1836	1331	28	36	18
	EVL2L2D1842	1464	28	42	18
	EVL2L2D2230	1370	28	30	22
	EVL2L2D2236	1406	28	36	22
EVL2L2D2242	1619	28	42	22	

# STORAGE

# LAMINATE LATERAL FILE

## COMBO LATERAL FILES FEATURES

- Worksurface supporting lateral files ship without a top
- All lateral files feature drawer interlocking system
- All file drawers come with adjustable rails for legal or letter size hanging folders
- "C" combo lateral includes a pencil tray with one box drawer.
- "C" combo lateral only locks on one side
- Locks are standard on all units and match pull finish
- File drawers are mounted on full extension ball bearing slides

## EVL2LCR - RIGHT-HAND WORKSURFACE SUPPORTING COMBO LATERAL FILE, 18"D & 22"D

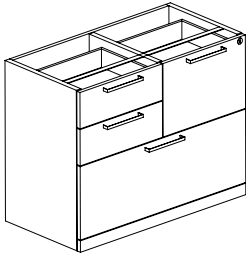
	DESCRIPTION	PRODUCT CODE	LIST PRICE	DIMENSIONS/INCHES		
				H	D	W
	Right-Hand Worksurface Supporting Combo Lateral File	EVL2LCR1830	2221	28	30	18
		EVL2LCR1836	2588	28	36	18
	EVL2LCR2230	2578	28	30	22	
	EVL2LCR2236	2712	28	36	22	

## EVL2LCL - LEFT-HAND WORKSURFACE SUPPORTING COMBO LATERAL FILE, 18"D & 22"D

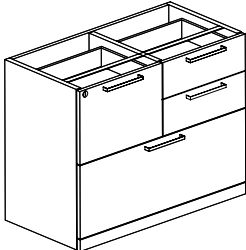
	DESCRIPTION	PRODUCT CODE	LIST PRICE	DIMENSIONS/INCHES		
				H	D	W
	2-Door Worksurface Supporting Lateral File	EVL2LCL1830	2221	28	30	18
		EVL2LCL1836	2588	28	36	18
	EVL2LCL2230	2578	28	30	22	
	EVL2LCL2236	2712	28	36	22	

# STORAGE

# PRIME STORAGE CABINET

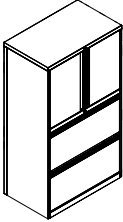
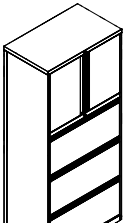
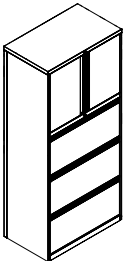

## UCCP - 12" OPENING MULTI STORAGE UNIT

- 2 lateral file drawers and storage with hinged doors.
- 2 Locks per unit is included, (1) for door (1) for drawers.
- Open shelving with one fixed and two adjustable shelves, Two lateral file drawers.
- Side-to-side hanging file bars included. Locking and full pull handle design.
- Counterweight (W2) available. Upcharge applies.
- Individually locking drawers (KID) available. Upcharge applies.

	DESCRIPTION	PRODUCT CODE	LIST PRICE	DIMENSIONS/INCHES		
				H	D	W
	12" Opening Multi Storage Unit - 4 High (50" High)	UUCC41G1830P	3213	49.6	18	30
		UUCC41G1836P	3439	49.6	18	36
		UUCC41G1842P	3702	49.6	18	42
			Add \$292 for counterweight (W2). Add \$408 for individually locking drawers (KID)			
	12" Opening Multi Storage Unit - 4 High (54" High)	UUCC41H1830P	3372	53.6	18	30
		UUCC41H1836P	3606	53.6	18	36
		UUCC41H1842P	3741	53.6	18	42
			Add \$292 for counterweight (W2). Add \$408 for individually locking drawers (KID)			
	12" Opening Multi Storage Unit - 5 High (3 Lateral)	UUC51C1830P	3750	65.6	18	30
		UUC51C1836P	4031	65.6	18	36
		UUC51C1842P	4348	65.6	18	42
			Add \$292 for counterweight (W2). Add \$822 for individually locking drawers (KID)			

## UUSC - 12" STORAGE CABINET WITH HINGED DOOR

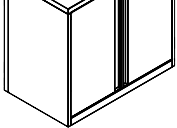
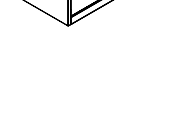
- SC2 - 28" high with 1 shelf.
- SC3 - 39.2" high with 2 shelves.
- SC4 - 53.6" high with 3 shelves.
- SC5 - 65.6" high with 4 shelves.
- Shelves are height adjustable.
- Lock is included.

	DESCRIPTION	PRODUCT CODE	LIST PRICE	DIMENSIONS/INCHES		
				H	D	W
	12" Storage Cabinet with Hinged Door - 2 High (WS Supporting)	UUSC21G1830P	1257	28	18	30
		UUSC21G1836P	1399	28	18	36
		UUSC21G1842P	1524	28	18	42
	12" Storage Cabinet with Hinged Door - 3 High	UUSC31G1830P	1551	39.2	18	30
		UUSC31G1836P	1759	39.2	18	36
		UUSC31G1842P	1945	39.2	18	42
	12" Storage Cabinet with Hinged Door - 4 High	UUSC41H1830P	1872	53.6	18	30
		UUSC41H1836P	2090	53.6	18	36
		UUSC41H1842P	2314	53.6	18	42
	12" Storage Cabinet with Hinged Door - 5 High	UUSC51C1830P	2112	65.6	18	30
		UUSC51C1836P	2368	65.6	18	36
		UUSC51C1842P	2622	65.6	18	42

# STORAGE

# ACCESSORIES

## FRONT TO BACK FILE BAS

- Includes two bars
- Finish in eco-grey.

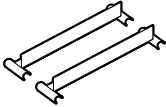
	DESCRIPTION	PRODUCT CODE	LIST PRICE	DIMENSIONS/INCHES		
				H	D	W
	Cross File Bars	UULFA0718	34	1	17.3	1

## HANGING FILE BARS

- One pair. Grey.
- For 30", 36" or 42" widths.
- Included in standard product.

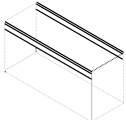
	DESCRIPTION	PRODUCT CODE	LIST PRICE	DIMENSIONS/INCHES		
				H	D	W
	Hanging File Bars	UULFA01	64	275	.5	1.3
	Pair	UULFA02	64	33.5	.5	1.3
		UULFA03	64	39.5	.5	1.3

## PLATE DIVIDERS

- Three per package.
- For use with Prime series lateral files.

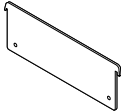
	DESCRIPTION	PRODUCT CODE	LIST PRICE	DIMENSIONS/INCHES		
				H	D	W
	Plate Dividers, 18D	UULFA1018	67	7.25	.2	13.25

## HALF HEIGHT DIVIDER PLATES

- Three per package.
- For use with Prime series lateral files.

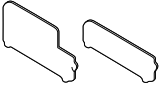
	DESCRIPTION	PRODUCT CODE	LIST PRICE	DIMENSIONS/INCHES		
				H	D	W
	Half Height divider plates, 18D	UULFA2418	67	3.95	.5	13.5

## EDP ADAPTER

- One pair. Grey.
- Extends side height of lateral file drawers by 1"

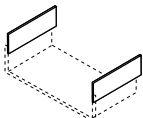
	DESCRIPTION	PRODUCT CODE	LIST PRICE	DIMENSIONS/INCHES		
				H	D	W
	EDP adapters	UULFA2018	65	2.65	.15	16.5

# STORAGE

# ACCESSORIES

## ADDITIONAL KEY

- For Prime series files.

	DESCRIPTION	PRODUCT CODE	LIST PRICE	DIMENSIONS/INCHES		
				H	D	W
	Additional Key	UUKY	19			

## REPLACEMENT LOCK AND LEY

- For Prime series files.

	DESCRIPTION	PRODUCT CODE	LIST PRICE	DIMENSIONS/INCHES		
				H	D	W
	Lock and Key	UUKC	55			

## EXTRA CABINET SHELF, NON SLOTTED

- For Prime series files.

	DESCRIPTION	PRODUCT CODE	LIST PRICE	DIMENSIONS/INCHES		
				H	D	W
	Cabinet Shelf - Non Slotted	UUSA11830	435	.8	16	28.4
		UUSA11836	488	.8	16	34.4
		UUSA11842	512	.8	16	40.4

## EXTRA CABINET SHELF, SLOTTED

- For Prime series files.

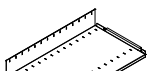
	DESCRIPTION	PRODUCT CODE	LIST PRICE	DIMENSIONS/INCHES		
				H	D	W
	Cabinet Shelf - Slotted	UUSA21830	512	5.25	16	28.4
		UUSA21836	595	5.25	16	34.4
		UUSA21842	631	5.25	16	40.4

# STORAGE

# LAMINATE STORAGE TOWERS

## STORAGE TOWERS W/CUPBOARD

- Storage tower with cupboard above FF or BBF and wardrobes will lock only the wardrobe and drawers
- Storage towers with wardrobe include a coat rod
- Locks are standard on all units and match pull finish

### EVL2TWBBF2DL - STORAGE TOWER W/CUPBOARD, BOX/BOX/FILE, RIGHT & LEFT HAND

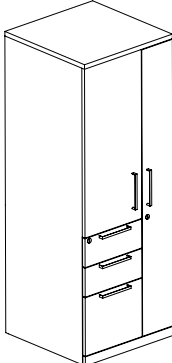
	DESCRIPTION	PRODUCT CODE	LIST PRICE	DIMENSIONS/INCHES			
				H	D	W	
 <p>Right Hand Shown</p>	Storage Tower w/Cupboard, Box/Box/File,	EVL2TWBBF2DL4224	2772	42	24	24	
		EVL2TWBBF2DL4824	2772	48	24	24	
		EVL2TWBBF2DL5424	2867	54	24	24	
		EVL2TWBBF2DL6624	3213	66	24	24	
			EVL2TWBBF2DR4224	2772	42	24	24
			EVL2TWBBF2DR4824	2772	48	24	24
			EVL2TWBBF2DR5424	2867	54	24	24
			EVL2TWBBF2DR6624	3213	66	24	24

### EVL2TW2F2DL - STORAGE TOWER W/CUPBOARD, FILE/FILE, RIGHT & LEFT HAND

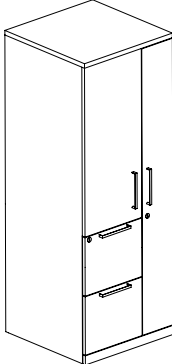
	DESCRIPTION	PRODUCT CODE	LIST PRICE	DIMENSIONS/INCHES			
				H	D	W	
 <p>Right Hand Shown</p>	Storage Tower w/Cupboard, File/File	EVL2TW2F2DL4224	2668	42	24	24	
		EVL2TW2F2DL4824	2668	48	24	24	
		EVL2TW2F2DL5424	2741	54	24	24	
		EVL2TW2F2DL6624	3072	66	24	24	
			EVL2TW2F2DR4224	2668	42	24	24
			EVL2TW2F2DR4824	2668	48	24	24
			EVL2TW2F2DR5424	2741	54	24	24
			EVL2TW2F2DR6624	3072	66	24	24

# STORAGE

# LAMINATE STORAGE TOWERS

## STORAGE TOWERS W/SIDE ACCESS

- Storage tower with cupboard above FF or BBF and wardrobes will lock only the wardrobe and drawers
- Storage towers with wardrobe include a coat rod
- Locks are standard on all units and match pull finish

### EVL2TWBBFDOL - STORAGE TOWER W/SIDE ACCESS, BOX/BOX/FILE, RIGHT & LEFT HAND

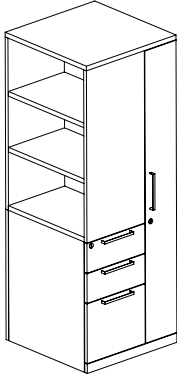
	DESCRIPTION	PRODUCT CODE	LIST PRICE	DIMENSIONS/INCHES			
				H	D	W	
 <p>Right Hand Shown</p>	Storage Tower w/Side Access, Box/Box/File,	EVL2TWBBFDOL4224	2551	42	24	24	
		EVL2TWBBFDOL4824	2551	48	24	24	
		EVL2TWBBFDOL5424	2618	54	24	24	
		EVL2TWBBFDOL6624	2911	66	24	24	
			EVL2TWBBFDOR4224	2551	42	24	24
			EVL2TWBBFDOR4824	2551	48	24	24
			EVL2TWBBFDOR5424	2618	54	24	24
			EVL2TWBBFDOR6624	2911	66	24	24

### EVL2TW2FDOL - STORAGE TOWER W/SIDE ACCESS, FILE/FILE, RIGHT & LEFT HAND

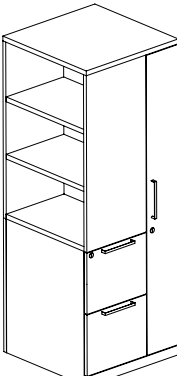
	DESCRIPTION	PRODUCT CODE	LIST PRICE	DIMENSIONS/INCHES			
				H	D	W	
 <p>Right Hand Shown</p>	Storage Tower w/Side Access, File/File,	EVL2TW2FDOL4224	2463	42	24	24	
		EVL2TW2FDOL4824	2463	48	24	24	
		EVL2TW2FDOL5424	2536	54	24	24	
		EVL2TW2FDOL6624	2831	66	24	24	
			EVL2TW2FDOR4224	2464	42	24	24
			EVL2TW2FDOR4824	2464	48	24	24
			EVL2TW2FDOR5424	2536	54	24	24
			EVL2TW2FDOR6624	2831	66	24	24

# STORAGE

# PRIME STORAGE TOWERS

## UUSLF - PRIME SERIES BOX/BOX/FILE STORAGE TOWER

- Wardrobe right side/right hand unit; wardrobe left side/left hand unit - indicated by last character of model number.
- Wardrobe section includes top shelf and coat bar.
- Hinged door compartment of 50"H and 54"H includes one adjustable shelf; 66"H includes two adjustable open shelves.
- Box-Box-File configuration.
- Wardrobe section includes top perforations for ventilation.
- Three locks included - wardrobe door, hinged door shelving compartment and drawers.
- Ships assembled one carton.

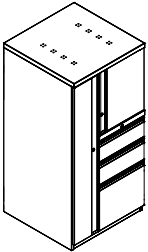
	DESCRIPTION	PRODUCT CODE	LIST PRICE	DIMENSIONS/INCHES		
				H	D	W
	Prime Series Box/Box File Storage Tower - 50" High	UUSLF4G24BCPL	3420	49.6	24	24
		UUSLF4G24BCPR	3420	49.6	24	24
	Prime Series Box/Box File Storage Tower - 54" High	UUSLF4H24BCPL	3420	53.6	24	24
		UUSLF4H24BCPR	3420	53.6	24	24
	Prime Series Box/Box/File Storage Tower - 65 7/8" High	UUSLF5024BCPL	3341	65.6	24	24
		UUSLF5024BCPR	3341	65.6	24	24

## UUSLF - PRIME SERIES FILE/FILE STORAGE TOWER

- Wardrobe right side/right hand unit; wardrobe left side/left hand unit - indicated by last character of model number.
- Wardrobe section includes top shelf and coat bar.
- Hinged door compartment of 50"H and 54"H includes one adjustable shelf; 66"H includes two adjustable open shelves.
- File-File drawer configuration.
- Wardrobe section includes top perforations for ventilation.
- Three locks included - wardrobe door, hinged door shelving compartment and drawers.
- Ships assembled one carton.

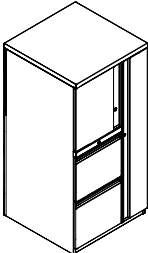
	DESCRIPTION	PRODUCT CODE	LIST PRICE	DIMENSIONS/INCHES		
				H	D	W
	Prime Series File/ File Storage Tower - 50" High	UUSLF4G24FCPL	3420	49.6	24	24
		UUSLF4G24FCPR	3420	49.6	24	24
	Prime Series File/File Storage Tower - 54" High	UUSLF4H24FCPL	3420	53.6	24	24
		UUSLF4H24FCPR	3420	53.6	24	24
	Prime Series File/File Storage Tower - 65 7/8" High	UUSLF5024FCPL	3575	65.6	24	24
		UUSLF5024FCPR	3575	65.6	24	24

# STORAGE

# PRIME STORAGE TOWERS

### UUSLS - PRIME SERIES SIDE OPENING BOX/BOX/FILE STORAGE TOWER

- Wardrobe right side/right hand unit; wardrobe left side/left hand unit - indicated by last character of model number.
- Wardrobe section includes top shelf and coat bar.
- 50"H and 54"H include open side shelf with one adjustable shelf; 66"H includes open side shelf with two adjustable shelves.
- Box-box-file drawer configuration.
- Wardrobe section includes top perforations for ventilation.
- Two locks included - wardrobe door and drawers.
- Ships assembled one carton.

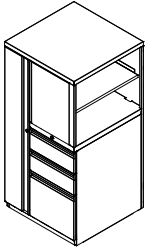
	DESCRIPTION	PRODUCT CODE	LIST PRICE	DIMENSIONS/INCHES		
				H	D	W
	Prime Series Side Opening	UUSLS4G2424BOPL	3597	50	24	24
	Box/Box/File Storage Tower - 50" High	UUSLS4G2424BOPR	3597	50	24	24
	Prime Series Side Opening	UUSLS4H2424BOPL	3779	54	24	24
	Box/Box/File Storage Tower - 54" High	UUSLS4H2424BOPR	3779	54	24	24
	Prime Series Side Opening	UUSLS502424BOPL	3841	65.875	24	24
	Box/Box/File Storage Tower - 65 7/8" High	UUSLS502424BOPR	3841	65.875	24	24

### UUSLS - PRIME SERIES SIDE OPENING FILE/FILE STORAGE TOWER

- Wardrobe right side/right hand unit; wardrobe left side/left hand unit - indicated by last character of model number.
- Wardrobe section includes top shelf and coat bar.
- 50"H and 54"H include open side shelf with one adjustable shelf; 66"H includes open side shelf with two adjustable shelves.
- File-file drawer configuration.
- Wardrobe section includes top perforations for ventilation.
- Two locks included - wardrobe door and drawers.
- Ships assembled one carton.

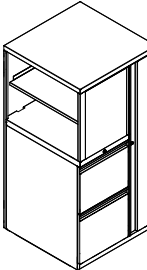
	DESCRIPTION	PRODUCT CODE	LIST PRICE	DIMENSIONS/INCHES		
				H	D	W
	Prime Series Side Opening	UUSLS4G2424FOPL	3757	50	24	24
	File/File Storage Tower - 50" High	UUSLS4G2424FOPR	3757	50	24	24
	Prime Series Side Opening	UUSLS4H2424FOPL	3779	54	24	24
	File/File Storage Tower - 54" High	UUSLS4H2424FOPR	3779	54	24	24
	Prime Series Side Opening	UUSLS502424FOPL	3841	65.875	24	24
	File/File Storage Tower - 65 7/8" High	UUSLS502424FOPR	3841	65.875	24	24

# STORAGE

# LAMINATE CREDENZA

## CREDENZA, BOX/FILE AND OPEN

- All lateral files feature drawer interlocking system
- All file drawers come with adjustable rails for legal or letter size hanging folders
- Locks are standard on all units and match pull finish
- File drawers are mounted on full extension ball bearing slides
- B/F Drawer Width -- 24" w on 48" w unit, 30" w on 54" w and 60" w units, 36" w on 66" w and 72" w units
- Two credenza spacers may be installed between a worksurface and credenza for support

### EVL2CRBFO - BOX/FILE/OPEN CREDENZA, 20" H

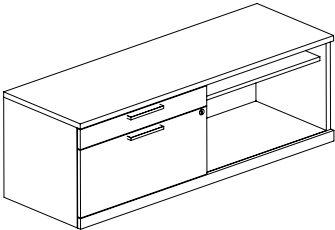
DESCRIPTION	PRODUCT CODE	LIST PRICE	DIMENSIONS/INCHES		
			H	D	W
 <p>Box/File/Open Credenza</p>	EVL2CRBFO2048	2162	20	48	20
	EVL2CRBFO2054	2361	20	54	20
	EVL2CRBFO2060	2508	20	60	20
	EVL2CRBFO2066	2632	20	66	20
	EVL2CRBFO2072	2728	20	72	20

### EVL2CROBF - OPEN/BOX/FILE CREDENZA, 20" H

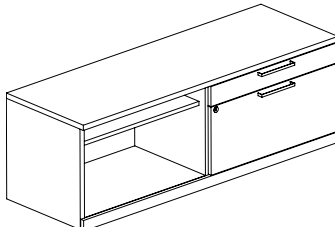
DESCRIPTION	PRODUCT CODE	LIST PRICE	DIMENSIONS/INCHES		
			H	D	W
 <p>Open/Box/File Credenza</p>	EVL2CROBF2048	2162	20	48	20
	EVL2CROBF2054	2361	20	54	20
	EVL2CROBF2060	2508	20	60	20
	EVL2CROBF2066	2632	20	66	20
	EVL2CROBF2072	2728	20	72	20

# STORAGE

# LAMINATE CREDENZA

## CREDENZA, SLIDING GLASS DOOR

- Sliding Door Credenzas are split evenly so door may cover either side
- Sliding door credenzas do not lock
- Two credenza spacers may be installed between a worksurface and credenza for support

### EVL2CRGSD - SLIDING GLASS DOOR CREDENZA, 20"H

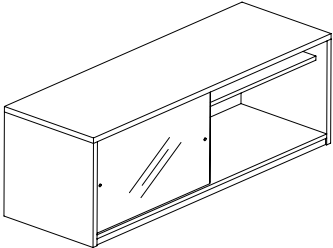
DESCRIPTION	PRODUCT CODE	LIST PRICE	DIMENSIONS/INCHES		
			H	D	W
 Sliding Glass Door Credenza	EVL2CRGSD2048	2895	20	48	20
	EVL2CRGSD2060	3182	20	60	20
	EVL2CRGSD2072	3482	20	72	20

### EVWSSL - CREDENZA TO WORKSURFACE SPACER

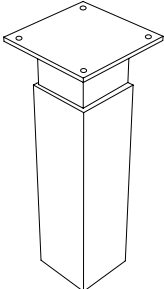
DESCRIPTION	PRODUCT CODE	LIST PRICE	DIMENSIONS/INCHES		
			H	D	W
 Credenza to Worksurface Spacer	EVWSSL08	83	8	3	3

# STORAGE

# KEY ALIKE FORM

SO#		PO#		TAG#		DATE			
KEY#	SETS REQ'D	KEY#	SETS REQ'D	KEY#	SETS REQ'D	KEY#	SETS REQ'D		
401		431		461		491		521	
402		432		462		492		522	
403		433		463		493		523	
404		434		464		494		524	
405		435		465		495		525	
406		436		466		496		526	
407		437		467		497		527	
408		438		468		498		528	
409		439		469		499		529	
410		440		470		500		530	
411		441		471		501		531	
412		442		472		502		532	
413		443		473		503		533	
414		444		474		504		534	
415		445		475		505		535	
416		446		476		506		536	
417		447		477		507		537	
418		448		478		508		538	
419		449		479		509		539	
420		450		480		510		540	
421		451		481		511		541	
422		452		482		512		542	
423		453		483		513		543	
424		454		484		514		544	
425		455		485		515		545	
426		456		486		516		546	
427		457		487		517		547	
428		458		488		518		548	
429		459		489		519		549	
430		460		490		520		550	

401 - 430 =	431 - 460 =	461 - 490 =	491 - 520 =	521 - 550 =
-------------	-------------	-------------	-------------	-------------

Total:

NOTE : If Key Alike Instructions are not submitted to EVOLVE with the Customer's Purchase Order, all components will be keyed randomly.

# accessories

# ACCESSORIES

## TV MOUNT / TACK BOARD / FELT DIVIDER

### EVHTVM - TV MOUNT

- Laminate panel with two mounting brackets to be installed on Evolve panels.
- TV Mount can be installed on panel of equal width or both brackets can be attached in middle for installing on single connector.
- TV frame not included, TV frame to be ordered separately.
- Holds up to 55" TV with a max load of 86 lbs.
- Note: TV frame must be securely attached to laminate panel. Care should be taken to attach TV frame using correct fasteners. Failure to do so may result in collapse of unit and subsequent possible injury.

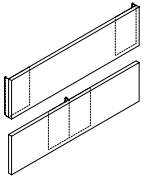
DESCRIPTION	PRODUCT CODE	LIST PRICE	DIMENSIONS/INCHES		
			H	W	D
 TV Mount	EVHTVM24	239	11	24	1
	EVHTVM30	256	11	30	1
	EVHTVM36	278	11	36	1
	EVHTVM42	299	11	42	1

### EVATB - TACK BOARD

- Provide a tackable surface for notes and memos in a work area.
- Includes two pairs of panel-mounting brackets.
- Only fabric must be specified.
- 17" to be installed under EVSOF13 or EVSOF16
- 21" specified for use under overhead shelf or storage bin.
- 24" for use without any overheads.
- All tackboards are 0.25" in thickness.

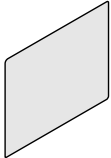
DESCRIPTION	PRODUCT CODE	LIST PRICE		DIMENSIONS/INCHES		
		Gr1	Gr2	H	W	D
 Tack Board - 17" High	EVATB1730	326	341	17	30	0.25
	EVATB1736	374	388	17	36	0.25
	EVATB1742	423	440	17	42	0.25
	EVATB1748	473	490	17	48	0.25
	EVATB1754	525	545	17	54	0.25
	EVATB1760	572	593	17	60	0.25
Tack Board - 21" High	EVATB2124	301	318	21	24	0.25
	EVATB2130	326	343	21	30	0.25
	EVATB2136	374	388	21	36	0.25
	EVATB2142	423	443	21	42	0.25
	EVATB2148	476	494	21	48	0.25
	EVATB2154	523	546	21	54	0.25
Tack Board - 24" High	EVATB2160	572	599	21	60	0.25
	EVATB2430	326	344	24	30	0.25
	EVATB2436	374	392	24	36	0.25
	EVATB2442	423	444	24	42	0.25
	EVATB2448	476	496	24	48	0.25
	EVATB2454	523	549	24	54	0.25
EVATB2460	572	599	24	60	0.25	

### EVFPDXXXWS - WORKSURFACE FELT DIVIDER

- Privacy felt divider integrated into an aluminum top trim.
- Attaches on top of a worksurface to add privacy or divide space.
- Must be used at connector location.
- Includes aluminum trim with channel, felt tile and brackets.
- 9 mm felt material is tackable and comes in 9 different colors. Please specify felt finish.
- Aluminum extrusion and brackets available in standard paint finishes.
- Felt tile and attachment hardware to ship separately.

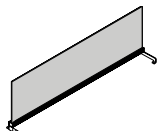
DESCRIPTION	PRODUCT CODE	LIST PRICE	DIMENSIONS/INCHES		
			H	W	D
 Felt Divider	EVFPD1818WS	221	18	18	
	EVFPD1824WS	247	18	24	
	EVFPD1830WS	278	18	30	
	EVFPD1836WS	302	18	36	

# ACCESSORIES

# WHITE MARKER BOARD / LOAD BARS

## EVAWB - WHITE MARKER BOARD

- Provides a writing surface within a work area.
- Includes two pairs of panel-mounting brackets.
- 21" specified for use under overhead shelf or storage bin.
- 24" for use without any overhangs.

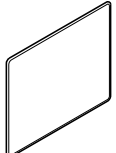
	DESCRIPTION	PRODUCT CODE	LIST PRICE	DIMENSIONS/INCHES		
				H	W	D
	White Marker Board - 21" High	EVAWB2130	348	21	30	
		EVAWB2136	393	21	36	
		EVAWB2142	442	21	42	
		EVAWB2148	514	21	48	
	White Marker Board - 24" High	EVAWB2430	348	24	30	
		EVAWB2436	393	24	36	
		EVAWB2442	442	24	42	
		EVAWB2448	514	24	48	

## EVAMT - MARKER TRAY

- Provides a tray for storage of markers, erasers, etc.
- Attaches to the bottom of the White Marker Board.
- Standard in anodized aluminum finish.

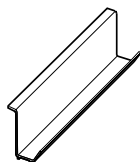
	DESCRIPTION	PRODUCT CODE	LIST PRICE	DIMENSIONS/INCHES		
				H	W	D
	Marker Tray	EVAMT12	23		12	

## EVALB2 - LOAD BAR - TOP

- Enables accessory items to be hung from a panel.
- Includes end caps and mounting brackets.
- Can be panel mounted.
- Can connect to EVALB2-2 and/or EVALB2-3 Load Bars to create a multi-level load bar or "Slat Wall"
- Note: can be used on its own.
- Available in standard and premium paint selections. See Textiles and Finishes (page 278) for complete offerings and conditions.

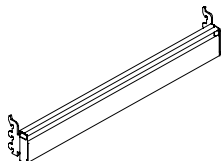
	DESCRIPTION	PRODUCT CODE	LIST PRICE	DIMENSIONS/INCHES		
				H	W	D
	Load Bar - Top	EVALB224	135	2.25	24	1
		EVALB230	141	2.25	30	1
		EVALB236	152	2.25	36	1
		EVALB242	161	2.25	42	1
		EVALB248	165	2.25	48	1
		EVALB254	172	2.25	54	1
		EVALB260	175	2.25	60	1

# ACCESSORIES

# LOAD BARS

## EVALB2-2 - LOAD BAR - MIDDLE

- Enables accessory items to be hung from a panel.
- Includes end caps and is to be used in conjunction with the Load Bar - Top (EVALB2). Mounting brackets NOT included.
- Can be panel mounted.
- Connects between EVALB2 and EVALB2-3 Load Bars to create a multi-level load bar or "Slat Wall"
- Note: Needs to be used in conjunction with both EVALB2 (as noted above) and EVALB2-3. Multiples of EVALB2-2 can be joined, one below the other, to create a "Slat Wall"

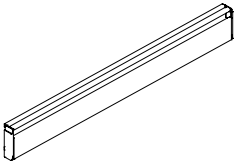
DESCRIPTION	PRODUCT CODE	LIST PRICE	DIMENSIONS/INCHES		
			H	W	D
 Load Bar - Middle	EVALB2-224	97	2.25	24	1
	EVALB2-230	101	2.25	30	1
	EVALB2-236	109	2.25	36	1
	EVALB2-242	116	2.25	42	1
	EVALB2-248	122	2.25	48	1
	EVALB2-254	132	2.25	54	1
	EVALB2-260	136	2.25	60	1

## EVALB2-3 - LOAD BAR - BOTTOM

- Enables accessory items to be hung from a panel.
- Includes end caps and mounting brackets.
- Can be panel mounted.
- Connects between EVALB2-2 and EVALB2-3 Load Bars to create a multi-level load bar or "Slat Wall"
- Note: Needs to be used in conjunction with an EVALB2 or a combination of EVALB2 and EVALB2-2

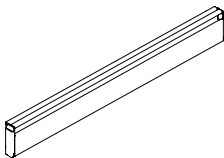
DESCRIPTION	PRODUCT CODE	LIST PRICE	DIMENSIONS/INCHES		
			H	W	D
 Load Bar - Bottom	EVALB2-324	132	2.25	24	1
	EVALB2-330	136	2.25	30	1
	EVALB2-336	141	2.25	36	1
	EVALB2-342	152	2.25	42	1
	EVALB2-348	162	2.25	48	1
	EVALB2-354	170	2.25	54	1
	EVALB2-360	173	2.25	60	1

## EVALB - LOAD BAR

- Enables accessory items to be hung from a panel.
- Includes end caps and mounting brackets.
- Can be panel or wall mounted.
- Must specify finish.
- Attachment slot dimensions = 0.115" W x 0.240" H.
- Slatwall mounted moitor arms will NOT hang on EVALB - load bar.

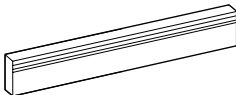
DESCRIPTION	PRODUCT CODE	LIST PRICE	DIMENSIONS/INCHES		
			H	W	D
 Load Bar	EVALB24	171	2.25	24	1
	EVALB30	188	2.25	30	1
	EVALB36	204	2.25	36	1
	EVALB42	236	2.25	42	1
	EVALB48	275	2.25	48	1
	EVALB54	289	2.25	54	1
	EVALB60	313	2.25	60	1

## EVHOMB - OFF MODULE WORKSURFACE BRACKET

- Supports the worksurface in the work station corner in the case where an adjoining panel is wider than the worksurface.
- Enhances the stability of the worksurface.
- Can be used only in conjunction with the Top Load Bar EVALB2xx (xx being the panel width of adjoining panel).
- Available in black only.
- Top Load Bar EVALB2xx must be ordered separately.

DESCRIPTION	PRODUCT CODE	LIST PRICE	DIMENSIONS/INCHES		
			H	W	D

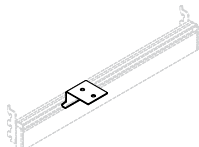
 Bracket	EVHOMB1	32	1.6	3	2.73
---	---------	----	-----	---	------

# ACCESSORIES

# WIRE MANAGER

## EVAFWMXXP - WIRE MANAGER

- PET Wire manager installed under worksurface
- Including attachment brackets
- Available in standard felt colors

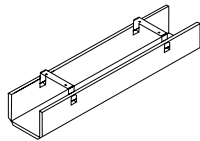

DESCRIPTION	PRODUCT CODE	LIST PRICE	DIMENSIONS/INCHES		
			H	W	D
PET Wire Manager	EVAFWM22P	137	3.375	22	4
	EVAFWM28P	158	3.375	28	4
	EVAFWM34P	174	3.375	34	4

## EVAFWMXXPL - WIRE MANAGER FOR 90 DEGREE CORNER-LEFT

- PET Wire manager installed under worksurface
- Including attachment brackets
- Available in standard felt colors

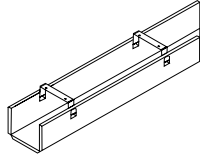

DESCRIPTION	PRODUCT CODE	LIST PRICE	DIMENSIONS/INCHES		
			H	W	D
PET Wire Manager 90 Degree Corner - Left	EVAFWM26PL	151	3.375	26	4
	EVAFWM32PL	170	3.375	32	4
	EVAFWM38PL	185	3.375	38	4

## EVAFWMXXPR - FELT WIRE MANAGER FOR 90 DEGREE CORNER-RIGHT

- Felt Wire manager installed under worksurface
- Including attachment brackets
- Available in standard felt colors

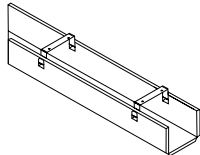

DESCRIPTION	PRODUCT CODE	LIST PRICE	DIMENSIONS/INCHES		
			H	W	D
PET Wire Manager 90 Degree Corner - Right	EVAFWM26PR	151	3.375	26	4
	EVAFWM32PR	170	3.375	32	4
	EVAFWM38PR	185	3.375	38	4

# ACCESSORIES

# RAIL ACCESSORIES

## EVABB01 - BINDER BIN

- Must be ordered in conjunction with a load bar option.
- Can be used with slat wall module.
- Available in standard and premium paint selections. See Textiles and Finishes (page 240) for a complete list of offerings and conditions.

DESCRIPTION	PRODUCT CODE	LIST PRICE	DIMENSIONS/INCHES		
			H	W	D

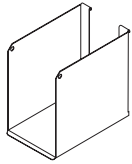

Binder Bin	EVABB01	88	9	4	10.25
------------	---------	----	---	---	-------

## EVALT01 - LETTER TRAY

- Must be ordered in conjunction with a load bar option.
- Can be used with slat wall module.
- Available in standard and premium paint selections. See Textiles and Finishes (page 240) for a complete list of offerings and conditions.

DESCRIPTION	PRODUCT CODE	LIST PRICE	DIMENSIONS/INCHES		
			H	W	D

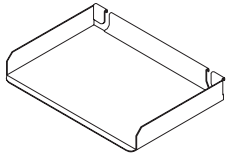

Letter Tray	EVALT01	70	2	13.5	9.25
-------------	---------	----	---	------	------

## EVALT02 - LEGAL TRAY

- Must be ordered in conjunction with a load bar option.
- Can be used with slat wall module.
- Available in standard and premium paint selections. See Textiles and Finishes (page 240) for a complete list of offerings and conditions.

DESCRIPTION	PRODUCT CODE	LIST PRICE	DIMENSIONS/INCHES		
			H	W	D

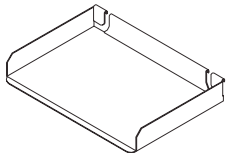

Legal Tray	EVALT02	80	1.75	14.7	8.75
------------	---------	----	------	------	------

## EVASS01 - SLANT SORTER

- Must be ordered in conjunction with a load bar option.
- Can be used with slat wall module.
- Available in standard and premium paint selections. See Textiles and Finishes (page 240) for a complete list of offerings and conditions.

DESCRIPTION	PRODUCT CODE	LIST PRICE	DIMENSIONS/INCHES		
			H	W	D

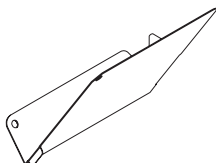

Slant Sorter	EVASS01L	57	9.5	5	10.25
	EVASS01R	57	9.5	5	10.25

# ACCESSORIES

# RAIL ACCESSORIES

## EVAMB01 - MEDIA BIN

- Must be ordered in conjunction with a load bar option.
- Can be used with slat wall module.
- Available in standard and premium paint selections. See Textiles and Finishes (page 240) for a complete list of offerings and conditions.

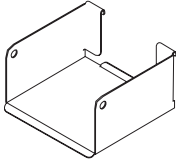
	DESCRIPTION	PRODUCT CODE	LIST PRICE	DIMENSIONS/INCHES		
				H	W	D
	Media Bin	EVAMB01	70	3	5.75	5.25

## EVAUT01 - UTILITY TRAY

- Must be ordered in conjunction with a load bar option.
- Can be used with slat wall module.
- Available in standard and premium paint selections. See Textiles and Finishes (page 240) for a complete list of offerings and conditions.

	DESCRIPTION	PRODUCT CODE	LIST PRICE	DIMENSIONS/INCHES		
				H	W	D
	Utility Tray	EVAUT01	48	1	8.5	3.75

## EVAFS01 - FLIP SORTER

- Must be ordered in conjunction with a load bar option.
- Can be used with slat wall module.
- Comes with nickel plated wire.
- Available in standard and premium paint selections. See Textiles and Finishes (page 240) for a complete list of offerings and conditions.

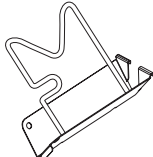
	DESCRIPTION	PRODUCT CODE	LIST PRICE	DIMENSIONS/INCHES		
				H	W	D
	Flip Sorter	EVAFS01	66	9.25	2.75	9.25

## EVAPP01 - MAIL BOX

- Must be ordered in conjunction with a load bar option.
- Can be used with slat wall module.
- Available in standard and premium paint selections. See Textiles and Finishes (page 240) for a complete list of offerings and conditions.

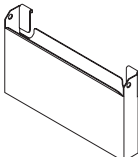
	DESCRIPTION	PRODUCT CODE	LIST PRICE	DIMENSIONS/INCHES		
				H	W	D
	Mail Box	EVAPP01	112	9	12	2.75

# ACCESSORIES

# RAIL ACCESSORIES

## EVATH01 - TELEPHONE HOLDER

- Must be ordered in conjunction with a load bar option.
- Can be used with slat wall module.
- Available in standard and premium paint selections. See Textiles and Finishes (page 240) for a complete list of offerings and conditions.

DESCRIPTION	PRODUCT CODE	LIST PRICE	DIMENSIONS/INCHES		
			H	W	D

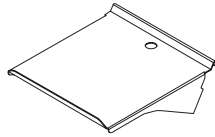

Telephone Holder	EVATH01	106	2	9	10
------------------	---------	-----	---	---	----

## EVANP02 - NAME PLATE

- Name Plate attached to 1" increment slots.
- Available in single sided (parallel to panel) or double sided (perpendicular to panel) for isle application displaying name on both sides.
- Injection molded frame and die cast base with black rubberized finish.
- Includes two slide-in name cards, steel brackets and fasteners.
- Available in black only.
- Free template for additional slide-in name cards are available at [http://evolvefurnituregroup.com/PDFs/Name\\_Plate\\_Template.doc](http://evolvefurnituregroup.com/PDFs/Name_Plate_Template.doc)

DESCRIPTION	PRODUCT CODE	LIST PRICE	DIMENSIONS/INCHES		
			H	W	D

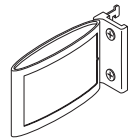

Name Plate	EVANP02	161	3.30	5.3	1.25
------------	---------	-----	------	-----	------

## EVACH01 - COAT HOOK

- Panel mounted coat hook.
- Available in all standard Evolve paint colors except Blizzard (BZD), Fog (FOG) and Stone Dust (SDT). Also available in premium paint selections (minimum quantities required to order).
- Ships individually (not in pack).

DESCRIPTION	PRODUCT CODE	LIST PRICE	DIMENSIONS/INCHES		
			H	W	D

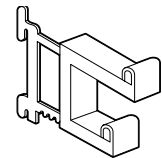

Coat Hook	EVACH01	118		3	.75
-----------	---------	-----	--	---	-----

## EVACH02 - PANEL COAT HOOK

- Panel mounted coat hook.
- Installed at panel top in groove between module and top trim.
- Available in standard and premium paint colors.
- Priced per six piece package.

DESCRIPTION	PRODUCT CODE	LIST PRICE	DIMENSIONS/INCHES		
			H	W	D

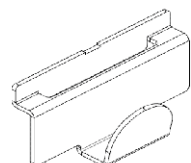

Panel Coat Hook	EVACH02	135		2.5	.625
-----------------	---------	-----	--	-----	------

# ACCESSORIES

# KEYBOARD SUPPORTS

## EVWAKM01 - SOFT TOUCH KEYBOARD SUPPORT MECHANISM

- Height range 6" (+1.0"/-5.0").
- Soft touch knob tilt adjustable range +15°/-15°.
- 360° base swivel.
- Soft touch knob for simultaneous height and tilt adjustment.
- Spring-assisted mechanism helps counter balance weight of keyboard and tray.
- Low profile design for maximum leg room.
- Includes 21.75" under worksurface glide track as standard. Optional 12" and 18" glide tracks are available at no upcharge. Contact Evolve Customer Support for details.
- Keyboard support mechanisms and trays available in Black only.

	DESCRIPTION	PRODUCT CODE	LIST PRICE	DIMENSIONS/INCHES		
				H	W	D

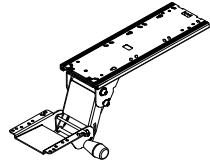

Soft Touch Keyboard Support Mechanism	EVWAKM01	342			
---------------------------------------	----------	-----	--	--	--

# ACCESSORIES

# MOUSE SUPPORTS

### EVWAKT01 - MDF TRAY WITH SLIDING MOUSE SUPPORT

- Formed MDF tray with textured finish and a foam anti-skid mat.
- Sliding retractable mouse support slides below tray for left or right mouse positioning.
- Extends 9.91" beyond the end of the keyboard tray.
- Keyboard support mechanisms and trays available in Black only.

DESCRIPTION	PRODUCT CODE	LIST PRICE	DIMENSIONS/INCHES		
			H	W	D

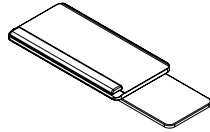

MDF Tray with Sliding Mouse Support	EVWAKT01	345	21.3	10.5	
-------------------------------------	----------	-----	------	------	--

### EVWAKT04 - 1/2" HDPE TRAY WITH HEIGHT ADJUSTABLE MOUSE SUPPORT

- 1/2" thick high density polyethylene with textured finish.
- HDPE includes removable plug-in, gel free foam palm rest and anti-skid straps.
- Height adjustable mouse support with ergonomic adjustment of tilt, swivel and height adjustment.
- Can mount left or right and includes mouse fence and cable manager.
- Keyboard support mechanisms and trays available in Black only.

DESCRIPTION	PRODUCT CODE	LIST PRICE	DIMENSIONS/INCHES		
			H	W	D

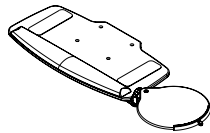

1/2 "HDPE Tray with Height Adjustable Mouse Support	EVWAKT04	534	23	11.5	
---	----------	-----	----	------	--

# ACCESSORIES

# KEYBOARD COMBINATION CHART

## KEYBOARD COMBINATION CHART - PACKAGED CODES

---

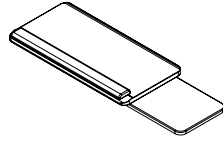

EVWAKT01

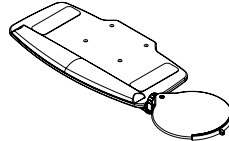

EVWAKT04

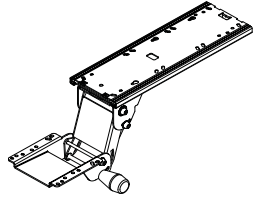

EVWAKM01

EVWAKK101  
681

EVWAKK104  
870

**MONITOR ARM SPECIFICATIONS (APPLIES TO ALL EVOLVE MONITOR ARMS LISTED BELOW):**

- VESA mounting plate contains 75mm & 100mm mounting configuration.
- VESA plate head is fully adjustable with 180° of tilt, 180° of swivel and 360° of rotation for portrait to landscape viewing.
- Keyhole slots in VESA plate for quick mounting of display screen.
- Counterbalance spring mechanism does not contain gas cylinders (that are prone to leakage).
- Cable management provided on arm swivel joints.
- Arm components manufactured from 100% recyclable aluminum dye cast material, providing stability and durability.
- 13" arm height adjustment on 11" stainless steel pole.
- Pole support ring doubles as cable manager.
- 360° of arm swivel around pole.
- Desk clamp and grommet mounting options standard on pole applications.

**EVLCD03 - MONITOR ARM - SINGLE SCREEN/SINGLE EXTENSION**

- Display viewing - 180° of tilt, 180° of swivel and 360° of rotation.
- Quick-release VESA plate included.
- 9" pole adjustment.
- Available in White (WHT), Black (BLK) and Silver (SIL). Post is chromed.

DESCRIPTION	PRODUCT CODE	LIST PRICE	DIMENSIONS/INCHES		
			H	D	W

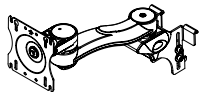

Monitor Arm - Single Screen  
Single Extension

EVLCD03 577

**EVLCD04 - MONITOR ARM - SINGLE SCREEN/DUAL EXTENSION/HEIGHT ADJUSTABLE**

- Frees up valuable worksurface space and supports a sit/stand working posture.
- Attaches to any standard worksurface with a flush edge, or through a grommet.
- Monitor arm adjusts from 3" to 12" above worksurface.
- Counterbalanced arm provides an additional 13" of height adjustment.
- Monitor connecting bracket swivels 360° and tilts +/- 90° (180°).
- Double extension has 19" of back and forth movement to allow for different vocal depths of viewing comfort.
- Built-in cable clips on underside of extension arms and pole base allows organized cable management.
- Quick-release VESA plate included.
- Available in White (WHT), Black (BLK) and Silver (SIL). Post is chromed.

DESCRIPTION	PRODUCT CODE	LIST PRICE	DIMENSIONS/INCHES		
			H	W	D

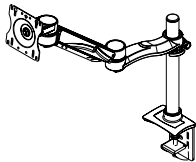

Monitor Arm - Single Screen  
Dual Extension/Height Adjustable

EVLCD04 824

**EVLCD05 - MONITOR ARM - DUAL SCREEN/DUAL EXTENSION**

- Frees up valuable worksurface space.
- Used for side-by-side or back-to-back applications.
- Attaches to any standard worksurface with flush edge or through a grommet.
- Monitor arm adjusts from 3" to 12" above worksurface.
- Monitor connecting extension has 19" of back and forth movement to allow for different vocal depths of viewing comfort.
- Built-in cable clips on underside of extension arms and pole base allows organized cable management.
- Quick-release VESA plate included.
- Available in White (WHT), Black (BLK) and Silver (SIL). Post is chromed.

DESCRIPTION	PRODUCT CODE	LIST PRICE	DIMENSIONS/INCHES		
			H	W	D

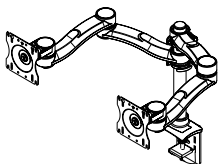

Monitor Arm - Dual Screen

EVLCD05 1211

**EVLCD06 - MONITOR ARM - DUAL SCREEN/DUAL EXTENSION/HEIGHT ADJUSTABLE**

- Frees up valuable worksurface space and supports a sit/stand working posture.
- Used for side-by-side or back-to-back applications.
- Attaches to any standard worksurface with flush edge or through a grommet.
- Monitor arm adjusts from 3" to 12" above worksurface.
- Counterbalanced arm provides an additional 13" of height adjustment.
- Monitor connecting bracket swivels 360° and tilts +/- 90° (180°).
- Double extension has 19" of back and forth movement to allow for different vocal depths of viewing comfort.
- Built in cable clips on underside of extension arms and pole base allows organized cable management.
- Quick-release VESA plate included.
- Available in White (WHT), Black (BLK) and Silver (SIL).
- Accommodates flat screen monitors up to 32" in size.

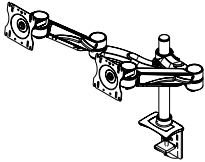
	DESCRIPTION	PRODUCT CODE	LIST PRICE	DIMENSIONS/INCHES		
				H	W	D
	Monitor Arm - Dual Screen Dual Extension/Height Adjustable	EVLCD06	1502			

**EVLCD08 - MONITOR ARM - SINGLE SCREEN/DUAL EXTENSION**

- 9 1/2" reach from center of pole to front of VESA plate.
- Display viewing - 180° of tilt, 180° of swivel and 360° of rotation.
- Quick-release VESA plate included.
- 9" pole adjustment.
- Available in White (WHT), Black (BLK) and Silver (SIL). Post is chromed.

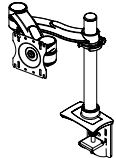
	DESCRIPTION	PRODUCT CODE	LIST PRICE	DIMENSIONS/INCHES		
				H	W	D
	Monitor Arm - Single Screen Dual Extension	EVLCD08	687			

**EVLCD09 - SINGLE SCREEN MONITOR ARM - FOR 5 TO 20LBS**

- Adjustable counterbalance cylinder provides smooth 14 1/2" of height adjustment with fingertip control - counterbalances monitors from 5 lbs. to 20 lbs.
- Double extension arms provide a maximum of 26 3/4" extension from the rear edge of the mounting surface to the VESA Plate for greater monitor adjustment on deep or corner workstations.
- Arms fold back to a minimum dimension of 4 1/2" to provide maximum desk utilization.
- Weight gauge provided to allow for quick and easy counterbalance adjustment of the arm prior to installing the screen.
- Saves time and guesswork especially for multiple arm installations.
- Die cast aluminum construction provides greater stability and contains high recycled material content with full recyclability.
- Adjustable rotation limiter to restrict arm rotation to 180°, preventing arms from hitting walls.
- Comes with all tools and mounting hardware for quick and easy installation (Tool-free).
- Available in White (WHT), Black (BLK) and Silver Metallic (SIL). Post is chromed.

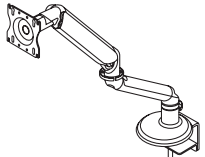
	DESCRIPTION	PRODUCT CODE	LIST PRICE	DIMENSIONS/INCHES		
				H	W	D
	Single Screen Monitor Arm - For 5 to 20 lbs.	EVLCD09	769	38	6	8.5

**EVCPU - CPU HOLDER**

- CPU holder with soft touch knob.
- Vertical underside storage space.
- Maintains CPU at set height.
- Inside width adjustment 3.5" — 9.25"
- Inside vertical adjustment 12.25" — 22.25"
- Load rating: 85lbs.
- Available in black only.

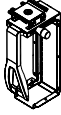
	DESCRIPTION	PRODUCT CODE	LIST PRICE	DIMENSIONS/INCHES		
				H	W	D
	CPU Holder	EVCPU01	372	14	8.25	7.75

**EVCPU02 - CPU HOLDER ON GLIDE TRACK**

- Accepts tower CPUs with a width range of 3.5" to 9.3" and a height range of 12.5" to 22.5".
- Soft touch knob for side clamp adjustment and bayonet lance for vertical height adjustment.
- 12" glide track mounted and 360-degree swivel for easy access to rear of CPU.
- Manufactured from steel and engineered resin, providing rugged durability and support.
- Available in Black only.

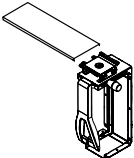
	DESCRIPTION	PRODUCT CODE	LIST PRICE	DIMENSIONS/INCHES		
				H	W	D
	CPU Holder on Glide Track	EVCPU02	393			

# ACCESSORIES

## EVATP - TOUCH-UP PAINT KIT

- Available in standard Evolve paint colors to facilitate easy touch-ups.
- 1/2 fl. ounce bottle (spray not available).
- Specify color.

	DESCRIPTION	PRODUCT CODE	LIST PRICE	DIMENSIONS/INCHES		
				H	W	D
	Touch-Up Paint Kit	EVATP01	55			



# textiles and finishes

## Care and Cleaning

The following guide encompasses the Evolve System line.

The guide was compiled using information from our "raw" material suppliers and is relevant only to our standard offering finishes and textiles.

---

### FABRICS

To extend the life of your upholstered panels, regularly dust the panel to prevent airborne particles from penetrating the fabric surface.

For light soiling, use a damp cloth and blot the spot with very slight pressure, taking care never to soak the fabric. Dry with a clean cloth by blotting - never rub fabric. More intense stains can be treated the same way, but with a mild detergent. Always test fabric first in an unseen area before using any cleaning method.

### PANEL FRAMES

The panel frames are manufactured out of sturdy aluminum with a powder coated enamel paint finish. To clean the frames of the panels, and all hardware associated with the Evolve line, simply utilize a clean, damp cloth. For stubborn stains on the panel frames, you may consider adding a mild detergent.

### GLAZED PANELS

Cleaning of the glazing in panels should only be done with a damp lint-free cloth. A mild detergent can be used if necessary. Do not use paper towels in combination with a window cleaner-this may cause scratches to the glazing.

### WORKSURFACES

The worksurfaces are manufactured using primarily Nevamar Brand laminates as the exposed surface. To properly clean these areas, it is best to use a clean, damp cloth and circular motion to prevent streaks. For stubborn stains, you are able to add a mild detergent to the water. Be certain not to use an ammonia-based solution. It will react with the PVC, or wood edge trim, causing permanent damage to the contacted areas.

### ACCESSORIES

The accessories sold with the Evolve product line can be simply cleaned with a clean, damp cloth. If they are really dirty, a mild, non-abrasive solution may be added. Wipe with a damp cloth after the solution, and finally, a dry cloth.

## TEXTILES & FINISHES

## LAMINATES AND VENEERS

### LAMINATES – THERMALLY FUSED & HIGH PRESSURE

Absolute Acajou*	<b>ACJ</b>
Asian Night*	<b>ASN</b>
Avant Cherry*	<b>AWC</b>
Avant Honey*	<b>AWH</b>
Black*	<b>BLK</b>
Blizzard*	<b>BZD</b>
Brushed Cobalt*	<b>BRC</b>
Clear Maple*	<b>CMB</b>
Custom Grey	<b>CGY</b>
Dark Espresso*	<b>DES</b>
Designer White*	<b>DWT</b>
Fashionista	<b>FAS</b>
First Class	<b>FCL</b>
Noce Biondo	<b>(NBL)</b>
Noce Grigio	<b>(NGL)</b>
Noce Leggero	<b>(NEL)</b>
Noce Medio	<b>(NML)</b>
Quartered Mahogany*	<b>QTM</b>
Sheer Beauty	<b>SBY</b>
Stone Dust	<b>SDT</b>
Storm Grey	<b>SOG</b>

Walnut Heights*	<b>WHE</b>
Winter Cherry*	<b>WCR</b>
White Chocolate*	<b>WHC</b>

Additional paint and laminates may be available. Contact Evolve Customer Support for details.

\* Matching Wood Grain PVC edge available.

\* PVC panel and connector trims are discontinued. Effective 12/2014

\* 1 1/8" Worksurfaces are discontinued. Effective December 2014

### PVC EDGE TRIM

Absolute Acajou	<b>AAE</b>
Asian Night	<b>ASE</b>
Avant Cherry	<b>ACE</b>
Avant Honey	<b>AHE</b>
Black	<b>BLK</b>
Blizzard	<b>BZD</b>
Brushed Cobalt	<b>BRC</b>
Charcoal	<b>CHR</b>
Clear Maple	<b>CME</b>
Dark Espresso*	<b>DES</b>
Designer White	<b>DWE</b>
Fashionista	<b>FAS</b>
First Class	<b>FCL</b>
Nevada	<b>NEV</b>
Quartered Mahogany*	<b>QTM</b>
Sheer Beauty	<b>SBY</b>
Silver	<b>SIL</b>
Taupe	<b>TPE</b>
Tungsten	<b>TUN</b>
Walnut Heights	<b>WHE</b>
Winter Cherry*	<b>WCR</b>
White Chocolate*	<b>CBE</b>

\* 1 7/16" HPW PVC Trim for Worksurfaces is not available in Dark Espresso (DES),

### WOOD VENEER WORKSURFACES\*

Almond Cherry	<b>AMW</b>
Amber Cherry	<b>ACW</b>
Biscotti	<b>BTW</b>
Cocoa Walnut	<b>CAW</b>
Coral	<b>CRW</b>
Dark Cherry	<b>DCW</b>
Dark Walnut	<b>DWW</b>
Espresso Walnut	<b>EWV</b>
Evening Oak	<b>EVV</b>
Grey on Oak	<b>GRW</b>
Hazlenut	<b>HAW</b>
Java	<b>JAW</b>
Latte Walnut	<b>LTW</b>
Mahogany on Walnut	<b>MHW</b>
Milestone	<b>MTW</b>
Natural Maple	<b>MPW</b>
Natural Walnut	<b>NLW</b>
Red Cherry	<b>RCW</b>
Umber Walnut	<b>ULW</b>
Vintage Cherry	<b>VNW</b>
Walnut	<b>WLW</b>
Warm Cherry	<b>WCW</b>
White Maple	<b>WMW</b>

All wood veneer worksurfaces are 1.38" thick.

\*Note: Wood veneer options for worksurfaces are available at an up charge and with an extended lead time. Contact Evolve Customer Support for details.

### STANDARD PAINT & FRAME COLORS

(for application to trim, steel components, PVC, vertical and horizontal members)

Black	<b>BLK</b>
Blizzard (Textured)	<b>BZD</b>
Charcoal	<b>CHR</b>
Designer White	<b>DWT</b>
Fog	<b>FOG</b>
Nevada	<b>NEV</b>
Silver	<b>SIL</b>
Stone Dust (Textured)	<b>SDT</b>
Taupe	<b>TPE</b>
Tungsten <sup>o</sup>	<b>TUN</b>

Additional paint and laminates may be available. Contact Evolve Customer Support for details.

<sup>o</sup>Tungsten paint is subject to 10% upcharge EXCEPT on Worksurfaces, PVC items, or when PVC trim components are ordered separately.

### PREMIUM PAINT & FRAME COLORS

Black Coffee*	<b>BKC</b>
Bone*	<b>BNE</b>
Business Grey*	<b>BGR</b>
Claret*	<b>CLT</b>
Dark Chocolate*	<b>DCH</b>
Desert Putty*	<b>DPT</b>
Grey*	<b>GRY</b>
Ice*	<b>ICE</b>
Ivory*	<b>IVR</b>
Light Grey*	<b>LGR</b>
Metro*	<b>MET</b>
Mocha*	<b>MCH</b>
Moss*	<b>MOS</b>
Navy*	<b>NAV</b>
Oyster*	<b>OYS</b>
Sky*	<b>SKY</b>
Stone*	<b>STN</b>
Storm Grey	<b>SGR</b>
Tahiti Sand*	<b>TSA</b>
Willow*	<b>WIL</b>

\*Premium paint selections are available on the following components: Panels (top trim and frame), Hardware, End-of run/Post Kits, and Accessories at a 22% upcharge. Storage with no upcharge.

\*Please note all Double Wall Storage units must be ordered in a minimum quantity of 50 when ordering in a premium paint finish. Different model types can be combined to achieve the minimum quantity required. See pages 192-193 for affected models.

All special and premium paint match orders of 50 panels or less will incur a \$500 net setup fee. Panels, hardware, accessories and storage may be combined on orders to achieve minimum of 50 pieces or more and will not be subject to \$500 net set up fee. Add on orders will not have that charge for 90 days after the original order has shipped and must have the original PO# quoted otherwise they will not qualify for the program.

Global matte paint finishes are available on most Evolve Storage pieces without an up charge regardless of quantities.

All Mica and Metallic paint finishes will incur a minimum up charge of 10%.

All non-standard paint finishes must be approved by Evolve prior to placing an order.

ADA Overheads are not available in Evolve premium color paints. ADA Overheads are available in Evolve standard paint colors only.

Frames for all Open Panel models, all panel retainers, PVC components for panels and connectors are unavailable in premium or special/custom paint colors. They are available in standard Evolve paint colors only.

# TEXTILE & FINISHES

# PANEL FABRICS

## PANEL FABRICS – GRADE 1

**Anchorage** - 35% Post - consumer Recycled Polyester and 65% Pre -consumer Recycled Polyester

Birch .....	<b>AN40</b>
Green Apple .....	<b>AN41</b>
Lapis .....	<b>AN42</b>
Straw .....	<b>AN43</b>
Wolf .....	<b>AN44</b>
Goose .....	<b>AN45</b>
Angora .....	<b>AN46</b>
Cumin .....	<b>AN47</b>
Asteroid .....	<b>AN48</b>
Geranium .....	<b>AN49</b>
Thistle .....	<b>AN50</b>
Graphite .....	<b>AN51</b>
Slate .....	<b>AN52</b>
Quarry Blue .....	<b>AN53</b>
Onyx .....	<b>AN54</b>
Pumpkin .....	<b>AN55</b>
Red Delicious .....	<b>AN56</b>
Sunshine .....	<b>AN57</b>
Waterfall .....	<b>AN59</b>
Vanilla .....	<b>AN61</b>
Vanilla .....	<b>AN61</b>
Cobalt .....	<b>AN62</b>
Cloud .....	<b>AN64</b>

**Aurora** - 100% Polyester, 80% minimum Post-Consumer Recycled Polyester

Cloud .....	<b>AU20</b>
Seal .....	<b>AU21</b>
Fog .....	<b>AU22</b>
Pewter .....	<b>AU23</b>
Granite .....	<b>AU24</b>
Oat .....	<b>AU25</b>
Coconut .....	<b>AU26</b>
Latte .....	<b>AU27</b>
Lake .....	<b>AU28</b>
Frost .....	<b>AU29</b>

**Chance** - 63% Virgin Polyester, 37% Post-Consumer Recycled Polyester

Mist .....	<b>CN51</b>
Dill .....	<b>CN52</b>
Island .....	<b>CN53</b>
Plaza .....	<b>CN54</b>
Tranquil .....	<b>CN55</b>
Malt .....	<b>CN56</b>
Navajo .....	<b>CN57</b>
Prairie .....	<b>CN58</b>
Cinder .....	<b>CN59</b>
Oasis .....	<b>CN66</b>

**Linea** - 100% Post Consumer Recycled Polyester

Queue .....	<b>LN41</b>
Cord .....	<b>LN42</b>
Twine .....	<b>LN43</b>
Thread .....	<b>LN44</b>
Contour .....	<b>LN45</b>
Silhouette .....	<b>LN46</b>
Cable .....	<b>LN47</b>
Route .....	<b>LN48</b>

**Lisbon** - 80% Polyester, 20% Post-Consumer Recycled Polyester

Gesso .....	<b>LS11</b>
Dusk .....	<b>LS12</b>
Grey .....	<b>LS13</b>
Ivory .....	<b>LS14</b>
Henna .....	<b>LS15</b>
Nocturnal .....	<b>LS16</b>
Moss .....	<b>LS17</b>
Navy .....	<b>LS18</b>
Buff .....	<b>LS19</b>
Spa .....	<b>LS20</b>

**Loopy** - 100% Recycled Polyester

Oyster .....	<b>LP60</b>
Putty .....	<b>LP61</b>
Marble .....	<b>LP62</b>
Hazelnut .....	<b>LP63</b>
Latte .....	<b>LP64</b>
Bay .....	<b>LP65</b>
Wild Rice .....	<b>LP66</b>
Harbor .....	<b>LP67</b>

**Melody** - 100% Recycled Polyester

Spray .....	<b>ME40</b>
Pond .....	<b>ME41</b>
Sand Bar .....	<b>ME42</b>
Silt .....	<b>ME43</b>
Pebble .....	<b>ME44</b>
Lake .....	<b>ME45</b>
Gravel .....	<b>ME46</b>
Boulder .....	<b>ME47</b>

**Merge** - 100% Polyester, 75% minimum Post-Consumer Recycled Polyester

Fawn .....	<b>MG20</b>
Marshmallow .....	<b>MG21</b>
Driftwood .....	<b>MG22</b>
Dove .....	<b>MG23</b>
Graphite .....	<b>MG24</b>
Slate .....	<b>MG25</b>
Eucalyptus .....	<b>MG26</b>
Fire Engine .....	<b>MG27</b>
Mediterranean .....	<b>MG28</b>
Midnight .....	<b>MG29</b>

**Pinpoint** - 100% Post-Consumer Recycled Polyester

Bliss .....	<b>PN11</b>
Delight .....	<b>PN12</b>
Dune .....	<b>PN13</b>
Infusion .....	<b>PN14</b>
Ebony .....	<b>PN15</b>
Fresh .....	<b>PN16</b>
Carrot .....	<b>PN17</b>
Splash .....	<b>PN18</b>
Vibe .....	<b>PN19</b>
Gala .....	<b>PN20</b>

**Streak** - 100% Recycled Polyester

Beach .....	<b>SR81</b>
Shade .....	<b>SR86</b>
Stretch .....	<b>SR88</b>
Sprint .....	<b>SR89</b>
Roll .....	<b>SR91</b>
Dart .....	<b>SR92</b>
Zoom .....	<b>SR93</b>
Splash .....	<b>SR94</b>
Whiz .....	<b>SR95</b>
Flash .....	<b>SR96</b>

**Tek** - 100% Recycled Polyester

Finesse .....	<b>TX60</b>
Grain .....	<b>TX61</b>
Essence .....	<b>TX62</b>
Warp .....	<b>TX64</b>
Mesh .....	<b>TX67</b>
Form .....	<b>TX69</b>
Spice .....	<b>TX71</b>
Glacier .....	<b>TX72</b>
Spring .....	<b>TX73</b>
Harmony .....	<b>TX74</b>
Smoke .....	<b>TX75</b>
Pebble .....	<b>TX76</b>

**Terrace** - 100% Post-Consumer Recycled Polyester

Lotus .....	<b>TC60</b>
Tigerlily .....	<b>TC61</b>
Shadow .....	<b>TC62</b>
Cobble .....	<b>TC63</b>
Cherry Blossom .....	<b>TC64</b>
Bluebell .....	<b>TC65</b>
Apple .....	<b>TC66</b>
Haze .....	<b>TC67</b>
Cerise .....	<b>TC68</b>
Twilight .....	<b>TC69</b>
Wintergreen .....	<b>TC70</b>
Ironwork .....	<b>TC71</b>
Flirt .....	<b>TC73</b>
Echo .....	<b>TC74</b>
Glacier .....	<b>TC75</b>

# TEXTILE & FINISHES

# PANEL FABRICS

## PANEL FABRICS— GRADE 2

**Cyclone** - 56% post-consumer recycled polyester and 44% polyester.

Stove Pipe .....	<b>IM37</b>
Stainless.....	<b>IM40</b>
Polished Pewter .....	<b>IM41</b>
Welded Steel .....	<b>IM43</b>
Etched Bronze.....	<b>IM44</b>
Fired Titanium.....	<b>IM46</b>
Chrome.....	<b>IM49</b>
Dark Annealed.....	<b>IM50</b>
Karat.....	<b>IM54</b>
Red Metal.....	<b>IM55</b>
Oxidized Bronze.....	<b>IM56</b>
Bright Ray.....	<b>IM57</b>
Bismuth Crystal .....	<b>IM58</b>
Gallium Blue.....	<b>IM59</b>

**Dashing** -100% Post-Consumer Recycled Polyester

Classic Silver.....	<b>DS21</b>
Refined Marble.....	<b>DS22</b>
Antique Sage.....	<b>DS23</b>
Polished Slate .....	<b>DS24</b>
Genteel Beige .....	<b>DS25</b>
Bespoke Tan .....	<b>DS26</b>
Dapper Grey.....	<b>DS27</b>

**Quadrille** - 52.5% Polyester / 47.5% Recycled Polyester

\*Maximum panel width is 48'

Escapade.....	<b>QU30</b>
Shenanigan .....	<b>QU31</b>
Revelry .....	<b>QU32</b>
Spring .....	<b>QU33</b>
Regalia .....	<b>QU34</b>
Soiree.....	<b>QU35</b>
Zest.....	<b>QU36</b>
Gambol.....	<b>QU37</b>
Fair .....	<b>QU39</b>
Fiesta.....	<b>QU40</b>
Carnival .....	<b>QU41</b>
Opus .....	<b>QU43</b>
Jubilee.....	<b>QU44</b>
Masquerade.....	<b>QU45</b>
Cabarets.....	<b>QU46</b>

## PET PANEL FABRICS

Amethyst.....	<b>GPH</b>
Apricot.....	<b>APR</b>
Black.....	<b>BLK</b>
Blue Smoke .....	<b>BSK</b>
Brick.....	<b>BRI</b>
Carnation.....	<b>CNN</b>
Denim .....	<b>DEN</b>
Emerald.....	<b>EMD</b>
Graphite.....	<b>GPH</b>
Harvest.....	<b>HVT</b>
Lapis.....	<b>LAP</b>
Mist.....	<b>MTS</b>
Navy.....	<b>NVY</b>
Pewter.....	<b>PWT</b>
Ruby.....	<b>RBV</b>
Shamrock.....	<b>SHR</b>
Sunflower.....	<b>SFR</b>
White.....	<b>WHT</b>



## TEXTILES & FINISHES

## PEDESTAL AND LATERAL CUSHIONS FABRICS

### GRADE 1

<b>Dobby</b> - 96% Recycled Polyester / 4% Virgin Polyester	
Snowcap.....	<b>DB30</b>
Bonsai.....	<b>DB31</b>
Cloud.....	<b>DB32</b>
Sand.....	<b>DB33</b>
Pewter.....	<b>DB34</b>
Sante Fe.....	<b>DB35</b>
Corfu.....	<b>DB36</b>
Medium Taupe.....	<b>DB37</b>
Charcoal.....	<b>DB38</b>
Berry.....	<b>DB39</b>
Royal.....	<b>DB40</b>
Titanium.....	<b>DB41</b>
Black.....	<b>DB42</b>

### Fusion - 90% Virgin Polyester/ 10% Post-Consumer Recycled Polyester

Tangerine.....	<b>FU71</b>
Fresh.....	<b>FU72</b>
Moss.....	<b>FU73</b>
Tomato.....	<b>FU74</b>
Aqua.....	<b>FU75</b>
Sandstone.....	<b>FU76</b>
Granite.....	<b>FU77</b>
Poppy.....	<b>FU78</b>
Cadet.....	<b>FU79</b>
Oasis.....	<b>FU80</b>
Graphite.....	<b>FU81</b>
Viola.....	<b>FU82</b>
Cobalt.....	<b>FU83</b>
Flax.....	<b>FU84</b>
Carbon.....	<b>FU85</b>

### Illusion - 100% Virgin Polyester

Cappuccino.....	<b>II01</b>
Paprika.....	<b>II02</b>
Tropic.....	<b>II03</b>
Wicker.....	<b>II04</b>
Hemp.....	<b>II05</b>
Cayenne.....	<b>II06</b>
Maui.....	<b>II07</b>
Dusk.....	<b>II08</b>
Smoke.....	<b>II09</b>
Currant.....	<b>II10</b>
Fiji.....	<b>II11</b>
Ozone.....	<b>II12</b>
Ebony.....	<b>II13</b>

### Jenny - 100% Polyester

Midnite.....	<b>JN01</b>
Ebony.....	<b>JN02</b>
Slate.....	<b>JN03</b>
Vermilion.....	<b>JN07</b>
Admiral.....	<b>JN08</b>
Charcoal.....	<b>JN11</b>
Silver Lining.....	<b>JN25</b>
Oatmeal.....	<b>JN26</b>
Sunflower.....	<b>JN27</b>
Cascade.....	<b>JN28</b>
Harvest.....	<b>JN29</b>
Mellon.....	<b>JN30</b>
Berry.....	<b>JN31</b>
Green Grass.....	<b>JN32</b>
Roast.....	<b>JN33</b>

### Quilt - 100% Polyester

Black.....	<b>QL10</b>
Charcoal Grey.....	<b>QL11</b>
Navy.....	<b>QL14</b>
Wine.....	<b>QL16</b>
Silver.....	<b>QL19</b>
Feather.....	<b>QL20</b>
Dune.....	<b>QL21</b>
Meadow.....	<b>QL22</b>
Cadet.....	<b>QL23</b>
Geranium.....	<b>QL24</b>
Daisy.....	<b>QL25</b>
Quest.....	<b>QL26</b>
Punch.....	<b>QL27</b>
Tangerine.....	<b>QL28</b>
Cocoa.....	<b>QL29</b>

### Terrace - 100% Post-Consumer Recycled Polyester

Lotus.....	<b>TC60</b>
Tigerlily.....	<b>TC61</b>
Shadow.....	<b>TC62</b>
Cobble.....	<b>TC63</b>
Cherry Blossom.....	<b>TC64</b>
Bluebell.....	<b>TC65</b>
Apple.....	<b>TC66</b>
Haze.....	<b>TC67</b>
Cerise.....	<b>TC68</b>
Twilight.....	<b>TC69</b>
Wintergreen.....	<b>TC70</b>
Ironwork.....	<b>TC71</b>
Pine Cone.....	<b>TC72</b>
Flirt.....	<b>TC73</b>
Echo.....	<b>TC74</b>

### Trak - 100% Recycled Polyester

Taupe.....	<b>TK40</b>
Mustard.....	<b>TK41</b>
Latte.....	<b>TK42</b>
Cement.....	<b>TK43</b>
Silver.....	<b>TK44</b>
Copper.....	<b>TK45</b>
Teal.....	<b>TK46</b>
Apple.....	<b>TK47</b>
Steel.....	<b>TK48</b>
Merlot.....	<b>TK49</b>
Midnight Sky.....	<b>TK50</b>
Mocha.....	<b>TK51</b>
Carbon.....	<b>TK52</b>

### Urban - 62% Recycled Polyester / 32% Polyester

Ocean Blue.....	<b>UR11</b>
Blue Bayou.....	<b>UR12</b>
Green Grass.....	<b>UR13</b>
Brown Ridge.....	<b>UR18</b>
White Sand.....	<b>UR19</b>
Granite Rock.....	<b>UR20</b>
Gravel Road.....	<b>UR21</b>
Black Coal.....	<b>UR22</b>

### Waterfall - 60% Virgin Polyester /40% Post - Consumer Recycled Polyester

Trance.....	<b>WA40</b>
Tryst.....	<b>WA41</b>
Splash.....	<b>WA42</b>
Victoria.....	<b>WA43</b>
Imagine.....	<b>WA44</b>
Sky.....	<b>WA45</b>
Rainforest.....	<b>WA46</b>
Rumble.....	<b>WA47</b>
Prism.....	<b>WA48</b>
Tranquility.....	<b>WA49</b>
Grand.....	<b>WA50</b>
Rushing.....	<b>WA51</b>
Majestic.....	<b>WA52</b>
Pacific.....	<b>WA53</b>
Dance.....	<b>WA54</b>

### Waterfall - 60% Virgin Polyester /40% Post - Consumer Recycled Polyester

Lime.....	<b>WV01</b>
Mint.....	<b>WV02</b>
Stone.....	<b>WV03</b>
Flame.....	<b>WV04</b>
Mykonos.....	<b>WV05</b>
Savannah.....	<b>WV06</b>
Mesa.....	<b>WV07</b>
Plasma.....	<b>WV08</b>
Cancun.....	<b>WV09</b>
Quartz.....	<b>WV10</b>
Moonrock.....	<b>WV11</b>
Rubine.....	<b>WV12</b>
Corfu.....	<b>WV13</b>
Bluejay.....	<b>WV14</b>

### GRADE 2 (FABRIC)

<b>Imprint</b> - 100% Post-Consumer Polyester	
Almond.....	<b>IM70</b>
Cork.....	<b>IM71</b>
Sand.....	<b>IM72</b>
Currie.....	<b>IM73</b>
Candy Apple.....	<b>IM74</b>
Ocean.....	<b>IM75</b>
Navy.....	<b>IM76</b>
Green Tea.....	<b>IM77</b>
Celery.....	<b>IM78</b>
Oregano.....	<b>IM79</b>
Walnut.....	<b>IM80</b>
Paprika.....	<b>IM81</b>
Graphite.....	<b>IM82</b>
Slate.....	<b>IM83</b>
Licorice.....	<b>IM84</b>

## TEXTILES & FINISHES

## PEDESTAL AND LATERAL CUSHIONS FABRICS

### GRADE 2 (VINYL)

For availability of chair series in Vinyl, please contact a Global Sales Representative.

**Allante FRee** - 100% Vinyl Face / 100% Polyester Backing

Illusion .....	<b>A01F</b>
Bright White .....	<b>A02F</b>
White Crush .....	<b>A03F</b>
Ivory .....	<b>A04F</b>
Ice .....	<b>A05F</b>
Bleached Sand .....	<b>A06F</b>
Taupe Fawn .....	<b>A07F</b>
Warm Smoke .....	<b>A08F</b>
Autumn Rain .....	<b>A09F</b>
Cookie .....	<b>A10F</b>
Sierra Brick .....	<b>A11F</b>
Gibraltar .....	<b>A12F</b>
Chateau Grey .....	<b>A13F</b>
Golden Green .....	<b>A14F</b>
Oasis Green .....	<b>A15F</b>
Ink Black .....	<b>A16F</b>
Purple impulse .....	<b>A17F</b>
Italian Rose .....	<b>A18F</b>
Mountain Sky .....	<b>A19F</b>
Old Navy .....	<b>A20F</b>
Galaxy .....	<b>A21F</b>
Red Truffle .....	<b>A22F</b>
Chocolate Sundae .....	<b>A23F</b>
Province Blue .....	<b>A24F</b>
Eclipse .....	<b>A25F</b>

### GRADE 3 (RECYCLED)

**Couture** - 100% Post-Consumer

Polyester	
Mocha .....	<b>CE71</b>
Sapphire .....	<b>CE74</b>
Neptune .....	<b>CE75</b>
Lake .....	<b>CE76</b>
Willow .....	<b>CE77</b>
Sassy .....	<b>CE78</b>
Persimmon .....	<b>CE80</b>
Carbon .....	<b>CE81</b>
Sterling .....	<b>CE82</b>

# PANEL C.O.M REQUEST FOR APPLICATION TEST

## SEND COMPLETED FORM AND FABRIC TO:

Evolve Furniture Group  
555 Petrolia Road, Unit 2  
Toronto, Ontario M3J2X8  
Attn: Nahum Schneider

Requested By: \_\_\_\_\_

Phone #: \_\_\_\_\_

Fax #: \_\_\_\_\_

Project Name \_\_\_\_\_

Dealer/Specifier \_\_\_\_\_

Dealer Contact: \_\_\_\_\_

Evolve CSR: \_\_\_\_\_

Phone #: \_\_\_\_\_

Fax #: \_\_\_\_\_

## FABRIC INFORMATION

Fabric Manufacturer: \_\_\_\_\_

Color Name: \_\_\_\_\_

Color #: \_\_\_\_\_

Pattern Name: \_\_\_\_\_

Pattern #: \_\_\_\_\_

Content: \_\_\_\_\_

Weight: \_\_\_\_\_

Width: \_\_\_\_\_

Repeat Horizontal: \_\_\_\_\_

Repeat Vertical: \_\_\_\_\_

Other Comments: \_\_\_\_\_

## REQUEST FOR APPLICATION TEST (THIS REQUIRES 1 YARDS OF FABRIC)

\_\_\_\_\_ Evolve Panel

\_\_\_\_\_ Evolve Tackboard

Total Number of yards for testing: \_\_\_\_\_

Please Note:

Evolve is not responsible for the duty and brokerage fees for C.O.M. Fabric to clear customs. These charges will be billed to the dealer on a separate invoice.



# PANEL FABRIC SPECIFICATION SHEET

**SEND COMPLETED FORM TO:**

EVOLVE Furniture Group  
555 Petrolia Road, Unit 2  
Toronto, Ontario M3J2X8  
Attn: Nahum Schneider

<b>SUPPLIER</b>  <b>PATTERN</b>  <b>WIDTH</b>  <b>CONTENT</b>	<b>REMARKS:</b> <hr/> <hr/> <hr/> <hr/>	
<b>LIGHT FASTNESS</b>  <b>FLAMMABILITY</b>  <b>TUNNER TEST</b>	<b>REMARKS:</b> <hr/> <hr/> <hr/> <hr/>	
<b>CUT PRICE</b>  <b>1 - 3 ROLLS</b>  <b>4 ROLLS</b>	<b>REMARKS:</b> <hr/> <hr/> <hr/> <hr/>	
<b>DIRECTIONAL</b>  <b>PANELS CORNERS</b>  <b>RACEWAY COVER</b>  <b>RACEWAY CORNERS</b>  <b>STRETCH</b>	<b>REMARKS:</b> <hr/> <hr/> <hr/> <hr/>	<b>EASY</b> <b>HARD</b> <b>X-HARD</b>
<b>APPROVED</b> <input type="checkbox"/> <b>NOT APPROVED</b> <input type="checkbox"/> <b>CONDITIONAL APPROVAL</b> <input type="checkbox"/>		
<b>REMARKS:</b> <hr/> <hr/> <hr/>		
<small>* This fabric is approved for upholster-ability only. The approval does not account for the durability of the fabric at the time of, and after installation of the product</small>		
<b>SIGNATURE:</b> _____ <b>PRINT NAME:</b> _____ <b>DATE:</b> _____		



**PANEL FABRIC SAMPLE**

**TOP**

**STAPLE  
MINIMUM 6" X 6"  
FABRIC SAMPLE HERE  
IN THE DIRECTION IT IS TO BE  
APPLIED TO THE PRODUCT**

**BOTTOM**

## APPENDIX

The Evolve Furniture Group has partnered with the software vendors listed below to provide you with an online source for viewing the 2019 Evolve Electronic Catalog. Please visit their websites for additional information and download details.

### **2020 Technologies**

www.2020technologies.com  
5503 Mile Road NW  
Grand Rapids, MI 49544  
Phone: 800-638-6002

### **Ice Edge Business Solutions**

www.ice-edge.com  
4001 S 700 East, Suite 450  
Salt Lake City, UT 84107  
Phone: 801-747-0373

### **KISP**

www.kisp.com  
Customer Support: 416-499-2457  
Cad Services Team: 416-499-2457 x3  
Customer Service e-mail: tellmemore@kisp.com  
CAD Services requests CadServices@kispstech.com

### **Project Matrix**

www.projectmatrix.com  
11655 Lebanon Rd.  
Cincinnati, OH 45241  
Tech Support Instant Messenger: projectmatrixtech@yahoo.com  
Phone: 513.554.1665  
Fax: 513.554.1255

### **Quintero-Smith Incorporated/Midnight Oil**

www.midnight-oil.com  
10469 Kinnard Avenue  
Los Angeles, CA 90024  
voice: 800-350-7434 (US Only)  
international: 310-478-5140  
fax: 310-478-4572  
e-mail: jimrsr@q-si.com

## TERMS & CONDITIONS

### APPLICATION OF STANDARD TERMS

Sales of Evolve products are made only on Evolve standard terms and conditions of sale which are contained in the Price Book and in Evolve's order acknowledgments. These standard terms and conditions may be modified or supplemented only by a separately written document signed by Evolve's authorized personnel at its head office in Marlton, New Jersey. An offer by Purchaser of said terms and conditions shall not be binding until accepted by Evolve in writing.

All illustrations, specifications and prices in this Price List are based on the latest product information available at the time of publication. Evolve reserves the right to make changes, at any time and without prior notice, to prices, colors, materials, specifications and models offered.

### PRICES AND PAYMENT

The prices shown in this Price List, as well as those quoted by Evolve, shall be in US dollars for orders shipped to destinations within the continental United States.

Prices listed herein are for standard product. Quotations for special product are available through Evolve Customer Support Department in Marlton, New Jersey.

If shipping date requested is more than 90 days from date of order Evolve shall use published list prices effective at the time of shipment.

Not included in the list price are special or export packing, unpacking and installation. Orders are invoiced at the time of shipment. The Customer agrees to pay a charge of 2% per month of invoices outstanding more than 30 days.

### FOR PAYMENTS ONLY, MAIL TO:

Evolve Furniture Group, a division of:  
Global Industries, Inc.  
17 West Stow Road  
P.O. Box 562  
Marlton, New Jersey 08053

Any products sold shall remain the property of Evolve until fully paid for in cash. The Purchaser agrees to perform all acts which may be necessary to perfect and assure retention of title to such products to Evolve until such time as the goods have been paid for in full.

Free freight applies to orders dock delivered to one commercial business location in the contiguous United States during normal business hours. Residential deliveries will incur additional delivery charges.

Please note exception below:

**All showroom and mock-up orders will be subject to actual freight charges.**

Evolve shall, in its sole discretion, determine the most appropriate method of shipment routing and carrier. Shipments of less than a full trailer load (LTL) shall ship via common carrier. **These LTL shipments are not subject to specific delivery days or times.** Full trailer loads will provide for dedicated delivery time and schedule. Purchaser may request special packaging or method of shipment at Purchaser's sole expense.

### TAXES

All sales, use, excise and other applicable taxes and the collection and reporting thereof (excluding only taxes on the net income of Evolve) are the Purchaser's responsibility and will be invoiced to the Purchaser. If Purchaser claims an exemption from such taxes, it shall be the Purchaser's responsibility to furnish an appropriate exemption certificate to Evolve.

### ORDER INFORMATION

Evolve requires that **all orders be submitted in writing** to avoid errors and/or duplication. Orders will be acknowledged with Evolve's acknowledgement forms governing the transaction. The details appearing on the acknowledgement will describe the items to be shipped to Purchaser who must ascertain that they are correct. If not correct, Purchaser should notify Evolve immediately by telephone or fax followed by written confirmation. Acknowledgment shows approximate shipping date of items ordered. **Shipping dates are assigned to orders based on the item having the longest manufacturing lead time.** Orders with Customer's Own Material (C.O.M.), or missing or incorrect information (finish selections, fabric selections, etc.) will be scheduled for manufacturing upon receipt of COM or correct complete information. Purchaser must indicate if multiple shipping schedules are required including noting if the shipping date requested is longer than standard posted lead time. Each shipment will be invoiced at time of shipping and will be subject to payment terms described herein.

### C.O.M. CUSTOMER'S OWN MATERIAL

Should Purchaser request a fabric, not standard to the Evolve upholstery line, Purchaser shall submit a sample of not less than two yards for approval. Evolve will determine whether fabric is suitable to manufacturing process and applicable UL or code requirements. Should Evolve be required to test such fabric, it shall so advise Purchaser, and Purchaser shall be responsible for all costs associated therewith. This includes all duty and brokerage fees.

Fabric yardage requirement will be determined by Evolve. An additional charge may be made to cover the cost of cutting, matching or sewing unusual or directional patterns. Evolve shall have no responsibility for condition, quality, performance, physical properties or any other aspect of C.O.M. For panels, price as if grade 1 fabric is used.

Evolve reserves the right to reject any C.O.M. deemed unsuitable.

Evolve reserves the right to cancel an order at any time if C.O.M. is, in the sole judgement of Evolve, inadequate for any reason.

### CHANGES AND CANCELLATION

The order may not be changed or cancelled by Purchaser without the written consent of Evolve. This charge can be as much as 100% based upon proximity to scheduled shipment date. Special order items and fabric-covered items already in production are not subject to change or cancellation under any circumstances. Fabric-covered items are considered to be in production once the fabric has been cut.

### DEPOSIT ON SPECIAL ORDERS

Orders for nonstandard products may, at Evolve's discretion, require deposit prior to scheduling of production, the amount of the deposit being credited against the total price of the project.

### SUSPENSION

In the event that the Purchaser defaults in the payment of any sum due Evolve, or in the event the Purchaser's financial condition becomes unsatisfactory to Evolve, Evolve shall have the right at its option, upon written notice to the Purchaser, to cancel shipment of any goods, unless within ten (10) days of Purchaser's receipt of such notice Purchaser provides assurance of payment to Evolve in such form, content and/or amounts as Evolve, in its sole discretion, deems adequate.

### COMBINED SHIPMENTS

Evolve will make every effort to combine shipments and orders on written request. However, acceptance of such request shall be with Evolve's sole discretion.

### CODE RESTRICTIONS

Evolve portable furniture may be subject to local fire, electrical and/or building codes applicable to portable furniture. It shall be Purchaser's sole responsibility for the proper application of Evolve items within the limitations of such local codes, which may be different from area to area.

### SERVICE

Service problems shall be handled by the authorized Evolve dealer. Where this cannot be accomplished on a local level, service problems should be referred to:

Evolve Furniture Group  
Customer Support  
17 West Stow Road  
Marlton, New Jersey USA 08053  
856-552-4000 888-827-2500  
Attention: Evolve Operations Manager

## TERMS & CONDITIONS

### STORAGE

In the event Purchaser requests postponement of delivery beyond the acknowledged shipping date, Evolve may transfer the goods to storage on Purchaser's account and at Purchaser's risk and expense subject to a daily storage rate. Such transfer to storage shall be deemed shipment to Purchaser for all purposes, including invoicing and payment.

### DELAYS

Evolve's order acknowledgement will state a shipping date which is Evolve's best estimate at the time the order is acknowledged. However, Evolve shall not incur any obligation or liability to Purchaser for failure to ship by a specified date. In addition, Evolve shall not be liable for any loss or damage resulting from any delay or failure in shipment or other failure to perform all or any part of the agreement between the parties with respect to the goods shown on the face of the order acknowledgement where such delay, failure, loss or damage is the proximate result of any act of any governmental authority or political subdivision thereof, revolution, riot, civil disorder or disturbance, act of enemies, delay or default in transportation, strike disputes among or between unions or other labor disputes, delay or inability in obtaining materials and facilities, fire, flood, act of God or any cause not within the reasonable control of Evolve, whether of the class of causes enumerated or otherwise. Without limiting the generality of the foregoing, Evolve may, without causing any breach or incurring liability, allocate goods which are in short supply, regardless of the reasons therefore, among purchasers, in any manner which Evolve, in its sole discretion, deems advisable.

### BACK CHARGES

Evolve will not accept charges for expense incurred by the Purchaser in expediting shipments or otherwise. Evolve will not accept charges for the repair of damage by others.

### CLAIMS

All goods are sold F.O.B. Toronto, Canada, unless otherwise agreed to in writing by Evolve. Evolve is not responsible for damage which occurs in transit or in storage. The carrier signs for all goods received in good order. It is the Purchaser's responsibility to examine goods upon receipt and to file any claims with the carrier. Any claims made against Evolve for apparent defects, errors or shortages must be made by the Purchaser in writing, within fifteen (15) working days after any delivery. Failure by the Purchaser to make any claim against Evolve within the above-described fifteen days shall constitute acceptance of the goods and a waiver of any apparent defects, errors or shortages.

### RETURNS

No returns of goods will be accepted without written consent and shipping instructions, including Evolve's Return Goods Authorization (R.G.A.) numbers, to Evolve. A minimum restocking charge of 35% is made on all authorized returns for credit or refund, provided goods are received by Evolve in the condition in which they left the factory. No credit will be given if goods cannot be reused. Special order items and fabric-covered items are in no event subject to return. All returns must be approved and authorized in writing by Evolve Customer Support, Marlton, New Jersey.

### LIFETIME WARRANTY

Evolve warrants that all commercial products are free from defects in material and workmanship, for the life of the product, to the original purchaser. This warranty is made by Evolve only to original customers acquiring the product directly from Evolve's authorized dealers. The customer's sole remedy pursuant to this warranty is limited to repair or replacement of parts or product at Evolve's option. Consent from Evolve must be obtained before any warranty work is performed. This warranty shall not apply to any products which must be replaced because of normal wear and tear, negligence, abuse or "accident", shipping damage, or product use and installation other than in accordance with written instructions or warnings. It shall also not apply when product has been modified or altered, repaired or refurbished by someone other than Evolve or an authorized dealer or because of natural variations over which Evolve has no control. In the event of repair and/or replacement of any defective product, Evolve does not warrant matching color, grain, texture or dye lots. Evolve's warranty does not cover the cost of transportation or labor. Repair or replacement will be at Evolve's option. Evolve makes no warranty that any of its products are suitable for any particular purpose and makes no other warranties, expressed or implied, other than those set forth in this Price List. As codes and standards vary from one jurisdiction to another, references to compliance are solely for convenience and without any representation as to accuracy or suitability. Users must verify the suitability of such information or product for their specific application. In no event shall Evolve be liable in either tort or contract for any loss or direct, special, incidental, consequential, or exemplary damages.

This Lifetime Warranty is NOT applicable to customers who use Evolve products for rental purposes and is effective only for products, parts or components manufactured after January 1, 2011.

Exceptions to this warranty include:

- Global fabrics and wood veneers, which are warranted for five years from date of delivery.
- Electrical components, which are warranted for ten years from the date of delivery.
- Moving parts such as glides, slides, casters, user-adjustable worksurface mechanisms, which are warranted for five years from date of delivery.

- Fading on fabric and wood veneers can be caused by exposure to U.V. rays/sunlight. Natural wood veneer, being a natural material, will have shade differences between veneer sheers, the difference will be more apparent between dye lots.

Evolve does not warrant color fastness on Customer's Own Material.

Because of natural variations over which Evolve has no control, this warranty does not extend to color, grain or texture of wood, and Evolve does not warrant matching of color, grain or texture.

Evolve makes no warranties, including implied warranties of merchantability and fitness for a particular purpose, other than the express warranties contained herein.

### LIMITATION OF REMEDY

Purchaser's sole and exclusive remedy (excluding the repair or replacement of goods for breach of the express warranty above) for any matter or claim arising under or relating to these terms and conditions, the goods covered hereby and any transaction involving or relating to such goods, whether in contract, tort (including negligence) or otherwise, shall be payment of the lesser of the cost to repair or replace said product or the purchase price for the goods to which the claim relates. In no event shall Evolve be liable for any special, indirect, consequential, or incidental damages, including without limitation, damages for loss of business profits, business interruptions, or loss of information.

### EVOLVE'S WARRANTY DOES NOT APPLY (FOR ANY PRODUCT CATEGORY) TO THE FOLLOWING:

- Failures due to wear and tear
- Failures which result from negligence, abuse, accident or misuse
- Failure to apply, install or maintain products according to Evolve's written instructions and warnings
- Modifications, attachments or repair methods not approved by Evolve
- Damage caused by a carrier in transit, or delivery/installation contractors
- The matching of colors, grains or textures (wood, leather, etc.) of natural materials and color matching of textiles
- Products exposed to extreme hot or cold temperatures or excessively dry or humid environments
- Colorfastness or the matching of color of textiles
- Damage by markings or staining; damage by sharp objects or imprinting from instruments
- Damage to textiles or laminate and wood surfaces/edges from exposure to sunlight (including UV rays)
- Products used for rental purposes

Evolve's warranty applies to products sold within the United States of America, Mexico, the Commonwealth of Puerto Rico and Canada.

evolve systems

showrooms and distribution centers throughout the united states

SHOWROOMS

**Atlanta**  
10 10th Street  
Suite 150  
Atlanta, GA 30309  
T 404.879.0998

**Chicago**  
The Merchandise Mart  
10th Floor, Suite 1035  
Chicago, IL 60654  
T 312.755.0843

**Miami**  
112 NE 41st Street  
6th floor  
Miami, FL 33137

**New York City**  
386 Park Avenue South,  
7th floor  
New York, NY 10016  
T 212.545.9900

**Phoenix**  
4675 East Cotton  
Center Boulevard,  
Suite 165  
Phoenix, AZ 85040  
T 602.426.0666

**Boston**  
One Harbor Street,  
Suite 104  
Boston, MA 02210  
T 617.406.5435

**Irvine**  
18400 Von Karman Ave.  
Suite 100  
Irvine, CA 92618

**New Jersey (Southern)**  
119 Greentree Road  
Marlton, NJ 08053  
T 856.596.3390

**Philadelphia**  
1735 Market Street  
38th Floor  
Philadelphia PA, 19103  
215.861.0963

**Washington, DC**  
1130 Connecticut  
Avenue  
Washington, DC 20036  
T 202.659.0230

SHOWROOMS + DISTRIBUTION CENTERS

**Atlanta Area**  
6715 Maple Ave.  
Suite 100  
Buford, GA 30518  
T 678.602.4130

**Cincinnati Area**  
8712 LeSaint Drive  
Fairfield, OH 45014  
T 513.777.0009

**Ft. Lauderdale Area**  
560 Sawgrass  
Corporate Parkway  
Sunrise, FL 33325  
T 954.846.8888

**Los Angeles Area**  
12320 Bloomfield  
Avenue, Unit A  
Santa Fe Springs, CA  
90670  
T 562.484.9686

**Baltimore Area**  
Troy Hill Corporate  
Center  
7030 Troy Hill Drive  
Elkridge, MD 21075  
T 410.379.8021

**Dallas Area**  
2025 W. Beltline Rd.,  
#100  
Carrollton, TX 75006  
T 972.236.1366

**Houston**  
7865 Northcourt Road,  
Building D, Suite 200  
Houston, TX 77040  
T 713.695.5777

**Seattle Area**  
Oakesdale Commerce  
Center  
820 Southwest 34th St.  
Building W7, Suite A  
Renton, WA 98057  
T 425.291.9282

**Chicago Area**  
27W501 North Avenue  
West Chicago, IL 60185  
T 630.681.2818

**Denver Area**  
19080 E 38th Ave.,  
#30  
Aurora, CO 80011  
T 303.340.1617

**Kansas Area**  
11617 West 81st Street  
Lenexa, KS 66214  
T 913.310.9963

**Tampa Area**  
10351 Windhorst Road  
Tampa, FL 33619  
T 813.621.6272

Global - USA Headquarters

17 West Stow Road P.O. Box 562  
Marlton, New Jersey U.S.A. 08053  
Tel (856) 596-3390 | (800) 220-1900  
www.globalfurnituregroup.com

Global - Canada Headquarters

1350 Flint Road  
Downsview, ON Canada M3J 2J7  
Sales & Marketing: Tel (1-877) 446-2251  
Customer Service: Fax (800) 361-3182  
Government Customer Service: Fax (416) 739-6319

Furniture & Accessories #ESCNJ 22/23-08 336



End Term: 7/2/2022 - 7/1/2024  
Extended to 7/1/2025  
Extended to 1/1/2026