

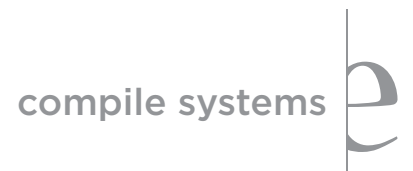

List Price Book  
Effective January 1, 2023  
Updated July 1, 2024



# compile systems



## PROTECTING THE ENVIRONMENT FOR FUTURE GENERATIONS

Our environmental success story began with the challenge to create an office system that would meet today's business requirements while maintaining a firm commitment to save and protect the environment.

Sustainability became a part of the creative focus and development of Compile that incorporates the latest technology and design features to provide excellent performance at a competitive price.

As government and industry environment ratings such as LEEDS & Greenguard become more prevalent, Compile offers designers and architects functional, attractive, and economical office designs that meet these standards.

Evolve Furniture Group is a leader in reducing waste in the manufacturing of its products as well as utilizing recycled materials wherever possible. We make extensive use of recycled plastic and wood waste from other Global factories.

Evolve Furniture Group is committed to the continuous improvement of our environmental systems, the prevention of pollution, and to comply with both the spirit and the letter of all relevant environmental legislation.

Compile Panels are 100% recyclable at the end of their lifespan. Nothing from an Evolve Panel needs to end up in a landfill.

## SUSTAINABILITY INFORMATION

Compile offers fabrics that are made from 100% recycled polyester, which means less waste going to landfills. These fabrics also reduced the demand for petroleum products, and decrease the environmental impacts of processing those petroleum products into polyester.

Compile's epoxy powder coating process involves no liquids and is solvent free. It contains no harmful VOC's or lead. Up to 99% of over sprayed powdered is reclaimed, mixed with virgin powder and reused.

Compile's entire panel is up to 82% recycled.

Compile masonite is up to 85% recycled.

Compile's entire product line is up to 99% recyclable.

## REFERENCES

Features, Benefits & General Information .....	3
Coding an Order .....	4
Textiles & Finishes .....	112
Panel COM Form .....	117
Panel Fabric Specification Sheet .....	118
Pedestal Cushions COM Form.....	119
Panel Fabric Sample.....	120
Appendix .....	121
Terms & Conditions.....	122

## PANELS

Panels – Technical Information.....	8
Panel – Types .....	9
Panel Package – Configuration .....	15
Monolithic Panel Packages.....	16
Segmented Panel Packages.....	18
Acoustic Panel Packages .....	20
Monolithic Laminate Panel Packages .....	22
Segmented Laminate Panel Packages.....	26
Segmented Writeboard Panel Packages .....	30
Single Segmented Open Bottom Panel Packages .....	34
Glazed Panel Packages .....	36
Partly Glazed Panel Packages.....	38
12" Top Partly Glazed Panel Packages.....	40
Privacy Glass.....	42
Over Panels .....	43
Gallery Panels .....	47
Sliding Doors.....	54
Post Packages .....	55
Raceway & Knockout Covers .....	57
Posts & Trim Inserts .....	58
Post Covers .....	60
Panel Legs.....	61
Post Separator.....	62

## ELECTRICAL

Electrical – Technical Information .....	64
Electrical – Wire Schematic .....	65
Electrical – Configuration.....	66
Power Distribution Housing .....	67
Cables.....	68
I Connector .....	68
Duplex Receptacle .....	69
Power Entry .....	70
Electrical Box.....	70
Post Extension.....	71

## ELECTRICAL

Ceiling Feed.....	71
Cable Cover.....	71
Task Lights.....	72

## WORKSURFACES

Worksurfaces – Technical Information .....	74
Worksurfaces – Configuration .....	75
Rectangular Worksurface .....	76
Straight Worksurfaces .....	77
Rectangular Worksurface for Height Adjustable Tables .....	78
Wedge Worksurfaces .....	79
Span a Post Rectangular Worksurfaces .....	79
Curvilinear Worksurface .....	80
Corner Worksurface .....	81
Extended Curved Corner.....	82
“D” Worksurface.....	83
Hatchet Worksurface .....	84
Straight Wedge Worksurfaces .....	84
Quarter Round Panel Worksurface .....	84
Transaction Worksurface .....	85
Accessories.....	86

## STORAGE

Storage – Technical Information .....	92
Storage – Configuration .....	93
Pedestals.....	94
Overhead Storage .....	96
Lateral File.....	98
Storage Towers .....	101
Key Alike Form .....	103

## ACCESSORIES

Tack Board.....	106
White Marker Board .....	106
Load Bars.....	107
Rail Accessories.....	107



## PANELS

- Panel Fabric modules consist of Module Frames, Module Interiors and Fabric Skins.

### Fabric

- Fabric offerings include selections woven with 100% recycled yarn.

### Panel Frame

- Typical workstation contains up to 62.2% recycled material.
- Panel is made of 82.3% recycled material.
- Acoustic panels are light tackable with 0.70 NRC and a 26 STC rating.
- Non Acoustic panels are not tackable with 0.17 NRC and a 28 STC rating.
- Raceway covers are aluminum.
- Plastic top cap vs Aluminum top cap.

### Metal Components/Raceway Finish

- All aluminum components are painted with environmentally friendly epoxy powder.
- Raceway interiors are coated with recycled epoxy powder.
- The entire Compile Panel and the processes used to manufacture it are designed to save and protect the environment. Compile Panels are made from recycled materials and are 99% recyclable.

### Panel Options

- Compile Panels come in 4 heights: 30", 42", 54" and 66".
- Panel widths come in 7 sizes including: 24", 30", 36", 42", 48", 54" and 60".
- Panels conform to CGSB and ANSI/BIFMA standards.
  - This is your assurance that the quality, and performance level of these Panels have been tested to equal or exceed the requirements of the US government.
- Rigid, aluminum Panel Frame is 2 3/8" thick.
- Aluminum Panel Frame combined with easy to assemble "Quick Connect" clips, create a rigid Panel Wall.
- Levelling glides extend 2". Enables the client to deal with severe undulations in the flooring levels of a building.
- Compile makes it easy to select a Panel function that is suitable for your application.
- Compile makes it easy to select a Panel type and height that is suitable for your application.

## VOICE/DATA AND ELECTRICAL POWER

- Voice/data cables can be inserted at the base. 8 wire, 4 circuit electrical capability, 2 utility + 2 dedicated circuits, each with 10 gauge (oversized) neutrals. All circuits can support up to 20 amps (15 CSA).
- Raceway Cover opening sizes conform to the ANSI/TIA/EIA Furniture Opening Standard of 1.345" x 2.680".
- Panels 24" wide include raceway covers with 2 knockouts.
- Panels 30" – 60" wide include raceway covers with 3 knockouts.

- Panels and electrical components are CSA/UL approved.
- Compile panel raceway is roughly 2.13" x 4.6" without power distribution housing installed. With power distribution housing installed inside, the dimension is reduced to roughly 2.13" x 2.13
- The base raceway cavity accommodates 50 .25" diameter communication cables without power installed or 30 .25" diameter communication cables with power installed.
- 90-degree posts accommodate 25 .25" diameter communication cables without a ceiling infeed or 20 .25" diameter communication cables with a ceiling infeed installed.
- 120-degree posts may not be utilized for power infeeds or communication cables. 90-degree posts may be utilized at the end of a 120-degree configuration if ceiling infeed of power and/or data cables is required.
- No tools are required to install electrical in the Compile Panel System.

## WORKSURFACES

- 1" thick worksurfaces come in a variety of shapes and sizes. Essentially, they are 24" or 30" deep and are available in 6" increments from 24" to 84" wide.
- Cable scoops located at the back of each Worksurface provide routing of power and data cables.
- This convenient feature, together with a 3/8" gap between the Worksurface and the Panel, allows access to cables without having grommet holes in the Worksurface.
- With this choice of product, we can tailor each installation to your requirements. The addition of custom sizes shows a commitment to client satisfaction that not every manufacturer offers.
- Thermally fused laminate tops are standard.
- All Worksurfaces utilize balanced construction.
- Predrilled holes in worksurfaces enable installer to properly align worksurface.

## STORAGE

- 19", 23" and 29" deep Pedestals. Freestanding and Worksurface supporting options available.
- Drawer divider and pencil tray included in all Freestanding Pedestals containing box drawers. Drawer divider and pencil tray not included in Worksurface Supporting Pedestals.
- Adjustable glides are accessible from the inside of the cabinet.
- Positive and secure locking system on all Pedestals is standard.
- Full height drawer sides are standard on all file drawers. This enables you to hang files from the drawer side so no extra hardware is necessary. File drawers accept letter sized files. Optional file bars are available to file legal and metric sized files.
- Steel construction guarantees the performance of the product over the long term. Welded joints with a full top, back and base ensure that the Pedestal will sit square and adequately support the Worksurface where necessary.

- Worksurface supporting Pedestals are standard with Compile.
- Shelves feature all metal construction.
- All storage components as well as the Panel Frames are epoxy powder coated.
- Glides enable you to level the cabinet to the floor and or Worksurface. The convenient adjustment feature allows the installer to adjust the height of the cabinet while it is under the Worksurface. This saves time in the installation process.
- For additional security and peace of mind, locks can be keyed alike or master keyed for additional convenience. Standard recessed handle offers uncluttered aesthetic.
- "Environmentally friendly" epoxy powder coat is 15 times more durable in independent testing than a wet paint spray. This helps maintain the look of the product over its many years of service.

## WARRANTIES AND PERFORMANCE

- A Lifetime Warranty
- Non Obsolescence Warranty
- Reduced cost of assembly and reconfiguration
- ISO9001:2008 Registered
- ISO14001:2004 Registered
- GreenGuard Certified
- Level 2 Certified
- ANSI/BIFMA CGSB testing on all products
- For piece of mind over the long term, we cover you with a comprehensive warranty that is supported by our dealer network.
- Some installation companies claim that the Compile Panels System can be installed in half the time it takes to install most of our competitor's segmented panels. This cost saving can amount to thousands of dollars over the lifetime of our furniture.
- Your assurance of consistent quality to an international standard. Evolve Furniture Group is committed to design, manufacture and distribute superior quality office furniture, which meets or exceeds the requirements of our customers.
- Confirmation that Evolve Furniture Group is committed (1) to providing product that, through their entire life cycle, minimize negative environmental impacts on the environment, (2) to continuous improvement to our environmental systems and programs and (3) to comply to all relevant environmental legislation and regulations.
- Compile Panel System can help a company meet LEED requirements for office furniture.
- Compile components are tested to the highest standard in the industry. This is your assurance of quality and longevity.
- Panel textiles, adjustable keyboard mechanisms, task lights and electrical devices = five (5) Years
- Other parts = Lifetime Warranty

Compile products have been coded using alphas that correspond with the product name. This creates an easy-to-remember code. The following breaks down the coding logic and highlights the required code components needed to order within each product category.

**Panels**

**Example:**                      **Product:**                      Compile Fabric Monolithic Panel

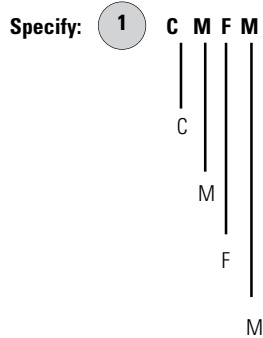

Base Code found on the product page to the left of the product name and a simple product illustration.

**CoM**pile product line

**F**abric-covered Panel

**M**onolithic panel category

**2**    CMFM**6648**

Panel size offering. Listed on every product page with price listing.

Note: Additional dimensions are provided for most products on the far right hand side of each page. These dimensions are not required in the ordering code.

**3**    CMFM6648-**BK**

Standard paint code for frame. See the Fabric & Finish listing in this section.

To specify fabric for a Compile Panel, please note:

**4**    CMFM6648-BK-**B84A**

Fabric code for all modules on both sides of the Panel\*. See the Fabric & Finish listing in this section.

\* **NOTE:** If different fabrics are to be included on a Compile Panel, please use the following ordering format. **Start at the bottom** of one side of a Panel and work to the top module of that Panel. Then start the process over on the other side of the Panel. As an example:

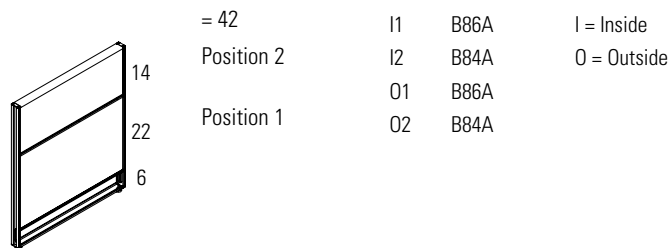

**Electrical**

**Example:**                    **Product:**                    Flexible Mesh Jumper Cable

**Specify:**                    **1**    **C E 8 C P 1 7**

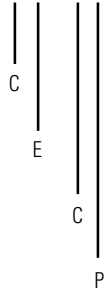

**2**    CE8CP17

Base Code found on the product page to the left of the product name and a simple product illustration.

**C**ompile product line.

**E**lectrical category.

**C**able Panel.

**P**ass-Through.

Product size offering – length. Listed on every product page with price listing. Note: Additional dimensions are provided for most products on the far right hand side of each page. These dimensions are not required in the ordering code.

**Worksurfaces**

**Example:**                    **Product:**                    Curvilinear Worksurface – Left

**Specify:**                    **1**    **C W V L**

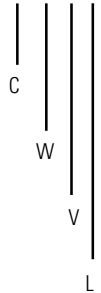

**2**    CWVL3042

**3**    CWVL3042–T431

**4**    CWVL3042–T890–CR

Base Code found on the product page to the left of the product name and a simple product illustration.

**C**ompile product line.

**W**orksurface category.

**C**ur**V**ilinear shape.

**L**eft hand configuration.

Worksurface size offering. Listed on every product page with price listing. Note: Additional dimensions are provided for most products on the far right hand side of each page. These dimensions are not required in the ordering code.

Laminate code for surface. See the Fabric & Finish listing in this section.

PVC code for trim. See the Fabric & Finish listing in this section.

Worksurfaces – Hardware

**Example:**            **Product:**    End Panel

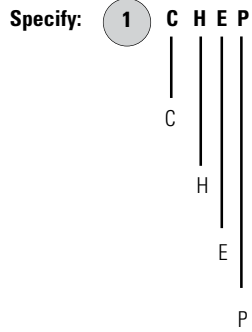

Base Code found on the product page to the left of the product name and a simple product illustration.

**C**ompile product line.

**H**ardware category.

**E**nd Panel.

End **P**anel.

**2**    CHEP-T431

Laminte code for End Panel. See the Fabric & Finish listing in this section.

**Storage**

**Example:**            **Product:**    Box, Box, File Pedestal

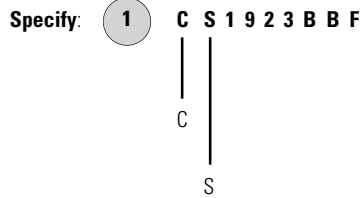

Base Code found on the product page to the left of the product name and a simple product illustration.

**C**ompile product line.

**S**torage category.

**2**    CS1923BBF

**19** Product Series.

**3**    CS1923BBF

**23**" Pedestal depth in inches.

**4**    CS1923BBF

**B**ox drawer, **B**ox drawer, **F**ile drawer.



panels



**THE INFORMATION LISTED BELOW PROVIDES YOU WITH BASIC FEATURES OF COMPILE PANELS:**

- Compile Panels are:
  - Available in four (5) heights: 30", 42", 48", 54" and 66"; and seven (7) widths: 24", 30", 36", 42", 48", 54" and 60".
  - 2 3/8" thick.
  - Monolithic, Segmented, Acoustic, and Glazed.
- Acoustic panels are lightly tackable with 0.70 NRC rating and a 26 STC rating.
- Compile Non - Acoustic panels are not tackable.
- Raceway openings are 1.375" x 2.680".
- Panels 24" wide include raceway covers with 2 knockouts.
- Panels 30" – 60" wide include raceway covers with 3 knockouts.
- Opposite sides of each Module may have a different fabric within the same grade at no upcharge.
- If different grades of fabric are used on one panel, the entire panel must be priced at the highest grade.
- Standard with aluminum frame.
- Individual fabric covered acoustic modules incorporated into an aluminum frame.
- Reinforced aluminum raceway covers are included when ordering panel packages or may be ordered and shipped separately. Raceway covers can be replaced in the field to change a panel from non-powered to powered (or vice versa).
- Base raceway lifts up and locks in an upright 90-degree position, or can be removed for open access to base raceway.
- Electric knockouts in the raceway have black plastic covers that snap into place from the outside of the cover, when a duplex is not required. Electric knockout covers must be specified separately. Available in standard paint finishes.
- 3 panel connector brackets per side for 30"h, 42"h and 54"h come installed on panels and universal posts.
- 4 panel connector brackets per side for 66"h panels come installed on panels and universal posts.
- Panel connector brackets are opposite direction of each other per panel side, and can be removed with one screw per bracket.



MONOLITHIC PANEL PACKAGES - PAGES 16 & 17, 22-25

Non-Powered Compile Monolithic Fabric Panel Package

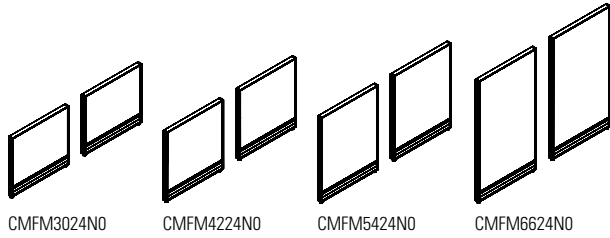

Powered Compile Monolithic Fabric Panel Package

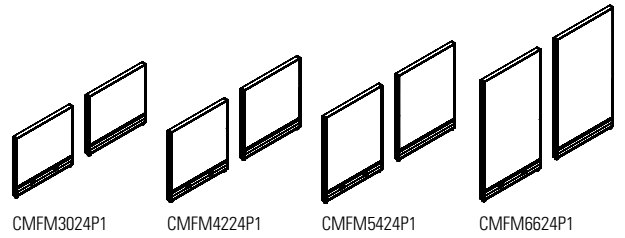

Non-Powered Compile Monolithic Fabric Panel Package

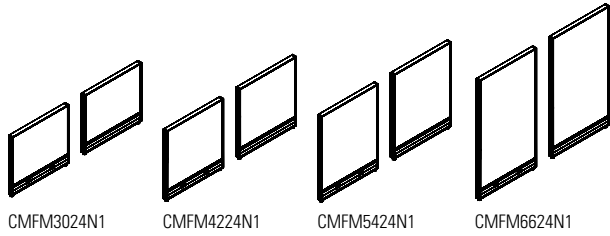

Powered Compile Monolithic Fabric Panel Package

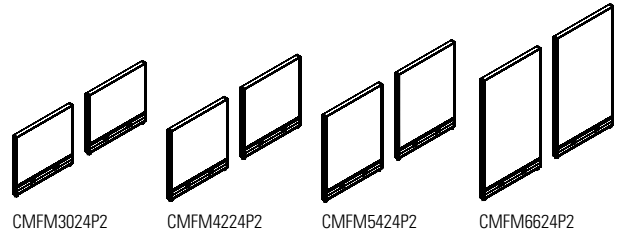

Non-Powered Compile Monolithic Fabric Panel Package

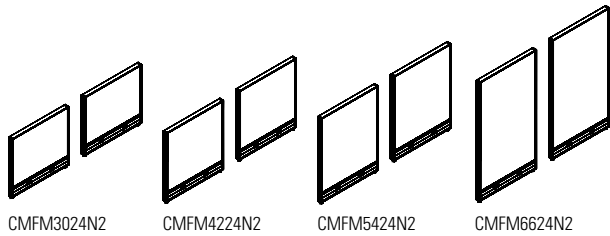

Non-Powered Compile Monolithic Laminate Panel Package

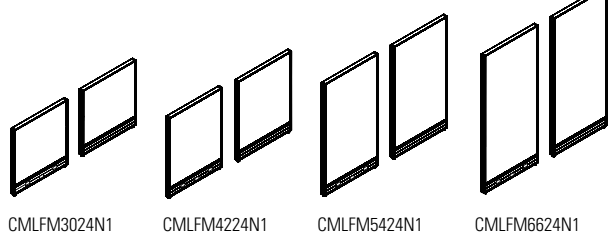

Non-Powered Compile Monolithic Laminate Panel Package

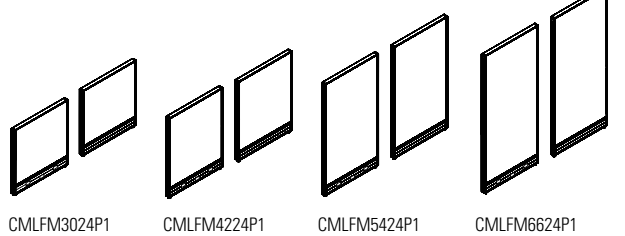

Model Definitions:

- N0 = No punch outs on raceways.
- N1 = Raceway punch out on one side.
- N2 = Raceway punch out on both sides.
- P1 = Power harness and raceway punch out on one side.
- P2 = Power harness and raceway punch outs on two sides.

RACEWAY COVER OPTIONS (Suffix)

- (N0) No Knockouts Side 1 and Side 2
- (N1) Knockouts Side 1 – No Knockout Side 2
- (N2) Knockouts Side 1 and Side
- (P1) Knockouts Side 1 – No Knockout Side 2
- (P2) Knockouts Side 1 and Side 2

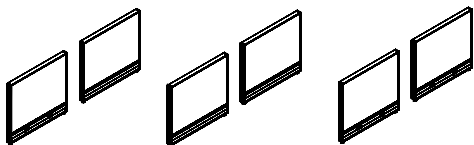

SEGMENTED - PANEL PACKAGES - PAGES 18 & 19, 26-35

Non-Powered Compile Single Segmented Fabric Panel Package

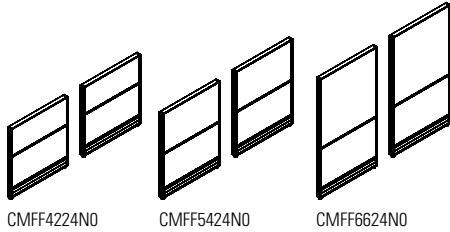

Powered Compile Single Segmented Fabric Panel Package

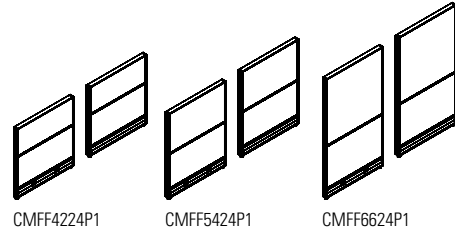

Non-Powered Compile Single Segmented Fabric Panel Package

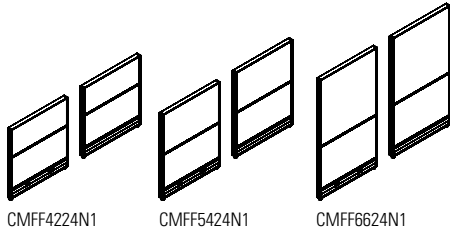

Powered Compile Single Segmented Fabric Panel Package

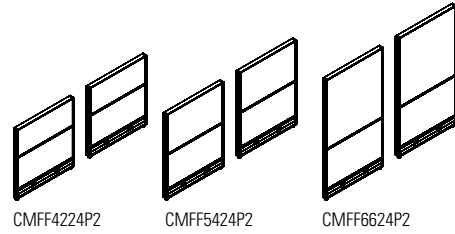

Non-Powered Compile Single Segmented Fabric Panel Package

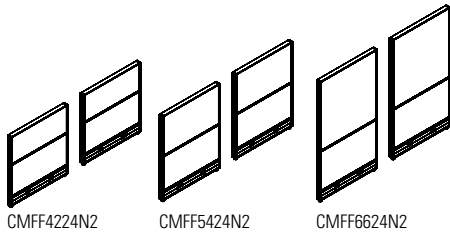

ACOUSTIC PANEL PACKAGES - PAGES 20 & 21

Non-Powered Compile Monolithic Acoustic Panel Package

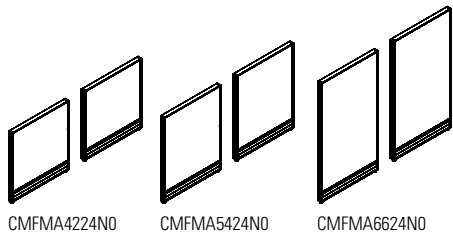

Powered Compile Monolithic Acoustic Panel Package

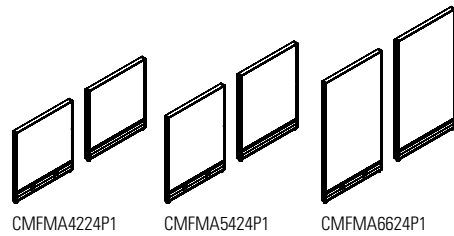

Non-Powered Compile Monolithic Acoustic Panel Package

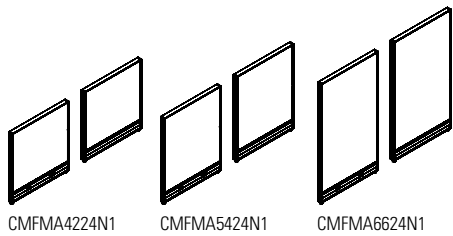

Powered Compile Monolithic Acoustic Panel Package

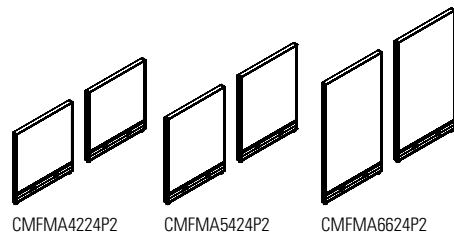

Non-Powered Compile Monolithic Acoustic Panel Package

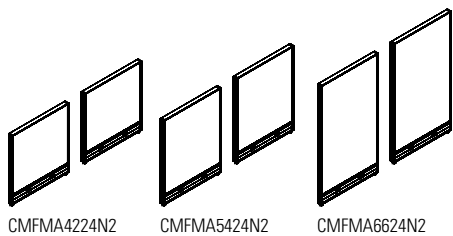

SINGLE SEGMENTED OPEN BOTTOM PANEL PACKAGES - PAGES 34-35

Non-Powered Compile Single Segmented Open Bottom Panel Package

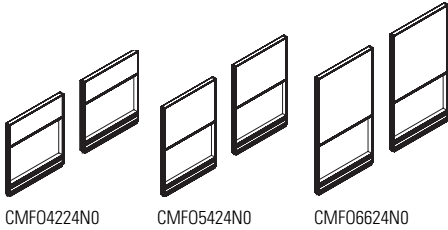

Powered Compile Single Segmented Open Bottom Panel Package

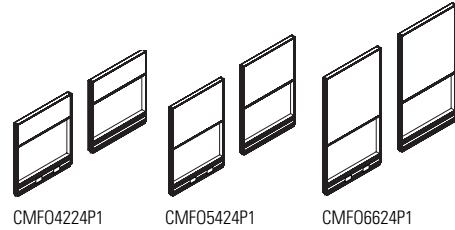

Non-Powered Compile Single Segmented Open Bottom Panel Package

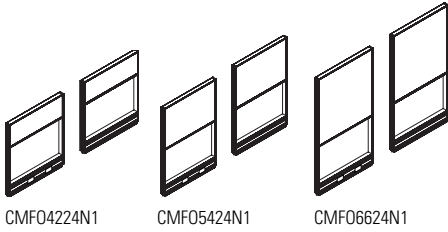

Powered Compile Single Segmented Open Bottom Panel Package

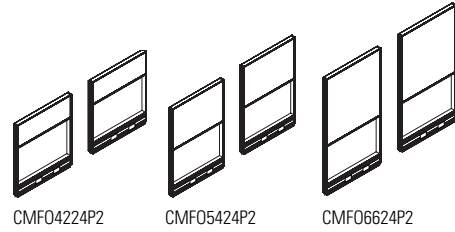

Non-Powered Compile Single Segmented Open Bottom Panel Package

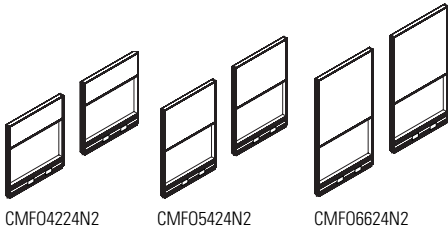

DOOR PANELS - PAGE 42

Sliding Privacy Door

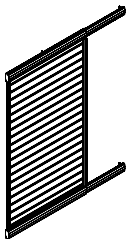

CMPDSL6636/42



GLAZED PANEL PACKAGES - PAGES 36-37

Non-Powered Compile Glazed Panel Package

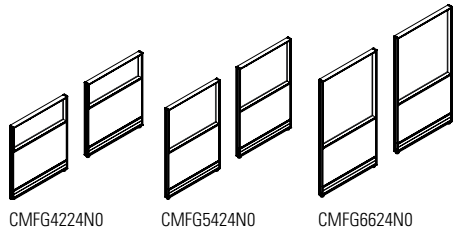

Powered Compile Glazed Panel Package

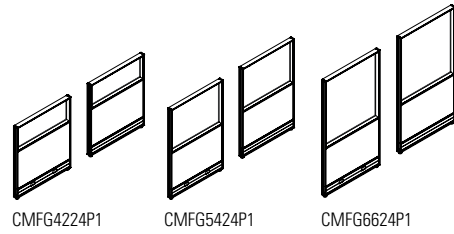

Non-Powered Compile Glazed Panel Package

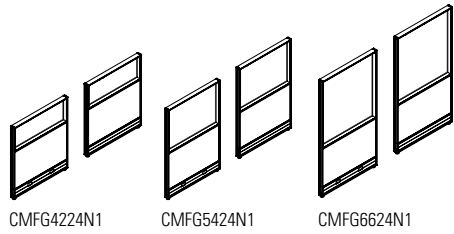

Powered Compile Glazed Panel Package

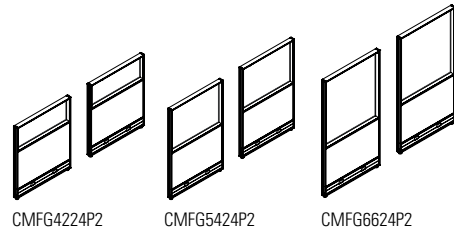

Non-Powered Compile Glazed Panel Package

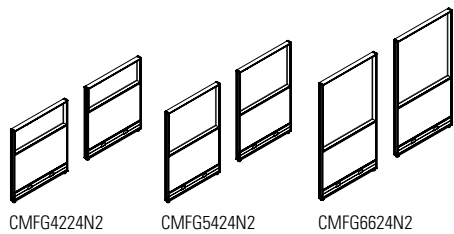

PARTLY GLAZED PANEL PACKAGES - PAGES 38-41

Non-Powered Compile Partly Glazed Panel Package

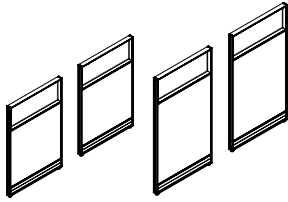

CMPG5424N0 CMPG6624N0

Powered Compile Partly Glazed Panel Package

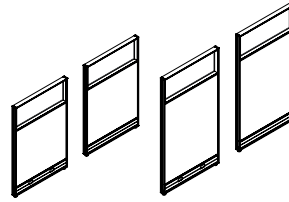

CMPG5424P1 CMPG6624P1

Non-Powered Compile Partly Glazed Panel Package

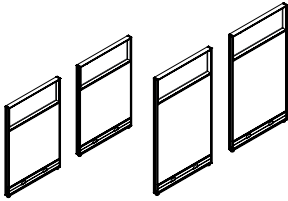

CMPG5424N1 CMPG6624N1

Powered Compile Partly Glazed Panel Package

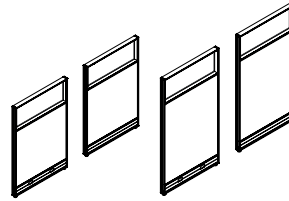

CMPG5424P2 CMPG6624P2

Non-Powered Compile Partly Glazed Panel Package

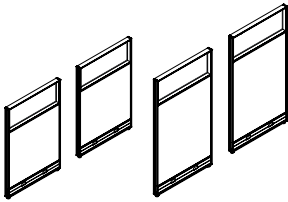

CMPG5424N2 CMPG6624N2

Compile Privacy Glass

Available in widths from 24" to 60".

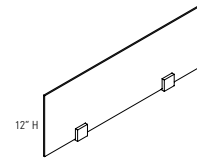

CMPS30

MINI PANEL KIT - PAGE 43

Mini Panel Kit

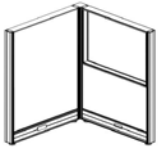

CMFMA2418KIT1



This page provides an exploded view of a sample Panel Package highlighting each **Panel** component included within the package.

### Package Components

#### Package 1 CMFM6636N0

- A. (1) 66" h x 36" w Monolithic Fabric Panel
- B. (2) 36" w Raceway Covers Without Knockouts

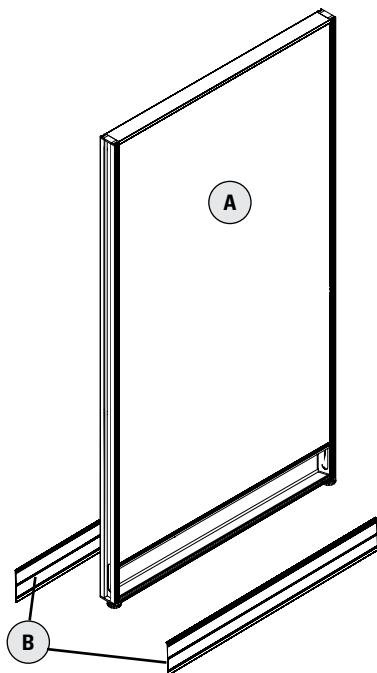

#### Package 2 CMFF6636P2

- C. (1) 66" h x 36" w Single Segmented Fabric Panel
- D. (2) 36" w Raceway Covers With Knockouts
- E. (1) 36" w Power Distribution Housing

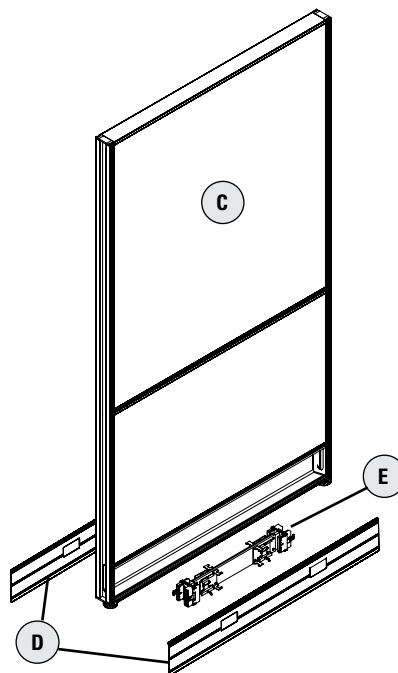

#### Package 3 CHP66-2

- F. (1) 66" h Universal Corner Post
- G. (2) Trim Inserts for 66" Universal Corner Post
- H. (1) Post Base Cover for 2-Way Application
- I. "Quick Connect" comes standard with Panels and Universal Corner Post

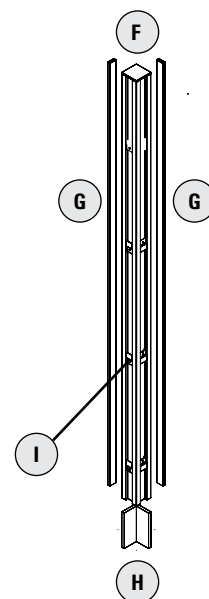



**CMFMXXYYN - NON-POWERED COMPILE FABRIC MONOLITHIC PANEL PACKAGE**

- Non powered.
- Includes one panel and two raceway covers with no punchouts.
- Individual fabric-covered modules incorporated into an aluminum frame.
- Opposite sides of each module may have a different fabric within the same grade at no upcharge.
- If different grades of fabric are used on one panel, the entire panel must be priced at highest grade.
- Panels are not tackable or acoustical.
- Note: Trim is not required at a straight connection between two panels of the same height.
- 3 Panel connector brackets per side come standard with 30”h, 42”h, 48”h and 54”h panels.
- 4 Panel connector brackets per side come standard with 66”h panels.
- Panels contain leveling glides. Maximum extension of glides is 2”.

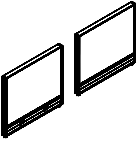
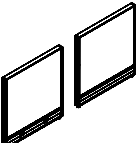
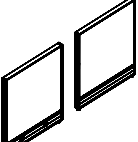
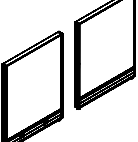
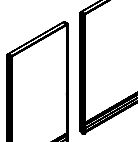
	DESCRIPTION	PRODUCT CODE	LIST PRICE		DIMENSIONS/INCHES		
			Gr1	Gr2	H	W	D
	Non-Powered Compile Fabric Monolithic Panel Package - 30"	CMFM3024N_	365	398	30	24	2 3/8
		CMFM3030N_	412	444	30	30	2 3/8
		CMFM3036N_	447	511	30	36	2 3/8
		CMFM3042N_	494	558	30	42	2 3/8
		CMFM3048N_	525	589	30	48	2 3/8
		CMFM3054N_	581	645	30	54	2 3/8
		CMFM3060N_	613	676	30	60	2 3/8
	Non-Powered Compile Fabric Monolithic Panel Package - 42"	CMFM4224N_	365	398	42	24	2 3/8
		CMFM4230N_	412	444	42	30	2 3/8
		CMFM4236N_	447	511	42	36	2 3/8
		CMFM4242N_	494	558	42	42	2 3/8
		CMFM4248N_	525	589	42	48	2 3/8
		CMFM4254N_	581	645	42	54	2 3/8
		CMFM4260N_	613	676	42	60	2 3/8
	Non-Powered Compile Fabric Monolithic Panel Package - 48"	CMFM4824N_	380	418	48	24	2 3/8
		CMFM4830N_	431	469	48	30	2 3/8
		CMFM4836N_	479	553	48	36	2 3/8
		CMFM4842N_	533	608	48	42	2 3/8
		CMFM4848N_	560	636	48	48	2 3/8
		CMFM4854N_	607	683	48	54	2 3/8
		CMFM4860N_	663	736	48	60	2 3/8
	Non-Powered Compile Fabric Monolithic Panel Package - 54"	CMFM5424N_	381	420	54	24	2 3/8
		CMFM5430N_	431	470	54	30	2 3/8
		CMFM5436N_	480	556	54	36	2 3/8
		CMFM5442N_	533	609	54	42	2 3/8
		CMFM5448N_	561	638	54	48	2 3/8
		CMFM5454N_	608	685	54	54	2 3/8
		CMFM5460N_	663	739	54	60	2 3/8
	Non-Powered Compile Fabric Monolithic Panel Package - 66"	CMFM6624N_	426	477	66	24	2 3/8
		CMFM6630N_	489	540	66	30	2 3/8
		CMFM6636N_	558	651	66	36	2 3/8
		CMFM6642N_	627	720	66	42	2 3/8
		CMFM6648N_	678	771	66	48	2 3/8
		CMFM6654N_	755	848	66	54	2 3/8
		CMFM6660N_	829	924	66	60	2 3/8

**Raceway Cover Options (1) Shown**

- **RACEWAY COVER OPTIONS (Suffix)**
  - (0) No Knockouts Side 1 and Side 2
  - (1) Knockouts Side 1 – No Knockout Side 2
  - (2) Knockouts Side 1 and Side 2



**CMFMXXYP - POWERED COMPILE FABRIC MONOLITHIC PANEL PACKAGE**

- With power distribution harness.
- Includes one panel, power harness, one raceway cover with punchout and one raceway cover with no punchout.
- Individual fabric-covered modules incorporated into an aluminum frame.
- Opposite sides of each module may have a different fabric within the same grade at no upcharge.
- If different grades of fabric are used on one panel, the entire panel must be priced at highest grade.
- Panels are not tackable or acoustical.
- Note: Trim is not required at a straight connection between two panels of the same height.
- 3 Panel connector brackets per side come standard with 30”h, 42”h, 48”h and 54”h panels.
- 4 Panel connector brackets per side come standard with 66”h panels.
- Panels contain leveling glides. Maximum extension of glides is 2”.

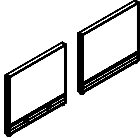
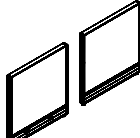
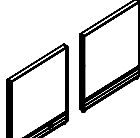
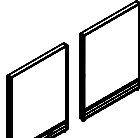
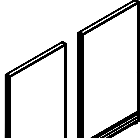
	DESCRIPTION	PRODUCT CODE	LIST PRICE		DIMENSIONS/INCHES		
			Gr1	Gr2	H	W	D
	Powered Compile Fabric Monolithic Panel Package - 30"	CMFM3024P_	519	552	30	24	2 3/8
		CMFM3030P_	619	651	30	30	2 3/8
		CMFM3036P_	665	729	30	36	2 3/8
		CMFM3042P_	715	779	30	42	2 3/8
		CMFM3048P_	764	828	30	48	2 3/8
		CMFM3054P_	820	884	30	54	2 3/8
		CMFM3060P_	854	917	30	60	2 3/8
	Powered Compile Fabric Monolithic Panel Package - 42"	CMFM4224P_	519	552	42	24	2 3/8
		CMFM4230P_	619	651	42	30	2 3/8
		CMFM4236P_	665	729	42	36	2 3/8
		CMFM4242P_	715	779	42	42	2 3/8
		CMFM4248P_	764	828	42	48	2 3/8
		CMFM4254P_	820	884	42	54	2 3/8
		CMFM4260P_	854	917	42	60	2 3/8
	Powered Compile Fabric Monolithic Panel Package - 48"	CMFM4824P_	533	572	48	24	2 3/8
		CMFM4830P_	635	673	48	30	2 3/8
		CMFM4836P_	693	768	48	36	2 3/8
		CMFM4842P_	753	828	48	42	2 3/8
		CMFM4848P_	801	876	48	48	2 3/8
		CMFM4854P_	844	920	48	54	2 3/8
		CMFM4860P_	902	977	48	60	2 3/8
	Powered Compile Fabric Monolithic Panel Package - 54"	CMFM5424P_	533	572	54	24	2 3/8
		CMFM5430P_	635	674	54	30	2 3/8
		CMFM5436P_	696	772	54	36	2 3/8
		CMFM5442P_	754	830	54	42	2 3/8
		CMFM5448P_	801	878	54	48	2 3/8
		CMFM5454P_	845	922	54	54	2 3/8
		CMFM5460P_	902	978	54	60	2 3/8
	Powered Compile Fabric Monolithic Panel Package - 66"	CMFM6624P_	578	629	66	24	2 3/8
		CMFM6630P_	696	747	66	30	2 3/8
		CMFM6636P_	775	868	66	36	2 3/8
		CMFM6642P_	847	940	66	42	2 3/8
		CMFM6648P_	918	1011	66	48	2 3/8
		CMFM6654P_	995	1088	66	54	2 3/8
		CMFM6660P_	1069	1164	66	60	2 3/8

**Raceway Cover Options (1) Shown**

- **RACEWAY COVER OPTIONS (Suffix)**
  - (1) Knockouts Side 1 – No Knockout Side 2
  - (2) Knockouts Side 1 and Side 2

**CMFFXXYYN - NON-POWERED COMPILE SINGLE SEGMENTED FABRIC PANEL PACKAGE**

- Non powered.
- Includes one panel, two raceway covers with no punchouts.
- Individual fabric-covered modules incorporated into an aluminum frame.
- Opposite sides of each module may have a different fabric within the same grade at no upcharge.
- If different grades of fabric are used on one panel, the entire panel must be priced at highest grade.
- Panels are not tackable or acoustical.
- Note: Trim is not required at a straight connection between two panels of the same height.
- 3 Panel connector brackets per side come standard with 42”h, 48”h and 54”h panels.
- 4 Panel connector brackets per side come standard with 66”h panels.
- Panels contain leveling glides. Maximum extension of glides is 2”.

	DESCRIPTION	PRODUCT CODE	LIST PRICE		DIMENSIONS/INCHES		
			Gr1	Gr2	H	W	D
	Non-Power Compile Single Segmented Fabric Panel Package - 42"	CMFF4224N_	382	415	42	24	2 3/8
		CMFF4230N_	431	464	42	30	2 3/8
		CMFF4236N_	456	519	42	36	2 3/8
		CMFF4242N_	520	584	42	42	2 3/8
		CMFF4248N_	555	619	42	48	2 3/8
		CMFF4254N_	616	680	42	54	2 3/8
		CMFF4260N_	659	723	42	60	2 3/8
		CMFF4266N_	777	901	42	66	2 3/8
		CMFF4272N_	819	943	42	72	2 3/8
	Non-Powered Compile Single Segmented Fabric Panel Package - 48"	CMFF4824N_	416	454	48	24	2 3/8
		CMFF4830N_	461	499	48	30	2 3/8
		CMFF4836N_	521	596	48	36	2 3/8
		CMFF4842N_	590	665	48	42	2 3/8
		CMFF4848N_	637	712	48	48	2 3/8
		CMFF4854N_	678	752	48	54	2 3/8
		CMFF4860N_	729	804	48	60	2 3/8
	Non-Powered Compile Single Segmented Fabric Panel Package - 54"	CMFF5424N_	417	455	54	24	2 3/8
		CMFF5430N_	462	501	54	30	2 3/8
		CMFF5436N_	522	598	54	36	2 3/8
		CMFF5442N_	590	666	54	42	2 3/8
		CMFF5448N_	638	714	54	48	2 3/8
		CMFF5454N_	678	754	54	54	2 3/8
		CMFF5460N_	729	805	54	60	2 3/8
	Non-Powered Compile Single Segmented Fabric Panel Package - 66"	CMFF6624N_	488	539	66	24	2 3/8
		CMFF6630N_	557	608	66	30	2 3/8
		CMFF6636N_	619	712	66	36	2 3/8
		CMFF6642N_	706	799	66	42	2 3/8
		CMFF6648N_	748	841	66	48	2 3/8
		CMFF6654N_	811	904	66	54	2 3/8
		CMFF6660N_	861	954	66	60	2 3/8

**Raceway Cover Options (1) Shown**

- **RACEWAY COVER OPTIONS (Suffix)**
  - (0) No Knockouts Side 1 and Side 2
  - (1) Knockouts Side 1 – No Knockout Side 2
  - (2) Knockouts Side 1 and Side 2



**CMFFXXYYP\_ - POWERED COMPILE SINGLE SEGMENTED FABRIC PANEL PACKAGE**

- With power distribution harness.
- Includes one panel, power harness, one raceway cover with punchout and one raceway cover with no punchout.
- Individual fabric-covered modules incorporated into an aluminum frame.
- Opposite sides of each module may have a different fabric within the same grade at no upcharge.
- If different grades of fabric are used on one panel, the entire panel must be priced at highest grade.
- Panels are not tackable or acoustical.
- Note: Trim is not required at a straight connection between two panels of the same height.
- 3 Panel connector brackets per side come standard with 42”h, 48”h and 54”h panels.
- 4 Panel connector brackets per side come standard with 66”h panels.
- Panels contain leveling glides. Maximum extension of glides is 2”.

	DESCRIPTION	PRODUCT CODE	LIST PRICE		DIMENSIONS/INCHES		
			Gr1	Gr2	H	W	D
	Powered Compile Single Segmented Fabric Panel Package - 42”	CMFF4224P_	534	567	42	24	2 3/8
		CMFF4230P_	635	668	42	30	2 3/8
		CMFF4236P_	673	736	42	36	2 3/8
		CMFF4242P_	742	806	42	42	2 3/8
		CMFF4248P_	791	855	42	48	2 3/8
		CMFF4254P_	857	921	42	54	2 3/8
		CMFF4260P_	899	963	42	60	2 3/8
		CMFF4266P_	1038	1161	42	66	2 3/8
		CMFF4272P_	1094	1217	42	72	2 3/8
	Powered Compile Single Segmented Fabric Panel Package - 48”	CMFF4824P_	570	607	48	24	2 3/8
		CMFF4830P_	668	706	48	30	2 3/8
		CMFF4836P_	739	812	48	36	2 3/8
		CMFF4842P_	811	886	48	42	2 3/8
		CMFF4848P_	877	952	48	48	2 3/8
		CMFF4854P_	919	993	48	54	2 3/8
		CMFF4860P_	971	1044	48	60	2 3/8
	Powered Compile Single Segmented Fabric Panel Package - 54”	CMFF5424P_	571	609	54	24	2 3/8
		CMFF5430P_	668	707	54	30	2 3/8
		CMFF5436P_	741	817	54	36	2 3/8
		CMFF5442P_	812	888	54	42	2 3/8
		CMFF5448P_	878	954	54	48	2 3/8
		CMFF5454P_	920	996	54	54	2 3/8
		CMFF5460P_	972	1048	54	60	2 3/8
	Powered Compile Single Segmented Fabric Panel Package - 66”	CMFF6624P_	640	691	66	24	2 3/8
		CMFF6630P_	763	814	66	30	2 3/8
		CMFF6636P_	834	927	66	36	2 3/8
		CMFF6642P_	927	1020	66	42	2 3/8
		CMFF6648P_	985	1078	66	48	2 3/8
		CMFF6654P_	1049	1142	66	54	2 3/8
		CMFF6660P_	1100	1193	66	60	2 3/8

**Raceway Cover Options (1) Shown**

- **RACEWAY COVER OPTIONS (Suffix)**
  - (1) Knockouts Side 1 – No Knockout Side 2
  - (2) Knockouts Side 1 and Side 2

**CMFMAXYYN\_ - NON-POWERED COMPILE MONOLITHIC ACOUSTIC PANEL PACKAGE**

- Non powered.
- Includes one panel and two raceway covers with no punchouts.
- Individual fabric-covered acoustic modules incorporated into an aluminum frame.
- Opposite sides of each module may have a different fabric within the same grade at no upcharge.
- If different grades of fabric are used on one panel, the entire panel must be priced at highest grade.
- Panels are lightly tackable.
- Note: Trim is not required at a straight connection between two panels of the same height.
- 3 Panel connector brackets per side come standard with 42”h, 48”h and 54”h panels.
- 4 Panel connector brackets per side come standard with 66”h panels.
- Panels contain leveling glides. Maximum extension of glides is 2”.

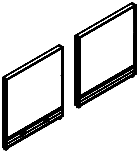
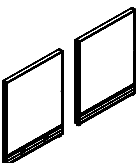
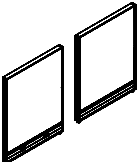
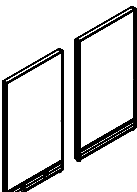
	DESCRIPTION	PRODUCT CODE	LIST PRICE		DIMENSIONS/INCHES		
			Gr1	Gr2	H	W	D
	Non-Powered Compile Monolithic Acoustic Panel Package - 42"	CMFMA4224N_	434	466	42	24	2 3/8
		CMFMA4230N_	488	520	42	30	2 3/8
		CMFMA4236N_	531	595	42	36	2 3/8
		CMFMA4242N_	583	647	42	42	2 3/8
		CMFMA4248N_	620	684	42	48	2 3/8
		CMFMA4254N_	686	750	42	54	2 3/8
		CMFMA4260N_	722	785	42	60	2 3/8
	Non-Powered Compile Monolithic Acoustic Panel Package - 48"	CMFMA4824N_	453	491	48	24	2 3/8
		CMFMA4830N_	510	532	48	30	2 3/8
		CMFMA4836N_	563	638	48	36	2 3/8
		CMFMA4842N_	630	705	48	42	2 3/8
		CMFMA4848N_	665	740	48	48	2 3/8
		CMFMA4854N_	713	788	48	54	2 3/8
		CMFMA4860N_	779	855	48	60	2 3/8
	Non-Powered Compile Monolithic Acoustic Panel Package - 54"	CMFMA5424N_	453	492	54	24	2 3/8
		CMFMA5430N_	511	550	54	30	2 3/8
		CMFMA5436N_	563	640	54	36	2 3/8
		CMFMA5442N_	630	707	54	42	2 3/8
		CMFMA5448N_	665	741	54	48	2 3/8
		CMFMA5454N_	714	791	54	54	2 3/8
		CMFMA5460N_	779	856	54	60	2 3/8
	Non-Powered Compile Monolithic Acoustic Panel Package - 66"	CMFMA6624N_	505	556	66	24	2 3/8
		CMFMA6630N_	580	631	66	30	2 3/8
		CMFMA6636N_	663	756	66	36	2 3/8
		CMFMA6642N_	745	838	66	42	2 3/8
		CMFMA6648N_	805	898	66	48	2 3/8
		CMFMA6654N_	893	988	66	54	2 3/8
		CMFMA6660N_	981	1074	66	60	2 3/8

**Raceway Cover Options (1) Shown**

- **RACEWAY COVER OPTIONS (Suffix)**
  - (0) No Knockouts Side 1 and Side 2
  - (1) Knockouts Side 1 – No Knockout Side 2
  - (2) Knockouts Side 1 and Side 2



**CMFMAXYYYP - POWERED COMPILE MONOLITHIC ACOUSTIC PANEL PACKAGE**

- With power distribution harness.
- Includes one panel, power harness, one raceway cover with punchout and one raceway cover with no punchout.
- Individual fabric-covered acoustic modules incorporated into an aluminum frame.
- Opposite sides of each module may have a different fabric within the same grade at no upcharge.
- If different grades of fabric are used on one panel, the entire panel must be priced at highest grade.
- Panels are lightly tackable.
- Note: Trim is not required at a straight connection between two panels of the same height.
- 3 Panel connector brackets per side come standard with 42" h, 48" h and 54" h panels.
- 4 Panel connector brackets per side come standard with 66" h panels.
- Panels contain leveling glides. Maximum extension of glides is 2".

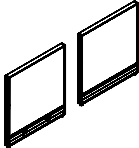
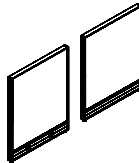
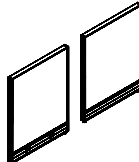
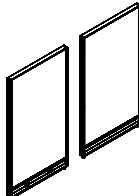
	DESCRIPTION	PRODUCT CODE	LIST PRICE		DIMENSIONS/INCHES		
			Gr1	Gr2	H	W	D
	Powered Compile Monolithic Acoustic Panel Package - 42"	CMFMA4224P_	587	619	42	24	2 3/8
		CMFMA4230P_	693	725	42	30	2 3/8
		CMFMA4236P_	748	812	42	36	2 3/8
		CMFMA4242P_	806	870	42	42	2 3/8
		CMFMA4248P_	858	922	42	48	2 3/8
		CMFMA4254P_	924	988	42	54	2 3/8
		CMFMA4260P_	961	1024	42	60	2 3/8
	Powered Compile Monolithic Acoustic Panel Package - 48"	CMFMA4824P_	604	642	48	24	2 3/8
		CMFMA4830P_	714	752	48	30	2 3/8
		CMFMA4836P_	780	856	48	36	2 3/8
		CMFMA4842P_	850	926	48	42	2 3/8
		CMFMA4848P_	902	977	48	48	2 3/8
		CMFMA4854P_	954	1030	48	54	2 3/8
		CMFMA4860P_	1019	1095	48	60	2 3/8
	Powered Compile Monolithic Acoustic Panel Package - 54"	CMFMA5424P_	607	646	54	24	2 3/8
		CMFMA5430P_	715	754	54	30	2 3/8
		CMFMA5436P_	780	857	54	36	2 3/8
		CMFMA5442P_	851	928	54	42	2 3/8
		CMFMA5448P_	902	978	54	48	2 3/8
		CMFMA5454P_	954	1031	54	54	2 3/8
		CMFMA5460P_	1020	1097	54	60	2 3/8
	Powered Compile Monolithic Acoustic Panel Package - 66"	CMFMA6624P_	659	710	66	24	2 3/8
		CMFMA6630P_	787	838	66	30	2 3/8
		CMFMA6636P_	879	972	66	36	2 3/8
		CMFMA6642P_	963	1056	66	42	2 3/8
		CMFMA6648P_	1042	1135	66	48	2 3/8
		CMFMA6654P_	1132	1227	66	54	2 3/8
		CMFMA6660P_	1219	1312	66	60	2 3/8

**Raceway Cover Options (1) Shown**

- **RACEWAY COVER OPTIONS (Suffix)**
  - (1) Knockouts Side 1 – No Knockout Side 2
  - (2) Knockouts Side 1 and Side 2

**CMLFMXXYYN - MONOLITHIC LAMINATE SINGLE SIDED PANEL – NON-POWERED**

- Individual modules, one in fabric and one in laminate, incorporated into an aluminum frame.
- Modules have laminate on one side and fabric on the other.
- Opposite sides of each module may have a different laminate within the same grade at no upcharge.
- Panels are not tackable.
- 3 panel connector brackets per side come standard with 30”h, 42”h, 48”h and 54”h panels.
- 4 panel connector brackets per side come standard with 66”h panels.
- 24” wide panels have two punchouts, one for electrical and one for data.
- 30” wide panels and wider have three punchouts, two for electrical and one for data.
- Note: Trim is not required at a straight connection between two panels of the same height.

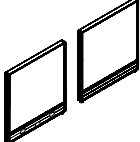
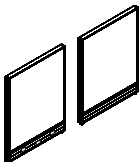
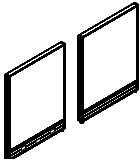
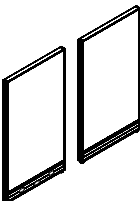
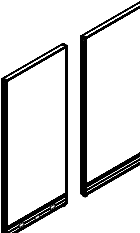
	DESCRIPTION	PRODUCT CODE	LIST PRICE		DIMENSIONS/INCHES		
			Gr1	Gr2	H	W	D
	Non-Powered Compile Monolithic Single Sided Panel Package - 30”	CMLFM3024N_	443	461	30	24	2 3/8
		CMLFM3030N_	514	527	30	30	2 3/8
		CMLFM3036N_	586	602	30	36	2 3/8
		CMLFM3042N_	665	678	30	42	2 3/8
		CMLFM3048N_	724	740	30	48	2 3/8
		CMLFM3054N_	799	818	30	54	2 3/8
		CMLFM3060N_	877	898	30	60	2 3/8
	Non-Powered Compile Monolithic Single Sided Panel Package - 42”	CMLFM4224N_	523	539	42	24	2 3/8
		CMLFM4230N_	613	632	42	30	2 3/8
		CMLFM4236N_	700	723	42	36	2 3/8
		CMLFM4242N_	794	817	42	42	2 3/8
		CMLFM4248N_	865	890	42	48	2 3/8
		CMLFM4254N_	957	987	42	54	2 3/8
		CMLFM4260N_	1050	1081	42	60	2 3/8
	Non-Powered Compile Monolithic Single Sided Panel Package - 48”	CMLFM4824N_	619	645	48	24	2 3/8
		CMLFM4830N_	726	745	48	30	2 3/8
		CMLFM4836N_	833	857	48	36	2 3/8
		CMLFM4842N_	944	973	48	42	2 3/8
		CMLFM4848N_	1030	1061	48	48	2 3/8
		CMLFM4854N_	1146	1180	48	54	2 3/8
		CMLFM4860N_	1258	1295	48	60	2 3/8
	Non-Powered Compile Monolithic Single Sided Panel Package - 54”	CMLFM5424N_	620	642	54	24	2 3/8
		CMLFM5430N_	726	751	54	30	2 3/8
		CMLFM5436N_	833	857	54	36	2 3/8
		CMLFM5442N_	945	975	54	42	2 3/8
		CMLFM5448N_	1030	1063	54	48	2 3/8
		CMLFM5454N_	1146	1180	54	54	2 3/8
		CMLFM5460N_	1258	1296	54	60	2 3/8
	Non-Powered Compile Monolithic Single Sided Panel Package - 66”	CMLFM6624N_	765	790	66	24	2 3/8
		CMLFM6630N_	896	926	66	30	2 3/8
		CMLFM6636N_	1033	1065	66	36	2 3/8
		CMLFM6642N_	1175	1209	66	42	2 3/8
		CMLFM6648N_	1278	1319	66	48	2 3/8
		CMLFM6654N_	1422	1467	66	54	2 3/8
		CMLFM6660N_	1565	1614	66	60	2 3/8

**Raceway Cover Options (1) Shown**

- **RACEWAY COVER OPTIONS (Suffix)**
  - (0) No Knockouts Side 1 and Side 2
  - (1) Knockouts Side 1 – No Knockout Side 2
  - (2) Knockouts Side 1 and Side 2



## CMLFMXXYP - MONOLITHIC LAMINATE SINGLE SIDED PANEL – POWERED

- Individual modules, one in fabric and one in laminate, incorporated into an aluminum frame.
- Modules have laminate on one side and fabric on the other.
- Opposite sides of each module may have a different laminate within the same grade at no upcharge.
- Panels are not tackable.
- 3 panel connector brackets per side come standard with 30”h, 42”h, 48”h and 54”h panels.
- 4 panel connector brackets per side come standard with 66”h panels.
- 24” wide panels have two punchouts, one for electrical and one for data.
- 30” wide panels and wider have three punchouts, two for electrical and one for data.
- Note: Trim is not required at a straight connection between two panels of the same height.

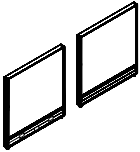
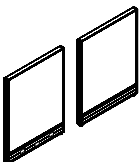
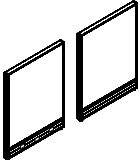
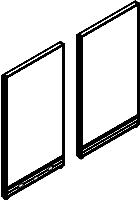
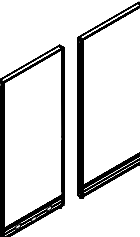
	DESCRIPTION	PRODUCT CODE	LIST PRICE		DIMENSIONS/INCHES		
			Gr1	Gr2	H	W	D
	Non-Powered Compile Monolithic Single Sided Panel Package - 30”	CMLFM3024P_	596	613	30	24	2 3/8
		CMLFM3030P_	719	790	30	30	2 3/8
		CMLFM3036P_	802	884	30	36	2 3/8
		CMLFM3042P_	886	974	30	42	2 3/8
		CMLFM3048P_	961	1058	30	48	2 3/8
		CMLFM3054P_	1038	1149	30	54	2 3/8
		CMLFM3060P_	1117	1237	30	60	2 3/8
	Non-Powered Compile Monolithic Single Sided Panel Package - 42”	CMLFM4224P_	676	751	42	24	2 3/8
		CMLFM4230P_	819	906	42	30	2 3/8
		CMLFM4236P_	918	1019	42	36	2 3/8
		CMLFM4242P_	1017	1130	42	42	2 3/8
		CMLFM4248P_	1104	1227	42	48	2 3/8
		CMLFM4254P_	1197	1337	42	54	2 3/8
		CMLFM4260P_	1293	1444	42	60	2 3/8
	Non-Powered Compile Monolithic Single Sided Panel Package - 48”	CMLFM4824P_	773	788	48	24	2 3/8
		CMLFM4830P_	932	954	48	30	2 3/8
		CMLFM4836P_	1049	1075	48	36	2 3/8
		CMLFM4842P_	1164	1193	48	42	2 3/8
		CMLFM4848P_	1268	1296	48	48	2 3/8
		CMLFM4854P_	1384	1421	48	54	2 3/8
		CMLFM4860P_	1499	1681	48	60	2 3/8
	Non-Powered Compile Monolithic Single Sided Panel Package - 54”	CMLFM5424P_	774	864	54	24	2 3/8
		CMLFM5430P_	932	1040	54	30	2 3/8
		CMLFM5436P_	1049	1169	54	36	2 3/8
		CMLFM5442P_	1164	1303	54	42	2 3/8
		CMLFM5448P_	1268	1418	54	48	2 3/8
		CMLFM5454P_	1385	1550	54	54	2 3/8
		CMLFM5460P_	1499	1682	54	60	2 3/8
	Non-Powered Compile Monolithic Single Sided Panel Package - 66”	CMLFM6624P_	920	1033	66	24	2 3/8
		CMLFM6630P_	1100	1232	66	30	2 3/8
		CMLFM6636P_	1250	1401	66	36	2 3/8
		CMLFM6642P_	1394	1565	66	42	2 3/8
		CMLFM6648P_	1516	1703	66	48	2 3/8
		CMLFM6654P_	1663	1870	66	54	2 3/8
		CMLFM6660P_	1807	2032	66	60	2 3/8

### Raceway Cover Options (1) Shown

- **RACEWAY COVER OPTIONS (Suffix)**
  - (0) No Knockouts Side 1 and Side 2
  - (1) Knockouts Side 1 – No Knockout Side 2
  - (2) Knockouts Side 1 and Side 2



**CMLLMXXYYN - MONOLITHIC LAMINATE DOUBLE SIDED PANEL - NON-POWERED**

- Individual laminate modules incorporated into an aluminum frame.
- Modules have laminate on both sides.
- Opposite sides of each module may have a different laminate within the same grade at no upcharge.
- 3 panel connector brackets per side come standard with 30”h, 42”h, 48”h and 54”h panels.
- 4 panel connector brackets per side come standard with 66”h panels.
- 24” wide panels have two punchouts, one for electrical and one for data.
- 30” wide panels and wider have three punchouts, two for electrical and one for data.
- Note: Trim is not required at a straight connection between two panels of the same height.

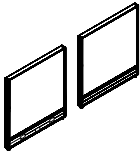
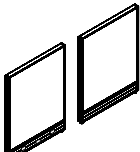
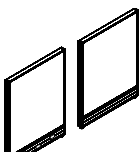
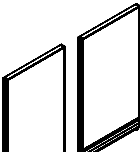
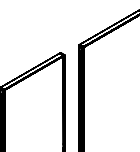
	DESCRIPTION	PRODUCT CODE	LIST PRICE Gr1	DIMENSIONS/INCHES		
				H	W	D
	Non-Powered Compile Monolithic	CMLLM3024N_	501	30	24	2 3/8
	Double Sided Laminate Panel Package - 30”	CMLLM3030N_	594	30	30	2 3/8
		CMLLM3036N_	678	30	36	2 3/8
		CMLLM3042N_	774	30	42	2 3/8
		CMLLM3048N_	864	30	48	2 3/8
		CMLLM3054N_	956	30	54	2 3/8
		CMLLM3060N_	1033	30	60	2 3/8
	Non-Powered Compile Monolithic	CMLLM4224N_	594	42	24	2 3/8
	Double Sided Laminate Panel Package - 42”	CMLLM4230N_	699	42	30	2 3/8
		CMLLM4236N_	814	42	36	2 3/8
		CMLLM4242N_	928	42	42	2 3/8
		CMLLM4248N_	1039	42	48	2 3/8
		CMLLM4254N_	1142	42	54	2 3/8
		CMLLM4260N_	1242	42	60	2 3/8
	Non-Powered Compile Monolithic	CMLLM4824N_	702	48	24	2 3/8
	Double Sided Laminate Panel Package - 48”	CMLLM4830N_	832	48	30	2 3/8
		CMLLM4836N_	965	48	36	2 3/8
		CMLLM4842N_	1103	48	42	2 3/8
		CMLLM4848N_	1240	48	48	2 3/8
		CMLLM4854N_	1366	48	54	2 3/8
		CMLLM4860N_	1444	48	60	2 3/8
	Non-Powered Compile Monolithic	CMLLM5424N_	702	54	24	2 3/8
	Double Sided Laminate Panel Package - 54”	CMLLM5430N_	832	54	30	2 3/8
		CMLLM5436N_	966	54	36	2 3/8
		CMLLM5442N_	1104	54	42	2 3/8
		CMLLM5448N_	1241	54	48	2 3/8
		CMLLM5454N_	1366	54	54	2 3/8
		CMLLM5460N_	1487	54	60	2 3/8
	Non-Powered Compile Monolithic	CMLLM6624N_	889	66	24	2 3/8
	Double Sided Laminate Panel Package - 66”	CMLLM6630N_	1050	66	30	2 3/8
		CMLLM6636N_	1218	66	36	2 3/8
		CMLLM6642N_	1395	66	42	2 3/8
		CMLLM6648N_	1565	66	48	2 3/8
		CMLLM6654N_	1726	66	54	2 3/8
		CMLLM6660N_	1887	66	60	2 3/8

**Raceway Cover Options (1) Shown**

- **RACEWAY COVER OPTIONS (Suffix)**
  - (0) No Knockouts Side 1 and Side 2
  - (1) Knockouts Side 1 – No Knockout Side 2
  - (2) Knockouts Side 1 and Side 2



**CMLLMXXYP\_ - MONOLITHIC LAMINATE DOUBLE SIDED PANEL – POWERED**

- Individual laminate modules incorporated into an aluminum frame.
- Modules have laminate on both sides.
- Opposite sides of each module may have a different laminate within the same grade at no upcharge.
- 3 panel connector brackets per side come standard with 30”h, 42”h, 48”h and 54”h panels.
- 4 panel connector brackets per side come standard with 66”h panels.
- 24” wide panels have two punchouts, one for electrical and one for data.
- 30” wide panels and wider have three punchouts, two for electrical and one for data.
- Note: Trim is not required at a straight connection between two panels of the same height.

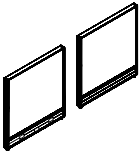
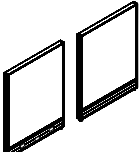
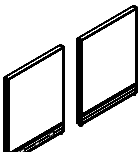
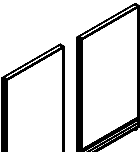
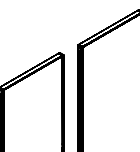
	DESCRIPTION	PRODUCT CODE	LIST PRICE Gr1	DIMENSIONS/INCHES		
				H	W	D
	Powered Compile Monolithic	CMLLM3024P_	657	30	24	2 3/8
	Double Sided Laminate Panel Package - 30”	CMLLM3030P_	801	30	30	2 3/8
		CMLLM3036P_	896	30	36	2 3/8
		CMLLM3042P_	994	30	42	2 3/8
		CMLLM3048P_	1100	30	48	2 3/8
		CMLLM3054P_	1196	30	54	2 3/8
		CMLLM3060P_	1274	30	60	2 3/8
	Powered Compile Monolithic	CMLLM4224P_	748	42	24	2 3/8
	Double Sided Laminate Panel Package - 42”	CMLLM4230P_	906	42	30	2 3/8
		CMLLM4236P_	1032	42	36	2 3/8
		CMLLM4242P_	1150	42	42	2 3/8
		CMLLM4248P_	1276	42	48	2 3/8
		CMLLM4254P_	1383	42	54	2 3/8
		CMLLM4260P_	1483	42	60	2 3/8
	Powered Compile Monolithic	CMLLM4824P_	855	48	24	2 3/8
	Double Sided Laminate Panel Package - 48”	CMLLM4830P_	1038	48	30	2 3/8
		CMLLM4836P_	1183	48	36	2 3/8
		CMLLM4842P_	1325	48	42	2 3/8
		CMLLM4848P_	1479	48	48	2 3/8
		CMLLM4854P_	1606	48	54	2 3/8
		CMLLM4860P_	1678	48	60	2 3/8
	Powered Compile Monolithic	CMLLM5424P_	855	54	24	2 3/8
	Double Sided Laminate Panel Package - 54”	CMLLM5430P_	1039	54	30	2 3/8
		CMLLM5436P_	1183	54	36	2 3/8
		CMLLM5442P_	1325	54	42	2 3/8
		CMLLM5448P_	1480	54	48	2 3/8
		CMLLM5454P_	1608	54	54	2 3/8
		CMLLM5460P_	1727	54	60	2 3/8
	Powered Compile Monolithic	CMLLM6624P_	1042	66	24	2 3/8
	Double Sided Laminate Panel Package - 66”	CMLLM6630P_	1258	66	30	2 3/8
		CMLLM6636P_	1435	66	36	2 3/8
		CMLLM6642P_	1617	66	42	2 3/8
		CMLLM6648P_	1802	66	48	2 3/8
		CMLLM6654P_	1966	66	54	2 3/8
		CMLLM6660P_	2128	66	60	2 3/8

**Raceway Cover Options (1) Shown**

- **RACEWAY COVER OPTIONS (Suffix)**
  - (0) No Knockouts Side 1 and Side 2
  - (1) Knockouts Side 1 – No Knockout Side 2
  - (2) Knockouts Side 1 and Side 2

**CMFLXXYYN - SEGMENTED LAMINATE SINGLE SIDED PANEL – NON-POWERED**

- Individual fabric or laminate covered modules incorporated into an aluminum frame.
- Modules have laminate on one side and fabric on the other.
- Opposite sides of each module may have a different laminate within the same grade at no upcharge.
- If different grades of fabric are used on one panel, the entire panel must be priced at highest grade.
- Panels are not tackable.
- Note: Trim is not required at a straight connection between two panels of the same height.
- 3 Panel connector brackets per side come standard with 42”h, 48h” and 54”h panels.
- 4 Panel connector brackets per side come standard with 66”h panels.
- 24” wide panels have two punchouts, one for electrical and one for data.
- 30” wide panels and wider have three punchouts, two for electrical and one for data.

	DESCRIPTION	PRODUCT CODE	LIST PRICE		DIMENSIONS/INCHES		
			Gr1	Gr2	H	W	D
	Non-Powered Compile Single Segmented Laminate Panel Package - 42"	CMFL4224N_	523	540	42	24	2.38
		CMFL4230N_	613	632	42	30	2.38
		CMFL4236N_	700	724	42	36	2.38
		CMFL4242N_	794	818	42	42	2.38
		CMFL4248N_	865	891	42	48	2.38
		CMFL4254N_	957	987	42	54	2.38
		CMFL4260N_	1050	1081	42	60	2.38
	Non-Powered Compile Single Segmented Laminate Panel Package - 48"	CMFL4824N_	619	638	48	24	2.38
		CMFL4830N_	726	745	48	30	2.38
		CMFL4836N_	833	858	48	36	2.38
		CMFL4842N_	944	974	48	42	2.38
		CMFL4848N_	1030	1060	48	48	2.38
		CMFL4854N_	1146	1371	48	54	2.38
		CMFL4860N_	1258	1297	48	60	2.38
	Non-Powered Compile Single Segmented Laminate Panel Package - 54"	CMFL5424N_	620	642	54	24	2.38
		CMFL5430N_	726	751	54	30	2.38
		CMFL5436N_	833	858	54	36	2.38
		CMFL5442N_	945	975	54	42	2.38
		CMFL5448N_	1030	1063	54	48	2.38
		CMFL5454N_	1146	1181	54	54	2.38
		CMFL5460N_	1258	1297	54	60	2.38
	Non-Powered Compile Single Segmented Lmainate Panel Package - 66"	CMFL6624N_	765	791	66	24	2.38
		CMFL6630N_	896	926	66	30	2.38
		CMFL6636N_	1033	1065	66	36	2.38
		CMFL6642N_	1175	1207	66	42	2.38
		CMFL6648N_	1278	1320	66	48	2.38
		CMFL6654N_	1422	1468	66	54	2.38
		CMFL6660N_	1565	1615	66	60	2.38

**Raceway Cover Options (1) Shown**

- **RACEWAY COVER OPTIONS (Suffix)**
  - (0) No Knockouts Side 1 and Side 2
  - (1) Knockouts Side 1 – No Knockout Side 2
  - (2) Knockouts Side 1 and Side 2



**CMFLXXYP\_ - SEGMENTED LAMINATE SINGLE SIDED PANEL – POWERED**

- Individual fabric or laminate covered modules incorporated into an aluminum frame.
- Modules have laminate on one side and fabric on the other.
- Opposite sides of each module may have a different laminate within the same grade at no upcharge.
- If different grades of fabric are used on one panel, the entire panel must be priced at highest grade.
- Panels are not tackable.
- Note: Trim is not required at a straight connection between two panels of the same height.
- 3 Panel connector brackets per side come standard with 42”h, 48h” and 54”h panels.
- 4 Panel connector brackets per side come standard with 66”h panels.
- 24” wide panels have two punchouts, one for electrical and one for data.
- 30” wide panels and wider have three punchouts, two for electrical and one for data.

	DESCRIPTION	PRODUCT CODE	LIST PRICE		DIMENSIONS/INCHES		
			Gr1	Gr2	H	W	D
	Powered Compile Single Segmented Laminate Panel Package - 42”	CMFL4224P_	676	751	42	24	2 3/8
		CMFL4230P_	819	906	42	30	2 3/8
		CMFL4236P_	918	1020	42	36	2 3/8
		CMFL4242P_	1017	1131	42	42	2 3/8
		CMFL4248P_	1104	1228	42	48	2 3/8
		CMFL4254P_	1197	1337	42	54	2 3/8
		CMFL4260P_	1293	1444	42	60	2 3/8
	Powered Compile Single Segmented Laminate Panel Package - 48”	CMFL4824P_	773	791	48	24	2 3/8
		CMFL4830P_	932	953	48	30	2 3/8
		CMFL4836P_	1049	1075	48	36	2 3/8
		CMFL4842P_	1164	1192	48	42	2 3/8
		CMFL4848P_	1268	1300	48	48	2 3/8
		CMFL4854P_	1384	1420	48	54	2 3/8
		CMFL4860P_	1499	1540	48	60	2 3/8
	Powered Compile Single Segmented Laminate Panel Package - 54”	CMFL5424P_	774	865	54	24	2 3/8
		CMFL5430P_	932	1040	54	30	2 3/8
		CMFL5436P_	1049	1169	54	36	2 3/8
		CMFL5442P_	1164	1303	54	42	2 3/8
		CMFL5448P_	1268	1419	54	48	2 3/8
		CMFL5454P_	1385	1550	54	54	2 3/8
		CMFL5460P_	1499	1683	54	60	2 3/8
	Powered Compile Single Segmented Laminate Panel Package - 66”	CMFL6624P_	920	1034	66	24	2 3/8
		CMFL6630P_	1100	1232	66	30	2 3/8
		CMFL6636P_	1212	1403	66	36	2 3/8
		CMFL6642P_	1394	1565	66	42	2 3/8
		CMFL6648P_	1516	1701	66	48	2 3/8
		CMFL6654P_	1663	1871	66	54	2 3/8
		CMFL6660P_	1807	2034	66	60	2 3/8

**Raceway Cover Options (1) Shown**

- **RACEWAY COVER OPTIONS (Suffix)**
  - (1) Knockouts Side 1 – No Knockout Side 2
  - (2) Knockouts Side 1 and Side 2

**CMLLXXYYN - SEGMENTED LAMINATE DOUBLE SIDED PANEL – NON-POWERED**

- Individual laminate covered modules incorporated into an aluminum frame. same height.
- Modules have laminate on one side and fabric on the other.
- Opposite sides of each module may have a different laminate within the same grade at no upcharge.
- If different grades of fabric are used on one panel, the entire panel must be priced at highest grade.
- Note: Trim is not required at a straight connection between two panels of the
- 3 Panel connector brackets per side come standard with 42”h, 48h” and 54”h panels.
- 4 Panel connector brackets per side come standard with 66”h panels.
- 24” wide panels have two punchouts, one for electrical and one for data.
- 30” wide panels and wider have three punchouts, two for electrical and one for data.

	DESCRIPTION	PRODUCT CODE	LIST PRICE Gr1	DIMENSIONS/INCHES		
				H	W	D
	Non-Powered Compile Single Segmented	CMLL4224N_	594	42	24	2 3/8
	Double Sided Laminate Panel Package - 42”	CMLL4230N_	699	42	30	2 3/8
		CMLL4236N_	814	42	36	2 3/8
		CMLL4242N_	928	42	42	2 3/8
		CMLL4248N_	1039	42	48	2 3/8
		CMLL4254N_	1142	42	54	2 3/8
		CMLL4260N_	1242	42	60	2 3/8
	Non-Powered Compile Single Segmented	CMLL4824N_	702	48	24	2 3/8
	Double Sided Laminate Panel Package - 48”	CMLL4830N_	832	48	30	2 3/8
		CMLL4836N_	965	48	36	2 3/8
		CMLL4842N_	1103	48	42	2 3/8
		CMLL4848N_	1240	48	48	2 3/8
		CMLL4854N_	1366	48	54	2 3/8
		CMLL4860N_	1485	48	60	2 3/8
	Non-Powered Compile Single Segmented	CMLL5424N_	702	54	24	2 3/8
	Double Sided Laminate Panel Package - 54”	CMLL5430N_	832	54	30	2 3/8
		CMLL5436N_	966	54	36	2 3/8
		CMLL5442N_	1104	54	42	2 3/8
		CMLL5448N_	1241	54	48	2 3/8
		CMLL5454N_	1366	54	54	2 3/8
		CMLL5460N_	1487	54	60	2 3/8
	Non-Powered Compile Single Segmented	CMLL6624N_	889	66	24	2 3/8
	Double Sided Laminate Panel Package - 66”	CMLL6630N_	1050	66	30	2 3/8
		CMLL6636N_	1218	66	36	2 3/8
		CMLL6642N_	1395	66	42	2 3/8
		CMLL6648N_	1565	66	48	2 3/8
		CMLL6654N_	1726	66	54	2 3/8
		CMLL6660N_	1887	66	60	2 3/8

**Raceway Cover Options (1) Shown**

- **RACEWAY COVER OPTIONS (Suffix)**
  - (0) No Knockouts Side 1 and Side 2
  - (1) Knockouts Side 1 – No Knockout Side 2
  - (2) Knockouts Side 1 and Side 2



**CMLLXXYP\_ - SEGMENTED LAMINATE DOUBLE SIDED PANEL – POWERED**

- Individual laminate covered modules incorporated into an aluminum frame.
- Modules have laminate on one side and fabric on the other.
- Opposite sides of each module may have a different laminate within the same grade at no upcharge.
- If different grades of fabric are used on one panel, the entire panel must be priced at highest grade.
- Note: Trim is not required at a straight connection between two panels of the same height.
- 3 Panel connector brackets per side come standard with 42”h, 48h” and 54”h panels.
- 4 Panel connector brackets per side come standard with 66” panels.
- 24” wide panels have two punchouts, one for electrical and one for data.
- 30” wide panels and wider have three punchouts, two for electrical and one for data.



	DESCRIPTION	PRODUCT CODE	LIST PRICE Gr1	DIMENSIONS/INCHES		
				H	W	D
	Powered Compile Single Segmented	CMLL4224P_	748	42	24	2.38
	Double Sided Laminate Panel Package - 42”	CMLL4230P_	906	42	30	2.38
		CMLL4236P_	1032	42	36	2.38
		CMLL4242P_	1150	42	42	2.38
		CMLL4248P_	1276	42	48	2.38
		CMLL4254P_	1383	42	54	2.38
		CMLL4260P_	1483	42	60	2.38
	Powered Compile Single Segmented	CMLL4824P_	855	48	24	2.38
	Double Sided Laminate Panel Package - 48”	CMLL4830P_	1038	48	30	2.38
		CMLL4836P_	1183	48	36	2.38
		CMLL4842P_	1325	48	42	2.38
		CMLL4848P_	1479	48	48	2.38
		CMLL4854P_	1606	48	54	2.38
		CMLL4860P_	1727	48	60	2.38
	Powered Compile Single Segmented	CMLL5424P_	855	54	24	2.38
	Double Sided Laminate Panel Package - 54”	CMLL5430P_	1039	54	30	2.38
		CMLL5436P_	1183	54	36	2.38
		CMLL5442P_	1325	54	42	2.38
		CMLL5448P_	1480	54	48	2.38
		CMLL5454P_	1608	54	54	2.38
		CMLL5460P_	1727	54	60	2.38
	Powered Compile Single Segmented	CMLL6624P_	1042	66	24	2.38
	Double Sided Laminate Panel Package - 66”	CMLL6630P_	1258	66	30	2.38
		CMLL6636P_	1435	66	36	2.38
		CMLL6642P_	1617	66	42	2.38
		CMLL6648P_	1802	66	48	2.38
		CMLL6654P_	1966	66	54	2.38
		CMLL6660P_	2128	66	60	2.38

**Raceway Cover Options (1) Shown**

- **RACEWAY COVER OPTIONS (Suffix)**
  - (0) No Knockouts Side 1 and Side 2
  - (1) Knockouts Side 1 – No Knockout Side 2
  - (2) Knockouts Side 1 and Side 2

**CMFWXXYYN\_ - SEGMENTED WRITE BOARD SINGLE SIDED PANEL – NON-POWERED**

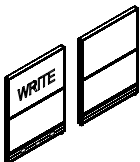
- Individual fabric or write board covered modules incorporated into an aluminum frame.
- Modules have write board on one side and fabric on the other at the top and fabric on two sides at the bottom.
- Opposite sides of each module may have a different fabric within the same grade at no upcharge.
- If different grades of fabric are used on one panel, the entire panel must be priced at highest grade.
- Panels are not tackable.
- Note: Trim is not required at a straight connection between two panels of the same height.
- 3 Panel connector brackets per side come standard with 48”h. and 54”h. panels.
- 4 Panel connector brackets per side come standard with 66”h. panels.
- 24” wide panels have two punchouts, one for electrical and one for data.
- 30” wide panels and wider have three punchouts, two for electrical and one for data.

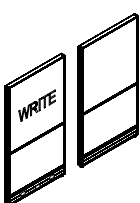
	DESCRIPTION	PRODUCT CODE	LIST PRICE		DIMENSIONS/INCHES		
			Gr1	Gr2	H	W	D
	Non-Powered Compile Write Board Single Sided Panel Package - 48” No punchouts	CMFW4824N_	555	582	48	24	2 3/8
		CMFW4830N_	670	702	48	30	2 3/8
		CMFW4836N_	743	779	48	36	2 3/8
		CMFW4842N_	838	702	48	42	2 3/8
		CMFW4848N_	942	990	48	48	2 3/8
		CMFW4854N_	1047	1084	48	54	2 3/8
		CMFW4860N_	1152	1214	48	60	2 3/8
	Non-Powered Compile Write Board Single Sided Panel Package - 54”	CMFW5424N_	556	578	54	24	2 3/8
		CMFW5430N_	671	696	54	30	2 3/8
		CMFW5436N_	744	768	54	36	2 3/8
		CMFW5442N_	839	869	54	42	2 3/8
		CMFW5448N_	943	976	54	48	2 3/8
		CMFW5454N_	1047	1082	54	54	2 3/8
		CMFW5460N_	1153	1192	54	60	2 3/8
	Non-Powered Compile Write Board Single Sided Panel Package - 66”	CMFW6624N_	700	726	66	24	2 3/8
		CMFW6630N_	832	862	66	30	2 3/8
		CMFW6636N_	927	959	66	36	2 3/8
		CMFW6642N_	1048	1083	66	42	2 3/8
		CMFW6648N_	1169	1211	66	48	2 3/8
		CMFW6654N_	1300	1344	66	54	2 3/8
		CMFW6660N_	1435	1483	66	60	2 3/8

**Raceway Cover Options (1) Shown**

- **RACEWAY COVER OPTIONS (Suffix)**
  - (0) No Knockouts Side 1 and Side 2
  - (1) Knockouts Side 1 – No Knockout Side 2
  - (2) Knockouts Side 1 and Side 2



**CMFWXXYYP\_ - SEGMENTED WRITE BOARD SINGLE SIDED PANEL – POWERED**

- Individual fabric or write board covered modules incorporated into an aluminum frame.
- Modules have write board on one side and fabric on the other at the top and fabric on two sides at the bottom.
- Opposite sides of each module may have a different fabric within the same grade at no upcharge.
- If different grades of fabric are used on one panel, the entire panel must be priced at highest grade.
- Panels are not tackable.
- Note: Trim is not required at a straight connection between two panels of the same height.
- 3 Panel connector brackets per side come standard with 48”h. and 54”h. panels.
- 4 Panel connector brackets per side come standard with 66”h. panels.
- 24” wide panels have two punchouts, one for electrical and one for data.
- 30” wide panels and wider have three punchouts, two for electrical and one for data.

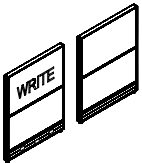
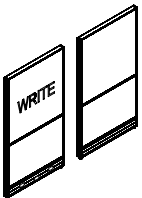
	DESCRIPTION	PRODUCT CODE	LIST PRICE		DIMENSIONS/INCHES		
			Gr1	Gr2	H	W	D
	Powered Compile Write Board Single Sided Panel Package - 48” Punchouts on one side	CMFW4824P_	707	734	48	24	2 3/8
		CMFW4830P_	877	909	48	30	2 3/8
		CMFW4836P_	959	995	48	36	2 3/8
		CMFW4842P_	1058	1104	48	42	2 3/8
		CMFW4848P_	1180	1226	48	48	2 3/8
		CMFW4854P_	1287	1323	48	54	2 3/8
		CMFW4860P_	1393	1454	48	60	2 3/8
	Powered Compile Write Board Single Sided Panel Package - 54”	CMFW5424P_	709	731	54	24	2 3/8
		CMFW5430P_	878	903	54	30	2 3/8
		CMFW5436P_	959	984	54	36	2 3/8
		CMFW5442P_	1059	1089	54	42	2 3/8
		CMFW5448P_	1180	1213	54	48	2 3/8
		CMFW5454P_	1289	1324	54	54	2 3/8
		CMFW5460P_	1393	1435	54	60	2 3/8
	Powered Compile Write Board Single Sided Panel Package - 66”	CMFW6624P_	854	879	66	24	2 3/8
		CMFW6630P_	1039	1069	66	30	2 3/8
		CMFW6636P_	1142	1174	66	36	2 3/8
		CMFW6642P_	1269	1304	66	42	2 3/8
		CMFW6648P_	1408	1447	66	48	2 3/8
		CMFW6654P_	1539	1585	66	54	2 3/8
		CMFW6660P_	1677	1727	66	60	2 3/8



**Raceway Cover Options (1) Shown**

- **RACEWAY COVER OPTIONS (Suffix)**
  - (0) No Knockouts Side 1 and Side 2
  - (1) Knockouts Side 1 – No Knockout Side 2
  - (2) Knockouts Side 1 and Side 2



**CMWWXXYYN\_ - SEGMENTED WRITE BOARD DOUBLE SIDED PANEL – NON-POWERED**

- Individual fabric or write board covered modules incorporated into an aluminum frame.
- Modules have write board on two sides at the top and fabric on two sides at the bottom.
- Opposite sides of each module may have a different fabric within the same grade at no upcharge.
- If different grades of fabric are used on one panel, the entire panel must be priced at highest grade.
- Panels are not tackable.
- Note: Trim is not required at a straight connection between two panels of the same height.
- 3 Panel connector brackets per side come standard with 48”h. and 54”h. panels.
- 4 Panel connector brackets per side come standard with 66”h. panels.
- 24” wide panels have two punchouts, one for electrical and one for data.
- 30” wide panels and wider have three punchouts, two for electrical and one for data.

	DESCRIPTION	PRODUCT CODE	LIST PRICE		DIMENSIONS/INCHES		
			Gr1	Gr2	H	W	D
	Non-Powered Compile Write Board Single Segmented Panel Package - 48” No Punchouts	CMWW4824N_	608	625	48	24	2.38
		CMWW4830N_	755	776	48	30	2.38
		CMWW4836N_	817	846	48	36	2.38
		CMWW4842N_	927	957	48	42	2.38
		CMWW4848N_	1085	1118	48	48	2.38
		CMWW4854N_	1204	1241	48	54	2.38
		CMWW4860N_	1327	1365	48	60	2.38
	Non-Powered Compile Write Board Single Segmented Panel Package - 54”	CMWW5424N_	609	642	54	24	2.38
		CMWW5430N_	755	788	54	30	2.38
		CMWW5436N_	817	881	54	36	2.38
		CMWW5442N_	928	992	54	42	2.38
		CMWW5448N_	1085	1149	54	48	2.38
		CMWW5454N_	1205	1269	54	54	2.38
		CMWW5460N_	1327	1391	54	60	2.38
	Non-Powered Compile Write Board Single Segmented Panel Package - 66”	CMWW6624N_	751	784	66	24	2.38
		CMWW6630N_	920	953	66	30	2.38
		CMWW6636N_	927	991	66	36	2.38
		CMWW6642N_	1138	1203	66	42	2.38
		CMWW6648N_	1308	1372	66	48	2.38
		CMWW6654N_	1460	1524	66	54	2.38
		CMWW6660N_	1610	1674	66	60	2.38



**Raceway Cover Options (1) Shown**

- **RACEWAY COVER OPTIONS (Suffix)**
  - (0) No Knockouts Side 1 and Side 2
  - (1) Knockouts Side 1 – No Knockout Side 2
  - (2) Knockouts Side 1 and Side 2



**CMWWXYYP\_ - SEGMENTED WRITE BOARD DOUBLE SIDED PANEL – POWERED**

- Individual fabric or write board covered modules incorporated into an aluminum frame.
- Modules have write board on two sides at the top and fabric on two sides at the bottom.
- Opposite sides of each module may have a different fabric within the same grade at no upcharge.
- If different grades of fabric are used on one panel, the entire panel must be priced at highest grade.
- Panels are not tackable.
- Note: Trim is not required at a straight connection between two panels of the same height.
- 3 Panel connector brackets per side come standard with 48”h. and 54”h. panels.
- 4 Panel connector brackets per side come standard with 66”h. panels.
- 24” wide panels have two punchouts, one for electrical and one for data.
- 30” wide panels and wider have three punchouts, two for electrical and one for data.

	DESCRIPTION	PRODUCT CODE	LIST PRICE		DIMENSIONS/INCHES		
			Gr1	Gr2	H	W	D
	Powered Compile Write Board	CMWW4824P_	761	779	48	24	2 3/8
	Single Segmented Panel Package - 48"	CMWW4830P_	961	982	48	30	2 3/8
	Punchouts on one side	CMWW4836P_	1034	1061	48	36	2 3/8
		CMWW4842P_	1149	1178	48	42	2 3/8
		CMWW4848P_	1322	1355	48	48	2 3/8
		CMWW4854P_	1444	1481	48	54	2 3/8
		CMWW4860P_	1568	1605	48	60	2 3/8
	Powered Compile Write Board	CMWW5424P_	761	794	54	24	2 3/8
	Single Segmented Panel Package - 54"	CMWW5430P_	961	994	54	30	2 3/8
		CMWW5436P_	1034	1098	54	36	2 3/8
		CMWW5442P_	1150	1214	54	42	2 3/8
		CMWW5448P_	1322	1386	54	48	2 3/8
		CMWW5454P_	1445	1509	54	54	2 3/8
		CMWW5460P_	1568	1632	54	60	2 3/8
	Powered Compile Write Board	CMWW6624P_	902	935	66	24	2 3/8
	Single Segmented Panel Package - 66"	CMWW6630P_	1125	1158	66	30	2 3/8
		CMWW6636P_	1219	1283	66	36	2 3/8
		CMWW6642P_	1358	1422	66	42	2 3/8
		CMWW6648P_	1547	1611	66	48	2 3/8
		CMWW6654P_	1700	1764	66	54	2 3/8
		CMWW6660P_	1851	1915	66	60	2 3/8

**Raceway Cover Options (1) Shown**

- **RACEWAY COVER OPTIONS (Suffix)**
  - (0) No Knockouts Side 1 and Side 2
  - (1) Knockouts Side 1 – No Knockout Side 2
  - (2) Knockouts Side 1 and Side 2

**CMFOXXYYN\_ - COMPILE SINGLE SEGMENTED OPEN BOTTOM PANEL PACKAGE – NON-POWERED**

- Non powered.
- Includes one panel and two raceways covers with no punchouts and a integrated aluminum top cap.
- Individual fabric-covered module in upper position incorporated into an aluminum frame. Bottom is open.
- Opposite sides of each module may have a different fabric within the same grade at no upcharge.
- If different grades of fabric are used on one panel, the entire panel must be priced at highest grade.
- Panels are not tackable or acoustical.
- Trim is not required at a straight connection between two panels of the same height.
- 3 Panel connector brackets per side come standard with 42”h, 48”h and 54”h panels.
- 4 Panel connector brackets per side come standard with 66”h panels.
- Panels contain leveling glides. Maximum extension of glides is 2”.

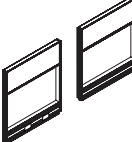
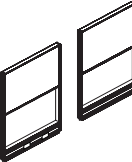
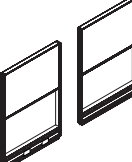
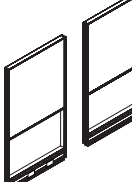
	DESCRIPTION	PRODUCT CODE	LIST PRICE		DIMENSIONS/INCHES		
			Gr1	Gr2	H	W	D
	Non-Powered Compile Single Segmented Open Bottom Panel Package - 42"	CMFO4224N_	355	371	42	24	2 3/8
		CMFO4230N_	398	412	42	30	2 3/8
		CMFO4236N_	422	449	42	36	2 3/8
		CMFO4242N_	482	509	42	42	2 3/8
		CMFO4248N_	513	540	42	48	2 3/8
		CMFO4254N_	572	586	42	54	2 3/8
		CMFO4260N_	611	638	42	60	2 3/8
	Non-Powered Compile Single Segmented Open Bottom Panel Package - 48"	CMFO4824N_	383	404	48	24	2 3/8
		CMFO4830N_	429	447	48	30	2 3/8
		CMFO4836N_	482	501	48	36	2 3/8
		CMFO4842N_	547	584	48	42	2 3/8
		CMFO4848N_	590	628	48	48	2 3/8
		CMFO4854N_	627	665	48	54	2 3/8
		CMFO4860N_	675	713	48	60	2 3/8
	Non-Powered Compile Single Segmented Open Bottom Panel Package - 54"	CMFO5424N_	384	406	54	24	2 3/8
		CMFO5430N_	429	451	54	30	2 3/8
		CMFO5436N_	483	505	54	36	2 3/8
		CMFO5442N_	547	585	54	42	2 3/8
		CMFO5448N_	590	628	54	48	2 3/8
		CMFO5454N_	627	666	54	54	2 3/8
		CMFO5460N_	676	714	54	60	2 3/8
	Non-Powered Compile Single Segmented Open Bottom Panel Package - 66"	CMFO6624N_	450	482	66	24	2 3/8
		CMFO6630N_	516	548	66	30	2 3/8
		CMFO6636N_	574	631	66	36	2 3/8
		CMFO6642N_	653	711	66	42	2 3/8
		CMFO6648N_	691	749	66	48	2 3/8
		CMFO6654N_	751	808	66	54	2 3/8
		CMFO6660N_	796	853	66	60	2 3/8



**Raceway Cover Options (1) Shown**

- **RACEWAY COVER OPTIONS (Suffix)**
  - (0) No Knockouts Side 1 and Side 2
  - (1) Knockouts Side 1 – No Knockout Side 2
  - (2) Knockouts Side 1 and Side 2

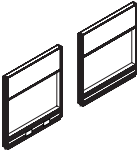
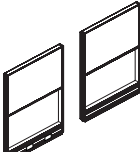
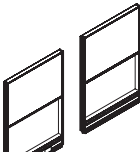

**CMFOXXYP - COMPILE SINGLE SEGMENTED - OPEN BOTTOM PANEL PACKAGE – POWERED**

- With power distribution harness.
- Includes one panel, power harness, one raceway cover with punchout, one raceway cover without punchout and a integrated aluminum top cap.
- Individual fabric-covered module in upper position incorporated into an aluminum frame. Bottom is open.
- Opposite sides of each module may have a different fabric within the same grade at no upcharge.
- If different grades of fabric are used on one panel, the entire panel must be priced at highest grade.
- Panels are not tackable or acoustical.
- Trim is not required at a straight connection between two panels of the same height.
- 3 Panel connector brackets per side come standard with 42”h, 48”h and 54”h panels.
- 4 Panel connector brackets per side come standard with 66”h panels.
- Panels contain leveling glides. Maximum extension of glides is 2”.
- 24” wide panels have one punchout, 30” wide panels or wider have two punchouts.

	DESCRIPTION	PRODUCT CODE	LIST PRICE		DIMENSIONS/INCHES		
			Gr1	Gr2	H	W	D
	Powered Compile Single Segmented Open Bottom Panel Package - 42”	CMFO4224P_	494	510	42	24	2 3/8
		CMFO4230P_	588	604	42	30	2 3/8
		CMFO4236P_	620	647	42	36	2 3/8
		CMFO4242P_	685	712	42	42	2 3/8
		CMFO4248P_	730	757	42	48	2 3/8
		CMFO4254P_	791	805	42	54	2 3/8
	Powered Compile Single Segmented Open Bottom Panel Package - 48”	CMFO4824P_	525	546	48	24	2 3/8
		CMFO4830P_	616	635	48	30	2 3/8
		CMFO4836P_	684	703	48	36	2 3/8
		CMFO4842P_	750	788	48	42	2 3/8
		CMFO4848P_	809	847	48	48	2 3/8
		CMFO4854P_	847	885	48	54	2 3/8
	Powered Compile Single Segmented Open Bottom Panel Package - 54”	CMFO5424P_	525	547	54	24	2 3/8
		CMFO5430P_	619	640	54	30	2 3/8
		CMFO5436P_	684	706	54	36	2 3/8
		CMFO5442P_	751	790	54	42	2 3/8
		CMFO5448P_	811	850	54	48	2 3/8
		CMFO5454P_	850	888	54	54	2 3/8
	Powered Compile Single Segmented Open Bottom Panel Package - 66”	CMFO6624P_	591	622	66	24	2 3/8
		CMFO6630P_	704	736	6	30	2 3/8
		CMFO6636P_	773	831	66	36	2 3/8
		CMFO6642P_	855	912	66	42	2 3/8
		CMFO6648P_	908	966	66	48	2 3/8
		CMFO6654P_	971	1028	66	54	2 3/8
		CMFO6660P_	1019	1077	66	60	2 3/8

**Raceway Cover Options (1) Shown**

- **RACEWAY COVER OPTIONS (Suffix)**
  - (1) Knockouts Side 1 – No Knockout Side 2
  - (2) Knockouts Side 1 and Side 2

**CMFGXXYYN - COMPILE GLAZED PANEL PACKAGE – NON-POWERED**

- Non powered.
- Includes one panel and two raceway covers with no punchouts.
- Individual fabric-covered module in lower position incorporated into a solid steel frame.
- Opposite sides of each module may have a different fabric within the same grade at no upcharge.
- If different grades of fabric are used on one panel, the entire panel must be priced at highest grade.
- Panels are not tackable or acoustical.
- Trim is not required at a straight connection between two panels of the same height.
- 3 Panel connector brackets per side come standard with 42”h, 48”h and 54”h panels.
- 4 Panel connector brackets per side come standard with 66”h panels.
- Panels contain leveling glides. Maximum extension of glides is 2”.
- Standard clear (CLR) plexi.
- Optional Frosted Plexi with 10% upcharge.
- PVC glass retainer in matching paint color.
- Glazing starts at 29” high to the top of the panel.

	DESCRIPTION	PRODUCT CODE	LIST PRICE		DIMENSIONS/INCHES		
			Gr1	Gr2	H	W	D
	Non-Powered Compile Glazed Panel Package - 42"	CMFG4224N_	480	498	42	24	2.38
		CMFG4230N_	547	568	42	30	2.38
		CMFG4236N_	612	638	42	36	2.38
		CMFG4242N_	684	713	42	42	2.38
		CMFG4248N_	748	778	42	48	2.38
		CMFG4254N_	841	873	42	54	2.38
		CMFG4260N_	927	964	42	60	2.38
	Non-Powered Compile Glazed Panel Package - 48"	CMFG4824N_	516	534	48	24	2.38
		CMFG4830N_	604	625	48	30	2.38
		CMFG4836N_	687	712	48	36	2.38
		CMFG4842N_	770	797	48	42	2.38
		CMFG4848N_	840	870	48	48	2.38
		CMFG4854N_	978	1011	48	54	2.38
		CMFG4860N_	1106	1145	48	60	2.38
	Non-Powered Compile Glazed Panel Package - 54"	CMFG5424N_	517	538	54	24	2.38
		CMFG5430N_	607	629	54	30	2.38
		CMFG5436N_	687	713	54	36	2.38
		CMFG5442N_	773	800	54	42	2.38
		CMFG5448N_	841	872	54	48	2.38
		CMFG5454N_	979	1012	54	54	2.38
		CMFG5460N_	1107	1146	54	60	2.38
	Non-Powered Compile Glazed Panel Package - 66"	CMFG6624N_	648	675	66	24	2.38
		CMFG6630N_	753	784	66	30	2.38
		CMFG6636N_	858	891	66	36	2.38
		CMFG6642N_	966	1009	66	42	2.38
		CMFG6648N_	1048	1095	66	48	2.38
		CMFG6654N_	1213	1264	66	54	2.38
		CMFG6660N_	1369	1423	66	60	2.38

**Raceway Cover Options (1) Shown**

- **RACEWAY COVER OPTIONS (Suffix)**
  - (0) No Knockouts Side 1 and Side 2
  - (1) Knockouts Side 1 – No Knockout Side 2
  - (2) Knockouts Side 1 and Side 2



**CMFGXXYP - COMPILE GLAZED PANEL PACKAGE – POWERED**

- With power distribution harness.
- Includes one panel, power harness, one raceway cover with punchout and one raceway cover with no punchout.
- Individual fabric-covered modules incorporated into an aluminum frame.
- Opposite sides of each module may have a different fabric within the same grade at no upcharge.
- If different grades of fabric are used on one panel, the entire panel must be priced at highest grade.
- Panels are not tackable or acoustical.
- Trim is not required at a straight connection between two panels of the same height.
- 3 Panel connector brackets per side come standard with 42”h, 48”h and 54”h panels.
- 4 Panel connector brackets per side come standard with 66”h panels.
- Panels contain leveling glides. Maximum extension of glides is 2”.
- Standard clear (CLR) plexi.
- Optional Frosted Plexi with 10% upcharge.
- PVC glass retainer in matching paint color.
- Glazing starts at 29” high to the top of the panel.

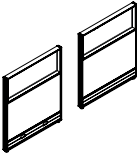
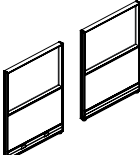
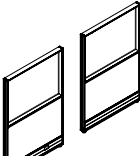
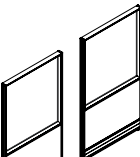
	DESCRIPTION	PRODUCT CODE	LIST PRICE		DIMENSIONS/INCHES		
			Gr1	Gr2	H	W	D
	Powered Compile Glazed Panel Package - 42"	CMFG4224P_	632	650	42	24	2 3/8
		CMFG4230P_	753	774	42	30	2 3/8
		CMFG4236P_	829	855	42	36	2 3/8
		CMFG4242P_	902	931	42	42	2 3/8
		CMFG4248P_	985	1015	42	48	2 3/8
		CMFG4254P_	1078	1110	42	54	2 3/8
		CMFG4260P_	1165	1202	42	60	2 3/8
	Powered Compile Glazed Panel Package - 48"	CMFG4824P_	668	687	48	24	2 3/8
		CMFG4830P_	809	830	48	30	2 3/8
		CMFG4836P_	902	928	48	36	2 3/8
		CMFG4842P_	992	1018	48	42	2 3/8
		CMFG4848P_	1076	1107	48	48	2 3/8
		CMFG4854P_	1216	1249	48	54	2 3/8
		CMFG4860P_	1347	1385	48	60	2 3/8
	Powered Compile Glazed Panel Package - 54"	CMFG5424P_	668	689	54	24	2 3/8
		CMFG5430P_	811	833	54	30	2 3/8
		CMFG5436P_	902	928	54	36	2 3/8
		CMFG5442P_	992	1019	54	42	2 3/8
		CMFG5448P_	1077	1108	54	48	2 3/8
		CMFG5454P_	1217	1250	54	54	2 3/8
		CMFG5460P_	1348	1387	54	60	2 3/8
	Powered Compile Glazed Panel Package - 66"	CMFG6624P_	801	828	66	24	2 3/8
		CMFG6630P_	959	990	66	30	2 3/8
		CMFG6636P_	1075	1108	66	36	2 3/8
		CMFG6642P_	1187	1230	66	42	2 3/8
		CMFG6648P_	1289	1336	66	48	2 3/8
		CMFG6654P_	1450	1501	66	54	2 3/8
		CMFG6660P_	1612	1666	66	60	2 3/8

**Raceway Cover Options (1) Shown**

- **RACEWAY COVER OPTIONS (Suffix)**
  - (1) Knockouts Side 1 – No Knockout Side 2
  - (2) Knockouts Side 1 and Side 2

**CMPGXXYYN\_ - COMPILER PARTLY GLAZED PANEL PACKAGE – NON-POWERED**

- Non powered.
- Includes one panel and two raceway covers with no punchouts.
- Individual fabric-covered module in lower position incorporated into a solid steel frame.
- Opposite sides of each module may have a different fabric within the same grade at no upcharge.
- If different grades of fabric are used on one panel, the entire panel must be priced at highest grade.
- Panels are not tackable or acoustical.
- Trim is not required at a straight connection between two panels of the same height.
- 3 Panel connector brackets per side come standard with 48”h and 54”h panels.
- 4 Panel connector brackets per side come standard with 66”h panels.
- Panels contain leveling glides. Maximum extension of glides is 2”.
- Standard clear (CLR) plexi.
- Optional Frosted Plexi with 10% upcharge.
- PVC glass retainer in matching paint color.
- Glazing is 14” nominal from the top of the panel.

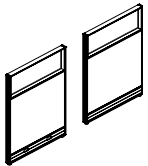
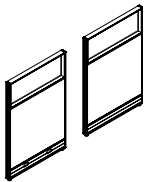
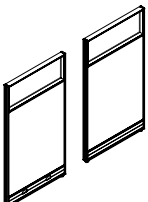
	DESCRIPTION	PRODUCT CODE	LIST PRICE		DIMENSIONS/INCHES		
			Gr1	Gr2	H	W	D
	Non-Powered Compile Partly Glazed Panel Package - 48"	CMPG4824N_	550	592	48	24	2 3/8
		CMPG4830N_	634	688	48	30	2 3/8
		CMPG4836N_	707	762	48	36	2 3/8
		CMPG4842N_	787	857	48	42	2 3/8
		CMPG4848N_	868	951	48	48	2 3/8
		CMPG4854N_	959	1044	48	54	2 3/8
	Non-Powered Compile Partly Glazed Panel Package - 54"	CMPG5424N_	550	593	54	24	2 3/8
		CMPG5430N_	634	689	54	30	2 3/8
		CMPG5436N_	709	766	54	36	2 3/8
		CMPG5442N_	788	857	54	42	2 3/8
		CMPG5448N_	868	951	54	48	2 3/8
		CMPG5454N_	959	1045	54	54	2 3/8
	Non-Powered Compile Partly Glazed Panel Package - 66"	CMPG6624N_	604	651	66	24	2 3/8
		CMPG6630N_	692	749	66	30	2 3/8
		CMPG6636N_	776	921	66	36	2 3/8
		CMPG6642N_	864	933	66	42	2 3/8
		CMPG6648N_	955	1037	66	48	2 3/8
		CMPG6654N_	1052	1136	66	54	2 3/8
		CMPG6660N_	1146	1237	66	60	2 3/8

**Raceway Cover Options (1) Shown**

- **RACEWAY COVER OPTIONS (Suffix)**
  - (0) No Knockouts Side 1 and Side 2
  - (1) Knockouts Side 1 – No Knockout Side 2
  - (2) Knockouts Side 1 and Side 2



**CMPGXXYP\_ - COMPILER PARTLY GLAZED PANEL PACKAGE – POWERED**

- With power distribution harness.
- Includes one panel, power harness, one raceway cover with punchout and one raceway cover with no punchout.
- Individual fabric-covered modules incorporated into an aluminum frame.
- Opposite sides of each module may have a different fabric within the same grade at no upcharge.
- If different grades of fabric are used on one panel, the entire panel must be priced at highest grade.
- Panels are not tackable or acoustical.
- Trim is not required at a straight connection between two panels of the same height.
- 3 Panel connector brackets per side come standard with 48”h and 54”h panels.
- 4 Panel connector brackets per side come standard with 66”h panels.
- Panels contain leveling glides. Maximum extension of glides is 2”.
- Standard clear (CLR) plexi.
- Optional Frosted Plexi with 10% upcharge.
- PVC glass retainer in matching paint color.
- Glazing is 14” nominal from the top of the panel.

	DESCRIPTION	PRODUCT CODE	LIST PRICE		DIMENSIONS/INCHES		
			Gr1	Gr2	H	W	D
	Powered Compile Partly Glazed Panel Package - 48"	CMPG4824P_	704	746	48	24	2 3/8
		CMPG4830P_	841	895	48	2 3/8	
		CMPG4836P_	923	978	48	36	2 3/8
		CMPG4842P_	1008	1076	48	42	2 3/8
		CMPG4848P_	1107	1189	48	48	2 3/8
		CMPG4854P_	1197	1283	48	54	2 3/8
		CMPG4860P_	1282	1377	48	60	2 3/8
	Powered Compile Partly Glazed Panel Package - 54"	CMPG5424P_	704	747	54	24	2 3/8
		CMPG5430P_	842	897	54	30	2 3/8
		CMPG5436P_	924	981	54	36	2 3/8
		CMPG5442P_	1008	1077	54	42	2 3/8
		CMPG5448P_	1108	1191	54	48	2 3/8
		CMPG5454P_	1198	1284	54	54	2 3/8
		CMPG5460P_	1282	1377	54	60	2 3/8
	Powered Compile Partly Glazed Panel Package - 66"	CMPG6624P_	755	802	66	24	2 3/8
		CMPG6630P_	898	955	66	30	2 3/8
		CMPG6636P_	992	1137	66	36	2 3/8
		CMPG6642P_	1085	1154	66	42	2 3/8
		CMPG6648P_	1192	1274	66	48	2 3/8
		CMPG6654P_	1293	1377	66	54	2 3/8
		CMPG6660P_	1386	1477	66	60	2 3/8

**Raceway Cover Options (1) Shown**

- **RACEWAY COVER OPTIONS (Suffix)**
  - (1) Knockouts Side 1 – No Knockout Side 2
  - (2) Knockouts Side 1 and Side 2



**CMPLGXXYYN - SINGLE 12" GLAZED AT TOP PANEL - NON-POWERED**

- Individual fabric-covered module in lower position with 12" H glazed module in upper position incorporated into an aluminum frame.
- Opposite sides of each module may have a different fabric within the same grade at no upcharge.
- If different grades of fabric are used on one panel, the entire panel must be priced at highest grade.
- Panels are not tackable.
- Note: Trim is not required at a straight connection between two panels of the same height.
- 3 Panel connector brackets per side come standard with 42"h, 48"h and 54"h

- panels.
- 4 Panel connector brackets per side come standard with 66"h. panels.
- Standard clear (CLR) plexi.
- Optional Frosted Plexi with 10% upcharge.
- 24" wide panels have two punchouts, one for electrical and one for data.
- 30" wide panels and wider have three punchouts, two for electrical and one for data.
- Glazing is 12" nominal from the top of the panel.

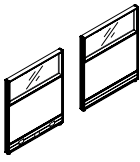
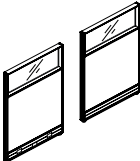
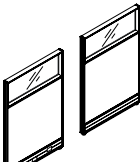
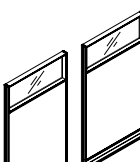
	DESCRIPTION	PRODUCT CODE	LIST PRICE		DIMENSIONS/INCHES		
			Gr1	Gr2	H	W	D
	Non-Powered Compile 12" Top Glazed Single Segmented Panel Package - 42"	CMPLG4224N_	527	546	42	24	2 3/8
		CMPLG4230N_	616	635	42	30	2 3/8
		CMPLG4236N_	707	745	42	36	2 3/8
		CMPLG4242N_	787	824	42	42	2 3/8
		CMPLG4248N_	855	893	42	48	2 3/8
		CMPLG4254N_	955	993	42	54	2 3/8
		CMPLG4260N_	1048	1086	42	60	2 3/8
	Non-Powered Compile 12" Top Glazed Single Segmented Panel Package - 48"	CMPLG4824N_	539	556	48	24	2 3/8
		CMPLG4830N_	621	639	48	30	2 3/8
		CMPLG4836N_	693	729	48	36	2 3/8
		CMPLG4842N_	770	806	48	42	2 3/8
		CMPLG4848N_	843	879	48	48	2 3/8
		CMPLG4854N_	942	975	48	54	2 3/8
		CMPLG4860N_	1022	1058	48	60	2 3/8
	Non-Powered Compile 12" Top Glazed Single Segmented Panel Package - 54"	CMPLG5424N_	542	563	54	24	2 3/8
		CMPLG5430N_	621	640	54	30	2 3/8
		CMPLG5436N_	696	733	54	36	2 3/8
		CMPLG5442N_	773	811	54	42	2 3/8
		CMPLG5448N_	854	892	54	48	2 3/8
		CMPLG5454N_	943	981	54	54	2 3/8
		CMPLG5460N_	1023	1061	54	60	2 3/8
	Non-Powered Compile 12" Top Glazed Single Segmented Panel Package - 66"	CMPLG6624N_	590	628	66	24	2 3/8
		CMPLG6630N_	678	716	66	30	2 3/8
		CMPLG6636N_	776	851	66	36	2 3/8
		CMPLG6642N_	847	922	66	42	2 3/8
		CMPLG6648N_	938	1012	66	48	2 3/8
		CMPLG6654N_	1033	1108	66	54	2 3/8
		CMPLG6660N_	1124	1199	66	60	2 3/8

**Raceway Cover Options (1) Shown**

- **RACEWAY COVER OPTIONS (Suffix)**
  - (0) No Knockouts Side 1 and Side 2
  - (1) Knockouts Side 1 – No Knockout Side 2
  - (2) Knockouts Side 1 and Side 2



**CMPLGXXYP\_ - SINGLE 12" GLAZED AT TOP PANEL – POWERED**

- Individual fabric-covered module in lower position with 12" H glazed module in upper position incorporated into an aluminum frame.
- Opposite sides of each module may have a different fabric within the same grade at no upcharge.
- If different grades of fabric are used on one panel, the entire panel must be priced at highest grade.
- Panels are not tackable.
- Note: Trim is not required at a straight connection between two panels of the same height.
- 3 Panel connector brackets per side come standard with 42"h, 48"h and 54"h panels.
- 4 Panel connector brackets per side come standard with 66"h panels.
- Standard clear (CLR) plexi.
- Optional Frosted Plexi with 10% upcharge.
- 24" wide panels have two punchouts, one for electrical and one for data.
- 30" wide panels and wider have three punchouts, two for electrical and one for data.
- Please specify duplex receptacles separately.
- Glazing is 12" nominal from the top of the panel.

	DESCRIPTION	PRODUCT CODE	LIST PRICE		DIMENSIONS/INCHES		
			Gr1	Gr2	H	W	D
	Powered Compile 12" Top Glazed Single Segmented Panel Package - 42"	CMPLG4224P_	680	701	42	24	2 3/8
		CMPLG4230P_	822	843	42	30	2 3/8
		CMPLG4236P_	923	960	42	36	2 3/8
		CMPLG4242P_	1007	1045	42	42	2 3/8
		CMPLG4248P_	1094	1132	42	48	2 3/8
		CMPLG4254P_	1194	1231	42	54	2 3/8
		CMPLG4260P_	1291	1328	42	60	2 3/8
	Powered Compile 12" Top Glazed Single Segmented Panel Package - 48"	CMPLG4824P_	692	713	48	24	2 3/8
		CMPLG4830P_	828	845	48	30	2 3/8
		CMPLG4836P_	911	946	48	36	2 3/8
		CMPLG4842P_	992	1025	48	42	2 3/8
		CMPLG4848P_	1073	1108	48	48	2 3/8
		CMPLG4854P_	1181	1216	48	54	2 3/8
		CMPLG4860P_	1265	1300	48	60	2 3/8
	Powered Compile 12" Top Glazed Single Segmented Panel Package - 54"	CMPLG5424P_	693	712	54	24	2 3/8
		CMPLG5430P_	829	848	54	30	2 3/8
		CMPLG5436P_	911	949	54	36	2 3/8
		CMPLG5442P_	992	1030	54	42	2 3/8
		CMPLG5448P_	1092	1130	54	48	2 3/8
		CMPLG5454P_	1181	1219	54	54	2 3/8
		CMPLG5460P_	1265	1303	54	60	2 3/8
	Powered Compile 12" Top Glazed Single Segmented Panel Package - 66"	CMPLG6624P_	745	782	66	24	2 3/8
		CMPLG6630P_	886	924	66	30	2 3/8
		CMPLG6636P_	979	1053	66	36	2 3/8
		CMPLG6642P_	1069	1143	66	42	2 3/8
		CMPLG6648P_	1176	1251	66	48	2 3/8
		CMPLG6654P_	1273	1348	66	54	2 3/8
		CMPLG6660P_	1364	1438	66	60	2 3/8

**Raceway Cover Options (1) Shown**

- **RACEWAY COVER OPTIONS (Suffix)**
  - (1) Knockouts Side 1 – No Knockout Side 2
  - (2) Knockouts Side 1 and Side 2

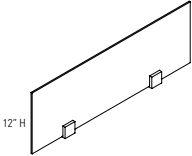
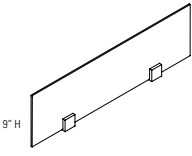
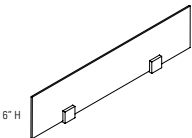

**CMPSXX - COMPILE PRIVACY GLASS**

- Attaches on top of Compile Panels to add privacy or divide space.
- Standard in clear (CLR) or frosted (FRST) glass.
- Clamps available in satin chrome finish only.
- Width dimensions given are width of glass only.
- Attachment hardware is provided for attaching to panels.
- Please note Privacy Glass in 24" - 54" widths includes 2 clamps and a Privacy Glass in 60" width includes 3 clamps.
- Square profile on clamps and glass corners.

	DESCRIPTION	PRODUCT CODE	LIST PRICE		DIMENSIONS/INCHES		
			CLR	FRST	H	W	D
 <p>12" H</p>	Compile Privacy Glass	CMPS24	295	357	12	24	6
		CMPS30	313	359	12	30	6
		CMPS36	330	363	12	36	6
		CMPS42	341	398	12	42	6
		CMPS48	350	426	12	48	6
		CMPS54	360	453	12	54	6
		CMPS60	376	488	12	60	6
 <p>9" H</p>		CMPS0924	295	357	9	24	6
		CMPS0930	313	359	9	30	6
		CMPS0936	330	363	9	36	6
		CMPS0942	341	398	9	42	6
		CMPS0948	350	426	9	48	6
		CMPS0954	360	453	9	54	6
		CMPS0960	376	488	9	60	6
 <p>6" H</p>		CMPS0624	295	357	6	24	6
		CMPS0630	313	359	6	30	6
		CMPS0636	330	363	6	36	6
		CMPS0642	341	398	6	42	6
		CMPS0648	350	426	6	48	6
		CMPS0654	360	453	6	54	6
		CMPS0660	376	488	6	60	6

**CMPSGX - COMPILE PRIVACY GLASS PANEL WIDTH**

- Attaches on top of Compile Panels to add privacy or divide space.
- Standard in clear (CLR) or frosted (FRST) glass.
- Width dimensions given are width of glass only.
- Attachment hardware is provided for attaching to panels.

	DESCRIPTION	PRODUCT CODE	LIST PRICE		DIMENSIONS/INCHES		
			CLR	FRST	H	W	D
	Compile Privacy Glass	CMPSEG0624	264	322	6	24	2.41
		CMPSEG0630	288	328	6	30	2.41
		CMPSEG0636	306	335	6	36	2.41
		CMPSEG0642	319	371	6	42	2.41
		CMPSEG0648	339	404	6	48	2.41
		CMPSEG0654	352	435	6	54	2.41
		CMPSEG0660	360	471	6	60	2.41
		CMPSEG0924	264	322	9	24	2.41
		CMPSEG0930	288	328	9	30	2.41
		CMPSEG0936	306	322	9	36	2.41
		CMPSEG0942	319	371	9	42	2.41
		CMPSEG0948	339	404	9	48	2.41
		CMPSEG0954	352	435	9	54	2.41
		CMPSEG0960	360	471	9	60	2.41
		CMPSEG1224	264	322	12	24	2.41
		CMPSEG1230	288	328	12	30	2.41
		CMPSEG1236	306	335	12	36	2.41
		CMPSEG1242	319	371	12	42	2.41
		CMPSEG1248	339	404	12	48	2.41
		CMPSEG1254	352	435	12	54	2.41
		CMPSEG1260	360	471	12	60	2.41



**CMPMP-GI-W - PRIVACY GLASS FOR 1" LAMINATE GALLERY PANELS**

- Privacy glass integrated with aluminum top trim.
- Attaches on top of gallery panels to add privacy or divide space.
- Includes aluminum trim with channel, end caps and glass tile.
- Top rail may also be used to hang accessories.
- Glass and attachment hardware ship separately.
- Please specify standard paint finish for the channel.
- Standard in clear (CLR) or frosted (FRST).

DESCRIPTION	PRODUCT CODE	LIST PRICE		DIMENSIONS/INCHES		
		Clear	Frosted	H	W	D
 6" H Privacy Glass w/ Aluminum Trim	CMPMP24GI6W	290	356	6	24	1
	CMPMP30GI6W	315	361	6	30	1
	CMPMP36GI6W	335	368	6	36	1
	CMPMP42GI6W	350	405	6	42	1
	CMPMP48GI6W	369	440	6	48	1
9" H Privacy Glass w/ Aluminum Trim	CMPMP24GI9W	290	356	9	24	1
	CMPMP30GI9W	315	361	9	30	1
	CMPMP36GI9W	335	368	9	36	1
	CMPMP42GI9W	350	405	9	42	1
	CMPMP48GI9W	369	440	9	48	1
12" H Privacy Glass w/ Aluminum Trim	CMPMP24GIW	290	356	12	24	1
	CMPMP30GIW	315	361	12	30	1
	CMPMP36GIW	335	368	12	36	1
	CMPMP42GIW	350	405	12	42	1
	CMPMP48GIW	369	440	12	48	1



**CMPFD-W - PRIVACY FELT FOR 1" LAMINATE GALLERY PANELS**

- Privacy felt integrated with aluminum top trim.
- Attaches on top of gallery panels to add privacy or divide space.
- Includes aluminum trim with channel, end caps and felt tile.
- Top rail may also be used to hang accessories.
- Felt and attachment hardware ship separately.
- Please specify standard paint finish for the channel.
- Please specify standard felt finish.

DESCRIPTION	PRODUCT CODE	LIST PRICE	DIMENSIONS/INCHES		
			H	W	D
 6" H Felt w/ Aluminum Trim	CMPFD0624W	116	6	24	1
	CMPFD0630W	135	6	30	1
	CMPFD0636W	160	6	36	1
	CMPFD0642W	180	6	42	1
	CMPFD0648W	264	6	48	1
	CMPFD0654W	289	6	54	1
	CMPFD0660W	310	6	60	1
	CMPFD0666W	327	6	66	1
	CMPFD0672W	369	6	72	1
9" H Felt w/ Aluminum Trim	CMPFD0924W	116	9	24	1
	CMPFD0930W	135	9	30	1
	CMPFD0936W	160	9	36	1
	CMPFD0942W	180	9	42	1
	CMPFD0948W	264	9	48	1
	CMPFD0954W	289	9	54	1
	CMPFD0960W	310	9	60	1
	CMPFD0966W	327	9	66	1
	CMPFD0972W	369	9	72	1
12" H Felt w/ Aluminum Trim	CMPFD1224W	116	12	24	1
	CMPFD1230W	135	12	30	1
	CMPFD1236W	160	12	36	1
	CMPFD1242W	180	12	42	1
	CMPFD1248W	264	12	48	1
	CMPFD1254W	289	12	54	1
	CMPFD1260W	310	12	60	1
	CMPFD1266W	327	12	66	1
	CMPFD1272W	369	12	72	1

**CMPSEF - EMBEDDED FELT DIVIDER OVER PANEL**

- Privacy felt panel intergrated with aluminum top trim.
- Attaches on top of panels to add privacy or divide space.
- Includes aluminum trim with channel and felt tile.
- Felt and attachment hardware to ship separately
- 9mm Felt material is tackable and comes in 12 different colors. Please specify color.

	DESCRIPTION	PRODUCT CODE	LIST PRICE	DIMENSIONS/INCHES		
				H	W	D
	6" Integrated Felt Divider, Panel Width	CMPSEF0624	107	6	24	2.41
		CMPSEF0630	124	6	30	2.41
		CMPSEF0636	148	6	36	2.41
		CMPSEF0642	163	6	42	2.41
		CMPSEF0648	244	6	48	2.41
		CMPSEF0654	263	6	54	2.41
		CMPSEF0660	285	6	60	2.41
	9" Integrated Felt Divider, Panel Width	CMPSEF0924	107	9	24	2.41
		CMPSEF0930	124	9	30	2.41
		CMPSEF0936	148	9	36	2.41
		CMPSEF0942	163	9	42	2.41
		CMPSEF0948	244	9	48	2.41
		CMPSEF0954	263	9	54	2.41
		CMPSEF0960	285	9	60	2.41
	12" Integrated Felt Divider, Panel Width	CMPSEF1224	107	12	24	2.41
		CMPSEF1230	124	12	30	2.41
		CMPSEF1236	148	12	36	2.41
		CMPSEF1242	163	12	42	2.41
		CMPSEF1248	244	12	48	2.41
		CMPSEF1254	263	12	54	2.41
		CMPSEF1260	285	12	60	2.41

**CMOF - COMPILE FABRIC OVER PANEL**

- Fabric-covered modules incorporated into an aluminum frame.
- Opposite sides of each module may have a different fabric within the same grade at no upcharge.
- If different grades of fabric are used on one panel, the entire panel must be priced at highest grade.
- One CSHD Slider Kit for Over Panel included
- Note: Trim is not required at a straight connection between two panels of the same height.
- Maximum stacking one high. Not load bearing.

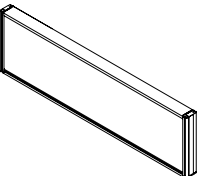
	DESCRIPTION	PRODUCT CODE	LIST PRICE		DIMENSIONS/INCHES		
			Gr1	Gr2	H	W	D
	Compile Fabric Over Panel	CMOF1224	205	231	12	24	2.3
		CMOF1230	240	266	12	30	2.3
		CMOF1236	267	294	12	36	2.3
		CMOF1242	302	329	12	42	2.3
		CMOF1248	349	376	12	48	2.3
		CMOF1254	362	389	12	54	2.3
		CMOF1260	429	455	12	60	2.3
		CMOF1624	239	269	16	24	2.3
		CMOF1630	278	309	16	30	2.3
		CMOF1636	294	324	16	36	2.3
		CMOF1642	350	381	16	42	2.3
		CMOF1648	401	432	16	48	2.3
		CMOF1654	420	450	16	54	2.3
		CMOF1660	491	522	16	60	2.3
		CMOF2424	308	351	24	24	2.3
		CMOF2430	356	399	24	30	2.3
		CMOF2436	398	441	24	36	2.3
		CMOF2442	446	489	24	42	2.3
		CMOF2448	481	524	24	48	2.3
		CMOF2454	534	577	24	54	2.3
CMOF2460	614	657	24	60	2.3		



**CMOLF - COMPILE LAMINATE ONE SIDE, FABRIC ONE SIDE OVER PANEL**

- One side in fabric and one side in laminate, incorporated into an aluminum frame.
- Opposite sides of each module may have a different fabric within the same grade at no upcharge.
- If different grades of fabric are used on one panel, the entire panel must be priced at highest grade.
- One CSHD Slider Kit for Over Panel included
- Note: Trim is not required at a straight connection between two panels of the same height.
- Maximum stacking one high. Not load bearing.

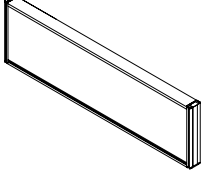
DESCRIPTION	PRODUCT CODE	LIST PRICE		DIMENSIONS/INCHES		
		Gr1	Gr2	H	W	D
 <p>Compile Laminate One Side, Fabric One Side Over Panel</p>	CMOLF1224	229	245	12	24	2.3
	CMOLF1230	270	286	12	30	2.3
	CMOLF1236	306	320	12	36	2.3
	CMOLF1242	347	361	12	42	2.3
	CMOLF1248	399	413	12	48	2.3
	CMOLF1254	421	435	12	54	2.3
	CMOLF1260	492	506	12	60	2.3
	CMOLF1624	274	292	16	24	2.3
	CMOLF1630	328	346	16	30	2.3
	CMOLF1636	362	380	16	36	2.3
	CMOLF1642	411	429	16	42	2.3
	CMOLF1648	469	487	16	48	2.3
	CMOLF1654	495	513	16	54	2.3
	CMOLF1660	576	594	16	60	2.3
	CMOLF2424	359	383	24	24	2.3
	CMOLF2430	429	451	24	30	2.3
	CMOLF2436	476	498	24	36	2.3
	CMOLF2442	535	559	24	42	2.3
	CMOLF2448	582	606	24	48	2.3
	CMOLF2454	649	671	24	54	2.3
CMOLF2460	742	764	24	60	2.3	

**CMOLL - COMPILE LAMINATE TWO SIDES OVER PANEL**

- Laminate modules incorporated into an aluminum frame.
- Opposite sides of each module may have a different fabric within the same grade at no upcharge.
- If different grades of fabric are used on one panel, the entire panel must be priced at highest grade.
- One CSHD Slider Kit for Over Panel included
- Note: Trim is not required at a straight connection between two panels of the same height.
- Maximum stacking one high. Not load bearing.

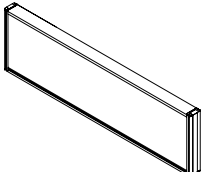
DESCRIPTION	PRODUCT CODE	LIST PRICE	DIMENSIONS/INCHES		
			H	W	D
 <p>Compile Laminate Two Sides Over Panel</p>	CMOLL1224	255	12	24	2.3
	CMOLL1230	289	12	30	2.3
	CMOLL1236	341	12	36	2.3
	CMOLL1242	388	12	42	2.3
	CMOLL1248	446	12	48	2.3
	CMOLL1254	473	12	54	2.3
	CMOLL1260	550	12	60	2.3
	CMOLL1624	305	16	24	2.3
	CMOLL1630	359	16	30	2.3
	CMOLL1636	409	16	36	2.3
	CMOLL1642	465	16	42	2.3
	CMOLL1648	532	16	48	2.3
	CMOLL1654	566	16	54	2.3
	CMOLL1660	653	16	60	2.3
	CMOLL2424	406	24	24	2.3
	CMOLL2430	479	24	30	2.3
	CMOLL2436	546	24	36	2.3
	CMOLL2442	619	24	42	2.3
	CMOLL2448	676	24	48	2.3
	CMOLL2454	753	24	54	2.3
CMOLL2460	857	24	60	2.3	

**CMOG - COMPILE GLAZED OVER PANEL**

- Glazed module incorporated into an aluminum frame.
- Opposite sides of each module may have a different fabric within the same grade at no upcharge.
- If different grades of fabric are used on one panel, the entire panel must be priced at highest grade.
- One CSHD Slider Kit for Over Panel included
- Note: Trim is not required at a straight connection between two panels of the same height.
- Maximum stacking one high. Not load bearing.

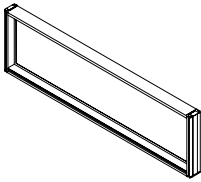
DESCRIPTION	PRODUCT CODE	LIST PRICE		DIMENSIONS/INCHES		
		CLR	FRST	H	W	D
 <p>Compile Glazed Over Panel</p>	CMOG1224	183	192	12	24	2.3
	CMOG1230	213	222	12	30	2.3
	CMOG1236	238	248	12	36	2.3
	CMOG1242	266	276	12	42	2.3
	CMOG1248	305	316	12	48	2.3
	CMOG1254	317	330	12	54	2.3
	CMOG1260	380	394	12	60	2.3
	CMOG1624	213	222	16	24	2.3
	CMOG1630	241	251	16	30	2.3
	CMOG1636	274	285	16	36	2.3
	CMOG1642	306	317	16	42	2.3
	CMOG1648	352	365	16	48	2.3
	CMOG1654	363	377	16	54	2.3
	CMOG1660	429	445	16	60	2.3
	CMOG2424	272	283	24	24	2.3
	CMOG2430	294	305	24	30	2.3
	CMOG2436	346	359	24	36	2.3
	CMOG2442	388	402	24	42	2.3
	CMOG2448	414	430	24	48	2.3
	CMOG2454	458	475	24	54	2.3
CMOG2460	531	549	24	60	2.3	

**CMOFW - COMPILE ONE SIDE WRITE BOARD OVER PANEL**

- Fabric or write board covered modules incorporated into an aluminum frame.
- Opposite sides of each module may have a different fabric within the same grade at no upcharge.
- If different grades of fabric are used on one panel, the entire panel must be priced at highest grade.
- One CSHD Slider Kit for Over Panel included
- Note: Trim is not required at a straight connection between two panels of the same height.
- Maximum stacking one high. Not load bearing.

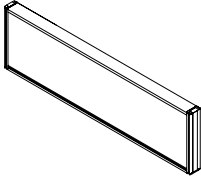
DESCRIPTION	PRODUCT CODE	LIST PRICE		DIMENSIONS/INCHES		
		Gr1	Gr2	H	W	D
 <p>Compile Fabric or Write Board Over Panel</p>	CMOFW1224	258	272	12	24	2.3
	CMOFW1230	306	320	12	30	2.3
	CMOFW1236	347	361	12	36	2.3
	CMOFW1242	395	409	12	42	2.3
	CMOFW1248	437	451	12	48	2.3
	CMOFW1254	482	496	12	54	2.3
	CMOFW1260	561	575	12	60	2.3
	CMOFW1624	311	329	16	24	2.3
	CMOFW1630	366	384	16	30	2.3
	CMOFW1636	418	435	16	36	2.3
	CMOFW1642	476	493	16	42	2.3
	CMOFW1648	544	562	16	48	2.3
	CMOFW1654	580	597	16	54	2.3
	CMOFW1660	667	684	16	60	2.3
	CMOFW2424	401	425	24	24	2.3
	CMOFW2430	462	484	24	30	2.3
	CMOFW2436	566	588	24	36	2.3
	CMOFW2442	633	657	24	42	2.3
	CMOFW2448	666	688	24	48	2.3
	CMOFW2454	796	818	24	54	2.3
CMOFW2460	884	906	24	60	2.3	



**CMOWW - COMPILE WRITE BOARD TWO SIDES OVER PANEL**

- Write board covered modules incorporated into an aluminum frame.
- Opposite sides of each module may have a different fabric within the same grade at no upcharge.
- If different grades of fabric are used on one panel, the entire panel must be priced at highest grade.
- One CSHD Slider Kit for Over Panel included
- Note: Trim is not required at a straight connection between two panels of the same height.
- Maximum stacking one high. Not load bearing.

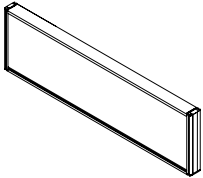
DESCRIPTION	PRODUCT CODE	LIST PRICE	DIMENSIONS/INCHES		
			H	W	D
 <p>Compile Write Board Over Panel</p>	CMOWW1224	314	12	24	2.3
	CMOWW1230	363	12	30	2.3
	CMOWW1236	432	12	36	2.3
	CMOWW1242	482	12	42	2.3
	CMOWW1248	566	12	48	2.3
	CMOWW1254	596	12	54	2.3
	CMOWW1260	689	12	60	2.3
	CMOWW1624	384	16	24	2.3
	CMOWW1630	459	16	30	2.3
	CMOWW1636	530	16	36	2.3
	CMOWW1642	607	16	42	2.3
	CMOWW1648	691	16	48	2.3
	CMOWW1654	747	16	54	2.3
	CMOWW1660	853	16	60	2.3
	CMOWW2424	525	24	24	2.3
	CMOWW2430	627	24	30	2.3
	CMOWW2436	725	24	36	2.3
	CMOWW2442	829	24	42	2.3
CMOWW2448	917	24	48	2.3	
CMOWW2454	1023	24	54	2.3	
CMOWW2460	1159	24	60	2.3	

**CHSD - SLIDER KIT FOR OVER PANEL**

- One kit required for installation of each Over Panel
- Included with each NEW Over Panel Kit

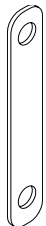
DESCRIPTION	PRODUCT CODE	LIST PRICE	DIMENSIONS/INCHES		
			H	W	D
 <p>One kit required for installation of each Over Panel</p>	CHSDKIT	6	.09	2.28	.43



**CMLEPXXXXNC - END OF RUN GALLERY PANEL WITH NO END CONNECTION**

- Provides floor standing support while enclosing the end of a panel run.
- Attached at the end of a straight panel run with connectors to form a T configuration.
- No connections at both ends, connection is at the center interior face.
- Includes all attachment hardware and glides.
- Total height is inclusive of panel glides extended to their full height.
- 51" wide gallery panel accommodates two 24" deep surface while the 63" wide accommodates two 30" deep surfaces.
- Please specify LP laminate finish and PVC edge finish.
- If a wood grain laminate is chosen, grain direction run horizontally.
- Gallery panel is edged in PVC on exposed edges and self edged on bottom.

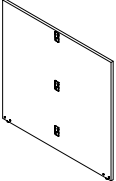
DESCRIPTION	PRODUCT CODE	LIST PRICE	DIMENSIONS/INCHES		
			H	W	D
 End of Run Gallery Panel	CMLEP4227NC	435	42	26.25	1
	CMLEP4251NC	789	42	50.30	1
	CMLEP4263NC	917	42	62.30	1
	CMLEP4827NC	479	48	26.25	1
	CMLEP4851NC	867	48	50.30	1
	CMLEP4863NC	1007	48	62.30	1
	CMLEP5427NC	522	54	26.25	1
	CMLEP5451NC	945	54	50.30	1
	CMLEP5463NC	1099	54	62.30	1

**CMLMPXXXXNC - MIDDLE OF RUN GALLERY PANEL WITH NO END CONNECTION**

- Provides floor standing support in the middle of a panel run.
- Attached in the middle of a straight panel run with connectors to form an X configuration.
- No connections at both ends, connection is at center on both faces.
- Includes all attachment hardware and glides.
- Total height is inclusive of panel glides extended to their full height.
- 51" wide gallery panel accommodates two 24" deep surface while the 63" wide accommodates two 30" deep surfaces.
- Please specify LP laminate finish and PVC edge finish.
- If a wood grain laminate is chosen, grain direction run horizontally.
- Gallery panel is edged in PVC on exposed edges and self edged on bottom.

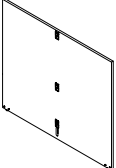
DESCRIPTION	PRODUCT CODE	LIST PRICE	DIMENSIONS/INCHES		
			H	W	D
 Middle of Run Gallery Panel	CMLMP4251NC	918	42	50.30	1
	CMLMP4263NC	1044	42	62.30	1
	CMLMP4851NC	996	48	50.30	1
	CMLMP4863NC	1136	48	62.30	1
	CMLMP5451NC	1074	54	50.30	1
	CMLMP5463NC	1228	54	62.30	1



**CMLSEPLXXXNC - SINGLE END OF RUN GALLERY PANEL WITH NO END CONNECTION**

- Provides floor standing support while enclosing the end of a panel run.
- Attached at the end of a straight panel run with connectors to form an L configuration.
- No connections at both ends, connection is at center on both faces.
- Includes all attachment hardware and glides.
- Total height is inclusive of panel glides extended to their full height.
- 27" wide gallery panel accommodate two 24" deep surface while the 33" wide accommodates two 30" deep surfaces.
- Please specify LP laminate finish and PVC edge finish.
- If a wood grain laminate is chosen, grain direction run horizontally.
- Gallery panel is edged in PVC on exposed edges and self edged on bottom.

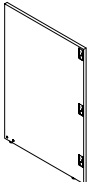
	DESCRIPTION	PRODUCT CODE	LIST PRICE	DIMENSIONS/INCHES		
				H	W	D
	Single End of Run Gallery Panel	CMLSEPL4215NC	327	42	14.25	1
		CMLSEPR4215NC	327	42	14.25	1
		CMLSEPL4227NC	601	42	26.30	1
		CMLSEPR4227NC	601	42	26.30	1
		CMLSEPL4815NC	356	48	14.25	1
		CMLSEPR4815NC	356	48	14.25	1
		CMLSEPL4827NC	657	48	26.30	1
		CMLSEPR4827NC	657	48	26.30	1
		CMLSEPL5415NC	383	54	14.25	1
		CMLSEPR5415NC	383	54	14.25	1
		CMLSEPL5427NC	713	54	26.30	1
		CMLSEPR5427NC	713	54	26.30	1
	Single End of Run Gallery Panel	CMLSEPL4233NC	620	42	32.33	1
		CMLSEPR4233NC	620	42	32.33	1
		CMLSEPL4833NC	677	48	32.33	1
		CMLSEPR4833NC	677	48	32.33	1
		CMLSEPL5433NC	734	54	32.33	1
		CMLSEPR5433NC	734	54	32.33	1

**CMLSMPXXXNC - SINGLE MIDDLE OF RUN GALLERY PANEL WITH NO END CONNECTION**

- Provides floor standing support at the middle of a panel run.
- Attached in the middle of a straight panel run with connectors to form a T configuration.
- No connections at the exposed end, connection is at both the interior and exterior face near the opposite end.
- Includes all attachment hardware and glides.
- Total height is inclusive of panel glides extended to their full height.
- 27" wide gallery panel accommodates a 24" deep surface while the 33" wide accommodates a 30" deep surface.
- Please specify LP laminate finish and PVC edge finish.
- If a wood grain laminate is chosen, grain direction run horizontally.
- Gallery panel is edged in PVC on exposed edges and self edged on bottom.

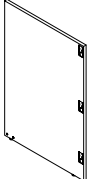
	DESCRIPTION	PRODUCT CODE	LIST PRICE	DIMENSIONS/INCHES		
				H	W	D
	Single Middle of Run Gallery Panel	CMLSMP4227NC	730	42	26.30	1
		CMLSMP4827NC	786	48	26.30	1
		CMLSMP5427NC	842	54	26.30	1
		CMLSMP4233NC	752	42	32.30	1
		CMLSMP4833NC	808	48	32.30	1
		CMLSMP5433NC	866	54	32.30	1

**CMLEPXXXX - END OF RUN GALLERY PANEL WITH END CONNECTIONS**

- Provides floor standing support while enclosing the end of a panel run.
- Attached at the end of a straight panel run with connectors to form a T configuration.
- Connections at both ends as well as the center on the interior face.
- Includes all attachment hardware and glides.
- Total height is inclusive of panel glides extended to their full height.
- 51" wide gallery panel accommodates two 24" deep surface while the 63" wide accommodates two 30" deep surfaces.
- Please specify LP laminate finish and PVC edge finish.
- If a wood grain laminate is chosen, grain direction run horizontally.
- Gallery panel is edged in PVC on exposed edges and self edged on edge connecting to panel and bottom edge.

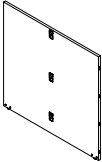
	DESCRIPTION	PRODUCT CODE	LIST PRICE	DIMENSIONS/INCHES		
				H	W	D
	End of Run Gallery Panel	CMLEP4251	821	42	50.30	1
		CMLEP4263	946	42	62.30	1
		CMLEP4851	898	48	50.30	1
		CMLEP4863	1038	48	62.30	1
		CMLEP5451	976	54	50.30	1
		CMLEP5463	1130	54	62.30	1

**CMLMPXXXX - MIDDLE OF RUN GALLERY PANEL WITH END CONNECTIONS**

- Provides floor standing support in the middle of a panel run.
- Attached in the middle of a straight panel run with connectors to form an X configuration.
- Connections at both ends as well as the center on the interior face.
- Includes all attachment hardware and glides.
- Total height is inclusive of panel glides extended to their full height.
- 51" wide gallery panel accommodates two 24" deep surface while the 63" wide accommodates two 30" deep surfaces.
- Please specify LP laminate finish and PVC edge finish.
- If a wood grain laminate is chosen, grain direction run horizontally.
- Gallery panel is edged in PVC on exposed edges and self edged on edge connecting to panel and bottom edge.

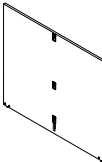
	DESCRIPTION	PRODUCT CODE	LIST PRICE	DIMENSIONS/INCHES		
				H	W	D
	Middle of Run Gallery Panel	CMLMP4251	923	42	50.30	1
		CMLMP4263	1049	42	62.30	1
		CMLMP4851	1001	48	50.30	1
		CMLMP4863	1141	48	62.30	1
		CMLMP5451	1078	54	50.30	1
		CMLMP5463	1235	54	62.30	1

**CMLSEPLXXXX - SINGLE END PANEL WITH END CONNECTIONS**

- Provides floor standing support while enclosing the end of a panel run.
- Attached at the end of a straight panel run with connectors to form an L configuration.
- Connections are at the exposed end on one side and near the end on the other interior face.
- Total height is inclusive of panel glides extended to their full height.
- 27" wide gallery panel accommodates a 24" deep surface while the 33" wide accommodates a 30" deep surface.
- Please specify LP laminate finish and PVC edge finish.
- If a wood grain laminate is chosen, grain direction run horizontally.
- Gallery panel is edged in PVC on exposed edges and self edged on edge connecting to panel and bottom edge.

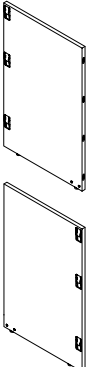
	DESCRIPTION	PRODUCT CODE	LIST PRICE	DIMENSIONS/INCHES		
				H	W	D
	Single End of Run Gallery Panel	CMLSEPL4227	615	42	26.30	1
		CMLSEPR4227	615	42	26.30	1
		CMLSEPL4827	673	48	26.30	1
		CMLSEPR4827	673	48	26.30	1
		CMLSEPL5427	728	54	26.30	1
		CMLSEPR5427	728	54	26.30	1
		CMLSEPL4233	635	42	32.33	1
		CMLSEPR4233	635	42	32.33	1
		CMLSEPL4833	691	48	32.33	1
		CMLSEPR4833	691	48	32.33	1
		CMLSEPL5433	750	54	32.33	1
		CMLSEPR5433	750	54	32.33	1



**CMLSMPXXXX - SINGLE MIDDLE OF RUN GALLERY PANEL WITH END CONNECTIONS**

- Provides floor standing support at the middle of a panel run.
- Attached in the middle of a straight panel run with connectors to form a T configuration
- Connections are at the exposed end and at the interior and exterior near the opposite end.
- Includes all attachment hardware and glides.
- Total height is inclusive of panel glides extended to their full height.
- 27" wide gallery panel accommodates a 24" deep surface while the 33" wide accommodates a 30" deep surface.
- Please specify LP laminate finish and PVC edge finish.
- If a wood grain laminate is chosen, grain direction run horizontally.
- Gallery panel is edged in PVC on exposed edges and self edged on edge connecting to panel and bottom edge.

	DESCRIPTION	PRODUCT CODE	LIST PRICE	DIMENSIONS/INCHES		
				H	W	D
	Single Middle of Run Gallery Panel	CMLSMP4227	744	42	26.30	1
		CMLSMP4827	801	48	26.30	1
		CMLSMP5427	855	54	26.30	1
		CMLSMP4233	767	42	32.30	1
		CMLSMP4833	824	48	32.30	1
		CMLSMP5433	882	54	32.30	1

**CML2PLXXXX - LEFT TWO WAY RETURN END OF RUN GALLERY PANEL WITH END CONNECTIONS**

- Provides floor standing support while enclosing the end of a panel run.
- Attached at the end of a gallery panel with connectors to form an L configuration.
- Connections are at one exposed end.
- Includes all attachment hardware and glides.
- Total height is inclusive of panel glides extended to their full height.
- 25" wide gallery panel accommodates a 24" deep surface while the 31" wide accommodates a 30" deep surface.
- Please specify LP laminate finish and PVC edge finish.
- If a wood grain laminate is chosen, grain direction run horizontally.
- Gallery panel is edged in PVC on exposed edges and self edged on edge connecting to panel and bottom edge.

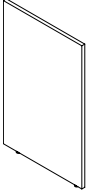
	DESCRIPTION	PRODUCT CODE	LIST PRICE	DIMENSIONS/INCHES		
				H	W	D
	Two Way Return	CML2PL4213	224	42	13	1
	End of Run Gallery Panel	CML2PL4225	488	42	25	1
		CML2PL4231	501	42	31	1
		CML2PL4813	251	48	13	1
		CML2PL4825	543	48	25	1
		CML2PL4831	558	48	31	1
		CML2PL5413	279	54	13	1
		CML2PL5425	598	54	25	1
		CML2PL5431	615	54	31	1

**CML2PRXXXX - RIGHT TWO WAY RETURN END OF RUN GALLERY PANEL WITH END CONNECTIONS**

- Provides floor standing support while enclosing the end of a panel run.
- Attached at the end of a gallery panel with connectors to form an L configuration.
- Connections are at one exposed end.
- Includes all attachment hardware and glides.
- Total height is inclusive of panel glides extended to their full height.
- 25" wide gallery panel accommodates a 24" deep surface while the 31" wide accommodates a 30" deep surface.
- Please specify LP laminate finish and PVC edge finish.
- If a wood grain laminate is chosen, grain direction run horizontally.
- Gallery panel is edged in PVC on exposed edges and self edged on edge connecting to panel and bottom edge.

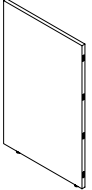
	DESCRIPTION	PRODUCT CODE	LIST PRICE	DIMENSIONS/INCHES		
				H	W	D
	Two Way Return	CML2PR4213	224	42	13	1
	End of Run Gallery Panel	CML2PR4225	488	42	25	1
		CML2PR4231	501	42	31	1
		CML2PR4813	251	48	13	1
		CML2PR4825	543	48	25	1
		CML2PR4831	558	48	31	1
		CML2PR5413	279	54	13	1
		CML2PR5425	598	54	25	1
		CML2PR5431	615	54	31	1

**CML3PLXXXX - LEFT THREE WAY RETURN END OF RUN GALLERY PANEL**

- Provides floor standing support while enclosing the end of a gallery panel run.
- Attached at the end of a gallery panel with connectors to form a T configuration.
- There are no connections at the exposed ends. Connection is at the center of the interior face.
- Connects to CMLXPLxxxx or CMLSEPLxxxx.
- Includes all attachment hardware and glides.
- Total height is inclusive of panel glides extended to their full height.
- 49" wide gallery panel accommodates two 24" deep surface while the 61" wide accommodates two 30" deep surfaces.
- Please specify LP laminate finish and PVC edge finish.
- If a wood grain laminate is chosen, grain direction run horizontally.
- Gallery panel is edged in PVC on exposed edges and self edged on edge connecting to panel and bottom edge.

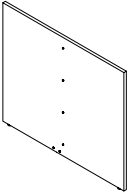
	DESCRIPTION	PRODUCT CODE	LIST PRICE	DIMENSIONS/INCHES		
				H	W	D
	Three Way Return	CML3PL4225	333	42	25	1
	End of Run Gallery Panel	CML3PL4249	676	42	49	1
		CML3PL4261	802	42	61	1
		CML3PL4825	374	48	25	1
		CML3PL4849	754	48	49	1
		CML3PL4861	894	48	61	1
		CML3PL5425	417	54	25	1
		CML3PL5449	830	54	49	1
		CML3PL5461	985	54	61	1

**CML3PRXXXX - RIGHT THREE WAY RETURN END OF RUN GALLERY PANEL**

- Provides floor standing support while enclosing the end of a gallery panel run.
- Attached at the end of a gallery panel with connectors to form a T configuration.
- There are no connections at the exposed ends. Connection is at the center of the interior face.
- Connects to CMLXPRxxxx or CMLSEPRxxxx.
- Includes all attachment hardware and glides.
- Total height is inclusive of panel glides extended to their full height.
- 49" wide gallery panel accommodates two 24" deep surface while the 61" wide accommodates two 30" deep surfaces.
- Please specify LP laminate finish and PVC edge finish.
- If a wood grain laminate is chosen, grain direction run horizontally.
- Gallery panel is edged in PVC on exposed edges and self edged on edge connecting to panel and bottom edge.

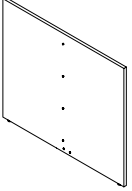
	DESCRIPTION	PRODUCT CODE	LIST PRICE	DIMENSIONS/INCHES		
				H	W	D
	Three Way Return	CML3PR4225	333	42	25	1
	End of Run Gallery Pane	CML3PR4249	676	42	49	1
		CML3PR4261	802	42	61	1
		CML3PR4825	374	48	25	1
		CML3PR4849	754	48	49	1
		CML3PR4861	894	48	61	1
		CML3PR5425	417	54	25	1
		CML3PR5449	830	54	49	1
		CML3PR5461	985	54	61	1



**CMLXPLXXXX - LEFT EXTENSION END OF RUN RETURN GALLERY PANEL WITH END CONNECTION**

- Provides floor standing support while enclosing the end of a gallery panel run.
- Attached at the end of a panel to allow for extending the gallery panel run.
- Connections at both exposed ends, one to connect to the panel and one to connect to another gallery panel.
- Includes all attachment hardware and glides.
- Total height is inclusive of panel glides extended to their full height.
- Please specify LP laminate finish and PVC edge finish.
- If a wood grain laminate is chosen, grain direction run horizontally.
- Gallery panel is edged in PVC on exposed edges and self edges on edge connecting to panel.

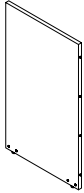
DESCRIPTION	PRODUCT CODE	LIST PRICE	DIMENSIONS/INCHES		
			H	W	D
 Extension End of Run Return Gallery Panel	CMLXPL4224	790	42	12.3	1
	CMLXPL4224	790	42	24	1
	CMLXPL4230	475	42	30	1
	CMLXPL4236	547	42	35	1
	CMLXPL4242	687	42	42	1
	CMLXPL4248	706	42	48	1
	CMLXPL4812	231	48	12.3	1
	CMLXPL4824	418	48	24	1
	CMLXPL4830	491	48	30	1
	CMLXPL4836	561	48	36	1
	CMLXPL4842	706	48	42	1
	CMLXPL4848	728	48	48	1
	CMLXPL5412	258	54	12.3	1
	CMLXPL5424	446	54	24	1
	CMLXPL5430	523	54	30	1
	CMLXPL5436	601	54	36	1
	CMLXPL5442	678	54	42	1
	CMLXPL5448	833	54	48	1

**CMLXPRXXXX - RIGHT EXTENSION END OF RUN RETURN GALLERY PANEL WITH END CONNECTION**

- Provides floor standing support while enclosing the end of a gallery panel run.
- Attached at the end of a panel to allow for extending the gallery panel run.
- Connections at both exposed ends, one to connect to the panel and one to connect to another gallery panel.
- Includes all attachment hardware and glides.
- Total height is inclusive of panel glides extended to their full height.
- Please specify LP laminate finish and PVC edge finish.
- If a wood grain laminate is chosen, grain direction run horizontally.
- Gallery panel is edged in PVC on exposed edges and self edges on edge connecting to panel.

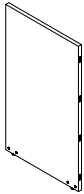
DESCRIPTION	PRODUCT CODE	LIST PRICE	DIMENSIONS/INCHES		
			H	W	D
 Extension End of Run Return Gallery Panel	CMLXPL4212	207	42	12.3	1
	CMLXPR4224	790	42	24	1
	CMLXPR4230	475	42	30	1
	CMLXPR4236	547	42	35	1
	CMLXPR4242	687	42	42	1
	CMLXPR4248	706	42	48	1
	CMLXPL4812	231	48	12.3	1
	CMLXPR4824	418	48	24	1
	CMLXPR4830	491	48	30	1
	CMLXPR4836	561	48	36	1
	CMLXPR4842	706	48	42	1
	CMLXPR4848	728	48	48	1
	CMLXPL5412	258	54	12.3	1
	CMLXPR5424	446	54	24	1
	CMLXPR5430	523	54	30	1
	CMLXPR5436	601	54	36	1
	CMLXPR5442	678	54	42	1
	CMLXPR5448	833	54	48	1

**CMLXPLXXXNC - EXTENSION END OF RUN, LEFT, NO CONNECTION**

- Provides floor standing support while enclosing the end of a gallery panel run.
- Attached at the end of a gallery panel to extend the gallery panel run.
- Connections only at one exposed end.
- Includes all attachment hardware and glides.
- Total height is inclusive of panel glides extended to their full height.
- Please specify LP laminate finish and PVC edge finish.
- If a wood grain laminate is chosen, grain direction run horizontally.
- Gallery panel is edged in PVC on exposed edges and self edged on edge connecting to panel.

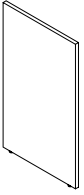
DESCRIPTION	PRODUCT CODE	LIST PRICE	DIMENSIONS/INCHES		
			H	W	D
 Extension End of Run Gallery Panel	CMLXPL4224NC	403	42	24	1
	CMLXPL4230NC	472	42	30	1
	CMLXPL4236NC	543	42	35	1
	CMLXPL4242NC	684	42	42	1
	CMLXPL4248NC	703	42	48	1
	CMLXPL4824NC	415	48	24	1
	CMLXPL4830NC	488	48	30	1
	CMLXPL4836NC	558	48	36	1
	CMLXPL4842NC	703	48	42	1
	CMLXPL4848NC	725	48	48	1
	CMLXPL5424NC	444	54	24	1
	CMLXPL5430NC	521	54	30	1
	CMLXPL5436NC	598	54	36	1
	CMLXPL5442NC	676	54	42	1
	CMLXPL5448NC	830	54	48	1

**CMLXPLXXXNC • EXTENSION END OF RUN, RIGHT, NO CONNECTION**

- Provides floor standing support while enclosing the end of a gallery panel run.
- Attached at the end of a gallery panel to extend the gallery panel run.
- Connections only at one exposed end.
- Includes all attachment hardware and glides.
- Total height is inclusive of panel glides extended to their full height.
- Please specify LP laminate finish and PVC edge finish.
- If a wood grain laminate is chosen, grain direction run horizontally.
- Gallery panel is edged in PVC on exposed edges and self edged on edge connecting to panel.

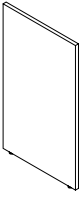
DESCRIPTION	PRODUCT CODE	LIST PRICE	DIMENSIONS/INCHES		
			H	W	D
 Extension End of Run Gallery Panel	CMLXPR4224NC	403	42	24	1
	CMLXPR4230NC	472	42	30	1
	CMLXPR4236NC	543	42	35	1
	CMLXPR4242NC	684	42	42	1
	CMLXPR4248NC	703	42	48	1
	CMLXPR4824NC	415	48	24	1
	CMLXPR4830NC	488	48	30	1
	CMLXPR4836NC	558	48	36	1
	CMLXPR4842NC	703	48	42	1
	CMLXPR4848NC	725	48	48	1
	CMLXPR5424NC	444	54	24	1
	CMLXPR5430NC	521	54	30	1
	CMLXPR5436NC	598	54	36	1
	CMLXPR5442NC	676	54	42	1
	CMLXPR5448NC	830	54	48	1

**CMHLPBB01 - GALLERY PANEL BRACKET**

- Gallery panel bottom bracket connects two gallery end panels at bottom with screws.
- Available in standard paint colors.
- Screws are included with the bracket.

DESCRIPTION	PRODUCT CODE	LIST PRICE	DIMENSIONS/INCHES		
			H	W	D
Bracket	CMHLPBB01	46	1.5	8	1

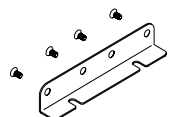

**CMHLPCB01 - GALLERY PANEL CORNER BRACKET**

- Gallery panel corner bottom bracket connects two laminate panels at 90 degrees.
- Screws are included with the bracket.
- Available in standard paint colors.

	DESCRIPTION	PRODUCT CODE	LIST PRICE	DIMENSIONS/INCHES		
				H	W	D
	Corner Bracket	CMHLPCB01	44	1.5	4	4

**CMPDSL/R - SLIDING PRIVACY DOOR**

- Sliding Privacy Door attaches to Compile Panels using standard connectors to add privacy. Brackets that attach to Connectors are included.
- This door must mount on panels of equal width. It is also intended to be used for openings of equal width.
- Left (L) or right-handedness (R) is determined by the direction of door movement (from compressed to expanded position), while facing the door on the panel mounted side.
- Painted frame may match any Compile Standard Paint Finish. The door interior is standard with a louvered acrylic finish.
- STL paint on Compile sliding doors is a smooth finish paint comparable to the standard STL paint offering.”
- Telescoping arms eliminate the need for thresholds, wheels or casters.
- Thickness of louvered acrylic is 6 mm.

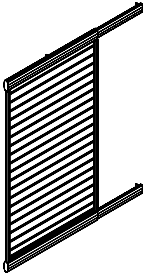
	DESCRIPTION	PRODUCT CODE	LIST PRICE	DIMENSIONS/INCHES		
				H	W	D
	Sliding Privacy Door - 66" High	CMPDSL6636R	3131	66	36	
		CMPDSL6636L	3131	66	36	
		CMPDSL6642R	3214	66	42	
		CMPDSL6642L	3214	66	42	

**CMFMA - MINI PANEL KIT**

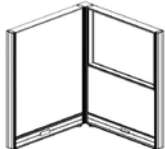

- Compile’s Mini Panel Kits are now available to our dealers and their sales staff. The Compile mini panel is an excellent sales tool featuring two panel and samples of various hardware and electrical components and consists of the following:
  - One Monolithic Mini Panel (Laminate side one / Acoustic side two).
  - One Segmented Glazed Mini panel.
  - One 2-way Universal Corner Post Kit.
  - Two 24” Raceway Cover with Punch Out.
  - Two 24” Raceway Cover with out Punch Out.
  - One Raceway Cut Out Cover.
  - One 3-way Post Base Cover.
  - One End of Run Trim.
  - One Pair of Corner Brackets.
  - One Mid span Worksurface Support Bracket.
  - One Duplex.
  - One Power Distribution Harness.
  - One Mesh jumper.
  - One Carry Bag.

	DESCRIPTION	PRODUCT CODE	LIST PRICE	DIMENSIONS/INCHES		
				H	W	D
	Mini Panel Kit	CMFMA2418KIT1	2434	30	24	2 7/8



**CHP POST PACKAGE**

- Universal Post with all "Quick-Connection" clips.
- Post trim(s)
- Post base and top cap

	DESCRIPTION	PRODUCT CODE	LIST PRICE	DIMENSIONS/INCHES		
				H	W	D
	2 - Way Post	CHP30-2	115	30	2.3	2.3
		CHP42-2	115	42	2.3	2.3
		CHP46-2	167	46	2.3	2.3
		CHP54-2	142	54	2.3	2.3
		CHP58-2	209	58	2.3	2.3
		CHP60-2	209	60	2.3	2.3
		CHP64-2	247	64	2.3	2.3
		CHP66-2	167	66	2.3	2.3
		CHP70-2	241	70	2.3	2.3
		CHP72-2	241	72	2.3	2.3
		CHP78-2	274	78	2.3	2.3
		CHP82-2	288	82	2.3	2.3
CHP90-2	288	90	2.3	2.3		
	3 - Way Post	CHP30-3	101	30	2.3	2.3
		CHP42-3	101	42	2.3	2.3
		CHP46-3	151	46	2.3	2.3
		CHP54-3	126	54	2.3	2.3
		CHP58-3	189	58	2.3	2.3
		CHP60-3	189	60	2.3	2.3
		CHP64-3	201	64	2.3	2.3
		CHP66-3	151	66	2.3	2.3
		CHP70-3	217	70	2.3	2.3
		CHP72-3	217	72	2.3	2.3
		CHP78-3	247	78	2.3	2.3
		CHP82-3	258	82	2.3	2.3
CHP90-3	286	90	2.3	2.3		
	4 - Way Post *No trim or base. Includes top cap only.	CHP30-4	82	30	2.3	2.3
		CHP42-4	82	42	2.3	2.3
		CHP46-4	138	46	2.3	2.3
		CHP54-4	106	54	2.3	2.3
		CHP58-4	154	58	2.3	2.3
		CHP60-4	154	60	2.3	2.3
		CHP64-4	163	64	2.3	2.3
		CHP66-4	126	66	2.3	2.3
		CHP70-4	180	70	2.3	2.3
		CHP72-4	180	72	2.3	2.3
		CHP78-4	204	78	2.3	2.3
		CHP82-4	213	82	2.3	2.3
CHP90-4	238	90	2.3	2.3		





**CHPXW - 90 DEGREE CORNER POST KIT FOR OVER PANELS**

- Specify the corner post height that matches the height of the over panel
- 2-way kits include 2 trims (CMETPxx), 2 way post base (CMPCxx) and post cap (CMPC).
- 3-way kits include 2 trim (CMETPxx), 3 way post base (CMPCxx) and post cap (CMPC).
- 4-way kits include post cap (CMPC) only.

	DESCRIPTION	PRODUCT CODE	LIST PRICE	DIMENSIONS/INCHES			
				H	W	D	
	90 Degree Corner Post Kit for Over Panels	CHOP12-2	75	12	2.3	2.3	
		CHOP12-3	64	12	2.3	2.3	
		CHOP12-4	44	12	2.3	2.3	

**CHPXW - 60 DEGREE POST PACKAGE**

- Universal Post with all "Quick-Connection" clips.
- Post trim is incorporated into 2 - Way aluminum post extrusion.
- Post top cap
- Outer part of the post is the full panel height and the inner part of the post is 6" shorter.
- 3 - Way post is 6" shorter than panel height to accommodate electric and base.
- PVC post trims can not be added to 60 degree posts.

	DESCRIPTION	PRODUCT CODE	LIST PRICE	DIMENSIONS/INCHES		
				H	W	D
	2 - Way - 60 Degree Post Package	CHP2W30	82	30	2.3	2.3
		CHP2W42	82	42	2.3	2.3
		CHP2W46	106	46	2.3	2.3
		CHP2W54	106	54	2.3	2.3
		CHP2W58	145	58	2.3	2.3
		CHP2W60	159	60	2.3	2.3
		CHP2W64	172	64	2.3	2.3
		CHP2W66	126	66	2.3	2.3
		CHP2W70	183	70	2.3	2.3
		CHP2W72	183	72	2.3	2.3
		CHP2W78	204	78	2.3	2.3
		CHP2W82	213	82	2.3	2.3
		CHP2W90	234	90	2.3	2.3
	3 - Way - 60 Degree Post Package	CHP3W30	82	30	2.3	2.3
		CHP3W42	82	42	2.3	2.3
		CHP3W46	116	46	2.3	2.3
		CHP3W54	106	54	2.3	2.3
		CHP3W58	145	58	2.3	2.3
		CHP3W60	159	60	2.3	2.3
		CHP3W64	172	64	2.3	2.3
		CHP3W66	126	66	2.3	2.3
		CHP3W70	183	70	2.3	2.3
		CHP3W72	183	72	2.3	2.3
		CHP3W78	204	78	2.3	2.3
		CHP3W82	213	82	2.3	2.3
		CHP3W90	234	90	2.3	2.3

**CMRCXXNP - COMPILE RACEWAY COVER - WITHOUT KNOCKOUTS**

- No electrical knockouts included.
- Note: Made of reinforced aluminum.

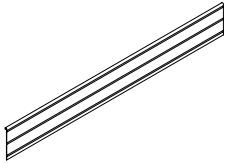
	DESCRIPTION	PRODUCT CODE	LIST PRICE	DIMENSIONS/INCHES		
				H	W	D
	Compile Raceway Cover Without Knockouts	CMRC24NP	18	24		
		CMRC30NP	22	30		
		CMRC36NP	25	36		
		CMRC42NP	27	42		
		CMRC48NP	30	48		
		CMRC54NP	37	54		
		CMRC60NP	39	60		

**CMRCXXPO - COMPILE RACEWAY COVER - WITH KNOCKOUTS**

- Contains one knockout for 24" w and three knockouts for 30" w+.
- Raceway Knockout Cover must be added to openings where duplex receptacles are not used.
- Note: Made of reinforced aluminum.

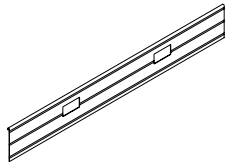
	DESCRIPTION	PRODUCT CODE	LIST PRICE	DIMENSIONS/INCHES		
				H	W	D
	Compile Raceway Cover With Knockouts	CMRC24PO	18	24		
		CMRC30PO	22	30		
		CMRC36PO	25	36		
		CMRC42PO	27	42		
		CMRC48PO	30	48		
		CMRC54PO	37	54		
		CMRC60PO	39	60		

**CMRCB01 - COMPILE RACEWAY KNOCKOUT COVER**

- Fills knockout when duplex is not used.
- Available in Black, White, Nevada, and Fog.
- Note: Knockout covers are made of plastic.

	DESCRIPTION	PRODUCT CODE	LIST PRICE	DIMENSIONS/INCHES		
				H	W	D
	Compile Raceway Knockout Cover	CMRCB01	17			



**CHP - 90-DEGREE UNIVERSAL CORNER POST**

- Available in 42", 54" and 66"h.
- Standard Compile paint options.
- Specify the corner post height that matches the tallest or smallest panel connection.
- Can be used for any variation of 90-degree connections: 2-way, 3-way or 4-way.
- Requires post trim inserts to finish off post where there are no panel connections. Post trim inserts are specified separately.
- 6" shorter than panel height to accommodate electric in base.
- Requires a post basecover to finish off post at the base (for 2- or 3-way). Refer to CMPC.
- See Panel Configuration Tips for application.
- Made of aluminum.

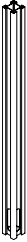
	DESCRIPTION	PRODUCT CODE	LIST PRICE	DIMENSIONS/INCHES		
				H	W	D
	90-Degree Universal Corner Post	CHP30	76	30		
		CHP42	76	36		
		CHP54	99	48		
		CHP66	121	60		

**CMET - END OF RUN TRIM INSERT FOR PANEL**

- Trim inserts are not included with panels.
- Cannot be used for a universal post application.
- Used at the end of each panel run and cannot be used to attach a panel run to a fixed wall.
- Vertical trims must be specified separately. Trim snaps in the panel at the end of run.
- Standard Compile paint options.
- See Panel Configuration Tips for application.
- Trims are PVC.

	DESCRIPTION	PRODUCT CODE	LIST PRICE	DIMENSIONS/INCHES		
				H	W	D
	End of Run Trim Insert for Panel	CMET16	18	16	2.3	0.5
		CMET30	21	30	2.3	0.5
		CMET42	21	42	2.3	0.5
		CMET46	22	46	2.3	0.5
		CMET48	25	48	2.3	0.5
		CMET54	25	54	2.3	0.5
		CMET58	26	58	2.3	0.5
		CMET60	26	60	2.3	0.5
		CMET64	27	64	2.3	0.5
		CMET66	27	66	2.3	0.5
		CMET70	29	70	2.3	0.5
		CMET72	29	72	2.3	0.5
		CMET78	31	78	2.3	0.5
		CMET82	32	82	2.3	0.5
		CMET90	38	90	2.3	0.5

**CMETP - TRIM INSERT FOR UNIVERSAL CORNER POST**

- Does not come with a post.
- Trim installs on all exposed sides of a Universal Corner Post.
- Specify to equal post height.
- Trims must be specified separately. Trim snaps in the post.
- Available in standard Compile paint options.
- 6" shorter than Universal Corner Post to accommodate Post Base Cover (must be specified separate)
- See Panel Configuration Tips for application.

DESCRIPTION	PRODUCT CODE	LIST PRICE	DIMENSIONS/INCHES		
			H	W	D
 Trim Insert for Universal Corner Post	CMETP30	17	30	2.3	0.5
	CMETP42	17	42	2.3	0.5
	CMETP46	22	46	2.3	0.5
	CMETP48	14	48	2.3	0.5
	CMETP54	18	54	2.3	0.5
	CMETP58	24	58	2.3	0.5
	CMETP60	26	60	2.3	0.5
	CMETP64	27	64	2.3	0.5
	CMETP66	19	66	2.3	0.5
	CMETP70	30	70	2.3	0.5
	CMETP72	30	72	2.3	0.5
	CMETP78	31	78	2.3	0.5
	CMETP82	33	82	2.3	0.5
	CMETP90	38	90	2.3	0.5

**CMET - TRIM INSERT FOR STEP DOWN**

- Does not come with a post. Trim inserts are not included with Universal Corner Posts.
- Specify to meet the taller post.
- Trim snaps in the post or end of run at a change in height.
- Available in standard Compile paint options.
- Can not be applied to 60 degree posts.
- See Panel Configuration Tips for application.

DESCRIPTION	PRODUCT CODE	LIST PRICE	DIMENSIONS/INCHES		
			H	W	D
 Trim Insert for Step Down	CMET06	11	6		
	CMET12	14	12		
	CMET18	18	18		
	CMET24	24	24		
	CMET36	29	36		

**CHWAXX - WALL ADAPTER**

- Same profile as vertical extrusion.
- Wall attachment hardware not provided.
- Made of aluminum.

DESCRIPTION	PRODUCT CODE	LIST PRICE	DIMENSIONS/INCHES		
			H	W	D
 Wall Adapter	CHWA30	47	30	2.36	.79
	CHWA42	64	42	2.36	.79
	CHWA46	64	46	2.36	.79
	CHWA48	64	48	2.36	.79
	CHWA54	81	54	2.36	.79
	CHWA58	81	58	2.36	.79
	CHWA60	94	60	2.36	.79
	CHWA64	94	64	2.36	
	CHWA66	94	66	2.36	.79
	CHWA70	108	70	2.36	.79
	CHWA72	108	72	2.36	.79
	CHWA78	121	78	2.36	.79
	CHWA82	136	82	2.36	.79
	CHWA90	149	90	2.36	.79



**CWMA - VERTICAL CHANNEL**

- Used to attach system components to fixed wall.
- Panel frame finish.
- Comes in 60" length only.
- Care should be taken to mount adapters only to wall studs using correct fasteners.
- Does not include mounting hardware. Mounting hardware selection to be based on wall material. Sold in pairs.
- Failure to do this may result in collapse of the unit and subsequent possible personal injury.
- Compile vertical channels cannot be shared.

	DESCRIPTION	PRODUCT CODE	LIST PRICE	DIMENSIONS/INCHES		
				H	W	D
	Vertical Channel	CWMA60	39	60	0.6	0.7

**CMPC - UNIVERSAL POST CAP**

- Comes standard with universal post.
- Specified separately for reconfiguration purposes.
- Available in standard Compile paint options.
- Made of PVC.

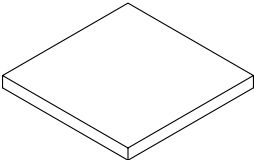
	DESCRIPTION	PRODUCT CODE	LIST PRICE	DIMENSIONS/INCHES		
				H	W	D
	Universal Post Cap	CMPC	8	2 3/8		

**CMPC - POST BASE COVER**

- Post Base Covers are not included with Universal Corner Posts.
- Base trim for universal post. These are connected with screws at the base and the trims at the post will slide to meet.
- Available for 2-way and 3-way configurations.
- Finish is smooth plastic.
- Available in standard Compile paint options.

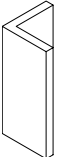
	DESCRIPTION	PRODUCT CODE	LIST PRICE	DIMENSIONS/INCHES		
				H	W	D
	Post Base Cover - 3-Way Connection	CMPC1	13	6		
	Post Base Cover - 2-Way Connection	CMPC2	14	6		

**CMHLPF - FLAT LEG FOR FREESTANDING PANELS**

- Not intended to add to a run of panels in conjunction with Leveling Glides. panel and replace it with the legs.
- Kit will contains one legs and all attachment hardware. • Please specify paint finish.
- For the installation the customer will have to remove the existing levelers on the

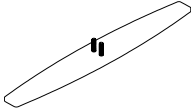
	DESCRIPTION	PRODUCT CODE	LIST PRICE	DIMENSIONS/INCHES		
				H	W	D
	Single Flat Leg	CMHLPF01	126	.31	21	3

**CMHLPF - FLAT LEG FOR FREESTANDING PANELS**

- Double kit for freestanding applications. • Please specify paint finish.
- Kit will contains two legs and all attachment hardware. • Note: Leg is on available for freestanding panels 42" to 60" wide.
- For the installation the customer will have to remove the existing levelers on the panel and replace it with the legs.

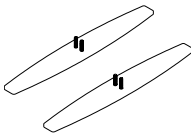
	DESCRIPTION	PRODUCT CODE	LIST PRICE	DIMENSIONS/INCHES		
				H	W	D
	Double Flat Leg	CMHLPF02	249	.31	21	3

**CMHLLP01 - LOW PROFILE FOOT**

- Provides added support to a panel under load. • Made of powder coated steel.
- Adjustable glides and connectors included.

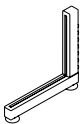
	DESCRIPTION	PRODUCT CODE	LIST PRICE	DIMENSIONS/INCHES		
				H	W	D
	Low Profile Foot	CMHLLP01	186	12	11	1.1

**CMHLLP02 - LOW PROFILE FOOT**

- Provides added support to a panel under load. • Made of powder coated steel.
- Adjustable glides and connectors included. • Set includes 2 complete legs.

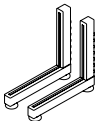
	DESCRIPTION	PRODUCT CODE	LIST PRICE	DIMENSIONS/INCHES		
				H	W	D
	Double Low Profile Foot	CMHLLP02	371	12	11	1.1



**CMPS - POST SEPARATOR**

- Creates a diagonal division within a compile post.
- Please specify post height.

DESCRIPTION	PRODUCT CODE	LIST PRICE	DIMENSIONS/INCHES		
			H	W	D



Post Separator

CMPS01

154

96

3.25

14





electrical

**STEP-BY-STEP SPECIFICATION – 8-WIRE ELECTRICAL SYSTEM**

**Step 1 Determine the location of the source power entering the Panel Run.**

1. At the base of the Panel.
  - (a) Use CE8FR1 Reversible Floor Power Entry (default to CE8FR1).
  - (b) Select the Panel to which the Floor Power Entry will be attached.
  - (c) Select the side of the Panel and the receptacle outlet to which the Floor Power Entry is to be attached.

Note: When using Pass Through Connectors in conditions other than a straight line, you must use a CE8CI-1 I-Connector along with a CE8CP17 Flexible Mesh Jumper Cable through the corner post.

**Step 2 Determine which Panels are to be powered.**

1. Use CE8PD Power Distribution Housing that corresponds with the width of the Panel.

**Step 3 Connect power to the powered Panels.**

1. Use CE8CP17 Flexible Mesh Jumper Cable between two adjacent powered Panels.
2. Use CE8CP17 Flexible Mesh Jumper Cable between two adjacent powered Panels separated by a post.
3. Use CE8CP17 Flexible Mesh cable (to turn the post) and a CE8CI-1 "I" Connector to attach the CE8CP Pass Through Cable.
  - (a) The length of the Pass-Through Cable is calculated by adding together the widths of the non-powered Panels that separate the two powered Panels and applying an additional 16" to the total. (CE8PD Power Distribution Housing is positioned 8" in from the ends of the powered Panel.)
  - (b) An additional 3" must be added to the Pass-Through Cable for each post that the cable passes through.
  - (c) Subtract 17" from the total length to find the pass through cable length required.
4. From the price list, select the CE8CP Pass-Through Cable that matches the calculated length. If the length is between listed sizes, use the next size up.

**Step 4 Determine the location and circuitry of the receptacles.**

1. Each powered Panel has four (4) potential locations for CE8RD Duplex Receptacles – 2 per side. (Exception: 24" wide Panel has only two potential locations – 1 per side.)
2. At each receptacle location there is a choice of four circuit options. Select a circuit option for each location. Circuits one & two are utility circuits; circuits A & B are dedicated circuits.

**COMPILE'S 8-WIRE ELECTRICAL SYSTEM**

**Electrical**

This modification allows for the integration of the commonly required "2+2" configuration (2 utility circuits, 2 dedicated circuits) found in the source power of most of today's North American buildings.

**This system is rated for connection to:**

1. A grounded 120/240V, single phase, 20 A, 60Hz
2. A 120/208V, 3 phase, 20 A, 60Hz branch circuit

**EQUIPMENT AMPERAGE**

Calculator .....	0.25
Electric Eraser .....	0.50
Pencil Sharpener.....	1.00
Radio .....	0.05
Paper Shredder.....	4.40 - 13.00
Electric Typewriter .....	1.20
Personal Computer .....	2.00 - 4.00
Video Display Terminal .....	0.08
Draft / Letter Quality Printer .....	1.20 - 3.00
Laser Printer.....	5.00 - 8.00
Processor / Disk Unit.....	1.00 - 10.00

**Data/Comm**

Compile's duplex receptacle openings (1.345 x 2.80) will conform to the ANSI/TIA/EIA Furniture Opening Standard of 1.38 +/- .035 x 2.71 +/- .04

Desk Top Plotter .....	1.50
Fan .....	1.00
Heater .....	8.50 - 12.50
Coffee Pot.....	15.00
Task Light .....	1.00
Slide Projector .....	2.00 - 6.00

Since some equipment, such as large copiers, printers, plotters, heaters and coffee makers would occupy most of the circuit capacity, it is recommended that such devices be supplied with the power directly from the wall or building receptacle.



Wiring Schematic

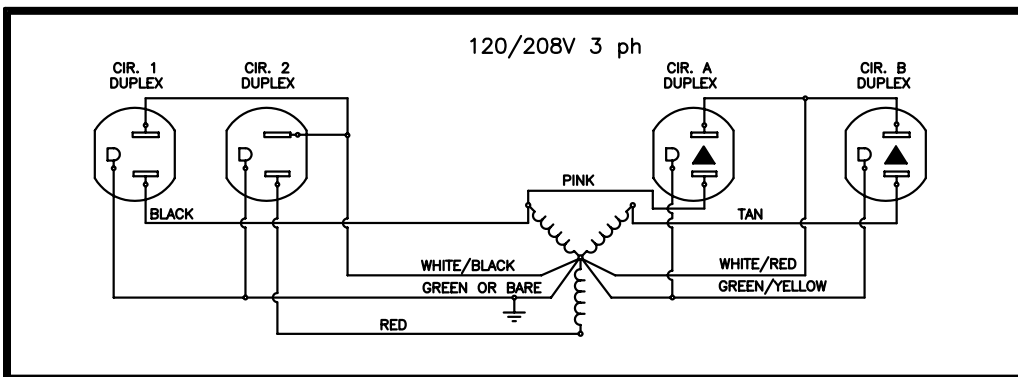
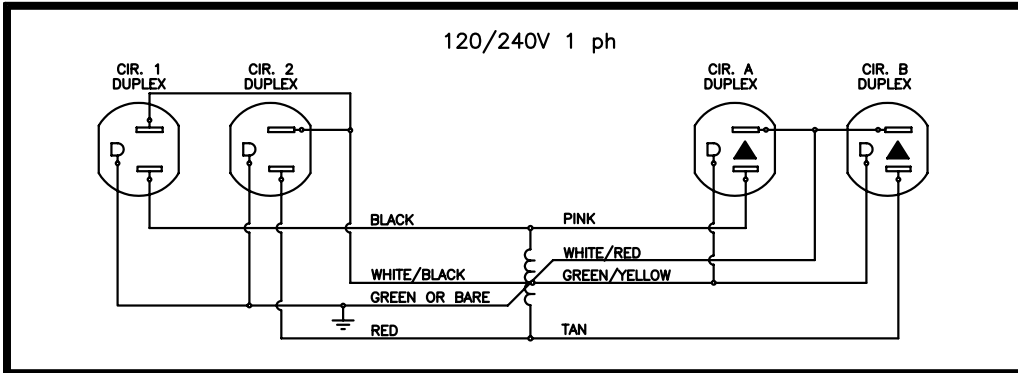

Defining "2 + 2" Wiring Configurations

**2 + 2 Configuration (8 wire, 4 circuit)**

Two Utility Circuits [Compile's new #1 & #2 circuits] share one neutral wire and one ground wire.  
 (2 hot [circuit] wires + 1 neutral wire\*\*\* + 1 green ground wire\* = 4 wires)

Two Dedicated Circuits [Compile's new "A" & "B" circuits] share one neutral wire and one ground wire.  
 (2 hot [circuit] wires + 1 neutral wire\*\*\* + 1 green/yellow ground wire\*\* = 4 wires)

Note:

It is the ground wire that makes the difference between "Utility" and "Dedicated" circuits. Refer to Wiring Schematics found above.

\* A Green ground wire is a "system" ground. This means it could be grounded to any piece of metal, including the Panel.

\*\* A Green/Yellow ground wire is isolated, within the wiring conduit, all the way back to the box at the source (building ground).

\*\*\* All Neutral Wires are 10 gauge rather than 12 gauge meaning they are larger than normal, allowing greater protection against "noise" or interference on the circuit.

This page provides an exploded view of a sample configuration highlighting each **Electrical** component required when specifying this configuration.

**Components**

- A. CE8PD36 Power Distribution Housing  
Note: 8 wire, 4 circuits, 2+2 configuration
- B. CE8CP17 Flexible Mesh Jumper Cable (connects two panels side by side or separated by a post)
- C. CE8RD Duplex Receptacle
- D. CE8CI-1 "I" Connector
- E. CE8CP Pass-Through Cable  
Note: Must run in a straight line application only  
Note: Pass-Through Extension Cable (CE8CPF154) available – extends power capability beyond 208".

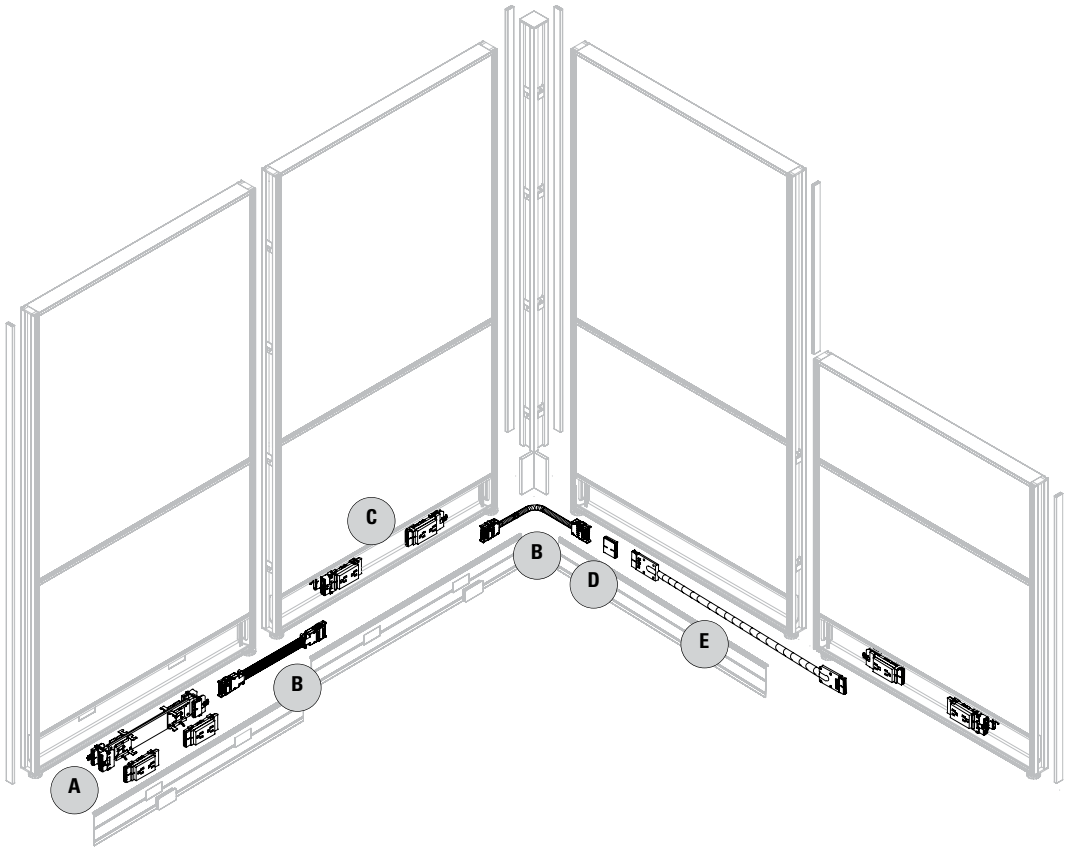

# ELECTRICAL

## CE8PD - POWER DISTRIBUTION HOUSING

- Power housing is specified per panel size (e.g. CE8PD36 is for use in a 36" panel).
- 8 wire, 4 circuits (4th circuit dedicated).
- Power distribution housing is required for each powered panel, the power distribution housing should equal the width of the panel that it is specified in.
- Provides two duplex receptacle ports per panel side on all panel widths except the 24" wide panel.
- 24" wide panel allows for only one (1) duplex receptacle on one panel side.
- Each power distribution housing supports 15-20 amps.
- Must specify Raceway Cover with Knockouts on panels, where Power Distribution Housings will be utilized.

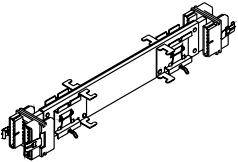
	DESCRIPTION	PRODUCT CODE	LIST PRICE	DIMENSIONS/INCHES		
				H	W	D
	Power Distribution Housing	CE8PD24	154		6 1/4	
		CE8PD30	209		11 1/2	
		CE8PD36	219		17 1/2	
		CE8PD42	224		23 1/2	
		CE8PD48	241		29 1/2	
		CE8PD60	244		41 1/2	

## CE8CP17 - FLEXIBLE MESH JUMPER CABLE

- 17" mesh jumper.
- Jumper cable is used to pass through a post or connect two panels together.

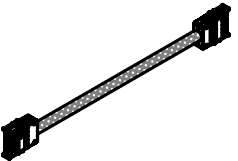
	DESCRIPTION	PRODUCT CODE	LIST PRICE	DIMENSIONS/INCHES		
				H	W	D
	Flexible Mesh Jumper Cable	CE8CP17	120		17	

# ELECTRICAL

## CE8CP - PASS THROUGH CABLE

- Flexible metal conduit is used to distribute electrical power through non-powered panels.
- Metal conduit pass through cables should be in used in a straight runs. Metal conduit pass through cables cannot pass through a post.
- Flexible conduit is required to turn a post. This only comes as 17" w. If panels at the posts do not all have power distribution housings, they must be added even if duplexes are not specified.
- To calculate the length of a Pass-Through Cable, add the widths of the non-powered panels separating the powered panels (panels with distribution housing attached). To this add 16" (distance from the edge of the panel to the distribution housing x 2).
- Add additional 3" when passing through a corner post. See the Tips at the beginning of the section for more details.

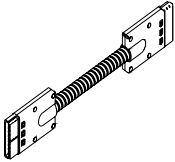
DESCRIPTION	PRODUCT CODE	LIST PRICE	DIMENSIONS/INCHES		
			H	W	D
 Pass Through Cable	CE8CP28	159	28	1/2	
	CE8CP40	167	40	1/2	
	CE8CP46	172	46	1/2	
	CE8CP52	178	52	1/2	
	CE8CP58	187	58	1/2	
	CE8CP64	197	64	1/2	
	CE8CP70	202	70	1/2	
	CE8CP76	205	76	1/2	
	CE8CP82	213	82	1/2	
	CE8CP88	219	88	1/2	
	CE8CP94	225	94	1/2	
	CE8CP100	231	100	1/2	

## CE8CI-1 - "I" CONNECTOR

- Female - Female connector connects two Pass-Through Cables.
- Connects 17" Flexible Jumper Cable or ceiling feeds to pass through cables.

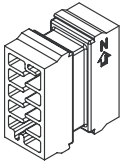
DESCRIPTION	PRODUCT CODE	LIST PRICE	DIMENSIONS/INCHES		
			H	W	D
 "I" Connector	CE8CI-1	88			



# ELECTRICAL

## CE8RD - DUPLEX RECEPTACLE

- Up to 3 receptacles per circuit
- Up to 6 receptacles per circuit (24 per infeed), not to exceed total of 15 Amps per circuit.
- Duplex Receptacles standard in Black (BLK).

- CE8RD1 = Circuit #1 (utility circuit)
- CE8RD2 = Circuit #2 (utility circuit)
- CE8RDA = Circuit A (dedicated)
- CE8RDB = Circuit B (dedicated)
- CE8RD1 and CE8RD2 (#1 and #2 share common ground)
- CE8RDA and CE8RDB (A and B share common ground)

DESCRIPTION	PRODUCT CODE	LIST PRICE	DIMENSIONS/INCHES		
			H	W	D

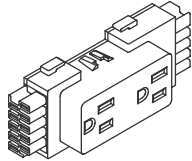

Duplex Receptacle

CE8RD1	33
CE8RD2	33
CE8RDA	33
CE8RDB	33

## CE8RDxca - CALIFORNIA CONTROLLED DUPLEX RECEPTACLE

- California Title 24 meets federal and LEED certification guidelines
- Allows circuit to be controlled or switched off when utility is not in use.
- Duplex receptacles are rated for 15 Amps.
- CE8RD1CA = Circuit #1 (utility circuit)
- CE8RD2CA = Circuit #2 (utility circuit)
- CE8RDACA = Circuit A (dedicated)
- CE8RDBCA = Circuit B (dedicated)

### NOTE:

- CE8RD1CA and CE8RD2CA (#1 and #2 share common ground)
- CE8RDACA and CE8RDBCA (A and B share common ground)
- Up to 6 receptacles per circuit (24 per infeed), not to exceed total of 15 Amps per circuit.
- Available in BLK finish only.

DESCRIPTION	PRODUCT CODE	LIST PRICE	DIMENSIONS/INCHES		
			H	W	D

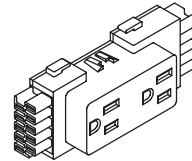

Duplex Receptacle

CE8RD1CA	38	2	4 5/8	1 1/4
CE8RD2CA	38	2	4 5/8	1 1/4
CE8RDACA	38	2	4 5/8	1 1/4
CE8RDBCA	38	2	4 5/8	1 1/4



# ELECTRICAL

## CE8FR1 - REVERSIBLE FLOOR POWER ENTRY

- Takes the place of a duplex receptacle by snapping into the base power way.
- Includes 72" long flexible metal conduit.
- Must be hard wired to source power by a licensed electrician.
- Diameter is 0.85"

## CE8FR2 - REVERSIBLE FLOOR POWER ENTRY

- Takes the place of a duplex receptacle by snapping into the base power way.
- Includes 144" long flexible metal conduit.
- Must be hard wired to source power by a licensed electrician.

DESCRIPTION	PRODUCT CODE	LIST PRICE	DIMENSIONS/INCHES		
			H	W	D

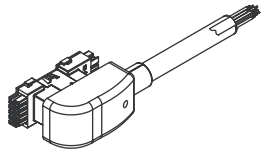

Reversible Floor Power Entry

CE8FR1  
CE8FR2

347  
447

72  
72

## CE8F - FLOOR POWER ENTRY

- Snaps in end of power distribution housing.
- Includes flexible vinyl conduit.

- Must be hard wired to source power by a licensed electrician.
- Diameter is 0.85"

DESCRIPTION	PRODUCT CODE	LIST PRICE	DIMENSIONS/INCHES		
			H	L	D

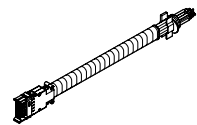

Reversible Floor Power Entry

CE8F1P  
CE8F2P

357  
461

72  
144

## CMEB01 - ELECTRICAL BOX - CHICAGO

- Can be retrofitted in any size of panel at the receptacle location.
- Gives access from one side only at each location.
- Customer to supply conduit, wiring, receptacle, and face plate.

- 2 per panel ,except 24" panel only one
- Note: A licensed electrician must provide hardware connection with the junction box.

DESCRIPTION	PRODUCT CODE	LIST PRICE	DIMENSIONS/INCHES		
			H	W	D

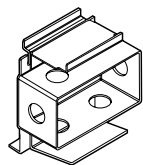

Electrical Box - Chicago

CMEB01

101

## CMEB02NY - ELECTRICAL BOX - NEW YORK

- Shipped assembled.
- Comes with pig tail electric.
- Use with 30" wide Panel of larger

- Post extension cable capacities: without electric, 30 with electric, 20
- Includes ceiling bezel and screws.

DESCRIPTION	PRODUCT CODE	LIST PRICE	DIMENSIONS/INCHES		
			H	W	D

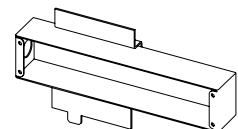

Electrical Box - New York

CMEB02NY

444



# ELECTRICAL

## CEPEXX - POST EXTENSION

- Same profile as post.
- Includes two post extension brackets, four screws and four trim inserts.
- Includes ceiling bezel and screws.



DESCRIPTION	PRODUCT CODE	LIST PRICE	DIMENSIONS/INCHES		
			H	W	D
Post Extension	CEPE64	192	64		
	CEPE82	241	82		

## CE8ECX - CEILING FEED

- Snaps into the end of a Power Distribution Housing.
- Flexible metal conduit extends into the ceiling through a corner post and post extension.
- Must be hard wired to source power by a licensed electrician.
- 4" junction box included.
- Post extension ordered separately

DESCRIPTION	PRODUCT CODE	LIST PRICE	DIMENSIONS/INCHES		
			H	W	D
Ceiling Feed	CE8EC2	469	144		

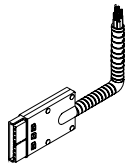

## CMECC - CABLE COVER

- Attaches to panels vertically between modules to provide enclosures for power or data cords.
- Available in 21" and 36" lengths, 6 per pack.
- Available in Steel (STL), Black (BLK), Nevada (NEV) only.

DESCRIPTION	PRODUCT CODE	LIST PRICE	DIMENSIONS/INCHES		
			H	W	D
Cord Cover	CMECC21	32	21	0.5	1
	CMECC36	50	36	0.5	1



# ELECTRICAL

## CMLEDES - STARTER LED TASK LIGHT

- Undercabinet slim profile LED linear light fixture with lens and On/Off switch.
- May be used as stand-alone or extended with add-on section below (CMLEDES\_DSC).
- Plug-in power supply with 72" cord length plus 78" DC cable.
- Includes magnet mounting bracket with optional adhesive metal plate.
- Light enclosure in clear anodizing finish. Color temperature cool white 4000K.
- Lifespan rated 30,000 hours.

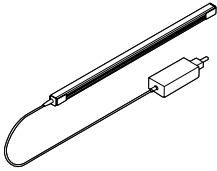
DESCRIPTION	PRODUCT CODE	LIST PRICE	DIMENSIONS/INCHES		
			H	W	D
 Led Task Light	CMLEDES24	277	1	22.9	1
	CMLEDES36	308	1	33.5	1
	CMLEDES48	318	1	45.5	1

## CMLEDES - ADD-ON LED TASK LIGHT

- Undercabinet slim profile LED linear add-on light fixture with lens.
- Daisy chain unit with 39" linking cable, no power supply.
- Add-on units can only be linked up to a total of 48 watts per power supply; this is equivalent to 10 feet of nominal length of light per power supply.
- Includes magnet mounting bracket with optional adhesive metal plate. Light enclosure in clear anodizing finish. Color temperature cool white 4000K. Lifespan rated 30,000 hours.

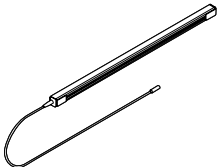
DESCRIPTION	PRODUCT CODE	LIST PRICE	DIMENSIONS/INCHES		
			H	W	D
 Led Task Light	CMLEDES24DSC	227	1	24	39
	CMLEDES36DSC	267	1	36	39
	CMLEDES48DSC	303	1	48	39

## CMLEDESOS - OCCUPANCY SENSOR

- Inline add-on controller for dimming and occupancy sensor.
- Sensor bypass switch.

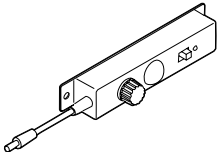
DESCRIPTION	PRODUCT CODE	LIST PRICE	DIMENSIONS/INCHES		
			H	W	D
 Occupancy Sensor	CMLEDESOS	114	6	2.4	2



worksurfaces

**The information listed below provides you with basic features of Compile Worksurfaces.**

- Compile thermally fused Worksurfaces are 1" thick and are finished with 3 mm PVC edging on all sides.
- Worksurfaces are predrilled to enable proper alignment with worksurface supports.
- Standard laminate offerings are available in thermally-fused (T). See laminate listings for details.
- Wood grain laminates on corner Worksurfaces up to 42" available in laminate run diagonally for an upcharge. Otherwise, standard horizontal application of laminate will be used.
- Most wood grain laminate Worksurfaces will have matching woodgrain trim unless specified otherwise.
- Depth of the Worksurface scoops are 1 1/8" when measured from the Panel the Worksurface is attached to.
- All Worksurfaces require support items. These are priced separately within this section.
- Grain Direction for Worksurfaces are as follows:

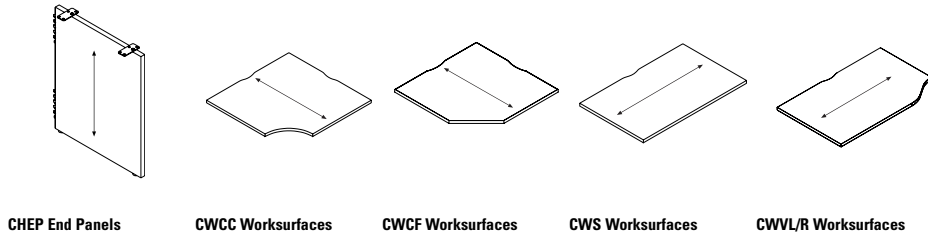

- Communication and electrical wires are routed through a cable scoop located at the back of the Worksurface. When specifying a Straight Worksurface (CWS) or a Curvilinear Worksurface (CWVL), note that the number of cable scoops depends upon the width of the Worksurface. All other Worksurface shapes have one scoop on Panel edges.

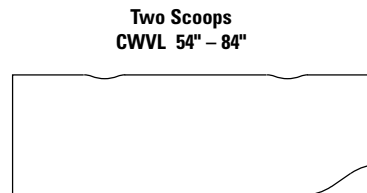
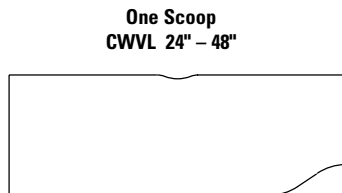
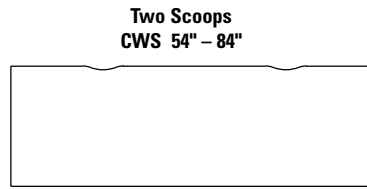
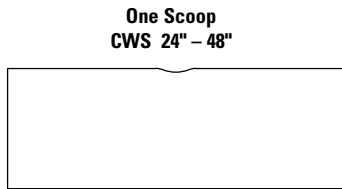

This page provides a three dimensional view of a sample configuration highlighting each **Worksurface** component required when specifying this configuration.

### Components

- A.** CWVL2436 Curvilinear Worksurface – Left  
 Note: When deepest end equals 24", opposite depth is 18"  
 When deepest end equals 30", opposite depth is 24"
- B.** CWCC3618 Corner Curved Worksurface
- C.** CWVR2436 Curvilinear Worksurface – Right

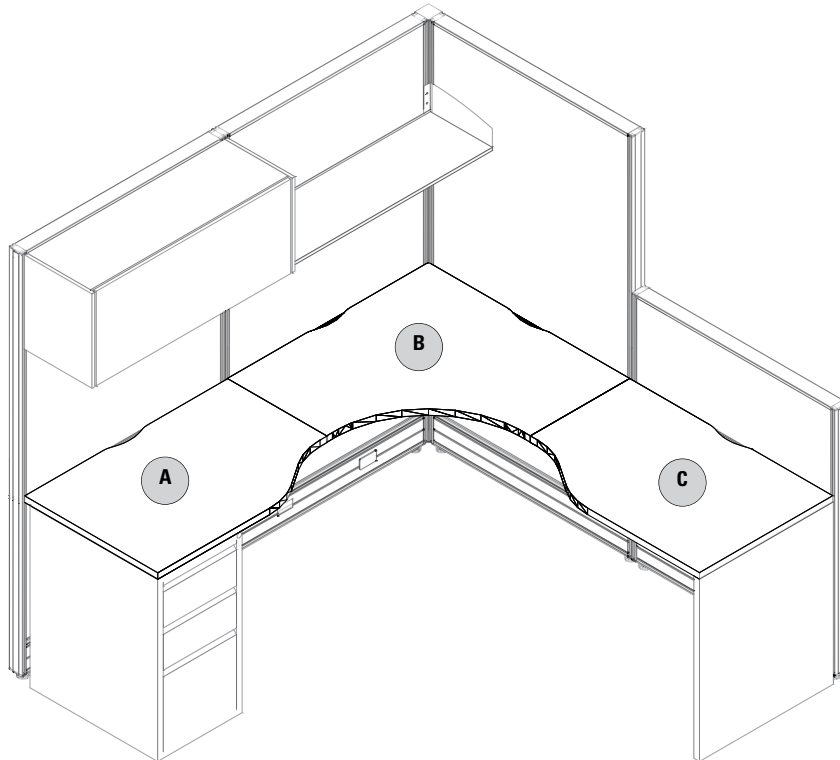

# WORKSURFACES

## CWS - RECTANGULAR WORKSURFACES

- All tops are thermally fused 1" thick with pilot holes to enable proper alignment with worksurface supports. Wood screws must be used.
- Compile worksurfaces feature a 3mm edge.
- Support hardware must be ordered separately. See the listings in this section.
- Width and depth dimensions listed include a nominal measurement (3/8") to account for wire management between the worksurface and adjoining panel.
- All surfaces over 48" will have two scoops, all others have one.
- Worksurfaces greater than 48" wide require additional structural support.

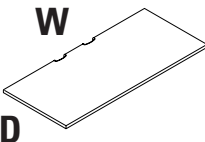
	DESCRIPTION	PRODUCT CODE	LIST PRICE	DIMENSIONS/INCHES		
				D	W	
	Rectangular Worksurfaces - 24" Deep	CWS2424P	139	24	24	
		CWS2430P	149	24	30	
		CWS2436P	167	24	36	
		CWS2442P	214	24	42	
		CWS2448P	258	24	48	
		CWS2454P	301	24	54	
		CWS2460P	339	24	60	
		CWS2466P	354	24	66	
		CWS2472P	367	24	72	
		CWS2478P	590	24	78	
		CWS2484P	597	24	84	
		CWS2490P	626	24	90	
		CWS2496P	668	24	96	
		Rectangular Worksurfaces - 30" Deep	CWS3024P	163	30	24
			CWS3030P	173	30	30
			CWS3036P	205	30	36
CWS3042P	288		30	42		
CWS3048P	301		30	48		
CWS3054P	330		30	54		
CWS3060P	354		30	60		
CWS3066P	366		30	66		
CWS3072P	388		30	72		
CWS3078P	734		30	78		
CWS3084P	748	30	84			



# WORKSURFACES

## CWSNSC - STRAIGHT WORKSURFACE NO SCOOP

- There is no scoop on this worksurface.
- Worksurface depth is exact, not nominal.
- Support hardware must be ordered separately. See listing in this section of the price book.
- For use with Bridges II or Princeton style legs.
- Surfaces not available in HPW.
- Worksurfaces greater than 48" wide require additional structural support.

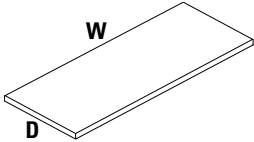
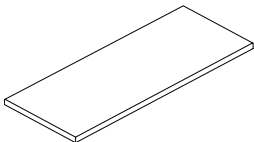
	DESCRIPTION	PRODUCT CODE	LIST PRICE	DIMENSIONS/INCHES	
				D	W
	Straight Worksurface No Scoops - 24" Deep	CWS2424NSC	139	24	24
		CWS2430NSC	149	24	30
		CWS2436NSC	167	24	36
		CWS2442NSC	214	24	42
		CWS2448NSC	258	24	48
		CWS2454NSC	301	24	54
		CWS2460NSC	339	24	60
		CWS2466NSC	354	24	66
		CWS2472NSC	367	24	72
		CWS2478NSC	590	24	78
		CWS2484NSC	597	24	84
		CWS2490NSC	702	24	90
		CWS2496NSC	668	24	96
	Straight Worksurface No Scoops - 30" Deep	CWS3024NSC	163	30	24
		CWS3030NSC	173	30	30
		CWS3036NSC	205	30	36
		CWS3042NSC	288	30	42
		CWS3048NSC	301	30	48
		CWS3054NSC	330	30	54
		CWS3060NSC	354	30	60
		CWS3066NSC	366	30	66
		CWS3072NSC	388	30	72
		CWS3078NSC	734	30	78
		CWS3084NSC	748	30	84



# WORKSURFACES

## CWSNSCP - RECTANGULAR WORKSURFACE, NO SCOOPS FOR HEIGHT ADJUSTABLE TABLES

- There is no scoop on this work surface.
- Worksurface depth is exact, not nominal.
- Support hardware must be ordered separately. See listing in this section of the price book.
- For use with Height Adjustable Tables
- Surfaces not available in HPW.

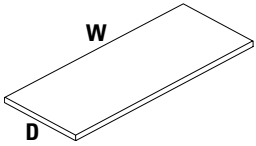
	DESCRIPTION	PRODUCT CODE	LIST PRICE	DIMENSIONS/INCHES		
				H	D	W
	Rectangular Worksurface No Scoops for Height Adjustable Tables	CWS2346NSCP	258	1	23	46
		CWS2352NSCP	301	1	23	52
		CWS2358NSCP	339	1	23	58
		CWS2364NSCP	354	1	23	64
		CWS2370NSCP	367	1	23	70
		CWS2946NSCP	301	1	29	46
		CWS2952NSCP	330	1	29	52
		CWS2958NSCP	354	1	29	58
		CWS2964NSCP	366	1	29	64
		CWS2970NSCP	388	1	29	70

# WORKSURFACES

## CWSWNSC - WEDGE WORKSURFACE NO SCOOP

- There is no scoop on this worksurface.
- Worksurface depth is exact, not nominal.
- Support hardware must be ordered separately. See listing in this section of the price book.
- For use with Bridges II or Princeton style legs.
- Surfaces not available in HPW.
- Worksurfaces greater than 48" wide require additional structural support.

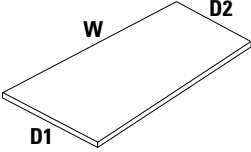
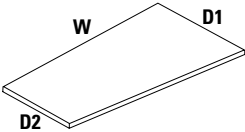
	DESCRIPTION	PRODUCT CODE	LIST PRICE	DIMENSIONS/INCHES		
				D1	D2	W
	Straight Wedge Worksurface No Scoops - Left	CWSW241848NSC	359	24	18	48
		CWSW241854NSC	405	24	18	54
		CWSW241860NSC	446	24	18	36
		CWSW241866NSC	494	24	18	42
		CWSW241872NSC	538	24	18	48
		CWSW302448NSC	446	30	24	60
		CWSW302454NSC	504	30	24	66
		CWSW302460NSC	560	30	24	72
		CWSW302466NSC	615	30	24	78
		CWSW302472NSC	674	30	24	84
	Straight Wedge Worksurface No Scoops - Right	CWSW182448NSC	359	24	18	24
		CWSW182454NSC	405	24	18	30
		CWSW182460NSC	446	24	18	36
		CWSW182466NSC	494	24	18	42
		CWSW182472NSC	538	24	18	48
		CWSW243048NSC	446	30	24	60
		CWSW243054NSC	504	30	24	66
		CWSW243060NSC	560	30	24	72
		CWSW243066NSC	615	30	24	78
		CWSW243072NSC	674	30	24	84

## CWSP - RECTANGULAR WORKSURFACES - SPAN A POST

- All tops are thermally fused 1" thick with pilot holes to enable proper alignment with worksurface supports. Wood screws must be used.
- Compile worksurfaces feature a 3mm edge.
- Support hardware must be ordered separately. See the listings in this section.
- Note: Width and depth dimensions listed include a nominal measurement (3/8") to account for wire management between the worksurface and adjoining panel.

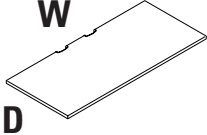
	DESCRIPTION	PRODUCT CODE	LIST PRICE	DIMENSIONS/INCHES		
				D	W	
	Rectangular Worksurfaces - 24" Deep Span a Post	CWSP2426P	167	24	26	
		CWSP2432P	201	24	32	
		CWSP2438P	234	24	38	
		CWSP2444P	264	24	44	
		CWSP2450P	299	24	50	
		CWSP2456P	330	24	56	
		CWSP2462P	437	24	62	
		CWSP2468P	476	24	68	
		CWSP2474P	517	24	74	
		CWSP2480P	556	24	80	
		CWSP2486P	634	24	86	
		Rectangular Worksurfaces - 30" Deep Span a Post	CWSP3026P	209	30	26
			CWSP3032P	250	30	32
			CWSP3038P	296	30	38
CWSP3044P	330		30	44		
CWSP3050P	373		30	50		
CWSP3056P	414		30	56		
CWSP3062P	546		30	62		
CWSP3068P	594		30	68		
CWSP3074P	646		30	74		
CWSP3080P	693		30	80		
CWSP3086P	791	30	86			

# WORKSURFACES

## CWVR - CURVILINEAR WORKSURFACES - RIGHT

- All tops are thermally fused 1" thick with pilot holes to enable proper alignment with worksurface supports. Wood screws must be used.
- Support hardware must be ordered separately. See the listings in this section.
- Compile worksurfaces feature a 3mm edge.
- Note: Width and depth dimensions listed include a nominal measurement (38") to account for wire management between the worksurface and adjoining panel.
- When deepest end equals 24", the opposite depth is 18". When deepest end equals 30", the opposite depth is 24"
- Worksurfaces greater than 48" wide require additional structural support.

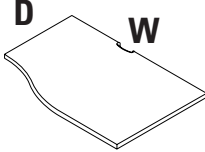
	DESCRIPTION	PRODUCT CODE	LIST PRICE	DIMENSIONS/INCHES		
				D	W	
	Curvilinear Worksurfaces - 24" Deep	CWVR2424P	179	24	24	
		CWVR2430P	185	24	30	
		CWVR2436P	223	24	36	
		CWVR2442P	258	24	42	
		CWVR2448P	295	24	48	
		CWVR2454P	330	24	54	
		CWVR2460P	358	24	60	
		CWVR2466P	396	24	66	
		CWVR2472P	426	24	72	
		CWVR2478P	590	24	78	
		CWVR2484P	597	24	84	
		Curvilinear Worksurfaces - 30" Deep	CWVR3024P	185	30	24
			CWVR3030P	196	30	30
CWVR3036P	231		30	36		
CWVR3042P	317		30	42		
CWVR3048P	330		30	48		
CWVR3054P	366		30	54		
CWVR3060P	396		30	60		
CWVR3066P	426		30	66		
CWVR3072P	453		30	72		
CWVR3078P	734		30	78		
CWVR3084P	748		30	84		

## CWVL - CURVILINEAR WORKSURFACES - LEFT

- All tops are thermally fused 1" thick with pilot holes to enable proper alignment with worksurface supports. Wood screws must be used.
- Support hardware must be ordered separately. See the listings in this section.
- Compile worksurfaces feature a 3mm edge.
- Note: Width and depth dimensions listed include a nominal measurement (38") to account for wire management between the worksurface and adjoining panel.
- When deepest end equals 24", the opposite depth is 18". When deepest end equals 30", the opposite depth is 24"

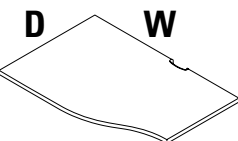
	DESCRIPTION	PRODUCT CODE	LIST PRICE	DIMENSIONS/INCHES		
				D	W	
	Curvilinear Worksurfaces - 24" Deep	CWVL2424P	179	24	24	
		CWVL2430P	185	24	30	
		CWVL2436P	223	24	36	
		CWVL2442P	258	24	42	
		CWVL2448P	295	24	48	
		CWVL2454P	330	24	54	
		CWVL2460P	358	24	60	
		CWVL2466P	396	24	66	
		CWVL2472P	426	24	72	
		CWVL2478P	590	24	78	
		CWVL2484P	597	24	84	
		Curvilinear Worksurfaces - 30" Deep	CWVL3024P	185	30	24
			CWVL3030P	196	30	30
CWVL3036P	231		30	36		
CWVL3042P	317		30	42		
CWVL3048P	330		30	48		
CWVL3054P	366		30	54		
CWVL3060P	396		30	60		
CWVL3066P	426		30	66		
CWVL3072P	453		30	72		
CWVL3078P	734		30	78		
CWVL3084P	748		30	84		



# WORKSURFACES

## CWCC - CORNER CURVED WORKSURFACES

- All tops are thermally fused 1" thick with pilot holes to enable proper alignment with worksurface supports. Wood screws must be used.
- Compile worksurfaces feature a 3mm edge.
- Support hardware must be ordered separately. See the listings in this section.
- Note: Width and depth dimensions listed include a nominal measurement (3/8") to account for wire management between the worksurface and adjoining panel.
- Note: Wood grain laminates do not run diagonally on corner worksurfaces.
- Worksurfaces greater than 48" wide require additional structural support.

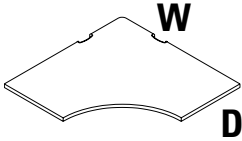
	DESCRIPTION	PRODUCT CODE	LIST PRICE	DIMENSIONS/INCHES	
				D	W
	Corner Curved Worksurfaces - 36"	CWCC3618P	466	18	36
		CWCC3624P	511	24	36
	Corner Curved Worksurfaces - 42"	CWCC4224P	689	24	42
		CWCC4230P	750	30	42
	Corner Curved Worksurfaces - 48"	CWCC4824P	806	24	48
		CWCC4830P	844	30	48

## CWCF - FIVE SIDED WORKSURFACES

- All tops are thermally fused 1" thick with pilot holes to enable proper alignment with worksurface supports. Wood screws must be used.
- Compile worksurfaces feature a 3mm edge.
- Support hardware must be ordered separately. See the listings in this section.
- Note: Width and depth dimensions listed include a nominal measurement (3/8") to account for wire management between the worksurface and adjoining panel.
- Note: Wood grain laminates do not run diagonally on corner worksurfaces.

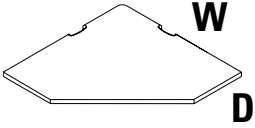
	DESCRIPTION	PRODUCT CODE	LIST PRICE	DIMENSIONS/INCHES	
				D	W
	Five Sided Worksurface - 36"	CWCF3618P	461	18	36
		CWCF3624P	511	24	36
	Five Sided Worksurface - 42"	CWCF4224P	689	24	42
		CWCF4230P	750	30	42
	Five Sided Worksurface - 48"	CWCF4824P	806	24	48
		CWCF4830P	844	30	48

# WORKSURFACES

## CWC6 - CURVED CORNER WORKSURFACE FOR 60° POST

- All tops are thermally fused 1" thick with pilot holes to enable proper alignment with worksurface supports. Wood screws must be used.
- Compile worksurfaces feature a 3mm edge.
- Support hardware must be ordered separately. See the listings in this section.
- Note: Width and depth dimensions listed include a nominal measurement (3/8") to account for wire management between the worksurface and adjoining panel.
- Note: Wood grain laminates do not run diagonally on corner worksurfaces.
- Worksurfaces greater than 48" wide require additional structural support.

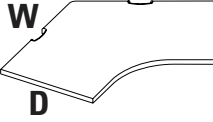
	DESCRIPTION	PRODUCT CODE	LIST PRICE TF	DIMENSIONS/INCHES	
				D	W
	Curved Corner Worksurface for 60° Post - 24"	CWC62424P	435	24	24
		CWC62430P	773	24	30
		CWC62436P	868	24	36
		CWC62442P	1327	24	42
		CWC62448P	1447	24	48
	Curved Corner Worksurface for 60° Post - 30"	CWC63024P	435	30	24
		CWC63030P	773	30	30
		CWC63036P	868	30	36
		CWC63042P	1327	30	42
		CWC63048P	1447	30	48

## CWC6L - EXTENDED CURVED CORNER - LEFT

- There are three cable scoops on this worksurface
- Support hardware must be ordered separately. See listing in this section of the price list
- Note: Wood Grain Laminates do not run diagonally on Extended Curved Corners

	DESCRIPTION	PRODUCT CODE	LIST PRICE	DIMENSIONS/INCHES		
				D1	D2	W
	Extended Curved Corner - 36" x 24"	CWC6L362448P	630	36	24	48
		CWC6L362460P	687	36	24	60
		CWC6L362466P	754	36	24	66
		CWC6L362472P	834	36	24	72
		CWC6L362478P	891	36	24	78
		CWC6L362484P	959	36	24	84
	Extended Curved Corner - 42" x 24"	CWC6L422460P	723	42	24	60
		CWC6L422466P	792	42	24	66
		CWC6L422472P	879	42	24	72
		CWC6L422478P	938	42	24	78
		CWC6L422484P	1012	42	24	84
	Extended Curved Corner - 42" x 30"	CWC6L423060P	813	42	30	60
		CWC6L423066P	891	42	30	66
		CWC6L423072P	975	42	30	72
		CWC6L423078P	1044	42	30	78
		CWC6L423084P	1113	42	30	84
	Extended Curved Corner - 48" x 24"	CWC6L482460P	855	48	24	60
		CWC6L482466P	924	48	24	66
		CWC6L482472P	992	48	24	72
		CWC6L482478P	1092	48	24	78
		CWC6L482484P	1135	48	24	84
	Extended Curved Corner - 48" x 30"	CWC6L483060P	905	48	30	60
		CWC6L483066P	985	48	30	66
		CWC6L483072P	1069	48	30	72
		CWC6L483078P	1150	48	30	78
		CWC6L483084P	1201	48	30	84



# WORKSURFACES

## CWCER - EXTENDED CURVED CORNER - RIGHT

- There are three cable scoops on this worksurface
- Support hardware must be ordered separately. See listing in this section of the price list
- Note: Wood Grain Laminates do not run diagonally on Extended Curved Corners
- Worksurfaces greater than 48" wide require additional structural support.

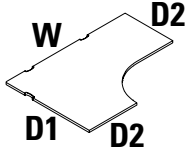
	DESCRIPTION	PRODUCT CODE	LIST PRICE	DIMENSIONS/INCHES		
				D1	D2	W
	Extended Curved Corner - 36" x 24"	CWCER362448P	630	36	24	48
		CWCER362460P	687	36	24	60
		CWCER362466P	754	36	24	66
		CWCER362472P	834	36	24	72
		CWCER362478P	891	36	24	78
		CWCER362484P	959	36	24	84
	Extended Curved Corner - 42" x 24"	CWCER422460P	723	42	24	60
		CWCER422466P	792	42	24	66
		CWCER422472P	879	42	24	72
		CWCER422478P	938	42	24	78
		CWCER422484P	1012	42	24	84
	Extended Curved Corner - 42" x 30"	CWCER423060P	813	42	30	60
		CWCER423066P	891	42	30	66
		CWCER423072P	975	42	30	72
		CWCER423078P	1044	42	30	78
		CWCER423084P	1113	42	30	84
	Extended Curved Corner - 48" x 24"	CWCER482460P	855	48	24	60
		CWCER482466P	924	48	24	66
		CWCER482472P	992	48	24	72
		CWCER482478P	1092	48	24	78
		CWCER482484P	1135	48	24	84
	Extended Curved Corner - 48" x 30"	CWCER483060P	905	48	30	60
		CWCER483066P	985	48	30	66
		CWCER483072P	1069	48	30	72
		CWCER483078P	1150	48	30	78
		CWCER483084P	1201	48	30	84

## CWD - "D" WORKSURFACE

- Support hardware must be ordered separately. See listing in this section of the price list
- Monoleg is included

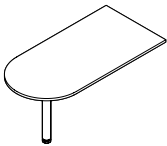
	DESCRIPTION	PRODUCT CODE	LIST PRICE	DIMENSIONS/INCHES	
				D	W
	"D" Worksurface - 24"	CWD2442P	516	24	42
		CWD2448P	530	24	48
		CWD2460P	556	24	60
		CWD2472P	594	24	72
	"D" Worksurface - 30"	CWD3042P	559	30	42
		CWD3048P	566	30	48
		CWD3060P	594	30	60
		CWD3072P	659	30	72

# WORKSURFACES

## CWH - HATCHET WORKSURFACE (LEFT SHOWN)

- Cable scoop is in the center of the 36" wide edge.
- Support hardware must be ordered separately. See listing in this section of the price list
- Monoleg is included
- Must be specified either left or right handed.
- Note: Wood Grain Laminates do not run diagonally on Hatchet Corners
- Worksurfaces greater than 48" wide require additional structural support.

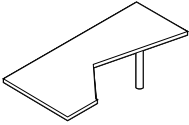
	DESCRIPTION	PRODUCT CODE	LIST PRICE	DIMENSIONS/INCHES		
				D1	D2	W
	Hatchet Worksurface - Left	CWHL3672P	1133	36	30	72
	Hatchet Worksurface - Right	CWHR3672P	1133	36	30	72

Right Shown

## CWSW - STRAIGHT WEDGE WORKSURFACES

- Support hardware must be ordered separately. See the listings in this section.
- Must be specified either left or right handed.

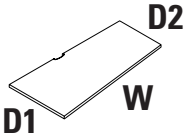
	DESCRIPTION	PRODUCT CODE	LIST PRICE	DIMENSIONS/INCHES		
				D1	D2	W
	Straight Wedge Worksurface - Left	CWSW241848P	359	24	18	48
		CWSW241854P	405	24	18	54
		CWSW241860P	446	24	18	60
		CWSW241866P	494	24	18	66
		CWSW241872P	538	24	18	72
		CWSW302448P	446	30	24	48
	Straight Wedge Worksurface - Right	CWSW302454P	504	30	24	54
		CWSW302460P	560	30	24	60
		CWSW302466P	615	30	24	66
		CWSW302472P	674	30	24	72
		CWSW182448P	359	18	24	48
		CWSW182454P	405	18	24	54
		CWSW182460P	446	18	24	60
		CWSW182466P	494	18	24	66
CWSW182472P	538	18	24	72		
Straight Wedge Worksurface - Right	CWSW243048P	446	24	30	48	
	CWSW243054P	504	24	30	54	
	CWSW243060P	560	24	30	60	
	CWSW243066P	615	24	30	66	
	CWSW243072P	674	24	30	72	

## CWQR - QUARTER ROUND PANEL WORKSURFACE

- The worksurface edge running along the panel is a slightly different length than that of the worksurface end, causing the surface to be handed.
- Left hand surface shown.
- Support hardware must be ordered separately. See the listings in this section.

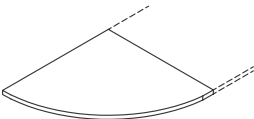
	DESCRIPTION	PRODUCT CODE	LIST PRICE	DIMENSIONS/INCHES	
				D	W
	Quarter Round Panel Worksurface - Left	CWQRL2424	214	24	24
		CWQRL3030	283	30	30
	Quarter Round Panel Worksurface - Right	CWQRR2424	214	24	24
		CWQRR3030	283	30	30



# WORKSURFACES

## CWQRC - QUARTER ROUND PANEL CORNER WORKSURFACE

- Wraps around a 90° corner post.
- Support hardware must be ordered separately. See the listing in this section.
- Worksurfaces greater than 48" wide require additional structural support.

DESCRIPTION	PRODUCT CODE	LIST PRICE	DIMENSIONS/INCHES	
			D	W
Quarter Round Panel Corner Worksurface	CWQRC2424	257	24	24
	CWQRC3030	316	30	30

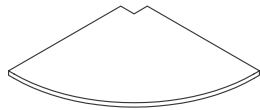

## CWT - STRAIGHT TRANSACTION WORKSURFACE

- Support hardware must be ordered separately. See the listings in this section.
- Compile worksurfaces feature a 3mm edge.

DESCRIPTION	PRODUCT CODE	LIST PRICE	DIMENSIONS/INCHES	
			D	W
Straight Transaction Worksurface	CWT1512	64	15	12
	CWT1518	85	15	18
	CWT1524	101	15	24
	CWT1530	121	15	30
	CWT1536	138	15	36
	CWT1542	154	15	42
	CWT1548	175	15	48
	CWT1554	191	15	54
	CWT1560	212	15	60
	CWT1566	227	15	66
	CWT1572	247	15	72
	CWT1578	264	15	78
	CWT1584	282	15	84

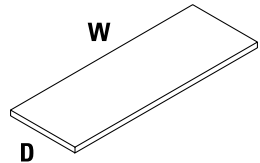

## CWTE - END TRANSACTION SURFACE

- Support hardware must be ordered separately. See the listings in this section.
- Extends 1.5" past end of run.
- Compile worksurfaces feature a 3mm edge.

DESCRIPTION	PRODUCT CODE	LIST PRICE	DIMENSIONS/INCHES	
			D	W
End Transaction Surface	CWTE1512	85	15	14
	CWTE1518	101	15	20
	CWTE1524	121	15	26
	CWTE1530	138	15	32
	CWTE1536	154	15	38
	CWTE1542	175	15	44
	CWTE1548	191	15	50
	CWTE1554	212	15	56
	CWTE1560	227	15	62
	CWTE1566	247	15	68
	CWTE1572	264	15	74

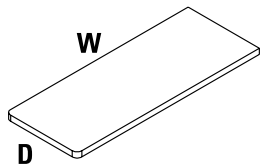



# WORKSURFACES

## CWTCL - "L" CORNER TRANSACTION SURFACE

- Support hardware must be ordered separately. See the listings in this section.
- When specifying this item along with a straight surface, deduct 12" from each return side.
- Worksurfaces greater than 48" wide require additional structural support.

DESCRIPTION	PRODUCT CODE	LIST PRICE	DIMENSIONS/INCHES	
			D	W
"L" Corner Transaction Surface	CWTCL90	180	15	21

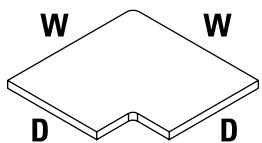

## CW9T - CORNER TRANSACTION SURFACE FOR 90° POST

- Support hardware must be ordered separately. See the listing in this section.

DESCRIPTION	PRODUCT CODE	LIST PRICE	DIMENSIONS/INCHES	
			D	W
Corner Transaction Surface for 90° Post	CW9T1524	245	15	32.861
	CW9T1530	292	15	38.861
	CW9T1536	338	15	44.861
	CW9T1542	383	15	50.861
	CW9T1548	434	15	56.861

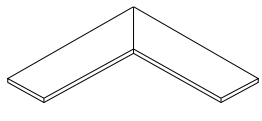

## CHCB2 - CORNER BRACKET

- Attaches the corner of any worksurface to a panel connector.
- Priced and shipped in pairs.
- Available in standard paint colors.
- Cannot be used off modular.
- Can be used when a panel is the same depth as the worksurface in the front and back application.

DESCRIPTION	PRODUCT CODE	LIST PRICE	DIMENSIONS/INCHES	
			D	W
Corner Bracket	CHCB2	22	2.5	

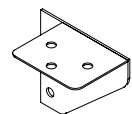

## CHWB1 - MID SPAN SUPPORT BRACKET

- Does not need to be on module.
- Used when a panel exceeds the depth of the adjacent worksurface.
- Can only be used with a Segmented Panel.
- Comes in unfinished zinc.

DESCRIPTION	PRODUCT CODE	LIST PRICE	DIMENSIONS/INCHES	
			D	W
Mid Span Support Bracket	CHWB1	14		

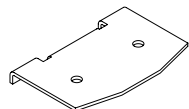

# WORKSURFACES

## CHC15 & CHC22- CANTILEVER

- Attaches a worksurface to a panel.
- Use one cantilever to support two convergent worksurfaces when specified with 3 Flat Brackets or two cantilevers with one flat bracket to support two convergent worksurfaces.
- Does not include Flat Brackets.
- Priced individually
- Specify handedness of each cantilever
- Available in standard paint colors.
- Right and left Cantilever needs to be specified unless flat brackets are also specified.

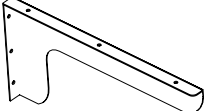
	DESCRIPTION	PRODUCT CODE	LIST PRICE	DIMENSIONS/INCHES	
				D	W
	Cantilever - 15"	CHC15L	50	15	6
		CHC15R	50	15	6
	Cantilever - 22"	CHC22L	77	22	6
		CHC22R	77	22	6

## CMHC - WORKSURFACE SUPPORT CHANNEL

- Support channel attaches to underside of worksurface with screws
- Support channel should be 14" shorter than top length.
- Screws are included.
- Only available in Black.
- Tops with post legs should be specified with support channel for structural reinforcement.

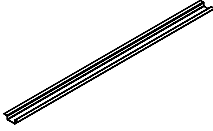
	DESCRIPTION	PRODUCT CODE	LIST PRICE	DIMENSIONS/INCHES	
				L	D
	Worksurface Support Channel	CMHC40 - for 54" wide table	84	40	5
		CMHC46 - for 60" wide table	91	46	5
		CMHC52 - for 66" wide table	101	52	5
		CMHC58 - for 72" wide table	114	58	5
		CMHC64 - for 78" wide table	124	64	5
		CMHC70 - for 84" wide table	138	70	5

## CHFB1 - FLAT BRACKET

- Use in conjunction with Cantilever to make it a shared Cantilever to support convergent worksurfaces.
- Used at the front of 2 convergent worksurfaces to keep worksurfaces flush at seams.
- Available in Black only.

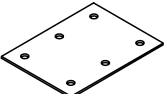
	DESCRIPTION	PRODUCT CODE	LIST PRICE	DIMENSIONS/INCHES	
				D	W
	Flat Bracket	CHFB1	21	3	4

## CHTB2 - TRANSACTION TOP BRACKETS

- Securely attaches a transaction surface to the top of a panel.
- One pair must be on each side of transaction surface.
- Priced and shipped in pairs.
- Available in Anodized Aluminum only.

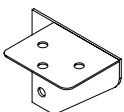
	DESCRIPTION	PRODUCT CODE	LIST PRICE	DIMENSIONS/INCHES	
				D	W
	Flat Bracket	CHTB2	22	2.5	

# WORKSURFACES

## CHEP - END PANEL

- Supports the worksurface and enhances the stability of connected panels.
- Provides solid support at the end of a run of worksurfaces.
- Finished in thermally-fused laminate.
- Includes flat brackets and hardware.
- End panel height is inclusive of panel glides extended to their fullest height.
- If wood grains is selected, grain runs vertically.

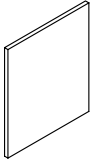
	DESCRIPTION	PRODUCT CODE	LIST PRICE	DIMENSIONS/INCHES	
				D	W
	End Panel - 28"High	CHEP2924	264	28	24
		CHEP2930	311	28	30

## CHMSL - MID SUPPORT LEG

- Provides support for a worksurface.
- Includes leveling glide, PVC Sleeve and 4.8" x 4.8" attachment plate.
- 1.5" diameter.
- Available in standard paint colors.

	DESCRIPTION	PRODUCT CODE	LIST PRICE	DIMENSIONS/INCHES
				H
	Mid Support Leg - Round	CHMSL1	91	28
	Mid Support Leg - Square	CHMSL2	91	28

## CMHCL & CHHCL - CORNER LEG WITH LEVELER

- Provides support for a worksurface.
- Includes leveling glide, PVC Sleeve and attachment plate.
- 1.5" diameter
- Available in standard paint colors.
- Legs can be used in the corner of a single worksurface or be rotated 45 degrees to support the corners of two worksurfaces.

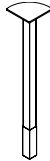
	DESCRIPTION	PRODUCT CODE	LIST PRICE	DIMENSIONS/INCHES
				H
 	Corner Leg Round	CMHCL1	127	28
	Corner Leg Square	CMHCL2	127	28

## CHWS - 5" SURFACE TO STORAGE SUPPORT LEG

- Provides support for a worksurface.
- Includes leveling glide, PVC Sleeve and 4.8" x 4.8" attachment plate.
- 1.5" diameter.
- Available in standard paint colors.

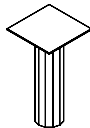
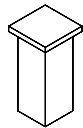
	DESCRIPTION	PRODUCT CODE	LIST PRICE	DIMENSIONS/INCHES
				H
 	5" Surface to Storage Support Leg - Round	CHWSRL01	59	4.5
	5" Surface to Storage Support Leg - Square	CHWSSL01	59	4.5

Round      Square



# WORKSURFACES

## CHMEGR - METAL END GABLE - RIGHT

- Supports the worksurface and enhances the stability of connected panels.
- Includes a levelling glide and decorative PVC sleeve to cover the glide.
- Available in standard paint colors.

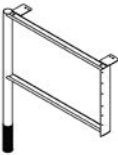
DESCRIPTION	PRODUCT CODE	LIST PRICE	DIMENSIONS/INCHES		
			H	D	W
 Metal End Gable - Right	CHMEG18R	267	28	17	4
	CHMEG24R	285	28	23	4
	CHMEG30R	300	28	29	4

## CHMEGL - METAL END GABLE - LEFT

- Supports the worksurface and enhances the stability of connected panels.
- Includes a levelling glide and decorative PVC sleeve to cover the glide.
- Available in standard paint colors.

DESCRIPTION	PRODUCT CODE	LIST PRICE	DIMENSIONS/INCHES		
			H	W	D
 Metal End Gable - Left	CHMEG18L	267	28	17	4
	CHMEG24L	285	28	23	4
	CHMEG30L	300	28	29	4

## CHMSL - METAL SUPPORT LEG

- Supports two adjoining worksurfaces and enhances the stability of connected panels.
- Includes a levelling glide and decorative PVC sleeve to cover the glide.
- Available in standard paint colors.
- Flat brackets recommended to ensure alignment of neighboring surface.

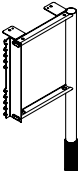
DESCRIPTION	PRODUCT CODE	LIST PRICE	DIMENSIONS/INCHES		
			H	W	D
 Metal Support Leg	CHMSL12	239	28	11	4

## PEDESTAL FILLER BRACKET

- Screws to back of pedestal
- Fills the gap between the pedestal and panel when wing pnael is not used.

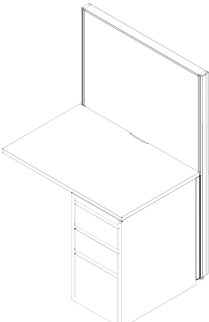
DESCRIPTION	PRODUCT CODE	LIST PRICE	DIMENSIONS/INCHES	
			D	W
 Pedestal Filler Bracket-	CHPBF	60	26.875	1.375

# WORKSURFACES

## DHPEDB - FLUSH PEDESTAL BRACKET

- Attaches metal or laminate storage or desking, to Compile panels for additional panel support
- Used in flush mount applications only
- Use CHPBF Pedestal Filler Bracket with CS19xx Pedestals and standard depth worksurfaces

DESCRIPTION	PRODUCT CODE	LIST PRICE	DIMENSIONS/INCHES		
			H	W	D
Flush Pedestal Bracket	DHPEDB	29	8	1	1



storage

## LATERAL FILE FEATURES

### DRAWERS/SHELVES

- Drawer interlocking system
- Three-stage, anti-bounceback suspension
- Pre-installed, side-to-side file bars for letter, legal and A4
- Front-to-back file bars – optional
- Full-height dividers – optional
- Angled full pull

### CONSTRUCTION

- Top stiffener bar
- Corner gussets
- Four (4) ganging drill points are marked to ensure correct positioning
- Cam lock included
- Leveling glides
- Counterweights are included in 2, 3 and 4 drawer cabinets. BIFMA does not require counterweight in 5 drawer cabinets.

## PEDESTAL FEATURES

### DRAWERS/SHELVES

- All drawer fronts feature a recessed, angled full pull.
- Drawers feature ball bearing suspension.

### CONSTRUCTION

- Central Core removable cam locks.
- Pedestals are 15" wide.
- Counterweight is standard on all Freestanding models.
- Worksurfaces supporting models have holes drilled in top to attach underneath a worksurface.

## STANDARD PAINT COLORS

BLACK	BLK
DESIGNER WHITE	DWT
NEVADA	NEV
STEEL	STL

## TEXTURED PAINT COLORS

Only available on Compile Storage.

BLIZZARD	BZD
STONE DUST	SDT

## GENERAL WARRANTY INFORMATION

- Evolve warrants all components of metal storage and filing for the lifetime of the product to the original purchaser.



This page provides a three dimensional view of a sample configuration highlighting each storage component required when specifying this configuration.

## Components

- A. CSOF13XX KD Overhead
- B. CSSL13XX Low-Profile Shelf
- C. CM19XXBBF Worksurface Supporting Box, Box, File Pedestal

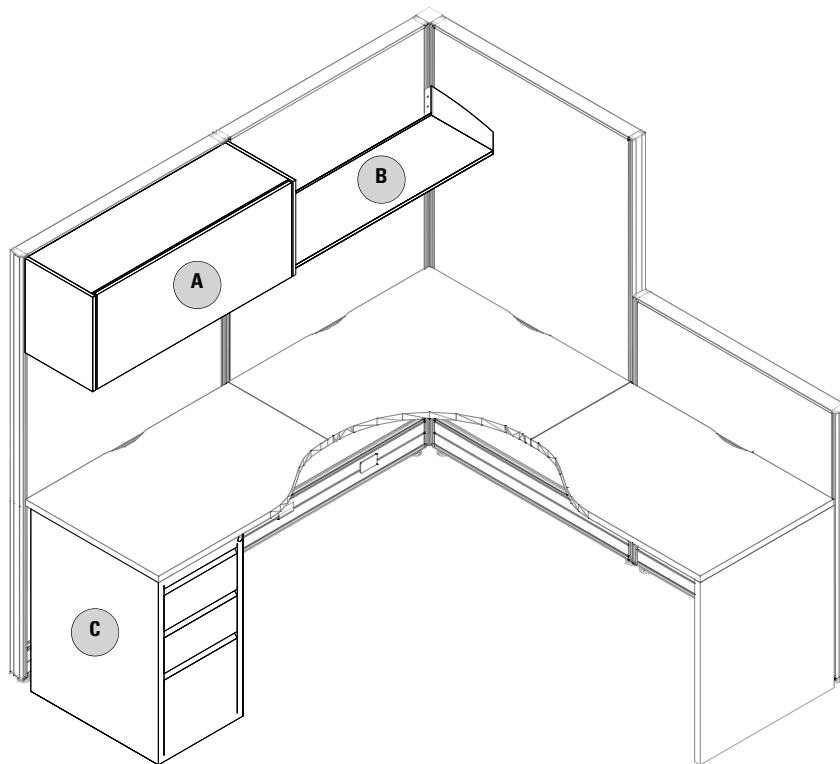



# STORAGE

## CS19XXBBF - WORKSURFACE SUPPORTING BOX/BOX/FILE 15" PEDESTAL

- Worksurface supporting, with predrilled holes in the top.
- Also available as freestanding with finished top.
- All drawer fronts feature a recessed, angled full pull.
- Pedestal height shown includes glide.
- Pencil tray and Lock included.
- File Bars are not included with Compile pedestals. To order file bars, use product code CSPEDHFB at \$15.00 each list.

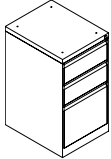
	DESCRIPTION	PRODUCT CODE	LIST PRICE	DIMENSIONS/INCHES		
				H	D	W
	Worksurface Supporting Box/Box/File 15" Pedestal	CS1919BBF	549	27 5/8	18 5/8	15
		CS1923BBF	565	27 5/8	22 5/8	15
		CS1929BBF	641	27 5/8	29 5/8	15

## CS19XXFF - WORKSURFACE SUPPORTING FILE/FILE 15" PEDESTAL

- Worksurface supporting, with predrilled holes in the top.
- Also available as freestanding with finished top.
- All drawer fronts feature a recessed, angled full pull.
- Pedestal height shown includes glide.
- Lock included.
- File Bars are not included with Compile pedestals. To order file bars, use product code CSPEDHFB at \$15.00 each list.

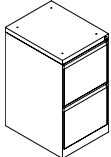
	DESCRIPTION	PRODUCT CODE	LIST PRICE	DIMENSIONS/INCHES		
				H	D	W
	Worksurface Supporting File/File 15" Pedestal	CS1919FF	549	27 5/8	18 5/8	15
		CS1923FF	565	27 5/8	22 5/8	15
		CS1929FF	641	27 5/8	29 5/8	15

## CS19FXBBF - FREESTANDING BOX/BOX/FILE 15" PEDESTAL

- All drawer fronts feature a recessed, angled full pull.
- Pedestal height shown includes glide.
- Finished top.
- Counterweight, Pencil tray and Lock included.
- File Bars are not included with Compile pedestals. To order file bars, use product code CSPEDHFB at \$15.00 each list.

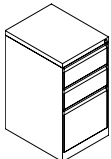
	DESCRIPTION	PRODUCT CODE	LIST PRICE	DIMENSIONS/INCHES		
				H	D	W
	Freestanding Box/Box/File 15" Pedestal	CS19F19BBF	565	27 5/8	18 5/8	15
		CS19F23BBF	582	27 5/8	22 5/8	15
		CS19F29BBF	655	27 5/8	29 5/8	15

## CS19FXFF - FREESTANDING FILE/FILE 15" PEDESTAL

- All drawer fronts feature a recessed, angled full pull.
- Pedestal height shown includes glide.
- Finished top.
- Counterweight and Lock included.
- File Bars are not included with Compile pedestals. To order file bars, use product code CSPEDHFB at \$15.00 each list.

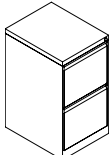
	DESCRIPTION	PRODUCT CODE	LIST PRICE	DIMENSIONS/INCHES		
				H	D	W
	Freestanding File/File 15" Pedestal	CS19F19FF	565	27 5/8	18 5/8	15
		CS19F23FF	582	27 5/8	22 5/8	15
		CS19F29FF	655	27 5/8	29 5/8	15



# STORAGE

## CS19MPXXBBF - MOBILE BOX/BOX/FILE PEDESTAL

- All drawer fronts feature a recessed, angled full pull.
- Pedestal height shown includes glide.
- Finished top.
- Counterweight, Pencil tray, and Lock included.
- File Bars are not included with Compile pedestals. To order file bars, use product code CSPEDHFB at \$15.00 each list.

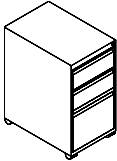
	DESCRIPTION	PRODUCT CODE	LIST PRICE	DIMENSIONS/INCHES		
				H	D	W
	Mobile Box/Box/File Pedestal	CS19MP19BBF	748	27 7/8	18 5/8	15
		CS19MP23BBF	787	27 7/8	22 5/8	15

## CS19MPXXFF - MOBILE FILE/FILE PEDESTAL

- All drawer fronts feature a recessed, angled full pull.
- Pedestal height shown includes glide.
- Finished top.
- Counterweight and Lock included.
- File Bars are not included with Compile pedestals. To order file bars, use product code CSPEDHFB at \$15.00 each list.

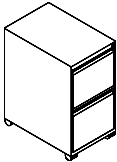
	DESCRIPTION	PRODUCT CODE	LIST PRICE	DIMENSIONS/INCHES		
				H	D	W
	Mobile File/File Pedestal	CS19MP19FF	748	27 7/8	18 5/8	15
		CS19MP23FF	787	27 7/8	22 5/8	15

## CSMCPXXBFNC - MOBILE BOX/FILE PEDESTAL WITH 60MM CASTERS

- Mobile pedestal that includes one pencil tray.
- Includes factory installed counterweight.
- Lock is standard.
- 60mm high castors.
- For use with pedestal seat cushion. See model below.
- Casters do not lock.

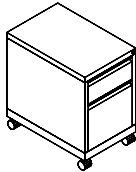
	DESCRIPTION	PRODUCT CODE	LIST PRICE	DIMENSIONS/INCHES		
				H	D	W
	Mobile Box/File Pedestal with 60mm Castors	CSMCP19BFNC	813	23.7/8	18.5/8	15
		CSMCP23BFNC	829	23.7/8	22.5/8	15

# STORAGE

## CSCUSH15 - PEDESTAL SEAT CUSHIONS

- Cushions will have single stitching at the seams.
- Velcro included for quick attachment to pedestal file.
- 1" Cushion will have a rectilinear design on all sides.
- 2" Cushion will have waterfall edges Front and Back,
- Cushions are for use on CSMCPXXBFNC Mobile Pedestals.
- Please choose a fabric from the standard cushion textiles on pages 94-96

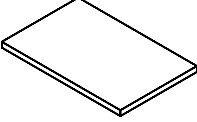
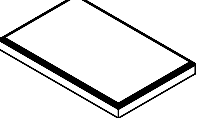
DESCRIPTION	PRODUCT CODE	LIST PRICE/GRADES															DIM./INCH			YRDS		
		1	2	3	4	5	6	7	8	9	10	11	12	13	14	15	16	17	H		D	W
 Pedestal Seat Cushions - 1" Thick	CSCUSH15X18-5/8X1	205	238	263	297	348	370	415	489	544	606	733	870	968	1102	1367	1633	1901	1	18.625	15	1
	CSCUSH15X22-5/8X1	229	262	287	321	372	394	439	513	568	630	757	894	989	1122	1389	1655	1924	1	22.625	15	1
 Pedestal Seat Cushions - 2" Thick	CSCUSH15X18-5/8X2	227	259	283	318	370	392	437	509	565	627	752	892	1246	1423	1777	2131	2490	2	18.625	15	2
	CSCUSH15X22-5/8X2	255	288	317	363	426	456	515	608	678	758	923	1097	1271	1449	1802	2158	2514	2	22.625	15	2

## CSSL13 - LOW PROFILE SHELF

- 13" deep panel-mounted storage shelf with backlip.
- Mounting brackets are included.

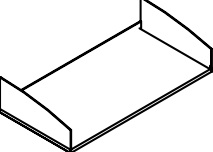
DESCRIPTION	PRODUCT CODE	LIST PRICE	DIMENSIONS/INCHES		
			H	D	W
 Low Profile Shelf - 13"	CSSL1324	136	5	13	24
	CSSL1330	150	5	13	30
	CSSL1336	163	5	13	36
	CSSL1342	175	5	13	42
	CSSL1348	184	5	13	48
	CSSL1354	192	5	13	54
	CSSL1360	198	5	13	60

## CSOF13 - KD OVERHEAD

- Mounting brackets are included.
- Door retracts up and over the cabinet.
- Ready for quick assembly on site.
- Quality steel construction.
- 60" unit is reinforced for proper weight distribution.
- Inside dimensions: 12" h x 12.75" d

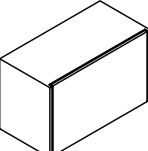
DESCRIPTION	PRODUCT CODE	LIST PRICE	DIMENSIONS/INCHES		
			H	D	W
 KD Overhead - 13"	CSOF1324	357	14.5	13	24
	CSOF1330	392	14.5	13	30
	CSOF1336	432	14.5	13	36
	CSOF1342	457	14.5	13	42
	CSOF1348	483	14.5	13	48
	CSOF1354	547	14.5	13	54
	CSOF1360	591	14.5	13	60

## CMSLK13 - LOCK FOR KD OVERHEAD

- Must be specified separately.

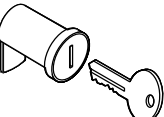
DESCRIPTION	PRODUCT CODE	LIST PRICE	DIMENSIONS/INCHES		
			H	D	W
 Lock for KD Overhead	CMSLK13	44			



# STORAGE

## CSLOCKKEY - CORE AND KEY

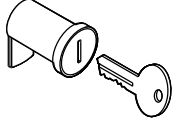
	DESCRIPTION	PRODUCT CODE	LIST PRICE	DIMENSIONS/INCHES		
				H	D	W
	LOCKKEY - Core and Key	CSLOCKKEY	42			

## CMEK93 - EXTRA KEY

- Must be specified at time of order.

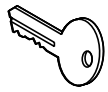
	DESCRIPTION	PRODUCT CODE	LIST PRICE	DIMENSIONS/INCHES		
				H	D	W
	Extra Key	CMEK93	19			

## CMDAOHXX - CENTER MOUNT OVERHEAD

- Inside dimensions 13" high x 13" deep.
- Laminate Overhead. No doors.
- Available in standard Compile laminate finishes.
- Top mount on panels.
- Overhead Support Brackets are included.

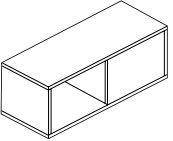
	DESCRIPTION	PRODUCT CODE	LIST PRICE	DIMENSIONS/INCHES		
				H	D	W
	Center Mount Overhead - 13"	CMDAOH36	1121	15	13	36
		CMDAOH42	1216	15	13	42
		CMDAOH48	1273	15	13	48
		CMDAOH54	1369	15	13	54
		CMDAOH60	1423	15	13	60

## CMADAXPM - ADA COMPLIANT OVERHEAD STORAGE UNIT

- Panel Mounted Overhead Storage with metal sides and opaque door that retracts on top of the unit
- Meets CSA B651 Barrier Free Design & ADA (American Disabilities Act).
- 16" high units accept standard and A4 binders.
- All shelves are reinforced for proper weight distribution.
- Inside dimensions: 14.25" high x 12" deep.
- Unit includes attachment hardware, lock and mounting brackets. Back not included.
- Shipped partially assembled.
- Available in standard Compile paint colors only. Door made of opaque plastic. \*\*add 10% upcharge for Fog.

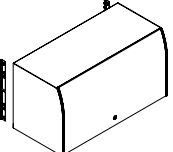
	DESCRIPTION	PRODUCT CODE	LIST PRICE	DIMENSIONS/INCHES		
				H	D	W
	ADA Compliant Overhead Storage Unit	CMADA30PM	1139	16	14.2	30
		CMADA36PM	1230	16	14.2	36
		CMADA42PM	1314	16	14.2	42
		CMADA48PM	1403	16	14.2	48
		CMADA54PM	1490	16	14.2	54
		CMADA60PM	1423	16	14.2	60

# STORAGE

## CWMA - VERTICAL CHANNEL

- Used to attach system components to fixed wall.
- Panel frame finish.
- Comes in 60" length only.
- Care should be taken to mount adapters only to wall studs using correct fasteners.
- Does not include mounting hardware. Mounting hardware selection to be based on wall material. Sold in pairs.
- Failure to do this may result in collapse of the unit and subsequent possible personal injury.
- Compile vertical channels cannot be shared.

DESCRIPTION	PRODUCT CODE	LIST PRICE	DIMENSIONS/INCHES		
			H	W	D
Vertical Channel	CWMA60	39	60	0.6	0.7

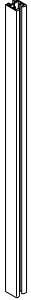

## CS19XX-1X1FH - ONE 1/2 HEIGHT FIXED FRONT & ONE 12" FIXED FRONT LATERAL FILE

- 1/2 Height Box Drawer.
- 1 Fixed Drawer Front.
- Includes Lock.
- Lateral File Top is required when not installed under a worksurface.
- Counterweights must be specified on lateral files with pull out drawers, unless worksurface supporting, ganged together or anchored to the floor or wall.

DESCRIPTION	PRODUCT CODE	LIST PRICE	DIMENSIONS/INCHES		
			H	D	W
One 1/2 Height Fixed Front & One 12" Fixed Front Lateral File	CS1930P-1X1FH	1241	21.1875	19.25	30
	CS1936P-1X1FH	1325	21.1875	19.25	36
	CS1942P-1X1FH	1407	21.1875	19.25	42

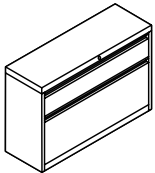

## CS19XX-1XSND - ONE 1/2 HEIGHT OPEN SHELF & ONE 12" OPEN SHELF LATERAL CABINET

- 1/2 Height Open Shelf.
- Bottom Open Shelf.

DESCRIPTION	PRODUCT CODE	LIST PRICE	DIMENSIONS/INCHES		
			H	D	W
One 1/2 Height Open Shelf & One 12" Open Shelf Lateral Cabinet	CS1930-1XSND	622	21.1875	19.25	30
	CS1936-1XSND	707	21.1875	19.25	36
	CS1942-1XSND	787	21.1875	19.25	42

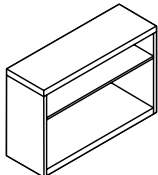

# STORAGE

## CSCUSH19 - LATERAL SEAT CUSHIONS

- Cushions will have single stitching at the seams,
- Velcro included for quick attachment to lateral file.
- 1" Cushion will have a rectilinear design on all sides.
- 2" Cushion will have waterfall edges Front and Back.
- Please choose a fabric from the standard cushion textiles on pages 244-246.

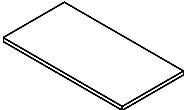
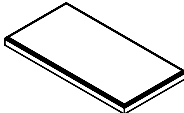
	DESCRIPTION	PRODUCT CODE	LIST PRICE/GRADES														DIM./INCH			YRDS			
			1	2	3	4	5	6	7	8	9	10	11	12	13	14	15	16	17		H	D	W
	Lateral Seat	CSCUSH19-25X30X1	374	416	448	494	564	595	658	755	830	914	1086	1268	1417	1597	1951	2306	2661	1	19	30	1
	Cushions - 1" Thick	CSCUSH19-25X36X1	388	430	462	510	578	609	672	769	844	928	1100	1281	1428	1606	1962	2317	2675	1	19	36	1
		CSCUSH19-25X42X1	402	443	476	522	591	622	684	780	856	941	1112	1295	1369	1547	1902	2257	2613	1	19	42	1
	Lateral Seat	CSCUSH19-25X30X2	415	457	489	535	605	636	697	793	869	954	1125	1308	1380	1558	1914	2268	2626	2	19	30	2
	Cushions - 2" Thick	CSCUSH19-25X36X2	426	468	500	546	615	647	708	804	880	965	1136	1319	1391	1568	1924	2277	2634	2	19	36	2
		CSCUSH19-25X42X2	442	484	516	564	632	663	724	823	896	981	1152	1335	1401	1580	1933	2290	2645	2	18	42	2

## CWFT - LATERAL FILE TOPS

- Available in standard Compile finishes.

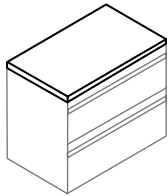
	DESCRIPTION	PRODUCT CODE	LIST PRICE	DIMENSIONS/INCHES		
			LP	H	D	W
	Lateral File Tops	CWFT1930	163	1	19.25	30
		CWFT1936	167	1	19.25	36
		CWFT1942	214	1	19.25	42
	2 Lateral Files SBS Top	CWFT1960	339	1	19.25	60
		CWFT1972	367	1	19.25	72
		CWFT1984	597	1	19.25	84
	4 Lateral File BTB Top	CWFT3860	673	1	38.75	60
		CWFT3872	765	1	38.75	72
		CWFT3884	907	1	38.75	84

## CS19XXP - 2F12 - LATERAL FILES - 2 DRAWERS WITH COUNTERWEIGHT

- Counterweight is standard. Two fixed front drawers.
- Side-to-side hanging file bars included.
- Drawers are 12.25" high.
- File cannot be used to store standard three ring binders.
- Lock included.

	DESCRIPTION	PRODUCT CODE	LIST PRICE	DIMENSIONS/INCHES		
				H	D	W
	Lateral Files - 2 Drawers	CS1930P-2F12	985	27.14	19.25	30
	with Counterweight	CS1936P-2F12	1061	27.14	19.25	36
		CS1942P-2F12	1103	27.14	19.25	42

# STORAGE

## CS19XXP - 3F12 - LATERAL FILES - 3 DRAWERS WITH COUNTERWEIGHT

- Counterweight is standard. Three fixed front drawers.
- Side-to-side hanging file bars included.
- Drawers are 12.25" high.
- File cannot be used to store standard three ring binders.
- Lock included.

	DESCRIPTION	PRODUCT CODE	LIST PRICE	DIMENSIONS/INCHES		
				H	D	W
	Lateral Files - 3 Drawers with Counterweight	CS1930P-3F12	1226	39.52	19.25	30
		CS1936P-3F12	1292	39.52	19.25	36
		CS1942P-3F12	1349	39.52	19.25	42

## CS19XXP - 4F12 - LATERAL FILES - 4 DRAWERS WITH COUNTERWEIGHT

- Counterweight is standard. Four fixed front drawers.
- Side-to-side hanging file bars included.
- Drawers are 12.25" high.
- File cannot be used to store standard three ring binders.
- Posting shelf option NOT available.
- Lock included.

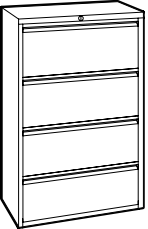
	DESCRIPTION	PRODUCT CODE	LIST PRICE	DIMENSIONS/INCHES		
				H	D	W
	Lateral Files - 4 Drawers with Counterweight	CS1930P-4F12	1565	51.89	19.25	30
		CS1936P-4F12	1639	51.89	19.25	36
		CS1942P-4F12	1764	51.89	19.25	42

## CS19XXP - 5F12 - LATERAL FILES - 5 DRAWERS

- Four fixed front drawers plus top drawer with receding door and roll-out shelf.
- Side-to-side hanging file bars included.
- Drawers are 12.25" high.
- File cannot be used to store standard three ring binders.
- Posting shelf option NOT available.
- Lock included.

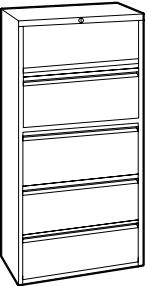
	DESCRIPTION	PRODUCT CODE	LIST PRICE	DIMENSIONS/INCHES		
				H	D	W
	Lateral Files - 5 Drawers	CS1930P-5F12	1863	66.39	19.25	30
		CS1936P-5F12	1945	66.39	19.25	36
		CS1942P-5F12	2052	66.39	19.25	42



# STORAGE

## CSPT - STORAGE TOWERS

- Model CSPT3-2BFL has wardrobe section on the left and drawers on the right. compartment, 2 box drawers and 1 file drawer. Locker compartment has one fixed shelf.
- Model CSPT3-2BFR has wardrobe section on the right and drawers on the left.
- Includes ventilated 24"D wardrobe section (ventilated on bottom of cabinet), locker • Locking.

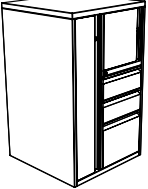
	DESCRIPTION	PRODUCT CODE	LIST PRICE	DIMENSIONS/INCHES		
				H	D	W
	Storage Tower - 2 Box/1 File Drawer	CSPT3-2BFL	2774	39.52	24	24
		CSPT3-2BFR	2774	39.52	24	24

## CSPT - STORAGE TOWERS

- Model CSPT3-2FL has wardrobe section on the left and drawers on the right. compartment, 2 box drawers and 1 file drawer. Locker compartment has one fixed shelf.
- Model CSPT3-2FR has wardrobe section on the right and drawers on the left.
- Includes ventilated 24"D wardrobe section (ventilated on bottom of cabinet), locker • Locking.

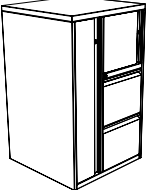
	DESCRIPTION	PRODUCT CODE	LIST PRICE	DIMENSIONS/INCHES		
				H	D	W
	Storage Tower - 2 File Drawers	CSPT3-2FL	2774	39.52	24	24
		CSPT3-2FR	2774	39.52	24	24

## CSPT - STORAGE TOWERS

- Model CSPT4-2BFL has wardrobe section on the left and drawers on the right. compartment, 2 box drawers and 1 file drawer. Locker compartment has one fixed shelf.
- Model CSPT4-2BFR has wardrobe section on the right and drawers on the left.
- Includes ventilated 24"D wardrobe section (ventilated on bottom of cabinet), locker • Locking.

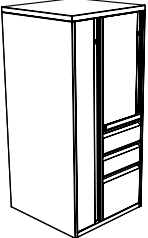
	DESCRIPTION	PRODUCT CODE	LIST PRICE	DIMENSIONS/INCHES		
				H	D	W
	Storage Tower - 2 Box/1 File Drawer	CSPT4-2BFL	2789	51.89	24	24
		CSPT4-2BFR	2789	51.89	24	24



# STORAGE

## CSPT - STORAGE TOWERS

- Model CSPT4-2FL has wardrobe section on the left and drawers on the right.
- Model CSPT4-2FR has wardrobe section on the right and drawers on the left.
- Includes ventilated 24"D wardrobe section (ventilated on bottom of cabinet), locker compartment, 2 box drawers and 1 file drawer. Locker compartment has one fixed shelf.
- Locking.

DESCRIPTION	PRODUCT CODE	LIST PRICE	DIMENSIONS/INCHES		
			H	D	W
Storage Tower - 2 File Drawers	CSPT4-2FL	2789	51.89	24	24
	CSPT4-2FR	2789	51.89	24	24

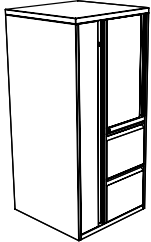

## CSPT - STORAGE TOWERS

- Model CSPT5-2BFL has wardrobe section on the left and drawers on the right.
- Model CSPT5-2BFR has wardrobe section on the right and drawers on the left.
- Includes ventilated 24"D wardrobe section (ventilated on bottom of cabinet), locker compartment, 2 box drawers and 1 file drawer. Locker compartment has one fixed shelf.
- Locking.

DESCRIPTION	PRODUCT CODE	LIST PRICE	DIMENSIONS/INCHES		
			H	D	W
Storage Tower - 2 Box/1 File Drawe	CSPT5-2BFL	2862	66.39	24	24
	CSPT5-2BFR	2862	66.39	24	24

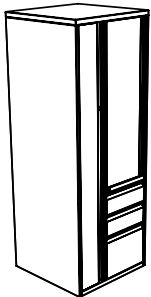

## CSPT - STORAGE TOWERS

- Model CSPT5-2FL has wardrobe section on the left and drawers on the right.
- Model CSPT5-2FR has wardrobe section on the right and drawers on the left.
- Includes ventilated 24"D wardrobe section (ventilated on bottom of cabinet), locker compartment, 2 box drawers and 1 file drawer. Locker compartment has one fixed shelf.
- Locking.

DESCRIPTION	PRODUCT CODE	LIST PRICE	DIMENSIONS/INCHES		
			H	D	W
Storage Tower - 2 File Drawers	CSPT5-2FL	2862	66.39	24	24
	CSPT5-2FR	2862	66.39	24	24

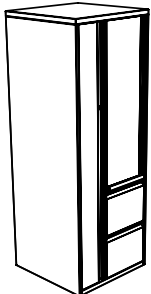

SO# \_\_\_\_\_ PO# \_\_\_\_\_ TAG# \_\_\_\_\_ Date \_\_\_\_\_

KEY#	SETS REQ'D	KEY#	SETS REQ'D	KEY#	SETS REQ'D	KEY#	SETS REQ'D	KEY#	SETS REQ'D
401		431		461		491		521	
402		432		462		492		522	
403		433		463		493		523	
404		434		464		494		524	
405		435		465		495		525	
406		436		466		496		526	
407		437		467		497		527	
408		438		468		498		528	
409		439		469		499		529	
410		440		470		500		530	
411		441		471		501		531	
412		442		472		502		532	
413		443		473		503		533	
414		444		474		504		534	
415		445		475		505		535	
416		446		476		506		536	
417		447		477		507		537	
418		448		478		508		538	
419		449		479		509		539	
420		450		480		510		540	
421		451		481		511		541	
422		452		482		512		542	
423		453		483		513		543	
424		454		484		514		544	
425		455		485		515		545	
426		456		486		516		546	
427		457		487		517		547	
428		458		488		518		548	
429		459		489		519		549	
430		460		490		520		550	

401-430 =	431-460 =	461-490 =	491-520 =	521-550 =
-----------	-----------	-----------	-----------	-----------

Total: \_\_\_\_\_

NOTE : If Key Alike Instructions are not submitted to EVOLVE with the Customer's Purchase Order, all components will be keyed randomly.



accessories

# ACCESSORIES

## CATB - TACK BOARD

- Provide a tackable surface for notes and memos in a work area.
- Includes two pairs of panel-mounting brackets.
- Only fabric must be specified.
- 10" to be installed on 42" h panels.
- 21" specified for use under overhead shelf or storage bin.
- 24" for use without any overheads.

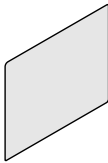
	DESCRIPTION	PRODUCT CODE	LIST PRICE		DIMENSIONS/INCHES		
			Gr1	Gr2	H	W	D
	Tack Board - 10" High	CATB1024	184	195	10	24	
		CATB1030	196	210	10	30	
		CATB1036	216	230	10	36	
		CATB1042	238	256	10	42	
		CATB1048	261	279	10	48	
		CATB1054	288	310	10	54	
	CATB1060	307	331	10	60		
	Tack Board - 21" High	CATB2124	266	277	21	24	
		CATB2130	289	303	21	30	
		CATB2136	328	339	21	36	
CATB2142		376	394	21	42		
CATB2148		420	436	21	48		
CATB2154		459	481	21	54		
Tack Board - 24" High	CATB2424	266	277	21	24		
	CATB2430	289	303	24	30		
	CATB2436	328	339	24	36		
	CATB2442	376	394	24	42		
	CATB2448	420	436	24	48		
	CATB2454	459	481	24	54		
CATB2460	504	528	24	60			

## CAWB - WHITE MARKER BOARD

- Provides a writing surface within a work area.
- Includes two pairs of panel-mounting brackets.
- 10" to be installed on 42" h panels.
- 21" specified for use under overhead shelf or storage bin.
- 24" for use without any overheads.

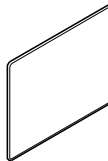
	DESCRIPTION	PRODUCT CODE	LIST PRICE		DIMENSIONS/INCHES		
					H	W	D
	White Marker Board - 10" High	CAWB1030	178		10	30	
		CAWB1036	200		10	36	
		CAWB1042	222		10	42	
		CAWB1048	255		10	48	
White Marker Board - 21" High	White Marker Board - 21" High	CAWB2130	308		21	30	
		CAWB2136	347		21	36	
		CAWB2142	391		21	42	
		CAWB2148	455		21	48	
White Marker Board - 24" High	White Marker Board - 24" High	CAWB2430	308		24	30	
		CAWB2436	347		24	36	
		CAWB2442	391		24	42	
		CAWB2448	455		24	48	



# ACCESSORIES

## CALB - LOAD BAR

- Frame available in Steel (STL), Black (BLK), and Nevada (NEV) only.
- Mounting brackets and clear end caps are included.

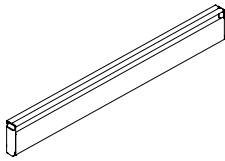
	DESCRIPTION	PRODUCT CODE	LIST PRICE	DIMENSIONS/INCHES		
				H	W	D
	Load Bar	CALB24	150	2.25	24	1
		CALB30	165	2.25	30	1
		CALB36	180	2.25	36	1
		CALB42	209	2.25	42	1
		CALB48	241	2.25	48	1
		CALB54	257	2.25	54	1
		CALB60	275	2.25	60	1

## CSABB01 - BINDER BIN

- Must be ordered in conjunction with a load bar option.
- Available in standard and premium paint selections. See "Textile & Finish Listings" in Introduction for complete list of offerings and conditions.

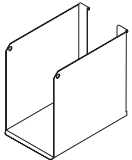
	DESCRIPTION	PRODUCT CODE	LIST PRICE	DIMENSIONS/INCHES		
				H	W	D
	Binder Bin	CSABB01	81	9	4	10.25

## CSALT01 - LETTER TRAY

- Must be ordered in conjunction with a load bar option.
- Available in standard and premium paint selections. See "Textile & Finish Listings" in Introduction for complete list of offerings and conditions.

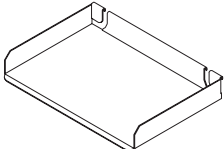
	DESCRIPTION	PRODUCT CODE	LIST PRICE	DIMENSIONS/INCHES		
				H	W	D
	Letter Tray	CSALT01	69	2	13.5	9.25

## CSASS01 - SLANT SORTER

- Must be ordered in conjunction with a load bar option.
- Available in standard and premium paint selections. See "Textile & Finish Listings" in Introduction for complete list of offerings and conditions.

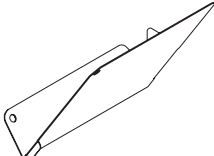
	DESCRIPTION	PRODUCT CODE	LIST PRICE	DIMENSIONS/INCHES		
				H	W	D
	Slant Sorter	CSASS01L	51	9.5	5	10.25
		CSASS01R	51	9.5	5	10.25

# ACCESSORIES

## EVAMB01 - MEDIA BIN

- Must be ordered in conjunction with a load bar option.
- Available in standard and premium paint selections. See "Textile & Finish Listings" in Introduction for complete list of offerings and conditions.

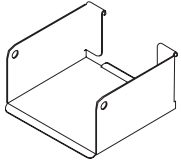
	DESCRIPTION	PRODUCT CODE	LIST PRICE	DIMENSIONS/INCHES		
				H	W	D
	Media Bin	CSAMB01	63	3	5.75	5.25

## CSAUT01 - UTILITY TRAY

- Must be ordered in conjunction with a load bar option.
- Available in standard and premium paint selections. See "Textile & Finish Listings" in Introduction for complete list of offerings and conditions.

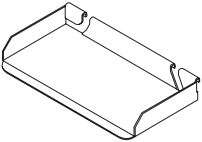
	DESCRIPTION	PRODUCT CODE	LIST PRICE	DIMENSIONS/INCHES		
				H	W	D
	Utility Tray	CSAUT01	43	1	8.5	3.75

## CSAFS01 - FLIP SORTER

- Must be ordered in conjunction with a load bar option. in Introduction for complete list of offerings and conditions.
- Comes with nickel plated wire.
- Available in standard and premium paint selections. See "Textile & Finish Listings"

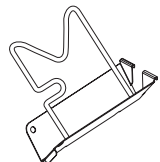
	DESCRIPTION	PRODUCT CODE	LIST PRICE	DIMENSIONS/INCHES		
				H	W	D
	Flip Sorter	CSAFS01	59	9.25	2.75	9.25

## CSAPP01 - MAIL BOX

- Must be ordered in conjunction with a load bar option.
- Available in standard and premium paint selections. See "Textile & Finish Listings" in Introduction for complete list of offerings and conditions.

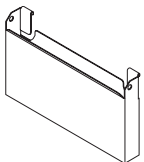
	DESCRIPTION	PRODUCT CODE	LIST PRICE	DIMENSIONS/INCHES		
				H	W	D
	Mail Box	CSAPP01	101	9	12	2.75



# ACCESSORIES

## CSATH01 - TELEPHONE HOLDER

- Must be ordered in conjunction with a load bar option.
- Available in standard and premium paint selections. See "Textile & Finish Listings" in Introduction for complete list of offerings and conditions.

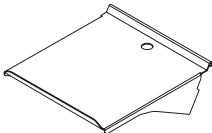
	DESCRIPTION	PRODUCT CODE	LIST PRICE	DIMENSIONS/INCHES		
				H	W	D
	Telephone Holder	CSATH01	96	2	9	10

## CPNP01 - NAME PLATE

- Name Plate attached to 1" increment slots.
- Available in single sided (parallel to panel) or double sided (perpendicular to panel) for isle application displaying name on both sides.
- Injection molded frame and die cast base with black rubberized finish.
- Includes two slide-in name cards, steel brackets and fasteners.
- Available in black only.
- Free template for additional slide-in name cards are available at [http://www.evolvefurnituregroup.com/Product\\_Sheets.html](http://www.evolvefurnituregroup.com/Product_Sheets.html)

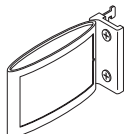
	DESCRIPTION	PRODUCT CODE	LIST PRICE	DIMENSIONS/INCHES		
				H	W	D
	Name Plate	CPNP01	147	3.30	5.3	1.25

## CMCH01 - COAT HOOK

- Coat hook for Compile panels.
- Available in standard Compile paint finishes: DWT, BLK, STL, NEV.

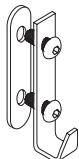
	DESCRIPTION	PRODUCT CODE	LIST PRICE	DIMENSIONS/INCHES		
				H	W	D
	Coat Hook	CMCH01	63	5.5	0.65	1

## CATP91 - TOUCH-UP PAINT KIT

- Available in standard paint colors to facilitate easy touch-ups.
- 1/2 fl. ounce bottle (spray not available).
- Specify color.

	DESCRIPTION	PRODUCT CODE	LIST PRICE	DIMENSIONS/INCHES		
				H	W	D
	Touch-Up Paint Kit	CATP91	50			





# textiles and finishes

## Care and Cleaning

The following guide encompasses the Compile System line.

The guide was compiled using information from our "raw" material suppliers and is relevant only to our standard offering finishes and textiles.

---

### FABRICS

To extend the life of your upholstered panels, regularly dust the panel to prevent airborne particles from penetrating the fabric surface.

For light soiling, use a damp cloth and blot the spot with very slight pressure, taking care never to soak the fabric. Dry with a clean cloth by blotting - never rub fabric. More intense stains can be treated the same way, but with a mild detergent. Always test fabric first in an unseen area before using any cleaning method.

### PANEL FRAMES

The panel frames are manufactured out of sturdy aluminum with a powder coated enamel paint finish. To clean the frames of the panels, and all hardware associated with the Evolve line, simply utilize a clean, damp cloth. For stubborn stains on the panel frames, you may consider adding a mild detergent.

### GLAZED PANELS

Cleaning of the glazing in panels should only be done with a damp lint-free cloth. A mild detergent can be used if necessary. Do not use paper towels in combination with a window cleaner-this may cause scratches to the glazing.

### WORKSURFACES

The worksurfaces are manufactured using primarily Nevamar Brand laminates as the exposed surface. To properly clean these areas, it is best to use a clean, damp cloth and circular motion to prevent streaks. For stubborn stains, you are able to add a mild detergent to the water. Be certain not to use an ammonia-based solution. It will react with the PVC, or wood edge trim, causing permanent damage to the contacted areas.

### ACCESSORIES

The accessories sold with the Evolve product line can be simply cleaned with a clean, damp cloth. If they are really dirty, a mild, non-abrasive solution may be added. Wipe with a damp cloth after the solution, and finally, a dry cloth.

**LAMINATES – THERMALLY FUSED & HIGH PRESSURE**

Absolute Acajou* .....	<b>ACJ</b>
Asian Night* .....	<b>ASN</b>
Avant Cherry* .....	<b>AWC</b>
Avant Honey* .....	<b>AWH</b>
Black .....	<b>BLK</b>
Blizzard .....	<b>BZD</b>
Blizzard Matrix .....	<b>BMX</b>
Brushed Cobalt* .....	<b>BRC</b>
Clear Maple* .....	<b>CMB</b>
Custom Grey .....	<b>CGY</b>
Dark Espresso* .....	<b>DES</b>
Designer White .....	<b>DWT</b>
Grey Matrix .....	<b>GRX</b>
Fashionista .....	<b>FAS</b>
First Class .....	<b>FCL</b>
Hayden Linen .....	<b>HLN</b>
Noce Biondo .....	<b>NBL</b>
Noce Grigio .....	<b>NGL</b>
Noce Leggero .....	<b>NEL</b>
Noce Medio .....	<b>NML</b>
Quartered Mahogany* .....	<b>QTM</b>
Sheer Beauty .....	<b>SBY</b>
Stone Dust .....	<b>SDT</b>
Stone Linen .....	<b>SLN</b>
Storm Grey .....	<b>SOG</b>
Studio White Matrix .....	<b>SWX</b>
String .....	<b>STG</b>
Walnut Heights* .....	<b>WHE</b>
Winter Cherry .....	<b>WCR</b>
White Chocolate* .....	<b>WHC</b>

Additional paint and laminates may be available. Contact Evolve Customer Care for details.

\* Matching Wood Grain PVC edge available.

**PVC EDGE TRIM**

Absolute Acajou .....	<b>AAE</b>
Asian Night .....	<b>ASE</b>
Avant Cherry .....	<b>ACE</b>
Avant Honey .....	<b>AHE</b>
Black .....	<b>BLK</b>
Blizzard .....	<b>BZD</b>
Brushed Cobalt .....	<b>BRC</b>
Charcoal .....	<b>CHR</b>
Clear Maple .....	<b>CMB</b>
Dark Espresso* .....	<b>DES</b>
Designer White .....	<b>DWE</b>
Fashionista .....	<b>FAS</b>
First Class .....	<b>FCL</b>
Nevada .....	<b>NEV</b>
Quartered Mahogany .....	<b>QTM</b>
Sheer Beauty .....	<b>SBY</b>
Silver .....	<b>SIL</b>
Taupe .....	<b>TPE</b>
Tungsten .....	<b>TUN</b>
Walnut Heights .....	<b>WHE</b>
White Chocolate* .....	<b>CBE</b>
Winter Cherry .....	<b>WCR</b>

\*1-7/16" HPW PVC Trim for Worksurfaces is not available in Dark Espresso (DES).

**WOOD VENEER WORKSURFACES\***

Almond Cherry .....	<b>AMW</b>
Amber Cherry .....	<b>ACW</b>
Biscotti .....	<b>BTW</b>
Cocoa Walnut .....	<b>CAW</b>
Coral .....	<b>CRW</b>
Dark Cherry .....	<b>DCW</b>
Dark Walnut .....	<b>DWW</b>
Espresso Walnut .....	<b>EWV</b>
Evening Oak .....	<b>EVW</b>
Grey on Oak .....	<b>GRW</b>
Hazelnut .....	<b>HAW</b>
Java .....	<b>JAW</b>
Latte Walnut .....	<b>LTW</b>
Mahogany on Walnut .....	<b>MHW</b>
Milestone .....	<b>MTW</b>
Natural Maple .....	<b>MPW</b>
Natural Walnut .....	<b>NLW</b>
Red Cherry .....	<b>RCW</b>
Umber Walnut .....	<b>ULW</b>
Vintage Cherry .....	<b>VNW</b>
Walnut .....	<b>WLW</b>
Warm Cherry .....	<b>WCW</b>
White Maple .....	<b>WMW</b>

All wood veneer worksurfaces are 1.38" thick.

\*Note: Wood veneer options for worksurfaces are available at an upcharge and with an extended lead time. Contact Evolve Customer Care for details.

**PAINT & FRAME COLORS**

(for application to trim, steel components, PVC, vertical and horizontal members)	
Black .....	<b>BLK</b>
Designer White .....	<b>DWT</b>
Fog .....	<b>FOG</b>
Nevada .....	<b>NEV</b>



**PANEL FABRICS – GRADE 1**

**Anchorage** - 35% Post - consumer Recycled Polyester and 65% Pre -consumer Recycled Polyester

Birch .....	<b>AN40</b>
Green Apple .....	<b>AN41</b>
Lapis .....	<b>AN42</b>
Straw .....	<b>AN43</b>
Wolf .....	<b>AN44</b>
Goose .....	<b>AN45</b>
Angora .....	<b>AN46</b>
Cumin .....	<b>AN47</b>
Asteroid .....	<b>AN48</b>
Geranium .....	<b>AN49</b>
Thistle .....	<b>AN50</b>
Graphite .....	<b>AN51</b>
Slate .....	<b>AN52</b>
Quarry Blue .....	<b>AN53</b>
Onyx .....	<b>AN54</b>
Pumpkin .....	<b>AN55</b>
Red Delicious .....	<b>AN56</b>
Sunshine .....	<b>AN57</b>
Waterfall .....	<b>AN59</b>
Vanilla .....	<b>AN61</b>
Vanilla .....	<b>AN61</b>
Cobalt .....	<b>AN62</b>
Cloud .....	<b>AN64</b>

**Aurora** - 100% Polyester, 80% minimum Post-Consumer Recycled Polyester

Cloud .....	<b>AU20</b>
Seal .....	<b>AU21</b>
Fog .....	<b>AU22</b>
Pewter .....	<b>AU23</b>
Granite .....	<b>AU24</b>
Oat .....	<b>AU25</b>
Coconut .....	<b>AU26</b>
Latte .....	<b>AU27</b>
Lake .....	<b>AU28</b>
Frost .....	<b>AU29</b>

**Chance** - 63% Virgin Polyester, 37% Post-Consumer Recycled Polyester

Mist .....	<b>CN51</b>
Dill .....	<b>CN52</b>
Island .....	<b>CN53</b>
Plaza .....	<b>CN54</b>
Tranquil .....	<b>CN55</b>
Malt .....	<b>CN56</b>
Navajo .....	<b>CN57</b>
Prairie .....	<b>CN58</b>
Cinder .....	<b>CN59</b>
Oasis .....	<b>CN66</b>

**Linea** - 100% Post Consumer Recycled Polyester

Queue .....	<b>LN41</b>
Cord .....	<b>LN42</b>
Twine .....	<b>LN43</b>
Thread .....	<b>LN44</b>
Contour .....	<b>LN45</b>
Silhouette .....	<b>LN46</b>
Cable .....	<b>LN47</b>
Route .....	<b>LN48</b>

**Lisbon** - 100% Polyester, 67% Post-Consumer Recycled Polyester

Gesso .....	<b>LS11</b>
Dusk .....	<b>LS12</b>
Grey .....	<b>LS13</b>
Ivory .....	<b>LS14</b>
Henna .....	<b>LS15</b>
Nocturnal .....	<b>LS16</b>
Moss .....	<b>LS17</b>
Navy .....	<b>LS18</b>
Buff .....	<b>LS19</b>
Spa .....	<b>LS20</b>

**Loopy** - 100% Recycled Polyester

Oyster .....	<b>LP60</b>
Putty .....	<b>LP61</b>
Marble .....	<b>LP62</b>
Hazelnut .....	<b>LP63</b>
Latte .....	<b>LP64</b>
Bay .....	<b>LP65</b>
Wild Rice .....	<b>LP66</b>
Harbor .....	<b>LP67</b>

**Melody** - 100% Recycled Polyester

Spray .....	<b>ME40</b>
Pond .....	<b>ME41</b>
Sand Bar .....	<b>ME42</b>
Silt .....	<b>ME43</b>
Pebble .....	<b>ME44</b>
Lake .....	<b>ME45</b>
Gravel .....	<b>ME46</b>
Boulder .....	<b>ME47</b>

**Merge** - 100% Polyester, 75% minimum Post-Consumer Recycled Polyester

Fawn .....	<b>MG20</b>
Marshmallow .....	<b>MG21</b>
Driftwood .....	<b>MG22</b>
Dove .....	<b>MG23</b>
Graphite .....	<b>MG24</b>
Slate .....	<b>MG25</b>
Eucalyptus .....	<b>MG26</b>
Fire Engine .....	<b>MG27</b>
Mediterranean .....	<b>MG28</b>
Midnight .....	<b>MG29</b>

**Pinpoint** - 100% Post-Consumer Recycled Polyester

Bliss .....	<b>PN11</b>
Delight .....	<b>PN12</b>
Dune .....	<b>PN13</b>
Infusion .....	<b>PN14</b>
Ebony .....	<b>PN15</b>
Fresh .....	<b>PN16</b>
Carrot .....	<b>PN17</b>
Splash .....	<b>PN18</b>
Vibe .....	<b>PN19</b>
Gala .....	<b>PN20</b>

**Streak** - 100% Recycled Polyester

Beach .....	<b>SR81</b>
Shade .....	<b>SR86</b>
Stretch .....	<b>SR88</b>
Sprint .....	<b>SR89</b>
Roll .....	<b>SR91</b>
Dart .....	<b>SR92</b>
Zoom .....	<b>SR93</b>
Splash .....	<b>SR94</b>
Whiz .....	<b>SR95</b>
Flash .....	<b>SR96</b>

**Tek** - 100% Recycled Polyester

Finesse .....	<b>TX60</b>
Grain .....	<b>TX61</b>
Essence .....	<b>TX62</b>
Warp .....	<b>TX64</b>
Mesh .....	<b>TX67</b>
Form .....	<b>TX69</b>
Spice .....	<b>TX71</b>
Glacier .....	<b>TX72</b>
Spring .....	<b>TX73</b>
Harmony .....	<b>TX74</b>
Smoke .....	<b>TX75</b>
Pebble .....	<b>TX76</b>

**Terrace** - 100% Post-Consumer Recycled Polyester

Lotus .....	<b>TC60</b>
Tigerlily .....	<b>TC61</b>
Shadow .....	<b>TC62</b>
Cobble .....	<b>TC63</b>
Cherry Blossom .....	<b>TC64</b>
Bluebell .....	<b>TC65</b>
Apple .....	<b>TC66</b>
Haze .....	<b>TC67</b>
Cerise .....	<b>TC68</b>
Twilight .....	<b>TC69</b>
Wintergreen .....	<b>TC70</b>
Ironwork .....	<b>TC71</b>
Flirt .....	<b>TC73</b>
Echo .....	<b>TC74</b>
Glacier .....	<b>TC75</b>

**PANEL FABRICS— GRADE 2**

**Cyclone** - 56% post-consumer recycled polyester and 44% polyester.

Stove Pipe .....	<b>IM37</b>
Stainless.....	<b>IM40</b>
Polished Pewter .....	<b>IM41</b>
Welded Steel .....	<b>IM43</b>
Etched Bronze.....	<b>IM44</b>
Fired Titanium.....	<b>IM46</b>
Chrome.....	<b>IM49</b>
Dark Annealed.....	<b>IM50</b>
Karat.....	<b>IM54</b>
Red Metal.....	<b>IM55</b>
Oxidized Bronze.....	<b>IM56</b>
Bright Ray.....	<b>IM57</b>
Bismuth Crystal .....	<b>IM58</b>
Gallium Blue.....	<b>IM59</b>

**Dashing** -100% Post-Consumer Recycled Polyester

Classic Silver.....	<b>DS21</b>
Refined Marble.....	<b>DS22</b>
Antique Sage.....	<b>DS23</b>
Polished Slate .....	<b>DS24</b>
Genteel Beige .....	<b>DS25</b>
Bespoke Tan .....	<b>DS26</b>
Dapper Grey .....	<b>DS27</b>

**Quadrille** - 52.5% Polyester / 47.5% Recycled Polyester

\*Maximum panel width is 48'

Escapade .....	<b>QU30</b>
Shenanigan .....	<b>QU31</b>
Revelry .....	<b>QU32</b>
Spring .....	<b>QU33</b>
Regalia .....	<b>QU34</b>
Soiree.....	<b>QU35</b>
Zest.....	<b>QU36</b>
Gambol.....	<b>QU37</b>
Fair .....	<b>QU39</b>
Fiesta.....	<b>QU40</b>
Carnival .....	<b>QU41</b>
Opus .....	<b>QU43</b>
Jubilee.....	<b>QU44</b>
Masquerade.....	<b>QU45</b>
Cabarets.....	<b>QU46</b>

**PET PANEL FABRICS**

Graphite.....	<b>GPH</b>
Mist.....	<b>MTS</b>
Pewter.....	<b>PWT</b>
Harvest.....	<b>HVT</b>
Shamrock.....	<b>SHR</b>
Brick.....	<b>BRI</b>
Denim.....	<b>DEN</b>
Black.....	<b>BLK</b>
White.....	<b>WHT</b>



**GRADE 1**

**Dobby** - 96% Recycled Polyester / 4% Virgin Polyester

Snowcap.....	<b>DB30</b>
Bonsai.....	<b>DB31</b>
Cloud.....	<b>DB32</b>
Sand.....	<b>DB33</b>
Pewter.....	<b>DB34</b>
Sante Fe.....	<b>DB35</b>
Corfu.....	<b>DB36</b>
Medium Taupe.....	<b>DB37</b>
Charcoal.....	<b>DB38</b>
Berry.....	<b>DB39</b>
Royal.....	<b>DB40</b>
Titanium.....	<b>DB41</b>
Black.....	<b>DB42</b>

**Fusion** - 90% Virgin Polyester/ 10% Post-Consumer Recycled Polyester

Tangerine.....	<b>FU71</b>
Fresh.....	<b>FU72</b>
Moss.....	<b>FU73</b>
TomatoF.....	<b>FU74</b>
Aqua.....	<b>FU75</b>
Sandstone.....	<b>FU76</b>
Granite.....	<b>FU77</b>
Poppy.....	<b>FU78</b>
Cadet.....	<b>FU79</b>
Oasis.....	<b>FU80</b>
Graphite.....	<b>FU81</b>
Viola.....	<b>FU82</b>
Cobalt.....	<b>FU83</b>
Flax.....	<b>FU84</b>
Carbon.....	<b>FU85</b>

**Illusion** - 100% Virgin Polyester

Cappuccino.....	<b>II01</b>
Paprika.....	<b>II02</b>
Tropic.....	<b>II03</b>
Wicker.....	<b>II04</b>
Hemp.....	<b>II05</b>
Cayenne.....	<b>II06</b>
Maui.....	<b>II07</b>
Dusk.....	<b>II08</b>
Smoke.....	<b>II09</b>
Currant.....	<b>II10</b>
Fiji.....	<b>II11</b>
Ozone.....	<b>II12</b>
Ebony.....	<b>II13</b>

**Jenny** - 100% Polyester

Midnite.....	<b>JN01</b>
Ebony.....	<b>JN02</b>
Slate.....	<b>JN03</b>
Vermilion.....	<b>JN07</b>
Admiral.....	<b>JN08</b>
Charcoal.....	<b>JN11</b>
Silver Lining.....	<b>JN25</b>
Oatmeal.....	<b>JN26</b>
Sunflower.....	<b>JN27</b>
Cascade.....	<b>JN28</b>
Harvest.....	<b>JN29</b>
Mellon.....	<b>JN30</b>
Berry.....	<b>JN31</b>
Green Grass.....	<b>JN32</b>
Roast.....	<b>JN33</b>

**Quilt** - 100% Polyester

Black.....	<b>QL10</b>
Charcoal Grey.....	<b>QL11</b>
Navy.....	<b>QL14</b>
Wine.....	<b>QL16</b>
Silver.....	<b>QL19</b>
Feather.....	<b>QL20</b>
Dune.....	<b>QL21</b>
Meadow.....	<b>QL22</b>
Cadet.....	<b>QL23</b>
Geranium.....	<b>QL24</b>
Daisy.....	<b>QL25</b>
Quest.....	<b>QL26</b>
Punch.....	<b>QL27</b>
Tangerine.....	<b>QL28</b>
Cocoa.....	<b>QL29</b>

**Terrace** - 100% Post-Consumer Recycled Polyester

Lotus.....	<b>TC60</b>
Tigerlily.....	<b>TC61</b>
Shadow.....	<b>TC62</b>
Cobble.....	<b>TC63</b>
Cherry Blossom.....	<b>TC64</b>
Bluebell.....	<b>TC65</b>
Apple.....	<b>TC66</b>
Haze.....	<b>TC67</b>
Cerise.....	<b>TC68</b>
Twilight.....	<b>TC69</b>
Wintergreen.....	<b>TC70</b>
Ironwork.....	<b>TC71</b>
Pine Cone.....	<b>TC72</b>
Flirt.....	<b>TC73</b>
Echo.....	<b>TC74</b>

**Trak** - 100% Recycled Polyester

Taupe.....	<b>TK40</b>
Mustard.....	<b>TK41</b>
Latte.....	<b>TK42</b>
Cement.....	<b>TK43</b>
Silver.....	<b>TK44</b>
Copper.....	<b>TK45</b>
Teal.....	<b>TK46</b>
Apple.....	<b>TK47</b>
Steel.....	<b>TK48</b>
Merlot.....	<b>TK49</b>
Midnight Sky.....	<b>TK50</b>
Mocha.....	<b>TK51</b>
Carbon.....	<b>TK52</b>

**Urban** - 62% Recycled Polyester / 32% Polyester

Red Rose.....	<b>UR10</b>
Ocean Blue.....	<b>UR11</b>
Blue Bayou.....	<b>UR12</b>
Green Grass.....	<b>UR13</b>
Sandcastle.....	<b>UR14</b>
Beach Day.....	<b>UR15</b>
Boardwalk.....	<b>UR16</b>
Earth.....	<b>UR17</b>
Brown Ridge.....	<b>UR18</b>
White Sand.....	<b>UR19</b>
Granite Rock.....	<b>UR20</b>
Gravel Road.....	<b>UR21</b>
Black Coal.....	<b>UR22</b>

**Waterfall** - 60% Virgin Polyester /40% Post - Consumer Recycled Polyester

Trance.....	<b>WA40</b>
Tryst.....	<b>WA41</b>
Splash.....	<b>WA42</b>
Victoria.....	<b>WA43</b>
Imagine.....	<b>WA44</b>
Sky.....	<b>WA45</b>
Rainforest.....	<b>WA46</b>
Rumble.....	<b>WA47</b>
Prism.....	<b>WA48</b>
Tranquility.....	<b>WA49</b>
Grand.....	<b>WA50</b>
Rushing.....	<b>WA51</b>
Majestic.....	<b>WA52</b>
Pacific.....	<b>WA53</b>
Dance.....	<b>WA54</b>

**Waterfall** - 60% Virgin Polyester /40% Post - Consumer Recycled Polyester

Lime.....	<b>WV01</b>
Mint.....	<b>WV02</b>
Stone.....	<b>WV03</b>
Flame.....	<b>WV04</b>
Mykonos.....	<b>WV05</b>
Savannah.....	<b>WV06</b>
Mesa.....	<b>WV07</b>
Plasma.....	<b>WV08</b>
Cancun.....	<b>WV09</b>
Quartz.....	<b>WV10</b>
Moonrock.....	<b>WV11</b>
Rubine.....	<b>WV12</b>
Corfu.....	<b>WV13</b>
Bluejay.....	<b>WV14</b>

**GRADE 2 (FABRIC)**

**Imprint** - 100% Post-Consumer Polyester

Almond.....	<b>IM70</b>
Cork.....	<b>IM71</b>
Sand.....	<b>IM72</b>
Currie.....	<b>IM73</b>
Candy Apple.....	<b>IM74</b>
Ocean.....	<b>IM75</b>
Navy.....	<b>IM76</b>
Green Tea.....	<b>IM77</b>
Celery.....	<b>IM78</b>
Oregano.....	<b>IM79</b>
Walnut.....	<b>IM80</b>
Paprika.....	<b>IM81</b>
Graphite.....	<b>IM82</b>
Slate.....	<b>IM83</b>
Licorice.....	<b>IM84</b>

**GRADE 2 (VINYL)**

For availability of chair series in Vinyl, please contact a Global Sales Representative.

**Allante FRee** - 100% Vinyl Face / 100% Polyester Backing

Illusion .....	<b>A01F</b>
Bright White .....	<b>A02F</b>
White Crush .....	<b>A03F</b>
Ivory .....	<b>A04F</b>
Ice .....	<b>A05F</b>
Bleached Sand .....	<b>A06F</b>
Taupe Fawn .....	<b>A07F</b>
Warm Smoke .....	<b>A08F</b>
Autumn Rain .....	<b>A09F</b>
Cookie .....	<b>A10F</b>
Sierra Brick .....	<b>A11F</b>
Gibraltar .....	<b>A12F</b>
Chateau Grey .....	<b>A13F</b>
Golden Green .....	<b>A14F</b>
Oasis Green .....	<b>A15F</b>
Ink Black .....	<b>A16F</b>
Purple impulse .....	<b>A17F</b>
Italian Rose .....	<b>A18F</b>
Mountain Sky .....	<b>A19F</b>
Old Navy .....	<b>A20F</b>
Galaxy .....	<b>A21F</b>
Red Truffle .....	<b>A22F</b>
Chocolate Sundae .....	<b>A23F</b>
Province Blue .....	<b>A24F</b>
Eclipse .....	<b>A25F</b>

**GRADE 3 (RECYCLED)**

**Couture** - 100% Post-Consumer

Polyester	
Mocha .....	<b>CE71</b>
Sapphire .....	<b>CE74</b>
Neptune .....	<b>CE75</b>
Lake .....	<b>CE76</b>
Willow .....	<b>CE77</b>
Sassy .....	<b>CE78</b>
Persimmon .....	<b>CE80</b>
Carbon .....	<b>CE81</b>
Sterling .....	<b>CE82</b>



# PANEL COM REQUEST FOR APPLICATION TEST

## SEND COMPLETED FORM AND FABRIC TO:

Compile Customer Service  
565 Petrolia Road, Doors 6-13  
Toronto, Ontario M3J2X8  
Phone: 416.739.5000  
Attn: Eric Sam

Requested By: \_\_\_\_\_  
\_\_\_\_\_

Phone #: \_\_\_\_\_

Fax #: \_\_\_\_\_

Project Name \_\_\_\_\_

Dealer/Specifier \_\_\_\_\_

Dealer Contact: \_\_\_\_\_

Evolve CSR: \_\_\_\_\_

Phone #: \_\_\_\_\_

Fax #: \_\_\_\_\_

### FABRIC INFORMATION

Fabric Manufacturer: \_\_\_\_\_  
\_\_\_\_\_

Color Name: \_\_\_\_\_

Color #: \_\_\_\_\_

Pattern Name: \_\_\_\_\_

Pattern #: \_\_\_\_\_

Content: \_\_\_\_\_  
\_\_\_\_\_

Weight: \_\_\_\_\_

Width: \_\_\_\_\_

Repeat Horizontal: \_\_\_\_\_

Repeat Vertical: \_\_\_\_\_

Other Comments: \_\_\_\_\_  
\_\_\_\_\_

### REQUEST FOR APPLICATION TEST (THIS REQUIRES 2 YARDS OF FABRIC)

\_\_\_\_\_ Compile Panel

\_\_\_\_\_ Compile Tackboard

Total Number of yards for testing: \_\_\_\_\_

Please Note:

Compile is not responsible for the duty and brokerage fees for C.O.M. Fabric to clear customs. These charges will be billed to the dealer on a separate invoice.



# PANEL FABRIC SPECIFICATION SHEET

**SEND COMPLETED FORM TO:**

Compile Customer Service  
 565 Petrolia Road, Doors 6-13  
 Toronto, Ontario M3J2X8  
 Phone: 416.739.5000  
 Attn: Eric Sam

<b>SUPPLIER</b>  <b>PATTERN</b>  <b>WIDTH</b>  <b>CONTENT</b>	<b>REMARKS:</b> _____ _____ _____ _____	
<b>LIGHT FASTNESS</b>  <b>FLAMMABILITY</b>  <b>TUNNER TEST</b>	<b>REMARKS:</b> _____ _____ _____ _____	
<b>CUT PRICE</b>  <b>1 - 3 ROLLS</b>  <b>4 ROLLS</b>	<b>REMARKS:</b> _____ _____ _____ _____	
<b>DIRECTIONAL</b>  <b>PANELS CORNERS</b>  <b>RACEWAY COVER</b>  <b>RACEWAY CORNERS</b>  <b>STRETCH</b>	<b>REMARKS:</b> _____ _____ _____ _____	<b>EASY</b> <b>HARD</b> <b>X-HARD</b>
<p> <b>APPROVED</b> <input type="checkbox"/>                      <b>NOT APPROVED</b> <input type="checkbox"/>                      <b>CONDITIONAL APPROVAL</b> <input type="checkbox"/> </p> <p> <b>REMARKS:</b>                  _____                  _____                  _____             </p> <p>                 * This fabric is approved for upholster-ability only. The approval does not account for the durability of the fabric at the time of, and after installation of the product             </p> <p> <b>APPROVAL SIGNATURE:</b> _____                      <b>DATE:</b> _____             </p>		





**PANEL FABRIC SAMPLE**

**TOP**

**STAPLE  
MINIMUM 6" X 6"  
FABRIC SAMPLE HERE  
IN THE DIRECTION IT IS TO BE  
APPLIED TO THE PRODUCT**

**BOTTOM**



# APPENDIX

The Evolve Furniture Group has partnered with the software vendors listed below to provide you with an online source for viewing the 2019 Compile Electronic Catalog. Please visit their websites for additional information and download details.

## **2020 Technologies**

www.2020technologies.com  
5503 Mile Road NW  
Grand Rapids, MI 49544  
Phone: 800-638-6002

## **Ice Edge Business Solutions**

www.ice-edge.com  
4001 S 700 East, Suite 450  
Salt Lake City, UT 84107  
Phone: 801-747-0373

## **KISP**

www.kisp.com  
Customer Support: 416-499-2457  
Cad Services Team: 416-499-2457 x3  
Customer Service e-mail: tellmemore@kisp.com  
CAD Services requests CadServices@kispstech.com

## **Project Matrix**

www.projectmatrix.com  
11655 Lebanon Rd.  
Cincinnati, OH 45241  
Tech Support Instant Messenger: projectmatrixtech@yahoo.com  
Phone: 513.554.1665  
Fax: 513.554.1255

## **Quintero-Smith Incorporated/Midnight Oil**

www.midnight-oil.com  
10469 Kinnard Avenue  
Los Angeles, CA 90024  
voice: 800-350-7434 (US Only)  
international: 310-478-5140  
fax: 310-478-4572  
e-mail: jimrsr@q-si.com



# TERMS & CONDITIONS

## APPLICATION OF STANDARD TERMS

Sales of Evolve products are made only on Evolve standard terms and conditions of sale which are contained in the Price Book and in Evolve's order acknowledgments. These standard terms and conditions may be modified or supplemented only by a separately written document signed by Evolve's authorized personnel at its head office in Marlton, New Jersey. An offer by Purchaser of said terms and conditions shall not be binding until accepted by Evolve in writing.

All illustrations, specifications and prices in this Price List are based on the latest product information available at the time of publication. Evolve reserves the right to make changes, at any time and without prior notice, to prices, colors, materials, specifications and models offered.

## PRICES AND PAYMENT

The prices shown in this Price List, as well as those quoted by Evolve, shall be in US dollars for orders shipped to destinations within the continental United States.

Prices listed herein are for standard product. Quotations for special product are available through Evolve Customer Support Department in Marlton, New Jersey.

If shipping date requested is more than 90 days from date of order Evolve shall use published list prices effective at the time of shipment.

Not included in the list price are special or export packing, unpacking and installation. Orders are invoiced at the time of shipment. The Customer agrees to pay a charge of 2% per month of invoices outstanding more than 30 days.

## FOR PAYMENTS ONLY, MAIL TO:

Evolve Furniture Group, a division of:  
Global Industries, Inc.  
17 West Stow Road  
P.O. Box 562  
Marlton, New Jersey 08053

Any products sold shall remain the property of Evolve until fully paid for in cash. The Purchaser agrees to perform all acts which may be necessary to perfect and assure retention of title to such products to Evolve until such time as the goods have been paid for in full.

Free freight applies to orders dock delivered to one commercial business location in the contiguous United States during normal business hours. Residential deliveries will incur additional delivery charges.

Please note exception below:

**All showroom and mock-up orders will be subject to actual freight charges.**

Evolve shall, in its sole discretion, determine the most appropriate method of shipment routing and carrier. Shipments of less than a full trailer load (LTL) shall ship via common carrier. **These LTL shipments are not subject to specific delivery days or times.** Full trailer loads will provide for dedicated delivery time and schedule. Purchaser may request special packaging or method of shipment at Purchaser's sole expense.

## TAXES

All sales, use, excise and other applicable taxes and the collection and reporting thereof (excluding only taxes on the net income of Evolve) are the Purchaser's responsibility and will be invoiced to the Purchaser. If Purchaser claims an exemption from such taxes, it shall be the Purchaser's responsibility to furnish an appropriate exemption certificate to Evolve.

## ORDER INFORMATION

Evolve requires that **all orders be submitted in writing** to avoid errors and/or duplication. Orders will be acknowledged with Evolve's acknowledgement forms governing the transaction. The details appearing on the acknowledgement will describe the items to be shipped to Purchaser who must ascertain that they are correct. If not correct, Purchaser should notify Evolve immediately by telephone or fax followed by written confirmation. Acknowledgment shows approximate shipping date of items ordered. **Shipping dates are assigned to orders based on the item having the longest manufacturing lead time.** Orders with Customer's Own Material (C.O.M.), or missing or incorrect information (finish selections, fabric selections, etc.) will be scheduled for manufacturing upon receipt of COM or correct complete information. Purchaser must indicate if multiple shipping schedules are required including noting if the shipping date requested is longer than standard posted lead time. Each shipment will be invoiced at time of shipping and will be subject to payment terms described herein.

## C.O.M. CUSTOMER'S OWN MATERIAL

Should Purchaser request a fabric, not standard to the Evolve upholstery line, Purchaser shall submit a sample of not less than two yards for approval. Evolve will determine whether fabric is suitable to manufacturing process and applicable UL or code requirements. Should Evolve be required to test such fabric, it shall so advise Purchaser, and Purchaser shall be responsible for all costs associated therewith. This includes all duty and brokerage fees.

Fabric yardage requirement will be determined by Evolve. An additional charge may be made to cover the cost of cutting, matching or sewing unusual or directional patterns. Evolve shall have no responsibility for condition, quality, performance, physical properties or any other aspect of C.O.M. For panels, price as if grade 1 fabric is used.

Evolve reserves the right to reject any C.O.M. deemed unsuitable.

Evolve reserves the right to cancel an order at any time if C.O.M. is, in the sole judgement of Evolve, inadequate for any reason.

## CHANGES AND CANCELLATION

The order may not be changed or cancelled by Purchaser without the written consent of Evolve. This charge can be as much as 100% based upon proximity to scheduled shipment date. Special order items and fabric-covered items already in production are not subject to change or cancellation under any circumstances. Fabric-covered items are considered to be in production once the fabric has been cut.

## DEPOSIT ON SPECIAL ORDERS

Orders for nonstandard products may, at Evolve's discretion, require deposit prior to scheduling of production, the amount of the deposit being credited against the total price of the project.

## SUSPENSION

In the event that the Purchaser defaults in the payment of any sum due Evolve, or in the event the Purchaser's financial condition becomes unsatisfactory to Evolve, Evolve shall have the right at its option, upon written notice to the Purchaser, to cancel shipment of any goods, unless within ten (10) days of Purchaser's receipt of such notice Purchaser provides assurance of payment to Evolve in such form, content and/or amounts as Evolve, in its sole discretion, deems adequate.

## COMBINED SHIPMENTS

Evolve will make every effort to combine shipments and orders on written request. However, acceptance of such request shall be with Evolve's sole discretion.

## CODE RESTRICTIONS

Evolve portable furniture may be subject to local fire, electrical and/or building codes applicable to portable furniture. It shall be Purchaser's sole responsibility for the proper application of Evolve items within the limitations of such local codes, which may be different from area to area.

## SERVICE

Service problems shall be handled by the authorized Evolve dealer. Where this cannot be accomplished on a local level, service problems should be referred to:

Evolve Furniture Group  
Customer Support  
17 West Stow Road  
Marlton, New Jersey USA 08053  
856-552-4000 888-827-2500  
Attention: Evolve Operations Manager



# TERMS & CONDITIONS

## STORAGE

In the event Purchaser requests postponement of delivery beyond the acknowledged shipping date, Evolve may transfer the goods to storage on Purchaser's account and at Purchaser's risk and expense subject to a daily storage rate. Such transfer to storage shall be deemed shipment to Purchaser for all purposes, including invoicing and payment.

## DELAYS

Evolve's order acknowledgement will state a shipping date which is Evolve's best estimate at the time the order is acknowledged. However, Evolve shall not incur any obligation or liability to Purchaser for failure to ship by a specified date. In addition, Evolve shall not be liable for any loss or damage resulting from any delay or failure in shipment or other failure to perform all or any part of the agreement between the parties with respect to the goods shown on the face of the order acknowledgement where such delay, failure, loss or damage is the proximate result of any act of any governmental authority or political subdivision thereof, revolution, riot, civil disorder or disturbance, act of enemies, delay or default in transportation, strike disputes among or between unions or other labor disputes, delay or inability in obtaining materials and facilities, fire, flood, act of God or any cause not within the reasonable control of Evolve, whether of the class of causes enumerated or otherwise. Without limiting the generality of the foregoing, Evolve may, without causing any breach or incurring liability, allocate goods which are in short supply, regardless of the reasons therefore, among purchasers, in any manner which Evolve, in its sole discretion, deems advisable.

## BACK CHARGES

Evolve will not accept charges for expense incurred by the Purchaser in expediting shipments or otherwise. Evolve will not accept charges for the repair of damage by others.

## CLAIMS

All goods are sold F.O.B. Toronto, Canada, unless otherwise agreed to in writing by Evolve. Evolve is not responsible for damage which occurs in transit or in storage. The carrier signs for all goods received in good order. It is the Purchaser's responsibility to examine goods upon receipt and to file any claims with the carrier. Any claims made against Evolve for apparent defects, errors or shortages must be made by the Purchaser in writing, within fifteen (15) working days after any delivery. Failure by the Purchaser to make any claim against Evolve within the above-described fifteen days shall constitute acceptance of the goods and a waiver of any apparent defects, errors or shortages.

## RETURNS

No returns of goods will be accepted without written consent and shipping instructions, including Evolve's Return Goods Authorization (R.G.A.) numbers, to Evolve. A minimum restocking charge of 35% is made on all authorized returns for credit or refund, provided goods are received by Evolve in the condition in which they left the factory. No credit will be given if goods cannot be reused. Special order items and fabric-covered items are in no event subject to return. All returns must be approved and authorized in writing by Evolve Customer Support, Marlton, New Jersey.

## LIFETIME WARRANTY

Evolve warrants that all commercial products are free from defects in material and workmanship, for the life of the product, to the original purchaser. This warranty is made by Evolve only to original customers acquiring the product directly from Evolve's authorized dealers. The customer's sole remedy pursuant to this warranty is limited to repair or replacement of parts or product at Evolve's option. Consent from Evolve must be obtained before any warranty work is performed. This warranty shall not apply to any products which must be replaced because of normal wear and tear, negligence, abuse or "accident", shipping damage, or product use and installation other than in accordance with written instructions or warnings. It shall also not apply when product has been modified or altered, repaired or refurbished by someone other than Evolve or an authorized dealer or because of natural variations over which Evolve has no control. In the event of repair and/or replacement of any defective product, Evolve does not warrant matching color, grain, texture or dye lots. Evolve's warranty does not cover the cost of transportation or labor. Repair or replacement will be at Evolve's option. Evolve makes no warranty that any of its products are suitable for any particular purpose and makes no other warranties, expressed or implied, other than those set forth in this Price List. As codes and standards vary from one jurisdiction to another, references to compliance are solely for convenience and without any representation as to accuracy or suitability. Users must verify the suitability of such information or product for their specific application. In no event shall Evolve be liable in either tort or contract for any loss or direct, special, incidental, consequential, or exemplary damages.

This Lifetime Warranty is NOT applicable to customers who use Evolve products for rental purposes and is effective only for products, parts or components manufactured after January 1, 2011.

Exceptions to this warranty include:

- Global fabrics and wood veneers, which are warranted for five years from date of delivery.
- Electrical components, which are warranted for ten years from the date of delivery.
- Moving parts such as glides, slides, casters, user-adjustable worksurface mechanisms, which are warranted for five years from date of delivery.

- Fading on fabric and wood veneers can be caused by exposure to U.V. rays/sunlight. Natural wood veneer, being a natural material, will have shade differences between veneer sheers, the difference will be more apparent between dye lots.

Evolve does not warrant color fastness on Customer's Own Material.

Because of natural variations over which Evolve has no control, this warranty does not extend to color, grain or texture of wood, and Evolve does not warrant matching of color, grain or texture.

Evolve makes no warranties, including implied warranties of merchantability and fitness for a particular purpose, other than the express warranties contained herein.

## LIMITATION OF REMEDY

Purchaser's sole and exclusive remedy (excluding the repair or replacement of goods for breach of the express warranty above) for any matter or claim arising under or relating to these terms and conditions, the goods covered hereby and any transaction involving or relating to such goods, whether in contract, tort (including negligence) or otherwise, shall be payment of the lesser of the cost to repair or replace said product or the purchase price for the goods to which the claim relates. In no event shall Evolve be liable for any special, indirect, consequential, or incidental damages, including without limitation, damages for loss of business profits, business interruptions, or loss of information.

## EVOLVE'S WARRANTY DOES NOT APPLY (FOR ANY PRODUCT CATEGORY) TO THE FOLLOWING:

- Failures due to wear and tear
- Failures which result from negligence, abuse, accident or misuse
- Failure to apply, install or maintain products according to Evolve's written instructions and warnings
- Modifications, attachments or repair methods not approved by Evolve
- Damage caused by a carrier in transit, or delivery/installation contractors
- The matching of colors, grains or textures (wood, leather, etc.) of natural materials and color matching of textiles
- Products exposed to extreme hot or cold temperatures or excessively dry or humid environments
- Colorfastness or the matching of color of textiles
- Damage by markings or staining; damage by sharp objects or imprinting from instruments
- Damage to textiles or laminate and wood surfaces/edges from exposure to sunlight (including UV rays)
- Products used for rental purposes

Evolve's warranty applies to products sold within the United States of America, Mexico, the Commonwealth of Puerto Rico and Canada.

showrooms and distribution centers throughout the united states

**SHOWROOMS**

**Atlanta**

10 10th Street  
Suite 150  
Atlanta, GA 30309  
T (404) 879-0998

**Chicago**

The Merchandise Mart  
10th Floor, Suite 1035  
Chicago, IL 60654  
T 312.755.0843

**New Jersey (Southern)**

119 Greentree Road  
Marlton, NJ 08053  
T 856.596.3390

**Philadelphia**

1735 Market Street  
38th Floor  
Philadelphia PA, 19103  
215.861.0963

**Washington, DC**

1130 Connecticut  
Avenue  
Washington, DC 20036  
T 202.659.0230

**Boston**

One Harbor Street,  
Suite 104  
Boston, MA 02210  
T 617.406.5435

**Miami**

112 NE 41st Street  
6th floor  
Miami, FL 33137

**New York City**

386 Park Avenue South,  
7th floor  
New York, NY 10016  
T 212.545.9900

**Phoenix**

4675 East Cotton  
Center Boulevard,  
Suite 165  
Phoenix, AZ 85040  
T 602.426.0666

**SHOWROOMS + DISTRIBUTION CENTERS**

**Atlanta Area**

6715 Maple Ave.  
Suite 100  
Buford, GA 30518  
T 678.602.4130

**Cincinnati Area**

8712 LeSaint Drive  
Fairfield, OH 45014  
T 513.777.0009

**Ft. Lauderdale Area**

560 Sawgrass  
Corporate Parkway  
Sunrise, FL 33325  
T 954.846.8888

**Los Angeles Area**

12320 Bloomfield  
Avenue, Unit A  
Santa Fe Springs, CA  
90670  
T 562.484.9686

**Baltimore Area**

Troy Hill Corporate  
Center  
7030 Troy Hill Drive  
Elkridge, MD 21075  
T 410.379.8021

**Dallas Area**

2025 W. Beltline Rd.,  
#100  
Carrollton, TX 75006  
T 972.236.1366

**Houston**

7865 Northcourt Road,  
Building D, Suite 200  
Houston, TX 77040  
T 713.695.5777

**Seattle Area**

Oakesdale Commerce  
Center  
820 Southwest 34th St.  
Building W7, Suite A  
Renton, WA 98057  
T 425.291.9282

**Chicago Area**

27W501 North Avenue  
West Chicago, IL 60185  
T 630.681.2818

**Denver Area**

16401 E. 33rd Dr., Ste. 50  
Aurora, CO 80011  
T 303.340.1617

**Kansas Area**

11617 West 81st Street  
Lenexa, KS 66214  
T 913.310.9963

**Tampa Area**

10351 Windhorst Road  
Tampa, FL 33619  
T 813.621.6272

**Global - USA Headquarters**

17 West Stow Road P.O. Box 562  
Marlton, New Jersey U.S.A. 08053  
Tel (856) 596-3390 (800) 220-1900  
Fax (856) 596-5684  
www.globalfurnituregroup.com

**Global - Canada Headquarters**

1350 Flint Road  
Downsview, ON Canada M3J 2J7  
Sales & Marketing: Tel (1-877) 446-2251  
Customer Service: Fax (800) 361-3182  
Government Customer Service: Fax (416) 739-6319



Association of Canadian Ergonomists  
Association Canadienne d'Ergonomie