

**Seating**

Effective July 14, 2025 – USA



PRICE LIST  
**seating**



# think global

## THE GLOBAL EDGE

### ERGONOMICS IN THE TOTAL OFFICE

- One stop shopping for a full range of office furniture.
- Seating, desks, tables, files, modular furniture, panels and accessories.
- Ergonomics, competitive pricing and built-in value.

### STRENGTH AND STABILITY

- Established in 1966.
- One of North America's largest office furniture manufacturers.
- Manufacturing and showrooms worldwide.

### QUICK SHIP - INSTOCK

- Thousands of products available in a 2 day quickship program.
- Hundreds of products in stock for immediate delivery.

### STRONG LOCAL REPRESENTATION

- Service and expert advice where you are, when you need it!

### MANUFACTURING CAPABILITY

- Vertical integration ensures "start to finish" control.
- Ongoing research and investment in new, innovative production technology.

### QUALITY ASSURANCE

- Quality Assurance Program is qualified by C.G.S.B. ISO9001 standards.
- On-site furniture testing facility.
- Product and components are tested to meet or exceed ANSI/BIFMA standards.

### ENVIRONMENTAL COMMITMENT

- Continuous development of "earth friendly" programs.
- One of the first molded foam manufacturers to create ozone friendly, CFC and HFC-free process.
- Seat and back pans are made from recyclable plastics and wood waste, enabling little waste and cost effective products.

## SYMBOL IDENTIFICATION

Each seating product with an RTA code identifies the assembly requirements.

**RTA 00** FULLY ASSEMBLED

**RTA 1** SIMPLE ASSEMBLY (No Tools Required)

Parts to Install:

- Casters
- Base
- Pneumatic Cylinder/Cover can

**RTA 2** MODEST ASSEMBLY (Tools Supplied, if necessary)

Parts to Install:

- Casters
- Base
- Pneumatic Cylinder/Cover can
- Back

**RTA 4** MODERATE ASSEMBLY (Tools Supplied)

Parts to Install:

- Casters
- Base
- Pneumatic Cylinder/Cover can
- Back
- Armrest

**RTA 8** FULL ASSEMBLY (Tools Supplied)

Parts to Install:

- Casters
- Base
- Pneumatic Cylinder/Cover can
- Back
- Armrest
- Mechanism



Global's Certified Products are in compliance with the stringent emission guidelines set by the GREENGUARD Environmental Institute and include all Upholstered Seating. To obtain a GREENGUARD or GREENGUARD Gold Certificate for any product, please go to the Environmental Commitment section on our website [www.globalfurnituregroup.com](http://www.globalfurnituregroup.com) and click on "GREENGUARD".



level™ certification, based on the ANSI/BIFMA e3-2012 furniture sustainability standard, sets furniture manufacturers on a path toward greater sustainability over time. Based on environmental and social criteria set forth in the standard, a product's entire supply chain is assessed.

Certification assessment includes an evaluation of specific corporate policies and guidelines and an assessment of associated company manufacturing facilities. Products must meet quantifiable milestones of environmental and social performance at every step of development.

The quantitative assessment addresses four categories: material use, energy and atmosphere impacts, human and ecosystem health and social responsibility.

Manufacturers earn points in each of the four categories. The level™ brand and its numeric rating of 1, 2 or 3 indicate what threshold of certification a product has achieved. level™ 3 is the highest rating.



All products with this designation are suitable for FedEx and UPS shipment throughout the United States.

# TABLE OF CONTENTS

<b>A</b>		<b>E</b>		<b>K</b>
Arno .....25		Enterprise .....32		Kate .....321
Arturo .....26		Erin .....167		
Aspen .....27				<b>L</b>
Auburn .....28		<b>F</b>		Layne .....175
		Factor.....36		Lite .....177
<b>B</b>		File Buddy .....171		Loover .....61
Bakhita .....132		Flap .....172		Luray .....65
Ballara .....256				Lux .....322
Beach .....135		<b>G</b>		
Beam Seating .....136		G1 .....38		<b>M</b>
Braden .....267		G20 .....40		Malaga .....67
Bridges II Collaborative Seating .....269		Global Accord .....41		Malaga TS .....399
		Goal .....44		Marche .....182
<b>C</b>		Graham .....46		Mayne .....184
Calidon .....277		Granada .....47		Mirage .....68
Camino .....283		Granada Deluxe .....52		ML .....324
Caprice .....146		Granada Deluxe TS .....399		ML Park .....324
Chap .....148		Graphic .....56		Moda Four-Legged .....185
Citi .....288				Moda Stacking .....186
Citi Square.....293		<b>I</b>		
Comet .....150		Include.....59		<b>N</b>
Concorde .....29		Industrial Seating .....421		Noetic.....69
		Industrial Wipe Down .....426		Novello .....74
<b>D</b>		Islands .....174		
Diplomat .....31				
Drift .....302		<b>J</b>		
Duet .....154		Jeo.....320		
Duet tables .....164				

# TABLE OF CONTENTS

## O

ObusForme Comfort + XL .....78

## P

Popcorn .....188

Prairie .....327

Prefer .....85

## R

Rambler .....328

Rebound .....193

River .....331

River Personal Harbor .....347

River+ .....349

Robust .....405

Roma .....87

Roma Nester .....198

## S

Sas .....200

Saxon .....406

Sidero .....202

Sirena .....376

Solar .....91

Solo .....93

Sonic .....206

Sora .....95

Spritz .....97

Spritz multi-purpose .....218

Spyker .....221

Stream .....222

Supra .....102

Supra X .....104

Synopsis .....107

## T

Traditional .....110

Triumph .....113

Truform .....114

Twilight .....231

Tye .....117

## V

Venture .....380

Vion .....120

Vion guest .....234

Vitrola .....383

## W

Weev .....128

Willow .....239

Wind .....385

Wind Linear .....389

## Z

Zoma .....253

## REFERENCES/PROGRAMS

Seating by Category Types ..... 4-11

Suggested Applications by Series ..... 12-13

Ergonomic Features and Benefits ..... 15

Mechanism Adjustments ..... 16

How to Order Seating ..... 17

Act Performance Symbols ..... 18

Fast ..... 19

Heavy Duty/24 Hour ..... 398

How to select armrests ..... 410

Arm selections ..... 411

Caster selections ..... 414

Cylinder chart ..... 416

Duet + Popcorn glide selections 1 ..... 418

Specialty seating ..... 421

Textiles + Finishes ..... 432









COM Authorization Form ..... 439

Terms/Conditions/Warranty ..... 442

















# SEATING BY CATEGORY TYPE



## Task

 Arno.....25	 Luray .....65	 Stream.....99
 Aspen .....27	 Malaga .....67	 Supra .....102
 Duet.....132	 Noetic.....69	 Supra X .....104
 Enterprise .....32	 Novello .....74	 Synopsis .....107
 Factor .....36	 ObusForme Comfort + XL .....78	 Triumph .....113
 G1 .....38	 Popcorn .....188	 Truform .....114
 G20 .....40	 Prefer .....85	 Tye .....117
 Goal .....44	 Roma .....87	 Vion .....120
 Graham .....46	 Solar .....91	 Weev .....128
 Granada .....47	 Solo .....93	
 Granada Deluxe .....52	 Sonic .....206	
 Graphic .....56	 Sora .....95	
 Loover .....61	 Spritz .....97	

**Conference/Management**

























 Arno .....25	 Jeo .....320	 Solar .....91
 Arturo .....26	 Kate .....321	 Solo .....93
 Diplomat .....31	 Luray .....65	 Supra .....102
 Enterprise .....32	 Mirage .....68	 Synopsis .....107
 Global Accord .....41	 Roma .....87	 Traditional .....110
 Graphic .....56		
 Include.....59		

# SEATING BY CATEGORY TYPE

## Executive















 Arno .....25	 Enterprise.....32	 Synopsis.....107
 Arturo .....26	 Global Accord .....41	 Traditional .....110
 Auburn .....28	 Luray .....65	
 Concorde .....29	 Mirage .....68	
 Diplomat.....31		

## Height Adjustable Stools





















 Aspen .....27	 Loover .....61	 Spritz .....97
 Duet.....154	 Malaga .....67	 Stream.....99
 Factor .....36	 Noetic.....69	 Supra X.....104
 G1 Ergo Select .....38	 Novello .....74	 Synopsis .....107
 Global Accord .....41	 ObusForme Comfort + XL .....78	 Truform .....114
 Goal .....44	 Prefer .....85	 Tye .....117
 Granada .....47	 Roma .....87	 Vion .....120
 Granada Deluxe .....52	 Solar .....91	 Weev .....128
 Graphic .....56		



**Stacking**





 Bakhita .....132	 Popcorn .....188	 Spyker .....221
 Comet .....150	 Rebound .....193	 Stream .....222
 Duet .....154	 Sas .....200	 Vion guest .....234
 Flap .....172	 Sidero .....202	 Willow .....239
 Moda .....186	 Sonic .....206	 Zoma .....253

**Guest (Metal)**

 Arno .....25	 Factor .....169	 Sas .....200
 Caprice .....146	 Jeo .....320	 Sidero .....202
 Comet .....150	 Kate .....321	 Sonic .....206
 Diplomat .....153	 Lite .....177	 Stream .....222
 Drift .....302	 Marche .....182	 Twilight .....231
 Enterprise .....32	 Popcorn .....188	 Vion guest .....234
 Erin .....167	 Rebound .....193	 Willow .....239

# SEATING BY CATEGORY TYPE















## Guest (Wood)

 Beach .....135	 Drift.....302	 Layne .....175
 Chap .....148	 Islands .....174	 Mayne .....184















## Nesting

 Roma Nester .....198	 Spritz Nester .....218
--	--

## Tandem/Beam/Pedestal

 Duet (Beam) .....141	 Sidero (Beam) .....143	 Synopsis (Pedestal).....107
 Duet (Pedestal).....154	 Sonic (Beam) .....143	 Vion (Beam) .....144
 Global Accord (Pedestal).....41	 Sonic (Pedestal).....206	 Vion (Pedestal).....120
 Luray (Pedestal).....65	 Spritz (Pedestal).....218	Beam Seating .....136
 Novello (Pedestal).....74	 Stream (Pedestal).....222	
 Popcorn (Beam) .....142		

## Stools

 Diplomat .....153	 ML.....324	 Sonic .....206
 Duet .....154	 Popcorn .....188	 Stream .....222
 Drift.....302	 Rebound.....193	 Twilight .....231
 File Buddy .....171	 Sas .....200	 Vion guest .....234
 Marche .....182	 Sidero .....202	 Willow.....239



Ballara.....256	Kate.....321	River+ .....349
Braden.....284	Lux.....322	Sirena.....376
Bridges II Collaborative Seating...269	ML.....324	Venture.....380
Camino.....283	ML Park .....326	Vitrola.....383
Citi.....288	Prairie.....327	Wind.....385
Drift.....302	Rambler.....328	Wind Linear.....389
Jeo .....320	River.....331	

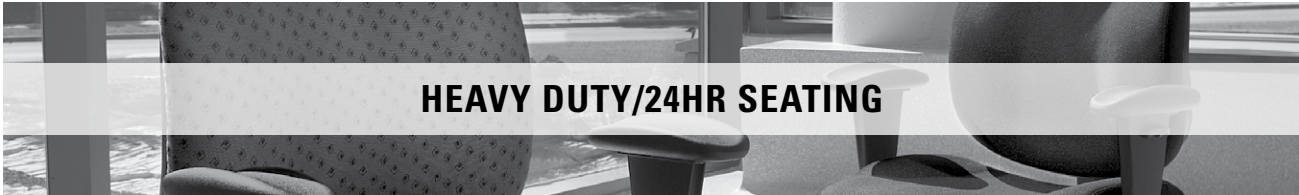

Concorde Executive 24HR .....402	Malaga TS .....399	Saxon .....406
G1 Ergo Select TS .....403	ObusForme Comfort TS .....400	Truform TS .....401
Granada TS .....398	Robust .....405	Vion TS .....407
Granada Deluxe TS .....399		

# SEATING BY CATEGORY TYPE



## EDUCATION

### Classroom

Duet .....	154	Rebound .....	193	Supra X .....	104
Duet tables .....	164	Roma Nester .....	198	Vion .....	120
Graphic .....	56	Sidero .....	202	Willow.....	239
Novello .....	74	Sonic .....	206		
Popcorn .....	188	Spritz Nester .....	218		

### Work + Task

Factor .....	36	Noetic.....	69	Sora .....	95
G1 .....	38	Novello .....	74	Spritz .....	97
Granada .....	47	ObusForme Comfort + XL .....	78	Supra X .....	104
Graphic .....	56	Prefer .....	85	Truform .....	114
Loover .....	61	Roma .....	87	Vion .....	120

# SEATING BY CATEGORY TYPE

## Guest

Caprice .....146	Rebound .....193	Vion guest .....234
Duet .....154	Roma Nester .....198	Willow.....239
Graphic .....56	Sidero .....202	Zoma .....253
Islands .....174	Sonic .....206	

## Lecture Hall

Duet (Beam) .....141	Sidero (Beam) .....143	Vion (Beam) .....144
Popcorn (Beam) .....142	Sonic (Beam) .....143	

## Lab Seating + Stools

Caprice .....146	Novello .....74	Spritz .....97
Duet .....154	Sidero .....202	Supra X .....104
Graphic .....56	Sonic .....206	Vion .....120

## Cafeteria

Bakhita .....132	Popcorn .....188	Spyker .....221
Duet .....154	Rebound .....193	Willow.....239
Sas .....200	Sonic .....206	

# SEATING BY CATEGORY TYPE



## EDUCATION

### Lounge

Ballara.....	256	Citi Square.....	293	Sirena.....	376
Citi.....	288	River.....	331	Wind Linear.....	389
Drift.....	302	River+.....	349		

### Stacking & Nesting

Bakhita.....	132	Roma Nester.....	198	Spritz Nester.....	218
Duet.....	154	Sas.....	200	Spyker.....	221
Popcorn.....	188	Sidero.....	202	Stream.....	222
Rebound.....	193	Sonic.....	206	Zoma.....	253

# SUGGESTED APPLICATIONS BY SERIES

SERIES	SUGGESTED APPLICATION	ACADEMIC SEATING	CAFETERIA SEATING	CONFERENCE ROOM SEATING	ERGONOMIC AND TASK	EXECUTIVE TASK SEATING	HEAVY DUTY SEATING	HOSPITALITY SEATING	GUEST SEATING	LOUNGE/RECEPTION SEATING	MANAGEMENT SEATING	MEETING ROOM SEATING	MULTI PURPOSE SEATING	PUBLIC SEATING	STACKING SEATING	STOODLS	TABLET SEATING	TECHNICAL SEATING	WOOD GUEST SEATING
ARNO			•						•		•	•							
ARTURO			•								•								
ASPEN				•	•						•	•							
AUBURN			•																
BAKHITA	•	•											•		•				
BALLARA								•		•							•		
BEACH								•	•	•			•	•					•
BEAM SEATING	•	•						•	•										
BRADEN										•									
BRIDGES II COLLAB. SEATING								•	•	•			•						
CAMINO								•	•	•									
CAPRICE		•							•				•			•			
CHAP								•	•	•									•
CITI & CITI SQUARE								•	•				•				•		
COMET		•							•	•		•	•						
CONCORDE					•	•													
DIPLOMAT			•						•	•	•					•			•
DUET	•	•	•	•					•		•	•	•	•	•	•	•		
ENTERPRISE			•	•					•		•	•							
FACTOR			•	•							•						•		
FILE BUDDY													•				•		
G1 ERGO SELECT			•	•	•						•							•	
G20			•	•	•						•	•							
GLOBAL ACCORD			•								•	•		•		•			
GOAL	•			•															•
GRAHAM				•															
GRANADA & GRANADA DELUXE	•			•		•		•									•		•
GRAPHIC			•								•						•		
ISLANDS								•	•	•									•
JEO									•	•			•						
KATE			•						•										
LAYNE								•	•										•
LITE	•	•						•	•	•			•						
LOOVER			•	•					•		•								
LURAY			•	•						•				•					
LUX								•	•										
MALAGA	•			•		•		•									•		
MARCHE								•	•			•				•			

# SUGGESTED APPLICATIONS BY SERIES

SERIES	SUGGESTED APPLICATION	ACADEMIC SEATING	CAFETERIA SEATING	CONFERENCE ROOM SEATING	ERGONOMIC AND TASK	EXECUTIVE TASK SEATING	HEAVY DUTY SEATING	HOSPITALITY SEATING	GUEST SEATING	LOUNGE/RECEPTION SEATING	MANAGEMENT SEATING	MEETING ROOM SEATING	MULTI PURPOSE SEATING	PUBLIC SEATING	STACKING SEATING	STOODLS	TABLET SEATING	TECHNICAL SEATING	WOOD GUEST SEATING
MAYNE								•	•										•
MIRAGE																			
ML			•					•	•	•									•
ML PARK			•					•	•	•									•
MODA			•						•										•
NOVELLO	•			•	•			•			•	•	•						•
OBUSFORME COMFORT				•	•					•									
POPCORN			•	•					•	•	•	•	•						
PRAIRIE									•										
RIVER								•	•	•				•					
ROBUST							•			•									
ROMA			•	•	•						•	•	•						•
ROMA NESTER												•	•						
SAS			•					•	•						•	•			•
SAXON							•												
SIDERO			•					•	•			•			•	•			
SIRENA								•	•									•	
SOLAR				•	•			•											
SOLO				•					•		•								
SONIC			•		•				•	•	•	•	•	•	•	•	•		
SPRITZ	•	•		•					•	•	•	•	•	•	•	•			
SPYKER			•									•			•				
STREAM	•	•		•				•	•	•	•	•	•	•	•	•	•		
SUPRA				•				•		•									
SUPRA X	•			•															•
SYNOPSIS				•	•			•		•	•								•
TRADITIONAL								•	•	•									
TRIUMPH					•					•									
TRUFORM				•		•				•									•
TWILIGHT			•					•			•	•							•
TYE				•	•			•			•								•
VENTURE								•		•				•					
VION				•	•	•	•	•		•				•	•	•			
VITROLA								•		•				•					
WEEV				•	•					•									•
WIND & WIND LINEAR									•										
ZOMA			•					•	•	•	•	•			•				

# ERGONOMIC FEATURES & BENEFITS

EACH GLOBAL CHAIR IS BUILT WITH FEATURES THAT ARE ERGONOMICALLY DESIGNED TO PROMOTE GOOD POSTURE AND PROVIDE MAXIMUM COMFORT.

WHILE FULLY SUPPORTING YOUR BODY, THESE FEATURES SHOULD ALSO ALLOW YOU TO ADJUST YOUR CHAIR TO FIT YOU.



## A TENSION ADJUSTMENT

Increase or decrease to match body weight. Allows you to rock comfortably, without heavy pushing, reducing muscle fatigue.



## B CHAIR TILT LOCK

Lock the tilt movement in position(s) to accommodate your working posture. Allows you to lock your chair in a comfortable and supportive position. (Can be either single position or infinite style).



## C SEAT HEIGHT

Raise or lower to allow your feet to rest flat on the floor. Avoids pressure under your thighs, easing blood flow.



## D BACK HEIGHT

Raise or lower to position lumbar support in your lumbar area. Reduces likelihood of back pain.



## E SEAT DEPTH

Change the depth of the seat to accommodate the length of your thighs. Keeps your back in contact with the backrest while avoiding pressure behind your knees.



## F FORWARD SEAT ANGLE

Allows chair to tilt forward changing the angle of your thighs in relation to the floor. Helps reduce disc pressure during forward leaning tasks.



## G BACK ANGLE

Adjust to change the angle of your torso in relation to your thighs. Helps reduce disc pressure and relaxes your back muscles.



## H ARM HEIGHT

Raise or lower to support your forearms. Reduces muscular effort in neck and shoulders, minimizing risk of pain.



## J KNEE-TILT MOVEMENT

Chair tilt pivot point is toward the front of the seat. Stability is maintained as the user reclines, keeping their feet on the floor and maintaining the same torso to thigh angle.



## L SYNCHRO-TILT MOVEMENT

The seat pivots at the center point, while the backrest reclines at a faster rate than the seat, increasing the angle between the user's torso and thighs. Enhances comfort and encourages dynamic body movement.



## M WATERFALL SEAT EDGE

Reduces pressure at the back of the knee, contributing to good blood flow.



## N CONTOURED CUSHION

Supports the body effectively, allowing you to sit longer without discomfort.



## P VIBRATING SEAT & BACK

Soothing effect contributes to your relaxation during work breaks.



## Q WIDTH ADJUSTABLE ARMS

Allows outward movement of armrests to match shoulder breadth. Ensures armrests properly support forearms, reducing muscular efforts in neck and shoulders.



## R ARM ROTATION

Rotate armcaps to support your forearms in various positions. Reduces muscular effort in neck and shoulders minimizing risk of pain.



## S CENTER TILT

Chair tilts at the center point of the seat allowing you to recline while maintaining the same torso to thigh angle. When your feet are well supported, blood flow is enhanced.



## U SOFT DESCENT PNEUMATIC LIFT

Gently and gradually lowering the seat helps you easily select proper seat height without causing a jerking motion.



## V LUMBAR DEPTH ADJUSTMENT

Increase or decrease curvature of the back to match the profile of your lower back. Enhances comfort and support in the lower lumbar area.

## MAXIMIZING YOUR ERGONOMIC SEATING

- Always select a chair that is designed for the type of work you perform and make certain the chair is comfortable for the length of time spent using it.
- Ensure that the seat and back cushions are contoured to fit your body, which will help eliminate pressure points.
- An ergonomically designed chair should allow changing positions easily.
- As you work, reposition yourself throughout the day to reduce strain and stress on specific muscle groups. If you change job functions, adjust your chair to fit the new task.
- Proper ergonomic seating should help eliminate many of the work related injuries that result from poor posture and poorly designed chairs.

**TASK (-6)**



**ADJUSTMENTS**

- (2) Pneumatic seat height
- (8) Manual seat depth
- Back height \*\*
- Swivel

**POSTURE TASK (-7)**

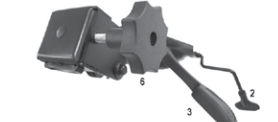

**ADJUSTMENTS**

- (2) Pneumatic seat height
- (3) Back angle
- (6) Back height \*\*
- Seat depth \*
- Swivel

**TILTER (-4)**

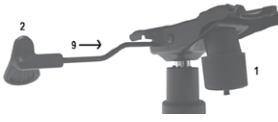

**ADJUSTMENTS**

- (2) Pneumatic seat height
- (9) Chair tilt lock \*
- Center-tilt action
- Swivel

**KNEE-TILTER (-2)**

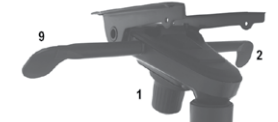

**ADJUSTMENTS**

- (1) Tilt tension
- (2) Pneumatic seat height
- (9) Chair tilt-lock \*
- Back height \*\*
- Knee-tilt action
- Swivel
- Optional sliding seat depth adjustment (MD)

**MULTI-TILTER (-3)**



**ADJUSTMENTS**

- (1) Tilt tension
- (2) Pneumatic seat height
- (3) Back angle adjustment
- (9) Infinite position seat tilt lock
- (7) Forward tilt lock \*
- (8) Sliding seat depth adjustment (MD)
- Back height \*\*
- Center-tilt action
- Swivel

**SYNCHRO-TILTER (-0, -8)**



**ADJUSTMENTS**

- (1) Tilt tension
- (2) Pneumatic seat height
- (3) Back angle adjustment
- (8) Sliding seat depth adjustment (MD)
- (9) Chair tilt lock Synchro-tilt action
- Anti-kickback \*
- Back height \*\*
- Swivel

**POSTURE-TILTER \***



**ADJUSTMENTS**

- (1) Tilt tension
- (2) Pneumatic seat height
- (8) Sliding seat depth adjustment (MD)
- (9) Infinite position seat tilt lock
- Back height \*\*
- Swivel

**OPERATOR (-5)**



**ADJUSTMENTS**

- (2) Pneumatic seat height
- (3) Back angle \*(Free Float/lock)
- (4) Seat angle \*(Free Float/lock)
- (4) Seat angle / Back angle
- Back height \*\*
- Free floating seat and back \*
- With single lever operator mechanism, seat and back angle are controlled using lever 4 \*
- Swivel

**NOTES**

- \* Selected models only.
- \*\* RATCHET back height adjustment on selected models.
- \*\*\* Mechanisms shown are generic depictions and may differ from one chair to another.

## HOW TO ORDER SEATING



**5451-3**

MODEL NUMBER

+



**MD**

MECHANISM OPTION

+



**BK**

FRAME FINISH

+



**AX27**

FABRIC CODE

### FABRIC CHAIR EXAMPLE

If there are any options for the chair they would be inserted between the Model Number with Arm Style and Frame Finish. For example (see above):

#### 5451-3 BK AX27

This would be the **Truform Medium Back Multi-Tilter** with standard Height Adjustable Arms and Multi-Tilter. Black Frame **BK** and Oxygen fabric in Axis, Noir **AX27**, complete the chair.

### CHAIR SAFETY TIPS

**Common sense guidelines to ensure that your Global chair will provide many years of comfort and service in a safe and productive environment:**

- Always read and follow assembly instructions. Make sure that all of the pieces of your Global chair are installed in the proper order to ensure structural integrity.
- Ensure that chair casters are fully inserted into the base of the unit.
- Inspect your chair for loose or worn parts at least once a year.
- Always keep the base of your chair completely on the floor.
- Most Global chairs are equipped with casters for use on carpeted surfaces. Other flooring surfaces may require different casters.
- Speak to your Global Sales Representative or refer to the Casters Section of this Price Book for appropriate custom selections.
- Many Global office chairs are equipped with tilt tension controls on the seating mechanism. The tension control compensates for different body weights and postures. Always ensure that the control is properly adjusted for a smooth and controlled tilt motion. Your Global Sales Representative can demonstrate the proper use of all the adjustments on your office chair.
- Do not stand on your Global chair or sit on the arms of your chair.
- Do not put electrical appliances on chairs. Even fire retardant fabrics can be damaged when exposed to direct heat or flame.
- Choose the right chair for your work environment. Global offers a full line of Intensive Use, Multi-Shift and Specialized chairs for environments with demanding health or safety requirements. Your Global Sales Representative is trained to help you make the right choice for your workplace.

THE ASSOCIATION FOR CONTRACT TEXTILES (ACT) HAS DEVELOPED THE FOLLOWING PERFORMANCE GUIDELINES TO MAKE FABRIC SPECIFICATION EASIER. THE FIVE SYMBOLS GIVE ARCHITECTS, DESIGNERS AND END USERS A VAST AMOUNT OF PERFORMANCE INFORMATION IN A SUCCINCT, VISUAL WAY. THIS CHART LISTS THE REQUIRED TESTS THAT CORRESPOND TO SPECIFIC END USES. AN EXPLANATION OF THE SYMBOL ALSO APPEARS.

## FIRE RETARDANCY



Flammability testing determines a fabric's performance and resistance to burning.

### APPLICATION

Upholstery  
Panels and upholstered walls

### PASSES

California bulletin 117, section E.  
ASTM E 84-03 Class A or Class 1 (unadhered method).

## COLOR FASTNESS TO WET & DRY CROCKING



Color fastness to wet & dry crocking refers to the rubbing off of color from the fabric onto clothing, hands or other materials and can occur under wet or dry conditions.

### APPLICATION

Upholstery  
Panels and upholstered walls

### PASSES

AATCC 8-2001 Dry crocking. Class 4 minimum.  
Wet crocking, Class 3 minimum.  
AATCC 8-2001 E 84 (unadhered method).

## COLOR FASTNESS TO LIGHT



Color fastness to light is the degree to which fabric will retain its color when exposed to light.

### APPLICATION

Upholstery  
Panels and upholstered walls

### PASSES

AATCC option 2-2003 or AATCC - option 3-2003.  
Class 4 minimum of 40 hours.  
AATCC option 2-2003 or AATCC - option 3-2003.  
Class 4 minimum of 40 hours.

## PHYSICAL PROPERTIES



Three physical property tests include: 1 - Brush pill test to determine a fabric's pilling (the formation of fuzzy galls of fiber on the surface of a fabric). 2 - Breaking/tensile strength is the ability of a fabric to withstand tension without breaking or tearing. 3 - Seam slippage is the pulling apart of fabrics at the seams.

### APPLICATION

Upholstery  
Panels and upholstered walls

### PASSES

Brush pill ASTM D3511-02, 3 minimum.  
Breaking strength ASTM D5034-95 (2001) 50 lbs. minimum in warp & weft.  
Seam slippage ASTM D4034 25 lbs. minimum in warp & weft.  
Breaking strength ASTM D5034-95 (2001) (grab test).  
35 lbs. minimum in warp & weft.

## ABRASION



Abrasion is the ability of a fabric to withstand damage from wear and rubbing. There is a general contract specification as well as a heavy duty specification.

### APPLICATION

General contract upholstery  
Heavy duty upholstery

### PASSES

ASTM D4157-02 (#10 cotton duck) 15,000 double rubs, Wyzenbeek method.  
ASTM D4966-98 (12 KPA pressure) 20,000 double rubs, Martindale method.  
ASTM D4157-02 (#10 cotton duck) 30,000 double rubs, Wyzenbeek method.  
ASTM D4966-98 (12 KPA pressure) 40,000 double rubs, Martindale method.

# fast5

Global's fast5 quick ship program offers many of our bestselling models upholstered in your choice of our most popular textiles.

- 20+ Series, 150+ Models, 200+ Textiles to customize your order
- No special order forms required

Global's fast production and shipping make it simple to order and ideal for tight deadlines!

## Color it your way

### GRADE 1

Carrera 100% Polyester	
CE84 Zest	CE85 Savannah
CE86 Slate	CE87 Rainforest
CE88 Aspen	CE89 Dune
CE90 Flannel	CE91 Azure
CE92 Chili	CE93 Jute
CE95 Ink	CE96 Sangria
CE97 Java	CE98 Charcoal

### Fusion 90% Virgin Polyester / 10% Post-Consumer Recycled Polyester

FU71 Tangerine	FU72 Fresh
FU73 Moss	FU74 Tomato
FU75 Aqua	FU76 Sandstone
FU77 Granite	FU78 Poppy
FU79 Cadet	FU80 Oasis
FU81 Graphite	FU82 Viola
FU83 Cobalt	FU84 Flax
FU85 Carbon	

### Illusion 100% Virgin Polyester

II01 Cappuccino	II02 Paprika
II03 Tropic	II04 Wicker
II05 Hemp	II06 Cayenne
II07 Maui	II08 Dusk
II09 Smoke	II10 Currant
II11 Fiji	II12 Ozone
II13 Ebony	

### Jenny 100% Polyester

JN01 Midnite	JN02 Ebony
JN03 Slate	JN07 Vermilion
JN08 Admiral	JN11 Charcoal
JN25 Silver Lining	JN26 Oatmeal
JN27 Sunflower	JN28 Cascade
JN29 Harvest	JN30 Melon
JN31 Berry	JN32 Green Grass
JN33 Roast	

### Quilt 100% Polyester

QL10 Black	QL11 Charcoal Grey
QL14 Navy	QL16 Wine
QL19 Silver	QL20 Feather
QL21 Dune	QL22 Meadow
QL23 Cadet	QL24 Geranium
QL25 Daisy	QL26 Quest
QL27 Punch	QL28 Tangerine
QL29 Cocoa	

### Trak 100% Recycled Polyester

TK40 Taupe	TK41 Mustard
TK42 Latte	TK43 Cement
TK44 Silver	TK45 Copper
TK46 Teal	TK47 Apple
TK48 Steel	TK49 Merlot
TK50 Midnight Sky	TK51 Mocha
TK52 Carbon	

### Urban 62% Recycled Polyester / 32% Polyester

UR11 Ocean Blue	UR12 Blue Bayou
UR13 Green Grass	UR18 Brown Ridge
UR19 White Sand	UR20 Granite Rock
UR21 Gravel Road	UR22 Black Coal

### Wavelength 100% Virgin Polyester

WV01 Lime	WV02 Mint
WV03 Stone	WV04 Flame
WV05 Mykonos	WV06 Savannah
WV07 Mesa	WV08 Plasma
WV09 Cancun	WV10 Quartz
WV11 Moonrock	WV12 Rubine
WV13 Corfu	WV14 Bluejay
WV14 Panther	

### GRADE 2

#### Allante Free 100% Vinyl Face / 100% Polyester Backing

A01F Illusion	A02F Bright White
A03F White Crush	A04F Ivory
A05F Ice	A06F Bleached Sand
A07F Taupe Fawn	A08F Warm Smoke
A09F Autumn Rain	A10F Cookie
A11F Sierra Brick	A12F Gibraltar
A13F Chateau Grey	A14F Garden Green
A15F Oasis Green	A16F Ink Black
A17F Purple Impulse	A18F Italian Rose
A19F Mountain Sky	A20F Old Navy
A21F Galaxy	A22F Red Truffle
A23F Chocolate Sundae	A24F Province Blue
A25F Eclipse	

#### Elevate 80% Post-Consumer Recycled Polyester/ 20% Rayon

EL51 Halo	EL52 Dove
EL53 Safari	EL54 Sunglow
EL55 Margarita	EL56 Fiji
EL57 Mist	EL58 Blaze
EL59 Wasabi	EL60 Mystic
EL61 Mica	EL62 Cherry
EL63 Scuba	EL64 Lapis
EL65 Onyx	

#### Etch 80% Post-Consumer Recycled Polyester/ 20% Rayon

ET81 Drift	ET82 Citron
ET83 Calypso	ET84 Mandarin
ET85 Crisp	ET86 Iris
ET87 Nickel	ET88 Paprika
ET89 Nutmeg	ET90 Marine
ET91 Magnet	ET92 Infrared
ET93 Espresso	ET94 Indigo
ET95 Anthracite	

### Imprint 100% Post-Consumer Polyester

IM70 Almond	IM71 Cork
IM72 Sand	IM73 Currie
IM74 Candy Apple	IM75 Ocean
IM76 Navy	IM77 Green Tea
IM78 Celery	IM79 Oregano
IM80 Walnut	IM81 Paprika
IM82 Graphite	IM83 Slate
IM84 Licorice	

### Luxhide 100% Vinyl Face / Bonded Leather Backing

BL20 Black	BL22 Parchment
BL23 Saddle	BL24 Dark Brown
BL26 Burgundy	BL27 Charcoal
BL28 White	
BL34 Light Grey	

### Release 100% Vinyl Face

RL11 White	RL12 Chalk
RL13 Stone	RL14 Taupe
RL15 Orange	RL16 Country
RL17 Tuscan	RL18 Cottage
RL19 Yellow	RL21 Red Barn
RL22 Brave Red	RL23 Gypsy Red
RL24 Cajun	RL25 Vineyard
RL26 Olive	RL27 Bonsai
RL28 Summer's Dream	RL29 Calico
RL31 Green	RL32 Blue
RL33 Black	RL34 Cool Grey
RL35 Thunder Grey	RL36 Navy
RL37 Dark Chocolate	RL38 Espresso

























### GRADE 10

Prescott Leather	
PC02 Zinc	PC04 Papyrus
PC05 Soul White	PC10 Caffè Latte
PC14 Avana	PC18 Swamp
PC41 Antique	PC54 Antipol
PC57 Chestnut	PC79 Oceania
PC80 Indigo	PC81 Deep
PC86 Santorini	PC96 Turtledove
PC97 Smoke	PD02 Grayshadow
PD03 Black Ink	

Textiles are subject to change, please confirm current selection.

## TERMS AND CONDITIONS

- All product series have MAXIMUM order quantities which can be fulfilled within the fast5 program. These are noted with each series' Specs + Options. For greater quantities, please contact CustomerCare for lead time and terms.
- Orders that exceed maximum unit quantities will receive standard lead times.
- Orders must clearly note "fast5" and be submitted as a separate purchase order. Global cannot mix fast5 and standard delivery or InStock products on the same purchase order.
- Purchase orders containing products from fast5 and fast10 programs will automatically receive fast10 lead time and shipping. Purchase order should be noted "fast10".
- Certain models, noted on the series' Specs + Options, are multi-packed and must be ordered in quantities accordingly. Package unit quantities cannot be changed.
- Program is limited to exact models, model options and textiles within series listed.
- Program is limited to exact textile pattern colorways listed in the fast5 program. Use the Textile Search Tool to confirm desired textile is approved for use on the selected series.
- Orders must be clean with correct model numbers, options, textiles, correct pricing, etc. to apply.
- Orders cannot be changed or canceled after order acknowledgment.
- Current Global list pricing applies at the time of order. fast5 orders may be shipped FedEx, UPS or via alternate carriers. Global reserves the right to ship "best way".
- fast5 products will be manufactured to your orders' specifications in 5 business days or less and ship immediately thereafter.
- Orders will ship to the dealer or commercial end-user directly. Delivery charges may apply for special handling, services, etc. Please consult your Territory Manager or CustomerCare Representative.
- Dealer must be in good standing and account within terms for order(s) to be processed without delay.
- fast5 program is available in the 48 contiguous United States.

Series	Model Numbers	Series	Model Numbers	Series	Model Numbers
<b>Aspen</b>	(maximum 20) 2851-3 2853-3	<b>Luray</b>	(maximum 20) 6461 6462	<b>Sonic</b>	Plastic (maximum 100) 6508 6508MB 6513 6513MB 6558 6558CS 6573 6573MB 6577 6577MB
					
<b>Comet</b>	(maximum 50) 2171WS 2172WS	<b>Noetic</b>	(maximum 50) 6070 6070NA 6071 6071NA 6072 6072NA 6073 6073NA 6074 6074NA 6075 6075NA 6076 6076NA 6077 6077NA		Upholstered (maximum 50) 6509 6509MB 6511 6514MB 6514 6574MB 6515 6578MB 6574 6517WS 6578
					
<b>Duet</b>	Plastic (maximum 100) 6620 6621	<b>Popcorn</b>	Plastic (maximum 100) 6710 6711	<b>Sora</b>	(maximum 20) 6941 6942
					
	Upholstered (maximum 50) 6622 6627 6623 6628 6624		Upholstered (maximum 50) 6712 6713 6715		
<b>Factor</b>	(maximum 50) 5540 5541 5540NA 5541NA	<b>Prefer</b>	(maximum 20) 8458 8459	<b>Spritz</b>	(maximum 50) 6761-4 6763-6 6761-8 6766-4 6762-6 6766-8
					
<b>G1 Ergo Select</b>	(maximum 50) 7331 7332	<b>Rebound</b>	Plastic (maximum 100) R5NPPG R5APPG R5NPPC R5APPC		Nester (maximum 50) 6764C 6465C
				<b>Synopsis</b>	(maximum 50) 5080-0 5081-3 5080-3 5080-4 5081-0 5091-4
			Upholstered (maximum 50) R5NPUG R5APUG R5NPUC R5APUC		
<b>Global Accord</b>	(maximum 50) 2670-2 2676-2 2670-4 2676-4 2671-2 2677-2 2671-4 2677-4 2672-6 2678-6	<b>Roma</b>	(maximum 50) 1890 1903 1896 1906 1897 1907 1901 1908 1902	<b>Truform</b>	(maximum 50) 5450-3 5458-6 5451-3 TS5450-3 5457-6 TS5451-3
					
			Nester (maximum 50) 1898 1900 1899	<b>Triumph</b>	(maximum 20) 3650-3 3651-3 3650-8 3651-8
<b>Goal</b>	(maximum 50) 2235-6 2237-5 2236-6 2237-6 2237-3 2239-6	<b>Sidero</b>	(maximum 50) 6900 6901 6900C 6901C 2125C	<b>Vion</b>	Mesh (maximum 50) 6321-0 6322-4 6321-3 6322-8 6321-4 6327-6 6321-8 6328-6 6322-0 TS6321-3 6322-3 TS6322-3
					
<b>Granada</b>	(maximum 50) 3212 3254 3278	<b>Solar</b>	(maximum 50) 8456 8457 8456NA 8457NA 8456S 8457S 8456SNA 8457SNA		Upholstered (maximum 50) 6331-0 6332-0 6331-3 6332-3 6331-4 6332-4 6331-8 6332-8
					
<b>Loover</b>	(maximum 50) 2661-0 2662-0 2661-3 2662-3 2661-4 2662-4 2661-8 2662-8	<b>Solo</b>	(maximum 50) 5228		Guest (maximum 50) 6324 6325 6324C 6325C
					

# fast10

Global's fast10 quick ship program offers many of our bestselling models upholstered in your choice of our most popular textiles.

- 5 Series, 25+ Models, 200+ Textiles to customize your order
- No special order forms required

Global's fast production and shipping make it simple to order and ideal for tight deadlines!

## Color it your way

### GRADE 1

Carrera 100% Polyester	
CE84 Zest	CE85 Savannah
CE86 Slate	CE87 Rainforest
CE88 Aspen	CE89 Dune
CE90 Flannel	CE91 Azure
CE92 Chili	CE93 Jute
CE95 Ink	CE96 Sangria
CE97 Java	CE98 Charcoal

### Fusion 90% Virgin Polyester / 10% Post-Consumer Recycled Polyester

FU71 Tangerine	FU72 Fresh
FU73 Moss	FU74 Tomato
FU75 Aqua	FU76 Sandstone
FU77 Granite	FU78 Poppy
FU79 Cadet	FU80 Oasis
FU81 Graphite	FU82 Viola
FU83 Cobalt	FU84 Flax
FU85 Carbon	

### Illusion 100% Virgin Polyester

II01 Cappuccino	II02 Paprika
II03 Tropic	II04 Wicker
II05 Hemp	II06 Cayenne
II07 Maui	II08 Dusk
II09 Smoke	II10 Currant
II11 Fiji	II12 Ozone
II13 Ebony	

### Jenny 100% Polyester

JN01 Midnite	JN02 Ebony
JN03 Slate	JN07 Vermilion
JN08 Admiral	JN11 Charcoal
JN25 Silver Lining	JN26 Oatmeal
JN27 Sunflower	JN28 Cascade
JN29 Harvest	JN30 Melon
JN31 Berry	JN32 Green Grass
JN33 Roast	

### Quilt 100% Polyester

QL10 Black	QL11 Charcoal Grey
QL14 Navy	QL16 Wine
QL19 Silver	QL20 Feather
QL21 Dune	QL22 Meadow
QL23 Cadet	QL24 Geranium
QL25 Daisy	QL26 Quest
QL27 Punch	QL28 Tangerine
QL29 Cocoa	

### Trak 100% Recycled Polyester

TK40 Taupe	TK41 Mustard
TK42 Latte	TK43 Cement
TK44 Silver	TK45 Copper
TK46 Teal	TK47 Apple
TK48 Steel	TK49 Merlot
TK50 Midnight Sky	TK51 Mocha
TK52 Carbon	

### Urban 62% Recycled Polyester / 32% Polyester

UR11 Ocean Blue	UR12 Blue Bayou
UR13 Green Grass	UR18 Brown Ridge
UR19 White Sand	UR20 Granite Rock
UR21 Gravel Road	UR22 Black Coal

### Wavelength 100% Virgin Polyester

WV01 Lime	WV02 Mint
WV03 Stone	WV04 Flame
WV05 Mykonos	WV06 Savannah
WV07 Mesa	WV08 Plasma
WV09 Cancun	WV10 Quartz
WV11 Moonrock	WV12 Rubine
WV13 Corfu	WV14 Bluejay
WV14 Panther	

### GRADE 2

#### Allante FRee 100% Vinyl Face / 100% Polyester Backing

A01F Illusion	A02F Bright White
A03F White Crush	A04F Ivory
A05F Ice	A06F Bleached Sand
A07F Taupe Fawn	A08F Warm Smoke
A09F Autumn Rain	A10F Cookie
A11F Sierra Brick	A12F Gibraltar
A13F Chateau Grey	A14F Garden Green
A15F Oasis Green	A16F Ink Black
A17F Purple Impulse	A18F Italian Rose
A19F Mountain Sky	A20F Old Navy
A21F Galaxy	A22F Red Truffle
A23F Chocolate Sundae	A24F Province Blue
A25F Eclipse	

#### Elevate 80% Post-Consumer Recycled Polyester/ 20% Rayon

EL51 Halo	EL52 Dove
EL53 Safari	EL54 Sunglow
EL55 Margarita	EL56 Fiji
EL57 Mist	EL58 Blaze
EL59 Wasabi	EL60 Mystic
EL61 Mica	EL62 Cherry
EL63 Scuba	EL64 Lapis
EL65 Onyx	

#### Etch 80% Post-Consumer Recycled Polyester/ 20% Rayon

ET81 Drift	ET82 Citron
ET83 Calypso	ET84 Mandarin
ET85 Crisp	ET86 Iris
ET87 Nickel	ET88 Paprika
ET89 Nutmeg	ET90 Marine
ET91 Magnet	ET92 Infrared
ET93 Espresso	ET94 Indigo
ET95 Anthracite	

### Imprint 100% Post-Consumer Polyester

IM70 Almond	IM71 Cork
IM72 Sand	IM73 Currie
IM74 Candy Apple	IM75 Ocean
IM76 Navy	IM77 Green Tea
IM78 Celery	IM79 Oregano
IM80 Walnut	IM81 Paprika
IM82 Graphite	IM83 Slate
IM84 Licorice	

### Luxhide 100% Vinyl Face / Bonded Leather Backing

BL20 Black	BL22 Parchment
BL23 Saddle	BL24 Dark Brown
BL26 Burgundy	BL27 Charcoal
BL28 White	
BL34 Light Grey	

### Release 100% Vinyl Face

RL11 White	RL12 Chalk
RL13 Stone	RL14 Taupe
RL15 Orange	RL16 Country
RL17 Tuscan	RL18 Cottage
RL19 Yellow	RL21 Red Barn
RL22 Brave Red	RL23 Gypsy Red
RL24 Cajun	RL25 Vineyard
RL26 Olive	RL27 Bonsai
RL28 Summer's Dream	RL29 Calico
RL31 Green	RL32 Blue
RL33 Black	RL34 Cool Grey
RL35 Thunder Grey	RL36 Navy
RL37 Dark Chocolate	RL38 Espresso

### GRADE 10

Prescott Leather	
PC02 Zinc	PC04 Papyrus
PC05 Soul White	PC10 Caffè Latte
PC14 Avana	PC18 Swamp
PC41 Antique	PC54 Antipol
PC57 Chestnut	PC79 Oceania
PC80 Indigo	PC81 Deep
PC86 Santorini	PC96 Turtledove
PC97 Smoke	PD02 Grayshadow
PD03 Black Ink	

Textiles are subject to change, please confirm current selection.

## TERMS AND CONDITIONS

- All models have MAXIMUM quantity of 10 pieces, noted on each sheet, which can be fulfilled within the fast10 program. These are noted next to each series' Specs + Options. For greater quantities, please contact CustomerCare for lead times and terms.
- Orders that exceed maximum unit quantities will receive standard lead times.
- Orders must clearly note "fast10" and be submitted as a separate purchase order. Global cannot mix "fast10" and standard delivery or InStock products on the same purchase order.

- Purchase orders containing products from fast5 and fast10 programs will automatically receive fast10 lead time and shipping. Purchase order should be noted "fast10".
- Program is limited to exact models, model options and textiles within series listed.
- Program is limited to exact textile pattern colorways listed in the fast10 program. Use the Textile Search Tool to confirm desired textile is approved for use on the selected series.
- Orders must be clean with correct model numbers, options, textiles, correct pricing, etc. to apply.
- Orders cannot be changed or canceled after order acknowledgment.
- Current Global list pricing applies at the time of order.

- fast10 models are not available for FEDEX or UPS shipping. Global reserves the right to ship "best way".
- fast10 products will be manufactured to your orders' specifications in 10 business days or less and be consolidated for shipping immediately thereafter.
- Orders will ship to the dealer or commercial end-user directly. Delivery charges may apply for special handling, services, etc. Please consult your Territory Manager or CustomerCare Representative.
- Dealer must be in good standing and account within terms for order(s) to be processed without delay.
- fast10 Program is available in the 48 contiguous United States.

Series	Model Numbers	Series	Model Numbers	Series	Model Numbers
<b>Citi</b> 	(maximum 10)	<b>Wind</b> 	(maximum 10)	<b>Drift</b> 	(maximum 10)
	7864		3361		8016
	7875		3362		8021
	7876		3363		8022
	7877				8023
	7879				8024
	7885		8026		
			8030		
			8032		
			8033		
			8034		
			8035		
			8036		
<hr/> <b>Citi Square</b>		<hr/> <b>sirena</b>			
	(maximum 10)		(maximum 10)		
	S7875		3371		
	S7876				
	S7877				
	S7877				
	S7911				

# work + task

Arno .....23	G1 Ergo Select .....38	Loover .....61
Arturo .....23	G20 .....23	Luray .....65
Aspen .....23	Global Accord .....23	Malaga .....67
Auburn .....23	Goal .....23	Mirage .....68
Concorde .....29	Graham .....23	Noetic.....69
Diplomat .....23	Granada .....23	Novello .....74
Enterprise .....23	Granada Deluxe .....23	ObusForme Comfort + XL .....78
Factor .....36	Graphic .....23	Prefer .....85
	Include.....59	

# work + task

Roma .....	87	Synopsis .....	107
Solar .....	91	Traditional .....	110
Solo .....	93	Triumph .....	113
Sora .....	95	Truform .....	114
Spritz .....	97	Tye .....	117
Stream.....	99	Vion .....	120
Supra .....	102	Weev .....	128
Supra X .....	104		

ARNO™



model 4003

STANDARD FEATURES

- Perforated leather inserts in the seat and back surfaces.
- Standard Black (BK) molded flared loop arms and a five-legged injection molded base with C65 casters.
- Standard in Luxhide. Not available in fabric. Starting at grade 5 pricing.
- Check textile availability prior to specifying upholstery material.

OPTIONAL FEATURES

- Please refer to the "Casters Selection" section of the price book for caster options. Optional casters may be priced higher than the standard casters for your chair and the difference will be charged. Lower priced optional casters will not be credited.
- An optional abrasion resistant outer back fabric (polyester) is available. Resistant to impact damage. Available in Black only. Add \$25.
- For hard surface flooring casters, please specify C10R. Add \$125.
- For fully assembled in box, please specify SU. Add \$81



HB Tilter

COM Yardage: 2.50  
 Freight Class: 250  
 Product Weight (lbs.): 39  
 Cubic Feet Per Carton: 11.50

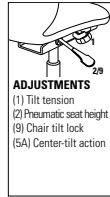

**ADJUSTMENTS**  
 (1) Tilt tension  
 (2) Pneumatic seat height  
 (3) Chair tilt lock  
 (5A) Center-tilt action

Ergonomic Features:  
 A, B, C, N, S

	1	2	3	4	5	6	7	8	9	10	11	12
<b>4003</b>	-	-	-	-	570	649	-	1042	1187	1421	1771	2192

OVERALL DIMENSIONS			SEAT DIMENSIONS			BACK DIMENSIONS	
W	D	H	W	D	H	W	H
25	29	42	20.5	19	16-20	21	24



**Armchair w/ Sled Base**  
 COM Yardage: 2.50  
 Freight Class: 250  
 Product Weight (lbs.): 33  
 Cubic Feet Per Carton: 13

Ergonomic Features:  
 N

	1	2	3	4	5	6	7	8	9	10	11	12
<b>4004</b>	-	-	-	-	570	649	-	1042	1187	1421	1771	2192

OVERALL DIMENSIONS			SEAT DIMENSIONS			BACK DIMENSIONS	
W	D	H	W	D	H	W	H
24.5	26.5	36	20	19	18	20.5	19



ARTURO™



model 3991







model 3992

STANDARD FEATURES

- Stitched seat and back design, padded headrest (model 3991) and upholstered open arms.
- All models are standard with a five prong, injection molded, fiberglass reinforced nylon Black spider base with (C65) dual wheel carpet casters.
- Base and frame are available in Black only.
- Standard in Luxhide. Not available in fabric. Starting at grade 5 pricing.
- Check textile availability prior to specifying upholstery material.

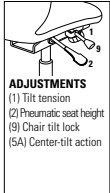
OPTIONAL FEATURES

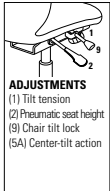
- There are no arm options for this series.
- An optional abrasion resistant outer back fabric (polyester) is available. Resistant to impact damage. Available in Black only. Specify (BKB). Add \$25.
- For hard surface flooring casters, specify (C65R). Add \$78.
- Please refer to the "Casters Selection" section of the price book for caster options. Optional casters may be priced higher than the standard casters for your chair and the difference will be charged. Lower priced optional casters will not be credited.
- For fully assembled in box, specify (SU). Add \$81.

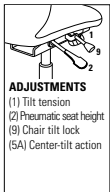
DESCRIPTION	FEATURES	MODEL#	STANDARD TEXTILE GRADES													
			1	2	3	4	5	6	7	8	9	10	11	12		
 <p><b>Extended HB Tilter</b> COM Yardage: 4 Freight Class: 250 Product Weight (lbs.): 54 Cubic Feet Per Carton: 14</p>	 <p><b>ADJUSTMENTS</b> (1) Tilt tension (2) Pneumatic seat height (9) Chair tilt lock (5A) Center-tilt action</p>	3991	-	-	-	-	1624	1744	1966	2375	2599	2976	3539	4213		
			<b>OVERALL DIMENSIONS</b>			<b>SEAT DIMENSIONS</b>			<b>BACK DIMENSIONS</b>							
			<b>W</b>	<b>D</b>	<b>H</b>	<b>W</b>	<b>D</b>	<b>H</b>	<b>W</b>	<b>H</b>						
			26	30.5	50	21	20	16.5-20.5	21.5	30.5						
			<b>RTA 1</b>			FedEx			UPS							
 <p><b>HB Tilter</b> COM Yardage: 3.50 Freight Class: 250 Product Weight (lbs.): 52 Cubic Feet Per Carton: 13.25</p>	 <p><b>ADJUSTMENTS</b> (1) Tilt tension (2) Pneumatic seat height (9) Chair tilt lock (5A) Center-tilt action</p>	3992	-	-	-	-	1503	1609	1804	2158	2358	2685	3181	3772		
			<b>OVERALL DIMENSIONS</b>			<b>SEAT DIMENSIONS</b>			<b>BACK DIMENSIONS</b>							
			<b>W</b>	<b>D</b>	<b>H</b>	<b>W</b>	<b>D</b>	<b>H</b>	<b>W</b>	<b>H</b>						
			26	30	43	20.5	19.5	16.5-20.5	20.5	25						
			<b>RTA 1</b>			FedEx			UPS							
 <p><b>LB Tilter</b> COM Yardage: 3.50 Freight Class: 250 Product Weight (lbs.): 44 Cubic Feet Per Carton: 11.50</p>	 <p><b>ADJUSTMENTS</b> (1) Tilt tension (2) Pneumatic seat height (9) Chair tilt lock (5A) Center-tilt action</p>	3993	-	-	-	-	1446	1554	1749	2105	2305	2637	3126	3715		
			<b>OVERALL DIMENSIONS</b>			<b>SEAT DIMENSIONS</b>			<b>BACK DIMENSIONS</b>							
			<b>W</b>	<b>D</b>	<b>H</b>	<b>W</b>	<b>D</b>	<b>H</b>	<b>W</b>	<b>H</b>						
			26	29.5	37	20.5	19.5	16.5-20.5	20.5	18						
			<b>RTA 1</b>			FedEx			UPS							

ASPEN™



model 2850-3



model 2851-3



**Lumbar Support**  
Back height can be adjusted to enable a user to reposition the contact zone of lumbar support.



model 2852-3





STANDARD FEATURES

- Aspen features a slender design and sensitive profile with a superior level of comfort.
- Extended back models are standard with a height adjustable headrest.
- All models offer 2.25" back/lumbar height adjustment via a concealed ratchet system.
- All models are standard with height and width adjustable arms (AS) that feature a sliding armcap providing extra support for all users.
- Models feature braille on the underside of all paddles.
- Base and arm detail is standard in Black.
- All models are shipped partially KD.
- C82 dual wheel carpet casters are standard.
- Side activated sliding seat depth adjustment is standard on multi-tilters. Provides 2" of seat adjustment.
- Check textile availability prior to specifying upholstery material.

OPTIONAL FEATURES

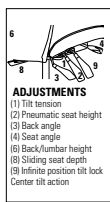
- Polished Aluminum base is available. Specify (AL). Add \$177.
- Coordinating Chrome finished arms are available at no upcharge. Specify (AC).
- Please refer to "Arm Selection" section of the price book for additional arm options.
- Please refer to "Cylinder Selection" section of the price book for additional cylinder options.
- For hard surface flooring casters, specify C9R. Add \$104
- For fully assembled in box, specify SU. Add \$81.

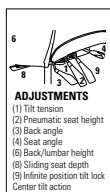

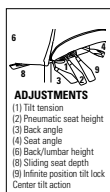
DESCRIPTION	FEATURES	MODEL#	STANDARD FABRIC GRADES											
			1	2	3	4	5	6	7	8	9	10	11	12
 <p><b>Extended Back Multi - Tilter</b> COM Yardage: 2.50 Freight Class: 150 Product Weight (lbs.): 66 Cubic Feet Per Carton: 14.75</p>	 <p><b>ADJUSTMENTS</b> (1) Tilt tension (2) Pneumatic seat height (3) Back angle (4) Seat angle (5) Back/lumbar height (6) Sliding seat depth (8) Infinite position tilt lock Center tilt action</p>	<p>2850-3</p>	1615	1710	1784	1894	2050	2105	2241	2501	2628	2868	3196	3604
			<b>OVERALL DIMENSIONS</b>			<b>SEAT DIMENSIONS</b>			<b>BACK DIMENSIONS</b>					
			<b>W</b>	<b>D</b>	<b>H</b>	<b>W</b>	<b>D</b>	<b>H</b>	<b>W</b>	<b>H</b>				
			25	24	45	19.5	19.5-21	16.5-20.5	18.5	26.5-29				
		<b>RTA 2</b>												
 <p><b>HB Multi - Tilter</b> COM Yardage: 2.25 Freight Class: 150 Product Weight (lbs.): 64 Cubic Feet Per Carton: 14.75</p>	 <p><b>ADJUSTMENTS</b> (1) Tilt tension (2) Pneumatic seat height (3) Back angle (4) Seat angle (5) Back/lumbar height (6) Sliding seat depth (8) Infinite position tilt lock Center tilt action</p>	<p>2851-3</p>	1443	1527	1596	1695	1835	1883	2007	2241	2353	2571	2865	3233
			<b>OVERALL DIMENSIONS</b>			<b>SEAT DIMENSIONS</b>			<b>BACK DIMENSIONS</b>					
			<b>W</b>	<b>D</b>	<b>H</b>	<b>W</b>	<b>D</b>	<b>H</b>	<b>W</b>	<b>H</b>				
			25	24	41	19.5	18-19.5	16.5-20.5	19.5	22.5				
		<b>RTA 2</b>												
 <p><b>MB Multi - Tilter</b> COM Yardage: 2 Freight Class: 150 Product Weight (lbs.): 62 Cubic Feet Per Carton: 13</p>	 <p><b>ADJUSTMENTS</b> (1) Tilt tension (2) Pneumatic seat height (3) Back angle (4) Seat angle (5) Back/lumbar height (6) Sliding seat depth (8) Infinite position tilt lock Center tilt action</p>	<p>2852-3</p>	1400	1478	1537	1625	1751	1793	1903	2111	2210	2403	2665	2992
			<b>OVERALL DIMENSIONS</b>			<b>SEAT DIMENSIONS</b>			<b>BACK DIMENSIONS</b>					
			<b>W</b>	<b>D</b>	<b>H</b>	<b>W</b>	<b>D</b>	<b>H</b>	<b>W</b>	<b>H</b>				
			25	24	37	19.5	18.5-21	16.5-20.5	18.5	18.5-21				
		<b>RTA 2</b>												



AUBURN



model 3767



**Optional Base**  
Polished Aluminum (ALU) finish is available on arm frame and base at an upcharge. Add \$353.



Wood-capped base



Polished Aluminum



**Optional Base**  
Wood-capped steel base with C1 casters is available at an upcharge (B4M). Add \$494

STANDARD FEATURES

- This transitional style judge's chair offers a scrolled urethane arm for durability and comfort.
- Arm frame is made from Black cast aluminum for exceptional strength and quality
- Standard with soft, durable, self-skinned urethane (SSU) armcaps that are warm to the touch
- Five prong, injection molded, fiberglass reinforced nylon Black spider base with **C10** dual wheel carpet casters.
- Standard in Luxhide. Not available in fabric. Starting at grade 5 pricing.
- Check textile availability prior to specifying upholstery material.

OPTIONAL FEATURES

- Oval style wood-capped steel base (**B4M**) with (**C1**) casters is available. Genuine maple faced veneers and solids are used. Available in Absolute (AAM), Black (BKM), Cherry (ACM), Espresso Cafe (ECM), English Oak (EOM), Fruitwood (TFM), Gray (HGM), Honey (AHM), Mahogany (TMM), Maple (AVM), Medium Walnut (MWM), Natural Walnut (NLW), Night (ASM), Noce Biondo (NBM), Noce Grigio (NGM), Noce Leggero (NEM), Noce Medio (NMM), Shaker Cherry (SKM), Walnut (TWM), WC Cream (WTM), White (WHM) and Winter Cherry (WCM). Please specify. Add \$494.
- Polished Aluminum base is available. A **B2** aluminum base with black scuff tips and **C10** casters. Add \$177.
- For hard flooring surface casters with wood-capped base, please specify **C9R**. Add \$19.
- For hard surface flooring please specify **C10R** casters. Add \$70.
- Please refer to the "Casters Selection" section of the price book for caster options. Optional casters may be priced higher than the standard casters for your chair and the difference will be charged. Lower priced optional casters will not be credited.

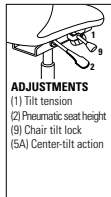
DESCRIPTION	FEATURES	MODEL#	STANDARD TEXTILE GRADES											
			1	2	3	4	5	6	7	8	9	10	11	12
 <p><b>HB Tilter</b> COM Yardage: 3 Freight Class: 250 Product Weight (lbs.): 63 Cubic Feet Per Carton: 22.25</p>	 <p><b>ADJUSTMENTS</b> (1) Tilt tension (2) Pneumatic seat height (9) Chair tilt lock (5A) Center-tilt action</p>	<b>3767</b>	-	-	-	1841	1929	-	2370	2529	2793	3188	3660	
		<b>OVERALL DIMENSIONS</b>			<b>SEAT DIMENSIONS</b>			<b>BACK DIMENSIONS</b>						
		<b>W</b>	<b>D</b>	<b>H</b>	<b>W</b>	<b>D</b>	<b>H</b>	<b>W</b>	<b>H</b>					
28	28	46.5	21.5	18	16.5-20.5	21.5	27.5							
			<b>RTA 00</b>											
		Ergonomic Features: A, B, C, M, N, S												

**CONCORDE™**



model 2400-18



model 2400-18



**Push Button**

Location within reach increases your adjustment. Promotes good posture as you move to various positions.



model 2409



**Polished Aluminum Base**

Concorde Presidential models are standard with a polished aluminum base.

**STANDARD FEATURES**

- All adjustments are made with easy-use button controls that are conveniently located in full view.
- Compound curved molded foam seat and back cushions.
- Standard with Allen-bolted width adjustable arms (Allen key included). Arms adjust 1.25" wider on each side for a total of 2.5" extra width.
- Push button controlled tilt lock and push button controlled seat height.
- Seat cushions are easily removed without tools for ease of cleaning.
- Five prong, injection molded, fiberglass reinforced nylon Black base with (C10) dual wheel carpet casters.
- Upholstery options: leather. Not available in vinyl.
- Model 2424 is rated for multi-shift use for persons up to 350 pounds.
- For 24 hour application, Global's limited lifetime warranty is applicable only on fabrics that are rated for 100,000 double rubs.
- Concorde is fully assembled in box, as standard.
- Check textile availability prior to specifying upholstery material.

**OPTIONAL FEATURES**

- There are no arm options for this series.
- Optional aluminum base is available. Add. \$177.
- For hard surface flooring casters, please specify (C10R). Add \$70.
- For additional caster options, please refer to the Arm and Caster section. Optional casters may be priced higher than the standard casters for your chair and the difference will be charged. Lower priced optional casters will not be credited.



**CONCORDE PRESIDENTIAL (MODEL #2409)**



**STANDARD FEATURES**

- Only available in Leather.
- Has a larger headrest, wider back and closed upholstered arms.
- Features decorative stitching, standard in a heavy gauge off-white stitch detail to show contrast with leather upholstery.
- Features perforated leather inserts in the seat and back cushions.
- Standard with (C25) dual wheel carpet casters.
- Standard with a Black arm button trim
- Standard with a Polished Aluminum base.

**OPTIONAL FEATURES**

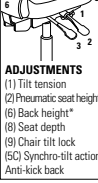
- Normal gauge color coordinated thread can be used upon request. Specify "matching thread" on order. No upcharge.
- Non-perforated leather inserts in the seat and back cushions are optional. Specify (NR).
- Optional with a Black base at no additional charge. Specify (BK).

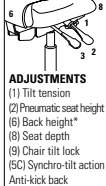
DESCRIPTION	FEATURES	MODEL#	STANDARD TEXTILE GRADES																								
			1	2	3	4	5	6	7	8	9	10	11	12													
 <p><b>HB Multi - Tilter</b> Concorde Executive COM Yardage: 2.50 Freight Class: 250 Product Weight (lbs.): 76 Cubic Feet Per Carton: 23.50</p>	 <p><b>ADJUSTMENTS</b> (1) Tilt tension (2) Pneumatic seat height (3) Back angle (6) Back height* (9) Chair tilt lock (5A) Center-tilt action</p>	<p>Ergonomic Features: A, B, C, D, G, M, N, Q, S, T</p>	<table border="1"> <tr> <td><b>2400-18</b></td> <td>-</td> <td>4509</td> <td>4587</td> <td>4703</td> <td>4863</td> <td>4922</td> <td>5063</td> <td>5326</td> <td>5455</td> <td>5703</td> <td>6047</td> <td>6468</td> </tr> </table>												<b>2400-18</b>	-	4509	4587	4703	4863	4922	5063	5326	5455	5703	6047	6468
			<b>2400-18</b>	-	4509	4587	4703	4863	4922	5063	5326	5455	5703	6047	6468												
			<table border="1"> <thead> <tr> <th colspan="3">OVERALL DIMENSIONS</th> <th colspan="3">SEAT DIMENSIONS</th> <th colspan="3">BACK DIMENSIONS</th> </tr> <tr> <th>W</th> <th>D</th> <th>H</th> <th>W</th> <th>D</th> <th>H</th> <th>W</th> <th>H</th> </tr> </thead> <tbody> <tr> <td>26</td> <td>28</td> <td>48</td> <td>21</td> <td>19.5</td> <td>17.5-21.5</td> <td>21</td> <td>31</td> </tr> </tbody> </table>			OVERALL DIMENSIONS			SEAT DIMENSIONS			BACK DIMENSIONS			W	D	H	W	D	H	W	H	26	28	48	21	19.5
OVERALL DIMENSIONS			SEAT DIMENSIONS			BACK DIMENSIONS																					
W	D	H	W	D	H	W	H																				
26	28	48	21	19.5	17.5-21.5	21	31																				
<p>RTA 00</p>																											
 <p><b>HB Synchro - Tilter Deluxe</b> Concorde Presidential COM Yardage: 23.50 Freight Class: 250 Product Weight (lbs.): 78 Cubic Feet Per Carton: 23.50</p>	 <p><b>ADJUSTMENTS</b> (1) Tilt tension (2) Pneumatic seat height (6) Back height* (8) Seat depth (9) Chair tilt lock (5C) Synchro-tilt action Anti-kick back</p>	<p>Ergonomic Features: A, B, C, D, E, L, M, N, Q, T</p>	<table border="1"> <tr> <td><b>2409</b></td> <td>-</td> <td>-</td> <td>-</td> <td>-</td> <td>-</td> <td>-</td> <td>-</td> <td>-</td> <td>-</td> <td>7395</td> <td>7955</td> <td>8540</td> </tr> </table>												<b>2409</b>	-	-	-	-	-	-	-	-	-	7395	7955	8540
			<b>2409</b>	-	-	-	-	-	-	-	-	-	7395	7955	8540												
			<table border="1"> <thead> <tr> <th colspan="3">OVERALL DIMENSIONS</th> <th colspan="3">SEAT DIMENSIONS</th> <th colspan="3">BACK DIMENSIONS</th> </tr> <tr> <th>W</th> <th>D</th> <th>H</th> <th>W</th> <th>D</th> <th>H</th> <th>W</th> <th>H</th> </tr> </thead> <tbody> <tr> <td>28.5</td> <td>27</td> <td>50</td> <td>21</td> <td>18-20</td> <td>18-22</td> <td>21</td> <td>28-31</td> </tr> </tbody> </table>			OVERALL DIMENSIONS			SEAT DIMENSIONS			BACK DIMENSIONS			W	D	H	W	D	H	W	H	28.5	27	50	21	18-20
OVERALL DIMENSIONS			SEAT DIMENSIONS			BACK DIMENSIONS																					
W	D	H	W	D	H	W	H																				
28.5	27	50	21	18-20	18-22	21	28-31																				
<p>RTA 00</p>																											

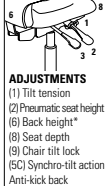
DESCRIPTION	FEATURES	MODEL#	STANDARD TEXTILE GRADES													
			1	2	3	4	5	6	7	8	9	10	11	12		
 <p><b>HB Synchro - Tilter</b> Concorde Executive 24HR COM Yardage: 2.50 Freight Class: 250 Product Weight (lbs.): 78 Cubic Feet Per Carton: 23.50</p>	 <p><b>ADJUSTMENTS</b> (1) Tilt tension (2) Pneumatic seat height (6) Back height* (8) Seat depth (9) Chair tilt lock (5C) Synchro-tilt action Anti-kick back</p>	<b>2424</b>	-	3375	3454	3568	3731	3790	3929	4194	4321	4570	4909	5331		
			<b>OVERALL DIMENSIONS</b>			<b>SEAT DIMENSIONS</b>			<b>BACK DIMENSIONS</b>							
			<b>W</b>	<b>D</b>	<b>H</b>	<b>W</b>	<b>D</b>	<b>H</b>	<b>W</b>	<b>H</b>						
			28.5	27	50	21	17.5-19	18-22	21	28-31						
			<b>RTA 00</b>													
 <p><b>HB Synchro - Tilter</b> Concorde Executive 24HR COM Yardage: 2.50 Freight Class: 250 Product Weight (lbs.): 78 Cubic Feet Per Carton: 23.50</p>	 <p><b>ADJUSTMENTS</b> (1) Tilt tension (2) Pneumatic seat height (6) Back height* (8) Seat depth (9) Chair tilt lock (5C) Synchro-tilt action Anti-kick back</p>	<b>2424-18</b>	-	3430	3514	3626	3784	3846	3990	4250	4382	4630	4971	5392		
			<b>OVERALL DIMENSIONS</b>			<b>SEAT DIMENSIONS</b>			<b>BACK DIMENSIONS</b>							
			<b>W</b>	<b>D</b>	<b>H</b>	<b>W</b>	<b>D</b>	<b>H</b>	<b>W</b>	<b>H</b>						
			28.5	27	50	21	17.5-19	18-22	21	28-31						
			<b>RTA 00</b>													

**DIPLOMAT**



model 2106



model 2107

Also see Diplomat Guest Chairs



For Diplomat guest chairs, please see 153.

**STANDARD FEATURES**







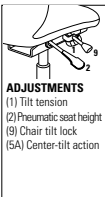

- A contoured seat and back are accented by wood arms and base (on tilter models), providing comfort and classic styling.
- Series includes tilters, guest chairs and bar stool. See page 163 for additional series
- **C1** casters are standard on tilter models.
- When upholstered in Leather, models will be in all Leather.
- Check textile availability prior to specifying upholstery material.

**OPTIONAL FEATURES**

- Wood-capped base and arms are available in Absolute (**AAM**), Black (**BKM**), Cherry (**ACM**), Espresso Cafe (**ECM**), English Oak (**EOM**), Fruitwood (**TFM**), Gray (**HGM**), Honey (**AHM**), Mahogany (**TMM**), Maple (**AVM**), Medium

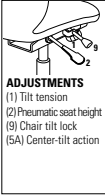
Walnut (**MWM**), Night (**ASM**), Shaker Cherry (**SKM**), Walnut (**TWM**), WC Cream (**WTM**), White (**WHM**) and Winter Cherry (**WCM**). Please Specify. Genuine maple faced veneers and solids are used.

- Please refer to the “Casters Selection” section of the price book for caster options. Optional casters may be priced higher than the standard casters for your chair and the difference will be charged. Lower priced optional casters will not be credited.
- For fully assembled in box, specify **SU**. Add \$81

DESCRIPTION	FEATURES	MODEL#	STANDARD TEXTILE GRADES														
			1	2	3	4	5	6	7	8	9	10	11	12			
 <p><b>HB Tilter</b> COM Yardage: 11.75 Freight Class: 250 Product Weight (lbs.): 40 Cubic Feet Per Carton: 11.75</p>	 <p><b>ADJUSTMENTS</b> (1) Tilt tension (2) Pneumatic seat height (9) Chair tilt lock (5A) Center-tilt action</p>	<p>Ergonomic Features: A, B, C, M, N, S</p>	<b>2106</b>	1227	1305	1364	1452	1578	1620	1730	1938	2037	2230	2492	2819		
			<b>OVERALL DIMENSIONS</b>			<b>SEAT DIMENSIONS</b>			<b>BACK DIMENSIONS</b>								
			<b>W</b>	<b>D</b>	<b>H</b>	<b>W</b>	<b>D</b>	<b>H</b>	<b>W</b>	<b>H</b>							
			24.5	27	43.5	21	18.5	17.5-21.5	21	27.5							
																	
 <p><b>MB Tilter</b> COM Yardage: 1.75 Freight Class: 250 Product Weight (lbs.): 39 Cubic Feet Per Carton: 11.50</p>	 <p><b>ADJUSTMENTS</b> (1) Tilt tension (2) Pneumatic seat height (9) Chair tilt lock (5A) Center-tilt action</p>	<p>Ergonomic Features: A, B, C, M, N, S</p>	<b>2107</b>	1195	1264	1316	1391	1501	1540	1634	1817	1906	2073	2302	2589		
			<b>OVERALL DIMENSIONS</b>			<b>SEAT DIMENSIONS</b>			<b>BACK DIMENSIONS</b>								
			<b>W</b>	<b>D</b>	<b>H</b>	<b>W</b>	<b>D</b>	<b>H</b>	<b>W</b>	<b>H</b>							
			24.5	26.5	37	19	20	17-21	22	19							
																	

ENTERPRISE®



model 4560



model 4565







model 4571-3

STANDARD FEATURES

- Gently sculpted seat and back provide lateral and lumbar support.
- Fixed height, impact and scuff resistant curved arms are standard on models 4560, 4561 and 4565. All other models are standard with adjustable height T-arms with teardrop shaped urethane armcaps (TD).
- All models (except armchair) are standard with a five prong, injection molded, fiberglass reinforced nylon Black base with dual wheel carpet casters (C65).
- Arms are available in Black (BK) only.
- Vari-Width (WA) width adjustable arm extensions are standard when chair is ordered with adjustable arms. Allows the arms to move away from the seat by 2" on each side to allow space if desired for broader hip widths.
- Model 4561-SC features a self centering cylinder which swivels and automatically returns to the starting seat location. This model is standard with a flat 5 star base in Black (BK) with C7 glides.
- Check textile availability prior to specifying upholstery material.

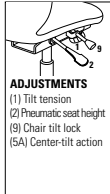
OPTIONAL FEATURES

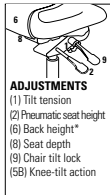
- An optional abrasion resistant outer back fabric (polyester) is available. Resistant to impact damage. Available in Black only (BKB). Add \$25.
- Available with back edge vinyl bumper guard option (VBG). Add \$28.
- Multi-Depth Mechanism a seat depth option available on multi-tilter models 4570-3 and 4571-3. Allows seat to move forward and backward over a 2" range with 5 locking positions to provide a more shallow or deeper seat. Specify "MDB". Add \$137.
- For hard surface flooring casters, specify C65R. Add \$78.
- For additional arm/caster options, please refer to the Arm and Caster section. Optional casters may be priced higher than the standard casters for your chair and the difference will be charged. Lower priced optional casters will not be credited.
- For fully assembled in box, specify SU. Add \$81.

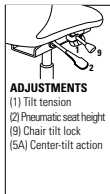
DESCRIPTION	FEATURES	MODEL#	STANDARD TEXTILE GRADES														
			1	2	3	4	5	6	7	8	9	10	11	12			
 <p><b>HB Tilter w/ Fixed Height Loop Arms</b> COM Yardage: 2 Freight Class: 250 Product Weight (lbs.): 39 Cubic Feet Per Carton: 11.50</p>	 <p><b>ADJUSTMENTS</b> (1) Tilt tension (2) Pneumatic seat height (9) Chair tilt lock (5A) Center-tilt action</p>	<p>Ergonomic Features: A, B, C, M, N, S</p>	4560	733	812	870	960	1089	1140	1248	1465	1566	1765	2033	2373		
			<b>OVERALL DIMENSIONS</b>			<b>SEAT DIMENSIONS</b>			<b>BACK DIMENSIONS</b>								
			<b>W</b>	<b>D</b>	<b>H</b>	<b>W</b>	<b>D</b>	<b>H</b>	<b>W</b>	<b>H</b>							
	24.5	27	45	20.5	18.5	17-22	20	26									
			<b>RTA 1</b>														
 <p><b>HB Knee - Tilter w/ Fixed Height Loop Arms</b> COM Yardage: 2 Freight Class: 250 Product Weight (lbs.): 41 Cubic Feet Per Carton: 13.25</p>	 <p><b>ADJUSTMENTS</b> (1) Tilt tension (2) Pneumatic seat height (6) Back height* (8) Seat depth (9) Chair tilt lock (5B) Knee-tilt action</p>	<p>Ergonomic Features: A, B, C, J, M, N</p>	4560-2	1006	1086	1147	1238	1369	1416	1529	1749	1855	2059	2334	2674		
			<b>OVERALL DIMENSIONS</b>			<b>SEAT DIMENSIONS</b>			<b>BACK DIMENSIONS</b>								
			<b>W</b>	<b>D</b>	<b>H</b>	<b>W</b>	<b>D</b>	<b>H</b>	<b>W</b>	<b>H</b>							
	24.5	27	45	21	19.5	17-21	21	25									
			<b>RTA 1</b>														
 <p><b>LB Tilter w/ Fixed Height Loop Arms</b> COM Yardage: 1.75 Freight Class: 250 Product Weight (lbs.): 36 Cubic Feet Per Carton: 9.75</p>	 <p><b>ADJUSTMENTS</b> (1) Tilt tension (2) Pneumatic seat height (9) Chair tilt lock (5A) Center-tilt action</p>	<p>Ergonomic Features: A, B, C, M, N, S</p>	4561	700	769	824	898	1013	1054	1154	1339	1431	1604	1840	2134		
			<b>OVERALL DIMENSIONS</b>			<b>SEAT DIMENSIONS</b>			<b>BACK DIMENSIONS</b>								
			<b>W</b>	<b>D</b>	<b>H</b>	<b>W</b>	<b>D</b>	<b>H</b>	<b>W</b>	<b>H</b>							
	24.5	26.5	39	20.5	18.5	17-22	20	21									
			<b>RTA 1</b>														

DESCRIPTION FEATURES MODEL# STANDARD TEXTILE GRADES



**MB Conference Chair** w/ Fixed Height Loop Arms  
 COM Yardage: 1.75  
 Freight Class: 250  
 Product Weight (lbs.): 36  
 Cubic Feet Per Carton: 9.75

	1	2	3	4	5	6	7	8	9	10	11	12
<b>4561-SC</b>	765	836	891	965	1086	1126	1225	1419	1509	1687	1927	2226

OVERALL DIMENSIONS			SEAT DIMENSIONS			BACK DIMENSIONS	
W	D	H	W	D	H	W	H
24.5	26.5	37	21	19.5	18	21	19

RTA 1



**LB Knee-Tilter** w/ Fixed Height Loop Arms  
 COM Yardage: 1.75  
 Freight Class: 250  
 Product Weight (lbs.): 39  
 Cubic Feet Per Carton: 11.50

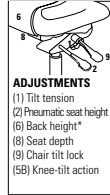

Ergonomic Features:  
 A, B, C, J, M, N

	1	2	3	4	5	6	7	8	9	10	11	12
<b>4561-2</b>	963	1036	1089	1171	1287	1326	1429	1617	1708	1885	2126	2424

OVERALL DIMENSIONS			SEAT DIMENSIONS			BACK DIMENSIONS	
W	D	H	W	D	H	W	H
25	26.5	39	12	19.5	17-21	21	19

RTA 1



**Armchair** w/ Fixed Height Loop Arms  
 COM Yardage: 1.75  
 Freight Class: 250  
 Product Weight (lbs.): 33  
 Cubic Feet Per Carton: 10

Ergonomic Features:  
 M, N

	1	2	3	4	5	6	7	8	9	10	11	12
<b>4565</b>	700	769	824	898	1013	1054	1154	1339	1431	1604	1840	2134

OVERALL DIMENSIONS			SEAT DIMENSIONS			BACK DIMENSIONS	
W	D	H	W	D	H	W	H
24.5	26.5	37	19.5	18-19.5	16.5-20.5	18	22.5

RTA 2



**HB Multi-Tilter** w/ Adjustable (TD) Arms  
 COM Yardage: 2  
 Freight Class: 150  
 Product Weight (lbs.): 54  
 Cubic Feet Per Carton: 11

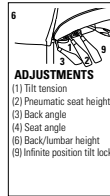

Ergonomic Features:  
 A, B, C, D, F, G, H, M, N, O, S

	1	2	3	4	5	6	7	8	9	10	11	12
<b>4570-3</b>	1339	1417	1477	1567	1695	1747	1854	2071	2173	2372	2640	2979

OVERALL DIMENSIONS			SEAT DIMENSIONS			BACK DIMENSIONS	
W	D	H	W	D	H	W	H
26.5	26.5	47	22	19	17-21	21.5	26-28

RTA 2



**HB Tilter** w/ Adjustable (TD) Arms  
 COM Yardage: 2  
 Freight Class: 150  
 Product Weight (lbs.): 47  
 Cubic Feet Per Carton: 11.50

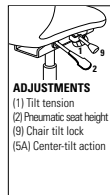











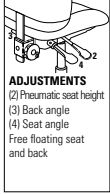

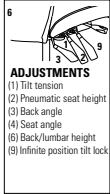
Ergonomic Features:  
 A, B, C, H, M, N, O, S

	1	2	3	4	5	6	7	8	9	10	11	12
<b>4570-4</b>	1196	1277	1337	1432	1554	1604	1715	1930	2033	2229	2838	1196

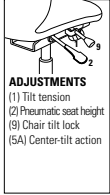
OVERALL DIMENSIONS			SEAT DIMENSIONS			BACK DIMENSIONS	
W	D	H	W	D	H	W	H
26.5	27	47.5	22	19	17-21	21.5	26-28

RTA 2

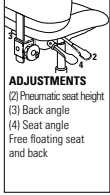

DESCRIPTION	FEATURES	MODEL#	STANDARD TEXTILE GRADES													
			1	2	3	4	5	6	7	8	9	10	11	12		
 <p><b>HB Operator</b> w/ Adjustable (TD) Arms COM Yardage: 2 Freight Class: 150 Product Weight (lbs.): 46 Cubic Feet Per Carton: 11</p>	 <p><b>ADJUSTMENTS</b> (2) Pneumatic seat height (3) Back angle (4) Seat angle Free floating seat and back</p>	<b>4570-5</b>	1320	1399	1458	1547	1676	1727	1835	2051	2156	2352	2624	2956		
			<b>OVERALL DIMENSIONS</b>			<b>SEAT DIMENSIONS</b>			<b>BACK DIMENSIONS</b>							
			<b>W</b>	<b>D</b>	<b>H</b>	<b>W</b>	<b>D</b>	<b>H</b>	<b>W</b>	<b>H</b>						
			26.5	26.5	47	22	19.5	17-21	21.5	26-28						
			<b>RTA 2</b>													
			Ergonomic Features: C, D, F, G, H, M, N, Q													
 <p><b>MB Multi-Tiler</b> w/ Adjustable (TD) Arms COM Yardage: 1.75 Freight Class: 150 Product Weight (lbs.): 52 Cubic Feet Per Carton: 9.50</p>	 <p><b>ADJUSTMENTS</b> (1) Tilt tension (2) Pneumatic seat height (3) Back angle (4) Seat angle (6) Back/lumbar height (9) Infinite position tilt lock</p>	<b>4571-3</b>	1205	1274	1327	1402	1517	1557	1657	1843	1933	2109	2342	2638		
			<b>OVERALL DIMENSIONS</b>			<b>SEAT DIMENSIONS</b>			<b>BACK DIMENSIONS</b>							
			<b>W</b>	<b>D</b>	<b>H</b>	<b>W</b>	<b>D</b>	<b>H</b>	<b>W</b>	<b>H</b>						
			26.5	26	41	22	19	17-21	21.5	20.5-22.5						
			<b>RTA 2</b>													
			Ergonomic Features: A, B, C, D, F, G, H, M, N, Q, S													
			 													
 <p><b>MB Tilter</b> w/ Adjustable (TD) Arms COM Yardage: 1.75 Freight Class: 150 Product Weight (lbs.): 46 Cubic Feet Per Carton: 11.50</p>	 <p><b>ADJUSTMENTS</b> (1) Tilt tension (2) Pneumatic seat height (9) Chair tilt lock (5A) Center-tilt action</p>	<b>4571-4</b>	1082	1151	1204	1281	1394	1437	1532	1720	1813	1986	2221	2515		
			<b>OVERALL DIMENSIONS</b>			<b>SEAT DIMENSIONS</b>			<b>BACK DIMENSIONS</b>							
			<b>W</b>	<b>D</b>	<b>H</b>	<b>W</b>	<b>D</b>	<b>H</b>	<b>W</b>	<b>H</b>						
			26.5	26	41.5	22	19	17-21	21.5	20.5-22.5						
			<b>RTA 2</b>													
			Ergonomic Features: A, B, C, H, M, N, Q, S													
			 													
 <p><b>LB Operator</b> w/ Adjustable (TD) Arms COM Yardage: 1.75 Freight Class: 150 Product Weight (lbs.): 43 Cubic Feet Per Carton: 8.25</p>	 <p><b>ADJUSTMENTS</b> (2) Pneumatic seat height (3) Back angle (4) Seat angle Free floating seat and back</p>	<b>4573-5</b>	1175	1245	1296	1375	1489	1530	1627	1816	1906	2079	2315	2608		
			<b>OVERALL DIMENSIONS</b>			<b>SEAT DIMENSIONS</b>			<b>BACK DIMENSIONS</b>							
			<b>W</b>	<b>D</b>	<b>H</b>	<b>W</b>	<b>D</b>	<b>H</b>	<b>W</b>	<b>H</b>						
			26.5	25	38	22	19.5	17-21	19	18.5-20.5						
			<b>RTA 2</b>													
			Ergonomic Features: C, D, F, G, H, M, N, Q													
			 													

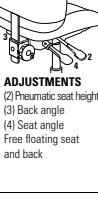
DESCRIPTION	FEATURES	MODEL#	STANDARD TEXTILE GRADES											
			1	2	3	4	5	6	7	8	9	10	11	12
 <p><b>LB Operator</b> Armless                      COM Yardage: 1.75                      Freight Class: 150                      Product Weight (lbs.): 36                      Cubic Feet Per Carton: 7</p>	 <p><b>ADJUSTMENTS</b>                      (2) Pneumatic seat height                      (3) Back angle                      (4) Seat angle                      Free floating seat and back</p> <p>Ergonomic Features:                      C, D, F, G, H, M, N</p>	<b>4577-5</b>	974	1043	1096	1172	1286	1328	1424	1614	1704	1878	2112	2408
			OVERALL DIMENSIONS			SEAT DIMENSIONS			BACK DIMENSIONS					
			W	D	H	W	D	H	W	H				
			26.5	25.5	40.5	22	19.5	17-21	19	18.5-20.5				
			RTA 2		FedEx		UPS							

WORK & TASK

FACTOR



model 5540



model 5541

STANDARD MODEL MECHANISM:

Task Basic Swivel mechanism (-6)

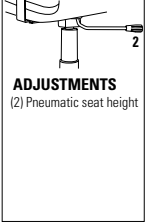

Ergonomic features:  
C

MECHANISM OPTIONS:

Tilter mechanism (-4)

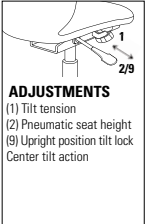

Ergonomic features:  
A, B, C, S

Weight sensing Synchro-tilter mechanism (-8)

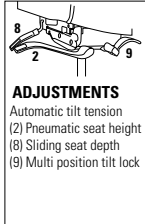

Ergonomic features:  
A, B, C, E, L



For Factor guest seating, see page 169.

STANDARD FEATURES

- Factor, a value seating series with a full spectrum of mesh colors. Enhanced in July 2023 with an improved softer sit, a better ride supporting a wider range of users, and a redesigned lumbar pad for optimal support.
- Adjustable lumbar support is standard on all models. Height adjustable and split down the middle to flex independently side-to-side.
- Standard with (-6) Task Basic Swivel mechanism.
- (U1) Standard with fixed, forward swept arms. Self-skinned urethane (SSU) armcaps will match the selected frame color (Black or Shadow); Cloud frame comes with coordinating Fog armcaps.
- Standard with five prong, injection molded, fiberglass reinforced nylon Black base with (C82) dual wheel carpet casters. Base will match frame color selection; casters coordinate with base color.
- Upholstery options: fabric, vinyl or leather.
- Check textile availability prior to specifying upholstery material.
- Standard Ergonomic features: C, D, M, N, U (see Ergonomic Features & Benefits page).

OPTIONAL FEATURES

- Weight Sensing Synchro-Tilter control mechanism (-8) includes side activated sliding seat depth adjustment.
- Optional Tilter mechanism (-4) is also available.
- (U2) Optional height adjustable arms are available. Ergonomic Feature: H
- (U3) Optional height adjustable arms with sliding armcaps are available. Ergonomic Feature: H,Q
- For additional arms/caster options, please refer to the Arm and Caster section. Optional casters may be priced higher than the standard casters for your chair and the difference will be charged. Lower priced optional casters will not be credited.
- For fully assembled in box, please specify (SU). Add \$81.

Please add option codes in the following order:

- **Model number**  
**5540** High back with arms.  
**5540NA** High back, no arms.  
**5541** Medium back with arms.  
**5541NA** Medium back, no arms.  
**5546** Medium task stool with arms (Task Basic Swivel mechanism only).  
**5546NA** Medium task stool, no arms (Task Basic Swivel mechanism only).
- **Mesh back** (colors shown on website)  
**(P-1)** Snow **(P-8)** Mocha  
**(P-2)** Sand **(P-9)** Eggplant  
**(P-3)** Pewter **(Q-1)** Buzz Blue  
**(P-4)** Silver Grey **(Q-2)** Poppy  
**(P-5)** Charcoal **(Q-3)** Pumpkin  
**(P-6)** Black **(Q-4)** Lime
- **Textile**  
Specify textile code for seat.
- **Frame color**  
**(BK)** Black. (Standard).  
**(SH)** Shadow. Add \$52 for armless models. Add \$68 for models with arms.  
**(IC)** Cloud. Add \$52 for armless models. Add \$68 for models with arms.
- **Arms**  
**(A-U1)** Fixed height arms. (Standard).  
**(A-U2)** Height adjustable arms. Add \$25.  
**(A-U3)** Height adjustable arms w/sliding armcaps. Add \$60.
- **Base**  
**(B7)** Nylon base. (Color matches frame).  
**(A7)** Polished Aluminum base. Add \$177.
- **Mechanism**  
**(-4)** Tilter mechanism. Add \$25.  
**(-6)** Task Basic Swivel mechanism (standard). No upcharge.  
**(-8)** Weight sensing synchro-tilter mechanism w/ standard seat slider. Add \$125.
- **Casters**  
**(C82)** Carpet Casters (Standard).  
**(C82R)** Rubber Hard Floor Casters. Add \$100

EXAMPLE FACTOR ORDER CODE:

5541	-P-5	-FU75	-8	-SH	A-U3	-B7	-C82R
------	------	-------	----	-----	------	-----	-------

Model #    Mesh Back    Textile    Mechanism    Frame Color    Arms    Base    Casters

DESCRIPTION    FEATURES    MODEL#    STANDARD TEXTILE GRADES



**High Back**  
COM Yardage: 1  
Freight Class: 250  
Product Weight (lbs.): 37 (armless 31)  
Cubic Feet Per Carton: 10.5

MODEL#	STANDARD TEXTILE GRADES											
	1	2	3	4	5	6	7	8	9	10	11	12
<b>5540</b> With arms	755	807	823	865	922	951	1002	1088	1151	1224	1367	1525















OVERALL DIMENSIONS    SEAT DIMENSIONS    BACK DIMENSIONS

W	D	H	W	D	H	W	H
---	---	---	---	---	---	---	---

26.5    24    41.5    20    17.5    16-20    18.5    23



1 per carton

DESCRIPTION	FEATURES	MODEL#	STANDARD TEXTILE GRADES												
			1	2	3	4	5	6	7	8	9	10	11	12	
	<b>High Back</b> COM Yardage: 1 Freight Class: 250 Product Weight (lbs.): 37 (armless 31) Cubic Feet Per Carton: 10.5	<b>5540NA</b> Armless	704	751	772	814	879	900	957	1043	1108	1180	1330	1496	
		<b>OVERALL DIMENSIONS</b>	<b>SEAT DIMENSIONS</b>			<b>BACK DIMENSIONS</b>									
		<b>W</b>	<b>D</b>	<b>H</b>	<b>W</b>	<b>D</b>	<b>H</b>	<b>W</b>	<b>H</b>						
		20	24	41.5	20	17.5	16-20	18.5	23						
					<b>RTA 2</b>	<b>FedEx</b> 				1 per carton					
	<b>Medium Back</b> COM Yardage: 1 Freight Class: 250 Product Weight (lbs.): 36 (armless 30) Cubic Feet Per Carton: 10.5	<b>5541</b> With arms	712	750	780	822	879	901	951	1037	1102	1166	1316	1467	
		<b>OVERALL DIMENSIONS</b>	<b>SEAT DIMENSIONS</b>			<b>BACK DIMENSIONS</b>									
		<b>W</b>	<b>D</b>	<b>H</b>	<b>W</b>	<b>D</b>	<b>H</b>	<b>W</b>	<b>H</b>						
		26.5	24	39	20	17.5	16-20	18.5	20						
					<b>RTA 2</b>	<b>FedEx</b> 				1 per carton					
	<b>Medium Back</b> COM Yardage: 1 Freight Class: 250 Product Weight (lbs.): 36 (armless 30) Cubic Feet Per Carton: 10.5	<b>5541NA</b> Armless	661	699	729	771	828	857	908	994	1057	1130	1280	1437	
		<b>OVERALL DIMENSIONS</b>	<b>SEAT DIMENSIONS</b>			<b>BACK DIMENSIONS</b>									
		<b>W</b>	<b>D</b>	<b>H</b>	<b>W</b>	<b>D</b>	<b>H</b>	<b>W</b>	<b>H</b>						
		20	24	39	20	17.5	16-20	18.5	20						
					<b>RTA 2</b>	<b>FedEx</b> 				1 per carton					
	<b>Stool</b> COM Yardage: 1 Freight Class: 250 Product Weight (lbs.): 40 (armless 34) Cubic Feet Per Carton: 10.5	<b>5546</b> With arms	877	915	945	987	1044	1073	1124	1210	1273	1346	1496	1653	
		<b>OVERALL DIMENSIONS</b>	<b>SEAT DIMENSIONS</b>			<b>BACK DIMENSIONS</b>									
		<b>W</b>	<b>D</b>	<b>H</b>	<b>W</b>	<b>D</b>	<b>H</b>	<b>W</b>	<b>H</b>						
		26.5	23.5	49	20	17.5	23.75-33.75	18.5	20.5						
					<b>RTA 2</b>	<b>FedEx</b> 				1 per carton					
	<b>Stool</b> COM Yardage: 1 Freight Class: 250 Product Weight (lbs.): 40 (armless 34) Cubic Feet Per Carton: 10.5	<b>5546NA</b> Armless	826	873	900	936	1008	1030	1079	1165	1237	1308	1459	1623	
		<b>OVERALL DIMENSIONS</b>	<b>SEAT DIMENSIONS</b>			<b>BACK DIMENSIONS</b>									
		<b>W</b>	<b>D</b>	<b>H</b>	<b>W</b>	<b>D</b>	<b>H</b>	<b>W</b>	<b>H</b>						
		20	23.5	49	20	17.5	23.75-33.75	18.5	20.5						
					<b>RTA 2</b>	<b>FedEx</b> 				1 per carton					

G1 ERGO SELECT™



model 7331



model 7333

MECHANISM OPTIONS:

Synchro-tilter mechanism (-0)

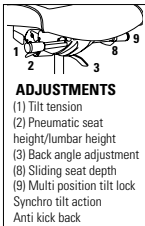

**Ergonomic features:**  
 A, B, C, D, E, G, H, L, M, N, Q, R, U

Multi-tilter mechanism (-3)

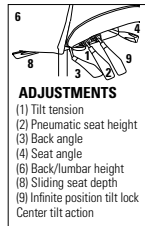

**Ergonomic features:**  
 A, B, C, D, E, F, G, H, M, N, Q, R, S, U

Weight sensing synchro-tilter mechanism (-8)

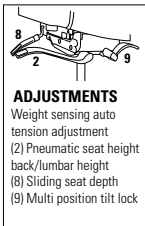

**Ergonomic features:**  
 A, B, C, D, E, H, L, M, N, Q, R, U

Posture task mechanism (-7)

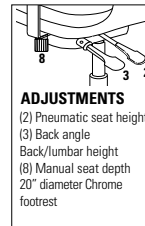

**Ergonomic features:**  
 C, D, G, H, M, N, Q, R, U, V

STANDARD FEATURES

- G1 Ergo Select was designed to provide exceptional support and comfort throughout the work day.
- Available in three back heights and three seat sizes, varying in depth and width, to fit a person's body type and movements while at work.
- Adjustable lumbar support standard on all models.
- Stitch detail on edges of seat and back is discrete, using matched thread as standard.
- Choice of three mechanisms; synchro-tilter, multi-tilter and weight sensing synchro-tilter. Stool model available with posture task mechanism only.
- Standard with Global's high quality Soft Descent™ pneumatic lift which slowly and gently lowers the seat height of the chair making it easy to obtain the exact seat height you desire.
- Standard with height and width adjustable (G5) arms with sliding armcaps. Armcaps also articulate inwards and outwards to aim toward the keyboard or mouse area.
- G1 Ergo Select is fully compliant with latest BIFMA G1, GSA, and CGSB specifications.
- Five prong, injection molded, fiberglass reinforced nylon Black base with (C82) dual wheel carpet casters.
- Upholstery options: fabric, vinyl or leather.
- Check textile availability prior to specifying upholstery material.

OPTIONAL FEATURES

- Upholstery is available with exaggerated top stitch detail (heavier thread). Fourteen coordinating or contrasting colors may be selected. Please specify.
- Optional Ergo Select arms are height (4") and width adjustable with sliding armcaps. Armcaps also articulate inwards (25°) and outwards (25°) to aim toward the keyboard or mouse area.
- For additional arms/caster options, please refer to the Arm and Caster section (page 414). Optional casters may be priced higher than the standard casters for your chair and the difference will be charged. Lower priced optional casters will not be credited.









Please add option codes in the following order:

- Model number**  
**7331** Medium back with arms  
**7332** High back with arms  
**7333** Extended high back with arms  
**7336** Medium task stool with arms (posture task mechanism only)  
**7336NA** Medium task stool, armless (posture task mechanism only)
- Textile**  
 Specify textile codes for back and seat
- Mechanism (No Upcharge)**  
 (-0) Synchro-tilter mechanism  
 (-3) Multi-tilter mechanism  
 (-8) Weight sensing synchro-tilter mechanism  
 (-7) Posture task mechanism (models 7336 / 7336NA only)
- Seat Size**  
 (P) Petite seat  
 (STAN) Standard seat  
 (GS) Generous seat
- Arms**  
 (G5) G5 arms ..... **Standard**  
 (H1) Ergo Select arms ..... **Add \$95**  
 (H2) Ergo Select arms w/wide armcaps ..... **Add \$132**
- Base**  
 (B7) Black nylon B7B base ..... **Standard**  
 (A7) Polished aluminum B7A base..... **Add \$177**
- Cylinder**  
 Please refer to "Cylinder Selection" section of the price book for cylinder options.
- Casters**  
 (C82) Dual wheel carpet casters..... **Standard**  
 (C82R) Dual wheel hard floor casters ..... **Add \$100**
- Stitch detail**  
 (MS) Color matched stitching  
 Decorative top stitch ..... **No upcharge**  
 (XP) Black (XB) Beige  
 (XG) Copen (XA) Graphite  
 (XK) Mahogany (XJ) Natural  
 (XH) Navy #3 (XD) New Grey  
 (XF) Nickel (XN) Off-White  
 (XL) Rubytone (XI) Scarlet  
 (XC) Smoke (XE) Taupe (colors shown on website)

EXAMPLE G1 ERGO SELECT ORDER CODE:

7332	-WA53	-WA53	-8	-STAN	-H1	-B7	-4L	-C82	-MS
Model #	Back fabric	Seat fabric	Mechanism	Seat size	Arms	Base	Cylinder	Casters	Stitch detail

G1 Ergo Select dimensional information: based on measurements with multi-tilter mechanism				
	Distance between arms	Standard arm height	Seat depth range	Standard seat height
<b>Petite seat (P)</b> Soft Descent 4" lift & (H1) arms	15.25" - 20.75" = 5.5" adjustment	7.3" - 11.4"	15.75" - 18.75"	16.5" - 20.5"
<b>Standard seat (STAN)</b> Soft Descent 4" lift & (H1) arms	16" - 21.5" = 5.5" adjustment		16.5" - 19.5"	
<b>Generous seat (GS)</b> Soft Descent 4" lift & (H1) arms	17.25" - 22.75" = 5.5" adjustment		17.25" - 19.5"	

DESCRIPTION	FEATURES	MODEL#	STANDARD TEXTILE GRADES											
			1	2	3	4	5	6	7	8	9	10	11	12
 <p><b>Medium Back</b> COM Yardage: 1.65 Freight Class: 125 Product Weight (lbs.): 66 Cubic Feet Per Carton: 10.50</p>	<p>See series notes for mechanism options.</p> <p>* Standard seat</p>	<b>7331</b>	1368	1432	1478	1550	1650	1700	1792	1938	2050	2177	2435	2709
			<b>OVERALL DIMENSIONS</b>			<b>SEAT DIMENSIONS*</b>			<b>BACK DIMENSIONS</b>					
			<b>W</b>	<b>D</b>	<b>H</b>	<b>W</b>	<b>D</b>	<b>H</b>	<b>W</b>	<b>H</b>				
			24	21.5	41	19.75	16.5-19.5	16.5-20.5	19	22				
						<b>RTA 2</b>	<b>FedEx</b> 		1 per carton					
 <p><b>High Back</b> COM Yardage: 1.75 Freight Class: 125 Product Weight (lbs.): 68 Cubic Feet Per Carton: 10.50</p>	<p>See series notes for mechanism options.</p> <p>* Standard seat</p>	<b>7332</b>	1444	1512	1561	1639	1746	1798	1895	2052	2175	2305	2583	2878
			<b>OVERALL DIMENSIONS</b>			<b>SEAT DIMENSIONS*</b>			<b>BACK DIMENSIONS</b>					
			<b>W</b>	<b>D</b>	<b>H</b>	<b>W</b>	<b>D</b>	<b>H</b>	<b>W</b>	<b>H</b>				
			24.5	23	44.5	19.75	16.5-19.5	16.5-20.5	19	24.5				
						<b>RTA 2</b>	<b>FedEx</b> 		1 per carton					
 <p><b>Extended High Back</b> COM Yardage: 2 Freight Class: 125 Product Weight (lbs.): 70 Cubic Feet Per Carton: 11</p>	<p>See series notes for mechanism options.</p> <p>* Standard seat</p>	<b>7333</b>	1517	1595	1653	1741	1867	1925	2038	2217	2356	2510	2828	3168
			<b>OVERALL DIMENSIONS</b>			<b>SEAT DIMENSIONS*</b>			<b>BACK DIMENSIONS</b>					
			<b>W</b>	<b>D</b>	<b>H</b>	<b>W</b>	<b>D</b>	<b>H</b>	<b>W</b>	<b>H</b>				
			26	24	50	19.75	16.5-19.5	16.5-20.5	19	27				
						<b>RTA 2</b>	<b>FedEx</b> 		1 per carton					
 <p><b>Medium Back Stool</b> COM Yardage: 1.65 Freight Class: 150 Product Weight (lbs.): 59 Cubic Feet Per Carton: 10.50</p>	<p>See series notes for mechanism options.</p> <p>* Standard seat</p>	<b>7336</b>	1479	1544	1590	1663	1763	1812	1905	2051	2162	2291	2550	2826
			<b>7336NA</b> Armless	1368	1435	1480	1555	1658	1705	1799	1947	2062	2188	2450
		<b>OVERALL DIMENSIONS</b>			<b>SEAT DIMENSIONS*</b>			<b>BACK DIMENSIONS</b>						
		<b>W</b>		<b>D</b>	<b>H</b>	<b>W</b>	<b>D</b>	<b>H</b>	<b>W</b>	<b>H</b>				
		24	22.5	46	18.5	16.5	22-30	19	22					
			<b>RTA 2</b>	<b>FedEx</b> 		1 per carton								

# WORK & TASK

G20



model 6007



**Lumbar Support**  
Automatic lumbar tension mechanism naturally adjusts to your posture while in upright or reclined position. The lumbar is also height adjustable.



Optional Fixed "C" Arm

## STANDARD FEATURES

- The striped mesh back is composed of a alternating vertical rows of clear elastomeric yarns and polyester yarns. This provides a very responsive back support.
- The inside of the mesh back is Black while the outside of the mesh is Silver to coordinate with the Polished Aluminum trim. Only available in a Black mesh back with Black arms and frame.
- Synchronized mechanism allows the back to smoothly tilt, while the seat gently reclines and slides to the rear. The seat does not lift up and keeps feet planted on floor. Four tilt positions, locks and infinite free float.
- Height adjustable self-skinned urethane (SSU) arms with sliding and pivoting armcaps.
- Independent lumbar adjustment on back (2.5" of height adjustment range on each side).
- Adjustable tilt tension knob located beside the seat. Simply rotate the knob for user preference.
- Side activated sliding seat depth adjustment is standard and provides 2" of adjustment.
- Base and frame are standard in Polished Aluminum with dual wheel carpet casters (**C82**).
- Check textile availability prior to specifying upholstery material.

## OPTIONAL FEATURES

- An optional black nylon base (**B7B**) is available. No upcharge.
- Optional fixed aluminum "C" arms with SSU armcaps (**DF**) are available. No upcharge.
- Please refer to "Cylinder Selection" section of the price book for additional cylinder options.
- For hard surface flooring casters, please specify (**C9R**). Add \$104
- For fully assembled in box, specify **SU**. Add \$81

DESCRIPTION	FEATURES	MODEL#	STANDARD TEXTILE GRADES											
			1	2	3	4	5	6	7	8	9	10	11	12
<p><b>ADJUSTMENTS</b> (1) Tilt tension (2) Pneumatic seat height (6) Back height* (8) Seat depth (9) Chair tilt lock (5C) Synchro-tilt action Anti-kick back</p>	<p>Ergonomic Features: A, B, C, D, E, H, L, M, N, Q, R, U</p>	<b>6007</b>	1865	1906	1936	1979	2042	2063	2117	2221	2273	2368	2501	2662
		OVERALL DIMENSIONS			SEAT DIMENSIONS			BACK DIMENSIONS						
			W	D	H	W	D	H	W	H				
			25.5	23	41.5	19.5	16	17.75-22.75	19	22				
<p><b>Synchro - Tilter</b> COM Yardage: 1 Freight Class: 150 Product Weight (lbs.): 53 Cubic Feet Per Carton: 11</p>			<p><b>RTA 4</b></p>											

GLOBAL ACCORD™



model 2670-2



model 2670-2



**Polished Aluminum Base**  
Arched aluminum spider base on all models add a distinctive look to the Global Accord series.



model 2671-4



model 2676-2



model 2671-4PB

STANDARD FEATURES

- Global Accord offers an elegant and refined design that features a sling back style that molds to and evenly supports the back and spine.
- Cast aluminum with a mirror finish accent the arms and base.
- Soft touch self-skinned urethane armcaps are available in Black Only.
- All models are standard with a five prong, polished cast aluminum spider base with dual wheel carpet casters (C1).
- Pedestal base models are offered on (-4) Tilter mechanisms only. These models provide fixed location seating for use in auditoriums, classrooms, jury boxes, public venues and more. The base must be mounted to the floor (mounting hardware not included). See Pedestal Base Installation Guide for details.
- Mesh back models are available featuring a breathable mesh sling style back in 24 brilliant Vue colors: Sandy Beach (VU10), Desert Sand (VU11), Orange Sunset (VU12), Chocolate Fountain (VU13), Arctic Blue (VU14), Quarry Grey (VU15), Tidal Wave (VU16), Ivy Moss (VU17), Red Rose (VU18), Coal Black (VU19), White (VU20), Lime (VU21), Chartreuse (VU23), Pool Blue (VU26), Sky (VU28), Primary Blue (VU32), Tangerine (VU34), Paprika (VU37), Grain (VU40), Yellow (VU43), Silver Grey (VU55), Silver (VU63), Hot Pink (VU65) and Red Mittens (VU70). Please specify
- Check textile availability prior to specifying upholstery material.

OPTIONAL FEATURES

- There are no arm options for the Accord series.
- Optional (B5) black plastic base with aluminum arms combination. No upcharge.
- For hard surface flooring casters, please specify (C9R). Add \$76
- Please refer to the "Casters Selection" section of the price book for caster options. Optional casters may be priced higher than the standard casters for your chair and the difference will be charged. Lower priced optional casters will not be credited.
- Pedestal Base models have Black bases with 2" height adjustable cylinders. Please specify: (SH) Swivel, auto return to max height. No upcharge. (SN) Non-swivel, auto return to max height. Add \$23. (SC) Swivel, self-centering and return to max height. Add \$35.
- For Memory Foam, specify (MF) and add \$124.
- For fully assembled in box, specify SU. Add \$81



DESCRIPTION FEATURES MODEL# STANDARD TEXTILE GRADES



**HB Knee - Tilter**  
COM Yardage: 2  
Freight Class: 150  
Product Weight (lbs.): 56  
Cubic Feet Per Carton: 13

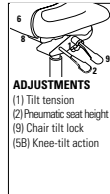

**ADJUSTMENTS**  
(1) Tilt tension  
(2) Pneumatic seat height  
(9) Chair tilt lock  
(5B) Knee-tilt action

Ergonomic Features:  
A, B, C, J, M, N, U

	1	2	3	4	5	6	7	8	9	10	11	12
<b>2670-2</b>	1675	1749	1807	1893	2031	2083	2190	2405	2508	2707	2976	3313

OVERALL DIMENSIONS			SEAT DIMENSIONS			BACK DIMENSIONS	
W	D	H	W	D	H	W	H
25	25	44	20	19	18-22	18.5	23



**HB Tilter**  
COM Yardage: 2  
Freight Class: 150  
Product Weight (lbs.): 43  
Cubic Feet Per Carton: 10.75

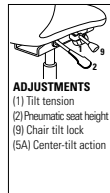











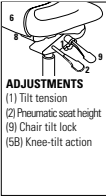



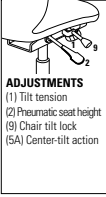

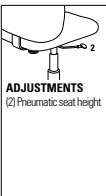

**ADJUSTMENTS**  
(1) Tilt tension  
(2) Pneumatic seat height  
(9) Chair tilt lock  
(5A) Center-tilt action



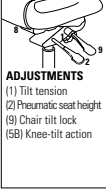

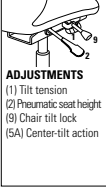

Ergonomic Features:  
A, B, C, M, N, S, U

	1	2	3	4	5	6	7	8	9	10	11	12
<b>2670-4</b>	1376	1454	1509	1594	1715	1784	1893	2055	2212	2340	2680	3016

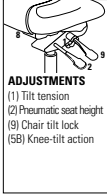
OVERALL DIMENSIONS			SEAT DIMENSIONS			BACK DIMENSIONS	
W	D	H	W	D	H	W	H
25	25	42.5	20	19	17-21	18.5	23

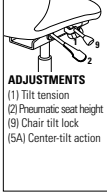

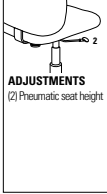
DESCRIPTION	FEATURES	MODEL#	STANDARD TEXTILE GRADES												
			1	2	3	4	5	6	7	8	9	10	11	12	
 <p><b>MB Knee - Tilter</b> COM Yardage: 1.75 Freight Class: 150 Product Weight (lbs.): 50 Cubic Feet Per Carton: 10.75</p>	 <p><b>ADJUSTMENTS</b> (1) Tilt tension (2) Pneumatic seat height (9) Chair tilt lock (5B) Knee-tilt action</p>	<b>2671-2</b>	1632	1706	1764	1848	1967	1984	2083	2309	2360	2595	2770	3064	
			<b>OVERALL DIMENSIONS</b>			<b>SEAT DIMENSIONS</b>			<b>BACK DIMENSIONS</b>						
			<b>W</b>	<b>D</b>	<b>H</b>	<b>W</b>	<b>D</b>	<b>H</b>	<b>W</b>	<b>H</b>					
			25	25	38.5	20	19	18-22	18.5	18					
			<p><b>RTA 1</b>       </p>												
 <p><b>MB Tilter</b> COM Yardage: 1.75 Freight Class: 250 Product Weight (lbs.): 40 Cubic Feet Per Carton: 10.75</p>	 <p><b>ADJUSTMENTS</b> (1) Tilt tension (2) Pneumatic seat height (9) Chair tilt lock (5A) Center-tilt action</p>	<b>2671-4</b>	1334	1408	1468	1552	1673	1688	1789	2013	2064	2298	2473	2769	
			<b>OVERALL DIMENSIONS</b>			<b>SEAT DIMENSIONS</b>			<b>BACK DIMENSIONS</b>						
			<b>W</b>	<b>D</b>	<b>H</b>	<b>W</b>	<b>D</b>	<b>H</b>	<b>W</b>	<b>H</b>					
			25	25	37	20	19	17-21	18.5	18					
			<p><b>RTA 1</b>       </p>												
 <p><b>MB Stool</b> COM Yardage: 1.75 Freight Class: 150 Product Weight (lbs.): 48 Cubic Feet Per Carton: 10.75</p>	 <p><b>ADJUSTMENTS</b> (2) Pneumatic seat height</p>	<b>2672-6</b>	1638	1707	1755	1834	1940	1975	2070	2248	2334	2499	2725	3006	
			<b>OVERALL DIMENSIONS</b>			<b>SEAT DIMENSIONS</b>			<b>BACK DIMENSIONS</b>						
			<b>W</b>	<b>D</b>	<b>H</b>	<b>W</b>	<b>D</b>	<b>H</b>	<b>W</b>	<b>H</b>					
			25	26	46.5	20	19	22.75-32.75	18.5	18					
			<p><b>RTA 1</b>       </p>												
 <p><b>Mesh HB Knee - Tilter</b> COM Yardage: 1 Freight Class: 150 Product Weight (lbs.): 56 Cubic Feet Per Carton: 13</p>	 <p><b>ADJUSTMENTS</b> (1) Tilt tension (2) Pneumatic seat height (9) Chair tilt lock (5B) Knee-tilt action</p>	<b>2676-2</b>	1813	1854	1883	1925	1990	2011	2065	2169	2221	2315	2446	2610	
			<b>OVERALL DIMENSIONS</b>			<b>SEAT DIMENSIONS</b>			<b>BACK DIMENSIONS</b>						
			<b>W</b>	<b>D</b>	<b>H</b>	<b>W</b>	<b>D</b>	<b>H</b>	<b>W</b>	<b>H</b>					
			25	25	44	20	19	18-22	18.5	23					
			<p><b>RTA 1</b>       </p>												
 <p><b>Mesh HB Tilter</b> COM Yardage: 1 Freight Class: 150 Product Weight (lbs.): 43 Cubic Feet Per Carton: 10.75</p>	 <p><b>ADJUSTMENTS</b> (1) Tilt tension (2) Pneumatic seat height (9) Chair tilt lock (5A) Center-tilt action</p>	<b>2676-4</b>	1515	1556	1586	1628	1692	1713	1767	1871	1923	2018	2151	2312	
			<b>OVERALL DIMENSIONS</b>			<b>SEAT DIMENSIONS</b>			<b>BACK DIMENSIONS</b>						
			<b>W</b>	<b>D</b>	<b>H</b>	<b>W</b>	<b>D</b>	<b>H</b>	<b>W</b>	<b>H</b>					
			25	25	42.5	20	19	17-21	18.5	23					
			<p><b>RTA 1</b>       </p>												

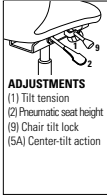
DESCRIPTION	FEATURES	MODEL#	STANDARD TEXTILE GRADES											
			1	2	3	4	5	6	7	8	9	10	11	12
 <p><b>Mesh MB Knee - Tilter</b> COM Yardage: 1 Freight Class: 150 Product Weight (lbs.): 50 Cubic Feet Per Carton: 10.75</p>	 <p><b>ADJUSTMENTS</b> (1) Tilt tension (2) Pneumatic seat height (9) Chair tilt lock (5B) Knee-tilt action</p>	<b>2677-2</b>	1755	1795	1824	1867	1930	1952	2006	2110	2162	2257	2388	2551
			<b>OVERALL DIMENSIONS</b>			<b>SEAT DIMENSIONS</b>			<b>BACK DIMENSIONS</b>					
			<b>W</b>	<b>D</b>	<b>H</b>	<b>W</b>	<b>D</b>	<b>H</b>	<b>W</b>	<b>H</b>				
			25	25	38.5	20	19	18-22	18.5	18				
	Ergonomic Features: A, B, C, J, M, N, U	<b>RTA 1</b>	FedEx		ups									
 <p><b>Mesh MB Tilter</b> COM Yardage: 1 Freight Class: 250 Product Weight (lbs.): 40 Cubic Feet Per Carton: 10.75</p>	 <p><b>ADJUSTMENTS</b> (1) Tilt tension (2) Pneumatic seat height (9) Chair tilt lock (5A) Center-tilt action</p>	<b>2677-4</b>	1456	1497	1526	1568	1633	1654	1708	1812	1864	1958	2089	2253
			<b>OVERALL DIMENSIONS</b>			<b>SEAT DIMENSIONS</b>			<b>BACK DIMENSIONS</b>					
			<b>W</b>	<b>D</b>	<b>H</b>	<b>W</b>	<b>D</b>	<b>H</b>	<b>W</b>	<b>H</b>				
			25	25	37	20	19	17-21	18.5	18				
	Ergonomic Features: A, B, C, M, N, S, U	<b>RTA 1</b>	FedEx		ups									
 <p><b>Mesh MB Stool</b> COM Yardage: 1 Freight Class: 150 Product Weight (lbs.): 48 Cubic Feet Per Carton: 10.75</p>	 <p><b>ADJUSTMENTS</b> (2) Pneumatic seat height</p>	<b>2678-6</b>	1742	1783	1812	1854	1917	1940	1994	2098	2150	2244	2375	2539
			<b>OVERALL DIMENSIONS</b>			<b>SEAT DIMENSIONS</b>			<b>BACK DIMENSIONS</b>					
			<b>W</b>	<b>D</b>	<b>H</b>	<b>W</b>	<b>D</b>	<b>H</b>	<b>W</b>	<b>H</b>				
			25	26	47	20	19	23.5-33.5	18.5	18				
	Ergonomic Features: C, M, N, U	<b>RTA 1</b>	FedEx		ups									
 <p><b>MB Tilter with Pedestal Base</b> COM Yardage: 1.75 Freight Class: 150 Product Weight (lbs.): 44 Cubic Feet Per Carton: 10.75</p>	 <p><b>ADJUSTMENTS</b> (1) Tilt tension (2) Pneumatic seat height (9) Chair tilt lock (5A) Center-tilt action</p>	<b>2671-4PB</b>	1578	1646	1709	1804	1939	2004	2050	2211	2338	2477	2764	3068
			<b>OVERALL DIMENSIONS</b>			<b>SEAT DIMENSIONS</b>			<b>BACK DIMENSIONS</b>					
			<b>W</b>	<b>D</b>	<b>H</b>	<b>W</b>	<b>D</b>	<b>H</b>	<b>W</b>	<b>H</b>				
			25	25	36	20	19	16.5-18.5	18.5	18				
	Ergonomic Features: A, B, C, M, N, S, U	<b>RTA 1</b>	FedEx		ups									

GOAL™



model 2237-3



model 2239-6

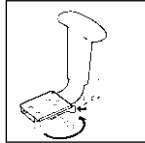

**Vari-Width Adapter Plate (WA)**  
Available when chair is ordered with adjustable height arms.





**STANDARD FEATURES**





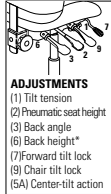

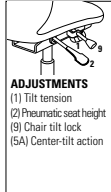

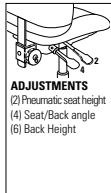
- Designed with substantial upholstery and cushioning treatment.
- Standard with adjustable height T-arms with curved urethane armcaps (3N) in Black only.
- All models are standard with a five-legged, injection molded "spider" base and C65 casters
- Base and frame available in Black (BK) only.
- Vari-Width Adapter Plate (WA) allows each arm to move outward an additional 2". Add \$92. Also height adjustable.
- Check textile availability prior to specifying upholstery material.

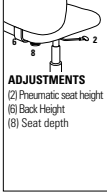
- Available with back edge vinyl bumper guard option (VBG). Add \$28.
- Please refer to the "Casters Selection" section of the price book for caster options. Optional casters may be priced higher than the standard casters for your chair and the difference will be charged. Lower priced optional casters will not be credited.
- For hard surface flooring casters, specify C65R. Add \$78.
- For fully assembled in box, please specify SU. Add \$81.

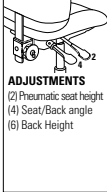
**OPTIONAL FEATURES**

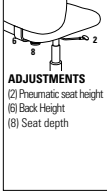
- Please refer to "Arms Selection" section of the price book for arm options.
- An optional abrasion resistant outer back fabric (polyester) is available. Resistant to impact damage. Available in Black only (BKB). Add \$25.

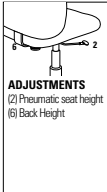
DESCRIPTION	FEATURES	MODEL#	STANDARD TEXTILE GRADES											
			1	2	3	4	5	6	7	8	9	10	11	12
 <p><b>LB Multi - Tilter</b> COM Yardage: 1.50 Freight Class: 150 Product Weight (lbs.): 53 Cubic Feet Per Carton: 9.25</p>	 <p><b>ADJUSTMENTS</b> (1) Tilt tension (2) Pneumatic seat height (3) Back angle (6) Back height* (7) Forward tilt lock (9) Chair tilt lock (SA) Center-tilt action</p>	<p>2237-3</p>	809	869	915	983	1079	1114	1197	1360	1435	1583	1784	2040
			<b>OVERALL DIMENSIONS</b>			<b>SEAT DIMENSIONS</b>			<b>BACK DIMENSIONS</b>					
			<b>W</b>	<b>D</b>	<b>H</b>	<b>W</b>	<b>D</b>	<b>H</b>	<b>W</b>	<b>H</b>				
			25	22.5	36	20	17	16.5-20.5	18.5	18-21				
			RTA 2			FedEx			ups					
 <p><b>LB Tilter</b> COM Yardage: 1.50 Freight Class: 150 Product Weight (lbs.): 43 Cubic Feet Per Carton: 9.25</p>	 <p><b>ADJUSTMENTS</b> (1) Tilt tension (2) Pneumatic seat height (9) Chair tilt lock (SA) Center-tilt action</p>	<p>2237-4</p>	700	762	808	874	970	1003	1089	1251	1326	1474	1676	1927
			<b>OVERALL DIMENSIONS</b>			<b>SEAT DIMENSIONS</b>			<b>BACK DIMENSIONS</b>					
			<b>W</b>	<b>D</b>	<b>H</b>	<b>W</b>	<b>D</b>	<b>H</b>	<b>W</b>	<b>H</b>				
			25	25	36.5	20	17	15.5-20.5	18.5	19				
			RTA 2			FedEx			ups					
 <p><b>LB Operator w/ Arms</b> COM Yardage: 1.50 Freight Class: 125 Product Weight (lbs.): 44 Cubic Feet Per Carton: 6.25</p>	 <p><b>ADJUSTMENTS</b> (2) Pneumatic seat height (4) Seat/Back angle (6) Back Height</p>	<p>2237-5</p>	637	701	745	814	907	942	1026	1188	1263	1411	1613	1868
			<b>OVERALL DIMENSIONS</b>			<b>SEAT DIMENSIONS</b>			<b>BACK DIMENSIONS</b>					
			<b>W</b>	<b>D</b>	<b>H</b>	<b>W</b>	<b>D</b>	<b>H</b>	<b>W</b>	<b>H</b>				
			25	22.5	36	20	17	15.5-20.5	18.5	18-21				
			RTA 2			FedEx			ups					

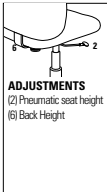
DESCRIPTION	FEATURES	MODEL#	STANDARD TEXTILE GRADES													
			1	2	3	4	5	6	7	8	9	10	11	12		
 <p><b>LB Task w/ Arms</b> COM Yardage: 1.50 Freight Class: 125 Product Weight (lbs.): 36 Cubic Feet Per Carton: 5.75</p>	 <p><b>ADJUSTMENTS</b> (2) Pneumatic seat height (6) Back Height (8) Seat depth</p>	<b>2237-6</b>	531	596	641	708	804	834	921	1082	1157	1306	1511	1766		
			<b>OVERALL DIMENSIONS</b>			<b>SEAT DIMENSIONS</b>			<b>BACK DIMENSIONS</b>							
			<b>W</b>	<b>D</b>	<b>H</b>	<b>W</b>	<b>D</b>	<b>H</b>	<b>W</b>	<b>H</b>						
			25	24.5	39	20	17-18.5	15.5-20.5	18.5	20.5-22						
	Ergonomic Features: C, D, E, H, N	<b>RTA 2</b>	<b>FedEx</b>	<b>UPS</b>												
 <p><b>LB Operator Armless</b> COM Yardage: 1.50 Freight Class: 125 Product Weight (lbs.): 30 Cubic Feet Per Carton: 4.90</p>	 <p><b>ADJUSTMENTS</b> (2) Pneumatic seat height (4) Seat/Back angle (6) Back Height</p>	<b>2239-5</b>	531	596	641	708	804	834	921	1082	1157	1306	1511	1766		
			<b>OVERALL DIMENSIONS</b>			<b>SEAT DIMENSIONS</b>			<b>BACK DIMENSIONS</b>							
			<b>W</b>	<b>D</b>	<b>H</b>	<b>W</b>	<b>D</b>	<b>H</b>	<b>W</b>	<b>H</b>						
			20.5	22.5	36	20	17	15.5-20.5	18.5	18-21						
	Ergonomic Features: C, D, F, G, H, N	<b>RTA 2</b>	<b>FedEx</b>	<b>UPS</b>												
 <p><b>LB Task Armless</b> COM Yardage: 1.50 Freight Class: 125 Product Weight (lbs.): 30 Cubic Feet Per Carton: 4.90</p>	 <p><b>ADJUSTMENTS</b> (2) Pneumatic seat height (6) Back Height (8) Seat depth</p>	<b>2239-6</b>	410	474	518	584	681	715	799	961	1034	1185	1386	1641		
			<b>OVERALL DIMENSIONS</b>			<b>SEAT DIMENSIONS</b>			<b>BACK DIMENSIONS</b>							
			<b>W</b>	<b>D</b>	<b>H</b>	<b>W</b>	<b>D</b>	<b>H</b>	<b>W</b>	<b>H</b>						
			20.5	24.5	39	20	17-18.5	15.5-20.5	18.5	20.5-22						
	Ergonomic Features: C, D, E, N	<b>RTA 2</b>	<b>FedEx</b>	<b>UPS</b>												
 <p><b>Height Adjustable Stool w/ Arms</b> COM Yardage: 1.50 Freight Class: 125 Product Weight (lbs.): 44 Cubic Feet Per Carton: 6.75</p>	 <p><b>ADJUSTMENTS</b> (2) Pneumatic seat height (6) Back Height</p>	<b>2235-6</b>	689	753	799	866	962	998	1079	1241	1318	1467	1669	1924		
			<b>OVERALL DIMENSIONS</b>			<b>SEAT DIMENSIONS</b>			<b>BACK DIMENSIONS</b>							
			<b>W</b>	<b>D</b>	<b>H</b>	<b>W</b>	<b>D</b>	<b>H</b>	<b>W</b>	<b>H</b>						
			25	24.5	48	20	17	23.5-33.5	18.5	20.5-22						
	Ergonomic Features: C, D, H, N	<b>RTA 2</b>	<b>FedEx</b>	<b>UPS</b>												
 <p><b>Height Adjustable Stool Armless</b> COM Yardage: 1.50 Freight Class: 150 Product Weight (lbs.): 36 Cubic Feet Per Carton: 6.75</p>	 <p><b>ADJUSTMENTS</b> (2) Pneumatic seat height (6) Back Height</p>	<b>2236-6</b>	607	671	715	784	877	912	996	1158	1231	1381	1583	1840		
			<b>OVERALL DIMENSIONS</b>			<b>SEAT DIMENSIONS</b>			<b>BACK DIMENSIONS</b>							
			<b>W</b>	<b>D</b>	<b>H</b>	<b>W</b>	<b>D</b>	<b>H</b>	<b>W</b>	<b>H</b>						
			20.5	24.5	48	20	17	23.5-33.5	18.5	20.5-22						
	Ergonomic Features: C, D, H, N	<b>RTA 2</b>	<b>FedEx</b>	<b>UPS</b>												

GRAHAM™



model 3144 (3N)

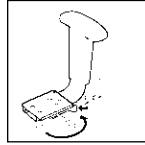

**Vari-Width Adapter Plate (WA)**  
Available when chair is ordered with adjustable height arms.

**STANDARD FEATURES**

- Features a multi-curved backrest with an impact resistant outer back shell.
- Standard with adjustable height T-arms with curved urethane armcaps (3N) in Black Only.
- All models are standard with a five-legged, injection molded "spider" base and C10 casters
- Base and frame available in Black (BK) Only.
- Check textile availability prior to specifying upholstery material.
- Vari-Width Adapter Plate (WA) allows each arm to move outward an additional 2". Specify "WA". Add \$92 also height adjustable.

**OPTIONAL FEATURES**

- Please refer to "Arms Selection" section of the price book for arm options.
- An optional abrasion resistant outer back fabric (polyester) is available. Resistant to impact damage. Available in Black only (BKB). Add \$25.
- Please refer to the "Casters Selection" section of the price book for caster options. Optional casters may be priced higher than the standard casters for your chair and the difference will be charged. Lower priced optional casters will not be credited.
- For hard surface flooring casters, specify C10R. Add \$70.
- For fully assembled in box, please specify SU. Add \$81.

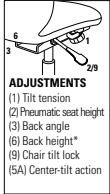
DESCRIPTION	FEATURES	MODEL#	STANDARD TEXTILE GRADES													
			1	2	3	4	5	6	7	8	9	10	11	12		
 <p><b>LB Ergo - Tilter</b> COM Yardage: 1.50 Freight Class: 150 Product Weight (lbs.): 50 Cubic Feet Per Carton: 9.25</p>	 <p><b>ADJUSTMENTS</b> (1) Tilt tension (2) Pneumatic seat height (3) Back angle (6) Back height* (9) Chair tilt lock (5A) Center-tilt action</p> <p>Ergonomic Features: A, B, C, D, G, H, M, N, S</p>	<b>3144</b>	808	864	912	979	1074	1111	1196	1358	1432	1580	1783	2037		
		OVERALL DIMENSIONS			SEAT DIMENSIONS			BACK DIMENSIONS								
		W	D	H	W	D	H	W	H							
25	26	37.5	20	19.5	17-21	19.5	17.5-20									
		<b>RTA 2</b>														

GRANADA®



model 3212 (3N)



model 3212 (3N)



model 3217



model 3217

STANDARD FEATURES

- Features a sculpted back with pronounced lumbar support.
- Standard with adjustable height T-arms with curved urethane armcaps (3N) in Black Only.(except for model 3262 which has a fixed height version of this same arm style.)
- Standard when chair is ordered with adjustable height arms (AA, O, OJ, SB, TD, UB, ZH, ZT, 3M, 3N, 4J, 4M, 4T, 6L, 9B and 9S). Allows each arm to move outward an additional 2" (for a total of 4" extra seat width) and locks with the use of an easy to maneuver lever.
- All models (except armchair and side chair styles) are standard with a five-legged, injection molded base.
- Base and frame are available in Black (BK) Only.
- All models are shipped partially KD.
- Height Adjustable Stools are equipped with a 20" diameter, height adjustable chrome foot ring.
- C65 casters are standard except for heavy duty models.
- Check textile availability prior to specifying upholstery material.
- Granada heavy duty models can be found under the Heavy Duty section.
- Upholstery options: fabric or vinyl only.

- When upholstered in vinyl, models may feature stitch detail across the seat and/ or back cushions and additional wrinkling may occur around seat perimeter and outside back will be attached with decorative screws.

OPTIONAL FEATURES

- Available with back edge vinyl bumper guard option (VBG). Add \$28.
- Please refer to "Arms Selection" section of the price book for arm options.
- An optional abrasion resistant outer back fabric (polyester) is available. Resistant to impact damage. Available in Black only (BKB). Add \$25
- For hard surface flooring please specify C10R. Add \$125.
- Please refer to the "Casters Selection" section of the price book for caster options. Optional casters may be priced higher than the standard casters for your chair and the difference will be charged. Lower priced optional casters will not be credited.
- For fully assembled in box, specify SU. Add \$81

DESCRIPTION FEATURES MODEL# STANDARD TEXTILE GRADES

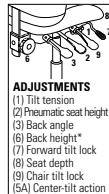

**LB Multi - Tilter** Plain Back Ratchet Back  
 COM Yardage: 1.50  
 Freight Class: 150  
 Product Weight (lbs.): 52  
 Cubic Feet Per Carton: 9.25

Ergonomic Features:  
 A, B, C, D, E, F, G, M, N, S



MODEL#	1	2	3	4	5	6	7	8	9	10	11	12
3121	1479	1541	1584	1648	1741	1776	1857	2013	2088	2233	2430	2674

OVERALL DIMENSIONS			SEAT DIMENSIONS			BACK DIMENSIONS	
W	D	H	W	D	H	W	H
26	24.5	40	20.5	16.5	17-21	19	17.5-20.5

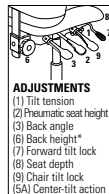

**HB Multi - Tilter** Plain Back Ratchet Back  
 COM Yardage: 1.75  
 Freight Class: 150  
 Product Weight (lbs.): 55  
 Cubic Feet Per Carton: 9.25

Ergonomic Features:  
 A, B, C, D, E, F, G, H, M, N, Q, S



MODEL#	1	2	3	4	5	6	7	8	9	10	11	12
3123	1632	1716	1777	1879	2014	2040	2147	2415	2466	2737	2934	3270

OVERALL DIMENSIONS			SEAT DIMENSIONS			BACK DIMENSIONS	
W	D	H	W	D	H	W	H
26	24.5	43	20.5	17-19.5	17-21	19	22-25

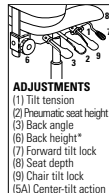











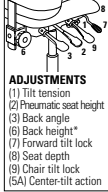



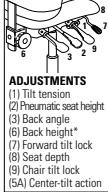

**LB Multi - Tilter** Detailed/Styled Back  
 COM Yardage: 1.50  
 Freight Class: 150  
 Product Weight (lbs.): 52  
 Cubic Feet Per Carton: 9.25

Ergonomic Features:  
 A, B, C, D, E, F, G, M, N, S

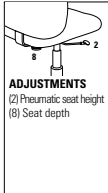

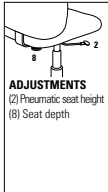

MODEL#	1	2	3	4	5	6	7	8	9	10	11	12
3202	1221	1286	1329	1398	1492	1527	1611	1772	1847	1996	2197	2454

OVERALL DIMENSIONS			SEAT DIMENSIONS			BACK DIMENSIONS	
W	D	H	W	D	H	W	H
26	22.5	40	19	16.5	18-22	18.5	21

DESCRIPTION	FEATURES	MODEL#	STANDARD TEXTILE GRADES													
			1	2	3	4	5	6	7	8	9	10	11	12		
 <p><b>LB Multi - Tilter</b> Plain Back COM Yardage: 1.50 Freight Class: 125 Product Weight (lbs.): 58 Cubic Feet Per Carton: 9.25</p>	 <p><b>ADJUSTMENTS</b> (1) Tilt tension (2) Pneumatic seat height (3) Back angle (6) Back height* (7) Forward tilt lock (8) Seat depth (9) Chair tilt lock (5A) Center-tilt action</p>	<p><b>3212</b></p>	1082	1146	1188	1259	1355	1391	1471	1634	1708	1856	2057	2313		
			<b>OVERALL DIMENSIONS</b>			<b>SEAT DIMENSIONS</b>			<b>BACK DIMENSIONS</b>							
			<b>W</b>	<b>D</b>	<b>H</b>	<b>W</b>	<b>D</b>	<b>H</b>	<b>W</b>	<b>H</b>						
			26	24	40	19	16.5	18-22	18.5	21						
<p>Ergonomic Features: A, B, C, D, E, F, G, H, M, N, Q, S</p>		<p>RTA 2</p>														
 <p><b>HB Multi - Tilter</b> Plain Back COM Yardage: 1.75 Freight Class: 150 Product Weight (lbs.): 57 Cubic Feet Per Carton: 10.50</p>	 <p><b>ADJUSTMENTS</b> (1) Tilt tension (2) Pneumatic seat height (3) Back angle (6) Back height* (7) Forward tilt lock (8) Seat depth (9) Chair tilt lock (5A) Center-tilt action</p>	<p><b>3217</b></p>	1217	1287	1339	1421	1530	1571	1669	1856	1947	2123	2357	2650		
			<b>OVERALL DIMENSIONS</b>			<b>SEAT DIMENSIONS</b>			<b>BACK DIMENSIONS</b>							
			<b>W</b>	<b>D</b>	<b>H</b>	<b>W</b>	<b>D</b>	<b>H</b>	<b>W</b>	<b>H</b>						
			26	24.5	43	19	17.5	18-22	18.5	26						
<p>Ergonomic Features: A, B, C, D, E, F, G, H, M, N, Q, S</p>		<p>RTA 2</p>														
 <p><b>Side Chair</b> Plain Back COM Yardage: 1.50 Freight Class: 300 Product Weight (lbs.): 32 Cubic Feet Per Carton: 17.25</p>		<p><b>3253</b></p>	872	937	982	1050	1145	1182	1264	1426	1503	1648	1853	2105		
			<b>OVERALL DIMENSIONS</b>			<b>SEAT DIMENSIONS</b>			<b>BACK DIMENSIONS</b>							
			<b>W</b>	<b>D</b>	<b>H</b>	<b>W</b>	<b>D</b>	<b>H</b>	<b>W</b>	<b>H</b>						
			20.5	23.5	37.5	19	16.5	19	18.5	21						
<p>Ergonomic Features: M, N</p>		<p>RTA 2</p>														
 <p><b>LB Task</b> Armless/Plain Back COM Yardage: 1.50 Freight Class: 250 Product Weight (lbs.): 32 Cubic Feet Per Carton: 9.25</p>	 <p><b>ADJUSTMENTS</b> (2) Pneumatic seat height (8) Seat depth</p>	<p><b>3254</b></p>	700	757	806	871	970	1002	1088	1250	1324	1473	1674	1927		
			<b>OVERALL DIMENSIONS</b>			<b>SEAT DIMENSIONS</b>			<b>BACK DIMENSIONS</b>							
			<b>W</b>	<b>D</b>	<b>H</b>	<b>W</b>	<b>D</b>	<b>H</b>	<b>W</b>	<b>H</b>						
			21	24	38	19	16.5	17-22	18.5	21						
<p>Ergonomic Features: C, E, M, N</p>		<p>RTA 2</p>														
 <p><b>LB Task</b> w/Arm/Plain Back COM Yardage: 1.50 Freight Class: 150 Product Weight (lbs.): 40 Cubic Feet Per Carton: 9.25</p>	 <p><b>ADJUSTMENTS</b> (2) Pneumatic seat height (8) Seat depth</p>	<p><b>3255</b></p>	881	941	986	1052	1151	1184	1268	1432	1505	1654	1855	2108		
			<b>OVERALL DIMENSIONS</b>			<b>SEAT DIMENSIONS</b>			<b>BACK DIMENSIONS</b>							
			<b>W</b>	<b>D</b>	<b>H</b>	<b>W</b>	<b>D</b>	<b>H</b>	<b>W</b>	<b>H</b>						
			26	24	38	19	16.5	17-22	18.5	21						
<p>Ergonomic Features: C, E, H, M, N, Q</p>		<p>RTA 2</p>														





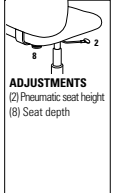

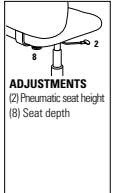

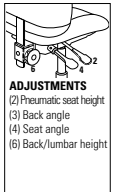

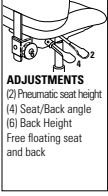



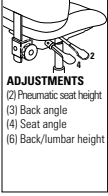

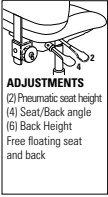

DESCRIPTION	FEATURES	MODEL#	STANDARD TEXTILE GRADES															
			1	2	3	4	5	6	7	8	9	10	11	12				
 <b>Armchair</b> Detailed/Styled Back COM Yardage: 1.50 Freight Class: 250 Product Weight (lbs.): 40 Cubic Feet Per Carton: 17	Ergonomic Features: M, N	3262	1145	1205	1253	1320	1413	1447	1533	1696	1769	1919	2121	2376				
			OVERALL DIMENSIONS			SEAT DIMENSIONS			BACK DIMENSIONS									
			W	D	H	W	D	H	W	H								
			26	23.5	37.5	19	16.5	19	18.5	21								
			RTA 2		FedEx		ups											

DESCRIPTION	FEATURES	MODEL#	STANDARD TEXTILE GRADES															
			1	2	3	4	5	6	7	8	9	10	11	12				
 <b>Side Chair</b> Detailed/Styled Back COM Yardage: 1.50 Freight Class: 300 Product Weight (lbs.): 32 Cubic Feet Per Carton: 17.25	Ergonomic Features: M, N	3263	929	991	1035	1104	1199	1232	1318	1480	1553	1703	1905	2160				
			OVERALL DIMENSIONS			SEAT DIMENSIONS			BACK DIMENSIONS									
			W	D	H	W	D	H	W	H								
			20.5	23.5	37.5	19	16.5	19	18.5	21								
			RTA 2		FedEx		ups											

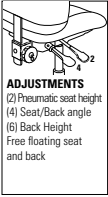
DESCRIPTION	FEATURES	MODEL#	STANDARD TEXTILE GRADES															
			1	2	3	4	5	6	7	8	9	10	11	12				
 <b>LB Task</b> Armless/Detailed/Styled Back COM Yardage: 1.50 Freight Class: 250 Product Weight (lbs.): 32 Cubic Feet Per Carton: 9.25	 ADJUSTMENTS (2) Pneumatic seat height (8) Seat depth	3264	740	804	850	915	1011	1046	1130	1291	1366	1514	1720	1973				
			OVERALL DIMENSIONS			SEAT DIMENSIONS			BACK DIMENSIONS									
			W	D	H	W	D	H	W	H								
			21	23.5	39	19	16.5	17-22	18.5	21								
			RTA 2		FedEx		ups											

DESCRIPTION	FEATURES	MODEL#	STANDARD TEXTILE GRADES															
			1	2	3	4	5	6	7	8	9	10	11	12				
 <b>LB Task</b> w/Arm/Detailed/Styled Back COM Yardage: 1.50 Freight Class: 150 Product Weight (lbs.): 40 Cubic Feet Per Carton: 9.25	 ADJUSTMENTS (2) Pneumatic seat height (8) Seat depth	3265	929	991	1035	1104	1199	1232	1318	1480	1553	1703	1905	2160				
			OVERALL DIMENSIONS			SEAT DIMENSIONS			BACK DIMENSIONS									
			W	D	H	W	D	H	W	H								
			26	23.5	39	19	16.5	17-22	18.5	21								
			RTA 2		FedEx													

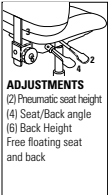
DESCRIPTION	FEATURES	MODEL#	STANDARD TEXTILE GRADES															
			1	2	3	4	5	6	7	8	9	10	11	12				
 <b>LB Operator</b> w/Arm/Plain Back COM Yardage: 1.50 Freight Class: 150 Product Weight (lbs.): 46 Cubic Feet Per Carton: 9.25	 ADJUSTMENTS (2) Pneumatic seat height (3) Back angle (4) Seat angle (6) Back/lumbar height	3275	1049	1114	1157	1226	1322	1358	1439	1601	1676	1823	2025	2280				
			OVERALL DIMENSIONS			SEAT DIMENSIONS			BACK DIMENSIONS									
			W	D	H	W	D	H	W	H								
			26	22.5	39	19	16.5	17-22	18.5	21								
			RTA 2		FedEx		ups											

DESCRIPTION	FEATURES	MODEL#	STANDARD TEXTILE GRADES											
			1	2	3	4	5	6	7	8	9	10	11	12
 <p><b>Height Adjustable Stool</b> Armless/Detailed/Styled Back COM Yardage: 1.50 Freight Class: 150 Product Weight (lbs.): 43 Cubic Feet Per Carton: 9.25</p>	 <p><b>ADJUSTMENTS</b> (2) Pneumatic seat height (4) Seat/Back angle (6) Back Height Free floating seat and back</p>	<b>3277</b>	1526	1590	1634	1701	1797	1835	1916	2077	2152	2301	2506	2757
			<b>OVERALL DIMENSIONS</b>			<b>SEAT DIMENSIONS</b>			<b>BACK DIMENSIONS</b>					
			<b>W</b>	<b>D</b>	<b>H</b>	<b>W</b>	<b>D</b>	<b>H</b>	<b>W</b>	<b>H</b>				
			21	22.5	48	19	16.5	24-34	18.5	21				
			<b>RTA 2</b>											
 <p><b>Height Adjustable Stool</b> Armless/Plain Back COM Yardage: 1.50 Freight Class: 150 Product Weight (lbs.): 43 Cubic Feet Per Carton: 9.25</p>	 <p><b>ADJUSTMENTS</b> (2) Pneumatic seat height (3) Back angle (4) Seat angle (6) Back/lumbar height</p>	<b>3278</b>	1466	1530	1574	1641	1736	1771	1855	2017	2092	2240	2441	2701
			<b>OVERALL DIMENSIONS</b>			<b>SEAT DIMENSIONS</b>			<b>BACK DIMENSIONS</b>					
			<b>W</b>	<b>D</b>	<b>H</b>	<b>W</b>	<b>D</b>	<b>H</b>	<b>W</b>	<b>H</b>				
			21	23.5	48	19	16.5	24-34	18.5	21				
			<b>RTA 2</b>											
 <p><b>LB Operator</b> Armless Detailed/Styled Back COM Yardage: 1.50 Freight Class: 150 Product Weight (lbs.): 40 Cubic Feet Per Carton: 9.25</p>	 <p><b>ADJUSTMENTS</b> (2) Pneumatic seat height (4) Seat/Back angle (6) Back Height Free floating seat and back</p>	<b>3284</b>	910	975	1018	1085	1183	1219	1300	1464	1536	1685	1886	2143
			<b>OVERALL DIMENSIONS</b>			<b>SEAT DIMENSIONS</b>			<b>BACK DIMENSIONS</b>					
			<b>W</b>	<b>D</b>	<b>H</b>	<b>W</b>	<b>D</b>	<b>H</b>	<b>W</b>	<b>H</b>				
			21	22.5	39	20.5	16.5	17-22	19	21				
			<b>RTA 2</b>											
 <p><b>LB Operator</b> w/Arms/Detailed/Styled Back COM Yardage: 1.50 Freight Class: 150 Product Weight (lbs.): 46 Cubic Feet Per Carton: 9.25</p>	 <p><b>ADJUSTMENTS</b> (2) Pneumatic seat height (4) Seat/Back angle (6) Back Height Free floating seat and back</p>	<b>3285</b>	1093	1157	1199	1268	1364	1399	1482	1644	1720	1869	2073	2328
			<b>OVERALL DIMENSIONS</b>			<b>SEAT DIMENSIONS</b>			<b>BACK DIMENSIONS</b>					
			<b>W</b>	<b>D</b>	<b>H</b>	<b>W</b>	<b>D</b>	<b>H</b>	<b>W</b>	<b>H</b>				
			26	22.5	39	19	16.5	17-22	18.5	21				
			<b>RTA 2</b>											
 <p><b>Height Adjustable Stool</b> w/Arms/Detailed/Styled Back COM Yardage: 1.50 Freight Class: 150 Product Weight (lbs.): 51 Cubic Feet Per Carton: 9.25</p>	 <p><b>ADJUSTMENTS</b> (2) Pneumatic seat height (4) Seat/Back angle (6) Back Height Free floating seat and back</p>	<b>3287</b>	1737	1802	1845	1915	2011	2047	2127	2291	2363	2512	2713	2972
			<b>OVERALL DIMENSIONS</b>			<b>SEAT DIMENSIONS</b>			<b>BACK DIMENSIONS</b>					
			<b>W</b>	<b>D</b>	<b>H</b>	<b>W</b>	<b>D</b>	<b>H</b>	<b>W</b>	<b>H</b>				
			26	22.5	48	19	16.5	24-34	18.5	21				
			<b>RTA 2</b>											

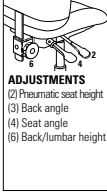
DESCRIPTION	FEATURES	MODEL#	STANDARD TEXTILE GRADES											
			1	2	3	4	5	6	7	8	9	10	11	12
 <p><b>Height Adjustable Stool</b> w/Arms/Plain Back                      COM Yardage: 1.50                      Freight Class: 150                      Product Weight (lbs.): 51                      Cubic Feet Per Carton: 9.25</p>	 <p><b>ADJUSTMENTS</b>                      (2) Pneumatic seat height                      (3) Back angle                      (4) Seat angle                      (6) Back/lumbar height</p>	<b>3288</b>	1683	1747	1793	1858	1953	1988	2073	2234	2309	2459	2663	2914
			OVERALL DIMENSIONS			SEAT DIMENSIONS			BACK DIMENSIONS					
			W	D	H	W	D	H	W	H				
			26	23.5	48	19	16.5	24-34	18.5	21				
			RTA 2		FedEx		UPS							

GRANADA® DELUXE



model 1170-3





model 1171-3







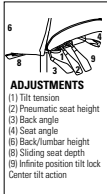

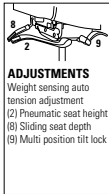

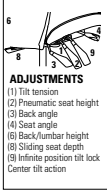

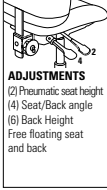

STANDARD FEATURES



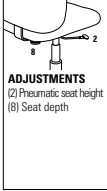



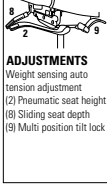



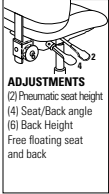

- Granada Deluxe offers dramatic seating comfort with a more contoured seat.
- Standard with height and width adjustable height T-arms with teardrop shaped urethane armcaps (3B).
- All models except the armchair and sidechair are standard with a five legged, injection molded reinforced nylon spider base with C65 casters.
- Base and frames are standard in Black (BK).
- Side activated sliding seat depth adjustment (MD) is standard on multi-tilters.
- Granada heavy duty models can be found under the Heavy Duty section.
- Upholstery options: fabric or vinyl only. When upholstered in vinyl, models may feature stitch detail across the seat and/or back cushions and additional wrinkling may occur around seat perimeter and outside back will be attached with decorative screws
- Check textile availability prior to specifying upholstery material.

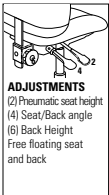

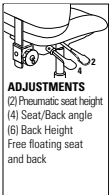

OPTIONAL FEATURES

- An optional abrasion resistant outer back fabric (polyester) is available. Resistant to impact damage. Available in Black only (BKB), add \$25.
- Available with back edge vinyl bumper guard option (VBG). Add \$28.
- Polished Aluminum base with black scuff tips. Specify "B2". Add \$177
- For hard surface flooring casters, specify C65R. Add \$78.
- For fully assembled in box, please specify SU. Add \$81
- Please refer to "Arms Selection" section of the price book for arm options.
- Please refer to "Cylinder Selection" section of the price book for additional cylinder options.

DESCRIPTION	FEATURES	MODEL#	STANDARD TEXTILE GRADES													
			1	2	3	4	5	6	7	8	9	10	11	12		
 <p><b>HB Multi - Tilter</b> COM Yardage: 2 Freight Class: 125 Product Weight (lbs.): 65 Cubic Feet Per Carton: 9.25</p>	 <p><b>ADJUSTMENTS</b> (1) Tilt tension (2) Pneumatic seat height (3) Back angle (4) Seat angle (5) Back/lumbar height (6) Sliding seat depth (8) Infinite position tilt lock Center tilt action</p>	<b>1170-3</b>	1291	1364	1416	1498	1613	1652	1751	1945	2035	2214	2454	2752		
		<b>OVERALL DIMENSIONS</b>			<b>SEAT DIMENSIONS</b>			<b>BACK DIMENSIONS</b>								
		<b>W</b>	<b>D</b>	<b>H</b>	<b>W</b>	<b>D</b>	<b>H</b>	<b>W</b>	<b>H</b>							
	26	23.5	45	21	18-20.5	16-20	20	23-28.25								
			<b>RTA 2</b>		FedEx		UPS									
 <p><b>HB Weight Sensing Synchro - Tilter</b> COM Yardage: 2 Freight Class: 125 Product Weight (lbs.): 61 Cubic Feet Per Carton: 9.25</p>	 <p><b>ADJUSTMENTS</b> Weight sensing auto tension adjustment (2) Pneumatic seat height (6) Sliding seat depth (9) Multi position tilt lock</p>	<b>1170-8</b>	1291	1362	1415	1498	1612	1651	1750	1945	2034	2213	2453	2752		
		<b>OVERALL DIMENSIONS</b>			<b>SEAT DIMENSIONS</b>			<b>BACK DIMENSIONS</b>								
		<b>W</b>	<b>D</b>	<b>H</b>	<b>W</b>	<b>D</b>	<b>H</b>	<b>W</b>	<b>H</b>							
	26	23.5	44	21	18-20.5	16.5-20.5	20	23-28.2								
			<b>RTA 2</b>													

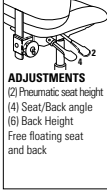
DESCRIPTION	FEATURES	MODEL#	STANDARD TEXTILE GRADES														
			1	2	3	4	5	6	7	8	9	10	11	12			
 <p><b>MB Multi - Tilter</b> COM Yardage: 1.75 Freight Class: 125 Product Weight (lbs.): 61 Cubic Feet Per Carton: 9.25</p>	 <p><b>ADJUSTMENTS</b> (1) Tilt tension (2) Pneumatic seat height (3) Back angle (4) Seat angle (5) Back/lumbar height (6) Sliding seat depth (8) Infinite position tilt lock Center tilt action</p>	<b>1171-3</b>	1159	1224	1269	1337	1437	1471	1556	1721	1799	1952	2160	2415			
			<b>OVERALL DIMENSIONS</b>			<b>SEAT DIMENSIONS</b>			<b>BACK DIMENSIONS</b>								
			<b>W</b>	<b>D</b>	<b>H</b>	<b>W</b>	<b>D</b>	<b>H</b>	<b>W</b>	<b>H</b>		<b>H</b>					
			26	23.5	42	21	18-20.5	16-20	20	23-28.25							
<p>Ergonomic Features: A, B, C, D, E, F, G, H, M, N, Q, S, U</p>   			1	2	3	4	5	6	7	8	9	10	11	12			
			 <p><b>MB Operator</b> COM Yardage: 1.75 Freight Class: 150 Product Weight (lbs.): 54 Cubic Feet Per Carton: 9.25</p>	 <p><b>ADJUSTMENTS</b> (2) Pneumatic seat height (4) Seat/Back angle (6) Back Height Free floating seat and back</p>	<b>1171-5</b>	1118	1183	1228	1296	1396	1430	1515	1680	1757	1911	2119	2374
						<b>OVERALL DIMENSIONS</b>			<b>SEAT DIMENSIONS</b>			<b>BACK DIMENSIONS</b>					
						<b>W</b>	<b>D</b>	<b>H</b>	<b>W</b>	<b>D</b>	<b>H</b>	<b>W</b>	<b>H</b>		<b>H</b>		
26	23.5	39				21	18	16.5-20.5	20	19-24.25							
<p>Ergonomic Features: C, D, F, G, H, M, N, Q, S, U</p>   			1	2	3	4	5	6	7	8	9	10	11	12			
			 <p><b>MB Task</b> COM Yardage: 1.75 Freight Class: 150 Product Weight (lbs.): 49 Cubic Feet Per Carton: 9.25</p>	 <p><b>ADJUSTMENTS</b> (2) Pneumatic seat height (8) Seat depth</p>	<b>1171-6</b>	943	1007	1053	1121	1221	1255	1340	1506	1582	1736	1944	2199
						<b>OVERALL DIMENSIONS</b>			<b>SEAT DIMENSIONS</b>			<b>BACK DIMENSIONS</b>					
						<b>W</b>	<b>D</b>	<b>H</b>	<b>W</b>	<b>D</b>	<b>H</b>	<b>W</b>	<b>H</b>		<b>H</b>		
26	23.5	38				21	17-18	16-21	20	19							
<p>Ergonomic Features: C, E, H, M, N, U, Q</p>   			1	2	3	4	5	6	7	8	9	10	11	12			
			 <p><b>MB Weight Sensing Synchro - Tilter</b> COM Yardage: 1.75 Freight Class: 125 Product Weight (lbs.): 61 Cubic Feet Per Carton: 9.25</p>	 <p><b>ADJUSTMENTS</b> Weight sensing auto tension adjustment (2) Pneumatic seat height (8) Sliding seat depth (9) Multi position tilt lock</p>	<b>1171-8</b>	1159	1221	1267	1334	1436	1470	1554	1719	1798	1950	2155	2413
						<b>OVERALL DIMENSIONS</b>			<b>SEAT DIMENSIONS</b>			<b>BACK DIMENSIONS</b>					
						<b>W</b>	<b>D</b>	<b>H</b>	<b>W</b>	<b>D</b>	<b>H</b>	<b>W</b>	<b>H</b>		<b>H</b>		
26	23.5	41				21	18-20.5	16.25-20.25	20	20 - 25.2							
<p>Ergonomic Features: A, B, C, D, E, H, L, M, N, Q</p> 			1	2	3	4	5	6	7	8	9	10	11	12			

DESCRIPTION	FEATURES	MODEL#	STANDARD TEXTILE GRADES												
			1	2	3	4	5	6	7	8	9	10	11	12	
 <p><b>MB Operator</b> Armless COM Yardage: 1.75 Freight Class: 150 Product Weight (lbs.): 49 Cubic Feet Per Carton: 9.25</p>	 <p><b>ADJUSTMENTS</b> (2) Pneumatic seat height (4) Seat/Back angle (6) Back Height Free-floating seat and back</p>	<p>Ergonomic Features: C, D, E, F, G, M, N, Q, S, U</p>	<b>1172-5</b>	924	984	1032	1101	1198	1230	1320	1482	1562	1713	1918	2180
			<b>OVERALL DIMENSIONS</b>			<b>SEAT DIMENSIONS</b>			<b>BACK DIMENSIONS</b>						
			<b>W</b>	<b>D</b>	<b>H</b>	<b>W</b>	<b>D</b>	<b>H</b>	<b>W</b>	<b>H</b>					
21	23.5	39	21	18	16.5-20.5	20	19-24.25								
			<b>RTA 2</b>												
 <p><b>MB Task</b> Armless COM Yardage: 1.75 Freight Class: 150 Product Weight (lbs.): 21. Cubic Feet Per Carton: 9.25</p>	 <p><b>ADJUSTMENTS</b> (2) Pneumatic seat height (8) Seat depth</p>	<p>Ergonomic Features: C, E, H, M, N, U, Q</p>	<b>1172-6</b>	751	813	859	928	1025	1061	1147	1311	1389	1542	1746	2005
			<b>OVERALL DIMENSIONS</b>			<b>SEAT DIMENSIONS</b>			<b>BACK DIMENSIONS</b>						
			<b>W</b>	<b>D</b>	<b>H</b>	<b>W</b>	<b>D</b>	<b>H</b>	<b>W</b>	<b>H</b>					
21	23.5	38	21	17-18	16-21	20	19								
			<b>RTA 2</b>												
 <p><b>Armchair</b> COM Yardage: 1.75 Freight Class: 150 Product Weight (lbs.): 40 Cubic Feet Per Carton: 10</p>		<p>Ergonomic Features: M, N</p>	<b>1175</b>	895	957	1003	1070	1169	1204	1291	1456	1532	1686	1890	2149
			<b>OVERALL DIMENSIONS</b>			<b>SEAT DIMENSIONS</b>			<b>BACK DIMENSIONS</b>						
			<b>W</b>	<b>D</b>	<b>H</b>	<b>W</b>	<b>D</b>	<b>H</b>	<b>W</b>	<b>H</b>					
24.5	24	38	21	18	18	20	20.5								
			<b>RTA 2</b>												
 <p><b>Height Adjustable Stool Operator</b> Armless COM Yardage: 1.75 Freight Class: 150 Product Weight (lbs.): 52 Cubic Feet Per Carton: 9.25</p>	 <p><b>ADJUSTMENTS</b> (2) Pneumatic seat height (4) Seat/Back angle (6) Back Height Free-floating seat and back</p>	<p>Ergonomic Features: C, D, F, G, H, M, N, S, U</p>	<b>1177-5</b>	1162	1222	1268	1337	1437	1472	1557	1722	1800	1951	2157	2416
			<b>OVERALL DIMENSIONS</b>			<b>SEAT DIMENSIONS</b>			<b>BACK DIMENSIONS</b>						
			<b>W</b>	<b>D</b>	<b>H</b>	<b>W</b>	<b>D</b>	<b>H</b>	<b>W</b>	<b>H</b>					
21	23.5	48	20	18	23.5-33.5	20	19-24.25								
			<b>RTA 2</b>												

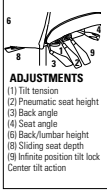
DESCRIPTION	FEATURES	MODEL#	STANDARD TEXTILE GRADES														
			1	2	3	4	5	6	7	8	9	10	11	12			
 <p><b>Height Adjustable Stool Operator w/Arm</b> COM Yardage: 1.75 Freight Class: 125 Product Weight (lbs.): 57 Cubic Feet Per Carton: 9.25</p>	 <p><b>ADJUSTMENTS</b> (2) Pneumatic seat height (4) Seat/Back angle (6) Back Height Free floating seat and back</p>	<b>1178-5</b>	1356	1416	1466	1533	1631	1666	1750	1916	1993	2147	2352	2610			
			<b>OVERALL DIMENSIONS</b>			<b>SEAT DIMENSIONS</b>			<b>BACK DIMENSIONS</b>								
			<b>W</b>	<b>D</b>	<b>H</b>	<b>W</b>	<b>D</b>	<b>H</b>	<b>W</b>	<b>H</b>							
			26	23.5	48	21	18	23.5-33.5	20	19-24.25							
<p><b>Height Adjustable Stool Operator w/Arm</b> COM Yardage: 1.75 Freight Class: 125 Product Weight (lbs.): 57 Cubic Feet Per Carton: 9.25</p>	<p>Ergonomic Features: C, D, F, G, H, M, N, S, U</p>	<p>RTA 2      FedEx      ups</p>															
			 <p><b>HB Multi - Tilter</b> COM Yardage: 2 Freight Class: 125 Product Weight (lbs.): 65 Cubic Feet Per Carton: 9.25</p>	 <p><b>ADJUSTMENTS</b> (1) Tilt tension (2) Pneumatic seat height (3) Back angle (4) Seat angle (6) Back/lumbar height (8) Sliding seat depth (9) Infinite position tilt lock Center tilt action</p>	<b>1190-3</b>	1592	1673	1735	1828	1959	2007	2122	2337	2442	2646	2920	3263
						<b>OVERALL DIMENSIONS</b>			<b>SEAT DIMENSIONS</b>			<b>BACK DIMENSIONS</b>					
						<b>W</b>	<b>D</b>	<b>H</b>	<b>W</b>	<b>D</b>	<b>H</b>	<b>W</b>	<b>H</b>				
26	23.5	45				21	18-20.5	16-20	20	23-28.25							
<p><b>HB Multi - Tilter</b> COM Yardage: 2 Freight Class: 125 Product Weight (lbs.): 65 Cubic Feet Per Carton: 9.25</p>	<p>Ergonomic Features: A, B, C, D, E, F, G, H, M, N, Q, S, U</p>	<p>RTA 2      FedEx      ups</p>															
			 <p><b>MB Multi - Tilter</b> COM Yardage: 1.75 Freight Class: 125 Product Weight (lbs.): 61 Cubic Feet Per Carton: 9.25</p>	 <p><b>ADJUSTMENTS</b> (1) Tilt tension (2) Pneumatic seat height (3) Back angle (4) Seat angle (6) Back/lumbar height (8) Sliding seat depth (9) Infinite position tilt lock Center tilt action</p>	<b>1191-3</b>	1446	1519	1576	1654	1770	1809	1912	2100	2193	2369	2610	2909
						<b>OVERALL DIMENSIONS</b>			<b>SEAT DIMENSIONS</b>			<b>BACK DIMENSIONS</b>					
						<b>W</b>	<b>D</b>	<b>H</b>	<b>W</b>	<b>D</b>	<b>H</b>	<b>W</b>	<b>H</b>				
26	23.5	42				21	18-20.5	16-20	20	23-28.25							
<p><b>MB Multi - Tilter</b> COM Yardage: 1.75 Freight Class: 125 Product Weight (lbs.): 61 Cubic Feet Per Carton: 9.25</p>	<p>Ergonomic Features: A, B, C, D, E, F, G, H, M, N, Q, S, U</p>	<p>RTA 2      FedEx      ups</p>															

GRAPHIC™



model 2739



model 2738MB



**Optional Base**

An optional five-legged, arched steel base in Tungsten finish is available. Specify (TTU). Add \$95.







**STANDARD FEATURES**



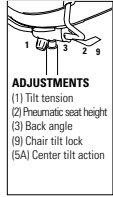

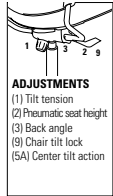

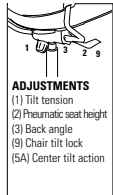

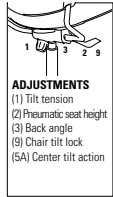

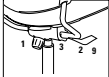



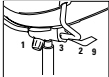

- European detailing and a clean slim profile.
- Features a generous compound curved back and seat.
- Three distinctive back styles: upholstered back, perforated Black nylon back and breathable Black mesh back.
- Posture back chairs with arms are standard with height adjustable, forward swept arms and sliding armcaps (G4).
- Vari-Width (WA) width adjustable arm extensions are standard when chair is ordered with adjustable arms. Allows the arms to move away from the seat by 2" on each side to allow space if desired for broader hip widths.
- Check textile availability prior to specifying upholstery material.

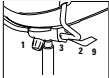

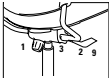

- Posture mechanism offers exceptional back support, two position tilt lock adjustment and tilt tension control.
- Five prong, injection molded, fiberglass reinforced nylon Black spider base with dual wheel carpet casters (C1).

**OPTIONAL FEATURES**

- For hard surface flooring please specify C9R. Add \$78.
- A steel base with Tungsten finish is available. Specify (TTU). Add \$95.
- Please refer to "Arms and Casters" section of the price book for arm and caster options.
- For fully assembled in box, specify SU. Add \$81

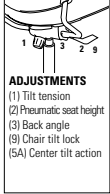
DESCRIPTION	FEATURES	MODEL#	STANDARD TEXTILE GRADES											
			1	2	3	4	5	6	7	8	9	10	11	12
 <p><b>Medium Posture Nylon Back</b> Armless COM Yardage: 1 Freight Class: 250 Product Weight (lbs.): 34 Cubic Feet Per Carton: 9.75</p>	 <p><b>ADJUSTMENTS</b> (1) Tilt tension (2) Pneumatic seat height (3) Back angle (9) Chair tilt lock (5A) Center tilt action</p>	<b>2736</b>	776	819	849	890	955	976	1031	1136	1186	1284	1412	1577
		<b>OVERALL DIMENSIONS</b>			<b>SEAT DIMENSIONS</b>			<b>BACK DIMENSIONS</b>						
		<b>W</b>	<b>D</b>	<b>H</b>	<b>W</b>	<b>D</b>	<b>H</b>	<b>W</b>		<b>H</b>				
		20	24	36	20	19	16.5-20.5	19		19				
		<b>RTA 1</b>		FedEx		ups								
 <p><b>Medium Posture Mesh Back</b> Armless COM Yardage: 1 Freight Class: 250 Product Weight (lbs.): 34 Cubic Feet Per Carton: 9.75</p>	 <p><b>ADJUSTMENTS</b> (1) Tilt tension (2) Pneumatic seat height (3) Back angle (9) Chair tilt lock (5A) Center tilt action</p>	<b>2736MB</b>	860	906	933	977	1041	1064	1116	1221	1270	1368	1497	1662
		<b>OVERALL DIMENSIONS</b>			<b>SEAT DIMENSIONS</b>			<b>BACK DIMENSIONS</b>						
		<b>W</b>	<b>D</b>	<b>H</b>	<b>W</b>	<b>D</b>	<b>H</b>	<b>W</b>		<b>H</b>				
		20	24	36	20	19	16.5-20.5	19		19				
		<b>RTA 1</b>		FedEx		ups								
 <p><b>Medium Posture Back - Fully Upholstered</b> Armless COM Yardage: 1.25 Freight Class: 250 Product Weight (lbs.): 34 Cubic Feet Per Carton: 9.75</p>	 <p><b>ADJUSTMENTS</b> (1) Tilt tension (2) Pneumatic seat height (3) Back angle (9) Chair tilt lock (5A) Center tilt action</p>	<b>2737</b>	860	910	948	1001	1080	1108	1174	1306	1369	1487	1654	1856
		<b>OVERALL DIMENSIONS</b>			<b>SEAT DIMENSIONS</b>			<b>BACK DIMENSIONS</b>						
		<b>W</b>	<b>D</b>	<b>H</b>	<b>W</b>	<b>D</b>	<b>H</b>	<b>W</b>		<b>H</b>				
		20	24	36	20	19	16.5-20.5	19		19				
		<b>RTA 1</b>		FedEx		ups								
 <p><b>Medium Posture Nylon Back</b> w/Arms COM Yardage: 1 Freight Class: 150 Product Weight (lbs.): 45 Cubic Feet Per Carton: 9.75</p>	 <p><b>ADJUSTMENTS</b> (1) Tilt tension (2) Pneumatic seat height (3) Back angle (9) Chair tilt lock (5A) Center tilt action</p>	<b>2738</b>	860	903	931	974	1038	1058	1115	1220	1269	1366	1496	1661
		<b>OVERALL DIMENSIONS</b>			<b>SEAT DIMENSIONS</b>			<b>BACK DIMENSIONS</b>						
		<b>W</b>	<b>D</b>	<b>H</b>	<b>W</b>	<b>D</b>	<b>H</b>	<b>W</b>		<b>H</b>				
		25	24	36	20	19	16.5-20.5	19		19				
		<b>RTA 1</b>		FedEx		ups								

DESCRIPTION	FEATURES	MODEL#	STANDARD TEXTILE GRADES													
			1	2	3	4	5	6	7	8	9	10	11	12		
 <p><b>Medium Posture Mesh Back w/Arms</b> COM Yardage: 1 Freight Class: 150 Product Weight (lbs.):45 Cubic Feet Per Carton: 9.75</p>	 <p><b>ADJUSTMENTS</b> (1) Tilt tension (2) Pneumatic seat height (3) Back angle (9) Chair tilt lock (5A) Center tilt action</p>	<b>2738MB</b>	949	995	1022	1066	1128	1153	1204	1309	1360	1457	1586	1750		
			<b>OVERALL DIMENSIONS</b>			<b>SEAT DIMENSIONS</b>			<b>BACK DIMENSIONS</b>							
			<b>W</b>	<b>D</b>	<b>H</b>	<b>W</b>	<b>D</b>	<b>H</b>	<b>W</b>	<b>H</b>						
			25	24	36	20	19	16.5-20.5	19	19						
<p>ERGONOMIC FEATURES: A, C, G, H, M, N, Q</p>	  															
		 <p><b>Medium Posture Back - Fully Upholstered w/Arms</b> COM Yardage: 1.25 Freight Class: 150 Product Weight (lbs.):45 Cubic Feet Per Carton: 9.75</p>	 <p><b>ADJUSTMENTS</b> (1) Tilt tension (2) Pneumatic seat height (3) Back angle (9) Chair tilt lock (5A) Center tilt action</p>	<b>2739</b>	949	999	1037	1090	1169	1197	1263	1395	1458	1576	1743	1945
					<b>OVERALL DIMENSIONS</b>			<b>SEAT DIMENSIONS</b>			<b>BACK DIMENSIONS</b>					
					<b>W</b>	<b>D</b>	<b>H</b>	<b>W</b>	<b>D</b>	<b>H</b>	<b>W</b>	<b>H</b>				
25	24				36	20	19	16.5-20.5	19	19						
<p>ERGONOMIC FEATURES: A, C, G, H, M, N, Q</p>	  															
		 <p><b>Medium Posture Stool Nylon Back w/Arms</b> COM Yardage: 1 Freight Class: 150 Product Weight (lbs.): 50 Cubic Feet Per Carton: 9.75</p>	 <p><b>ADJUSTMENTS</b> (1) Tilt tension (2) Pneumatic seat height (3) Back angle (9) Chair tilt lock (5A) Center tilt action</p>	<b>2748</b>	\$1085	\$1128	\$1159	\$1206	\$1270	\$1294	\$1353	\$1460	\$1513	\$1616	\$1752	\$1922
					<b>OVERALL DIMENSIONS</b>			<b>SEAT DIMENSIONS</b>			<b>BACK DIMENSIONS</b>					
					<b>W</b>	<b>D</b>	<b>H</b>	<b>W</b>	<b>D</b>	<b>H</b>	<b>W</b>	<b>H</b>				
25	24				46	20	19	23-33	19	19						
<p>ERGONOMIC FEATURES: A, C, G, H, M, N, Q</p>	  															
		 <p><b>Medium Posture Stool Mesh Back w/Arms</b> COM Yardage: 1 Freight Class: 150 Product Weight (lbs.): 51 Cubic Feet Per Carton: 9.75</p>	 <p><b>ADJUSTMENTS</b> (1) Tilt tension (2) Pneumatic seat height (3) Back angle (9) Chair tilt lock (5A) Center tilt action</p>	<b>2748MB</b>	\$1176	\$1219	\$1250	\$1297	\$1361	\$1384	\$1443	\$1550	\$1603	\$1706	\$1843	\$2013
					<b>OVERALL DIMENSIONS</b>			<b>SEAT DIMENSIONS</b>			<b>BACK DIMENSIONS</b>					
					<b>W</b>	<b>D</b>	<b>H</b>	<b>W</b>	<b>D</b>	<b>H</b>	<b>W</b>	<b>H</b>				
25	24				46	20	19	23-33	19	19						
<p>ERGONOMIC FEATURES: A, C, G, H, M, N, Q</p>	  															

DESCRIPTION	FEATURES	MODEL#	STANDARD TEXTILE GRADES											
			1	2	3	4	5	6	7	8	9	10	11	12
 <p><b>Medium Posture Stool - Fully Upholstered</b> w/Arms                      COM Yardage: 1.25                      Freight Class: 150                      Product Weight (lbs.): 52                      Cubic Feet Per Carton: 9.75</p>	 <p><b>ADJUSTMENTS</b>                      (1) Tilt tension                      (2) Pneumatic seat height                      (3) Back angle                      (9) Chair tilt lock                      (5A) Center tilt action</p>	<b>2749</b>	\$1172	\$1223	\$1264	\$1322	\$1402	\$1432	\$1505	\$1640	\$1705	\$1833	\$2003	\$2218
			<b>OVERALL DIMENSIONS</b> W      D      H			<b>SEAT DIMENSIONS</b> W      D      H			<b>BACK DIMENSIONS</b> W      H					
			25	24	46	20	19	23-33	19	19				
	Ergonomic Features: A, C, G, H, M, N, Q	  												

INCLUDE



**Model IN30AHB**  
High Back Weight  
Sensing Synchro-Tilter



**Model IN30AMB**  
Mid Back Weight  
Sensing Synchro-tilter



Contrasting Textile Application.

**MECHANISM:**

Weight sensing synchro-tilter mechanism

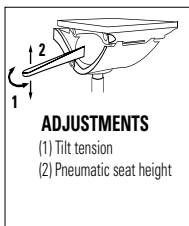

**Ergonomic features:**  
B, C, L, M, N, U

**STANDARD FEATURES**

- Include chairs combine exceptional comfort with refined elegance. The series is Global's first to offer new kinetic motion, weight balanced synchronous tilt providing smooth action and support. Include goes beyond the boardroom, from collaboration to light work and executive offices.
- Available in two back heights. Backs are contoured with an inner flexible structure and lumbar with over-molded foam and includes an integrated, passive adjustment lumbar pad to create a new level of comfort in an upholstered back.
- The durable, injected molded foam seat includes a waterfall front edge and an under seat structure with a sleek, fastener-free aesthetic.
- The series offers fixed arm and armless models.
- The polished aluminum fixed arm is standard with a flush-mount, soft, durable and warm to the touch urethane (**SSU**) arm cap. Select arm cap finish in standard Black (**BLK**) or optional Kalua (**KAL**) and Shadow (**SHW**), see upcharges.
- A (**4Z**) 4" gas cylinder is standard and matches the selected base finish. The cylinder supports a 17" to 21" seat height with a max arm height clearing tables with under-surface clearance of 27". Note, higher range cylinders are not recommended with fixed arm models and may result in arm contact with table edge. Check clearance to avoid damage.
- Five prong, injection molded, fiberglass reinforced Black nylon base (**B7**) is standard. Polished aluminum base is optional. See upcharge.
- C82, 2.5" dual wheel carpet casters (**82**), standard. C82R, Hard floor caster (**8R**) are optional. See upcharge.
- The series is available to specify with two textiles, one for the seat cushion and one for the back. For pricing, start with the base price and add upcharges for both back graded textile upcharge and the seat graded textile upcharge. Upholstery options include fabric, coated fabric or leather.
- To minimize potential for cleaning liquids and spills entering the seat cushion, a moisture barrier (**MB**) creates a protective layer under permeable textiles and the seat foam, see upcharge. Moisture barrier is not available with sealed seams (**SE**).
- For approved coated textiles, sealed seat seams (**SE**) are available, see upcharge. Sealing the seams of water resistant materials ensures the seams are protected. Note, some puckering may occur at curves and corners due to the added material thickness. Chairs ship (**PAS**) Partially assembled, standard. Include's weight capacity is 300 lbs and is covered under Global's limited lifetime warranty.
- Note the Blended Textile Matrix is not applicable to this series when specified as noted above. For other multi-fabric applications, contact Customer Care.





**OPTIONAL FEATURES**

Please add option codes in the following order:

- **Model number**  
Specify model number
- **Back textile**  
Specify textile code. See upcharges.
- **Seat seams and textile**  
(**NS**) No sealed seams.  
(**SE**) Sealed seams. Add \$24  
Specify textile code.
- **Armcap finish**  
(**BLK**) Black. No Upcharge.  
(**KAL**) Kalua. Add \$10  
(**SHW**) Shadow. Add \$10
- **Base finish**  
(**B7**) Black nylon base  
(**A7**) Polished aluminum base. Add \$140
- **Cylinder Type**  
(**4Z**) 4" Gas , 27" max arm height standard. Matches base finish.
- **Caster type**  
(**82**) 2.5" casters for carpet (C82).  
(**8R**) 2.5" casters for most hard surfaces (C82R). Add \$94
- **Moisture barrier** (seat only, not available with sealed seams)  
(**NB**) No moisture barrier  
(**MB**) Moisture barrier. Add \$107
- **Assembly type**  
(**PAS**) Partially assembled. No upcharge

**EXAMPLE INCLUDE ORDER CODE:**

IN30AHB	FU75	NS	FU75	BLK	B7	4Z	82	NB	PAS
Model	Back Textile	Sealed Seat Seams	Seat Textile	Armcap Finish	Base Finish	Cylinder Type	Caster Type	Moisture Barrier	Assembly Type

DESCRIPTION	MODEL#/ FEATURES	STANDARD TEXTILE GRADES												
		1/COM	2	3	4	5	6	7	8	9	10	11	12	
 <p><b>High Back Weight Sensing Synchro Tilter with Arms</b> COM Yardage: Back 1.25; Seat: .75 Freight Class: 150 Product Weight (lbs.): 56.5 Cubic Feet Per Carton: 10.5</p>	<b>IN30AHB</b>	Base Price:	\$1431											
		Back upcharge:	<b>+0</b>	\$40	\$72	\$118	\$183	\$210	\$267	\$355	\$422	\$494	\$645	\$804
	Seat upcharge:	<b>+0</b>	\$24	\$43	\$71	\$110	\$126	\$160	\$213	\$253	\$297	\$387	\$483	
	<b>OVERALL DIMENSIONS</b>			<b>SEAT DIMENSIONS</b>			<b>BACK DIMENSIONS</b>							
	<b>W D H</b>			<b>W D H</b>			<b>W H</b>							
	24.5 24.5 42.5			21 18 17-21			18 25							
	<b>RTA 1</b> 1 per carton													
	 <p><b>High Back Weight Sensing Synchro Tilter Armless</b> COM Yardage: Back 1.25; Seat: .75 Freight Class: 150 Product Weight (lbs.): 50 Cubic Feet Per Carton: 10.5</p>	<b>IN30NHB</b>	Base Price:	\$1244										
			Back upcharge:	<b>+0</b>	\$40	\$72	\$118	\$183	\$210	\$267	\$355	\$422	\$494	\$645
		Seat upcharge:	<b>+0</b>	\$24	\$43	\$71	\$110	\$126	\$160	\$213	\$253	\$297	\$387	\$483
<b>OVERALL DIMENSIONS</b>			<b>SEAT DIMENSIONS</b>			<b>BACK DIMENSIONS</b>								
<b>W D H</b>			<b>W D H</b>			<b>W H</b>								
24.5 24.5 42.5			21 18 17-21			18 25								
<b>RTA 1</b> 1 per carton														
 <p><b>Mid Back Weight Sensing Synchro Tilter with Arms</b> COM Yardage: Seat: Back 1; Seat: .75 Freight Class: 150 Product Weight (lbs.): 55 Cubic Feet Per Carton: 10.5</p>		<b>IN30AMB</b>	Base Price:	\$1398										
			Back upcharge:	<b>+0</b>	\$32	\$57	\$94	\$146	\$168	\$213	\$284	\$337	\$395	\$516
		Seat upcharge:	<b>+0</b>	\$24	\$43	\$71	\$110	\$126	\$160	\$213	\$253	\$297	\$387	\$483
	<b>OVERALL DIMENSIONS</b>			<b>SEAT DIMENSIONS</b>			<b>BACK DIMENSIONS</b>							
	<b>W D H</b>			<b>W D H</b>			<b>W H</b>							
	24.5 24 37.5			21 18 17-21			18 20.5							
	<b>RTA 1</b> 1 per carton													
	 <p><b>Mid Back Weight Sensing Synchro Tilter Armless</b> COM Yardage: Seat: Back 1; Seat: .75 Freight Class: 150 Product Weight (lbs.): 48.5 Cubic Feet Per Carton: 10.5</p>	<b>IN30NMB</b>	Base Price:	\$1211										
			Back upcharge:	<b>+0</b>	\$32	\$57	\$94	\$146	\$168	\$213	\$284	\$337	\$395	\$516
		Seat upcharge:	<b>+0</b>	\$24	\$43	\$71	\$110	\$126	\$160	\$213	\$253	\$297	\$387	\$483
<b>OVERALL DIMENSIONS</b>			<b>SEAT DIMENSIONS</b>			<b>BACK DIMENSIONS</b>								
<b>W D H</b>			<b>W D H</b>			<b>W H</b>								
21 24 37.5			21 18 17-21			18 20.5								
<b>RTA 1</b> 1 per carton														

LOOVER



model 2660-8



model 2660-3



**Memory Foam**  
Available, use code "MF" and Add \$124.



model 2661-8



model 2662-3

STANDARD FEATURES

- Global's first chair to feature a weight sensing synchro-tilter mechanism that requires no tilt tension adjustment.
- A live lumber support is incorporated into the back design which is height adjustable via a concealed ratchet system, offering a 2.25" height adjustment.
- Standard with Global's high quality Soft Descent™ pneumatic lift which slowly and gently lowers the seat height of the chair making it easy to obtain the exact seat height you desire.
- Side activated sliding seat depth adjustment, is standard on for Multi-Tilters, Synchro-Tilters, and Weight Sensing Synchro-Tilter. Provides 2"-3" of seat depth adjustment.
- Height and width (WA) adjustable G5 lockable arms. Armcaps are soft to the touch Self Skinned Urethane, depth adjustable (slide forward and backward) movements can be locked to avoid unintentional movement). Armcaps also articulate inwards and outwards 30° to aim toward the keyboard or mouse arena.
- Vari-Width (WA) Width Adjustable Arm Extensions are standard, allowing the arms to move away from the seat by 2" on each side to allow space if desired for broader hip widths.
- Five prong, injection molded, fiberglass reinforced, Nylon medium rise base B7B with C1 dual wheel carpet casters.

- Check textile availability prior to specifying upholstery material.
- Mesh backs are available in 24 brilliant Vue colors: Sandy Beach (VU10), Desert Sand (VU11), Orange Sunset (VU12), Chocolate Fountain (VU13), Arctic Blue (VU14), Quarry Grey (VU15), Tidal Wave (VU16), Ivy Moss (VU17), Red Rose (VU18), Coal Black (VU19), White (VU20), Lime (VU21), Chartreuse (VU23), Pool Blue (VU26), Sky (VU28), Primary Blue (VU32), Tangerine (VU34), Paprika (VU37), Grain (VU40), Yellow (VU43), Silver Grey (VU55), Silver (VU63), Hot Pink (VU65) and Red Mittens (VU70). Please specify

OPTIONAL FEATURES

- Petite models are available at no upcharge. Please specify P. Seat is overall 1 inch smaller in depth and 1.5 inch smaller in width. Model numbers are listed below.
- Seat available in memory foam (MF). Add \$124.
- Optional Polished Aluminum base (B7A) Please specify (ALU) base. Add \$177.
- For hard surface flooring casters, please specify C9R. Add \$76.
- Please refer to "Arms Selection" section of the price book for arm options. Please refer to "Cylinder Selection" section of the price book for additional cylinder options.
- For fully assembled in box, specify SU. Add \$81..

DESCRIPTION FEATURES MODEL# STANDARD TEXTILE GRADES



Extended HB Synchro - Tilter w/Back Angle Adjustment

COM Yardage: 1  
Freight Class: 125  
Product Weight (lbs.): 68  
Cubic Feet Per Carton: 11

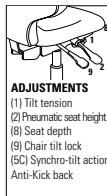

**ADJUSTMENTS**  
(1) Tilt tension  
(2) Pneumatic seat height  
(3) Seat depth  
(9) Chair tilt lock  
(5C) Synchro-tilt action  
Anti-Kick back

Ergonomic Features:  
A, B, C, D, E, G, H, L, M, N, Q, R, U

MODEL#	1	2	3	4	5	6	7	8	9	10	11	12
2660-0	\$1280	\$1323	\$1353	\$1397	\$1459	\$1478	\$1536	\$1640	\$1690	\$1788	\$1917	\$2081

OVERALL DIMENSIONS			SEAT DIMENSIONS			BACK DIMENSIONS	
W	D	H	W	D	H	W	H
25.5	25	45.5	19	19-22	16.25-20.25	19.5	26.5-29

RTA 2



Extended HB Multi Tilter

COM Yardage: 1  
Freight Class: 125  
Product Weight (lbs.): 68  
Cubic Feet Per Carton: 11

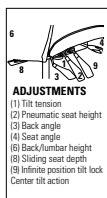

**ADJUSTMENTS**  
(1) Tilt tension  
(2) Pneumatic seat height  
(3) Back angle  
(4) Seat angle  
(6) Back/lumbar height  
(8) Sliding seat depth  
(9) Infinite position tilt lock  
Center tilt action

Ergonomic Features:  
A, B, C, D, E, F, G, H, M, N, Q, R, S, U

MODEL#	1	2	3	4	5	6	7	8	9	10	11	12
2660-3 2660P-3 Small Seat	\$1280	\$1323	\$1353	\$1397	\$1459	\$1478	\$1536	\$1640	\$1690	\$1788	\$1917	\$2081

OVERALL DIMENSIONS			SEAT DIMENSIONS			BACK DIMENSIONS	
W	D	H	W	D	H	W	H
25.5	25	45.5	20	19-22	16-20	19.5	26.5-29

RTA 2



Extended HB Tilter

COM Yardage: 1  
Freight Class: 150  
Product Weight (lbs.): 62  
Cubic Feet Per Carton: 11

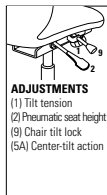

**ADJUSTMENTS**  
(1) Tilt tension  
(2) Pneumatic seat height  
(9) Chair tilt lock  
(5A) Center-tilt action











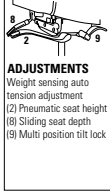



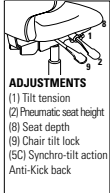

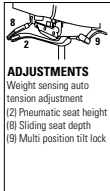

Ergonomic Features:  
A, B, C, D, H, M, N, Q, R, S, U



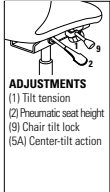



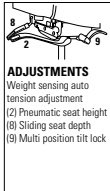



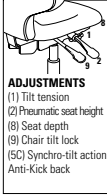



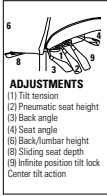



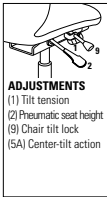

MODEL#	1	2	3	4	5	6	7	8	9	10	11	12
2660-4	\$1119	\$1160	\$1190	\$1233	\$1297	\$1316	\$1374	\$1475	\$1528	\$1625	\$1755	\$1917

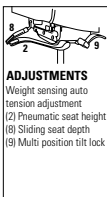

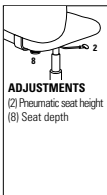

OVERALL DIMENSIONS			SEAT DIMENSIONS			BACK DIMENSIONS	
W	D	H	W	D	H	W	H
25.5	25	45.5	20	19-20	16-21	19.5	26.5-29

RTA 2

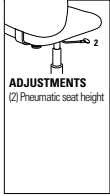

DESCRIPTION	FEATURES	MODEL#	STANDARD TEXTILE GRADES											
			1	2	3	4	5	6	7	8	9	10	11	12
 <p><b>Extended HB Weight Sensing Synchro - Tilter</b>                      COM Yardage: 1                      Freight Class: 125                      Product Weight (lbs.): 66                      Cubic Feet Per Carton: 11</p>	 <p><b>ADJUSTMENTS</b>                      (1) Weight sensing auto tension adjustment                      (2) Pneumatic seat height                      (8) Sliding seat depth                      (9) Multi position tilt lock</p>	<p>Ergonomic Features:                      A, B, C, D, E, H, L, M, N, Q, R, U</p>	<p><b>2660-8</b>    \$1280 \$1323 \$1353 \$1397 \$1459 \$1478 \$1536 \$1640 \$1690 \$1788 \$1917 \$2081                      2660P-8 Small Seat</p>											
			<p><b>OVERALL DIMENSIONS</b></p> <p>W    D    H</p>			<p><b>SEAT DIMENSIONS</b></p> <p>W    D    H</p>			<p><b>BACK DIMENSIONS</b></p> <p>W    H</p>					
			25.5    25    45.5			20    19-22    16-21			19.5    26.5-27.5					
			<p><b>RTA 2</b>     </p>											
 <p><b>HB Synchro - Tilter w/Back Angle Adjustment</b>                      COM Yardage: 1                      Freight Class: 125                      Product Weight (lbs.): 66                      Cubic Feet Per Carton: 10.5</p>	 <p><b>ADJUSTMENTS</b>                      (1) Tilt tension                      (2) Pneumatic seat height                      (8) Seat depth                      (9) Chair tilt lock                      (5C) Synchro-tilt action                      Anti-Kick back</p>	<p>Ergonomic Features:                      A, B, C, D, E, G, H, L, M, N, Q, R, U</p>	<p><b>2661-0</b>    \$1195 \$1235 \$1266 \$1309 \$1373 \$1392 \$1450 \$1551 \$1604 \$1701 \$1831 \$1993</p>											
			<p><b>OVERALL DIMENSIONS</b></p> <p>W    D    H</p>			<p><b>SEAT DIMENSIONS</b></p> <p>W    D    H</p>			<p><b>BACK DIMENSIONS</b></p> <p>W    H</p>					
			25.5    24    42.5			20    19-22    16.25-20.25			19.5    19.5-27.5					
			<p><b>RTA 2</b>     </p>											
 <p><b>HB Multi - Tilter</b>                      COM Yardage: 1                      Freight Class: 125                      Product Weight (lbs.): 68                      Cubic Feet Per Carton: 10.5</p>	 <p><b>ADJUSTMENTS</b>                      (1) Tilt tension                      (2) Pneumatic seat height                      (3) Back angle                      (4) Seat angle                      (6) Back/lumbar height                      (8) Sliding seat depth                      (9) Infinite position tilt lock                      Center tilt action</p>	<p>Ergonomic Features:                      A, B, C, D, E, F, G, H, M, N, Q, R, S, U</p>	<p><b>2661-3</b>    \$1195 \$1235 \$1266 \$1309 \$1373 \$1392 \$1450 \$1551 \$1604 \$1701 \$1831 \$1993                      2661P-3 Small Seat</p>											
			<p><b>OVERALL DIMENSIONS</b></p> <p>W    D    H</p>			<p><b>SEAT DIMENSIONS</b></p> <p>W    D    H</p>			<p><b>BACK DIMENSIONS</b></p> <p>W    H</p>					
			25.5    25    42.5			20    19-22    16-20			19.5    25-27.5					
			<p><b>RTA 2</b>     </p>											
 <p><b>HB Tilter</b>                      COM Yardage: 1                      Freight Class: 150                      Product Weight (lbs.): 62                      Cubic Feet Per Carton: 10.5</p>	 <p><b>ADJUSTMENTS</b>                      (1) Tilt tension                      (2) Pneumatic seat height                      (9) Chair tilt lock                      (5A) Center-tilt action</p>	<p>Ergonomic Features:                      A, B, C, D, H, M, N, Q, R, S, U</p>	<p><b>2661-4</b>    \$1050 \$1091 \$1121 \$1164 \$1228 \$1247 \$1305 \$1408 \$1459 \$1556 \$1686 \$1848</p>											
			<p><b>OVERALL DIMENSIONS</b></p> <p>W    D    H</p>			<p><b>SEAT DIMENSIONS</b></p> <p>W    D    H</p>			<p><b>BACK DIMENSIONS</b></p> <p>W    H</p>					
			25.5    25    42.5			20    19-20    16-21			19.5    25-27.5					
			<p><b>RTA 2</b>     </p>											
 <p><b>HB Weight Sensing Synchro - Tilter</b>                      COM Yardage: 1                      Freight Class: 125                      Product Weight (lbs.): 66                      Cubic Feet Per Carton: 10.5</p>	 <p><b>ADJUSTMENTS</b>                      (1) Weight sensing auto tension adjustment                      (2) Pneumatic seat height                      (8) Sliding seat depth                      (9) Multi position tilt lock</p>	<p>Ergonomic Features:                      A, B, C, D, E, H, L, M, N, Q, R, U</p>	<p><b>2661-8</b>    \$1195 \$1236 \$1266 \$1309 \$1373 \$1392 \$1450 \$1551 \$1604 \$1701 \$1831 \$1993                      2661P-8 Small Seat</p>											
			<p><b>OVERALL DIMENSIONS</b></p> <p>W    D    H</p>			<p><b>SEAT DIMENSIONS</b></p> <p>W    D    H</p>			<p><b>BACK DIMENSIONS</b></p> <p>W    H</p>					
			25.5    24    42.5			20    19-20    16-21			19.5    25-27.5					
			<p><b>RTA 2</b>     </p>											

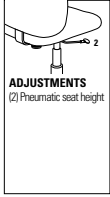
DESCRIPTION	FEATURES	MODEL#	STANDARD TEXTILE GRADES											
			1	2	3	4	5	6	7	8	9	10	11	12
 <p><b>MB Synchro - Tilter w/Back Angle Adjustment</b> COM Yardage: 1 Freight Class: 125 Product Weight (lbs.): 64 Cubic Feet Per Carton: 10.5</p>	 <p><b>ADJUSTMENTS</b> (1) Tilt tension (2) Pneumatic seat height (8) Seat depth (9) Chair tilt lock (5C) Synchro-tilt action Anti-Kick back</p>	<p><b>2662-0</b>    \$1143 \$1184 \$1214 \$1257 \$1321 \$1341 \$1398 \$1501 \$1553 \$1649 \$1780 \$1941</p>												
			<b>OVERALL DIMENSIONS</b>			<b>SEAT DIMENSIONS</b>			<b>BACK DIMENSIONS</b>					
			<b>W</b>	<b>D</b>	<b>H</b>	<b>W</b>	<b>D</b>	<b>H</b>	<b>W</b>	<b>H</b>				
			25.5	24	39.5	20	19-22	16.25-20.25	19.5	22-24.5				
<p>Ergonomic Features: A, B, C, D, E, G, H, L, M, N, Q, R, U</p>														
 <p><b>MB Multi Tilter</b> COM Yardage: 1 Freight Class: 125 Product Weight (lbs.): 66 Cubic Feet Per Carton: 10.5</p>	 <p><b>ADJUSTMENTS</b> (1) Tilt tension (2) Pneumatic seat height (3) Back angle (4) Seat angle (8) Back/lumbar height (9) Sliding seat depth (9) Infinite position tilt lock Center tilt action</p>	<p><b>2662-3</b>    \$1143 \$1184 \$1214 \$1257 \$1321 \$1341 \$1398 \$1501 \$1553 \$1649 \$1780 \$1941 2662P-3 Small Seat</p>												
			<b>OVERALL DIMENSIONS</b>			<b>SEAT DIMENSIONS</b>			<b>BACK DIMENSIONS</b>					
			<b>W</b>	<b>D</b>	<b>H</b>	<b>W</b>	<b>D</b>	<b>H</b>	<b>W</b>	<b>H</b>				
			25.5	25	39.5	20	19-22	16-20	19.5	22-24.5				
<p>Ergonomic Features: A, B, C, D, E, F, G, H, M, N, Q, R, S, U</p>														
 <p><b>MB Tilter</b> COM Yardage: 1 Freight Class: 150 Product Weight (lbs.): 60 Cubic Feet Per Carton: 10.5</p>	 <p><b>ADJUSTMENTS</b> (1) Tilt tension (2) Pneumatic seat height (9) Chair tilt lock (5A) Center-tilt action</p>	<p><b>2662-4</b>    \$1016 \$1057 \$1087 \$1130 \$1194 \$1213 \$1271 \$1374 \$1425 \$1522 \$1652 \$1814</p>												
			<b>OVERALL DIMENSIONS</b>			<b>SEAT DIMENSIONS</b>			<b>BACK DIMENSIONS</b>					
			<b>W</b>	<b>D</b>	<b>H</b>	<b>W</b>	<b>D</b>	<b>H</b>	<b>W</b>	<b>H</b>				
			25.5	25	39.5	20	19-20	16-21	19.5	22-24.5				
<p>Ergonomic Features: A, B, C, D, H, M, N, Q, R, S, U</p>														
 <p><b>MB Weight Sensing Synchro - Tilter</b> COM Yardage: 1 Freight Class: 125 Product Weight (lbs.): 64 Cubic Feet Per Carton: 10.5</p>	 <p><b>ADJUSTMENTS</b> Weight sensing auto tension adjustment (2) Pneumatic seat height (8) Sliding seat depth (9) Multi position tilt lock</p>	<p><b>2662-8</b>    \$1143 \$1184 \$1213 \$1255 \$1320 \$1341 \$1396 \$1499 \$1552 \$1646 \$1776 \$1940 2662P-8 Small Seat</p>												
			<b>OVERALL DIMENSIONS</b>			<b>SEAT DIMENSIONS</b>			<b>BACK DIMENSIONS</b>					
			<b>W</b>	<b>D</b>	<b>H</b>	<b>W</b>	<b>D</b>	<b>H</b>	<b>W</b>	<b>H</b>				
			25.5	24	39.5	20	19-22	16-21	19.5	22-24.5				
<p>Ergonomic Features: A, B, C, D, E, H, L, M, N, Q, R, U</p>														
 <p><b>MB Task</b> COM Yardage: 1 Freight Class: 150 Product Weight (lbs.): 45 Cubic Feet Per Carton: 10.5</p>	 <p><b>ADJUSTMENTS</b> (2) Pneumatic seat height (8) Seat depth</p>	<p><b>2662-6</b>    \$1080 \$1121 \$1151 \$1194 \$1258 \$1277 \$1335 \$1436 \$1489 \$1586 \$1716 \$1878</p>												
			<b>OVERALL DIMENSIONS</b>			<b>SEAT DIMENSIONS</b>			<b>BACK DIMENSIONS</b>					
			<b>W</b>	<b>D</b>	<b>H</b>	<b>W</b>	<b>D</b>	<b>H</b>	<b>W</b>	<b>H</b>				
			25.5	25	39.5	20	19-20	16.5-21.5	19.5	21				
<p>Ergonomic Features: C, E, H, M, N, Q, R, U</p>														

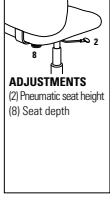
DESCRIPTION	FEATURES	MODEL#	STANDARD TEXTILE GRADES														
			1	2	3	4	5	6	7	8	9	10	11	12			
 <p><b>MB Height Adjustable Stool - Task</b>                      COM Yardage: 1                      Freight Class: 150                      Product Weight (lbs.): 50                      Cubic Feet Per Carton: 10.5</p>	 <p><b>ADJUSTMENTS</b> (2) Pneumatic seat height</p>	Ergonomic Features: C, E, H, M, N, Q, R, U	2663-6	\$1484	\$1525	\$1555	\$1598	\$1662	\$1682	\$1739	\$1842	\$1893	\$1990	\$2121	\$2282		
			<b>OVERALL DIMENSIONS</b>			<b>SEAT DIMENSIONS</b>			<b>BACK DIMENSIONS</b>								
			<b>W</b>	<b>D</b>	<b>H</b>	<b>W</b>	<b>D</b>	<b>H</b>	<b>W</b>	<b>H</b>							
			25.5	25	50	20	19-20	24-34	19.5	21							
			RTA 2	FedEx		ups											
 <p><b>MB Height Adjustable Stool - Task</b>                      COM Yardage: 1                      Freight Class: 150                      Product Weight (lbs.): 44                      Cubic Feet Per Carton: 10.5</p>	 <p><b>ADJUSTMENTS</b> (2) Pneumatic seat height</p>	Ergonomic Features: C, E, M, N, U	2664-6	\$1349	\$1390	\$1420	\$1463	\$1527	\$1546	\$1604	\$1705	\$1758	\$1855	\$1985	\$2147		
			<b>OVERALL DIMENSIONS</b>			<b>SEAT DIMENSIONS</b>			<b>BACK DIMENSIONS</b>								
			<b>W</b>	<b>D</b>	<b>H</b>	<b>W</b>	<b>D</b>	<b>H</b>	<b>W</b>	<b>H</b>							
			20	25	50	20	19-20	24-34	19.5	21							
			RTA 2	FedEx		ups											
 <p><b>MB Task</b>                      COM Yardage: 1                      Freight Class: 250                      Product Weight (lbs.): 39                      Cubic Feet Per Carton: 10.5</p>	 <p><b>ADJUSTMENTS</b> (2) Pneumatic seat height (8) Seat depth</p>	Ergonomic Features: C, E, M, N, U	2665-6	\$939	\$980	\$1010	\$1053	\$1117	\$1136	\$1194	\$1297	\$1348	\$1445	\$1575	\$1737		
			<b>OVERALL DIMENSIONS</b>			<b>SEAT DIMENSIONS</b>			<b>BACK DIMENSIONS</b>								
			<b>W</b>	<b>D</b>	<b>H</b>	<b>W</b>	<b>D</b>	<b>H</b>	<b>W</b>	<b>H</b>							
			20	25	39.5	20	19-20	16.5-21.5	19.5	16.5							
			RTA 2	FedEx		ups											

LURAY



Luray is offered in three back heights.



Standard Black Nylon Base/Arms with Self Skinned Urethane Armcaps

Optional Aluminum Base/Arms with Self Skinned Urethane Armcaps

Optional Aluminum Base/Arms with Wood Armcaps



Model 6461PB

MECHANISMS OPTIONS

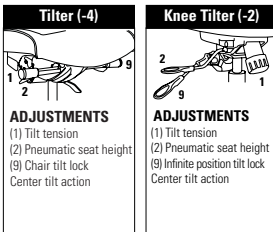

Ergonomic Features:  
A, B, C, M, N, S, U

Ergonomic Features:  
A, B, C, J, M, N, U

STANDARD FEATURES

- Luray is designed for boardrooms, meeting rooms and executive offices.
- Luray offers a choice of finishes to match any environment: from durable nylon components to sophisticated polished aluminum and elegant wood trim.
- Three back heights are available, featuring horizontal sewing details.
- Stitch detail on edges of seat and back is discrete, using matched thread as standard.
- Choice of two mechanisms; tilter and knee-tilter.
- Standard with Global's high quality Soft Descent™ pneumatic lift which slowly and gently lowers the seat height of the chair making it easy to obtain the exact seat height you desire.
- Fixed loop arm design comes standard in Black fiberglass reinforced nylon with a self-skinned urethane (SSU) armcap; which is soft, durable and warm to the touch. The armcap overhangs the front and side of the arm so that chair to table contact is cushioned by the pliable edge.
- Five prong, injection molded, fiberglass reinforced, nylon medium rise base (B7B) with (C1) dual wheel carpet casters.
- Check textile availability prior to specifying upholstery material.
- Pedestal base models are offered on (-4) Tilter mechanisms only. These models provide fixed location seating for use in auditoriums, classrooms, jury boxes, public venues and more. The base must be mounted to the floor (mounting hardware not included). See Pedestal Base Installation Guide for details.

OPTIONAL FEATURES

- Upholstery is available with exaggerated top stitch detail (heavier thread). Fourteen coordinating or contrasting colors may be selected. Please specify.
- For Additional caster options, please refer to the Arm and Caster section of the Price Book. Optional casters may be priced higher than the standard casters for your chair and the difference will be charged. Lower priced optional casters will not be credited.
- Please refer to "Cylinder Selection" section of the price book for additional cylinder options.
- For Memory Foam, specify (MF) and add \$124.
- Pedestal Base models have black bases with 2" height adjust cylinders. Specify (SCC) swivel, auto return to max height (no upcharge); (SN) non-swivel, auto return to max height (Add \$23); or (SC) swivel, self-centering and return to max height (Add \$35).

OPTION CODES











Please Add option codes in the following order:

- **Model number**  
6460 Extended high back  
6461 High back  
6462 Medium back

- **Fabric**  
Specify fabric code.
- **Mechanism**  
(-4) Tilter mechanism ..... **No Upcharge**  
(-2) Knee-tilt mechanism ..... **Add \$161**
- **Arms**  
(SSU) Black nylon arms w/SSU armcaps ..... **No Upcharge**  
(ANU) Aluminum arms w/SSU armcaps ..... **Add \$238**  
Aluminum arms w/Wood armcaps ..... **Add \$238**  
Specify finish from the following:  
(AAM) Absolute  
(BKM) Black  
(ACM) Cherry  
(EOM) English Oak  
(ECM) Espresso Café  
(HGM) Gray  
(AHM) Honey  
(TMM) Mahogany  
(AVM) Maple  
(MWM) Medium Walnut  
(NLW) Natural Walnut  
(ASM) Night  
(NBM) Noce Biondo  
(NGM) Noce Grigio  
(NEM) Noce Leggero  
(NMM) Noce Medio  
(SKM) Shaker Cherry  
(TFM) Fruitwood  
(TWM) Walnut  
(WTM) WC Cream  
(WHM) White  
(WCM) Winter Cherry (colors shown on website)
- **Base**  
(B7) Black nylon base.  
(A7) Polished aluminum ..... **Add \$177**
- **Casters**  
(C1) Dual wheel carpet casters.  
(C9R) Dual wheel hard floor casters ..... **Add \$78**
- **Stitch detail**  
(MS) Color matched stitching  
Decorative top stitch ..... **No Upcharge**  
(XP) Black (XB) Beige  
(XG) Copen (XA) Graphite  
(XK) Mahogany (XJ) Natural  
(XH) Navy (XD) New Grey  
(XF) Nickel (XN) Off White  
(XL) Rubytone (XI) Scarlett  
(XC) Smoke (XE) Taupe (colors shown on website)
- **Seat foam**  
(SF) Standard foam  
(MF) Memory foam ..... **Add \$124**
- **Chair assembly**  
(SU) Assembled in Box ..... **Add \$81**
- **Cylinder (for Pedestal Base)**  
(SH) Swivel, auto return turn to max height  
(SN) Non-swivel, auto return turn to max height  
**Add \$23**  
(SC) Swivel, self-centering and return to max height **Add \$35**

EXAMPLE OF ORDER CODE:

6460	WA50	4	AHM	A7	C1	MS	SF	SU
Model Number	Fabric	Mechanism	Arms	Base	Casters	Stitch Detail	Seat Foam	Chair Assembly

DESCRIPTION	FEATURES	MODEL#	STANDARD TEXTILE GRADES											
			1	2	3	4	5	6	7	8	9	10	11	12
 <p><b>Extended High Back</b> COM Yardage: 2.25 Freight Class: 250 Product Weight (lbs.): 46 Cubic Feet Per Carton: 14.75</p>		<b>6460</b>	1358	1452	1524	1632	1784	1855	1994	2213	2382	2573	2960	3374
			<b>OVERALL DIMENSIONS</b>			<b>SEAT DIMENSIONS</b>			<b>BACK DIMENSIONS</b>					
			<b>W</b>	<b>D</b>	<b>H</b>	<b>W</b>	<b>D</b>	<b>H</b>	<b>W</b>	<b>H</b>				
			25	26.5	46	20	19	16.5-21.5	20	27.5				
			<b>RTA 1</b>											
 <p><b>High Back</b> COM Yardage: 2 Freight Class: 44 Product Weight (lbs.): 44 Cubic Feet Per Carton: 13.75</p>		<b>6461</b>	1318	1401	1464	1559	1695	1758	1882	2079	2229	2396	2741	3109
			<b>OVERALL DIMENSIONS</b>			<b>SEAT DIMENSIONS</b>			<b>BACK DIMENSIONS</b>					
			<b>W</b>	<b>D</b>	<b>H</b>	<b>W</b>	<b>D</b>	<b>H</b>	<b>W</b>	<b>H</b>				
			25	26.5	42.5	20	19	16.5-21.5	20	24				
			<b>RTA 1</b>											
			 											
 <p><b>Medium Back</b> COM Yardage: 1.75 Freight Class: 250 Product Weight (lbs.): 40 Cubic Feet Per Carton: 13.75</p>		<b>6462</b>	1278	1354	1409	1495	1612	1667	1775	1946	2076	2224	2526	2848
			<b>OVERALL DIMENSIONS</b>			<b>SEAT DIMENSIONS</b>			<b>BACK DIMENSIONS</b>					
			<b>W</b>	<b>D</b>	<b>H</b>	<b>W</b>	<b>D</b>	<b>H</b>	<b>W</b>	<b>H</b>				
			25	26.5	39.5	20	19	16.5-21.5	20	21				
			<b>RTA 1</b>											
			 											
 <p><b>High Back with Pedestal Base</b> COM Yardage: 2 Freight Class: 45 Product Weight (lbs.): 45 Cubic Feet Per Carton: 13.75</p>		<b>6461PB</b>	1562	1641	1700	1789	1918	1979	2094	2278	2420	2580	2904	3250
			<b>OVERALL DIMENSIONS</b>			<b>SEAT DIMENSIONS</b>			<b>BACK DIMENSIONS</b>					
			<b>W</b>	<b>D</b>	<b>H</b>	<b>W</b>	<b>D</b>	<b>H</b>	<b>W</b>	<b>H</b>				
			25	26.5	41	20	19	16.5-21.5	20	24				
			<b>RTA 1</b>											
 <p><b>Medium Back with Pedestal Base</b> COM Yardage: 1.75 Freight Class: 250 Product Weight (lbs.): 40 Cubic Feet Per Carton: 13.75</p>		<b>6462PB</b>	1521	1590	1643	1719	1832	1884	1987	2145	2272	2408	2693	2995
			<b>OVERALL DIMENSIONS</b>			<b>SEAT DIMENSIONS</b>			<b>BACK DIMENSIONS</b>					
			<b>W</b>	<b>D</b>	<b>H</b>	<b>W</b>	<b>D</b>	<b>H</b>	<b>W</b>	<b>H</b>				
			25	26.5	37	20	19	16.5-21.5	20	21				
			<b>RTA 1</b>											
			 											

MALAGA®



model 3140-3 (TD)



model 3140-3 (TD/PSB)



model 3141-3



model 3141-3

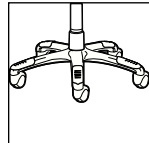

**Optional Base**  
Polished Aluminum base with black scuff tips. Specify "B2". Add \$177.







**STANDARD FEATURES**

- A contoured molded foam seat, built-in lumbar support and an upholstered outer back shell is standard on all models.
- Standard with adjustable height T-arms with teardrop shaped (TD) self-skinned urethane (SSU) armcaps.
- All models are standard with a five prong, injection molded, fiberglass reinforced nylon Black spider base with dual wheel carpet casters (C10).
- Base and frame are available in Black (BK) Only.
- Side activated sliding seat depth adjustment is standard on all models.
- All models (except high back) are shipped partially KD.
- Check textile availability prior to specifying upholstery material.

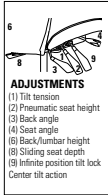
**OPTIONAL FEATURES**

- To order a Malaga arm kit as a separate stand-alone item without a chair, use model number 3200 with the appropriate letter from the Arm Chart Price List for the arm style of your choice. Please refer to "Arms Selection" section of the price book.
- Available with an impact resistant polypropylene back shroud in Black Only. Specify (PSB). No upcharge.

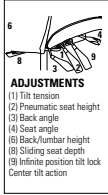
- Optional abrasion resistant outer back fabric (polyester) is available. Resistant to impact damage. Available in Black only (BKB). Add \$25.
- Optional Polished Aluminum base with black scuff tips. Specify "B2". Add \$177
- Please refer to the "Casters Selection" section of the price book for caster options. Optional casters may be priced higher than the standard casters for your chair and the difference will be charged. Lower priced optional casters will not be credited.
- Please refer to "Cylinder Selection" section of the price book for additional cylinder options.
- For hard surface flooring please specify C10R. Add \$70.
- For fully assembled in box, specify SU. Add \$81.

DESCRIPTION	FEATURES	MODEL#	STANDARD TEXTILE GRADES																										
			1	2	3	4	5	6	7	8	9	10	11	12															
 <p><b>HB Multi - Tilter</b> COM Yardage: 1.75 Freight Class: 150 Product Weight (lbs.): 54 Cubic Feet Per Carton: 9.25</p>	 <p><b>ADJUSTMENTS</b> (1) Tilt tension (2) Pneumatic seat height (3) Back angle (4) Seat angle (5) Back/lumbar height (6) Sliding seat depth (8) Infinite position tilt lock Center tilt action</p>	<p>Ergonomic Features: A, B, C, D, E, F, G, H, M, N, Q, S</p>	<table border="1"> <tr> <td><b>3140-3</b></td> <td>\$1526</td> <td>\$1596</td> <td>\$1650</td> <td>\$1726</td> <td>\$1840</td> <td>\$1881</td> <td>\$1981</td> <td>\$2166</td> <td>\$2257</td> <td>\$2432</td> <td>\$2668</td> <td>\$2961</td> </tr> </table>												<b>3140-3</b>	\$1526	\$1596	\$1650	\$1726	\$1840	\$1881	\$1981	\$2166	\$2257	\$2432	\$2668	\$2961		
			<b>3140-3</b>	\$1526	\$1596	\$1650	\$1726	\$1840	\$1881	\$1981	\$2166	\$2257	\$2432	\$2668	\$2961														
			<table border="1"> <thead> <tr> <th colspan="3">OVERALL DIMENSIONS</th> <th colspan="3">SEAT DIMENSIONS</th> <th colspan="3">BACK DIMENSIONS</th> </tr> <tr> <th>W</th> <th>D</th> <th>H</th> <th>W</th> <th>D</th> <th>H</th> <th>W</th> <th colspan="2">H</th> </tr> </thead> <tbody> <tr> <td>26</td> <td>25</td> <td>41</td> <td>20</td> <td>18</td> <td>16.5-20.5</td> <td>18.5</td> <td colspan="2">22.5-25</td> </tr> </tbody> </table>			OVERALL DIMENSIONS			SEAT DIMENSIONS			BACK DIMENSIONS			W	D	H	W	D	H	W	H		26	25	41	20	18	16.5-20.5
OVERALL DIMENSIONS			SEAT DIMENSIONS			BACK DIMENSIONS																							
W	D	H	W	D	H	W	H																						
26	25	41	20	18	16.5-20.5	18.5	22.5-25																						
<p>RTA 2  </p>																													
 <p><b>LB Multi - Tilter</b> COM Yardage: 1.5 Freight Class: 150 Product Weight (lbs.): 52 Cubic Feet Per Carton: 9.25</p>	 <p><b>ADJUSTMENTS</b> (1) Tilt tension (2) Pneumatic seat height (3) Back angle (4) Seat angle (5) Back/lumbar height (6) Sliding seat depth (8) Infinite position tilt lock Center tilt action</p>	<p>Ergonomic Features: A, B, C, D, E, F, G, H, M, N, Q, S</p>	<table border="1"> <tr> <td><b>3141-3</b></td> <td>\$1393</td> <td>\$1450</td> <td>\$1499</td> <td>\$1568</td> <td>\$1663</td> <td>\$1698</td> <td>\$1781</td> <td>\$1944</td> <td>\$2017</td> <td>\$2167</td> <td>\$2368</td> <td>\$2624</td> </tr> </table>												<b>3141-3</b>	\$1393	\$1450	\$1499	\$1568	\$1663	\$1698	\$1781	\$1944	\$2017	\$2167	\$2368	\$2624		
			<b>3141-3</b>	\$1393	\$1450	\$1499	\$1568	\$1663	\$1698	\$1781	\$1944	\$2017	\$2167	\$2368	\$2624														
			<table border="1"> <thead> <tr> <th colspan="3">OVERALL DIMENSIONS</th> <th colspan="3">SEAT DIMENSIONS</th> <th colspan="3">BACK DIMENSIONS</th> </tr> <tr> <th>W</th> <th>D</th> <th>H</th> <th>W</th> <th>D</th> <th>H</th> <th>W</th> <th colspan="2">H</th> </tr> </thead> <tbody> <tr> <td>26</td> <td>24</td> <td>37</td> <td>20</td> <td>18</td> <td>16.5-20.5</td> <td>18.5</td> <td colspan="2">19-21.5</td> </tr> </tbody> </table>			OVERALL DIMENSIONS			SEAT DIMENSIONS			BACK DIMENSIONS			W	D	H	W	D	H	W	H		26	24	37	20	18	16.5-20.5
OVERALL DIMENSIONS			SEAT DIMENSIONS			BACK DIMENSIONS																							
W	D	H	W	D	H	W	H																						
26	24	37	20	18	16.5-20.5	18.5	19-21.5																						
<p>RTA 2  </p>																													

MIRAGE™



model 2790-4



model 2791-4





Standard with a polished aluminum loop arm with SSU armcap.

STANDARD FEATURES

- Ideal for management seating and meeting rooms, Mirage offers both function and style.
- There are no arm options for this series.
- Base and frame are standard in polished aluminum only.
- **C10** carpet casters are standard.
- Check textile availability prior to specifying upholstery material.

OPTIONAL FEATURES

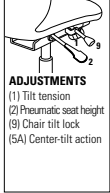
- For hard surface flooring casters, specify **C10R** and Add \$70.
- For fully assembled in box, please specify **SU**. Add \$81..

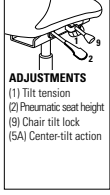
DESCRIPTION	FEATURES	MODEL#	STANDARD TEXTILE GRADES														
			1	2	3	4	5	6	7	8	9	10	11	12			
 <p><b>HB Tilter</b> COM Yardage: 2 Freight Class: 250 Product Weight (lbs.): 0 Cubic Feet Per Carton: 20.25</p>	 <p><b>ADJUSTMENTS</b> (1) Tilt tension (2) Pneumatic seat height (9) Chair tilt lock (5A) Center-tilt action</p>	<p>Ergonomic Features: A, B, C, M, N, S</p>	<b>2790-4</b>	\$1316	\$1394	\$1452	\$1541	\$1667	\$1708	\$1819	\$2027	\$2126	\$2319	\$2579	\$2906		
			<b>OVERALL DIMENSIONS</b>			<b>SEAT DIMENSIONS</b>			<b>BACK DIMENSIONS</b>								
			<b>W</b>	<b>D</b>	<b>H</b>	<b>W</b>	<b>D</b>	<b>H</b>	<b>W</b>	<b>H</b>							
			26.5	26.5	42.5	20.5	19	16-20	20.5	24.5							
			<b>RTA 00</b>														
 <p><b>MB Tilter</b> COM Yardage: 1.75 Freight Class: 250 Product Weight (lbs.): 50 Cubic Feet Per Carton: 15.75</p>	 <p><b>ADJUSTMENTS</b> (1) Tilt tension (2) Pneumatic seat height (9) Chair tilt lock (5A) Center-tilt action</p>	<p>Ergonomic Features: A, B, C, M, N, S</p>	<b>2791-4</b>	\$1279	\$1348	\$1400	\$1475	\$1585	\$1621	\$1718	\$1901	\$1987	\$2157	\$2386	\$2673		
			<b>OVERALL DIMENSIONS</b>			<b>SEAT DIMENSIONS</b>			<b>BACK DIMENSIONS</b>								
			<b>W</b>	<b>D</b>	<b>H</b>	<b>W</b>	<b>D</b>	<b>H</b>	<b>W</b>	<b>H</b>							
			26	25.5	36.5	19	19	16-20	19.5	17							
			<b>RTA 00</b>														

NOETIC™



**Model 6074**  
Mesh Back Chair, Weight Sensing Synchro-tilter



**Model 6075**  
Upholstered Back Chair, Weight Sensing Synchro-tilter

MECHANISM OPTIONS:

Multi-tilter mechanism

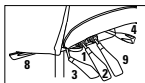

- ADJUSTMENTS**
- (1) Tilt tension
  - (2) Pneumatic seat height
  - (3) Back angle
  - (4) Seat angle
  - (8) Sliding seat depth
  - (9) Infinite position tilt lock

**Ergonomic features:**  
A, B, C, E, F, G, M, N, S

Task basic swivel mechanism

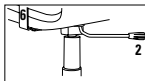

- ADJUSTMENTS**
- (2) Pneumatic seat height
  - (6) Back/lumbar height

**Ergonomic features:**  
C, M, N

Weight sensing synchro-tilter mechanism

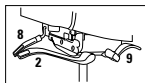

- ADJUSTMENTS**
- Weight sensing auto tension adjustment
  - (2) Pneumatic seat height back/lumbar height
  - (8) Sliding seat depth
  - (9) Multi position tilt lock

**Ergonomic features:**  
B, C, E, L, M, N

Stitch detail on coated textile and leather upholstered seats



STANDARD FEATURES

- Noetic is a thoughtful ergonomic task chair designed to inspire each individual's best work.
- Task chairs are available with three different mechanisms: task basic swivel, multi-tilter and weight-sensing synchro-tilter. Height adjustable stools are available with task basic swivel mechanism only.
- Chairs are available in four frame colors: Black, Shadow, Cloud and Fog (see upcharges).
- Mesh back models are available with either Digital Mesh (6 colors) or Dimension Mesh (7 colors).
- Upholstered back models have a front textile (select from available approved textiles). The outer back is Dimension Mesh which coordinates with the selected frame color (BLK frame - DBK mesh; SHW frame - DGM mesh; FOG frame - DST mesh; IVC Frame - DCL Mesh).
- Task chairs with multi-tilter and weight sensing synchro-tilter mechanisms are standard with a 2.5" adjustable sliding seat depth.
- Arm and armless models are available. Models with arms are standard with fixed, P-style arms. Adjustable height arms with either (2D) arms with front/back sliding armcap or (4D) arms with front/ back/side sliding and rotating armcaps are available, see upcharges. Black and Shadow frames receive color matching arms and armcaps. Cloud frames receive color matching arms with Fog armcaps. Fog frame height adjustable arms match the frame with Shadow armcap, height control button and accent trim.
- An adjustable lumbar support is available on mesh back models, see upcharge. Lumbar adjusts up/ down and coordinates with frame finish (Black with BLK; Cloud with IVC; Shadow with SHW and FOG).
- All models are available with a color matching nylon five prong base or chrome base (with upcharge).
- Casters are available for carpet (type C82) or hard surface flooring (type C82R, see upcharge) and coordinate with base finish. Black or Shadow bases have Black casters. Cloud and Fog bases have Fog casters. Aluminum bases receive Black casters.
- Upholstery options: fabric, coated textile or leather. Coated textiles and leather seats will include perimeter stitch detail.
- To calculate pricing for mesh back models, start with the model base price and add the appropriate seat textile grade upcharge.
- For upholstered back models, two textiles (inside back and seat textiles) may be selected. For pricing, start with the model base price shown and add the appropriate grade upcharges for the inside back textile and the seat textile. The Blended Textile Matrix does not apply to this series.
- Weight capacity is 300 lbs.





OPTIONAL FEATURES





Please add option codes in the following order:





- **Model number**  
Specify model number
- **Mesh Finish** (mesh back models)  
(D50) Digital Mesh Red  
(D51) Digital Mesh Blue  
(D52) Digital Mesh Navy  
(D53) Digital Mesh Shadow  
(D54) Digital Mesh Fog  
(D55) Digital Mesh Black  
(DBK) Dimension Mesh Black  
(DST) Dimension Mesh Fog  
(DCL) Dimension Mesh Chalk  
(DGM) Dimension Mesh Shadow  
(DCH) Dimension Mesh Charcoal  
(DSD) Dimension Mesh Sand  
(DPB) Dimension Mesh Pool Blue
- **Inside back textile** (upholstered back models, outer back mesh matches frame finish). Specify textile code. See model grade upcharges.
- **Seat textile**  
Specify textile code. See model grade upcharges.
- **Frame finish**  
(BLK) Black  
(SHW) Shadow. Add \$81  
(FOG) Fog. Add \$81  
(IVC) Cloud. Add \$81
- **Arm Type** (armed models only, see notes for color matching)  
(FP) Fixed P Arm. No charge.  
(2D) Height adjustable with depth sliding armcap. Add \$50.  
(4D) Height adjustable with width, depth and rotating sliding armcap. Add \$70.
- **Base type**  
(B7) Nylon base (color matches frame).  
(A7) Polished aluminum base. Add \$177
- **Caster type**  
(C82) 2.5" casters for carpet  
(C82R) 2.5" casters for most hard surfaces. Add \$100
- **Lumbar** (mesh back models)  
(NAL) No lumbar  
(ADL) Adjustable lumbar. Add \$51
- **Moisture Barrier** (seat)  
(NB) No moisture barrier  
(MB) Moisture barrier. Add \$107

EXAMPLE NOETIC ORDER CODE:

6074	DBK	FU75	BLK	2D	B7	C82	ADL	NB
Model	Mesh Finish	Textile	Frame Finish	Arm Type	Base Type	Caster Type	Lumbar	Moisture Barrier

DESCRIPTION	MODEL#/ FEATURES	STANDARD TEXTILE GRADES											
		1/COM	2	3	4	5	6	7	8	9	10	11	12
 <p><b>Mesh Back Chair, Multi-tilter</b> COM Yardage: Seat: 0.75 Freight Class: 150 Product Weight (lbs.): 60 Cubic Feet Per Carton: 10.5</p>	<p><b>6070</b> Base Price: \$945 Seat upcharge: +0</p>												
		<b>OVERALL DIMENSIONS</b>			<b>SEAT DIMENSIONS</b>			<b>BACK DIMENSIONS</b>					
		<b>W</b>	<b>D</b>	<b>H</b>	<b>W</b>	<b>D</b>	<b>H</b>	<b>W</b>	<b>H</b>				
		26	24	41.5	20	17.5	17.5 - 21.5	16	22				
		<b>RTA 2</b> 1 per carton											
 <p><b>Armless Mesh Back Chair, Multi-tilter</b> COM Yardage: Seat: 0.75 Freight Class: 150 Product Weight (lbs.): 55 Cubic Feet Per Carton: 10.5</p>	<p><b>6070NA</b> Base Price: \$862 Seat upcharge: +0</p>												
		<b>OVERALL DIMENSIONS</b>			<b>SEAT DIMENSIONS</b>			<b>BACK DIMENSIONS</b>					
		<b>W</b>	<b>D</b>	<b>H</b>	<b>W</b>	<b>D</b>	<b>H</b>	<b>W</b>	<b>H</b>				
		20	24	41.5	20	17.5	17.5 - 21.5	16	22				
		<b>RTA 2</b> 1 per carton											
 <p><b>Upholstered Back Chair, Multi-tilter</b> COM Yardage: Back: .75 ; Seat: .75 Freight Class: 150 Product Weight (lbs.): 60 Cubic Feet Per Carton: 10.5</p>	<p><b>6071</b> Base Price: \$1132 Back upcharge: +0 Seat upcharge: +0</p>												
		<b>OVERALL DIMENSIONS</b>			<b>SEAT DIMENSIONS</b>			<b>BACK DIMENSIONS</b>					
		<b>W</b>	<b>D</b>	<b>H</b>	<b>W</b>	<b>D</b>	<b>H</b>	<b>W</b>	<b>H</b>				
		26	24	41.5	20	18.5	17.5 - 21.5	16	21				
		<b>RTA 2</b> 1 per carton											
 <p><b>Armless Upholstered Back Chair, Multi-tilter</b> COM Yardage: Back: .75 ; Seat: .75 Freight Class: 150 Product Weight (lbs.): 55 Cubic Feet Per Carton: 10.5</p>	<p><b>6071NA</b> Base Price: \$1052 Back upcharge: +0 Seat upcharge: +0</p>												
		<b>OVERALL DIMENSIONS</b>			<b>SEAT DIMENSIONS</b>			<b>BACK DIMENSIONS</b>					
		<b>W</b>	<b>D</b>	<b>H</b>	<b>W</b>	<b>D</b>	<b>H</b>	<b>W</b>	<b>H</b>				
		20	24	41.5	20	17	17.5 - 21	16	21				
		<b>RTA 2</b> 1 per carton											
 <p><b>Mesh Back Chair, Task Basic Swivel</b> COM Yardage: Seat: 0.75 Freight Class: 150 Product Weight (lbs.): 44 Cubic Feet Per Carton: 10.5</p>	<p><b>6072</b> Base Price: \$861 Seat upcharge: +0</p>												
		<b>OVERALL DIMENSIONS</b>			<b>SEAT DIMENSIONS</b>			<b>BACK DIMENSIONS</b>					
		<b>W</b>	<b>D</b>	<b>H</b>	<b>W</b>	<b>D</b>	<b>H</b>	<b>W</b>	<b>H</b>				
		26	24	41.25	20	17	16.25 - 20.25	16	21				
		<b>RTA 2</b> 1 per carton											

DESCRIPTION	MODEL#/ FEATURES	STANDARD TEXTILE GRADES												
		1/COM	2	3	4	5	6	7	8	9	10	11	12	
 <p><b>Armless Mesh Back Chair, Task Basic Swivel</b> COM Yardage: Seat: 0.75 Freight Class: 250 Product Weight (lbs.): 39.5 Cubic Feet Per Carton: 10.5</p>	6072NA	Base Price:	\$782											
	Seat upcharge:	+0	\$26	\$46	\$75	\$117	\$133	\$169	\$225	\$267	\$314	\$409	\$510	
		OVERALL DIMENSIONS			SEAT DIMENSIONS			BACK DIMENSIONS						
		W	D	H	W	D	H	W	H					
		20	24	41.25	20	17	16.25 - 20.25	16	21					
		<div style="text-align: center;"><b>RTA 2</b> 1 per carton</div>												
 <p><b>Upholstered Back Chair, Task Basic Swivel</b> COM Yardage: Back: .75 ; Seat: .75 Freight Class: 150 Product Weight (lbs.): 44 Cubic Feet Per Carton: 10.5</p>	6073	Base Price:	\$1041											
	Back upcharge:	+0	\$26	\$46	\$75	\$117	\$133	\$169	\$225	\$267	\$314	\$409	\$510	
	Seat upcharge:	+0	\$26	\$46	\$75	\$117	\$133	\$169	\$225	\$267	\$314	\$409	\$510	
		OVERALL DIMENSIONS			SEAT DIMENSIONS			BACK DIMENSIONS						
		W	D	H	W	D	H	W	H					
	26	24	41.25	20	17	16.25 - 20.25	16	21						
		<div style="text-align: center;"><b>RTA 2</b> 1 per carton</div>												
 <p><b>Armless Upholstered Back Chair, Task Basic Swivel</b> COM Yardage: Back: .75 ; Seat: .75 Freight Class: 250 Product Weight (lbs.): 39.5 Cubic Feet Per Carton: 10.5</p>	6073NA	Base Price:	\$980											
	Back upcharge:	+0	\$26	\$46	\$75	\$117	\$133	\$169	\$225	\$267	\$314	\$409	\$510	
	Seat upcharge:	+0	\$26	\$46	\$75	\$117	\$133	\$169	\$225	\$267	\$314	\$409	\$510	
		OVERALL DIMENSIONS			SEAT DIMENSIONS			BACK DIMENSIONS						
		W	D	H	W	D	H	W	H					
	20	24	41.25	20	17	16.25 - 20.25	16	21						
		<div style="text-align: center;"><b>RTA 2</b> 1 per carton</div>												
 <p><b>Mesh Back Chair, Weight Sensing Synchro-tilter</b> COM Yardage: Seat: 0.75 Freight Class: 150 Product Weight (lbs.): 45.5 Cubic Feet Per Carton: 10.5</p>	6074	Base Price:	\$915											
	Seat upcharge:	+0	\$26	\$46	\$75	\$117	\$133	\$169	\$225	\$267	\$314	\$409	\$510	
		OVERALL DIMENSIONS			SEAT DIMENSIONS			BACK DIMENSIONS						
		W	D	H	W	D	H	W	H					
		26	24	40	20	17.5	17 - 21	16	21					
		<div style="text-align: center;"><b>RTA 2</b> 1 per carton</div>												
 <p><b>Armless Mesh Back Chair, Weight Sensing Synchro-tilter</b> COM Yardage: Seat: 0.75 Freight Class: 150 Product Weight (lbs.): 54 Cubic Feet Per Carton: 10.5</p>	6074NA	Base Price:	\$842											
	Seat upcharge:	+0	\$26	\$46	\$75	\$117	\$133	\$169	\$225	\$267	\$314	\$409	\$510	
		OVERALL DIMENSIONS			SEAT DIMENSIONS			BACK DIMENSIONS						
		W	D	H	W	D	H	W	H					
		20	24	40	20	17.5	17 - 21	16	21					
		<div style="text-align: center;"><b>RTA 2</b> 1 per carton</div>												

DESCRIPTION	MODEL#/ FEATURES	STANDARD TEXTILE GRADES											
		1/COM	2	3	4	5	6	7	8	9	10	11	12
 <p><b>Upholstered Back Chair, Weight Sensing Synchro-tilter</b> COM Yardage: Back: .75 ; Seat: .75 Freight Class: 150 Product Weight (lbs.): 44.5 Cubic Feet Per Carton: 10.5</p>	<b>6075</b>	Base Price:	\$1096										
		Back upcharge:	+0	\$26	\$46	\$75	\$117	\$133	\$169	\$225	\$267	\$314	\$409
	Seat upcharge:	+0	\$26	\$46	\$75	\$117	\$133	\$169	\$225	\$267	\$314	\$409	\$510
	<b>OVERALL DIMENSIONS</b>			<b>SEAT DIMENSIONS</b>			<b>BACK DIMENSIONS</b>						
	W D H			W D H			W H						
	26 24 40			20 17.5 17 - 21			16 21						
<b>RTA 2</b> 1 per carton													
 <p><b>Armless Upholstered Back Chair, Weight Sensing Synchro-tilter</b> COM Yardage: Back: .75 ; Seat: .75 Freight Class: 150 Product Weight (lbs.): 54 Cubic Feet Per Carton: 10.5</p>	<b>6075NA</b>	Base Price:	\$1039										
		Back upcharge:	+0	\$26	\$46	\$75	\$117	\$133	\$169	\$225	\$267	\$314	\$409
	Seat upcharge:	+0	\$26	\$46	\$75	\$117	\$133	\$169	\$225	\$267	\$314	\$409	\$510
	<b>OVERALL DIMENSIONS</b>			<b>SEAT DIMENSIONS</b>			<b>BACK DIMENSIONS</b>						
	W D H			W D H			W H						
	20 24 40			20 17.5 17 - 21			16 21						
<b>RTA 2</b> 1 per carton													
 <p><b>Mesh Back Height Adjustable Stool</b> COM Yardage: Seat: 0.75 Freight Class: 150 Product Weight (lbs.): 49 Cubic Feet Per Carton: 10.5</p>	<b>6076</b>	Base Price:	\$1041										
		Seat upcharge:	+0	\$26	\$46	\$75	\$117	\$133	\$169	\$225	\$267	\$314	\$409
	<b>OVERALL DIMENSIONS</b>			<b>SEAT DIMENSIONS</b>			<b>BACK DIMENSIONS</b>						
	W D H			W D H			W H						
	26 24 51			20 17.5 25 - 35			16 21						
	<b>RTA 2</b> 1 per carton												
 <p><b>Armless Mesh Back Height Adjustable stool</b> COM Yardage: Seat: 0.75 Freight Class: 150 Product Weight (lbs.): 45 Cubic Feet Per Carton: 10.5</p>	<b>6076NA</b>	Base Price:	\$947										
		Seat upcharge:	+0	\$26	\$46	\$75	\$117	\$133	\$169	\$225	\$267	\$314	\$409
	<b>OVERALL DIMENSIONS</b>			<b>SEAT DIMENSIONS</b>			<b>BACK DIMENSIONS</b>						
	W D H			W D H			W H						
	20 24 51			20 17.5 25 - 35			16 21						
	<b>RTA 2</b> 1 per carton												
 <p><b>Upholstered Back Height Adjustable Stool</b> COM Yardage: Back: .75 ; Seat: .75 Freight Class: 150 Product Weight (lbs.): 49.5 Cubic Feet Per Carton: 10.5</p>	<b>6077</b>	Base Price:	\$1221										
		Back upcharge:	+0	\$26	\$46	\$75	\$117	\$133	\$169	\$225	\$267	\$314	\$409
	Seat upcharge:	+0	\$26	\$46	\$75	\$117	\$133	\$169	\$225	\$267	\$314	\$409	\$510
	<b>OVERALL DIMENSIONS</b>			<b>SEAT DIMENSIONS</b>			<b>BACK DIMENSIONS</b>						
	W D H			W D H			W H						
	26 24 51			20 17 25 - 35			16 21						
<b>RTA 2</b> 1 per carton													

DESCRIPTION	MODEL#/ FEATURES	STANDARD TEXTILE GRADES											
		1/COM	2	3	4	5	6	7	8	9	10	11	12
 <p><b>Armless Upholstered Back Height Adjustable Stool</b>                      COM Yardage: Back: .75 ; Seat: .75                      Freight Class: 150                      Product Weight (lbs.): 46                      Cubic Feet Per Carton: 10.5</p>	<b>6077NA</b>	Base Price:	\$1138										
	Back upcharge:	<b>+0</b>	<b>\$26</b>	<b>\$46</b>	<b>\$75</b>	<b>\$117</b>	<b>\$133</b>	<b>\$169</b>	<b>\$225</b>	<b>\$267</b>	<b>\$314</b>	<b>\$409</b>	<b>\$510</b>
	Seat upcharge:	<b>+0</b>	<b>\$26</b>	<b>\$46</b>	<b>\$75</b>	<b>\$117</b>	<b>\$133</b>	<b>\$169</b>	<b>\$225</b>	<b>\$267</b>	<b>\$314</b>	<b>\$409</b>	<b>\$510</b>
	<b>OVERALL DIMENSIONS</b>			<b>SEAT DIMENSIONS</b>			<b>BACK DIMENSIONS</b>						
	<b>W</b>	<b>D</b>	<b>H</b>	<b>W</b>	<b>D</b>	<b>H</b>	<b>W</b>	<b>H</b>					
20	24	51	20	17	25 - 35	16	21						
			<b>RTA 2</b>		1 per carton								

## NOVELLO



Novello is offered in three frame finishes: Black, Fog and Ivory Cloud.



Model 6402PB

### STANDARD MECHANISMS

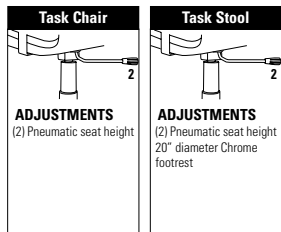

Ergonomic Features:  
C, M

Ergonomic Features:  
C, M

### STANDARD FEATURES

- A revolutionary new task chair that can go anywhere - it requires no adjustments and provides exceptional comfort for any size user.
- Novello features a special polymer shell that flexes, allowing the seat to glide smoothly on a concealed track system. It is strong and durable, with clean lines and offers effective support.
- Chairs are molded with one-piece flexible shells; available in Black (BK), Fog (FG) or Cloud (IC). Black is the base list price.
- Chairs with Black shells are standard with five prong, injection molded, fiberglass reinforced nylon Black base (B5) with (C82) dual wheel carpet casters.
- Chairs with Fog or Cloud shells are standard with a five prong, polished cast aluminum base with Black accents (BA) and black (C82) dual wheel carpet casters.
- Fog and Cloud chairs and Black models with an aluminum base come with a chrome gas cylinder.
- All models with arms are standard with Black armcaps.
- Standard with Global's high quality Soft Descent™ pneumatic lift which slowly and gently lowers the seat height of the chair making it easy to obtain the exact seat height you desire.
- Check textile availability prior to specifying upholstery material.
- Pedestal base models are offered on with Tilter mechanisms only. These models provide fixed location seating for use in auditoriums, classrooms, jury boxes, public venues and more. The base must be mounted to the floor (mounting hardware not included). See Pedestal Base Installation Guide for details.

### OPTIONAL FEATURES

- There are no arm options for this series.
- For Additional caster options, please refer to the Arm and Caster section.
- Optional casters may be priced higher than the standard casters for your chair and the difference will be charged. Lower priced optional casters will not be credited.
- Please refer to "Cylinder Selection" section of the price book for additional cylinder options.
- Pedestal Base models have black bases with 2" height adjust cylinders. Specify (SCC) swivel, auto return to max height (no upcharge); (SN) non-swivel, auto return to max height (Add \$23); or (SC) swivel, self-centering and return to max height (Add \$35).











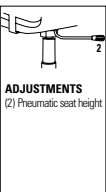



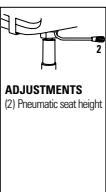



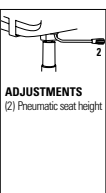

### OPTION CODES

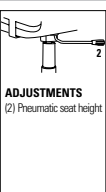

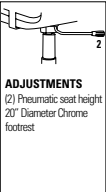

Please Add option codes in the following order:

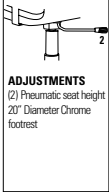

- **Model Number**
  - 6400 Chair with arms
  - 6401 Chair, armless
  - 6402 Chair with arms, fully upholstered
  - 6403 Chair, armless, fully upholstered
  - 6410 Stool with arms
  - 6411 Stool, armless
  - 6412 Stool with arms, fully upholstered
  - 6413 Stool, armless, fully upholstered
- **Fabric**  
Specify fabric code
- **Shell/arm color**
  - (BK) Black shell ..... **No Upcharge**
  - (FG) Fog shell ..... **Add \$36**
  - (IC) Cloud shell ..... **Add \$36**
- **Armcaps (No Upcharge)**
  - (BP) Black self-skinned urethane.
  - (FP) Fog self-skinned urethane.
  - (CP) Cloud self-skinned urethane.
- **Base**
  - (BB5) Black nylon base ..... **No Upcharge**
  - (FB5) Fog nylon base ..... **Add \$50**
  - (CB5) Cloud nylon base ..... **Add \$50**
  - (BBA) Polished aluminum w/Black accent ..... **Add \$81**
  - (FBA) Polished aluminum w/Fog accent ..... **Add \$81**
  - (CBA) Polished aluminum w/Cloud accent ..... **Add \$81**
- **Adjustable Footring (stool models)**
  - (R3) Black footring ..... **No Upcharge**
- **Casters**
  - (C82) Black dual wheel carpet casters ..... **No Upcharge**
  - (C82R) Black dual wheel hard floor casters ..... **Add \$104**
  - (C82F) Fog dual wheel carpet casters ..... **No Upcharge**
  - (C82FR) Fog dual wheel hard floor casters ..... **Add \$104**
- **Seat foam**
  - (SF) Standard foam ..... **No Upcharge**
  - (PF) Extra plush cushion ..... **No Upcharge**
- **Chair Assembly**
  - (SU) Assembled in Box ..... **\$81**
- **Cylinder (for Pedestal Base)**
  - (SH) Swivel, auto return turn to max height
  - (SN) Non-swivel, auto return turn to max height. **Add \$23**
  - (SC) Swivel, self-centering and return to max height. **Add \$35**

### EXAMPLE OF ORDER CODE:

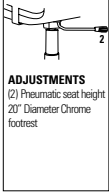
6400BK	WA50	EG	BK	AL	R3	C9R	SU
Model Number	Fabric	Shell/Arms	Armcaps	Base	Footring	Casters	Chair Assembly

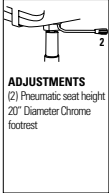
DESCRIPTION	FEATURES	MODEL#	STANDARD TEXTILE GRADES											
			1	2	3	4	5	6	7	8	9	10	11	12
 <p><b>Task Chair w/Arms</b> COM Yardage: 0.75 Freight Class: 150 Product Weight (lbs.): 40 Cubic Feet Per Carton: 8.25</p>	 <p><b>ADJUSTMENTS</b> (2) Pneumatic seat height</p>	<b>6400</b>	1060	1096	1122	1158	1210	1228	1277	1363	1405	1487	1595	1734
			<b>OVERALL DIMENSIONS</b>			<b>SEAT DIMENSIONS</b>			<b>BACK DIMENSIONS</b>					
			<b>W</b>	<b>D</b>	<b>H</b>	<b>W</b>	<b>D</b>	<b>H</b>	<b>W</b>	<b>H</b>				
			25	22	36	18.5	18	16.5-21.5	20.5	18.5				
			  											
 <p><b>Armless Task Chair</b> COM Yardage: 0.75 Freight Class: 150 Product Weight (lbs.): 35 Cubic Feet Per Carton: 6.75</p>	 <p><b>ADJUSTMENTS</b> (2) Pneumatic seat height</p>	<b>6401</b>	959	995	1019	1053	1104	1127	1176	1248	1304	1368	1495	1635
			<b>OVERALL DIMENSIONS</b>			<b>SEAT DIMENSIONS</b>			<b>BACK DIMENSIONS</b>					
			<b>W</b>	<b>D</b>	<b>H</b>	<b>W</b>	<b>D</b>	<b>H</b>	<b>W</b>	<b>H</b>				
			21.5	22	36	18.5	18	16.5-21.5	20.5	18.5				
			  											
 <p><b>Task Chair w/Arms</b> COM Yardage: 0.75 Freight Class: 150 Product Weight (lbs.): 40 Cubic Feet Per Carton: 8.25</p>	 <p><b>ADJUSTMENTS</b> (2) Pneumatic seat height</p>	<b>6402</b>	1145	1180	1205	1239	1290	1313	1362	1434	1490	1554	1681	1821
			<b>OVERALL DIMENSIONS</b>			<b>SEAT DIMENSIONS</b>			<b>BACK DIMENSIONS</b>					
			<b>W</b>	<b>D</b>	<b>H</b>	<b>W</b>	<b>D</b>	<b>H</b>	<b>W</b>	<b>H</b>				
			25	22	36	18.5	17.5	16.5-21.5	20.5	18.5				
			  											
 <p><b>Armless Task Chair</b> COM Yardage: 0.75 Freight Class: 150 Product Weight (lbs.): 37 Cubic Feet Per Carton: 6.75</p>	 <p><b>ADJUSTMENTS</b> (2) Pneumatic seat height</p>	<b>6403</b>	1053	1090	1115	1148	1199	1222	1271	1343	1400	1463	1592	1730
			<b>OVERALL DIMENSIONS</b>			<b>SEAT DIMENSIONS</b>			<b>BACK DIMENSIONS</b>					
			<b>W</b>	<b>D</b>	<b>H</b>	<b>W</b>	<b>D</b>	<b>H</b>	<b>W</b>	<b>H</b>				
			21.5	22	36	18.5	17.5	16.5-21.5	20.5	18.5				
			  											
 <p><b>Task Stool w/Arms</b> COM Yardage: 0.75 Freight Class: 150 Product Weight (lbs.): 44 Cubic Feet Per Carton: 8.25</p>	 <p><b>ADJUSTMENTS</b> (2) Pneumatic seat height 20" Diameter Chrome footrest</p>	<b>6410</b>	1217	1254	1279	1312	1363	1386	1435	1507	1564	1627	1756	1894
			<b>OVERALL DIMENSIONS</b>			<b>SEAT DIMENSIONS</b>			<b>BACK DIMENSIONS</b>					
			<b>W</b>	<b>D</b>	<b>H</b>	<b>W</b>	<b>D</b>	<b>H</b>	<b>W</b>	<b>H</b>				
			25	22	46	18.5	18	24-34	20.5	18.5				
			  											

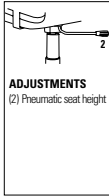
DESCRIPTION	FEATURES	MODEL#	STANDARD TEXTILE GRADES													
			1	2	3	4	5	6	7	8	9	10	11	12		
 <p><b>Armless Task Stool</b> COM Yardage: 0.75 Freight Class: 150 Product Weight (lbs.): 39 Cubic Feet Per Carton: 8.25</p>	 <p><b>ADJUSTMENTS</b> (2) Pneumatic seat height 20" Diameter Chrome footrest</p> <p>Upholstered seat/ Polypropylene back</p> <p>Ergonomic Features: C, M</p>	<b>6411</b>	1115	1151	1175	1209	1260	1283	1332	1404	1460	1524	1651	1791		
		<b>OVERALL DIMENSIONS</b>			<b>SEAT DIMENSIONS</b>			<b>BACK DIMENSIONS</b>								
		<b>W</b>	<b>D</b>	<b>H</b>	<b>W</b>	<b>D</b>	<b>H</b>	<b>W</b>	<b>H</b>							
		25	21.5	46	18.5	17.5	24-34	20.5	18.5							
			<b>RTA 2</b>	<b>FedEx</b>	<b>ups</b>											
 <p><b>Task Stool w/Arms</b> COM Yardage: 0.75 Freight Class: 150 Product Weight (lbs.): 46 Cubic Feet Per Carton: 8.25</p>	 <p><b>ADJUSTMENTS</b> (2) Pneumatic seat height 20" Diameter Chrome footrest</p> <p>Upholstered seat &amp; back</p> <p>Ergonomic Features: C, M</p>	<b>6412</b>	1302	1338	1364	1400	1452	1470	1519	1605	1644	1728	1837	1976		
		<b>OVERALL DIMENSIONS</b>			<b>SEAT DIMENSIONS</b>			<b>BACK DIMENSIONS</b>								
		<b>W</b>	<b>D</b>	<b>H</b>	<b>W</b>	<b>D</b>	<b>H</b>	<b>W</b>	<b>H</b>							
		25	22	46	18.5	18	24-34	20.5	18.5							
			<b>RTA 2</b>	<b>FedEx</b>	<b>ups</b>											
 <p><b>Armless Task Stool</b> COM Yardage: 0.75 Freight Class: 150 Product Weight (lbs.): 39 Cubic Feet Per Carton: 8.25</p>	 <p><b>ADJUSTMENTS</b> (2) Pneumatic seat height 20" Diameter Chrome footrest</p> <p>Upholstered seat &amp; back</p> <p>Ergonomic Features: C, M</p>	<b>6413</b>	1201	1237	1261	1295	1346	1369	1418	1490	1546	1610	1737	1877		
		<b>OVERALL DIMENSIONS</b>			<b>SEAT DIMENSIONS</b>			<b>BACK DIMENSIONS</b>								
		<b>W</b>	<b>D</b>	<b>H</b>	<b>W</b>	<b>D</b>	<b>H</b>	<b>W</b>	<b>H</b>							
		25	21.5	46	18.5	18	24-34	20.5	18.5							
			<b>RTA 2</b>	<b>FedEx</b>	<b>ups</b>											

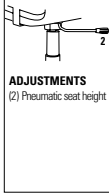
DESCRIPTION	FEATURES	MODEL#	STANDARD TEXTILE GRADES											
			1	2	3	4	5	6	7	8	9	10	11	12
 <p><b>Task Chair w/Arms with Pedestal Base</b>                      COM Yardage: 0.75                      Freight Class: 150                      Product Weight (lbs.): 44                      Cubic Feet Per Carton: 8.25</p>	 <p><b>ADJUSTMENTS</b>                      (2) Pneumatic seat height</p>	<b>6402PB</b>	1390	1418	1440	1470	1515	1535	1575	1638	1687	1742	1853	1972
			<b>OVERALL DIMENSIONS</b>			<b>SEAT DIMENSIONS</b>			<b>BACK DIMENSIONS</b>					
			<b>W</b>	<b>D</b>	<b>H</b>	<b>W</b>	<b>D</b>	<b>H</b>	<b>W</b>	<b>H</b>				
			25	22	34	18.5	17.5	16.5-21.5	20.5	18.5				
			<b>RTA 2</b>	<b>FedEx</b>	<b>UPS</b>									
 <p><b>Armless Task Chair</b>                      COM Yardage: 0.75                      Freight Class: 125                      Product Weight (lbs.): 41                      Cubic Feet Per Carton: 6.75</p>	 <p><b>ADJUSTMENTS</b>                      (2) Pneumatic seat height</p>	<b>6403PB</b>	1298	1326	1348	1379	1423	1444	1485	1547	1596	1651	1764	1882
			<b>OVERALL DIMENSIONS</b>			<b>SEAT DIMENSIONS</b>			<b>BACK DIMENSIONS</b>					
			<b>W</b>	<b>D</b>	<b>H</b>	<b>W</b>	<b>D</b>	<b>H</b>	<b>W</b>	<b>H</b>				
			21.5	22	34	18.5	17.5	16.5-21.5	20.5	18.5				
			<b>RTA 2</b>	<b>FedEx</b>	<b>UPS</b>									

OBUSFORME® COMFORT



model 1240-3



model 1241-3



**Memory Foam**  
Available, use code "MF" and Add \$124.



model 1261-3







STANDARD FEATURES



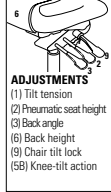

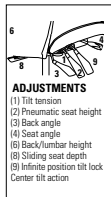

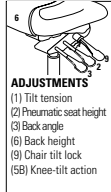



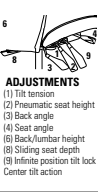





- ObusForme Comfort is recommended by chiropractors worldwide.
- Features a new elastomeric back support system that provides impressive, comfortable support with no pressure points along the spine.
- Height, width and depth adjustable (**G3**) arms with self-skinned urethane (SSU) arm pads. Armcaps articulate inwards 30°
- Five prong, injection molded, fiberglass reinforced nylon Black spider base with dual wheel carpet casters (**C65**).
- Standard seat foam is a dual cushion with a soft top layer and a firmly supportive lower layer.
- Side activated sliding seat depth adjustment is standard on multi-tilters.
- Schukra™ depth adjustable lumbar support for personalized back support and comfort is standard on select models.
- Vari-Width (**WA**) width adjustable arm extensions are standard when chair is ordered with adjustable arms. Allows the arms to move away from the seat by 2" on each side to allow space if desired for broader hip widths.
- All models are shipped partially KD.
- Check textile availability prior to specifying upholstery material.

- "P" petite seat models have a seat that is 0.75" shallower and 1.5" narrower than the standard seat.
- Petite seats have the same list prices as standard models.

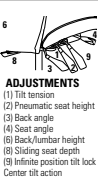
OPTIONAL FEATURES

- Optional Memory Foam (**MF**) seats are available. This slow release foam molds to your contour and evenly distributes body weight. Please specify. Add \$124.
- An optional Polished Aluminum base with scuff resistant tips is available. Please specify (**ALU**). Add \$177
- Please refer to the "Casters Selection" section of the price book for caster options. Optional casters may be priced higher than the standard casters for your chair and the difference will be charged. Lower priced optional casters will not be credited.
- Please refer to "Cylinder Selection" section of the price book for additional cylinder options.
- Please specify **C65R** for hard surface flooring. Add \$78
- For fully assembled in box, please **SU**. Add \$81.

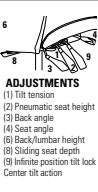
DESCRIPTION	FEATURES	MODEL#	STANDARD TEXTILE GRADES											
			1	2	3	4	5	6	7	8	9	10	11	12
 <p><b>HB Knee - Tilter</b> COM Yardage: 2.25 Freight Class: 125 Product Weight (lbs.): 67 Cubic Feet Per Carton: 11</p>	 <p><b>ADJUSTMENTS</b> (1) Tilt tension (2) Pneumatic seat height (3) Back angle (6) Back height (9) Chair tilt lock (5B) Knee-tilt action</p>	<b>1240-2</b>	\$1527	\$1625	\$1698	\$1808	\$1966	\$2024	\$2163	\$2426	\$2551	\$2795	\$3128	\$3540
		<b>OVERALL DIMENSIONS</b>			<b>SEAT DIMENSIONS</b>			<b>BACK DIMENSIONS</b>						
		<b>W</b>	<b>D</b>	<b>H</b>	<b>W</b>	<b>D</b>	<b>H</b>	<b>W</b>	<b>H</b>					
		26	25	48.5	21	17.5-20	16.5-20.5	19	27.5					
														
 <p><b>HB Multi - Tilter</b> COM Yardage: 2.25 Freight Class: 125 Product Weight (lbs.): 69 Cubic Feet Per Carton: 11</p>	 <p><b>ADJUSTMENTS</b> (1) Tilt tension (2) Pneumatic seat height (3) Back angle (4) Seat angle (6) Back/lumbar height (8) Sliding seat depth (9) Infinite position tilt lock Center tilt action</p>	<b>1240-3</b>	\$1304	\$1402	\$1475	\$1585	\$1743	\$1801	\$1940	\$2203	\$2328	\$2572	\$2905	\$3317
		<b>OVERALL DIMENSIONS</b>			<b>SEAT DIMENSIONS</b>			<b>BACK DIMENSIONS</b>						
		<b>W</b>	<b>D</b>	<b>H</b>	<b>W</b>	<b>D</b>	<b>H</b>	<b>W</b>	<b>H</b>					
		26	25	48	21	17.5-20	16-20	19	27					
														
 <p><b>MB Knee - Tilter</b> COM Yardage: 2 Freight Class: 125 Product Weight (lbs.): 67 Cubic Feet Per Carton: 10.5</p>	 <p><b>ADJUSTMENTS</b> (1) Tilt tension (2) Pneumatic seat height (3) Back angle (6) Back height (9) Chair tilt lock (5B) Knee-tilt action</p>	<b>1241-2</b>	\$1463	\$1547	\$1615	\$1712	\$1853	\$1903	\$2025	\$2259	\$2372	\$2587	\$2881	\$3251
		<b>OVERALL DIMENSIONS</b>			<b>SEAT DIMENSIONS</b>			<b>BACK DIMENSIONS</b>						
		<b>W</b>	<b>D</b>	<b>H</b>	<b>W</b>	<b>D</b>	<b>H</b>	<b>W</b>	<b>H</b>					
		26	25	44.5	21	17.5-20	16.5-20.5	19.5	22-27.5					
														

DESCRIPTION	FEATURES	MODEL#	STANDARD TEXTILE GRADES																								
			1	2	3	4	5	6	7	8	9	10	11	12													
 <p><b>MB Multi -Tilter</b> COM Yardage: 2 Freight Class: 125 Product Weight (lbs.): 67 Cubic Feet Per Carton: 10.5</p>	 <p><b>ADJUSTMENTS</b> (1) Tilt tension (2) Pneumatic seat height (3) Back angle (4) Seat angle (5) Back/lumbar height (6) Sliding seat depth (7) Infinite position tilt lock Center tilt action</p>	<p>Ergonomic Features: A, B, C, D, E, F, G, H, M, N, Q, R, S, U</p>	<table border="1"> <tr> <td><b>1241-3</b></td> <td>\$1239</td><td>\$1323</td><td>\$1391</td><td>\$1488</td><td>\$1629</td><td>\$1679</td><td>\$1801</td><td>\$2035</td><td>\$2148</td><td>\$2363</td><td>\$2657</td><td>\$3027</td> </tr> </table>												<b>1241-3</b>	\$1239	\$1323	\$1391	\$1488	\$1629	\$1679	\$1801	\$2035	\$2148	\$2363	\$2657	\$3027
			<b>1241-3</b>	\$1239	\$1323	\$1391	\$1488	\$1629	\$1679	\$1801	\$2035	\$2148	\$2363	\$2657	\$3027												
			<b>OVERALL DIMENSIONS</b>			<b>SEAT DIMENSIONS</b>			<b>BACK DIMENSIONS</b>																		
			<b>W</b>	<b>D</b>	<b>H</b>	<b>W</b>	<b>D</b>	<b>H</b>	<b>W</b>	<b>D</b>	<b>H</b>	<b>W</b>	<b>H</b>														
26	25	44	21	17.5-20	16-20	19.5	22																				
			<p>RTA 2  </p>																								
 <p><b>Armless chair - Sled Base</b> COM Yardage: 1.75 Freight Class: 250 Product Weight (lbs.): 35 Cubic Feet Per Carton: 10</p>	<p>Ergonomic Features: M, N</p>	<table border="1"> <tr> <td><b>1246</b></td> <td>\$798</td><td>\$871</td><td>\$925</td><td>\$1005</td><td>\$1120</td><td>\$1159</td><td>\$1261</td><td>\$1449</td><td>\$1543</td><td>\$1721</td><td>\$1961</td><td>\$2261</td> </tr> </table>												<b>1246</b>	\$798	\$871	\$925	\$1005	\$1120	\$1159	\$1261	\$1449	\$1543	\$1721	\$1961	\$2261	
		<b>1246</b>	\$798	\$871	\$925	\$1005	\$1120	\$1159	\$1261	\$1449	\$1543	\$1721	\$1961	\$2261													
		<b>OVERALL DIMENSIONS</b>			<b>SEAT DIMENSIONS</b>			<b>BACK DIMENSIONS</b>																			
		<b>W</b>	<b>D</b>	<b>H</b>	<b>W</b>	<b>D</b>	<b>H</b>	<b>W</b>	<b>D</b>	<b>H</b>	<b>W</b>	<b>H</b>															
21	24	38	21	18	18	20	20.5																				
			<p>RTA 2  </p>																								
 <p><b>Armchair - Sled Base</b> COM Yardage: 1.75 Freight Class: 250 Product Weight (lbs.): 40 Cubic Feet Per Carton: 13</p>	<p>Ergonomic Features: M, N</p>	<table border="1"> <tr> <td><b>1247</b></td> <td>\$1050</td><td>\$1123</td><td>\$1177</td><td>\$1258</td><td>\$1372</td><td>\$1412</td><td>\$1513</td><td>\$1704</td><td>\$1795</td><td>\$1974</td><td>\$2214</td><td>\$2511</td> </tr> </table>												<b>1247</b>	\$1050	\$1123	\$1177	\$1258	\$1372	\$1412	\$1513	\$1704	\$1795	\$1974	\$2214	\$2511	
		<b>1247</b>	\$1050	\$1123	\$1177	\$1258	\$1372	\$1412	\$1513	\$1704	\$1795	\$1974	\$2214	\$2511													
		<b>OVERALL DIMENSIONS</b>			<b>SEAT DIMENSIONS</b>			<b>BACK DIMENSIONS</b>																			
		<b>W</b>	<b>D</b>	<b>H</b>	<b>W</b>	<b>D</b>	<b>H</b>	<b>W</b>	<b>D</b>	<b>H</b>	<b>W</b>	<b>H</b>															
26.5	24	38	21	18	18	20	20.5																				
			<p>RTA 2  </p>																								
 <p><b>HB Multi -Tilter w/Schukra</b> COM Yardage: 2.25 Freight Class: 125 Product Weight (lbs.): 69 Cubic Feet Per Carton: 11</p>	 <p><b>ADJUSTMENTS</b> (1) Tilt tension (2) Pneumatic seat height (3) Back angle (4) Seat angle (5) Back/lumbar height (6) Sliding seat depth (7) Infinite position tilt lock Center tilt action</p>	<p>Ergonomic Features: A, B, C, D, E, F, G, H, M, N, Q, R, S, U, V</p>	<table border="1"> <tr> <td><b>1260-3</b></td> <td>\$1476</td><td>\$1574</td><td>\$1647</td><td>\$1757</td><td>\$1915</td><td>\$1973</td><td>\$2112</td><td>\$2375</td><td>\$2500</td><td>\$2744</td><td>\$3077</td><td>\$3489</td> </tr> </table>												<b>1260-3</b>	\$1476	\$1574	\$1647	\$1757	\$1915	\$1973	\$2112	\$2375	\$2500	\$2744	\$3077	\$3489
			<b>1260-3</b>	\$1476	\$1574	\$1647	\$1757	\$1915	\$1973	\$2112	\$2375	\$2500	\$2744	\$3077	\$3489												
			<b>OVERALL DIMENSIONS</b>			<b>SEAT DIMENSIONS</b>			<b>BACK DIMENSIONS</b>																		
			<b>W</b>	<b>D</b>	<b>H</b>	<b>W</b>	<b>D</b>	<b>H</b>	<b>W</b>	<b>D</b>	<b>H</b>	<b>W</b>	<b>H</b>														
26	25	48	21	17.5-20	16-20	19.5	27-32.25																				
			<p>RTA 2  </p>																								
 <p><b>MB Multi -Tilter w/Schukra</b> COM Yardage: 2 Freight Class: 125 Product Weight (lbs.): 67 Cubic Feet Per Carton: 10.5</p>	 <p><b>ADJUSTMENTS</b> (1) Tilt tension (2) Pneumatic seat height (3) Back angle (4) Seat angle (5) Back/lumbar height (6) Sliding seat depth (7) Infinite position tilt lock Center tilt action</p>	<p>Ergonomic Features: A, B, C, D, E, F, G, H, M, N, Q</p>	<table border="1"> <tr> <td><b>1261-3</b></td> <td>\$1413</td><td>\$1501</td><td>\$1566</td><td>\$1665</td><td>\$1805</td><td>\$1853</td><td>\$1977</td><td>\$2210</td><td>\$2323</td><td>\$2541</td><td>\$2835</td><td>\$3203</td> </tr> </table>												<b>1261-3</b>	\$1413	\$1501	\$1566	\$1665	\$1805	\$1853	\$1977	\$2210	\$2323	\$2541	\$2835	\$3203
			<b>1261-3</b>	\$1413	\$1501	\$1566	\$1665	\$1805	\$1853	\$1977	\$2210	\$2323	\$2541	\$2835	\$3203												
			<b>OVERALL DIMENSIONS</b>			<b>SEAT DIMENSIONS</b>			<b>BACK DIMENSIONS</b>																		
			<b>W</b>	<b>D</b>	<b>H</b>	<b>W</b>	<b>D</b>	<b>H</b>	<b>W</b>	<b>D</b>	<b>H</b>	<b>W</b>	<b>H</b>														
26	25	44	21	17.5-20	16-20	19.5	22																				
			<p>RTA 2  </p>																								

OBUSFORME® COMFORT XL



STANDARD FEATURES

- ObusForme Comfort XL is the newest Addition to the ObusForme family and is recommended by chiropractors worldwide.
- All models provided Additional height and/or seat depth, design to meet the requirements of the large occupant chair.
- Features a elastomeric back support system that provides impressive comfortable support with no pressure points along the spine, with a compound curved back and seat.
- Standard seat foam is extra thick dual cushion with a soft top layer and a firmly supportive lower layer.
- Standard with height and width adjustable forward swept arms with "sliding armcaps" (G3).
- Standard with Global's high quality Soft Descent™ Pneumatic lift which slowly and gently lowers the seat height of the chair making it easy to obtain exactly the right seat height you desire.
- Vari - Width Adapter Plate (WA) is standard. Allows each arm to move outward an additional 2" (for a total of 4" extra seat width) and locks with the use of an easy to maneuver lever.
- Check textile availability prior to specifying.

- Sliding seat depth is standard on all models.
- Vertical back height ratchet adjustment of 5 1/4", standard on all models.
- Standard five-legged, injection moulded, fiberglass reinforced nylon black spider base.
- C65 dual wheel carpet casters are standard.
- All models are rated for 400lbs. Covered under Global's limited lifetime warranty. For 3-shift environments (TS models covered under Global's Heavy Duty, 12 year, 24/7 warranty) see terms and conditions.
- All models ship fully assembled in the box.







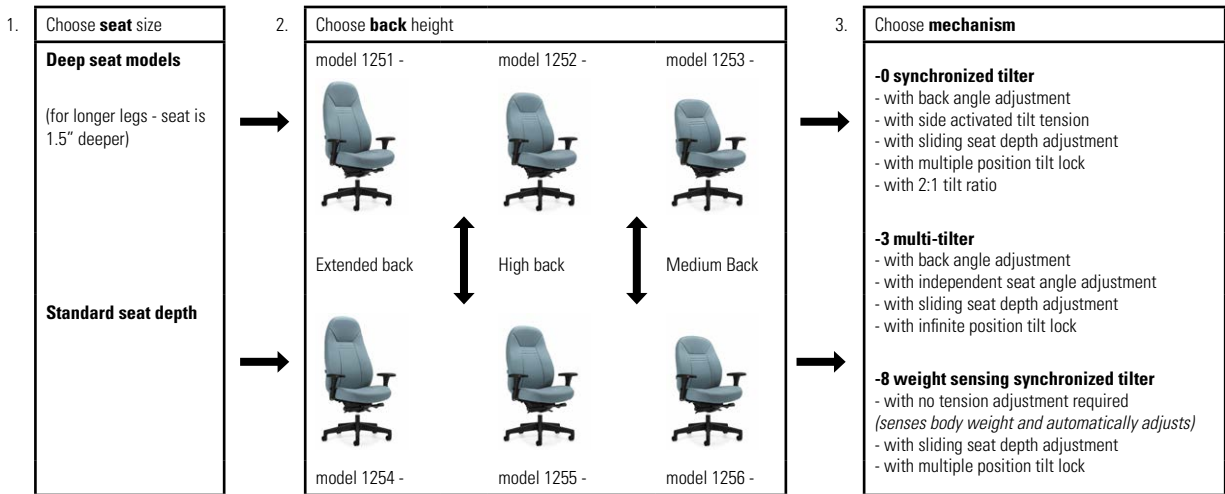

OPTIONAL FEATURES

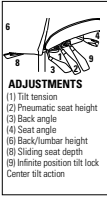

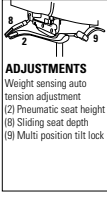

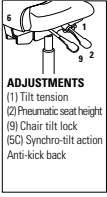

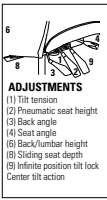

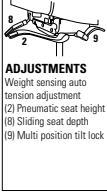
- Please specify C65R for hard surface flooring. Add \$78.

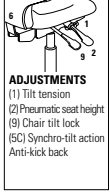

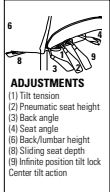

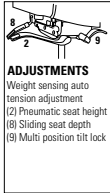

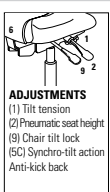

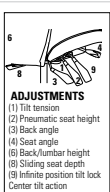
Big & Tall ObusForme Comfort XL: Product Map  
For users of above average height or weight

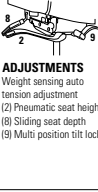

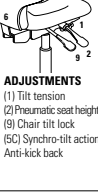

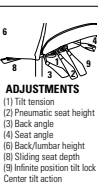
DESCRIPTION	FEATURES	MODEL#	STANDARD TEXTILE GRADES											
			1	2	3	4	5	6	7	8	9	10	11	12
 <b>Extended Back Synchro - Tilter w/ Back Angle Adj.</b> COM Yardage: 2.75 Freight Class: 250 Product Weight (lbs.): 69 Cubic Feet Per Carton: 24.25	 <b>ADJUSTMENTS</b> (1) Tilt tension (2) Pneumatic seat height (3) Chair tilt lock (5C) Synchro-tilt action Anti-kick back  Extra Tall/Wide Back. Wide/Deep Seat.  Ergonomic Features: A, B, C, D, E, G, H, L, M, N, O, R, U	1251-0	1997	2103	2182	2303	2475	2536	2685	2971	3108	3372	3735	4185
		<b>OVERALL DIMENSIONS</b> W D H			<b>SEAT DIMENSIONS</b> W D H			<b>BACK DIMENSIONS</b> W H						
			28	26	53	23.5	19-21.5	17-21	22	31-36.25				

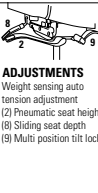
DESCRIPTION	FEATURES	MODEL#	STANDARD TEXTILE GRADES														
			1	2	3	4	5	6	7	8	9	10	11	12			
 <p><b>Extended Back Multi - Tilter</b> COM Yardage: 2.75 Freight Class: 250 Product Weight (lbs.): 71 Cubic Feet Per Carton: 24.25</p>	 <p><b>ADJUSTMENTS</b> (1) Tilt tension (2) Pneumatic seat height (3) Back angle (4) Seat angle (5) Back/lumbar height (6) Sliding seat depth (9) Infinite position tilt lock Center tilt action</p>	<p>1251-3</p>	1997	2103	2182	2303	2475	2536	2685	2971	3108	3372	3735	4185			
			<b>OVERALL DIMENSIONS</b>			<b>SEAT DIMENSIONS</b>			<b>BACK DIMENSIONS</b>								
			<b>W</b>	<b>D</b>	<b>H</b>	<b>W</b>	<b>D</b>	<b>H</b>	<b>W</b>	<b>H</b>							
			28	26	53	23.5	19-21.5	17-21	22	31-36.25							
			<b>RTA 00</b>														
 <p><b>Extended Back Weight Sensing Synchro - Tilter</b> COM Yardage: 2.75 Freight Class: 250 Product Weight (lbs.): 66 Cubic Feet Per Carton: 24.25</p>	 <p><b>ADJUSTMENTS</b> Weight sensing auto tension adjustment (2) Pneumatic seat height (6) Sliding seat depth (9) Multi position tilt lock</p>	<p>1251-8</p>	1997	2103	2182	2303	2475	2536	2685	2971	3108	3372	3735	4185			
			<b>OVERALL DIMENSIONS</b>			<b>SEAT DIMENSIONS</b>			<b>BACK DIMENSIONS</b>								
			<b>W</b>	<b>D</b>	<b>H</b>	<b>W</b>	<b>D</b>	<b>H</b>	<b>W</b>	<b>H</b>							
			28	26	53	23.5	19-21.5	17-21	22	31-36.25							
			<b>RTA 00</b>														
 <p><b>High Back Synchro - Tilter w/ Back Angle Adj.</b> COM Yardage: 2.50 Freight Class: 250 Product Weight (lbs.): 65 Cubic Feet Per Carton: 22.25</p>	 <p><b>ADJUSTMENTS</b> (1) Tilt tension (2) Pneumatic seat height (9) Chair tilt lock (5C) Synchro-tilt action Anti-kick back</p>	<p>1252-0</p>	1908	2003	2077	2187	2343	2398	2534	2794	2921	3161	3489	3897			
			<b>OVERALL DIMENSIONS</b>			<b>SEAT DIMENSIONS</b>			<b>BACK DIMENSIONS</b>								
			<b>W</b>	<b>D</b>	<b>H</b>	<b>W</b>	<b>D</b>	<b>H</b>	<b>W</b>	<b>H</b>							
			28	26	48.5	23.5	19-21.5	17-21	22	26.5-31.75							
			<b>RTA 00</b>														
 <p><b>High Back Multi - Tilter</b> COM Yardage: 2.50 Freight Class: 250 Product Weight (lbs.): 67 Cubic Feet Per Carton: 22.25</p>	 <p><b>ADJUSTMENTS</b> (1) Tilt tension (2) Pneumatic seat height (3) Back angle (4) Seat angle (5) Back/lumbar height (6) Sliding seat depth (9) Infinite position tilt lock Center tilt action</p>	<p>1252-3</p>	1908	2003	2077	2187	2343	2398	2534	2794	2921	3161	3489	3897			
			<b>OVERALL DIMENSIONS</b>			<b>SEAT DIMENSIONS</b>			<b>BACK DIMENSIONS</b>								
			<b>W</b>	<b>D</b>	<b>H</b>	<b>W</b>	<b>D</b>	<b>H</b>	<b>W</b>	<b>H</b>							
			28	26	48.5	23.5	19-21.5	17-21	22	26.5-31.75							
			<b>RTA 00</b>														
 <p><b>High Back Weight Sensing Synchro - Tilter</b> COM Yardage: 2.50 Freight Class: 250 Product Weight (lbs.): 62 Cubic Feet Per Carton: 22.25</p>	 <p><b>ADJUSTMENTS</b> Weight sensing auto tension adjustment (2) Pneumatic seat height (6) Sliding seat depth (9) Multi position tilt lock</p>	<p>1252-8</p>	1908	2003	2077	2187	2343	2398	2534	2794	2921	3161	3489	3897			
			<b>OVERALL DIMENSIONS</b>			<b>SEAT DIMENSIONS</b>			<b>BACK DIMENSIONS</b>								
			<b>W</b>	<b>D</b>	<b>H</b>	<b>W</b>	<b>D</b>	<b>H</b>	<b>W</b>	<b>H</b>							
			28	26	48.5	23.5	19-21.5	17-21	22	26.5-31.75							
			<b>RTA 00</b>														

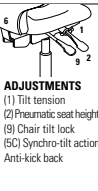
DESCRIPTION	FEATURES	MODEL#	STANDARD TEXTILE GRADES													
			1	2	3	4	5	6	7	8	9	10	11	12		
 <p><b>Mid Back Synchro - Tilter w/ Back Angle Adj.</b> COM Yardage: 1.75 Freight Class: 150 Product Weight (lbs.): 46 Cubic Feet Per Carton: 10.50</p>	 <p><b>ADJUSTMENTS</b> (1) Tilt tension (2) Pneumatic seat height (9) Chair tilt lock (5C) Synchro-tilt action Anti-kick back</p>	<b>1253-0</b>	1821	1916	1990	2100	2256	2311	2447	2707	2834	3074	3402	3810		
		<b>OVERALL DIMENSIONS</b>			<b>SEAT DIMENSIONS</b>			<b>BACK DIMENSIONS</b>								
		<b>W</b>	<b>D</b>	<b>H</b>	<b>W</b>	<b>D</b>	<b>H</b>	<b>W</b>	<b>H</b>							
	28	26	44.5	23.5	19-21.5	17-21	22	22-27.25								
				<b>RTA 00</b>												
 <p><b>Mid Back Multi - Tilter</b> COM Yardage: 1.75 Freight Class: 150 Product Weight (lbs.): 41 Cubic Feet Per Carton: 10.50</p>	 <p><b>ADJUSTMENTS</b> (1) Tilt tension (2) Pneumatic seat height (3) Back angle (4) Seat angle (6) Back/lumbar height (8) Sliding seat depth (9) Infinite position tilt lock Center tilt action</p>	<b>1253-3</b>	1821	1916	1990	2100	2256	2311	2447	2707	2834	3074	3402	3810		
		<b>OVERALL DIMENSIONS</b>			<b>SEAT DIMENSIONS</b>			<b>BACK DIMENSIONS</b>								
		<b>W</b>	<b>D</b>	<b>H</b>	<b>W</b>	<b>D</b>	<b>H</b>	<b>W</b>	<b>H</b>							
	28	26	44.5	23.5	19-21.5	17-21	22	22-27.25								
				<b>RTA 00</b>												
 <p><b>Mid Back Weight Sensing Synchro - Tilter</b> COM Yardage: 1.75 Freight Class: 150 Product Weight (lbs.): 35 Cubic Feet Per Carton: 10.50</p>	 <p><b>ADJUSTMENTS</b> Weight sensing auto tension adjustment (2) Pneumatic seat height (8) Sliding seat depth (9) Multi position tilt lock</p>	<b>1253-8</b>	1821	1916	1990	2100	2256	2311	2447	2707	2834	3074	3402	3810		
		<b>OVERALL DIMENSIONS</b>			<b>SEAT DIMENSIONS</b>			<b>BACK DIMENSIONS</b>								
		<b>W</b>	<b>D</b>	<b>H</b>	<b>W</b>	<b>D</b>	<b>H</b>	<b>W</b>	<b>H</b>							
	28	26	44.5	23.5	19-21.5	17-21	22	22-27.25								
				<b>RTA 00</b>												
 <p><b>Extended Back Synchro - Tilter w/ Back Angle Adj.</b> COM Yardage: 1.75 Freight Class: 250 Product Weight (lbs.): 40 Cubic Feet Per Carton: 10</p>	 <p><b>ADJUSTMENTS</b> (1) Tilt tension (2) Pneumatic seat height (9) Chair tilt lock (5C) Synchro-tilt action Anti-kick back</p>	<b>1254-0</b>	1908	2014	2093	2217	2386	2447	2597	2882	3019	3283	3646	4096		
		<b>OVERALL DIMENSIONS</b>			<b>SEAT DIMENSIONS</b>			<b>BACK DIMENSIONS</b>								
		<b>W</b>	<b>D</b>	<b>H</b>	<b>W</b>	<b>D</b>	<b>H</b>	<b>W</b>	<b>H</b>							
	28	24.5	53	23.5	17-19.5	17-21	22	31-36.25								
				<b>RTA 00</b>												
 <p><b>Extended Back Multi - Tilter</b> COM Yardage: 1.75 Freight Class: 250 Product Weight (lbs.): 49 Cubic Feet Per Carton: 10.50</p>	 <p><b>ADJUSTMENTS</b> (1) Tilt tension (2) Pneumatic seat height (3) Back angle (4) Seat angle (6) Back/lumbar height (8) Sliding seat depth (9) Infinite position tilt lock Center tilt action</p>	<b>1254-3</b>	1908	2014	2093	2217	2386	2447	2597	2882	3019	3283	3646	4096		
		<b>OVERALL DIMENSIONS</b>			<b>SEAT DIMENSIONS</b>			<b>BACK DIMENSIONS</b>								
		<b>W</b>	<b>D</b>	<b>H</b>	<b>W</b>	<b>D</b>	<b>H</b>	<b>W</b>	<b>H</b>							
	28	24.5	53	23.5	17-19.5	17-21	22	31-36.25								
				<b>RTA 00</b>												

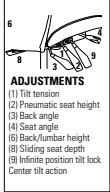
DESCRIPTION	FEATURES	MODEL#	STANDARD TEXTILE GRADES											
			1	2	3	4	5	6	7	8	9	10	11	12
 <p><b>Extended Back Weight Sensing Synchro - Tilter</b> COM Yardage: 1.75 Freight Class: 250 Product Weight (lbs.): 54 Cubic Feet Per Carton: 10.50</p>	 <p><b>ADJUSTMENTS</b> Weight sensing auto tension adjustment (2) Pneumatic seat height (8) Sliding seat depth (9) Multi position tilt lock</p>	<b>1254-8</b>	1908	2014	2093	2217	2386	2447	2597	2882	3019	3283	3646	4096
			<b>OVERALL DIMENSIONS</b>			<b>SEAT DIMENSIONS</b>			<b>BACK DIMENSIONS</b>					
			<b>W</b>	<b>D</b>	<b>H</b>	<b>W</b>	<b>D</b>	<b>H</b>	<b>W</b>	<b>H</b>				
			28	24.5	53	23.5	17-19.5	17-21	22	31-36.25				
<p>Extra Tall/Wide Back. Standard Seat.</p> <p>Ergonomic Features: A, B, C, D, E, H, L, M, N, Q, R, U</p>		<b>RTA 00</b>												
 <p><b>High Back Synchro - Tilter w/ Back Angle Adj.</b> COM Yardage: 2.25 Freight Class: 250 Product Weight (lbs.): 67 Cubic Feet Per Carton: 11</p>	 <p><b>ADJUSTMENTS</b> (1) Tilt tension (2) Pneumatic seat height (9) Chair tilt lock (5C) Synchro-tilt action Anti-kick back</p>	<b>1255-0</b>	1821	1916	1990	2100	2256	2311	2447	2707	2834	3074	3402	3810
			<b>OVERALL DIMENSIONS</b>			<b>SEAT DIMENSIONS</b>			<b>BACK DIMENSIONS</b>					
			<b>W</b>	<b>D</b>	<b>H</b>	<b>W</b>	<b>D</b>	<b>H</b>	<b>W</b>	<b>H</b>				
			28	24.5	48	23.5	17-19.5	17-21	22	26.5-31.75				
<p>High/Wide Back. Standard Seat.</p> <p>Ergonomic Features: A, B, C, D, E, G, H, L, M, N, Q, R, U</p>		<b>RTA 00</b>												
 <p><b>High Back Multi - Tilter</b> COM Yardage: 2.25 Freight Class: 250 Product Weight (lbs.): 69 Cubic Feet Per Carton: 11</p>	 <p><b>ADJUSTMENTS</b> (1) Tilt tension (2) Pneumatic seat height (3) Back angle (4) Seat angle (6) Back/lumbar height (8) Sliding seat depth (9) Infinite position tilt lock Center tilt action</p>	<b>1255-3</b>	1821	1916	1990	2100	2256	2311	2447	2707	2834	3074	3402	3810
			<b>OVERALL DIMENSIONS</b>			<b>SEAT DIMENSIONS</b>			<b>BACK DIMENSIONS</b>					
			<b>W</b>	<b>D</b>	<b>H</b>	<b>W</b>	<b>D</b>	<b>H</b>	<b>W</b>	<b>H</b>				
			28	24.5	48.5	23.5	17-19.5	17-21	22	26.5-31.75				
<p>High/Wide Back. Standard Seat.</p> <p>Ergonomic Features: A, B, C, D, E, F, G, H, M, N, Q, R, S, U</p>		<b>RTA 00</b>												
 <p><b>High Back Weight Sensing Synchro - Tilter</b> COM Yardage: 2 Freight Class: 250 Product Weight (lbs.): 67 Cubic Feet Per Carton: 10.50</p>	 <p><b>ADJUSTMENTS</b> Weight sensing auto tension adjustment (2) Pneumatic seat height (8) Sliding seat depth (9) Multi position tilt lock</p>	<b>1255-8</b>	1821	1916	1990	2100	2256	2311	2447	2707	2834	3074	3402	3810
			<b>OVERALL DIMENSIONS</b>			<b>SEAT DIMENSIONS</b>			<b>BACK DIMENSIONS</b>					
			<b>W</b>	<b>D</b>	<b>H</b>	<b>W</b>	<b>D</b>	<b>H</b>	<b>W</b>	<b>H</b>				
			28	24.5	48.5	23.5	17-19.5	17-21	22	26.5-31.75				
<p>High/Wide Back. Standard Seat.</p> <p>Ergonomic Features: A, B, C, D, E, H, L, M, N, Q, R, U</p>		<b>RTA 00</b>												
 <p><b>Mid Back Synchro - Tilter w/ Back Angle Adj.</b> COM Yardage: 2 Freight Class: 150 Product Weight (lbs.): 67 Cubic Feet Per Carton: 10.50</p>	 <p><b>ADJUSTMENTS</b> (1) Tilt tension (2) Pneumatic seat height (9) Chair tilt lock (5C) Synchro-tilt action Anti-kick back</p>	<b>1256-0</b>	1736	1831	1905	2015	2171	2226	2362	2622	2749	2989	3317	3725
			<b>OVERALL DIMENSIONS</b>			<b>SEAT DIMENSIONS</b>			<b>BACK DIMENSIONS</b>					
			<b>W</b>	<b>D</b>	<b>H</b>	<b>W</b>	<b>D</b>	<b>H</b>	<b>W</b>	<b>H</b>				
			28	24.5	44.5	23.5	17-19.5	17-21	22	22-27.25				
<p>Mid/Wide Back. Standard Seat.</p> <p>Ergonomic Features: A, B, C, D, E, G, H, L, M, N, Q, R, U</p>		<b>RTA 00</b>												

DESCRIPTION	FEATURES	MODEL#	STANDARD TEXTILE GRADES												
			1	2	3	4	5	6	7	8	9	10	11	12	
 <p><b>Mid Back Multi - Tilter</b> COM Yardage: 2 Freight Class: 150 Product Weight (lbs.): 67 Cubic Feet Per Carton: 10.50</p>	 <p><b>ADJUSTMENTS</b> (1) Tilt tension (2) Pneumatic seat height (3) Back angle (4) Seat angle (5) Back/Jumper height (6) Sliding seat depth (8) Infinite position tilt lock Center tilt action</p>	1256-3	1736	1831	1905	2015	2171	2226	2362	2622	2749	2989	3317	3725	
			<b>OVERALL DIMENSIONS</b>			<b>SEAT DIMENSIONS</b>			<b>BACK DIMENSIONS</b>						
			<b>W</b>	<b>D</b>	<b>H</b>	<b>W</b>	<b>D</b>	<b>H</b>	<b>W</b>	<b>H</b>					
			28	24.5	44.5	23.5	17-19.5	17-21	22	22-27.25					
		Ergonomic Features: A, B, C, D, E, F, G, H, M, N, Q		<b>RTA 00</b>											

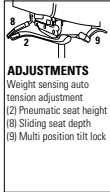
DESCRIPTION	FEATURES	MODEL#	STANDARD TEXTILE GRADES												
			1	2	3	4	5	6	7	8	9	10	11	12	
 <p><b>Mid Back Weight Sensing Synchro - Tilter</b> COM Yardage: 2 Freight Class: 150 Product Weight (lbs.): 67 Cubic Feet Per Carton: 10.50</p>	 <p><b>ADJUSTMENTS</b> Weight sensing auto tension adjustment (2) Pneumatic seat height (8) Sliding seat depth (9) Multi position tilt lock</p>	1256-8	1736	1831	1905	2015	2171	2226	2362	2622	2749	2989	3317	3725	
			<b>OVERALL DIMENSIONS</b>			<b>SEAT DIMENSIONS</b>			<b>BACK DIMENSIONS</b>						
			<b>W</b>	<b>D</b>	<b>H</b>	<b>W</b>	<b>D</b>	<b>H</b>	<b>W</b>	<b>H</b>					
			28	24.5	44.5	23.5	17-19.5	17-21	22	22-27.25					
		Ergonomic Features: A, B, C, D, E, H, L, M, N, Q, R, U		<b>RTA 00</b>											

**PREFER**



model 8458NA



model 8459



























**STANDARD FEATURES**

- A sleek and comfortable all-purpose chair beautifully suited for conference, collaboration and training environments. Designed by Norbert Geelen.
- Swivel tilt function with no visible levers or mechanism.
- Standard with Asphalt or Alabaster frame and base, armless or with fixed arms.
- Integrated seat height adjustment lever is intuitive and easy to utilize.
- Dual wheel carpet casters are standard. Black (C82) casters standard on Asphalt models. Fog Grey (C82F) casters standard on Alabaster models.
- Check textile availability prior to specifying upholstery material.

**OPTIONAL FEATURES**

- Dimension Mesh is available in Black (DBK), Charcoal (DCH), Pool Blue (DPB), Sand (DSD), Fog (DST), Chalk (DCL), and Shadow (DGM).
- Polished Aluminum (ALU) base available for Asphalt and Alabaster frames. Add \$181.
- Polished Aluminum (AL) arms available for Asphalt and Alabaster fixed arm models. Add \$181.
- For Alabaster base on the Asphalt frame, please specify (ABR). For Asphalt base on the Alabaster frame, please specify (ABT). Add \$81.
- Optional low black glides (G) are available at no upcharge.
- For hard floor surface casters, please specify (C82R) for Black and (C82FR) for Fog. Add \$100.
- For fully assembled in the box, specify (SU). Add \$81.

DESCRIPTION	FEATURES	MODEL#	STANDARD TEXTILE GRADES												
			1	2	3	4	5	6	7	8	9	10	11	12	
 <p><b>Multi-task chair- Asphalt Base/Frame</b> COM Yardage: 1 Freight Class: 250 Product Weight (lbs.): 29 Cubic Feet Per Carton: 9</p>	Ergonomic Features: C, M	  	8458	1302	1338	1366	1404	1459	1486	1537	1616	1678	1749	1889	2040
			<b>OVERALL DIMENSIONS</b>			<b>SEAT DIMENSIONS</b>			<b>BACK DIMENSIONS</b>						
			<b>W</b>	<b>D</b>	<b>H</b>	<b>W</b>	<b>D</b>	<b>H</b>	<b>W</b>	<b>H</b>					
			25.5	25	36	20	20	17.5-22	21	20					
 <p><b>Multi-task chair, armless- Asphalt Base/Frame</b> COM Yardage: 1 Freight Class: 250 Product Weight (lbs.): 29 Cubic Feet Per Carton: 9</p>	Ergonomic Features: C, M	  	8458NA	1140	1176	1201	1239	1293	1318	1367	1445	1507	1574	1710	1858
			<b>OVERALL DIMENSIONS</b>			<b>SEAT DIMENSIONS</b>			<b>BACK DIMENSIONS</b>						
			<b>W</b>	<b>D</b>	<b>H</b>	<b>W</b>	<b>D</b>	<b>H</b>	<b>W</b>	<b>H</b>					
			22	25	36	20	20	17.5-22	21	20					
 <p><b>Height Adjustable Stool- Asphalt Base/Frame</b> COM Yardage: 1 Freight Class: 250 Product Weight (lbs.): 36 Cubic Feet Per Carton: 9</p>	Ergonomic Features: C, M	  	8458S	1499	1527	1548	1577	1619	1637	1676	1736	1781	1834	1939	2053
			<b>OVERALL DIMENSIONS</b>			<b>SEAT DIMENSIONS</b>			<b>BACK DIMENSIONS</b>						
			<b>W</b>	<b>D</b>	<b>H</b>	<b>W</b>	<b>D</b>	<b>H</b>	<b>W</b>	<b>H</b>					
			25.5	25	42	20	20	23-31	21	20					
 <p><b>Height Adjustable Stool, armless- Asphalt Base/Frame</b> COM Yardage: 1 Freight Class: 250 Product Weight (lbs.): 36 Cubic Feet Per Carton: 9</p>	Ergonomic Features: C, M	  	8458NAS	1366	1401	1428	1466	1522	1548	1599	1679	1741	1807	1950	2102
			<b>OVERALL DIMENSIONS</b>			<b>SEAT DIMENSIONS</b>			<b>BACK DIMENSIONS</b>						
			<b>W</b>	<b>D</b>	<b>H</b>	<b>W</b>	<b>D</b>	<b>H</b>	<b>W</b>	<b>H</b>					
			25.5	25	42	20	20	23-31	21	20					

DESCRIPTION	FEATURES	MODEL#	STANDARD TEXTILE GRADES											
			1	2	3	4	5	6	7	8	9	10	11	12
 <p><b>Multi-task chair- Alabaster Base/Frame</b>                      COM Yardage: 1                      Freight Class: 250                      Product Weight (lbs.): 29                      Cubic Feet Per Carton: 9</p>	Ergonomic Features: C, M	<b>8459</b>	1366	1401	1428	1466	1522	1548	1599	1679	1741	1807	1950	2102
			<b>OVERALL DIMENSIONS</b>			<b>SEAT DIMENSIONS</b>			<b>BACK DIMENSIONS</b>					
			<b>W</b>	<b>D</b>	<b>H</b>	<b>W</b>	<b>D</b>	<b>H</b>	<b>W</b>	<b>H</b>				
			25.5	25	36	20	20	17.5-22	21	20				
			<b>RTA 1</b>											
 <p><b>Multi-task chair, armless- Alabaster Base/Frame</b>                      COM Yardage: 1                      Freight Class: 250                      Product Weight (lbs.): 29                      Cubic Feet Per Carton: 9</p>	Ergonomic Features: C, M	<b>8459NA</b>	1251	1287	1313	1353	1408	1435	1487	1567	1629	1700	1843	1995
			<b>OVERALL DIMENSIONS</b>			<b>SEAT DIMENSIONS</b>			<b>BACK DIMENSIONS</b>					
			<b>W</b>	<b>D</b>	<b>H</b>	<b>W</b>	<b>D</b>	<b>H</b>	<b>W</b>	<b>H</b>				
			22	25	36	20	20	17.5-22	21	20				
			<b>RTA 1</b>											
 <p><b>Height Adjustable Stool- Alabaster Base/Frame</b>                      COM Yardage: 1                      Freight Class: 250                      Product Weight (lbs.): 36                      Cubic Feet Per Carton: 9</p>	Ergonomic Features: C, M	<b>8459S</b>	1562	1598	1626	1664	1719	1746	1797	1876	1938	2008	2149	2300
			<b>OVERALL DIMENSIONS</b>			<b>SEAT DIMENSIONS</b>			<b>BACK DIMENSIONS</b>					
			<b>W</b>	<b>D</b>	<b>H</b>	<b>W</b>	<b>D</b>	<b>H</b>	<b>W</b>	<b>H</b>				
			25.5	25	42	20	20	23-31	21	20				
			<b>RTA 1</b>											
 <p><b>Height Adjustable Stool, armless- Alabaster Base/Frame</b>                      COM Yardage: 1                      Freight Class: 250                      Product Weight (lbs.): 36                      Cubic Feet Per Carton: 9</p>	Ergonomic Features: C, M	<b>8459NAS</b>	1435	1472	1499	1537	1592	1619	1670	1749	1812	1882	2023	2174
			<b>OVERALL DIMENSIONS</b>			<b>SEAT DIMENSIONS</b>			<b>BACK DIMENSIONS</b>					
			<b>W</b>	<b>D</b>	<b>H</b>	<b>W</b>	<b>D</b>	<b>H</b>	<b>W</b>	<b>H</b>				
			25.5	25	42	20	20	23-31	21	20				
			<b>RTA 1</b>											

ROMA®



model 1906



model 1908



**Optional Arms**

A height adjustable arm is optionally available for task seating. Please specify (RA). Add \$91

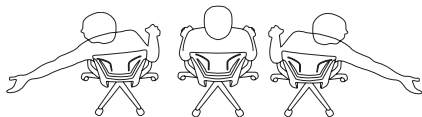

The Polypropylene Medium Back and the Upholstered Medium Back feature a flexible back construction that provides support, proper spinal alignment and comfort when moving or reaching in a seated position.













**STANDARD FEATURES**





- Flexible, elegant and affordable, Roma offers a family of seating with simple clean lines.
- Roma features an exclusive chair control mechanism which allows the chair back and arms to recline together while the chair seat moves just enough to ensure comfort.
- The series includes nesting chairs, task seating and height adjustable stools, with and without arms.
- For Nesting chairs see page 198.
- Four back versions are available: mesh, upholstered, flexible polypropylene or honeycomb polypropylene.
- Flexible polypropylene back chair features a built in lumbar support designed to move as you move and is available exclusively in black.
- The task chair upholstered back features a removable cover for on-site replacement and cleaning.
- Fixed arms are durable fiberglass reinforced nylon, fixed height. Standard with soft, durable, self-skinned urethane (SSU) armcaps that are warm to the touch.
- Standard with Global's high quality Soft Descent™ pneumatic lift which slowly and gently lowers the seat height of the chair making it easy to obtain the exact seat height you desire.
- Task chairs and stools are standard with a five prong, injection molded, fiberglass reinforced nylon Black spider base with dual wheel carpet casters (C1).
- All models upholstered in leather have two-piece seats with a radius towards the rear of the seat.
- Check textile availability prior to specifying upholstery material.





**OPTIONAL FEATURES**

- Breathable mesh back is available in six colors: Autumn Orange (AO), Spring Green (SG) Winter Grey (WG), Midnight Black (MB), Summer Blue (SB), Fall Burgundy (FB).
- An optional polished aluminum base is available at an upcharge. Specify (ALU). Add \$177!
- Please refer to "Cylinder Selection" section of the price book for additional cylinder options.
- Optional height adjustable arms are available, on task models. Please specify (RA). Add \$91.
- For hard surface flooring casters, please specify C9R. Add \$76.
- For fully assembled in box, please specify SU. Add \$81.

DESCRIPTION	FEATURES	MODEL#	STANDARD TEXTILE GRADES											
			1	2	3	4	5	6	7	8	9	10	11	12
 <p><b>Mesh MB - Armless Height Adjustable Stool</b>                      COM Yardage: 1                      Freight Class: 150                      Product Weight (lbs): 43                      Cubic Feet Per Carton: 9.25</p>		1871	1165	1208	1236	1282	1343	1363	1420	1523	1575	1671	1802	1963
			OVERALL DIMENSIONS			SEAT DIMENSIONS			BACK DIMENSIONS					
			W	D	H	W	D	H	W	H				
			19.5	23.5	48	19.5	18	24.5-34.5	18.5	19				
	Ergonomic Features: B, C, M, N		RTA 2		FedEx		UPS							

DESCRIPTION	FEATURES	MODEL#	STANDARD TEXTILE GRADES													
			1	2	3	4	5	6	7	8	9	10	11	12		
 <p><b>Polypropylene MB - Armless Height Adjustable Stool</b>                      COM Yardage: 1                      Freight Class: 150                      Product Weight (lbs.): 43                      Cubic Feet Per Carton: 9.25</p>	Ergonomic Features: B, C, M, N	<b>1872</b>	1165	1208	1236	1282	1343	1363	1420	1523	1575	1671	1802	1963		
			<b>OVERALL DIMENSIONS</b> W D H			<b>SEAT DIMENSIONS</b> W D H			<b>BACK DIMENSIONS</b> W H							
			19.5	23.5	48	19.5	18	24.5-34.5	18.5	19						
			<b>RTA 2</b>													
 <p><b>Honeycomb MB - Armless Height Adjustable Stool</b>                      COM Yardage: 1                      Freight Class: 150                      Product Weight (lbs.): 43                      Cubic Feet Per Carton: 9.25</p>	Ergonomic Features: B, C, M, N	<b>1874</b>	1211	1252	1281	1325	1388	1408	1463	1567	1620	1715	1847	2008		
			<b>OVERALL DIMENSIONS</b> W D H			<b>SEAT DIMENSIONS</b> W D H			<b>BACK DIMENSIONS</b> W H							
			19.5	23.5	48	19.5	18	24.5-34.5	18.5	19						
			<b>RTA 2</b>			 										
 <p><b>Mesh MB - Height Adjustable Stool</b>                      COM Yardage: 1                      Freight Class: 150                      Product Weight (lbs.): 50                      Cubic Feet Per Carton: 9.25</p>	Ergonomic Features: B, C, M, N	<b>1876</b>	1239	1279	1308	1352	1414	1436	1491	1594	1647	1742	1872	2035		
			<b>OVERALL DIMENSIONS</b> W D H			<b>SEAT DIMENSIONS</b> W D H			<b>BACK DIMENSIONS</b> W H							
			25.5	23.5	48	19.5	18	24.5-34.5	18.5	19						
			<b>RTA 2</b>			 										
 <p><b>Polypropylene MB - Height Adjustable Stool</b>                      COM Yardage: 1                      Freight Class: 150                      Product Weight (lbs.): 50                      Cubic Feet Per Carton: 9.25</p>	Ergonomic Features: B, C, M, N	<b>1877</b>	1239	1282	1310	1356	1417	1437	1494	1597	1649	1745	1876	2037		
			<b>OVERALL DIMENSIONS</b> W D H			<b>SEAT DIMENSIONS</b> W D H			<b>BACK DIMENSIONS</b> W H							
			25.5	23.5	48	19.5	18	24.5-34.5	18.5	19						
			<b>RTA 2</b>			 										
 <p><b>Honeycomb MB - Height Adjustable Stool</b>                      COM Yardage: 1                      Freight Class: 150                      Product Weight (lbs.): 50                      Cubic Feet Per Carton: 9.25</p>	Ergonomic Features: B, C, M, N	<b>1879</b>	1284	1325	1354	1398	1461	1481	1539	1640	1693	1788	1920	2082		
			<b>OVERALL DIMENSIONS</b> W D H			<b>SEAT DIMENSIONS</b> W D H			<b>BACK DIMENSIONS</b> W H							
			25.5	23.5	48	19.5	18	24.5-34.5	18.5	19						
			<b>RTA 2</b>			 										

DESCRIPTION	FEATURES	MODEL#	STANDARD TEXTILE GRADES											
			1	2	3	4	5	6	7	8	9	10	11	12
 <p><b>Honeycomb MB - Armless</b> COM Yardage: 1 Freight Class: 150 Product Weight (lbs.): 38 Cubic Feet Per Carton: 9.25</p>	Ergonomic Features: B, C, M, N	1896	941	982	1012	1055	1119	1139	1196	1299	1350	1447	1578	1739
			<b>OVERALL DIMENSIONS</b>			<b>SEAT DIMENSIONS</b>			<b>BACK DIMENSIONS</b>					
			<b>W</b>	<b>D</b>	<b>H</b>	<b>W</b>	<b>D</b>	<b>H</b>	<b>W</b>	<b>H</b>				
			19.5	23.5	38	19.5	18	15-19	18.5	19				
			<b>RTA 2</b>	<b>FedEx</b>	<b>ups</b>									
 <p><b>Honeycomb MB - w/Arms</b> COM Yardage: 1 Freight Class: 150 Product Weight (lbs.): 45 Cubic Feet Per Carton: 9.25</p>	Ergonomic Features: B, C, M, N	1897	1005	1046	1076	1119	1183	1202	1260	1363	1414	1511	1641	1803
			<b>OVERALL DIMENSIONS</b>			<b>SEAT DIMENSIONS</b>			<b>BACK DIMENSIONS</b>					
			<b>W</b>	<b>D</b>	<b>H</b>	<b>W</b>	<b>D</b>	<b>H</b>	<b>W</b>	<b>H</b>				
			25.5	23.5	38	19.5	18	15-19	18.5	19				
			<b>RTA 2</b>	<b>FedEx</b>	<b>ups</b>									
 <p><b>Mesh MB - Armless</b> COM Yardage: 1 Freight Class: 150 Product Weight (lbs.): 38 Cubic Feet Per Carton: 9.25</p>	Ergonomic Features: B, C, M, N	1901	941	984	1015	1062	1126	1150	1208	1316	1369	1472	1609	1778
			<b>OVERALL DIMENSIONS</b>			<b>SEAT DIMENSIONS</b>			<b>BACK DIMENSIONS</b>					
			<b>W</b>	<b>D</b>	<b>H</b>	<b>W</b>	<b>D</b>	<b>H</b>	<b>W</b>	<b>H</b>				
			19.5	23.5	36.25	19.5	18	15-19	18.5	19				
			<b>RTA 2</b>	<b>FedEx</b>	<b>ups</b>									
 <p><b>Polypropylene MB - Armless</b> COM Yardage: 1 Freight Class: 150 Product Weight (lbs.): 36.25 Cubic Feet Per Carton: 9.25</p>	Ergonomic Features: B, C, M, N	1902	941	984	1015	1062	1126	1150	1208	1316	1369	1472	1609	1778
			<b>OVERALL DIMENSIONS</b>			<b>SEAT DIMENSIONS</b>			<b>BACK DIMENSIONS</b>					
			<b>W</b>	<b>D</b>	<b>H</b>	<b>W</b>	<b>D</b>	<b>H</b>	<b>W</b>	<b>H</b>				
			19.5	23.5	36.25	19.5	18	15-19	18.5	19				
			<b>RTA 2</b>	<b>FedEx</b>	<b>ups</b>									
 <p><b>Upholstered MB - Armless</b> COM Yardage: 1.75 Freight Class: 150 Product Weight (lbs.): 38 Cubic Feet Per Carton: 9.25</p>	Ergonomic Features: B, C, M, N	1903	1013	1086	1139	1221	1335	1374	1476	1667	1757	1937	2176	2474
			<b>OVERALL DIMENSIONS</b>			<b>SEAT DIMENSIONS</b>			<b>BACK DIMENSIONS</b>					
			<b>W</b>	<b>D</b>	<b>H</b>	<b>W</b>	<b>D</b>	<b>H</b>	<b>W</b>	<b>H</b>				
			19.5	23.5	36.25	19.5	18	15-19	18.5	19				
			<b>RTA 2</b>	<b>FedEx</b>	<b>ups</b>									

DESCRIPTION	FEATURES	MODEL#	STANDARD TEXTILE GRADES											
			1	2	3	4	5	6	7	8	9	10	11	12
 <p><b>Mesh MB - w/Arms</b>                      COM Yardage: 1                      Freight Class: 150                      Product Weight (lbs.): 45                      Cubic Feet Per Carton: 9.25</p>	Ergonomic Features: B, C, M, N	1906	1005	1046	1078	1122	1190	1213	1269	1376	1431	1534	1669	1842
			<b>OVERALL DIMENSIONS</b>			<b>SEAT DIMENSIONS</b>			<b>BACK DIMENSIONS</b>					
			<b>W</b>	<b>D</b>	<b>H</b>	<b>W</b>	<b>D</b>	<b>H</b>	<b>W</b>	<b>H</b>				
			25.5	23.5	36.25	19.5	18	15-19	18.5	19				
			<b>RTA 2</b>	<b>FedEx</b>	<b>ups</b>									
 <p><b>Polypropylene MB - w/Arms</b>                      COM Yardage: 1                      Freight Class: 150                      Product Weight (lbs.): 45                      Cubic Feet Per Carton: 9.25</p>	Ergonomic Features: B, C, M, N	1907	1005	1048	1079	1126	1190	1214	1272	1379	1433	1535	1672	1842
			<b>OVERALL DIMENSIONS</b>			<b>SEAT DIMENSIONS</b>			<b>BACK DIMENSIONS</b>					
			<b>W</b>	<b>D</b>	<b>H</b>	<b>W</b>	<b>D</b>	<b>H</b>	<b>W</b>	<b>H</b>				
			25.5	23.5	36.25	19.5	18	15-19	18.5	19				
			<b>RTA 2</b>	<b>FedEx</b>	<b>ups</b>									
 <p><b>Upholstered MB - w/Arms</b>                      COM Yardage: 1.75                      Freight Class: 150                      Product Weight (lbs.): 45                      Cubic Feet Per Carton: 9.25</p>	Ergonomic Features: B, C, M, N	1908	1080	1149	1201	1276	1386	1425	1519	1702	1791	1958	2187	2474
			<b>OVERALL DIMENSIONS</b>			<b>SEAT DIMENSIONS</b>			<b>BACK DIMENSIONS</b>					
			<b>W</b>	<b>D</b>	<b>H</b>	<b>W</b>	<b>D</b>	<b>H</b>	<b>W</b>	<b>H</b>				
			25.5	23.5	36.25	19.5	18	16.5-20.5	18.5	19				
			<b>RTA 2</b>	<b>FedEx</b>	<b>ups</b>									
 <p><b>Upholstered Back Pad</b>                      COM Yardage: 1                      Freight Class: 70                      Product Weight (lbs.): 1.5                      Cubic Feet Per Carton: 1.1</p>		1909	204	247	278	326	392	413	472	579	634	735	872	1044
			<b>OVERALL DIMENSIONS</b>			<b>SEAT DIMENSIONS</b>			<b>BACK DIMENSIONS</b>					
			<b>W</b>	<b>D</b>	<b>H</b>	<b>W</b>	<b>D</b>	<b>H</b>	<b>W</b>	<b>H</b>				
			20.5	19	0.38	21	18	18	20	20.5				
			<b>RTA 00</b>	<b>FedEx</b>	<b>ups</b>									

SOLAR



model 8456



model 8457



model 8456NA





model 8457NA





STANDARD FEATURES

- A sophisticated and versatile seating solution for conference and collaborative environments. Designed by Paul Brooks.
- One piece molded frame is extremely light (chair weighs 24 lbs.) and exceeds BIFMA standard for commercial applications.
- Cascading forward seat surface and reverse edge profile provide better leg clearance and comfort.
- Integrated seat height adjustment lever is intuitive and easy to utilize.
- The under seat structure maintains the seamless and fluid aesthetic that defines Solar.
- All bases are standard with Black (C1) dual wheel carpet casters.
- Check textile availability prior to specifying upholstery material.

OPTIONAL FEATURES

- Mesh is available in Midnight (MDN), Storm (STM), and Dove (DVE).
- Polished Aluminum (ALU) base is available. Add \$177.
- Alabaster (ABR) base can be ordered on an Asphalt frame, please specify. Add \$81
- Asphalt (APT) base can be ordered on an Alabaster frame, please specify. Add \$81.
- Optional hard surface Black Glide (C7) is available. No upcharge.
- For hard floor surface casters please specify C9R, please add \$76.

DESCRIPTION	FEATURES	MODEL#	STANDARD TEXTILE GRADES											
			1	2	3	4	5	6	7	8	9	10	11	12
 <p><b>MB Mesh Tilter - Asphalt Base/Frame</b> COM Yardage: N/A Freight Class: 250 Product Weight (lbs.): 27 Cubic Feet Per Carton: 9.5</p> <p>Ergonomic Features: C, M</p>		8456	1148	-	-	-	-	-	-	-	-	-	-	-
		<b>OVERALL DIMENSIONS</b>			<b>SEAT DIMENSIONS</b>			<b>BACK DIMENSIONS</b>						
		<b>W</b>	<b>D</b>	<b>H</b>	<b>W</b>	<b>D</b>	<b>H</b>	<b>W</b>	<b>H</b>					
		23.25	25	36	19.25	18	17-21	19	19					
 <p><b>MB Mesh Tilter - Alabaster Base/Frame</b> COM Yardage: N/A Freight Class: 250 Product Weight (lbs.): 27 Cubic Feet Per Carton: 9.5</p> <p>Ergonomic Features: C, M</p>		8457	1259	-	-	-	-	-	-	-	-	-	-	
		<b>OVERALL DIMENSIONS</b>			<b>SEAT DIMENSIONS</b>			<b>BACK DIMENSIONS</b>						
		<b>W</b>	<b>D</b>	<b>H</b>	<b>W</b>	<b>D</b>	<b>H</b>	<b>W</b>	<b>H</b>					
		23.25	25	36	19.25	18	17-21	19	19					
 <p><b>MB Mesh Stool - Asphalt Base/Frame</b> COM Yardage: N/A Freight Class: 250 Product Weight (lbs.): 31 Cubic Feet Per Carton: 9.5</p> <p>Ergonomic Features: C, M</p>		8456S	1464	-	-	-	-	-	-	-	-	-	-	
		<b>OVERALL DIMENSIONS</b>			<b>SEAT DIMENSIONS</b>			<b>BACK DIMENSIONS</b>						
		<b>W</b>	<b>D</b>	<b>H</b>	<b>W</b>	<b>D</b>	<b>H</b>	<b>W</b>	<b>H</b>					
		23.25	25	42	19.25	18	22.5-30.5	19	19					

DESCRIPTION	FEATURES	MODEL#	STANDARD TEXTILE GRADES													
			1	2	3	4	5	6	7	8	9	10	11	12		
 <p><b>MB Mesh Stool - Alabaster Base/Frame</b> COM Yardage: N/A Freight Class: 250 Product Weight (lbs.): 31 Cubic Feet Per Carton: 9.5</p>	Ergonomic Features: C, M	<b>8457S</b>	1575	-	-	-	-	-	-	-	-	-	-	-	-	
			<b>OVERALL DIMENSIONS</b>			<b>SEAT DIMENSIONS</b>			<b>BACK DIMENSIONS</b>							
			<b>W</b>	<b>D</b>	<b>H</b>	<b>W</b>	<b>D</b>	<b>H</b>	<b>W</b>	<b>H</b>						
			23.25	25	42	19.25	18	22.5-30.5	19	19						
		RTA 1		FedEx		ups										
 <p><b>MB Mesh Tilter - Asphalt Base/Frame</b> COM Yardage: N/A Freight Class: 250 Product Weight (lbs.): 25 Cubic Feet Per Carton: 9.5</p>	Ergonomic Features: C, M	<b>8456NA</b>	1102	-	-	-	-	-	-	-	-	-	-	-	-	
			<b>OVERALL DIMENSIONS</b>			<b>SEAT DIMENSIONS</b>			<b>BACK DIMENSIONS</b>							
			<b>W</b>	<b>D</b>	<b>H</b>	<b>W</b>	<b>D</b>	<b>H</b>	<b>W</b>	<b>H</b>						
			23.25	25	36	19.25	18	17-21	19	19						
		RTA 1		FedEx		ups										
 <p><b>MB Mesh Tilter - Alabaster Base/Frame</b> COM Yardage: N/A Freight Class: 250 Product Weight (lbs.): 25 Cubic Feet Per Carton: 9.5</p>	Ergonomic Features: C, M	<b>8457NA</b>	1214	-	-	-	-	-	-	-	-	-	-	-	-	
			<b>OVERALL DIMENSIONS</b>			<b>SEAT DIMENSIONS</b>			<b>BACK DIMENSIONS</b>							
			<b>W</b>	<b>D</b>	<b>H</b>	<b>W</b>	<b>D</b>	<b>H</b>	<b>W</b>	<b>H</b>						
			23.25	25	36	19.25	18	17-21	19	19						
		RTA 1		FedEx		ups										
 <p><b>MB Mesh Stool - Asphalt Base/Frame</b> COM Yardage: N/A Freight Class: 250 Product Weight (lbs.): 29 Cubic Feet Per Carton: 9.5</p>	Ergonomic Features: C, M	<b>8456SNA</b>	1417	-	-	-	-	-	-	-	-	-	-	-	-	
			<b>OVERALL DIMENSIONS</b>			<b>SEAT DIMENSIONS</b>			<b>BACK DIMENSIONS</b>							
			<b>W</b>	<b>D</b>	<b>H</b>	<b>W</b>	<b>D</b>	<b>H</b>	<b>W</b>	<b>H</b>						
			23.25	25	42	19.25	18	22.5-30.5	19	19						
		RTA 1		FedEx		ups										
 <p><b>MB Mesh Stool - Alabaster Base/Frame</b> COM Yardage: N/A Freight Class: 250 Product Weight (lbs.): 31 Cubic Feet Per Carton: 9</p>	Ergonomic Features: C, M	<b>8457SNA</b>	1528	-	-	-	-	-	-	-	-	-	-	-	-	
			<b>OVERALL DIMENSIONS</b>			<b>SEAT DIMENSIONS</b>			<b>BACK DIMENSIONS</b>							
			<b>W</b>	<b>D</b>	<b>H</b>	<b>W</b>	<b>D</b>	<b>H</b>	<b>W</b>	<b>H</b>						
			23.25	25	42	19.25	18	22.5-30.5	19	19						
		RTA 1		FedEx		ups										

SOLO®



model 5228



model 5226

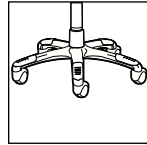



**Optional Base**  
Polished Aluminum base with black scuff tips. Specify "B2". Add \$177.

**STANDARD FEATURES**

- Contoured seat and back, waterfall seat edge and SSU armcaps provide extended comfort.
- All models (except armchairs and side chairs) are standard with a five prong, injection molded base with dual wheel carpet casters (**C65**).
- Seat frame and arm frame are standard in Black.
- Ganging clamp 5233 used for models 5225 and 5226 sled base models. Can be used for Supra models 5332 and 5332L.
- Ganging Clamp 2755 For model 5226. Zinc plated.
- Specifications and pricing is for 1 chair.
- Armchair models are standard with Black glides.
- Check textile availability prior to specifying upholstery material.
- An optional abrasion resistant outer back fabric (polyester) is available. Resistant to impact damage. Available in Black only. Add \$25.
- Vinyl Bumper Guard available with back edge vinyl bumper guard option (**VBG**). Add \$28.
- Non-marking (**NM**) glides are available at no charge to replace Black glides. Please Specify.
- Polished Aluminum base with black scuff tips. Specify "**B2**". Add \$177.
- Please refer to the "Casters Selection" section of the price book for caster options. Optional casters may be priced higher than the standard casters for your chair and the difference will be charged. Lower priced optional casters will not be credited.
- For hard surface flooring casters, specify **C65R**, add \$78.

**OPTIONAL FEATURES**

- Chrome upper finish with Black base available on models 5227 and 5228 Add 10% of opening published grade price.
- Model 5225 and 5226 frame finishes are standard in Black (**TBL**), Shadow (**TSH**), and Tungsten (**TTU**). Chrome (**CHM**) is also available. Add \$43

DESCRIPTION	FEATURES	MODEL#	STANDARD TEXTILE GRADES											
			1	2	3	4	5	6	7	8	9	10	11	12
 <p><b>Armchair</b> COM Yardage: 1.25 Freight Class: 250 Product Weight (lbs.): 25 Cubic Feet Per Carton: 10.13 (2 per carton)</p> <p>Ergonomic Features: M, N</p>		<b>5225</b>	451	501	542	599	678	707	781	910	975	1099	1268	1477
			<b>OVERALL DIMENSIONS</b>			<b>SEAT DIMENSIONS</b>			<b>BACK DIMENSIONS</b>					
			<b>W</b>	<b>D</b>	<b>H</b>	<b>W</b>	<b>D</b>	<b>H</b>	<b>W</b>	<b>H</b>				
			24	25	34	20	18	18	20	18				
			<b>RTA 00</b>			<b>FedEx</b>			<b>UPS</b>					
 <p><b>Side Chair</b> COM Yardage: 1.25 Freight Class: 250 Product Weight (lbs.): 21 Cubic Feet Per Carton: 8.75 (2 per carton)</p> <p>Ergonomic Features: M, N</p>		<b>5226</b>	417	470	509	567	645	676	747	877	941	1067	1235	1477
			<b>OVERALL DIMENSIONS</b>			<b>SEAT DIMENSIONS</b>			<b>BACK DIMENSIONS</b>					
			<b>W</b>	<b>D</b>	<b>H</b>	<b>W</b>	<b>D</b>	<b>H</b>	<b>W</b>	<b>H</b>				
			22	25.5	34	20	18	18	20	18				
			<b>RTA 00</b>											
 <p><b>Ganging Clamp</b> COM Yardage: N/A Freight Class: 70 Product Weight (lbs.): 0.3 Cubic Feet Per Carton: 0.1</p>		<b>2755</b>	37	-	-	-	-	-	-	-	-	-	-	-
			<b>OVERALL DIMENSIONS</b>			<b>SEAT DIMENSIONS</b>			<b>BACK DIMENSIONS</b>					
			<b>W</b>	<b>D</b>	<b>H</b>	<b>W</b>	<b>D</b>	<b>H</b>	<b>W</b>	<b>H</b>				
			0	00	0	-	-	-	-	-				
			<b>RTA 00</b>			<b>FedEx</b>			<b>UPS</b>					

DESCRIPTION	FEATURES	MODEL#	STANDARD TEXTILE GRADES											
			1	2	3	4	5	6	7	8	9	10	11	12
		<b>5233</b>	35	-	-	-	-	-	-	-	-	-	-	-

**Ganging Clamps - Set of 2**  
 COM Yardage: N/A  
 Freight Class: 70  
 Product Weight: .20  
 Cubic Feet Per Carton: .04

OVERALL DIMENSIONS			SEAT DIMENSIONS			BACK DIMENSIONS	
W	D	H	W	D	H	W	H
.87	7.75	1.5					



**HB Tilter**  
 COM Yardage: 1.5  
 Freight Class: 250  
 Product Weight (lbs.): 34  
 Cubic Feet Per Carton: 10.13 (2 per carton)

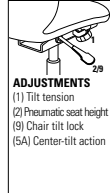

**ADJUSTMENTS**  
 (1) Tilt tension  
 (2) Pneumatic seat height  
 (9) Chair tilt lock  
 (5A) Center-tilt action

Ergonomic Features:  
 A, B, C, M, N, S

MODEL#	STANDARD TEXTILE GRADES											
	1	2	3	4	5	6	7	8	9	10	11	12
<b>5227</b>	664	726	772	838	935	969	1053	1218	1290	1439	1640	1895
	OVERALL DIMENSIONS			SEAT DIMENSIONS			BACK DIMENSIONS					
	W	D	H	W	D	H	W	H				
	24	25.5	38	20	18.5	17.75-21.75	20	19.5				

RTA 00



**LB Tilter**  
 COM Yardage: 1.25  
 Freight Class: 250  
 Product Weight (lbs.): 32  
 Cubic Feet Per Carton: 10.13 (2 per carton)

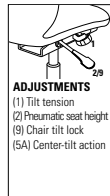

**ADJUSTMENTS**  
 (1) Tilt tension  
 (2) Pneumatic seat height  
 (9) Chair tilt lock  
 (5A) Center-tilt action

Ergonomic Features:  
 A, B, C, M, N, S

MODEL#	STANDARD TEXTILE GRADES											
	1	2	3	4	5	6	7	8	9	10	11	12
<b>5228</b>	597	647	686	743	823	853	923	1055	1119	1244	1413	1622
	OVERALL DIMENSIONS			SEAT DIMENSIONS			BACK DIMENSIONS					
	W	D	H	W	D	H	W	H				
	24	24.5	34	20	18.5	17.75-21.75	20	17.5				

RTA 00

## SORA™



model 6941



model 6942

## MECHANISM:

Weight sensing  
synchro-tilter mechanism (-8)

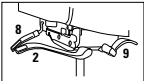

## ADJUSTMENTS

Weight sensing auto  
tension adjustment  
(2) Pneumatic seat height  
back/lumbar height  
(8) Sliding seat depth  
(9) Multi position tilt lock

## Ergonomic features:

B, C, D, E, H, L, M, N, O, Q, R, U, V

## STANDARD FEATURES

- Designed in three seat sizes and two back sizes to accommodate many body shapes.
- The upper back shape encourages free lateral movement.
- Features a weight sensing synchro-tilter mechanism (-8) that requires no tilt tension adjustment.
- Side activated sliding seat depth adjustment.
- 4.4" adjustable lumbar area for personalized comfort and support is standard.
- Standard with Global's high quality Soft Descent™ 4" travel pneumatic lift which slowly and gently lowers the seat height of the chair making it easy to obtain the exact seat height you desire.
- 4.5" travel height adjustable arms.
- Five prong, injection molded, fiberglass reinforced nylon base with dual wheel casters.
- Sora is fully compliant with the latest BIFMA G1, GSA, and CGSB specifications.
- Frame is only available in Black.
- Check textile availability prior to specifying upholstery material.

## OPTIONAL FEATURES

- Height (E2), height and width adjustable (E3), and fully ergonomic arms (E4) are available.
- Fully ergonomic arms (E4) are height and width (1.4" travel) adjustable arms with sliding armcaps. Sliding armcaps travel 1" in width and 2" in depth, and articulate 20° inwards and 10° outwards to aim toward the keyboard or mouse area.
- Mesh backs are available in 24 brilliant Vue colors.

Please add option codes in the following order:



- **Model number**  
6941 High back  
6942 Medium back
- **Fabric**  
Specify fabric code
- **Mechanism**  
(-8) Weight sensing synchro-tilt
- **Arms**  
(E2) Height adjustable arms..... **No upcharge**  
(E3) Height and width adjustable arms..... **Add \$102**  
(E4) Fully ergonomic arms..... **Add \$226**
- **Base**  
(B7) Black nylon base..... **No upcharge**  
(A7) Polished aluminum base..... **Add \$177**
- **Casters**  
(C82) Dual wheel carpet casters..... **No upcharge**  
(C82R) Dual wheel hard floor casters..... **Add \$100**
- **Mesh** (colors shown on website)  
(VU10) Sandy Beach (VU23) Chartreuse  
(VU11) Desert Sand (VU26) Pool Blue  
(VU12) Orange Sunset (VU28) Sky  
(VU13) Chocolate Fountain (VU32) Primary Blue  
(VU14) Arctic Blue (VU34) Tangerine  
(VU15) Quarry Grey (VU37) Paprika  
(VU16) Tidal Wave (VU40) Grain  
(VU17) Ivy Moss (VU43) Yellow  
(VU18) Red Rose (VU55) Silver Grey  
(VU19) Coal Black (VU63) Silver  
(VU20) White (VU65) Hot Pink  
(VU21) Lime (VU70) Red Mittens
- **Seat Size**  
(P) Petite seat, 17" wide  
(STAN) Standard seat, 18.5" wide  
(GS) Generous seat, 19.5" wide
- **Cylinder (No Upcharge)**  
(4L) Standard (4")  
(5L) High (5")  
(4S) Short (4"). Seat height: 14.8" - 18.7"  
Seat height range achieved using (C1) casters.

## EXAMPLE SORA ORDER CODE

6942	-HD08	-8	-E4	-A7	-C82	-VU32	-STAN	-4L
Model #	Fabric	Mechanism	Arm	Base	Casters	Mesh	Seat	Cylinder

Sora recommended dimensional information: based on measurements with weight sensing synchro-tilter mechanism				
	Distance between arms (pivot not included)	Standard arm height	Seat depth range	Standard seat height
<b>Petite seat (P)</b> Soft Descent 4" lift & (E4) arm	14.7" - 17.5" = 2.8" adjustment	7" - 11.5"	15.5" - 18.5"	16.1" - 20.1"
<b>Standard seat (STAN)</b> Soft Descent 4" lift & (E4) arm	16.2" - 19" = 2.8" adjustment		16.5" - 19.5"	
<b>Generous seat (GS)</b> Soft Descent 4" lift & (E4) arm	17.2" - 20" = 2.8" adjustment		17.5" - 19.75"	

Measurements shown are measured to the requirements of BIFMA G1-2013 / CGSB 44.232-2008.

DESCRIPTION	FEATURES	MODEL#	STANDARD TEXTILE GRADES											
			1	2	3	4	5	6	7	8	9	10	11	12
 <p><b>HB Weight Sensing Synchro-Tilter</b>                      COM Yardage: 1                      Freight Class: 250                      Product Weight (lbs.): 60                      Cubic Feet Per Carton: 20.5</p>		<b>6941</b>	1449	1490	1520	1562	1626	1656	1709	1801	1867	1943	2103	2268
			<b>OVERALL DIMENSIONS</b>			<b>SEAT DIMENSIONS</b>			<b>BACK DIMENSIONS</b>					
			<b>W</b>	<b>D</b>	<b>H</b>	<b>W</b>	<b>D</b>	<b>H</b>	<b>W</b>	<b>H</b>				
			25	24	42.5	18.5	16.5-19.5	16.1-20.1	18.5	26				
						<b>RTA 1</b>	1 per carton							
 <p><b>MB Weight Sensing Synchro-Tilter</b>                      COM Yardage: 1                      Freight Class: 250                      Product Weight (lbs.): 58                      Cubic Feet Per Carton: 20.5</p>		<b>6942</b>	1392	1433	1463	1505	1569	1599	1654	1745	1811	1889	2047	2214
			<b>OVERALL DIMENSIONS</b>			<b>SEAT DIMENSIONS</b>			<b>BACK DIMENSIONS</b>					
			<b>W</b>	<b>D</b>	<b>H</b>	<b>W</b>	<b>D</b>	<b>H</b>	<b>W</b>	<b>H</b>				
			25	24	40.5	18.5	16.5-19.5	16.1-20.1	18.5	24				
						<b>RTA 1</b>	1 per carton							

**SPRITZ™**



**Tilter**  
6761-4



**Weight Sensing Synchro-Tilter**  
6761-8



**Tilter with Headrest**  
6766-4



**Optional Lumber (LSP)**  
Black plastic back of headrest

**MECHANISMS OPTIONS**

**Tilter (-4)**

**ADJUSTMENTS**  
(1) Tilt tension  
(2) Pneumatic seat height  
(9) Upright position tilt lock  
Center tilt action

**Ergonomic Features:**  
A, B, C, D, H, M, N, Q, S, U

**Weight Sensing (-8)**

**ADJUSTMENTS**  
Weight sensing auto tension adjustment  
(2) Pneumatic seat height  
(8) Sliding seat depth  
(9) Multi position tilt lock

**Ergonomic Features:**  
A, B, C, E, H, L, M, N, Q, U

**SPRITZ NESTING/MULTI-PURPOSE CHAIRS**



For Spritz Nesting/Multi-Purpose chairs, please refer to Multi-Purpose section of price book.

**STANDARD FEATURES**

- An exceptionally comfortable chair series featuring a sophisticated, translucent mesh and models for all applications.
- Side activated sliding seat depth adjustment is standard on weight sensing synchro tilter control mechanism.
- Standard with height adjustable, forward swept arms and sliding armcaps (G4).
- Standard with Global's high quality Soft Descent™ pneumatic lift which slowly and gently lowers the seat height of the chair making it easy to obtain the exact seat height you desire.
- Five prong, injection molded, fiberglass reinforced nylon Black base with C10 dual wheel carpet casters.
- 6766 models come standard with an adjustable headrest, upholstered in the selected seat textile. Headrest has a black plastic back panel.
- Check textile availability prior to specifying upholstery material.
- Models can be ordered in Leather using appropriate grade.

**OPTIONAL FEATURES**

- For additional caster options, please refer to the Arm and Caster section.
- Optional casters may be priced higher than the standard casters for your chair and the difference will be charged. Lower priced optional casters will not be credited.

**OPTION CODES**

Please add option codes in the following order:











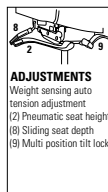

- **Model number**  
6761 Task Chair  
6766 Task Chair with Headrest
- Add (-4) to model number if ordering Tilter mechanism  
Add (-8) to model number if ordering Weight Sensing Synchro-Tilter mechanism
- **Fabric**  
Specify fabric code for seat.
- **Arms**  
(G4) Black nylon arms w/SSU armcaps..... **Standard**
- **Lumbar Pad Option**  
(LSP) Lumbar Pad..... **Add \$43**
- **Base**  
(BK) Black nylon base..... **Standard**  
(M2) Chrome Spider Base..... **Add \$71**
- **Casters**  
(C10) Dual wheel carpet casters ..... **Standard**  
(C10R) Dual wheel hard floor casters..... **Add \$70**
- **Mesh Back**  
(U1) Black  
(U2) Burgundy  
(U3) Blue  
(U4) Green  
(colors shown on website)
- **Vari-Width**  
(WA) Width adjustable arm extensions..... **Add \$92**
- **Chair Assembly**  
(-SU) Assembled in Box..... **Add \$81**

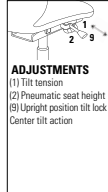
**EXAMPLE OF ORDER CODE:**

6761-4	WA50	G4	LSP	SD	C10	U2	WA	SU
Model Number	Fabric	Arms	Lumbar Pad	Base	Casters	Mesh Back	Vari-Width	Chair Assembly

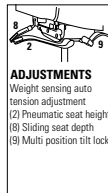
DESCRIPTION	FEATURES	MODEL#	STANDARD TEXTILE GRADES											
			1	2	3	4	5	6	7	8	9	10	11	12
 <b>Tilter</b> COM Yardage: 1 Freight Class: 150 Product Weight (lbs.): 48 Cubic Feet Per Carton: 10.5	 <b>ADJUSTMENTS</b> (1) Tilt tension (2) Pneumatic seat height (9) Upright position tilt lock Center tilt action	6761-4	1028	1068	1098	1141	1205	1235	1290	1380	1447	1525	1684	1851
		<b>OVERALL DIMENSIONS</b>			<b>SEAT DIMENSIONS</b>			<b>BACK DIMENSIONS</b>						
			<b>W</b>	<b>D</b>	<b>H</b>	<b>W</b>	<b>D</b>	<b>H</b>	<b>W</b>	<b>H</b>				
			26	24	38.5	19.5	19	16-20	17.5	20				



DESCRIPTION	FEATURES	MODEL#	STANDARD TEXTILE GRADES													
			1	2	3	4	5	6	7	8	9	10	11	12		
 <p><b>Weight Sensing Synchro-Tilter</b> COM Yardage: 1 Freight Class: 150 Product Weight (lbs.): 54 Cubic Feet Per Carton: 10.5</p>	 <p><b>ADJUSTMENTS</b> Weight sensing auto tension adjustment (2) Pneumatic seat height (8) Sliding seat depth (9) Multi position tilt lock</p>	6761-8	1176	1216	1246	1289	1353	1383	1438	1529	1596	1674	1834	2000		
			<b>OVERALL DIMENSIONS</b>			<b>SEAT DIMENSIONS</b>			<b>BACK DIMENSIONS</b>							
			<b>W</b>	<b>D</b>	<b>H</b>	<b>W</b>	<b>D</b>	<b>H</b>	<b>W</b>	<b>H</b>						
			26	24	38.5	19.5	19-21.5	16-20	17.5	20						
												  				
 <p><b>Tilter w/Adjustable Headrest</b> COM Yardage: 1 Freight Class: 150 Product Weight (lbs.): 49 Cubic Feet Per Carton: 11</p>	 <p><b>ADJUSTMENTS</b> (1) Tilt tension (2) Pneumatic seat height (9) Upright position tilt lock Center tilt action</p>	6766-4	1053	1087	1115	1155	1212	1239	1291	1373	1438	1508	1654	1809		
			<b>OVERALL DIMENSIONS</b>			<b>SEAT DIMENSIONS</b>			<b>BACK DIMENSIONS</b>							
			<b>W</b>	<b>D</b>	<b>H</b>	<b>W</b>	<b>D</b>	<b>H</b>	<b>W</b>	<b>H</b>						
			26	24	45	19.5	19-21.5	16-20	17.5	20						
												  				
 <p><b>Weight Sensing Synchro-Tilter w/Adjustable Headrest</b> COM Yardage: 1 Freight Class: 150 Product Weight (lbs.): 55 Cubic Feet Per Carton: 11</p>	 <p><b>ADJUSTMENTS</b> Weight sensing auto tension adjustment (2) Pneumatic seat height (8) Sliding seat depth (9) Multi position tilt lock</p>	6766-8	1225	1260	1288	1330	1388	1415	1469	1554	1619	1692	1842	2001		
			<b>OVERALL DIMENSIONS</b>			<b>SEAT DIMENSIONS</b>			<b>BACK DIMENSIONS</b>							
			<b>W</b>	<b>D</b>	<b>H</b>	<b>W</b>	<b>D</b>	<b>H</b>	<b>W</b>	<b>H</b>						
			26	24	45	19.5	19-21.5	16-20	17.5	20						
												  				

**STREAM**



model 2073APP



model 2074AUU

**MECHANISMS OPTIONS**

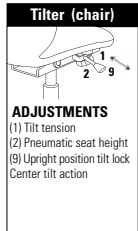

**Ergonomic Features:**  
A, B, C, M, N, S.

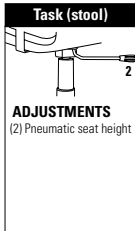

**Ergonomic Features:**  
C, M, N

**STANDARD FEATURES**

- Our popular Stream series now features 5-star base task chairs and heights adjustable stools.
- Task chairs are available with tilter mechanism only.
- Height adjustable stools are available with simple swivel mechanism only.
- Task chairs and height adjustable stools have a five-prong base with dual wheel casters.
- Units available with or without arms. Arms match seat/back finish.
- Perforated Polypropylene seats and backs are available in 14 colors.
- Check textile availability prior to specifying upholstery material.

**OPTIONAL FEATURES**

- Base is Black nylon, no upcharge, or Polished Aluminum, add **\$167**.
- Choose (82) carpet casters, no upcharge, or (8R) hard floor casters, add **\$77**.

Please add option codes in the following order:

- **Model number**  
**2073** Task chair  
**2074** Height adjustable stool
- **Textile**  
 Specify textile code for back (UU models only).  
 Specify textile code for seat (PU, UU models only).
- **Seat/back finish** (no upcharge)  
**(BZB)** Buzz Blue                      **(FRO)** Frost  
**(CCT)** Cactus                            **(INK)** Ink  
**(CRO)** Carrot                            **(LAB)** Latte  
**(IVC)** Cloud                              **(BLK)** Night  
**(DJN)** Dijon                              **(SND)** Sand  
**(EGP)** Eggplant                        **(SAR)** Scarlet  
**(FOG)** Fog                                **(SHW)** Shadow
- **Frame finish**  
**(BK)** Black. No upcharge.  
**(TN)** Tungsten. No upcharge.  
**(CM)** Chrome. Add \$51
- **Base**  
**(B7)** Black nylon base. No upcharge.  
**(A7)** Polished Aluminum base. Add \$177.
- **Casters**  
**(82)** 82 dual wheel carpet casters. No upcharge.  
**(8R)** 8R dual wheel hard floor casters. Add **\$94**



**Stream Multi-Purpose Chairs**











For Stream multi-purpose chairs, please see page 222.

**EXAMPLE STREAM TASK ORDER CODE:**

2073APP	-	-	-IVC	-CM	-A7	-82
Model #	Back Textile	Seat Textile	Seat/back finish	Frame finish	Base	Caster

DESCRIPTION	FEATURES	MODEL#	STANDARD TEXTILE GRADES												
			1	2	3	4	5	6	7	8	9	10	11	12	
 <b>Tilter Chair w/Arms</b> COM Yardage: N/A Freight Class: 250 Product Weight (lbs.):34 Cubic Feet Per Carton: 15.5		<b>2073APP</b>	920	Polypropylene seat & back											
				<b>OVERALL DIMENSIONS</b>			<b>SEAT DIMENSIONS</b>			<b>BACK DIMENSIONS</b>					
				<b>W</b>	<b>D</b>	<b>H</b>	<b>W</b>	<b>D</b>	<b>H</b>	<b>W</b>	<b>H</b>				
				24	23.5	33.5	18	18	15.5-20.5	16	16.5				
		<b>RTA 00</b>		1 per carton											
 <b>2073APU</b>		<b>2073APU</b>	1115	1144	1165	1198	1242	1263	1304	1370	1420	1475	1591	1712	
				Upholstered seat											
			<b>2073AUU</b>	1236	1265	1286	1317	1362	1384	1424	1489	1538	1594	1709	1830
				Upholstered seat & back											
				<b>OVERALL DIMENSIONS</b>			<b>SEAT DIMENSIONS</b>			<b>BACK DIMENSIONS</b>					
			<b>W</b>	<b>D</b>	<b>H</b>	<b>W</b>	<b>D</b>	<b>H</b>	<b>W</b>	<b>H</b>					
			24	23.5	33.5	18	18	16-21	16	16					
		<b>RTA 00</b>		1 per carton											

DESCRIPTION	FEATURES	MODEL#	STANDARD TEXTILE GRADES												
			1	2	3	4	5	6	7	8	9	10	11	12	
 <b>Armless Tilter Chair</b> COM Yardage: N/A Freight Class: 300 Product Weight (lbs.): 30 Cubic Feet Per Carton:		<b>2073NPP</b>	822	Polypropylene seat & back											
				<b>OVERALL DIMENSIONS</b>			<b>SEAT DIMENSIONS</b>			<b>BACK DIMENSIONS</b>					
				<b>W</b>	<b>D</b>	<b>H</b>	<b>W</b>	<b>D</b>	<b>H</b>	<b>W</b>	<b>H</b>				
				20.5	23.5	33.5	18	18	15.5-20.5	16	16.5				
			<b>RTA 00</b>	1 per carton											
  <b>2073NPU</b> <b>2073NUU</b> <b>Armless Tilter Chair</b> COM Yardage: 0.75 Freight Class: 250 Product Weight: 33 Cubic Feet Per Carton: 15.5		<b>2073NPU</b>	1016	1045	1066	1097	1142	1163	1204	1268	1318	1372	1488	1609	
				Upholstered seat											
			<b>2073NUU</b>	1137	1166	1187	1218	1262	1284	1324	1388	1438	1492	1606	1726
				Upholstered seat & back											
			<b>RTA 00</b>	1 per carton											
 <b>Height Adjustable Stool w/Arms</b> COM Yardage: N/A Freight Class: 300 Product Weight (lbs.): 37 Cubic Feet Per Carton: 19.5		<b>2074APP</b>	1039	Polypropylene seat & back											
				<b>OVERALL DIMENSIONS</b>			<b>SEAT DIMENSIONS</b>			<b>BACK DIMENSIONS</b>					
				<b>W</b>	<b>D</b>	<b>H</b>	<b>W</b>	<b>D</b>	<b>H</b>	<b>W</b>	<b>H</b>				
				24	23.5	43	18	18	22-32	16	16.5				
			<b>RTA 00</b>	1 per carton											
  <b>2074APU</b> <b>2074AUU</b> <b>Height Adjustable Stool w/Arms</b> COM Yardage: 0.75 Freight Class: 250 Product Weight: 40 Cubic Feet Per Carton: 19.5		<b>2074APU</b>	1231	1263	1284	1319	1365	1387	1429	1498	1551	1608	1728	1857	
				Upholstered seat											
			<b>2074AUU</b>	1352	1381	1404	1437	1484	1505	1548	1614	1666	1726	1844	1971
				Upholstered seat & back											
			<b>RTA 00</b>	1 per carton											
 <b>Armless Height Adjustable Stool</b> COM Yardage: N/A Freight Class: 300 Product Weight (lbs.): 33 Cubic Feet Per Carton: 19.5		<b>2074NPP</b>	918	Polypropylene seat & back											
				<b>OVERALL DIMENSIONS</b>			<b>SEAT DIMENSIONS</b>			<b>BACK DIMENSIONS</b>					
				<b>W</b>	<b>D</b>	<b>H</b>	<b>W</b>	<b>D</b>	<b>H</b>	<b>W</b>	<b>H</b>				
				20.5	23.5	43	18	18	22-32	16	16.5				
			<b>RTA 00</b>	1 per carton											

DESCRIPTION	FEATURES	MODEL#	STANDARD TEXTILE GRADES											
			1	2	3	4	5	6	7	8	9	10	11	12
 <b>2074NPU</b>		<b>2074NPU</b>	1110	1139	1161	1194	1241	1261	1304	1370	1421	1478	1597	1719
			Upholstered seat											
 <b>2074NUU</b>		<b>2074NUU</b>	1233	1264	1285	1317	1364	1385	1427	1492	1544	1600	1715	1840
			Upholstered seat & back											
<b>OVERALL DIMENSIONS</b>			<b>SEAT DIMENSIONS</b>			<b>BACK DIMENSIONS</b>								
<b>W D H</b>			<b>W D H</b>			<b>W H</b>								
20.5 23.5 43			18 18 22.5-32.5			16 16								
<b>Armless Height Adjustable Stool</b> COM Yardage: 0.75 Freight Class: 300 Product Weight: 38 Cubic Feet Per Carton: 19.5			<b>RTA 00</b>		1 per carton									

SUPRA™



model 5330-4 (UB)



model 5332 (TUN)



**Impact Resistant Back**  
All models are standard with an impact resistant back cover, in Black Only.



**Optional Base**  
Arched aluminum base available as an option on models that are standard with a black arched base. Specify "TB5". Add \$177.







model 5332

STANDARD FEATURES



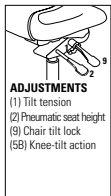

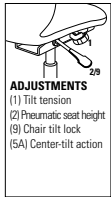

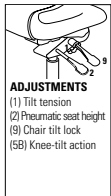





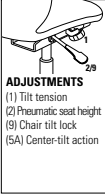

- Contoured cushions support the user in a comfortable, contemporary style.
- Stylish arm/frame design sweeps from under the seat through the back and culminates in a hoop at the rear of the seat.
- Tilters are standard with a Tungsten (TUB) finish and Black nylon base. Armchairs are standard with a Tungsten finish (TTU).
- Molded self-skinned urethane waterfall armrests are available in Black (BK) Only.
- The impact resistant outer back shell adds a decorative look and protects from damage. Available in Black (BK) Only.
- Five prong base models: dual wheel carpet casters
- (C65) are standard.
- Model 5331-4SC features a self centering cylinder which swivels and automatically returns to the starting seat location. This model is standard with a flat 5 star base in Black (BK) with C7 glides.
- Check textile availability prior to specifying upholstery material.

OPTIONAL FEATURES

- Models 5332 and 5332L can be joined together using ganging clamp model 5233.
- Optional steel cushioned glides (B) are available on models 5332 and 5332L. Specify. Add \$36.
- Optional frame finishes include: Please Specify a Tungsten finish with Tungsten base (TUT)\* on Tilter models. Add \$\*\$95. (\* Equipped with a 3" cylinder instead of the standard 4" cylinder to maintain seat height range.)
- Arm frames are available in Black finish with Black nylon base, please specify (TBB). No upcharge.
- Armchair optional frame finishes include: (TBL) Black and (TTU) Tungsten. For a Chrome (CHM) finish on armchairs, add \$134.
- Please refer to the "Casters Selection" section of the price book for caster options. Optional casters may be priced higher than the standard casters for your chair and the difference will be charged. Lower priced optional casters will not be credited.
- For hard surface flooring casters, please specify C65R casters. Add \$78.
- For fully assembled in box, please specify SU. Add \$81

DESCRIPTION	FEATURES	MODEL#	STANDARD TEXTILE GRADES													
			1	2	3	4	5	6	7	8	9	10	11	12		
 <p><b>HB Knee - Tilter</b> COM Yardage: 1.5 Freight Class: 250 Product Weight (lbs.): 41 Cubic Feet Per Carton: 13.25</p> <p>Ergonomic Features: A, B, C, J, M, N</p>	 <p><b>ADJUSTMENTS</b> (1) Tilt tension (2) Pneumatic seat height (9) Chair tilt lock (5B) Knee-tilt action</p>	5330-2	1009	1073	1117	1186	1280	1314	1399	1560	1636	1784	1985	2240		
			<b>OVERALL DIMENSIONS</b>			<b>SEAT DIMENSIONS</b>			<b>BACK DIMENSIONS</b>							
			<b>W</b>	<b>D</b>	<b>H</b>	<b>W</b>	<b>D</b>	<b>H</b>	<b>W</b>	<b>H</b>						
			26	27	42.5	21	18.5	17.5-21.5	20	24						
			RTA 2			FedEx			ups							
 <p><b>HB Tilter</b> COM Yardage: 1.5 Freight Class: 250 Product Weight (lbs.): 40 Cubic Feet Per Carton: 12</p> <p>Ergonomic Features: A, B, C, M, N, S</p>	 <p><b>ADJUSTMENTS</b> (1) Tilt tension (2) Pneumatic seat height (9) Chair tilt lock (5A) Center-tilt action</p>	5330-4	765	827	871	940	1035	1070	1154	1316	1392	1541	1741	1996		
			<b>OVERALL DIMENSIONS</b>			<b>SEAT DIMENSIONS</b>			<b>BACK DIMENSIONS</b>							
			<b>W</b>	<b>D</b>	<b>H</b>	<b>W</b>	<b>D</b>	<b>H</b>	<b>W</b>	<b>H</b>						
			26	27	42	21	18.5	16.5-20.5	20	24						
			RTA 2			FedEx			ups							
 <p><b>MB Knee - Tilter</b> COM Yardage: 1.25 Freight Class: 250 Product Weight (lbs.): 39 Cubic Feet Per Carton: 13.25</p> <p>Ergonomic Features: A, B, C, J, M, N</p>	 <p><b>ADJUSTMENTS</b> (1) Tilt tension (2) Pneumatic seat height (9) Chair tilt lock (5B) Knee-tilt action</p>	5331-2	956	1007	1048	1102	1183	1212	1286	1414	1479	1604	1773	1982		
			<b>OVERALL DIMENSIONS</b>			<b>SEAT DIMENSIONS</b>			<b>BACK DIMENSIONS</b>							
			<b>W</b>	<b>D</b>	<b>H</b>	<b>W</b>	<b>D</b>	<b>H</b>	<b>W</b>	<b>H</b>						
			26	26	39.5	21	18.5	17.5-21.5	20	19.5						
			RTA 2			FedEx			ups							



DESCRIPTION	FEATURES	MODEL#	STANDARD TEXTILE GRADES												
			1	2	3	4	5	6	7	8	9	10	11	12	
 5331-4	 5331L-4	 <p><b>ADJUSTMENTS</b>                      (1) Tilt tension                      (2) Pneumatic seat height                      (9) Chair tilt lock                      (5A) Center-tilt action</p>	5331-4	716	766	809	861	942	973	1042	1176	1239	1364	1533	1742
			<b>OVERALL DIMENSIONS</b>			<b>SEAT DIMENSIONS</b>			<b>BACK DIMENSIONS</b>						
<p><b>MB Tilter</b>                      COM Yardage: 1.25                      Freight Class: 250                      Product Weight (lbs.): 37                      Cubic Feet Per Carton: 12</p>			<p>Ergonomic Features:                      A, B, C, M, N, S</p>			<p>RTA 2</p>			 						
			26	26	39	21	18.5	16.5-20.5	20	19.5					
 5331-4SC	 5331L-4SC		5331-4SC	795	850	888	945	1030	1055	1128	1264	1330	1459	1628	1844
			<b>OVERALL DIMENSIONS</b>			<b>SEAT DIMENSIONS</b>			<b>BACK DIMENSIONS</b>						
<p><b>MB Conference Chair</b>                      COM Yardage: 1.25                      Freight Class: 250                      Product Weight (lbs.): 37                      Cubic Feet Per Carton: 11.5</p>			<p>Ergonomic Features:                      A, B, C, M, N, S</p>			<p>RTA 2</p>			 						
			26	26	37	21	18.5	18	20	19.5					
 5332	 5332L		5332	597	647	686	743	823	853	923	1055	1119	1244	1413	1622
			<b>OVERALL DIMENSIONS</b>			<b>SEAT DIMENSIONS</b>			<b>BACK DIMENSIONS</b>						
<p><b>Armchair</b>                      COM Yardage: 1.25                      Freight Class: 300                      Product Weight (lbs.): 28                      Cubic Feet Per Carton: 17</p>			<p>Ergonomic Features:                      M, N</p>			<p>RTA 00</p>									
			25	25.5	36	21	18.5	17.5	20	19.5					
 5332C	 5332LC		5332C	785	836	877	935	1015	1045	1118	1254	1319	1445	1616	1834
			<b>OVERALL DIMENSIONS</b>			<b>SEAT DIMENSIONS</b>			<b>BACK DIMENSIONS</b>						
<p><b>Armchair Casters</b>                      COM Yardage: 1.25                      Freight Class: 300                      Product Weight (lbs.): 28                      Cubic Feet Per Carton: 17</p>			<p>Ergonomic Features:                      M, N</p>			<p>RTA 00</p>									
			25	25.5	38	21	18.5	17.5	20	19.5					
 5335	 5335L		5335	716	766	809	861	942	973	1042	1176	1239	1364	1533	1742
			<b>OVERALL DIMENSIONS</b>			<b>SEAT DIMENSIONS</b>			<b>BACK DIMENSIONS</b>						
<p><b>Armchair Sled base</b>                      COM Yardage: 1.25                      Freight Class: 300                      Product Weight (lbs.): 33                      Cubic Feet Per Carton: 17.5</p>			<p>Ergonomic Features:                      M, N</p>			<p>RTA 00</p>									
			25	28	38	21	18.5	18.5	20	19.5					

SUPRA X™



**Impact Resistant Back**  
All models are standard with an impact resistant back cover, in Black Only.

model 5336-5



**Additional stitch detail for leather upholstery**

model 5337-6

STANDARD FEATURES

- Ergonomic office seating with height adjustable lumbar support.
- Control knobs on the outside of the back allow the adjustment of the lumbar support.
- An impact resistant outer back shell adds a distinctive look to this series and protects against damage.
- Height and depth adjustable lumbar support.
- Standard with adjustable height forward swept arms with kidney shaped urethane armcaps (SC).
- Base and frame are standard in Black (BK).
- All models are standard with a five-legged, injection molded "spider" base.
- C65 casters are standard.
- Check textile availability prior to specifying upholstery material.

OPTIONAL FEATURES

- Please refer to "Arms Selection" section of the price book for arm options.
- Please refer to "Cylinder Selection" section of the price book for additional cylinder options.
- Please refer to the "Casters Selection" section of the price book for caster options. Optional casters may be priced higher than the standard casters for your chair and the difference will be charged. Lower priced optional casters will not be credited.
- For hard surface flooring casters, please specify C65R casters. Add \$78
- Vari-Width Adapter Plate (WA) is standard when chair is ordered with adjustable height arms. Allows each arm to move outward an additional 2" (for a total of 4" extra seat width) and locks with the use of an easy to maneuver lever (WA).
- For fully assembled in box, please SU. Add \$81

DESCRIPTION FEATURES MODEL# STANDARD TEXTILE GRADES



**HB Multi - Tilter**  
COM Yardage: 1.5  
Freight Class: 150  
Product Weight (lbs.): 58  
Cubic Feet Per Carton: 10.5

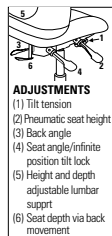

Ergonomic Features:  
A, B, C, E, G, H, M, N, S

MODEL#	1	2	3	4	5	6	7	8	9	10	11	12
5333-3	1147	1211	1257	1325	1424	1458	1544	1709	1785	1940	2144	2401

OVERALL DIMENSIONS			SEAT DIMENSIONS			BACK DIMENSIONS	
W	D	H	W	D	H	W	H
26	26.5	41	20	19-20	16-20	18	23.5

RTA 2 FedEx UPS



**HB Tilter**  
COM Yardage: 1.5  
Freight Class: 150  
Product Weight (lbs.): 55  
Cubic Feet Per Carton: 10.5

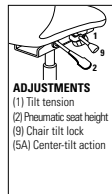

Ergonomic Features:  
A, B, C, E, H, M, N, S

MODEL#	1	2	3	4	5	6	7	8	9	10	11	12
5333-4	1070	1134	1181	1249	1347	1380	1468	1632	1709	1861	2067	2326

OVERALL DIMENSIONS			SEAT DIMENSIONS			BACK DIMENSIONS	
W	D	H	W	D	H	W	H
26	25.5	41.5	21	18-19	16-20	18	23

RTA 2 FedEx UPS



**MB Synchro - Tilter**  
COM Yardage: 1.25  
Freight Class: 150  
Product Weight (lbs.): 57  
Cubic Feet Per Carton: 10.5

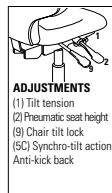









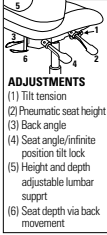



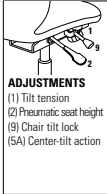



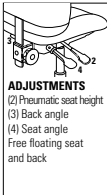



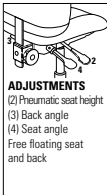

Ergonomic Features:  
A, B, C, H, L, M, N, Q

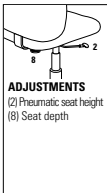
MODEL#	1	2	3	4	5	6	7	8	9	10	11	12
5336-1	1339	1396	1433	1492	1574	1601	1674	1809	1874	2004	2170	2388

OVERALL DIMENSIONS			SEAT DIMENSIONS			BACK DIMENSIONS	
W	D	H	W	D	H	W	H
26	26.5	37.5	20	19-20	16-20	18	16.5

RTA 2 FedEx UPS

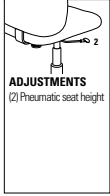
DESCRIPTION	FEATURES	MODEL#	STANDARD TEXTILE GRADES													
			1	2	3	4	5	6	7	8	9	10	11	12		
 <p><b>MB Multi - Tilter</b> COM Yardage: 1.25 Freight Class: 150 Product Weight (lbs.): 55 Cubic Feet Per Carton: 10.5</p>	 <p><b>ADJUSTMENTS</b> (1) Tilt tension (2) Pneumatic seat height (3) Back angle (4) Seat angle/infinite position tilt lock (5) Height and depth adjustable lumbar support (6) Seat depth via back movement</p>	<b>5336-3</b>	975	1023	1055	1107	1180	1213	1278	1383	1464	1553	1737	1934		
			<b>OVERALL DIMENSIONS</b>			<b>SEAT DIMENSIONS</b>			<b>BACK DIMENSIONS</b>							
			<b>W</b>	<b>D</b>	<b>H</b>	<b>W</b>	<b>D</b>	<b>H</b>	<b>W</b>	<b>H</b>						
			26	26.5	37.5	20	17-18.5	17-21	18	20						
<p>Ergonomic Features: A, B, C, E, G, H, M, N, Q, S</p>	  															
		 <p><b>MB Tilter</b> COM Yardage: 1.25 Freight Class: 150 Product Weight (lbs.): 53 Cubic Feet Per Carton: 10.5</p>	 <p><b>ADJUSTMENTS</b> (1) Tilt tension (2) Pneumatic seat height (9) Chair tilt lock (5A) Center-tilt action</p>	<b>5336-4</b>	975	1025	1063	1120	1199	1236	1309	1424	1511	1612	1814	2033
					<b>OVERALL DIMENSIONS</b>			<b>SEAT DIMENSIONS</b>			<b>BACK DIMENSIONS</b>					
					<b>W</b>	<b>D</b>	<b>H</b>	<b>W</b>	<b>D</b>	<b>H</b>	<b>W</b>	<b>H</b>				
26	25.5				37.5	21	18-19	16-20	19	19						
<p>Ergonomic Features: A, B, C, E, H, M, N, Q, S</p>	  															
		 <p><b>MB Operator</b> COM Yardage: 1.25 Freight Class: 150 Product Weight (lbs.): 49 Cubic Feet Per Carton: 9.25</p>	 <p><b>ADJUSTMENTS</b> (2) Pneumatic seat height (3) Back angle (4) Seat angle Free floating seat and back</p>	<b>5336-5</b>	943	991	1026	1080	1156	1192	1261	1370	1455	1548	1741	1949
					<b>OVERALL DIMENSIONS</b>			<b>SEAT DIMENSIONS</b>			<b>BACK DIMENSIONS</b>					
					<b>W</b>	<b>D</b>	<b>H</b>	<b>W</b>	<b>D</b>	<b>H</b>	<b>W</b>	<b>H</b>				
26	27.5				37.5	20	17-18.5	16.5-21.5	18	20						
<p>Ergonomic Features: C, E, F, G, H, M, N, Q, S</p>	  															
		 <p><b>MB Operator Armless</b> COM Yardage: 1.25 Freight Class: 150 Product Weight (lbs.): 43 Cubic Feet Per Carton: 9.25</p>	 <p><b>ADJUSTMENTS</b> (2) Pneumatic seat height (3) Back angle (4) Seat angle Free floating seat and back</p>	<b>5337-5</b>	781	829	865	918	995	1032	1101	1212	1296	1391	1586	1795
					<b>OVERALL DIMENSIONS</b>			<b>SEAT DIMENSIONS</b>			<b>BACK DIMENSIONS</b>					
					<b>W</b>	<b>D</b>	<b>H</b>	<b>W</b>	<b>D</b>	<b>H</b>	<b>W</b>	<b>H</b>				
20	27.5				37.5	20	17-18.5	16.5-21.5	18	20						
<p>Ergonomic Features: C, E, F, G, M, N, Q, S</p>	  															
		 <p><b>MB Task Armless</b> COM Yardage: 1.25 Freight Class: 150 Product Weight (lbs.): 30 Cubic Feet Per Carton: 6.75</p>	 <p><b>ADJUSTMENTS</b> (2) Pneumatic seat height (8) Seat depth</p>	<b>5337-6</b>	633	683	722	779	859	897	969	1087	1177	1277	1483	1703
					<b>OVERALL DIMENSIONS</b>			<b>SEAT DIMENSIONS</b>			<b>BACK DIMENSIONS</b>					
					<b>W</b>	<b>D</b>	<b>H</b>	<b>W</b>	<b>D</b>	<b>H</b>	<b>W</b>	<b>H</b>				
20	25				38.5	20	17-18.5	16.5-21.5	18	20						
<p>Ergonomic Features: C, E, M, N, Q</p>	  															

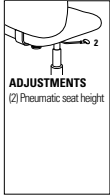
DESCRIPTION	FEATURES	MODEL#	STANDARD TEXTILE GRADES													
			1	2	3	4	5	6	7	8	9	10	11	12		
 <p><b>Height Adjustable Chair Task</b>                      COM Yardage: 1.25                      Freight Class: 125                      Product Weight (lbs.): 42                      Cubic Feet Per Carton: 6.75</p>	 <p><b>ADJUSTMENTS</b>                      (2) Pneumatic seat height</p>	<b>5338-6</b>	1302	1354	1393	1450	1532	1570	1643	1762	1853	1953	2162	2383		
			<b>OVERALL DIMENSIONS</b>			<b>SEAT DIMENSIONS</b>			<b>BACK DIMENSIONS</b>							
			<b>W</b>	<b>D</b>	<b>H</b>	<b>W</b>	<b>D</b>	<b>H</b>	<b>W</b>	<b>H</b>						
			26	25	46.5	20	18.5-19.5	23.5-33.5	18	19						
			<b>RTA 2</b>	<b>FedEx</b>	<b>ups</b>											
 <p><b>Height Adjustable Chair Task Armless</b>                      COM Yardage: 1.25                      Freight Class: 150                      Product Weight (lbs.): 36                      Cubic Feet Per Carton: 6.75</p>	 <p><b>ADJUSTMENTS</b>                      (2) Pneumatic seat height</p>	<b>5339-6</b>	1137	1189	1228	1287	1370	1408	1484	1603	1695	1797	2008	2230		
			<b>OVERALL DIMENSIONS</b>			<b>SEAT DIMENSIONS</b>			<b>BACK DIMENSIONS</b>							
			<b>W</b>	<b>D</b>	<b>H</b>	<b>W</b>	<b>D</b>	<b>H</b>	<b>W</b>	<b>H</b>						
			20	25	46.5	20	18.5-19.5	23.5-33.5	18	19						
			<b>RTA 2</b>	<b>FedEx</b>	<b>ups</b>											

SYNOPSIS®



model 5080-3



model 5091-4





model 5090-4PB







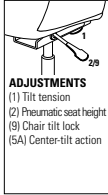

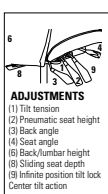
STANDARD FEATURES

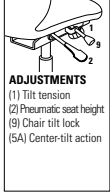

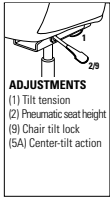

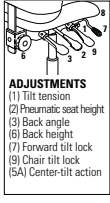

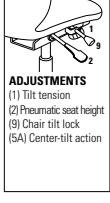

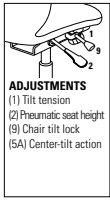

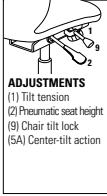

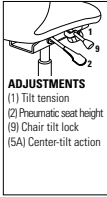

- A compound curved back adds a distinct look while maximizing comfort.
- Fixed height, impact and scuff resistant curved arms are standard on models 5090-4, 5091-4 and 5092
- Tilter, Synchro-Tilter, and Multi-Tilter models (starting with 5080) are standard with adjustable height T arms with teardrop shaped urethane armcaps (3B).
- Ratchet style back height and pneumatic seat height adjustments is standard on Synchro-Tilter and Multi-Tilter models.
- Vari-Width (WA), Width adjustable arm extensions are standard with adjustable height T arms.
- Synchro-Tilter and Multi-Tilters feature a black impact resistant outer back shell. Height adjustable stools have a plastic back panel. All other models feature a fully upholstered outer back.
- Sliding seat depth is available on Synchro-Tilters and Multi-Tilters. Seat depth can be adjusted with a lever on the side of the chair.
- All models (except armchair) are standard with a five-legged, injection molded base.
- Base and arms are available in Black (BK) Only.
- C65 casters are standard.
- Pedestal base models are offered on 5090 and 5091 (-4) Tilter mechanisms only. These models provide fixed location seating for use in auditoriums, classrooms, jury boxes, public venues and more. The base must be mounted to the floor (mounting hardware not included). See Pedestal Base Installation Guide for details.
- Check textile availability prior to specifying upholstery material.

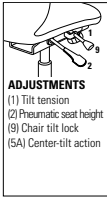
OPTIONAL FEATURES

- Polished Aluminum base with black scuff tips. Specify "B2". Add \$177. Available on select models: 5080-0, 5080-4, 5081-0, 5081-4, 5090-4, and 5091-4.
- Please refer to "Arms Selection" section of the price book for arm options.
- Please refer to "Cylinder Selection" section of the price book for additional cylinder options.
- For hard surface flooring casters, specify C65R, add \$78.
- Please refer to the "Casters Selection" section of the price book for caster options. Optional casters may be priced higher than the standard casters for your chair and the difference will be charged. Lower priced optional casters will not be credited.
- For fully assembled in box, specify SU. Add \$81
- Pedestal Base models have black bases with 2" height adjust cylinders. Specify (SH) swivel, auto return to max height (no upcharge); (SN) non-swivel, auto return to max height (Add \$23); or (SC) swivel, self-centering and return to max height (Add \$35).

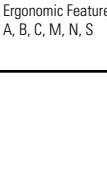
DESCRIPTION	FEATURES	MODEL#	STANDARD TEXTILE GRADES																																				
			1	2	3	4	5	6	7	8	9	10	11	12																									
 <p><b>HB Synchro - Tilter w/Back Angle Adjustment</b> COM Yardage: 2 Freight Class: 150 Product Weight (lbs.): 65 Cubic Feet Per Carton: 14.25</p>	 <p><b>ADJUSTMENTS</b> (1) Tilt tension (2) Pneumatic seat height (9) Chair tilt lock (5A) Center-tilt action</p>	<p>Ergonomic Features: A, B, C, E, H, L, M, N, R</p>	<p><b>RTA 1</b></p> <table border="1"> <thead> <tr> <th colspan="3">OVERALL DIMENSIONS</th> <th colspan="3">SEAT DIMENSIONS</th> <th colspan="3">BACK DIMENSIONS</th> </tr> <tr> <th>W</th> <th>D</th> <th>H</th> <th>W</th> <th>D</th> <th>H</th> <th>W</th> <th>H</th> </tr> </thead> <tbody> <tr> <td>24</td> <td>25</td> <td>46</td> <td>19.5</td> <td>18-20.5</td> <td>17-21</td> <td>19</td> <td>26-28.5</td> </tr> </tbody> </table>												OVERALL DIMENSIONS			SEAT DIMENSIONS			BACK DIMENSIONS			W	D	H	W	D	H	W	H	24	25	46	19.5	18-20.5	17-21	19	26-28.5
			OVERALL DIMENSIONS			SEAT DIMENSIONS			BACK DIMENSIONS																														
			W	D	H	W	D	H	W	H																													
24	25	46	19.5	18-20.5	17-21	19	26-28.5																																
<table border="1"> <thead> <tr> <th colspan="3">OVERALL DIMENSIONS</th> <th colspan="3">SEAT DIMENSIONS</th> <th colspan="3">BACK DIMENSIONS</th> </tr> <tr> <th>W</th> <th>D</th> <th>H</th> <th>W</th> <th>D</th> <th>H</th> <th>W</th> <th>H</th> </tr> </thead> <tbody> <tr> <td>24</td> <td>25</td> <td>46</td> <td>19.5</td> <td>18-20.5</td> <td>17-21</td> <td>19</td> <td>26-28.5</td> </tr> </tbody> </table>												OVERALL DIMENSIONS			SEAT DIMENSIONS			BACK DIMENSIONS			W	D	H	W	D	H	W	H	24	25	46	19.5	18-20.5	17-21	19	26-28.5			
OVERALL DIMENSIONS			SEAT DIMENSIONS			BACK DIMENSIONS																																	
W	D	H	W	D	H	W	H																																
24	25	46	19.5	18-20.5	17-21	19	26-28.5																																
 <p><b>HB Multi - Tilter</b> COM Yardage: 2 Freight Class: 150 Product Weight (lbs.): 67 Cubic Feet Per Carton: 14.25</p>	 <p><b>ADJUSTMENTS</b> (1) Tilt tension (2) Pneumatic seat height (3) Back angle (4) Seat angle (6) Back/Lumbar height (8) Sliding seat depth (9) Infinite position tilt lock Center tilt action</p>	<p>Ergonomic Features: A, B, C, D, E, F, G, H, M, N, O, S</p>	<p><b>RTA 1</b></p> <table border="1"> <thead> <tr> <th colspan="3">OVERALL DIMENSIONS</th> <th colspan="3">SEAT DIMENSIONS</th> <th colspan="3">BACK DIMENSIONS</th> </tr> <tr> <th>W</th> <th>D</th> <th>H</th> <th>W</th> <th>D</th> <th>H</th> <th>W</th> <th>H</th> </tr> </thead> <tbody> <tr> <td>24</td> <td>25</td> <td>46</td> <td>19.5</td> <td>18-20.5</td> <td>17-21</td> <td>19</td> <td>26-28.5</td> </tr> </tbody> </table>												OVERALL DIMENSIONS			SEAT DIMENSIONS			BACK DIMENSIONS			W	D	H	W	D	H	W	H	24	25	46	19.5	18-20.5	17-21	19	26-28.5
			OVERALL DIMENSIONS			SEAT DIMENSIONS			BACK DIMENSIONS																														
			W	D	H	W	D	H	W	H																													
24	25	46	19.5	18-20.5	17-21	19	26-28.5																																
<table border="1"> <thead> <tr> <th colspan="3">OVERALL DIMENSIONS</th> <th colspan="3">SEAT DIMENSIONS</th> <th colspan="3">BACK DIMENSIONS</th> </tr> <tr> <th>W</th> <th>D</th> <th>H</th> <th>W</th> <th>D</th> <th>H</th> <th>W</th> <th>H</th> </tr> </thead> <tbody> <tr> <td>24</td> <td>25</td> <td>46</td> <td>19.5</td> <td>18-20.5</td> <td>17-21</td> <td>19</td> <td>26-28.5</td> </tr> </tbody> </table>												OVERALL DIMENSIONS			SEAT DIMENSIONS			BACK DIMENSIONS			W	D	H	W	D	H	W	H	24	25	46	19.5	18-20.5	17-21	19	26-28.5			
OVERALL DIMENSIONS			SEAT DIMENSIONS			BACK DIMENSIONS																																	
W	D	H	W	D	H	W	H																																
24	25	46	19.5	18-20.5	17-21	19	26-28.5																																

DESCRIPTION	FEATURES	MODEL#	STANDARD TEXTILE GRADES													
			1	2	3	4	5	6	7	8	9	10	11	12		
 <p><b>HB Tilter</b> COM Yardage: 2 Freight Class: 150 Product Weight (lbs.): 45 Cubic Feet Per Carton: 9.75</p>	 <p><b>ADJUSTMENTS</b> (1) Tilt tension (2) Pneumatic seat height (9) Chair tilt lock (5A) Center-tilt action</p>	<p>Ergonomic Features: A, B, C, M, N, S</p>	<b>5080-4</b>	1088	1166	1225	1313	1439	1481	1591	1799	1898	2091	2353	2680	
			<b>OVERALL DIMENSIONS</b>			<b>SEAT DIMENSIONS</b>			<b>BACK DIMENSIONS</b>							
			<b>W</b>	<b>D</b>	<b>H</b>	<b>W</b>	<b>D</b>	<b>H</b>	<b>W</b>	<b>H</b>						
			24.5	26.5	43.5	19.5	18-19.5	16.5-20.5	19	25.5						
			<b>RTA 2</b>	<b>FedEx</b>		<b>ups</b>										
 <p><b>MB Synchro - Tilter w/Back Angle Adjustment</b> COM Yardage: 1.75 Freight Class: 150 Product Weight (lbs.): 62 Cubic Feet Per Carton: 14.25</p>	 <p><b>ADJUSTMENTS</b> (1) Tilt tension (2) Pneumatic seat height (9) Chair tilt lock (5A) Center-tilt action</p>	<p>Ergonomic Features: A, B, C, E, H, L, M, N, R</p>	<b>5081-0</b>	1148	1274	1327	1403	1511	1552	1646	1827	1915	2083	2313	2600	
			<b>OVERALL DIMENSIONS</b>			<b>SEAT DIMENSIONS</b>			<b>BACK DIMENSIONS</b>							
			<b>W</b>	<b>D</b>	<b>H</b>	<b>W</b>	<b>D</b>	<b>H</b>	<b>W</b>	<b>H</b>						
			24	25	42	19.5	18-20.5	17-21	19	22-24.5						
			<b>RTA 1</b>													
 <p><b>MB Multi - Tilter</b> COM Yardage: 1.75 Freight Class: 150 Product Weight (lbs.): 64 Cubic Feet Per Carton: 14.25</p>	 <p><b>ADJUSTMENTS</b> (1) Tilt tension (2) Pneumatic seat height (3) Back angle (6) Back height (7) Forward tilt lock (9) Chair tilt lock (5A) Center-tilt action</p>	<p>Ergonomic Features: A, B, C, D, E, F, G, H, M, N, Q, S</p>	<b>5081-3</b>	1148	1274	1327	1403	1511	1552	1646	1827	1915	2083	2313	2600	
			<b>OVERALL DIMENSIONS</b>			<b>SEAT DIMENSIONS</b>			<b>BACK DIMENSIONS</b>							
			<b>W</b>	<b>D</b>	<b>H</b>	<b>W</b>	<b>D</b>	<b>H</b>	<b>W</b>	<b>H</b>						
			24	25	42	19.5	18-20.5	17-21	19	22-24.5						
			<b>RTA 1</b>													
 <p><b>MB Tilter</b> COM Yardage: 1.75 Freight Class: 150 Product Weight (lbs.): 45 Cubic Feet Per Carton: 9.75</p>	 <p><b>ADJUSTMENTS</b> (1) Tilt tension (2) Pneumatic seat height (9) Chair tilt lock (5A) Center-tilt action</p>	<p>Ergonomic Features: A, B, C, M, N, S</p>	<b>5081-4</b>	956	1030	1087	1172	1289	1344	1450	1623	1754	1901	2202	2523	
			<b>OVERALL DIMENSIONS</b>			<b>SEAT DIMENSIONS</b>			<b>BACK DIMENSIONS</b>							
			<b>W</b>	<b>D</b>	<b>H</b>	<b>W</b>	<b>D</b>	<b>H</b>	<b>W</b>	<b>H</b>						
			24.5	26.5	43.5	19.5	18-19.5	16.5-20.5	19	25.5						
			<b>RTA 2</b>	<b>FedEx</b>		<b>ups</b>										
 <p><b>HB Tilter w/ Fixed Arm</b> COM Yardage: 2 Freight Class: 250 Product Weight (lbs.): 41 Cubic Feet Per Carton: 11.5</p>	 <p><b>ADJUSTMENTS</b> (1) Tilt tension (2) Pneumatic seat height (9) Chair tilt lock (5A) Center-tilt action</p>	<p>Ergonomic Features: A, B, C, M, N, S</p>	<b>5090-4</b>	794	908	968	1056	1183	1225	1333	1541	1641	1838	2096	2424	
			<b>OVERALL DIMENSIONS</b>			<b>SEAT DIMENSIONS</b>			<b>BACK DIMENSIONS</b>							
			<b>W</b>	<b>D</b>	<b>H</b>	<b>W</b>	<b>D</b>	<b>H</b>	<b>W</b>	<b>H</b>						
			24.5	26.5	43.5	19.5	19.5	16.5-20.5	19	25.5						
			<b>RTA 1</b>	<b>FedEx</b>		<b>ups</b>										

DESCRIPTION	FEATURES	MODEL#	STANDARD TEXTILE GRADES													
			1	2	3	4	5	6	7	8	9	10	11	12		
 <p><b>MB Tilter w/ Fixed Arm</b> COM Yardage: 1.75 Freight Class: 250 Product Weight (lbs.): 38 Cubic Feet Per Carton: 11.5</p>	 <p><b>ADJUSTMENTS</b> (1) Tilt tension (2) Pneumatic seat height (9) Chair tilt lock (5A) Center-tilt action</p>	<b>5091-4</b>	744	850	900	976	1084	1124	1220	1402	1488	1658	1887	2173		
			<b>OVERALL DIMENSIONS</b>			<b>SEAT DIMENSIONS</b>			<b>BACK DIMENSIONS</b>							
			<b>W</b>	<b>D</b>	<b>H</b>	<b>W</b>	<b>D</b>	<b>H</b>	<b>W</b>	<b>H</b>						
			24.5	26.5	39.5	19.5	19.5	16.5-20.5	19	21.5						
<p>Ergonomic Features: A, B, C, M, N, S</p>	  															
		 <p><b>Armchair</b> COM Yardage: 1.75 Freight Class: 250 Product Weight (lbs.): 40 Cubic Feet Per Carton: 17</p>	 <p><b>ADJUSTMENTS</b> (1) Tilt tension (2) Pneumatic seat height (9) Chair tilt lock (5A) Center-tilt action</p>	<b>5092</b>	755	861	912	987	1097	1140	1231	1413	1502	1669	1900	2184
					<b>OVERALL DIMENSIONS</b>			<b>SEAT DIMENSIONS</b>			<b>BACK DIMENSIONS</b>					
					<b>W</b>	<b>D</b>	<b>H</b>	<b>W</b>	<b>D</b>	<b>H</b>	<b>W</b>	<b>H</b>				
25	26				37	19.5	19	16.5	19	27						
<p>Ergonomic Features: M, N</p>																
		 <p><b>HB Tilter with Pedestal Base</b> COM Yardage: 2 Freight Class: 250 Product Weight (lbs.): 44 Cubic Feet Per Carton: 11.5</p>	 <p><b>ADJUSTMENTS</b> (1) Tilt tension (2) Pneumatic seat height (9) Chair tilt lock (5A) Center-tilt action</p>	<b>5090-4PB</b>	1038	1111	1169	1254	1372	1428	1536	1711	1842	1991	2296	2622
					<b>OVERALL DIMENSIONS</b>			<b>SEAT DIMENSIONS</b>			<b>BACK DIMENSIONS</b>					
					<b>W</b>	<b>D</b>	<b>H</b>	<b>W</b>	<b>D</b>	<b>H</b>	<b>W</b>	<b>H</b>				
24.5	26.5				39.5	19.5	19.5	16.5-20.5	19	25.5						
<p>Ergonomic Features: A, B, C, M, N, S</p>	  															
		 <p><b>MB Tilter with Pedestal Base</b> COM Yardage: 1.75 Freight Class: 250 Product Weight (lbs.): 41 Cubic Feet Per Carton: 11.5</p>	 <p><b>ADJUSTMENTS</b> (1) Tilt tension (2) Pneumatic seat height (9) Chair tilt lock (5A) Center-tilt action</p>	<b>5091-4PB</b>	989	1056	1102	1178	1283	1330	1427	1580	1696	1826	2094	2379
					<b>OVERALL DIMENSIONS</b>			<b>SEAT DIMENSIONS</b>			<b>BACK DIMENSIONS</b>					
					<b>W</b>	<b>D</b>	<b>H</b>	<b>W</b>	<b>D</b>	<b>H</b>	<b>W</b>	<b>H</b>				
24.5	26.5				37.5	19.5	19.5	16.5-20.5	19	21.5						
<p>Ergonomic Features: A, B, C, M, N, S</p>	  															

**TRADITIONAL™**



model 3720



model 3722

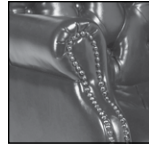

**Standard Feature**  
Attractive brass-colored nail head trim is standard on all models

**STANDARD FEATURES**







- Tilter chairs are standard with a traditional style wood capped steel base.
- All models are Tufted design with brass-colored nail head trim and vinyl bumper guards. Pneumatic seat height adjustment and tilt tension control.
- **C1** casters are standard.
- All models ship fully assembled in the box.
- Check textile availability prior to specifying upholstery material.



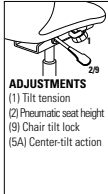

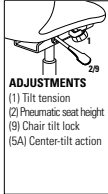

**OPTIONAL FEATURES**

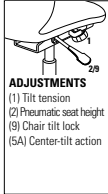

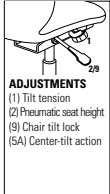



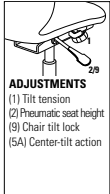

- Wood base, arms and frames are available in Absolute (**AAM**), Black (**BKM**), Cherry (**ACM**), Espresso Cafe (**ECM**), English Oak (**EOM**), Fruitwood (**TFM**), Gray (**HGM**), Honey (**AHM**), Mahogany (**TMM**), Maple (**AVM**), Medium Walnut (**MWM**), Natural Walnut (**NLW**), Night (**ASM**), Noce Biondo (**NBM**), Noce Grigio (**NGM**), Noce Leggero (**NEM**), Noce Medio (**NMM**), Shaker Cherry (**SKM**), Walnut (**TWM**), WC Cream (**WTM**), White (**WHM**) and Winter Cherry (**WCM**). Please Specify. Genuine maple faced veneers and solids are used.
- Tilter models can be ordered with an optional Black nylon base upon request, at no upcharge.
- Please refer to the "Casters Selection" section of the price book for caster options. Optional casters may be priced higher than the standard casters for your chair and the difference will be charged. Lower priced optional casters will not be credited.
- For hard surface flooring casters. Specify **C9R**, Add \$76.

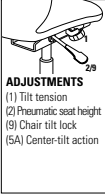

model 3747

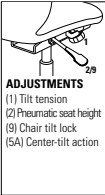
DESCRIPTION	FEATURES	MODEL#	STANDARD FABRIC GRADES													
			1	2	3	4	5	6	7	8	9	10	11	12		
 <p><b>HB Tilter</b> Queen Anne Style COM Yardage: 4.75 Freight Class: 250 Product Weight (lbs.): 64 Cubic Feet Per Carton: 22.25</p>	 <p><b>ADJUSTMENTS</b> (1) Tilt tension (2) Pneumatic seat height (9) Chair tilt lock (SA) Center-tilt action</p>	<b>3720</b>	1741	1923	2067	--	2585	2698	--	3470	3712	4187	4826	5626		
		<b>OVERALL DIMENSIONS</b>			<b>SEAT DIMENSIONS</b>			<b>BACK DIMENSIONS</b>								
		<b>W</b>	<b>D</b>	<b>H</b>	<b>W</b>	<b>D</b>	<b>H</b>	<b>W</b>	<b>H</b>							
		29	30	44.5	19.5	19.5	19-23	19	26							
<p>*Fabrics Limited, See notes</p> <p>Ergonomic Features: A, C, M, N, S</p>		<b>RTA 00</b>														
 <p><b>ArmChair</b> Banker's Style COM Yardage: 2 Freight Class: 250 Product Weight (lbs.): 31 Cubic Feet Per Carton: 11.25</p>	 <p><b>ADJUSTMENTS</b> (1) Tilt tension (2) Pneumatic seat height (9) Chair tilt lock (SA) Center-tilt action</p>	<b>3722</b>	875	956	--	--	1230	1283	--	1609	1711	1907	2181	2513		
		<b>OVERALL DIMENSIONS</b>			<b>SEAT DIMENSIONS</b>			<b>BACK DIMENSIONS</b>								
		<b>W</b>	<b>D</b>	<b>H</b>	<b>W</b>	<b>D</b>	<b>H</b>	<b>W</b>	<b>H</b>							
		25	22.5	31	25	18	19.5	23	11							
<p>*Fabrics Limited, See notes</p> <p>Ergonomic Features: M, N</p>		<b>RTA 00</b>	 													
 <p><b>HB Tilter</b> Martha Washington Style COM Yardage: 3 Freight Class: 250 Product Weight (lbs.): 52 Cubic Feet Per Carton: 20.25</p>	 <p><b>ADJUSTMENTS</b> (1) Tilt tension (2) Pneumatic seat height (9) Chair tilt lock (SA) Center-tilt action</p>	<b>3730</b>	1683	1797	--	--	2217	2290	--	2776	2931	3227	3630	4136		
		<b>OVERALL DIMENSIONS</b>			<b>SEAT DIMENSIONS</b>			<b>BACK DIMENSIONS</b>								
		<b>W</b>	<b>D</b>	<b>H</b>	<b>W</b>	<b>D</b>	<b>H</b>	<b>W</b>	<b>H</b>							
		0	0	0	18	18	17.5-21.5	19	23							
<p>*Fabrics Limited, See notes</p> <p>Ergonomic Features: A, C, M, N, S</p>		<b>RTA 00</b>														

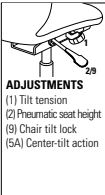
DESCRIPTION	FEATURES	MODEL#	STANDARD FABRIC GRADES											
			1	2	3	4	5	6	7	8	9	10	11	12
 <p><b>LB Tilter</b> Martha Washington Style COM Yardage: 2.75 Freight Class: 250 Product Weight (lbs.): 46 Cubic Feet Per Carton: 15.75</p>	 <p><b>ADJUSTMENTS</b> (1) Tilt tension (2) Pneumatic seat height (9) Chair tilt lock (5A) Center-tilt action</p>	3731	1561	1667	--	--	2053	2113	--	2562	2704	2977	3349	3812
			<b>OVERALL DIMENSIONS</b>			<b>SEAT DIMENSIONS</b>			<b>BACK DIMENSIONS</b>					
			<b>W</b>	<b>D</b>	<b>H</b>	<b>W</b>	<b>D</b>	<b>H</b>	<b>W</b>	<b>H</b>				
			25.5	26	36	18	18	17.5-21.5	19	18				
			<b>RTA 00</b>											
 <p><b>LB Armchair</b> Martha Washington Style COM Yardage: 2.75 Freight Class: 300 Product Weight (lbs.): 28 Cubic Feet Per Carton: 15.75</p>	<p>*Fabrics Limited, See notes</p> <p>Ergonomic Features: A, C, M, N, S</p>	3732	1295	1403	--	--	1787	1848	--	2297	2438	2711	3084	3545
			<b>OVERALL DIMENSIONS</b>			<b>SEAT DIMENSIONS</b>			<b>BACK DIMENSIONS</b>					
			<b>W</b>	<b>D</b>	<b>H</b>	<b>W</b>	<b>D</b>	<b>H</b>	<b>W</b>	<b>H</b>				
			25.5	24.5	34	20	18	19	19	18				
			<b>RTA 00</b>											
 <p><b>HB Armchair</b> Martha Washington Style COM Yardage: 3 Freight Class: 300 Product Weight (lbs.): 32 Cubic Feet Per Carton: 20.25</p>	<p>*Fabrics Limited, See notes</p> <p>Ergonomic Features: M, N</p>	3735	1417	1529	--	--	1949	2020	--	2507	2665	2961	3365	3871
			<b>OVERALL DIMENSIONS</b>			<b>SEAT DIMENSIONS</b>			<b>BACK DIMENSIONS</b>					
			<b>W</b>	<b>D</b>	<b>H</b>	<b>W</b>	<b>D</b>	<b>H</b>	<b>W</b>	<b>H</b>				
			25	27.5	39.5	20	18	19	19	22.5				
			<b>RTA 00</b>											
 <p><b>LB Tilter</b> Martha Washington Style COM Yardage: 2.75 Freight Class: 250 Product Weight (lbs.): 47 Cubic Feet Per Carton: 15.75</p>	 <p><b>ADJUSTMENTS</b> (1) Tilt tension (2) Pneumatic seat height (9) Chair tilt lock (5A) Center-tilt action</p>	3741	1583	1689	--	--	2073	2135	--	2584	2726	2999	3371	3834
			<b>OVERALL DIMENSIONS</b>			<b>SEAT DIMENSIONS</b>			<b>BACK DIMENSIONS</b>					
			<b>W</b>	<b>D</b>	<b>H</b>	<b>W</b>	<b>D</b>	<b>H</b>	<b>W</b>	<b>H</b>				
			0	0	0	20	18	17.5-21.5	19	18				
			<b>RTA 00</b>											
 <p><b>LB Armchair</b> Martha Washington Style COM Yardage: 2.75 Freight Class: 300 Product Weight (lbs.): 28 Cubic Feet Per Carton: 15.75</p>	<p>*Fabrics Limited, See notes</p> <p>Ergonomic Features: M, N</p>	3742	1317	1426	--	--	1809	1871	--	2320	2460	2734	3105	3567
			<b>OVERALL DIMENSIONS</b>			<b>SEAT DIMENSIONS</b>			<b>BACK DIMENSIONS</b>					
			<b>W</b>	<b>D</b>	<b>H</b>	<b>W</b>	<b>D</b>	<b>H</b>	<b>W</b>	<b>H</b>				
			25	34.5	34.5	20	18	19	19	18				
			<b>RTA 00</b>											

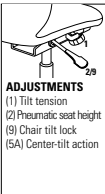
DESCRIPTION	FEATURES	MODEL#	STANDARD FABRIC GRADES													
			1	2	3	4	5	6	7	8	9	10	11	12		
 <p><b>HB Armchair</b> Martha Washington Style COM Yardage: 3 Freight Class: 300 Product Weight (lbs.): 26 Cubic Feet Per Carton: 20.25</p>	<p>*Fabrics Limited, See notes</p> <p>Ergonomic Features: M, N</p>	<p><b>3745</b></p>	1442	1556	--	--	1977	2050	--	2538	2690	2988	3390	3897		
			<b>OVERALL DIMENSIONS</b>			<b>SEAT DIMENSIONS</b>			<b>BACK DIMENSIONS</b>							
			<b>W</b>	<b>D</b>	<b>H</b>	<b>W</b>	<b>D</b>	<b>H</b>	<b>W</b>	<b>H</b>						
			25	27.5	39.5	20	18	19	19	22.5						
 <p><b>MB Tilter</b> Martha Washington Style COM Yardage: 3 Freight Class: 300 Product Weight (lbs.): 40 Cubic Feet Per Carton: 20.25</p>	 <p><b>ADJUSTMENTS</b> (1) Tilt tension (2) Pneumatic seat height (9) Chair tilt lock (5A) Center-tilt action</p>	<p><b>3746</b></p>	1561	1675	--	--	2095	2164	--	2657	2809	3104	3510	4016		
			<b>OVERALL DIMENSIONS</b>			<b>SEAT DIMENSIONS</b>			<b>BACK DIMENSIONS</b>							
			<b>W</b>	<b>D</b>	<b>H</b>	<b>W</b>	<b>D</b>	<b>H</b>	<b>W</b>	<b>H</b>						
			26.5	29	38	20	18	17-21	20	24						
 <p><b>MB Tilter</b> Martha Washington Style COM Yardage: 3 Freight Class: 250 Product Weight (lbs.): 48 Cubic Feet Per Carton: 20.25</p>	 <p><b>ADJUSTMENTS</b> (1) Tilt tension (2) Pneumatic seat height (9) Chair tilt lock (5A) Center-tilt action</p>	<p><b>3747</b></p>	1533	1647	--	--	2067	2140	--	2629	2781	3079	3483	3987		
			<b>OVERALL DIMENSIONS</b>			<b>SEAT DIMENSIONS</b>			<b>BACK DIMENSIONS</b>							
			<b>W</b>	<b>D</b>	<b>H</b>	<b>W</b>	<b>D</b>	<b>H</b>	<b>W</b>	<b>H</b>						
			0	0	0	20	18	17-21	20	24						
 <p><b>HB Tilter</b> Judge's Style COM Yardage: 5 Freight Class: 250 Product Weight (lbs.): 63 Cubic Feet Per Carton: 28.25</p>	 <p><b>ADJUSTMENTS</b> (1) Tilt tension (2) Pneumatic seat height (9) Chair tilt lock (5A) Center-tilt action</p>	<p><b>3760</b></p>	1937	2130	--	--	2827	2940	--	3756	4014	4507	5187	6024		
			<b>OVERALL DIMENSIONS</b>			<b>SEAT DIMENSIONS</b>			<b>BACK DIMENSIONS</b>							
			<b>W</b>	<b>D</b>	<b>H</b>	<b>W</b>	<b>D</b>	<b>H</b>	<b>W</b>	<b>H</b>						
			29	32	48	20.5	18.5	18-22	20.5	26						
 <p><b>HB Tilter</b> Judge's Style COM Yardage: 4.75 Freight Class: 250 Product Weight (lbs.): 70 Cubic Feet Per Carton: 28.25</p>	 <p><b>ADJUSTMENTS</b> (1) Tilt tension (2) Pneumatic seat height (9) Chair tilt lock (5A) Center-tilt action</p>	<p><b>3766</b></p>	1980	2162	--	--	2827	2934	--	3709	3952	4425	5067	5865		
			<b>OVERALL DIMENSIONS</b>			<b>SEAT DIMENSIONS</b>			<b>BACK DIMENSIONS</b>							
			<b>W</b>	<b>D</b>	<b>H</b>	<b>W</b>	<b>D</b>	<b>H</b>	<b>W</b>	<b>H</b>						
			29	32	48	20.5	18.5	18-22	20.5	26						

TRIUMPH™



model 3650-3

model 3651-3



**Lumbar Support**







Adjusted in and out by turning the knob and vertically by moving up and down the slider.

**STANDARD FEATURES**

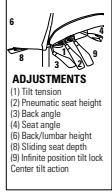
- Contemporary seating series featuring exceptional comfort, support and adjustment.
- Standard with adjustable height, forward swept arms with "sliding armcaps" (G1).
- Outer back knob can be adjusted in and out for lumbar support and vertically for optimal positioning.
- Frame is standard with a polished aluminum arched base and accentuated with polished aluminum back trim.
- Side activated sliding seat depth adjustment is standard on both control mechanisms. Provides 2" of seat depth adjustment.
- C1 casters are standard.

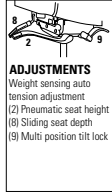
**OPTIONAL FEATURES**

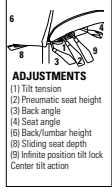
- For hard surface flooring please specify C9R. Add \$78.
- Check textile availability prior to specifying upholstery material.
- Please refer to the "Casters Selection" section of the price book for caster options.
- Please refer to "Cylinder Selection" section of the price book for additional cylinder options.
- For fully assembled in box, please specify SU. Add \$81

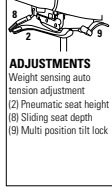
DESCRIPTION	FEATURES	MODEL#	STANDARD FABRIC GRADES											
 <p><b>HB Multi-Tilter</b> COM Yardage: 2 Freight Class: 250 Product Weight (lbs.): 66 Cubic Feet Per Carton: 23.5</p>	 <p><b>ADJUSTMENTS</b> (1) Tilt tension (2) Pneumatic seat height (3) Back angle (4) Seat angle (6) Back/lumbar height (8) Sliding seat depth (9) Infinite position tilt lock Center tilt action</p>	<p><b>3650-3</b></p>	1	2	3	4	5	6	7	8	9	10	11	12
			1732	1899	1958	2052	2183	2230	2342	2561	2666	2870	3145	3489
			<b>OVERALL DIMENSIONS</b>			<b>SEAT DIMENSIONS</b>			<b>BACK DIMENSIONS</b>					
			W	D	H	W	D	H	W	H				
			26	25	46.5	21	18-20.5	17-21	20	27				
			<b>RTA 00</b>											
 <p><b>HB Weight Sensing Synchro - Tilter</b> COM Yardage: 2 Freight Class: 250 Product Weight (lbs.): 66 Cubic Feet Per Carton: 23.5</p>	 <p><b>ADJUSTMENTS</b> Weight sensing auto tension adjustment (2) Pneumatic seat height (8) Sliding seat depth (9) Multi position tilt lock</p>	<p><b>3650-8</b></p>	1	2	3	4	5	6	7	8	9	10	11	12
			1732	1899	1958	2052	2183	2230	2342	2561	2666	2870	3145	3489
			<b>OVERALL DIMENSIONS</b>			<b>SEAT DIMENSIONS</b>			<b>BACK DIMENSIONS</b>					
			W	D	H	W	D	H	W	H				
			26	25	46.5	21	18-20.5	17-21	20	27				
			<b>RTA 00</b>											
 <p><b>MB Multi - Tilter</b> COM Yardage: 1.75 Freight Class: 250 Product Weight (lbs.): 64 Cubic Feet Per Carton: 20.5</p>	 <p><b>ADJUSTMENTS</b> (1) Tilt tension (2) Pneumatic seat height (3) Back angle (4) Seat angle (6) Back/lumbar height (8) Sliding seat depth (9) Infinite position tilt lock Center tilt action</p>	<p><b>3651-3</b></p>	1	2	3	4	5	6	7	8	9	10	11	12
			1697	1863	1924	2018	2149	2195	2309	2527	2631	2836	3110	3455
			<b>OVERALL DIMENSIONS</b>			<b>SEAT DIMENSIONS</b>			<b>BACK DIMENSIONS</b>					
			W	D	H	W	D	H	W	H				
			26	25	39.5	21	18-20.5	17-21	20	21				
			<b>RTA 00</b>											
 <p><b>MB Weight Sensing Synchro - Tilter</b> COM Yardage: 1.75 Freight Class: 250 Product Weight (lbs.): 64 Cubic Feet Per Carton: 20.5</p>	 <p><b>ADJUSTMENTS</b> Weight sensing auto tension adjustment (2) Pneumatic seat height (8) Sliding seat depth (9) Multi position tilt lock</p>	<p><b>3651-8</b></p>	1	2	3	4	5	6	7	8	9	10	11	12
			1697	1863	1924	2018	2149	2195	2309	2527	2631	2836	3110	3455
			<b>OVERALL DIMENSIONS</b>			<b>SEAT DIMENSIONS</b>			<b>BACK DIMENSIONS</b>					
			W	D	H	W	D	H	W	H				
			26	25	39.5	21	18-20.5	17-21	20	21				
			<b>RTA 00</b>											

TRUFORM™



model 5450-3



model 5451-3

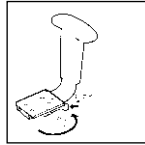











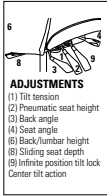

**Vari-Width (WA)**  
Width Adjustable Arm Extensions is standard when order with adjustable height arms.

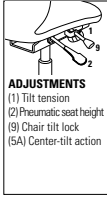



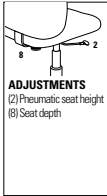





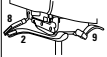







STANDARD FEATURES

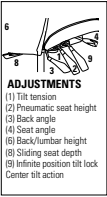



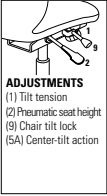

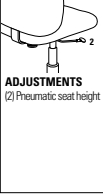

- A range of models available, all featuring gently curved, streamlined seat and back cushions
- Standard with adjustable height **SC** arms.
- All models are standard with a high rise, injection molded base, standard in black.
- All models are shipped partially **KD**.
- **C1** casters are standard.
- Check textile availability prior to specifying upholstery material.

OPTIONAL FEATURES

- Seat depth adjustment is standard on models 5450-8, 5451-0, 5451-3.
- An optional polished aluminum base is available, specify **ALU**. Add **\$177**.
- Please refer to "Arms Selection" section of the price book for arm options.
- Please refer to "Cylinder Selection" section of the price book for additional cylinder options.
- Please refer to the "Casters Selection" section of the price book for caster options. Optional casters may be priced higher than the standard casters for your chair and the difference will be charged. Lower priced optional casters will not be credited.
- For hard surface flooring please specify **C9R** and Add \$76.
- For fully assembled in box, please specify **SU**. Add \$81

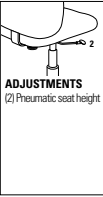
DESCRIPTION	FEATURES	MODEL#	STANDARD FABRIC GRADES													
			1	2	3	4	5	6	7	8	9	10	11	12		
 <p><b>HB Multi - Tilter</b> COM Yardage: 2 Freight Class: 125 Product Weight (lbs.): 63 Cubic Feet Per Carton: 10.5</p> <p>Ergonomic Features: A, B, C, D, F, G, H, M, N, Q, S</p>	 <p><b>ADJUSTMENTS</b> (1) Tilt tension (2) Pneumatic seat height (3) Back angle (4) Seat angle (5) Back/Jumper height (6) Sliding seat depth (9) Infinite position tilt lock Center tilt action</p>	<b>5450-3</b>	1019	1100	1157	1247	1375	1421	1531	1742	1845	2044	2310	2643		
		<b>OVERALL DIMENSIONS</b>			<b>SEAT DIMENSIONS</b>			<b>BACK DIMENSIONS</b>								
		<b>W</b>	<b>D</b>	<b>H</b>	<b>W</b>	<b>D</b>	<b>H</b>	<b>W</b>	<b>H</b>							
		26	25	42	20	18-20.5	16.5-20.5	20	23.5-26							
			  													
 <p><b>HB Tilter</b> COM Yardage: 2 Freight Class: 150 Product Weight (lbs.): 50 Cubic Feet Per Carton: 10.5</p> <p>Ergonomic Features: A, B, C, J, M, N</p>	 <p><b>ADJUSTMENTS</b> (1) Tilt tension (2) Pneumatic seat height (9) Chair tilt lock (5A) Center-tilt action</p>	<b>5450-4</b>	906	985	1046	1136	1264	1310	1418	1630	1732	1930	2198	2530		
		<b>OVERALL DIMENSIONS</b>			<b>SEAT DIMENSIONS</b>			<b>BACK DIMENSIONS</b>								
		<b>W</b>	<b>D</b>	<b>H</b>	<b>W</b>	<b>D</b>	<b>H</b>	<b>W</b>	<b>H</b>							
		26	25	42	20	18-20.5	16.5-20.5	20	23-26							
			  													
 <p><b>HB Task</b> COM Yardage: 2 Freight Class: 250 Product Weight (lbs.): 44 Cubic Feet Per Carton: 10.5</p> <p>Ergonomic Features: C, E, H, M, N, Q</p>	 <p><b>ADJUSTMENTS</b> (2) Pneumatic seat height (8) Seat depth</p>	<b>5450-6</b>	834	913	974	1064	1192	1238	1347	1558	1660	1858	2126	2458		
		<b>OVERALL DIMENSIONS</b>			<b>SEAT DIMENSIONS</b>			<b>BACK DIMENSIONS</b>								
		<b>W</b>	<b>D</b>	<b>H</b>	<b>W</b>	<b>D</b>	<b>H</b>	<b>W</b>	<b>H</b>							
		26	25	41.5	20	18-20.5	16-20	20	23.5-26							
			  													

DESCRIPTION	FEATURES	MODEL#	STANDARD FABRIC GRADES											
			1	2	3	4	5	6	7	8	9	10	11	12
 <p><b>HB Weight Sensing Synchro - Tilter</b> COM Yardage: 2 Freight Class: 125 Product Weight (lbs.): 64 Cubic Feet Per Carton: 10.5</p>	 <p><b>ADJUSTMENTS</b> Weight-sensing auto tension adjustment (2) Pneumatic seat height (8) Sliding seat depth (9) Multi-position tilt lock</p>	<b>5450-8</b>	1019	1097	1156	1245	1371	1412	1523	1731	1831	2023	2284	2611
			<b>OVERALL DIMENSIONS</b>			<b>SEAT DIMENSIONS</b>			<b>BACK DIMENSIONS</b>					
			<b>W</b>	<b>D</b>	<b>H</b>	<b>W</b>	<b>D</b>	<b>H</b>	<b>W</b>	<b>H</b>				
			26	25	41.5	20	18-20.5	16.5-20.5	20	23.5-26				
			  											
 <p><b>MB Synchro - Tilter w/Back Angle Adjustment</b> COM Yardage: 1.75 Freight Class: 125 Product Weight (lbs.): 63 Cubic Feet Per Carton: 10.5</p>	 <p><b>ADJUSTMENTS</b> (1) Tilt tension (2) Pneumatic seat height (6) Back height (9) Chair tilt lock (5C) Synchro-tilt action Anti-kick back</p>	<b>5451-0</b>	976	1047	1102	1180	1289	1330	1427	1613	1700	1875	2107	2398
			<b>OVERALL DIMENSIONS</b>			<b>SEAT DIMENSIONS</b>			<b>BACK DIMENSIONS</b>					
			<b>W</b>	<b>D</b>	<b>H</b>	<b>W</b>	<b>D</b>	<b>H</b>	<b>W</b>	<b>H</b>				
			26	25	38.5	20	18-20.5	17-21	20	23.5-26				
			  											
 <p><b>MB Multi - Tilter</b> COM Yardage: 1.75 Freight Class: 150 Product Weight (lbs.): 60 Cubic Feet Per Carton: 10.5</p>	 <p><b>ADJUSTMENTS</b> (1) Tilt tension (2) Pneumatic seat height (3) Back angle (4) Seat angle (6) Back/lumbar height (8) Sliding seat depth (9) Infinite position tilt lock Center tilt action</p>	<b>5451-3</b>	976	1047	1102	1180	1289	1330	1427	1613	1700	1875	2107	2398
			<b>OVERALL DIMENSIONS</b>			<b>SEAT DIMENSIONS</b>			<b>BACK DIMENSIONS</b>					
			<b>W</b>	<b>D</b>	<b>H</b>	<b>W</b>	<b>D</b>	<b>H</b>	<b>W</b>	<b>H</b>				
			26	25	38.5	20	18-20.5	16.5-20.5	20	20-22.5				
			  											
 <p><b>MB Tilter</b> COM Yardage: 1.75 Freight Class: 150 Product Weight (lbs.): 48 Cubic Feet Per Carton: 10.5</p>	 <p><b>ADJUSTMENTS</b> (1) Tilt tension (2) Pneumatic seat height (9) Chair tilt lock (5A) Center-tilt action</p>	<b>5451-4</b>	865	936	987	1065	1177	1219	1315	1498	1588	1761	1995	2286
			<b>OVERALL DIMENSIONS</b>			<b>SEAT DIMENSIONS</b>			<b>BACK DIMENSIONS</b>					
			<b>W</b>	<b>D</b>	<b>H</b>	<b>W</b>	<b>D</b>	<b>H</b>	<b>W</b>	<b>H</b>				
			26	25	38.5	20	18-20.5	16.5-20.5	20	20-22.5				
			  											

DESCRIPTION	FEATURES	MODEL#	STANDARD FABRIC GRADES											
			1	2	3	4	5	6	7	8	9	10	11	12
 <p><b>MB Height Adjustable Stool</b> Armless                      COM Yardage: 1.75                      Freight Class: 250                      Product Weight (lbs.): 38                      Cubic Feet Per Carton: 10.5</p>	 <p><b>ADJUSTMENTS</b>                      (2) Pneumatic seat height</p>	<b>5457-6</b>	1160	1231	1286	1364	1473	1513	1612	1797	1884	2059	2293	2582
			<b>OVERALL DIMENSIONS</b>			<b>SEAT DIMENSIONS</b>			<b>BACK DIMENSIONS</b>					
			<b>W</b>	<b>D</b>	<b>H</b>	<b>W</b>	<b>D</b>	<b>H</b>	<b>W</b>	<b>H</b>				
			20	25	47	20	17.5-19	22-30	20	20				
														
 <p><b>MB Height Adjustable Stool</b>                      COM Yardage: 1.75                      Freight Class: 150                      Product Weight (lbs.): 44                      Cubic Feet Per Carton: 10.5</p>	 <p><b>ADJUSTMENTS</b>                      (2) Pneumatic seat height</p>	<b>5458-6</b>	1355	1424	1477	1553	1666	1707	1805	1988	2076	2250	2485	2776
			<b>OVERALL DIMENSIONS</b>			<b>SEAT DIMENSIONS</b>			<b>BACK DIMENSIONS</b>					
			<b>W</b>	<b>D</b>	<b>H</b>	<b>W</b>	<b>D</b>	<b>H</b>	<b>W</b>	<b>H</b>				
			26	25	47	20	17.5-19	22-30	20	20				
														

TYE™



model 1950-4 (3N)



model 1951-4 (3N)







model 1953





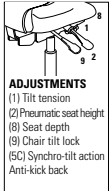

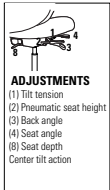

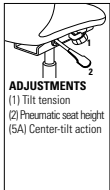

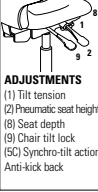



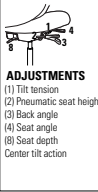

STANDARD FEATURES

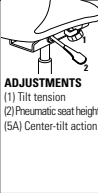

- Contemporary mesh fabric and upholstered panels are used on chair backs.
- Standard with adjustable height T-arms with curved urethane armcaps (3N) in Black Only, (except model 1953 which has a fixed height version of this same arm style). All models (except armchair) are standard with a five-legged, injection molded "spider" base.
- C65 casters are standard.
- Where fabric is approved for use only on seat, Luxhide Bonded Leather is recommended for the back textile selection.
- Seat depth and pneumatic seat height adjustments. Tilt tension adjustment with tilt lock.
- Mesh available in Black only.
- Check textile availability prior to specifying upholstery material.

OPTIONAL FEATURES

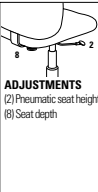
- Cantilever frame on armchair (model 1953) is available in Black (TBL) or Tungsten (TTU). No upcharge. For Chrome (CHM) finish, add 10% of opening published grade price.. Please refer to "Arms Selection" section of the price book for arm options.
- Please refer to the "Casters Selection" section of the price book for caster options. Optional casters may be priced higher than the standard casters for your chair and the difference will be charged. Lower priced optional casters will not be credited.
- For hard surface flooring, specify C65R. Add \$78.
- For fully assembled in box, specify SU. Add \$81

DESCRIPTION	FEATURES	MODEL#	STANDARD TEXTILE GRADES											
			1	2	3	4	5	6	7	8	9	10	11	12
 <p><b>HB Synchro - Tilter</b> COM Yardage: 1.5 Freight Class: 150 Product Weight (lbs.): 56 Cubic Feet Per Carton: 11</p>	 <p><b>ADJUSTMENTS</b> (1) Tilt tension (2) Pneumatic seat height (8) Seat depth (9) Chair tilt lock (5C) Synchro-tilt action Anti-kick back</p>	<b>1950-1</b>	1115	1179	1223	1292	1386	1421	1507	1666	1742	1891	2091	2348
		<b>OVERALL DIMENSIONS</b>			<b>SEAT DIMENSIONS</b>			<b>BACK DIMENSIONS</b>						
		<b>W</b>	<b>D</b>	<b>H</b>	<b>W</b>	<b>D</b>	<b>H</b>	<b>W</b>	<b>H</b>					
	25	26	45	21	19-20.5	17.5-21.5	19.5	27						
				<b>RTA 2</b>	<b>FedEx</b>	<b>ups</b>								
 <p><b>HB Multi - Tilter</b> COM Yardage: 1.5 Freight Class: 150 Product Weight (lbs.): 55 Cubic Feet Per Carton: 11</p>	 <p><b>ADJUSTMENTS</b> (1) Tilt tension (2) Pneumatic seat height (3) Back angle (4) Seat angle (8) Seat depth Center tilt action</p>	<b>1950-3</b>	1093	1153	1198	1267	1361	1398	1481	1643	1719	1868	2069	2326
		<b>OVERALL DIMENSIONS</b>			<b>SEAT DIMENSIONS</b>			<b>BACK DIMENSIONS</b>						
		<b>W</b>	<b>D</b>	<b>H</b>	<b>W</b>	<b>D</b>	<b>H</b>	<b>W</b>	<b>H</b>					
	25	26	45	21	19-20.5	17.5-21.5	19.5	27						
				<b>RTA 2</b>	<b>FedEx</b>	<b>ups</b>								
 <p><b>HB Tilter</b> COM Yardage: 1.5 Freight Class: 150 Product Weight (lbs.): 52 Cubic Feet Per Carton: 11</p>	 <p><b>ADJUSTMENTS</b> (1) Tilt tension (2) Pneumatic seat height (5A) Center-tilt action</p>	<b>1950-4</b>	930	987	1035	1107	1198	1231	1320	1480	1554	1703	1905	2161
		<b>OVERALL DIMENSIONS</b>			<b>SEAT DIMENSIONS</b>			<b>BACK DIMENSIONS</b>						
		<b>W</b>	<b>D</b>	<b>H</b>	<b>W</b>	<b>D</b>	<b>H</b>	<b>W</b>	<b>H</b>					
	25	26	45.5	21	19-20.5	16.5-20.5	19.5	27						
				<b>RTA 2</b>	<b>FedEx</b>	<b>ups</b>								

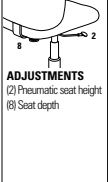
DESCRIPTION	FEATURES	MODEL#	STANDARD TEXTILE GRADES																					
			1	2	3	4	5	6	7	8	9	10	11	12										
 <p><b>MB Synchro - Tilter</b> COM Yardage: 1.25 Freight Class: 150 Product Weight (lbs.): 54 Cubic Feet Per Carton: 10.5</p>	 <p><b>ADJUSTMENTS</b> (1) Tilt tension (2) Pneumatic seat height (8) Seat depth (9) Chair tilt lock (5C) Synchro-tilt action Anti-kick back</p>	<p>1951-1</p>	1079	1130	1170	1224	1304	1332	1403	1537	1602	1724	1895	2104										
			<b>OVERALL DIMENSIONS</b>			<b>SEAT DIMENSIONS</b>			<b>BACK DIMENSIONS</b>															
			<b>W</b>	<b>D</b>	<b>H</b>	<b>W</b>	<b>D</b>	<b>H</b>	<b>W</b>	<b>H</b>														
			25	26	40.5	21	19-20.5	17-21	19.5	23														
<p>COM Yardage: 1.25 Freight Class: 150 Product Weight (lbs.): 54 Cubic Feet Per Carton: 10.5</p>	<p>Ergonomic Features: A, B, C, E, H, L, M, N</p>	<p>RTA 2</p>																						
					 <p><b>MB Multi - Tilter</b> COM Yardage: 1.25 Freight Class: 150 Product Weight (lbs.): 53 Cubic Feet Per Carton: 10.5</p>	 <p><b>ADJUSTMENTS</b> (1) Tilt tension (2) Pneumatic seat height (3) Back angle (4) Seat angle (8) Seat depth Center tilt action</p>	<p>1951-3</p>	1054	1105	1145	1197	1280	1307	1376	1510	1576	1699	1871	2080					
								<b>OVERALL DIMENSIONS</b>			<b>SEAT DIMENSIONS</b>			<b>BACK DIMENSIONS</b>										
								<b>W</b>	<b>D</b>	<b>H</b>	<b>W</b>	<b>D</b>	<b>H</b>	<b>W</b>	<b>H</b>									
25	26	40.5	21	19-20.5				17-21	19.5	23														
<p>COM Yardage: 1.25 Freight Class: 150 Product Weight (lbs.): 53 Cubic Feet Per Carton: 10.5</p>	<p>Ergonomic Features: A, B, C, E, F, H, M, N, S</p>	<p>RTA 2</p>																						
					 <p><b>MB Tilter</b> COM Yardage: 1.25 Freight Class: 150 Product Weight (lbs.): 50 Cubic Feet Per Carton: 10.5</p>	 <p><b>ADJUSTMENTS</b> (1) Tilt tension (2) Pneumatic seat height (5A) Center-tilt action</p>	<p>1951-4</p>	889	939	980	1034	1115	1145	1219	1349	1411	1537	1707	1915					
								<b>OVERALL DIMENSIONS</b>			<b>SEAT DIMENSIONS</b>			<b>BACK DIMENSIONS</b>										
								<b>W</b>	<b>D</b>	<b>H</b>	<b>W</b>	<b>D</b>	<b>H</b>	<b>W</b>	<b>H</b>									
25	26	41	21	19-20.5				17-21	19.5	23														
<p>COM Yardage: 1.25 Freight Class: 150 Product Weight (lbs.): 50 Cubic Feet Per Carton: 10.5</p>	<p>Ergonomic Features: A, C, E, H, M, N</p>	<p>RTA 2</p>																						
					 <p><b>Armchair</b> COM Yardage: 1 Freight Class: 250 Product Weight (lbs.): 36 Cubic Feet Per Carton: 10.25</p>	<p>Ergonomic Features: M, N</p>	<p>RTA 1</p>																	
										 <p><b>LB Task Armless</b> COM Yardage: 1 Freight Class: 150 Product Weight (lbs.): 37 Cubic Feet Per Carton: 9.25</p>	 <p><b>ADJUSTMENTS</b> (2) Pneumatic seat height (8) Seat depth</p>	<p>1954-6</p>	661	710	749	807	886	913	983	1116	1183	1305	1476	1685
													<b>OVERALL DIMENSIONS</b>			<b>SEAT DIMENSIONS</b>			<b>BACK DIMENSIONS</b>					
<b>W</b>	<b>D</b>	<b>H</b>	<b>W</b>	<b>D</b>									<b>H</b>	<b>W</b>	<b>H</b>									
25	26	35	21	19-20.5	17-22	19.5	16																	
<p>COM Yardage: 1 Freight Class: 150 Product Weight (lbs.): 37 Cubic Feet Per Carton: 9.25</p>	<p>Ergonomic Features: C, E, M, N</p>	<p>RTA 2</p>																						

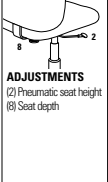
DESCRIPTION	FEATURES	MODEL#	STANDARD TEXTILE GRADES														
			1	2	3	4	5	6	7	8	9	10	11	12			
 <p><b>LB Task Height Adjustable Chair</b> COM Yardage: 1 Freight Class: 150 Product Weight (lbs.): 47 Cubic Feet Per Carton: 9.25</p>	 <p><b>ADJUSTMENTS</b> (2) Pneumatic seat height (8) Seat depth</p>	<b>1922-6</b>	923	964	996	1044	1108	1130	1190	1297	1350	1452	1588	1760			
			OVERALL DIMENSIONS			SEAT DIMENSIONS			BACK DIMENSIONS								
			W	D	H	W	D	H	W	H							
	25	26	44.5	21	19-20.5	24-34	19.5	16									
				<b>RTA 2</b>	<b>FedEx</b>	<b>UPS</b>											
 <p><b>LB Task Height Adjustable Chair Armless</b> COM Yardage: 1 Freight Class: 150 Product Weight (lbs.): 40 Cubic Feet Per Carton: 9.25</p>	 <p><b>ADJUSTMENTS</b> (2) Pneumatic seat height (8) Seat depth</p>	<b>1924-6</b>	812	853	882	925	987	1010	1064	1168	1220	1315	1448	1609			
			OVERALL DIMENSIONS			SEAT DIMENSIONS			BACK DIMENSIONS								
			W	D	H	W	D	H	W	H							
	25	26	44.5	21	19-20.5	24-34	19.5	16									
				<b>RTA 2</b>	<b>FedEx</b>	<b>UPS</b>											

VION



model 6321-0



model 6331-8



**Optional Live Lumbar Support Pad (LS)**

Lumbar Pad is spring loaded, providing pressure sensitive depth adjustment and 3 inches of height adjustment.



model 6322-4 (C)



model 6321-4PB



Vion Guest Chair please see 234

STANDARD FEATURES

- Vion is a comprehensive seating series offering a family of models to address multiple applications: task, management, conference, guest, pedestal base, heavy duty 24/7 and stools.
- Vion Care Compliant models, with "GC" model code prefix, are available for select models (GC6322-0, GC6322-4, GC6331-0, GC6331-4). These models have standard high density, ultracell foam and polyurethane seat underside with sealed connections. Optional sealed seat seams and moisture barrier are available on these models only.
- Vion Heavy Duty models can be found in the Heavy Duty section of the price book (407).
- Series offers mid and high back models with either a mesh or upholstered back.
- Five different control mechanism options to suit all price points and ergonomic requirements.
- All models are standard with height and width adjustable arms (AS) that feature a front to back sliding armcap.
- Standard with Global's high quality Soft Descent™ pneumatic lift which slowly and gently lowers the seat height of the chair, making it easy to obtain the desired position.
- Side activated sliding seat depth adjustment is standard on multi-tilter, synchro tilter with back angle adjustment and weight sensing synchro tilter control mechanisms.
- Standard with Black five prong, injection molded, fiberglass reinforced nylon Governor base (B7) with dual wheel carpet casters (C1).
- Mesh back models are available in 10 standard Vion colors: Aqua (MS75), Black (MS69), Black Cherry (MS76), Blue (MS72), Dust (MS77), Ivory (MS78), Natural (MS74), Paprika (MS79), Rope (MS73) and Stone (MS71).
- Upholstered back models feature black fabric Jenny (JN02) on the back side as standard.
- Check textile availability prior to specifying upholstery material.
- Pedestal base models are offered on (-4) Tilter and (-6) Task (basic swivel) mechanisms only. These models provide fixed location seating for use in auditoriums, classrooms, jury boxes, public venues and more. The base must be mounted to the floor (mounting hardware not included). See Pedestal Base Installation Guide for details.

OPTIONAL FEATURES

- Vion back frames, arms and bases are available in three colors: Black, Shadow and Fog. See Vion finishes chart for options and upcharges. Armcaps are always Black.
- Mesh back models are also available in 7 Dimension Mesh colors: Black (DBK), Fog (DST), Chalk (DCL), Shadow (DGM), Charcoal (DCH), Sand (DSD), Pool Blue (DPB). Add \$29.
- Upholstered back models offer a Matching Outer (MO) upholstery option. Due to the Additional material needed, these models are listed separately and are priced differently than the standard upholstered back models.
- Optional lumbar pad can be added at the time of order. Please specify (LS) and add \$43 Lumbar pad can also be ordered after sale as a kit, specify model 6339 at \$46 list. The lumbar pad is adjustable up to 3".
- Seat available in memory foam. Please specify (MF) and add \$124.
- Petite seat models (2" shorter and 2" narrower than the standard size seat) are available. Specify (ST) for standard foam or (P) for petite seat, no upcharge.
- A moisture barrier is available for the seat cushion on GC Vion models only. Specify (NB) for no moisture barrier, no upcharge, or (MB) for Moisture Barrier. Add \$117.
- Sealed seams are available on the seat of GC Vion models when specified with approved coated textile. Contact Customer Care for availability. Specify (NS) for no sealed seams, no upcharge, or (SE) for sealed seat seams. Add \$26.
- For hard surface flooring casters, please specify (C9R). Add \$76.
- Two featured "T" arm options that include height and width adjusting arms, one with sliding arm caps (AS) and one without sliding arm caps (AF). Also, available is a stylish fixed urethane arm (C) for conference/management environments.
- For additional arm/caster options, please refer to the Arm and Caster section (409). Optional casters may be priced higher than the standard casters for your chair and the difference will be charged. Lower priced optional casters will not be credited.
- Please refer to "Cylinder Selection" section of the price book for additional cylinder options.
- For fully assembled in box, please specify SU. Add \$81.
- Pedestal Base models have black bases with 2" height adjust cylinders. Specify (SH) swivel, auto return to max height (no upcharge); (SN) non-swivel, auto return to max height (Add \$23); or (SC) swivel, self-centering and return to max height (Add \$35).

VION FINISHES - TASK SEATING				
Back Frame	Base	Specify Code	Arm Option	Specify Code
Black	Black	BLK no upcharge	Adj. "T" arm (Black) Adj. "T" arm, fixed armcap (Black) Adj. "T" arm (Black, Chrome accent)	AS AF AC
Black	Polished Aluminum	BAU Add \$177	Adj. "T" arm, fixed armcap (Black, Chrome accent) Fixed "C" arm (Black) Fixed "C" arm (Polished Aluminum)	A C CA - Add \$214
Shadow	Shadow	SHW Add \$81	Adj. "T" arm (Shadow) Adj. "T" arm, fixed armcap (Shadow) Adj. "T" arm (Shadow, Chrome accent)	SHA SHF SHR
Shadow	Polished Aluminum	SAU Add \$255	Adj. "T" arm, fixed armcap (Shadow, Chrome accent) Fixed "C" arm (Shadow) Fixed "C" arm (Polished Aluminum)	SHD SHC CA - Add \$214
Fog	Fog	FOG Add \$81	Adj. "T" arm (Fog) Adj. "T" arm, fixed armcap (Fog) Adj. "T" arm (Fog, Chrome accent)	FA FF FC
Fog	Polished Aluminum	FAU Add \$255	Adj. "T" arm, fixed armcap (Fog, Chrome accent) Fixed "C" arm (Fog) Fixed "C" arm (Polished Aluminum)	CF CC CA - Add \$214

\* All arms have Black SSU Armcaps.

DESCRIPTION



**HB Synchro - Tilter w/Back Angle Adjustment**  
COM Yardage: 1  
Freight Class: 150  
Product Weight (lbs.): 60  
Cubic Feet Per Carton: 10.5

FEATURES

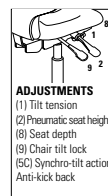

**ADJUSTMENTS**  
(1) Tilt tension  
(2) Pneumatic seat height  
(8) Seat depth  
(9) Chair tilt lock  
(5C) Synchro-tilt action  
Anti-kick back

Mesh Back

Ergonomic Features:  
A, B, C, E, G, H, L, M, N, Q, U

MODEL#

STANDARD TEXTILE GRADES

	1	2	3	4	5	6	7	8	9	10	11	12
<b>6321-0</b>	1053	1093	1122	1165	1227	1250	1304	1408	1460	1555	1686	1848

OVERALL DIMENSIONS

W	D	H
25.5	24	41.5









SEAT DIMENSIONS

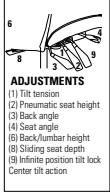

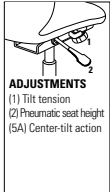

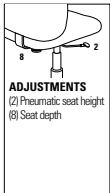

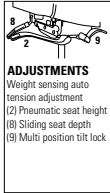

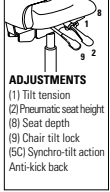
W	D	H
20	17-20	17.5-22.5

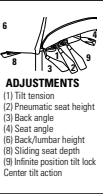

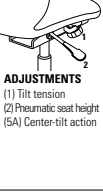

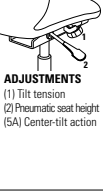

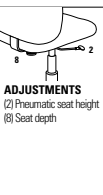

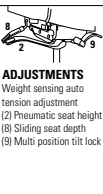
BACK DIMENSIONS

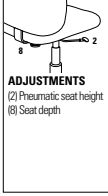

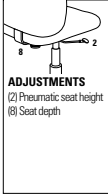

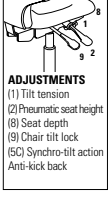

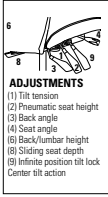

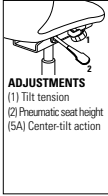

W	H
18.5	23











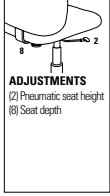



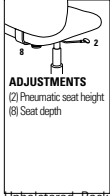



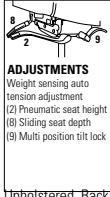

DESCRIPTION	FEATURES	MODEL#	STANDARD TEXTILE GRADES											
			1	2	3	4	5	6	7	8	9	10	11	12
 <p><b>HB Multi - Tilter</b> COM Yardage: 1 Freight Class: 150 Product Weight (lbs.): 62 Cubic Feet Per Carton: 10.5</p>	 <p><b>ADJUSTMENTS</b> (1) Tilt tension (2) Pneumatic seat height (3) Back angle (4) Seat angle (5) Back/Jumbo height (6) Sliding seat depth (8) Infinite position tilt lock Center-tilt action</p>	<b>6321-3</b>	1053	1093	1122	1165	1227	1250	1304	1408	1460	1555	1686	1848
			<b>OVERALL DIMENSIONS</b>			<b>SEAT DIMENSIONS</b>			<b>BACK DIMENSIONS</b>					
			<b>W</b>	<b>D</b>	<b>H</b>	<b>W</b>	<b>D</b>	<b>H</b>	<b>W</b>	<b>H</b>				
			25.5	24	41	20	17-20	17.25-22.25	18.5	23				
			<b>RTA 2</b>	<b>FedEx</b>		<b>ups</b>								
 <p><b>HB Tilter</b> COM Yardage: 1 Freight Class: 150 Product Weight (lbs.): 54 Cubic Feet Per Carton: 10.5</p>	 <p><b>ADJUSTMENTS</b> (1) Tilt tension (2) Pneumatic seat height (5A) Center-tilt action</p>	<b>6321-4</b>	943	983	1013	1056	1118	1141	1195	1299	1351	1446	1576	1739
			<b>OVERALL DIMENSIONS</b>			<b>SEAT DIMENSIONS</b>			<b>BACK DIMENSIONS</b>					
			<b>W</b>	<b>D</b>	<b>H</b>	<b>W</b>	<b>D</b>	<b>H</b>	<b>W</b>	<b>H</b>				
			25.5	24	39.25	20	17.5	16-21	18.5	23				
			<b>RTA 2</b>	<b>FedEx</b>		<b>ups</b>								
 <p><b>HB Task</b> COM Yardage: 1 Freight Class: 150 Product Weight (lbs.): 49 Cubic Feet Per Carton: 10.5</p>	 <p><b>ADJUSTMENTS</b> (2) Pneumatic seat height (8) Seat depth</p>	<b>6321-6</b>	904	944	974	1016	1079	1101	1156	1260	1311	1406	1537	1699
			<b>OVERALL DIMENSIONS</b>			<b>SEAT DIMENSIONS</b>			<b>BACK DIMENSIONS</b>					
			<b>W</b>	<b>D</b>	<b>H</b>	<b>W</b>	<b>D</b>	<b>H</b>	<b>W</b>	<b>H</b>				
			25.5	24	39.25	20	17.5	17-22	18.5	23				
			<b>RTA 2</b>	<b>FedEx</b>		<b>ups</b>								
 <p><b>HB Weight Sensing Synchro - Tilter</b> COM Yardage: 1 Freight Class: 150 Product Weight (lbs.): 57 Cubic Feet Per Carton: 10.5</p>	 <p><b>ADJUSTMENTS</b> Weight sensing auto tension adjustment (2) Pneumatic seat height (8) Sliding seat depth (9) Multi position tilt lock</p>	<b>6321-8</b>	1053	1093	1122	1165	1227	1250	1304	1408	1460	1555	1686	1848
			<b>OVERALL DIMENSIONS</b>			<b>SEAT DIMENSIONS</b>			<b>BACK DIMENSIONS</b>					
			<b>W</b>	<b>D</b>	<b>H</b>	<b>W</b>	<b>D</b>	<b>H</b>	<b>W</b>	<b>H</b>				
			25.5	24	40	20	17-20	16.5-21.5	18.5	23				
			<b>RTA 2</b>	<b>FedEx</b>		<b>ups</b>								
 <p><b>MB Synchro - Tilter w/Back Angle Adjustment</b> COM Yardage: 1 Freight Class: 150 Product Weight (lbs.): 58 Cubic Feet Per Carton: 10.5</p>	 <p><b>ADJUSTMENTS</b> (1) Tilt tension (2) Pneumatic seat height (8) Seat depth (9) Chair tilt lock (5C) Synchro-tilt action Anti-kick back</p>	<b>6322-0</b>	997	1035	1066	1109	1171	1194	1248	1352	1404	1499	1630	1792
			<b>OVERALL DIMENSIONS</b>			<b>SEAT DIMENSIONS</b>			<b>BACK DIMENSIONS</b>					
			<b>W</b>	<b>D</b>	<b>H</b>	<b>W</b>	<b>D</b>	<b>H</b>	<b>W</b>	<b>H</b>				
			25.5	24	39.5	20	17-20	17.5-22.5	18.5	21				
			<b>RTA 2</b>	<b>FedEx</b>		<b>ups</b>								

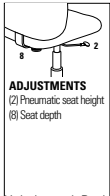
DESCRIPTION	FEATURES	MODEL#	STANDARD TEXTILE GRADES																																					
			1	2	3	4	5	6	7	8	9	10	11	12																										
 <p><b>MB Multi - Tilter</b> COM Yardage: 1 Freight Class: 150 Product Weight (lbs.): 60 Cubic Feet Per Carton: 10.5</p>	 <p><b>ADJUSTMENTS</b> (1) Tilt tension (2) Pneumatic seat height (3) Back angle (4) Seat angle (5) Back/Jumper height (6) Sliding seat depth (9) Infinite position tilt lock Center-tilt action</p>	<p>Mesh Back</p> <p>Ergonomic Features: A, B, C, E, F, G, H, M, N, Q, U, S</p>	<table border="1"> <tr> <td>6322-3</td> <td>997</td> <td>1035</td> <td>1066</td> <td>1109</td> <td>1171</td> <td>1194</td> <td>1248</td> <td>1352</td> <td>1404</td> <td>1499</td> <td>1630</td> <td>1792</td> </tr> </table>												6322-3	997	1035	1066	1109	1171	1194	1248	1352	1404	1499	1630	1792													
			6322-3	997	1035	1066	1109	1171	1194	1248	1352	1404	1499	1630	1792																									
			<b>OVERALL DIMENSIONS</b>			<b>SEAT DIMENSIONS</b>			<b>BACK DIMENSIONS</b>																															
			<b>W</b>	<b>D</b>	<b>H</b>	<b>W</b>	<b>D</b>	<b>H</b>	<b>W</b>		<b>H</b>																													
			25.5	24	39	20	17-20	17.25-22.25	18.5		21																													
RTA 2			FedEx			ups																																		
 <p><b>MB Tilter</b> COM Yardage: 1 Freight Class: 150 Product Weight (lbs.): 52 Cubic Feet Per Carton: 10.5</p>	 <p><b>ADJUSTMENTS</b> (1) Tilt tension (2) Pneumatic seat height (5A) Center-tilt action</p>	<p>Mesh Back</p> <p>Ergonomic Features: A, B, C, E, H, M, N, Q, S, U</p>	<table border="1"> <tr> <td>6322-4</td> <td>887</td> <td>928</td> <td>958</td> <td>1001</td> <td>1064</td> <td>1085</td> <td>1140</td> <td>1245</td> <td>1296</td> <td>1391</td> <td>1523</td> <td>1684</td> </tr> <tr> <td>GC6322-4</td> <td>-</td> <td>\$1254</td> <td>1286</td> <td>1327</td> <td>1385</td> <td>1411</td> <td>\$1464</td> <td>\$1549</td> <td>\$1614</td> <td>\$1686</td> <td>\$1833</td> <td>\$1992</td> </tr> </table>												6322-4	887	928	958	1001	1064	1085	1140	1245	1296	1391	1523	1684	GC6322-4	-	\$1254	1286	1327	1385	1411	\$1464	\$1549	\$1614	\$1686	\$1833	\$1992
			6322-4	887	928	958	1001	1064	1085	1140	1245	1296	1391	1523	1684																									
			GC6322-4	-	\$1254	1286	1327	1385	1411	\$1464	\$1549	\$1614	\$1686	\$1833	\$1992																									
			<b>OVERALL DIMENSIONS</b>			<b>SEAT DIMENSIONS</b>			<b>BACK DIMENSIONS</b>																															
			<b>W</b>	<b>D</b>	<b>H</b>	<b>W</b>	<b>D</b>	<b>H</b>	<b>W</b>		<b>H</b>																													
25.5	24	37.5	20	17.5	16-21	18.5		21																																
RTA 2			FedEx			ups																																		
 <p><b>MB Task</b> COM Yardage: 1 Freight Class: 150 Product Weight (lbs.): 52 Cubic Feet Per Carton: 10.5</p>	 <p><b>ADJUSTMENTS</b> (1) Tilt tension (2) Pneumatic seat height (8) Seat depth</p>	<p>Mesh Back</p> <p>Ergonomic Features: C, E, M, N, Q, U</p>	<table border="1"> <tr> <td>6322-6</td> <td>857</td> <td>898</td> <td>927</td> <td>969</td> <td>1032</td> <td>1055</td> <td>1109</td> <td>1213</td> <td>1265</td> <td>1359</td> <td>1490</td> <td>1653</td> </tr> </table>												6322-6	857	898	927	969	1032	1055	1109	1213	1265	1359	1490	1653													
			6322-6	857	898	927	969	1032	1055	1109	1213	1265	1359	1490	1653																									
			<b>OVERALL DIMENSIONS</b>			<b>SEAT DIMENSIONS</b>			<b>BACK DIMENSIONS</b>																															
			<b>W</b>	<b>D</b>	<b>H</b>	<b>W</b>	<b>D</b>	<b>H</b>	<b>W</b>		<b>H</b>																													
			25.5	24	37.5	20	17.5	17-22	18.5		21																													
RTA 2			FedEx			ups																																		
 <p><b>MB Task - Armless</b> COM Yardage: 1 Freight Class: 250 Product Weight (lbs.): 41 Cubic Feet Per Carton: 10.5</p>	 <p><b>ADJUSTMENTS</b> (2) Pneumatic seat height (8) Seat depth</p>	<p>Mesh Back</p> <p>Ergonomic Features: C, E, M, N, U</p>	<table border="1"> <tr> <td>6323-6</td> <td>810</td> <td>851</td> <td>880</td> <td>923</td> <td>985</td> <td>1008</td> <td>1062</td> <td>1166</td> <td>1218</td> <td>1313</td> <td>1446</td> <td>1606</td> </tr> </table>												6323-6	810	851	880	923	985	1008	1062	1166	1218	1313	1446	1606													
			6323-6	810	851	880	923	985	1008	1062	1166	1218	1313	1446	1606																									
			<b>OVERALL DIMENSIONS</b>			<b>SEAT DIMENSIONS</b>			<b>BACK DIMENSIONS</b>																															
			<b>W</b>	<b>D</b>	<b>H</b>	<b>W</b>	<b>D</b>	<b>H</b>	<b>W</b>		<b>H</b>																													
			20	24	37.5	20	17.5	17-22	18.5		21																													
RTA 2			FedEx			ups																																		
 <p><b>MB Weight Sensing Synchro - Tilter</b> COM Yardage: 1 Freight Class: 150 Product Weight (lbs.): 55 Cubic Feet Per Carton: 10.5</p>	 <p><b>ADJUSTMENTS</b> Weight-sensing auto tension adjustment (2) Pneumatic seat height (8) Sliding seat depth (9) Multi position tilt lock</p>	<p>Mesh Back</p> <p>Ergonomic Features: A, B, C, E, H, L, M, N, Q, U</p>	<table border="1"> <tr> <td>6322-8</td> <td>997</td> <td>1035</td> <td>1066</td> <td>1109</td> <td>1171</td> <td>1194</td> <td>1248</td> <td>1352</td> <td>1404</td> <td>1499</td> <td>1630</td> <td>1792</td> </tr> </table>												6322-8	997	1035	1066	1109	1171	1194	1248	1352	1404	1499	1630	1792													
			6322-8	997	1035	1066	1109	1171	1194	1248	1352	1404	1499	1630	1792																									
			<b>OVERALL DIMENSIONS</b>			<b>SEAT DIMENSIONS</b>			<b>BACK DIMENSIONS</b>																															
			<b>W</b>	<b>D</b>	<b>H</b>	<b>W</b>	<b>D</b>	<b>H</b>	<b>W</b>		<b>H</b>																													
			25.5	24	38	20	17-20	16.5-21.5	18.5		21																													
RTA 2			FedEx			ups																																		

DESCRIPTION	FEATURES	MODEL#	STANDARD TEXTILE GRADES														
			1	2	3	4	5	6	7	8	9	10	11	12			
 <p><b>MB Height Adjustable Stool - Task Armless</b> COM Yardage: 1 Freight Class: 150 Product Weight (lbs.): 50 Cubic Feet Per Carton: 10.5</p>	 <p><b>ADJUSTMENTS</b> (2) Pneumatic seat height (8) Seat depth</p>	<p>Mesh Back</p> <p>Ergonomic Features: C, E, M, N, U</p>	6327-6	904	945	975	1017	1081	1103	1157	1262	1313	1407	1540	1702		
			<b>OVERALL DIMENSIONS</b>			<b>SEAT DIMENSIONS</b>			<b>BACK DIMENSIONS</b>								
			<b>W</b>	<b>D</b>	<b>H</b>	<b>W</b>	<b>D</b>	<b>H</b>	<b>W</b>	<b>H</b>							
			20	24	48	20	17.5	23.5-33.5	18.5	21							
			RTA 2	FedEx		ups											
 <p><b>MB Height Adjustable Stool - Task</b> COM Yardage: 1 Freight Class: 150 Product Weight (lbs.): 44 Cubic Feet Per Carton: 10.5</p>	 <p><b>ADJUSTMENTS</b> (2) Pneumatic seat height (8) Seat depth</p>	<p>Mesh Back</p> <p>Ergonomic Features: C, E, H, M, N, Q, U</p>	6328-6	1020	1061	1091	1133	1197	1218	1272	1376	1428	1523	1656	1816		
			<b>OVERALL DIMENSIONS</b>			<b>SEAT DIMENSIONS</b>			<b>BACK DIMENSIONS</b>								
			<b>W</b>	<b>D</b>	<b>H</b>	<b>W</b>	<b>D</b>	<b>H</b>	<b>W</b>	<b>H</b>							
			20	24	48	20	17.5	23.5-33.5	18.5	21							
			RTA 2	FedEx		ups											
 <p><b>HB Synchro - Tilter w/Back Angle Adjustment</b> COM Yardage: 1.25 Freight Class: 150 Product Weight (lbs.): 61 Cubic Feet Per Carton: 10.50</p>	 <p><b>ADJUSTMENTS</b> (1) Tilt tension (2) Pneumatic seat height (8) Seat depth (9) Chair tilt lock (5C) Synchro-tilt action Anti-kick back</p>	<p>Upholstered Back</p> <p>Ergonomic Features: A, B, C, E, G, H, L, M, N, Q, U</p>	6331-0	1194	1245	1279	1334	1413	1443	1508	1641	1702	1821	1987	2189		
			6331-OMO	1258	1332	1394	1479	1605	1650	1759	1966	2066	2259	2521	2847		
			GC6331-0	-	\$1465	\$1500	\$1548	\$1616	\$1649	\$1711	\$1810	\$1885	\$1971	\$2145	\$2331		
			<b>OVERALL DIMENSIONS</b>			<b>SEAT DIMENSIONS</b>			<b>BACK DIMENSIONS</b>								
<b>W</b>	<b>D</b>	<b>H</b>	<b>W</b>	<b>D</b>	<b>H</b>	<b>W</b>	<b>H</b>										
25.5	24	41.5	20	17-20	17.5-22.5	18.5	23										
			RTA 2	FedEx		ups											
 <p><b>HB Multi - Tilter</b> COM Yardage: 1.25 Freight Class: 125 Product Weight (lbs.): 63 Cubic Feet Per Carton: 10.5</p>	 <p><b>ADJUSTMENTS</b> (1) Tilt tension (2) Pneumatic seat height (3) Back angle (4) Seat angle (6) Back/lumbar height (8) Sliding seat depth (9) Infinite position tilt lock Center tilt action</p>	<p>Upholstered back</p> <p>Ergonomic Features: A, B, C, E, F, G, H, M, N, Q, U, S</p>	6331-3	1194	1245	1279	1334	1413	1443	1508	1641	1702	1821	1987	2189		
			6331-3MO	1258	1332	1394	1479	1605	1650	1759	1966	2066	2259	2521	2847		
			<b>OVERALL DIMENSIONS</b>			<b>SEAT DIMENSIONS</b>			<b>BACK DIMENSIONS</b>								
			<b>W</b>	<b>D</b>	<b>H</b>	<b>W</b>	<b>D</b>	<b>H</b>	<b>W</b>	<b>H</b>							
25.5	24	41	20	17-20	17.25-22.25	18.5	23										
			RTA 2	FedEx		ups											
 <p><b>HB Tilter</b> COM Yardage: 1.25 Freight Class: 150 Product Weight (lbs.): 55 Cubic Feet Per Carton: 10.5</p>	 <p><b>ADJUSTMENTS</b> (1) Tilt tension (2) Pneumatic seat height (5A) Center-tilt action</p>	<p>Upholstered back</p> <p>Ergonomic Features: A, B, C, E, H, M, N, Q, S, U</p>	6331-4	1067	1118	1156	1210	1288	1316	1381	1514	1576	1696	1861	2062		
			6331-4MO	1131	1209	1267	1355	1478	1524	1633	1840	1941	2133	2394	2723		
			GC6331-4	-	\$1280	\$1316	\$1365	\$1436	\$1469	\$1533	\$1634	\$1714	\$1801	\$1980	\$2172		
			<b>OVERALL DIMENSIONS</b>			<b>SEAT DIMENSIONS</b>			<b>BACK DIMENSIONS</b>								
<b>W</b>	<b>D</b>	<b>H</b>	<b>W</b>	<b>D</b>	<b>H</b>	<b>W</b>	<b>H</b>										
25.5	24	39.25	20	17.5	16-21	18.5	23										
			RTA 2	FedEx		ups											

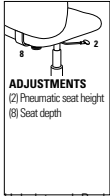
DESCRIPTION	FEATURES	MODEL#	STANDARD TEXTILE GRADES																																					
			1	2	3	4	5	6	7	8	9	10	11	12																										
 <p><b>HB Task</b> COM Yardage: 1.25 Freight Class: 150 Product Weight (lbs.): 49 Cubic Feet Per Carton: 10.5</p>	 <p><b>ADJUSTMENTS</b> (2) Pneumatic seat height (8) Seat depth</p>	<p>Upholstered Back</p> <p>Ergonomic Features: C, E, M, N</p>	<table border="1"> <tr> <td><b>6331-6</b></td> <td>1037</td> <td>1087</td> <td>1122</td> <td>1177</td> <td>1256</td> <td>1284</td> <td>1351</td> <td>1483</td> <td>1545</td> <td>1664</td> <td>1830</td> <td>2032</td> </tr> <tr> <td><b>6331-6MO</b></td> <td>1100</td> <td>1176</td> <td>1236</td> <td>1324</td> <td>1450</td> <td>1493</td> <td>1602</td> <td>1809</td> <td>1909</td> <td>2102</td> <td>2363</td> <td>2690</td> </tr> </table>												<b>6331-6</b>	1037	1087	1122	1177	1256	1284	1351	1483	1545	1664	1830	2032	<b>6331-6MO</b>	1100	1176	1236	1324	1450	1493	1602	1809	1909	2102	2363	2690
			<b>6331-6</b>	1037	1087	1122	1177	1256	1284	1351	1483	1545	1664	1830	2032																									
			<b>6331-6MO</b>	1100	1176	1236	1324	1450	1493	1602	1809	1909	2102	2363	2690																									
			<table border="1"> <tr> <th colspan="3">OVERALL DIMENSIONS</th> <th colspan="3">SEAT DIMENSIONS</th> <th colspan="3">BACK DIMENSIONS</th> </tr> <tr> <th>W</th> <th>D</th> <th>H</th> <th>W</th> <th>D</th> <th>H</th> <th>W</th> <th>H</th> </tr> <tr> <td>25.5</td> <td>24</td> <td>39.25</td> <td>20</td> <td>17.5</td> <td>17-22</td> <td>18.5</td> <td>23</td> </tr> </table>			OVERALL DIMENSIONS			SEAT DIMENSIONS			BACK DIMENSIONS			W	D	H	W	D	H	W	H	25.5	24	39.25	20	17.5	17-22	18.5	23	<p>RTA 2</p> <p>FedEx UPS</p>									
OVERALL DIMENSIONS			SEAT DIMENSIONS			BACK DIMENSIONS																																		
W	D	H	W	D	H	W	H																																	
25.5	24	39.25	20	17.5	17-22	18.5	23																																	
 <p><b>HB Weight Sensing Synchro - Tilter</b> COM Yardage: 1.25 Freight Class: 150 Product Weight (lbs.): 58 Cubic Feet Per Carton: 10.5</p>	 <p><b>ADJUSTMENTS</b> Weight sensing auto tension adjustment (2) Pneumatic seat height (8) Sliding seat depth (9) Multi position tilt lock</p>	<p>Upholstered Back</p> <p>Ergonomic Features: A, B, C, E, H, L, M, N, Q, U</p>	<table border="1"> <tr> <td><b>6331-8</b></td> <td>1194</td> <td>1245</td> <td>1279</td> <td>1334</td> <td>1413</td> <td>1443</td> <td>1508</td> <td>1641</td> <td>1702</td> <td>1821</td> <td>1987</td> <td>2189</td> </tr> <tr> <td><b>6331-8MO</b></td> <td>1258</td> <td>1332</td> <td>1394</td> <td>1479</td> <td>1605</td> <td>1650</td> <td>1759</td> <td>1966</td> <td>2066</td> <td>2259</td> <td>2521</td> <td>2847</td> </tr> </table>												<b>6331-8</b>	1194	1245	1279	1334	1413	1443	1508	1641	1702	1821	1987	2189	<b>6331-8MO</b>	1258	1332	1394	1479	1605	1650	1759	1966	2066	2259	2521	2847
			<b>6331-8</b>	1194	1245	1279	1334	1413	1443	1508	1641	1702	1821	1987	2189																									
			<b>6331-8MO</b>	1258	1332	1394	1479	1605	1650	1759	1966	2066	2259	2521	2847																									
			<table border="1"> <tr> <th colspan="3">OVERALL DIMENSIONS</th> <th colspan="3">SEAT DIMENSIONS</th> <th colspan="3">BACK DIMENSIONS</th> </tr> <tr> <th>W</th> <th>D</th> <th>H</th> <th>W</th> <th>D</th> <th>H</th> <th>W</th> <th>H</th> </tr> <tr> <td>25.5</td> <td>24</td> <td>40</td> <td>20</td> <td>17-20</td> <td>16.5-21.5</td> <td>18.5</td> <td>23</td> </tr> </table>			OVERALL DIMENSIONS			SEAT DIMENSIONS			BACK DIMENSIONS			W	D	H	W	D	H	W	H	25.5	24	40	20	17-20	16.5-21.5	18.5	23	<p>RTA 2</p> <p>FedEx UPS</p>									
OVERALL DIMENSIONS			SEAT DIMENSIONS			BACK DIMENSIONS																																		
W	D	H	W	D	H	W	H																																	
25.5	24	40	20	17-20	16.5-21.5	18.5	23																																	
 <p><b>MB Synchro - Tilter w/Back Angle Adjustment</b> COM Yardage: 1.25 Freight Class: 150 Product Weight (lbs.): 59 Cubic Feet Per Carton: 10.5</p>	 <p><b>ADJUSTMENTS</b> (1) Tilt tension (2) Pneumatic seat height (8) Seat depth (9) Chair tilt lock (5C) Synchro-tilt action Anti-kick back</p>	<p>Upholstered Back</p> <p>Ergonomic Features: A, B, C, E, G, H, L, M, N, Q, U</p>	<table border="1"> <tr> <td><b>6332-0</b></td> <td>1139</td> <td>1190</td> <td>1224</td> <td>1279</td> <td>1358</td> <td>1387</td> <td>1453</td> <td>1586</td> <td>1647</td> <td>1766</td> <td>1932</td> <td>2134</td> </tr> <tr> <td><b>6332-0MO</b></td> <td>1201</td> <td>1282</td> <td>1349</td> <td>1446</td> <td>1578</td> <td>1641</td> <td>1765</td> <td>1961</td> <td>2111</td> <td>2280</td> <td>2625</td> <td>2992</td> </tr> </table>												<b>6332-0</b>	1139	1190	1224	1279	1358	1387	1453	1586	1647	1766	1932	2134	<b>6332-0MO</b>	1201	1282	1349	1446	1578	1641	1765	1961	2111	2280	2625	2992
			<b>6332-0</b>	1139	1190	1224	1279	1358	1387	1453	1586	1647	1766	1932	2134																									
			<b>6332-0MO</b>	1201	1282	1349	1446	1578	1641	1765	1961	2111	2280	2625	2992																									
			<table border="1"> <tr> <th colspan="3">OVERALL DIMENSIONS</th> <th colspan="3">SEAT DIMENSIONS</th> <th colspan="3">BACK DIMENSIONS</th> </tr> <tr> <th>W</th> <th>D</th> <th>H</th> <th>W</th> <th>D</th> <th>H</th> <th>W</th> <th>H</th> </tr> <tr> <td>25.5</td> <td>24</td> <td>39.5</td> <td>20</td> <td>17-20</td> <td>17.5-22.5</td> <td>18.5</td> <td>21</td> </tr> </table>			OVERALL DIMENSIONS			SEAT DIMENSIONS			BACK DIMENSIONS			W	D	H	W	D	H	W	H	25.5	24	39.5	20	17-20	17.5-22.5	18.5	21	<p>RTA 2</p> <p>FedEx UPS</p>									
OVERALL DIMENSIONS			SEAT DIMENSIONS			BACK DIMENSIONS																																		
W	D	H	W	D	H	W	H																																	
25.5	24	39.5	20	17-20	17.5-22.5	18.5	21																																	
 <p><b>MB Multi - Tilter</b> COM Yardage: 1.25 Freight Class: 150 Product Weight (lbs.): 61 Cubic Feet Per Carton: 10.5</p>	 <p><b>ADJUSTMENTS</b> (1) Tilt tension (2) Pneumatic seat height (3) Back angle (4) Seat angle (6) Back/lumbar height (8) Sliding seat depth (9) Infinite position tilt lock Center tilt action</p>	<p>Upholstered Back</p> <p>Ergonomic Features: A, B, C, E, F, G, H, M, N, Q, U, S</p>	<table border="1"> <tr> <td><b>6332-3</b></td> <td>1139</td> <td>1190</td> <td>1224</td> <td>1279</td> <td>1358</td> <td>1387</td> <td>1453</td> <td>1586</td> <td>1647</td> <td>1766</td> <td>1932</td> <td>2134</td> </tr> <tr> <td><b>6332-3MO</b></td> <td>1201</td> <td>1282</td> <td>1349</td> <td>1446</td> <td>1578</td> <td>1641</td> <td>1765</td> <td>1961</td> <td>2111</td> <td>2280</td> <td>2625</td> <td>2992</td> </tr> </table>												<b>6332-3</b>	1139	1190	1224	1279	1358	1387	1453	1586	1647	1766	1932	2134	<b>6332-3MO</b>	1201	1282	1349	1446	1578	1641	1765	1961	2111	2280	2625	2992
			<b>6332-3</b>	1139	1190	1224	1279	1358	1387	1453	1586	1647	1766	1932	2134																									
			<b>6332-3MO</b>	1201	1282	1349	1446	1578	1641	1765	1961	2111	2280	2625	2992																									
			<table border="1"> <tr> <th colspan="3">OVERALL DIMENSIONS</th> <th colspan="3">SEAT DIMENSIONS</th> <th colspan="3">BACK DIMENSIONS</th> </tr> <tr> <th>W</th> <th>D</th> <th>H</th> <th>W</th> <th>D</th> <th>H</th> <th>W</th> <th>H</th> </tr> <tr> <td>25.5</td> <td>24</td> <td>39</td> <td>20</td> <td>17-20</td> <td>17.25-22.25</td> <td>18.5</td> <td>21</td> </tr> </table>			OVERALL DIMENSIONS			SEAT DIMENSIONS			BACK DIMENSIONS			W	D	H	W	D	H	W	H	25.5	24	39	20	17-20	17.25-22.25	18.5	21	<p>RTA 2</p> <p>FedEx UPS</p>									
OVERALL DIMENSIONS			SEAT DIMENSIONS			BACK DIMENSIONS																																		
W	D	H	W	D	H	W	H																																	
25.5	24	39	20	17-20	17.25-22.25	18.5	21																																	
 <p><b>MB Tilter</b> COM Yardage: 1.25 Freight Class: 150 Product Weight (lbs.): 53 Cubic Feet Per Carton: 10.5</p>	 <p><b>ADJUSTMENTS</b> (1) Tilt tension (2) Pneumatic seat height (5A) Center-tilt action</p>	<p>Upholstered Back</p> <p>Ergonomic Features: A, B, C, E, H, M, N, Q, S, U</p>	<table border="1"> <tr> <td><b>6332-4</b></td> <td>1020</td> <td>1070</td> <td>1108</td> <td>1161</td> <td>1240</td> <td>1268</td> <td>1333</td> <td>1466</td> <td>1528</td> <td>1647</td> <td>1813</td> <td>2015</td> </tr> <tr> <td><b>6332-4MO</b></td> <td>1085</td> <td>1163</td> <td>1221</td> <td>1309</td> <td>1432</td> <td>1478</td> <td>1587</td> <td>1794</td> <td>1895</td> <td>2087</td> <td>2348</td> <td>2677</td> </tr> </table>												<b>6332-4</b>	1020	1070	1108	1161	1240	1268	1333	1466	1528	1647	1813	2015	<b>6332-4MO</b>	1085	1163	1221	1309	1432	1478	1587	1794	1895	2087	2348	2677
			<b>6332-4</b>	1020	1070	1108	1161	1240	1268	1333	1466	1528	1647	1813	2015																									
			<b>6332-4MO</b>	1085	1163	1221	1309	1432	1478	1587	1794	1895	2087	2348	2677																									
			<table border="1"> <tr> <th colspan="3">OVERALL DIMENSIONS</th> <th colspan="3">SEAT DIMENSIONS</th> <th colspan="3">BACK DIMENSIONS</th> </tr> <tr> <th>W</th> <th>D</th> <th>H</th> <th>W</th> <th>D</th> <th>H</th> <th>W</th> <th>H</th> </tr> <tr> <td>25.5</td> <td>24</td> <td>37.5</td> <td>20</td> <td>17.5</td> <td>16-21</td> <td>18.5</td> <td>21</td> </tr> </table>			OVERALL DIMENSIONS			SEAT DIMENSIONS			BACK DIMENSIONS			W	D	H	W	D	H	W	H	25.5	24	37.5	20	17.5	16-21	18.5	21	<p>RTA 2</p> <p>FedEx UPS</p>									
OVERALL DIMENSIONS			SEAT DIMENSIONS			BACK DIMENSIONS																																		
W	D	H	W	D	H	W	H																																	
25.5	24	37.5	20	17.5	16-21	18.5	21																																	

DESCRIPTION	FEATURES	MODEL#	STANDARD TEXTILE GRADES												
			1	2	3	4	5	6	7	8	9	10	11	12	
 <p><b>MB Task</b> COM Yardage: 1.25 Freight Class: 150 Product Weight (lbs.): 48 Cubic Feet Per Carton: 10.5</p>	 <p><b>ADJUSTMENTS</b> (2) Pneumatic seat height (8) Seat depth</p> <p>Upholstered Back</p> <p>Ergonomic Features: C, E, M, N, Q, U</p>		1	2	3	4	5	6	7	8	9	10	11	12	
		<b>6332-6</b>	991	1042	1079	1132	1211	1240	1305	1438	1500	1618	1785	1986	
		<b>6332-6MO</b>	1054	1130	1190	1275	1401	1447	1555	1762	1863	2055	2315	2644	
		<b>OVERALL DIMENSIONS</b>	<b>W</b>	<b>D</b>	<b>H</b>	<b>SEAT DIMENSIONS</b>	<b>W</b>	<b>D</b>	<b>H</b>	<b>BACK DIMENSIONS</b>	<b>W</b>	<b>H</b>			
	25.5	24	37.5	20	17.5	17-22	18.5	21							
				<b>RTA 2</b>											
 <p><b>MB Task - Armless</b> COM Yardage: 1.25 Freight Class: 150 Product Weight (lbs.): 42 Cubic Feet Per Carton: 10.5</p>	 <p><b>ADJUSTMENTS</b> (2) Pneumatic seat height (8) Seat depth</p> <p>Upholstered Back</p> <p>Ergonomic Features: C, E, M, N, U</p>		1	2	3	4	5	6	7	8	9	10	11	12	
		<b>6333-6</b>	943	993	1028	1083	1162	1191	1256	1389	1451	1569	1736	1938	
		<b>6333-6MO</b>	1016	1094	1152	1241	1366	1409	1517	1724	1825	2018	2281	2605	
		<b>OVERALL DIMENSIONS</b>	<b>W</b>	<b>D</b>	<b>H</b>	<b>SEAT DIMENSIONS</b>	<b>W</b>	<b>D</b>	<b>H</b>	<b>BACK DIMENSIONS</b>	<b>W</b>	<b>H</b>			
	20	24	37.5	20	17.5	17-22	18.5	21							
				<b>RTA 2</b>											
 <p><b>MB Weight Sensing Synchro - Tilter</b> COM Yardage: 1.25 Freight Class: 150 Product Weight (lbs.): 56 Cubic Feet Per Carton: 10.5</p>	 <p><b>ADJUSTMENTS</b> Weight sensing auto tension adjustment (2) Pneumatic seat height (8) Sliding seat depth (9) Multi position tilt lock</p> <p>Upholstered Back</p> <p>Ergonomic Features: A, B, C, E, H, L, M, N, Q, U</p>		1	2	3	4	5	6	7	8	9	10	11	12	
		<b>6332-8</b>	1139	1190	1224	1279	1358	1387	1453	1586	1647	1766	1932	2134	
		<b>6332-8MO</b>	1201	1282	1349	1446	1578	1641	1765	1961	2111	2280	2625	2992	
		<b>OVERALL DIMENSIONS</b>	<b>W</b>	<b>D</b>	<b>H</b>	<b>SEAT DIMENSIONS</b>	<b>W</b>	<b>D</b>	<b>H</b>	<b>BACK DIMENSIONS</b>	<b>W</b>	<b>H</b>			
	25.5	24	38	20	17-20	16.5-21.5	18.5	21							
				<b>RTA 2</b>											
 <p><b>MB Height Adjustable Stool - Task Armless</b> COM Yardage: 1.25 Freight Class: 150 Product Weight (lbs.): 45 Cubic Feet Per Carton: 10.5</p>	 <p><b>ADJUSTMENTS</b> (2) Pneumatic seat height (8) Seat depth</p> <p>Upholstered Back</p> <p>Ergonomic Features: C, E, M, N, U</p>		1	2	3	4	5	6	7	8	9	10	11	12	
		<b>6337-6</b>	1020	1071	1109	1163	1241	1269	1336	1467	1529	1649	1814	2016	
		<b>6337-6MO</b>	1090	1166	1224	1314	1437	1482	1591	1798	1899	2091	2351	2680	
		<b>OVERALL DIMENSIONS</b>	<b>W</b>	<b>D</b>	<b>H</b>	<b>SEAT DIMENSIONS</b>	<b>W</b>	<b>D</b>	<b>H</b>	<b>BACK DIMENSIONS</b>	<b>W</b>	<b>H</b>			
	20	24	48	20	17.5	23.5-33.5	18.5	21							
				<b>RTA 2</b>											
 <p><b>MB Height Adjustable Stool - Task</b> COM Yardage: 1.25 Freight Class: 150 Product Weight (lbs.): 51 Cubic Feet Per Carton: 10.5</p>	 <p><b>ADJUSTMENTS</b> (2) Pneumatic seat height (8) Seat depth</p> <p>Upholstered Back</p> <p>Ergonomic Features: C, E, H, M, N, Q, U</p>		1	2	3	4	5	6	7	8	9	10	11	12	
		<b>6338-6</b>	1145	1196	1233	1288	1365	1394	1459	1592	1654	1772	1939	2140	
		<b>6338-6MO</b>	1214	1292	1350	1438	1561	1607	1715	1922	2023	2215	2477	2803	
		<b>OVERALL DIMENSIONS</b>	<b>W</b>	<b>D</b>	<b>H</b>	<b>SEAT DIMENSIONS</b>	<b>W</b>	<b>D</b>	<b>H</b>	<b>BACK DIMENSIONS</b>	<b>W</b>	<b>H</b>			
	20	24	48	20	17.5	23.5-33.5	18.5	21							
				<b>RTA 2</b>											

DESCRIPTION FEATURES MODEL# STANDARD TEXTILE GRADES

	1	2	3	4	5	6	7	8	9	10	11	12
--	---	---	---	---	---	---	---	---	---	----	----	----

6339 46 - - - - - - - - - - - -

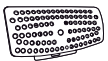

**Lumbar Pad Kit**  
 COM Yardage: N/A  
 Freight Class: 70  
 Product Weight (lbs.): 1.5  
 Cubic Feet Per Carton: 0.5

OVERALL DIMENSIONS SEAT DIMENSIONS BACK DIMENSIONS

W	D	H	W	D	H	W	H
---	---	---	---	---	---	---	---

10.25 3.5 5.25



	1	2	3	4	5	6	7	8	9	10	11	12
--	---	---	---	---	---	---	---	---	---	----	----	----

6322-4PB 1131

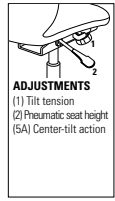

**MB Tilter with Pedestal Base**  
 COM Yardage: 1  
 Freight Class: 150  
 Product Weight (lbs.): 52  
 Cubic Feet Per Carton: 10.5

Mesh Back  
 Ergonomic Features:  
 A, B, C, E, H, M, N, O, S, U

OVERALL DIMENSIONS SEAT DIMENSIONS BACK DIMENSIONS

W	D	H	W	D	H	W	H
---	---	---	---	---	---	---	---

25.5 24 37.5 20 17.5 16-21 18.5 21



	1	2	3	4	5	6	7	8	9	10	11	12
--	---	---	---	---	---	---	---	---	---	----	----	----

6364-6PB \$1193 \$1234 \$1263 \$1306 \$1370 \$1400 \$1455 \$1545 \$1613 \$1690 \$1849 \$2016



mesh back

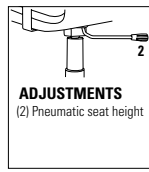

**Armless Task with Pedestal Base**  
 COM Yardage: 1  
 Freight Class: 150  
 Product Weight (lbs.): 33  
 Cubic Feet Per Carton: 15.75

Ergonomic features: M, N

OVERALL DIMENSIONS SEAT DIMENSIONS BACK DIMENSIONS

W	D	H	W	D	H	W	H
---	---	---	---	---	---	---	---

23.5 29 35.5 19 18 16-21 19 17

RTA 00 1 per carton

	1	2	3	4	5	6	7	8	9	10	11	12
--	---	---	---	---	---	---	---	---	---	----	----	----

6364-6LPB 1533 1573 1602 1645 1708 1739 1793 1885 1952 2030 2188 2356  
 6364-6RPB



mesh back

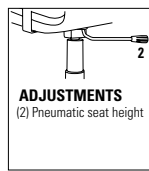

**Armless Task w/Tablet and Pedestal Base**  
 COM Yardage: 1  
 Freight Class: 150  
 Product Weight (lbs.): 33  
 Cubic Feet Per Carton: 17.75

Ergonomic features: M, N  
 Specify (L) left or (R) right tablet.  
 (Example: 6364-6L or 6364-6R).

OVERALL DIMENSIONS SEAT DIMENSIONS BACK DIMENSIONS

W	D	H	W	D	H	W	H
---	---	---	---	---	---	---	---

23.5 29 35.5 19 18 16-21 19 17

RTA 00 1 per carton

	1	2	3	4	5	6	7	8	9	10	11	12
--	---	---	---	---	---	---	---	---	---	----	----	----

6374-6PB \$1193 \$1243 \$1281 \$1334 \$1412 \$1449 \$1519 \$1631 \$1717 \$1813 \$2011 \$2221



upholstered back

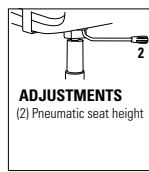

**Armless Task with Pedestal Base**  
 COM Yardage: 1.25  
 Freight Class: 150  
 Product Weight (lbs.): 33  
 Cubic Feet Per Carton: 15.75

Ergonomic features: M, N

OVERALL DIMENSIONS SEAT DIMENSIONS BACK DIMENSIONS

W	D	H	W	D	H	W	H
---	---	---	---	---	---	---	---

23.5 29 35.5 19 18 16-21 19 17

RTA 00 1 per carton

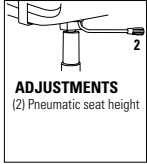
DESCRIPTION	FEATURES	MODEL#	STANDARD TEXTILE GRADES																								
			1	2	3	4	5	6	7	8	9	10	11	12													
 <p>upholstered back</p> <p><b>Armless Task w/Tablet and Pedestal Base</b>                      COM Yardage: 1.25                      Freight Class: 250                      Product Weight (lbs.): 44                      Cubic Feet Per Carton: 11.75</p>	 <p><b>ADJUSTMENTS</b>                      (2) Pneumatic seat height</p>	<b>6374-6LPB</b> <b>6374-6RPB</b>	1533	1582	1618	1673	1751	1788	1858	1970	2057	2153	2351	2561													
		<table border="1"> <thead> <tr> <th colspan="3">OVERALL DIMENSIONS</th> <th colspan="3">SEAT DIMENSIONS</th> <th colspan="2">BACK DIMENSIONS</th> </tr> <tr> <th>W</th> <th>D</th> <th>H</th> <th>W</th> <th>D</th> <th>H</th> <th>W</th> <th>H</th> </tr> </thead> <tbody> <tr> <td>23.5</td> <td>29</td> <td>35.5</td> <td>19</td> <td>18</td> <td>16-21</td> <td>19</td> <td>17</td> </tr> </tbody> </table>	OVERALL DIMENSIONS			SEAT DIMENSIONS			BACK DIMENSIONS		W	D	H	W	D	H	W	H	23.5	29	35.5	19	18	16-21	19	17	Ergonomic features: M, N  Specify (L) left or (R) right tablet. (Example: 6374-6L or 6374-6R, 6374-6MOL or 6374-6MOR).
OVERALL DIMENSIONS			SEAT DIMENSIONS			BACK DIMENSIONS																					
W	D	H	W	D	H	W	H																				
23.5	29	35.5	19	18	16-21	19	17																				

**WEEV**



model 2220-3



model 2221-4



Stitch detail on Leather upholstered seat

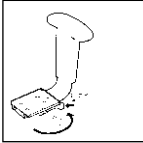

**Vari-Width (WA)**  
Width Adjustable Arm Extensions is standard when order with adjustable height arms.





**STANDARD FEATURES**





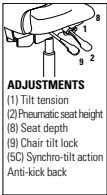

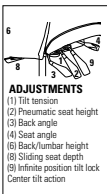

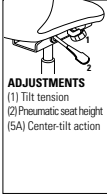

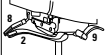



- A beautiful, breathable mesh, functional task seating series, at affordable pricing.
- Weev series includes six mechanisms, a Synchro-Tilter with Back Angle, Weight Sensing Synchro-Tilter, Multi-Tilter, Tilter, and Task.
- The Black mesh for the back of the chair is woven to breathe and give as the user leans into it removing pressure points along the spine.
- The lumbar support built into the design of the back is flexible and reshapes itself to match and support the user's body profile.
- Side activated sliding seat depth adjustment is standard on Multi-Tilters and Synchro-Tilters providing 2" of seat depth adjustment.
- Height and width (WA) adjustable GL arms. Armcaps are soft to the touch Self-Skinned Urethane. Armcaps are depth adjustable (slide forward and backward) to suit user preference.
- Vari-Width (WA) Width Adjustable Arm Extensions are standard, allowing the arms to move away from the seat by 2" on each side to allow space for broader hip widths. Five legged, injection molded, fiberglass reinforced, nylon base **B7B** is standard.
- **C1** dual wheel carpet casters are standard.









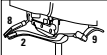

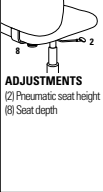

- Models upholstered in leather have a straight seam across the seat.
- Check textile availability prior to specifying upholstery material.

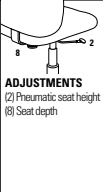
**OPTIONAL FEATURES**

- Please refer to the "Arm Selection" section of the price book for arm options.
- Please refer to "Cylinder Selection" section of the price book for additional cylinder options.
- For optional polished Aluminum base (**B7A**) Please specify **ALU** base. Add \$177.
- For hard surface flooring casters, specify **C9R**. Add \$78.
- Please refer to the "Casters Selection" section of the price book for caster options. Optional casters may be priced higher than the standard casters for your chair and the difference will be charged. Lower priced optional casters will not be credited.
- For fully assembled in box, specify **SU**. Add \$81.

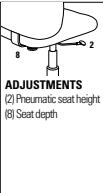
DESCRIPTION	FEATURES	MODEL#	STANDARD TEXTILE GRADES											
			1	2	3	4	5	6	7	8	9	10	11	12
 <p><b>HB Synchro - Tilter w/Back Angle Adjustment</b> COM Yardage: 1 Freight Class: 125 Product Weight (lbs.): 68 Cubic Feet Per Carton: 10.5</p> <p>Ergonomic Features: A, B, C, E, H, L, M, N, Q</p>	 <p><b>ADJUSTMENTS</b> (1) Tilt tension (2) Pneumatic seat height (8) Seat depth (9) Chair tilt lock (5C) Synchro-tilt action Anti-lock back</p>	<b>2220-0</b>	976	1017	1047	1090	1155	1174	1229	1332	1385	1480	1613	1773
		<b>OVERALL DIMENSIONS</b>			<b>SEAT DIMENSIONS</b>			<b>BACK DIMENSIONS</b>						
		<b>W</b>	<b>D</b>	<b>H</b>	<b>W</b>	<b>D</b>	<b>H</b>	<b>W</b>		<b>H</b>				
		25	24	42	19	18-20.5	16-20	19		27				
			RTA 2			FedEx			UPS					
 <p><b>HB Multi - Tilter</b> COM Yardage: 1 Freight Class: 125 Product Weight (lbs.): 70 Cubic Feet Per Carton: 10.5</p> <p>Ergonomic Features: A, B, C, E, F, G, H, M, N, Q, S</p>	 <p><b>ADJUSTMENTS</b> (1) Tilt tension (2) Pneumatic seat height (3) Back angle (4) Seat angle (6) Back/lumbar height (8) Sliding seat depth (9) Infinite position tilt lock Center tilt action</p>	<b>2220-3</b>	976	1017	1047	1090	1155	1174	1229	1332	1385	1480	1613	1773
		<b>OVERALL DIMENSIONS</b>			<b>SEAT DIMENSIONS</b>			<b>BACK DIMENSIONS</b>						
		<b>W</b>	<b>D</b>	<b>H</b>	<b>W</b>	<b>D</b>	<b>H</b>	<b>W</b>		<b>H</b>				
		25	24	42	19	18-20.5	16-20	19		27				
			RTA 2			FedEx			UPS					
 <p><b>HB Tilter</b> COM Yardage: 1 Freight Class: 150 Product Weight (lbs.): 59 Cubic Feet Per Carton: 10.5</p> <p>Ergonomic Features: A, B, C, E, H, M, N, Q, S</p>	 <p><b>ADJUSTMENTS</b> (1) Tilt tension (2) Pneumatic seat height (5A) Center-tilt action</p>	<b>2220-4</b>	837	878	908	954	1015	1035	1092	1195	1247	1343	1474	1635
		<b>OVERALL DIMENSIONS</b>			<b>SEAT DIMENSIONS</b>			<b>BACK DIMENSIONS</b>						
		<b>W</b>	<b>D</b>	<b>H</b>	<b>W</b>	<b>D</b>	<b>H</b>	<b>W</b>		<b>H</b>				
		25	24	42.5	19	18-20.5	16-20	19		27				
			RTA 2			FedEx			UPS					

DESCRIPTION	FEATURES	MODEL#	STANDARD TEXTILE GRADES																														
			1	2	3	4	5	6	7	8	9	10	11	12																			
 <p><b>HB Weight Sensing Synchro - Tilter</b> COM Yardage: 1 Freight Class: 125 Product Weight (lbs.): 70 Cubic Feet Per Carton: 10.5</p>	 <p><b>ADJUSTMENTS</b> Weight sensing auto tension adjustment (2) Pneumatic seat height (8) Sliding seat depth (9) Multi position tilt lock</p>	<p>Ergonomic Features: A, B, C, E, H, J, M, N, Q</p>	<table border="1"> <tr> <td><b>2220-8</b></td> <td>976</td> <td>1017</td> <td>1047</td> <td>1090</td> <td>1155</td> <td>1174</td> <td>1229</td> <td>1332</td> <td>1385</td> <td>1480</td> <td>1613</td> <td>1773</td> </tr> </table>												<b>2220-8</b>	976	1017	1047	1090	1155	1174	1229	1332	1385	1480	1613	1773						
			<b>2220-8</b>	976	1017	1047	1090	1155	1174	1229	1332	1385	1480	1613	1773																		
			<table border="1"> <tr> <th colspan="3">OVERALL DIMENSIONS</th> <th colspan="3">SEAT DIMENSIONS</th> <th colspan="3">BACK DIMENSIONS</th> </tr> <tr> <th>W</th> <th>D</th> <th>H</th> <th>W</th> <th>D</th> <th>H</th> <th>W</th> <th>H</th> </tr> <tr> <td>25</td> <td>24</td> <td>42</td> <td>19</td> <td>18-20.5</td> <td>16-20</td> <td>19</td> <td>27</td> </tr> </table>			OVERALL DIMENSIONS			SEAT DIMENSIONS			BACK DIMENSIONS			W	D	H	W	D	H	W	H	25	24	42	19	18-20.5	16-20	19	27	<p>RTA 2</p>  		
			OVERALL DIMENSIONS			SEAT DIMENSIONS			BACK DIMENSIONS																								
W	D	H	W	D	H	W	H																										
25	24	42	19	18-20.5	16-20	19	27																										
 <p><b>MB Synchro - Tilter w/Back Angle Adjustment</b> COM Yardage: 1 Freight Class: 125 Product Weight (lbs.): 66 Cubic Feet Per Carton: 10.5</p>	 <p><b>ADJUSTMENTS</b> (1) Tilt tension (2) Pneumatic seat height (8) Seat depth (9) Chair tilt lock (5C) Synchro-tilt action Anti-kick back</p>	<p>Ergonomic Features: A, B, C, E, H, L, M, N, Q</p>	<table border="1"> <tr> <td><b>2221-0</b></td> <td>945</td> <td>983</td> <td>1014</td> <td>1057</td> <td>1120</td> <td>1142</td> <td>1197</td> <td>1300</td> <td>1352</td> <td>1448</td> <td>1578</td> <td>1741</td> </tr> </table>												<b>2221-0</b>	945	983	1014	1057	1120	1142	1197	1300	1352	1448	1578	1741						
			<b>2221-0</b>	945	983	1014	1057	1120	1142	1197	1300	1352	1448	1578	1741																		
			<table border="1"> <tr> <th colspan="3">OVERALL DIMENSIONS</th> <th colspan="3">SEAT DIMENSIONS</th> <th colspan="3">BACK DIMENSIONS</th> </tr> <tr> <th>W</th> <th>D</th> <th>H</th> <th>W</th> <th>D</th> <th>H</th> <th>W</th> <th>H</th> </tr> <tr> <td>25</td> <td>24</td> <td>39</td> <td>19</td> <td>18-20.5</td> <td>16-20</td> <td>19</td> <td>24</td> </tr> </table>			OVERALL DIMENSIONS			SEAT DIMENSIONS			BACK DIMENSIONS			W	D	H	W	D	H	W	H	25	24	39	19	18-20.5	16-20	19	24	<p>RTA 2</p>  		
			OVERALL DIMENSIONS			SEAT DIMENSIONS			BACK DIMENSIONS																								
W	D	H	W	D	H	W	H																										
25	24	39	19	18-20.5	16-20	19	24																										
 <p><b>MB Multi - Tilter</b> COM Yardage: 1 Freight Class: 125 Product Weight (lbs.): 68 Cubic Feet Per Carton: 10.5</p>	 <p><b>ADJUSTMENTS</b> (1) Tilt tension (2) Pneumatic seat height (3) Back angle (4) Seat angle (6) Back/lumbar height (8) Sliding seat depth (9) Infinite position tilt lock Center tilt action</p>	<p>Ergonomic Features: A, B, C, E, F, G, H, M, N, Q, S</p>	<table border="1"> <tr> <td><b>2221-3</b></td> <td>945</td> <td>983</td> <td>1014</td> <td>1057</td> <td>1120</td> <td>1142</td> <td>1197</td> <td>1300</td> <td>1352</td> <td>1448</td> <td>1578</td> <td>1741</td> </tr> </table>												<b>2221-3</b>	945	983	1014	1057	1120	1142	1197	1300	1352	1448	1578	1741						
			<b>2221-3</b>	945	983	1014	1057	1120	1142	1197	1300	1352	1448	1578	1741																		
			<table border="1"> <tr> <th colspan="3">OVERALL DIMENSIONS</th> <th colspan="3">SEAT DIMENSIONS</th> <th colspan="3">BACK DIMENSIONS</th> </tr> <tr> <th>W</th> <th>D</th> <th>H</th> <th>W</th> <th>D</th> <th>H</th> <th>W</th> <th>H</th> </tr> <tr> <td>25</td> <td>24</td> <td>39</td> <td>19</td> <td>18-20.5</td> <td>16-20</td> <td>19</td> <td>24</td> </tr> </table>			OVERALL DIMENSIONS			SEAT DIMENSIONS			BACK DIMENSIONS			W	D	H	W	D	H	W	H	25	24	39	19	18-20.5	16-20	19	24	<p>RTA 2</p>  		
			OVERALL DIMENSIONS			SEAT DIMENSIONS			BACK DIMENSIONS																								
W	D	H	W	D	H	W	H																										
25	24	39	19	18-20.5	16-20	19	24																										
 <p><b>MB Tilter</b> COM Yardage: 1 Freight Class: 150 Product Weight (lbs.): 57 Cubic Feet Per Carton: 10.5</p>	 <p><b>ADJUSTMENTS</b> (1) Tilt tension (2) Pneumatic seat height (5A) Center-tilt action</p>	<p>Ergonomic Features: A, B, C, E, H, M, N, Q, S</p>	<table border="1"> <tr> <td><b>2221-4</b></td> <td>808</td> <td>849</td> <td>877</td> <td>921</td> <td>983</td> <td>1005</td> <td>1060</td> <td>1163</td> <td>1216</td> <td>1310</td> <td>1441</td> <td>1604</td> </tr> </table>												<b>2221-4</b>	808	849	877	921	983	1005	1060	1163	1216	1310	1441	1604						
			<b>2221-4</b>	808	849	877	921	983	1005	1060	1163	1216	1310	1441	1604																		
			<table border="1"> <tr> <th colspan="3">OVERALL DIMENSIONS</th> <th colspan="3">SEAT DIMENSIONS</th> <th colspan="3">BACK DIMENSIONS</th> </tr> <tr> <th>W</th> <th>D</th> <th>H</th> <th>W</th> <th>D</th> <th>H</th> <th>W</th> <th>H</th> </tr> <tr> <td>25</td> <td>24</td> <td>39.5</td> <td>19</td> <td>18-20.5</td> <td>16-20</td> <td>19</td> <td>24</td> </tr> </table>			OVERALL DIMENSIONS			SEAT DIMENSIONS			BACK DIMENSIONS			W	D	H	W	D	H	W	H	25	24	39.5	19	18-20.5	16-20	19	24	<p>RTA 2</p>  		
			OVERALL DIMENSIONS			SEAT DIMENSIONS			BACK DIMENSIONS																								
W	D	H	W	D	H	W	H																										
25	24	39.5	19	18-20.5	16-20	19	24																										
 <p><b>MB Weight Sensing Synchro - Tilter</b> COM Yardage: 1 Freight Class: 125 Product Weight (lbs.): 68 Cubic Feet Per Carton: 10.5</p>	 <p><b>ADJUSTMENTS</b> Weight sensing auto tension adjustment (2) Pneumatic seat height (8) Sliding seat depth (9) Multi position tilt lock</p>	<p>Ergonomic Features: A, B, C, E, H, J, M, N, Q</p>	<table border="1"> <tr> <td><b>2221-8</b></td> <td>945</td> <td>983</td> <td>1014</td> <td>1057</td> <td>1120</td> <td>1142</td> <td>1197</td> <td>1300</td> <td>1352</td> <td>1448</td> <td>1578</td> <td>1741</td> </tr> </table>												<b>2221-8</b>	945	983	1014	1057	1120	1142	1197	1300	1352	1448	1578	1741						
			<b>2221-8</b>	945	983	1014	1057	1120	1142	1197	1300	1352	1448	1578	1741																		
			<table border="1"> <tr> <th colspan="3">OVERALL DIMENSIONS</th> <th colspan="3">SEAT DIMENSIONS</th> <th colspan="3">BACK DIMENSIONS</th> </tr> <tr> <th>W</th> <th>D</th> <th>H</th> <th>W</th> <th>D</th> <th>H</th> <th>W</th> <th>H</th> </tr> <tr> <td>25</td> <td>24</td> <td>39</td> <td>19</td> <td>18-20.5</td> <td>16-20</td> <td>19</td> <td>24</td> </tr> </table>			OVERALL DIMENSIONS			SEAT DIMENSIONS			BACK DIMENSIONS			W	D	H	W	D	H	W	H	25	24	39	19	18-20.5	16-20	19	24	<p>RTA 2</p>		
			OVERALL DIMENSIONS			SEAT DIMENSIONS			BACK DIMENSIONS																								
W	D	H	W	D	H	W	H																										
25	24	39	19	18-20.5	16-20	19	24																										

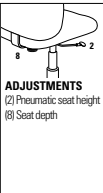
DESCRIPTION	FEATURES	MODEL#	STANDARD TEXTILE GRADES																																																
			1	2	3	4	5	6	7	8	9	10	11	12																																					
 <p><b>MB Task</b> COM Yardage: 1 Freight Class: 150 Product Weight (lbs.): 48 Cubic Feet Per Carton: 10.5</p>	 <p><b>ADJUSTMENTS</b> (2) Pneumatic seat height (8) Seat depth</p>	<p>Ergonomic Features: C, E, H, M, N, Q</p>	<table border="1"> <thead> <tr> <th colspan="12">STANDARD TEXTILE GRADES</th> </tr> <tr> <th>1</th><th>2</th><th>3</th><th>4</th><th>5</th><th>6</th><th>7</th><th>8</th><th>9</th><th>10</th><th>11</th><th>12</th> </tr> </thead> <tbody> <tr> <td>2221-6</td><td>808</td><td>849</td><td>877</td><td>921</td><td>983</td><td>1005</td><td>1060</td><td>1163</td><td>1216</td><td>1310</td><td>1441</td><td>1604</td> </tr> </tbody> </table>												STANDARD TEXTILE GRADES												1	2	3	4	5	6	7	8	9	10	11	12	2221-6	808	849	877	921	983	1005	1060	1163	1216	1310	1441	1604
			STANDARD TEXTILE GRADES																																																
			1	2	3	4	5	6	7	8	9	10	11	12																																					
			2221-6	808	849	877	921	983	1005	1060	1163	1216	1310	1441	1604																																				
<table border="1"> <thead> <tr> <th colspan="3">OVERALL DIMENSIONS</th> <th colspan="3">SEAT DIMENSIONS</th> <th colspan="2">BACK DIMENSIONS</th> </tr> <tr> <th>W</th><th>D</th><th>H</th> <th>W</th><th>D</th><th>H</th> <th>W</th><th>H</th> </tr> </thead> <tbody> <tr> <td>25</td><td>24</td><td>41</td> <td>19</td><td>17.5-18.5</td><td>16.5-20.5</td> <td>19</td><td>24</td> </tr> </tbody> </table>			OVERALL DIMENSIONS			SEAT DIMENSIONS			BACK DIMENSIONS		W	D	H	W	D	H	W	H	25	24	41	19	17.5-18.5	16.5-20.5	19	24																									
OVERALL DIMENSIONS			SEAT DIMENSIONS			BACK DIMENSIONS																																													
W	D	H	W	D	H	W	H																																												
25	24	41	19	17.5-18.5	16.5-20.5	19	24																																												
<p>RTA 2  </p>																																																			
 <p><b>MB Task Armless</b> COM Yardage: 1 Freight Class: 150 Product Weight (lbs.): 42 Cubic Feet Per Carton: 10.5</p>	 <p><b>ADJUSTMENTS</b> (2) Pneumatic seat height (8) Seat depth</p>	<p>Ergonomic Features: C, E, M, N</p>	<table border="1"> <thead> <tr> <th colspan="12">STANDARD TEXTILE GRADES</th> </tr> <tr> <th>1</th><th>2</th><th>3</th><th>4</th><th>5</th><th>6</th><th>7</th><th>8</th><th>9</th><th>10</th><th>11</th><th>12</th> </tr> </thead> <tbody> <tr> <td>2222-6</td><td>676</td><td>719</td><td>749</td><td>790</td><td>855</td><td>874</td><td>931</td><td>1034</td><td>1085</td><td>1180</td><td>1312</td><td>1474</td> </tr> </tbody> </table>												STANDARD TEXTILE GRADES												1	2	3	4	5	6	7	8	9	10	11	12	2222-6	676	719	749	790	855	874	931	1034	1085	1180	1312	1474
			STANDARD TEXTILE GRADES																																																
			1	2	3	4	5	6	7	8	9	10	11	12																																					
			2222-6	676	719	749	790	855	874	931	1034	1085	1180	1312	1474																																				
<table border="1"> <thead> <tr> <th colspan="3">OVERALL DIMENSIONS</th> <th colspan="3">SEAT DIMENSIONS</th> <th colspan="2">BACK DIMENSIONS</th> </tr> <tr> <th>W</th><th>D</th><th>H</th> <th>W</th><th>D</th><th>H</th> <th>W</th><th>H</th> </tr> </thead> <tbody> <tr> <td>25</td><td>24</td><td>41</td> <td>19</td><td>17.5-18.5</td><td>16.5-20.5</td> <td>19</td><td>24</td> </tr> </tbody> </table>			OVERALL DIMENSIONS			SEAT DIMENSIONS			BACK DIMENSIONS		W	D	H	W	D	H	W	H	25	24	41	19	17.5-18.5	16.5-20.5	19	24																									
OVERALL DIMENSIONS			SEAT DIMENSIONS			BACK DIMENSIONS																																													
W	D	H	W	D	H	W	H																																												
25	24	41	19	17.5-18.5	16.5-20.5	19	24																																												
<p>RTA 2  </p>																																																			
 <p><b>MB Height Adjustable Stool Task</b> COM Yardage: 1 Freight Class: 150 Product Weight (lbs.): 51 Cubic Feet Per Carton: 10.5</p>	 <p><b>ADJUSTMENTS</b> (2) Pneumatic seat height (8) Seat depth</p>	<p>Ergonomic Features: C, E, H, M, N, Q</p>	<table border="1"> <thead> <tr> <th colspan="12">STANDARD TEXTILE GRADES</th> </tr> <tr> <th>1</th><th>2</th><th>3</th><th>4</th><th>5</th><th>6</th><th>7</th><th>8</th><th>9</th><th>10</th><th>11</th><th>12</th> </tr> </thead> <tbody> <tr> <td>2223-6</td><td>1259</td><td>1299</td><td>1328</td><td>1371</td><td>1436</td><td>1455</td><td>1511</td><td>1614</td><td>1666</td><td>1762</td><td>1892</td><td>2055</td> </tr> </tbody> </table>												STANDARD TEXTILE GRADES												1	2	3	4	5	6	7	8	9	10	11	12	2223-6	1259	1299	1328	1371	1436	1455	1511	1614	1666	1762	1892	2055
			STANDARD TEXTILE GRADES																																																
			1	2	3	4	5	6	7	8	9	10	11	12																																					
			2223-6	1259	1299	1328	1371	1436	1455	1511	1614	1666	1762	1892	2055																																				
<table border="1"> <thead> <tr> <th colspan="3">OVERALL DIMENSIONS</th> <th colspan="3">SEAT DIMENSIONS</th> <th colspan="2">BACK DIMENSIONS</th> </tr> <tr> <th>W</th><th>D</th><th>H</th> <th>W</th><th>D</th><th>H</th> <th>W</th><th>H</th> </tr> </thead> <tbody> <tr> <td>20.5</td><td>24.5</td><td>48</td> <td>19</td><td>17.5-18.5</td><td>24-34</td> <td>19</td><td>24</td> </tr> </tbody> </table>			OVERALL DIMENSIONS			SEAT DIMENSIONS			BACK DIMENSIONS		W	D	H	W	D	H	W	H	20.5	24.5	48	19	17.5-18.5	24-34	19	24																									
OVERALL DIMENSIONS			SEAT DIMENSIONS			BACK DIMENSIONS																																													
W	D	H	W	D	H	W	H																																												
20.5	24.5	48	19	17.5-18.5	24-34	19	24																																												
<p>RTA 2  </p>																																																			
 <p><b>MB Height Adjustable Stool Task Armless</b> COM Yardage: 1 Freight Class: 150 Product Weight (lbs.): 45 Cubic Feet Per Carton: 10.5</p>	 <p><b>ADJUSTMENTS</b> (2) Pneumatic seat height (8) Seat depth</p>	<p>Ergonomic Features: C, E, M, N</p>	<table border="1"> <thead> <tr> <th colspan="12">STANDARD TEXTILE GRADES</th> </tr> <tr> <th>1</th><th>2</th><th>3</th><th>4</th><th>5</th><th>6</th><th>7</th><th>8</th><th>9</th><th>10</th><th>11</th><th>12</th> </tr> </thead> <tbody> <tr> <td>2224-6</td><td>1123</td><td>1164</td><td>1194</td><td>1237</td><td>1301</td><td>1321</td><td>1376</td><td>1479</td><td>1531</td><td>1627</td><td>1760</td><td>1920</td> </tr> </tbody> </table>												STANDARD TEXTILE GRADES												1	2	3	4	5	6	7	8	9	10	11	12	2224-6	1123	1164	1194	1237	1301	1321	1376	1479	1531	1627	1760	1920
			STANDARD TEXTILE GRADES																																																
			1	2	3	4	5	6	7	8	9	10	11	12																																					
			2224-6	1123	1164	1194	1237	1301	1321	1376	1479	1531	1627	1760	1920																																				
<table border="1"> <thead> <tr> <th colspan="3">OVERALL DIMENSIONS</th> <th colspan="3">SEAT DIMENSIONS</th> <th colspan="2">BACK DIMENSIONS</th> </tr> <tr> <th>W</th><th>D</th><th>H</th> <th>W</th><th>D</th><th>H</th> <th>W</th><th>H</th> </tr> </thead> <tbody> <tr> <td>19</td><td>24</td><td>50.5</td> <td>19</td><td>17.5-18.5</td><td>24-34</td> <td>19</td><td>24</td> </tr> </tbody> </table>			OVERALL DIMENSIONS			SEAT DIMENSIONS			BACK DIMENSIONS		W	D	H	W	D	H	W	H	19	24	50.5	19	17.5-18.5	24-34	19	24																									
OVERALL DIMENSIONS			SEAT DIMENSIONS			BACK DIMENSIONS																																													
W	D	H	W	D	H	W	H																																												
19	24	50.5	19	17.5-18.5	24-34	19	24																																												
<p>RTA 2</p>																																																			

# multi-purpose

Bakhita .....	132	Islands .....	174	Sas .....	200
Beach .....	135	Layne .....	175	Sidero .....	202
Beam Seating .....	136	Lite .....	177	Sonic .....	206
Caprice .....	146	Marche .....	182	Spritz .....	218
Chap .....	148	Mayne .....	184	Spyker .....	221
Comet .....	150	Moda Four-Legged .....	185	Stream .....	222
Diplomat .....	153	Moda Stacking .....	186	Twilight .....	231
Duet .....	154	Popcorn .....	188	Vion guest .....	234
Erin .....	167	Rebound .....	193	Willow .....	239
File Buddy .....	171	Roma Nester .....	198	Zoma .....	253

**BAKHITA**



model 6750



model 6753





model 6754







model 6785

**STANDARD FEATURES**

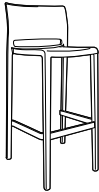
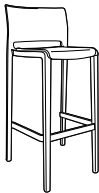
- A comfortable, high-quality, lightweight, stacking chair that is incredibly strong and durable.
- Bakhita is an all polymer chair intended for use indoors or outdoors. Products must be stored inside during extreme and inclement weather. See Global's Outdoor Furniture warranty for additional information.
- Weather resistant, UV and stain resistant, with a modern design.
- Standard height models (6750, 6751) are suitable for use in MRI rooms.
- Chairs are simultaneously molded with two different materials. Inside is a structural fiberglass frame for strength. Outside is a durable polypropylene light fast compound.
- Armchairs and Armless Chairs are finished with a smooth surface. Bar Stools and Counter Stools are finished with a slightly textured surface.
- Upholstered seats will only fit on a frame made for this purpose, it is not possible to add an upholstered seat onto an existing all plastic chair in the field.
- Upholstered seats are fixed and non-removable.
- Chair legs are equipped with translucent non-marking glides as standard. Suitable for outdoor environments, carpet and hard surface flooring.
- Check textile availability prior to specifying upholstery material.
- All Bakhita products (except upholstered models) are only available through Global's InStock program. Contact CustomerCare for lead times and quotation for quantities beyond InStock inventory.
- For outdoor use Global recommends marine grade vinyls or Sunbrella fabrics with UV resistance.
- Chairs are available in 3 plastic colors: Alloy (**ALY**), Char (**CHA**), and Milk (**MLK**).
- Tables are available in standard or bar height and are suitable for outdoor use.
- Tables are available with a Silver base and Milk (**MLK**) top only.
- Table tops are constructed from technopolymer compounds with high structural, heat and abrasion resistance. Tops are UV, shock and stain resistant.
- Bakhita achieves its strength and durability using glass filled polymer. Evidence of this material may be visible on the surface and is often more evident in darker colors.

DESCRIPTION	FEATURES	MODEL#	STANDARD TEXTILE GRADES													
			1	2	3	4	5	6	7	8	9	10	11	12		
 <p><b>Armchair Poly Seat &amp; Back</b> COM Yardage: N/A Freight Class: 150 Product Weight (lbs.): 14.25 Cubic Feet Per Carton: 3.38(4 per carton)</p>	Stacks 8 high on floor. Stacks 10 high on dolly.	6750	311													
					<b>OVERALL DIMENSIONS</b>			<b>SEAT DIMENSIONS</b>			<b>BACK DIMENSIONS</b>					
					<b>W</b>	<b>D</b>	<b>H</b>	<b>W</b>	<b>D</b>	<b>H</b>	<b>W</b>	<b>H</b>				
					22.5	21	31.5	16	16	17.25	17	14.5				
					<b>RTA 00</b>	<b>FedEx</b>			<b>ups</b>	4 per carton (pricing and specifications are for one chair)						
 <p><b>Armless Chair Poly Seat &amp; Back</b> COM Yardage: N/A Freight Class: 150 Product Weight (lbs.): 13 Cubic Feet Per Carton: 2.88(4 per carton)</p>	Stacks 8 high on floor. Stacks 12 high on dolly.	6751	276													
					<b>OVERALL DIMENSIONS</b>			<b>SEAT DIMENSIONS</b>			<b>BACK DIMENSIONS</b>					
					<b>W</b>	<b>D</b>	<b>H</b>	<b>W</b>	<b>D</b>	<b>H</b>	<b>W</b>	<b>H</b>				
					18	21	31.5	16	16	17.25	17	14.5				
					<b>RTA 00</b>	<b>FedEx</b>			<b>ups</b>	4 per carton (pricing and specifications are for one chair)						
 <p><b>Armchair Uph Seat &amp; Poly Back</b> COM Yardage: 0.75 Freight Class: 250 Product Weight (lbs.): 16 Cubic Feet Per Carton: 4.5 (3 per carton)</p>	Stacks 8 high on floor. Stacks 10 high on dolly.	6752	559	587	607	637	679	697	737	797	846	896	1006	1119		
					<b>OVERALL DIMENSIONS</b>			<b>SEAT DIMENSIONS</b>			<b>BACK DIMENSIONS</b>					
					<b>W</b>	<b>D</b>	<b>H</b>	<b>W</b>	<b>D</b>	<b>H</b>	<b>W</b>	<b>H</b>				
					22.5	21	31.5	16	16	18	17	14.5				
					<b>RTA 00</b>	<b>FedEx</b>			<b>ups</b>	3 per carton (pricing and specifications are for one chair)						

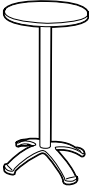
DESCRIPTION	FEATURES	MODEL#	STANDARD TEXTILE GRADES													
			1	2	3	4	5	6	7	8	9	10	11	12		
 <p><b>Armless Chair Uph Seat &amp; Poly Back</b>                      COM Yardage: 0.75                      Freight Class: 250                      Product Weight (lbs.): 14.67                      Cubic Feet Per Carton: 3.83(3 per carton)</p>	Stacks 8 high on floor. Stacks 12 high on dolly	6753	\$511	\$539	\$559	\$589	\$631	\$649	\$689	\$749	\$798	\$848	\$958	\$1071		
			<b>OVERALL DIMENSIONS</b> W D H			<b>SEAT DIMENSIONS</b> W D H			<b>BACK DIMENSIONS</b> W H							
			18	21	31.5	16	16	18	17	14.5						
			RTA 00			FedEx			ups			3 per carton (pricing and specifications are for one chair)				
 <p><b>Armless Bar Stool Poly Seat &amp; Back</b>                      COM Yardage: 0.75                      Freight Class: 250                      Product Weight (lbs.): 14.67                      Cubic Feet Per Carton: 3.19 (4 per carton)</p>	Stacks 4 high on floor.	6754	1	2	3	4	5	6	7	8	9	10	11	12		
			RTA 00			FedEx			ups			4 per carton (pricing and specifications are for one chair)				
			<b>OVERALL DIMENSIONS</b> W D H			<b>SEAT DIMENSIONS</b> W D H			<b>BACK DIMENSIONS</b> W H							
			19.25	18.75	40.5	14	15	30	17	10.5						
 <p><b>Armless Bar Stool Uph Seat &amp; Poly Back</b>                      COM Yardage: 0.75                      Freight Class: 250                      Product Weight (lbs.): 14.67                      Cubic Feet Per Carton: 4.25 (3 per carton)</p>	Stacks 4 high on floor.	6755	1	2	3	4	5	6	7	8	9	10	11	12		
			RTA 00			FedEx			ups			3 per carton (pricing and specifications are for one chair)				
			<b>OVERALL DIMENSIONS</b> W D H			<b>SEAT DIMENSIONS</b> W D H			<b>BACK DIMENSIONS</b> W H							
			19	18	40	14	15	30.75	17	10.5						
 <p><b>Chair Dolly</b>                      COM Yardage: N/A                      Freight Class: 250                      Product Weight (lbs.): 11                      Cubic Feet Per Carton: 2.9</p>		6783	1	2	3	4	5	6	7	8	9	10	11	12		
			RTA 00			FedEx			ups			1 per carton				
			<b>OVERALL DIMENSIONS</b> W D H			<b>SEAT DIMENSIONS</b> W D H			<b>BACK DIMENSIONS</b> W H							
			19.75	23.25	9.75	-	-	-	-	-						

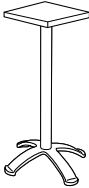
DESCRIPTION	FEATURES	MODEL#	STANDARD TEXTILE GRADES												
			1	2	3	4	5	6	7	8	9	10	11	12	
 <p><b>Round Table - Café Height</b>                      COM Yardage: N/A                      Freight Class: 100                      Product Weight (lbs.): 40                      Cubic Feet Per Carton: 4.49 (3 cartons per one model)</p>		6780	600												
 <p><b>Round Table - Bar Height</b>                      COM Yardage: N/A                      Freight Class: 100                      Product Weight (lbs.): 41                      Cubic Feet Per Carton: 4.49 (3 cartons per one model)</p>		6781	613												
 <p><b>Square Table - Café Height</b>                      COM Yardage: N/A                      Freight Class: 100                      Product Weight (lbs.): 42.5                      Cubic Feet Per Carton: 4.49 (3 cartons per one model)</p>		6785	656												
 <p><b>Square Table - Bar Height</b>                      COM Yardage: N/A                      Freight Class: 100                      Product Weight (lbs.): 43.5                      Cubic Feet Per Carton: 4.49 (3 cartons per one model)</p>		6786	669												

NOT ON CONTRACT

BEACH™



model 4077





model 4078

STANDARD FEATURES

- Elegant wood seating with a choice of an upholstered or vertical wood slat back.
- Frame construction is beech hardwood.
- Furniture legs are equipped with white non marking polypropylene glides as standard. Suitable for both carpet and hard surface flooring.
- All cushions are fixed and non-removable.
- Cushions are highly resilient foam and seats are equipped with a synthetic rubberized webbing suspension system for extra comfort.

OPTIONAL FEATURES

- Frame available in Absolute (AAM), Black (BKM), Cherry (ACM), Espresso Cafe (ECM), English Oak (EOM), Fruitwood (TFM), Gray (HGM), Honey (AHM), Mahogany (TMM), Maple (AVM), Medium Walnut (MWM), Natural Walnut (NLW), Night (ASM), NoceBiondo (NBM), Noce Grigio (NGM), Noce Leggero (NEM), Noce Medio (NMM), Shaker Cherry (SKM), Walnut (TWM), WC Cream (WTM), White (WHM) and Winter Cherry (WCM). Please Specify.
- Check textile availability prior to specifying upholstery material.

DESCRIPTION	FEATURES	MODEL#	STANDARD TEXTILE GRADES													
			1	2	3	4	5	6	7	8	9	10	11	12		
 <p><b>Armchair w/Upholstered back.</b> COM Yardage: 1.50 Freight Class: 300 Product Weight (lbs.): 20 Cubic Feet Per Carton: 11.75</p>	Does not stack.	<b>4077</b>	\$944	\$985	\$1015	\$1057	\$1121	\$1151	\$1206	\$1297	\$1363	\$1441	\$1599	\$1766		
		<b>OVERALL DIMENSIONS</b>			<b>SEAT DIMENSIONS</b>			<b>BACK DIMENSIONS</b>								
		<b>W</b>	<b>D</b>	<b>H</b>	<b>W</b>	<b>D</b>	<b>H</b>	<b>W</b>	<b>H</b>							
		22	23	33.5	19.5	18.5	18.75	19.5	15.5							
			<b>RTA 00</b>	<b>FedEx</b>		<b>ups</b>										
 <p><b>Armchair w/Vertical Wood Slat back.</b> COM Yardage: 1.00 Freight Class: 300 Product Weight (lbs.): 20 Cubic Feet Per Carton: 11.75</p>	Does not stack.	<b>4078</b>	\$991	\$1032	\$1064	\$1111	\$1175	\$1207	\$1265	\$1358	\$1429	\$1512	\$1674	\$1851		
		<b>OVERALL DIMENSIONS</b>			<b>SEAT DIMENSIONS</b>			<b>BACK DIMENSIONS</b>								
		<b>W</b>	<b>D</b>	<b>H</b>	<b>W</b>	<b>D</b>	<b>H</b>	<b>W</b>	<b>H</b>							
		22	23	33.5	19.5	18.5	18.75	19.5	15.5							
			<b>RTA 00</b>													

**BEAM SEATING**



\*see sample layout SON507 for models included above.

**STANDARD FEATURES**

- The universal beam units and tables listed are shown here, along with beam seating upper components from several seating lines.
- Beams are standard in Black. The “T” shaped legs are available in Chrome only with Black anti scuff tips and trim.
- Corner beam creates 90° turn in beam seating. Only table units can be attached.
- Beams and legs are shipped fully assembled.
- Upper seating units include mounting brackets and all necessary hardware for attachment to beam.
- Upper seating units and/or tables can be placed in any order along the beam.
- Power monument has two AC outlets, dual 2.1 amp USB ports.
- **Specifications and pricing are for 1 chair.**

**OPTIONAL FEATURES**

- Check textile availability prior to specifying upholstery material.
- Optional universal aluminum arm with soft pad available for mounting on beam in multiple positions, model 6500A8. \$170 list.
- Sonic seating units are available in mesh back, Black only.
- Vion seating units available in 10 mesh colors: Black (MS69), Stone (MS71), Blue (MS72), Rope (MS73), Natural (MS74), Aqua (MS75), Black Cherry (MS76), Dust (MS77), Ivory (MS78) and Paprika (MS79). Please specify. No upcharge.

**OPTIONAL FEATURES** (continued)

- Vion is available with a Black (BLK) Back Frame as standard or an optional Fog (FOG) Back Frame, please add \$81.
- Duet, Popcorn and Sonic seating units are available in 14 designer colors. Choose from Buzz Blue (BZB), Cactus (CCT), Carrot (CRO), Cloud (IVC), Dijon (DJN), Eggplant (EGP), Fog (FOG), Frost (FRO), Ink (INK), Latte (LAB), Night (BLK), Sand (SND), Scarlet (SAR), and Shadow (SHW).
- Duet arms will match the specified polypropylene color.
- Sidero, Sonic and Vion arm models are standard in Black only.
- Sonic is available in the following frame finishes: Chrome (CHM), Black (TBL), Buzz Blue (TBZ), Cactus (TCC), Carrot (TCR), Dijon (TDJ), Designer White (TDW), Eggplant (TEG), Fog (TFO), Frost (TFR), Ink (TIN), Cloud (TIV), Kalua (TKA), Latte (TLA), Mocha (TMO), Nevada (TNE), Toast (TOA), Shadow (TSH), Sand (TSN), Scarlet (TSR) and Tungsten (TTU). Please specify
- Duet and Popcorn are standard in a Chrome (CH) frame finish. Sidero and Vion are standard in Black (BK) frame finish.
- Beam seating laminate table tops are available in Absolute Acajou (ACJ), Asian Night (ASN), Avant Cherry (AWC), Avant Honey (AWH), Blizzard (BZD), Brushed Cobalt (BRC), Clear Maple (CMB), Custom Grey (CGY), Dark Espresso (DES), Designer White (DWT), Fashionista (FAS), First Class (FCL), Noce Biondo (NBL), Noce Grigio (NGL), Noce Leggero (NEL), Noce Medio (NML), Sheer Beauty (SBY), Stone Dust (SDT), Walnut Heights (WHE), Winter Cherry (WCR), White Chocolate (WHC). Please specify. No upcharge.

**SAMPLE LAYOUTS**

**VON501 - Shown**



Approximate dimensions: 74”W x 24”D

Kit Layout	Description	Total (Grd. 1)
<b>VON501</b>	<b>Vion armless seat units with Beam components:</b> 6340 (3 seats), 6500S3 (1 beam)	<b>\$3,569</b>
DUT501	Duet armless seat units with Beam components: 6691 (3 seats), 6500S3 (1 beam)	\$1,901
POP501	Popcorn armless seat units with Beam components: 6717 (3 seats), 6500S3 (1 beam)	\$2,033
SID501	Sidero armless seat units with Beam components: 6931 (3 seats), 6500S3 (1 beam)	\$3,026
SON501	Sonic armless seat units with Beam components: 6501 (3 seats), 6500S3 (1 beam)	\$2,309

\*See next pages for individual model description, dimensions and starting list price.

**SON502 - Shown**



Approximate dimensions: 100”W x 24”D

Kit Layout	Description	Total (Grd. 1)
<b>SON502</b>	<b>Sonic arm seat units with Beam components:</b> 6506 (4 seats), 6500S4 (1 beam)	<b>\$3,928</b>
DUT502	Duet arm seat units with Beam components: 6690 (4 seats), 6500S4 (1 beam)	\$3,064
POP502	Popcorn armless seat units with Universal arms and Beam components: 6717 (4 seats), 6500S4 (1 beam), and 6500A8 (5 arms)	\$3,618
SID502	Sidero arm seat units with Beam components: 6930 (4 seats), 6500S4 (1 beam)	\$4,352
VON502	Vion arm seat units with Beam components: 6342 (4 seats), 6500S4 (1 beam)	\$4,552

\*See next pages for individual model description, dimensions and starting list price.

**SAMPLE LAYOUTS**

**DUT503 - Shown**



Approximate dimensions: 100"W x 24"D

Kit Layout	Description	Total (Grd. 1)
<b>DUT503</b>	<b>Duet armless seat units with Beam components:</b> 6691 (3 seats), 6500S4 (1 beam), 6507 (1 table)	<b>\$ 2,620</b>
POP503	Popcorn armless seat units with Beam components: 6717 (3 seats), 6500S4 (1 beam), 6507 (1 table)	\$2,752
SID503	Sidero armless seat units with Beam components: 6931 (3 seats), 6500S4 (1 beam), 6507 (1 table)	\$3,745
SON503	Sonic armless seat units with Beam components: 6501 (3 seats), 6500S4 (1 beam), 6507 (1 table)	\$3,028
VON503	Vion armless seat units with Beam components: 6340 (3 seats), 6500S4 (1 beam), 6507 (1 table)	\$4,4288

\*See next pages for individual model description, dimensions and starting list price.

**POP504 - Shown**



Approximate dimensions: 122"W x 24"D

Kit Layout	Description	Total (Grd. 1)
<b>POP504</b>	<b>Popcorn seat units with Universal arms and Beam components:</b> 6717 (4 seats), 6500A8 (6 arms), 6500S3 (1 beam), 6500A2 (1 beam), 6507 (1 table), 6591B (1 Module)	<b>\$5,023</b>
DUT504	Duet arm seat units with Beam components: 6690 (4 seats), 6500S3 (1 beam), 6500A2 (1 beam), 6507 (1 table), 6591B (1 Module)	\$4,299
SID504	Sidero arm seat units with Beam components: 6930 (4 seats), 6500S3 (1 beam), 6500A2 (1 beam), 6507 (1 table), 6591B (1 Module)	\$5,587
SON504	Sonic arm seat units with Beam components: 6504 (4 seats), 6500S3 (1 beam), 6500A2 (1 beam), 6507 (1 table), 6591B (1 Module)	\$4,699
VON504	Vion arm seat units with Beam components: 6342 (4 seats), 6500S3 (1 beam), 6500A2 (1 beam), 6507 (1 table), 6591B (1 Module)	\$5,787

\*See next pages for individual model description, dimensions and starting list price.

**SID505 - Shown**



Approximate dimensions: 147"W x 24"D

Kit Layout	Description	Total (Grd. 1)
<b>SID505</b>	<b>Sidero armless seat units with Beam components:</b> 6931 (4 seats), 6500S3 (1 beam), 6500A3 (1 beam), 6507 (2 table)	<b>\$5,200</b>
DUT505	Duet armless seat units with Beam components: 6691 (4 seats), 6500S3 (1 beam), 6500A3 (1 beam), 6507 (2 table)	\$3,700
POP505	Popcorn armless seat units with Beam components: 6717 (4 seats), 6500S3 (1 beam), 6500A3 (1 beam), 6507 (2 table)	\$3,876
SON505	Sonic armless seat units with Beam components: 6501 (4 seats), 6500S3 (1 beam), 6500A3 (1 beam), 6507 (2 table)	\$4,244
VON505	Vion armless seat units with Beam components 6340 (4 seats), 6500S3 (1 beam), 6500A3 (1 beam), 6507 (2 table)	\$5,924

\*See next pages for individual model description, dimensions and starting list price.

**VON506 - Shown**



Approximate dimensions: 103"W x 103"D

Kit Layout	Description	Total (Grd. 1)
<b>VON506</b>	<b>Vion arm seat units with Beam components:</b> 6342 (6 seats), 6500S3 (2 beams), 6507-T2 (1 table), 6500A9 (1 Connector)	<b>\$7,539</b>
DUT504	Duet arm seat units with Beam components: 6690 (6 seats), 6500S3 (2 beams), 6507-T2 (1 table), 6500A9 (1 Connector)	\$5,307
POP505	Popcorn armless seat units with Universal arms and Beam components: 6717 (6 seats), 6500A8 (8 arms), 6500S3 (2 beams), 6507-T2 (1 table), 6500A9 (1 Connector)	\$6,223
SID504	Sidero arm seat units with Beam components: 6930 (6 seats), 6500S3 (2 beams), 6507-T2 (1 table), 6500A9 (1 Connector)	\$7,239
SON504	Sonic arm seat units with Beam components: 6504 (6 seats), 6500S3 (2 beams), 6507-T2 (1 table), 6500A9 (1 Connector)	\$5907

\*See next pages for individual model description, dimensions and starting list price.

**SAMPLE LAYOUTS**

**SON507 - Shown**



Approximate dimensions: 103"W x 103"D

Kit Layout	Description	Total (Grd. 1)
<b>SON507</b>	<b>Sonic arm seat units with Beam components:</b> 6506 (6 seats), 6500S3 (2 beams), 6507-T2 (1 table), 6500A9 (1 connector)	<b>\$6,603</b>
DUT507	Duet arm seat units with Beam components: 6690 (6 seats), 6500S3 (2 beams), 6507-T2 (1 table), 6500A9 (1 connector)	\$5,307
POP507	Popcorn armless seat units with Universal arms and Beam components: 6717 (6 seats), 6500S3 (2 beams), 6507-T2 (1 table), 6500A9 (1 connector) and 6500A8 (8 arms)	\$6,223
SID507	Sidero arm seat units with Beam components: 6930 (6 seats), 6500S3 (2 beams), 6507-T2 (1 table), 6500A9 (1 connector)	\$7,239
VON507	Vion arm seat units with Beam components: 6342 (6 seats), 6500S3 (2 beams), 6507-T2 (1 table), 6500A9 (1 connector)	\$7,539

\*See next pages for individual model description, dimensions and starting list price.

**DUT508 - Shown**



Approximate dimensions: 131"W x 78"D

Kit Layout	Description	Total (Grd. 1)
<b>DUT508</b>	<b>Duet armless seat units with Beam components:</b> 6691 (7 seats), 6500S3 (1 Beam), 6500S2 (2 Beams), 6507-T2 (2 Tables), 6500A9 (2 Connector), 6591B (2 Modules)	<b>\$7,669</b>
POP508	Popcorn armless seat units with Beam components: 6717 (7 seats), 6500S3 (1 Beam), 6500S2 (2 Beams), 6507-T2 (2 Tables), 6500A9 (2 Connector), 6591B (2 Modules)	\$7,977
SID508	Sidero armless seat units with Beam components: 6931 (7 seats), 6500S3 (1 Beam), 6500S2 (2 Beams), 6507-T2 (2 Tables), 6500A9 (2 Connector), 6591B (2 Modules)	\$10,294
SON508	Sonic armless seat units with Beam components: 6501 (7 seats), 6500S3 (1 Beam), 6500S2 (2 Beams), 6507-T2 (2 Tables), 6500A9 (2 Connector), 6591B (2 Modules)	\$8,621
VON507	Vion armless seat units with Beam components: 6340 (7 seats), 6500S3 (1 Beam), 6500S2 (2 Beams), 6507-T2 (2 Tables), 6500A9 (2 Connector), 6591B (2 Modules)	\$11,561

\*See next pages for individual model description, dimensions and starting list price.

DESCRIPTION	FEATURES	MODEL#	STANDARD TEXTILE GRADES											
-------------	----------	--------	-------------------------	--	--	--	--	--	--	--	--	--	--	--

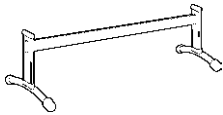

**Beam - Accommodates 2 Seats**  
COM Yardage: N/A  
Freight Class: 250  
Product Weight (lbs.): 37  
Cubic Feet Per Carton: 11 (1 per carton)

Freestanding

	1	2	3	4	5	6	7	8	9	10	11	12
<b>6500S2</b>	\$790	-	-	-	-	-	-	-	-	-	-	-

OVERALL DIMENSIONS			SEAT DIMENSIONS			BACK DIMENSIONS	
W	D	H	W	D	H	W	H

49.5	24	16	-	-	-	-	-
------	----	----	---	---	---	---	---

**RTA 00**

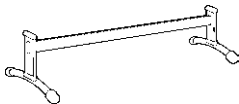

**Beam - Accommodates 3 Seats**  
COM Yardage: N/A  
Freight Class: 250  
Product Weight (lbs.): 43  
Cubic Feet Per Carton: 16 (1 per carton)

Freestanding

	1	2	3	4	5	6	7	8	9	10	11	12
<b>6500S3</b>	\$911	-	-	-	-	-	-	-	-	-	-	-





OVERALL DIMENSIONS			SEAT DIMENSIONS			BACK DIMENSIONS	
W	D	H	W	D	H	W	H

74	24	16	-	-	-	-	-
----	----	----	---	---	---	---	---

**RTA 00**

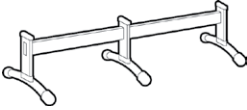



# MULTI-PURPOSE

# BEAM SEATING B

DESCRIPTION	FEATURES	MODEL#	STANDARD TEXTILE GRADES												
			1	2	3	4	5	6	7	8	9	10	11	12	
 <p><b>Beam - Accommodates 4 Seats</b> COM Yardage: N/A Freight Class: 250 Product Weight (lbs.): 58 Cubic Feet Per Carton: 22 (1 per carton)</p>	Freestanding	6500S4	\$1272	-	-	-	-	-	-	-	-	-	-	-	-
		<b>OVERALL DIMENSIONS</b>			<b>SEAT DIMENSIONS</b>			<b>BACK DIMENSIONS</b>							
		<b>W</b>	<b>D</b>	<b>H</b>	<b>W</b>	<b>D</b>	<b>H</b>	<b>W</b>	<b>H</b>						
		100	24	16	-	-	-	-	-						
			<b>RTA 00</b>												
 <p><b>Beam Extender - Accommodates 2 Seats</b> COM Yardage: N/A Freight Class: 85 Product Weight (lbs.): 36 Cubic Feet Per Carton: 10.5 (1 per carton)</p>	Not Freestanding. Includes hardware.	6500A2	\$603	-	-	-	-	-	-	-	-	-	-	-	-
		<b>OVERALL DIMENSIONS</b>			<b>SEAT DIMENSIONS</b>			<b>BACK DIMENSIONS</b>							
		<b>W</b>	<b>D</b>	<b>H</b>	<b>W</b>	<b>D</b>	<b>H</b>	<b>W</b>	<b>H</b>						
		47.5	24	16	-	-	-	-	-						
			<b>RTA 00</b>												
 <p><b>Beam Extender - Accommodates 3 Seats</b> COM Yardage: N/A Freight Class: 85 Product Weight (lbs.): 43 Cubic Feet Per Carton: 16 (1 per carton)</p>	Not Freestanding. Includes hardware.	6500A3	\$757	-	-	-	-	-	-	-	-	-	-	-	-
		<b>OVERALL DIMENSIONS</b>			<b>SEAT DIMENSIONS</b>			<b>BACK DIMENSIONS</b>							
		<b>W</b>	<b>D</b>	<b>H</b>	<b>W</b>	<b>D</b>	<b>H</b>	<b>W</b>	<b>H</b>						
		72	24	16	-	-	-	-	-						
			<b>RTA 00</b>												
 <p><b>Beam Extender - Accommodates 4 Seats</b> COM Yardage: N/A Freight Class: 85 Product Weight (lbs.): 58 Cubic Feet Per Carton: 21.75 (1 per carton)</p>	Not Freestanding. Includes hardware.	6500A4	\$1134	-	-	-	-	-	-	-	-	-	-	-	-
		<b>OVERALL DIMENSIONS</b>			<b>SEAT DIMENSIONS</b>			<b>BACK DIMENSIONS</b>							
		<b>W</b>	<b>D</b>	<b>H</b>	<b>W</b>	<b>D</b>	<b>H</b>	<b>W</b>	<b>H</b>						
		98	24	16	-	-	-	-	-						
			<b>RTA 00</b>												
 <p><b>Universal Aluminum Arm w/Pad</b> COM Yardage: N/A Freight Class: 85 Product Weight (lbs.): 3.5 Cubic Feet Per Carton: 0.5 (1 per carton)</p>	Includes hardware.	6500A8	\$170	-	-	-	-	-	-	-	-	-	-	-	-
		<b>OVERALL DIMENSIONS</b>			<b>SEAT DIMENSIONS</b>			<b>BACK DIMENSIONS</b>							
		<b>W</b>	<b>D</b>	<b>H</b>	<b>W</b>	<b>D</b>	<b>H</b>	<b>W</b>	<b>H</b>						
		2.5	10	14	-	-	-	-	-						
			<b>RTA 00</b>												





# B BEAM SEATING

# MULTI-PURPOSE

DESCRIPTION	FEATURES	MODEL#	STANDARD TEXTILE GRADES													
			1	2	3	4	5	6	7	8	9	10	11	12		
 <p><b>Corner Connector Beam</b> COM Yardage: N/A Freight Class: 85 Product Weight (lbs.): 9 Cubic Feet Per Carton: 0.07 (1 per carton)</p>	Not Freestanding. Includes hardware.	6500A9	\$331	-	-	-	-	-	-	-	-	-	-	-		
			<b>OVERALL DIMENSIONS</b>			<b>SEAT DIMENSIONS</b>			<b>BACK DIMENSIONS</b>							
			<b>W</b>	<b>D</b>	<b>H</b>	<b>W</b>	<b>D</b>	<b>H</b>	<b>W</b>	<b>H</b>						
			1.75	24	3.25	-	-	-	-	-						
			<b>RTA 00</b>													
 <p><b>Bolt Down Kit</b> COM Yardage: N/A Freight Class: 85 Product Weight (lbs.): 8 Cubic Feet Per Carton: 0.6 (1 per carton)</p>	Set of 4 brackets. Includes hardware.	6500BD	\$157	-	-	-	-	-	-	-	-	-	-			
			<b>OVERALL DIMENSIONS</b>			<b>SEAT DIMENSIONS</b>			<b>BACK DIMENSIONS</b>							
			<b>W</b>	<b>D</b>	<b>H</b>	<b>W</b>	<b>D</b>	<b>H</b>	<b>W</b>	<b>H</b>						
			17.75	17.75	1	-	-	-	-	-						
			<b>RTA 00</b>			<b>FedEx</b>										
 <p><b>Power Module</b> COM Yardage: N/A Freight Class: 85 Product Weight (lbs.): 3.2 Cubic Feet Per Carton: 0.5 (1 per carton)</p>	Under mount, 10 ft. cord. Black only.	6591B	\$637	-	-	-	-	-	-	-	-	-	-			
			<b>OVERALL DIMENSIONS</b>			<b>SEAT DIMENSIONS</b>			<b>BACK DIMENSIONS</b>							
			<b>W</b>	<b>D</b>	<b>H</b>	<b>W</b>	<b>D</b>	<b>H</b>	<b>W</b>	<b>H</b>						
			21	21	1	-	-	-	-	-						
			<b>RTA 00</b>			<b>FedEx</b>										
 <p><b>End Table Top</b> COM Yardage: N/A Freight Class: 85 Product Weight (lbs.): 8 Cubic Feet Per Carton: 0.6 (1 per carton)</p>	Includes hardware. Use on beams.	6507	\$356	-	-	-	-	-	-	-	-	-	-			
			<b>OVERALL DIMENSIONS</b>			<b>SEAT DIMENSIONS</b>			<b>BACK DIMENSIONS</b>							
			<b>W</b>	<b>D</b>	<b>H</b>	<b>W</b>	<b>D</b>	<b>H</b>	<b>W</b>	<b>H</b>						
			17.75	17.75	1	-	-	-	-	-						
			<b>RTA 00</b>			<b>FedEx</b>										

















# MULTI-PURPOSE





# BEAM SEATING B

DESCRIPTION	FEATURES	MODEL#	STANDARD TEXTILE GRADES											
			1	2	3	4	5	6	7	8	9	10	11	12
 <p><b>Radius Corner Table Top</b> COM Yardage: N/A Freight Class: 85 Product Weight (lbs.): 14 Cubic Feet Per Carton: 1.9 (1 per carton)</p>	Includes hardware. Use on beams.	<b>6507-T2</b>	\$466	-	-	-	-	-	-	-	-	-	-	
		<b>OVERALL DIMENSIONS</b>			<b>SEAT DIMENSIONS</b>			<b>BACK DIMENSIONS</b>						
		<b>W</b>	<b>D</b>	<b>H</b>	<b>W</b>	<b>D</b>	<b>H</b>	<b>W</b>	<b>H</b>					
		21	21	1	-	-	-	-	-					
			<b>RTA 00</b>											
 <p><b>Seat Unit w/Arms</b> COM Yardage: N/A Freight Class: 250 Product Weight (lbs.): 19 Cubic Feet Per Carton: 4.88 (2 per carton)</p>	<b>Duet</b> Use with beams.	<b>6690</b>	\$448	-	-	-	-	-	-	-	-	-		
		<b>OVERALL DIMENSIONS</b>			<b>SEAT DIMENSIONS</b>			<b>BACK DIMENSIONS</b>						
		<b>W</b>	<b>D</b>	<b>H</b>	<b>W</b>	<b>D</b>	<b>H</b>	<b>W</b>	<b>H</b>					
		25.5	21	18	18	17.5	-	18	16					
			<b>RTA 00</b>	FedEx		UPS								
 <p><b>Armless Seat Unit</b> COM Yardage: N/A Freight Class: 150 Product Weight (lbs.): 18 Cubic Feet Per Carton: 3.25 (2 per carton)</p>	<b>Duet</b> Use with beams.	<b>6691</b>	\$330	-	-	-	-	-	-	-	-	-		
		<b>OVERALL DIMENSIONS</b>			<b>SEAT DIMENSIONS</b>			<b>BACK DIMENSIONS</b>						
		<b>W</b>	<b>D</b>	<b>H</b>	<b>W</b>	<b>D</b>	<b>H</b>	<b>W</b>	<b>H</b>					
		18	21	18	18	17.5	-	18	16					
			<b>RTA 00</b>	FedEx		UPS								
 <p><b>Seat Unit w/Arms</b> COM Yardage: 0.75 Freight Class: 250 Product Weight (lbs.): 19 Cubic Feet Per Carton: 4.88 (2 per carton)</p>	<b>Duet</b> Upholstered Seat. Use with beams.	<b>6692</b>	\$548	\$589	\$619	\$662	\$726	\$745	\$803	\$904	\$957	\$1054	\$1184	\$1346
		<b>OVERALL DIMENSIONS</b>			<b>SEAT DIMENSIONS</b>			<b>BACK DIMENSIONS</b>						
		<b>W</b>	<b>D</b>	<b>H</b>	<b>W</b>	<b>D</b>	<b>H</b>	<b>W</b>	<b>H</b>					
		25.5	21	18	18	17.5	-	18	16					
			<b>RTA 00</b>	FedEx		UPS								

# B BEAM SEATING



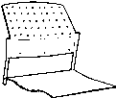

# MULTI-PURPOSE

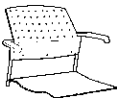

DESCRIPTION	FEATURES	MODEL#	STANDARD TEXTILE GRADES											
			1	2	3	4	5	6	7	8	9	10	11	12
 <p><b>Armless Seat Unit</b> COM Yardage: 0.75 Freight Class: 150 Product Weight (lbs.): 19 Cubic Feet Per Carton: 3.25 (2 per carton)</p>	<p><b>Duet</b> Upholstered Seat. Use with beams.</p>	<p><b>6693</b></p>	\$426	\$467	\$496	\$540	\$603	\$623	\$679	\$782	\$835	\$930	\$1062	\$1223
			<p><b>OVERALL DIMENSIONS</b></p>			<p><b>SEAT DIMENSIONS</b></p>			<p><b>BACK DIMENSIONS</b></p>					
			W	D	H	W	D	H	W	H				
			18	21	18	18	17.5	-	18	16				
														
 <p><b>Seat Unit w/Arms</b> COM Yardage: 0.75 Freight Class: 150 Product Weight (lbs.): 20 Cubic Feet Per Carton: 4.88 (2 per carton)</p>	<p><b>Duet</b> Upholstered Seat and Back. Use with beams.</p>	<p><b>6697</b></p>	\$581	\$622	\$651	\$695	\$758	\$778	\$834	\$937	\$990	\$1085	\$1217	\$1378
			<p><b>OVERALL DIMENSIONS</b></p>			<p><b>SEAT DIMENSIONS</b></p>			<p><b>BACK DIMENSIONS</b></p>					
			W	D	H	W	D	H	W	H				
			25.5	21	18	18	17.5	-	18	16				
														
 <p><b>Armless Seat Unit</b> COM Yardage: 0.75 Freight Class: 150 Product Weight (lbs.): 19 Cubic Feet Per Carton: 3.25 (2 per carton)</p>	<p><b>Duet</b> Upholstered Seat and Back. Use with beams.</p>	<p><b>6698</b></p>	\$474	\$515	\$545	\$588	\$652	\$671	\$729	\$832	\$883	\$980	\$1110	\$1272
			<p><b>OVERALL DIMENSIONS</b></p>			<p><b>SEAT DIMENSIONS</b></p>			<p><b>BACK DIMENSIONS</b></p>					
			W	D	H	W	D	H	W	H				
			18	21	18	18	17.5	-	18	16				
														
 <p><b>Armless Seat Unit</b> COM Yardage: N/A Freight Class: 150 Product Weight (lbs.): 17 Cubic Feet Per Carton: 6.5 (2 per carton)</p>	<p><b>Popcorn</b> Polypropylene Seat and Back. use with beam</p>	<p><b>6717</b></p>	374	-	-	-	-	-	-	-	-	-	-	-
			<p><b>OVERALL DIMENSIONS</b></p>			<p><b>SEAT DIMENSIONS</b></p>			<p><b>BACK DIMENSIONS</b></p>					
			W	D	H	W	D	H	W	H				
			20	21	18	18	18	-	19.5	16				
														
 <p><b>Armless Seat Unit</b> COM Yardage: 0.75 Freight Class: 150 Product Weight (lbs.): 18 Cubic Feet Per Carton: 6.5 (2 per carton)</p>	<p><b>Popcorn</b> Upholstered Seat and Polypropylene Back. Use with beam.</p>	<p><b>6719</b></p>	488	524	548	582	633	656	705	777	833	897	1024	1164
			<p><b>OVERALL DIMENSIONS</b></p>			<p><b>SEAT DIMENSIONS</b></p>			<p><b>BACK DIMENSIONS</b></p>					
			W	D	H	W	D	H	W	H				
			20	21	18	18	18	-	19.5	16				
														

DESCRIPTION	FEATURES	MODEL#	STANDARD TEXTILE GRADES											
			1	2	3	4	5	6	7	8	9	10	11	12
 <p><b>Seat Unit w/Arms</b> COM Yardage: 1.25 Freight Class: 300 Product Weight (lbs.): 20 Cubic Feet Per Carton: 9.75</p>	<p><b>Sidero</b> Upholstered Seat and Back. Use with beam.</p>	<b>6930</b>	770	823	864	925	1008	1048	1125	1247	1342	1447	1663	1890
		<b>OVERALL DIMENSIONS</b>			<b>SEAT DIMENSIONS</b>			<b>BACK DIMENSIONS</b>						
		<b>W</b>	<b>D</b>	<b>H</b>	<b>W</b>	<b>D</b>	<b>H</b>	<b>W</b>	<b>H</b>					
		25.5	23.5	19	19.5	18	-	19	15.5					
			<b>RTA 00</b>											
 <p><b>Armless Seat Unit</b> COM Yardage: 1.25 Freight Class: 300 Product Weight (lbs.): 18 Cubic Feet Per Carton: 9.75</p>	<p><b>Sidero</b> Upholstered Seat and Back. Use with beam.</p>	<b>6931</b>	705	758	799	860	943	983	1060	1182	1277	1382	1598	1825
		<b>OVERALL DIMENSIONS</b>			<b>SEAT DIMENSIONS</b>			<b>BACK DIMENSIONS</b>						
		<b>W</b>	<b>D</b>	<b>H</b>	<b>W</b>	<b>D</b>	<b>H</b>	<b>W</b>	<b>H</b>					
		21	23.5	19	19.5	18	-	19	15.5					
			<b>RTA 00</b>											
 <p><b>Armless Seat Unit</b> COM Yardage: N/A Freight Class: 250 Product Weight (lbs.): 12 Cubic Feet Per Carton: 3.25 (2 per carton)</p>	<p><b>Sonic</b> Polypropylene Seat and Back. Use with Beam.</p>	<b>6501</b>	\$466	-	-	-	-	-	-	-	-	-	-	-
		<b>OVERALL DIMENSIONS</b>			<b>SEAT DIMENSIONS</b>			<b>BACK DIMENSIONS</b>						
		<b>W</b>	<b>D</b>	<b>H</b>	<b>W</b>	<b>D</b>	<b>H</b>	<b>W</b>	<b>H</b>					
		20	21.5	17	17	16	-	17	15					
			<b>RTA 00</b>			FedEx			ups					
 <p><b>Armless Seat Unit</b> COM Yardage: 0.75 Freight Class: 250 Product Weight (lbs.): 12 Cubic Feet Per Carton: 3.25 (2 per carton)</p>	<p><b>Sonic</b> Upholstered Seat and Polypropylene Back. Use with Beam.</p>	<b>6502</b>	\$525	\$558	\$578	\$614	\$665	\$680	\$724	\$805	\$845	\$920	\$1023	\$1154
		<b>OVERALL DIMENSIONS</b>			<b>SEAT DIMENSIONS</b>			<b>BACK DIMENSIONS</b>						
		<b>W</b>	<b>D</b>	<b>H</b>	<b>W</b>	<b>D</b>	<b>H</b>	<b>W</b>	<b>H</b>					
		20	22	17	17	16	-	17	15					
			<b>RTA 00</b>			FedEx			ups					
 <p><b>Armless Seat Unit</b> COM Yardage: 0.75 Freight Class: 150 Product Weight (lbs.): 13 Cubic Feet Per Carton: 3.25 (2 per carton)</p>	<p><b>Sonic</b> Upholstered Seat and Back. Use with Beam.</p>	<b>6503</b>	\$581	\$612	\$634	\$670	\$719	\$737	\$778	\$861	\$901	\$976	\$1082	\$1208
		<b>OVERALL DIMENSIONS</b>			<b>SEAT DIMENSIONS</b>			<b>BACK DIMENSIONS</b>						
		<b>W</b>	<b>D</b>	<b>H</b>	<b>W</b>	<b>D</b>	<b>H</b>	<b>W</b>	<b>H</b>					
		20	22	17	17	16	-	17	15					
			<b>RTA 00</b>			FedEx			ups					

# B BEAM SEATING

# MULTI-PURPOSE

DESCRIPTION	FEATURES	MODEL#	STANDARD TEXTILE GRADES											
			1	2	3	4	5	6	7	8	9	10	11	12
 <p><b>Seat Unit w/Arms</b> COM Yardage: N/A Freight Class: 150 Product Weight (lbs.): 13 Cubic Feet Per Carton: 3.25 (2 per carton)</p>	<p><b>Sonic</b> Polypropylene Seat. Use with Beam.</p>	6504	\$548	-	-	-	-	-	-	-	-	-	-	-
		<b>OVERALL DIMENSIONS</b>			<b>SEAT DIMENSIONS</b>			<b>BACK DIMENSIONS</b>						
		<b>W</b>	<b>D</b>	<b>H</b>	<b>W</b>	<b>D</b>	<b>H</b>	<b>W</b>	<b>H</b>					
		23	21.5	17	17	16	-	17	15					
			RTA 00	FedEx		ups								
 <p><b>Seat Unit w/Arms</b> COM Yardage: 0.75 Freight Class: Z2 Product Weight (lbs.): 13 Cubic Feet Per Carton: 3.25 (2 per carton)</p>	<p><b>Sonic</b> Upholstered Seat. Use with Beam.</p>	6505	\$608	\$637	\$661	\$696	\$746	\$761	\$806	\$886	\$926	\$1002	\$1106	\$1235
		<b>OVERALL DIMENSIONS</b>			<b>SEAT DIMENSIONS</b>			<b>BACK DIMENSIONS</b>						
		<b>W</b>	<b>D</b>	<b>H</b>	<b>W</b>	<b>D</b>	<b>H</b>	<b>W</b>	<b>H</b>					
		23	22	17	17	16	-	17	15					
			RTA 00	FedEx		ups								
 <p><b>Seat Unit w/Arms</b> COM Yardage: 0.75 Freight Class: 150 Product Weight (lbs.): 14 Cubic Feet Per Carton: 3.25 (2 per carton)</p>	<p><b>Sonic</b> Upholstered Seat and Back Use with Beam.</p>	6506	\$664	\$697	\$719	\$755	\$804	\$821	\$863	\$945	\$986	\$1061	\$1167	\$1293
		<b>OVERALL DIMENSIONS</b>			<b>SEAT DIMENSIONS</b>			<b>BACK DIMENSIONS</b>						
		<b>W</b>	<b>D</b>	<b>H</b>	<b>W</b>	<b>D</b>	<b>H</b>	<b>W</b>	<b>H</b>					
		23	22	17	17	16	-	17	15					
			RTA 00	FedEx		ups								
 <p><b>Armless Seat Unit</b> COM Yardage: 1 Freight Class: 250 Product Weight (lbs.): 20 Cubic Feet Per Carton: 7.25</p>	<p><b>Vion</b> Upholstered Seat and Mesh Back. Use with beam.</p>	6340	\$886	\$932	\$962	\$1011	\$1079	\$1110	\$1170	\$1268	\$1344	\$1427	\$1601	\$1786
		<b>OVERALL DIMENSIONS</b>			<b>SEAT DIMENSIONS</b>			<b>BACK DIMENSIONS</b>						
		<b>W</b>	<b>D</b>	<b>H</b>	<b>W</b>	<b>D</b>	<b>H</b>	<b>W</b>	<b>H</b>					
		21	23.5	20.5	17.5	18	-	19	17					
			RTA 00											
 <p><b>Armless Seat Unit</b> COM Yardage: 1 Freight Class: 250 Product Weight (lbs.): 20 Cubic Feet Per Carton: 7.25</p>	<p><b>Vion</b> Upholstered Seat and Back. Use with beam.</p>	6341	\$1032	\$1084	\$1125	\$1185	\$1270	\$1309	\$1387	\$1509	\$1604	\$1709	\$1922	\$2152
		<b>OVERALL DIMENSIONS</b>			<b>SEAT DIMENSIONS</b>			<b>BACK DIMENSIONS</b>						
		<b>W</b>	<b>D</b>	<b>H</b>	<b>W</b>	<b>D</b>	<b>H</b>	<b>W</b>	<b>H</b>					
		21	23.5	20.5	17.5	18	-	19	17					
			RTA 00											

DESCRIPTION	FEATURES	MODEL#	STANDARD TEXTILE GRADES													
			1	2	3	4	5	6	7	8	9	10	11	12		
 <p><b>Seat Unit w/Arms</b> COM Yardage: 1 Freight Class: 250 Product Weight (lbs.): 21 Cubic Feet Per Carton: 9.75</p>	<p><b>Vion</b> Upholstered Seat and Mesh Back. Use with beam.</p>	<b>6342</b>	\$820	\$863	\$896	\$944	\$1010	\$1041	\$1104	\$1201	\$1275	\$1360	\$1533	\$1717		
		<b>OVERALL DIMENSIONS</b>			<b>SEAT DIMENSIONS</b>			<b>BACK DIMENSIONS</b>								
		<b>W</b>	<b>D</b>	<b>H</b>	<b>W</b>	<b>D</b>	<b>H</b>	<b>W</b>	<b>H</b>							
		25.5	23.5	20.5	17.5	18	-	19	17							
			<b>RTA 00</b>													
 <p><b>Seat Unit w/Arms</b> COM Yardage: 1 Freight Class: 250 Product Weight (lbs.): 21 Cubic Feet Per Carton: 9.75</p>	<p><b>Vion</b> Upholstered Seat and Back. Use with beam.</p>	<b>6343</b>	\$949	\$1001	\$1042	\$1101	\$1186	\$1224	\$1302	\$1423	\$1517	\$1623	\$1839	\$2068		
		<b>OVERALL DIMENSIONS</b>			<b>SEAT DIMENSIONS</b>			<b>BACK DIMENSIONS</b>								
		<b>W</b>	<b>D</b>	<b>H</b>	<b>W</b>	<b>D</b>	<b>H</b>	<b>W</b>	<b>H</b>							
		25.5	23.5	20.5	17.5	18	-	19	17							
			<b>RTA 00</b>													

**CAPRICE™**



model 3365 (TUN)



model 3365C (TUN)

**STANDARD FEATURES**

- Modern light scale guest seating.
- Durable molded armcaps in Black Only.
- Frame is standard in a Tungsten colored finish (TUN).
- Standard with Black "bullet style" glides.
- Non-castered models can be joined together using ganging clamp model 6522.
- **C1** dual wheel carpet casters are standard on models 3365C.
- Does not stack.
- Check textile availability prior to specifying upholstery material.

• **Frame finish**

- (TBL) Black
- (TCC) Cactus
- (TDJ) Dijon
- (TEG) Eggplant
- (TFR) Frost
- (TIV) Cloud
- (TLA) Latte
- (TNE) Nevada
- (TSN) Sand
- (TTU) Tungsten
- (BCH) Brushed Chrome. Add **\$240**
- (CHM) Chrome. **Upcharge varies.** Please Specify.
- (TBZ) Buzz Blue
- (TCR) Carrot
- (TDW) Designer White
- (TFO) Fog
- (TIN) Ink
- (TKA) Kalua
- (TOA) Toast
- (TSH) Shadow
- (TSR) Scarlet
- A Chrome (CHM) finish is also available. Add \$86 for side chairs. Add \$143 for counter and bar stools.

**OPTIONAL FEATURES**

- Optional steel cushioned glides (**B**) are available. Add \$33. Please specify.
- For hard surface flooring casters, specify **C9R**. Add \$76.

DESCRIPTION	FEATURES	MODEL#	STANDARD TEXTILE GRADES											
			1	2	3	4	5	6	7	8	9	10	11	12



**Armchair** 4 Legged  
COM Yardage: 1.25  
Freight Class: 300  
Product Weight (lbs.): 22  
Cubic Feet Per Carton: 14.5

Does not stack.

<b>3365</b>	\$939	\$989	\$1031	\$1087	\$1165	\$1196	\$1269	\$1402	\$1468	\$1589	\$1758	\$1967
-------------	-------	-------	--------	--------	--------	--------	--------	--------	--------	--------	--------	--------

OVERALL DIMENSIONS			SEAT DIMENSIONS			BACK DIMENSIONS	
W	D	H	W	D	H	W	H
25	24	31.5	19.5	19.5	18.5	18	13

**RTA 00**



**Armchair** 4 Legged w/casters  
COM Yardage: 1.25  
Freight Class: 300  
Product Weight (lbs.): 23  
Cubic Feet Per Carton: 14.5

Does not stack.

<b>3365C</b>	\$1092	\$1143	\$1183	\$1242	\$1319	\$1351	\$1424	\$1560	\$1625	\$1752	\$1923	\$2138
--------------	--------	--------	--------	--------	--------	--------	--------	--------	--------	--------	--------	--------

OVERALL DIMENSIONS			SEAT DIMENSIONS			BACK DIMENSIONS	
W	D	H	W	D	H	W	H
25	23.5	32.5	19.5	18.5	18	18	14.5

**RTA 00**



**Barstool** - 4 Legged  
COM Yardage: 1.25  
Freight Class: 300  
Product Weight (lbs.): 32  
Cubic Feet Per Carton: 20

Does not stack.

<b>3369</b>	\$1187	\$1238	\$1278	\$1337	\$1417	\$1447	\$1519	\$1655	\$1719	\$1847	\$2017	\$2233
-------------	--------	--------	--------	--------	--------	--------	--------	--------	--------	--------	--------	--------

OVERALL DIMENSIONS			SEAT DIMENSIONS			BACK DIMENSIONS	
W	D	H	W	D	H	W	H
25	26.5	45.5	19.5	19.5	30.5	18	13

**RTA 00**

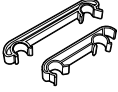
DESCRIPTION	FEATURES	MODEL#	STANDARD TEXTILE GRADES											
			1	2	3	4	5	6	7	8	9	10	11	12
 <p><b>Ganging Brackets</b>                      COM Yardage: N/A                      Freight Class: 70                      Product Weight (lbs.): 0.16                      Cubic Feet Per Carton: 1 (25 per Carton)</p>		6522	\$37	-	-	-	-	-	-	-	-	-	-	
			<b>OVERALL DIMENSIONS</b>			<b>SEAT DIMENSIONS</b>			<b>BACK DIMENSIONS</b>					
			<b>W</b>	<b>D</b>	<b>H</b>	<b>W</b>	<b>D</b>	<b>H</b>	<b>W</b>	<b>H</b>				
			00.87	7.75	1.5	-	-	-	-	-				
			<b>RTA 00</b>											

CHAP™



Wood Back Armchair model 1010



Upholstered Back Armchair model 1015



Upholstered Round Back Armchair model 1004



Wood Round Back Armchair model 1005



Underseat panel (USP)





STANDARD FEATURES

- Chap offers mid-century modern styling in a finely crafted beechwood armchair series.
- Straight and round back models have upholstered seats with upholstered or open wood frame backs.
- Straight back models are available with exposed wood or upholstered front seat rails
- For reorders of discontinued models 1002 and 1003, use models 1004 and 1005 with 18" reduced seat depth.
- Custom stain matching is not available on models 1004 and 1005.
- Chairs are standard with a black liner under seat cushion. An underseat panel (USP) is available which conceals seat structure. It is covered with a coated textile and secured with tamperproof fasteners.
- For graded pricing, select model base price. Add graded textile upcharges for seat or for upholstered back models, both seat and back.
- The Blended Textile matrix does not apply to this series.
- Upholstery options include fabric, coated textiles and leather.
- Chap series is covered under Global's Limited Lifetime warranty, for single shift use.
- For multi-shift environments, and coverage under Globalcare's 24/7 warranty, Ultracell foam - 24/7 warranty (UC) must be selected.
- Textiles with a minimum of 100,000 double rubs must be specified to meet Global's 24/7 warranty coverage. For healthcare textiles, visit the website at [globalfurnituregroup.com](http://globalfurnituregroup.com).
- Does not stack.
- Custom stain matching is not available on round back models.

Please add option codes in the following order:

- **Model number**  
Specify model number
- **Back textile**  
Specify textile code
- **Seat textile**  
Specify textile code
- **Frame finish** (Round back models)  
1004 and 1005 available in select finishes (\*).  
(AAM) Absolute\*  
(BKM) Black\*  
(ACM) Cherry\*  
(EOM) English Oak  
(ECM) Espresso Cafe\*  
(TFM) Fruitwood  
(HGM) Gray  
(AHM) Honey  
(TMM) Mahogany\*  
(AVM) Maple  
(MWM) Medium Walnut\*  
(NLW) Natural Walnut  
(ASM) Night\*  
(NBM) Noce Biondo  
(NGM) Noce Grigio  
(NEM) Noce Leggero  
(NMM) Noce Medio\*  
(SKM) Shaker Cherry\*  
(TWM) Walnut\*  
(WTM) WC Cream\*  
(WHM) White\*  
(WCM) Winter Cherry
- **Glides**  
(XG) No Glide for Carpeted Surfaces.  
(NM) White Non-marking Nylon Glide for most floor surfaces.  
(SG) Steel Cushioned Glide for carpeted surfaces. Add \$36  
(FG) Felt Glide for most hard floor surfaces. Add \$36  
(RG) Rubber Non-slip Glide for most hard floor surfaces. Add \$36
- **Sealed Seams** (on approved coated textiles)  
(NS) No sealed seams  
(SSS) Sealed seat seams. Add \$67
- **Moisture barrier** (seat only, not available with sealed seams)  
(NB) No moisture barrier. No upcharge  
(MB) Moisture barrier. Add \$113.
- **Seat foam**  
(SF) Standard foam  
(UC) Ultracell foam - 24/7 warranty
- **Seat underside**  
(USL) Under seat liner  
(USP) Under seat panel. Add \$84

DESCRIPTION	FEATURES	MODEL#	STANDARD TEXTILE GRADES											
			1/COM	2	3	4	5	6	7	8	9	10	11	12
 <p><b>Wood Back Armchair w/ Upholstered Seat Front</b> COM Yardage: 1 Freight Class: 250 Product Weight (lbs.): 33 Cubic Feet Per Carton: 15.75</p>	<p>Does not stack. Active weight 350 lbs. Ergonomic Features M, N</p>	1010	\$1379	\$1413	\$1440	\$1479	\$1534	\$1557	\$1604	\$1679	\$1735	\$1796	\$1924	\$2058
			<p><b>OVERALL DIMENSIONS</b></p> <p>W D H</p>			<p><b>SEAT DIMENSIONS</b></p> <p>W D H</p>			<p><b>BACK DIMENSIONS</b></p> <p>W H</p>					
			25.5	25	31	21	20	18	20.5	13.5				
			<b>RTA 00</b>											

DESCRIPTION	FEATURES	MODEL#											
		1/COM	2	3	4	5	6	7	8	9	10	11	12
 <p><b>Upholstered Back Armchair w/ Upholstered Seat Front</b>                      COM Yardage: Back: .75; Seat: .75                      Freight Class: 250                      Product Weight (lbs.): 33                      Cubic Feet Per Carton: 15.75</p>	<p>1011</p> <p>Base Price: \$1388                      Seat upcharge: +0                      Back upcharge: +0</p>	\$1388											
	<p>Does not stack.                      Active weight 350 lbs.                      Ergonomic Features M, N</p>	<b>RTA 00</b>											
	<p><b>OVERALL DIMENSIONS</b></p> <p>W D H</p>	<p><b>SEAT DIMENSIONS</b></p> <p>W D H</p>			<p><b>BACK DIMENSIONS</b></p> <p>W H</p>								
	25.5 25 31.5	21	20	18	20.5	13.5							
 <p><b>Wood Back Armchair w/ Wood Front Rail</b>                      COM Yardage: 1                      Freight Class: 250                      Product Weight (lbs.): 33                      Cubic Feet Per Carton: 15.75</p>	<p>1014</p>	\$1379	\$1413	\$1440	\$1479	\$1534	\$1557	\$1604	\$1679	\$1735	\$1796	\$1924	\$2058
	<p>Does not stack.                      Active weight 350 lbs.                      Ergonomic Features M, N</p>	<b>RTA 00</b>											
	<p><b>OVERALL DIMENSIONS</b></p> <p>W D H</p>	<p><b>SEAT DIMENSIONS</b></p> <p>W D H</p>			<p><b>BACK DIMENSIONS</b></p> <p>W H</p>								
	25.5 25 31	21	20	18	20.5	13.5							
 <p><b>Upholstered Back Armchair w/ Wood Front Rail</b>                      COM Yardage: Back: .75; Seat: .75                      Freight Class: 250                      Product Weight (lbs.): 33                      Cubic Feet Per Carton: 15.75</p>	<p>1015</p> <p>Base Price: \$1388                      Seat upcharge: +0                      Back upcharge: +0</p>	\$1388											
	<p>Does not stack.                      Active weight 350 lbs.                      Ergonomic Features M, N</p>	<b>RTA 00</b>											
	<p><b>OVERALL DIMENSIONS</b></p> <p>W D H</p>	<p><b>SEAT DIMENSIONS</b></p> <p>W D H</p>			<p><b>BACK DIMENSIONS</b></p> <p>W H</p>								
	25.5 25 31.5	21	20	18	20.5	13.5							
 <p><b>Upholstered Roundback Armchair w/ Upholstered Seat Front</b>                      COM Yardage: Back: .75 ; Seat: .75                      Freight Class: 300                      Product Weight (lbs.): 26                      Cubic Feet Per Carton: 13.25</p>	<p>1004</p> <p>Base Price: \$1570                      Seat upcharge: +0                      Back upcharge: +0</p>	\$1570											
	<p>Does not stack.                      Active weight 350 lbs.                      Ergonomic Features M, N</p>	<b>RTA 00</b>											
	<p><b>OVERALL DIMENSIONS</b></p> <p>W D H</p>	<p><b>SEAT DIMENSIONS</b></p> <p>W D H</p>			<p><b>BACK DIMENSIONS</b></p> <p>W H</p>								
	24.5 22.5 30	22	18	18	20	12.5							
 <p><b>Round Wood Back Armchair w/ Upholstered Seat Front</b>                      COM Yardage: 1                      Freight Class: 300                      Product Weight (lbs.): 25                      Cubic Feet Per Carton: 13.25</p>	<p>1005</p>	\$1383	\$1417	\$1444	\$1483	\$1538	\$1561	\$225	\$1683	\$1739	\$1800	\$1928	\$2062
	<p>Does not stack.                      Active weight 350 lbs.                      Ergonomic Features M, N</p>	<b>RTA 00</b>											
	<p><b>OVERALL DIMENSIONS</b></p> <p>W D H</p>	<p><b>SEAT DIMENSIONS</b></p> <p>W D H</p>			<p><b>BACK DIMENSIONS</b></p> <p>W H</p>								
	24.5 22.5 30	22	18	18	20	12.5							

COMET™



model 2171 (BK)



model 2172 (TUN)



model 2174 (TUN)



model 2183 (BK)

STANDARD FEATURES













- Reinforced models incorporate welded corner gussets for additional strength and support.
- Heavy Duty models 2173 and 2174 use Ultracell seat foam for lasting comfort.
- Models 2171 and 2172 stack 5 high on floor or 8 high on dolly 2125WS for easy storage.
- **WS** models have a wall saver frame design.
- Models with corner gussets are not recommended for stacking due to their heavy duty design.
- Stacked chairs may leave frame impressions in chair(s) below.
- Two ganging plates are packed at no charge with each table to attach to two chairs only. Order separately for additional chair-to-chair ganging.
- All Specifications and Pricing are for 1 chair.

OPTIONAL FEATURES











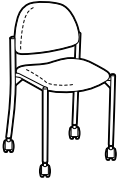





- Optional steel cushioned glides (**B**) are available on models 2171, 2172, 2173, 2174, 2183, and 2184. Add \$36. Please specify.
- **Frame finish**  
Please Specify:  



( <b>TBL</b> ) Black	( <b>TBZ</b> ) Buzz Blue
( <b>TCC</b> ) Cactus	( <b>TCR</b> ) Carrot
( <b>TDJ</b> ) Dijon	( <b>TDW</b> ) Designer White
( <b>TEG</b> ) Eggplant	( <b>TFO</b> ) Fog
( <b>TFR</b> ) Frost	( <b>TIN</b> ) Ink
( <b>TIV</b> ) Cloud	( <b>TKA</b> ) Kalua
( <b>TLA</b> ) Latte	( <b>TMO</b> ) Mocha
( <b>TOA</b> ) Toast	( <b>TNE</b> ) Nevada
( <b>TSH</b> ) Shadow	( <b>TSN</b> ) Sand
( <b>TSR</b> ) Scarlet	( <b>TTU</b> ) Tungsten

 Plated finish - Add \$36:  
 (**CHM**) Chrome
- Check textile availability prior to specifying upholstery material.

DESCRIPTION	FEATURES	MODEL#	STANDARD TEXTILE GRADES											
			1	2	3	4	5	6	7	8	9	10	11	12
 <p><b>Nesting Chair</b> COM Yardage: 1 Freight Class: 250 Product Weight (lbs.): 15.33 Cubic Feet Per Carton: 3.92 (3 per carton)</p>	<p>Stacks 5 high on floor. Stacks 8 high on dolly. Ergonomic Features: M, N</p>	<p><b>2171WS</b></p>	\$435	\$481	\$509	\$557	\$623	\$643	\$703	\$810	\$863	\$966	\$1103	\$1275
			<b>OVERALL DIMENSIONS</b>			<b>SEAT DIMENSIONS</b>			<b>BACK DIMENSIONS</b>					
			<b>W</b>	<b>D</b>	<b>H</b>	<b>W</b>	<b>D</b>	<b>H</b>	<b>W</b>	<b>H</b>				
			23	23	32.5	18	17	18.5	17.5	15				
			  											
 <p><b>Reinforced Armchair w/casters</b> COM Yardage: 1 Freight Class: 250 Product Weight (lbs.): 46 Cubic Feet Per Carton: 11.75 (1 per carton)</p>	<p>Does not stack.  Ergonomic Features: M, N</p>	<p><b>2171C</b></p>	\$567	\$608	\$637	\$679	\$742	\$765	\$818	\$921	\$966	\$1064	\$1190	\$1352
			<b>OVERALL DIMENSIONS</b>			<b>SEAT DIMENSIONS</b>			<b>BACK DIMENSIONS</b>					
			<b>W</b>	<b>D</b>	<b>H</b>	<b>W</b>	<b>D</b>	<b>H</b>	<b>W</b>	<b>H</b>				
			23	22	32.5	18	17.5	18.5	17	14				
			  											
 <p><b>Armless Stacking Chair</b> COM Yardage: 1 Freight Class: 250 Product Weight (lbs.): 14.33 Cubic Feet Per Carton: 3.83 (3 per carton)</p>	<p>Stacks 5 high on floor. Ergonomic Features: M, N</p>	<p><b>2172WS</b></p>	\$345	\$391	\$419	\$467	\$530	\$554	\$615	\$722	\$773	\$876	\$1013	\$1182
			<b>OVERALL DIMENSIONS</b>			<b>SEAT DIMENSIONS</b>			<b>BACK DIMENSIONS</b>					
			<b>W</b>	<b>D</b>	<b>H</b>	<b>W</b>	<b>D</b>	<b>H</b>	<b>W</b>	<b>H</b>				
			19	23	32.5	18	17.5	18.5	17.5	14				
			  											

# MULTI-PURPOSE

DESCRIPTION	FEATURES	MODEL#	STANDARD TEXTILE GRADES													
			1	2	3	4	5	6	7	8	9	10	11	12		
 <p><b>Reinforced Armless Chair</b> w/casters COM Yardage: 1 Freight Class: 250 Product Weight (lbs.): 14.33 Cubic Feet Per Carton: 4.5 (3 per carton)</p>	<p>Does not stack. Ergonomic Features: M, N</p>	<b>2172C</b>	\$467	\$507	\$535	\$579	\$636	\$661	\$714	\$818	\$866	\$960	\$1089	\$1248		
			<b>OVERALL DIMENSIONS</b>			<b>SEAT DIMENSIONS</b>			<b>BACK DIMENSIONS</b>							
			<b>W</b>	<b>D</b>	<b>H</b>	<b>W</b>	<b>D</b>	<b>H</b>	<b>W</b>	<b>H</b>						
			19	22	32.5	17.5	17.5	14	17	15						
																
 <p><b>Reinforced Armchair</b> COM Yardage: 1 Freight Class: 250 Product Weight (lbs.): 15.33 Cubic Feet Per Carton: 3.92 (3 per carton)</p>	<p>Does not stack. Ergonomic Features: M, N</p>	<b>2173WS</b>	\$591	\$634	\$665	\$712	\$776	\$800	\$858	\$966	\$1019	\$1121	\$1258	\$1428		
			<b>OVERALL DIMENSIONS</b>			<b>SEAT DIMENSIONS</b>			<b>BACK DIMENSIONS</b>							
			<b>W</b>	<b>D</b>	<b>H</b>	<b>W</b>	<b>D</b>	<b>H</b>	<b>W</b>	<b>H</b>						
			23	23	32.5	18	17.5	18.5	17.5	14						
																
 <p><b>Reinforced Armless Chair</b> COM Yardage: 1 Freight Class: 250 Product Weight (lbs.): 14.33 Cubic Feet Per Carton: 3.83 (3 per carton)</p>	<p>Does not stack. Ergonomic Features: M, N</p>	<b>2174WS</b>	\$493	\$536	\$567	\$615	\$678	\$702	\$763	\$870	\$921	\$1024	\$1161	\$1330		
			<b>OVERALL DIMENSIONS</b>			<b>SEAT DIMENSIONS</b>			<b>BACK DIMENSIONS</b>							
			<b>W</b>	<b>D</b>	<b>H</b>	<b>W</b>	<b>D</b>	<b>H</b>	<b>W</b>	<b>H</b>						
			19	23	32.5	18	17	18.5	17.5	13.5						
																
 <p><b>Ganging Plate</b> COM Yardage: N/A Freight Class: 70 Product Weight (lbs.): 2.1 Cubic Feet Per Carton: 0.1</p>		<b>2176</b>	\$91	-	-	-	-	-	-	-	-	-	-	-		
			<b>OVERALL DIMENSIONS</b>			<b>SEAT DIMENSIONS</b>			<b>BACK DIMENSIONS</b>							
			<b>W</b>	<b>D</b>	<b>H</b>	<b>W</b>	<b>D</b>	<b>H</b>	<b>W</b>	<b>H</b>						
			13.25	4.75	00.06	-	-	-	-	-						
																

DESCRIPTION	FEATURES	MODEL#	STANDARD TEXTILE GRADES											
			1	2	3	4	5	6	7	8	9	10	11	12
 <p><b>Ganging Clamp</b> COM Yardage: N/A Freight Class: 70 Product Weight (lbs.): 0.2 Cubic Feet Per Carton: 0.04</p>		2180	\$37	-	-	-	-	-	-	-	-	-	-	-
		<b>OVERALL DIMENSIONS</b>			<b>SEAT DIMENSIONS</b>			<b>BACK DIMENSIONS</b>						
		<b>W</b>	<b>D</b>	<b>H</b>	<b>W</b>	<b>D</b>	<b>H</b>	<b>W</b>	<b>H</b>					
		00.87	7.75	1.5	-	-	-	-	-					
		RTA 00	FedEx	ups										
 <p><b>Reinforced Armchair</b> Square Back COM Yardage: 1 Freight Class: 250 Product Weight (lbs.): 15.33 Cubic Feet Per Carton: 4.17 (3 per carton)</p>	Does not stack. Ergonomic Features: M, N	2183	\$452	\$495	\$523	\$569	\$633	\$660	\$712	\$823	\$874	\$974	\$1107	\$1276
		<b>OVERALL DIMENSIONS</b>			<b>SEAT DIMENSIONS</b>			<b>BACK DIMENSIONS</b>						
		<b>W</b>	<b>D</b>	<b>H</b>	<b>W</b>	<b>D</b>	<b>H</b>	<b>W</b>	<b>H</b>					
		23	20	32	18	17.5	18.5	18	13.5					
		RTA 00	FedEx	ups										
 <p><b>Reinforced Armless Chair</b> Square Back COM Yardage: 1 Freight Class: 250 Product Weight (lbs.): 14.33 Cubic Feet Per Carton: 4.17 (3 per carton)</p>	Does not stack. Ergonomic Features: M, N	2184	\$356	\$397	\$427	\$473	\$537	\$560	\$618	\$723	\$773	\$873	\$1007	\$1175
		<b>OVERALL DIMENSIONS</b>			<b>SEAT DIMENSIONS</b>			<b>BACK DIMENSIONS</b>						
		<b>W</b>	<b>D</b>	<b>H</b>	<b>W</b>	<b>D</b>	<b>H</b>	<b>W</b>	<b>H</b>					
		19.5	20	32	18	17.5	18.5	18	13.5					
		RTA 00	FedEx	ups										

DIPLOMAT





model 2105

STANDARD FEATURES

- A contoured seat and back are accented by wood arms providing comfort and classic styling.
- Models 2105 and 2108 can be joined together using model 6526 ganging clamp.
- Does not stack.
- When upholstered in Leather, models will be in all Leather.
- Check textile availability prior to specifying upholstery material.

OPTIONAL FEATURES

- Frames are standard in a Black (TBL), Tungsten (TTU), or (TSH) Shadow frame finish at no upcharge and Chrome (CHM) frame finish, please add \$68.
- Wood capped arms are available in Absolute (AAM), Black (BKM), Cherry (ACM), Espresso Cafe (ECM), English Oak (EOM), Fruitwood (TFM), Gray (HGM), Honey (AHM), Mahogany (TMM), Maple (AVM), Medium Walnut (MWM), Natural Walnut (NLW), Night (ASM), Noce Biondo (NBM), Noce Grigio (NGM), Noce Leggero (NEM), Noce Medio (NMM), Shaker Cherry (SKM), Walnut (TWM), WC Cream (WTM), White (WHM) and Winter Cherry (WCM). Please Specify. Genuine maple faced veneers and solids are used.
- Optional steel cushioned glides (B) on model 2105. Add \$33. Please specify.

DESCRIPTION	FEATURES	MODEL#	STANDARD TEXTILE GRADES											
			1	2	3	4	5	6	7	8	9	10	11	12
 <p><b>Armchair</b> Wood caps arms COM Yardage: 1.25 Freight Class: 250 Product Weight (lbs.): 25 Cubic Feet Per Carton: 11.75</p>	<p>Does not stack.</p> <p>Ergonomic Features: M, N</p>	<p>2105</p>	\$798	\$848	\$886	\$939	\$1018	\$1046	\$1112	\$1244	\$1307	\$1425	\$1592	\$1794
			OVERALL DIMENSIONS			SEAT DIMENSIONS			BACK DIMENSIONS					
			W	D	H	W	D	H	W	H				
			24	22	34.5	20.5	17	18.5	20.5	16				
			RTA 00		FedEx		ups							
 <p><b>Armless Side Chair</b> COM Yardage: 1.25 Freight Class: 300 Product Weight (lbs.): 22 Cubic Feet Per Carton: 11.75</p>	<p>Does not stack.</p> <p>Ergonomic Features: M, N</p>	<p>2108</p>	\$566	\$616	\$655	\$714	\$794	\$825	\$898	\$1034	\$1100	\$1226	\$1397	\$1612
			OVERALL DIMENSIONS			SEAT DIMENSIONS			BACK DIMENSIONS					
			W	D	H	W	D	H	W	H				
			21.5	22	34.5	20.5	17	18.5	20.5	16				
			RTA 00											
 <p><b>Armless Barstool</b> COM Yardage: 1.25 Freight Class: 250 Product Weight (lbs.): 30 Cubic Feet Per Carton: 14.75</p>	<p>Does not stack.</p> <p>Ergonomic Features: M, N</p>	<p>2109</p>	\$816	\$866	\$907	\$964	\$1046	\$1075	\$1149	\$1285	\$1349	\$1476	\$1647	\$1861
			OVERALL DIMENSIONS			SEAT DIMENSIONS			BACK DIMENSIONS					
			W	D	H	W	D	H	W	H				
			21	23.5	44.5	20	17	28	20.5	17.5				
			RTA 00											

DUET™



model 6620



model 6621G



model 6627



model 6623TR



model 6632



model 6721PB



model 6720



model 6692 (2 units) on 6500S2 (Beam)

STANDARD FEATURES











- Unique high density seating that is both comfortable and durable.
- Tablet arms are extremely rugged and meets ANSI-BIFMA testing requirements. Tablet hinges up to allow ease of egress. Tablet slides forward and back to accommodate any body size comfortably. Tablet models do not stack.
- Standard tablet (**D8**) size is 18"D x 14 1/2"W and is made of black polymer. Tablets are attached at the left or right (as seated). Tablet arms are not available on stools. Tablet models do not stack.
- All sled-base models have a wall saver frame design with rear legs contacting the wall first leaving clearance between the seat back and wall.
- Armless "G" models feature a patented interlocking feature that allows chairs to be ganged together in rows.
- Model 6626 ganging clamp set is available for use on all armchairs and standard armless models. These brackets snap on the front and rear of the sled base allowing these models to connect together in rows. In Black finish only.
- Clear polycarbonate glides (**CG**) are standard and suitable for carpet, rubber or concrete flooring.
- Weight capacity for this series is 300 lbs.
- Dual wheel carpet casters (**C1**) are standard on task chairs.
- Duet beam seating consists of upper seat units (models 6690, 6691, 6692, 6693, 6697 and 6698) including mounting brackets and all hardware necessary for attachment to beam.
- For all beam components, tables and a complete list of available upper seat units, see Beam Seating series.
- **Specifications and pricing are for 1 chair.**
- Pedestal base models provide fixed location seating for use in auditoriums, classrooms, jury boxes, public venues and more. The base must be mounted to the floor (mounting hardware not included). See Pedestal Base Installation Guide for details.
- Check textile availability prior to specifying upholstery material.









OPTIONAL FEATURES

- Polypropylene seats, backs and coordinating arms are available in 14 designer colors. Choose from Buzz Blue (**BZB**), Cactus (**CCT**), Carrot (**CRO**), Cloud (**IVC**), Dijon (**DJN**), Eggplant (**EGP**), Fog (**FOG**), Frost (**FRO**), Ink (**INK**), Latte (**LAB**), Night (**BLK**), Sand (**SND**), Scarlet (**SAR**), and Shadow (**SHW**).
- An optional 18.5"D x 18.5"W high pressure laminate writing tablet is available. The core is hardwood veneer plywood with radiused edge finished in clear lacquer. This writing tablet is offered in the following finishes: Black (**BLK**), Clear Maple (**CMB**), Designer White (**DWT**) and Noce Grigio (**NGL**). Please specify. Add \$68.
- Chairs will have additional stitch details when upholstered in vinyl.
- A selection of glide options is available. Glide must be chosen to best suit flooring type and site conditions.
- Chrome frame is optionally available without glides (**WS**) and is suitable for rubberized and carpeted floors, please specify. No upcharge
- Glides with felt pads (**FG**) are available for vinyl sheet, cork or laminate flooring, please specify. Add \$36
- Glides with rubber pads (**RG**) are available for vinyl, hardwood, laminate, stone or ceramic flooring, please specify. Add \$36.
- Glides with stainless steel pads (**SG**) are available for carpet or rubber flooring, please specify. Add \$36.
- For task base models, hard surface flooring casters are available. Specify (**C9R**). Add \$76.
- Pedestal base models have black base with 2" height adjustable cylinders. Specify (**SH**) swivel, auto return to max height (no upcharge); (**SN**) non-swivel, auto return to max height (Add \$23); or, (**SC**) swivel, self-centering and return to max height (add \$35).

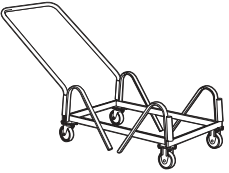





	Duet Chairs Stacking Capability		Duet Stools Stacking Capability	
	Stacking on floor	Stacking on dolly #6624	Stacking on floor	Stacking on dolly
<b>Armless</b>				
Polypropylene seat & back	up to 12 high	up to 40* high	up to 12 high	N/A
Polypropylene back & upholstered seat	up to 5 high	up to 12 high	up to 5 high	N/A
Upholstered seat & back	up to 5 high	up to 12 high	up to 5 high	N/A
<b>With Arms</b>				
Polypropylene seat & back	up to 5 high	up to 24 high	up to 5 high	N/A
Polypropylene back & upholstered seat	up to 5 high	up to 12 high	up to 5 high	N/A
Upholstered seat & back	up to 5 high	up to 12 high	up to 5 high	N/A





\* THROUGH 80" DOORWAY, STACKS 36 HIGH

DESCRIPTION	FEATURES	MODEL#	STANDARD TEXTILE GRADES											
			1	2	3	4	5	6	7	8	9	10	11	12
 <p><b>ArmChair</b> COM Yardage: N/A Freight Class: 150 Product Weight (lbs.): 19 Cubic Feet Per Carton: 4.63 (4 per carton)</p>	<p>Stacks 5 high on floor. Stacks 24 high on dolly.</p>	<b>6620</b>	\$389	-	-	-	-	-	-	-	-	-	-	-
		<b>OVERALL DIMENSIONS</b>			<b>SEAT DIMENSIONS</b>			<b>BACK DIMENSIONS</b>						
		<b>W</b>	<b>D</b>	<b>H</b>	<b>W</b>	<b>D</b>	<b>H</b>	<b>W</b>	<b>H</b>					
		25.5	22.75	33.25	18	17.5	16.5	18	16					
			<b>RTA 00</b>											
  <p><b>6621</b>      <b>6621G</b></p> <p><b>Armless Chair</b> COM Yardage: N/A Freight Class: 150 Product Weight (lbs.): 20.5 Cubic Feet Per Carton: 3.5(4 per carton)</p>	<p>Stacks 12 high on floor. Stacks 40 high on dolly.</p>	<b>6621</b>	\$276	-	-	-	-	-	-	-	-	-	-	
		<b>6621G</b>	\$293	-	-	-	-	-	-	-	-	-	-	
		<b>OVERALL DIMENSIONS</b>			<b>SEAT DIMENSIONS</b>			<b>BACK DIMENSIONS</b>						
		<b>W</b>	<b>D</b>	<b>H</b>	<b>W</b>	<b>D</b>	<b>H</b>	<b>W</b>	<b>H</b>					
20.75	22.75	33.25	18	17.5	17	18	16							
			<b>RTA 00</b>  											
 <p><b>Armless Chair w/Back pack rack</b> COM Yardage: N/A Freight Class: 250 Product Weight (lbs.): 25 Cubic Feet Per Carton: 11.25 (1 per carton)</p>	<p>Does not stack.</p>	<b>6621P</b>	\$459	-	-	-	-	-	-	-	-	-	-	
		<b>OVERALL DIMENSIONS</b>			<b>SEAT DIMENSIONS</b>			<b>BACK DIMENSIONS</b>						
		<b>W</b>	<b>D</b>	<b>H</b>	<b>W</b>	<b>D</b>	<b>H</b>	<b>W</b>	<b>H</b>					
		20.75	22.75	33.25	18	17.5	16.5	18	16					
			<b>RTA 00</b>  											
 <p><b>Armchair</b> COM Yardage: 0.75 Freight Class: 150 Product Weight (lbs.): 25 Cubic Feet Per Carton: 5.56 (4 per carton)</p>	<p>Upholstered Seat. Stacks 5 high on floor. Stacks 12 high on dolly.</p>	<b>6622</b>	\$503	\$544	\$574	\$617	\$680	\$701	\$756	\$861	\$912	\$1007	\$1139	\$1301
		<b>OVERALL DIMENSIONS</b>			<b>SEAT DIMENSIONS</b>			<b>BACK DIMENSIONS</b>						
		<b>W</b>	<b>D</b>	<b>H</b>	<b>W</b>	<b>D</b>	<b>H</b>	<b>W</b>	<b>H</b>					
		25.5	23	33.25	18	17.5	17	18	16					
			<b>RTA 00</b>											
  <p><b>6623</b>      <b>6623G</b></p> <p><b>Armless Chair</b> COM Yardage: 0.75 Freight Class: 150 Product Weight (lbs.): 21 Cubic Feet Per Carton: 4.63 (4 per carton)</p>	<p>Upholstered Seat. Stacks 5 high on floor. Stacks 12 high on dolly.</p>	<b>6623</b>	\$382	\$423	\$453	\$496	\$559	\$580	\$635	\$740	\$791	\$886	\$1018	\$1180
		<b>6623G</b>	\$411	\$452	\$482	\$525	\$588	\$609	\$664	\$769	\$820	\$915	\$1047	\$1209
		<b>OVERALL DIMENSIONS</b>			<b>SEAT DIMENSIONS</b>			<b>BACK DIMENSIONS</b>						
		<b>W</b>	<b>D</b>	<b>H</b>	<b>W</b>	<b>D</b>	<b>H</b>	<b>W</b>	<b>H</b>					
20.5	23	33.25	18	17.5	17	18	16							
			<b>RTA 00</b>											

DESCRIPTION	FEATURES	MODEL#	STANDARD TEXTILE GRADES											
			1	2	3	4	5	6	7	8	9	10	11	12
 <p><b>Armless Chair</b> w/Back pack rack COM Yardage: 0.75 Freight Class: 250 Product Weight (lbs.): 28 Cubic Feet Per Carton: 11.25 (1 per carton)</p>	Upholstered Seat. Does not stack.	<b>6623P</b>	\$569	\$612	\$643	\$689	\$754	\$778	\$836	\$943	\$996	\$1099	\$1234	\$1406
		<b>OVERALL DIMENSIONS</b>			<b>SEAT DIMENSIONS</b>			<b>BACK DIMENSIONS</b>						
		<b>W</b>	<b>D</b>	<b>H</b>	<b>W</b>	<b>D</b>	<b>H</b>	<b>W</b>	<b>H</b>					
		20.5	23	33.25	18	17.5	17	18	16					
			<b>RTA 00</b>											
 <p><b>Armless Chair</b> w/Tablet COM Yardage: 1 Freight Class: 250 Product Weight (lbs.): 29 Cubic Feet Per Carton: 16 (2 per carton)</p>	Upholstered Seat. Does not stack.	<b>6623TR</b> <b>6623TL</b>	\$801	\$848	\$880	\$928	\$997	\$1021	\$1083	\$1199	\$1256	\$1364	\$1512	\$1697
		<b>OVERALL DIMENSIONS</b>			<b>SEAT DIMENSIONS</b>			<b>BACK DIMENSIONS</b>						
		<b>W</b>	<b>D</b>	<b>H</b>	<b>W</b>	<b>D</b>	<b>H</b>	<b>W</b>	<b>H</b>					
		24.5	27.75	33.25	18	17.5	17	18	15.5					
			<b>RTA 00</b>											
 <p><b>Dolly</b> COM Yardage: N/A Freight Class: 150 Product Weight (lbs.): 40 Cubic Feet Per Carton: 9.5 (1 per carton)</p>		<b>6624</b>	\$815	-	-	-	-	-	-	-	-	-	-	-
		<b>OVERALL DIMENSIONS</b>			<b>SEAT DIMENSIONS</b>			<b>BACK DIMENSIONS</b>						
		<b>W</b>	<b>D</b>	<b>H</b>	<b>W</b>	<b>D</b>	<b>H</b>	<b>W</b>	<b>H</b>					
		22.5	51	38.25	-	-	-	-	-					
			<b>RTA 1</b>  											
 <p><b>Ganging Clamp Set - 2 Clamps</b> COM Yardage: N/A Freight Class: 70 Product Weight (lbs.): 0.3 Cubic Feet Per Carton: 0.01 (1 set per carton)</p>		<b>6626</b>	\$32	-	-	-	-	-	-	-	-	-	-	-
		<b>OVERALL DIMENSIONS</b>			<b>SEAT DIMENSIONS</b>			<b>BACK DIMENSIONS</b>						
		<b>W</b>	<b>D</b>	<b>H</b>	<b>W</b>	<b>D</b>	<b>H</b>	<b>W</b>	<b>H</b>					
		1	6.5	00.75	-	-	-	-	-					
			<b>RTA 00</b>  											
 <p><b>Armchair</b> COM Yardage: 0.75 Freight Class: 150 Product Weight (lbs.): 27 Cubic Feet Per Carton: 5.56 (4 per carton)</p>	Upholstered Seat and Back. Stacks 5 high on floor. Stacks 12 high on dolly.	<b>6627</b>	\$554	\$625	\$658	\$700	\$770	\$789	\$847	\$956	\$1008	\$1109	\$1248	\$1422
		<b>OVERALL DIMENSIONS</b>			<b>SEAT DIMENSIONS</b>			<b>BACK DIMENSIONS</b>						
		<b>W</b>	<b>D</b>	<b>H</b>	<b>W</b>	<b>D</b>	<b>H</b>	<b>W</b>	<b>H</b>					
		25.5	23	33.25	18	17.5	17	18	16					
			<b>RTA 00</b>											

# MULTI-PURPOSE





DESCRIPTION	FEATURES	MODEL#	STANDARD TEXTILE GRADES												
			1	2	3	4	5	6	7	8	9	10	11	12	
 6628	 6628G		6628	\$449	\$517	\$547	\$590	\$658	\$679	\$736	\$846	\$900	\$1000	\$1137	\$1309
			6628G	\$466	\$533	\$561	\$606	\$674	\$698	\$755	\$864	\$917	\$1018	\$1154	\$1325
<b>Armless Chair</b> COM Yardage: 0.75 Freight Class: 150 Product Weight (lbs.): 23 Cubic Feet Per Carton: 4.63 (4 per carton)			Upholstered Seat and Back. Stacks 5 high on floor. Stacks 12 high on dolly.			<b>OVERALL DIMENSIONS</b> W D H			<b>SEAT DIMENSIONS</b> W D H			<b>BACK DIMENSIONS</b> W H			
			20.5	23	33.25	18	17	17	18	15.5	<b>RTA 00</b>				
 6628P			6628P	\$643	\$686	\$717	\$765	\$828	\$852	\$911	\$1018	\$1073	\$1174	\$1310	\$1480
			<b>Armless Chair w/Back pack rack</b> COM Yardage: 0.75 Freight Class: 250 Product Weight (lbs.): 30 Cubic Feet Per Carton: 11.25 (1 per carton)			Upholstered Seat and Back. Does not stack.			<b>OVERALL DIMENSIONS</b> W D H			<b>SEAT DIMENSIONS</b> W D H			<b>BACK DIMENSIONS</b> W H
			20.5	23	33.25	18	17	17	18	15.5	<b>RTA 00</b>				
 6630			6630	\$677	-	-	-	-	-	-	-	-	-	-	-
			<b>Barstool with Arms</b> COM Yardage: N/A Freight Class: 250 Product Weight (lbs.): 30 Cubic Feet Per Carton: 10.75 (2 per carton)			Stacks 5 high on floor.			<b>OVERALL DIMENSIONS</b> W D H			<b>SEAT DIMENSIONS</b> W D H			<b>BACK DIMENSIONS</b> W H
			25.5	23.5	45	18	17.5	29.5	18	16	<b>RTA 00</b>				
 6631			6631	\$504	-	-	-	-	-	-	-	-	-	-	-
			<b>Armless Barstool</b> COM Yardage: N/A Freight Class: 250 Product Weight (lbs.): 29 Cubic Feet Per Carton: 8.75 (2 per carton)			Stacks 12 high on floor.			<b>OVERALL DIMENSIONS</b> W D H			<b>SEAT DIMENSIONS</b> W D H			<b>BACK DIMENSIONS</b> W H
			20.75	23.5	45	18	17.5	29.5	18	16	<b>RTA 00</b>				
 6632			6632	\$780	\$820	\$851	\$894	\$959	\$977	\$1036	\$1140	\$1189	\$1286	\$1416	\$1578
			<b>Barstool with Arms</b> COM Yardage: 0.75 Freight Class: 250 Product Weight (lbs.): 31 Cubic Feet Per Carton: 10.75 (2 per carton)			Upholstered Seat Stacks 5 high on floor			<b>OVERALL DIMENSIONS</b> W D H			<b>SEAT DIMENSIONS</b> W D H			<b>BACK DIMENSIONS</b> W H
			25.5	23.5	45	18	17.5	30	18	15.5	<b>RTA 00</b>				

DESCRIPTION	FEATURES	MODEL#	STANDARD TEXTILE GRADES											
			1	2	3	4	5	6	7	8	9	10	11	12
 <p><b>Armless Barstool</b> COM Yardage: 0.75 Freight Class: 250 Product Weight (lbs.): 30 Cubic Feet Per Carton: 17.5 (2 per carton)</p>	<p>Upholstered Seat. Stacks 5 high on floor.</p>	<p><b>6633</b></p>	\$603	\$644	\$674	\$717	\$781	\$801	\$858	\$961	\$1012	\$1109	\$1240	\$1401
			<p><b>OVERALL DIMENSIONS</b></p>			<p><b>SEAT DIMENSIONS</b></p>			<p><b>BACK DIMENSIONS</b></p>					
			W	D	H	W	D	H	W	H				
			20.75	23.5	45	18	17.5	30	18	15.5				
			<p><b>RTA 00</b></p>											
 <p><b>Barstool with Arms</b> COM Yardage: 0.75 Freight Class: 250 Product Weight (lbs.): 31.5 Cubic Feet Per Carton: 10.75 (2 per carton)</p>	<p>Upholstered Seat and Back. Stacks 3 high on floor.</p>	<p><b>6637</b></p>	\$824	\$864	\$894	\$938	\$1002	\$1021	\$1079	\$1182	\$1233	\$1330	\$1460	\$1622
			<p><b>OVERALL DIMENSIONS</b></p>			<p><b>SEAT DIMENSIONS</b></p>			<p><b>BACK DIMENSIONS</b></p>					
			W	D	H	W	D	H	W	H				
			25.5	23.5	45	18	17.5	30	18	15.5				
			<p><b>RTA 00</b></p>											
 <p><b>Armless Barstool</b> COM Yardage: 0.75 Freight Class: 250 Product Weight (lbs.): 30.5 Cubic Feet Per Carton: 8.75 (2 per carton)</p>	<p>Upholstered Seat and Back. Stacks 3 high on floor.</p>	<p><b>6638</b></p>	\$707	\$748	\$778	\$820	\$885	\$904	\$962	\$1065	\$1116	\$1211	\$1340	\$1505
			<p><b>OVERALL DIMENSIONS</b></p>			<p><b>SEAT DIMENSIONS</b></p>			<p><b>BACK DIMENSIONS</b></p>					
			W	D	H	W	D	H	W	H				
			20.75	23.5	45	18	17.5	30	18	15.5				
			<p><b>RTA 00</b></p>											
 <p><b>Counter Stool with Arms</b> COM Yardage: N/A Freight Class: 250 Product Weight (lbs.): 25 Cubic Feet Per Carton: 10.75 (2 per carton)</p>	<p>Stacks 5 high on floor.</p>	<p><b>6660</b></p>	\$677	-	-	-	-	-	-	-	-	-	-	-
			<p><b>OVERALL DIMENSIONS</b></p>			<p><b>SEAT DIMENSIONS</b></p>			<p><b>BACK DIMENSIONS</b></p>					
			W	D	H	W	D	H	W	H				
			25.5	23.5	39.5	18	17.5	24	18	16				
			<p><b>RTA 00</b></p>											
 <p><b>Armless Counter Stool</b> COM Yardage: N/A Freight Class: 250 Product Weight (lbs.): 24</p>	<p>Stacks 12 high on floor.</p>	<p><b>6661</b></p>	\$504	-	-	-	-	-	-	-	-	-	-	
			<p><b>OVERALL DIMENSIONS</b></p>			<p><b>SEAT DIMENSIONS</b></p>			<p><b>BACK DIMENSIONS</b></p>					
			W	D	H	W	D	H	W	H				
			20.75	23.5	39.5	18	17.5	24	18	16				
			<p><b>RTA 00</b></p>											





















# MULTI-PURPOSE





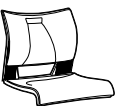



DUET™

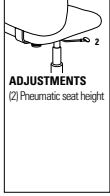

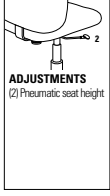

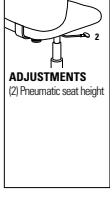

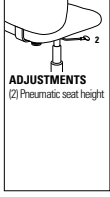

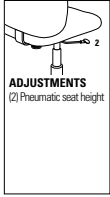
D

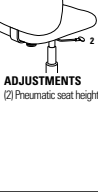



DESCRIPTION	FEATURES	MODEL#	STANDARD TEXTILE GRADES											
			1	2	3	4	5	6	7	8	9	10	11	12
 <p><b>Counter Stool w/Arms</b> COM Yardage: 0.75 Freight Class: 250 Product Weight (lbs.): 26 Cubic Feet Per Carton: 10.75 (2 per carton)</p>	Upholstered Seat. Stacks 5 high on floor.	6662	\$780	\$820	\$850	\$894	\$959	\$977	\$1036	\$1140	\$1189	\$1286	\$1416	\$1578
			<b>OVERALL DIMENSIONS</b>			<b>SEAT DIMENSIONS</b>			<b>BACK DIMENSIONS</b>					
			<b>W</b>	<b>D</b>	<b>H</b>	<b>W</b>	<b>D</b>	<b>H</b>	<b>W</b>	<b>H</b>				
			20.75	23.5	39.5	18	17.5	24	18	16				
			<b>RTA 00</b>											
 <p><b>Armless Counter Stool</b> COM Yardage: 0.75 Freight Class: 250 Product Weight (lbs.): 25 Cubic Feet Per Carton: 8.75 (2 per carton)</p>	Upholstered Seat. Stacks 5 high on floor.	6663	\$603	\$644	\$674	\$717	\$781	\$801	\$858	\$961	\$1012	\$1109	\$1240	\$1401
			<b>OVERALL DIMENSIONS</b>			<b>SEAT DIMENSIONS</b>			<b>BACK DIMENSIONS</b>					
			<b>W</b>	<b>D</b>	<b>H</b>	<b>W</b>	<b>D</b>	<b>H</b>	<b>W</b>	<b>H</b>				
			20.75	23.5	39.5	18	17.5	24	18	16				
			<b>RTA 00</b>											
 <p><b>Counter Stool w/Arms</b> COM Yardage: 0.75 Freight Class: 250 Product Weight (lbs.): 26.5 Cubic Feet Per Carton: 10.75 (2 per carton)</p>	Upholstered Seat and Back. Stacks 3 high on floor.	6667	\$824	\$864	\$894	\$938	\$1002	\$1021	\$1079	\$1182	\$1233	\$1330	\$1460	\$1622
			<b>OVERALL DIMENSIONS</b>			<b>SEAT DIMENSIONS</b>			<b>BACK DIMENSIONS</b>					
			<b>W</b>	<b>D</b>	<b>H</b>	<b>W</b>	<b>D</b>	<b>H</b>	<b>W</b>	<b>H</b>				
			25.5	23.5	39.5	18	17.5	24	18	16				
			<b>RTA 00</b>											
 <p><b>Armless Counter Stool</b> COM Yardage: 0.75 Freight Class: 250 Product Weight (lbs.): 25.5 Cubic Feet Per Carton: 8.75 (2 per carton)</p>	Upholstered Seat and Back. Stacks 3 high on floor.	6668	\$707	\$748	\$778	\$820	\$885	\$904	\$962	\$1065	\$1116	\$1211	\$1340	\$1505
			<b>OVERALL DIMENSIONS</b>			<b>SEAT DIMENSIONS</b>			<b>BACK DIMENSIONS</b>					
			<b>W</b>	<b>D</b>	<b>H</b>	<b>W</b>	<b>D</b>	<b>H</b>	<b>W</b>	<b>H</b>				
			20.75	23.5	39.5	18	17.5	24	18	16				
			<b>RTA 00</b>											
 <p><b>Seat Unit w/Arms</b> COM Yardage: N/A Freight Class: 250 Product Weight (lbs.): 19 Cubic Feet Per Carton: 4.88 (2 per carton)</p>	Use with beams.	6690	\$448	-	-	-	-	-	-	-	-	-	-	-
			<b>OVERALL DIMENSIONS</b>			<b>SEAT DIMENSIONS</b>			<b>BACK DIMENSIONS</b>					
			<b>W</b>	<b>D</b>	<b>H</b>	<b>W</b>	<b>D</b>	<b>H</b>	<b>W</b>	<b>H</b>				
			25.5	21	18	18	17.5	-	18	16				
			<b>RTA 00</b>											

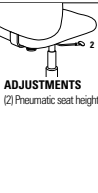

DESCRIPTION	FEATURES	MODEL#	STANDARD TEXTILE GRADES													
			1	2	3	4	5	6	7	8	9	10	11	12		
 <p><b>Armless Seat Unit</b> COM Yardage: N/A Freight Class: 150 Product Weight (lbs.): 18 Cubic Feet Per Carton: 3.25 (2 per carton)</p>	Use with beams.	6691	\$330	-	-	-	-	-	-	-	-	-	-	-	-	
		<b>OVERALL DIMENSIONS</b>			<b>SEAT DIMENSIONS</b>			<b>BACK DIMENSIONS</b>								
		<b>W</b>	<b>D</b>	<b>H</b>	<b>W</b>	<b>D</b>	<b>H</b>	<b>W</b>	<b>H</b>							
		18	21	18	18	17.5	-	18	16							
																
 <p><b>Seat Unit w/Arms</b> COM Yardage: 0.75 Freight Class: 250 Product Weight (lbs.): 19 Cubic Feet Per Carton: 4.88 (2 per carton)</p>	Upholstered Seat. Use with beams.	6692	\$548	\$589	\$619	\$662	\$726	\$745	\$803	\$904	\$957	\$1054	\$1184	\$1346		
		<b>OVERALL DIMENSIONS</b>			<b>SEAT DIMENSIONS</b>			<b>BACK DIMENSIONS</b>								
		<b>W</b>	<b>D</b>	<b>H</b>	<b>W</b>	<b>D</b>	<b>H</b>	<b>W</b>	<b>H</b>							
		25.5	21	18	18	17.5	-	18	15.5							
																
 <p><b>Armless Seat Unit</b> COM Yardage: 0.75 Freight Class: 150 Product Weight (lbs.): 19 Cubic Feet Per Carton: 3.25 (2 per carton)</p>	Upholstered Seat. Use with beams.	6693	\$426	\$467	\$496	\$540	\$603	\$623	\$679	\$782	\$835	\$930	\$1062	\$1223		
		<b>OVERALL DIMENSIONS</b>			<b>SEAT DIMENSIONS</b>			<b>BACK DIMENSIONS</b>								
		<b>W</b>	<b>D</b>	<b>H</b>	<b>W</b>	<b>D</b>	<b>H</b>	<b>W</b>	<b>H</b>							
		18	21	18	18	17.5	-	18	15.5							
																
 <p><b>Seat Unit w/Arms</b> COM Yardage: 0.75 Freight Class: 150 Product Weight (lbs.): 20 Cubic Feet Per Carton: 4.88 (2 per carton)</p>	Upholstered Seat and Back. Use with beams.	6697	\$581	\$622	\$651	\$695	\$758	\$778	\$834	\$937	\$990	\$1085	\$1217	\$1378		
		<b>OVERALL DIMENSIONS</b>			<b>SEAT DIMENSIONS</b>			<b>BACK DIMENSIONS</b>								
		<b>W</b>	<b>D</b>	<b>H</b>	<b>W</b>	<b>D</b>	<b>H</b>	<b>W</b>	<b>H</b>							
		25.5	21	18	18	17	-	18	15.5							
																
 <p><b>Armless Seat Unit</b> COM Yardage: 0.75 Freight Class: 150 Product Weight (lbs.): 19 Cubic Feet Per Carton: 3.25 (2 per carton)</p>	Upholstered Seat and Back. Use with beams.	6698	\$474	\$515	\$545	\$588	\$652	\$671	\$729	\$832	\$883	\$980	\$1110	\$1272		
		<b>OVERALL DIMENSIONS</b>			<b>SEAT DIMENSIONS</b>			<b>BACK DIMENSIONS</b>								
		<b>W</b>	<b>D</b>	<b>H</b>	<b>W</b>	<b>D</b>	<b>H</b>	<b>W</b>	<b>H</b>							
		18	21	18	18	17	-	18	15.5							
																

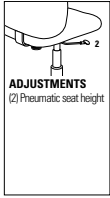
DESCRIPTION	FEATURES	MODEL#	STANDARD TEXTILE GRADES													
			1	2	3	4	5	6	7	8	9	10	11	12		
 <p><b>Task w/Arms</b> COM Yardage: N/A Freight Class: 250 Product Weight (lbs.): 32 Cubic Feet Per Carton: 9.75</p>	 <p><b>ADJUSTMENTS</b> (2) Pneumatic seat height</p>	<p>Polypropylene Seat and Back</p> <p>Ergonomic Features: C, M</p>	6720	\$644	-	-	-	-	-	-	-	-	-	-	-	
			<b>OVERALL DIMENSIONS</b>			<b>SEAT DIMENSIONS</b>			<b>BACK DIMENSIONS</b>							
			<b>W</b>	<b>D</b>	<b>H</b>	<b>W</b>	<b>D</b>	<b>H</b>	<b>W</b>	<b>H</b>						
			25.5	21.5	32.5	18	17.5	14-19	18	16						
			<b>RTA 1</b>	<b>FedEx</b>		<b>ups</b>										
 <p><b>Task Armless</b> COM Yardage: N/A Freight Class: 250 Product Weight (lbs.): 31 Cubic Feet Per Carton: 9.75</p>	 <p><b>ADJUSTMENTS</b> (2) Pneumatic seat height</p>	<p>Polypropylene Seat and Back</p> <p>Ergonomic Features: C, M</p>	6721	\$494	-	-	-	-	-	-	-	-	-	-		
			<b>OVERALL DIMENSIONS</b>			<b>SEAT DIMENSIONS</b>			<b>BACK DIMENSIONS</b>							
			<b>W</b>	<b>D</b>	<b>H</b>	<b>W</b>	<b>D</b>	<b>H</b>	<b>W</b>	<b>H</b>						
			18	21.5	32.5	18	17.5	14-19	18	16						
			<b>RTA 1</b>	<b>FedEx</b>		<b>ups</b>										
 <p><b>Task w/Arms</b> COM Yardage: 0.75 Freight Class: 250 Product Weight (lbs.): 33 Cubic Feet Per Carton: 9.75</p>	 <p><b>ADJUSTMENTS</b> (2) Pneumatic seat height</p>	<p>Upholstered Seat</p> <p>Ergonomic Features: C, M</p>	6722	\$708	\$749	\$779	\$822	\$885	\$906	\$961	\$1066	\$1117	\$1212	\$1344	\$1506	
			<b>OVERALL DIMENSIONS</b>			<b>SEAT DIMENSIONS</b>			<b>BACK DIMENSIONS</b>							
			<b>W</b>	<b>D</b>	<b>H</b>	<b>W</b>	<b>D</b>	<b>H</b>	<b>W</b>	<b>H</b>						
			25.5	21.5	32.5	18	17.5	14.5-19.5	18	15.5						
			<b>RTA 1</b>	<b>FedEx</b>		<b>ups</b>										
 <p><b>Task Armless</b> COM Yardage: 0.75 Freight Class: 250 Product Weight (lbs.): 32 Cubic Feet Per Carton: 9.75</p>	 <p><b>ADJUSTMENTS</b> (2) Pneumatic seat height</p>	<p>Upholstered Seat</p> <p>Ergonomic Features: C, M</p>	6723	\$580	\$620	\$650	\$693	\$755	\$777	\$831	\$935	\$988	\$1082	\$1213	\$1375	
			<b>OVERALL DIMENSIONS</b>			<b>SEAT DIMENSIONS</b>			<b>BACK DIMENSIONS</b>							
			<b>W</b>	<b>D</b>	<b>H</b>	<b>W</b>	<b>D</b>	<b>H</b>	<b>W</b>	<b>H</b>						
			18	21.5	32.5	18	17	14.5-19.5	18	15.5						
			<b>RTA 1</b>	<b>FedEx</b>		<b>ups</b>										
 <p><b>Task w/Arms</b> COM Yardage: 0.75 Freight Class: 250 Product Weight (lbs.): 34 Cubic Feet Per Carton: 9.75</p>	 <p><b>ADJUSTMENTS</b> (2) Pneumatic seat height</p>	<p>Upholstered Seat and Back</p> <p>Ergonomic Features: C, M</p>	6727	\$808	\$849	\$879	\$922	\$985	\$1006	\$1061	\$1166	\$1217	\$1312	\$1444	\$1605	
			<b>OVERALL DIMENSIONS</b>			<b>SEAT DIMENSIONS</b>			<b>BACK DIMENSIONS</b>							
			<b>W</b>	<b>D</b>	<b>H</b>	<b>W</b>	<b>D</b>	<b>H</b>	<b>W</b>	<b>H</b>						
			25.5	21.5	32.5	18	17	14.5-19.5	18	16						
			<b>RTA 1</b>	<b>FedEx</b>		<b>ups</b>										

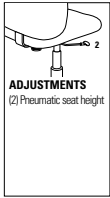
DESCRIPTION	FEATURES	MODEL#	STANDARD TEXTILE GRADES												
			1	2	3	4	5	6	7	8	9	10	11	12	
 <p><b>Task Armless</b> COM Yardage: 0.75 Freight Class: 250 Product Weight (lbs.): 33 Cubic Feet Per Carton: 9.75</p>	 <p><b>ADJUSTMENTS</b> (2) Pneumatic seat height</p> <p>Upholstered Seat and Back</p> <p>Ergonomic Features: C, M</p>	<p><b>6728</b></p>	\$659	\$700	\$730	\$773	\$836	\$857	\$912	\$1017	\$1068	\$1163	\$1295	\$1456	
			<b>OVERALL DIMENSIONS</b>			<b>SEAT DIMENSIONS</b>			<b>BACK DIMENSIONS</b>						
			<b>W</b>	<b>D</b>	<b>H</b>	<b>W</b>	<b>D</b>	<b>H</b>	<b>W</b>	<b>H</b>					
	18	21.5	32.5	18	17	14.5-19.5	18	15.5							
				<p><b>RTA 1</b></p>											
 <p><b>Height Adjustable Stool w/Arms</b> COM Yardage: N/A Freight Class: 250 Product Weight (lbs.): 38 Cubic Feet Per Carton: 9.75</p>	 <p><b>ADJUSTMENTS</b> (2) Pneumatic seat height</p> <p>Polypropylene Seat and Back</p> <p>Ergonomic Features: C, M</p>	<p><b>6730</b></p>	\$857	-	-	-	-	-	-	-	-	-	-	-	
			<b>OVERALL DIMENSIONS</b>			<b>SEAT DIMENSIONS</b>			<b>BACK DIMENSIONS</b>						
			<b>W</b>	<b>D</b>	<b>H</b>	<b>W</b>	<b>D</b>	<b>H</b>	<b>W</b>	<b>H</b>					
	25.5	21.5	41	18	17.5	21-31	18	16							
				<p><b>RTA 1</b> <b>FedEx</b></p>											
 <p><b>Height Adjustable Stool - Armless</b> COM Yardage: N/A Freight Class: 250 Product Weight (lbs.): 37 Cubic Feet Per Carton: 9.75</p>	 <p><b>ADJUSTMENTS</b> (2) Pneumatic seat height</p> <p>Polypropylene Seat and Back</p> <p>Ergonomic Features: C, M</p>	<p><b>6731</b></p>	\$758	-	-	-	-	-	-	-	-	-	-	-	
			<b>OVERALL DIMENSIONS</b>			<b>SEAT DIMENSIONS</b>			<b>BACK DIMENSIONS</b>						
			<b>W</b>	<b>D</b>	<b>H</b>	<b>W</b>	<b>D</b>	<b>H</b>	<b>W</b>	<b>H</b>					
	18	21.5	41	18	17.5	21.5-31.5	18	15.5							
				<p><b>RTA 1</b> <b>FedEx</b> <b>ups</b></p>											
 <p><b>Height Adjustable Stool w/Arms</b> COM Yardage: 0.75 Freight Class: 150 Product Weight (lbs.): 39 Cubic Feet Per Carton: 9.75</p>	 <p><b>ADJUSTMENTS</b> (2) Pneumatic seat height</p> <p>Upholstered Seat</p> <p>Ergonomic Features: C, M</p>	<p><b>6732</b></p>	\$953	\$996	\$1026	\$1070	\$1131	\$1153	\$1208	\$1313	\$1363	\$1459	\$1590	\$1751	
			<b>OVERALL DIMENSIONS</b>			<b>SEAT DIMENSIONS</b>			<b>BACK DIMENSIONS</b>						
			<b>W</b>	<b>D</b>	<b>H</b>	<b>W</b>	<b>D</b>	<b>H</b>	<b>W</b>	<b>H</b>					
	25.5	21.5	41	18	17.5	21.5-31.5	18	15.5							
				<p><b>RTA 1</b></p>											
 <p><b>Height Adjustable Stool - Armless</b> COM Yardage: 0.75 Freight Class: 250 Product Weight (lbs.): 38 Cubic Feet Per Carton: 9.75</p>	 <p><b>ADJUSTMENTS</b> (2) Pneumatic seat height</p> <p>Upholstered Seat</p> <p>Ergonomic Features: C, M</p>	<p><b>6733</b></p>	\$857	\$898	\$928	\$971	\$1034	\$1055	\$1110	\$1215	\$1266	\$1361	\$1493	\$1654	
			<b>OVERALL DIMENSIONS</b>			<b>SEAT DIMENSIONS</b>			<b>BACK DIMENSIONS</b>						
			<b>W</b>	<b>D</b>	<b>H</b>	<b>W</b>	<b>D</b>	<b>H</b>	<b>W</b>	<b>H</b>					
	18	21.5	41	18	17.5	21.5-31.5	18	15.5							
				<p><b>RTA 1</b> <b>FedEx</b> <b>ups</b></p>											

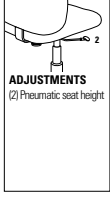
DESCRIPTION	FEATURES	MODEL#	STANDARD TEXTILE GRADES											
			1	2	3	4	5	6	7	8	9	10	11	12
 <p><b>Height Adjustable Stool w/Arms</b>                      COM Yardage: 0.75                      Freight Class: 150                      Product Weight (lbs.): 40                      Cubic Feet Per Carton: 9.75</p>	 <p><b>ADJUSTMENTS</b> (2) Pneumatic seat height</p> <p>Upholstered Seat and Back</p> <p>Ergonomic Features: C, M</p>	<b>6737</b>	\$1052	\$1093	\$1123	\$1166	\$1229	\$1250	\$1305	\$1410	\$1461	\$1556	\$1688	\$1850
			<b>OVERALL DIMENSIONS</b>			<b>SEAT DIMENSIONS</b>			<b>BACK DIMENSIONS</b>					
			<b>W</b>	<b>D</b>	<b>H</b>	<b>W</b>	<b>D</b>	<b>H</b>	<b>W</b>	<b>H</b>				
			25.5	21.5	41	18	17	21.5-31.5	18	15.5				
			<b>RTA 1</b>											
 <p><b>Height Adjustable Stool - Armless</b>                      COM Yardage: 0.75                      Freight Class: 150                      Product Weight (lbs.): 39                      Cubic Feet Per Carton: 9.75</p>	 <p><b>ADJUSTMENTS</b> (2) Pneumatic seat height</p> <p>Upholstered Seat and Back</p> <p>Ergonomic Features: C, M</p>	<b>6738</b>	\$953	\$994	\$1024	\$1067	\$1130	\$1151	\$1206	\$1311	\$1362	\$1457	\$1589	\$1751
			<b>OVERALL DIMENSIONS</b>			<b>SEAT DIMENSIONS</b>			<b>BACK DIMENSIONS</b>					
			<b>W</b>	<b>D</b>	<b>H</b>	<b>W</b>	<b>D</b>	<b>H</b>	<b>W</b>	<b>H</b>				
			18	21.5	41	18	17	21.5-31.5	18	16.5				
			<b>RTA 1</b>											
 <p><b>Task Armless w/ Pedestal Base</b>                      COM Yardage: N/A                      Freight Class: 250                      Product Weight (lbs.): 37                      Cubic Feet Per Carton: 10.75</p>	 <p><b>ADJUSTMENTS</b> (2) Pneumatic seat height</p> <p>Polypropylene Seat and Back</p> <p>Ergonomic Features: C, M</p>	<b>6721PB</b>	\$750	-	-	-	-	-	-	-	-	-	-	-
			<b>OVERALL DIMENSIONS</b>			<b>SEAT DIMENSIONS</b>			<b>BACK DIMENSIONS</b>					
			<b>W</b>	<b>D</b>	<b>H</b>	<b>W</b>	<b>D</b>	<b>H</b>	<b>W</b>	<b>H</b>				
			18	21.5	33	18	17.5	14-19	18	16				
			<b>RTA 1 FedEx</b>											



Duet tables are multi-purpose stacking tables that offer optimum space utilization and flexibility. Their personality and simple design make them ideal for use in any learning or training environment at post-secondary and adult levels. Temporarily and easily convert auditoriums and other spaces into examination and seminar spaces. They can be partnered with stacking chairs such as Duet or Popcorn in matching or complementary colors (stacking chairs can be found in the Multi-Purpose section of the Seating price list).

The one-piece molded top and modesty are gently contoured providing an eased edge with an elegant waterfall transition from top to modesty.

Tops are available in a wide array of colors in 0.5" thick polypropylene. Polypropylene material offers strength and ease of cleaning with a slightly textured surface to offer scratch resistance.



#### Features and Benefits

- One-piece molded top and modesty are 0.5" thick polypropylene.
- Tables are rated 250 lbs. capacity.
- Surface includes factory installed metal inserts for solid and secure connection to the sled frame.
- 0.5" diameter solid steel rod sled frame.
- Bumpers on the underside for protection when stacking.
- Model with ADA width compliant frame is available.
- Shipped fully assembled.



One-piece top and modesty.



Stacks 5 high on floor or 20 high on dolly.

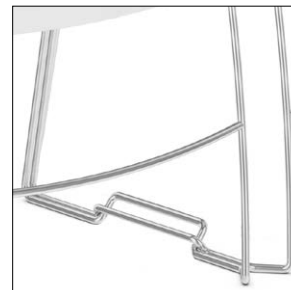

Ganging frame to keep tables evenly aligned.

**GENERAL INFORMATION**

- Duet tables are multi-purpose stacking tables ideal for auditoriums, seminars or any learning or training environment.
- Lightweight and easy to handle whether stacking for storage or setting up a room.
- Made of durable materials to withstand more demanding environments.
- Shipped fully assembled. Packaged 4 per carton.
- Global products are in compliance with stringent emission guidelines set out by the Greenguard Environmental Institute under the standards for low emitting products and materials. [www.greenguard.org](http://www.greenguard.org).
- Covered by Global's Lifetime Warranty.
- **Level 2 Certified.**

**WORKSURFACES**

26" W x 18" D x 9.75" H

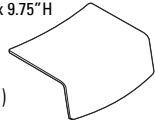

- Top and modesty are a one-piece injection molded design in 0.5" thick polypropylene.
- Available in a wide array of colors (see right column "FINISHES") to complement any space or to define sections by color.
- One-piece molded top and modesty are contoured providing an eased user edge, with an elegant waterfall transition from top to modesty.

**CONSTRUCTION**

- Surface includes molded in threaded inserts to provide a secure metal-to-metal connection to the sled frame.
- Bumpers are included on the underside of top and inside modesty to protect surfaces when stacking.

**FRAME**

- 0.5" diameter solid steel rod sled frame.
- Available in a durable Chrome finish.
- Model with ganging frame keeps tables evenly positioned and aligned. No tools or fasteners required for ganging; the frames simply interlock.
- Model with ADA compliant frame is also available. The frame is 33" wide and the polypropylene top/modesty remain a constant size.
- Tables are standard without glides and are suitable for carpet, rubber or cork flooring.
- Glide options are available (see right column "GLIDES"). Glides must be chosen to best suit flooring type and site conditions. Upcharges apply.

**DOLLY**

- For space saving storage and transport.
- Constructed from 1.5" x 0.5" steel tubing with heavy duty casters (two locking) and a removable handle.
- Dolly can stack up to 20 tables.
- Stacking height on dollies is up to 68".

**Required specifications**

Top finish\*

**Optional specifications**

Glide option\*

**FINISHES**

- |                      |                    |
|----------------------|--------------------|
| <b>BZB</b> Buzz Blue | <b>FRD</b> Frost   |
| <b>CCT</b> Cactus    | <b>INK</b> Ink     |
| <b>CRO</b> Carrot    | <b>LAB</b> Latte   |
| <b>IVC</b> Cloud     | <b>BLK</b> Night   |
| <b>DJN</b> Dijon     | <b>SND</b> Sand    |
| <b>EGP</b> Eggplant  | <b>SAR</b> Scarlet |
| <b>FOG</b> Fog       | <b>SHW</b> Shadow  |

**GLIDES**

- CG** Clear polycarbonate (for carpet, rubber or concrete flooring). Height added to table: 0.18". Add \$19/set.
- SG** Glides with stainless steel pads (for carpet or rubber flooring). Height added to table: 0.17". Add \$36/set.
- FG** Glides with felt pads (for vinyl, cork or laminate flooring). Height added to table: 0.24". Add \$36/set.
- RG** Glides with rubber pads (for vinyl, hardwood, laminate, stone or ceramic flooring). Height added to table: 0.16". Add \$36/set.

**SPECIFICATIONS**

- Specifications marked with an \* are applicable to only those products which have the\* symbol beside the product name.

**EXAMPLE DUET TABLE ORDER CODE:**

Duet stacking table, polypropylene surface in Shadow, clear polycarbonate glides

DTS1828P	-SHW	-CG
Model #	Surface finish	Glides

NOT ON CONTRACT

**STACKING TABLES**      **MODEL#**      **DIMENSIONS**      **FREIGHT CLASS**      **WT./LBS.**      **CUBIC FT.**      **LIST PRICE**

D x W x H

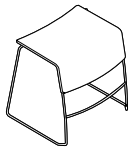

**Stacking Table\***

DTS1828P	25 x 29 x 28	150	26	17.75	<b>\$545</b>
----------	--------------	-----	----	-------	--------------

One-piece polypropylene top and modesty with Chrome frame. Shipped fully assembled, 4 per carton.

- Price shown is per table. It is recommended to order in multiples of 4.
- Please be sure to select the appropriate glide (see previous page) for the flooring surface, as scratches could occur.
- Worksurface is 18"D x 28"W

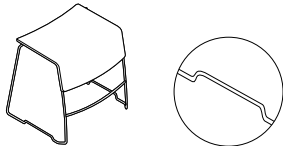

**Stacking Table, Ganging Frame\***

DTS1828PG	25 x 30.75 x 28	150	26	17.75	<b>\$581</b>
-----------	-----------------	-----	----	-------	--------------

One-piece polypropylene top and modesty with Chrome ganging frame. Shipped fully assembled, 4 per carton.

- Price shown is per table. It is recommended to order in multiples of 4.
- Please be sure to select the appropriate glide (see previous page) for the flooring surface, as scratches could occur.
- Worksurface is 18"D x 28"W

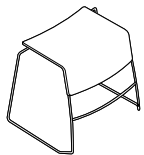

**Stacking Table, 32" Wide\***

DTA1832P	25 x 33 x 28	150	26	17.75	<b>\$616</b>
----------	--------------	-----	----	-------	--------------

ADA (American with Disabilities Act) compliant. 33" wide. One-piece polypropylene top and modesty with Chrome frame. Underside clearance is 27.1" H (extra height if glides are selected). Stacks up to 5 high on floor only; dolly does not accommodate. Shipped fully assembled, 4 per carton.

- Price shown is per table. It is recommended to order in multiples of 4.
- Please be sure to select the appropriate glide (see previous page) for the flooring surface, as scratches could occur.
- Worksurface is 18"D x 32"W

**DOLLY**



**Dolly**

DTD20	29.5 x 63 x 38.5	250	50	21	<b>\$791</b>
-------	------------------	-----	----	----	--------------

For use with tables DTS1828P and DTS1828PG. Can stack up to 20 tables. Black only. Removable handle for storage. Shipped fully assembled in 1 carton.

## ERIN



**model GC36531**  
Armless Guest Chair,  
Metal Legs



**model GC36532**  
Guest Armchair,  
Wood Legs

### STANDARD FEATURES

- Erin offers a streamlined silhouette brimming with mid-century modern style.
- A rounded arch gently curves around and under the seat to give extra support to a user's upper back and sides, while creating an open clean-out space at the back of the cushion.
- The series is available to specify with two textiles, one for the seat cushion and one for the back, arms and front rail (see model image).
- For pricing, start with the base price and add both back/arms graded textile upcharge and the seat graded textile upcharge.
- Tapered legs add style and elegance.
- Legs are available in wood or metal painted/plated finishes (noted).
- The seat underside is sealed with a non-porous material to support housekeeping and infection control protocols.
- Additional improved cleaning options include sealed seams (back and/or seat) and moisture barrier (seat). Upcharges apply.
- Assembled with tamper-resistant fasteners for greater security.
- For added comfort, the seat cushions are standard with high density Ultracell foam.
- Glides are self-leveling. Choose from standard non-marking glides, rubber non-slip glides or felt glides (upcharges apply).
- The Globalcare warranty (for healthcare and 24/7 environments) applies for all Erin GC models when performance textiles are selected. Visit the website at [globalfurnituregroup.com/healthcare](http://globalfurnituregroup.com/healthcare).
- Global's standard lifetime warranty applies when approved standard Global textiles are selected.
- For alternate textile applications, contact Global specials. The Blended Textile matrix does not apply to this series.
- Shipped fully assembled.

### SUGGESTED APPLICATIONS

- Dining/Cafeteria
- Guest seating
- Lobbies
- Lounge/Waiting
- Patient rooms
- Resident rooms





### OPTIONAL FEATURES

Please add option codes in the following order:

- **Model number**  
**GC36530** Guest armless chair, wood legs  
**GC36531** Guest armless chair, metal legs  
**GC36532** Guest armchair, wood legs  
**GC36533** Guest armchair, metal legs
- **Back/Arm Textile**  
Specify textile code. See model grade upcharges.
- **Seat Textile**  
Specify textile code. See model grade upcharges.
- **Wood leg finish** (models GC36530 and GC36532)  
**(AAM)** Absolute      **(MWM)** Medium Walnut  
**(BKM)** Black      **(NLW)** Natural Walnut  
**(CJM)** Charcoal Java      **(ASM)** Night  
**(ACM)** Cherry      **(NBM)** Noce Biondo  
**(EMM)** Empire Mahogany      **(NGM)** Noce Grigio  
**(EOM)** English Oak      **(NEM)** Noce Leggero  
**(ECM)** Espresso Cafe      **(NMM)** Noce Medio  
**(TFM)** Fruitwood      **(SBM)** Sandy Beach  
**(HGM)** Grey      **(SKM)** Shaker Cherry  
**(HOM)** Harvest Oak      **(SOM)** Silver Oak  
**(AHM)** Honey      **(TWM)** Walnut  
**(JOM)** Jet Onyx      **(WTM)** WC Cream  
**(LHM)** Light Honey      **(WHM)** White  
**(TMM)** Mahogany      **(WCM)** Winter Cherry  
**(AVM)** Maple
- **Metal leg finish** (models GC36531 and GC36533)  
**(CHM)** Chrome      **(TTU)** Tungsten  
**(TBL)** Black      **(TKA)** Kalua  
**(TLA)** Latte      **(TMO)** Mocha  
**(TSH)** Shadow      **(TOA)** Toast
- **Glides**  
**(NM)** Non-marking glide. No upcharge  
**(RG)** Rubber, non-slip glide. Add \$64.  
**(FG)** Felt glide. Add \$64.
- **Sealed Back Seams** (Contact Customer Care for approved textiles)  
**(NBS)** No sealed back seams  
**(SBS)** Sealed back seams. Upcharges vary, see model.
- **Sealed Seat Seams** (Contact Customer Care for approved textiles)  
**(NSS)** No sealed seat seams  
**(SSS)** Sealed seat seams. Add \$22
- **Moisture Barrier** (Not available with Sealed Seams)  
**(NB)** No moisture barrier.  
**(MB)** Moisture barrier (seat only). Add \$117.

### EXAMPLE ERIN ORDER CODE:

GC36530	CE90	CE90	AAM	NM	NBS	NSS	NB
Model #	Seat/Arm textile	Seat textile	Leg finish	Glide	Sealed Back Seams	Sealed Seat Seams	Moisture Barrier

DESCRIPTION	MODEL#/ FEATURES	STANDARD TEXTILE GRADES											
		1/COM	2	3	4	5	6	7	8	9	10	11	12
 <p><b>Armless Guest Chair, Wood Legs</b> COM Yardage: Back/Arm: 1.75; Seat: 1 Freight Class: 250 Product Weight (lbs.): 32.5 Cubic Feet Per Carton: 13.25</p>	<b>GC36530</b> Base Price:	<b>\$1997</b>											
	Back/Arm upcharge:	<b>+0</b>	<b>+\$60</b>	<b>+\$106</b>	<b>+\$175</b>	<b>+\$271</b>	<b>+\$311</b>	<b>+\$394</b>	<b>+\$525</b>	<b>+\$623</b>	<b>+\$731</b>	<b>+\$953</b>	<b>+\$1188</b>
	Seat upcharge:	<b>+0</b>	<b>+\$34</b>	<b>+\$61</b>	<b>+\$100</b>	<b>+\$155</b>	<b>+\$178</b>	<b>+\$225</b>	<b>+\$300</b>	<b>+\$356</b>	<b>+\$417</b>	<b>+\$545</b>	<b>+\$679</b>
		<b>OVERALL DIMENSIONS</b>			<b>SEAT DIMENSIONS</b>			<b>BACK DIMENSIONS</b>					
		<b>W</b>	<b>D</b>	<b>H</b>	<b>W</b>	<b>D</b>	<b>H</b>	<b>W</b>	<b>H</b>				
	24	22.25	34	19	18	19	15	15.5					
	Active weight 350 lbs.												
	Add \$52 for (SBS), \$22 for (SSS)												
 <p><b>Armless Guest Chair, Metal Legs</b> COM Yardage: Back/Arm: 1.75; Seat: 1 Freight Class: 250 Product Weight (lbs.): 34.5 Cubic Feet Per Carton: 13.25</p>	<b>GC36531</b> Base Price:	<b>\$1901</b>											
	Back/Arm upcharge:	<b>+0</b>	<b>+\$60</b>	<b>+\$106</b>	<b>+\$175</b>	<b>+\$271</b>	<b>+\$311</b>	<b>+\$394</b>	<b>+\$525</b>	<b>+\$623</b>	<b>+\$731</b>	<b>+\$953</b>	<b>+\$1188</b>
	Seat upcharge:	<b>+0</b>	<b>+\$34</b>	<b>+\$61</b>	<b>+\$100</b>	<b>+\$155</b>	<b>+\$178</b>	<b>+\$225</b>	<b>+\$300</b>	<b>+\$356</b>	<b>+\$417</b>	<b>+\$545</b>	<b>+\$679</b>
		<b>OVERALL DIMENSIONS</b>			<b>SEAT DIMENSIONS</b>			<b>BACK DIMENSIONS</b>					
		<b>W</b>	<b>D</b>	<b>H</b>	<b>W</b>	<b>D</b>	<b>H</b>	<b>W</b>	<b>H</b>				
	24	22.25	34	19	18	19	15	15.5					
	Active weight 350 lbs.												
	Add \$52 for (SBS), \$22 for (SSS)												
 <p><b>Guest Armchair, Wood Legs</b> COM Yardage: Back/Arm: 1.75; Seat: 1 Freight Class: 250 Product Weight (lbs.): 33 Cubic Feet Per Carton: 13.25</p>	<b>GC36532</b> Base Price:	<b>\$1997</b>											
	Back/Arm upcharge:	<b>+0</b>	<b>+\$60</b>	<b>+\$106</b>	<b>+\$175</b>	<b>+\$271</b>	<b>+\$311</b>	<b>+\$394</b>	<b>+\$525</b>	<b>+\$623</b>	<b>+\$731</b>	<b>+\$953</b>	<b>+\$1188</b>
	Seat upcharge:	<b>+0</b>	<b>+\$34</b>	<b>+\$61</b>	<b>+\$100</b>	<b>+\$155</b>	<b>+\$178</b>	<b>+\$225</b>	<b>+\$300</b>	<b>+\$356</b>	<b>+\$417</b>	<b>+\$545</b>	<b>+\$679</b>
		<b>OVERALL DIMENSIONS</b>			<b>SEAT DIMENSIONS</b>			<b>BACK DIMENSIONS</b>					
		<b>W</b>	<b>D</b>	<b>H</b>	<b>W</b>	<b>D</b>	<b>H</b>	<b>W</b>	<b>H</b>				
	24	22	34.25	19	18.5	18.5	17	17.5					
	Active weight 350 lbs.												
	Add \$55 for (SBS), \$22 for (SSS)												
 <p><b>Guest Armchair, Metal Legs</b> COM Yardage: Back/Arm: 1.75; Seat: 1 Freight Class: 250 Product Weight (lbs.): 35 Cubic Feet Per Carton: 13.25</p>	<b>GC36533</b> Base Price:	<b>\$1901</b>											
	Back/Arm upcharge:	<b>+0</b>	<b>+\$60</b>	<b>+\$106</b>	<b>+\$175</b>	<b>+\$271</b>	<b>+\$311</b>	<b>+\$394</b>	<b>+\$525</b>	<b>+\$623</b>	<b>+\$731</b>	<b>+\$953</b>	<b>+\$1188</b>
	Seat upcharge:	<b>+0</b>	<b>+\$34</b>	<b>+\$61</b>	<b>+\$100</b>	<b>+\$155</b>	<b>+\$178</b>	<b>+\$225</b>	<b>+\$300</b>	<b>+\$356</b>	<b>+\$417</b>	<b>+\$545</b>	<b>+\$679</b>
		<b>OVERALL DIMENSIONS</b>			<b>SEAT DIMENSIONS</b>			<b>BACK DIMENSIONS</b>					
		<b>W</b>	<b>D</b>	<b>H</b>	<b>W</b>	<b>D</b>	<b>H</b>	<b>W</b>	<b>H</b>				
	24	22	34.25	19	18.5	18.5	17	17.5					
	Active weight 350 lbs.												
	Add \$55 for (SBS), \$22 for (SSS)												

## FACTOR



Armless, Mesh Back  
5545NM



Armchair, Mesh Back, Casters  
5545AMC



For Factor task seating, see 36.

## STANDARD FEATURES





- Factor, a value seating series with a full spectrum of mesh colors offering models to address multiple applications: task, management, conference and guest.
- The full series offers mesh back task and guest chair models with upholstered seats, with and without arms. Guest chairs are described below.
- Factor Guest mesh back frame is available in three colors with a flexible base connection adding the perfect balance of support and movement.
- Strong, nylon arms have a gently curved loop design. Arm color matches back frame color.
- The seat comfort is achieved with contoured, molded foam while the refined aesthetic is finished with an under-seat shroud matching the selected back frame color.
- The four-legged guest chairs are designed and constructed from durable steel tubing.
- Arm and armless chairs with and without glides or casters do not stack.
- Due to the flex back design, it is recommended the chair be positioned away from the wall for use.
- All models are standard with colored nylon glides **(ST)** in two finishes **(BLK)** Black or **(SND)** Sand. A variety of other glide options are available for various flooring types, including **(NM)** White non-marking, **(FG)** Felt, **(RG)** Rubber non-slip, and **(SG)** Steel cushioned. See Glide type for upcharges. See glide matrix for recommended glides by flooring type.
- Caster models are standard with **(DC)** 2" Black dual wheel carpet casters. Optional hard floor **(RC)** Black dual wheel casters are available with C114 wheels, with upcharge.
- Upholstery options: fabric, vinyl or leather.
- Factor guest models are designed to support 300 lb. capacity and are covered under Global's Limited Lifetime Warranty.

Please add option codes in the following order:

- Model Number**  
Specify model number  
5545AM Armchair with mesh back (glides)  
5545AMC Armchair with mesh back (casters)  
5545NM Armless chair with mesh back (glides)  
5545NMC Armless chair with mesh back (casters)
- Mesh Back** (Factor Mesh colors shown on website)  
**(P1)** Snow **(P2)** Sand  
**(P3)** Pewter **(P4)** Silver Grey  
**(P5)** Charcoal **(P6)** Black  
**(P8)** Mocha **(P9)** Eggplant  
**(Q1)** Buzz Blue **(Q2)** Poppy  
**(Q3)** Pumpkin **(Q4)** Lime
- Seat Textile**  
Specify textile code
- Back Frame and Arm Finish**  
**(BLK)** Black. No upcharge.  
**(IVC)** Cloud. Add \$57.  
**(SHW)** Shadow. Add \$57.
- Leg Finish**  
Painted finishes:  
**(TBL)** Black  
**(TSH)** Shadow  
**(TIV)** Cloud  
Plated finishes:  
**(CHM)** Chrome. Add \$45.
- Glide Type** (for four-leg glide models)  
**(ST)** Colored nylon glide for most floor surfaces (select color). No upcharge.  
**(NM)** White, non-marking nylon glide for most surfaces. No upcharge.  
**(SG)** Steel cushioned glide for carpeted surfaces. Add \$36.  
**(FG)** Felt glide for most hard floor surfaces. Add \$36.  
**(RG)** Rubber non-slip glide for most hard floor surfaces. Add \$36.
- Glide Color** (for ST colored glide type)  
**(BLK)** Black  
**(SND)** Sand
- Caster Type** (for four-leg caster models)  
**(DC)** 2" Black caster for carpeted surfaces  
**(RC)** 2" Black caster for most hard floor surfaces. Add \$53.
- Seat Moisture Barrier**  
**(NB)** No moisture barrier  
**(MB)** Moisture barrier. Add \$124.

## EXAMPLE FACTOR ORDER CODE:

5545AM	P1	FU75	BLK	CHM	RC	NM	BLK	NB
Model #	Mesh finish	Seat textile	Back frame and arm finish	Leg finish	Caster type	Glide type	Glide color	Moisture barrier

DESCRIPTION	FEATURES	MODEL#	STANDARD TEXTILE GRADES											
			1/COM	2	3	4	5	6	7	8	9	10	11	12
 <p><b>Armchair, Mesh Back</b> COM Yardage: 1 Freight Class: 250 Product Weight (lbs.): 32.5 Cubic Feet Per Carton: 15.5</p>	5545AM	Does not stack.	\$670	\$704	\$730	\$768	\$821	\$847	\$895	\$973	\$1033	\$1100	\$1238	\$1385
			<b>OVERALL DIMENSIONS</b>			<b>SEAT DIMENSIONS</b>			<b>BACK DIMENSIONS</b>					
			<b>W</b>	<b>D</b>	<b>H</b>	<b>W</b>	<b>D</b>	<b>H</b>	<b>W</b>	<b>H</b>				
			24.5	23.5	33	20	16.5	17.5	17.5	15.25				
			<b>RTA 00</b>	1 per carton										
 <p><b>Armchair, Mesh Back, Casters</b> COM Yardage: 1 Freight Class: 250 Product Weight (lbs.): 30 Cubic Feet Per Carton: 13.75</p>	5545AMC	Does not stack.	\$770	\$803	\$829	\$867	\$920	\$946	\$994	\$1072	\$1132	\$1199	\$1337	\$1484
			<b>OVERALL DIMENSIONS</b>			<b>SEAT DIMENSIONS</b>			<b>BACK DIMENSIONS</b>					
			<b>W</b>	<b>D</b>	<b>H</b>	<b>W</b>	<b>D</b>	<b>H</b>	<b>W</b>	<b>H</b>				
			24.5	22.5	33	20	16.5	17.5	17.5	15.5				
			<b>RTA 00</b>	1 per carton										
 <p><b>Armless, Mesh Back</b> COM Yardage: 1 Freight Class: 300 Product Weight (lbs.): 27 Cubic Feet Per Carton: 13.75</p>	5545NM	Does not stack.	\$622	\$656	\$682	\$720	\$773	\$799	\$847	\$925	\$985	\$1052	\$1190	\$1337
			<b>OVERALL DIMENSIONS</b>			<b>SEAT DIMENSIONS</b>			<b>BACK DIMENSIONS</b>					
			<b>W</b>	<b>D</b>	<b>H</b>	<b>W</b>	<b>D</b>	<b>H</b>	<b>W</b>	<b>H</b>				
			20	23.5	33	20	16.5	17.5	17.5	15.5				
			<b>RTA 00</b>	1 per carton										
 <p><b>Armless, Mesh Back, Casters</b> COM Yardage: 1 Freight Class: 250 Product Weight (lbs.): 28 Cubic Feet Per Carton: 13.75</p>	5545NMC	Does not stack.	\$722	\$755	\$781	\$819	\$872	\$898	\$947	\$1024	\$1085	\$1152	\$1289	\$1437
			<b>OVERALL DIMENSIONS</b>			<b>SEAT DIMENSIONS</b>			<b>BACK DIMENSIONS</b>					
			<b>W</b>	<b>D</b>	<b>H</b>	<b>W</b>	<b>D</b>	<b>H</b>	<b>W</b>	<b>H</b>				
			20	22.5	33	20	16.5	17.5	17.5	15.5				
			<b>RTA 00</b>	1 per carton										

## FILE BUDDY™



model 1105



model 1110 Shown with 25-400 Vertical File

### STANDARD FEATURES

- Standard with C65 casters.
- Shipped R.T.A. (Ready to assemble).
- Pneumatic. Black, five-legged, injection molded base.
- 14" diameter seat.
- Check textile availability prior to specifying upholstery material.

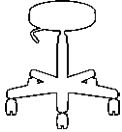
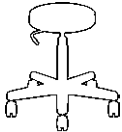
DESCRIPTION	FEATURES	MODEL#	STANDARD TEXTILE GRADES											
			1	2	3	4	5	6	7	8	9	10	11	12
 <p><b>Swivel Stool 5"</b> Pneumatic, 20" Base COM Yardage: 0.75 Freight Class: 150 Product Weight (lbs.): 14 Cubic Feet Per Carton: 2.9</p>		<b>1105</b>	\$441	\$472	\$494	\$530	\$577	\$602	\$636	\$718	\$754	\$828	\$930	\$1057
			<b>OVERALL DIMENSIONS</b>			<b>SEAT DIMENSIONS</b>			<b>BACK DIMENSIONS</b>					
			<b>W</b>	<b>D</b>	<b>H</b>	<b>W</b>	<b>D</b>	<b>H</b>	<b>W</b>	<b>H</b>				
			14	14	18.5	14	-	16.5-21.5	-	-				
			<b>RTA 1</b>	<b>FedEx</b>	<b>UPS</b>									
 <p><b>Swivel Stool 10"</b> Pneumatic, 22" Base COM Yardage: 0.75 Freight Class: 150 Product Weight (lbs.): 14 Cubic Feet Per Carton: 2.9</p>		<b>1110</b>	\$517	\$544	\$568	\$606	\$650	\$676	\$710	\$791	\$828	\$902	\$1005	\$1133
			<b>OVERALL DIMENSIONS</b>			<b>SEAT DIMENSIONS</b>			<b>BACK DIMENSIONS</b>					
			<b>W</b>	<b>D</b>	<b>H</b>	<b>W</b>	<b>D</b>	<b>H</b>	<b>W</b>	<b>H</b>				
			14	14	18.5	14	-	22.5-32.5	-	-				
			<b>RTA 1</b>	<b>FedEx</b>	<b>UPS</b>									

FLAP™



Folding Chair  
model 6775

STANDARD FEATURES

- A modern design, high quality, lightweight, all polymer folding chair intended for use indoors or outdoors. Products must be stored inside during extreme and inclement weather. See Global's Outdoor Furniture warranty for additional information.
- Weather resistant, UV resistant, stain resistant, 100% non-ferrous, and recyclable design that is 1:10 bleach solution cleanable.
- Chair legs are equipped with clear non-marking glides as standard. Suitable for outdoor environments, carpet and hard surface flooring
- Chairs are stocked in 2 colors: Alloy (**ALY**) and Milk (**MLK**)
- No upholstery options available
- Rated to 275 lbs.
- Single chair folds flat to 2.2" (55 mm).
- Flap achieves its strength and durability using glass filled polymer. Evidence of this material may be visible on the surface and is often more evident in darker colors.
- All Flap products are only available through Global's InStock program. Contact CustomerCare for lead times and quotation for quantities beyond InStock inventory.
- Two Flap Wall Hooks, sold individually, support either one (6776S) or two (6776) folded Flap chairs. Mounting hardware not included. Recommended mounting into stud. These Milk (**MLK**) colored plastic hooks mount on walls or inside closets and wardrobe cabinets providing easy access to extra seating.



- A single chair and hook require 3.7" (94 mm) minimum clearance from wall. Two adhesive wall bumpers are provided in box, recommended for use when mounting behind doors. Two chairs and hook require 7.3" (185 mm) minimum clearance from wall. Wall bumpers not included.
- Flap Ganging Brackets (6778) are sold 12 to a box. These translucent, frosted plastic brackets attach across two adjacent chairs, just above or below the seat to provide temporary ganging for organized events.
- The Flap Dolly (6777), ordered separately, supports up to 24 chairs folded and stacked flat. Includes strap to secure chairs for storage and transport.
- Flap achieves its strength and durability using glass filled polymer. Evidence of this material may be visible on the surface and is often more evident in darker colors.

Please add option codes in the following order

- **Model number**  
6775 Folding Chair  
6776 Wall Hook, Two Chairs  
6776S Wall Hook, Single Chair  
6777 Dolly  
6778 Ganging Brackets
- **Chair Color**  
(ALY) Alloy  
(MLK) Milk

EXAMPLE OF FLAP ORDER CODE:

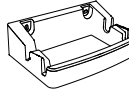
6775	ALY
Model Number	Finish

DESCRIPTION	FEATURES	MODEL#	STANDARD TEXTILE GRADES														
			1	2	3	4	5	6	7	8	9	10	11	12			
 <p><b>Folding Chair</b> COM Yardage: N/A Freight Class: 100 Product Weight (lbs.): 13.5 Cubic Feet Per Carton: 1.6</p>	<p>Shipped 2 per box. Ordered as each.</p>	<p><b>6775</b></p>	226														
			<b>OVERALL DIMENSIONS</b>			<b>SEAT DIMENSIONS</b>			<b>BACK DIMENSIONS</b>								
			<b>W</b>	<b>D</b>	<b>H</b>	<b>W</b>	<b>D</b>	<b>H</b>	<b>W</b>	<b>H</b>							
			19	21.5	33.5	16	16.5	18.5	18.5	16							
			<b>RTA 00</b>		<b>FedEx</b>	2 per carton (pricing and specifications are for one chair)											
 <p><b>Flap Wall Hook, Two Chairs</b> COM Yardage: N/A Freight Class: 70 Product Weight (lbs.): 0.75 Cubic Feet Per Carton: 0.2</p>		<p><b>6776</b></p>	57														
			<b>OVERALL DIMENSIONS</b>			<b>SEAT DIMENSIONS</b>			<b>BACK DIMENSIONS</b>								
			<b>W</b>	<b>D</b>	<b>H</b>	<b>W</b>	<b>D</b>	<b>H</b>	<b>W</b>	<b>H</b>							
			9	6	2.75												
			<b>RTA 00</b>		<b>FedEx</b> 	1 per carton											

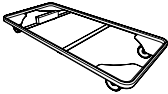
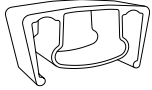
DESCRIPTION	FEATURES	MODEL#	STANDARD TEXTILE GRADES																				
			1	2	3	4	5	6	7	8	9	10	11	12									
 <p><b>Flap Wall Hook, Single Chair</b>                      COM Yardage: N/A                      Freight Class: 70                      Product Weight (lbs.): 0.06                      Cubic Feet Per Carton: 0.03</p>		<b>6776S</b>	57																				
		<b>OVERALL DIMENSIONS</b>			<b>SEAT DIMENSIONS</b>			<b>BACK DIMENSIONS</b>															
		W D H			W D H			W H															
		8.5 3.67 2.21																					
			RTA 00	FedEx			ups	1 per carton															
 <p><b>Dolly for Flap Folding Chairs</b>                      COM Yardage: N/A                      Freight Class: 150                      Product Weight (lbs.): 23                      Cubic Feet Per Carton: 4.5</p>	Holds up to 24 Flap folded chairs. Includes tether strap.	<b>6777</b>	648																				
		<b>OVERALL DIMENSIONS</b>			<b>SEAT DIMENSIONS</b>			<b>BACK DIMENSIONS</b>															
		W D H			W D H			W H															
		20.75 44 5.25																					
			RTA 00	FedEx			ups	1 per carton															
 <p><b>Flap Ganging Bracket (box of 12)</b>                      COM Yardage: N/A                      Freight Class: 70                      Product Weight (lbs.): 0.29                      Cubic Feet Per Carton: 0.03</p>		<b>6778</b>	199																				
		<b>OVERALL DIMENSIONS</b>			<b>SEAT DIMENSIONS</b>			<b>BACK DIMENSIONS</b>															
		W D H			W D H			W H															
		0 0 0																					
			RTA 00	FedEx			ups	12 per carton (pricing and specifications are for box of 12)															

ISLANDS™



model 4075



model 4076





Leather upholstered seat and back additional stitch detail shown.

STANDARD FEATURES

- Islands offers wood guest seating with contemporary styling.
- Offered in two styles; Upholstered back pad or Horizontal wood slat.
- Check textile availability prior to specifying upholstery material.
- When upholstered in Leather, there are additional stitching details with a seam across the middle of the back and two seams on the seat.
- Does not stack.

OPTIONAL FEATURES

- Frame available in Absolute (AAM), Black (BKM), Cherry (ACM), Espresso Cafe (ECM), English Oak (EOM), Fruitwood (TFM), Gray (HGM), Honey (AHM), Mahogany (TMM), Maple (AVM), Medium Walnut (MWM), Natural Walnut (NLW), Night (ASM), Noce Biondo (NBM), Noce Grigio (NGM), Noce Leggero (NEM), Noce Medio (NMM), Shaker Cherry (SKM), Walnut (TWM), WC Cream (WTM), White (WHM) and Winter Cherry (WCM). Please Specify. Genuine maple faced veneers and solids are used.

DESCRIPTION	FEATURES	MODEL#	STANDARD TEXTILE GRADES											
			1	2	3	4	5	6	7	8	9	10	11	12
 <p><b>4075</b></p> <p><b>Armchair</b> Upholstered back. COM Yardage: 1.5 Freight Class: 300 Product Weight (lbs.): 25 Cubic Feet Per Carton: 13.25</p>	<p>Does not stack.</p> <p>Ergonomic Features: M, N</p>	<p><b>4075</b></p>	\$1016	\$1076	\$1121	\$1184	\$1278	\$1322	\$1406	\$1540	\$1643	\$1759	\$1997	\$2249
			<p><b>OVERALL DIMENSIONS</b></p> <p>W D H</p>			<p><b>SEAT DIMENSIONS</b></p> <p>W D H</p>			<p><b>BACK DIMENSIONS</b></p> <p>W H</p>					
			24.5	23.5	32	20.5	18	18.5	19	13				
 <p><b>4076</b></p> <p><b>Armchair</b> Horizontal wood slat back. COM Yardage: 1 Freight Class: 300 Product Weight (lbs.): 25 Cubic Feet Per Carton: 13.25</p>	<p>Does not stack.</p> <p>Ergonomic Features: M, N</p>	<p><b>4076</b></p>	\$1078	\$1119	\$1149	\$1191	\$1255	\$1285	\$1340	\$1431	\$1497	\$1575	\$1733	\$1900
			<p><b>OVERALL DIMENSIONS</b></p> <p>W D H</p>			<p><b>SEAT DIMENSIONS</b></p> <p>W D H</p>			<p><b>BACK DIMENSIONS</b></p> <p>W H</p>					
			24.5	23.5	32	20.5	18	18.5	19	13				
			<p>RTA 00</p> <p>FedEx</p> <p>ups</p>											

LAYNE™



model 8520T







model 8525T

STANDARD FEATURES

- Layne offers classic styling and value in a finely crafted wood framed side chair series.
- Frame construction is beechwood.
- Legs are equipped with White non-marking polypropylene glides. Suitable for both carpet and hard surface flooring.
- Offered in four back styles; Fully Upholstered, Picture Frame or Vertical Wood Slat.
- Check textile availability prior to specifying upholstery material.
- Does not stack.

OPTIONAL FEATURES

- Wood frames are available in Absolute (AAM), Black (BKM), Cherry (ACM), Espresso Cafe (ECM), English Oak (EOM), Fruitwood (TFM), Gray (HGM), Honey (AHM), Mahogany (TMM), Maple (AVM), Medium Walnut (MWM), Natural Walnut (NLW), Night (ASM), Noce Biondo (NBM), Noce Grigio (NGM), Noce Leggero (NEM), Noce Medio (NMM), Shaker Cherry (SKM), Walnut (TWM), WC Cream (WTM), White (WHM) and Winter Cherry (WCM). Please Specify.

DESCRIPTION	FEATURES	MODEL#	STANDARD TEXTILE GRADES												
			1	2	3	4	5	6	7	8	9	10	11	12	
 <p><b>Armless Upholstered Side Chair</b> COM Yardage: 1 Freight Class: 300 Product Weight (lbs.): 21 Cubic Feet Per Carton: 13.25</p>	<p>Does not stack.</p> <p>Ergonomic Features: M, N</p>	<b>8520T</b>	\$911	\$960	\$995	\$1047	\$1124	\$1149	\$1216	\$1339	\$1399	\$1514	\$1671	\$1867	
		<b>OVERALL DIMENSIONS</b>			<b>SEAT DIMENSIONS</b>			<b>BACK DIMENSIONS</b>							
		<b>W</b>	<b>D</b>	<b>H</b>	<b>W</b>	<b>D</b>	<b>H</b>	<b>W</b>	<b>H</b>						
		22.75	24	33	20	18.25	18	17.5	14						
			<b>RTA 00</b>												
 <p><b>Fully Upholstered Armchair</b> COM Yardage: 2.25 Freight Class: 300 Product Weight (lbs.): 22 Cubic Feet Per Carton: 13.25</p>	<p>Does not stack</p> <p>Ergonomic Features: M, N</p>	<b>8521T</b>	\$982	\$1076	\$1150	\$1261	\$1418	\$1492	\$1633	\$1860	\$2035	\$2228	\$2628	\$3055	
		<b>OVERALL DIMENSIONS</b>			<b>SEAT DIMENSIONS</b>			<b>BACK DIMENSIONS</b>							
		<b>W</b>	<b>D</b>	<b>H</b>	<b>W</b>	<b>D</b>	<b>H</b>	<b>W</b>	<b>H</b>						
		22.75	24	33	20	18.25	18	17.5	14						
			<b>RTA 00</b>												
 <p><b>Picture Frame Armchair</b> COM Yardage: 1.25 Freight Class: 300 Product Weight (lbs.): 22 Cubic Feet Per Carton: 13.25</p>	<p>Does not stack</p> <p>Ergonomic Features: M, N</p>	<b>8522T</b>	\$1110	\$1150	\$1178	\$1220	\$1278	\$1300	\$1355	\$1450	\$1500	\$1592	\$1718	\$1873	
		<b>OVERALL DIMENSIONS</b>			<b>SEAT DIMENSIONS</b>			<b>BACK DIMENSIONS</b>							
		<b>W</b>	<b>D</b>	<b>H</b>	<b>W</b>	<b>D</b>	<b>H</b>	<b>W</b>	<b>H</b>						
		22.75	24	33	20	18.25	18	17.5	14						
			<b>RTA 00</b>												
 <p><b>Upholstered Armchair</b> COM Yardage: 1 Freight Class: 300 Product Weight (lbs.): 22 Cubic Feet Per Carton: 13.25</p>	<p>Does not stack</p> <p>Ergonomic Features: M, N</p>	<b>8525T</b>	\$1037	\$1087	\$1122	\$1178	\$1257	\$1285	\$1351	\$1483	\$1546	\$1664	\$1831	\$2033	
		<b>OVERALL DIMENSIONS</b>			<b>SEAT DIMENSIONS</b>			<b>BACK DIMENSIONS</b>							
		<b>W</b>	<b>D</b>	<b>H</b>	<b>W</b>	<b>D</b>	<b>H</b>	<b>W</b>	<b>H</b>						
		22.75	24	33	20	18.25	18	17.5	14						
			<b>RTA 00</b>												

DESCRIPTION	FEATURES	MODEL#	STANDARD TEXTILE GRADES													
			1	2	3	4	5	6	7	8	9	10	11	12		
 <p><b>Vertical Wood Slat Armchair</b>            COM Yardage: 1            Freight Class: 300            Product Weight (lbs.): 22            Cubic Feet Per Carton: 13.25</p>	Does not stack.  Ergonomic Features: M, N	<b>8526T</b>	\$1077	\$1114	\$1142	\$1185	\$1243	\$1271	\$1325	\$1410	\$1474	\$1549	\$1699	\$1859		
			OVERALL DIMENSIONS			SEAT DIMENSIONS			BACK DIMENSIONS							
			W	D	H	W	D	H	W	H						
			22.75	24	33	20	18.25	18	17.5	14						
			<b>RTA 00</b>													

LITE



model 5940



model 5944



Closed Loop Arms.



model 5945



model 5951C

STANDARD FEATURES



- Lite is a modern series inspired by classic designs.
- Arms are standard in cantilevered or closed loop. Both are made from fiberglass reinforced nylon, available in Black only.
- Frame is heavy duty, equipped with Sytex™ high-strength polyester webbing suspension system for extra comfort.
- Cantilever frame models are 1" diameter 12 gauge tubular steel.
- Four legged frames are 1" diameter 12 gauge tubular steel front legs and 7/8" diameter 14 gauge tubular steel rear legs, depending on the model.
- Glides are non-marking polypropylene (NM) suitable for both carpet and hard surface flooring.
- All models are rated for active user load of 300 lbs. per seat.
- Dual wheel carpet casters (C82) are standard on caster models.
- Check textile availability prior to specifying upholstery material.

















OPTIONAL FEATURES







- Mesh models are available in any of the 24 standard Vue Mesh colors. Seat and back will be the same color mesh. Specify color: Sandy Beach (VU10), Dessert Sand (VU11), Orange Sunset (VU12), Chocolate Fountain (VU13), Artic Blue (VU14), Quarry Grey (VU15), Tidal Wave (VU16), Ivy Moss (VU17), Red Rose (VU18), Black (VU19), White (VU20), Lime (VU21), Chartreuse (VU23), Pool Blue (VU26), Sky (VU28), Ice (VU30), Primary Blue (VU32), Tangerine (VU34), Paprika (VU37), Grain (VU40), Yellow (VU43), Silver Grey (VU55), Silver (VU63), Hot Pink (VU65) and Red Mittens (VU70)
- A selection of glide options is available for four-legged chairs (models 5940, 5941, 5942, 5950, 5951 and 5952). Glides must be chosen to best suit flooring type and site conditions.
- Glides with felt pads (FG) are available for vinyl sheet, cork or laminate flooring, please specify. Add \$64.
- Glides with rubber pads (RG) are available for vinyl, hardwood, laminate, stone or ceramic flooring, please specify. Add \$64.
- For hard floor surface flooring casters please specify C9R, add \$104.
- **Frame finish**  

(TBL) Black	(TBZ) Buzz Blue
(TCC) Cactus	(TCR) Carrot
(TDJ) Dijon	(TDW) Designer White
(TEG) Eggplant	(TFO) Fog
(TFR) Frost	(TIN) Ink
(TIV) Cloud	(TKA) Kalua
(TLA) Latte	(TMO) Mocha
(TOA) Toast	(TNE) Nevada
(TSH) Shadow	(TSN) Sand
(TSR) Scarlet	(TTU) Tungsten

**(CHM) Chrome. Add \$106**  
**(BCH) Brushed Chrome. Add \$113** for four-legged frame. **Add \$240** for cantilever frame. Please Specify.

DESCRIPTION	FEATURES	MODEL#	STANDARD TEXTILE GRADES												
			1	2	3	4	5	6	7	8	9	10	11	12	
 <p><b>Four-legged Frame Armless</b>                      COM Yardage: N/A                      Freight Class: 150                      Product Weight (lbs.): 26                      Cubic Feet Per Carton: 12.5</p>	Does not stack.	5940	\$846												
					<b>OVERALL DIMENSIONS</b>			<b>SEAT DIMENSIONS</b>			<b>BACK DIMENSIONS</b>				
		W	D	H	W	D	H	W	H						
			21.75	24.75	34.25	20	17	19	16	19					
						<b>RTA 00</b>									
 <p><b>Four-legged Frame Armless w/Casters</b>                      COM Yardage: N/A                      Freight Class: 150                      Product Weight (lbs.): 26                      Cubic Feet Per Carton: 12.5</p>	Does not stack.	5940C	\$977												
					<b>OVERALL DIMENSIONS</b>			<b>SEAT DIMENSIONS</b>			<b>BACK DIMENSIONS</b>				
		W	D	H	W	D	H	W	H						
			21.75	24.75	34.25	20	17	19	16	19					
						<b>RTA 00</b>									

DESCRIPTION	FEATURES	MODEL#	STANDARD TEXTILE GRADES											
			1	2	3	4	5	6	7	8	9	10	11	12
 <p><b>Four-legged Frame w/Cantilever Arms</b> COM Yardage: N/A Freight Class: 150 Product Weight (lbs.): 29 Cubic Feet Per Carton: 13.75</p>	Does not stack.	5941	\$972											
			OVERALL DIMENSIONS			SEAT DIMENSIONS			BACK DIMENSIONS					
			W	D	H	W	D	H	W	H				
			24	25.5	34.25	20	17	19	16	19				
			  											
 <p><b>Four-legged Frame w/Cantilever Arms &amp; Casters</b> COM Yardage: N/A Freight Class: 150 Product Weight (lbs.): 29 Cubic Feet Per Carton: 13.75</p>	Does not stack.	5941C	\$1104											
			OVERALL DIMENSIONS			SEAT DIMENSIONS			BACK DIMENSIONS					
			W	D	H	W	D	H	W	H				
			24	25.5	34.25	20	17	19	16	19				
			  											
 <p><b>Four-legged Frame w/ Loop Arms</b> COM Yardage: N/A Freight Class: 150 Product Weight (lbs.): 29 Cubic Feet Per Carton: 13.75</p>	Does not stack.	5942	\$972											
			OVERALL DIMENSIONS			SEAT DIMENSIONS			BACK DIMENSIONS					
			W	D	H	W	D	H	W	H				
			23.75	25.5	34.25	20	17	19	16	19				
			  											
 <p><b>Four-legged Frame w/ Loop Arms &amp; Casters</b> COM Yardage: N/A Freight Class: 150 Product Weight (lbs.): 29 Cubic Feet Per Carton: 13.75</p>	Does not stack.	5942C	\$1104											
			OVERALL DIMENSIONS			SEAT DIMENSIONS			BACK DIMENSIONS					
			W	D	H	W	D	H	W	H				
			23.75	25.5	34.25	20	17	19	16	19				
														
 <p><b>Cantilever Frame Armless</b> COM Yardage: N/A Freight Class: 150 Product Weight (lbs.): 27 Cubic Feet Per Carton: 12.5</p>	Does not stack.	5943	\$916											
			OVERALL DIMENSIONS			SEAT DIMENSIONS			BACK DIMENSIONS					
			W	D	H	W	D	H	W	H				
			21.75	23.5	34.25	20	17	19	16	19				
														

DESCRIPTION	FEATURES	MODEL#	STANDARD TEXTILE GRADES												
			1	2	3	4	5	6	7	8	9	10	11	12	
 <p><b>Cantilever Frame w/Cantilever Arms</b> COM Yardage: N/A Freight Class: 150 Product Weight (lbs.): 35 Cubic Feet Per Carton: 13.75</p>	Does not stack.	5944	\$1042												
		<b>OVERALL DIMENSIONS</b>			<b>SEAT DIMENSIONS</b>			<b>BACK DIMENSIONS</b>							
		W	D	H	W	D	H	W	H						
		24	23.5	34.25	20	17	19	16	19						
		RTA 00													
 <p><b>Cantilever Frame w/Loop Arms</b> COM Yardage: N/A Freight Class: 150 Product Weight (lbs.): 35 Cubic Feet Per Carton: 13.75</p>	Does not stack.	5945	\$1042												
		<b>OVERALL DIMENSIONS</b>			<b>SEAT DIMENSIONS</b>			<b>BACK DIMENSIONS</b>							
		W	D	H	W	D	H	W	H						
		23.75	23.5	34.25	20	17	19	16	19						
		RTA 00  													
 <p><b>Upholstered Four-legged Frame Armless</b> COM Yardage: 1.50 Freight Class: 150 Product Weight (lbs.): 26 Cubic Feet Per Carton: 12.5</p>	Does not stack.	5950	\$700	\$767	\$812	\$884	\$984	\$1033	\$1126	\$1272	\$1383	\$1510	\$1770	\$2045	
		<b>OVERALL DIMENSIONS</b>			<b>SEAT DIMENSIONS</b>			<b>BACK DIMENSIONS</b>							
		W	D	H	W	D	H	W	H						
		21.75	24.75	34.25	20	17	19	16	19						
		RTA 00													
 <p><b>Upholstered Four-legged Frame Armless w/Casters</b> COM Yardage: 1.50 Freight Class: 150 Product Weight (lbs.): 26 Cubic Feet Per Carton: 12.5</p>	Does not stack.	5950C	\$833	\$900	\$945	\$1017	\$1117	\$1166	\$1259	\$1405	\$1516	\$1643	\$1903	1362	
		<b>OVERALL DIMENSIONS</b>			<b>SEAT DIMENSIONS</b>			<b>BACK DIMENSIONS</b>							
		W	D	H	W	D	H	W	H						
		21.75	24.75	34.25	20	17	19	16	19						
		RTA 00													
 <p><b>Upholstered Four-legged Frame w/Cantilever Arms</b> COM Yardage: 1.50 Freight Class: 150 Product Weight (lbs.): 29 Cubic Feet Per Carton: 13.75</p>	Does not stack.	5951	\$822	\$889	\$934	\$1006	\$1106	\$1155	\$1248	\$1394	\$1505	\$1632	\$1892	1357	
		<b>OVERALL DIMENSIONS</b>			<b>SEAT DIMENSIONS</b>			<b>BACK DIMENSIONS</b>							
		W	D	H	W	D	H	W	H						
		24	25.5	34.25	20	17	19	16	19						
		RTA 00													

DESCRIPTION	FEATURES	MODEL#	STANDARD TEXTILE GRADES												
			1	2	3	4	5	6	7	8	9	10	11	12	
 <p><b>Upholstered Four-legged Frame w/Cantilever Arms &amp; Casters</b>                      COM Yardage: 1.50                      Freight Class: 150                      Product Weight (lbs.): 29                      Cubic Feet Per Carton: 13.75</p>	Does not stack.	<b>5951C</b>	\$957	\$1024	\$1069	\$1141	\$1241	\$1290	\$1383	\$1529	\$1640	\$1767	\$2027	1439	
		<b>OVERALL DIMENSIONS</b>			<b>SEAT DIMENSIONS</b>			<b>BACK DIMENSIONS</b>							
		<b>W</b>	<b>D</b>	<b>H</b>	<b>W</b>	<b>D</b>	<b>H</b>	<b>W</b>	<b>H</b>						
		24	25.5	34.25	20	17	19	16	19						
<b>RTA 00</b>															

DESCRIPTION	FEATURES	MODEL#	STANDARD TEXTILE GRADES												
			1	2	3	4	5	6	7	8	9	10	11	12	
 <p><b>Upholstered Four-legged Frame w/Loop Arms</b>                      COM Yardage: 1.50                      Freight Class: 150                      Product Weight (lbs.): 29                      Cubic Feet Per Carton: 13.75</p>	Does not stack.	<b>5952</b>	\$822	\$889	\$934	\$1006	\$1106	\$1155	\$1248	\$1394	\$1505	\$1632	\$1892	1357	
		<b>OVERALL DIMENSIONS</b>			<b>SEAT DIMENSIONS</b>			<b>BACK DIMENSIONS</b>							
		<b>W</b>	<b>D</b>	<b>H</b>	<b>W</b>	<b>D</b>	<b>H</b>	<b>W</b>	<b>H</b>						
		23.75	25.5	34.25	20	17	19	16	19						
<b>RTA 00</b>															

DESCRIPTION	FEATURES	MODEL#	STANDARD TEXTILE GRADES												
			1	2	3	4	5	6	7	8	9	10	11	12	
 <p><b>Upholstered Four-legged Frame w/Loop Arms &amp; Casters</b>                      COM Yardage: 1.50                      Freight Class: 150                      Product Weight (lbs.): 29                      Cubic Feet Per Carton: 13.75</p>	Does not stack.	<b>5952C</b>	\$957	\$1024	\$1069	\$1141	\$1241	\$1290	\$1383	\$1529	\$1640	\$1767	\$2027	1439	
		<b>OVERALL DIMENSIONS</b>			<b>SEAT DIMENSIONS</b>			<b>BACK DIMENSIONS</b>							
		<b>W</b>	<b>D</b>	<b>H</b>	<b>W</b>	<b>D</b>	<b>H</b>	<b>W</b>	<b>H</b>						
		23.75	25.5	34.25	20	17	19	16	19						
<b>RTA 00</b>															

DESCRIPTION	FEATURES	MODEL#	STANDARD TEXTILE GRADES												
			1	2	3	4	5	6	7	8	9	10	11	12	
 <p><b>Upholstered Cantilever Frame Armless</b>                      COM Yardage: 1.50                      Freight Class: 150                      Product Weight (lbs.): 27                      Cubic Feet Per Carton: 12.5</p>	Does not stack.	<b>5953</b>	\$766	\$833	\$878	\$950	\$1050	\$1099	\$1192	\$1338	\$1449	\$1576	\$1836	1323	
		<b>OVERALL DIMENSIONS</b>			<b>SEAT DIMENSIONS</b>			<b>BACK DIMENSIONS</b>							
		<b>W</b>	<b>D</b>	<b>H</b>	<b>W</b>	<b>D</b>	<b>H</b>	<b>W</b>	<b>H</b>						
		21.75	23.5	34.25	20	17	19	16	19						
<b>RTA 00</b>															

DESCRIPTION	FEATURES	MODEL#	STANDARD TEXTILE GRADES												
			1	2	3	4	5	6	7	8	9	10	11	12	
 <p><b>Upholstered Cantilever Frame w/Cantilever Arms</b>                      COM Yardage: 1.50                      Freight Class: 150                      Product Weight (lbs.): 35                      Cubic Feet Per Carton: 13.75</p>	Does not stack.	<b>5954</b>	\$894	\$961	\$1006	\$1078	\$1178	\$1227	\$1320	\$1466	\$1577	\$1704	\$1964	\$2239	
		<b>OVERALL DIMENSIONS</b>			<b>SEAT DIMENSIONS</b>			<b>BACK DIMENSIONS</b>							
		<b>W</b>	<b>D</b>	<b>H</b>	<b>W</b>	<b>D</b>	<b>H</b>	<b>W</b>	<b>H</b>						
		24	23.5	34.25	20	17	19	16	19						
<b>RTA 00</b>															

# MULTI-PURPOSE

LITE™ L

DESCRIPTION	FEATURES	MODEL#	STANDARD TEXTILE GRADES												
			1	2	3	4	5	6	7	8	9	10	11	12	
 <p><b>Upholstered Cantilever Frame w/Loop Arms</b>                      COM Yardage: 1.50                      Freight Class: 150                      Product Weight (lbs.): 35                      Cubic Feet Per Carton: 13.75</p>	Does not stack.	<b>5955</b>	\$894	\$961	\$1006	\$1078	\$1178	\$1227	\$1320	\$1466	\$1577	\$1704	\$1964	1400	
		OVERALL DIMENSIONS			SEAT DIMENSIONS			BACK DIMENSIONS							
		W	D	H	W	D	H	W	H						
			23.75	23.5	34.25	20	17	19	16	19					
			<b>RTA 00</b>												

MARCHE™



STANDARD FEATURES

- A contemporary wood seating series.
- Legs are standard in Black with Black non-marking glides.
- Does not stack.
- Check textile availability prior to specifying upholstery material.

OPTIONAL FEATURES

- Wood backs are available in Absolute (AAM), Black (BKM), Cherry (ACM), English Oak (EOM), Espresso Cafe (ECM), Fruitwood (TFM), Gray (HGM), Honey (AHM), Mahogany (TMM), Maple (AVM), Medium Walnut (MWM), Night (ASM),

Noce Biondo (NBM), Noce Grigio (NGM), Noce Leggero (NEM), Noce Medio (NMM), Shaker Cherry (SKM), Walnut (TWM), WC Cream (WTM), White (WHM) and Winter Cherry (WCM). Please Specify.

- Optional finishes are available at an upcharge. For models 8621, 8622 or 8624 add \$100 for Chrome (CHM) or Brushed Chrome (BCH), Add \$69 for Tungsten (TTU). For models 8621S, 8622S or 8624S add \$132 for Chrome (CHM) or Brushed Chrome (BCH), Add \$94 for Tungsten (TTU).

DESCRIPTION	FEATURES	MODEL#	STANDARD TEXTILE GRADES											
			1	2	3	4	5	6	7	8	9	10	11	12



**Side Chair** Open wood back  
COM Yardage: 1  
Freight Class: 250  
Product Weight (lbs.): 18.1  
Cubic Feet Per Carton: 11.25

Does not stack.

8621	\$1248	\$1288	\$1319	\$1365	\$1429	\$1458	\$1518	\$1611	\$1683	\$1763	\$1928	\$2103
------	--------	--------	--------	--------	--------	--------	--------	--------	--------	--------	--------	--------

OVERALL DIMENSIONS			SEAT DIMENSIONS			BACK DIMENSIONS	
W	D	H	W	D	H	W	H

20	21	31.5	19	16.5	19	20	13.5
----	----	------	----	------	----	----	------

RTA 00 FedEx



**Side Chair** Closed Upholstered Wood back  
COM Yardage: 2.25  
Freight Class: 250  
Product Weight (lbs.): 22.05  
Cubic Feet Per Carton: 11.25

Does not stack.

8622	\$1259	\$1367	\$1402	\$1455	\$1530	\$1557	\$1621	\$1747	\$1804	\$1920	\$2077	\$2273
------	--------	--------	--------	--------	--------	--------	--------	--------	--------	--------	--------	--------

OVERALL DIMENSIONS			SEAT DIMENSIONS			BACK DIMENSIONS	
W	D	H	W	D	H	W	H

20	21	31.5	19	16.5	19	20	13.5
----	----	------	----	------	----	----	------

RTA 00



**Side Chair** Closed Wood Back  
COM Yardage: 1  
Freight Class: 250  
Product Weight (lbs.): 20.22  
Cubic Feet Per Carton: 11.25

Does not stack.

8624	\$1248	\$1288	\$1319	\$1365	\$1429	\$1458	\$1518	\$1611	\$1683	\$1763	\$1928	\$2103
------	--------	--------	--------	--------	--------	--------	--------	--------	--------	--------	--------	--------

OVERALL DIMENSIONS			SEAT DIMENSIONS			BACK DIMENSIONS	
W	D	H	W	D	H	W	H

20	21	31.5	19	16.5	19	20	13.5
----	----	------	----	------	----	----	------

RTA 00



**Counter Stool** Open Wood Back  
COM Yardage: 1  
Freight Class: 300  
Product Weight (lbs.): 32  
Cubic Feet Per Carton: 13





Does not stack.

8621S26	\$1539	\$1575	\$1599	\$1633	\$1684	\$1707	\$1756	\$1828	\$1884	\$1948	\$2075	\$2215
---------	--------	--------	--------	--------	--------	--------	--------	--------	--------	--------	--------	--------

OVERALL DIMENSIONS			SEAT DIMENSIONS			BACK DIMENSIONS	
W	D	H	W	D	H	W	H

20	21	38.5	19	16.5	26	20	13.5
----	----	------	----	------	----	----	------

RTA 00

DESCRIPTION	FEATURES	MODEL#	STANDARD TEXTILE GRADES											
			1	2	3	4	5	6	7	8	9	10	11	12
 <p><b>Counter Stool</b> Closed Upholstered Wood Back COM Yardage: 2.25 Freight Class: 250 Product Weight (lbs.): 32 Cubic Feet Per Carton: 13</p>	Does not stack.	<b>8622S26</b>	\$1601	\$1689	\$1754	\$1856	\$1998	\$2068	\$2197	\$2403	\$2563	\$2740	\$3104	\$3495
			<b>OVERALL DIMENSIONS</b>			<b>SEAT DIMENSIONS</b>			<b>BACK DIMENSIONS</b>					
			<b>W</b>	<b>D</b>	<b>H</b>	<b>W</b>	<b>D</b>	<b>H</b>	<b>W</b>	<b>H</b>				
			20	21	38.5	19	16.5	26	20	13.5				
			<b>RTA 00</b>											
 <p><b>Counter Stool</b> Closed Wood Back COM Yardage: 1 Freight Class: 250 Product Weight (lbs.): 32 Cubic Feet Per Carton: 13</p>	Does not stack.	<b>8624S26</b>	\$1539	\$1575	\$1599	\$1633	\$1684	\$1707	\$1756	\$1828	\$1884	\$1948	\$2075	\$2215
			<b>OVERALL DIMENSIONS</b>			<b>SEAT DIMENSIONS</b>			<b>BACK DIMENSIONS</b>					
			<b>W</b>	<b>D</b>	<b>H</b>	<b>W</b>	<b>D</b>	<b>H</b>	<b>W</b>	<b>H</b>				
			20	21	38.5	19	16.5	26	20	13.5				
			<b>RTA 00</b>											
 <p><b>Barstool</b> Open Wood Back COM Yardage: 1 Freight Class: 250 Product Weight (lbs.): 38 Cubic Feet Per Carton: 14</p>	Does not stack.	<b>8621S30</b>	\$1621	\$1732	\$1751	\$1785	\$1829	\$1842	\$1881	\$1957	\$1994	\$2061	\$2156	\$2272
			<b>OVERALL DIMENSIONS</b>			<b>SEAT DIMENSIONS</b>			<b>BACK DIMENSIONS</b>					
			<b>W</b>	<b>D</b>	<b>H</b>	<b>W</b>	<b>D</b>	<b>H</b>	<b>W</b>	<b>H</b>				
			20	21	42.5	19	16.5	30	20	13.5				
			<b>RTA 00</b>											
 <p><b>Barstool</b> Closed Upholstered Wood Back COM Yardage: 2.25 Freight Class: 250 Product Weight (lbs.): 38 Cubic Feet Per Carton: 14</p>	Does not stack.	<b>8622S30</b>	\$1683	\$1771	\$1836	\$1938	\$2080	\$2149	\$2277	\$2485	\$2645	\$2822	\$3186	\$3575
			<b>OVERALL DIMENSIONS</b>			<b>SEAT DIMENSIONS</b>			<b>BACK DIMENSIONS</b>					
			<b>W</b>	<b>D</b>	<b>H</b>	<b>W</b>	<b>D</b>	<b>H</b>	<b>W</b>	<b>H</b>				
			20	21	42.5	19	16.5	30	20	13.5				
			<b>RTA 00</b>											
 <p><b>Barstool</b> Closed Wood Back COM Yardage: 1 Freight Class: 250 Product Weight (lbs.): 38 Cubic Feet Per Carton: 14</p>	Does not stack.	<b>8624S30</b>	\$1621	\$1732	\$1751	\$1785	\$1829	\$1842	\$1881	\$1957	\$1994	\$2061	\$2156	\$2272
			<b>OVERALL DIMENSIONS</b>			<b>SEAT DIMENSIONS</b>			<b>BACK DIMENSIONS</b>					
			<b>W</b>	<b>D</b>	<b>H</b>	<b>W</b>	<b>D</b>	<b>H</b>	<b>W</b>	<b>H</b>				
			20	21	42.5	19	16.5	30	20	13.5				
			<b>RTA 00</b>											



model 8335T





model 8336T

**STANDARD FEATURES**

- Mayne offers classic styling and value in a finely crafted wood framed side chair.
- Frame construction is beechwood.
- Legs are equipped with White non-marking polypropylene glides Suitable for both carpet and hard surface flooring.
- Offered in two back styles; Upholstered back or Vertical wood slat.
- Check textile availability prior to specifying upholstery material.
- Does not stack.

**MULTI-PURPOSE**  
**OPTIONAL FEATURES**

- Wood frames available in Absolute (**AAM**), Black (**BKM**), Cherry (**ACM**), Espresso Cafe (**ECM**), English Oak (**EOM**), Fruitwood (**TFM**), Gray (**HGM**), Honey (**AHM**), Mahogany (**TMM**), Maple (**AVM**), Medium Walnut (**MWWM**), Natural Walnut (**NLW**), Night (**ASM**), Noce Biondo (**NBM**), Noce Grigio (**NGM**), Noce Leggero (**NEM**), Noce Medio (**NMM**), Shaker Cherry (**SKM**), Walnut (**TWM**), WC Cream (**WTM**), White (**WHM**) and Winter Cherry (**WCM**). Please Specify..

DESCRIPTION	FEATURES	MODEL #	STANDARD TEXTILE GRADES											
			1	2	3	4	5	6	7	8	9	10	11	12
 <p><b>Upholstered Armchair</b> COM Yardage: 1 Freight Class: 250 Product Weight (lbs.): 27 Cubic Feet Per Carton: 13.25</p>	<p>Does not stack.</p> <p>Ergonomic Features: M, N</p>	<p><b>8335T</b></p> <p><b>RTA 00</b></p>	\$1100	\$1148	\$1184	\$1236	\$1310	\$1337	\$1403	\$1527	\$1587	\$1702	\$1859	\$2054
			<b>OVERALL DIMENSIONS</b>			<b>SEAT DIMENSIONS</b>			<b>BACK DIMENSIONS</b>					
			<b>W</b>	<b>D</b>	<b>H</b>	<b>W</b>	<b>D</b>	<b>H</b>	<b>W</b>	<b>H</b>				
			23	24.5	33	20	18.25	18	17.5	14				
 <p><b>Vertical Wood Slat Armchair</b> COM Yardage: 1 Freight Class: 300 Product Weight (lbs.): 25 Cubic Feet Per Carton: 13.25</p>	<p>Does not stack.</p> <p>Ergonomic Features: M, N</p>	<p><b>8336T</b></p> <p><b>RTA 00</b></p>	\$1139	\$1176	\$1204	\$1245	\$1303	\$1329	\$1384	\$1465	\$1531	\$1601	\$1748	\$1904
			<b>OVERALL DIMENSIONS</b>			<b>SEAT DIMENSIONS</b>			<b>BACK DIMENSIONS</b>					
			<b>W</b>	<b>D</b>	<b>H</b>	<b>W</b>	<b>D</b>	<b>H</b>	<b>W</b>	<b>H</b>				
			23	24.5	33	20	18.25	18	17.5	14				

MODA™



model 6960



model 6961

Also see Moda Stacking Chairs



For Moda stacking chairs, please see 186.

STANDARD FEATURES

- Moda is an upscale, classic looking multi-purpose product, ideal for conference rooms, training, break out and collaboration areas as well as light-use tasking.
- Chairs are molded with a one-piece shell. Available in Night (BLK), Cloud (IVC) or Shadow (SHW).
- Chair frame consists of a Polished Aluminum chassis on four steel legs in a durable Chrome finish.
- Standard with nylon glides (N1), suitable for carpet, rubber or concrete flooring.
- Check textile availability prior to specifying upholstery material.
- Four legged chairs do not stack.

OPTIONAL FEATURES

- All models are available with optional armcaps in Black self-skinned urethane (SSU), or in Black, White or Clear Grey finish hard plastic.
- Model 6961 armcaps can also be upholstered in the matching fabric, vinyl or leather.
- Glides with felt pads (FG) are available for vinyl sheet, cork or laminate flooring, please specify. Add \$40.
- Glides with felt pads (RG) are available for vinyl sheet, hardwood, laminate, stone or ceramic flooring, please specify. Add \$40.
- Adjustable swivel glides (SWG) are available for uneven floors, please specify. No upcharge



OPTION CODES

Please add option codes in the following order:

- **Model number**  
6960 Armchair  
6961 Armchair w/upholstered seat
- **Textile**  
Specify textile code for seat (model 6961 only).
- **Shell color** (no upcharge)  
(BLK) Night  
(IVC) Cloud  
(SHW) Shadow
- **Frame finish**  
(CHM) Chrome. No upcharge.  
(TBL) Black. Add \$92.  
(TTU) Tungsten. Add \$92.  
(BT) Butternut woodgrain. Add \$188.  
(EB) Ebony woodgrain. Add \$188.  
(WU) Walnut woodgrain. Add \$188.
- **Armcaps**  
(NC) No armcaps.  
(SS) Black SSU. Add \$7.  
(GC) Clear Grey hard plastic. Add \$40.  
(H3) Black hard plastic. Add \$40.  
(H4) White hard plastic. Add \$40.  
**Armcaps** (to match woodgrain frame finish only)  
(BT) Butternut woodgrain. Add \$130.  
(EB) Ebony woodgrain. Add \$130.  
(WU) Walnut woodgrain. Add \$130.  
**Armcaps** (upholstered model 6961 only)  
(UP) Matching upholstery. Add \$78.
- **Glide style** (no upcharge)  
(FX) Fixed glide (STD)  
(SWG) Adjustable swivel
- **Glide type**  
(N1) Standard nylon. No upcharge.  
(FG) Felt. Add \$40.  
(RG) Rubber. Add \$40.

EXAMPLE MODA ORDER CODE:

6960	-HD05	-IVC	-CHM	-NC	-FX	-N1
Model #	Textile	Shell	Frame	Armcaps	Glide style	Glide type

DESCRIPTION	FEATURES	MODEL #	STANDARD TEXTILE GRADES														
			1	2	3	4	5	6	7	8	9	10	11	12			
 <p><b>Four-Legged Armchair</b> COM Yardage: N/A Freight Class: 300 Product Weight (lbs.): 16 Cubic Feet Per Carton: 14.5</p>	Polypropylene seat & back.	6960	\$816														
					<b>OVERALL DIMENSIONS</b> W D H			<b>SEAT DIMENSIONS</b> W D H			<b>BACK DIMENSIONS</b> W H						
		25	25	31	20.5	18	15.5	20	16								
					<b>RTA 1</b>			1 per carton									
 <p><b>Four-Legged Armchair</b> COM Yardage: 0.75 Freight Class: 300 Product Weight (lbs.): 17 Cubic Feet Per Carton: 14.5</p>	Upholstered seat/polypropylene back.	6961	\$963	\$1001	\$1030	\$1072	\$1130	\$1159	\$1214	\$1300	\$1367	\$1441	\$1593	\$1756			
					<b>OVERALL DIMENSIONS</b> W D H			<b>SEAT DIMENSIONS</b> W D H			<b>BACK DIMENSIONS</b> W H						
		25	25	31	20.5	18	16	20	15.5								
					<b>RTA 1</b>			1 per carton									

MODA



model 6962



model 6963

Also see Moda Stacking Chairs



For Moda four-legged chairs, please see 185.

STANDARD FEATURES

- Moda is an upscale, classic looking multi-purpose product, ideal for conference rooms, training, break out and collaboration areas as well as light-use tasking.
- Chairs are molded with a one-piece shell. Available in Night (**BLK**), Cloud (**IVC**) or Shadow (**SHW**).
- Chair frame consists of 0.5" diameter solid steel rod available exclusively in a durable Chrome finish. No crossbar to interfere with feet or leg positions.
- Chairs can be ganged together using ganging clamp set 6970.
- Standard with shell-matching nylon glides (**N1**), suitable for carpet, rubber or concrete flooring.
- Check textile availability prior to specifying upholstery material.

OPTIONAL FEATURES



- All models are available with optional armcaps in Black self-skinned urethane (SSU), or in Black, White or Clear Grey finish hard plastic.
- Model 6963 armcaps can also be upholstered in the matching fabric, vinyl or leather.
- Glides with felt pads (**FG**) are available for vinyl sheet, cork or laminate flooring, please specify. Add \$40.
- Glides with felt pads (**RG**) are available for vinyl sheet, hardwood, laminate, stone or ceramic flooring, please specify. Add \$40.



Please add option codes in the following order:

- **Model number**  
**6962** Armchair  
**6963** Armchair w/upholstered seat
- **Textile**  
Specify textile code for seat (model 6963 only).
- **Shell color** (no upcharge)  
**(BLK)** Night  
**(IVC)** Cloud  
**(SHW)** Shadow
- **Armcaps**  
**(NC)** No armcaps.  
**(SS)** Black SSU. Add \$70.  
**(GC)** Clear Grey hard plastic. Add \$93  
**(H3)** Black hard plastic. Add \$40.  
**(H4)** White hard plastic. Add \$40.  
**(UP)** Matching upholstery (upholstered model 6963 only). Add \$78.
- **Glides**  
**(N1)** Standard nylon. No upcharge.  
**(FG)** Felt. Add \$40.  
**(RG)** Rubber. Add \$40.

EXAMPLE MODA ORDER CODE:

6963	-HD05	-IVC	-NC	-N1
Model #	Textile	Shell	Armcaps	Glides

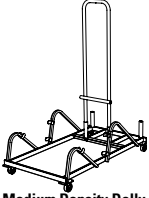
DESCRIPTION	FEATURES	MODEL #	STANDARD TEXTILE GRADES												
			1	2	3	4	5	6	7	8	9	10	11	12	
 <p><b>Armchair</b>                      COM Yardage: N/A                      Freight Class: 300                      Product Weight (lbs.): 16                      Cubic Feet Per Carton: 15.75</p>	Polypropylene seat & back. Stacks 5 high on floor Stacks 14 high on dolly	6962	\$728												
					<b>OVERALL DIMENSIONS</b> W D H			<b>SEAT DIMENSIONS</b> W D H			<b>BACK DIMENSIONS</b> W H				
		25	25	31	20.5	18	17	20	15						
					<b>RTA 1</b>			2 per carton							
 <p><b>Armchair</b>                      COM Yardage: 0.75                      Freight Class: 300                      Product Weight (lbs.): 17                      Cubic Feet Per Carton: 15.75</p>	Upholstered seat/polypropylene back. Stacks 4 high on floor Stacks 8 high on dolly.	6963	\$875	\$913	\$942	\$984	\$1043	\$1071	\$1124	\$1211	\$1277	\$1352	\$1502	\$1666	
					<b>OVERALL DIMENSIONS</b> W D H			<b>SEAT DIMENSIONS</b> W D H			<b>BACK DIMENSIONS</b> W H				
		25	25	31	20.5	18	17.5	20	15						
					<b>RTA 1</b>			2 per carton							

DESCRIPTION	FEATURES	MODEL #	STANDARD TEXTILE GRADES															
			1	2	3	4	5	6	7	8	9	10	11	12				
 <p><b>Medium Density Dolly</b> COM Yardage: N/A Freight Class: 150 Product Weight (lbs.): 43 Cubic Feet Per Carton: 13.25</p>	For use w/ sled base chairs only	<b>6969</b>	\$1088															
		<b>OVERALL DIMENSIONS</b>			<b>SEAT DIMENSIONS</b>			<b>BACK DIMENSIONS</b>										
		W D H			W D H			W H										
		25 63 36.75			- - -			- - -										
		RTA 00			FedEx ups			1 per carton										
 <p><b>Ganging Clamp</b> COM Yardage: N/A Freight Class: 70 Product Weight (lbs.): 0.13 Cubic Feet Per Carton: 0.3</p>	Two per chair recommended. Packed 2 per bag For use w/ sled base chairs only	<b>6970</b>	\$64															
		<b>OVERALL DIMENSIONS</b>			<b>SEAT DIMENSIONS</b>			<b>BACK DIMENSIONS</b>										
		W D H			W D H			W H										
		3.0 1.5 0.75			- - -			- - -										
		RTA 00			FedEx ups			25 per carton										

**POPCORN**



model 6711



model 6712



model 6743TR



Hand Hold Feature



	Chair Stacking Capability		Stool Stacking Capability
	Stacks on floor	Stacks on dolly	Stacks on floor
<b>Armless</b>			
Polypropylene seat	up to 10 high	up to 34 high	up to 8 high
Upholstered seat	up to 8 high	up to 15 high	up to 8 high
<b>With Arms</b>			
Polypropylene seat	up to 10 high	up to 34 high	up to 8 high
Upholstered seat	up to 8 high	up to 15 high	up to 8 high





**STANDARD FEATURES**

- Popcorn a high quality stacking chair that is ideal for multi-purpose stack applications within corporate, government and healthcare facilities.
- Chair frame is constructed of 1/2" diameter solid chrome steel rod available exclusively in a durable chrome finish. There is no crossbar to interfere with feet or leg positions. Chrome frame without glides is standard and suitable for cork, rubberized and carpeted floors.
- Wall saver frame design; the base touches the wall before the upper back to protect the wall from damage.
- Upper back features a cut out hand hold to assist in stacking and transportation.
- Seat and back is a one piece polypropylene shell for strength and ease of cleaning and disinfecting.
- Chairs can be ganged together using ganging clamp set (6626), providing a 2" space between armchair models and 5" space between armless models.
- Upholstered models are equipped with a smooth black shroud underneath the seat to help prevent frame imprints on the lower chair while stacked.
- Task chairs are available with a tablet. Tablet arms are extremely rugged and meets ANSI-BIFMA testing requirements. Tablet hinges up to allow ease of egress. Tablet slides forward and back to accommodate any body size comfortably. Tablet models do not stack.
- Standard tablet (DB) size is 18"D x 14.5"W and is made of Black polymer. Tablets are attached at the left or right (as seated) of the task chair.
- Popcorn beam seating consists of upper seat units (6717, 6719) including mounting brackets and all hardware necessary for attachment to beam.
- For all beam components, tables and a complete list of available upper seat units, see Beam Seating series.
- **Specifications and pricing are for 1 chair.**



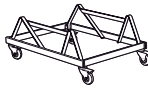
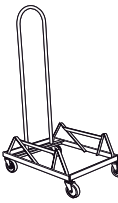

**OPTIONAL FEATURES**



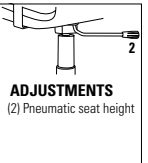

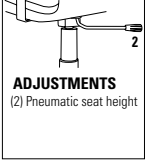
- Polypropylene shell and coordinating arms are available in 14 designer colors. Choose from Buzz Blue (**BZB**), Cactus (**CCT**), Carrot (**CRO**), Cloud (**IVC**), Dijon (**DJN**), Eggplant (**EGP**), Fog (**FOG**), Frost (**FRO**), Ink (**INK**), Latte (**LAB**), Night (**BLK**), Sand (**SND**), Scarlet (**SAR**), and Shadow (**SHW**).
- An optional 18.5"D x 18.5"W high pressure laminate writing tablet is available. The core is hardwood veneer plywood with radiused edge finished in clear lacquer. This writing tablet is offered in the following finishes: Black (**BLK**), Clear Maple (**CMB**), Designer White (**DWT**) and Noce Grigio (**NGL**). Please specify. Add \$68.
- Check textile availability prior to specifying upholstery material.
- Chairs will have additional stitch details when upholstered in vinyl.
- For hard surface flooring casters on Task chairs, please specify (**C9R**). Add \$76.
- A selection of glide options is available. Glides must be chosen to best suit flooring type and site conditions.
- Clear polycarbonate glides (**CG**) are available for carpet, rubber or concrete flooring, please specify. Add \$19
- Glides with felt pads (**FG**) are available for vinyl sheet, cork or laminate flooring, please specify. Add \$36.
- Glides with rubber pads (**RG**) are available for vinyl, hardwood, laminate, stone or ceramic flooring, please specify. Add \$36.
- Glides with stainless steel pads (**SG**) are available for carpet or rubber flooring, specify. Add \$36.

DESCRIPTION	FEATURES	MODEL#	STANDARD TEXTILE GRADES											
			1	2	3	4	5	6	7	8	9	10	11	12
 <b>Armchair</b> COM Yardage: N/A Freight Class: 150 Product Weight (lbs.): 23.5 Cubic Feet Per Carton: 4.44 (4 per carton)	Polypropylene Seat and Back. Stacks 10 high on floor. Stacks 34 high on dolly	<b>6710</b> \$367	<b>OVERALL DIMENSIONS</b>			<b>SEAT DIMENSIONS</b>			<b>BACK DIMENSIONS</b>					
			<b>W</b>	<b>D</b>	<b>H</b>	<b>W</b>	<b>D</b>	<b>H</b>	<b>W</b>	<b>H</b>				
			24.5	23.5	32.5	18	18	16.5	19.5	16				
			<div style="background-color: black; color: white; padding: 2px; display: inline-block;">RTA 00</div>											
 <b>Armless Chair</b> COM Yardage: N/A Freight Class: 150 Product Weight (lbs.): 17.25 Cubic Feet Per Carton: 14.75 (4 per carton)	Polypropylene Seat and Back. Stacks 10 high on floor. Stacks 34 high on dolly	<b>6711</b> \$241	<b>OVERALL DIMENSIONS</b>			<b>SEAT DIMENSIONS</b>			<b>BACK DIMENSIONS</b>					
			<b>W</b>	<b>D</b>	<b>H</b>	<b>W</b>	<b>D</b>	<b>H</b>	<b>W</b>	<b>H</b>				
			20	23.5	32.5	18	18	16.5	19.5	16				
			<div style="background-color: black; color: white; padding: 2px; display: inline-block;">RTA 00</div>											

DESCRIPTION	FEATURES	MODEL#	STANDARD TEXTILE GRADES													
			1	2	3	4	5	6	7	8	9	10	11	12		
 <p><b>Armchair</b> COM Yardage: 0.75 Freight Class: 150 Product Weight (lbs.): 24.5 Cubic Feet Per Carton: 4.81 (4 per carton)</p>	<p>Upholstered seat and Polypropylene Back Stacks 8 high on floor. Stacks 15 high on dolly</p>	<b>6712</b>	\$479	\$514	\$534	\$568	\$615	\$632	\$673	\$752	\$785	\$857	\$955	1078		
		<b>OVERALL DIMENSIONS</b>			<b>SEAT DIMENSIONS</b>			<b>BACK DIMENSIONS</b>								
		<b>W</b>	<b>D</b>	<b>H</b>	<b>W</b>	<b>D</b>	<b>H</b>	<b>W</b>	<b>H</b>							
		24.5	23.5	32.5	18	18	17	19.5	15.5							
			RTA 00		FedEx		ups									
 <p><b>Armless Chair</b> COM Yardage: 0.75 Freight Class: 250 Product Weight (lbs.): 16 Cubic Feet Per Carton: 9 (4 per carton)</p>	<p>Upholstered seat and Polypropylene Back Stacks 8 high on floor. Stacks 15 high on dolly</p>	<b>6713</b>	\$355	\$388	\$408	\$443	\$488	\$506	\$548	\$625	\$660	\$735	\$832	953		
		<b>OVERALL DIMENSIONS</b>			<b>SEAT DIMENSIONS</b>			<b>BACK DIMENSIONS</b>								
		<b>W</b>	<b>D</b>	<b>H</b>	<b>W</b>	<b>D</b>	<b>H</b>	<b>W</b>	<b>H</b>							
		20	23.5	32.5	18	18	17	19.5	15.5							
			RTA 00													
 <p><b>Medium Density Dolly</b> COM Yardage: N/A Freight Class: 250 Product Weight (lbs.): 29 Cubic Feet Per Carton: 9</p>	<p>For upholstered models Can stack chairs up to 15 high Fits through standard 80" door frame</p>	<b>6714</b>	\$815	-	-	-	-	-	-	-	-	-	-	-		
		<b>OVERALL DIMENSIONS</b>			<b>SEAT DIMENSIONS</b>			<b>BACK DIMENSIONS</b>								
		<b>W</b>	<b>D</b>	<b>H</b>	<b>W</b>	<b>D</b>	<b>H</b>	<b>W</b>	<b>H</b>							
		23	31	18.5	-	-	-	-	-							
			RTA 00		FedEx		ups									
 <p><b>High Density Dolly</b> COM Yardage: N/A Freight Class: 125 Product Weight (lbs.): 30 Cubic Feet Per Carton: 5.5</p>	<p>For polypropylene models Can stack chairs up to 34 high Fits through standard 80" door frame</p>	<b>6715</b>	\$815	-	-	-	-	-	-	-	-	-	-	-		
		<b>OVERALL DIMENSIONS</b>			<b>SEAT DIMENSIONS</b>			<b>BACK DIMENSIONS</b>								
		<b>W</b>	<b>D</b>	<b>H</b>	<b>W</b>	<b>D</b>	<b>H</b>	<b>W</b>	<b>H</b>							
		21.37	31.75	51.75	-	-	-	-	-							
			RTA 00		FedEx		ups									
 <p><b>Armless Seat Unit</b> COM Yardage: N/A Freight Class: 150 Product Weight (lbs.): 17 Cubic Feet Per Carton: 6.5 (2 per carton)</p>	<p>Polypropylene Seat and Back. Use with beam.</p>	<b>6717</b>	\$374	-	-	-	-	-	-	-	-	-	-	-		
		<b>OVERALL DIMENSIONS</b>			<b>SEAT DIMENSIONS</b>			<b>BACK DIMENSIONS</b>								
		<b>W</b>	<b>D</b>	<b>H</b>	<b>W</b>	<b>D</b>	<b>H</b>	<b>W</b>	<b>H</b>							
		20	21	18	18	18	-	19.5	16							
			RTA 00													

DESCRIPTION	FEATURES	MODEL#	STANDARD TEXTILE GRADES											
			1	2	3	4	5	6	7	8	9	10	11	12
 <p><b>Armless Seat Unit</b> COM Yardage: 0.75 Freight Class: 150 Product Weight (lbs.): 18 Cubic Feet Per Carton: 6.5 (2 per carton)</p>	<p><b>Popcorn</b> Upholstered Seat and Polypropylene Back. Use with beam.</p>	<p><b>6719</b></p>	\$488	\$524	\$548	\$582	\$633	\$656	\$705	\$777	\$833	\$897	\$1024	\$1164
			<p><b>OVERALL DIMENSIONS</b></p>			<p><b>SEAT DIMENSIONS</b></p>			<p><b>BACK DIMENSIONS</b></p>					
			<b>W</b>	<b>D</b>	<b>H</b>	<b>W</b>	<b>D</b>	<b>H</b>	<b>W</b>	<b>H</b>				
			20	21	18	18	18	-	19.5	16				
			<p><b>RTA 00</b></p>											
 <p><b>Ganging Clamp Set - 2 Clamps</b> COM Yardage: N/A Freight Class: 70 Product Weight (lbs.): 0.3 Cubic Feet Per Carton: 0.01 (1 set per carton)</p>		<p><b>6626</b></p>	\$32	-	-	-	-	-	-	-	-	-	-	-
			<p><b>OVERALL DIMENSIONS</b></p>			<p><b>SEAT DIMENSIONS</b></p>			<p><b>BACK DIMENSIONS</b></p>					
			<b>W</b>	<b>D</b>	<b>H</b>	<b>W</b>	<b>D</b>	<b>H</b>	<b>W</b>	<b>H</b>				
			1	6.5	00.75	-	-	-	-	-				
			<p><b>RTA 00</b></p>											
 <p><b>Armless Task</b> COM Yardage: N/A Freight Class: 250 Product Weight (lbs.): 31 Cubic Feet Per Carton: 14.25</p>	 <p><b>ADJUSTMENTS</b> (2) Pneumatic seat height</p>	<p><b>6741</b></p>	<p>List price</p>											
			<p><b>OVERALL DIMENSIONS</b></p>			<p><b>SEAT DIMENSIONS</b></p>			<p><b>BACK DIMENSIONS</b></p>					
			<b>W</b>	<b>D</b>	<b>H</b>	<b>W</b>	<b>D</b>	<b>H</b>	<b>W</b>	<b>H</b>				
			20	23	30.5	18	18	15.5	19.5	16				
			<p><b>RTA 00</b> 1 per carton</p>											
 <p><b>Armless Task</b> COM Yardage: 0.75 Freight Class: 250 Product Weight (lbs.): 33 Cubic Feet Per Carton: 14.25</p>	 <p><b>ADJUSTMENTS</b> (2) Pneumatic seat height</p>	<p><b>6743</b></p>	\$651	\$686	\$707	\$745	\$796	\$817	\$865	\$940	\$993	\$1059	\$1187	\$1327
			<p><b>OVERALL DIMENSIONS</b></p>			<p><b>SEAT DIMENSIONS</b></p>			<p><b>BACK DIMENSIONS</b></p>					
			<b>W</b>	<b>D</b>	<b>H</b>	<b>W</b>	<b>D</b>	<b>H</b>	<b>W</b>	<b>H</b>				
			20	23	30.5	18	18	16	19.5	16				
			<p><b>RTA 00</b> 1 per carton</p>											

DESCRIPTION	FEATURES	MODEL#	STANDARD TEXTILE GRADES													
			1	2	3	4	5	6	7	8	9	10	11	12		
 <p><b>Armless Task w/Tablet</b> COM Yardage: 0.75 Freight Class: 250 Product Weight (lbs.): 42 Cubic Feet Per Carton: 15.75</p>	 <p><b>ADJUSTMENTS</b> (2) Pneumatic seat height</p> <p>Upholstered seat/polypropylene back.</p> <p>Ergonomic features: C</p> <p><b>Specify (L) left or (R) right tablet.</b></p>	6743TR	1008	1039	1060	1093	1141	1163	1205	1274	1324	1385	1502	1631		
		<b>OVERALL DIMENSIONS</b>			<b>SEAT DIMENSIONS</b>			<b>BACK DIMENSIONS</b>								
		<b>W</b>	<b>D</b>	<b>H</b>	<b>W</b>	<b>D</b>	<b>H</b>	<b>W</b>	<b>H</b>							
		24.75	26	30.5	18	18	16	19.5	16							
											<b>RTA 00</b> 1 per carton					
 <p><b>Barstool w/Arms</b> COM Yardage: N/A Freight Class: 250 Product Weight (lbs.): 29 Cubic Feet Per Carton: 21.50 (2 per carton)</p>	<p>Polypropylene Seat and Back. Stacks 8 high on floor.</p>	6710BS	\$592													
		<b>OVERALL DIMENSIONS</b>			<b>SEAT DIMENSIONS</b>			<b>BACK DIMENSIONS</b>								
		<b>W</b>	<b>D</b>	<b>H</b>	<b>W</b>	<b>D</b>	<b>H</b>	<b>W</b>	<b>H</b>							
		24.5	25.5	44.5	18	18	29	19.5	16							
											<b>RTA 00</b>					
 <p><b>Counter stool w/Arms</b> COM Yardage: N/A Freight Class: 250 Product Weight (lbs.): 24 Cubic Feet Per Carton: 21.50 (2 per carton)</p>	<p>Polypropylene Seat and Back. Stacks 8 high on floor.</p>	6710CS	\$592													
		<b>OVERALL DIMENSIONS</b>			<b>SEAT DIMENSIONS</b>			<b>BACK DIMENSIONS</b>								
		<b>W</b>	<b>D</b>	<b>H</b>	<b>W</b>	<b>D</b>	<b>H</b>	<b>W</b>	<b>H</b>							
		24.5	25.5	40.5	18	18	24	19.5	16							
											<b>RTA 00</b>					
 <p><b>Armless Barstool</b> COM Yardage: N/A Freight Class: 250 Product Weight (lbs.): 27 Cubic Feet Per Carton: 17.50 (2 per carton)</p>	<p>Polypropylene Seat and Back. Stacks 8 high on floor.</p>	6711BS	\$428													
		<b>OVERALL DIMENSIONS</b>			<b>SEAT DIMENSIONS</b>			<b>BACK DIMENSIONS</b>								
		<b>W</b>	<b>D</b>	<b>H</b>	<b>W</b>	<b>D</b>	<b>H</b>	<b>W</b>	<b>H</b>							
		20	25.5	44.5	18	18	29	19.5	16							
											<b>RTA 00</b>					
 <p><b>Armless Counter Stool</b> COM Yardage: N/A Freight Class: 250 Product Weight (lbs.): 22 Cubic Feet Per Carton: 17.50 (2 per carton)</p>	<p>Polypropylene Seat and Back. Stacks 8 high on floor.</p>	6711CS	\$428													
		<b>OVERALL DIMENSIONS</b>			<b>SEAT DIMENSIONS</b>			<b>BACK DIMENSIONS</b>								
		<b>W</b>	<b>D</b>	<b>H</b>	<b>W</b>	<b>D</b>	<b>H</b>	<b>W</b>	<b>H</b>							
		20	25.5	40.5	18	18	24	19.5	16							
											<b>RTA 00</b>					

DESCRIPTION	FEATURES	MODEL#	STANDARD TEXTILE GRADES											
			1	2	3	4	5	6	7	8	9	10	11	12
 <p><b>Barstool w/Arms</b> COM Yardage: 0.75 Freight Class: 150 Product Weight (lbs.): 24.5 Cubic Feet Per Carton: 4.81 (2 per carton)</p>	Upholstered seat and Polypropylene Back Stacks 8 high on floor.	<b>6712BS</b>	\$712	\$747	\$769	\$805	\$855	\$879	\$928	\$1001	\$1054	\$1120	\$1247	\$1386
			<b>OVERALL DIMENSIONS</b>			<b>SEAT DIMENSIONS</b>			<b>BACK DIMENSIONS</b>					
			<b>W</b>	<b>D</b>	<b>H</b>	<b>W</b>	<b>D</b>	<b>H</b>	<b>W</b>	<b>H</b>				
			24.5	25.5	44.5	18	18	29.5	19.5	16				
			<b>RTA 00</b>											
 <p><b>Counter Stool w/Arms</b> COM Yardage: 0.75 Freight Class: 150 Product Weight (lbs.): 24.5 Cubic Feet Per Carton: 4.81 (2 per carton)</p>	Upholstered seat and Polypropylene Back Stacks 8 high on floor.	<b>6712CS</b>	\$712	\$748	\$772	\$806	\$857	\$880	\$929	\$1001	\$1057	\$1121	\$1248	\$1388
			<b>OVERALL DIMENSIONS</b>			<b>SEAT DIMENSIONS</b>			<b>BACK DIMENSIONS</b>					
			<b>W</b>	<b>D</b>	<b>H</b>	<b>W</b>	<b>D</b>	<b>H</b>	<b>W</b>	<b>H</b>				
			24.5	25.5	18	18	18	24.5	19.5	16				
			<b>RTA 00</b>											
 <p><b>Armless Barstool</b> COM Yardage: 0.75 Freight Class: 250 Product Weight (lbs.): 29 Cubic Feet Per Carton: 9 (2 per carton)</p>	Upholstered seat and Polypropylene Back Stacks 8 high on floor.	<b>6713BS</b>	\$582	\$617	\$639	\$675	\$725	\$749	\$798	\$871	\$924	\$990	\$1117	\$1256
			<b>OVERALL DIMENSIONS</b>			<b>SEAT DIMENSIONS</b>			<b>BACK DIMENSIONS</b>					
			<b>W</b>	<b>D</b>	<b>H</b>	<b>W</b>	<b>D</b>	<b>H</b>	<b>W</b>	<b>H</b>				
			20	25.5	18	18	18	29.5	19.5	16				
			<b>RTA 00</b>											
 <p><b>Armless Counter Stool</b> COM Yardage: 0.75 Freight Class: 250 Product Weight (lbs.): 29 Cubic Feet Per Carton: 9 (2 per carton)</p>	Upholstered seat and Polypropylene Back Stacks 8 high on floor.	<b>6713CS</b>	\$582	\$617	\$639	\$675	\$725	\$749	\$798	\$871	\$924	\$990	\$1117	\$1256
			<b>OVERALL DIMENSIONS</b>			<b>SEAT DIMENSIONS</b>			<b>BACK DIMENSIONS</b>					
			<b>W</b>	<b>D</b>	<b>H</b>	<b>W</b>	<b>D</b>	<b>H</b>	<b>W</b>	<b>H</b>				
			20	25.5	18	18	18	24.5	19.5	16				
			<b>RTA 00</b>											

REBOUND™



Model R5APUG  
Armchair, Upholstered Seat



Model R5CSAPUG  
Counter Stool, Arms, Upholstered Seat

	Chair Stacking Capability		Stools Stacking Capability
	stacks on floor	stacks on dolly (RDOL)	stacks on floor only
<b>Four-Leg (Glide/Caster) + Sled Base Models</b>			
Polypropylene	up to 5 high	up to 10 high	up to 5 high
Upholstered seat	up to 5 high	up to 10 high	up to 5 high

EXAMPLE REBOUND ORDER CODE:

R5APUG	CCT	BL20	CHM	NM
Model #	Back, seat and arm Textile	Seat Textile	Frame Finish	Glide Type

STANDARD FEATURES





- Designed by Alessandro Piretti, the Rebound series has a flexible back designed for ultimate comfort in multi-purpose seating. The series includes: four-leg and sled base chairs and four leg counter and bar stools.
- Features a cleanable, easy to wipe down, all polypropylene shell design in a wide variety of finishes.
- Models available with all polypropylene back/seat or polypropylene back/upholstered seat.
- Models available with or without arms. Arms match selected shell finish.
- Four leg and sled base models have tubular steel bases available in a wide variety of painted and metallic finishes.
- Chairs with four legs are available with glides (G suffix models) and casters (C suffix models). Select from a variety of glide types to best suit the flooring type and site conditions. See upcharges.
- Sled base chairs are available with either Black or White nylon glides.
- Four leg (glide and caster) chairs and sled base chairs are stackable up to 5 high on floor and 10 high on dolly (RDOL). Models with upholstered seats stack 5 high on floor and 10 high on the dolly. Counter and Bar stools stack up to 5 high on floor.
- All models are equipped with a color coordinated under seat shroud.
- Due to the flex back design, it is recommended the chair be positioned away from wall for use.
- Upholstery seat options: fabric, coated materials (such as vinyl) or leather
- The series is designed for use across a range of facilities and is covered under Global's limited lifetime warranty for single-shift use. Specify from approved textiles.
- Active weight capacity is 300 lbs. for four leg seating with casters, 400 lbs. for seating on glides.





OPTIONAL FEATURES





Please add option codes in the following order:



- **Model number**  
R5\_ \_ \_ (G or C) Four-legged chair, glides or casters  
R6\_ \_ \_ Sled Base  
R5BS\_ \_ \_ Bar stool  
R5CS\_ \_ \_ Counter stool  
RDOL Stacking Dolly
  - **Back seat and arm finish**  
(BZB) Buzz Blue (CCT) Cactus  
(CRO) Carrot (IVC) Cloud  
(DJN) Dijon (EGP) Eggplant  
(FOG) Fog (FRO) Frost  
(INK) Ink (LAB) Latte  
(BLK) Night (SND) Sand  
(SAR) Scarlet (SHW) Shadow
  - **Seat textile** (PU models)  
Specify textile
  - **Frame finish**  
Painted Finishes:  
Black (TBL) Buzz Blue (TBZ)  
Cactus (TCC) Carrot (TCR)  
Cloud (TIV) Designer White (TDW)  
Dijon (TDJ) Eggplant (TEG)  
Fog (TFO) Frost (TFR)  
Ink (TIN) Kalua (TKA)  
Latte (TLA) Mocha (TMO)  
Nevada (TNE) Sand (TSN)  
Scarlet (TSR) Shadow (TSH)  
Toast (TOA) Tungsten (TTU)
- Metallics:  
See upcharge chart for applicable upcharges.  
(CHM) Chrome (BCH) Brushed Chrome  
**Glide type** (chairs and stools with four legs)  
(BG) Black nylon glide for most floor surfaces.  
(NM) White nylon Glide non-marking glide for most floor surfaces  
(FG) Felt glide for most hard floor surfaces. Add \$36.  
(RG) Rubber non-slip glide for most hard floor surfaces. Add \$36.  
(SG) Steel cushioned glide for carpeted surfaces. Add \$36
- **Glide type** (sled base models)  
(GL) Black nylon glide for most floor surfaces.  
(NM) White nylon glide for most floor surfaces.
  - **Caster type** (caster chair models)  
(DC) 2" Caster for Carpeted Surfaces  
(RC) 2" Caster for Most Hard Floor Surfaces. Add 53.

PLATED FRAME FINISH UPCHARGES		
	Chrome (CHM)	Brushed Chrome (BCH)
4 legged chair	\$42	\$147
Sled base	\$53	\$180
Stools	\$75	\$244

DESCRIPTION	MODEL#/ FEATURES	STANDARD TEXTILE GRADES											
		1/COM	2	3	4	5	6	7	8	9	10	11	12
	<b>R5APPG</b> Glides	590											
	<b>R5APPC</b> Casters	649											
		<b>OVERALL DIMENSIONS</b>			<b>SEAT DIMENSIONS</b>			<b>BACK DIMENSIONS</b>					
		<b>W</b>	<b>D</b>	<b>H</b>	<b>W</b>	<b>D</b>	<b>H</b>	<b>W</b>	<b>H</b>				
		26.25	20.5	32.75	19.25	17.75	17.5	18.5	15.25				
<b>Armchair, Polypropylene Seat</b> COM Yardage: N/A Freight Class: 300 Product Weight (lbs.): 13.5 Cubic Feet Per Carton: 7.63		Active weight with casters 300 lbs. Active weight with glides 400 lbs. Stacks 5 high on floor. Stacks 10 high on dolly.											
		<b>RTA 00</b> 2 per carton (pricing and specifications are for one seat unit)											
	<b>R5APUG</b> Glides	764	790	810	839	881	897	933	989	1031	1078	1173	1274
	<b>R5APUC</b> Casters	823	849	869	898	940	956	992	1048	1090	1137	1232	1333
		<b>OVERALL DIMENSIONS</b>			<b>SEAT DIMENSIONS</b>			<b>BACK DIMENSIONS</b>					
		<b>W</b>	<b>D</b>	<b>H</b>	<b>W</b>	<b>D</b>	<b>H</b>	<b>W</b>	<b>H</b>				
		26.25	20.5	32.75	19.25	17.75	18.5	18.5	15.25				
<b>Armchair, Upholstered Seat</b> COM Yardage: 0.75 Freight Class: 300 Product Weight (lbs.): 14.5 Cubic Feet Per Carton: 7.63		Active weight with casters 300 lbs. Active weight with glides 400 lbs. Stacks 5 high on floor. Stacks 10 high on dolly.											
		<b>RTA 00</b> 2 per carton (pricing and specifications are for one seat unit)											
	<b>R5NPPG</b> Glides	473											
	<b>R5NPPC</b> Casters	532											
		<b>OVERALL DIMENSIONS</b>			<b>SEAT DIMENSIONS</b>			<b>BACK DIMENSIONS</b>					
		<b>W</b>	<b>D</b>	<b>H</b>	<b>W</b>	<b>D</b>	<b>H</b>	<b>W</b>	<b>H</b>				
		22	20.5	32.75	19.25	17.75	17.5	18.5	15.25				
<b>Armless Chair, Polypropylene Seat</b> COM Yardage: N/A Freight Class: 300 Product Weight (lbs.): 12.25 Cubic Feet Per Carton: 6.38		Active weight with casters 300 lbs. Active weight with glides 400 lbs. Stacks 5 high on floor. Stacks 10 high on dolly.											
		<b>RTA 00</b> 2 per carton (pricing and specifications are for one seat unit)											
	<b>R5NPUG</b> Glides	647	673	693	722	764	780	816	872	914	961	1056	1157
	<b>R5NPUC</b> Casters	706	732	752	781	823	839	875	931	973	1020	1115	1216
		<b>OVERALL DIMENSIONS</b>			<b>SEAT DIMENSIONS</b>			<b>BACK DIMENSIONS</b>					
		<b>W</b>	<b>D</b>	<b>H</b>	<b>W</b>	<b>D</b>	<b>H</b>	<b>W</b>	<b>H</b>				
		22	20.5	32.75	19.25	17.75	18.5	18.5	14.25				
<b>Armless Chair, Upholstered Seat</b> COM Yardage: 0.75 Freight Class: 300 Product Weight (lbs.): 12.25 Cubic Feet Per Carton: 6.38		Active weight with casters 300 lbs. Active weight with glides 400 lbs. Stacks 5 high on floor. Stacks 10 high on dolly.											
		<b>RTA 00</b> 2 per carton (pricing and specifications are for one seat unit)											
	<b>R6APP</b>	624											
		<b>OVERALL DIMENSIONS</b>			<b>SEAT DIMENSIONS</b>			<b>BACK DIMENSIONS</b>					
		<b>W</b>	<b>D</b>	<b>H</b>	<b>W</b>	<b>D</b>	<b>H</b>	<b>W</b>	<b>H</b>				
		26.25	21.5	32.75	19.25	17.75	17.5	18.5	15.25				
<b>Armchair, Polypropylene Seat, Sled Base</b> COM Yardage: N/A Freight Class: 300 Product Weight (lbs.): 13.75 Cubic Feet Per Carton: 7.63		Active weight 400 lbs. Stacks 5 high on floor. Stacks 10 high on dolly.											
		<b>RTA 00</b> 2 per carton (pricing and specifications are for one seat unit)											

DESCRIPTION	MODEL#/ FEATURES	STANDARD TEXTILE GRADES											
		1/COM	2	3	4	5	6	7	8	9	10	11	12
 <p><b>Armchair, Upholstered Seat, Sled Base</b> COM Yardage: 0.75 Freight Class: 300 Product Weight (lbs.): 14.75 Cubic Feet Per Carton: 7.63</p>	<p><b>R6APU</b></p> <p>Active weight 400 lbs. Stacks 5 high on floor. Stacks 10 high on dolly.</p>	797	823	843	872	914	930	966	1022	1064	1111	1206	1307
		<b>OVERALL DIMENSIONS</b>			<b>SEAT DIMENSIONS</b>			<b>BACK DIMENSIONS</b>					
		<b>W</b>	<b>D</b>	<b>H</b>	<b>W</b>	<b>D</b>	<b>H</b>	<b>W</b>	<b>H</b>				
		26.25	21.5	32.75	19.25	17.75	18.5	18.5	14.25				
		<p><b>RTA 00</b> 2 per carton (pricing and specifications are for one seat unit)</p>											
 <p><b>Armless Chair, Polypropylene Seat, Sled Base</b> COM Yardage: N/A Freight Class: 300 Product Weight (lbs.): 12.25 Cubic Feet Per Carton: 6.38</p>	<p><b>R6NPP</b></p> <p>Active weight 400 lbs. Stacks 5 high on floor. Stacks 10 high on dolly.</p>	507											
		<b>OVERALL DIMENSIONS</b>			<b>SEAT DIMENSIONS</b>			<b>BACK DIMENSIONS</b>					
		<b>W</b>	<b>D</b>	<b>H</b>	<b>W</b>	<b>D</b>	<b>H</b>	<b>W</b>	<b>H</b>				
		22	21.5	32.75	19.25	17.75	17.5	18.5	15.25				
		<p><b>RTA 00</b> 2 per carton (pricing and specifications are for one seat unit)</p>											
 <p><b>Armless Chair, Upholstered Seat, Sled Base</b> COM Yardage: 0.75 Freight Class: 250 Product Weight (lbs.): 13.25 Cubic Feet Per Carton: 6.38</p>	<p><b>R6NPU</b></p> <p>Active weight 400 lbs. Stacks 5 high on floor. Stacks 10 high on dolly.</p>	680	706	726	755	797	813	849	905	947	994	1089	1190
		<b>OVERALL DIMENSIONS</b>			<b>SEAT DIMENSIONS</b>			<b>BACK DIMENSIONS</b>					
		<b>W</b>	<b>D</b>	<b>H</b>	<b>W</b>	<b>D</b>	<b>H</b>	<b>W</b>	<b>H</b>				
		22	21.5	32.75	19.25	17.75	18.5	18.5	14.25				
		<p><b>RTA 00</b> 2 per carton (pricing and specifications are for one seat unit)</p>											
 <p><b>Counter Stool, Arms, Polypropylene Seat</b> COM Yardage: N/A Freight Class: 300 Product Weight (lbs.): 16 Cubic Feet Per Carton: 8.88</p>	<p><b>R5CSAPP</b></p> <p>Polypropylene seat &amp; back.</p> <p>Active weight 400 lbs. Stacks 5 high on floor.</p>	695											
		<b>OVERALL DIMENSIONS</b>			<b>SEAT DIMENSIONS</b>			<b>BACK DIMENSIONS</b>					
		<b>W</b>	<b>D</b>	<b>H</b>	<b>W</b>	<b>D</b>	<b>H</b>	<b>W</b>	<b>H</b>				
		26.25	21.75	38.25	19.25	17.75	23.75	18.5	15.25				
		<p><b>RTA 00</b> 2 per carton (pricing and specifications are for one seat unit)</p>											
 <p><b>Counter Stool, Arms, Upholstered Seat</b> COM Yardage: 0.75 Freight Class: 300 Product Weight (lbs.): 17 Cubic Feet Per Carton: 8.88</p>	<p><b>R5CSAPU</b></p> <p>Active weight 400 lbs. Stacks 5 high on floor.</p>	868	894	914	943	985	1001	1037	1093	1135	1182	1277	1378
		<b>OVERALL DIMENSIONS</b>			<b>SEAT DIMENSIONS</b>			<b>BACK DIMENSIONS</b>					
		<b>W</b>	<b>D</b>	<b>H</b>	<b>W</b>	<b>D</b>	<b>H</b>	<b>W</b>	<b>H</b>				
		26.25	21.75	38.25	19.25	17.75	23.75	18.5	15.25				
		<p><b>RTA 00</b> 2 per carton (pricing and specifications are for one seat unit)</p>											

DESCRIPTION	MODEL#/ FEATURES	STANDARD TEXTILE GRADES											
		1/COM	2	3	4	5	6	7	8	9	10	11	12
 <p><b>Armless Counter Stool, Polypropylene Seat</b> COM Yardage: N/A Freight Class: 300 Product Weight (lbs.): 14.5 Cubic Feet Per Carton: 8.88</p>	<b>R5CSNPP</b>  Polypropylene seat & back.  Active weight 400 lbs. Stacks 5 high on floor.	578											
		<b>OVERALL DIMENSIONS</b>			<b>SEAT DIMENSIONS</b>			<b>BACK DIMENSIONS</b>					
		<b>W</b>	<b>D</b>	<b>H</b>	<b>W</b>	<b>D</b>	<b>H</b>	<b>W</b>	<b>H</b>				
		22	21.75	38.25	19.25	17.75	23.75	18.5	15.25				
			<b>RTA 00</b>	2 per carton (pricing and specifications are for one seat unit)									
 <p><b>Armless Counter Stool, Upholstered Seat</b> COM Yardage: 0.75 Freight Class: 300 Product Weight (lbs.): 15.5 Cubic Feet Per Carton: 8.88</p>	<b>R5CSNPU</b>  Active weight 400 lbs. Stacks 5 high on floor.	752	778	798	827	869	885	921	977	1019	1066	1161	1262
		<b>OVERALL DIMENSIONS</b>			<b>SEAT DIMENSIONS</b>			<b>BACK DIMENSIONS</b>					
		<b>W</b>	<b>D</b>	<b>H</b>	<b>W</b>	<b>D</b>	<b>H</b>	<b>W</b>	<b>H</b>				
		22	21.75	38.25	19.25	17.75	24.75	18.5	14.25				
			<b>RTA 00</b>	2 per carton (pricing and specifications are for one seat unit)									
 <p><b>Bar Stool, Arms, Polypropylene Seat</b> COM Yardage: N/A Freight Class: 300 Product Weight (lbs.): 16.75 Cubic Feet Per Carton: 9.75</p>	<b>R5BSAPP</b>  Polypropylene seat & back.  Active weight 400 lbs. Stacks 5 high on floor.	708											
		<b>OVERALL DIMENSIONS</b>			<b>SEAT DIMENSIONS</b>			<b>BACK DIMENSIONS</b>					
		<b>W</b>	<b>D</b>	<b>H</b>	<b>W</b>	<b>D</b>	<b>H</b>	<b>W</b>	<b>H</b>				
		26.25	21.75	43.25	19.25	17.75	28.75	18.5	15.25				
			<b>RTA 00</b>	2 per carton (pricing and specifications are for one seat unit)									
 <p><b>Bar Stool, Arms, Upholstered Seat</b> COM Yardage: 0.75 Freight Class: 300 Product Weight (lbs.): 17.75 Cubic Feet Per Carton: 9.75</p>	<b>R5BSAPU</b>  Active weight 400 lbs. Stacks 5 high on floor.	882	908	928	957	999	1015	1051	1107	1149	1196	1291	1392
		<b>OVERALL DIMENSIONS</b>			<b>SEAT DIMENSIONS</b>			<b>BACK DIMENSIONS</b>					
		<b>W</b>	<b>D</b>	<b>H</b>	<b>W</b>	<b>D</b>	<b>H</b>	<b>W</b>	<b>H</b>				
		26.25	21.75	43.25	19.25	17.75	29.75	18.5	14.25				
			<b>RTA 00</b>	2 per carton (pricing and specifications are for one seat unit)									
 <p><b>Armless Bar Stool, Polypropylene Seat</b> COM Yardage: N/A Freight Class: 300 Product Weight (lbs.): 14.5 Cubic Feet Per Carton: 8.25</p>	<b>R5BSNPP</b>  Polypropylene seat & back.  Active weight 400 lbs. Stacks 5 high on floor.	591											
		<b>OVERALL DIMENSIONS</b>			<b>SEAT DIMENSIONS</b>			<b>BACK DIMENSIONS</b>					
		<b>W</b>	<b>D</b>	<b>H</b>	<b>W</b>	<b>D</b>	<b>H</b>	<b>W</b>	<b>H</b>				
		26.25	21.75	43.25	19.25	17.75	28.75	18.5	15.25				
			<b>RTA 00</b>	2 per carton (pricing and specifications are for one seat unit)									

DESCRIPTION	MODEL#/ FEATURES	STANDARD TEXTILE GRADES											
		1/COM	2	3	4	5	6	7	8	9	10	11	12
 <p><b>Armless Bar Stool, Upholstered Seat</b>                      COM Yardage: 0.75                      Freight Class: 300                      Product Weight (lbs.): 15.5                      Cubic Feet Per Carton: 8.25</p>	<p><b>R5BSNPU</b></p> <p>Active weight 400 lbs.                      Stacks 5 high on floor.</p>	765	791	811	840	882	898	934	990	1032	1079	1174	1275
		<b>OVERALL DIMENSIONS</b>			<b>SEAT DIMENSIONS</b>			<b>BACK DIMENSIONS</b>					
		<b>W</b>	<b>D</b>	<b>H</b>	<b>W</b>	<b>D</b>	<b>H</b>	<b>W</b>	<b>H</b>				
		26.25	21.75	43.25	19.25	17.75	29.75	18.5	14.25				
						<b>RTA 00</b>	2 per carton (pricing and specifications are for one seat unit)						
 <p><b>Stacking Dolly</b>                      COM Yardage: N/A                      Freight Class: 150                      Product Weight (lbs.): 18                      Cubic Feet Per Carton: 4.4</p>	<p><b>RDOL</b></p>	450											
		<b>OVERALL DIMENSIONS</b>											
		<b>W</b>	<b>D</b>	<b>H</b>									
		23.75	21.25	12.25									
						<b>RTA 00</b>							

# R ROMA® NESTER

## ROMA® NESTER



model 1898



model 1899

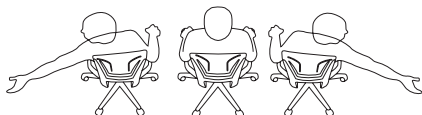

(Models 1890 and 1900)

The Polypropylene Medium Back and the Upholstered Medium Back feature a flexible back construction that provides support, proper spinal alignment and comfort when moving or reaching in a seated position.

# MULTI-PURPOSE

## STANDARD FEATURES



- Flexible, elegant and affordable, Roma offers a family of seating with simple clean lines.
- Please see Work + Task section for additional Roma models.
- Four back versions are available. Choose from Mesh, Flexible Polypropylene or Honeycomb Polypropylene back.
- Models upholstered in leather have a curved seam across the seat.
- Flexible polypropylene back chair features a built in lumbar support designed to move as you move and is available exclusively in black.
- The horizontal nesting chairs are easy to store. Simply flip the seat upward and then roll into nesting position, like a shopping cart.
- When nesting horizontal nesting chairs, each additional chair adds 8" to depth.
- Arms are durable fiberglass reinforced Nylon, fixed height. Armcaps are durable Polyurethane (SSU), soft and warm to the touch.
- C1 casters are standard.





## OPTIONAL FEATURES

- Breathable mesh back is available in six colors. Choose from Autumn Orange (AO), Spring Green (SG) Winter Grey (WG), Midnight Black (MB), Summer Blue (SB), Fall Burgundy (FB).
- Nesting chairs are standard in Black (TBL), Tungsten (TTU) or Shadow (TSH). Optional Chrome (CHM) frame is available. Add \$47.
- Check textile availability prior to specifying upholstery material.



Stitch detail on Leather upholstered seat

DESCRIPTION	FEATURES	MODEL#	STANDARD TEXTILE GRADES													
			1	2	3	4	5	6	7	8	9	10	11	12		
 <p><b>Honeycomb MB - Armless Flip Seat Nesting Chair</b> COM Yardage: 1 Freight Class: 250 Product Weight (lbs.): 29 Cubic Feet Per Carton: 13.75</p>	<p>Nesting chair.</p> <p>Ergonomic Features: M, N</p>	<p><b>1888</b></p> <p><b>RTA 00</b></p>	\$762	\$802	\$832	\$874	\$939	\$959	\$1015	\$1118	\$1170	\$1265	\$1393	\$1559		
			<b>OVERALL DIMENSIONS</b>			<b>SEAT DIMENSIONS</b>			<b>BACK DIMENSIONS</b>							
			<b>W</b>	<b>D</b>	<b>H</b>	<b>W</b>	<b>D</b>	<b>H</b>	<b>W</b>	<b>H</b>						
			24.5	23.5	36	19.5	17	18	18.5	18						
 <p><b>Mesh MB - Armless Flip Seat Nesting Chair</b> COM Yardage: 1 Freight Class: 250 Product Weight (lbs.): 29 Cubic Feet Per Carton: 13.75</p>	<p>Nesting chair.</p> <p>Ergonomic Features: M, N</p>	<p><b>1889</b></p> <p><b>RTA 00</b></p>	\$752	\$793	\$823	\$866	\$930	\$949	\$1007	\$1110	\$1161	\$1258	\$1388	\$1550		
			<b>OVERALL DIMENSIONS</b>			<b>SEAT DIMENSIONS</b>			<b>BACK DIMENSIONS</b>							
			<b>W</b>	<b>D</b>	<b>H</b>	<b>W</b>	<b>D</b>	<b>H</b>	<b>W</b>	<b>H</b>						
			24.5	23.5	36	19.5	17	18	18.5	18						
 <p><b>Polypropylene MB - Armless Flip Seat Nesting Chair</b> COM Yardage: 1 Freight Class: 250 Product Weight (lbs.): 29 Cubic Feet Per Carton: 13.75</p>	<p>Nesting chair.</p> <p>Ergonomic Features: M, N</p>	<p><b>1890</b></p> <p><b>RTA 00</b></p>	\$752	\$793	\$823	\$866	\$930	\$949	\$1007	\$1110	\$1161	\$1258	\$1388	\$1550		
			<b>OVERALL DIMENSIONS</b>			<b>SEAT DIMENSIONS</b>			<b>BACK DIMENSIONS</b>							
			<b>W</b>	<b>D</b>	<b>H</b>	<b>W</b>	<b>D</b>	<b>H</b>	<b>W</b>	<b>H</b>						
			24.5	23.5	36	19.5	17	18	18.5	18						

DESCRIPTION	FEATURES	MODEL#	STANDARD TEXTILE GRADES											
			1	2	3	4	5	6	7	8	9	10	11	12
 <p><b>Honeycomb MB - Flip Seat Nesting Armchair</b>                      COM Yardage: 1                      Freight Class: 250                      Product Weight (lbs.): 30                      Cubic Feet Per Carton: 13.75</p>	Nesting chair.  Ergonomic Features: M, N	<b>1898</b>	\$829	\$870	\$899	\$942	\$1007	\$1026	\$1082	\$1185	\$1237	\$1333	\$1465	\$1626
			<b>OVERALL DIMENSIONS</b>			<b>SEAT DIMENSIONS</b>			<b>BACK DIMENSIONS</b>					
			<b>W</b>	<b>D</b>	<b>H</b>	<b>W</b>	<b>D</b>	<b>H</b>	<b>W</b>	<b>H</b>				
			24.5	23.5	36	19.5	17	18	18.5	18				
			<b>RTA 00</b>											
 <p><b>Mesh MB - Flip Seat Nesting Armchair</b>                      COM Yardage: 1                      Freight Class: 250                      Product Weight (lbs.): 30                      Cubic Feet Per Carton: 13.75</p>	Nesting chair.  Ergonomic Features: M, N	<b>1899</b>	\$816	\$857	\$887	\$930	\$994	\$1013	\$1071	\$1172	\$1225	\$1322	\$1452	\$1614
			<b>OVERALL DIMENSIONS</b>			<b>SEAT DIMENSIONS</b>			<b>BACK DIMENSIONS</b>					
			<b>W</b>	<b>D</b>	<b>H</b>	<b>W</b>	<b>D</b>	<b>H</b>	<b>W</b>	<b>H</b>				
			24.5	23.5	36	19.5	17	18	18.5	18				
			<b>RTA 00</b>											
 <p><b>Polypropylene MB - Flip Seat Nesting Armchair</b>                      COM Yardage: 1                      Freight Class: 250                      Product Weight (lbs.): 30                      Cubic Feet Per Carton: 13.75</p>	Nesting chair.  Ergonomic Features: M, N	<b>1900</b>	\$816	\$857	\$887	\$930	\$994	\$1013	\$1071	\$1172	\$1225	\$1322	\$1452	\$1614
			<b>OVERALL DIMENSIONS</b>			<b>SEAT DIMENSIONS</b>			<b>BACK DIMENSIONS</b>					
			<b>W</b>	<b>D</b>	<b>H</b>	<b>W</b>	<b>D</b>	<b>H</b>	<b>W</b>	<b>H</b>				
			24.5	23.5	36	19.5	17	18	18.5	18				
			<b>RTA 00</b>											
 <p><b>Upholstered Back Pad</b>                      COM Yardage: 1                      Freight Class: 70                      Product Weight (lbs.): 1.5                      Cubic Feet Per Carton: 1.1</p>		<b>1909</b>	\$204	\$247	\$278	\$326	\$392	\$413	\$472	\$579	\$634	\$735	\$872	\$1044
	<b>OVERALL DIMENSIONS</b>			<b>SEAT DIMENSIONS</b>			<b>BACK DIMENSIONS</b>							
	<b>W</b>		<b>D</b>	<b>H</b>	<b>W</b>	<b>D</b>	<b>H</b>	<b>W</b>	<b>H</b>					
	20.5		19	0.38	21	18	18	20	20.5					
			<b>RTA 00</b>											

SAS™



Mid Back Side Chair  
model 8647



Low Back Counter Stool  
model 8648LBS24



Mid Back Counter Stool  
model 8648PS24



Mid Back Bar Stool  
model 8648PS30

STANDARD FEATURES

- The Sas side chair and stools have a single, molded plywood shell of wood veneer.
- Available with two seat options: unupholstered seat and upholstered seat (P).
- Available in three heights: side chair, counter stool and bar stool.
- Sas side chair in mid back height only. Counter and bar height stools available with mid or low backs.
- Dimensions shown are for unupholstered models.
- Unupholstered side chairs can be stacked up to 4 high on the floor and up to 10 high on the available dolly. Unupholstered stools can be stacked up to 4 high on the floor only. Upholstered models cannot be stacked.
- Check textile availability prior to specifying upholstery material.

OPTIONAL FEATURES



Tubular frame is available in the following finishes:

- **Frame finish**  
(TBL) Black  
(TDW) Designer White  
(TTU) Tungsten  
(CHM) Chrome. Add \$125
- **Shell**  
(AAM) Absolute  
(BKM) Black  
(ACM) Cherry  
(EOM) English Oak  
(ECM) Espresso Cafe  
(TFM) Fruitwood  
(HGM) Gray  
(AHM) Honey  
(TMM) Mahogany  
(AVM) Maple  
(MWM) Medium Walnut  
(ASM) Night  
(NBM) Noce Biondo  
(NGM) Noce Grigio  
(NEM) Noce Leggero  
(NMM) Noce Medio  
(SKM) Shaker Cherry  
(TWM) Walnut  
(WTM) WC Cream  
(WHM) White. Add \$114  
(WCM) Winter Cherry  
Please Specify.

EXAMPLE SAS ORDER CODE:

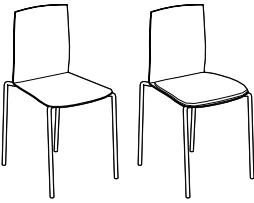
8647P	-HD05	-TBL	-AAM
Model #	Textile	Frame Color	Shell

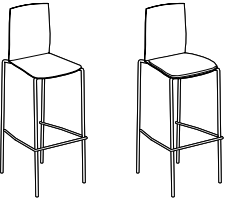
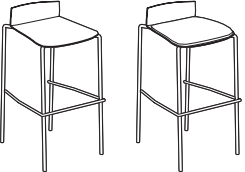
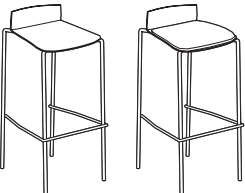
DESCRIPTION	FEATURES	MODEL#	STANDARD TEXTILE GRADES												
			1	2	3	4	5	6	7	8	9	10	11	12	
 <p><b>Mid Back Side Chair</b> COM Yardage: 0.75 Freight Class: 250 Product Weight (lbs.): 12 Cubic Feet Per Carton: 12</p> <p>Stacks 4 high on floor. Stacks 10 high on dolly. Upholstered models do not stack.</p>		<b>8647</b>	\$626	-	-	-	-	-	-	-	-	-	-	-	-
		<b>8647P</b>	\$808	\$839	\$859	\$891	\$934	\$955	\$995	\$1059	\$1107	\$1162	\$1276	\$1395	
		<b>OVERALL DIMENSIONS</b>			<b>SEAT DIMENSIONS</b>			<b>BACK DIMENSIONS</b>							
		W	D	H	W	D	H	W	H						
		18.75	21	33	16	15.5	18	16	15						
		<b>RTA 00</b>		<b>FedEx</b>		<b>ups</b>		2 per carton							
<p><b>Mid Back Counter Stool, 24"</b> COM Yardage: 0.75 Freight Class: 400 Product Weight (lbs.): 16 Cubic Feet Per Carton: 14.5</p> <p>Stacks 4 high on floor only. Upholstered models do not stack.</p>		<b>8648S24</b>	\$861	-	-	-	-	-	-	-	-	-	-	-	
		<b>8648PS24</b>	\$1061	\$1089	\$1110	\$1139	\$1181	\$1199	\$1238	\$1298	\$1343	\$1396	\$1501	\$1614	
		<b>OVERALL DIMENSIONS</b>			<b>SEAT DIMENSIONS</b>			<b>BACK DIMENSIONS</b>							
		W	D	H	W	D	H	W	H						
		19.5	22	39	16	15.5	24	16	15						
		<b>RTA 00</b>		1 per carton											

DESCRIPTION	FEATURES	MODEL#	STANDARD TEXTILE GRADES														
 <p><b>Mid Back Bar Stool, 30"</b> COM Yardage: 0.75 Freight Class: 400 Product Weight (lbs.): 16 Cubic Feet Per Carton: 14.5</p>	Stacks 4 high on floor only. Upholstered models do not stack.		1	2	3	4	5	6	7	8	9	10	11	12			
		<b>8648S30</b>	\$861	-	-	-	-	-	-	-	-	-	-	-	-		
		<b>8648PS30</b>	\$1061	\$1089	\$1110	\$1139	\$1181	\$1199	\$1238	\$1298	\$1343	\$1396	\$1501	\$1614			
		Upholstered Seat															
		<b>OVERALL DIMENSIONS</b>			<b>SEAT DIMENSIONS</b>			<b>BACK DIMENSIONS</b>									
			<b>W</b>	<b>D</b>	<b>H</b>	<b>W</b>	<b>D</b>	<b>H</b>	<b>W</b>	<b>H</b>							
			19.5	22	45	16	15.5	30	16	15							
			<b>RTA 00</b>			1 per carton											
 <p><b>Low Back Counter Stool, 24"</b> COM Yardage: 0.75 Freight Class: 400 Product Weight (lbs.): 16 Cubic Feet Per Carton: 8.25</p>	Stacks 4 high on floor only. Upholstered models do not stack.		1	2	3	4	5	6	7	8	9	10	11	12			
		<b>8648LBNS24</b>	\$924	-	-	-	-	-	-	-	-	-	-	-	-		
		<b>8648LBPS24</b>	\$1061	\$1089	\$1110	\$1139	\$1181	\$1199	\$1238	\$1298	\$1343	\$1396	\$1501	\$1614			
		Upholstered Seat															
		<b>OVERALL DIMENSIONS</b>			<b>SEAT DIMENSIONS</b>			<b>BACK DIMENSIONS</b>									
			<b>W</b>	<b>D</b>	<b>H</b>	<b>W</b>	<b>D</b>	<b>H</b>	<b>W</b>	<b>H</b>							
			19.5	22	26.25	16	15.5	24	16	2.25							
			<b>RTA 00</b>			1 per carton											
 <p><b>Low Back Bar Stool, 30"</b> COM Yardage: 0.75 Freight Class: 400 Product Weight (lbs.): 22 Cubic Feet Per Carton: 17</p>	Stacks 4 high on floor only. Upholstered models do not stack.		1	2	3	4	5	6	7	8	9	10	11	12			
		<b>8648LBNS30</b>	\$924	-	-	-	-	-	-	-	-	-	-	-	-		
		<b>8648LBPS30</b>	\$1061	\$1089	\$1110	\$1139	\$1181	\$1199	\$1238	\$1298	\$1343	\$1396	\$1501	\$1614			
		Upholstered Seat															
		<b>OVERALL DIMENSIONS</b>			<b>SEAT DIMENSIONS</b>			<b>BACK DIMENSIONS</b>									
			<b>W</b>	<b>D</b>	<b>H</b>	<b>W</b>	<b>D</b>	<b>H</b>	<b>W</b>	<b>H</b>							
			19.5	22	32.25	16	15.5	30	16	2.25							
			<b>RTA 00</b>			1 per carton											
 <p><b>Dolly</b> COM Yardage: N/A Freight Class: 250 Product Weight (lbs.): 19 Cubic Feet Per Carton: 10.75</p>			1	2	3	4	5	6	7	8	9	10	11	12			
	<b>8649</b>	\$575	-	-	-	-	-	-	-	-	-	-	-	-			
		<b>OVERALL DIMENSIONS</b>			<b>SEAT DIMENSIONS</b>			<b>BACK DIMENSIONS</b>									
			<b>W</b>	<b>D</b>	<b>H</b>	<b>W</b>	<b>D</b>	<b>H</b>	<b>W</b>	<b>H</b>							
			25.75	28.5	22	-	-	-	-	-							
			<b>RTA 00</b>			FedEx			ups			1 per carton					

SIDERO



model 6901 (BLK)



model 6900 (BLK) Stacked



model 6901TR



model 6900C



model 6905



model 6903

Sidero Chairs Stacking Capability		
Models Types	Stacking on floor	Stacking on dolly
Arm Chairs without Casters	up to 5 high	up to 8 high
Arm Chairs with Casters	up to 3 high	N/A
Armless Chairs without Casters	up to 5 high	up to 8 high
Armless Chairs with Casters	up to 3 high	N/A
Preschool Armless Models	up to 4 high	N/A

STANDARD FEATURES

- Sidero seating has a sculptured appearance, featuring wide curved arms and a round tubular steel frame, with wall safe construction.
- Sidero series includes side chairs (arms and armless), available with casters or with a sled base, counter stools and barstools.
- Arms are 2 1/8 inches wide and full length, offering support to help stabilize users as they sit in or exit chairs.
- The gently curved arms are made from incredibly strong fiberglass reinforced nylon.
- The back of the chair is compound curved to provide comfort and support in multiple seating positions. No visible back attachment hardware. Backs are attached using concealed hardware only.
- The outer back is upholstered in the same material selection as the rest of the chair.
- Chairs are "Wall Safe." Rear legs hit the baseboard first leaving clearance between the back of the chair and the wall, saving both the chair and the wall from damage.
- Legs flair out to the rear to provide additional stability.
- The rugged steel frame is made from round welded steel tubing 7/8" dia.
- Armchairs (four legged and sled base) can be joined together using ganging clamp model 5233. Armless chairs (four legged and sled base) can be joined together using ganging clamp model 6526.
- Equipped with a polypropylene seat shroud that helps stabilize chairs when stacked and avoid frame imprints on upholstered seats.
- Four legged models can be stacked. Stools and sled base models do not stack. Please note when stacking painted frame chairs, paint may scratch.
- Standard glide is a durable Black Polypropylene foot.
- Four Legged chairs with casters are standard with (C82) dual wheel carpet casters.
- Sidero beam seating consists of upper seat units (6930, 6931) including mounting brackets and all hardware necessary for attachment to beam.
- For all beam components, tables and a complete list of available upper seat units, see Beam Seating series.

- Tablet arms are extremely rugged and meet ANSI-BIFMA testing requirements. Tablet hinges up to allow ease of egress. Tablet slides forward and back to accommodate any body size comfortably. Tablet models do not stack.
- Standard tablet (D8) size is 18"D x 14.5"W and is made of Black polymer. Tablets are attached at the left or right (as seated) Tablet arms are not available on stools. Specify (L) left or (R) right tablet. (Example: 6901TL or 6901TR).
- Check textile availability prior to specifying upholstery material.

OPTIONAL FEATURES

- **Frame finish**  
 (TBL) Black (TDW) Designer White  
 (TFO) Fog (TFR) Frost  
 (TIV) Cloud (TKA) Kalua  
 (TLA) Latte (TMO) Mocha  
 (TNE) Nevada (TOA) Toast  
 (TSH) Shadow (TSN) Sand  
 (TTU) Tungsten  
 (CHM) Chrome. Add \$47. Please Specify.
- An optional 18.5"D x 18.5"W high pressure laminate writing tablet is available. The core is hardwood veneer plywood with radiused edge finished in clear lacquer. This writing tablet is offered in the following finishes: Black (BLK), Clear Maple (CMB), Designer White (DWT) and Noce Grigio (NGL). Please specify. Add \$68.
- Glides with felt pads (FG) are available for vinyl sheet, cork or laminate flooring, please specify. Add \$60.
- Glides with rubber pads (RG) are available for vinyl, hardwood, laminate, stone or ceramic flooring, please specify. Add \$64
- For chairs used on hard surface floors PLEASE SPECIFY Opaque (off White) Non-Marking Glides (NM). No upcharge.
- Double cushioned self-leveling glide is optionally available. Please specify (B), add \$36
- For hard surface flooring please Specify (C9R). with rubber covered wheels. Add \$104.
- An optional abrasion-resistant outer back fabric (polyester) is available. Resistant to impact damage. Available in Black only. Add \$25.
- Optional 1 inch additional seat foam. Please specify (3F). Add \$46.

DESCRIPTION FEATURES MODEL# STANDARD TEXTILE GRADES



**Armchair**  
 COM Yardage: 1.25  
 Freight Class: 250  
 Product Weight (lbs.): 29  
 Cubic Feet Per Carton: 13.5

Stacks 5 high on floor.  
 Stacks 8 high on dolly.  
 Tablet models do not stack.

MODEL#	1	2	3	4	5	6	7	8	9	10	11	12
6900	\$621	\$670	\$706	\$759	\$840	\$867	\$935	\$1067	\$1129	\$1248	\$1412	\$1616

OVERALL DIMENSIONS			SEAT DIMENSIONS			BACK DIMENSIONS		
W	D	H	W	D	H	W	H	
25.5	24	33	19.5	18	17.5	19	15.5	

















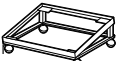





**Armchair w/ Casters**  
 COM Yardage: 1.25  
 Freight Class: 250  
 Product Weight (lbs.): 29  
 Cubic Feet Per Carton: 13.5





Stacks 3 high on floor.  
 Tablet models do not stack.

MODEL#	1	2	3	4	5	6	7	8	9	10	11	12
6900C	\$707	\$756	\$795	\$848	\$927	\$955	\$1023	\$1153	\$1216	\$1334	\$1501	\$1703



OVERALL DIMENSIONS			SEAT DIMENSIONS			BACK DIMENSIONS		
W	D	H	W	D	H	W	H	
25.5	24	33	19.5	18	17.5	19	15.5	



DESCRIPTION	FEATURES	MODEL#	STANDARD TEXTILE GRADES														
			1	2	3	4	5	6	7	8	9	10	11	12			
 <p><b>Side Chair</b> COM Yardage: 1.25 Freight Class: 250 Product Weight (lbs.): 26 Cubic Feet Per Carton: 11.25</p>	<p>Stacks 5 high on floor. Stacks 8 high on dolly. Tablet models do not stack.</p> <p>Available with tablet: Specify (L) left or (R) right tablet.</p>	<b>6901</b>	\$561	\$610	\$646	\$701	\$780	\$808	\$877	\$1007	\$1069	\$1188	\$1354	\$1556			
		<b>6901T</b>	\$901	\$949	\$984	\$1035	\$1110	\$1147	\$1212	\$1319	\$1404	\$1495	\$1684	\$1887			
		<b>OVERALL DIMENSIONS</b>			<b>SEAT DIMENSIONS</b>			<b>BACK DIMENSIONS</b>									
		<b>W</b>	<b>D</b>	<b>H</b>	<b>W</b>	<b>D</b>	<b>H</b>	<b>W</b>	<b>H</b>								
			21	24	33	19.5	18	17.5	19	15.5							
			  														
 <p><b>Side Chair w/ Casters</b> COM Yardage: 1.25 Freight Class: 250 Product Weight (lbs.): 26 Cubic Feet Per Carton: 11.25</p>	<p>Stacks 3 high on floor. Tablet models do not stack.</p> <p>Available with tablet: Specify (L) left or (R) right tablet.</p>	<b>6901C</b>	\$673	\$723	\$762	\$816	\$894	\$924	\$993	\$1120	\$1183	\$1302	\$1468	\$1670			
		<b>6901CT</b>	\$1028	\$1076	\$1111	\$1162	\$1238	\$1273	\$1340	\$1447	\$1530	\$1622	\$1811	\$2014			
		<b>OVERALL DIMENSIONS</b>			<b>SEAT DIMENSIONS</b>			<b>BACK DIMENSIONS</b>									
		<b>W</b>	<b>D</b>	<b>H</b>	<b>W</b>	<b>D</b>	<b>H</b>	<b>W</b>	<b>H</b>								
			21	24	33	19.5	18	17.5	19	15.5							
			  														
 <p><b>Armchair - Sled Base</b> COM Yardage: 1.25 Freight Class: 250 Product Weight (lbs.): 32 Cubic Feet Per Carton: 13.5</p>	<p>Does not stack.</p>	<b>6902</b>	\$776	\$826	\$865	\$919	\$997	\$1024	\$1092	\$1223	\$1286	\$1405	\$1570	\$1773			
		<b>OVERALL DIMENSIONS</b>			<b>SEAT DIMENSIONS</b>			<b>BACK DIMENSIONS</b>									
		<b>W</b>	<b>D</b>	<b>H</b>	<b>W</b>	<b>D</b>	<b>H</b>	<b>W</b>	<b>H</b>								
					25.5	24	33	19.5	18	17.5	19	15.5					
			  														
 <p><b>Side Chair - Sled Base</b> COM Yardage: 1.25 Freight Class: 250 Product Weight (lbs.): 29 Cubic Feet Per Carton: 11.25</p>	<p>Does not stack.</p>	<b>6903</b>	\$720	\$770	\$809	\$861	\$940	\$968	\$1036	\$1166	\$1229	\$1347	\$1514	\$1717			
		<b>OVERALL DIMENSIONS</b>			<b>SEAT DIMENSIONS</b>			<b>BACK DIMENSIONS</b>									
		<b>W</b>	<b>D</b>	<b>H</b>	<b>W</b>	<b>D</b>	<b>H</b>	<b>W</b>	<b>H</b>								
					21	24	33	19.5	18	17.5	19	15.5					
			  														
 <p><b>Dolly</b> COM Yardage: N/A Freight Class: 150 Product Weight (lbs.): 16 Cubic Feet Per Carton: 3.8</p>		<b>2125WS</b>	\$477	-	-	-	-	-	-	-	-	-	-	-			
		<b>OVERALL DIMENSIONS</b>			<b>SEAT DIMENSIONS</b>			<b>BACK DIMENSIONS</b>									
		<b>W</b>	<b>D</b>	<b>H</b>	<b>W</b>	<b>D</b>	<b>H</b>	<b>W</b>	<b>H</b>								
					23.25	24.75	12.25	-	-	-	-	-					
			  														

DESCRIPTION	FEATURES	MODEL#	STANDARD TEXTILE GRADES											
			1	2	3	4	5	6	7	8	9	10	11	12
 <p><b>Counter Stool w/Arms</b> COM Yardage: 1.25 Freight Class: 300 Product Weight (lbs.): 32 Cubic Feet Per Carton: 17.5</p>	Does not stack.	<b>6904</b>	\$839	\$890	\$930	\$982	\$1060	\$1090	\$1159	\$1289	\$1349	\$1470	\$1634	\$1840
			<b>OVERALL DIMENSIONS</b>			<b>SEAT DIMENSIONS</b>			<b>BACK DIMENSIONS</b>					
			<b>W</b>	<b>D</b>	<b>H</b>	<b>W</b>	<b>D</b>	<b>H</b>	<b>W</b>	<b>H</b>				
			25.5	24	40.5	19.5	18	24.5	19	15.5				
			<b>RTA 00</b>											
 <p><b>Armless Counter Stool</b> COM Yardage: 1.25 Freight Class: 300 Product Weight (lbs.): 28 Cubic Feet Per Carton: 14.5</p>	Does not stack.	<b>6905</b>	\$774	\$823	\$862	\$914	\$994	\$1021	\$1088	\$1220	\$1283	\$1401	\$1567	\$1770
			<b>OVERALL DIMENSIONS</b>			<b>SEAT DIMENSIONS</b>			<b>BACK DIMENSIONS</b>					
			<b>W</b>	<b>D</b>	<b>H</b>	<b>W</b>	<b>D</b>	<b>H</b>	<b>W</b>	<b>H</b>				
			21	24	40.5	19.5	18	24.5	19	15.5				
			<b>RTA 00</b>											
 <p><b>Barstool w/Arms</b> COM Yardage: 1.25 Freight Class: 300 Product Weight (lbs.): 34 Cubic Feet Per Carton: 20</p>	Does not stack.	<b>6906</b>	\$877	\$928	\$968	\$1020	\$1098	\$1128	\$1197	\$1327	\$1387	\$1508	\$1672	\$1878
			<b>OVERALL DIMENSIONS</b>			<b>SEAT DIMENSIONS</b>			<b>BACK DIMENSIONS</b>					
			<b>W</b>	<b>D</b>	<b>H</b>	<b>W</b>	<b>D</b>	<b>H</b>	<b>W</b>	<b>H</b>				
			25.5	24	44.5	19.5	18	28.5	19	15.5				
			<b>RTA 00</b>											
 <p><b>Armless Barstool</b> COM Yardage: 1.25 Freight Class: 300 Product Weight (lbs.): 30 Cubic Feet Per Carton: 15.75</p>	Does not stack.	<b>6907</b>	\$792	\$841	\$880	\$933	\$1012	\$1040	\$1108	\$1238	\$1301	\$1419	\$1586	\$1789
			<b>OVERALL DIMENSIONS</b>			<b>SEAT DIMENSIONS</b>			<b>BACK DIMENSIONS</b>					
			<b>W</b>	<b>D</b>	<b>H</b>	<b>W</b>	<b>D</b>	<b>H</b>	<b>W</b>	<b>H</b>				
			21	24	44.5	19.5	18	28.5	19	15.5				
			<b>RTA 00</b>											
 <p><b>Armless Chair - 13" High Seat</b> COM Yardage: 1 Freight Class: 250 Product Weight (lbs.): 15 Cubic Feet Per Carton: 4.1</p>	Stack up to 4 high on floor. For Preschool to Grade 2.	<b>6909</b>	\$503	\$546	\$574	\$620	\$681	\$701	\$758	\$861	\$913	\$1009	\$1140	\$1301
			<b>OVERALL DIMENSIONS</b>			<b>SEAT DIMENSIONS</b>			<b>BACK DIMENSIONS</b>					
			<b>W</b>	<b>D</b>	<b>H</b>	<b>W</b>	<b>D</b>	<b>H</b>	<b>W</b>	<b>H</b>				
			15.5	15.5	24	14	10	13	13.5	11				
			<b>RTA 00</b>											



DESCRIPTION	FEATURES	MODEL#	STANDARD TEXTILE GRADES													
			1	2	3	4	5	6	7	8	9	10	11	12		
 <p><b>Seat Unit w/Arms</b> COM Yardage: 1.25 Freight Class: 300 Product Weight (lbs.): 20 Cubic Feet Per Carton: 9.75</p>	<p>Upholstered Seat and Back. Use with beam.</p>	<b>6930</b>	\$770	\$823	\$864	\$925	\$1008	\$1048	\$1125	\$1247	\$1342	\$1447	\$1663	\$1890		
		<b>OVERALL DIMENSIONS</b>			<b>SEAT DIMENSIONS</b>			<b>BACK DIMENSIONS</b>								
		<b>W</b>	<b>D</b>	<b>H</b>	<b>W</b>	<b>D</b>	<b>H</b>	<b>W</b>	<b>H</b>							
		25.5	23.5	19	19.5	18	-	19	15.5							
			<b>RTA 00</b>													
 <p><b>Armless Seat Unit</b> COM Yardage: 1.25 Freight Class: 300 Product Weight (lbs.): 18 Cubic Feet Per Carton: 9.75</p>	<p>Upholstered Seat and Back. Use with beam.</p>	<b>6931</b>	705	\$758	\$799	\$860	\$943	\$983	\$1060	\$1182	\$1277	\$1382	\$1598	\$1825		
		<b>OVERALL DIMENSIONS</b>			<b>SEAT DIMENSIONS</b>			<b>BACK DIMENSIONS</b>								
		<b>W</b>	<b>D</b>	<b>H</b>	<b>W</b>	<b>D</b>	<b>H</b>	<b>W</b>	<b>H</b>							
		21	23.5	19	19.5	18	-	19	15.5							
			<b>RTA 00</b>													

## SONIC™



model 6508MBWS



model 6513WS



model 6509TRWS



model 6525



model 6569



model 6564

## STANDARD FEATURES

- Sonic multi-purpose series includes: four-leg, sled base, 5 star base task, and fixed pedestal base and beam seating in addition to bar, counter and height adjustable stools.
- Four-legged/freestanding models are standard with a straight leg or with a "WS" wall saver frame and durable polypropylene glides.
- WS models have a wall saver frame design; the base touches the wall before the upper back to protect the wall from damage.
- Four-legged/freestanding chairs are available with painted or chrome legs.
- Models are available with or without arms. As of January 1, 2025, arms will match the poly seat color selection. For Black arms (to match previous standard), specify **BLK** for arm finish selection.
- Freestanding models are stackable up to 5 high on floor and 10 high on dolly 6517WS. **Caster models do not stack.**
- Tablet arms are available on all seated height base types (not available on stools).
- Tablet arms are extremely rugged and meet ANSI-BIFMA testing requirements. Tablet hinges up to allow ease of egress. Tablet slides forward and back to accommodate any body size comfortably. Tablet models do not stack.
- Standard tablet (**D8**) size is 18" d x 14 1/2" w and is made of black polymer. Tablets are attached at the left or right (as seated). Optional 18.5"D x 18.5"W high pressure laminate writing tablet is available. Core is hardwood veneer plywood with radiused edge finished in clear lacquer. Please specify.
- Sonic beam seating consists of upper seat units (models 6501, 6502, 6503, 6504, 6505, and 6506) including mounting brackets and all hardware necessary for attachment to beam
- For all beam components, tables and a complete list of available upper seat units, see Beam Seating series.
- Task chairs and height adjustable stools have a five star, reinforced, black nylon base.
- All Sonic models with casters have black, dual-wheel casters. Select caster based on flooring type.
- Pedestal base models provide fixed location seating for use in auditoriums, classrooms, jury boxes, public venues and more. The base must be mounted to the floor (mounting hardware not included). See Pedestal Base Installation Guide for details.
- Upholstery inserts are simple to replace for ease of on-site long term maintenance.
- Mesh back models (MB suffix) are available with Black back frames and Black mesh only.
- **Specifications and pricing are for 1 chair.**
- Check textile availability prior to specifying upholstery material.

## OPTIONAL FEATURES

- **Arm finish**  
(**MSH**) Matching arms (standard).  
(**BLK**) Black arms. No upcharge.
- **Back, seat and arm finish**  
Polypropylene seats, backs and nylon arms are available in 14 designer colors. Arms match selected seat/back finish or can be specified with Black (BLK) arms. No upcharge.  
(**BZB**) Buzz Blue (**EGP**) Eggplant (**BLK**) Night  
(**CCT**) Cactus (**FOG**) Fog (**SND**) Sand  
(**CRO**) Carrot (**FRO**) Frost (**SAR**) Scarlet  
(**IVC**) Cloud (**INK**) Ink (**SHW**) Shadow  
(**DJN**) Dijon (**LAB**) Latte
- **Frame finish**  
Painted finishes:  
(**TBL**) Black (**TFO**) Fog (**TMO**) Mocha  
(**TBZ**) Buzz Blue (**TFR**) Frost (**TNE**) Nevada  
(**TCC**) Cactus (**TIN**) Tin (**TOA**) Toast  
(**TCR**) Carrot (**TIV**) Cloud (**TSH**) Shadow  
(**TBL**) Dijon (**TKA**) Kalua (**TSD**) Sand  
(**TDW**) Designer White (**TSR**) Scarlet  
(**TEG**) Eggplant (**TLA**) Latte (**TTU**) Tungsten  
Metallics:  
(**CHM**) Chrome
- **Glide type** (four-legged chair + stool models)  
(**BG**) Black nylon glide for most floor surfaces.  
(**NM**) White nylon Glide non-marking glide for most floor surfaces.  
(**FG**) Felt glide for most hard floor surfaces. Add \$64  
(**RG**) Rubber non-slip glide for most hard floor surfaces. Add \$64.  
(**B**) Steel cushioned self-leveling glide for most floor surfaces. Add \$36.
- **Glide type** (sled base chair models)  
(**GLD**) Black, non-marking glides for most floor surfaces.  
(**NM**) White nylon Glide non-marking glide for most floor surfaces.
- **Caster type** (four-legged chair models)  
(**C1**) 2" carpet casters.  
(**C9R**) 2-1/2" hard surface flooring casters. Add \$62  
(**C15**) 2" manual locking casters. Add \$111.  
(**C14R**) 2" auto-locking, rubber caster. Add \$290.
- **Caster type** (task base models)  
(**C65**) 2" carpet casters or  
(**C65R**) 2" hard surface flooring casters. Add \$78
- **Tablets** (standard)  
(**D8**) Black polymer. 18"D x 14.5"W
- **Tablets** (high pressure laminate)  
Add \$68  
(**BLK**) Black (**DWT**) Designer White  
(**CMB**) Clear Maple (**NGL**) Noce Grigio
- **Pedestal base**  
Black metal base with 2" height adjust cylinders.  
(**SH**) Swivel, auto return to max height.  
(**SN**) Non-swivel, auto return to max height. Add \$23.  
(**SC**) Swivel, self-centering and return to max height. Add \$35.

## DESCRIPTION

## FEATURES

## MODEL#

## STANDARD TEXTILE GRADES

	1	2	3	4	5	6	7	8	9	10	11	12
6500BR	\$249	-	-	-	-	-	-	-	-	-	-	-



## Book Rack

COM Yardage: N/A  
Freight Class: 250  
Product Weight (lbs.): 5  
Cubic Feet Per Carton: 1.40 (1 per carton)

Use with Tablet models.

## OVERALL DIMENSIONS

## SEAT DIMENSIONS

## BACK DIMENSIONS

## W D H

## W D H



## W H







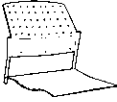

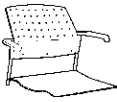
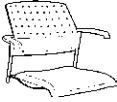
19.25	14.75	6	-	-	-	-	-	-
-------	-------	---	---	---	---	---	---	---

















RTA 00











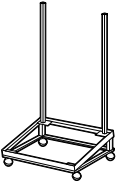
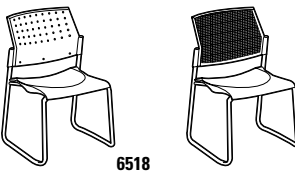
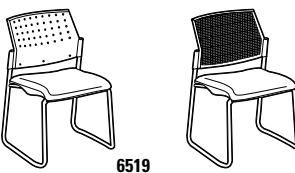

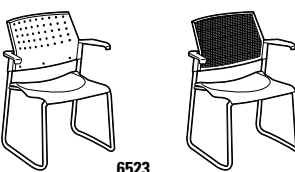

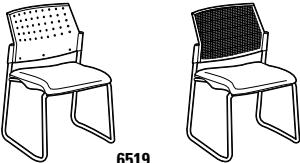

FedEx



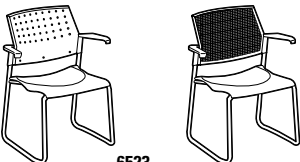

UPS

DESCRIPTION	FEATURES	MODEL#	STANDARD TEXTILE GRADES											
			1	2	3	4	5	6	7	8	9	10	11	12
 <p><b>Armless Seat Unit</b> COM Yardage: N/A Freight Class: 250 Product Weight (lbs.): 12 Cubic Feet Per Carton: 3.25 (2 per carton)</p>	Polypropylene Seat and Back. Use with Beam.	6501	\$466	-	-	-	-	-	-	-	-	-	-	-
		<b>OVERALL DIMENSIONS</b>			<b>SEAT DIMENSIONS</b>			<b>BACK DIMENSIONS</b>						
		<b>W</b>	<b>D</b>	<b>H</b>	<b>W</b>	<b>D</b>	<b>H</b>	<b>W</b>	<b>H</b>					
		20	21.5	17	17	16	-	17	15					
			<b>RTA 00</b>	<b>FedEx</b>		<b>ups</b>								
 <p><b>Armless Seat Unit</b> COM Yardage: 0.75 Freight Class: 250 Product Weight (lbs.): 12 Cubic Feet Per Carton: 3.25 (2 per carton)</p>	Upholstered Seat and Polypropylene Back. Use with Beam.	6502	\$525	\$558	\$578	\$614	\$665	\$680	\$724	\$805	\$845	\$920	\$1023	\$1154
		<b>OVERALL DIMENSIONS</b>			<b>SEAT DIMENSIONS</b>			<b>BACK DIMENSIONS</b>						
		<b>W</b>	<b>D</b>	<b>H</b>	<b>W</b>	<b>D</b>	<b>H</b>	<b>W</b>	<b>H</b>					
		20	22	17	17	16	-	17	15					
			<b>RTA 00</b>	<b>FedEx</b>		<b>ups</b>								
 <p><b>Armless Seat Unit</b> COM Yardage: 0.75 Freight Class: 150 Product Weight (lbs.): 13 Cubic Feet Per Carton: 3.25 (2 per carton)</p>	Upholstered Seat and Back. Use with Beam.	6503	\$581	\$612	\$634	\$670	\$719	\$737	\$778	\$861	\$901	\$976	\$1082	\$1208
		<b>OVERALL DIMENSIONS</b>			<b>SEAT DIMENSIONS</b>			<b>BACK DIMENSIONS</b>						
		<b>W</b>	<b>D</b>	<b>H</b>	<b>W</b>	<b>D</b>	<b>H</b>	<b>W</b>	<b>H</b>					
		20	22	17	17	15.5	-	17	15					
			<b>RTA 00</b>	<b>FedEx</b>		<b>ups</b>								
 <p><b>Seat Unit w/Arms</b> COM Yardage: N/A Freight Class: 150 Product Weight (lbs.): 13 Cubic Feet Per Carton: 3.25 (2 per carton)</p>	Polypropylene Seat and Back. Use with Beam.	6504	\$548	-	-	-	-	-	-	-	-	-	-	-
		<b>OVERALL DIMENSIONS</b>			<b>SEAT DIMENSIONS</b>			<b>BACK DIMENSIONS</b>						
		<b>W</b>	<b>D</b>	<b>H</b>	<b>W</b>	<b>D</b>	<b>H</b>	<b>W</b>	<b>H</b>					
		23	21.5	17	17	16	-	17	15					
			<b>RTA 00</b>	<b>FedEx</b>		<b>ups</b>								
 <p><b>Seat Unit w/Arms</b> COM Yardage: 0.75 Freight Class: 22 Product Weight (lbs.): 13 Cubic Feet Per Carton: 3.25 (2 per carton)</p>	Upholstered Seat and Polypropylene Back. Use with Beam.	6505	\$608	\$637	\$661	\$696	\$746	\$761	\$806	\$886	\$926	\$1002	\$1106	\$1235
		<b>OVERALL DIMENSIONS</b>			<b>SEAT DIMENSIONS</b>			<b>BACK DIMENSIONS</b>						
		<b>W</b>	<b>D</b>	<b>H</b>	<b>W</b>	<b>D</b>	<b>H</b>	<b>W</b>	<b>H</b>					
		23	22	17	17	16	-	17	15					
			<b>RTA 00</b>	<b>FedEx</b>		<b>ups</b>								

DESCRIPTION	FEATURES	MODEL#	STANDARD TEXTILE GRADES												
			1	2	3	4	5	6	7	8	9	10	11	12	
 <p><b>Seat Unit w/Arms</b> COM Yardage: 0.75 Freight Class: 150 Product Weight (lbs.): 14 Cubic Feet Per Carton: 3.25 (2 per carton)</p>	Upholstered Seat and Back Use with Beam.	<b>6506</b>	\$664	\$697	\$719	\$755	\$804	\$821	\$863	\$945	\$986	\$1061	\$1167	\$1293	
		<b>OVERALL DIMENSIONS</b>			<b>SEAT DIMENSIONS</b>			<b>BACK DIMENSIONS</b>							
		<b>W</b>	<b>D</b>	<b>H</b>	<b>W</b>	<b>D</b>	<b>H</b>	<b>W</b>	<b>H</b>						
		23	22	17	17	16	-	17	15						
			RTA 00			FedEx			ups						
  <p><b>6508</b>      <b>6508MB</b> (Mesh back)</p> <p><b>Armless Chair</b> COM Yardage: N/A Freight Class: 250 Product Weight (lbs.): 10 Cubic Feet Per Carton: 13.5 (2 per carton)</p>	Polypropylene Seat. Stacks 5 high on floor. Stacks 10 high on dolly.	<b>6508</b>	\$350	-	-	-	-	-	-	-	-	-	-	-	
		<b>6508WS</b>	\$383	-	-	-	-	-	-	-	-	-	-	-	-
		<b>6508MB</b>	\$418	-	-	-	-	-	-	-	-	-	-	-	-
		<b>6508WSMB</b>	\$451	-	-	-	-	-	-	-	-	-	-	-	-
<b>OVERALL DIMENSIONS</b>			<b>SEAT DIMENSIONS</b>			<b>BACK DIMENSIONS</b>									
<b>W</b>	<b>D</b>	<b>H</b>	<b>W</b>	<b>D</b>	<b>H</b>	<b>W</b>	<b>H</b>								
21.5	21.5	33	17	16	18	17	15								
			RTA 00			FedEx			ups						
  <p><b>6508TR</b>      <b>6508TRMB</b> (Mesh back)</p> <p><b>Armless Chair w/Tablet</b> COM Yardage: N/A Freight Class: 250 Product Weight (lbs.): 26 Cubic Feet Per Carton: 14.25 (1 per carton)</p>	Polypropylene Seat. Does not stack. <b>Must specify (L) Left or (R) Right Tablet</b> (Example: 6508TL or 6508TR)	<b>6508T</b>	\$697	-	-	-	-	-	-	-	-	-	-		
		<b>6508TWS</b>	\$734	-	-	-	-	-	-	-	-	-	-	-	
		<b>6508TMB</b>	\$762	-	-	-	-	-	-	-	-	-	-	-	
		<b>6508TWSMB</b>	\$796	-	-	-	-	-	-	-	-	-	-	-	
<b>OVERALL DIMENSIONS</b>			<b>SEAT DIMENSIONS</b>			<b>BACK DIMENSIONS</b>									
<b>W</b>	<b>D</b>	<b>H</b>	<b>W</b>	<b>D</b>	<b>H</b>	<b>W</b>	<b>H</b>								
24.75	26.5	32.5	17	16	18	17	15								
			RTA 00			FedEx			ups						
  <p><b>6509</b>      <b>6509MB</b> (Mesh Back)</p> <p><b>Armless Chair</b> COM Yardage: 0.75 Freight Class: 300 Product Weight (lbs.): 10 Cubic Feet Per Carton: 13.5 (2 per carton)</p>	Upholstered Seat. Stacks 5 high on floor. Stacks 10 high on dolly.	<b>6509</b>	\$404	\$437	\$457	\$495	\$541	\$560	\$602	\$684	\$720	\$796	\$894	\$1024	
		<b>6509MB</b>	\$470	\$503	\$523	\$561	\$607	\$626	\$668	\$750	\$786	\$862	\$968	\$1097	
		<b>6509WS</b>	\$470	\$499	\$521	\$559	\$606	\$621	\$665	\$745	\$782	\$857	\$958	\$1088	
		<b>6509WSMB</b>	\$509	\$544	\$564	\$600	\$650	\$665	\$709	\$790	\$830	\$906	\$1011	\$1138	
<b>OVERALL DIMENSIONS</b>			<b>SEAT DIMENSIONS</b>			<b>BACK DIMENSIONS</b>									
<b>W</b>	<b>D</b>	<b>H</b>	<b>W</b>	<b>D</b>	<b>H</b>	<b>W</b>	<b>H</b>								
21.5	22	33	17	16	18.5	17	15								
			RTA 00			FedEx			ups						
  <p><b>6509TR</b>      <b>6509TRMB</b> (Mesh back)</p> <p><b>Armless Chair w/Tablet</b> COM Yardage: 0.75 Freight Class: 250 Product Weight (lbs.): 28 Cubic Feet Per Carton: 14.25 (1 per carton)</p>	Upholstered Seat. Does not stack. <b>Must specify (L) Left or (R) Right Tablet</b> (Example: 6509TL or 6509TR)	<b>6509T</b>	\$745	\$781	\$807	\$843	\$895	\$913	\$962	\$1048	\$1090	\$1172	\$1280	\$1419	
		<b>6509TWS</b>	\$780	\$816	\$842	\$878	\$930	\$948	\$997	\$1083	\$1125	\$1207	\$1315	\$1454	
		<b>6509TMB</b>	\$808	\$844	\$870	\$906	\$958	\$976	\$1025	\$1111	\$1153	\$1235	\$1343	\$1482	
		<b>6509TWSMB</b>	\$843	\$879	\$905	\$941	\$993	\$1011	\$1060	\$1146	\$1188	\$1270	\$1378	\$1517	
<b>OVERALL DIMENSIONS</b>			<b>SEAT DIMENSIONS</b>			<b>BACK DIMENSIONS</b>									
<b>W</b>	<b>D</b>	<b>H</b>	<b>W</b>	<b>D</b>	<b>H</b>	<b>W</b>	<b>H</b>								
24.75	26.5	32.5	17	16	18.5	17	15								
			RTA 00			FedEx			ups						

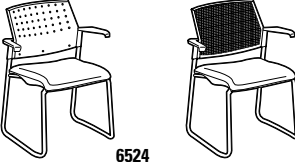
DESCRIPTION	FEATURES	MODEL#	STANDARD TEXTILE GRADES											
			1	2	3	4	5	6	7	8	9	10	11	12
 <p><b>6511</b></p> <p><b>Armless Chair</b> COM Yardage: 0.75 Freight Class: 300 Product Weight (lbs.): 11 Cubic Feet Per Carton: 13.5 (2 per carton)</p>	<p>Upholstered Seat and Back. Stacks 5 high on floor. Stacks 10 high on dolly.</p>	<p><b>6511</b>    \$452   \$485   \$509   \$543   \$590   \$608   \$649   \$730   \$766   \$845   \$944   \$1071  <b>6511WS</b>   \$485   \$520   \$542   \$576   \$623   \$641   \$682   \$764   \$801   \$874   \$977   \$1105</p>	<b>OVERALL DIMENSIONS</b>			<b>SEAT DIMENSIONS</b>			<b>BACK DIMENSIONS</b>					
			<b>W</b>	<b>D</b>	<b>H</b>	<b>W</b>	<b>D</b>	<b>H</b>	<b>W</b>	<b>H</b>				
			21.5	21.5	32	17	16	18.5	17	15				
			<p><b>RTA 00</b>     </p>											
 <p><b>6511T</b></p> <p><b>Armless Chair w/Tablet</b> COM Yardage: 0.75 Freight Class: 250 Product Weight (lbs.): 28 Cubic Feet Per Carton: 14.25 (1 per carton)</p>	<p>Upholstered Seat &amp; Back. Does not stack. <b>Must specify (L) Left or (R) Right Tablet</b> (Example: 6511TL or 6511TR)</p>	<p><b>6511T</b>    \$802   \$838   \$864   \$900   \$952   \$970   \$1019   \$1105   \$1147   \$1229   \$1337   \$1476</p>	<b>OVERALL DIMENSIONS</b>			<b>SEAT DIMENSIONS</b>			<b>BACK DIMENSIONS</b>					
			<b>W</b>	<b>D</b>	<b>H</b>	<b>W</b>	<b>D</b>	<b>H</b>	<b>W</b>	<b>H</b>				
			24.75	26.5	32.5	17	16	18.5	17	15				
			<p><b>RTA 00</b>     </p>											
 <p><b>6513</b></p>  <p><b>6513MB (Mesh back)</b></p> <p><b>Armchair w/Tablet</b> COM Yardage: N/A Freight Class: 250 Product Weight (lbs.): 11 Cubic Feet Per Carton: 13.5 (2 per carton)</p>	<p>Polypropylene Seat. Stacks 5 high on floor. Stacks 10 high on dolly.</p>	<p><b>6513</b>    \$426   -   -   -   -   -   -   -   -   -   -  <b>6513WS</b>   \$470   -   -   -   -   -   -   -   -   -   -  <b>6513MB</b>   \$492   -   -   -   -   -   -   -   -   -   -  <b>6513WSMB</b> \$536   -   -   -   -   -   -   -   -   -   -</p>	<b>OVERALL DIMENSIONS</b>			<b>SEAT DIMENSIONS</b>			<b>BACK DIMENSIONS</b>					
			<b>W</b>	<b>D</b>	<b>H</b>	<b>W</b>	<b>D</b>	<b>H</b>	<b>W</b>	<b>H</b>				
			23	21.5	33	17	16	18	17	15				
			<p><b>RTA 00</b>     </p>											
 <p><b>6514</b></p>  <p><b>6514MB (Mesh Back)</b></p> <p><b>Armchair</b> COM Yardage: 0.75 Freight Class: 300 Product Weight (lbs.): 11 Cubic Feet Per Carton: 13.5 (2 per carton)</p>	<p>Upholstered Seat. Stacks 5 high on floor. Stacks 10 high on dolly.</p>	<p><b>6514</b>    \$476   \$507   \$529   \$565   \$613   \$627   \$672   \$753   \$789   \$864   \$965   \$1094  <b>6514WS</b>   \$510   \$541   \$563   \$599   \$646   \$661   \$705   \$785   \$823   \$898   \$999   \$1128  <b>6514MB</b>   \$547   \$583   \$604   \$640   \$690   \$706   \$751   \$829   \$869   \$944   \$1049   \$1177  <b>6514WSMB</b> \$591   \$608   \$629   \$664   \$716   \$731   \$773   \$858   \$896   \$971   \$1074   \$1206</p>	<b>OVERALL DIMENSIONS</b>			<b>SEAT DIMENSIONS</b>			<b>BACK DIMENSIONS</b>					
			<b>W</b>	<b>D</b>	<b>H</b>	<b>W</b>	<b>D</b>	<b>H</b>	<b>W</b>	<b>H</b>				
			23	22	33	17	16	18.5	17	15				
			<p><b>RTA 00</b>     </p>											
 <p><b>6515</b></p> <p><b>Armchair</b> COM Yardage: 0.75 Freight Class: 300 Product Weight (lbs.): 11.50 Cubic Feet Per Carton: 5.88 (2 per carton)</p>	<p>Upholstered Seat and Back. Stacks 5 high on floor. Stacks 10 high on dolly.</p>	<p><b>6515</b>    \$522   \$553   \$575   \$613   \$658   \$677   \$719   \$800   \$835   \$911   \$1011   \$1141  <b>6515WS</b>   \$559   \$590   \$612   \$650   \$696   \$712   \$754   \$836   \$872   \$947   \$1047   \$1178</p>	<b>OVERALL DIMENSIONS</b>			<b>SEAT DIMENSIONS</b>			<b>BACK DIMENSIONS</b>					
			<b>W</b>	<b>D</b>	<b>H</b>	<b>W</b>	<b>D</b>	<b>H</b>	<b>W</b>	<b>H</b>				
			23	22	34	17	15.5	18.5	17	15				
			<p><b>RTA 00</b>     </p>											

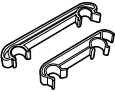
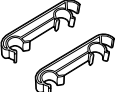
DESCRIPTION	FEATURES	MODEL#	STANDARD TEXTILE GRADES													
			1	2	3	4	5	6	7	8	9	10	11	12		
 <p><b>Dolly - Wall Saver</b> COM Yardage: N/A Freight Class: 150 Product Weight (lbs.): 20 Cubic Feet Per Carton: 4 ( 0.5 per carton)</p>	Accommodates 10 chairs.	6517WS	\$606	-	-	-	-	-	-	-	-	-	-	-	-	
		<b>OVERALL DIMENSIONS</b>			<b>SEAT DIMENSIONS</b>			<b>BACK DIMENSIONS</b>								
		<b>W</b>	<b>D</b>	<b>H</b>	<b>W</b>	<b>D</b>	<b>H</b>	<b>W</b>	<b>H</b>							
		23.25	24.75	12.25	-	-	-	-	-							
			  													
 <p><b>6518</b>      <b>6518MB (Mesh Back)</b></p> <p><b>Armless Chair w/Sled Base</b> COM Yardage: N/A Freight Class: 250 Product Weight (lbs.): 14 Cubic Feet Per Carton: 11.75 (2 per carton)</p>	Polypropylene Seat. Stacks 5 high on floor. Stacks 10 high on dolly.	6518	\$419	-	-	-	-	-	-	-	-	-	-	-	-	
		6518WS	\$456	-	-	-	-	-	-	-	-	-	-	-	-	
		6518MB	\$490	-	-	-	-	-	-	-	-	-	-	-	-	
		6518WSMB	\$529	-	-	-	-	-	-	-	-	-	-	-	-	
<b>OVERALL DIMENSIONS</b>			<b>SEAT DIMENSIONS</b>			<b>BACK DIMENSIONS</b>										
<b>W</b>	<b>D</b>	<b>H</b>	<b>W</b>	<b>D</b>	<b>H</b>	<b>W</b>	<b>H</b>									
22	21	32.5	17	16	17	17	15									
			  													
 <p><b>6519</b>      <b>6519MB (Mesh Back)</b></p> <p><b>Armless Chair w/Sled Base</b> COM Yardage: 0.75 Freight Class: 250 Product Weight (lbs.): 14 Cubic Feet Per Carton: 5.88 (2 per carton)</p>	Upholstered Seat. Stacks 5 high on floor. Stacks 10 high on dolly.	6519	\$472	\$503	\$525	\$561	\$608	\$623	\$667	\$747	\$784	\$859	\$960	\$1090		
		6519WS	\$516	\$552	\$576	\$609	\$659	\$677	\$720	\$800	\$840	\$913	\$1020	\$1146		
		6519MB	\$539	\$574	\$596	\$630	\$680	\$696	\$743	\$820	\$861	\$936	\$1042	\$1168		
		6519WSMB	\$586	\$621	\$643	\$678	\$726	\$742	\$786	\$866	\$907	\$983	\$1088	\$1215		
<b>OVERALL DIMENSIONS</b>			<b>SEAT DIMENSIONS</b>			<b>BACK DIMENSIONS</b>										
<b>W</b>	<b>D</b>	<b>H</b>	<b>W</b>	<b>D</b>	<b>H</b>	<b>W</b>	<b>H</b>									
22	21	33	17	16	17	17	15									
																
 <p><b>6521</b></p> <p><b>Armless Chair w/Sled Base</b> COM Yardage: 0.75 Freight Class: 250 Product Weight (lbs.): 15 Cubic Feet Per Carton: 13.5 (2 per carton)</p>	Upholstered Seat and Back. Stacks 5 high on floor. Stacks 10 high on dolly.	6521	\$515	\$548	\$570	\$607	\$653	\$670	\$712	\$792	\$828	\$903	\$1005	\$1134		
		6521WS	\$554	\$587	\$607	\$642	\$687	\$705	\$747	\$825	\$860	\$934	\$1031	\$1153		
		<b>OVERALL DIMENSIONS</b>			<b>SEAT DIMENSIONS</b>			<b>BACK DIMENSIONS</b>								
		<b>W</b>	<b>D</b>	<b>H</b>	<b>W</b>	<b>D</b>	<b>H</b>	<b>W</b>	<b>H</b>							
22	21	33	17	16	18.5	17	15									
			  													
 <p><b>6523</b>      <b>6523MB (Mesh Back)</b></p> <p><b>Armchair w/Sled Base</b> COM Yardage: N/A Freight Class: 250 Product Weight (lbs.): 15 Cubic Feet Per Carton: 13.5 (2 per carton)</p>	Polypropylene Seat. Stacks 5 high on floor. Stacks 10 high on dolly.	6523	\$488	-	-	-	-	-	-	-	-	-	-	-		
		6523WS	\$536	-	-	-	-	-	-	-	-	-	-	-		
		6523MB	\$568	-	-	-	-	-	-	-	-	-	-	-		
		6523WSMB	\$594	-	-	-	-	-	-	-	-	-	-	-		
<b>OVERALL DIMENSIONS</b>			<b>SEAT DIMENSIONS</b>			<b>BACK DIMENSIONS</b>										
<b>W</b>	<b>D</b>	<b>H</b>	<b>W</b>	<b>D</b>	<b>H</b>	<b>W</b>	<b>H</b>									
23	21	32.5	17	16	17	17	15									
			  													

DESCRIPTION	FEATURES	MODEL#	STANDARD TEXTILE GRADES											
			1	2	3	4	5	6	7	8	9	10	11	12
 <p><b>6524</b>      <b>6524MB (Mesh Back)</b></p> <p><b>Armchair w/Sled Base</b> COM Yardage: 0.75 Freight Class: 250 Product Weight (lbs.): 15 Cubic Feet Per Carton: 13.5 (2 per carton)</p>	<p>Upholstered Seat. Stacks 5 high on floor. Stacks 10 high on dolly.</p>	<p><b>6524</b></p>	\$536	\$569	\$589	\$625	\$673	\$692	\$732	\$815	\$852	\$926	\$1026	\$1155
			\$603	\$636	\$658	\$694	\$744	\$759	\$801	\$884	\$925	\$999	\$1105	\$1230
			\$621	\$656	\$678	\$713	\$761	\$777	\$821	\$901	\$942	\$1015	\$1124	\$1250
			\$667	\$702	\$724	\$759	\$808	\$826	\$867	\$949	\$991	\$1065	\$1171	\$1298
			<b>OVERALL DIMENSIONS</b>			<b>SEAT DIMENSIONS</b>			<b>BACK DIMENSIONS</b>					
			<b>W</b>	<b>D</b>	<b>H</b>	<b>W</b>	<b>D</b>	<b>H</b>	<b>W</b>	<b>H</b>				
			33	21	33	17	16	17.5	17	15				
			<b>RTA 00</b>	<b>FedEx</b>		<b>ups</b>								
 <p><b>6525</b></p> <p><b>Armchair</b> COM Yardage: 0.75 Freight Class: 250 Product Weight (lbs.): 16 Cubic Feet Per Carton: 13.5 (2 per carton)</p>	<p>Upholstered Seat and Back. Stacks 5 high on floor. Stacks 10 high on dolly.</p>	<p><b>6525</b></p>	\$586	\$621	\$643	\$678	\$724	\$741	\$784	\$864	\$900	\$976	\$1076	\$1205
			\$644	\$677	\$699	\$735	\$785	\$800	\$842	\$926	\$966	\$1041	\$1147	\$1271
			<b>OVERALL DIMENSIONS</b>			<b>SEAT DIMENSIONS</b>			<b>BACK DIMENSIONS</b>					
			<b>W</b>	<b>D</b>	<b>H</b>	<b>W</b>	<b>D</b>	<b>H</b>	<b>W</b>	<b>H</b>				
			23	21	33	17	15.5	17.5	17	15				
			<b>RTA 00</b>	<b>FedEx</b>		<b>ups</b>								
 <p><b>6522</b></p> <p><b>Ganging Brackets</b> COM Yardage: N/A Freight Class: 70 Product Weight (lbs.): 0.2 Cubic Feet Per Carton: 1 (25 per carton)</p>	<p>For four legged models only.</p>	<p><b>6522</b></p>	\$37	-	-	-	-	-	-	-	-	-	-	
						<b>OVERALL DIMENSIONS</b>			<b>SEAT DIMENSIONS</b>			<b>BACK DIMENSIONS</b>		
			<b>W</b>	<b>D</b>	<b>H</b>	<b>W</b>	<b>D</b>	<b>H</b>	<b>W</b>	<b>H</b>				
			0.87	7.75	1.5	-	-	-	-	-				
			<b>RTA 00</b>	<b>FedEx</b>		<b>ups</b>								
 <p><b>6526</b></p> <p><b>Ganging Brackets</b> COM Yardage: N/A Freight Class: 70 Product Weight (lbs.): 0.25 Cubic Feet Per Carton: 1 (25 per carton)</p>	<p>Sled base models only.</p>	<p><b>6526</b></p>	\$28	-	-	-	-	-	-	-	-	-	-	
						<b>OVERALL DIMENSIONS</b>			<b>SEAT DIMENSIONS</b>			<b>BACK DIMENSIONS</b>		
			<b>W</b>	<b>D</b>	<b>H</b>	<b>W</b>	<b>D</b>	<b>H</b>	<b>W</b>	<b>H</b>				
			0.75	5.75	1.25	-	-	-	-	-				
			<b>RTA 00</b>	<b>FedEx</b>		<b>ups</b>								
 <p><b>6537</b>      <b>6537MB</b></p> <p><b>Armless LB Task</b> COM Yardage: N/A Freight Class: 250 Product Weight (lbs.): 21.5 Cubic Feet Per Carton: 6.5</p>	<p>Polypropylene seat. Ergonomic features: C</p>	<p><b>ADJUSTMENTS</b> (2) Pneumatic seat height</p>	\$566											
			\$637											
			<b>OVERALL DIMENSIONS</b>			<b>SEAT DIMENSIONS</b>			<b>BACK DIMENSIONS</b>					
			<b>W</b>	<b>D</b>	<b>H</b>	<b>W</b>	<b>D</b>	<b>H</b>	<b>W</b>	<b>H</b>				
			20.5 24	20.5 26	32.5 33	17 17	16 16	15.5-19.5 15.5-19.5	17 17	15 15				
			<b>RTA 1</b>	<b>FedEx</b>		<b>ups</b>		1 per carton						

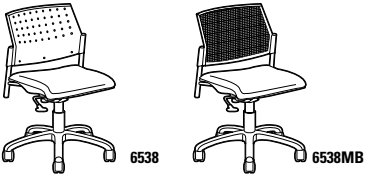
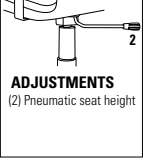

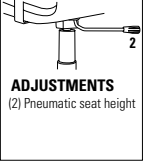

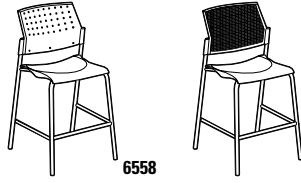

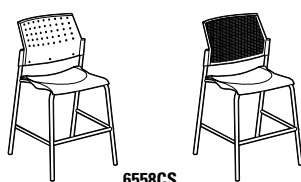

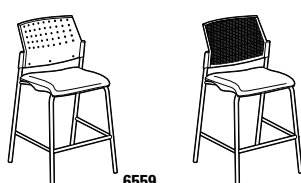
DESCRIPTION	FEATURES	MODEL#	STANDARD TEXTILE GRADES												
			1	2	3	4	5	6	7	8	9	10	11	12	
 <p><b>6538</b>      <b>6538MB</b></p> <p><b>Armless LB Task</b> COM Yardage: 0.75 Freight Class: 250 Product Weight (lbs.): 22.5 Cubic Feet Per Carton: 6.5</p>	 <p><b>ADJUSTMENTS</b> (2) Pneumatic seat height</p> <p>Upholstered seat. Ergonomic features: C</p>		1	2	3	4	5	6	7	8	9	10	11	12	
		<b>6538</b>	\$612	\$645	\$665	\$701	\$749	\$768	\$808	\$891	\$928	\$1002	\$1101	\$1230	
		<b>6538MB</b>	\$688	\$723	\$743	\$779	\$829	\$845	\$888	\$969	\$1010	\$1085	\$1191	\$1317	
			<b>OVERALL DIMENSIONS</b>			<b>SEAT DIMENSIONS</b>			<b>BACK DIMENSIONS</b>						
			<b>W</b>	<b>D</b>	<b>H</b>	<b>W</b>	<b>D</b>	<b>H</b>	<b>W</b>	<b>H</b>					
			20.5	20.5	32.5	17	16	16-20	17	14.5					
			24	26	33	17	16	16-20	17	14.5					
			<b>RTA 1</b>	<b>FedEx</b>		<b>ups</b>	1 per carton								











DESCRIPTION	FEATURES	MODEL#	STANDARD TEXTILE GRADES												
			1	2	3	4	5	6	7	8	9	10	11	12	
 <p><b>6539</b></p> <p><b>Armless LB Task</b> COM Yardage: 6.5 Freight Class: 250 Product Weight (lbs.): 23.5 Cubic Feet Per Carton: 6.5</p>	 <p><b>ADJUSTMENTS</b> (2) Pneumatic seat height</p> <p>Upholstered seat &amp; back. Ergonomic features: C</p>		1	2	3	4	5	6	7	8	9	10	11	12	
		<b>6539</b>	\$659	\$692	\$714	\$751	\$796	\$814	\$857	\$938	\$973	\$1048	\$1149	\$1278	
			<b>OVERALL DIMENSIONS</b>			<b>SEAT DIMENSIONS</b>			<b>BACK DIMENSIONS</b>						
			<b>W</b>	<b>D</b>	<b>H</b>	<b>W</b>	<b>D</b>	<b>H</b>	<b>W</b>	<b>H</b>					
			20.5	20.5	33	17	15.5	16-20	17	15					
			24	26	33	17	16	16-20	17	14.5					
			<b>RTA 1</b>	<b>FedEx</b>		<b>ups</b>	1 per carton								







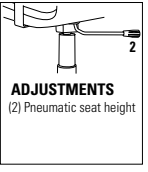



DESCRIPTION	FEATURES	MODEL#	STANDARD TEXTILE GRADES											
			1	2	3	4	5	6	7	8	9	10	11	12
 <p><b>6558</b>      <b>6558MB (Mesh Back)</b></p> <p><b>Armless Bar Stool</b> COM Yardage: N/A Freight Class: 300 Product Weight (lbs.): 18 Cubic Feet Per Carton: 14.75 (1 per carton)</p>	<p>Polypropylene Seat. Stacks 5 high on floor.</p>		1	2	3	4	5	6	7	8	9	10	11	12
		<b>6558</b>	\$546	-	-	-	-	-	-	-	-	-	-	-
		<b>6558MB</b>	\$637	-	-	-	-	-	-	-	-	-	-	-
			<b>OVERALL DIMENSIONS</b>			<b>SEAT DIMENSIONS</b>			<b>BACK DIMENSIONS</b>					
			<b>W</b>	<b>D</b>	<b>H</b>	<b>W</b>	<b>D</b>	<b>H</b>	<b>W</b>	<b>H</b>				
			22	23	42	17	16	28	17	15				
			<b>RTA 00</b>											

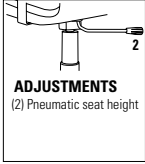

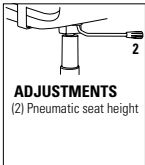



DESCRIPTION	FEATURES	MODEL#	STANDARD TEXTILE GRADES											
			1	2	3	4	5	6	7	8	9	10	11	12
 <p><b>6558CS</b>      <b>6558CSMB (Mesh Back)</b></p> <p><b>Armless Counter Stool</b> COM Yardage: N/A Freight Class: 300 Product Weight (lbs.): 20 Cubic Feet Per Carton: 14.5 (2 per carton)</p>	<p>Polypropylene Seat. Stacks 5 high on floor.</p>		1	2	3	4	5	6	7	8	9	10	11	12
		<b>6558CS</b>	\$546	-	-	-	-	-	-	-	-	-	-	-
		<b>6558CSMB</b>	\$637	-	-	-	-	-	-	-	-	-	-	-
			<b>OVERALL DIMENSIONS</b>			<b>SEAT DIMENSIONS</b>			<b>BACK DIMENSIONS</b>					
			<b>W</b>	<b>D</b>	<b>H</b>	<b>W</b>	<b>D</b>	<b>H</b>	<b>W</b>	<b>H</b>				
			22.5	22	38	17	16	24	17	15				
			<b>RTA 00</b>											

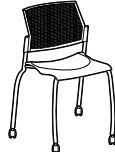

DESCRIPTION	FEATURES	MODEL#	STANDARD TEXTILE GRADES											
			1	2	3	4	5	6	7	8	9	10	11	12
 <p><b>6559</b>      <b>6559MB (Mesh Back)</b></p> <p><b>Armless Bar Stool</b> COM Yardage: 0.75 Freight Class: 300 Product Weight (lbs.): 18 Cubic Feet Per Carton: 14.75 (1 per carton)</p>	<p>Upholstered Seat. Stacks 5 high on floor.</p>		1	2	3	4	5	6	7	8	9	10	11	12
		<b>6559</b>	\$592	\$625	\$648	\$683	\$729	\$748	\$788	\$870	\$905	\$982	\$1081	\$1210
		<b>6559MB</b>	\$663	\$698	\$720	\$755	\$804	\$822	\$863	\$944	\$985	\$1061	\$1167	\$1292
			<b>OVERALL DIMENSIONS</b>			<b>SEAT DIMENSIONS</b>			<b>BACK DIMENSIONS</b>					
			<b>W</b>	<b>D</b>	<b>H</b>	<b>W</b>	<b>D</b>	<b>H</b>	<b>W</b>	<b>H</b>				
			22	23	42	17	16	28.5	17	15				
			<b>RTA 00</b>											

DESCRIPTION	FEATURES	MODEL#	STANDARD TEXTILE GRADES											
			1	2	3	4	5	6	7	8	9	10	11	12
 6559CS	 6559CSMB (Mesh Back)		1	2	3	4	5	6	7	8	9	10	11	12
			6559CS	\$592	\$625	\$648	\$683	\$729	\$748	\$788	\$870	\$905	\$982	\$1081
<p><b>Armless Counter Stool</b> COM Yardage: 0.75 Freight Class: 300 Product Weight (lbs.): 24 Cubic Feet Per Carton: 14.5 (2 per carton)</p>	<p>Upholstered Seat. Stacks 5 high on floor.</p>		<b>OVERALL DIMENSIONS</b>			<b>SEAT DIMENSIONS</b>			<b>BACK DIMENSIONS</b>					
			<b>W</b>	<b>D</b>	<b>H</b>	<b>W</b>	<b>D</b>	<b>H</b>	<b>W</b>	<b>H</b>				
			22.5	22	38	17	16	24.5	17	15				
			<b>RTA 00</b>											
 6561			1	2	3	4	5	6	7	8	9	10	11	12
			6561	\$644	\$677	\$699	\$735	\$784	\$797	\$840	\$922	\$958	\$1033	\$1134
<p><b>Armless Bar Stool</b> COM Yardage: 0.75 Freight Class: 300 Product Weight (lbs.): 18 Cubic Feet Per Carton: 14.75 (1 per carton)</p>	<p>Upholstered Seat and back. Stacks 5 high on floor. Stacks 10 high on dolly.</p>		<b>OVERALL DIMENSIONS</b>			<b>SEAT DIMENSIONS</b>			<b>BACK DIMENSIONS</b>					
			<b>W</b>	<b>D</b>	<b>H</b>	<b>W</b>	<b>D</b>	<b>H</b>	<b>W</b>	<b>H</b>				
			22	23	42.5	17	16	28.5	17	15				
			<b>RTA 00</b>											
 6561CS			1	2	3	4	5	6	7	8	9	10	11	12
			6561CS	\$644	\$675	\$699	\$733	\$782	\$797	\$839	\$921	\$958	\$1033	\$1134
<p><b>Armless Counter Stool</b> COM Yardage: 0.75 Freight Class: 300 Product Weight (lbs.): 27 Cubic Feet Per Carton: 14.75 (2 per carton)</p>	<p>Upholstered Seat and back. Stacks 5 high on floor.</p>		<b>OVERALL DIMENSIONS</b>			<b>SEAT DIMENSIONS</b>			<b>BACK DIMENSIONS</b>					
			<b>W</b>	<b>D</b>	<b>H</b>	<b>W</b>	<b>D</b>	<b>H</b>	<b>W</b>	<b>H</b>				
			22.5	22	38	17	16	24.5	17	15				
			<b>RTA 00</b>											
 6563	 6563MB (Mesh Back)		1	2	3	4	5	6	7	8	9	10	11	12
			6563	\$620	-	-	-	-	-	-	-	-	-	-
<p><b>Bar Stool w/Arms</b> COM Yardage: N/A Freight Class: 300 Product Weight (lbs.): 19 Cubic Feet Per Carton: 14.75 (1 per carton)</p>	<p>Polypropylene Seat. Stacks 5 high on floor. Stacks 10 high on dolly.</p>		6563MB	\$712	-	-	-	-	-	-	-	-	-	
			<b>OVERALL DIMENSIONS</b>			<b>SEAT DIMENSIONS</b>			<b>BACK DIMENSIONS</b>					
			<b>W</b>	<b>D</b>	<b>H</b>	<b>W</b>	<b>D</b>	<b>H</b>	<b>W</b>	<b>H</b>				
			23	23	42	17	16	28	17	15				
			<b>RTA 00</b>											
 6563CS	 6563CSMB (Mesh Back)		1	2	3	4	5	6	7	8	9	10	11	12
			6563CS	\$620	-	-	-	-	-	-	-	-	-	-
<p><b>Counter Stool w/Arms</b> COM Yardage: N/A Freight Class: 300 Product Weight (lbs.): 21 Cubic Feet Per Carton: 14.5 (2 per carton)</p>	<p>Polypropylene Seat. Stacks 5 high on floor.</p>		6563CSMB	\$712	-	-	-	-	-	-	-	-	-	
			<b>OVERALL DIMENSIONS</b>			<b>SEAT DIMENSIONS</b>			<b>BACK DIMENSIONS</b>					
			<b>W</b>	<b>D</b>	<b>H</b>	<b>W</b>	<b>D</b>	<b>H</b>	<b>W</b>	<b>H</b>				
			22.5	23	38	17	16	24	17	15				
			<b>RTA 00</b>											

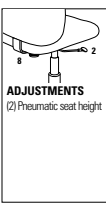
DESCRIPTION	FEATURES	MODEL#	STANDARD TEXTILE GRADES											
			1	2	3	4	5	6	7	8	9	10	11	12
 6564	 6564MB (Mesh Back)		\$661	\$696	\$717	\$752	\$797	\$816	\$858	\$939	\$977	\$1049	\$1151	\$1279
			Upholstered Seat. Stacks 5 high on floor.											
<b>Bar Stool w/Arms</b> COM Yardage: 0.75 Freight Class: 300 Product Weight (lbs.): 19 Cubic Feet Per Carton: 14.75 (1 per carton)			<b>RTA 00</b>											
 6564CS	 6564CSMB (Mesh Back)		\$661	\$696	\$717	\$752	\$797	\$816	\$858	\$939	\$977	\$1049	\$1151	\$1279
			Upholstered Seat. Stacks 5 high on floor.											
<b>Counter Stool w/Arms</b> COM Yardage: 0.75 Freight Class: 300 Product Weight (lbs.): 25 Cubic Feet Per Carton: 14.75 (2 per carton)			<b>RTA 00</b>											
 6565			\$705	\$741	\$762	\$797	\$843	\$862	\$903	\$985	\$1026	\$1098	\$1198	\$1325
			Upholstered seat and back. Stacks 5 high on floor.											
<b>Bar Stool w/Arms</b> COM Yardage: 0.75 Freight Class: 300 Product Weight (lbs.): 19 Cubic Feet Per Carton: 14.75 (1 per carton)			<b>RTA 00</b>											
 6565CS			\$705	\$741	\$762	\$797	\$843	\$862	\$903	\$985	\$1026	\$1098	\$1198	\$1325
			Upholstered Seat. Stacks 5 high on floor.											
<b>Counter Stool w/Arms</b> COM Yardage: 0.75 Freight Class: 300 Product Weight (lbs.): 27 Cubic Feet Per Carton: 14.75 (2 per carton)			<b>RTA 00</b>											
 6567	 6567MB	 <b>ADJUSTMENTS</b> (2) Pneumatic seat height	List price											
			\$637											
<b>LB Task w/Arms</b> COM Yardage: N/A Freight Class: 250 Product Weight (lbs.): 23 Cubic Feet Per Carton: 6.5			\$637											
			\$712											
Polypropylene seat. Ergonomic features: C			<b>RTA 1</b>											
			<b>OVERALL DIMENSIONS</b> W D H			<b>SEAT DIMENSIONS</b> W D H			<b>BACK DIMENSIONS</b> W H					
			23	20.5	32.5	17	16	15.5-20.5	17	15				
			<b>FedEx</b>  1 per carton											

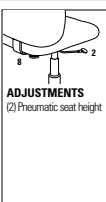
DESCRIPTION	FEATURES	MODEL#	STANDARD TEXTILE GRADES											
			1	2	3	4	5	6	7	8	9	10	11	12
 <b>6568</b>	 <b>6568MB</b>	 <b>ADJUSTMENTS</b> (2) Pneumatic seat height	Upholstered seat. Ergonomic features: C											
			Overall Dimensions: W 23, D 20.5, H 32.5 Seat Dimensions: W 17, D 16, H 16-21 Back Dimensions: W 17, H 14.5											
<b>LB Task w/Arms</b> COM Yardage: N/A Freight Class: 250 Product Weight (lbs.): 24 Cubic Feet Per Carton: 6.5			RTA 1      FedEx      ups      1 per carton											
	 <b>ADJUSTMENTS</b> (2) Pneumatic seat height	Upholstered seat & back. Ergonomic features: C												
		Overall Dimensions: W 23, D 20.5, H 33 Seat Dimensions: W 17, D 15.5, H 16-21 Back Dimensions: W 17, H 15												
<b>LB Task w/Arms</b> COM Yardage: N/A Freight Class: 250 Product Weight (lbs.): 25 Cubic Feet Per Carton: 6.5			RTA 1      FedEx      ups      1 per carton											
 <b>6573</b>	 <b>6573MB (Mesh Back)</b>	Polypropylene Seat. Does not stack.												
		Overall Dimensions: W 23, D 21, H 32 Seat Dimensions: W 17, D 16, H 17.5 Back Dimensions: W 17, H 14.5												
<b>Armchair w/Casters</b> COM Yardage: N/A Freight Class: 250 Product Weight (lbs.): 14 Cubic Feet Per Carton: 13.5 (2 per carton)			RTA 00      FedEx      ups											
 <b>6574</b>	 <b>6574MB (Mesh Back)</b>	Upholstered Seat. Does not stack.												
		Overall Dimensions: W 23, D 21.5, H 33 Seat Dimensions: W 17, D 16, H 18 Back Dimensions: W 17, H 14												
<b>Armchair w/Casters</b> COM Yardage: 0.75 Freight Class: 300 Product Weight (lbs.): 15 Cubic Feet Per Carton: 13.5 (1 per carton)			RTA 00      FedEx      ups											
	Upholstered Seat and Back. Does not stack.													
	Overall Dimensions: W 23, D 21.5, H 32.5 Seat Dimensions: W 17, D 15.5, H 18 Back Dimensions: W 17, H 14.5													
<b>Armchair w/Casters</b> COM Yardage: 0.75 Freight Class: 250 Product Weight (lbs.): 15 Cubic Feet Per Carton: 13.5 (2 per carton)			RTA 00											

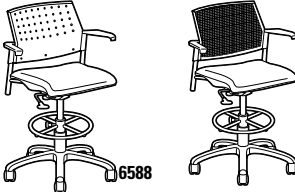
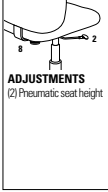
DESCRIPTION	FEATURES	MODEL#	STANDARD TEXTILE GRADES											
			1	2	3	4	5	6	7	8	9	10	11	12
 6577	 6577MB (Mesh Back)		1	2	3	4	5	6	7	8	9	10	11	12
			6577	\$446	-	-	-	-	-	-	-	-	-	-
<b>Armless Chair w/Casters</b> COM Yardage: N/A Freight Class: 300 Product Weight (lbs.): 12 Cubic Feet Per Carton: 13.5 (2 per carton)	Polypropylene Seat. Does not stack.		OVERALL DIMENSIONS			SEAT DIMENSIONS			BACK DIMENSIONS					
			W	D	H	W	D	H	W	H				
			21	21	33	17	16	17.5	17	14.5				
			RTA 00	FedEx	ups									
 6578	 6578MB (Mesh Back)		1	2	3	4	5	6	7	8	9	10	11	12
			6578	\$492	\$527	\$547	\$584	\$630	\$649	\$690	\$770	\$808	\$885	\$984
<b>Armless Chair w/Casters</b> COM Yardage: 0.75 Freight Class: 300 Product Weight (lbs.): 13 Cubic Feet Per Carton: 13.5 (2 per carton)	Upholstered Seat. Does not stack.		OVERALL DIMENSIONS			SEAT DIMENSIONS			BACK DIMENSIONS					
			W	D	H	W	D	H	W	H				
			21	21.5	33	17	16	18	17	14				
			RTA 00	FedEx	ups									
 6579			1	2	3	4	5	6	7	8	9	10	11	12
			6579	\$539	\$572	\$592	\$628	\$677	\$694	\$735	\$817	\$853	\$929	\$1029
<b>Armless chair w/Casters</b> COM Yardage: 0.75 Freight Class: 250 Product Weight (lbs.): 13 Cubic Feet Per Carton: 13.5 (2 per carton)	Upholstered Seat and Back. Does not stack.		OVERALL DIMENSIONS			SEAT DIMENSIONS			BACK DIMENSIONS					
			W	D	H	W	D	H	W	H				
			21	21.5	32.5	17	15.5	18	17	14.5				
			RTA 00	FedEx	ups									
 6586	 ADJUSTMENTS (2) Pneumatic seat height		1	2	3	4	5	6	7	8	9	10	11	12
			6586	\$996	\$1029	\$1053	\$1088	\$1134	\$1155	\$1196	\$1277	\$1318	\$1393	\$1498
<b>LB Task Height Adjustable Chair</b> COM Yardage: 0.75 Freight Class: 250 Product Weight (lbs.): 28 Cubic Feet Per Carton: 8.25 (1 per carton)	Upholstered Seat and Back. Ergonomic Features: C, M		OVERALL DIMENSIONS			SEAT DIMENSIONS			BACK DIMENSIONS					
			W	D	H	W	D	H	W	H				
			24	21.5	21.5	17	16	22-32	17	14.5				
			RTA 1	FedEx	ups									
 6587	 ADJUSTMENTS (2) Pneumatic seat height		1	2	3	4	5	6	7	8	9	10	11	12
			6587	\$836	-	-	-	-	-	-	-	-	-	-
<b>LB Task Height Adjustable Chair</b> COM Yardage: N/A Freight Class: 250 Product Weight (lbs.): 26 Cubic Feet Per Carton: 8.25 (1 per carton)	Polypropylene Seat. Ergonomic Features: C, M		OVERALL DIMENSIONS			SEAT DIMENSIONS			BACK DIMENSIONS					
			W	D	H	W	D	H	W	H				
			24.0	21.5	42.5	17	16	22-32	17	14.5				
			RTA 1	FedEx	ups									

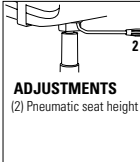
DESCRIPTION	FEATURES	MODEL#	STANDARD TEXTILE GRADES											
			1	2	3	4	5	6	7	8	9	10	11	12
 <p><b>6588</b></p> <p><b>6588MB</b></p> <p><b>LB Task Height Adjustable Chair</b>                      COM Yardage: 0.75                      Freight Class: 250                      Product Weight (lbs.): 28                      Cubic Feet Per Carton: 8.25 (1 per carton)</p>	 <p><b>ADJUSTMENTS</b> (2) Pneumatic seat height</p> <p>Upholstered Seat.                      Ergonomic Features:                      C, M</p>	<b>6588</b>	\$944	\$977	\$999	\$1032	\$1084	\$1100	\$1142	\$1223	\$1265	\$1339	\$1446	\$1571
		<b>6588MB</b>	\$923	\$956	\$980	\$1015	\$1063	\$1080	\$1123	\$1205	\$1245	\$1320	\$1426	\$1554
			<b>OVERALL DIMENSIONS</b>			<b>SEAT DIMENSIONS</b>			<b>BACK DIMENSIONS</b>					
			<b>W</b>	<b>D</b>	<b>H</b>	<b>W</b>	<b>D</b>	<b>H</b>	<b>W</b>	<b>H</b>				
			24	21.5	42.5	17	16	22-32	17	14.5				
			<b>RTA 1</b>	<b>FedEx</b>		<b>UPS</b>								
 <p><b>Armless LB Task with Pedestal Base</b>                      COM Yardage: 6.5                      Freight Class: 250                      Product Weight (lbs.): 23.5                      Cubic Feet Per Carton: 6.5</p>	 <p><b>ADJUSTMENTS</b> (2) Pneumatic seat height</p> <p>Upholstered seat &amp; back.                      Ergonomic features: C</p> <p><b>Available with tablet:</b>  <b>Specify (L) left or (R) right tablet.</b>  <b>(Example: 6539TL or 6539TR).</b></p>	<b>6539TLPB</b>	\$1331	\$1366	\$1388	\$1426	\$1481	\$1505	\$1551	\$1628	\$1686	\$1750	\$1884	\$2027
		<b>6539TRPB</b>												
			<b>OVERALL DIMENSIONS</b>			<b>SEAT DIMENSIONS</b>			<b>BACK DIMENSIONS</b>					
			<b>W</b>	<b>D</b>	<b>H</b>	<b>W</b>	<b>D</b>	<b>H</b>	<b>W</b>	<b>H</b>				
			24	20.5	31	17	15.5	16-20	17	15				
			24	26	31	17	16	16-20	17	14.5				
			<b>RTA 1</b>	1 per carton										

**SPRITZ™**



**Model 6762-6**



**Model 6765C**



**Model 6768-6**

**NESTING FEATURES**



Articulating back on nesting chairs and height adjustable stools.



Flip up seat on nesting chairs.

**MECHANISMS OPTIONS**

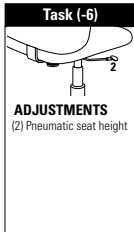

**Ergonomic Features:**  
C, G, M, N, U

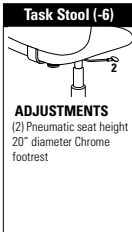

**Ergonomic Features:**  
C, G, M, N, U

**SPRITZ WORK & TASK CHAIRS**



For Spritz Task chairs, please refer to Work + Task section of pricebook.

**STANDARD FEATURES**

- An exceptionally comfortable chair series featuring a sophisticated, translucent mesh and models for all applications.
- Features an auto-adjusting comfort back.
- Spring loaded back reacts to body pressure and articulates 12°.
- Multi-purpose models standard with Global's high quality Soft Descent™ pneumatic lift which slowly and gently lowers the seat height of the chair making it easy to obtain the exact seat height you desire.
- Five prong, injection molded, fiberglass reinforced nylon Black base with **C10** dual wheel carpet casters.
- Nesting chairs have a flip up seat allowing chairs to stack horizontally.
- When nesting horizontal nesting chairs, each additional chair adds 10" to depth.
- Nesting chairs are standard with four Black nylon glides, **C1** carpet casters or with two casters at front, two glides at rear.
- Chairs are "Wall Safe". Rear legs hit the baseboard first leaving clearance between the back of the chair and the wall, saving both the chair and the wall from damage.
- Check textile availability prior to specifying upholstery material.
- Models can be ordered in Leather using appropriate grade.

**OPTIONAL FEATURES**

- For additional caster options, please refer to the Arm and Caster section.
- Optional casters may be priced higher than the standard casters for your chair and the difference will be charged. Lower priced optional casters will not be credited.
- P.

**OPTION CODES**

Please add option codes in the following order:





- **Model number**  
**6762-6** Task Chair w/Arms  
**6763-6** Task Chair without Arms  
**6764** Nesting Chair on Glides  
**6765** Nesting Chair w/arms on Glides  
**6767-6** Height Adjustable Stool without Arms  
**6768-6** Height Adjustable Stool w/Arms
- Add **(-C)** to model number if ordering with casters. Add **(-FC)** to model number if ordering Front casters/rear glides.
- **Fabric**  
Specify fabric code for seat.
- **Frame**  
**(TBL)** Black frame finish..... **Standard**  
**(TSH)** Shadow frame finish..... **Standard**  
**(TTU)** Tungsten frame finish..... **Standard**  
**(CHM)** Chrome frame finish..... **Add \$68**
- **Base** (task models/ height adjustable stools only)  
**(B-BK)** Black nylon base..... **Standard**
- **Casters** (task models /height adjustable stools only)  
**(C10)** Dual wheel carpet casters ..... **Standard**  
**(C10R)** Dual wheel hard floor casters..... **Add \$70**
- **Casters** (nesting models only)  
**(C1)** Dual wheel carpet casters ..... **Standard**  
**(C9R)** Dual wheel hard floor casters..... **Add \$78**
- **Mesh Back**  
**(U1)** Black  
**(U2)** Burgundy  
**(U3)** Blue  
**(U4)** Green  
(colors shown on website)
- **Chair Assembly**  
(task models /height adjustable stools only)  
**(-SU)** Assembled in Box..... **Add \$81**

**EXAMPLE OF ORDER CODE:** (Task models/Height Adjustable Stool Models)

6762-6	WA50	TBL	B-BK	C10	U2	SU
Model Number	Fabric	Frame	Base	Casters	Mesh	Chair Assembly

**EXAMPLE OF ORDER CODE:** (Nesting Models)

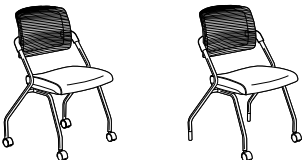
6764C	WA50	TTU	C9R	U2
Model Number	Fabric	Frame	Casters	Mesh

DESCRIPTION	FEATURES	MODEL#	STANDARD TEXTILE GRADES											
			1	2	3	4	5	6	7	8	9	10	11	12
 <p><b>Task Chair w/Arms</b> COM Yardage: 00.75 Freight Class: 250 Product Weight (lbs.): 29 Cubic Feet Per Carton: 9.75</p>		<b>6762-6</b>	830	865	886	922	970	994	1038	1108	1162	1222	1345	1479
			<b>OVERALL DIMENSIONS</b>			<b>SEAT DIMENSIONS</b>			<b>BACK DIMENSIONS</b>					
			<b>W</b>	<b>D</b>	<b>H</b>	<b>W</b>	<b>D</b>	<b>H</b>	<b>W</b>	<b>H</b>				
			23.5	20.5	31	18	16.5	15.5	17	16.5				
			<b>RTA 00</b>	<b>FedEx</b>		<b>ups</b>								
 <p><b>Task Chair without Arms</b> COM Yardage: 00.75 Freight Class: 250 Product Weight (lbs.): 28 Cubic Feet Per Carton: 9.75</p>		<b>6763-6</b>	794	827	849	885	932	956	1001	1071	1126	1186	1309	1443
			<b>OVERALL DIMENSIONS</b>			<b>SEAT DIMENSIONS</b>			<b>BACK DIMENSIONS</b>					
			<b>W</b>	<b>D</b>	<b>H</b>	<b>W</b>	<b>D</b>	<b>H</b>	<b>W</b>	<b>H</b>				
			20.5	20.5	31	18	16.5	15.5	17	16.5				
			<b>RTA 00</b>											
 <p><b>Armless Flip Seat Nesting Chair w/Glides</b> COM Yardage: 00.75 Freight Class: 300 Product Weight (lbs.): 22 Cubic Feet Per Carton: 11.25</p>	Seat Flips up for nesting Ergonomic Features: G, M, N	<b>6764</b>	689	722	744	778	826	851	896	964	1020	1079	1201	1336
			<b>OVERALL DIMENSIONS</b>			<b>SEAT DIMENSIONS</b>			<b>BACK DIMENSIONS</b>					
			<b>W</b>	<b>D</b>	<b>H</b>	<b>W</b>	<b>D</b>	<b>H</b>	<b>W</b>	<b>H</b>				
			20.5	23	33	18	17	17	17	16				
				<b>RTA 00</b>	<b>FedEx</b>		<b>ups</b>							
 <p><b>6764C</b>      <b>6764FC</b></p> <p><b>Armless Flip Seat Nesting Chair w/Casters</b> COM Yardage: 00.75 Freight Class: 300 Product Weight (lbs.): 22 Cubic Feet Per Carton: 11.25</p>	C= Casters all 4 legs FC= Casters on front legs only Seat Flips up for nesting Ergonomic Features: G, M, N	<b>6764C</b>	689	722	744	778	826	851	896	964	1020	1079	1201	1336
			<b>OVERALL DIMENSIONS</b>			<b>SEAT DIMENSIONS</b>			<b>BACK DIMENSIONS</b>					
			<b>W</b>	<b>D</b>	<b>H</b>	<b>W</b>	<b>D</b>	<b>H</b>	<b>W</b>	<b>H</b>				
			20.5	23	33	18	17	17	17	16				
				<b>RTA 00</b>	<b>FedEx</b>		<b>ups</b>							
 <p><b>Flip Seat Nesting Chair w/Arms &amp; Glides</b> COM Yardage: 0.75 Freight Class: 300 Product Weight (lbs.): 23 Cubic Feet Per Carton: 11.75</p>	Seat Flips up for nesting Ergonomic Features: G, M, N	<b>6765</b>	734	767	789	825	872	898	942	1011	1066	1126	1251	1384
			<b>OVERALL DIMENSIONS</b>			<b>SEAT DIMENSIONS</b>			<b>BACK DIMENSIONS</b>					
			<b>W</b>	<b>D</b>	<b>H</b>	<b>W</b>	<b>D</b>	<b>H</b>	<b>W</b>	<b>H</b>				
			23.75	23	33	18.5	17	17	17	16				
				<b>RTA 00</b>	<b>FedEx</b>		<b>ups</b>							

DESCRIPTION	FEATURES	MODEL#	STANDARD TEXTILE GRADES											
-------------	----------	--------	-------------------------	--	--	--	--	--	--	--	--	--	--	--

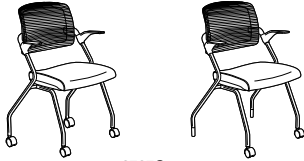

6765C

6765FC

**Flip Seat Nesting Chair w/Arms & Casters**

COM Yardage: 00.75  
 Freight Class: 300  
 Product Weight (lbs.): 23  
 Cubic Feet Per Carton: 11.75

C= Casters all 4 legs  
 FC=Casters on front legs only  
 Seat Flips up for nesting  
 Ergonomic Features:  
 G, M, N

MODEL#	1	2	3	4	5	6	7	8	9	10	11	12
6765C	734	767	789	825	872	898	942	1011	1066	1126	1251	1384
6765FC	734	767	789	825	872	898	942	1011	1066	1126	1251	1384

OVERALL DIMENSIONS			SEAT DIMENSIONS			BACK DIMENSIONS	
W	D	H	W	D	H	W	H
23.75	23	33	18.5	17	17	17	16



**Armless Height Adjustable Stool**

COM Yardage: 00.75  
 Freight Class: 250  
 Product Weight (lbs.): 28  
 Cubic Feet Per Carton: 9.75

MODEL#	1	2	3	4	5	6	7	8	9	10	11	12
6767-6	911	942	964	996	1043	1066	1107	1175	1225	1284	1401	1528

OVERALL DIMENSIONS			SEAT DIMENSIONS			BACK DIMENSIONS	
W	D	H	W	D	H	W	H
20.5	20.5	42.5	18	16.5	22	17	16.5



**Height Adjustable Stool w/Arms**

COM Yardage: 00.75  
 Freight Class: 250  
 Product Weight (lbs.): 31  
 Cubic Feet Per Carton: 9.75

MODEL#	1	2	3	4	5	6	7	8	9	10	11	12
6768-6	949	982	1004	1037	1082	1105	1145	1215	1265	1323	1441	1567

OVERALL DIMENSIONS			SEAT DIMENSIONS			BACK DIMENSIONS	
W	D	H	W	D	H	W	H
23.5	20.5	42.5	18	16.5	22	17	16.5



SPYKER™



Armless Chair  
model 6791



Armchair  
model 6790

STANDARD FEATURES



- A comfortable, high quality, lightweight, all polymer stacking chair intended for use indoors or outdoors. Products must be stored inside during extreme and inclement weather. See Global's Outdoor Furniture warranty for additional information.
- Perforations in the chair's seat and back provide ventilation and wet weather drainage.
- Weather resistant, UV resistant and stain resistant with a modern design.
- Chair legs are equipped with translucent non-marking glides as standard. Suitable for outdoor environments, carpet and hard surface flooring.
- All Spyker products are only available through Global's InStock program. Contact CustomerCare for lead times and quotation for quantities beyond InStock inventory.

- Chairs are stocked in 3 plastic finishes:  
Alloy (ALY)  
Char (CHA)  
Milk (MLK)
- No upholstery options available.
- Rated to 300 lbs.
- Spyker achieves its strength and durability using glass filled polymer. Evidence of this material may be visible on the surface and is often more evident in darker colors.

Chair Stacking Capability		
	Stacks on floor	Stacks on dolly
<b>Armless</b>		
6791	up to 10 high	up to 12 high (use 6783)
<b>With Arms</b>		
6790	up to 7 high	up to 7 high (use 6783)

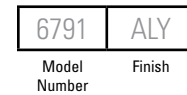
EXAMPLE OF SPYKER ORDER CODE:

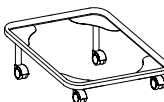

DESCRIPTION	FEATURES	MODEL#	STANDARD TEXTILE GRADES											
			1	2	3	4	5	6	7	8	9	10	11	12
 <b>Arm Chair</b> COM Yardage: N/A Freight Class: 92.5 Product Weight (lbs.): 9 Cubic Feet Per Carton: 16.24 (4 per carton)	Stacks 7 high on floor. Stacks 7 high on dolly.	6790	276											
			OVERALL DIMENSIONS			SEAT DIMENSIONS			BACK DIMENSIONS					
		23.23	20.86	31.29	17	17.75	17.71	17	15					
			RTA 00      FedEx      4 per carton (pricing and specifications are for one chair)											
 <b>Armless Chair</b> COM Yardage: N/A Freight Class: 92.5 Product Weight (lbs.): 8.2 Cubic Feet Per Carton: 14.08 (4 per carton)	Stacks 10 high on floor. Stacks 12 high on dolly.	6791	247											
			OVERALL DIMENSIONS			SEAT DIMENSIONS			BACK DIMENSIONS					
		17.91	20.86	31.29	17	17.75	17.71	17	15					
			RTA 00      4 per carton (pricing and specifications are for one chair)											
 <b>Dolly for Spyker and Bakhita Chairs</b> COM Yardage: N/A Freight Class: 250 Product Weight (lbs.): 11 Cubic Feet Per Carton: 2.9		6783	367											
			OVERALL DIMENSIONS			SEAT DIMENSIONS			BACK DIMENSIONS					
		19.75	23.25	9.75										
			RTA 00      FedEx      1 per carton											

## STREAM



model 2075APP  
Stacking, 4-Leg Arm Chair



model 2076NPU  
Stacking, Sled Base Chair, Armless



model 2075APPT  
4-Leg Chair, w/Tablet



model 2075CSAPP  
Stacking Bar Stool, w/Arms



model 2073APP  
Titrer Chair w/Arms

	Stream Chairs Stacking Capability		Stream Stools Stacking Capability
	Chair Stacking Capability		Stool Stacking Capability
	Stacks on floor	Stacks on dolly 2085	Stacks on floor only
<b>Four-Leg (Glide/Caster) + Sled Base Models</b>			
Polypropylene seat	up to 5 high	up to 15 high	up to 5 high
Poly back & Upholstered seat	up to 5 high	up to 10 high	up to 5 high
Upholstered seat & back	up to 5 high	up to 10 high	up to 5 high

## STANDARD FEATURES

- Stream multi-purpose product family includes: four-leg, sled base and 5 star base chairs in addition to bar, counter and height adjustable stools.
- Seats and backs are made of perforated polypropylene, with or without arms. Choose from 14 finishes, arm color matches seat/back finish.
- Four-leg and sled base chairs and stools are stackable. See stacking chart for details. Bases are available in 20 painted or four metallic finishes (see upcharges).
- Four-leg chair models are available with glides or casters, see upcharge. Chairs stack with glides and casters.
- A selection of glide options is available. Glides must be chosen to best suit flooring type and site conditions. For more information, please refer to the glide section.
- Bullet-shaped glides may be specified in any plastic color. A natural, non-marking bullet-shaped glide is available where colored glides may be a concern. Bullet-shaped glides are not recommended for LVT flooring.
- Glides are included on sled base chairs. Select black or opaque, non-marking glide finish.
- Upholstered models are equipped with a color matching shroud beneath the seat.
- Tablet models are available. Backpack racks are available on four-leg models only.
- Chairs with tablet or backpack racks do not stack.
- Tablet arms are extremely rugged and meet ANSI-BIFMA testing requirements. Tablets hinge up to allow ease of egress and slide forward and back to comfortably fit most users.
- Standard tablet size is 18"D x 14.5"W and is made of Black polymer (D8). Tablets are specified left (LT) or right (RT) as seated.
- Five-star base chairs have a swivel tilt mechanism.
- Height adjustable stools have a simple swivel mechanism.
- Five-star and height-adjustable stool bases are Black nylon or Polished Aluminum (see upcharge). Dual wheel casters are available for carpet or hard floor casters. See upcharge.
- Check textile availability prior to specifying upholstery material.

## OPTIONAL FEATURES







- An optional 18.5"D x 18.5"W high pressure laminate writing tablet is available. The core is hardwood veneer plywood with radiused edge finished in clear lacquer. This writing tablet is offered in the following finishes: Black (BLK), Clear Maple (CMB), Designer White (DWT) and Noce Grigio (NGL). Please specify. Add \$68.



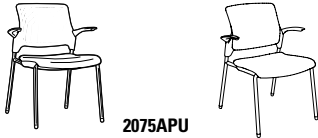

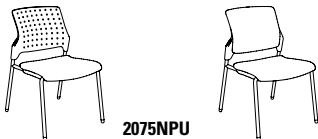

Add options codes in the following order:









- Model number**  
Enter Model number.
- Textile** (UU and PU models)  
Specify textile code for back (UU models only). Specify textile code for seat (PU, UU models only).
- Seat/back finish** (no upcharge)  
(BZB) Buzz Blue (CCT) Cactus  
(CRB) Carrot (IVC) Cloud  
(DJB) Dijon (EGP) Eggplant  
(FOG) Fog (FRO) Frost  
(INK) Ink (LAB) Latte  
(BLK) Night (SND) Sand  
(SAR) Scarlet (SHW) Shadow
- Frame Type** (four-leg base models)  
(FG) Glides  
(FC) Casters. Add \$117
- Glide Type** (four-leg base)  
(BG) Bullet Glide for Some Hard Floor and Carpeted Surfaces.  
(FG) Felt Glide for Most Hard Floor Surfaces. Add \$36.  
(RG) Rubber Non-slip Glide for Most Hard Floor Surfaces. Add \$36.  
(SG) Steel Cushioned Glide for Carpeted Surfaces. Add \$36.
- Bullet glide finish** (four-legged chair and stool models)  
(BZB) Buzz Blue (CCT) Cactus  
(CRB) Carrot (IVC) Cloud  
(DJB) Dijon (EGP) Eggplant  
(FOG) Fog (FRO) Frost  
(INK) Ink (LAB) Latte  
(BLK) Night (SND) Sand  
(SAR) Scarlet (SHW) Shadow  
(NAT) Natural non-marking
- Glide Type** (sled base models)  
(GL) Black glides.  
(NM) Opaque non-marking glides.
- Frame Finish** (Four-legged/sled base models only)  
(TBL) Black (TBZ) Buzz Blue  
(TCC) Cactus (TCR) Carrot  
(TDJ) Dijon (TDW) Designer White  
(TEG) Eggplant (TFO) Fog  
(TFR) Frost (TIN) Ink  
(TIV) Cloud (TKA) Kalua  
(TLA) Latte (TMO) Mocha  
(TOA) Toast (TNE) Nevada  
(TSH) Shadow (TSN) Sand  
(TSR) Scarlet (TTU) Tungsten  
Metallic Finishes: Chairs Stools  
(BCH) Brushed Chrome Add \$184 Add \$274  
(CHM) Chrome. Add \$51 Add \$98  
**Caster type** (four-leg with FC caster selection)  
(DC) C107 carpet.  
(RC) C107R hard floor. Add \$25.
- Base (five star base models)**  
(B7) Black nylon base. No upcharge.  
(A7) Polished Aluminum base. Add 177.
- Caster type (Five star base)**  
(82) 82 dual wheel carpet casters. No upcharge.  
(8R) 8R dual wheel hard floor casters. Add \$94.
- Tablet** ("T" models)  
(LT) Left  
(RT) Right
- Tablet option** ("T" models)  
(D8) Black polymer. Black polymer 18"Dx14.5"W. No upcharge.  
Laminate finish (18.5"D x 18.5"W). Add \$68  
(BLK) Black laminate. Add \$68.  
(CMB) Clear Maple laminate. Add \$68.  
(DWT) Designer White laminate. Add \$68.  
(NGL) Noce Grigio laminate. Add \$68.









## EXAMPLE STREAM ORDER CODE:





2075NPP	-	-	-IVC	-FG	-BLK	-CHM	-	-	-
Model #	Back textile	Seat textile	Seat/back finish	Glides/Casters	Glide color	Frame finish	Caster type	Tablet	Tablet finish





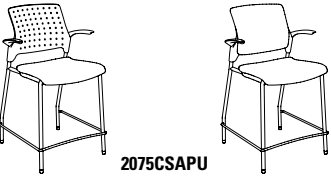

DESCRIPTION	FEATURES	MODEL#	STANDARD TEXTILE GRADES														
			1	2	3	4	5	6	7	8	9	10	11	12			
 <p><b>Armchair</b> COM Yardage: N/A Freight Class: 250 Product Weight (lbs.): 15.5 Cubic Feet Per Carton: 14</p>	<p>Glides + Casters Stacks 5 high on floor. Stacks 15 high on dolly.</p>	<p><b>2075APP</b> 523 Polypropylene seat &amp; back</p>															
			<b>OVERALL DIMENSIONS</b>			<b>SEAT DIMENSIONS</b>			<b>BACK DIMENSIONS</b>								
			<b>W</b>	<b>D</b>	<b>H</b>	<b>W</b>	<b>D</b>	<b>H</b>	<b>W</b>	<b>H</b>							
			24	25	33.25	18	18	17	16	16.5							
			<p><b>RTA 00</b> 4 per carton (pricing and specifications are for one seat unit)</p>														
  <p><b>2075APU</b>      <b>2075AAU</b></p>	<p>Glides + Casters Stacks 5 high on floor. Stacks 10 high on dolly.</p>	<p><b>2075APU</b> 716 743 764 792 835 853 892 952 997 1049 1154 1268 Upholstered seat</p> <p><b>2075AAU</b> 836 863 884 911 955 973 1012 1072 1117 1170 1275 1390 Upholstered seat &amp; back</p>															
			<b>OVERALL DIMENSIONS</b>			<b>SEAT DIMENSIONS</b>			<b>BACK DIMENSIONS</b>								
			<b>W</b>	<b>D</b>	<b>H</b>	<b>W</b>	<b>D</b>	<b>H</b>	<b>W</b>	<b>H</b>							
			24	25	33.25	17.5	18	17.5	16	16							
			<p><b>RTA 00</b> 4 per carton (pricing and specifications are for one seat unit)</p>														
 <p><b>Armless Chair</b> COM Yardage: N/A Freight Class: 250 Product Weight: 12.25 Cubic Feet Per Carton: 13</p>	<p>Glides + Casters Stacks 5 high on floor. Stacks 15 high on dolly.</p>	<p><b>2075NPP</b> 407 Polypropylene seat &amp; back</p>															
			<b>OVERALL DIMENSIONS</b>			<b>SEAT DIMENSIONS</b>			<b>BACK DIMENSIONS</b>								
			<b>W</b>	<b>D</b>	<b>H</b>	<b>W</b>	<b>D</b>	<b>H</b>	<b>W</b>	<b>H</b>							
			20.5	25	33.25	18	18	18	16	16.5							
			<p><b>RTA 00</b> 4 per carton (pricing and specifications are for one seat unit)</p>														
  <p><b>2075NPU</b>      <b>2075NUU</b></p>	<p>Glides + Casters Stacks 5 high on floor. Stacks 10 high on dolly.</p>	<p><b>2075NPU</b> 608 635 654 681 720 740 776 834 879 928 1030 1140 Upholstered seat</p> <p><b>2075NUU</b> 724 752 772 798 838 858 893 952 998 1046 1150 1258 Upholstered seat &amp; back</p>															
			<b>OVERALL DIMENSIONS</b>			<b>SEAT DIMENSIONS</b>			<b>BACK DIMENSIONS</b>								
			<b>W</b>	<b>D</b>	<b>H</b>	<b>W</b>	<b>D</b>	<b>H</b>	<b>W</b>	<b>H</b>							
			20.5	25	33.25	18	18	17.5	16	16							
			<p><b>RTA 00</b> 4 per carton (pricing and specifications are for one seat unit)</p>														
 <p><b>Armchair w/Tablet</b> COM Yardage: N/A Freight Class: 300 Product Weight: 26 Cubic Feet Per Carton: 14.75</p>	<p>Specify (L) left or (R) right tablet (Example: 2075APPTL or 2075APPTR). Does not stack.</p>	<p><b>2075APPT</b> 857 Polypropylene seat &amp; back</p>															
			<b>OVERALL DIMENSIONS</b>			<b>SEAT DIMENSIONS</b>			<b>BACK DIMENSIONS</b>								
			<b>W</b>	<b>D</b>	<b>H</b>	<b>W</b>	<b>D</b>	<b>H</b>	<b>W</b>	<b>H</b>							
			26.5	27.25	33.25	18	18	17	16	16.5							
			<p><b>RTA 00</b> 1 per carton</p>														





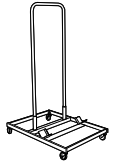

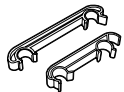
DESCRIPTION	FEATURES	MODEL#	STANDARD TEXTILE GRADES											
			1	2	3	4	5	6	7	8	9	10	11	12
 <b>2075NPUT</b>	 <b>2075NUUT</b>	<b>2075NPUT</b> 934 963 985 1018 1065 1086 1129 1195 1247 1305 1423 1549 Upholstered seat												
			<b>2075NUUT</b> 1054 1083 1105 1138 1184 1205 1248 1313 1365 1421 1537 1662 Upholstered seat & back											
<b>OVERALL DIMENSIONS</b> W D H			<b>SEAT DIMENSIONS</b> W D H			<b>BACK DIMENSIONS</b> W H								
26.5 27.25 33.25			18 18 17.5			16 16								
Armless Chair w/Tablet COM Yardage: 0.75 Freight Class: 250 Product Weight: 31 Cubic Feet Per Carton: 14.75			Specify (L) left or (R) right tablet  Does not stack.			<b>RTA 00</b> 1 per carton								
		<b>2075NPPT</b> 741 Polypropylene seat & back												
	<b>OVERALL DIMENSIONS</b> W D H			<b>SEAT DIMENSIONS</b> W D H			<b>BACK DIMENSIONS</b> W H							
25 27.25 33.25			18 18 17			16.5 16								
Armless Chair w/Tablet COM Yardage: N/A Freight Class: 300 Product Weight: 26 Cubic Feet Per Carton: 14.75			Specify (L) left or (R) right tablet  Does not stack.			<b>RTA 00</b> 1 per carton								
 <b>2075NPUT</b>	 <b>2075NUUT</b>	<b>2075NPUT</b> 934 963 985 1018 1065 1086 1129 1195 1247 1305 1423 1549 Upholstered seat												
			<b>2075NUUT</b> 1054 1083 1105 1138 1184 1205 1248 1313 1365 1421 1537 1662 Upholstered seat & back											
<b>OVERALL DIMENSIONS</b> W D H			<b>SEAT DIMENSIONS</b> W D H			<b>BACK DIMENSIONS</b> W H								
25 27.25 33.25			18 18 17.5			16 16.5								
Armless Chair w/Tablet COM Yardage: 0.75 Freight Class: 300 Product Weight: 29 Cubic Feet Per Carton: 14.75			Specify (L) left or (R) right tablet  Does not stack.			<b>RTA 00</b> 1 per carton								
		<b>2075BRAPP</b> 681 Polypropylene seat & back												
	<b>OVERALL DIMENSIONS</b> W D H			<b>SEAT DIMENSIONS</b> W D H			<b>BACK DIMENSIONS</b> W H							
24 25 33.25			18 18 17			16 16.5								
Armchair w/Backpack Rack COM Yardage: N/A Freight Class: 300 Product Weight: 24 Cubic Feet Per Carton: 14			Does not stack.			<b>RTA 00</b> 1 per carton								
		<b>2075BRNPP</b> 573 Polypropylene seat & back												
	<b>OVERALL DIMENSIONS</b> W D H			<b>SEAT DIMENSIONS</b> W D H			<b>BACK DIMENSIONS</b> W H							
20.5 25 33.25			18 18 18			16 16.5								
Armless Chair w/Backpack Rack COM Yardage: N/A Freight Class: 300 Product Weight: 20			Does not stack.			<b>RTA 00</b> 1 per carton								

DESCRIPTION	FEATURES	MODEL#	STANDARD TEXTILE GRADES													
			1	2	3	4	5	6	7	8	9	10	11	12		
 2075BRNPU  2075BRNUU	Does not stack.	2075BRNPU 766 795 816 846 890 911 950 1012 1060 1114 1222 1340 Upholstered seat  2075BRNUU 889 917 938 968 1011 1032 1070 1134 1181 1234 1344 1462 Upholstered seat & back	OVERALL DIMENSIONS			SEAT DIMENSIONS			BACK DIMENSIONS							
			W	D	H	W	D	H	W	H						
			20.5	25	33.25	18	18	17.5	16	16						
			<b>RTA 00</b>	1 per carton												
 2075BRNPPT	Specify (L) left or (R) right tablet Does not stack.	2075BRNPPT 900 Polypropylene seat & back	OVERALL DIMENSIONS			SEAT DIMENSIONS			BACK DIMENSIONS							
			W	D	H	W	D	H	W	H						
			27.25	27.25	33.25	18	18	17	16	16.5						
			<b>RTA 00</b>	1 per carton												
 2075BRNPUT  2075BRNUUT	Specify (L) left or (R) right tablet Does not stack.	2075BRNPUT \$1092 \$1121 \$1143 \$1175 \$1219 \$1242 \$1282 \$1348 \$1397 \$1453 \$1569 \$1691 Upholstered seat  2075BRNUUT \$1215 \$1244 \$1265 \$1298 \$1341 \$1363 \$1404 \$1468 \$1518 \$1575 \$1689 \$1811 Upholstered seat & back	OVERALL DIMENSIONS			SEAT DIMENSIONS			BACK DIMENSIONS							
			W	D	H	W	D	H	W	H						
			25	27.25	33.25	18	18	17.5	16	16						
			<b>RTA 00</b>	1 per carton												
 2076APU  2076AAU	Stacks 5 high on floor. Stacks 15 high on dolly.	2076APP \$587 Polypropylene seat & back	OVERALL DIMENSIONS			SEAT DIMENSIONS			BACK DIMENSIONS							
			W	D	H	W	D	H	W	H						
			25.5	24	33.25	18	18	17	16	16.5						
			<b>RTA 00</b>	4 per carton (pricing and specifications are for one seat unit)												
 2076APU  2076AAU	Stacks 5 high on floor. Stacks 10 high on dolly.	2076APU 779 807 827 857 898 917 956 1016 1061 1114 1219 1334 Upholstered seat  2076AAU 901 930 950 980 1022 1041 1079 1139 1188 1238 1347 1461 Upholstered seat & back	OVERALL DIMENSIONS			SEAT DIMENSIONS			BACK DIMENSIONS							
			W	D	H	W	D	H	W	H						
			24	25	33.25	18	18	17.5	16	16						
			<b>RTA 00</b>	4 per carton (pricing and specifications are for one seat unit)												

DESCRIPTION	FEATURES	MODEL#	STANDARD TEXTILE GRADES											
			1	2	3	4	5	6	7	8	9	10	11	12
 <b>2076APU</b>	 <b>2076AAU</b>	<b>2076APU</b> 779 807 827 857 898 917 956 1016 1061 1114 1219 1334 Upholstered seat  <b>2076AAU</b> 901 930 950 980 1022 1041 1079 1139 1188 1238 1347 1461 Upholstered seat & back	<b>OVERALL DIMENSIONS</b>			<b>SEAT DIMENSIONS</b>			<b>BACK DIMENSIONS</b>					
			<b>W</b>	<b>D</b>	<b>H</b>	<b>W</b>	<b>D</b>	<b>H</b>	<b>W</b>	<b>H</b>				
Armchair w/Sled Base COM Yardage: 0.75 Freight Class: 250 Product Weight: 19.5 Cubic Feet Per Carton: 14			Stacks 5 high on floor. Stacks 10 high on dolly.			<b>RTA 00</b>			4 per carton (pricing and specifications are for one seat unit)					
	<b>2076NPP</b> 470 Polypropylene seat & back	<b>OVERALL DIMENSIONS</b>			<b>SEAT DIMENSIONS</b>			<b>BACK DIMENSIONS</b>						
		<b>W</b>	<b>D</b>	<b>H</b>	<b>W</b>	<b>D</b>	<b>H</b>	<b>W</b>	<b>H</b>					
Armless Chair w/Sled Base COM Yardage: N/A Freight Class: 250 Product Weight: 12 Cubic Feet Per Carton: 13		Stacks 5 high on floor. Stacks 15 high on dolly.		<b>RTA 00</b>		4 per carton (pricing and specifications are for one seat unit)								
 <b>2076NPU</b>	 <b>2076NUU</b>	<b>2076NPU</b> 664 691 710 737 776 796 832 890 935 984 1084 1195 Upholstered seat  <b>2076NUU</b> 786 813 833 860 899 919 955 1014 1059 1108 1212 1321 Upholstered seat & back	<b>OVERALL DIMENSIONS</b>			<b>SEAT DIMENSIONS</b>			<b>BACK DIMENSIONS</b>					
			<b>W</b>	<b>D</b>	<b>H</b>	<b>W</b>	<b>D</b>	<b>H</b>	<b>W</b>	<b>H</b>				
Armless Chair w/Sled Base COM Yardage: 0.75 Freight Class: 150 Product Weight: 15 Cubic Feet Per Carton: 13		Stacks 5 high on floor. Stacks 10 high on dolly.		<b>RTA 00</b>		4 per carton (pricing and specifications are for one seat unit)								
	<b>2075BSAPP</b> 740 Polypropylene seat & back	<b>OVERALL DIMENSIONS</b>			<b>SEAT DIMENSIONS</b>			<b>BACK DIMENSIONS</b>						
		<b>W</b>	<b>D</b>	<b>H</b>	<b>W</b>	<b>D</b>	<b>H</b>	<b>W</b>	<b>H</b>					
Bar Stool w/Arms COM Yardage: N/A Freight Class: 250 Product Weight: 25 Cubic Feet Per Carton: 10.75		Stacks 5 high on floor.		<b>RTA 00</b>		2 per carton (pricing and specifications are for one seat unit)								
 <b>2075BSAPU</b>	 <b>2075BSAAU</b>	<b>2075BSAPU</b> 932 960 981 1012 1054 1075 1114 1178 1226 1280 1390 1509 Upholstered seat  <b>2075BSAAU</b> 1053 1081 1102 1132 1175 1196 1235 1299 1346 1401 1511 1628 Upholstered seat & back	<b>OVERALL DIMENSIONS</b>			<b>SEAT DIMENSIONS</b>			<b>BACK DIMENSIONS</b>					
			<b>W</b>	<b>D</b>	<b>H</b>	<b>W</b>	<b>D</b>	<b>H</b>	<b>W</b>	<b>H</b>				
Bar Stool w/Arms COM Yardage: 0.75 Freight Class: 250 Product Weight: 28 Cubic Feet Per Carton: 21.5		Stacks 5 high on floor.		<b>RTA 00</b>		2 per carton (pricing and specifications are for one seat unit)								

DESCRIPTION	FEATURES	MODEL#	STANDARD TEXTILE GRADES														
			1	2	3	4	5	6	7	8	9	10	11	12			
 <p><b>Armless Bar Stool</b> COM Yardage: N/A Freight Class: 250 Product Weight: 21 Cubic Feet Per Carton: 17.75</p>	Stacks 5 high on floor.	2075BSNPP 625 Polypropylene seat & back															
			<b>OVERALL DIMENSIONS</b>			<b>SEAT DIMENSIONS</b>			<b>BACK DIMENSIONS</b>								
			<b>W</b>	<b>D</b>	<b>H</b>	<b>W</b>	<b>D</b>	<b>H</b>	<b>W</b>	<b>H</b>							
			22	24.75	45	18	18	29	16	16.5							
			<b>RTA 00</b>	2 per carton (pricing and specifications are for one seat unit)													
 <p><b>2075BSNPU</b>      <b>2075BSNUU</b></p> <p><b>Armless Bar Stool</b> COM Yardage: 0.75 Freight Class: 250 Product Weight: 24 Cubic Feet Per Carton: 17.75</p>	Stacks 5 high on floor.	<b>2075BSNPU</b> 817 845 865 895 936 955 994 1054 1099 1152 1258 1372 Upholstered seat  <b>2075BSNUU</b> 938 967 987 1017 1059 1078 1116 1177 1225 1275 1385 1498 Upholstered seat & back															
			<b>OVERALL DIMENSIONS</b>			<b>SEAT DIMENSIONS</b>			<b>BACK DIMENSIONS</b>								
			<b>W</b>	<b>D</b>	<b>H</b>	<b>W</b>	<b>D</b>	<b>H</b>	<b>W</b>	<b>H</b>							
			22	24.75	45	18	18	29.5	16	16							
			<b>RTA 00</b>	2 per carton (pricing and specifications are for one seat unit)													
 <p><b>Counter Stool w/Arms</b> COM Yardage: N/A Freight Class: 250 Product Weight: 24 Cubic Feet Per Carton: 21.5</p>	Stacks 5 high on floor.	2075CSAPP 740 Polypropylene seat & back															
			<b>OVERALL DIMENSIONS</b>			<b>SEAT DIMENSIONS</b>			<b>BACK DIMENSIONS</b>								
			<b>W</b>	<b>D</b>	<b>H</b>	<b>W</b>	<b>D</b>	<b>H</b>	<b>W</b>	<b>H</b>							
			24	24.75	40	18	18	24	16	16.5							
			<b>RTA 00</b>	2 per carton (pricing and specifications are for one seat unit)													
 <p><b>2075CSAPU</b>      <b>2075CSAUAU</b></p> <p><b>Counter Stool w/Arms</b> COM Yardage: 0.75 Freight Class: 250 Product Weight: 27 Cubic Feet Per Carton: 21.5</p>	Stacks 5 high on floor.	<b>2075CSAPU</b> 932 963 984 1017 1064 1087 1129 1196 1250 1307 1426 1554 Upholstered seat  <b>2075CSAUAU</b> 1053 1082 1104 1137 1184 1205 1248 1314 1366 1424 1543 1669 Upholstered seat & back															
			<b>OVERALL DIMENSIONS</b>			<b>SEAT DIMENSIONS</b>			<b>BACK DIMENSIONS</b>								
			<b>W</b>	<b>D</b>	<b>H</b>	<b>W</b>	<b>D</b>	<b>H</b>	<b>W</b>	<b>H</b>							
			24	24.75	40	18	18	24.5	16	16							
			<b>RTA 00</b>	2 per carton (pricing and specifications are for one seat unit)													
 <p><b>Armless Counter Stool</b> COM Yardage: N/A Freight Class: 250 Product Weight: 20 Cubic Feet Per Carton: 19</p>	Stacks 5 high on floor.	2075CSNPP 625 Polypropylene seat & back															
			<b>OVERALL DIMENSIONS</b>			<b>SEAT DIMENSIONS</b>			<b>BACK DIMENSIONS</b>								
			<b>W</b>	<b>D</b>	<b>H</b>	<b>W</b>	<b>D</b>	<b>H</b>	<b>W</b>	<b>H</b>							
			22	24.75	40	18	18	24	16	16.5							
			<b>RTA 00</b>	2 per carton (pricing and specifications are for one seat unit)													

DESCRIPTION	FEATURES	MODEL#	STANDARD TEXTILE GRADES																																																															
			1	2	3	4	5	6	7	8	9	10	11	12																																																				
 <b>2075CSNPU</b>	 <b>2075CSNUU</b>		<table border="1"> <tr> <td><b>2075CSNPU</b></td> <td>817</td> <td>846</td> <td>868</td> <td>900</td> <td>947</td> <td>968</td> <td>1010</td> <td>1074</td> <td>1127</td> <td>1183</td> <td>1298</td> <td>1422</td> </tr> <tr> <td colspan="13">Upholstered seat</td> </tr> <tr> <td><b>2075CSNUU</b></td> <td>938</td> <td>967</td> <td>989</td> <td>1021</td> <td>1065</td> <td>1088</td> <td>1128</td> <td>1194</td> <td>1244</td> <td>1300</td> <td>1415</td> <td>1537</td> </tr> <tr> <td colspan="13">Upholstered seat &amp; back</td> </tr> </table>												<b>2075CSNPU</b>	817	846	868	900	947	968	1010	1074	1127	1183	1298	1422	Upholstered seat													<b>2075CSNUU</b>	938	967	989	1021	1065	1088	1128	1194	1244	1300	1415	1537	Upholstered seat & back												
			<b>2075CSNPU</b>	817	846	868	900	947	968	1010	1074	1127	1183	1298	1422																																																			
Upholstered seat																																																																		
<b>2075CSNUU</b>	938	967	989	1021	1065	1088	1128	1194	1244	1300	1415	1537																																																						
Upholstered seat & back																																																																		
<b>OVERALL DIMENSIONS</b> W    D    H			<b>SEAT DIMENSIONS</b> W    D    H			<b>BACK DIMENSIONS</b> W    H																																																												
22    24.75    40			18    18    24.5			16    16																																																												
<b>Armless Counter Stool</b> COM Yardage: 0.75 Freight Class: 250 Product Weight: 23 Cubic Feet Per Carton: 19			Stacks 5 high on floor.			<b>RTA 00</b>			2 per carton (pricing and specifications are for one seat unit)																																																									
			<table border="1"> <tr> <td><b>2085</b></td> <td>834</td> <td></td> <td></td> <td></td> <td></td> <td></td> <td></td> <td></td> <td></td> <td></td> <td></td> <td></td> </tr> </table>												<b>2085</b>	834																																																		
			<b>2085</b>	834																																																														
<b>OVERALL DIMENSIONS</b> W    D    H			<b>SEAT DIMENSIONS</b> W    D    H			<b>BACK DIMENSIONS</b> W    H																																																												
24    33.5    53																																																																		
<b>Dolly</b> COM Yardage: N/A Freight Class: 125 Product Weight: 41 Cubic Feet Per Carton: 6.75			Accommodates 10-15 chairs depending on model.			<b>RTA 00</b>			 2 per carton																																																									
			<table border="1"> <tr> <td><b>5233</b></td> <td>\$35</td> <td></td> <td></td> <td></td> <td></td> <td></td> <td></td> <td></td> <td></td> <td></td> <td></td> <td></td> </tr> </table>												<b>5233</b>	\$35																																																		
			<b>5233</b>	\$35																																																														
<b>OVERALL DIMENSIONS</b> W    D    H			<b>SEAT DIMENSIONS</b> W    D    H			<b>BACK DIMENSIONS</b> W    H																																																												
.87    0.75    1																																																																		
<b>Ganging Clamps - Set of 2</b> COM Yardage: N/A Freight Class: 70 Product Weight: .20 Cubic Feet Per Carton: .04			For use with armchair models. Chair clearance 0.25"			<b>RTA 00</b>			Pricing is for the set, specifications are for one clamp																																																									
			<table border="1"> <tr> <td><b>6526</b></td> <td>\$28</td> <td></td> <td></td> <td></td> <td></td> <td></td> <td></td> <td></td> <td></td> <td></td> <td></td> <td></td> </tr> </table>												<b>6526</b>	\$28																																																		
			<b>6526</b>	\$28																																																														
<b>OVERALL DIMENSIONS</b> W    D    H			<b>SEAT DIMENSIONS</b> W    D    H			<b>BACK DIMENSIONS</b> W    H																																																												
0.75    5.75    1.25																																																																		
<b>Ganging Brackets - Set of 2</b> COM Yardage: N/A Freight Class: 70 Product Weight: 0.01 Cubic Feet Per Carton: 0.02			For use with armless models. Chair clearance 0.25"			<b>RTA 00</b>			Pricing is for the set, specifications are for one clamp																																																									
			<table border="1"> <tr> <td><b>2073APP</b></td> <td>\$920</td> <td></td> <td></td> <td></td> <td></td> <td></td> <td></td> <td></td> <td></td> <td></td> <td></td> <td></td> </tr> <tr> <td colspan="13">Polypropylene seat &amp; back</td> </tr> </table>												<b>2073APP</b>	\$920												Polypropylene seat & back																																						
			<b>2073APP</b>	\$920																																																														
Polypropylene seat & back																																																																		
<b>OVERALL DIMENSIONS</b> W    D    H			<b>SEAT DIMENSIONS</b> W    D    H			<b>BACK DIMENSIONS</b> W    H																																																												
24    23.5    33.5			18    18    15.5-20.5			16    16.5																																																												
<b>Tilter Chair w/Arms</b> COM Yardage: N/A Freight Class: 250 Product Weight (lbs.):34 Cubic Feet Per Carton: 15.5						<b>RTA 00</b>			1 per carton																																																									





DESCRIPTION	FEATURES	MODEL#	STANDARD TEXTILE GRADES											
			1	2	3	4	5	6	7	8	9	10	11	12
 <b>2073APU</b>	 <b>2073AUU</b>	<b>2073APU</b>	\$1115	\$1144	\$1165	\$1198	\$1242	\$1263	\$1304	\$1370	\$1420	\$1475	\$1591	\$1712
		Upholstered seat												
		<b>2073AUU</b>	\$1236	\$1265	\$1286	\$1317	\$1362	\$1384	\$1424	\$1489	\$1538	\$1594	\$1709	\$1830
		Upholstered seat & back												
		<b>OVERALL DIMENSIONS</b>			<b>SEAT DIMENSIONS</b>			<b>BACK DIMENSIONS</b>						
		<b>W</b>	<b>D</b>	<b>H</b>	<b>W</b>	<b>D</b>	<b>H</b>	<b>W</b>	<b>H</b>					
		24	23.5	33.5	18	18	16-21	16	16					
				<b>RTA 00</b>	1 per carton									
		<b>2073NPP</b>	\$822	Polypropylene seat & back										
	<b>OVERALL DIMENSIONS</b>													
<b>W D H</b>														
20.5 23.5 33.5														
<b>SEAT DIMENSIONS</b>														
<b>W D H</b>														
18 18 15.5-20.5														
<b>BACK DIMENSIONS</b>														
<b>W H</b>														
16 16.5														
				<b>RTA 00</b>	1 per carton									
 <b>2073NPU</b>	 <b>2073NUU</b>	<b>2073NPU</b>	\$1016	\$1045	\$1066	\$1097	\$1142	\$1163	\$1204	\$1268	\$1318	\$1372	\$1488	\$1609
		Upholstered seat												
		<b>2073NUU</b>	\$1137	\$1166	\$1187	\$1218	\$1262	\$1284	\$1324	\$1388	\$1438	\$1492	\$1606	\$1726
		Upholstered seat & back												
		<b>OVERALL DIMENSIONS</b>			<b>SEAT DIMENSIONS</b>			<b>BACK DIMENSIONS</b>						
		<b>W</b>	<b>D</b>	<b>H</b>	<b>W</b>	<b>D</b>	<b>H</b>	<b>W</b>	<b>H</b>					
		20.5	23.5	33.5	18	18	16-21	16	16					
				<b>RTA 00</b>	1 per carton									
		<b>2074APP</b>	\$1039	Polypropylene seat & back										
	<b>OVERALL DIMENSIONS</b>													
<b>W D H</b>														
24 23.5 43														
<b>SEAT DIMENSIONS</b>														
<b>W D H</b>														
18 18 22-32														
<b>BACK DIMENSIONS</b>														
<b>W H</b>														
16 16.5														
				<b>RTA 00</b>	1 per carton									

**Tilter Chair w/Arms**  
 COM Yardage: .75  
 Freight Class: 250  
 Product Weight: 39  
 Cubic Feet Per Carton: 15.5

**Armless Tilter Chair**  
 COM Yardage: N/A  
 Freight Class: 300  
 Product Weight (lbs.): 30  
 Cubic Feet Per Carton:

**Armless Tilter Chair**  
 COM Yardage: 0.75  
 Freight Class: 300  
 Product Weight: 33  
 Cubic Feet Per Carton: 15.5

**Height Adjustable Stool w/Arms**  
 COM Yardage: N/A  
 Freight Class: 300  
 Product Weight (lbs.): 37  
 Cubic Feet Per Carton: 19.5

DESCRIPTION	FEATURES	MODEL#	STANDARD TEXTILE GRADES											
			1	2	3	4	5	6	7	8	9	10	11	12
 <b>2074APU</b>	 <b>2074AUU</b>	<b>2074APU</b> \$1231 \$1263 \$1284 \$1319 \$1365 \$1387 \$1429 \$1498 \$1551 \$1608 \$1728 \$1857 Upholstered seat												
		<b>2074AUU</b> \$1352 \$1381 \$1404 \$1437 \$1484 \$1505 \$1548 \$1614 \$1666 \$1726 \$1844 \$1971 Upholstered seat & back												
<b>Height Adjustable Stool w/Arms</b> COM Yardage: 0.75 Freight Class: 250 Product Weight: 40 Cubic Feet Per Carton: 19.5			<b>OVERALL DIMENSIONS</b> <b>W D H</b>			<b>SEAT DIMENSIONS</b> <b>W D H</b>			<b>BACK DIMENSIONS</b> <b>W H</b>					
			24	23.5	43	18	18	22.5-32.5	16	16				
		<b>RTA 00</b>	1 per carton											
		<b>2074NPP</b> \$918 Polypropylene seat & back												
	<b>Armless Height Adjustable Stool</b> COM Yardage: N/A Freight Class: 300 Product Weight (lbs.): 33 Cubic Feet Per Carton: 19.5			<b>OVERALL DIMENSIONS</b> <b>W D H</b>			<b>SEAT DIMENSIONS</b> <b>W D H</b>			<b>BACK DIMENSIONS</b> <b>W H</b>				
			20.5	23.5	43	18	18	22-32	16	16.5				
		<b>RTA 00</b>	1 per carton											
 <b>2074NPU</b>	 <b>2074NUU</b>	<b>2074NPU</b> \$1110 \$1139 \$1161 \$1194 \$1241 \$1261 \$1304 \$1370 \$1421 \$1478 \$1597 \$1719 Upholstered seat												
		<b>2074NUU</b> \$1233 \$1264 \$1285 \$1317 \$1364 \$1385 \$1427 \$1492 \$1544 \$1600 \$1715 \$1840 Upholstered seat & back												
<b>Armless Height Adjustable Stool</b> COM Yardage: 0.75 Freight Class: 300 Product Weight: 38 Cubic Feet Per Carton: 19.5			<b>OVERALL DIMENSIONS</b> <b>W D H</b>			<b>SEAT DIMENSIONS</b> <b>W D H</b>			<b>BACK DIMENSIONS</b> <b>W H</b>					
			20.5	23.5	43	18	18	22.5-32.5	16	16				
		<b>RTA 00</b>	1 per carton											

TWILIGHT™



model 2194 (BK)







model 2198C (TUN)

STANDARD FEATURES

- Twilight series armchairs and barstools feature a flared back design.
- Chairs can stack 5 high on floor and 8 high on dolly 2125WS. Stools do not stack.
- Comet series tables and connecting brackets are compatible with Twilight models.
- Arm and Armless models can be joined together using ganging clamp model 2180.
- All Twilight models have welded corner gussets for additional strength & support.
- **Specifications and pricing are for 1 chair.**
- Check textile availability prior to specifying upholstery material.

OPTIONAL FEATURES

- Frames available in Black (TBL) or Tungsten (TTU).
- Optional steel cushioned glides (B) are available on all models. Add \$33. Please specify.
- Models featuring a wood veneer back are available in Absolute (AAM), Black (BKM), Cherry (ACM), Espresso Cafe (ECM), English Oak (EOM), Fruitwood (TFM), Gray (HGM), Honey (AHM), Mahogany (TMM), Maple (AVM), Medium Walnut (MWM), Night (ASM), Noce Biondo (NBM), Noce Grigio (NGM), Noce Leggero (NEM), Noce Medio (NMM), Shaker Cherry (SKM), Walnut (TWM), WC Cream (WTM), White (WHM) and Winter Cherry (WCM). Please Specify. Genuine maple faced veneers and solids are used.
- Models featuring wood veneer backs can incorporate a custom logo. Please contact Customer Service for further details.

DESCRIPTION	FEATURES	MODEL#	STANDARD TEXTILE GRADES													
			1	2	3	4	5	6	7	8	9	10	11	12		
 2194	 2194WS	Armchair Upholstered Back COM Yardage: 1.25 Freight Class: 250 Product Weight (lbs.): 21 Cubic Feet Per Carton: 6.25 (2 per carton)	Stacks 5 high on floor. Stacks 8 high on dolly. Ergonomic Features: M, N	2194	\$682	\$733	\$771	\$820	\$899	\$939	\$1012	\$1110	\$1212	\$1291	\$1501	\$1712
				2194WS	\$708	\$758	\$800	\$856	\$938	\$967	\$1041	\$1177	\$1241	\$1368	\$1539	\$1754
				OVERALL DIMENSIONS			SEAT DIMENSIONS			BACK DIMENSIONS						
				W	D	H	W	D	H	W	H					
				23.5	22	35	18	16	18	18	16					
				RTA 00												
 2194C	Armchair w/Casters Upholstered Back COM Yardage: 1.25 Freight Class: 250 Product Weight (lbs.): 21 Cubic Feet Per Carton: 6.25 (2 per carton)	Stacks 5 high on floor. Stacks 8 high on dolly. Ergonomic Features: M, N	2194C	\$800	\$850	\$889	\$938	\$1018	\$1046	\$1111	\$1238	\$1302	\$1417	\$1580	\$1781	
							OVERALL DIMENSIONS			SEAT DIMENSIONS			BACK DIMENSIONS			
				W	D	H	W	D	H	W	H					
				23.5	22	35	18	16	18	18	18.5					
				RTA 00												
 2195	 2195WS	Armless Chair Upholstered Back COM Yardage: 1.25 Freight Class: 250 Product Weight (lbs.): 18 Cubic Feet Per Carton: 6.25 (2 per carton)	Stacks 5 high on floor. Stacks 8 high on dolly. Ergonomic Features: M, N	2195	\$591	\$639	\$675	\$729	\$808	\$846	\$917	\$1017	\$1114	\$1193	\$1407	\$1617
				2195WS	\$616	\$667	\$708	\$766	\$846	\$876	\$949	\$1084	\$1149	\$1277	\$1447	\$1662
				OVERALL DIMENSIONS			SEAT DIMENSIONS			BACK DIMENSIONS						
				W	D	H	W	D	H	W	H					
				20	22	35	18	16	18.5	18	16					
				RTA 00												

DESCRIPTION FEATURES MODEL# STANDARD TEXTILE GRADES



**Armless Chair w/Catsers Upholstered Back**  
 COM Yardage: 1.25  
 Freight Class: 250  
 Product Weight (lbs.): 18  
 Cubic Feet Per Carton: 6.25 (2 per carton)

Stacks 5 high on floor.  
 Stacks 8 high on dolly.  
 Ergonomic Features:  
 M, N

	1	2	3	4	5	6	7	8	9	10	11	12
<b>2195C</b>	\$708	\$756	\$793	\$848	\$926	\$954	\$1019	\$1146	\$1210	\$1326	\$1488	\$1688

OVERALL DIMENSIONS			SEAT DIMENSIONS			BACK DIMENSIONS	
W	D	H	W	D	H	W	H

20	22	35	18	16	18	18.5	16
----	----	----	----	----	----	------	----

RTA 00



2198



2198WS

**Armchair Wood Veneer Back**  
 COM Yardage: 0.75  
 Freight Class: 250  
 Product Weight (lbs.): 20  
 Cubic Feet Per Carton: 6.25 (2 per carton)

Stacks 5 high on floor.  
 Stacks 8 high on dolly.  
 Ergonomic Features:  
 M, N

	1	2	3	4	5	6	7	8	9	10	11	12
<b>2198</b>	\$730	\$758	\$781	\$815	\$860	\$886	\$927	\$987	\$1044	\$1093	\$1220	\$1348

<b>2198WS</b>	\$750	\$785	\$810	\$843	\$890	\$909	\$954	\$1031	\$1072	\$1148	\$1253	\$1377
Wall Saver												

OVERALL DIMENSIONS			SEAT DIMENSIONS			BACK DIMENSIONS	
W	D	H	W	D	H	W	H

23.5	22	35	18	17.5	18	18.5	16.5
------	----	----	----	------	----	------	------

RTA 00



**Armchair w/Catsers Wood Veneer Back**  
 COM Yardage: 0.75  
 Freight Class: 250  
 Product Weight (lbs.): 20  
 Cubic Feet Per Carton: 6.25 (2 per carton)

Stacks 5 high on floor.  
 Stacks 8 high on dolly.  
 Ergonomic Features:  
 M, N

	1	2	3	4	5	6	7	8	9	10	11	12
<b>2198C</b>	\$757	\$792	\$814	\$848	\$890	\$907	\$950	\$1025	\$1060	\$1131	\$1227	\$1348

OVERALL DIMENSIONS			SEAT DIMENSIONS			BACK DIMENSIONS	
W	D	H	W	D	H	W	H

23.5	22	35	18	16	18	18.5	16
------	----	----	----	----	----	------	----

RTA 00



2199



2199WS

**Armless Chair Wood Veneer Back**  
 COM Yardage: 0.75  
 Freight Class: 250  
 Product Weight (lbs.): 18  
 Cubic Feet Per Carton: 6.25 (2 per carton)

Stacks 5 high on floor.  
 Stacks 8 high on dolly.  
 Ergonomic Features:  
 M, N

	1	2	3	4	5	6	7	8	9	10	11	12
<b>2199</b>	\$630	\$658	\$680	\$710	\$755	\$782	\$826	\$885	\$942	\$992	\$1119	\$1248

<b>2199WS</b>	\$652	\$685	\$709	\$744	\$790	\$811	\$852	\$933	\$974	\$1049	\$1154	\$1281
Wall Saver												

OVERALL DIMENSIONS			SEAT DIMENSIONS			BACK DIMENSIONS	
W	D	H	W	D	H	W	H

20	22	35	18	17.5	18	18.5	16.5
----	----	----	----	------	----	------	------

RTA 00



**Armless Chair w/Catsers Wood Veneer Back**  
 COM Yardage: 0.75  
 Freight Class: 250  
 Product Weight (lbs.): 18  
 Cubic Feet Per Carton: 6.25 (2 per carton)

Stacks 5 high on floor.  
 Stacks 8 high on dolly.  
 Ergonomic Features:  
 M, N



	1	2	3	4	5	6	7	8	9	10	11	12
<b>2199C</b>	\$669	\$704	\$720	\$754	\$802	\$817	\$858	\$936	\$971	\$1042	\$1138	\$1258

OVERALL DIMENSIONS			SEAT DIMENSIONS			BACK DIMENSIONS	
W	D	H	W	D	H	W	H

20	22	35	18	17.5	18	18.5	16
----	----	----	----	------	----	------	----

RTA 00

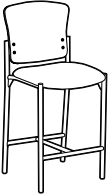

DESCRIPTION	FEATURES	MODEL#	STANDARD TEXTILE GRADES											
			1	2	3	4	5	6	7	8	9	10	11	12
 <p><b>Barstool w/Arms</b> Wood Veneer Back COM Yardage: 0.75 Freight Class: 300 Product Weight (lbs.): 27 Cubic Feet Per Carton: 14.75 (1 per carton)</p>	<p>Does not stack.</p> <p>Ergonomic Features: M, N</p>	<b>2188</b>	\$1049	\$1085	\$1109	\$1142	\$1194	\$1208	\$1253	\$1333	\$1374	\$1448	\$1555	\$1680
			<b>OVERALL DIMENSIONS</b>			<b>SEAT DIMENSIONS</b>			<b>BACK DIMENSIONS</b>					
			<b>W</b>	<b>D</b>	<b>H</b>	<b>W</b>	<b>D</b>	<b>H</b>	<b>W</b>	<b>H</b>				
			23	22	45	18	16	29	18.5	16				
			<b>RTA 00</b>											
 <p><b>Armless Barstool</b> Wood Veneer Back COM Yardage: 0.75 Freight Class: 300 Product Weight (lbs.): 25 Cubic Feet Per Carton: 14.75 (1 per carton)</p>	<p>Does not stack.</p> <p>Ergonomic Features: M, N</p>	<b>2189</b>	\$949	\$986	\$1009	\$1043	\$1092	\$1110	\$1153	\$1233	\$1273	\$1348	\$1453	\$1582
			<b>OVERALL DIMENSIONS</b>			<b>SEAT DIMENSIONS</b>			<b>BACK DIMENSIONS</b>					
			<b>W</b>	<b>D</b>	<b>H</b>	<b>W</b>	<b>D</b>	<b>H</b>	<b>W</b>	<b>H</b>				
			20	22	45	18	16	29	18.5	16				
			<b>RTA 00</b>											
 <p><b>Barstool w/Arms</b> Upholstered Back COM Yardage: 1.25 Freight Class: 300 Product Weight (lbs.): 28 Cubic Feet Per Carton: 14.75 (1 per carton)</p>	<p>Does not stack.</p> <p>Ergonomic Features: M, N</p>	<b>2196</b>	\$1007	\$1060	\$1099	\$1158	\$1239	\$1269	\$1340	\$1477	\$1541	\$1668	\$1840	\$2057
			<b>OVERALL DIMENSIONS</b>			<b>SEAT DIMENSIONS</b>			<b>BACK DIMENSIONS</b>					
			<b>W</b>	<b>D</b>	<b>H</b>	<b>W</b>	<b>D</b>	<b>H</b>	<b>W</b>	<b>H</b>				
			23	22	45	18	16	29	18.5	16				
			<b>RTA 00</b>											
 <p><b>Armless Barstool w/</b> Upholstered Back COM Yardage: 1.25 Freight Class: 300 Product Weight (lbs.): 22 Cubic Feet Per Carton: 14.75 (1 per carton)</p>	<p>Does not stack.</p> <p>Ergonomic Features: M, N</p>	<b>2197</b>	\$908	\$961	\$1000	\$1056	\$1138	\$1167	\$1240	\$1376	\$1442	\$1569	\$1739	\$1954
			<b>OVERALL DIMENSIONS</b>			<b>SEAT DIMENSIONS</b>			<b>BACK DIMENSIONS</b>					
			<b>W</b>	<b>D</b>	<b>H</b>	<b>W</b>	<b>D</b>	<b>H</b>	<b>W</b>	<b>H</b>				
			20	22	45	18	16	29	18.5	16				
			<b>RTA 00</b>											

VION







VION FINISHES - GUEST SEATING				
Back Frame	Specify Code	Frame	Specify Code	Arm Option
Black	BLK	Black	TBL	Fiber Glass Reinforced Nylon (Black)
Shadow	SHW Add \$81	Fog	TFO	
		Shadow	TSH	
Fog	FOG Add \$81	Tungsten	TTU	
		Chrome	CHM - Add \$43	





















STANDARD FEATURES









- Vion is a comprehensive seating series offering a family of models to Address multiple applications: task, management, conference, guest, heavy duty 24-7, and height adjustable stools.
- Series offers models with either a mesh or upholstered back.
- Vion guest chairs offer a wall saver frame design, which is constructed from 7/8" diameter steel tubing.
- Vion guest chairs can stack 4 high on the floor.
- Arm design is gently curved and made from strong fiberglass reinforced black nylon.
- Guest chairs are standard with durable polypropylene glides.
- Dual wheel carpet casters (C82) are standard on guest models with casters.
- Mesh back models are available in 10 standard colors: Aqua (MS75), Black (MS69), Black Cherry (MS76), Blue (MS72), Dust (MS77), Ivory (MS78), Natural (MS74), Paprika (MS79), Rope (MS73) and Stone (MS71).
- Upholstered back models feature Black fabric (Jenny JN02) on the back side as standard.
- Check textile availability prior to specifying upholstery material.
- Vion beam seating consists of upper seat units (6340-6343) including mounting brackets and all hardware necessary for attachment to beam.
- For all beam components, tables and a complete list of available upper seat units, see Beam seating section.





OPTIONAL FEATURES



- Please refer to the chart for optional back frame and base frame finishes.
- Mesh back models are also available in 7 Dimension Mesh colors: Black (DBK), Fog (DST), Chalk (DCL), Shadow (DGM), Charcoal (DCH), Sand (DSD), and Pool Blue (DPB). Add \$29
- Upholstered back models offer a Matching Outer (MO) upholstery option. Due to the additional material needed, these models are listed separately and are priced differently than the standard upholstered back models.
- Seat available in memory foam. Please specify (MF). Add \$124.
- Opaque off-white non-marking glides for hard surface flooring are optional for guest chairs, please specify (NM). No upcharge.
- Felt glides (FG) and rubber glides (RG) are available on guest chairs, please specify and add \$64.
- Steel cushioned self-leveling glides (B) are available on guest chairs (adds 0.5" to seat height), please specify and add \$36.
- Dolly available for stacking guest chairs up to 8 high. Specify model 2125WS, \$477 List.
- Please refer to chart for optional Arms, Back, Base and Frame finishes.

DESCRIPTION	FEATURES	MODEL#	STANDARD TEXTILE GRADES												
			1	2	3	4	5	6	7	8	9	10	11	12	
 <p>mesh back</p> <p><b>Armless Side Chair</b> COM Yardage: 1 Freight Class: 250 Product Weight (lbs.): 24 Cubic Feet Per Carton: 11.75</p>	<p>Stacks 4 high on floor. Stacks 8 high on dolly. Ergonomic Features: M, N</p>	<b>6324</b>	661	701	730	773	835	858	912	1016	1068	1163	1294	1457	
		OVERALL DIMENSIONS			SEAT DIMENSIONS			BACK DIMENSIONS							
			W	D	H	W	D	H	W	H					
			20	24	34.5	19	17.5	17.5	19	17					
															

DESCRIPTION	FEATURES	MODEL#	STANDARD TEXTILE GRADES												
			1	2	3	4	5	6	7	8	9	10	11	12	
 <p>mesh back</p> <p><b>Armless Side Chair w/Casters</b>                      COM Yardage: 1                      Freight Class: 250                      Product Weight (lbs.): 24                      Cubic Feet Per Carton: 11.75</p>	Does not stack.  Ergonomic Features: M, N	<b>6324C</b>	738	778	808	851	913	935	989	1094	1146	1241	1371	1534	
			<b>OVERALL DIMENSIONS</b>			<b>SEAT DIMENSIONS</b>			<b>BACK DIMENSIONS</b>						
			<b>W</b>	<b>D</b>	<b>H</b>	<b>W</b>	<b>D</b>	<b>H</b>	<b>W</b>	<b>H</b>					
			20	24	34.5	19	17.5	17.5	19	17					
			  												
 <p>mesh back</p> <p><b>Side Chair</b>                      COM Yardage: 1                      Freight Class: 300                      Product Weight (lbs.): 26                      Cubic Feet Per Carton: 13.75</p>	Stacks 4 high on floor. Stacks 8 high on dolly.  Ergonomic Features: M, N	<b>6325</b>	708	749	778	821	883	906	960	1064	1116	1211	1344	1504	
			<b>OVERALL DIMENSIONS</b>			<b>SEAT DIMENSIONS</b>			<b>BACK DIMENSIONS</b>						
			<b>W</b>	<b>D</b>	<b>H</b>	<b>W</b>	<b>D</b>	<b>H</b>	<b>W</b>	<b>H</b>					
			25.5	24	34.5	19	17.5	17.5	19	17					
			  												
 <p>mesh back</p> <p><b>Side Chair w/Casters</b>                      COM Yardage: 1                      Freight Class: 300                      Product Weight (lbs.): 26                      Cubic Feet Per Carton: 13.75</p>	Does not stack.  Ergonomic Features: M, N	<b>6325C</b>	783	824	854	897	960	981	1035	1141	1192	1287	1419	1580	
			<b>OVERALL DIMENSIONS</b>			<b>SEAT DIMENSIONS</b>			<b>BACK DIMENSIONS</b>						
			<b>W</b>	<b>D</b>	<b>H</b>	<b>W</b>	<b>D</b>	<b>H</b>	<b>W</b>	<b>H</b>					
			25.5	24	34.5	19	17.5	17.5	19	17					
			  												
 <p>upholstered back</p> <p><b>Armless Side Chair</b>                      COM Yardage: 1.25                      Freight Class: 250                      Product Weight (lbs.): 25                      Cubic Feet Per Carton: 11.75</p>	Stacks 4 high on floor. Stacks 8 high on dolly.  Ergonomic Features: M, N	<b>6334</b>	723	774	813	870	951	990	1064	1182	1274	1374	1583	1805	
			<b>6334MO</b>	783	861	920	1008	1133	1176	1286	1492	1593	1786	2048	2373
				<b>OVERALL DIMENSIONS</b>			<b>SEAT DIMENSIONS</b>			<b>BACK DIMENSIONS</b>					
				<b>W</b>	<b>D</b>	<b>H</b>	<b>W</b>	<b>D</b>	<b>H</b>	<b>W</b>	<b>H</b>				
20	24	34.5		19	17.5	17.5	19	17							
			  												
 <p>upholstered back</p> <p><b>Armless Side Chair w/Casters</b>                      COM Yardage: 1.25                      Freight Class: 250                      Product Weight (lbs.): 25                      Cubic Feet Per Carton: 11.75</p>	Does not stack.  Ergonomic Features: M, N	<b>6334C</b>	809	858	893	947	1026	1062	1131	1244	1331	1427	1624	1833	
			<b>6334CMO</b>	868	944	1004	1092	1215	1260	1369	1576	1676	1869	2131	2456
				<b>OVERALL DIMENSIONS</b>			<b>SEAT DIMENSIONS</b>			<b>BACK DIMENSIONS</b>					
				<b>W</b>	<b>D</b>	<b>H</b>	<b>W</b>	<b>D</b>	<b>H</b>	<b>W</b>	<b>H</b>				
20	24	34.5		19	17.5	17.5	19	17							
			  												

DESCRIPTION	FEATURES	MODEL#	STANDARD TEXTILE GRADES														
			1	2	3	4	5	6	7	8	9	10	11	12			
 <p>upholstered back</p> <p><b>Side Chair</b> COM Yardage: 1.25 Freight Class: 300 Product Weight (lbs.): 27 Cubic Feet Per Carton: 13.75</p>	<p>Stacks 4 high on floor. Stacks 8 high on dolly.</p> <p>Ergonomic Features: M, N</p>	<p>RTA 00</p>  	6335	772	823	862	919	999	1038	1111	1227	1317	1419	1624	1844		
			6335MO	831	909	967	1056	1178	1224	1332	1540	1641	1834	2096	2423		
			OVERALL DIMENSIONS			SEAT DIMENSIONS			BACK DIMENSIONS								
			W	D	H	W	D	H	W	H							
			25.5	24	34.5	19	17.5	17.5	19	17							
 <p>upholstered back</p> <p><b>Side Chair w/Casters</b> COM Yardage: 1.25 Freight Class: 300 Product Weight (lbs.): 27 Cubic Feet Per Carton: 13.75</p>	<p>Does not stack.</p> <p>Ergonomic Features: M, N</p>	<p>RTA 00</p>  	6335C	855	904	939	993	1071	1107	1176	1287	1374	1467	1664	1873		
			6335CMO	912	988	1048	1136	1262	1305	1413	1620	1721	1914	2177	2502		
			OVERALL DIMENSIONS			SEAT DIMENSIONS			BACK DIMENSIONS								
			W	D	H	W	D	H	W	H							
			25.5	24	34.5	19	18	17.5	19	17							
	<p>Upholstered seat/mesh back. Use with beam.</p>	<p>RTA 00</p>	6340	\$886	\$932	\$962	\$1011	\$1079	\$1110	\$1170	\$1268	\$1344	\$1427	\$1601	\$1786		
			OVERALL DIMENSIONS			SEAT DIMENSIONS			BACK DIMENSIONS								
			W	D	H	W	D	H	W	H							
						21	23.5	20.5	17.5	18	-	19	17				
	<p>Upholstered seat and back. Use with beam.</p>	<p>RTA 00</p>	6341	1032	1084	1125	1185	1270	1309	1387	1509	1604	1709	1922	2152		
			OVERALL DIMENSIONS			SEAT DIMENSIONS			BACK DIMENSIONS								
			W	D	H	W	D	H	W	H							
						21	23.5	20.5	17.5	18	-	19	17				
	<p>Upholstered seat/mesh back. Use with beam.</p>	<p>RTA 00</p>	6342	820	863	896	944	1010	1041	1104	1201	1275	1360	1533	1717		
			OVERALL DIMENSIONS			SEAT DIMENSIONS			BACK DIMENSIONS								
			W	D	H	W	D	H	W	H							
						25.5	23.5	20.5	17.5	18	-	19	17				

DESCRIPTION	FEATURES	MODEL.#	STANDARD TEXTILE GRADES											
			1	2	3	4	5	6	7	8	9	10	11	12
 <p><b>Seat Unit w/Arms</b> COM Yardage: 1 Freight Class: 250 Product Weight (lbs.): 27 Cubic Feet Per Carton: 9.75</p>	<p>Upholstered seat and back. Use with beam.</p>	<b>6343</b>	949	1001	1042	1101	1186	1224	1302	1423	1517	1623	1839	2068
			<b>OVERALL DIMENSIONS</b>			<b>SEAT DIMENSIONS</b>			<b>BACK DIMENSIONS</b>					
			<b>W</b>	<b>D</b>	<b>H</b>	<b>W</b>	<b>D</b>	<b>H</b>	<b>W</b>	<b>H</b>				
			25.5	23.5	20.5	17.5	18	-	19	17				
			<b>RTA 00</b>											
 <p><b>Bar Height Stool w/Arms</b> COM Yardage: 1.00 Freight Class: 300 Product Weight (lbs.): 35 Cubic Feet Per Carton: 20</p>	<p>Mesh Back. Does not stack.</p> <p>Ergonomic Features: M, N</p>	<b>6350</b>	919	962	993	1043	1109	1140	1201	1300	1374	1459	1632	1816
			<b>OVERALL DIMENSIONS</b>			<b>SEAT DIMENSIONS</b>			<b>BACK DIMENSIONS</b>					
			<b>W</b>	<b>D</b>	<b>H</b>	<b>W</b>	<b>D</b>	<b>H</b>	<b>W</b>	<b>H</b>				
			25.5	25	44.5	19	17.5	28.5	18	16				
			<b>RTA 00</b>											
 <p><b>Armless Bar Height Stool</b> COM Yardage: 1.00 Freight Class: 250 Product Weight (lbs.): 33 Cubic Feet Per Carton: 15.75</p>	<p>Mesh Back. Does not stack.</p> <p>Ergonomic Features: M, N</p>	<b>6351</b>	875	918	951	999	1065	1096	1159	1256	1330	1415	1588	1772
			<b>OVERALL DIMENSIONS</b>			<b>SEAT DIMENSIONS</b>			<b>BACK DIMENSIONS</b>					
			<b>W</b>	<b>D</b>	<b>H</b>	<b>W</b>	<b>D</b>	<b>H</b>	<b>W</b>	<b>H</b>				
			21	25	44.5	19	17.5	28.5	18	16				
			<b>RTA 00</b>											
 <p><b>Counter Height Stool w/Arms</b> COM Yardage: 1.00 Freight Class: 300 Product Weight (lbs.): 25 Cubic Feet Per Carton: 18.5</p>	<p>Mesh Back. Does not stack.</p> <p>Ergonomic Features: M, N</p>	<b>6352</b>	919	962	993	1043	1109	1140	1201	1300	1374	1459	1632	1816
			<b>OVERALL DIMENSIONS</b>			<b>SEAT DIMENSIONS</b>			<b>BACK DIMENSIONS</b>					
			<b>W</b>	<b>D</b>	<b>H</b>	<b>W</b>	<b>D</b>	<b>H</b>	<b>W</b>	<b>H</b>				
			25.5	24.5	40.5	19	17.5	24.5	18	16				
			<b>RTA 00</b>											
 <p><b>Armless Counter Height Stool</b> COM Yardage: 1.00 Freight Class: 250 Product Weight (lbs.): 31 Cubic Feet Per Carton: 14.50</p>	<p>Mesh Back. Does not stack.</p> <p>Ergonomic Features: M, N</p>	<b>6353</b>	875	918	951	999	1065	1096	1159	1256	1330	1415	1588	1772
			<b>OVERALL DIMENSIONS</b>			<b>SEAT DIMENSIONS</b>			<b>BACK DIMENSIONS</b>					
			<b>W</b>	<b>D</b>	<b>H</b>	<b>W</b>	<b>D</b>	<b>H</b>	<b>W</b>	<b>H</b>				
			21	24.5	40.5	19	17.5	24.5	18	16				
			<b>RTA 00</b>											

DESCRIPTION	FEATURES	MODEL#	STANDARD TEXTILE GRADES												
			1	2	3	4	5	6	7	8	9	10	11	12	
 <p><b>Bar Height Stool w/Arms</b> COM Yardage: 1.25 Freight Class: 300 Product Weight (lbs.): 35</p>	Upholstered Back Does not stack.  Ergonomic Features:		1002	1054	1095	1154	1240	1277	1355	1476	1570	1678	1892	2121	
		<b>6360MO</b>	1060	1143	1208	1301	1437	1500	1624	1820	1970	2138	2483	2851	
		<b>OVERALL DIMENSIONS</b>			<b>SEAT DIMENSIONS</b>			<b>BACK DIMENSIONS</b>							
		<b>W</b>	<b>D</b>	<b>H</b>	<b>W</b>	<b>D</b>	<b>H</b>	<b>W</b>	<b>H</b>						
	25.5	25	44.5	19	17.5	28.5	18	16							
				<b>RTA 00</b>											
 <p><b>Armless Bar Height Stool</b> COM Yardage: 1.25 Freight Class: 250 Product Weight (lbs.): 33 Cubic Feet Per Carton: 15.75 Cubic Feet Per Carton: 18.5</p>	Upholstered Back Does not stack.  Ergonomic Features: M, N M, N		957	1009	1051	1110	1196	1235	1312	1434	1529	1635	1848	2079	
		<b>6361MO</b>	1016	1099	1164	1257	1394	1456	1582	1776	1927	2095	2440	2807	
		<b>OVERALL DIMENSIONS</b>			<b>SEAT DIMENSIONS</b>			<b>BACK DIMENSIONS</b>							
		<b>W</b>	<b>D</b>	<b>H</b>	<b>W</b>	<b>D</b>	<b>H</b>	<b>W</b>	<b>H</b>						
	21	25	44.5	19	17.5	28.5	18	16							
				<b>RTA 00</b>											
 <p><b>Bar Counter Height Stool w/Arms</b> COM Yardage: 1.25 Freight Class: 300 Product Weight (lbs.): 33 Cubic Feet Per Carton: 18.5</p>	Upholstered Back Does not stack.  Ergonomic Features: M, N		1002	1054	1095	1154	1240	1277	1355	1476	1570	1678	1892	2121	
		<b>6362MO</b>	1060	1143	1208	1301	1437	1500	1624	1820	1970	2138	2483	2851	
		<b>OVERALL DIMENSIONS</b>			<b>SEAT DIMENSIONS</b>			<b>BACK DIMENSIONS</b>							
		<b>W</b>	<b>D</b>	<b>H</b>	<b>W</b>	<b>D</b>	<b>H</b>	<b>W</b>	<b>H</b>						
	25.5	24.5	40.5	19	17.5	24.5	18	16							
				<b>RTA 00</b>											
 <p><b>Armless Counter Height Stool</b> COM Yardage: 1.25 Freight Class: 250 Product Weight (lbs.): 31 Cubic Feet Per Carton: 14.50</p>	Upholstered Back Does not stack.  Ergonomic Features: M, N		957	1009	1051	1110	1196	1235	1312	1434	1529	1635	1848	2079	
		<b>6363MO</b>	1016	1099	1164	1257	1394	1456	1582	1776	1927	2095	2440	2807	
		<b>OVERALL DIMENSIONS</b>			<b>SEAT DIMENSIONS</b>			<b>BACK DIMENSIONS</b>							
		<b>W</b>	<b>D</b>	<b>H</b>	<b>W</b>	<b>D</b>	<b>H</b>	<b>W</b>	<b>H</b>						
	21	25	40.5	19	17.5	24.5	18	16							
				<b>RTA 00</b>											

## WILLOW



**model W5AUUG**  
Armchair, Upholstered Seat & Back



Wipeable shroud edge does not collect debris



No visible brackets or upholstery staples

### Arm Options



**Waterfall Arm (WFA)**



**Forward Grip Assist (GAA)**

	Willow Chair Stacking Capability	
	Stacks on floor	Stacks on dolly
<b>Four leg arm and armless chairs with glides only</b>		
Poly/poly chairs	up to 6 high	up to 10 high
Upholstered chairs	up to 4 high	up to 8 high
Bariatric Models	up to 4 high	up to 8 high
<b>Four leg bar and counter stools</b>		
Stools with arms	Does not stack	N/A
Armless stools	up to 4 high	N/A

Plastic Component Finish Matching Chart		
Chair Types	Seat Shroud	Arms and Back Shroud
Poly back and seat	Matches seat/back	Matches seat/back
Upholstered back and seat	Specify	Specify
Poly back/upholstered seat	Specify	Specify
Upholstered back/poly seat	Matches seat	Specify



For linking tables, see 250.

### EXAMPLE WILLOW ORDER CODE:

W5AUU	PU75	NS	PU75	WFA	BLK
-------	------	----	------	-----	-----

Model #    Back Textile    Seat    Seat Textile    Arm Style    Seat Shroud Finish

CHM	ST	BLK	NS	NB
-----	----	-----	----	----

Frame Finish    Glide Type    Glide Finish    Back seams    Moisture Barrier

### STANDARD FEATURES

- Willow's durable design and open, welcoming form will ensure years of use. Freestanding chairs are available with four legs or sled base, in seated standard or bariatric widths. Additional models include hip, counter and bar height stools. Freestanding and corner, in-line and end tables are also available to complement the line.
- Seated height chairs may be ganged with ganging brackets or with in-line and corner tables.
- Plastic seats and backs, reinforced nylon arms, back shrouds and seat shrouds are available in a wide range of colors. See finish chart for matching color components.
- Tubular steel frame is available in 20 paint finishes and 4 metallic finishes (upcharge applies).
- Frame design features a wall saver leg to prevent contact with walls.
- Active weight capacity is 300 lbs. for four-leg seating with casters, 400 lbs. for seating on glides and 600 lbs. for 30" wide bariatric and parent/child models.
- Plastic seat shrouds are standard on all models.
- Upholstered seats have no seams for ease of cleaning.
- Four-leg chairs with glides are stackable, see matrix. Stacking of caster models is not recommended due to damage to plastic and upholstery.
- Armless counter and bar height stools are stackable on the floor only. See chart for details.
- Four-leg and stool models are available with a variety of glide types. Glides must be chosen to best suit flooring type and site conditions. For more information, refer to glide selection chart.
- Tables used with Willow armchairs require 28" clearance under the surface top; counter height stools require 34.25" clearance; bar height stools require 40.25" clearance.
- Sled base models have nylon colored glides, non-marking natural glides for use on most floor surfaces, or no glides for use on carpeted floors.
- For healthcare textiles, visit the website at [globalfurnituregroup.com](http://globalfurnituregroup.com).
- Check textile availability prior to specifying upholstery material.
- The series is available to specify with two textiles on upholstered seat and back models. For pricing, start with the base price and add applicable graded textile upcharges for the back and the seat.
- The blended textile matrix does not apply to this series.
- The series is designed for use across a range of facilities and is covered under Global's limited lifetime warranty for single-shift use. Specify from approved textiles.
- Shipped fully assembled.

### OPTIONAL FEATURES

- Additional weight (**CW**) of 24 lbs. is available. Weighted four-leg chairs are not stackable.
- Power/USB units are available, ordered separately, for use with in-line, corner and end tables. See model for details.
- Tables are pre-drilled for field installation of undermount power. Clamp mount units are available. Order power units separately for field installation.
- Moisture barrier may be specified on seats.
- Sled base models offer a floor mount (**FM**) option. See upcharges. Mounting hardware not included.





Add option codes in the following order:





- Model number**  
Enter model number.
- Back, Seat and Seat Shroud Finish** (plastic back and seat models)  
Plastic finishes:  

<b>(BZB)</b> Buzz Blue	<b>(KAL)</b> Kalua
<b>(CCT)</b> Cactus	<b>(LAB)</b> Latte
<b>(CRO)</b> Carrot	<b>(J52)</b> Mocha
<b>(IVC)</b> Cloud	<b>(BLK)</b> Night
<b>(DJN)</b> Dijon	<b>(SND)</b> Sand
<b>(EGP)</b> Eggplant	<b>(SAR)</b> Scarlet
<b>(FOG)</b> Fog	<b>(SHW)</b> Shadow
<b>(FRO)</b> Frost	<b>(TOA)</b> Toast
<b>(INK)</b> Ink	
- Back Finish** (plastic back and upholstered seat models)  
See Plastic finishes.
- Back Textile** (for upholstered back models)  
Specify back textile.
- Seat Textile** (for upholstered seat models)  
**(NS)** Seamless seat  
Specify seat textile.
- Arm Style** (for chairs with arms)  
**(WFA)** Waterfall arm  
**(GAA)** Grip assist arm. Add \$35.
- Arm and Back Shroud Finish**  
See Plastic finishes.
- Seat and Seat Shroud Finish** (for upholstered back and plastic seat models).  
See Plastic finishes.
- Leg Type** (for sled base models)  
**(NF)** No floor mount  
**(FM)** Floor mounted. Add \$13.
- Frame finish**  
Paint finishes:  
Black (**TBL**), Buzz Blue (**TBZ**), Cactus (**TCC**), Carrot (**TCR**), Cloud (**TIV**), Designer White (**TDW**), Dijon (**TDJ**), Eggplant (**TEG**), Fog (**TFO**), Frost (**TFR**), Ink (**TIN**), Kalua (**TKA**), Latte (**TLA**), Mocha (**TMO**), Nevada (**TNE**), Sand (**TSN**), Scarlet (**TSR**), Shadow (**TSH**), Toast (**TOA**) and Tungsten (**TTU**).  
Plated finishes - see chart for upcharges:  
**(CHM)** Chrome  
**(BCH)** Brushed Chrome
- Glide type** (four leg glides)  
**(ST)** Nylon, colored glide for most surfaces  
**(NM)** White, non-marking Nylon glide for most surfaces  
**(SG)** Steel cushion glide for carpeted surfaces. Add \$36.  
**(FG)** Felt glide for most hard floor surfaces. Add \$36.  
**(RG)** Rubber, non-slip glide for most hard floor surfaces. Add \$36.
- Glide type** (sled bases)  
**(ST)** Nylon, colored glide for most surfaces  
**(NM)** White, non-marking Nylon glide for most surfaces  
**(XG)** No glide for carpeted surfaces
- Glide Finish** (ST glides)  
**(BLK)** Black  
**(SND)** Sand
- Caster Type** (caster models)  
**(C114)** 2" caster for carpeted surface  
**(C114R)** 2" caster for most hard floor surfaces. Add \$53.
- Back Seams**  
**(NS)** No sealed back seams  
**(SBS)** Sealed back seams
- Moisture Barrier** (on seat)  
**(NB)** No moisture barrier.  
**(MB)** Moisture barrier. Add \$107. For bariatric, add \$161.
- Additional Weight**  
**(NC)** No counterweight.  
**(CW)** Counterweight. Add \$78.

DESCRIPTION	FEATURES		MODEL#		STANDARD TEXTILE GRADES			
	GLIDES							
	Standard colored (ST) + non-marking (NM) glides - standard height		Steel cushion (SG) glides - 0.313" higher than standard		Felt pad (FG) glides - 0.375" higher than standard		Rubber non-slip (RG) glides - 0.563" higher than standard	
	SEAT HEIGHT (in)	ARM HEIGHT (in)	SEAT HEIGHT (in)	ARM HEIGHT (in)	SEAT HEIGHT (in)	ARM HEIGHT (in)	SEAT HEIGHT (in)	ARM HEIGHT (in)
<b>ARMCHAIRS</b>								
Plastic seat, standard arms	17	26.75	17.31	27.06	17.38	27.13	17.56	27.31
Plastic seat, grip assist arms	17	27	17.31	27.31	17.38	27.38	17.56	27.56
Upholstered seat, standard arms	18.25	26.75	18.56	27.06	18.63	27.13	18.81	27.31
Upholstered seat, grip assist arms	18.25	27	18.56	27.31	18.63	27.38	18.81	27.56
<b>COUNTER STOOLS WITH ARMS</b>								
Plastic seat, standard arms	23.25	33	23.56	33.31	23.63	33.38	23.81	33.56
Plastic seat, grip assist arms	23.25	33.25	23.56	33.56	23.63	33.63	23.81	33.81
Upholstered seat, standard arms	24.25	33	24.56	33.31	24.63	33.38	24.81	33.56
Upholstered seat, grip assist arms	24.25	33.25	24.56	33.56	24.63	33.63	24.81	33.81
<b>BAR STOOLS WITH ARMS</b>								
Plastic seat, standard arms	29.25	39	29.56	39.31	29.63	39.38	29.81	39.56
Plastic seat, grip assist arms	29.25	39.25	29.56	39.56	29.63	39.63	29.81	39.81
Upholstered seat, standard arms	30.25	39	30.56	39.31	30.63	39.38	30.81	39.56
Upholstered seat, grip assist arms	30.25	39.25	30.56	39.56	30.63	39.63	30.81	39.81

PLATED FRAME FINISH UPCHARGES		
	Chrome (CHM)	Brushed Chrome (BCH)
<b>FOUR LEG BASE</b>		
Standard, arm and armless	\$42	\$147
Bariatric	\$71	\$229
Hip chairs, standard and bariatric	\$71	\$229
Counter stools, arm and armless	\$75	\$244
Bar stools, arm and armless	\$75	\$244
<b>SLED BASE</b>		
Standard, arm and armless	\$53	\$180
Bariatric	\$71	\$229

DESCRIPTION	FEATURES	MODEL#	STANDARD TEXTILE GRADES											
 <p><b>Armchair, Polypropylene Seat and Back</b> COM Yardage: n/a Freight Class: 250 Product Weight (lbs.): 20.88 Cubic Feet Per Carton: 5.56</p>		List Price												
	<b>W5APPG</b> with glides	\$563												
	<b>W5APPC</b> with casters	\$707												
				OVERALL DIMENSIONS			SEAT DIMENSIONS			BACK DIMENSIONS				
			W	D	H	W	D	H	W	H				
			24.25	23.5	32	17.75	17.5	17	16	16				
			Active weight with casters 300 lbs.; does not stack. Active weight with glides 400 lbs.; stacks 6 high on floor. 2 per carton (pricing and specifications are for one seat unit)											
 <p><b>Armchair, Upholstered Back and Polypropylene Seat</b> COM Yardage: 0.5 Freight Class: 250 Product Weight (lbs.): 21.88 Cubic Feet Per Carton: 5.56</p>		1/COM	2	3	4	5	6	7	8	9	10	11	12	
	<b>W5AUPG</b> with glides	\$662	\$679	\$693	\$712	\$740	\$751	\$775	\$812	\$841	\$871	\$935	\$1002	
	<b>W5AUPC</b> with casters	\$780	\$797	\$811	\$830	\$858	\$869	\$893	\$930	\$959	\$989	\$1053	\$1120	
				OVERALL DIMENSIONS			SEAT DIMENSIONS			BACK DIMENSIONS				
			W	D	H	W	D	H	W	H				
			24.25	21.75	32.25	17.75	16.75	17	16.5	16				
			Active weight with casters 300 lbs.; does not stack. Active weight with glides 400 lbs.; stacks 4 high on floor. Add \$16 for (SBS) 2 per carton (pricing and specifications are for one seat unit)											
 <p><b>Armchair, Polypropylene Back and Upholstered Seat</b> COM Yardage: 0.75 Freight Class: 250 Product Weight (lbs.): 21.38 Cubic Feet Per Carton: 5.56</p>		1/COM	2	3	4	5	6	7	8	9	10	11	12	
	<b>W5APUG</b> with glides	\$662	\$688	\$708	\$737	\$779	\$795	\$831	\$887	\$929	\$976	\$1071	\$1172	
	<b>W5APUC</b> with casters	\$780	\$806	\$826	\$855	\$897	\$913	\$949	\$1005	\$1047	\$1094	\$1189	\$1290	
				OVERALL DIMENSIONS			SEAT DIMENSIONS			BACK DIMENSIONS				
			W	D	H	W	D	H	W	H				
			24.25	23.5	32	18.25	17.75	18.25	16	15.25				
			Active weight with casters 300 lbs.; does not stack. Active weight with glides 400 lbs.; stacks 4 high on floor. 2 per carton (pricing and specifications are for one seat unit)											
 <p><b>Armchair, Upholstered Seat and Back</b> COM Yardage: Back: 0.5; Seat: 0.75 Freight Class: 250 Product Weight (lbs.): 21.88 Cubic Feet Per Carton: 5.56</p>		1/COM	2	3	4	5	6	7	8	9	10	11	12	
	<b>W5AUUG</b> with glides	Base Price: \$696 Seat upcharge: +0 Back upcharge: +0	+0	+\$26	+\$46	+\$75	+\$117	+\$133	+\$169	+\$225	+\$267	+\$314	+\$409	+\$510
	<b>W5AUUC</b> with casters	Base Price: \$847 Seat upcharge: +0 Back upcharge: +0	+0	+\$26	+\$46	+\$75	+\$117	+\$133	+\$169	+\$225	+\$267	+\$314	+\$409	+\$510
				OVERALL DIMENSIONS			SEAT DIMENSIONS			BACK DIMENSIONS				
			W	D	H	W	D	H	W	H				
			24.25	22	32.25	18.25	17	18.25	16.5	15.25				
			Active weight with casters 300 lbs.; does not stack. Active weight with glides 400 lbs.; stacks 4 high on floor. Add \$16 for (SBS). 2 per carton (pricing and specifications are for one seat unit)											

DESCRIPTION	FEATURES	MODEL#	STANDARD TEXTILE GRADES										
		List Price											
	<b>W5NPPG</b> with glides	\$513											
	<b>W5NPPC</b> with casters	\$656											
				OVERALL DIMENSIONS			SEAT DIMENSIONS			BACK DIMENSIONS			
			W	D	H	W	D	H	W	H			
<b>Armless Chair, Polypropylene Seat and Back</b> COM Yardage: n/a Freight Class: 250 Product Weight (lbs.): 18 Cubic Feet Per Carton: 4.63	Active weight with casters 300 lbs.; does not stack. Active weight with glides 400 lbs.; stacks 6 high on floor. 2 per carton (pricing and specifications are for one seat unit)		20.75	23.5	32	17.75	17.5	17	16	16			
		1/COM	2	3	4	5	6	7	8	9	10	11	12
	<b>W5NUPG</b> with glides	\$610	\$627	\$641	\$660	\$688	\$699	\$723	\$760	\$789	\$819	\$883	\$950
	<b>W5NUPC</b> with casters	\$727	\$744	\$758	\$777	\$805	\$816	\$840	\$877	\$906	\$936	\$1000	\$1067
				OVERALL DIMENSIONS			SEAT DIMENSIONS			BACK DIMENSIONS			
			W	D	H	W	D	H	W	H			
<b>Armless Chair, Upholstered Back and Polypropylene Seat</b> COM Yardage: 0.5 Freight Class: 250 Product Weight (lbs.): 18.5 Cubic Feet Per Carton: 4.63	Active weight with casters 300 lbs.; does not stack. Active weight with glides 400 lbs.; stacks 4 high on floor. Add \$16 for (SBS) 2 per carton (pricing and specifications are for one seat unit)		20.75	23.5	32.25	17.75	16.75	17	16.5	16			
		1/COM	2	3	4	5	6	7	8	9	10	11	12
	<b>W5NPUG</b> with glides	\$610	\$636	\$656	\$685	\$727	\$743	\$779	\$835	\$877	\$924	\$1019	\$1120
	<b>W5NPUC</b> with casters	\$727	\$753	\$773	\$802	\$844	\$860	\$896	\$952	\$994	\$1041	\$1136	\$1237
				OVERALL DIMENSIONS			SEAT DIMENSIONS			BACK DIMENSIONS			
			W	D	H	W	D	H	W	H			
<b>Armless Chair, Polypropylene Back and Upholstered Seat</b> COM Yardage: 0.75 Freight Class: 250 Product Weight (lbs.): 18.5 Cubic Feet Per Carton: 4.63	Active weight with casters 300 lbs.; does not stack. Active weight with glides 400 lbs.; stacks 4 high on floor. 2 per carton (pricing and specifications are for one seat unit)		20.75	23.5	32	18.25	17.75	18.25	16	15.25			
		1/COM	2	3	4	5	6	7	8	9	10	11	12
	<b>W5NUUG</b> with glides	Base Price: \$646											
		Seat upcharge: +0	+\$26	+\$46	+\$75	+\$117	+\$133	+\$169	+\$225	+\$267	+\$314	+\$409	+\$510
		Back upcharge: +0	+\$17	+\$31	+\$50	+\$78	+\$89	+\$113	+\$150	+\$179	+\$209	+\$273	+\$340
<b>W5NUUC</b> with casters	Base Price: \$794												
	Seat upcharge: +0	+\$26	+\$46	+\$75	+\$117	+\$133	+\$169	+\$225	+\$267	+\$314	+\$409	+\$510	
	Back upcharge: +0	+\$17	+\$31	+\$50	+\$78	+\$89	+\$113	+\$150	+\$179	+\$209	+\$273	+\$340	
			OVERALL DIMENSIONS			SEAT DIMENSIONS			BACK DIMENSIONS				
			W	D	H	W	D	H	W	H			
<b>Armless Chair, Upholstered Seat and Back</b> COM Yardage: Back: 0.5; Seat: 0.75 Freight Class: 150 Product Weight (lbs.): 19 Cubic Feet Per Carton: 4.63	Active weight with casters 300 lbs.; does not stack. Active weight with glides 400 lbs.; stacks 4 high on floor. Add \$16 for (SBS). 2 per carton (pricing and specifications are for one seat unit)		20.75	23.5	32.25	18.25	17	18.25	16.5	15.25			





DESCRIPTION	FEATURES	MODEL#											
		1/COM	2	3	4	5	6	7	8	9	10	11	12
 <p><b>Bariatric Armchair, Upholstered Seat and Back</b> COM Yardage: Back: 1 Seat: .75 Freight Class: 250 Product Weight (lbs.): 41 Cubic Feet Per Carton: 20.5</p>	<p><b>W530AUU</b> Base Price: \$1091 Seat upcharge: +0 Back upcharge: +0</p>												
	<p>Active weight 600 lbs. Stacks 4 high on floor. Caster model not available. Add \$25 for (SBS). One per carton (pricing and specifications are for one seat unit)</p>												
		OVERALL DIMENSIONS			SEAT DIMENSIONS			BACK DIMENSIONS					
		W	D	H	W	D	H	W	H				
		35.25	23.5	32.25	29	17	18.25	26.75	15.25				

DESCRIPTION	FEATURES	MODEL#											
		1/COM	2	3	4	5	6	7	8	9	10	11	12
 <p><b>Bariatric Armless Chair, Upholstered Seat and Back</b> COM Yardage: Back: 1 Seat: .75 Freight Class: 250 Product Weight (lbs.): 37.5 Cubic Feet Per Carton: 16.75</p>	<p><b>W530NUU</b> Base Price: \$1040 Seat upcharge: +0 Back upcharge: +0</p>												
	<p>Active weight 600 lbs. Stacks 4 high on floor. Caster model not available. Add \$25 for (SBS). One per carton (pricing and specifications are for one seat unit)</p>												
		OVERALL DIMENSIONS			SEAT DIMENSIONS			BACK DIMENSIONS					
		W	D	H	W	D	H	W	H				
		31.75	23.5	32.25	29	17	0	26.75	15.25				

DESCRIPTION	FEATURES	List Price											
 <p><b>Armchair, Sled Base, Polypropylene Seat and Back</b> COM Yardage: n/a Freight Class: 250 Product Weight (lbs.): 29.5 Cubic Feet Per Carton: 13.25</p>	<p><b>W6APP</b></p>	\$722											
	<p>Active weight 400 lbs. Does not stack.</p>												
		OVERALL DIMENSIONS			SEAT DIMENSIONS			BACK DIMENSIONS					
		W	D	H	W	D	H	W	H				
		24.25	23.75	32	17.75	17.75	17.75	16	16				

DESCRIPTION	FEATURES	MODEL#											
		1/COM	2	3	4	5	6	7	8	9	10	11	12
 <p><b>Armchair, Sled Base, Upholstered Back and Polypropylene Seat</b> COM Yardage: 0.5 Freight Class: 250 Product Weight (lbs.): 30 Cubic Feet Per Carton: 13.25</p>	<p><b>W6AUP</b></p>	\$794	\$811	\$825	\$844	\$872	\$883	\$907	\$944	\$973	\$1003	\$1067	\$1134
	<p>Active weight 400 lbs. Does not stack. Add \$16 for (SBS).</p>												
		OVERALL DIMENSIONS			SEAT DIMENSIONS			BACK DIMENSIONS					
		W	D	H	W	D	H	W	H				
		24.25	23.75	32.25	17.75	17.75	17.75	16.5	16				

DESCRIPTION	FEATURES	MODEL#											
		1/COM	2	3	4	5	6	7	8	9	10	11	12
 <p><b>Armchair, Sled Base, Polypropylene Back and Upholstered Seat</b> COM Yardage: 0.75 Freight Class: 250 Product Weight (lbs.): 30 Cubic Feet Per Carton: 13.25</p>	<p><b>W6APU</b></p>	\$794	\$820	\$840	\$869	\$911	\$927	\$963	\$1019	\$1061	\$1108	\$1203	\$1304
	<p>Active weight 400 lbs. Does not stack.</p>												
		OVERALL DIMENSIONS			SEAT DIMENSIONS			BACK DIMENSIONS					
		W	D	H	W	D	H	W	H				
		24.25	23.75	32	18.25	17.75	18.25	16	15.25				

DESCRIPTION	FEATURES	MODEL#	STANDARD TEXTILE GRADES																			
			1/COM	2	3	4	5	6	7	8	9	10	11	12								
 <p><b>Armchair, Sled Base, Upholstered Seat and Back</b> COM Yardage: Back: 0.5; Seat: 0.75 Freight Class: 250 Product Weight (lbs.): 30.5 Cubic Feet Per Carton: 13.25</p>	<p>Active weight 400 lbs. Does not stack. Add \$16 for (SBS).</p>	W6AUU	Base Price:	\$860																		
		Seat upcharge:	+0	+\$26	+\$46	+\$75	+\$117	+\$133	+\$169	+\$225	+\$267	+\$314	+\$409	+\$510								
		Back upcharge:	+0	+\$17	+\$31	+\$50	+\$78	+\$89	+\$113	+\$150	+\$179	+\$209	+\$273	+\$340								
		<b>OVERALL DIMENSIONS</b>			<b>W</b>	<b>D</b>	<b>H</b>	<b>SEAT DIMENSIONS</b>			<b>W</b>	<b>D</b>	<b>H</b>	<b>BACK DIMENSIONS</b>		<b>W</b>	<b>H</b>					
			24.25	23.75	32.25	18.25	16.5	18.25	16.5	15.25												
 <p><b>Armless Chair, Sled Base, Polypropylene Seat and Back</b> COM Yardage: n/a Freight Class: 250 Product Weight (lbs.): 26.5 Cubic Feet Per Carton: 11.75</p>	<p>Active weight 400 lbs. Does not stack.</p>	List Price		W6NPP	\$669																	
		<b>OVERALL DIMENSIONS</b>			<b>W</b>	<b>D</b>	<b>H</b>	<b>SEAT DIMENSIONS</b>			<b>W</b>	<b>D</b>	<b>H</b>	<b>BACK DIMENSIONS</b>		<b>W</b>	<b>H</b>					
					20.75	23.5	32	17.75	17.75	17.75	16	16										
 <p><b>Armless Chair, Sled Base, Upholstered Back and Polypropylene Seat</b> COM Yardage: n/a Freight Class: 250 Product Weight (lbs.): 27 Cubic Feet Per Carton: 11.75</p>	<p>Active weight 400 lbs. Does not stack. Add \$16 for (SBS)</p>	List Price		W6NUP	\$742	\$759	\$773	\$792	\$820	\$831	\$855	\$892	\$921	\$951	\$1015	\$1082						
		<b>OVERALL DIMENSIONS</b>			<b>W</b>	<b>D</b>	<b>H</b>	<b>SEAT DIMENSIONS</b>			<b>W</b>	<b>D</b>	<b>H</b>	<b>BACK DIMENSIONS</b>		<b>W</b>	<b>H</b>					
					20.75	23.5	32.25	17.75	17.75	17.75	16.5	16										
 <p><b>Armless Chair, Sled Base, Polypropylene Back and Upholstered Seat</b> COM Yardage: 0.75 Freight Class: 250 Product Weight (lbs.): 27 Cubic Feet Per Carton: 11.75</p>	<p>Active weight 400 lbs. Does not stack.</p>	List Price		W6NPU	\$742	\$768	\$788	\$817	\$859	\$875	\$911	\$967	\$1009	\$1056	\$1151	\$1252						
		<b>OVERALL DIMENSIONS</b>			<b>W</b>	<b>D</b>	<b>H</b>	<b>SEAT DIMENSIONS</b>			<b>W</b>	<b>D</b>	<b>H</b>	<b>BACK DIMENSIONS</b>		<b>W</b>	<b>H</b>					
					20.75	23.5	32	18.25	17.75	18.25	16	15.25										
 <p><b>Armless Chair, Sled Base, Upholstered Seat and Back</b> COM Yardage: Back: 0.5; Seat: 0.75 Freight Class: 250 Product Weight (lbs.): 27.5 Cubic Feet Per Carton: 11.75</p>	<p>Active weight 400 lbs. Does not stack. Add \$16 for (SBS).</p>	List Price		W6NUU	Base Price:	\$809																
		Seat upcharge:	+0	+\$26	+\$46	+\$75	+\$117	+\$133	+\$169	+\$225	+\$267	+\$314	+\$409	+\$510								
		Back upcharge:	+0	+\$17	+\$31	+\$50	+\$78	+\$89	+\$113	+\$150	+\$179	+\$209	+\$273	+\$340								
		<b>OVERALL DIMENSIONS</b>			<b>W</b>	<b>D</b>	<b>H</b>	<b>SEAT DIMENSIONS</b>			<b>W</b>	<b>D</b>	<b>H</b>	<b>BACK DIMENSIONS</b>		<b>W</b>	<b>H</b>					
			20.75	23.5	32.25	18.25	16.5	18.25	16.5	15.25												

DESCRIPTION	FEATURES	MODEL#											
		1/COM	2	3	4	5	6	7	8	9	10	11	12
	<b>W630AUU</b>	Base Price:	\$1223										
	Seat upcharge:	<b>+0</b>	<b>+\$34</b>	<b>+\$61</b>	<b>+\$100</b>	<b>+\$155</b>	<b>+\$178</b>	<b>+\$225</b>	<b>+\$300</b>	<b>+\$356</b>	<b>+\$417</b>	<b>+\$545</b>	<b>+\$679</b>
	Back upcharge:	<b>+0</b>	<b>+\$26</b>	<b>+\$46</b>	<b>+\$75</b>	<b>+\$117</b>	<b>+\$133</b>	<b>+\$169</b>	<b>+\$225</b>	<b>+\$267</b>	<b>+\$314</b>	<b>+\$409</b>	<b>+\$510</b>
		<b>OVERALL DIMENSIONS</b>			<b>SEAT DIMENSIONS</b>			<b>BACK DIMENSIONS</b>					
		<b>W</b>	<b>D</b>	<b>H</b>	<b>W</b>	<b>D</b>	<b>H</b>	<b>W</b>	<b>H</b>				
		35.25	23.5	32.25	29	17	18.25	26.75	15.25				
<b>Bariatric Armchair, Sled Base, Upholstered Seat and Back</b>		Active weight 600 lbs. Does not stack. Add \$25 for (SBS).											
COM Yardage: Back: 1 Seat:.75													
Freight Class: 250													
Product Weight (lbs.): 45													
Cubic Feet Per Carton: 20.5													

DESCRIPTION	FEATURES	MODEL#											
		1/COM	2	3	4	5	6	7	8	9	10	11	12
	<b>W630NUU</b>	Base Price:	\$1172										
	Seat upcharge:	<b>+0</b>	<b>+\$34</b>	<b>+\$61</b>	<b>+\$100</b>	<b>+\$155</b>	<b>+\$178</b>	<b>+\$225</b>	<b>+\$300</b>	<b>+\$356</b>	<b>+\$417</b>	<b>+\$545</b>	<b>+\$679</b>
	Back upcharge:	<b>+0</b>	<b>+\$26</b>	<b>+\$46</b>	<b>+\$75</b>	<b>+\$117</b>	<b>+\$133</b>	<b>+\$169</b>	<b>+\$225</b>	<b>+\$267</b>	<b>+\$314</b>	<b>+\$409</b>	<b>+\$510</b>
		<b>OVERALL DIMENSIONS</b>			<b>SEAT DIMENSIONS</b>			<b>BACK DIMENSIONS</b>					
		<b>W</b>	<b>D</b>	<b>H</b>	<b>W</b>	<b>D</b>	<b>H</b>	<b>W</b>	<b>H</b>				
		31.75	23.5	32.25	29	17	18.25	26.75	15.25				
<b>Bariatric Armless Chair, Sled Base, Upholstered Seat and Back</b>		Active weight 600 lbs. Does not stack. Add \$25 for (SBS).											
COM Yardage: Back: 1 Seat:.75													
Freight Class: 250													
Product Weight (lbs.): 41.5													
Cubic Feet Per Carton: 16.75													

DESCRIPTION	FEATURES	MODEL#											
		1/COM	2	3	4	5	6	7	8	9	10	11	12
	<b>W5CSAPP</b>	List Price											
		\$790											
		<b>OVERALL DIMENSIONS</b>			<b>SEAT DIMENSIONS</b>			<b>BACK DIMENSIONS</b>					
		<b>W</b>	<b>D</b>	<b>H</b>	<b>W</b>	<b>D</b>	<b>H</b>	<b>W</b>	<b>H</b>				
		24.25	23.5	38.25	17.75	17.15	23.25	16	16				
<b>Counter Stool with Arms, Polypropylene Seat and Back</b>		Active weight 400 lbs. Does not stack.											
COM Yardage: n/a													
Freight Class: 250													
Product Weight (lbs.): 32.5													
Cubic Feet Per Carton: 15													

DESCRIPTION	FEATURES	MODEL#											
		1/COM	2	3	4	5	6	7	8	9	10	11	12
	<b>W5CSAUP</b>	\$861	\$878	\$892	\$911	\$939	\$950	\$974	\$1011	\$1040	\$1070	\$1134	\$1201
		<b>OVERALL DIMENSIONS</b>			<b>SEAT DIMENSIONS</b>			<b>BACK DIMENSIONS</b>					
		<b>W</b>	<b>D</b>	<b>H</b>	<b>W</b>	<b>D</b>	<b>H</b>	<b>W</b>	<b>H</b>				
		24.25	23.5	38.25	17.75	16.5	23.25	16.5	16				
<b>Counter Stool with Arms, Upholstered Back and Polypropylene Seat</b>		Active weight 400 lbs. Does not stack. Add \$16 for (SBS).											
COM Yardage: 0.5													
Freight Class: 250													
Product Weight (lbs.): 33													
Cubic Feet Per Carton: 15													

DESCRIPTION	FEATURES	MODEL#											
		1/COM	2	3	4	5	6	7	8	9	10	11	12
	<b>W5CSAPU</b>	\$861	\$887	\$907	\$936	\$978	\$994	\$1030	\$1086	\$1128	\$1175	\$1270	\$1371
		<b>OVERALL DIMENSIONS</b>			<b>SEAT DIMENSIONS</b>			<b>BACK DIMENSIONS</b>					
		<b>W</b>	<b>D</b>	<b>H</b>	<b>W</b>	<b>D</b>	<b>H</b>	<b>W</b>	<b>H</b>				
		24.25	23.5	38.25	18.25	17.75	24.25	16	15.25				
<b>Counter Stool with Arms, Polypropylene Back and Upholstered Seat</b>		Active weight 400 lbs. Does not stack.											
COM Yardage: 0.75													
Freight Class: 250													
Product Weight (lbs.): 33													
Cubic Feet Per Carton: 15													





DESCRIPTION	FEATURES	MODEL#	STANDARD TEXTILE GRADES											
			1/COM	2	3	4	5	6	7	8	9	10	11	12
 <p><b>Counter Stool with Arms, Upholstered Seat and Back</b> COM Yardage: Back: 0.5; Seat: 0.75 Freight Class: 250 Product Weight (lbs.): 33.5 Cubic Feet Per Carton: 15</p>	<p><b>W5CSAUU</b> Base Price: \$929 Seat upcharge: +0 Back upcharge: +0</p>													
		<b>OVERALL DIMENSIONS</b>			<b>SEAT DIMENSIONS</b>			<b>BACK DIMENSIONS</b>						
		<b>W</b>	<b>D</b>	<b>H</b>	<b>W</b>	<b>D</b>	<b>H</b>	<b>W</b>	<b>H</b>					
		24.25	23.5	38.25	18.25	17	24.25	16.5	15.25					
<p>Active weight 400 lbs. Does not stack. Add \$16 for (SBS).</p>														





DESCRIPTION	FEATURES	MODEL#	STANDARD TEXTILE GRADES											
			1/COM	2	3	4	5	6	7	8	9	10	11	12
 <p><b>Armless Counter Stool, Polypropylene Seat and Back</b> COM Yardage: n/a Freight Class: 250 Product Weight (lbs.): 29.5 Cubic Feet Per Carton: 13.75</p>	<p><b>W5CSNPP</b> Base Price: \$737</p>													
		<b>OVERALL DIMENSIONS</b>			<b>SEAT DIMENSIONS</b>			<b>BACK DIMENSIONS</b>						
		<b>W</b>	<b>D</b>	<b>H</b>	<b>W</b>	<b>D</b>	<b>H</b>	<b>W</b>	<b>H</b>					
		21.75	23.5	38.25	17.75	17.15	23.25	16	16					
<p>Active weight 400 lbs. Stacks 4 high on floor.</p>														

DESCRIPTION	FEATURES	MODEL#	STANDARD TEXTILE GRADES											
			1/COM	2	3	4	5	6	7	8	9	10	11	12
 <p><b>Armless Counter Stool, Upholstered Back and Polypropylene Seat</b> COM Yardage: 0.5 Freight Class: 250 Product Weight (lbs.): 30 Cubic Feet Per Carton: 13.75</p>	<p><b>W5CSNUP</b> Base Price: \$810 Seat upcharge: +\$26 Back upcharge: +\$17</p>													
		<b>OVERALL DIMENSIONS</b>			<b>SEAT DIMENSIONS</b>			<b>BACK DIMENSIONS</b>						
		<b>W</b>	<b>D</b>	<b>H</b>	<b>W</b>	<b>D</b>	<b>H</b>	<b>W</b>	<b>H</b>					
		21.75	23.5	38.25	17.75	16.5	23.25	16.5	16					
<p>Active weight 400 lbs. Stacks 4 high on floor. Add \$16 for (SBS).</p>														

DESCRIPTION	FEATURES	MODEL#	STANDARD TEXTILE GRADES											
			1/COM	2	3	4	5	6	7	8	9	10	11	12
 <p><b>Armless Counter Stool, Polypropylene Back and Upholstered Seat</b> COM Yardage: 0.75 Freight Class: 250 Product Weight (lbs.): 30 Cubic Feet Per Carton: 13.75</p>	<p><b>W5CSNPU</b> Base Price: \$810 Seat upcharge: +\$26 Back upcharge: +\$17</p>													
		<b>OVERALL DIMENSIONS</b>			<b>SEAT DIMENSIONS</b>			<b>BACK DIMENSIONS</b>						
		<b>W</b>	<b>D</b>	<b>H</b>	<b>W</b>	<b>D</b>	<b>H</b>	<b>W</b>	<b>H</b>					
		21.75	23.5	38.25	18.25	17.75	24.25	16	15.25					
<p>Active weight 400 lbs. Stacks 4 high on floor.</p>														

DESCRIPTION	FEATURES	MODEL#	STANDARD TEXTILE GRADES											
			1/COM	2	3	4	5	6	7	8	9	10	11	12
 <p><b>Armless Counter Stool, Upholstered Seat and Back</b> COM Yardage: Back: 0.5; Seat: 0.75 Freight Class: 250 Product Weight (lbs.): 30.5 Cubic Feet Per Carton: 13.75</p>	<p><b>W5CSNUU</b> Base Price: \$876 Seat upcharge: +0 Back upcharge: +0</p>													
		<b>OVERALL DIMENSIONS</b>			<b>SEAT DIMENSIONS</b>			<b>BACK DIMENSIONS</b>						
		<b>W</b>	<b>D</b>	<b>H</b>	<b>W</b>	<b>D</b>	<b>H</b>	<b>W</b>	<b>H</b>					
		21.75	23.5	38.25	18.25	17	24.25	16.5	15.25					
<p>Active weight 400 lbs. Stacks 4 high on floor. Add \$16 for (SBS).</p>														

DESCRIPTION	FEATURES	MODEL#	STANDARD TEXTILE GRADES												
 <p><b>Bar Stool with Arms, Polypropylene Seat and Back</b> COM Yardage: n/a Freight Class: 250 Product Weight (lbs.): 34.5 Cubic Feet Per Carton: 17</p>	<p>Active weight 400 lbs. Stacks 4 high on floor.</p>	List Price													
		W5BSAPP	\$801												
					OVERALL DIMENSIONS			SEAT DIMENSIONS			BACK DIMENSIONS				
			W	D	H	W	D	H	W	H					
			24.25	23.5	44	17.75	17.5	29.25	16	16					
 <p><b>Bar Stool with Arms, Upholstered Back and Polypropylene Seat</b> COM Yardage: 0.5 Freight Class: 250 Product Weight (lbs.): 35 Cubic Feet Per Carton: 17</p>	<p>Active weight 400 lbs. Stacks 4 high on floor. Add \$16 for (SBS).</p>	1/COM	2	3	4	5	6	7	8	9	10	11	12		
		W5BSAUP	\$874	\$891	\$905	\$924	\$952	\$963	\$987	\$1024	\$1053	\$1083	\$1147	\$1214	
					OVERALL DIMENSIONS			SEAT DIMENSIONS			BACK DIMENSIONS				
			W	D	H	W	D	H	W	H					
			24.25	23.5	44.5	17.75	16.5	29.25	16.5	16					
 <p><b>Bar Stool with Arms, Polypropylene Back and Upholstered Seat</b> COM Yardage: 0.75 Freight Class: 250 Product Weight (lbs.): 35 Cubic Feet Per Carton: 17</p>	<p>Active weight 400 lbs. Stacks 4 high on floor.</p>	1/COM	2	3	4	5	6	7	8	9	10	11	12		
		W5BSAPU	\$874	\$891	\$905	\$924	\$952	\$963	\$987	\$1024	\$1053	\$1083	\$1147	\$1214	
					OVERALL DIMENSIONS			SEAT DIMENSIONS			BACK DIMENSIONS				
			W	D	H	W	D	H	W	H					
			24.25	23.5	44	18.25	17.5	30.25	16	15.25					
 <p><b>Bar Stool with Arms, Upholstered Seat and Back</b> COM Yardage: Back: 0.5; Seat: 0.75 Freight Class: 250 Product Weight (lbs.): 35.5 Cubic Feet Per Carton: 17</p>	<p>Active weight 400 lbs. Stacks 4 high on floor. Add \$16 for (SBS).</p>	1/COM	2	3	4	5	6	7	8	9	10	11	12		
		W5BSAAU	Base Price: \$941 Seat upcharge: +0 Back upcharge: +0	+0	+\$26	+\$46	+\$75	+\$117	+\$133	+\$169	+\$225	+\$267	+\$314	+\$409	+\$510
					OVERALL DIMENSIONS			SEAT DIMENSIONS			BACK DIMENSIONS				
			W	D	H	W	D	H	W	H					
			24.25	23.5	44.5	18.25	16.75	30.25	16.5	15.25					
 <p><b>Armless Bar Stool, Polypropylene Seat and Back</b> COM Yardage: n/a Freight Class: 250 Product Weight (lbs.): 31.5 Cubic Feet Per Carton: 15.75</p>	<p>Active weight 400 lbs. Stacks 4 high on floor.</p>	List Price													
		W5BSNPP	\$750												
					OVERALL DIMENSIONS			SEAT DIMENSIONS			BACK DIMENSIONS				
			W	D	H	W	D	H	W	H					
			20.75	23.5	44	17.75	17.5	29.25	16	16					

DESCRIPTION	FEATURES	MODEL#	STANDARD TEXTILE GRADES											
 <p><b>Armless Bar Stool, Upholstered Back and Polypropylene Seat</b> COM Yardage: 0.5 Freight Class: 250 Product Weight (lbs.): 32 Cubic Feet Per Carton: 15.75</p>	<p><b>W5BSNUP</b></p> <p>Active weight 400 lbs. Stacks 4 high on floor. Add \$16 for (SBS).</p>	1/COM	2	3	4	5	6	7	8	9	10	11	12	
		\$822	\$839	\$853	\$872	\$900	\$911	\$935	\$972	\$1001	\$1031	\$1095	\$1162	
		<b>OVERALL DIMENSIONS</b>			<b>SEAT DIMENSIONS</b>			<b>BACK DIMENSIONS</b>						
			<b>W</b>	<b>D</b>	<b>H</b>	<b>W</b>	<b>D</b>	<b>H</b>	<b>W</b>	<b>H</b>				
			20.75	23.5	44.5	17.75	16.5	29.25	16.5	16				
 <p><b>Armless Bar Stool, Polypropylene Back and Upholstered Seat</b> COM Yardage: 0.75 Freight Class: 250 Product Weight (lbs.): 32 Cubic Feet Per Carton: 15.75</p>	<p><b>W5BSNPU</b></p> <p>Active weight 400 lbs. . Stacks 4 high on floor.</p>	1/COM	2	3	4	5	6	7	8	9	10	11	12	
		\$822	\$848	\$868	\$897	\$939	\$955	\$991	\$1047	\$1089	\$1136	\$1231	\$1332	
		<b>OVERALL DIMENSIONS</b>			<b>SEAT DIMENSIONS</b>			<b>BACK DIMENSIONS</b>						
			<b>W</b>	<b>D</b>	<b>H</b>	<b>W</b>	<b>D</b>	<b>H</b>	<b>W</b>	<b>H</b>				
			20.75	23.5	44	18.25	17.5	30.25	16	15.25				
 <p><b>Armless Bar Stool, Upholstered Seat and Back</b> COM Yardage: Back: 0.5; Seat: 0.75 Freight Class: 250 Product Weight (lbs.): 32.5 Cubic Feet Per Carton: 15.75</p>	<p><b>W5BSNUU</b></p> <p>Base Price: \$889 Seat upcharge: Back upcharge:</p>	1/COM	2	3	4	5	6	7	8	9	10	11	12	
		+\$0	+\$26	+\$46	+\$75	+\$117	+\$133	+\$169	+\$225	+\$267	+\$314	+\$409	+\$510	
		+\$0	+\$17	+\$31	+\$50	+\$78	+\$89	+\$113	+\$150	+\$179	+\$209	+\$273	+\$340	
<b>OVERALL DIMENSIONS</b>			<b>SEAT DIMENSIONS</b>			<b>BACK DIMENSIONS</b>								
			<b>W</b>	<b>D</b>	<b>H</b>	<b>W</b>	<b>D</b>	<b>H</b>	<b>W</b>	<b>H</b>				
			20.75	23.5	44.5	18.25	16.75	30.25	16.5	15.25				
 <p><b>Hip Chair, Polypropylene Seat and Back</b> COM Yardage: n/a Freight Class: 250 Product Weight (lbs.): 35.5 Cubic Feet Per Carton: 17.75</p>	<p><b>W524APP</b></p> <p>List Price: \$814</p> <p>Active weight 400 lbs. Does not stack.</p>													
		<b>OVERALL DIMENSIONS</b>			<b>SEAT DIMENSIONS</b>			<b>BACK DIMENSIONS</b>						
					<b>W</b>	<b>D</b>	<b>H</b>	<b>W</b>	<b>D</b>	<b>H</b>	<b>W</b>	<b>H</b>		
			24.25	24.25	38	17.75	17.5	22.25	16	16				
 <p><b>Hip Chair, Upholstered Back and Polypropylene Seat</b> COM Yardage: 0.5 Freight Class: 250 Product Weight (lbs.): 36 Cubic Feet Per Carton: 17.75</p>	<p><b>W524AUP</b></p> <p>Active weight 400 lbs. Does not stack. Add \$16 for (SBS).</p>	1/COM	2	3	4	5	6	7	8	9	10	11	12	
		\$886	\$903	\$917	\$936	\$964	\$975	\$999	\$1036	\$1065	\$1095	\$1159	\$1226	
		<b>OVERALL DIMENSIONS</b>			<b>SEAT DIMENSIONS</b>			<b>BACK DIMENSIONS</b>						
			<b>W</b>	<b>D</b>	<b>H</b>	<b>W</b>	<b>D</b>	<b>H</b>	<b>W</b>	<b>H</b>				
			24.25	24.25	38.25	17.75	16.5	22.25	16.5	16.25				

DESCRIPTION	FEATURES	MODEL#											
		1/COM	2	3	4	5	6	7	8	9	10	11	12
 <p><b>Hip Chair, Polypropylene Back and Upholstered Seat</b> COM Yardage: 0.75 Freight Class: 250 Product Weight (lbs.): 36 Cubic Feet Per Carton: 17.75</p>	<b>W524APU</b>	\$886	\$912	\$932	\$961	\$1003	\$1019	\$1055	\$1111	\$1153	\$1200	\$1295	\$1396
		<b>OVERALL DIMENSIONS</b>			<b>SEAT DIMENSIONS</b>			<b>BACK DIMENSIONS</b>					
		<b>W</b>	<b>D</b>	<b>H</b>	<b>W</b>	<b>D</b>	<b>H</b>	<b>W</b>	<b>H</b>				
		24.25	24.25	38	18.25	17.5	23.25	16	15.25				

DESCRIPTION	FEATURES	MODEL#											
		1/COM	2	3	4	5	6	7	8	9	10	11	12
 <p><b>Hip Chair, Upholstered Seat and Back</b> COM Yardage: Back: 0.5; Seat: 0.75 Freight Class: 250 Product Weight (lbs.): 36.5 Cubic Feet Per Carton: 17.75</p>	<b>W524AU</b>	Base Price: \$952											
		Seat upcharge: +0	+\$26	+\$46	+\$75	+\$117	+\$133	+\$169	+\$225	+\$267	+\$314	+\$409	+\$510
		Back upcharge: +0	+\$17	+\$31	+\$50	+\$78	+\$89	+\$113	+\$150	+\$179	+\$209	+\$273	+\$340
			<b>OVERALL DIMENSIONS</b>			<b>SEAT DIMENSIONS</b>			<b>BACK DIMENSIONS</b>				
		<b>W</b>	<b>D</b>	<b>H</b>	<b>W</b>	<b>D</b>	<b>H</b>	<b>W</b>	<b>H</b>				
		24.25	24.25	38.25	18.25	16.5	23.25	16.5	15.25				

DESCRIPTION	FEATURES	MODEL#											
		1/COM	2	3	4	5	6	7	8	9	10	11	12
 <p><b>Bariatric Hip Chair, Upholstered Seat and Back</b> COM Yardage: Back: 1 Seat: .75 Freight Class: 250 Product Weight (lbs.): 50 Cubic Feet Per Carton: 23.75</p>	<b>W324AU</b>	Base Price: \$1254											
		Seat upcharge: +0	+\$34	+\$61	+\$100	+\$155	+\$178	+\$225	+\$300	+\$356	+\$417	+\$545	+\$679
		Back upcharge: +0	+\$26	+\$46	+\$75	+\$117	+\$133	+\$169	+\$225	+\$267	+\$314	+\$409	+\$510
			<b>OVERALL DIMENSIONS</b>			<b>SEAT DIMENSIONS</b>			<b>BACK DIMENSIONS</b>				
		<b>W</b>	<b>D</b>	<b>H</b>	<b>W</b>	<b>D</b>	<b>H</b>	<b>W</b>	<b>H</b>				
		35.25	24.25	38.5	29	17.5	23.25	26.75	15.25				

List Price														
 <p><b>Dolly</b> COM Yardage: n/a Freight Class: 150 Product Weight (lbs.): 16 Cubic Feet Per Carton: 3.5</p>	<b>WDOL</b>	\$368												
			<b>OVERALL DIMENSIONS</b>			<b>SEAT DIMENSIONS</b>			<b>BACK DIMENSIONS</b>					
			<b>W</b>	<b>D</b>	<b>H</b>	<b>W</b>	<b>D</b>	<b>H</b>	<b>W</b>	<b>H</b>				
			22	23.75	9.25	Accommodates 10 standard 4-legged chairs.								

List Price														
 <p><b>Bariatric Dolly</b> COM Yardage: n/a Freight Class: 250 Product Weight (lbs.): 19 Cubic Feet Per Carton: 5</p>	<b>WDOL30</b>	\$408												
			<b>OVERALL DIMENSIONS</b>			<b>SEAT DIMENSIONS</b>			<b>BACK DIMENSIONS</b>					
			<b>W</b>	<b>D</b>	<b>H</b>	<b>W</b>	<b>D</b>	<b>H</b>	<b>W</b>	<b>H</b>				
			32.12	23.75	9.25	Accommodates 4 bariatric 4-legged chairs.								

**WILLOW LINKING TABLES**



**WPT12G**  
120 degree corner linking table



**WPT12GL**  
End linking table, left



For Willow seating, see 239.

**STANDARD FEATURES**

- Linking tables can be used together in any combination with Willow four-leg or sled chairs to create a wide variety of layouts.
- Connecting hardware is included.
- Legs and ganging brackets are available in 20 paint finishes and 4 plated finishes.
- All tables are laminate, choose thermally fused or high pressure, and feature a flat edge with edgeband.
- Tables are available with a variety of glide types. Glides must be chosen to best suit flooring type and site conditions. See Glide Type.
- All tables (except 9" In-line Linking) are pre-drilled for center front, field installed, undermount power. Specified separately.
- Undermount power unit (SU2P10U) includes 1 AC and 2 USB-A charging ports with a 10' power cord and 3-prong plug, specify Jet Black or White. Power units do not link.
- Clamp mount (SU2P10C) power, with 1 AC and 2 USB-A charging ports with a 10' power cord, available Jet Black or White. These units can be mounted on the back edge of all linking tables. Specified separately for field installation. Power units do not link.

Add option codes in the following order:

- **Model number**  
Enter model number.
- **Surface Type**  
(**TFL**) Thermally fused laminate  
(**HPL**) High pressure laminate
- **Top finish**  
(**ACJ**) Absolute Acajou  
(**ASN**) Asian Night  
(**AWC**) Avant Cherry  
(**AWH**) Avant Honey  
(**BLK**) Black  
(**BRC**) Brushed Cobalt  
(**BZD**) Blizzard  
(**CGY**) Custom Grey  
(**CMB**) Clear Maple  
(**DES**) Dark Espresso  
(**DWT**) Designer White  
(**FAS**) Fashonista  
(**FCL**) Flat Class  
(**NBL**) Noce Biscotto  
(**NGL**) Noce Ingio  
(**NEL**) Noce Leggero  
(**NML**) Noce Medio  
(**EMH**) Emerger Mahogany  
(**SBY**) Sheer Beauty  
(**SDT**) Stonedust  
(**SGG**) Storm Grey  
(**WCR**) Winter Cherry  
(**WHC**) White Chocolate  
(**WHE**) Walnut Heights
- **Leg Finish** (for tables with legs)  
Paint finishes:  
Black (**TBL**), Buzz Blue (**TBZ**), Cactus (**TCC**), Carrot (**TCR**), Cloud (**TIV**), Designer White (**TDW**), Dijon (**TDJ**), Eggplant (**TEG**), Fog (**TFO**), Frost (**TFR**), Ink (**TIN**), Kalua (**TKA**), Latte (**TLA**), Mocha (**TMO**), Nevada (**TNE**), Sand (**TSN**), Scarlet (**TSR**), Shadow (**TSH**), Toast (**TOA**) and Tungsten (**TTU**).  
Plated finishes:  
(**CHM**) Chrome. Add \$45.  
(**BCH**) Brushed Chrome. Add \$156.
- **Bracket Finish** (for linking tables and ganging bracket)  
Paint finishes:  
Black (**TBL**), Cloud (**TIV**), Designer White (**TDW**), Fog (**TFO**), Frost (**TFR**), Kalua (**TKA**), Latte (**TLA**), Mocha (**TMO**), Nevada (**TNE**), Sand (**TSN**), Shadow (**TSH**), Toast (**TOA**) and Tungsten (**TTU**).
- **Glide type** (for models with legs)  
(**ST**) Nylon colored glide for most surfaces  
(**NM**) White, non-marking Nylon glide for most surfaces  
(**SG**) Steel cushion glide for carpeted surfaces. Add \$9 for models with one leg. Add \$16 for models with two legs.  
(**FG**) Felt glide for most hard floor surfaces. Add \$9 for models with one leg. Add \$16 for models with two legs.  
(**RG**) Rubber, non-slip glide for most hard floor surfaces. Add \$9 for models with one leg. Add \$16 for models with two legs.
- **Glide Finish** (for ST glides only)  
(**BLK**) Black  
(**SND**) Sand

**EXAMPLE WILLOW TABLE ORDER CODE:**

WPT90G	HPL	ACJ	CHM	-ST	-SND
Model #	Surface type	Top finish	Leg finish	Glide type	Glide finish

TABLES	MODEL#	DIMENSIONS	FREIGHT CLASS	WT/LBS.	CUBIC FT.	LIST PRICE
--------	--------	------------	---------------	---------	-----------	------------



**90° Corner Linking Table**

WPT90G	26.12 x 26.12 x 17.62	100	24	2.6	<b>\$592</b>
--------	-----------------------	-----	----	-----	--------------

- Pricing shown for a thermally fused laminate top (LP).
- For a high pressure laminate top (HP), add **\$152**.

Coordinating edge on laminate surfaces with metal frame and legs. Must be connected to a four-leg or sled base chair. Includes one set of U-channel connectors and hardware. 1 per carton. Shipped KD for assembly on site.



**120° Corner Linking Table**

WPT12G	31 x 12.62 x 17.5	92.5	16.5	1.5	<b>\$509</b>
--------	-------------------	------	------	-----	--------------

- Pricing shown for a thermally fused laminate top (LP).
- For a high pressure laminate top (HP), add **\$98**.

Coordinating edge on laminate surfaces with metal frame and legs. Must be connected to a four-leg or sled base chair. Includes one set of U-channel connectors and hardware. 1 per carton. Shipped KD for assembly on site.



**16" In-Line Linking Table**

WPT16G	15 x 16 x 2.75	85	12	0.9	<b>\$333</b>
--------	----------------	----	----	-----	--------------

- Pricing shown for a thermally fused laminate top (LP).
- For a high pressure laminate top (HP), add **\$62**.

Coordinating edge on laminate surfaces with metal frame and legs. Must be connected to a four-leg or sled base chair. Includes one set of U-channel connectors and hardware. 1 per carton. Shipped KD for assembly on site.



**9" In-Line Linking Table**

WPT09G	8.5 x 8.5 x 2.75	85	8.5	0.7	<b>\$259</b>
--------	------------------	----	-----	-----	--------------

- Pricing shown for a thermally fused laminate top (LP).
- For a high pressure laminate top (HP), add **\$44**.

Coordinating edge on laminate surfaces with metal frame and legs. Must be connected to a four-leg or sled base chair. Includes one set of U-channel connectors and hardware. 1 per carton. Shipped KD for assembly on site.

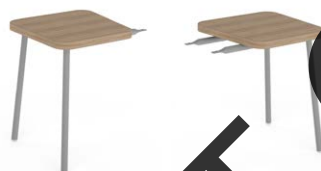

**End Linking Table**

WPT16GL (Left)	15 x 14 x 17.62	85	13	1	<b>\$516</b>
----------------	-----------------	----	----	---	--------------

WPT16GR (Right)	15 x 14 x 17.62	85	13	1	<b>\$516</b>
-----------------	-----------------	----	----	---	--------------

- Pricing shown for a thermally fused laminate top (LP).
- For a high pressure laminate top (HP), add **\$59**.



Coordinating edge on laminate surfaces with metal frame and legs. Must be connected to a four-leg or sled base chair. Includes one set of U-channel connectors and hardware. 1 per carton. Shipped KD for assembly on site.



**Gangng Bracket**

WPGBRK	9 x 15 x 1.25	300	2	2	<b>\$114</b>
--------	---------------	-----	---	---	--------------

For use between two seated height arm or armless chairs where table top is not desired. Not for use with stools. Does not accept power units. 1 per carton.

TABLES	MODEL#	DIMENSIONS	FREIGHT CLASS	WT/LBS.	CUBIC FT.	LIST PRICE
 <p><b>Power Unit, Clamp Attachment</b></p>	SU2P10C		70	0.01	0.5	\$588
<p>Tamper-resistant clamp mount power, with 1 AC and 2 USB-A charging ports with a 10' power cord and 3-prong plug. Available in Jet Black or White. Can be mounted on the back edge of all linking tables. Must be specified separately for field installation. Power units do not link.</p>						
 <p><b>Power Unit, Under Mount Attachment</b></p>	SU2P10U		70	0.01	2	\$556
<p>Tamper-resistant undermount power, with 1 AC and 2 USB-A charging ports with a 10' power cord and 3-prong plug. Available in Jet Black or White. Must be specified separately for field installation. Power units do not link.</p>						

NOT ON CONTRACT

ZOMA™



model 6656



model 6657



STANDARD FEATURES

- Design sensitive guest seating featuring a wide flat, flared arms and elliptical tubular construction.
- The back of the chair is heavily compound curved to provide comfort and support in multiple seating positions.
- No visible back attachment hardware. Backs are attached using concealed hardware only.
- The outer back is upholstered in the same material selection as the rest of the chair.
- Arms are wide and full length, offering support to help stabilize the user as they sit in or exit chairs.
- The gently curved arms are made from incredibly strong black fiberglass reinforced nylon.
- The rugged frame is made from welded elliptical (oval) steel tubing 1.5" wide.

- Zoma is equipped with a polypropylene seat shroud that helps stabilize chairs when stacked and avoid frame imprints on upholstered seats.
- Stacks up to 4 high on the floor or on a dolly (2125WS).
- Standard glide is a durable Black Polypropylene oval glide.
- Check textile availability prior to specifying upholstery material.

OPTIONAL FEATURES

- Frame is standard in a choice of Black (TBL), Shadow (TSH) or Tungsten (TTU) Finish must be specified. A chrome frame is optionally available. Please Specify (CHM), add \$47.
- A durable polypropylene outer back shroud is available at no charge. Optional shroud is Black only. Please specify (PSB).
- For chairs used on hard surface floors PLEASE SPECIFY Opaque (off White), Non-Marking Glides (NM).

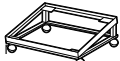
DESCRIPTION	FEATURES	MODEL#	STANDARD TEXTILE GRADES													
			1	2	3	4	5	6	7	8	9	10	11	12		
 <p><b>Armchair</b> COM Yardage: 1.25 Freight Class: 250 Product Weight (lbs.): 28 Cubic Feet Per Carton: 13.75</p>	<p>Stacks 4 high on floor or dolly.</p> <p>Ergonomic Features: M, N</p>	<b>6656</b>	\$650	\$700	\$739	\$791	\$870	\$898	\$966	\$1096	\$1159	\$1277	\$1444	\$1647		
		<b>OVERALL DIMENSIONS</b>			<b>SEAT DIMENSIONS</b>			<b>BACK DIMENSIONS</b>								
		<b>W</b>	<b>D</b>	<b>H</b>	<b>W</b>	<b>D</b>	<b>H</b>	<b>W</b>	<b>H</b>							
		26.5	24	32.5	20	19	17	18	15							
			<b>RTA 00</b>													
 <p><b>Armless Side Chair</b> COM Yardage: 1.25 Freight Class: 250 Product Weight (lbs.): 26 Cubic Feet Per Carton: 11.75</p>	<p>Stacks 4 high on floor or dolly.</p> <p>Ergonomic Features: M, N</p>	<b>6657</b>	\$593	\$642	\$681	\$733	\$813	\$840	\$907	\$1039	\$1102	\$1220	\$1386	\$1589		
		<b>OVERALL DIMENSIONS</b>			<b>SEAT DIMENSIONS</b>			<b>BACK DIMENSIONS</b>								
		<b>W</b>	<b>D</b>	<b>H</b>	<b>W</b>	<b>D</b>	<b>H</b>	<b>W</b>	<b>H</b>							
		22.5	24	32.5	20	19	17	18	15							
			<b>RTA 00</b>	<b>FedEx</b>	<b>ups</b>											
 <p><b>Dolly</b> COM Yardage: N/A Freight Class: 150 Product Weight (lbs.): 16 Cubic Feet Per Carton: 3.8</p>		<b>2125WS</b>	\$477	-	-	-	-	-	-	-	-	-	-	-		
		<b>OVERALL DIMENSIONS</b>			<b>SEAT DIMENSIONS</b>			<b>BACK DIMENSIONS</b>								
		<b>W</b>	<b>D</b>	<b>H</b>	<b>W</b>	<b>D</b>	<b>H</b>	<b>W</b>	<b>H</b>							
		23.25	24.75	12.25	-	-	-	-	-							
			<b>RTA 1</b>	<b>FedEx</b>	<b>ups</b>											



# lounge

Ballara .....	256	Jeo .....	320	Venture .....	380
Braden .....	267	Kate .....	321	Vitrola .....	383
Bridges II Collaborative Seating .....	269	Lux .....	322	Wind Seating .....	385
calidon .....	277	ML .....	324	Wind Tables .....	387
calidon tables .....	280	ML Park .....	326	Wind Linear .....	389
Camino .....	283	Prairie .....	327	Wind Linear Tables .....	394
Citi .....	288	Rambler .....	328		
Citi Square .....	293	River .....	331		
Drift .....	302	River+ .....	349		
Drift Tables .....	315	Sirena .....	376		

BALLARA™



model 9751

model 9751NA & 9757L



**Quilted Seat Option**  
See optional features for more details.



model 9752NA Two Seat Sofa, 9755 Corner Table, 9751NA Lounge Chair, 9757L Left Tablet

**STANDARD FEATURES**

- An all inclusive, modular series which includes seating, storage, power, tables and tablets.
- Fulfill many space planning scenarios including corner, in-line, open concept as well as traditional reception.
- Furniture pieces, seating or tables can be used as stand alone items or linked together with ganging brackets to create infinite configurations.
- Four high back (banquette) models available in two different heights (42" or 48") and two sizes (two-seat or three-seat armless sofas).
- Tablets can be mounted outside seats to accommodate various work and collaborative settings. Tablets have a 14" round surface and come with a 2-point locking mechanism for easy handling and stability.
- Fixed cushions are accented by a metal base and frame.
- Tables features durable and matching 3mm edges.
- Power modules include one power outlet and two USB ports and can be mounted under any seat or table. Wire management is included.
- All models are standard with Black polypropylene foot glides.
- Check textile availability prior to specifying upholstery material.

**OPTIONAL FEATURES**

- Quilted Seat (**Q**) is available. Backless stools, add **\$113** each. Single seat models, add **\$224**. Two seater sofa, add **\$440**. Three seater sofa, add **\$661**.
- **Seating and Table Frame Finish:**  
All chair frames, table frames, tablet metal components, ganging brackets and power modules are available in the following finishes  
(**TBL**) Black  
(**TDW**) Designer White  
(**TTU**) Tungsten  
(**CHM**) Chrome. **Upcharge varies.**  
(**BCH**) Brushed Chrome. **Upcharge varies.**  
Please Specify.

- Brushed Chrome (**BCH**) and Chrome (**CHM**) are available at an upcharge. Add **\$238** for counter height and bar height stools. Add **\$256** for single seat lounge chairs. Add **\$339** for two seat sofas. Add **\$424** for three seat sofas. Add **\$256** for storage/end tables. Add **\$339** for storage/coffee tables. Add **\$131** for tablets. Add **\$33** for ganging brackets. Add **\$26** for power modules.
- **Table Tops**  
Corner tables, storage tables and tablets are offered in the following High Pressure Laminate finishes:  
(**ACJ**) Absolute Acajou (**ASN**) Asian Night  
(**AWC**) Avant Cherry (**AWH**) Avant Honey  
(**BLK**) Black (**BRC**) Brushed Cobalt  
(**BZD**) Blizzard (**CMB**) Clear Maple  
(**CGY**) Custom Grey (**DES**) Dark Espresso  
(**DWT**) Designer White (**FAS**) Fashionista  
(**FCL**) First Class (**NBL**) Noce Biondo  
(**NGL**) Noce Grigio (**NEL**) Noce Leggero  
(**NML**) Noce Medio  
(**QTM**) Quartered Mahogany  
(**SBY**) Sheer Beauty (**SDT**) Stonedust  
(**SOG**) Storm Grey (**WHE**) Walnut Heights  
(**WHC**) White Chocolate (**WCR**) Winter Cherry

**SAMPLE LAYOUTS**

**Layout A**



Qty	Model Number	Description	Dimensions	List Price
1	<b>9751L</b>	Lounge Chair - Left Arm	28.5 x 29.5 x 30	2227
1	<b>9751R</b>	Lounge Chair - Right Arm	28.5 x 29.5 x 30	2227
1	<b>9755</b>	Corner Table	27.25 x 27.25 x 16.5	887
2	<b>9759</b>	Ganging Bracket	1 x 0.75 x 10	27 x 2
<b>SAMPLE LAYOUT TOTAL IN STANDARD FRAME FINISHES</b>				<b>\$5,395</b>
<b>SAMPLE LAYOUT TOTAL IN OPTIONAL FRAME FINISHES</b>				<b>\$6,229</b>

## SAMPLE LAYOUTS

### Layout B



Qty	Model Number	Description	Dimensions	List Price
1	<b>9751L</b>	Lounge Chair - Left Arm	28.5 x 29.5 x 30	2227
1	<b>9751R</b>	Lounge Chair - Right Arm	28.5 x 29.5 x 30	2227
1	<b>9755</b>	Corner Table	27.25 x 27.25 x 16.5	887
2	<b>9759</b>	Ganging Bracket	1 x 0.75 x 10	27 x 2

**SAMPLE LAYOUT TOTAL IN STANDARD BLACK FRAME**

**\$5,395**

**SAMPLE LAYOUT TOTAL IN OPTIONAL FRAME FINISHES**

**\$6,229**

### Layout C

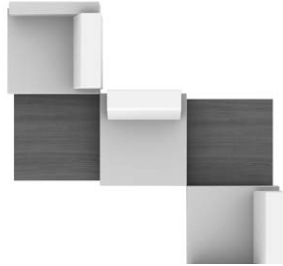

Qty	Model Number	Description	Dimensions	List Price
1	<b>9751L</b>	Lounge Chair - Left Arm	28.5 x 29.5 x 30	2227
1	<b>9751R</b>	Lounge Chair - Right Arm	28.5 x 29.5 x 30	2227
1	<b>9751NA</b>	Lounge Chair - No Arms	27.5 x 29.5 x 30	1846
2	<b>9755</b>	Corner Table	27.25 x 27.25 x 16.5	887 x 2
4	<b>9759</b>	Ganging Bracket	1 x 0.75 x 10	27 x 4

**SAMPLE LAYOUT TOTAL IN STANDARD BLACK FRAME**

**\$8,182**

**SAMPLE LAYOUT TOTAL IN OPTIONAL FRAME FINISHES**

**\$9,594**

### Layout D



Qty	Model Number	Description	Dimensions	List Price
1	<b>9751L</b>	Lounge Chair - Left Arm	28.5 x 29.5 x 30	2227
1	<b>9751R</b>	Lounge Chair - Right Arm	28.5 x 29.5 x 30	2227
1	<b>9751NA</b>	Lounge Chair - Armless	27.5 x 29.5 x 30	1846
2	<b>9755</b>	Corner Table	27.25 x 27.25 x 16.5	887 x 2
1	<b>9757L</b>	Left Tablet	14 x 14 x 17.25	682
1	<b>9758R</b>	Right Tablet	14 x 14 x 17.25	682
4	<b>9759</b>	Ganging Bracket	1 x 0.75 x 10	27 x 4

**SAMPLE LAYOUT TOTAL IN STANDARD BLACK FRAME**

**\$9,546**

**SAMPLE LAYOUT TOTAL IN OPTIONAL FRAME FINISHES**

**\$11,220**

### Layout E



Qty	Model Number	Description	Dimensions	List Price
1	<b>9752L-OB</b>	Two Seat Sofa Open Back - Left Arm	55 x 29.5 x 30	3627
1	<b>9752NA</b>	Two Seat Sofa - Armless	54 x 29.5 x 30	3331
1	<b>9754</b>	Storage Table	27.25 x 27.25 x 16.5	1407
1	<b>9755</b>	Corner Table	27.25 x 27.25 x 16.5	887
1	<b>9757R</b>	Right Tablet	14 x 14 x 17.25	682
2	<b>9759</b>	Ganging Bracket	1 x 0.75 x 10	27 x 2

**SAMPLE LAYOUT TOTAL IN STANDARD BLACK FRAME**

**\$10,042**

**SAMPLE LAYOUT TOTAL IN OPTIONAL FRAME FINISHES**

**\$11,429**

**SAMPLE LAYOUTS**

**Layout F**

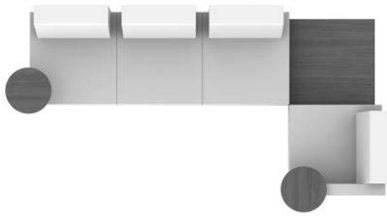

Qty	Model Number	Description	Dimensions	List Price
1	<b>9753NA-OB</b>	Three Seat Sofa Open Back - Armless	80.5 x 29.5 x 30	4670
1	<b>9751L</b>	Lounge Chair - Left Arm	28.5 x 29.5 x 30	2227
1	<b>9755</b>	Corner Table	27.25 x 27.25 x 16.5	887
1	<b>9757L</b>	Left Tablet	14 x 14 x 17.25	682
1	<b>9758R</b>	Right Tablet	14 x 14 x 17.25	682
2	<b>9759</b>	Ganging Bracket	1 x 0.75 x 10	27 x 2

**SAMPLE LAYOUT TOTAL IN STANDARD FRAME FINISHES**  
**SAMPLE LAYOUT TOTAL IN OPTIONAL FRAME FINISHES**

**\$9,202**  
**\$10,466**

**Layout G**



Qty	Model Number	Description	Dimensions	List Price
1	<b>9753NA-OB</b>	Three Seat Sofa Open Back - Armless	80.5 x 29.5 x 30	4670
1	<b>9751</b>	Lounge Chair	29.5 x 29.5 x 30	2603
1	<b>9755</b>	Corner Table	27.25 x 27.25 x 16.5	887
1	<b>9757L</b>	Left Tablet	14 x 14 x 17.25	682
1	<b>9759</b>	Ganging Bracket	1 x 0.75 x 10	27 x 1

**SAMPLE LAYOUT TOTAL IN STANDARD FRAME FINISHES**  
**SAMPLE LAYOUT TOTAL IN OPTIONAL FRAME FINISHES**

**\$8,869**  
**\$9,969**

**Layout H**



Qty	Model Number	Description	Dimensions	List Price
1	<b>9751L</b>	Lounge Chair - Left Arm	28.5 x 29.5 x 30	2227
1	<b>9751R</b>	Lounge Chair - Right Arm	28.5 x 29.5 x 30	2227
1	<b>9751NA</b>	Lounge Chair - No Arms	27.5 x 29.5 x 30	1846
2	<b>9755</b>	Corner Table	27.25 x 27.25 x 16.5	887 x 2
4	<b>9759</b>	Ganging Bracket	1 x 0.75 x 10	27 x 4

**SAMPLE LAYOUT TOTAL IN STANDARD FRAME FINISHES**  
**SAMPLE LAYOUT TOTAL IN OPTIONAL FRAME FINISHES**

**\$8,182**  
**\$9,594**

**Layout I**

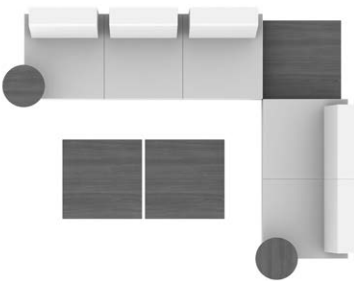

Qty	Model Number	Description	Dimensions	List Price
1	<b>9753NA-OB</b>	Three Seat Sofa Open Back - Armless	80.5 x 29.5 x 30	4670
1	<b>9752NA</b>	Two Seat Sofa - Armless	54 x 29.5 x 30	3331
2	<b>9754</b>	Storage Table	27.25 x 27.25 x 16.5	1407 x 2
1	<b>9755</b>	Corner Table	27.25 x 27.25 x 16.5	887
1	<b>9757L</b>	Left Tablet	14 x 14 x 17.25	682
1	<b>9758R</b>	Right Tablet	14 x 14 x 17.25	682
2	<b>9759</b>	Ganging Bracket	1 x 0.75 x 10	27 x 2

**SAMPLE LAYOUT TOTAL IN STANDARD FRAME FINISHES**  
**SAMPLE LAYOUT TOTAL IN OPTIONAL FRAME FINISHES**

**\$13,120**  
**\$14,979**

**SAMPLE LAYOUTS**

**Layout J**

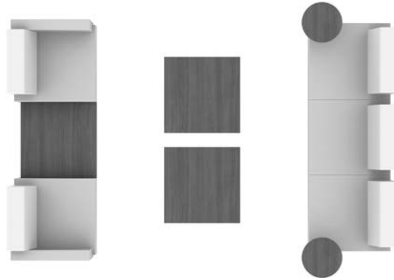

Qty	Model Number	Description	Dimensions	List Price
1	<b>9753NA-OB</b>	Three Seat Sofa Open Back - Armless	80.5 x 29.5 x 30	4670
1	<b>9751L</b>	Lounge Chair - Left Arm	28.5 x 29.5 x 30	2227
1	<b>9751R</b>	Lounge Chair - Right Arm	28.5 x 29.5 x 30	2227
2	<b>9754</b>	Storage Table	27.25 x 27.25 x 16.5	1407 x2
1	<b>9755</b>	Corner Table	27.25 x 27.25 x 16.5	887
1	<b>9757L</b>	Left Tablet	14 x 14 x 17.25	682
1	<b>9758R</b>	Right Tablet	14 x 14 x 17.25	682
2	<b>9759</b>	Ganging Bracket	1 x 0.75 x 10	27 x 2

**SAMPLE LAYOUT TOTAL IN STANDARD FRAME FINISHES \$14,243**  
**SAMPLE LAYOUT TOTAL IN OPTIONAL FRAME FINISHES \$16,275**

**Layout K**

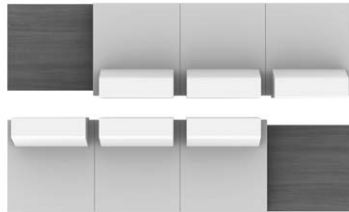

Qty	Model Number	Description	Dimensions	List Price
2	<b>9753NA-OB</b>	Three Seat Sofa Open Back - Armless	80.5 x 29.5 x 30	4670 x 2
2	<b>9755</b>	Corner Table	27.25 x 27.25 x 16.5	887 x 2
2	<b>9759</b>	Ganging Bracket	1 x 0.75 x 10	27 x 2

**SAMPLE LAYOUT TOTAL IN STANDARD FRAME FINISHES \$11,168**  
**SAMPLE LAYOUT TOTAL IN OPTIONAL FRAME FINISHES \$12,594**

**Layout L**



Qty	Model Number	Description	Dimensions	List Price
1	<b>9752NA</b>	Two Seat Sofa - Armless	54 x 29.5 x 30	3331
1	<b>9751L</b>	Lounge Chair - Left Arm	28.5 x 29.5 x 30	2227
1	<b>9751R</b>	Lounge Chair - Right Arm	28.5 x 29.5 x 30	2227
2	<b>9755</b>	Corner Table	27.25 x 27.25 x 16.5	887 x 2
4	<b>9759</b>	Ganging Bracket	1 x 0.75 x 10	27 x 4

**SAMPLE LAYOUT TOTAL IN STANDARD FRAME FINISHES \$9,667**  
**SAMPLE LAYOUT TOTAL IN OPTIONAL FRAME FINISHES \$11,162**

**Layout M**



Qty	Model Number	Description	Dimensions	List Price
1	<b>9753NA-OB</b>	Three Seat Sofa Open Back - Armless	80.5 x 29.5 x 30	4670
1	<b>9752L-OB</b>	Two Seat Sofa Open Back - Left Arm	55 x 29.5 x 30	3627
1	<b>9752NA</b>	Two Seat Sofa - Armless	54 x 29.5 x 30	3331
2	<b>9755</b>	Corner Table	27.25 x 27.25 x 16.5	887 x 2
1	<b>9754</b>	Storage Table	27.25 x 27.25 x 16.5	1407
1	<b>9758R</b>	Right Tablet	14 x 14 x 17.25	682
4	<b>9759</b>	Ganging Bracket	1 x 0.75 x 10	27 x 4

**SAMPLE LAYOUT TOTAL IN STANDARD FRAME FINISHES \$15,599**  
**SAMPLE LAYOUT TOTAL IN OPTIONAL FRAME FINISHES \$17,732**

**SAMPLE LAYOUTS**

**Layout N**

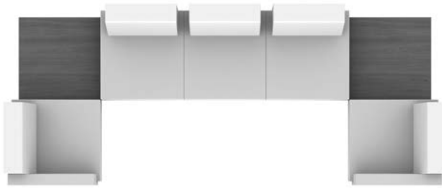

Qty	Model Number	Description	Dimensions	List Price
1	<b>9753NA-OB</b>	Three Seat Sofa Open Back - Armless	80.5 x 29.5 x 30	4670
1	<b>9751L</b>	Lounge Chair - Left Arm	28.5 x 29.5 x 30	2227
1	<b>9751R</b>	Lounge Chair - Right Arm	28.5 x 29.5 x 30	2227
2	<b>9755</b>	Corner Table	27.25 x 27.25 x 16.5	887 x 2
4	<b>9759</b>	Ganging Bracket	1 x 0.75 x 10	27 x 4

**SAMPLE LAYOUT TOTAL IN STANDARD FRAME FINISHES**  
**SAMPLE LAYOUT TOTAL IN OPTIONAL FRAME FINISHES**

**\$11,006**  
**\$12,586**

**Layout O**

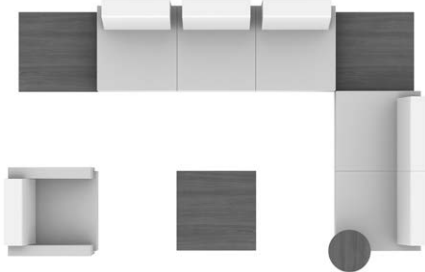

Qty	Model Number	Description	Dimensions	List Price
1	<b>9753NA-OB</b>	Three Seat Sofa Open Back - Armless	80.5 x 29.5 x 30	4670
1	<b>9752NA</b>	Two Seat Sofa - Armless	54 x 29.5 x 30	3331
1	<b>9751</b>	Lounge Chair	29.5 x 29.5 x 30	2603
1	<b>9754</b>	Storage Table	27.25 x 27.25 x 16.5	1407
2	<b>9755</b>	Corner Table	27.25 x 27.25 x 16.5	887 x 2
1	<b>9757L</b>	Left Tablet	14 x 14 x 17.25	682
3	<b>9759</b>	Ganging Bracket	1 x 0.75 x 10	27 x 3

**SAMPLE LAYOUT TOTAL IN STANDARD FRAME FINISHES**  
**SAMPLE LAYOUT TOTAL IN OPTIONAL FRAME FINISHES**

**\$14,548**  
**\$16,532**

**Layout P**

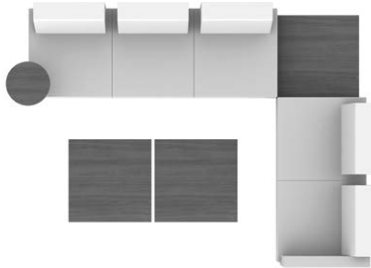

Qty	Model Number	Description	Dimensions	List Price
1	<b>9753NA-OB</b>	Three Seat Sofa Open Back - Armless	80.5 x 29.5 x 30	4670
1	<b>9752L-OB</b>	Two Seat Sofa Open Back - Left Arm	55 x 29.5 x 30	3627
2	<b>9754</b>	Storage Table	27.25 x 27.25 x 16.5	1407 x 2
1	<b>9755</b>	Corner Table	27.25 x 27.25 x 16.5	887
1	<b>9758R</b>	Right Tablet	14 x 14 x 17.25	682
2	<b>9759</b>	Ganging Bracket	1 x 0.75 x 10	27 x 2

**SAMPLE LAYOUT TOTAL IN STANDARD FRAME FINISHES**  
**SAMPLE LAYOUT TOTAL IN OPTIONAL FRAME FINISHES**

**\$12,734**  
**\$14,462**



**Lounge Chair**  
 COM Yardage: 4.25  
 Freight Class: 250  
 Product Weight (lbs.): 71  
 Cubic Feet Per Carton: 21.5

	1	2	3	4	5	6	7	8	9	10	11	12
<b>9751</b>	2603	2748	2859	3029	3264	3350	3559	3956	4147	4518	5018	5643

OVERALL DIMENSIONS			SEAT DIMENSIONS			BACK DIMENSIONS	
W	D	H	W	D	H	W	H
30.5	31	30	24	20.5	18.5	22	12.5

**RTA 00**



**9751R**



**9751L**



**Lounge Chair - One Arm**  
 COM Yardage: 3.25  
 Freight Class: 250  
 Product Weight (lbs.): 61  
 Cubic Feet Per Carton: 20

Ganging clip required for sectional use

	1	2	3	4	5	6	7	8	9	10	11	12
<b>9751R</b> <b>9751L</b>	2227	2347	2441	2581	2780	2875	3056	3344	3565	3811	4860	5403

OVERALL DIMENSIONS			SEAT DIMENSIONS			BACK DIMENSIONS	
W	D	H	W	D	H	W	H
28.5	31	30	24	20.5	18.5	22	12.5

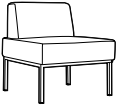
**RTA 00**

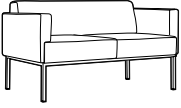
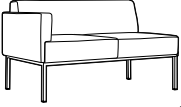
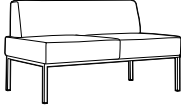
DESCRIPTION	FEATURES	MODEL#	STANDARD TEXTILE GRADES													
			1	2	3	4	5	6	7	8	9	10	11	12		
 <p><b>Lounge Chair - Armless</b> COM Yardage: 2.25 Freight Class: 250 Product Weight (lbs.): 51 Cubic Feet Per Carton: 18.75</p>	Ganging clip required for sectional use	<b>9751NA</b>	1846	1934	1998	2097	2236	2301	2428	2628	2784	2957	3312	3692		
		<b>OVERALL DIMENSIONS</b>			<b>SEAT DIMENSIONS</b>			<b>BACK DIMENSIONS</b>								
		<b>W</b>	<b>D</b>	<b>H</b>	<b>W</b>	<b>D</b>	<b>H</b>	<b>W</b>	<b>H</b>							
		26.5	31	30	24	20.5	18.5	22	12.5							
			<b>RTA 00</b>													
 <p><b>Corner Unit</b> COM Yardage: 3 Freight Class: 250 Product Weight (lbs.): 72 Cubic Feet Per Carton: 18.5</p>	Ganging clip required for sectional use	<b>9764</b>	2393	2519	2614	2762	2972	3047	3230	3577	3745	4068	4507	5054		
		<b>OVERALL DIMENSIONS</b>			<b>SEAT DIMENSIONS</b>			<b>BACK DIMENSIONS</b>								
		<b>W</b>	<b>D</b>	<b>H</b>	<b>W</b>	<b>D</b>	<b>H</b>	<b>W</b>	<b>H</b>							
		28.5	28.5	30	22	20.5	18.5	22	12.5							
			<b>RTA 00</b>													
 <p><b>Two Seat Sofa</b> COM Yardage: 6.25 Freight Class: 250 Product Weight (lbs.): 111 Cubic Feet Per Carton: 37.5</p>		<b>9752</b>	4097	4314	4482	4734	5089	5217	5530	6126	6412	6965	7718	8659		
		<b>OVERALL DIMENSIONS</b>			<b>SEAT DIMENSIONS</b>			<b>BACK DIMENSIONS</b>								
		<b>W</b>	<b>D</b>	<b>H</b>	<b>W</b>	<b>D</b>	<b>H</b>	<b>W</b>	<b>H</b>							
		56	31	30	48	20.5	18.5	44	12.5							
			<b>RTA 00</b>													
 <p><b>Two Seat Sofa - One Arm</b> COM Yardage: 5 Freight Class: 250 Product Weight (lbs.): 101 Cubic Feet Per Carton: 36.25</p>	Ganging clip required for sectional use	<b>9752R</b>	3668	3846	3988	4198	4492	4600	4862	5356	5598	6058	6686	7466		
		<b>OVERALL DIMENSIONS</b>			<b>SEAT DIMENSIONS</b>			<b>BACK DIMENSIONS</b>								
		<b>W</b>	<b>D</b>	<b>H</b>	<b>W</b>	<b>D</b>	<b>H</b>	<b>W</b>	<b>H</b>							
		54	31	30	48	20.5	18.5	44	12.5							
			<b>RTA 00</b>													
 <p><b>Two Seat Sofa - Armless</b> COM Yardage: 4 Freight Class: 250 Product Weight (lbs.): 91 Cubic Feet Per Carton: 35.5</p>	Ganging clip required for sectional use	<b>9752NA</b>	3331	3477	3588	3758	3996	4082	4290	4687	4877	5247	5750	6374		
		<b>OVERALL DIMENSIONS</b>			<b>SEAT DIMENSIONS</b>			<b>BACK DIMENSIONS</b>								
		<b>W</b>	<b>D</b>	<b>H</b>	<b>W</b>	<b>D</b>	<b>H</b>	<b>W</b>	<b>H</b>							
		52	31	30	48	20.5	18.5	44	12.5							
			<b>RTA 00</b>													

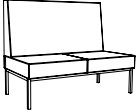

DESCRIPTION	FEATURES	MODEL#	STANDARD TEXTILE GRADES												
			1	2	3	4	5	6	7	8	9	10	11	12	
	Ganging clip required for sectional use	<b>9752NAHB42</b>	3023	3317	3549	3896	4387	4619	5067	5777	6327	6935	8191	9528	
		OVERALL DIMENSIONS			SEAT DIMENSIONS			BACK DIMENSIONS							
		W	D	H	W	D	H	W	H						
<b>Two Seat Sofa - 42" High Back</b> COM Yardage: 8 Freight Class: 250 Product Weight (lbs.): 120 Cubic Feet Per Carton: 48.5			52	31	42	48	20.5	18.5	44	24.5					
		<b>RTA 00</b>													

DESCRIPTION	FEATURES	MODEL#	STANDARD TEXTILE GRADES												
			1	2	3	4	5	6	7	8	9	10	11	12	
	Ganging clip required for sectional use	<b>9752NAHB48</b>	\$3128	\$3449	\$3702	\$4082	\$4618	\$4873	\$5361	\$6139	\$6740	\$7407	\$8779	\$10242	
		OVERALL DIMENSIONS			SEAT DIMENSIONS			BACK DIMENSIONS							
		W	D	H	W	D	H	W	H						
<b>Two Seat Sofa - 48" High Back</b> COM Yardage: 6 Freight Class: 250 Product Weight (lbs.): 130 Cubic Feet Per Carton: 35.25			52	31	48	48	20.5	18.5	44	30.5					
		<b>RTA 00</b>													

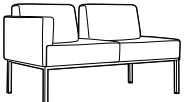
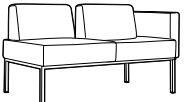
DESCRIPTION	FEATURES	MODEL#	STANDARD TEXTILE GRADES												
			1	2	3	4	5	6	7	8	9	10	11	12	
		<b>9752-OB</b>	4052	4266	4433	4685	5043	5170	5481	6078	6365	6919	7672	8609	
		OVERALL DIMENSIONS			SEAT DIMENSIONS			BACK DIMENSIONS							
		W	D	H	W	D	H	W	H						
<b>Two Seat Sofa - Open Back</b> COM Yardage: 6.25 Freight Class: 250 Product Weight (lbs.): 111 Cubic Feet Per Carton: 35.25			56	29.5	30	54	20.5	18.5	48	12.5					
		<b>RTA 00</b>													

DESCRIPTION	FEATURES	MODEL#	STANDARD TEXTILE GRADES												
			1	2	3	4	5	6	7	8	9	10	11	12	
 	Ganging clip required for sectional use	<b>9752R-OB</b>	3627	3805	3945	4156	4453	4560	4821	5317	5556	6017	6645	6017	
		<b>9752L-OB</b>													
		OVERALL DIMENSIONS			SEAT DIMENSIONS			BACK DIMENSIONS							
			W	D	H	W	D	H	W	H					
<b>Two Seat Sofa - Open Back - One Arm</b> COM Yardage: 5.25 Freight Class: 250 Product Weight (lbs.): 101 Cubic Feet Per Carton: 36.25			54	31	30	48	20.5	18.5	44	12.5					
		<b>RTA 00</b>													

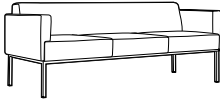
DESCRIPTION	FEATURES	MODEL#	STANDARD TEXTILE GRADES												
			1	2	3	4	5	6	7	8	9	10	11	12	
		<b>9752NA-OB</b>	3287	3432	3544	3713	3951	4034	4244	4643	4833	5202	5702	6327	
		OVERALL DIMENSIONS			SEAT DIMENSIONS			BACK DIMENSIONS							
		W	D	H	W	D	H	W	H						
<b>Two Seat Sofa - Open Back - Armless</b> COM Yardage: 4.25 Freight Class: 250 Product Weight (lbs.): 91 Cubic Feet Per Carton: 35.5			52	31	30	48	20.5	18.5	44	12.5					
		<b>RTA 00</b>													

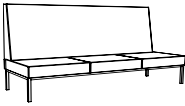
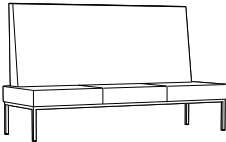
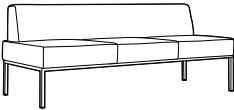
DESCRIPTION	FEATURES	MODEL#	STANDARD TEXTILE GRADES												
			1	2	3	4	5	6	7	8	9	10	11	12	
 <b>Three Seat Sofa</b> COM Yardage: 9.5 Freight Class: 250 Product Weight (lbs.): 153 Cubic Feet Per Carton: 54.5		<b>9753</b>	5480	5816	6084	6485	7056	7324	7838	8660	9295	9999	11450	12996	
			<b>OVERALL DIMENSIONS</b>			<b>SEAT DIMENSIONS</b>			<b>BACK DIMENSIONS</b>						
			<b>W</b>	<b>D</b>	<b>H</b>	<b>W</b>	<b>D</b>	<b>H</b>	<b>W</b>	<b>H</b>					
			82.5	31	30	76.5	20.5	18.5	66	12.5					
			<b>RTA 00</b>												
 <b>Three Seat Sofa - One Arm</b> COM Yardage: 8.25 Freight Class: 250 Product Weight (lbs.): 143 Cubic Feet Per Carton: 54.5	Ganging clip required for sectional use	<b>9753R</b>	5121	5416	5651	5998	6495	6726	7176	7892	8446	9058	10322	11668	
				<b>OVERALL DIMENSIONS</b>			<b>SEAT DIMENSIONS</b>			<b>BACK DIMENSIONS</b>					
				<b>W</b>	<b>D</b>	<b>H</b>	<b>W</b>	<b>D</b>	<b>H</b>	<b>W</b>	<b>H</b>				
				81.5	31	30	80.5	20.5	18.5	74	12.5				
			<b>RTA 00</b>												
 <b>Three Seat Sofa - 42" High Back</b> COM Yardage: 12.25 Freight Class: 300 Product Weight (lbs.): 143 Cubic Feet Per Carton: 72.50	Ganging clip required for sectional use	<b>9753NAHB42</b>	\$4554	\$4991	\$5336	\$5858	\$6597	\$6943	\$7612	\$8677	\$9500	\$10412	\$12293	\$14301	
				<b>OVERALL DIMENSIONS</b>			<b>SEAT DIMENSIONS</b>			<b>BACK DIMENSIONS</b>					
				<b>W</b>	<b>D</b>	<b>H</b>	<b>W</b>	<b>D</b>	<b>H</b>	<b>W</b>	<b>H</b>				
				80.5	31	42	74	20.5	18.5	74	24.5				
			<b>RTA 00</b>												
 <b>Three Seat Sofa - 48" High Back</b> COM Yardage: 13.25 Freight Class: 250 Product Weight (lbs.): 168 Cubic Feet Per Carton: 82.25	Ganging clip required for sectional use	<b>9753NAHB48</b>	4593	5042	5397	5932	6688	7044	7729	8821	9665	10600	12528	14585	
				<b>OVERALL DIMENSIONS</b>			<b>SEAT DIMENSIONS</b>			<b>BACK DIMENSIONS</b>					
				<b>W</b>	<b>D</b>	<b>H</b>	<b>W</b>	<b>D</b>	<b>H</b>	<b>W</b>	<b>H</b>				
				80.5	31	48	74	20.5	18.5	74	30.5				
			<b>RTA 00</b>												
 <b>Three Seat Sofa - Armless</b> COM Yardage: 7 Freight Class: 250 Product Weight (lbs.): 133 Cubic Feet Per Carton: 51.5	Ganging clip required for sectional use	<b>9753NA</b>	4717	4968	5166	5462	5884	6082	6465	7075	7545	8066	9141	10288	
				<b>OVERALL DIMENSIONS</b>			<b>SEAT DIMENSIONS</b>			<b>BACK DIMENSIONS</b>					
				<b>W</b>	<b>D</b>	<b>H</b>	<b>W</b>	<b>D</b>	<b>H</b>	<b>W</b>	<b>H</b>				
				80.5	31	30	80.5	20.5	18.5	74	12.5				
			<b>RTA 00</b>												

DESCRIPTION	FEATURES	MODEL#	STANDARD TEXTILE GRADES											
			1	2	3	4	5	6	7	8	9	10	11	12

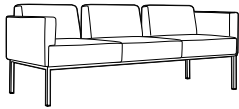

**Three Seat Sofa - Open Back**  
 COM Yardage: 8  
 Freight Class: 250  
 Product Weight (lbs.): 153  
 Cubic Feet Per Carton: 54.5

<b>9753-OB</b>	5441	5722	5949	6285	6760	6930	7348	8143	8526	9264	10267	11515
----------------	------	------	------	------	------	------	------	------	------	------	-------	-------

OVERALL DIMENSIONS			SEAT DIMENSIONS			BACK DIMENSIONS	
W	D	H	W	D	H	W	H
82.5	31	30	80.5	20.5	18.5	74	12.5

**RTA 00**

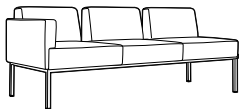

**9753R-OB**

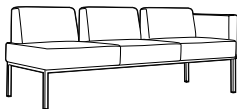

**9753L-OB**

**Three Seat Sofa - Open Back - One Arm**  
 COM Yardage: 7  
 Freight Class: 250  
 Product Weight (lbs.): 143  
 Cubic Feet Per Carton: 54.5

Ganging clip required for sectional use

<b>9753R-OB</b>	5075	5324	5521	5814	6231	6379	6745	7442	7777	8421	9299	10394
<b>9753L-OB</b>												

OVERALL DIMENSIONS			SEAT DIMENSIONS			BACK DIMENSIONS	
W	D	H	W	D	H	W	H
81.5	31	30	80.5	20.5	17.5	74	12.5

**RTA 00**

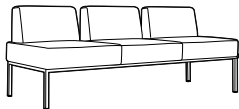

**Three Seat Sofa - Open Back - Armless**  
 COM Yardage: 6.25  
 Freight Class: 250  
 Product Weight (lbs.): 133  
 Cubic Feet Per Carton: 51.5

Ganging clip required for sectional use

<b>9753NA-OB</b>	4670	4887	5055	5307	5662	5790	6103	6699	6987	7538	8292	9232
------------------	------	------	------	------	------	------	------	------	------	------	------	------

OVERALL DIMENSIONS			SEAT DIMENSIONS			BACK DIMENSIONS	
W	D	H	W	D	H	W	H
80.5	31	30	80.5	20.5	17.5	74	12.5

**RTA 00**



**Storage Table**  
 COM Yardage: N/A  
 Freight Class: 125  
 Product Weight (lbs.): 65  
 Cubic Feet Per Carton: 11.5

Ganging clip required for sectional use

<b>9754</b>	1407	-	-	-	-	-	-	-	-	-	-	-
-------------	------	---	---	---	---	---	---	---	---	---	---	---

OVERALL DIMENSIONS			SEAT DIMENSIONS			BACK DIMENSIONS	
W	D	H	W	D	H	W	H
27.25	27.25	16.5	-	-	-	-	-

**RTA 00**







**Corner Table**  
 COM Yardage: N/A  
 Freight Class: 150  
 Product Weight (lbs.): 40  
 Cubic Feet Per Carton: 8

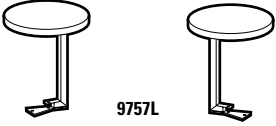

Ganging clip required for sectional use

<b>9755</b>	887	-	-	-	-	-	-	-	-	-	-	-
-------------	-----	---	---	---	---	---	---	---	---	---	---	---

OVERALL DIMENSIONS			SEAT DIMENSIONS			BACK DIMENSIONS	
W	D	H	W	D	H	W	H
27.25	27.25	12.5	-	-	-	-	-

**RTA 00**

DESCRIPTION	FEATURES	MODEL#	STANDARD TEXTILE GRADES														
			1	2	3	4	5	6	7	8	9	10	11	12			
 <p><b>Ganging Bracket</b> COM Yardage: N/A Freight Class: 70 Product Weight (lbs.): 0.52 Cubic Feet Per Carton: 0.02</p>	Only one set is needed per connection.	9759	27	-	-	-	-	-	-	-	-	-	-	-			
			<b>OVERALL DIMENSIONS</b>			<b>SEAT DIMENSIONS</b>			<b>BACK DIMENSIONS</b>								
			W	D	H	W	D	H	W	H							
			1	0.75	10	-	-	-	-	-							
			RTA 00		FedEx		ups										
 <p>9757L      9758R</p>		9757L 9758R	682	-	-	-	-	-	-	-	-	-	-	-			
			<b>OVERALL DIMENSIONS</b>			<b>SEAT DIMENSIONS</b>			<b>BACK DIMENSIONS</b>								
			W	D	H	W	D	H	W	H							
			14	17.25	14	-	-	-	-	-							
			RTA 1		FedEx		ups										
 <p>9760</p>		9760	\$430	-	-	-	-	-	-	-	-	-	-	-			
						10 Ft. power cord											
			<b>OVERALL DIMENSIONS</b>			<b>SEAT DIMENSIONS</b>			<b>BACK DIMENSIONS</b>								
			W	D	H	W	D	H	W	H							
			RTA 00		FedEx		ups										
		9761	1381	1455	1512	1598	1718	1776	1885	2061	2197	2346	2656	2984			
			<b>OVERALL DIMENSIONS</b>			<b>SEAT DIMENSIONS</b>			<b>BACK DIMENSIONS</b>								
			W	D	H	W	D	H	W	H							
			27.5	28.5	17.5	-	-	-	-	-							
			RTA 00		FedEx		ups										
		9762	2458	2604	2718	2890	3135	3250	3469	3821	4093	4394	5015	5676			
			<b>OVERALL DIMENSIONS</b>			<b>SEAT DIMENSIONS</b>			<b>BACK DIMENSIONS</b>								
			W	D	H	W	D	H	W	H							
			54	28.5	17.5	-	-	-	-	-							
			RTA 00		FedEx		ups										

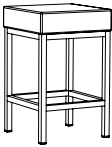
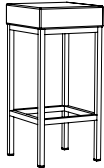
DESCRIPTION	FEATURES	MODEL#	STANDARD TEXTILE GRADES											
			1	2	3	4	5	6	7	8	9	10	11	12
 <p><b>Three Seat Bench</b> COM Yardage: 6 Freight Class: 250 Product Weight (lbs.): 80 Cubic Feet Per Carton: 29.5</p>	Ganging clip required for sectional use	<b>9763</b>	3478	3695	3863	4117	4479	4648	4973	5494	5893	6341	7258	8239
		<b>OVERALL DIMENSIONS</b>			<b>SEAT DIMENSIONS</b>			<b>BACK DIMENSIONS</b>						
		<b>W</b>	<b>D</b>	<b>H</b>	<b>W</b>	<b>D</b>	<b>H</b>	<b>W</b>	<b>H</b>					
		80.5	28.5	17.5	-	-	-	-	-					
			<b>RTA 00</b>											
 <p><b>Coffee Storage Table (2 Seat Length)</b> COM Yardage: N/A Freight Class: 150 Product Weight (lbs.): 112 Cubic Feet Per Carton: 20.5</p>	Ganging clip required for sectional use	<b>9765</b>	2564	-	-	-	-	-	-	-	-	-	-	-
		<b>OVERALL DIMENSIONS</b>			<b>SEAT DIMENSIONS</b>			<b>BACK DIMENSIONS</b>						
		<b>W</b>	<b>D</b>	<b>H</b>	<b>W</b>	<b>D</b>	<b>H</b>	<b>W</b>	<b>H</b>					
		53.75	27.25	16.5	-	-	-	-	-					
			<b>RTA 00</b>											
 <p><b>Coffee Table (2 Seat Length)</b> COM Yardage: N/A Freight Class: 150 Product Weight (lbs.): 68 Cubic Feet Per Carton: 17.75</p>		<b>9766</b>	1659	-	-	-	-	-	-	-	-	-	-	-
		<b>OVERALL DIMENSIONS</b>			<b>SEAT DIMENSIONS</b>			<b>BACK DIMENSIONS</b>						
		<b>W</b>	<b>D</b>	<b>H</b>	<b>W</b>	<b>D</b>	<b>H</b>	<b>W</b>	<b>H</b>					
		54	27.5	13	-	-	-	-	-					
			<b>RTA 00</b>											
 <p><b>24" Stool</b> COM Yardage: 0.75 Freight Class: 150 Product Weight (lbs.): 22 Cubic Feet Per Carton: 4.75</p>		<b>9769S24</b>	\$906	\$935	\$956	\$987	\$1032	\$1053	\$1094	\$1158	\$1207	\$1262	\$1376	\$1498
		<b>OVERALL DIMENSIONS</b>			<b>SEAT DIMENSIONS</b>			<b>BACK DIMENSIONS</b>						
		<b>W</b>	<b>D</b>	<b>H</b>	<b>W</b>	<b>D</b>	<b>H</b>	<b>W</b>	<b>H</b>					
		15	15	24	15	15	3	-	-					
			<b>RTA 00</b>											
 <p><b>30" Stool</b> COM Yardage: .50 Freight Class: 150 Product Weight (lbs.): 23 Cubic Feet Per Carton: 5.5</p>		<b>9769S30</b>	\$987	\$1016	\$1037	\$1068	\$1112	\$1133	\$1172	\$1235	\$1284	\$1339	\$1449	\$1568
		<b>OVERALL DIMENSIONS</b>			<b>SEAT DIMENSIONS</b>			<b>BACK DIMENSIONS</b>						
		<b>W</b>	<b>D</b>	<b>H</b>	<b>W</b>	<b>D</b>	<b>H</b>	<b>W</b>	<b>H</b>					
		15	15	30	15	15	30	-	-					
			<b>RTA 00</b>											

BRADEN™



model 7871



model 7870R, 7870, 7870L

STANDARD FEATURES

- A flexible modular seating system that is exceptionally durable. Combine these seating components into a configuration that suits your space.
- Braden uses a unique ganging feature which locks units solidly together, but allows them to be separated and reconfigured when necessary. Locking "Pins" will always be on the left side of a ganging unit, while the pin receptacle will always be on the right side, seated.
- Check textile availability prior to specifying upholstery material.

OPTIONAL FEATURES

- For ganging hardware please use the following codes: Add "GB" for both sides. Add "GR" for right side seated only. Add "GL" for Left side seated only. Add "GC" for corner units only, both sides.
- For highly resilient, high density Ultracell foam on seat, Please specify (UC) after the model number. Add \$78 for the seat. Add \$151 for the seat and back.
- Optional Non-slip glide for hard surface flooring. Please specify (NSG). Add \$37.
- Model 7874 Table (top) is offered in all the standard laminates. Please specify.

DESCRIPTION	FEATURES	MODEL#	STANDARD TEXTILE GRADES											
-------------	----------	--------	-------------------------	--	--	--	--	--	--	--	--	--	--	--

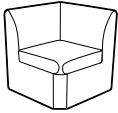

**Corner Unit**  
 COM Yardage: 16.5  
 Freight Class:  
 Product Weight (lbs.): 38  
 Cubic Feet Per Carton: 16.5

	1	2	3	4	5	6	7	8	9	10	11	12
<b>7867</b>	1372	1537	1665	1854	2126	2251	2499	2890	3189	3527	4216	4951

OVERALL DIMENSIONS			SEAT DIMENSIONS			BACK DIMENSIONS	
W	D	H	W	D	H	W	H
24	27.5	30	20	17	20.5	19.5	12.5

RTA 00



**Single Seater**  
 COM Yardage: 2.75  
 Freight Class: 250  
 Product Weight (lbs.): 38  
 Cubic Feet Per Carton: 16.5

	1	2	3	4	5	6	7	8	9	10	11	12
<b>7870</b>	853	973	1062	1198	1388	1461	1627	1950	2102	2401	2806	3312

OVERALL DIMENSIONS			SEAT DIMENSIONS			BACK DIMENSIONS	
W	D	H	W	D	H	W	H
24	27.5	30	24	19.5	16.5	24	13.5

RTA 00



**Single Seater - Left Arm**  
 COM Yardage: 3.75  
 Freight Class: 250  
 Product Weight (lbs.): 45  
 Cubic Feet Per Carton: 16.5

	1	2	3	4	5	6	7	8	9	10	11	12
<b>7870L</b>	972	1131	1253	1441	1703	1795	2026	2464	2676	3080	3634	4324

OVERALL DIMENSIONS			SEAT DIMENSIONS			BACK DIMENSIONS	
W	D	H	W	D	H	W	H
27	27.5	30	24	19.5	16.5	24	13.5

RTA 00



**Single Seater - Right Arm**  
 COM Yardage: 3.75  
 Freight Class: 250  
 Product Weight (lbs.): 45  
 Cubic Feet Per Carton: 16.5

	1	2	3	4	5	6	7	8	9	10	11	12
<b>7870R</b>	972	1131	1253	1441	1703	1795	2026	2464	2676	3080	3634	4324

OVERALL DIMENSIONS			SEAT DIMENSIONS			BACK DIMENSIONS	
W	D	H	W	D	H	W	H
27	27.5	30	24	19.5	16.5	24	13.5

RTA 00



DESCRIPTION	FEATURES	MODEL#	STANDARD TEXTILE GRADES											
			1	2	3	4	5	6	7	8	9	10	11	12

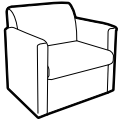

**Single Seater - with Arms**  
 COM Yardage: 4.75  
 Freight Class: 250  
 Product Weight (lbs.): 52  
 Cubic Feet Per Carton: 16.5

<b>7871</b>	1199	1381	1525	1739	2043	2152	2417	2930	3172	3644	4286	5083
-------------	------	------	------	------	------	------	------	------	------	------	------	------

OVERALL DIMENSIONS			SEAT DIMENSIONS			BACK DIMENSIONS	
W	D	H	W	D	H	W	H
30	27.5	30	24	19.5	16.5	24	13.5

RTA 00



**Corner Unit**  
 COM Yardage: 2.75  
 Freight Class: 300  
 Product Weight (lbs.): 31  
 Cubic Feet Per Carton: 16.5

<b>7872</b>	788	908	997	1133	1323	1396	1562	1885	2037	2336	2741	3247
-------------	-----	-----	-----	------	------	------	------	------	------	------	------	------

OVERALL DIMENSIONS			SEAT DIMENSIONS			BACK DIMENSIONS	
W	D	H	W	D	H	W	H
24	27.5	30	20	19.5	16.5	15	13.5

RTA 00

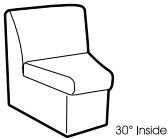

**Corner Unit**  
 COM Yardage: 2.75  
 Freight Class: 300  
 Product Weight (lbs.): 31  
 Cubic Feet Per Carton: 16.5

<b>7873</b>	788	908	997	1133	1323	1396	1562	1885	2037	2336	2741	3247
-------------	-----	-----	-----	------	------	------	------	------	------	------	------	------

OVERALL DIMENSIONS			SEAT DIMENSIONS			BACK DIMENSIONS	
W	D	H	W	D	H	W	H
24	27.5	30	16	19.5	16.5	21.5	13.5

RTA 00

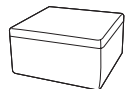

**Table - 24" Square w/Upholstered Sides**  
 COM Yardage: 1.75  
 Freight Class: 125  
 Product Weight (lbs.): 38  
 Cubic Feet Per Carton: 6.25

<b>7874</b>	644	720	777	863	985	1032	1137	1342	1439	1630	1887	2209
-------------	-----	-----	-----	-----	-----	------	------	------	------	------	------	------

OVERALL DIMENSIONS			SEAT DIMENSIONS			BACK DIMENSIONS	
W	D	H	W	D	H	W	H
24	24	14.5	-	-	-	-	-

RTA 00



**Foot Stool/Single Bench - 24" Square**  
 COM Yardage: 1.75  
 Freight Class: 125  
 Product Weight (lbs.): 38  
 Cubic Feet Per Carton: 6.25

<b>7874FS</b>	734	825	893	998	1145	1197	1326	1571	1688	1916	2226	2611
---------------	-----	-----	-----	-----	------	------	------	------	------	------	------	------

OVERALL DIMENSIONS			SEAT DIMENSIONS			BACK DIMENSIONS	
W	D	H	W	D	H	W	H
24	24	17.5	-	-	-	-	-

RTA 00

BRIDGES II COLLABORATIVE SEATING



model BRTSE2424B



model BRTSE6060B



model BRTST2448F

STANDARD FEATURES

- For all Bridges II components, please see the Bridges II section of the Desking Price Book.
- Bridges collaborative seating collection consists of seating, privacy screens, tables, tablets and power.
- It is a versatile modular furniture series which can be configured into many space planning scenarios, including corner, in-line, open concept, traditional reception, as well as secluded seating with high privacy partitions.
- Furniture pieces can be used as stand alone items or can be mechanically linked together to form a variety of seating configurations.
- Seat and backrest can be integrated with Bridges tables.
- Corner tables and in-line 6" table modules double as power delivery centers.
- Dedicated seat backrests feature dual USB charging port.
- Some in line 6" table modules are furnished with grommets to support tablets.
- Legs are available in standard Bridges metal painted finishes and anodized aluminum finish.
- Bridges Collaborative Seating upholstery features a single stitch, thick white thread around the edges. The white, wide stitch along with crisp corners are part of its distinctive personality.
- In order to achieve crisp edges and to minimize "pillow" effect caused by taut fabric, the upholstery material has been applied deliberately loose, which may over time, produce puckering of the upholstery surface material. This can be easily corrected by stretching the fabric by hand or during vacuuming.
- Freestanding 17"h table. Central partition divides space under top surface into two 11" deep compartments.

- In order to efficiently utilize fabric yield, all 60" seats and backs feature a seam in the middle. The double stitch seam is sewn with a thin thread, closely matching the upholstery material in color.
- Some complicated fabric patterns prevent pattern matching and will be upholstered without the seam at the discretion of the factory.
- Should you require no middle seam by cutting into the roll, please specify "NO SEAM" at time of your order.
- Check textile availability prior to specifying upholstery material.

OPTIONAL FEATURES

- Optional Anodized Aluminum Leg on all models. Add \$79.
- Models BRTS2406BT and BRTS2406BPT include 9.5" x 14.5" swivel tablet. If top is specified in high pressure laminate, tablet will also be manufactured in high pressure laminate.
- Bridges II tables and tablets are offered in the following laminate finishes: Absolute Acajou (ACJ), Asian Night (ASN), Avant Cherry (AWC), Avant Honey (AWH), Black (BLK), Brushed Cobalt (BRC), Clear Maple (CMB), Custom Grey (CGY), Dark Espresso (DES), Designer White (DWT), Fashionista (FAS), First Class (FCL), Noce Biondo (NBL), Noce Grigio (NGL), Noce Leggero (NEL), Noce Medio (NML), Quartered Mahogany (QTM), Sheer Beauty (SBY) Storm Grey (SOG), Walnut Heights (WHE), White Chocolate (WHC) and Winter Cherry (WCR). Please Specify.

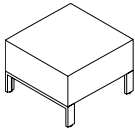
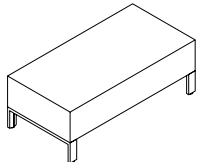
DESCRIPTION	FEATURES	MODEL#	STANDARD TEXTILE GRADES											
			1	2	3	4	5	6	7	8	9	10	11	12
 <p><b>Lounge Seat - 24"</b> COM Yardage: 1.25 Freight Class: 150 Product Weight (lbs.): 22.70 Cubic Feet Per Carton: 5.57</p>		<b>BRTSE24NB</b>	839	920	920	972	1044	1077	1143	1247	1328	1418	1600	1797
			<b>OVERALL DIMENSIONS</b>			<b>SEAT DIMENSIONS</b>			<b>BACK DIMENSIONS</b>					
			<b>W</b>	<b>D</b>	<b>H</b>	<b>W</b>	<b>D</b>	<b>H</b>	<b>W</b>	<b>H</b>				
			24	24	17	-	-	-	-	-				
		<b>RTA 00</b>												
 <p><b>Lounge Seat - 48"</b> COM Yardage: 2 Freight Class: 250 Product Weight (lbs.): 36.90 Cubic Feet Per Carton: 11.33</p>		<b>BRTSE48NB</b>	1527	1655	1655	1737	1851	1907	2012	2179	2306	2451	2746	3058
			<b>OVERALL DIMENSIONS</b>			<b>SEAT DIMENSIONS</b>			<b>BACK DIMENSIONS</b>					
			<b>W</b>	<b>D</b>	<b>H</b>	<b>W</b>	<b>D</b>	<b>H</b>	<b>W</b>	<b>H</b>				
			48	24	17	-	-	-	-	-				
		<b>RTA 00</b>												



DESCRIPTION	FEATURES	MODEL#	STANDARD TEXTILE GRADES											
			1	2	3	4	5	6	7	8	9	10	11	12

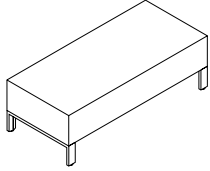

**Lounge Seat - 60"**  
 COM Yardage: 2  
 Freight Class: 250  
 Product Weight (lbs.): 47  
 Cubic Feet Per Carton: 14.17

<b>BRTSE60NB</b>	1767	1857	1925	2025	2172	2238	2370	2579	2740	2920	3285	3679
------------------	------	------	------	------	------	------	------	------	------	------	------	------

OVERALL DIMENSIONS			SEAT DIMENSIONS			BACK DIMENSIONS	
W	D	H	W	D	H	W	H
60	24	17	-	-	-	-	-

**RTA 00**

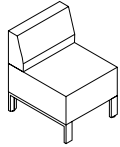

**Lounge Seat, Full Backrest - 24"**  
 COM Yardage: 2.25  
 Freight Class: 250  
 Product Weight (lbs.): 33  
 Cubic Feet Per Carton: 9.57

<b>BRTSE2424B</b>	1320	1463	1463	1554	1684	1745	1864	2051	2196	2358	2690	3042
-------------------	------	------	------	------	------	------	------	------	------	------	------	------

OVERALL DIMENSIONS			SEAT DIMENSIONS			BACK DIMENSIONS	
W	D	H	W	D	H	W	H
24	24	29	-	-	-	-	-

**RTA 00**

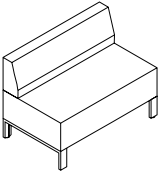

**Lounge Seat, Full Backrest - 48"**  
 COM Yardage: 3.5  
 Freight Class: 250  
 Product Weight (lbs.): 55.50  
 Cubic Feet Per Carton: 19.33

<b>BRTSE4848B</b>	2435	2654	2654	2797	3001	3095	3277	3569	3794	4045	4561	5110
-------------------	------	------	------	------	------	------	------	------	------	------	------	------

OVERALL DIMENSIONS			SEAT DIMENSIONS			BACK DIMENSIONS	
W	D	H	W	D	H	W	H
48	24	29	-	-	-	-	-

**RTA 00**

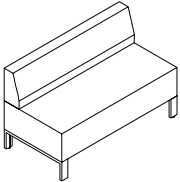

**Lounge Seat, Full Backrest - 60"**  
 COM Yardage: 4.5  
 Freight Class: 250  
 Product Weight (lbs.): 70  
 Cubic Feet Per Carton: 24.17

<b>BRTSE6060B</b>	2822	3103	3103	3286	3545	3668	3906	4280	4568	4890	5554	6261
-------------------	------	------	------	------	------	------	------	------	------	------	------	------

OVERALL DIMENSIONS			SEAT DIMENSIONS			BACK DIMENSIONS	
W	D	H	W	D	H	W	H
60	60	29	-	-	-	-	-

**RTA 00**

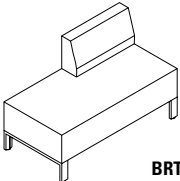

**BRTSE2448BR**

**Lounge Seat, 24" Offset Backrest**  
 COM Yardage: 3  
 Freight Class: 250  
 Product Weight (lbs.): 46.1  
 Cubic Feet Per Carton: 19.33

<b>BRTSE2448BR</b>	2007	2198	2198	2317	2492	2574	2731	2983	3175	3387	3831	4302
--------------------	------	------	------	------	------	------	------	------	------	------	------	------

<b>BRTSE2448BL</b>	2007	2198	2198	2317	2492	2574	2731	2983	3175	3387	3831	4302
--------------------	------	------	------	------	------	------	------	------	------	------	------	------

OVERALL DIMENSIONS			SEAT DIMENSIONS			BACK DIMENSIONS	
W	D	H	W	D	H	W	H
48	24	29	-	-	-	-	-

**RTA 00**

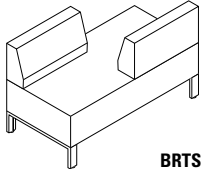
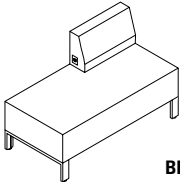
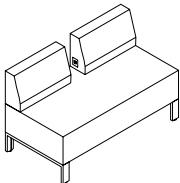
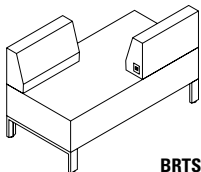
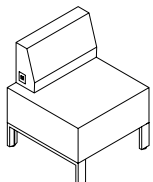
DESCRIPTION	FEATURES	MODEL#	STANDARD TEXTILE GRADES											
			1	2	3	4	5	6	7	8	9	10	11	12
 <p><b>BRTSE2448BODR</b></p> <p><b>Lounge Seat, Two 24" Offset Backrests</b>                      COM Yardage: 4                      Freight Class: 250                      Product Weight (lbs.): 46.5                      Cubic Feet Per Carton: 19.33</p>														
	<b>BRTSE2448BODR</b>	2488	2738	2738	2902	3132	3241	3452	3786	4041	4330	4919	5545	
	<b>BRTSE2448BODL</b>	2488	2629	2738	2902	3132	3241	3452	3786	4041	4330	4919	5545	
	<b>OVERALL DIMENSIONS</b>	<b>W</b>	<b>D</b>	<b>H</b>	<b>SEAT DIMENSIONS</b>			<b>BACK DIMENSIONS</b>						
	48	24	29	-	-	-	-	-						
	<b>RTA 00</b>													
 <p><b>BRTSE2148EBR</b></p> <p><b>Lounge Seat, 21" USB Backrest</b>                      COM Yardage: 3                      Freight Class: 250                      Product Weight (lbs.): 33                      Cubic Feet Per Carton: 9.67</p>														
	<b>BRTSE2148EBR</b>	2326	2436	2517	2636	2811	2893	3050	3302	3494	3706	4150	4621	
	<b>BRTSE2148EBL</b>	2326	2436	2517	2636	2811	2893	3050	3302	3494	3706	4150	4621	
	<b>OVERALL DIMENSIONS</b>	<b>W</b>	<b>D</b>	<b>H</b>	<b>SEAT DIMENSIONS</b>			<b>BACK DIMENSIONS</b>						
	48	24	29	-	-	-	-	-						
	<b>RTA 00</b>													
 <p><b>BRTSE2148E2B</b></p> <p><b>Lounge Seat, Two 21" USB Backrests</b>                      COM Yardage: 4                      Freight Class: 250                      Product Weight (lbs.): 57                      Cubic Feet Per Carton: 19.33</p>														
	<b>BRTSE2148E2B</b>	3125	3266	3372	3536	3767	3878	4088	4422	4678	4964	5553	6181	
	<b>OVERALL DIMENSIONS</b>	<b>W</b>	<b>D</b>	<b>H</b>	<b>SEAT DIMENSIONS</b>			<b>BACK DIMENSIONS</b>						
		48	24	29	-	-	-	-	-					
	<b>RTA 00</b>													
 <p><b>BRTSE2148EBODR</b></p> <p><b>Lounge Seat, Two Offset USB Backrests</b>                      COM Yardage: 4                      Freight Class: 250                      Product Weight (lbs.): 57                      Cubic Feet Per Carton: 19.33</p>														
	<b>BRTSE2148EBODR</b>	3125	3266	3372	3536	3767	3878	4088	4422	4678	4964	5553	6181	
	<b>BRTSE2148EBODL</b>	3125	3266	3372	3536	3767	3878	4088	4422	4678	4964	5553	6181	
	<b>OVERALL DIMENSIONS</b>	<b>W</b>	<b>D</b>	<b>H</b>	<b>SEAT DIMENSIONS</b>			<b>BACK DIMENSIONS</b>						
	48	24	29	-	-	-	-	-						
	<b>RTA 00</b>													
 <p><b>BRTSE2124EBR</b></p> <p><b>Lounge Seat, 21" USB Backrest</b>                      COM Yardage: 2.25                      Freight Class: 250                      Product Weight (lbs.): 46.10                      Cubic Feet Per Carton: 19.33</p>														
	<b>BRTSE2124EBR</b>	3125	1719	1782	1872	2002	2066	2183	2370	2514	2676	3008	3360	
	<b>BRTSE2124EBL</b>	1638	1719	1782	1872	2002	2066	2183	2370	2514	2676	3008	3360	
	<b>OVERALL DIMENSIONS</b>	<b>W</b>	<b>D</b>	<b>H</b>	<b>SEAT DIMENSIONS</b>			<b>BACK DIMENSIONS</b>						
	48	24	29	-	-	-	-	-						
	<b>RTA 00</b>													

DESCRIPTION	FEATURES	MODEL#	STANDARD TEXTILE GRADES											
			1	2	3	4	5	6	7	8	9	10	11	12

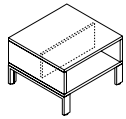

**Low Table - 24"**  
 COM Yardage: N/A  
 Freight Class: 125  
 Product Weight (lbs.): 40.70  
 Cubic Feet Per Carton: 5.67

<b>BRTST2424F</b>	938	-	-	-	-	-	-	-	-	-	-	-	-
-------------------	-----	---	---	---	---	---	---	---	---	---	---	---	---

OVERALL DIMENSIONS			SEAT DIMENSIONS			BACK DIMENSIONS	
W	D	H	W	D	H	W	H
24	24	17	-	-	-	-	-

**RTA 00**

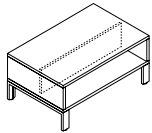

**Low Table - 48"**  
 COM Yardage: N/A  
 Freight Class: 125  
 Product Weight (lbs.): 69  
 Cubic Feet Per Carton: 11.33

<b>BRTST2448F</b>	938	-	-	-	-	-	-	-	-	-	-	-	-
-------------------	-----	---	---	---	---	---	---	---	---	---	---	---	---

OVERALL DIMENSIONS			SEAT DIMENSIONS			BACK DIMENSIONS	
W	D	H	W	D	H	W	H
48	24	17	-	-	-	-	-

**RTA 00**

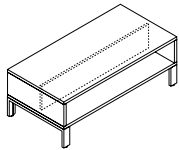

**Low Table - 60"**  
 COM Yardage: N/A  
 Freight Class: 150  
 Product Weight (lbs.): 83.60  
 Cubic Feet Per Carton: 14.17

<b>BRTST2460F</b>	938	-	-	-	-	-	-	-	-	-	-	-	-
-------------------	-----	---	---	---	---	---	---	---	---	---	---	---	---

OVERALL DIMENSIONS			SEAT DIMENSIONS			BACK DIMENSIONS	
W	D	H	W	D	H	W	H
60	24	17	-	-	-	-	-

**RTA 00**

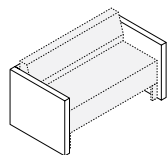

**Seat Partitions - 24"**  
 COM Yardage:  
 Freight Class: 250  
 Product Weight (lbs.): 32  
 Cubic Feet Per Carton: 12.04

<b>BRTPP2424L1</b>	1547	-	-	-	-	-	-	-	-	-	-	-	-
--------------------	------	---	---	---	---	---	---	---	---	---	---	---	---

OVERALL DIMENSIONS			SEAT DIMENSIONS			BACK DIMENSIONS	
W	D	H	W	D	H	W	H
29	28.7	25	-	-	-	-	-

**RTA 00**

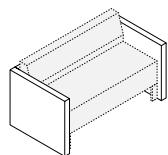

**Seat Partitions - 48"**  
 COM Yardage:  
 Freight Class: 300  
 Product Weight (lbs.): 41  
 Cubic Feet Per Carton: 22.01

<b>BRTPP2448L1</b>	2068	-	-	-	-	-	-	-	-	-	-	-	-
--------------------	------	---	---	---	---	---	---	---	---	---	---	---	---

OVERALL DIMENSIONS			SEAT DIMENSIONS			BACK DIMENSIONS	
W	D	H	W	D	H	W	H
53	28.7	25	-	-	-	-	-

**RTA 00**

# LOUNGE

# BRIDGES II COLLABORATIVE SEATING B

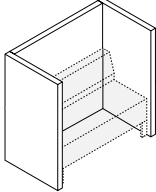
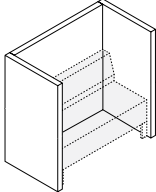
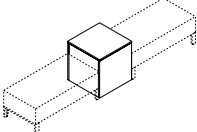
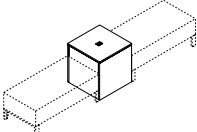
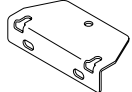
DESCRIPTION	FEATURES	MODEL#	STANDARD TEXTILE GRADES													
			1	2	3	4	5	6	7	8	9	10	11	12		
 <p><b>Seat Privacy Partitions - 24"</b> COM Yardage: Freight Class: 300 Product Weight (lbs.): 32 Cubic Feet Per Carton: 24.08</p>	Fully 3 - Part Kit  Seating not included. Panel textiles only.	<b>BRTPP2424L2</b>	2342	-	-	-	-	-	-	-	-	-	-	-		
			<b>OVERALL DIMENSIONS</b>			<b>SEAT DIMENSIONS</b>			<b>BACK DIMENSIONS</b>							
			<b>W</b>	<b>D</b>	<b>H</b>	<b>W</b>	<b>D</b>	<b>H</b>	<b>W</b>	<b>H</b>						
			29	28.7	50	-	-	-	-	-						
			<b>RTA 00</b>													
 <p><b>Seat Privacy Partitions - 48"</b> COM Yardage: Freight Class: 400 Product Weight (lbs.): 41 Cubic Feet Per Carton: 44.01</p>	Fully 3 - Part Kit Seating not included.	<b>BRTPP2448L2</b>	2996	-	-	-	-	-	-	-	-	-	-	-		
			<b>OVERALL DIMENSIONS</b>			<b>SEAT DIMENSIONS</b>			<b>BACK DIMENSIONS</b>							
			<b>W</b>	<b>D</b>	<b>H</b>	<b>W</b>	<b>D</b>	<b>H</b>	<b>W</b>	<b>H</b>						
			53	28.7	50	-	-	-	-	-						
			<b>RTA 00</b>													
 <p><b>Square Table Block - No Power</b> COM Yardage: N/A Freight Class: 250 Product Weight (lbs.): 32 Cubic Feet Per Carton: 12.04</p>	Freestanding Table. Seating not included. Includes 2 brackets and screws	<b>BRTS2424B</b>	660	-	-	-	-	-	-	-	-	-	-	-		
			<b>OVERALL DIMENSIONS</b>			<b>SEAT DIMENSIONS</b>			<b>BACK DIMENSIONS</b>							
			<b>W</b>	<b>D</b>	<b>H</b>	<b>W</b>	<b>D</b>	<b>H</b>	<b>W</b>	<b>H</b>						
			24	24	25	-	-	-	-	-						
			<b>RTA 00</b>													
 <p><b>Square Table Block w/ Center Power</b> COM Yardage: N/A Freight Class: 125 Product Weight (lbs.): 59.30 Cubic Feet Per Carton: 8.33</p>	Freestanding Table. Seating not included. Includes 2 brackets and screws	<b>BRTS2424BP</b>	660	-	-	-	-	-	-	-	-	-	-	-		
			<b>OVERALL DIMENSIONS</b>			<b>SEAT DIMENSIONS</b>			<b>BACK DIMENSIONS</b>							
			<b>W</b>	<b>D</b>	<b>H</b>	<b>W</b>	<b>D</b>	<b>H</b>	<b>W</b>	<b>H</b>						
			24	24	25	-	-	-	-	-						
			<b>RTA 00</b>													
 <p><b>Square Table Block Ganging Bracket Kit</b> COM Yardage: N/A Freight Class: 70 Product Weight (lbs.): 0.05 Cubic Feet Per Carton: 0.01</p>	Includes 2 brackets and screws. Black Only.	<b>BRTSTBG</b>	51	-	-	-	-	-	-	-	-	-	-	-		
			<b>OVERALL DIMENSIONS</b>			<b>SEAT DIMENSIONS</b>			<b>BACK DIMENSIONS</b>							
			<b>W</b>	<b>D</b>	<b>H</b>	<b>W</b>	<b>D</b>	<b>H</b>	<b>W</b>	<b>H</b>						
			5	2.4	1.1	-	-	-	-	-						
			<b>RTA 00</b>													

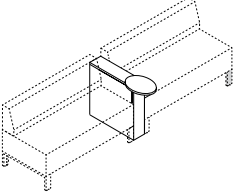

DESCRIPTION	FEATURES	MODEL#	STANDARD TEXTILE GRADES																										
			1	2	3	4	5	6	7	8	9	10	11	12															
 <p><b>Inline 6" Table Block w/ Front Power &amp; Tablet Arm</b>                      COM Yardage: N/A                      Freight Class: 92.50                      Product Weight (lbs.): 24.30                      Cubic Feet Per Carton: 2.08</p>	<p>Must use with seating.                      Seating not included.                      Includes 2 brackets and screws</p>	<b>BRTS2406BPT</b>	1733	-	-	-	-	-	-	-	-	-	-	-															
		<table border="1"> <thead> <tr> <th colspan="3">OVERALL DIMENSIONS</th> <th colspan="3">SEAT DIMENSIONS</th> <th colspan="2">BACK DIMENSIONS</th> </tr> <tr> <th>W</th> <th>D</th> <th>H</th> <th>W</th> <th>D</th> <th>H</th> <th>W</th> <th>H</th> </tr> </thead> <tbody> <tr> <td>6</td> <td>24</td> <td>25</td> <td>-</td> <td>-</td> <td>-</td> <td>-</td> <td>-</td> </tr> </tbody> </table>			OVERALL DIMENSIONS			SEAT DIMENSIONS			BACK DIMENSIONS		W	D	H	W	D	H	W	H	6	24	25	-	-	-	-	-	<p><b>RTA 00</b></p>
OVERALL DIMENSIONS			SEAT DIMENSIONS			BACK DIMENSIONS																							
W	D	H	W	D	H	W	H																						
6	24	25	-	-	-	-	-																						

CALIDON



GC36305  
Wood Lounge Single Seat, Open Arms



GC36301  
Wood Guest Single Seat, Open Arms



GC36308  
Wood Lounge Single Seat, Closed Arms



For Calidon tables, see page 280

EXAMPLE CALIDON ORDER CODE:

GC36308	PU75	AAM	NBS
Model #	Textile	Frame Finish	Sealed Back Seams
NSS	NB	NM	SRT
Sealed Seat Seams	Moisture Barrier	Glides	Power

STANDARD FEATURES

- Calidon series consists of wood frame guest, lounge, bariatric and bench seating in addition to fully upholstered lounge seating. Freestanding and tandem/bridge tables also available to complement the line.
- Calidon is designed for the rigors of high use environments. Lounge units include metal frame supports.
- The seating in this series is available to specify with two textiles, one for the seat cushion and one for the back and arms (see model image).
- For pricing, start with the base price and add both back/arms graded textile upcharge and the seat graded textile upcharge.
- Frame design features a wall saver leg to prevent back contact and damage to walls.
- All guest and lounge chairs feature a clean out between seat and back, replaceable seat cushions and tall legs for ease of cleaning.
- For added comfort, seats are standard with high density Ultracell foam.
- Active weight capacity up to 400 lbs/seat for standard seating; up to 600 lbs for bariatric seating.
- For healthcare textiles, visit the website at [globalfurnituregroup.com](http://globalfurnituregroup.com).
- Textiles with a minimum of 100,000 double rubs must be specified to meet Global's 24/7 warranty coverage.
- Can be upholstered in standard Global textiles if Healthcare 24/7 warranty compliance is not required.
- For alternate textile applications, contact Global specials. The Blended Textile matrix does not apply to this series.
- Tandem table models connect to guest seating only. See Calidon tables.
- No seating or bench models gang together.
- Shipped fully assembled.

OPTIONAL FEATURES

- All guest and lounge models can be specified with or without armcaps. Urethane armcaps are available on Wood arm guest and lounge chairs. Solid surface armcaps are available on all chair models. Armcaps are field replaceable, securely fastened with metal-to-metal connectors. Armcaps cannot be retrofitted in the field on units with no existing armcaps.
- Fully upholstered lounge chairs can be specified with a tamperproof Black power/USB unit, which includes one AC outlet, two 10 watt USB ports, and a 10 ft long power cord. Power is factory installed and must be specified at time of order. Add **\$251** each. Power locations vary by model. See power location diagram.
- For moisture barrier on seat, specify **(MB)**. Upcharges vary, see model.
- To add sealed seams, specify **(SBS)** for seat back and arms and/or **(SSS)** for seat. Upcharges vary, see model.
- A tamperproof power unit is available to specify in various locations on closed arm lounge models only. See diagrams.

SUGGESTED APPLICATIONS

- Guest seating
- Lobby/Lounge
- Treatment/Exam rooms



Please add option codes in the following order:

- **Model number**  
See models.  
For Calidon tables, refer to calidon tables 280
- **Back/Arm Textile**  
Specify textile code. See model grade upcharges.
- **Seat Textile**  
Specify textile code. See model grade upcharges.
- **Armcaps option**  
**(FNA)** No armcaps  
**(FAC)** With armcaps. Upcharges vary, see model.
- **Frame finish**  
**(AAM)** Absolute  
**(CJM)** Charcoal Java  
**(ACM)** Cherry  
**(EMM)** Empire Mahogany  
**(EOM)** English Oak  
**(ECM)** Espresso Cafe  
**(TFM)** Fruitwood  
**(HGM)** Grey  
**(HOM)** Harvest Oak  
**(AHM)** Honey  
**(JOM)** Jet Onyx  
**(LHM)** Light Honey  
**(TMM)** Mahogany  
**(AVM)** Maple  
**(MWM)** Medium Walnut  
**(ASM)** Night  
**(NBM)** Noce Biondo  
**(NGM)** Noce Grigio  
**(NEM)** Noce Leggero  
**(NMM)** Noce Medio  
**(SBM)** Sandy Beach  
**(SKM)** Shaker Cherry  
**(SOM)** Silver Oak  
**(TWM)** Walnut  
**(WTM)** WC Cream  
**(WHM)** White  
**(WCM)** Winter Cherry
- **Armcaps finish**  
**(SSU)** Urethane (for wood arm models of guest and lounge seating with FAC specified).  
Urethane finishes (upcharges vary, see model):  
**(BLK)** Black  
**(J52)** Mocha  
**(KAL)** Kalua  
**(SHW)** Shadow  
**(LAB)** Latte  
**(TOA)** Toast  
**(CO)** Solid Surface (for all wood and fully upholstered arm models with FAC specified). Solid Surface Finishes:  
Grade 1: (Upcharges vary, see model)  
**(SWH)** Designer White  
Grade 2: (Upcharges vary, see model)  
**(SBT)** Beige Tempest  
**(SBX)** Black Onyx Mirage  
**(SMG)** Milk Glass Spectra  
**(SFW)** Frosty White Mirage  
**(SHS)** Hot Stone  
**(SNM)** Northern Melange
- **Sealed Back Seams** (Contact Customer Care for approved textiles.)  
**(NBS)** No sealed back seams  
**(SBS)** Sealed back seams. Upcharges vary, see model.
- **Sealed Seat Seams** (Contact Customer Care for approved textiles.)  
**(NSS)** No sealed seat seams  
**(SSS)** Sealed seat seams. Upcharges vary, see model.
- **Glides**  
**(NM)** Non-marking  
**(NS)** Non-slip  
Guest single seat, bariatric and lounge chairs, add \$31.  
Guest two seater, Add \$47.  
Guest three seater, add \$60.
- **Moisture Barrier** (seat only) (Not available with Sealed Seams)  
**(NB)** No moisture barrier  
**(MB)** Moisture barrier. Upcharges vary, see model.
- **Power/USB unit position** (lounge models only). Add **\$251**.  
**(NPM)** No power  
**(TPM)** Tamperproof power unit  
**(J)** Black  
**(SRT)** Side right  
**(SLT)** Side left  
**(FLT)** Front left (three seater only)  
**(FRT)** Front right (three seater only)  
**(CRF)** Center front (two seater only)  
**(SLR)** Side left and right. Add **\$498**.  
**(FLR)** Front left and right. Add **\$498**.

# LOUNGE

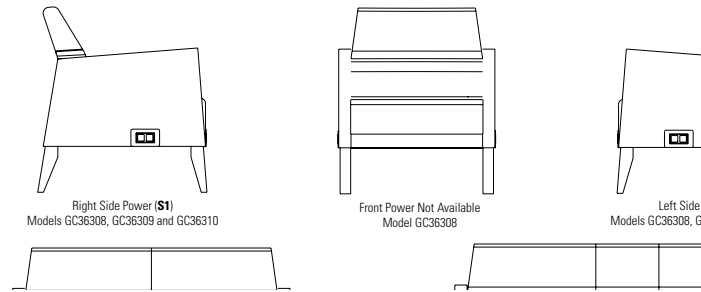
## POWER LOCATION DIAGRAM



DESCRIPTION	MODEL#/ FEATURES	STANDARD TEXTILE GRADES											
		1/COM	2	3	4	5	6	7	8	9	10	11	12
 <p><b>Wood Guest Single Seat</b> COM Yardage: Back: 0.9; Seat: 1 Freight Class: 250 Product Weight (lbs.): 38 Cubic Feet Per Carton: 16.5</p>	<b>GC36301</b>	Base Price:	\$1261										
	Back upcharge:	+0	+\$31	+\$55	+\$90	+\$140	+\$161	+\$203	+\$271	+\$321	+\$376	+\$491	+\$611
	Seat upcharge:	+0	+\$34	+\$61	+\$100	+\$155	+\$178	+\$225	+\$300	+\$356	+\$417	+\$545	+\$679
	Active weight 400 lbs.	<b>OVERALL DIMENSIONS</b>			<b>SEAT DIMENSIONS</b>			<b>BACK DIMENSIONS</b>					
		W	D	H	W	D	H	W	H				
	23.5	26.5	34.5	21.5	18	18	21.5	16.5					
<p>Add \$118 for Urethane armcaps Add \$393 for (CO) Grade 1 armcaps Add \$437 for (CO) Grade 2 armcaps Add \$133 for (MB) Add \$29 for (SSS), \$41 for (SBS)</p>													
 <p><b>Wood Guest Two Seater, Full Center Arm</b> COM Yardage: Back: 1.8; Seat: 2 Freight Class: 250 Product Weight (lbs.): 68 Cubic Feet Per Carton: 31.75</p>	<b>GC36302</b>	Base Price:	\$2333										
	Back upcharge:	+0	+\$62	+\$109	+\$180	+\$278	+\$320	+\$406	+\$541	+\$641	+\$751	+\$981	+\$1222
	Seat upcharge:	+0	+\$68	+\$121	+\$199	+\$309	+\$355	+\$450	+\$600	+\$712	+\$834	+\$1089	+\$1357
	Active weight 400 lbs./seat	<b>OVERALL DIMENSIONS</b>			<b>SEAT DIMENSIONS</b>			<b>BACK DIMENSIONS</b>					
		W	D	H	W	D	H	W	H				
	46	26.5	34.5	21.5	18	18	21.5	16.5					
<p>Add \$177 for Urethane armcaps Add \$618 for (CO) Grade 1 armcap Add \$656 for (CO) Grade 2 armcaps Add \$264 for (MB) Add \$56 for (SSS), \$80 for (SBS)</p>													
 <p><b>Wood Guest Three Seater, Full Center Arms</b> COM Yardage: Back: 2.7; Seat: 3 Freight Class: 250 Product Weight (lbs.): 101 Cubic Feet Per Carton: 47.5</p>	<b>GC36303</b>	Base Price:	\$3435										
	Back upcharge:	+0	+\$92	+\$163	+\$268	+\$417	+\$479	+\$608	+\$810	+\$961	+\$1126	+\$1471	+\$1833
	Seat upcharge:	+0	+\$102	+\$181	+\$298	+\$463	+\$532	+\$675	+\$899	+\$1067	+\$1251	+\$1634	+\$2036
	Active weight 400 lbs./seat	<b>OVERALL DIMENSIONS</b>			<b>SEAT DIMENSIONS</b>			<b>BACK DIMENSIONS</b>					
		W	D	H	W	D	H	W	H				
	68	26.5	34.5	21.5	18	18	21.5	16.5					
<p>Add \$235 for Urethane armcaps Add \$823 for (CO) Grade 1 armcaps Add \$874 for (CO) Grade 2 armcaps Add \$394 for (MB) Add \$84 for (SSS), \$119 for (SBS)</p>													

DESCRIPTION MODEL#/ FEATURES STANDARD TEXTILE GRADES



**Wood Guest Bariatric Chair,**  
COM Yardage: Back: 1.25; Seat: 1.25  
Freight Class: 250  
Product Weight (lbs.): 55  
Cubic Feet Per Carton: 22.25

**GC36304** Base Price:  
Back upcharge:  
Seat upcharge:  
Active weight 600 lbs.  
Add \$235 for Urethane armcaps  
Add \$412 for (CO) Grade 1 armcaps  
Add \$437 for (CO) Grade 2 armcaps  
Add \$198 for (MB)  
Add \$29 for (SSS), \$47 for (SBS)

1/COM	2	3	4	5	6	7	8	9	10	11	12
\$1928											
<b>+0</b>	<b>+\$43</b>	<b>+\$76</b>	<b>+\$125</b>	<b>+\$194</b>	<b>+\$222</b>	<b>+\$282</b>	<b>+\$375</b>	<b>+\$446</b>	<b>+\$522</b>	<b>+\$681</b>	<b>+\$849</b>
<b>+0</b>	<b>+\$43</b>	<b>+\$76</b>	<b>+\$125</b>	<b>+\$194</b>	<b>+\$222</b>	<b>+\$282</b>	<b>+\$375</b>	<b>+\$446</b>	<b>+\$522</b>	<b>+\$681</b>	<b>+\$849</b>
OVERALL DIMENSIONS			SEAT DIMENSIONS			BACK DIMENSIONS					
W	D	H	W	D	H	W	H				
32.75	26.5	34.5	31	18	18	30.5	16.5				



**Wood Lounge Single Seat**  
COM Yardage: Back: 1.25; Seat: 1.25  
Freight Class: 250  
Product Weight (lbs.): 49  
Cubic Feet Per Carton: 18.25

**GC36305** Base Price:  
Back upcharge:  
Seat upcharge:  
Active weight 400 lbs.  
Add \$177 for Urethane armcaps  
Add \$432 for (CO) Grade 1 armcaps  
Add \$457 for (CO) Grade 2 armcap  
Add \$133 for (MB)  
Add \$35 for (SSS), \$48 for (SBS)

1/COM	2	3	4	5	6	7	8	9	10	11	12
\$1762											
<b>+0</b>	<b>+\$43</b>	<b>+\$76</b>	<b>+\$125</b>	<b>+\$194</b>	<b>+\$222</b>	<b>+\$282</b>	<b>+\$375</b>	<b>+\$446</b>	<b>+\$522</b>	<b>+\$681</b>	<b>+\$849</b>
<b>+0</b>	<b>+\$43</b>	<b>+\$76</b>	<b>+\$125</b>	<b>+\$194</b>	<b>+\$222</b>	<b>+\$282</b>	<b>+\$375</b>	<b>+\$446</b>	<b>+\$522</b>	<b>+\$681</b>	<b>+\$849</b>
OVERALL DIMENSIONS			SEAT DIMENSIONS			BACK DIMENSIONS					
W	D	H	W	D	H	W	H				
25.75	29.5	32.5	24	21	16	23.5	16.5				



**Wood Lounge Two Seater**  
COM Yardage: Back: 1.75; Seat: 2.25  
Freight Class: 250  
Product Weight (lbs.): 77  
Cubic Feet Per Carton: 32.75

**GC36306** Base Price:  
Back upcharge:  
Seat upcharge:  
Active weight 400 lbs./seat  
Add \$177 for Urethane armcaps  
Add \$432 for (CO) Grade 1 armcaps  
Add \$457 for (CO) Grade 2 armcaps  
Add \$264 for (MB)  
Add \$51 for (SSS), \$67 for (SBS)

1/COM	2	3	4	5	6	7	8	9	10	11	12
\$2478											
<b>+0</b>	<b>+\$60</b>	<b>+\$106</b>	<b>+\$175</b>	<b>+\$271</b>	<b>+\$311</b>	<b>+\$394</b>	<b>+\$525</b>	<b>+\$623</b>	<b>+\$731</b>	<b>+\$953</b>	<b>+\$1188</b>
<b>+0</b>	<b>+\$76</b>	<b>+\$137</b>	<b>+\$224</b>	<b>+\$348</b>	<b>+\$399</b>	<b>+\$507</b>	<b>+\$675</b>	<b>+\$801</b>	<b>+\$938</b>	<b>+\$1225</b>	<b>+\$1527</b>
OVERALL DIMENSIONS			SEAT DIMENSIONS			BACK DIMENSIONS					
W	D	H	W	D	H	W	H				
47.5	29.5	32.5	45	21	16	44.5	16.5				



**Wood Lounge Three Seater,**  
COM Yardage: Back: 2.5; Seat: 2.75  
Freight Class: 250  
Product Weight (lbs.): 109  
Cubic Feet Per Carton: 50.75

**GC36307** Base Price:  
Back upcharge:  
Seat upcharge:  
Active weight 400 lbs./seat  
Add \$177 for Urethane armcaps  
Add \$432 for (CO) Grade 1 armcaps  
Add \$457 for (CO) Grade 2 armcaps  
Add \$394 for (MB)  
Add \$67 for (SSS), \$85 for (SBS)





1/COM	2	3	4	5	6	7	8	9	10	11	12
\$3098											
<b>+0</b>	<b>+\$85</b>	<b>+\$151</b>	<b>+\$248</b>	<b>+\$386</b>	<b>+\$444</b>	<b>+\$563</b>	<b>+\$750</b>	<b>+\$890</b>	<b>+\$1043</b>	<b>+\$1361</b>	<b>+\$1697</b>
<b>+0</b>	<b>+\$93</b>	<b>+\$166</b>	<b>+\$274</b>	<b>+\$425</b>	<b>+\$488</b>	<b>+\$619</b>	<b>+\$824</b>	<b>+\$978</b>	<b>+\$1147</b>	<b>+\$1498</b>	<b>+\$1867</b>
OVERALL DIMENSIONS			SEAT DIMENSIONS			BACK DIMENSIONS					
W	D	H	W	D	H	W	H				
70.5	29.5	32.5	68	21	16	67.5	16.5				



**Fully Upholstered Wood Lounge Single Seat**  
COM Yardage: Back/Arm: 2.75; Seat: 1.25  
Freight Class: 250  
Product Weight (lbs.): 58  
Cubic Feet Per Carton: 18.75

**GC36308** Base Price:  
Back/Arm upcharge:  
Seat upcharge:  
Active weight 400 lbs.  
Add \$426 for (CO) Grade 1 armcaps  
Add \$455 for (CO) Grade 2 armcaps  
Add \$133 for (MB)  
Add \$38 for (SSS), \$151 for (SBS)  
Power/USB unit available.

1/COM	2	3	4	5	6	7	8	9	10	11	12
\$1998											
<b>+0</b>	<b>+\$93</b>	<b>+\$166</b>	<b>+\$274</b>	<b>+\$425</b>	<b>+\$488</b>	<b>+\$619</b>	<b>+\$824</b>	<b>+\$978</b>	<b>+\$1147</b>	<b>+\$1498</b>	<b>+\$1867</b>
<b>+0</b>	<b>+\$43</b>	<b>+\$76</b>	<b>+\$125</b>	<b>+\$194</b>	<b>+\$222</b>	<b>+\$282</b>	<b>+\$375</b>	<b>+\$446</b>	<b>+\$522</b>	<b>+\$681</b>	<b>+\$849</b>
OVERALL DIMENSIONS			SEAT DIMENSIONS			BACK DIMENSIONS					
W	D	H	W	D	H	W	H				
27.5	29.5	33.5	24	21	16	23.5	17.5				

DESCRIPTION	MODEL#/ FEATURES	STANDARD TEXTILE GRADES											
 <p><b>Fully Upholstered Wood Lounge Two Seater</b> COM Yardage: Back/Arm: 3.5; Seat: 2.25 Freight Class: 250 Product Weight (lbs.): 89 Cubic Feet Per Carton: 33.75</p>	<p><b>GC36309</b> Base Price: \$2685 Back/Arm upcharge: +0 Seat upcharge: +0 Active weight 400 lbs./seat</p>	1/COM	2	3	4	5	6	7	8	9	10	11	12
		+0	+\$119	+\$211	+\$348	+\$540	+\$621	+\$788	+\$1049	+\$1245	+\$1460	+\$1906	+\$2375
		+0	+\$76	+\$137	+\$224	+\$348	+\$399	+\$507	+\$675	+\$801	+\$938	+\$1225	+\$1527
		<b>OVERALL DIMENSIONS</b>			<b>SEAT DIMENSIONS</b>			<b>BACK DIMENSIONS</b>					
		49.5	29.5	33.5	44.5	18	16	45.5	17.5				
	<p>Add \$426 for (CO) Grade 1 armcaps Add \$455 for (CO) Grade 2 armcaps Add \$264 for (MB) Add \$55 for (SSS), \$169 for (SBS) Power/USB unit available.</p>												
 <p><b>Fully Upholstered Wood Lounge Three Seater</b> COM Yardage: Back/Arm: 4.25; Seat: 2.75 Freight Class: 250 Product Weight (lbs.): 123 Cubic Feet Per Carton: 52</p>	<p><b>GC36310</b> Base Price: \$3372 Back/Arm upcharge: +0 Seat upcharge: +0 Active weight 400 lbs./seat</p>	1/COM	2	3	4	5	6	7	8	9	10	11	12
		+0	+\$144	+\$257	+\$422	+\$656	+\$754	+\$956	+\$1274	+\$1512	+\$1772	+\$2314	+\$2884
		+0	+\$93	+\$166	+\$274	+\$425	+\$488	+\$619	+\$824	+\$978	+\$1147	+\$1498	+\$1867
		<b>OVERALL DIMENSIONS</b>			<b>SEAT DIMENSIONS</b>			<b>BACK DIMENSIONS</b>					
		71.5	29.5	33.5	66.5	18	16	67.5	17.5				
	<p>Add \$426 for (CO) Grade 1 armcaps Add \$455 for (CO) Grade 2 armcaps Add \$394 for (MB) Add \$70 for (SSS), \$189 for (SBS) Power/USB unit available.</p>												
 <p><b>Single Seat Bench</b> COM Yardage: 1 Freight Class: 150 Product Weight (lbs.): 41 Cubic Feet Per Carton: 10</p>	<p><b>GC36311</b> Base Price: \$1350 Seat upcharge: +0 Active weight 400 lbs.</p>	1/COM	2	3	4	5	6	7	8	9	10	11	12
		+0	+\$34	+\$61	+\$100	+\$155	+\$178	+\$225	+\$300	+\$356	+\$417	+\$545	+\$679
		<b>OVERALL DIMENSIONS</b>			<b>SEAT DIMENSIONS</b>			<b>BACK DIMENSIONS</b>					
				24	28	18	24	26.75	18				
	<p>Add \$133 for (MB) Add \$33 for (SSS)</p>												
 <p><b>Two Seat Bench</b> COM Yardage: 2 Freight Class: 250 Product Weight (lbs.): 61 Cubic Feet Per Carton: 18.75</p>	<p><b>GC36312</b> Base Price: \$2135 Seat upcharge: +0 Active weight 400 lbs./seat</p>	1/COM	2	3	4	5	6	7	8	9	10	11	12
		+0	+\$68	+\$121	+\$199	+\$309	+\$355	+\$450	+\$600	+\$712	+\$834	+\$1089	+\$1357
		<b>OVERALL DIMENSIONS</b>			<b>SEAT DIMENSIONS</b>			<b>BACK DIMENSIONS</b>					
				48	28	18	48	26.75	18				
	<p>Add \$264 for (MB) Add \$65 for (SSS)</p>												
 <p><b>Three Seat Bench</b> COM Yardage: 3 Freight Class: 250 Product Weight (lbs.): 97 Cubic Feet Per Carton: 27.75</p>	<p><b>GC36313</b> Base Price: \$2547 Seat upcharge: +0 Active weight 400 lbs./seat</p>	1/COM	2	3	4	5	6	7	8	9	10	11	12
		+0	+\$102	+\$181	+\$298	+\$463	+\$532	+\$675	+\$899	+\$1067	+\$1251	+\$1634	+\$2036
		<b>OVERALL DIMENSIONS</b>			<b>SEAT DIMENSIONS</b>			<b>BACK DIMENSIONS</b>					
				72	28	18	72	26.75	18				
	<p>Add \$394 for (MB) Add \$94 for (SSS)</p>												

CALIDON TABLES



Square end table - 22"  
GC36314



Rectangular Coffee Table  
GC36317



Tandem Side Table, Right  
GC36319R



For Calidon seating, refer to page 277

EXAMPLE CALIDON TABLE ORDER CODE:

GC36319R	-HP	-ACJ	-CNT
Model #	Top material	Laminate finish	Power

TABLE TOP FINISHES:

See finishes section for solid wood/laminate coordination chart.

Thermally fused laminate (LP):

- Absolute Acajou (ACJ)
- Asian Night (ASN)
- Avant Cherry (AWC)
- Avant Honey (AWH)
- Black (BLK)
- Blizzard (BZD)
- Brushed Cobalt (BRC)
- Clear Maple (CMB)
- Custom Grey (CGY)
- Dark Espresso (DES)
- Designer White (DWT)
- Fashionista (FAS)
- First Class (FCL)
- Noce Biondo (NBL)
- Noce Grigio (NGL)
- Noce Leggero (NEL)
- Noce Medio (NML)
- Quartered Mahogany (QTM)
- Sheer Beauty (SBY)
- Stonedust (SDT)
- Walnut Heights (WHE)
- White Chocolate (WHC)
- Winter Cherry (WCR)

High pressure laminate (HP):

- Absolute Acajou (ACJ)
- Asian Night (ASN)
- Avant Cherry (AWC)
- Avant Honey (AWH)
- Black (BLK)
- Blizzard (BZD)
- Brushed Cobalt (BRC)
- Clear Maple (CMB)
- Custom Grey (CGY)
- Dark Espresso (DES)
- Designer White (DWT)
- Fashionista (FAS)
- First Class (FCL)
- Noce Biondo (NBL)
- Noce Grigio (NGL)
- Noce Leggero (NEL)
- Noce Medio (NML)
- Quartered Mahogany (QTM)
- Sheer Beauty (SBY)
- Stonedust (SDT)
- Walnut Heights (WHE)
- White Chocolate (WHC)
- Winter Cherry (WCR)

Solid Surface\* (CO):

- Grade 1: (SWH) Designer White
- Grade 2: (SBT) Beige Tempest (SBX) Black Onyx Mirage (SMG) Milk Glass Spectra (SFW) Frosty White Mirage (SHS) Hot Stone (SNM) Northern Melange

\*For detailed material information, please reference WilsonArt's Solid Surface collection.

TABLE STANDARD FEATURES

- Designed as part of the Calidon seating series, Calidon tables coordinate with a range of lounge and guest seating.
- A variety of wood leg tables are available, including various height end tables, coffee tables and tandem tables.
- Wood legs/frames are specifiable Global solid wood seating finishes.
- Table tops are 1" thick, available in thermally fused laminate (LP), high pressure laminate (HP), and solid surface (CO). Upcharges vary, see model for pricing.
- Laminate top tables include color coordinating vinyl edge band.
- Tandem/bridge table models (GC36318 to GC36321) connect to Calidon guest seating only and include ganging brackets.
- Tandem tables are specified left or right, as seated.

TABLE OPTIONAL FEATURES

- A tamperproof tabletop power unit may be specified on laminate top, tandem and square end tables only. Specify CNT. Add \$378. The power unit is located centered 15" from the edge of the surface. See power location diagrams for reference.

SUGGESTED APPLICATIONS



- Lounge/Lobby
- Resident rooms
- Patient rooms
- Private office

Please add option codes in the following order:

- Table model number**  
GC36314 to GC36317 Freestanding tables  
GC36318 to GC36321 Tandem/bridge tables  
GC36324 to GC36326 23"H Freestanding tables  
For Calidon seating, refer to page 277
- Top Material (tables)**  
(LP) Thermally fused laminate. Specify finish - See LP finishes.  
(HP) High pressure laminate. Upcharges vary - see model. Specify finish - see HP finishes.  
(CO) Solid surface. Upcharges vary - see model. Specify finish - see CO finishes and grades.
- Leg finish**  
(AAM) Absolute (MWM) Medium Walnut  
(CJM) Charcoal Java (ASM) Night  
(ACM) Cherry (NBM) Noce Biondo  
(EMM) Empire Mahogany (NGL) Noce Grigio  
(EOM) English Oak (NEM) Noce Leggero  
(ECM) Espresso (NMM) Noce Medio  
(FEM) Fruitwood (SBM) Sandy Beach  
(HEM) Grey (SKM) Shaker Cherry  
(HOM) Harvest Oak (SOM) Silver Oak  
(AHM) Honey (TWM) Walnut  
(JOM) Jet Onyx (WTM) WC Cream  
(LOM) Light Honey (WHM) White  
(MOM) Mahogany (WCM) Winter Cherry  
(AVM) Maple
- Power/USB unit position** (laminate tandem and end tables with laminate tops only).  
(NPM) No power  
(CNT) Center top power. Jet Black. Add \$378.  
(RBP) Right back top power. Jet Black. Add \$378.  
(LBP) Left back top power. Jet Black. Add \$378.

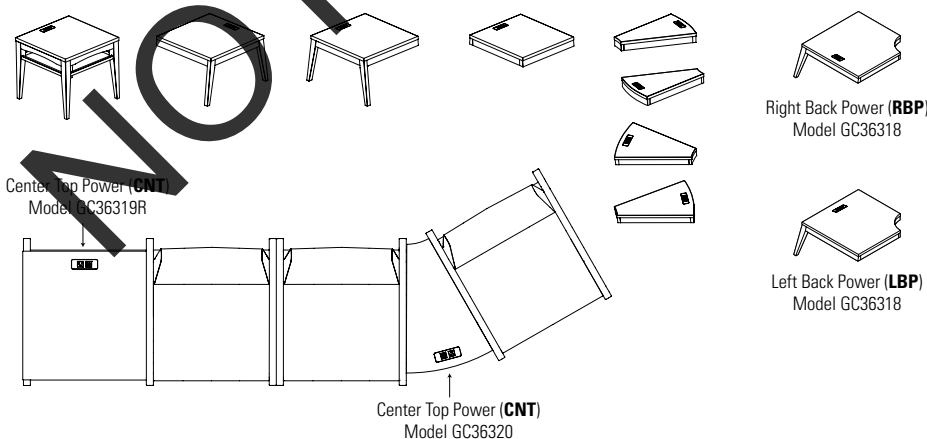
POWER LOCATION DIAGRAM



TABLES	MODEL#	DIMENSIONS	FREIGHT CLASS	WT/LBS.	CUBIC FT.	LIST PRICE
	GC36314	22 x 22 x 20.25	150	36	7.75	<b>\$872</b>
<b>Square End Table, 22" x 22" x 20.25" H</b>		<ul style="list-style-type: none"> <li>• Pricing shown for a thermally fused laminate top (LP).</li> <li>• For a high pressure laminate top (HP), add <b>\$69</b>.</li> <li>• For a solid surface top (CO), add <b>\$1130</b> for Grade 1 and add <b>\$1388</b> for Grade 2.</li> </ul> <p>Coordinating edge on laminate surfaces with solid wood frame and legs. 1 per carton. Power/USB unit can be specified in the surface of laminate top tables (CNT). Add <b>\$378</b>.</p>				
	GC36324	22 x 22 x 23	150	23.5	6.75	<b>\$1081</b>
<b>Square End Table, 22" x 22" x 23" H</b>		<ul style="list-style-type: none"> <li>• Pricing shown for a thermally fused laminate top (LP).</li> <li>• For a high pressure laminate top (HP), add <b>\$69</b>.</li> <li>• For a solid surface top (CO), add <b>\$1130</b> for Grade 1 and add <b>\$1388</b> for Grade 2.</li> </ul> <p>Coordinating edge on laminate surfaces with solid wood frame and legs. 1 per carton. Power/USB unit can be specified in the surface of laminate top tables (CNT). Add <b>\$378</b>.</p>				
	GC36325	22 x 12 x 23	125	34	10.75	<b>\$888</b>
<b>Rectangular End Table, 23" H</b>		<ul style="list-style-type: none"> <li>• Pricing shown for a thermally fused laminate top (LP).</li> <li>• For a high pressure laminate top (HP), add <b>\$57</b>.</li> <li>• For a solid surface top (CO), add <b>\$933</b> for Grade 1 and add <b>\$1120</b> for Grade 2.</li> </ul> <p>Coordinating edge on laminate surfaces with solid wood frame and legs. 1 per carton. Power/USB unit can be specified in the surface of laminate top tables (CNT). Add <b>\$378</b>.</p>				
	GC36326	24 x 25 x 23	150	34	12.75	<b>\$1142</b>
<b>Corner 30° End Table, 23" H</b>		<ul style="list-style-type: none"> <li>• Pricing shown for a thermally fused laminate top (LP).</li> <li>• For a high pressure laminate top (HP), add <b>\$74</b>.</li> <li>• For a solid surface top (CO), add <b>\$1282</b> for Grade 1 and add <b>\$1545</b> for Grade 2.</li> </ul> <p>Coordinating edge on laminate surfaces with solid wood frame and legs. 1 per carton. Power/USB unit can be specified in the surface of laminate top tables (CNT). Add <b>\$378</b>.</p>				
	GC36315	24 x 24 x 17.25	250	37	9.5	<b>\$905</b>
<b>Square Coffee Table, 24"</b>		<ul style="list-style-type: none"> <li>• Pricing shown for a thermally fused laminate top (LP).</li> <li>• For a high pressure laminate top (HP), add <b>\$69</b>.</li> <li>• For a solid surface top (CO), add <b>\$1372</b> for Grade 1 and add <b>\$1694</b> for Grade 2.</li> </ul> <p>Coordinating edge on laminate surfaces with solid wood frame and legs. 1 per carton.</p>				
	GC36316	36 x 36 x 17.25	250	65	18.25	<b>\$1082</b>
<b>Square Coffee Table, 36"</b>		<ul style="list-style-type: none"> <li>• Pricing shown for a thermally fused laminate top (LP).</li> <li>• For a high pressure laminate top (HP), add <b>\$148</b>.</li> <li>• For a solid surface top (CO), add <b>\$3143</b> for Grade 1 and add <b>\$3787</b> for Grade 2.</li> </ul> <p>Coordinating edge on laminate surfaces with solid wood frame and legs. 1 per carton.</p>				
	GC36317	24 x 48 x 17.25	250	56	16.5	<b>\$1185</b>
<b>Rectangular Coffee Table</b>		<ul style="list-style-type: none"> <li>• Pricing shown for a thermally fused laminate top (LP).</li> <li>• For a high pressure laminate top (HP), add <b>\$134</b>.</li> <li>• For a solid surface top (CO), add <b>\$2618</b> for Grade 1 and add <b>\$3054</b> for Grade 2.</li> </ul> <p>Coordinating edge on laminate surfaces with solid wood frame and legs. 1 per carton.</p>				

NOT A CONTRACT

TABLES	MODEL#	DIMENSIONS	FREIGHT CLASS	WT/LBS.	CUBIC FT.	LIST PRICE
	GC36318	31.25 x 31.25 x 15.75	250	46	14.5	\$1082
<b>Corner Table, 90°</b>						<ul style="list-style-type: none"> <li>• Pricing shown for a thermally fused laminate top (LP).</li> <li>• For a high pressure laminate top (HP), add \$110.</li> <li>• For a solid surface top (CO), add \$718 for Grade 1 and add \$3249 for Grade 2.</li> </ul> <p>Coordinating edge on laminate surfaces with solid wood frame and legs. Must be connected between two guest chairs. Includes two sets of U-channel connectors and hardware. 1 per carton. Power/USB unit can be specified in the surface of laminate top tables (RBP) or (LBP). Add \$378. See power location diagram for placement.</p>
	GC36319L	26.5 x 22.25 x 15.75	250	20	6.75	\$755
<b>Tandem Side Table, Left</b>						<ul style="list-style-type: none"> <li>• Pricing shown for a thermally fused laminate top (LP).</li> <li>• For a high pressure laminate top (HP), add \$69.</li> <li>• For a solid surface top (CO), add \$1149 for Grade 1 and add \$1384 for Grade 2.</li> </ul> <p>Coordinating edge on laminate surfaces with solid wood frame and legs. Must be connected to a guest chair. Includes one set of U-channel connectors and hardware. 1 per carton. Power/USB unit can be specified in the surface of laminate top tables (CNT). Add \$378.</p>
	GC36319R	26.5 x 22.25 x 15.75	250	20	6.75	\$755
<b>Tandem Side Table, Right</b>						<ul style="list-style-type: none"> <li>• Pricing shown for a thermally fused laminate top (LP).</li> <li>• For a high pressure laminate top (HP), add \$69.</li> <li>• For a solid surface top (CO), add \$1149 for Grade 1 and add \$1384 for Grade 2.</li> </ul> <p>Coordinating edge on laminate surfaces with solid wood frame and legs. Must be connected to a guest chair. Includes one set of U-channel connectors and hardware. 1 per carton. Power/USB unit can be specified in the surface of laminate top tables (CNT). Add \$378.</p>
	GC36320	22.5 x 15.75 x 3	92.5	16	1.5	\$594
<b>Corner Table, 30 Degree</b>						<ul style="list-style-type: none"> <li>• Pricing shown for a thermally fused laminate top (LP).</li> <li>• For a high pressure laminate top (HP), add \$69.</li> <li>• For a solid surface top (CO), add \$961 for Grade 1 and add \$1154 for Grade 2.</li> </ul> <p>Coordinating edge on laminate surfaces with solid wood frame and legs. Must be connected between two guest chairs. Includes two sets of U-channel connectors and hardware. 1 per carton. Power/USB unit can be specified in the surface of laminate top tables (CNT). Add \$378.</p>
	GC36321	21 x 23.5 x 3	92.5	20	1.9	\$630
<b>In-Line Table, Square</b>						<ul style="list-style-type: none"> <li>• Pricing shown for a thermally fused laminate top (LP).</li> <li>• For a high pressure laminate top (HP), add \$69.</li> <li>• For a solid surface top (CO), add \$994 for Grade 1 and add \$1225 for Grade 2.</li> </ul> <p>Coordinating edge on laminate surfaces with solid wood frame and legs. Must be connected between two guest chairs. Includes two sets of U-channel connectors and hardware. 1 per carton. Power/USB unit can be specified in the surface of laminate top tables (CNT). Add \$378.</p>
	GC36322	2.87 x 1.5 x 1.62	70	0.75	0.03	\$51
<b>U-Channel (set of 2)</b>						Includes hardware. 4 sets per carton.

NOT A CONTRACT

## CAMINO



models shown: 5471-CP Lounge Chair, 5475-W End Table, 5472-CP Two Seat Sofa.



model 5471-CP



model 5475-W





model 5485-W

### STANDARD FEATURES

- A transitional soft seating series composed of one, two and three seat units. The series also offers tables with coordinating details and finishes.
- Frame is a heavy duty, interlocking plywood, puzzle box construction suitable for public environments.
- The soft seating leg system utilizes a continuous visible frame between the front and rear leg. Each leg frame is bolted directly to the sofa frame with large bolts to provide a very durable leg construction.
- Legs are equipped with translucent non marking glides as standard. Suitable for both carpet and hard surface flooring.
- Seating features as standard, decorative double stitch detail, which make seams lay flat and add extra seam strength.
- Cushions are highly resilient foam and seats are equipped with a synthetic rubberized sheet webbing suspension system for extra comfort. Cushions are fixed and non-removable.
- Tables are made with a choice of tops: Genuine Wood tops (**W**) with a reverse beveled edge, Thermally Fused Laminate tops (**LP**) with matching PVC edging or High Pressure Laminate top (**HP**) with matching PVC edging. Custom high pressure laminate finishes will be considered upon requested.
- Regardless of top chosen all tables have wood aprons and a unique tapered leg design.
- Some table assembly required, see RTA code with each item below.
- Measurement shown for weight is for one unit, measurement for volume is per carton.
- Check textile availability prior to specifying upholstery material.

### OPTIONAL FEATURES

- Optional cushions and arms can have tailored piping details.
- For piping made in fabric matching the rest of the upholstery fabric please use **MP** models (matching piping after the model number). This is no upcharge.
- For contrast piping made in a fabric that does not match the rest of the upholstery fabric, you can specify any grade 1 or 2 upholstery material for this purpose, please see model numbers ending in **CP** which reflect the appropriate upcharge.
- For contrast piping in a fabric higher than grade 2, you must ask for a special quotation. Per unit price will vary depending on the number of units being ordered.
- Seating unit and tables come with a choice of wood legs or a polished cast aluminum. The table leg finishes coordinate with the legs on the soft seating units.
- Seating and tables with polished aluminum legs are shown as separate skus.
- Tops finishes coordinate with the laminate finishes for Global Desking and wood seating finishes. Specify laminate finishes from the Adaptabilities or Zira sections of the price list.
- Wood legs for seating are available in select Global wood seating finishes - see seating finishes. Only finishes ending in "**M**" are available for this series.

DESCRIPTION	FEATURES	MODEL#	STANDARD TEXTILE GRADES											
			1	2	3	4	5	6	7	8	9	10	11	12
 <p><b>Lounge Chair w/ Wood Legs</b> COM Yardage: 4 Freight Class: 250 Product Weight (lbs.): 60 Cubic Feet Per Carton: 19.25</p>	No Piping.	<b>5471</b>	2771	2936	3064	3253	3525	3650	3898	4289	4588	4926	5615	6350
		<b>OVERALL DIMENSIONS</b>			<b>SEAT DIMENSIONS</b>			<b>BACK DIMENSIONS</b>						
		<b>W</b>	<b>D</b>	<b>H</b>	<b>W</b>	<b>D</b>	<b>H</b>	<b>W</b>	<b>H</b>					
		29.5	29	30.5	21	19.5	18	20	11.5					
			<b>RTA.00</b>											
 <p><b>Lounge Chair w/ Wood Legs &amp; Piping</b> COM Yardage: 4 Freight Class: 250 Product Weight (lbs.): 60 Cubic Feet Per Carton: 19.25</p>	CP = Contrast Piping MP = Matching Piping	<b>5471-CP</b>	2983	3148	3276	3465	3737	3862	4110	4501	4800	5138	5827	6562
		<b>5471-MP</b>	2771	2936	3064	3253	3525	3650	3898	4289	4588	4926	5615	6350
		<b>OVERALL DIMENSIONS</b>			<b>SEAT DIMENSIONS</b>			<b>BACK DIMENSIONS</b>						
		<b>W</b>	<b>D</b>	<b>H</b>	<b>W</b>	<b>D</b>	<b>H</b>	<b>W</b>	<b>H</b>					
			29.5	29	30.5	21	19.5	18	20	11.5				
			<b>RTA.00</b>											

DESCRIPTION FEATURES MODEL# STANDARD TEXTILE GRADES

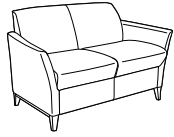

**Two Seat Sofa w/ Wood Legs**  
 COM Yardage: 5.75  
 Freight Class: 250  
 Product Weight (lbs.): 84  
 Cubic Feet Per Carton: 36

No Piping.

	1	2	3	4	5	6	7	8	9	10	11	12
<b>5472</b>	3926	4161	4342	4616	5006	5187	5542	6104	6536	7019	8009	9070

OVERALL DIMENSIONS			SEAT DIMENSIONS			BACK DIMENSIONS	
W	D	H	W	D	H	W	H
51	29	30.5	42	19.5	18	41	11.5

RTA 00

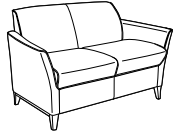

**Two Seat Sofa w/ Wood Legs**  
 COM Yardage: 5.75  
 Freight Class: 250  
 Product Weight (lbs.): 84  
 Cubic Feet Per Carton: 36

CP = Contrast Piping  
 MP = Matching Piping

	1	2	3	4	5	6	7	8	9	10	11	12
<b>5472-CP</b>	4207	4442	4623	4897	5287	5468	5823	6385	6817	7300	8290	9351
<b>5472-MP</b>	3926	4161	4342	4616	5006	5187	5542	6104	6536	7019	8009	9070

OVERALL DIMENSIONS			SEAT DIMENSIONS			BACK DIMENSIONS	
W	D	H	W	D	H	W	H
51	29	30.5	42	19.5	18	41	11.5

RTA 00

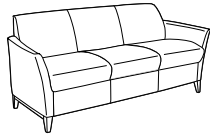

**Three Seat Sofa w/ Wood Legs**  
 COM Yardage: 7.5  
 Freight Class: 250  
 Product Weight (lbs.): 110  
 Cubic Feet Per Carton: 50.25

No Piping.

	1	2	3	4	5	6	7	8	9	10	11	12
<b>5473</b>	5081	5384	5621	5981	6487	6726	7186	7919	8487	9114	10408	11788

OVERALL DIMENSIONS			SEAT DIMENSIONS			BACK DIMENSIONS	
W	D	H	W	D	H	W	H
71	29	30.5	63	19.5	18	62	11.5

RTA 00

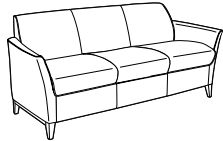

**Three Seat Sofa w/ Wood Legs**  
 COM Yardage: 7.5  
 Freight Class: 250  
 Product Weight (lbs.): 110  
 Cubic Feet Per Carton: 50.25

CP = Contrast Piping  
 MP = Matching Piping

	1	2	3	4	5	6	7	8	9	10	11	12
<b>5473-CP</b>	5431	5733	5972	6331	6837	7076	7537	8269	8837	9464	10758	12138
<b>5473-MP</b>	5081	5384	5621	5981	6487	6726	7186	7919	8487	9114	10408	11788

OVERALL DIMENSIONS			SEAT DIMENSIONS			BACK DIMENSIONS	
W	D	H	W	D	H	W	H
71	29	30.5	63	19.5	18	62	11.5

RTA 00



**Coffee Table - 22" x 48" Rectangular w/Wood Legs**  
 COM Yardage: N/A  
 Freight Class: 92.5  
 Product Weight (lbs.): 40  
 Cubic Feet Per Carton: 4

	1	2	3	4	5	6	7	8	9	10	11	12
<b>5474-LP</b>	2142	-	-	-	-	-	-	-	-	-	-	-
<b>5474-HP</b>	2297	-	-	-	-	-	-	-	-	-	-	-
<b>5474-W</b>	2764	-	-	-	-	-	-	-	-	-	-	-

LP = Laminite Top HP = High Pressure Laminite Top W = Wood Top

OVERALL DIMENSIONS			SEAT DIMENSIONS			BACK DIMENSIONS	
W	D	H	W	D	H	W	H
22	48	17.5	-	-	-	-	-

RTA 8



NOT ON CONTRACT

DESCRIPTION	FEATURES	MODEL#	STANDARD TEXTILE GRADES											
			1	2	3	4	5	6	7	8	9	10	11	12



**End Table - 21"x 21" Square w/Wood Legs**  
 COM Yardage: N/A  
 Freight Class: 100  
 Product Weight (lbs.): 20  
 Cubic Feet Per Carton: 2.1

MODEL#	1	2	3	4	5	6	7	8	9	10	11	12
5475-LP	1595	-	-	-	-	-	-	-	-	-	-	-
5475-HP	1754	-	-	-	-	-	-	-	-	-	-	-
5475-W	1931	-	-	-	-	-	-	-	-	-	-	-

LP = Laminate Top HP = High Pressure Laminate Top W = Wood Top

OVERALL DIMENSIONS			SEAT DIMENSIONS			BACK DIMENSIONS	
W	D	H	W	D	H	W	H

21	21	17.5	-	-	-	-	-
----	----	------	---	---	---	---	---

RTA 8



**End Table - 24" Round w/Wood Legs**  
 COM Yardage: N/A  
 Freight Class: 92.5  
 Product Weight (lbs.): 21  
 Cubic Feet Per Carton: 2.1

MODEL#	1	2	3	4	5	6	7	8	9	10	11	12
5476-LP	1840	-	-	-	-	-	-	-	-	-	-	-
5476-HP	1811	-	-	-	-	-	-	-	-	-	-	-
5476-W	2055	-	-	-	-	-	-	-	-	-	-	-

LP = Laminate Top HP = High Pressure Laminate Top W = Wood Top

OVERALL DIMENSIONS			SEAT DIMENSIONS			BACK DIMENSIONS	
W	D	H	W	D	H	W	H

24	24	17.5	-	-	-	-	-
----	----	------	---	---	---	---	---

RTA 8



**Coffee Table - 32" Round w/Wood Legs**  
 COM Yardage: N/A  
 Freight Class: 125  
 Product Weight (lbs.): 35  
 Cubic Feet Per Carton: 4.4

MODEL#	1	2	3	4	5	6	7	8	9	10	11	12
5477-LP	2491	-	-	-	-	-	-	-	-	-	-	-
5477-HP	2649	-	-	-	-	-	-	-	-	-	-	-
5477-W	3150	-	-	-	-	-	-	-	-	-	-	-

LP = Laminate Top HP = High Pressure Laminate Top W = Wood Top

OVERALL DIMENSIONS			SEAT DIMENSIONS			BACK DIMENSIONS	
W	D	H	W	D	H	W	H

32	32	17.5	-	-	-	-	-
----	----	------	---	---	---	---	---

RTA 8



**Lounge Chair w/Aluminum Legs**  
 COM Yardage: 4  
 Freight Class: 250  
 Product Weight (lbs.): 62  
 Cubic Feet Per Carton: 19.25

No Piping.

MODEL#	1	2	3	4	5	6	7	8	9	10	11	12
5481	2771	2936	3064	3253	3525	3650	3898	4289	4588	4926	5615	6350

OVERALL DIMENSIONS			SEAT DIMENSIONS			BACK DIMENSIONS	
W	D	H	W	D	H	W	H

29.5	29	30.5	21	19.5	18	20	11.5
------	----	------	----	------	----	----	------

RTA 00



**Lounge Chair w/Aluminum Legs**  
 COM Yardage: 4  
 Freight Class: 250  
 Product Weight (lbs.): 62  
 Cubic Feet Per Carton: 19.25

CP = Contrast Piping.  
 MP = Matching Piping.

MODEL#	1	2	3	4	5	6	7	8	9	10	11	12
5481-CP	2983	3148	3276	3465	3737	3862	4110	4501	4800	5138	5827	6562
5481-MP	2771	2936	3064	3253	3525	3650	3898	4289	4588	4926	5615	6350

OVERALL DIMENSIONS			SEAT DIMENSIONS			BACK DIMENSIONS	
W	D	H	W	D	H	W	H

29.5	29	30.5	21	19.5	18	20	11.5
------	----	------	----	------	----	----	------

RTA 00

DESCRIPTION FEATURES MODEL# STANDARD TEXTILE GRADES

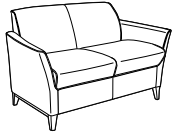

**Two Seat Sofa w/ Aluminum Legs**  
 COM Yardage: 5.75  
 Freight Class: 250  
 Product Weight (lbs.): 86  
 Cubic Feet Per Carton: 36

No Piping.

1	2	3	4	5	6	7	8	9	10	11	12	
5482	3926	4161	4342	4616	5006	5187	5542	6104	6536	7019	8009	9070

OVERALL DIMENSIONS			SEAT DIMENSIONS			BACK DIMENSIONS	
W	D	H	W	D	H	W	H
51	29	30.5	42	19.5	18	41	11.5

RTA 00

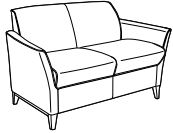

**Two Seat Sofa w/ Aluminum Legs**  
 COM Yardage: 5.75  
 Freight Class: 250  
 Product Weight (lbs.): 86  
 Cubic Feet Per Carton: 36

CP = Contrast Piping.  
 MP = Matching Piping.

1	2	3	4	5	6	7	8	9	10	11	12	
5482-CP	4207	4442	4623	4442	4623	4897	5287	5468	5823	6385	6817	9351
5482-MP	3926	4161	4342	4616	5006	5187	5542	6104	6536	7019	8009	9070

OVERALL DIMENSIONS			SEAT DIMENSIONS			BACK DIMENSIONS	
W	D	H	W	D	H	W	H
51	29	30.5	42	19.5	18	41	11.5

RTA 00

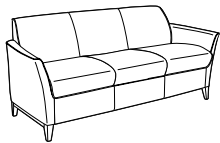

**Three Seat Sofa w/ Aluminum Legs**  
 COM Yardage: 7.5  
 Freight Class: 250  
 Product Weight (lbs.): 112  
 Cubic Feet Per Carton: 50.25

No Piping.

1	2	3	4	5	6	7	8	9	10	11	12	
5483	5081	5384	5621	5384	6487	6726	7186	7919	8487	9114	10408	11788

OVERALL DIMENSIONS			SEAT DIMENSIONS			BACK DIMENSIONS	
W	D	H	W	D	H	W	H
71	29	30.5	63	19.5	18	62	11.5

RTA 00

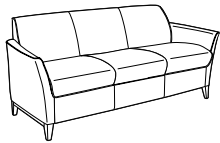

**Three Seat Sofa w/Aluminum Legs**  
 COM Yardage: 7.5  
 Freight Class: 250  
 Product Weight (lbs.): 112  
 Cubic Feet Per Carton: 50.25

CP = Contrast Piping.  
 MP = Matching Piping.

1	2	3	4	5	6	7	8	9	10	11	12	
5483-CP	5431	5734	5972	6331	6837	7076	7537	8269	8837	12138	10758	12138
5483-MP	5081	5384	5621	5981	6487	6726	7186	7919	8487	9114	10408	11788

OVERALL DIMENSIONS			SEAT DIMENSIONS			BACK DIMENSIONS	
W	D	H	W	D	H	W	H
30.5	29	30.5	63	19.5	18	62	11.5

RTA 00





**Coffee Table - 22" x 48" Rectangular w/Aluminum Legs**  
 COM Yardage: N/A  
 Freight Class: 92.5  
 Product Weight (lbs.): 46  
 Cubic Feet Per Carton: 4

1	2	3	4	5	6	7	8	9	10	11	12
5484-LP	2260	-	-	-	-	-	-	-	-	-	-
5484-HP	2418	-	-	-	-	-	-	-	-	-	-
5484-W	2882	-	-	-	-	-	-	-	-	-	-

OVERALL DIMENSIONS			SEAT DIMENSIONS			BACK DIMENSIONS	
W	D	H	W	D	H	W	H
22	48	17.5	-	-	-	-	-

RTA 6

NOT ON CONTRACT

DESCRIPTION	FEATURES	MODEL#	STANDARD TEXTILE GRADES											
			1	2	3	4	5	6	7	8	9	10	11	12
 <p><b>End Table - 21" x 21" Square w/Aluminum Legs</b>                      COM Yardage: N/A                      Freight Class: 85                      Product Weight (lbs.): 26                      Cubic Feet Per Carton: 2.1</p>			1	2	3	4	5	6	7	8	9	10	11	12
	5485-LP	1713	-	-	-	-	-	-	-	-	-	-	-	-
	5485-HP	1872	-	-	-	-	-	-	-	-	-	-	-	-
	5485-W	2049	-	-	-	-	-	-	-	-	-	-	-	-
LP = Laminate Top HP = High Pressure Laminate Top W = Wood Top			OVERALL DIMENSIONS			SEAT DIMENSIONS			BACK DIMENSIONS					
			W	D	H	W	D	H	W	H				
			21	21	17.5	-	-	-	-	-				
			RTA 8		FedEx		ups							
 <p><b>End Table - 24" Round w/Aluminum Legs</b>                      COM Yardage: N/A                      Freight Class: 85                      Product Weight (lbs.): 27                      Cubic Feet Per Carton: 2.1</p>			1	2	3	4	5	6	7	8	9	10	11	12
	5486-LP	1769	-	-	-	-	-	-	-	-	-	-	-	-
	5486-HP	1928	-	-	-	-	-	-	-	-	-	-	-	-
	5486-W	2217	-	-	-	-	-	-	-	-	-	-	-	-
LP = Laminate Top HP = High Pressure Laminate Top W = Wood Top			OVERALL DIMENSIONS			SEAT DIMENSIONS			BACK DIMENSIONS					
			W	D	H	W	D	H	W	H				
			24	24	17.5	-	-	-	-	-				
			RTA 8		FedEx		ups							
 <p><b>Coffee Table - 32" Round w/Aluminum Legs</b>                      COM Yardage: N/A                      Freight Class: 100                      Product Weight (lbs.): 41                      Cubic Feet Per Carton: 4.4</p>			1	2	3	4	5	6	7	8	9	10	11	12
	5487-LP	2610	-	-	-	-	-	-	-	-	-	-	-	-
	5487-HP	2789	-	-	-	-	-	-	-	-	-	-	-	-
	5487-W	3268	-	-	-	-	-	-	-	-	-	-	-	-
LP = Laminate Top HP = High Pressure Laminate Top W = Wood Top			OVERALL DIMENSIONS			SEAT DIMENSIONS			BACK DIMENSIONS					
			W	D	H	W	D	H	W	H				
			32	32	17.5	-	-	-	-	-				
			RTA 8											

NOT ON CONTRACT

CITI™



model 7875LTL (BK)



model 7889



Citi Modular Group & Tables - Shown in Tungsten



5" tubular metal leg  
(shown in Tungsten)



5" tapered wood leg  
(shown in Maple)

STANDARD FEATURES

- Fully upholstered contemporary design, complements the timeless decor of many offices. Proportions are compact, 31" deep, and work well in public spaces.
- All models have fixed, non-removable cushions.
- For increased durability with a softer sit, a highly resilient, high density Ultracell foam (UC) option is available. See upcharges.
- Arm height on all models is 25".
- Casters are not available on this series.
- Citi seating and table legs are 5" high tubular metal. Seating also available with wood, tapered, softened square legs.
- Citi table tops are available in either tempered glass or laminate.
- Laminate tablet seating models (TL suffix) are available specified as seated. Specify right (RTL) or left (LTL). For additional tablet arm models, contact CustomerCare for pricing. The tablet is 0.75" thick with thermally fused laminate and measure 12"D x 16.5"W.
- Ganging brackets (7892) are sold separately.
- Ganging brackets are to be used on armless seating if interconnection to another armless seating unit is required. Bench and ottomans only gang to other benches/ottomans, cannot gang with seating units. Brackets come with a template for installation.
- Upholstery options: fabric, vinyl or leather. Starting at grade 5 pricing. Leather models feature a stitch detail across the seat and/or back cushions, if applicable.
- If you would like fabric/vinyl on the shell of the chair with leather seat and back cushions or other combinations, please complete "Multi Fabric" Form and submit with your order. Multi Fabric grade will apply.

Add option codes in the following order:

- Model Number**  
Specify model number.

- Seat Foam Upgrade** (add option to end of model number)  
(RF) Standard Foam  
(UC) Soft Ultracell foam. For Lounge and corner chairs add \$145; Two Seat Sofas add \$284; Three Seat Sofas add \$426.
- Leg Type** (Lounge only)  
(MTL) Metal Legs  
(WDL) Wood Legs. Add \$333
- Leg Finish:**  
Metal leg finish (lounge and tables):  
(TBL) Black  
(TTU) Tungsten  
(CHM) Chrome. **Add \$117.**  
Wood leg finish (lounge only):  
(AAM) Absolute (BKM) Black  
(ACM) Cherry (EOM) English Oak  
(ECM) Espresso Cafe (TFM) Fruitwood  
(HGM) Gray (AHM) Honey  
(TMM) Mahogany (AVM) Maple  
(MWM) Medium Walnut (NLW) Natural Walnut  
(ASM) Night (NBM) Noce Biondo  
(NGM) Noce Grigio (NEM) Noce Leggero  
(NMM) Noce Medio (SKM) Shaker Cherry  
(TWM) Walnut (WTM) WC Cream  
(VHM) White (WCM) Winter Cherry
- Glide Type** (wood legs)  
(NM) White, non-marking nylon glide for most surfaces  
(SG) Steel cushioned glide for carpeted surfaces. Add \$36  
(RG) Non-slip rubber glide for most hard floor surfaces. Add \$36.  
(FG) Felt glide for most hard floor surfaces. Add \$36.
- Laminate Finish** (tables and tablets)  
(ACJ) Absolute Acajou (ASN) Asian Night  
(AVC) Avant Cherry (AVH) Avant Honey  
(BLK) Black (BRC) Brushed Cobalt  
(BZD) Blizzard (CGY) Custom Grey  
(CMB) Clear Maple (DES) Dark Espresso  
(DWT) Designer White (FAS) Fashionista  
(FCL) First Class (NBL) Noce Biondo  
(NEL) Noce Leggero (NGL) Noce Grigio  
(NML) Noce Medio  
(QTM) Quartered Mahogany  
(SBY) Sheer Beauty (SDT) Stonedust  
(SOG) Storm Grey (WCR) Winter Cherry  
(WHC) White Chocolate (WHE) Walnut Heights

SAMPLE LAYOUTS

Layout A

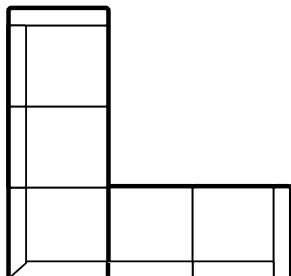





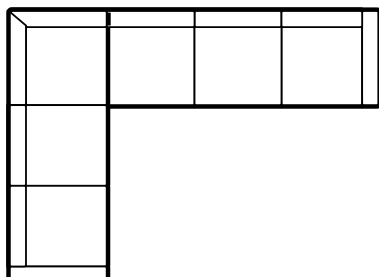



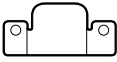





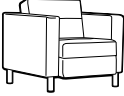

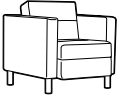
Qty	Model Number	Description	Dimensions	List Price
1	<b>7890LNB</b>	Two Seat Sofa w/Left Arm	48 x 31 x 30.75	2251
1	<b>7862</b>	Corner Seat	37 x 37 x 31	2444
1	<b>7890RNB</b>	Two Seat Sofa w/Right Arm	48 x 31 x 30.75	2251
2	<b>7892</b>	Ganging Bracket	0.5 x 3.87 x 2	34
<b>SAMPLE LAYOUT TOTAL IN STANDARD FEET FINISH</b>				<b>\$6,980</b>

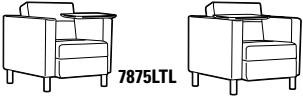
Layout B





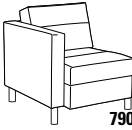
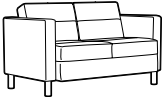

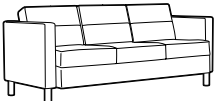
Qty	Model Number	Description	Dimensions	List Price
1	<b>7890RNB</b>	Two Seat Sofa w/Right Arm	48 x 31 x 30.75	2251
1	<b>7862</b>	Corner Seat	37 x 37 x 31	2444
1	<b>7891LNB</b>	Three Seat Sofa w/Left Arm	77 x 31 x 30.75	3007
2	<b>7892</b>	Ganging Bracket	0.5 x 3.87 x 2	34 x 2
<b>SAMPLE LAYOUT TOTAL IN STANDARD FEET FINISH</b>				<b>\$7,770</b>

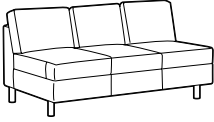

DESCRIPTION	FEATURES	MODEL#	STANDARD TEXTILE GRADES											
			1	2	3	4	5	6	7	8	9	10	11	12
 <p><b>Ganging Bracket</b> COM Yardage: N/a Freight Class: 70 Product Weight (lbs.): 0.25 Cubic Feet Per Carton: 0.01</p>	<p>Kit includes 2 brackets, 4 screws and a template.</p>	7892	34	-	-	-	-	-	-	-	-	-	-	
		<b>OVERALL DIMENSIONS</b>			<b>SEAT DIMENSIONS</b>			<b>BACK DIMENSIONS</b>						
		W	D	H	W	D	H	W	H					
		-			-			-						
			  											
 <p><b>Corner Seat</b> COM Yardage: 6.25 Freight Class: 250 Product Weight (lbs.): 65 Cubic Feet Per Carton: 30.25</p>		7862	-	-	-	-	2444	2625	2966	3578	3928	4492	5349	6369
	<b>OVERALL DIMENSIONS</b>			<b>SEAT DIMENSIONS</b>			<b>BACK DIMENSIONS</b>							
	W	D	H	W	D	H	W	H						
	37	37	30.75	26	26	17.5	26	13.5						
														
 <p><b>Large Lounge Chair - for 6'+ Tall Users</b> COM Yardage: 5.50 Freight Class: 250 Product Weight (lbs.): 70 Cubic Feet Per Carton: 24.25</p>		7864	-	-	-	-	2167	-	-	3163	3473	3969	4723	5622
	<b>OVERALL DIMENSIONS</b>			<b>SEAT DIMENSIONS</b>			<b>BACK DIMENSIONS</b>							
	W	D	H	W	D	H	W	H						
	34	33	30	23	20	19	23	13.5						
														
 <p><b>Lounge Chair</b> COM Yardage: 4.5 Freight Class: 250 Product Weight (lbs.): 67 Cubic Feet Per Carton: 21</p>		7875	-	-	-	-	1601	1738	1990	2447	2704	3122	3756	4514
	<b>OVERALL DIMENSIONS</b>			<b>SEAT DIMENSIONS</b>			<b>BACK DIMENSIONS</b>							
	W	D	H	W	D	H	W	H						
	30	31	30	21	19.5	17.5	21	12.5						
														
 <p><b>Lounge Chair w/Laminate Tablet</b> COM Yardage: 4.5 Freight Class: 250 Product Weight (lbs.): 75 Cubic Feet Per Carton: 22.5</p>		7875LTL 7875RTL	-	-	-	-	2401	2539	2798	3260	3523	3953	4601	5370
	<b>OVERALL DIMENSIONS</b>			<b>SEAT DIMENSIONS</b>			<b>BACK DIMENSIONS</b>							
	W	D	H	W	D	H	W	H						
	31.5	33.5	33.5	21	19.5	17.5	21	12.5						
														

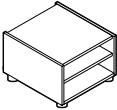
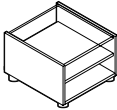

DESCRIPTION	FEATURES	MODEL#	STANDARD TEXTILE GRADES											
			1	2	3	4	5	6	7	8	9	10	11	12
 <p><b>Lounge Chair- Armless</b> COM Yardage: 3 Freight Class: 250 Product Weight (lbs.): 45 Cubic Feet Per Carton: 15.5</p>		<b>7895</b>	-	-	-	-	1603	1694	1856	2150	2318	2589	2999	3490
			<b>OVERALL DIMENSIONS</b>			<b>SEAT DIMENSIONS</b>			<b>BACK DIMENSIONS</b>					
			<b>W</b>	<b>D</b>	<b>H</b>	<b>W</b>	<b>D</b>	<b>H</b>	<b>W</b>	<b>H</b>				
			22	31	30.75	21	19.5	17.5	21	14				
			<b>RTA 00</b>											
  <p><b>Lounge Chair- Single Arm</b> COM Yardage: 4 Freight Class: 250 Product Weight (lbs.): 65 Cubic Feet Per Carton: 21</p>		<b>7901L</b> <b>7901R</b>	-	-	-	-	1829	1939	2143	2467	2715	2995	3568	4176
			<b>OVERALL DIMENSIONS</b>			<b>SEAT DIMENSIONS</b>			<b>BACK DIMENSIONS</b>					
			<b>W</b>	<b>D</b>	<b>H</b>	<b>H</b>	<b>W</b>	<b>D</b>	<b>H</b>	<b>W</b>	<b>H</b>			
			26	31	30	22	19.5	17.5	22	12.5				
			<b>RTA 00</b>											
 <p><b>Two Seat Sofa</b> COM Yardage: 6.25 Freight Class: 250 Product Weight (lbs.): 125 Cubic Feet Per Carton: 36</p>		<b>7876</b>	-	-	-	-	2159	2348	2695	3324	3687	4267	5150	6204
			<b>OVERALL DIMENSIONS</b>			<b>SEAT DIMENSIONS</b>			<b>BACK DIMENSIONS</b>					
			<b>W</b>	<b>D</b>	<b>H</b>	<b>W</b>	<b>D</b>	<b>H</b>	<b>W</b>	<b>H</b>				
			51.25	31	30	42.5	19.5	17.5	42.5	12.5				
			<b>RTA 00</b>											
 <p><b>Two Seat Sofa - Armless</b> COM Yardage: 5 Freight Class: 250 Product Weight (lbs.): 93 Cubic Feet Per Carton: 36</p>		<b>7896</b>	-	-	-	-	1994	2140	2412	2903	3181	3636	4319	5134
			<b>OVERALL DIMENSIONS</b>			<b>SEAT DIMENSIONS</b>			<b>BACK DIMENSIONS</b>					
			<b>W</b>	<b>D</b>	<b>H</b>	<b>W</b>	<b>D</b>	<b>H</b>	<b>W</b>	<b>H</b>				
			43.25	31	30.75	42.5	19.5	17.5	42.5	12.5				
			<b>RTA 00</b>											
 <p><b>Three Seat Sofa</b> COM Yardage: 8.75 Freight Class: 250 Product Weight (lbs.): 163 Cubic Feet Per Carton: 50.25</p>		<b>7877</b>	-	-	-	-	2717	2976	3469	4353	4856	5671	6908	8377
			<b>OVERALL DIMENSIONS</b>			<b>SEAT DIMENSIONS</b>			<b>BACK DIMENSIONS</b>					
			<b>W</b>	<b>D</b>	<b>H</b>	<b>W</b>	<b>D</b>	<b>H</b>	<b>W</b>	<b>H</b>				
			72.5	31	30	63.5	19.5	17.5	63.5	12.5				
			<b>RTA 00</b>											



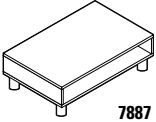
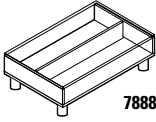



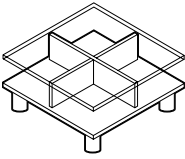

DESCRIPTION	FEATURES	MODEL#	STANDARD TEXTILE GRADES											
			1	2	3	4	5	6	7	8	9	10	11	12
 <p><b>Three Seat Sofa - Armless</b> COM Yardage: 7.25 Freight Class: 250 Product Weight (lbs.): 131 Cubic Feet Per Carton: 50.25</p>		<b>7897</b>	-	-	-	-	2625	2834	3232	3939	4344	5000	5993	7178
			<b>OVERALL DIMENSIONS</b>			<b>SEAT DIMENSIONS</b>			<b>BACK DIMENSIONS</b>					
			<b>W</b>	<b>D</b>	<b>H</b>	<b>W</b>	<b>D</b>	<b>H</b>	<b>W</b>	<b>H</b>				
			64.5	31	30.75	63.5	19.5	17.5	63.5	12.5				
		<b>RTA 00</b>												

DESCRIPTION	FEATURES	MODEL#	STANDARD TEXTILE GRADES											
			1	2	3	4	5	6	7	8	9	10	11	12
 <p><b>Ottoman</b> COM Yardage: 1.5 Freight Class: 250 Product Weight (lbs.): 27 Cubic Feet Per Carton: 7.5</p>		<b>7879</b>	-	-	-	-	620	668	752	907	995	1141	1355	1611
			<b>OVERALL DIMENSIONS</b>			<b>SEAT DIMENSIONS</b>			<b>BACK DIMENSIONS</b>					
			<b>W</b>	<b>D</b>	<b>H</b>	<b>W</b>	<b>D</b>	<b>H</b>	<b>W</b>	<b>H</b>				
			22	22	17	-	-	17	-	-				
		<b>RTA 00</b>	 											

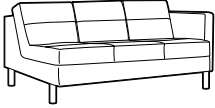
DESCRIPTION	FEATURES	MODEL#	STANDARD TEXTILE GRADES												
			1	2	3	4	5	6	7	8	9	10	11	12	
  <p><b>End Table</b> COM Yardage: N/A Freight Class: 100 Product Weight (lbs.): 53 Cubic Feet Per Carton: 6</p>		<b>7885</b>	873	-	-	-	-	-	-	-	-	-	-	-	
			<b>7886</b>	1231	-	-	-	-	-	-	-	-	-	-	
				<b>OVERALL DIMENSIONS</b>			<b>SEAT DIMENSIONS</b>			<b>BACK DIMENSIONS</b>					
				<b>W</b>	<b>D</b>	<b>H</b>	<b>W</b>	<b>D</b>	<b>H</b>	<b>W</b>	<b>H</b>				
			20	24	20	-	-	-	-	-					
		<b>RTA 1</b>	 												

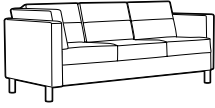
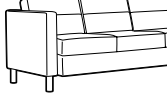
DESCRIPTION	FEATURES	MODEL#	STANDARD TEXTILE GRADES												
			1	2	3	4	5	6	7	8	9	10	11	12	
  <p><b>Coffee Table Rectangular</b> COM Yardage: N/A Freight Class: 100 Product Weight (lbs.): 60 Cubic Feet Per Carton: 6.5</p>		<b>7887</b>	911	-	-	-	-	-	-	-	-	-	-		
			<b>7888</b>	1417	-	-	-	-	-	-	-	-	-		
				<b>OVERALL DIMENSIONS</b>			<b>SEAT DIMENSIONS</b>			<b>BACK DIMENSIONS</b>					
				<b>W</b>	<b>D</b>	<b>H</b>	<b>W</b>	<b>D</b>	<b>H</b>	<b>W</b>	<b>H</b>				
			40	20	15	-	-	-	-	-					
		<b>RTA 1</b>	 												

DESCRIPTION	FEATURES	MODEL#	STANDARD TEXTILE GRADES												
			1	2	3	4	5	6	7	8	9	10	11	12	
 <p><b>Coffee Table Square</b> COM Yardage: N/A Freight Class: 92.5 Product Weight (lbs.): 90 Cubic Feet Per Carton: 8.75</p>		<b>7889</b>	1720	-	-	-	-	-	-	-	-	-	-		
				<b>OVERALL DIMENSIONS</b>			<b>SEAT DIMENSIONS</b>			<b>BACK DIMENSIONS</b>					
				<b>W</b>	<b>D</b>	<b>H</b>	<b>W</b>	<b>D</b>	<b>H</b>	<b>W</b>	<b>H</b>				
				33	33	15	-	-	-	-	-				
		<b>RTA 1</b>	 												

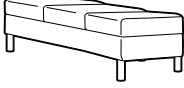
DESCRIPTION	FEATURES	MODEL#	STANDARD TEXTILE GRADES											
			1	2	3	4	5	6	7	8	9	10	11	12
 7890LNB  7890RNB	**Intended to be free standing. No connecting hardware.	7890LNB	-	-	-	-	2251	2410	2711	3252	3557	4056	4812	5714
		7890RNB												
<b>Two Seat Sofa - No Connector</b> COM Yardage: 5.25 Freight Class: 250 Product Weight (lbs.): 107 Cubic Feet Per Carton: 36			<b>OVERALL DIMENSIONS</b> W D H			<b>SEAT DIMENSIONS</b> W D H			<b>BACK DIMENSIONS</b> W H					
			0	0	0		42.5	19.5	17.5		42.5		13.25	
			<div style="border: 1px solid black; padding: 2px; display: inline-block;">RTA 00</div>											
 7891LNB  7891RNB	**Intended to be free standing. No connecting hardware.	7891LNB	-	-	-	-	3007	3216	3614	4321	4726	5382	6375	7560
		7891RNB												
<b>Three Seat Sofa - No Connector</b> COM Yardage: 7.25 Freight Class: 250 Product Weight (lbs.): 138 Cubic Feet Per Carton: 50.25			<b>OVERALL DIMENSIONS</b> W D H			<b>SEAT DIMENSIONS</b> W D H			<b>BACK DIMENSIONS</b> W H					
			0	0	0		63.5	19.5	17.5		63.5		13.25	
			<div style="border: 1px solid black; padding: 2px; display: inline-block;">RTA 00</div>											
 7891L-RCNB  7891R-RCNB	**Intended to be free standing. No connecting hardware.	7891L-RCNB	-	-	-	-	3622	3877	4365	5238	5737	6545	7767	9226
		7891R-RCNB												
<b>Three Seat Sofa - No Connector</b> COM Yardage: 8.5 Freight Class: 250 Product Weight (lbs.): 154 Cubic Feet Per Carton: 55.5			<b>OVERALL DIMENSIONS</b> W D H			<b>SEAT DIMENSIONS</b> W D H			<b>BACK DIMENSIONS</b> W H					
			0	0	0		60	19.5	17.5		60		13.25	
			<div style="border: 1px solid black; padding: 2px; display: inline-block;">RTA 00</div>											
 7893		7893	-	-	-	-	1230	1300	1427	1662	1793	2005	2329	2717
<b>Two Seat Bench</b> COM Yardage: 2.25 Freight Class: 250 Product Weight (lbs.): 42 Cubic Feet Per Carton: 11.5			<b>OVERALL DIMENSIONS</b> W D H			<b>SEAT DIMENSIONS</b> W D H			<b>BACK DIMENSIONS</b> W H					
			43	21.5	17		-	-	17		-		-	
			<div style="border: 1px solid black; padding: 2px; display: inline-block;">RTA 00</div>  											
 7894		7894	-	-	-	-	1755	1872	2087	2470	2690	3051	3587	4229
<b>Three Seat Bench</b> COM Yardage: 3.75 Freight Class: 250 Product Weight (lbs.): 62 Cubic Feet Per Carton: 16.75			<b>OVERALL DIMENSIONS</b> W D H			<b>SEAT DIMENSIONS</b> W D H			<b>BACK DIMENSIONS</b> W H					
			64.5	21.5	17		-	-	17		-		-	
			<div style="border: 1px solid black; padding: 2px; display: inline-block;">RTA 00</div>											

CITI™ SQUARE



model S7875LT



Sample Layout A - Models shown: S7875UC and S7911



Sample Layout B - Models shown: S7890RUC, S7862UC (2), S7897UC, S7890LUC and S7912

STANDARD FEATURES

- Fully upholstered lounge series with a complete range of sectional components for all applications. Proportions are compact, 31" and 33.5" deep so it works well in public spaces.
- All models have fixed, non-removable cushions.
- Upholstery options: fabric, vinyl and leather. Leather models may feature a horizontal stitch detail across the seat and/or back cushions if applicable.
- The 5 inch high leg frame for seating and occasional tables lightens the look, it is available in Tungsten (S1) as standard or optionally available in Black (S2) Please specify finish, no upcharge added.
- Casters are not available on this series.
- Arm height on all models is 25"
- Tablet arms are made from thermally fused laminate, measure 12"D x 16.5"W 3/4" thick. Available right hand seated (RT), left Hand seated (LT) or both right and left hand (LRT).
- Ganging Brackets are sold separately. Ganging brackets are to be used on armless seating if interconnection to another armless seating unit is required. Bench and ottomans only gang to other benches/ottomans, cannot gang with seating units.
- Brackets come with a template for installation: unless noted otherwise all armless skus are equipped with the steel on steel connectors to receive this bracket.
- Upholstery options: fabric, vinyl and leather. Leather models feature a horizontal stitch detail across the seat and/or back cushions if applicable.
- Check textile availability prior to specifying upholstery material.
- If you would like fabric/vinyl on the shell of the chair with leather seat and back cushions or other combinations, please complete "Multi Fabric" Form and submit with your order. Multi Fabric grade will apply.
- Measurement shown for weight is for one unit. Measurement for volume is per carton.

- (TFR) Frost
- (TIV) Cloud
- (TLA) Latte
- (TOA) Toast
- (TSH) Shadow
- (TSR) Scarlet
- (CHM) Chrome. Add \$217
- (TIN) Ink
- (TKA) Kalua
- (TMO) Mocha
- (TNE) Nevada
- (TSN) Sand
- (TTU) Tungsten

- (BCH) Brushed Chrome. Add \$317 for corner units. Add \$227 for single seat units. Add \$348 for two seat units. Add \$348 for three seat units. Add \$411 for four seat units.
- Laminate Tables and Tablet arms are made with high pressure laminate and are offered in the following finishes: Absolute Acajou (ACJ), Asian Night (ASN), Avant Cherry (AWC), Avant Honey (AWH), Black (BLK), Blizzard (BZD), Brushed Cobalt (BRC), Clear Maple (CMB), Custom Grey (CGY), Dark Espresso (DES), Designer White (DWT), Fashionista (FAS), First Class (FCL), Noce Biondo (NBL), Noce Grigio (NGL), Noce Leggero (NEL), Noce Medio (NML), Quartered Mahogany (QTM), Sheer Beauty (SBY), Storm Grey (SOG), Stonedust (SDT), Walnut Heights (WHE), White Chocolate (WHC) and Winter Cherry (WCR). Please Specify. Custom high pressure laminate finishes will be considered upon request.
- For high resilient, high density Ultracell foam on seat, specify (UC) after the model number. One Seater, add \$145. Two Seater, add \$284. Three Seater, add \$426, and Four Seater, add \$566
- Power/USB modules are available in the Citi Square tables. Each module includes a double power outlet and two USB terminals. It is equipped with a 6' long three-prong power cord with standard three prong plug. The Power monuments are available in Jet Black (J1) or White (W1). Add \$997 per unit. Please see Electrical Placement below for predetermined locations.

OPTIONAL FEATURES

- Seating and Table Leg Finishes**  
Metal legs are available in the following finishes:  
(TBL) Black (TBZ) Buzz Blue  
(TCC) Cactus (TCR) Carrot  
(TDJ) Dijon (TDW) Designer White  
(TEG) Eggplant (TFO) Fog

ELECTRICAL PLACEMENT

Coffee/End Tables: Predetermined Location is on the end/side of the unit J1 (black) or W1 (white).

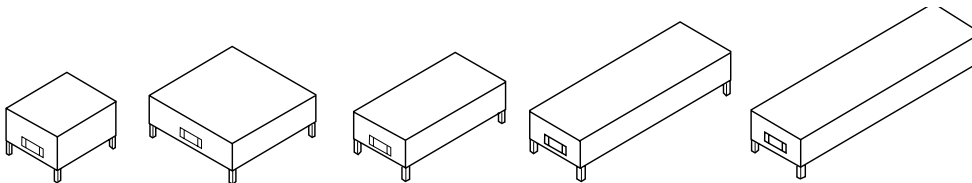

	1	2	3	4	5	6	7	8	9	10	11	12
7892	34	-	-	-	-	-	-	-	-	-	-	-





**Ganging Bracket**  
COM Yardage: N/A  
Freight Class: 70  
Product Weight (lbs.): 00.25  
Cubic Feet Per Carton: 00.01

Two brackets included.  
Only one set is needed per connection.

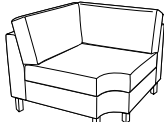
OVERALL DIMENSIONS			SEAT DIMENSIONS			BACK DIMENSIONS	
W	D	H	W	D	H	W	H
0.5	3.87	2	-	-	-	-	-

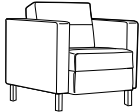

DESCRIPTION	FEATURES	MODEL#	STANDARD TEXTILE GRADES											
			1	2	3	4	5	6	7	8	9	10	11	12
 <p><b>Linking Corner Unit</b> COM Yardage: 6.25 Freight Class: 250 Product Weight (lbs.): 75 Cubic Feet Per Carton: 30.25</p>	No ganging hardware Armless side(s) can be equipped with ganging brackets, model 7892.	<b>S7862</b>	-	-	-	-	2731	2937	3319	3931	4399	4923	6003	7152
		<b>OVERALL DIMENSIONS</b>			<b>SEAT DIMENSIONS</b>			<b>BACK DIMENSIONS</b>						
		<b>W</b>	<b>D</b>	<b>H</b>	<b>W</b>	<b>D</b>	<b>H</b>	<b>W</b>	<b>H</b>					
		37	37	31	26	26	17.5	26	13.5					
<b>RTA 00</b>														

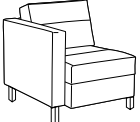

DESCRIPTION	FEATURES	MODEL#	STANDARD TEXTILE GRADES											
			1	2	3	4	5	6	7	8	9	10	11	12
 <p><b>Single Seat w/Arms</b> COM Yardage: 4.5 Freight Class: 250 Product Weight (lbs.): 81 Cubic Feet Per Carton: 21</p>	Free standing unit only.	<b>S7875</b>	-	-	-	-	1930	2078	2356	2795	3134	3513	4288	5114
		<b>OVERALL DIMENSIONS</b>			<b>SEAT DIMENSIONS</b>			<b>BACK DIMENSIONS</b>						
		<b>W</b>	<b>D</b>	<b>H</b>	<b>W</b>	<b>D</b>	<b>H</b>	<b>W</b>	<b>H</b>					
		30	31	30	21	19.5	17.5	21	12.5					
<b>RTA 00</b>														

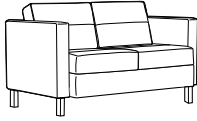
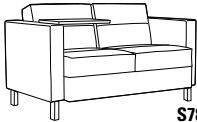
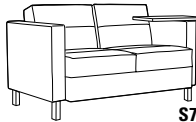
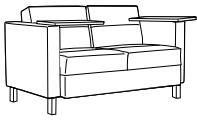
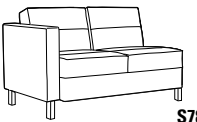

DESCRIPTION	FEATURES	MODEL#	STANDARD TEXTILE GRADES											
			1	2	3	4	5	6	7	8	9	10	11	12
 <p><b>Single Seat w/Arms &amp; Laminate Tablet</b> COM Yardage: 4.5 Freight Class: 250 Product Weight (lbs.): 89 Cubic Feet Per Carton: 22.5</p>	Free standing unit only. Tablets are Right Hand Seated (RT) or Left Hand Seated (LT).	<b>S7875RT</b>	-	-	-	-	2583	2731	3009	3448	3785	4166	4941	5767
		<b>S7875LT</b>	-	-	-	-	2583	2731	3009	3448	3785	4166	4941	5767
		<b>OVERALL DIMENSIONS</b>			<b>SEAT DIMENSIONS</b>			<b>BACK DIMENSIONS</b>						
		<b>W</b>	<b>D</b>	<b>H</b>	<b>W</b>	<b>D</b>	<b>H</b>	<b>W</b>	<b>H</b>					
31.5	33.5	30	21	19.5	17.5	21	12.5							
<b>RTA 00</b>														

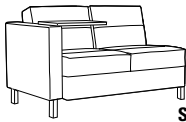

DESCRIPTION	FEATURES	MODEL#	STANDARD TEXTILE GRADES											
			1	2	3	4	5	6	7	8	9	10	11	12
 <p><b>Single Seat w/One Arm</b> COM Yardage: 4 Freight Class: 250 Product Weight (lbs.): 65 Cubic Feet Per Carton: 21</p>	No ganging hardware. Armless side can be equipped with ganging brackets, model 7892. Arms are Right Hand Seated (RT) or Left Hand Seated (LT).	<b>S7901R</b>	-	-	-	-	1930	2047	2262	2604	2865	3161	3765	4407
		<b>S7901L</b>	-	-	-	-	1930	2047	2262	2604	2865	3161	3765	4407
		<b>OVERALL DIMENSIONS</b>			<b>SEAT DIMENSIONS</b>			<b>BACK DIMENSIONS</b>						
		<b>W</b>	<b>D</b>	<b>H</b>	<b>W</b>	<b>D</b>	<b>H</b>	<b>W</b>	<b>H</b>					
26	31	30.75	21	19.5	17.5	21	12.5							
<b>RTA 00</b>														

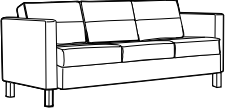
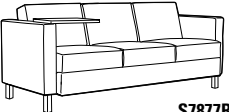
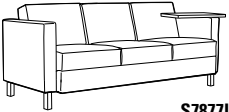
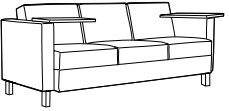

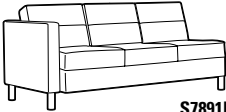
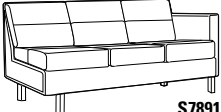
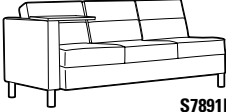
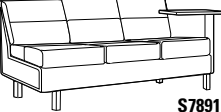
DESCRIPTION	FEATURES	MODEL#	STANDARD TEXTILE GRADES											
			1	2	3	4	5	6	7	8	9	10	11	12
 <p><b>Single Seat w/One Arm &amp; Laminate Tablet</b> COM Yardage: 4 Freight Class: 250 Product Weight (lbs.): 73 Cubic Feet Per Carton: 22.5</p>	No ganging hardware. Armless side(s) can be equipped with ganging brackets, model 7892. Tablets are Arms are Right Hand Seated (RT) or Left Hand Seated (LT).	<b>S7901RRT</b>	-	-	-	-	2583	2915	1783	3257	3518	3814	4418	5060
		<b>S7901LLT</b>	-	-	-	-	2583	2700	2915	3257	3518	3814	4418	5060
		<b>OVERALL DIMENSIONS</b>			<b>SEAT DIMENSIONS</b>			<b>BACK DIMENSIONS</b>						
		<b>W</b>	<b>D</b>	<b>H</b>	<b>W</b>	<b>D</b>	<b>H</b>	<b>W</b>	<b>H</b>					
27.5	31	30.75	21	19.5	17.5	21	12.5							
<b>RTA 00</b>														

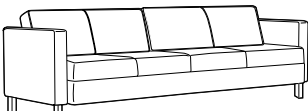
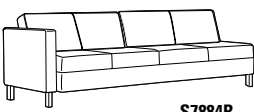
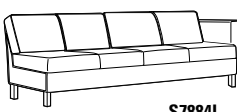
DESCRIPTION	FEATURES	MODEL#	STANDARD TEXTILE GRADES												
			1	2	3	4	5	6	7	8	9	10	11	12	
 <p><b>Armless Single Seat</b> COM Yardage: 3 Freight Class: 2250 Product Weight (lbs.): 45 Cubic Feet Per Carton: 15.5</p>	<p>No ganging hardware. Armless side(s) can be equipped with ganging brackets, model 7892.</p>	<b>S7895</b>	-	-	-	-	1930	2030	2212	2509	2733	2987	3504	4056	
			<b>OVERALL DIMENSIONS</b>			<b>SEAT DIMENSIONS</b>			<b>BACK DIMENSIONS</b>						
			<b>W</b>	<b>D</b>	<b>H</b>	<b>W</b>	<b>D</b>	<b>H</b>	<b>W</b>	<b>H</b>					
			22	31	30.75	21	18.5	17.5	21	12.5					
			<b>RTA 00</b>												
 <p><b>Two Seater w/Arms</b> COM Yardage: 6.25 Freight Class: 250 Product Weight (lbs.): 122 Cubic Feet Per Carton: 36</p>	<p>Free standing unit only.</p>	<b>S7876</b>	-	-	-	-	2731	2937	3319	3931	4399	4923	6003	7152	
			<b>OVERALL DIMENSIONS</b>			<b>SEAT DIMENSIONS</b>			<b>BACK DIMENSIONS</b>						
			<b>W</b>	<b>D</b>	<b>H</b>	<b>W</b>	<b>D</b>	<b>H</b>	<b>W</b>	<b>H</b>					
			51.25	31	30	42.5	19.5	17.5	42.5	12.5					
			<b>RTA 00</b>												
 <p><b>S7876RT</b></p>  <p><b>S7876LT</b></p> <p><b>Two Seater w/Arms &amp; Laminate Tablet</b> COM Yardage: 6.25 Freight Class: 250 Product Weight (lbs.): 130 Cubic Feet Per Carton: 41.25</p>	<p>Free standing unit only. Tablets are Right Hand Seated (RT) or Left Hand Seated (LT).</p>	<b>S7876RT</b>	-	-	-	-	3385	3589	3973	4582	5053	5577	6657	7806	
			<b>S7876LT</b>	-	-	-	-	3385	3589	3973	4582	5053	5577	6657	7806
				<b>OVERALL DIMENSIONS</b>			<b>SEAT DIMENSIONS</b>			<b>BACK DIMENSIONS</b>					
				<b>W</b>	<b>D</b>	<b>H</b>	<b>W</b>	<b>D</b>	<b>H</b>	<b>W</b>	<b>H</b>				
52.75	33.5	30		42.5	19.5	17.5	42.5	12.5							
			<b>RTA 00</b>												
 <p><b>Two Seater w/Arms &amp; Laminate Tablets</b> COM Yardage: 6.25 Freight Class: 250 Product Weight (lbs.): 138 Cubic Feet Per Carton: 41.25</p>	<p>Free standing unit only. With both Left and Right Tablets.</p>	<b>S7876LRT</b>	-	-	-	-	4040	4244	4628	5237	5708	6232	7312	8461	
			<b>OVERALL DIMENSIONS</b>			<b>SEAT DIMENSIONS</b>			<b>BACK DIMENSIONS</b>						
			<b>W</b>	<b>D</b>	<b>H</b>	<b>W</b>	<b>D</b>	<b>H</b>	<b>W</b>	<b>H</b>					
			54.25	33.5	30	42.5	19.5	17.5	42.5	12.5					
			<b>RTA 00</b>												
 <p><b>S7890R</b></p>  <p><b>S7890L</b></p> <p><b>Two Seater w/One Arm</b> COM Yardage: 5.25 Freight Class: 250 Product Weight (lbs.): 106 Cubic Feet Per Carton: 36</p>	<p>No ganging hardware. Armless side can be equipped with ganging brackets, model 7892. Arms are Right Hand Seated (RT) or Left Hand Seated (LT).</p>	<b>S7890R</b>	-	-	-	-	2536	2707	3029	3543	3939	4381	5284	6251	
			<b>S7890L</b>	-	-	-	-	2536	2707	3029	3543	3939	4381	5284	6251
				<b>OVERALL DIMENSIONS</b>			<b>SEAT DIMENSIONS</b>			<b>BACK DIMENSIONS</b>					
				<b>W</b>	<b>D</b>	<b>H</b>	<b>W</b>	<b>D</b>	<b>H</b>	<b>W</b>	<b>H</b>				
47.25	31	30.75		42.5	19.5	17.5	42.5	13.25							
			<b>RTA 00</b>												

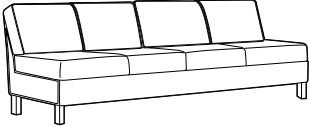
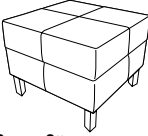
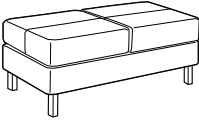
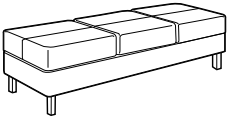
DESCRIPTION	FEATURES	MODEL#	STANDARD TEXTILE GRADES											
			1	2	3	4	5	6	7	8	9	10	11	12
 <p><b>S7890RRT</b></p>	 <p><b>S7890LLT</b></p>		-	-	-	-	3189	3360	3682	4196	4592	5033	5937	6903
			-	-	-	-	3189	3360	3682	4196	4592	5033	5937	6903
<p><b>Two Seater w/One Arm and Laminate Tablet</b> COM Yardage: 5.25 Freight Class: 250 Product Weight (lbs.): 114 Cubic Feet Per Carton: 41.25</p>			<p>No ganging hardware. Armless side(s) can be equipped with ganging brackets, model 7892. Tablets are Arms are Right Hand Seated (RT) or Left Hand Seated (LT).</p>			<p><b>OVERALL DIMENSIONS</b> W D H</p>			<p><b>SEAT DIMENSIONS</b> W D H</p>			<p><b>BACK DIMENSIONS</b> W H</p>		
			48.75	33.5	30.75	42.5	19.5	17.5	42.5	13.25				
			<b>RTA 00</b>											
 <p><b>S7896</b></p>			-	-	-	-	2536	2701	3006	3497	3874	4294	5156	6074
			-	-	-	-	2536	2701	3006	3497	3874	4294	5156	6074
<p><b>Armless Two Seater</b> COM Yardage: 5 Freight Class: 250 Product Weight (lbs.): 43.25 Cubic Feet Per Carton: 36</p>			<p>No ganging hardware. Armless side(s) can be equipped with ganging brackets, model 7892.</p>			<p><b>OVERALL DIMENSIONS</b> W D H</p>			<p><b>SEAT DIMENSIONS</b> W D H</p>			<p><b>BACK DIMENSIONS</b> W H</p>		
			43.25	31	30.75	42.5	19.5	17.5	42.5	13.25				
			<b>RTA 00</b>											
 <p><b>S7877</b></p>			-	-	-	-	3536	3818	4356	5214	5871	6605	8113	9724
			-	-	-	-	3536	3818	4356	5214	5871	6605	8113	9724
<p><b>Three Seater w/Arms</b> COM Yardage: 8.75 Freight Class: 250 Product Weight (lbs.): 163 Cubic Feet Per Carton: 50.25</p>			<p>Free standing unit only.</p>			<p><b>OVERALL DIMENSIONS</b> W D H</p>			<p><b>SEAT DIMENSIONS</b> W D H</p>			<p><b>BACK DIMENSIONS</b> W H</p>		
			72.5	31	30	63.5	19.5	17.5	63.5	12.5				
			<b>RTA 00</b>											
 <p><b>S7877RT</b></p>	 <p><b>S7877LT</b></p>		-	-	-	-	4188	4469	5008	5866	6523	7257	8765	10376
			-	-	-	-	4188	4469	5008	5866	6523	7257	8765	10376
<p><b>Three Seater w/Arms and Laminate Tablet</b> COM Yardage: 8.75 Freight Class: 250 Product Weight (lbs.): 171 Cubic Feet Per Carton: 55.5</p>			<p>Free standing unit only. Tablets are Right Hand Seated (RT) or Left Hand Seated (LT).</p>			<p><b>OVERALL DIMENSIONS</b> W D H</p>			<p><b>SEAT DIMENSIONS</b> W D H</p>			<p><b>BACK DIMENSIONS</b> W H</p>		
			74	33.5	30	63.5	19.5	17.5	63.5	12.5				
			<b>RTA 00</b>											
 <p><b>S7877LRT</b></p>			-	-	-	-	4841	5122	5661	6519	7176	7910	9418	11029
			-	-	-	-	4841	5122	5661	6519	7176	7910	9418	11029
<p><b>Three Seater w/Arms and Laminate Tablets</b> COM Yardage: 8.75 Freight Class: 250 Product Weight (lbs.): 250 Cubic Feet Per Carton: 55.5</p>			<p>Free standing unit only. With both Left and Right Tablets.</p>			<p><b>OVERALL DIMENSIONS</b> W D H</p>			<p><b>SEAT DIMENSIONS</b> W D H</p>			<p><b>BACK DIMENSIONS</b> W H</p>		
			75.5	33.5	30	63.5	19.5	17.5	63.5	12.5				
			<b>RTA 00</b>											

DESCRIPTION	FEATURES	MODEL#	STANDARD TEXTILE GRADES													
			1	2	3	4	5	6	7	8	9	10	11	12		
 <p><b>S7891R</b></p> <p><b>Three Seater w/One Arm</b> COM Yardage: 7.25 Freight Class: 250 Product Weight (lbs.): 147 Cubic Feet Per Carton: 50.25</p>	 <p><b>S7891L</b></p> <p>No ganging hardware. Armless side can be equipped with ganging brackets, model 7892. Arms are Right Hand Seated (RT) or Left Hand Seated (LT) .</p>	<p><b>S7891R</b></p> <p><b>S7891L</b></p>	-	-	-	-	3424	3660	4104	4816	5361	5968	7219	8552		
		<p><b>OVERALL DIMENSIONS</b></p> <p>W D H</p>			<p><b>SEAT DIMENSIONS</b></p> <p>W D H</p>			<p><b>BACK DIMENSIONS</b></p> <p>W H</p>			68.5	31	30.75	63.5	19.5	17.5
			<b>RTA 00</b>													
 <p><b>S7891RRT</b></p> <p><b>Three Seater w/One Arm and Laminate Table</b> COM Yardage: 7.25 Freight Class: 250 Product Weight (lbs.): 155 Cubic Feet Per Carton: 55.5</p>	 <p><b>S7891LLT</b></p> <p>No ganging hardware. Armless side(s) can be equipped with ganging brackets, model 7892. Tables are Arms are Right Hand Seated (RT) or Left Hand Seated (LT).</p>	<p><b>S7891RRT</b></p> <p><b>S7891LLT</b></p>	-	-	-	-	4077	4313	4756	5469	6014	6621	7872	9205		
		<p><b>OVERALL DIMENSIONS</b></p> <p>W D H</p>			<p><b>SEAT DIMENSIONS</b></p> <p>W D H</p>			<p><b>BACK DIMENSIONS</b></p> <p>W H</p>			70	33.5	30.75	63.5	19.5	17.5
			<b>RTA 00</b>													
 <p><b>S7897</b></p> <p><b>Armless Three Seater</b> COM Yardage: 7.25 Freight Class: 250 Product Weight (lbs.): 131 Cubic Feet Per Carton: 20.25</p>	<p>No ganging hardware. Armless side(s) can be equipped with ganging brackets, model 7892.</p>	<p><b>S7897</b></p>	-	-	-	-	3424	3660	4104	4816	5361	5968	7219	8552		
		<p><b>OVERALL DIMENSIONS</b></p> <p>W D H</p>			<p><b>SEAT DIMENSIONS</b></p> <p>W D H</p>			<p><b>BACK DIMENSIONS</b></p> <p>W H</p>			64.5	31	30.75	63.5	19.5	17.5
			<b>RTA 00</b>													
 <p><b>S7884</b></p> <p><b>Four Seater w/Arms</b> COM Yardage: 10.25 Freight Class: 250 Product Weight (lbs.): 204 Cubic Feet Per Carton: 69</p>	<p>Free standing unit only.</p>	<p><b>S7884</b></p>	-	-	-	-	5201	5533	6162	7164	7935	8795	10562	12448		
		<p><b>OVERALL DIMENSIONS</b></p> <p>W D H</p>			<p><b>SEAT DIMENSIONS</b></p> <p>W D H</p>			<p><b>BACK DIMENSIONS</b></p> <p>W H</p>			93.5	31	30	84	19.5	17.5
			<b>RTA 00</b>													
 <p><b>S7884R</b></p> <p><b>Four Seater w/One Arm</b> COM Yardage: 9.5 Freight Class: 250 Product Weight (lbs.): 188 Cubic Feet Per Carton: 69</p>	 <p><b>S7884L</b></p> <p>No ganging hardware. Armless side can be equipped with ganging brackets, model 7892. Arms are Right Hand Seated (RT) or Left Hand Seated (LT) .</p>	<p><b>S7884R</b></p> <p><b>S7884L</b></p>	-	-	-	-	5089	5394	5979	6906	7624	8420	10057	11806		
		<p><b>OVERALL DIMENSIONS</b></p> <p>W D H</p>			<p><b>SEAT DIMENSIONS</b></p> <p>W D H</p>			<p><b>BACK DIMENSIONS</b></p> <p>W H</p>			89.5	31	30.75	84	19.5	17.5
			<b>RTA 00</b>													

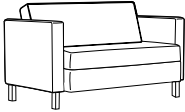
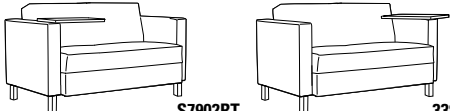
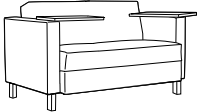
DESCRIPTION	FEATURES	MODEL#	STANDARD TEXTILE GRADES											
			1	2	3	4	5	6	7	8	9	10	11	12
 <p><b>Armless Four Seater</b> COM Yardage: 8.75 Freight Class: 250 Product Weight (lbs.): 172 Cubic Feet Per Carton: 61.5</p>	<p>No ganging hardware. Armless side(s) can be equipped with ganging brackets, model 7892.</p>	<b>S7884NA</b>	-	-	-	-	5089	5370	5909	6767	7424	8158	9666	11277
			<b>OVERALL DIMENSIONS</b>			<b>SEAT DIMENSIONS</b>			<b>BACK DIMENSIONS</b>					
			<b>W</b>	<b>D</b>	<b>H</b>	<b>W</b>	<b>D</b>	<b>H</b>	<b>W</b>	<b>H</b>				
			85.5	31	30.75	84	19.5	17.5	84	12.5				
			<b>RTA 00</b>											
 <p><b>Square Ottoman</b> COM Yardage: 1.5 Freight Class: 250 Product Weight (lbs.): 27 Cubic Feet Per Carton: 7.5</p>	<p>No ganging hardware. Side(s) can be equipped with ganging brackets, model 7892. Does not gang to seating units.</p>	<b>S7879</b>	-	-	-	-	801	852	946	1094	1208	1332	1592	1866
			<b>OVERALL DIMENSIONS</b>			<b>SEAT DIMENSIONS</b>			<b>BACK DIMENSIONS</b>					
			<b>W</b>	<b>D</b>	<b>H</b>	<b>W</b>	<b>D</b>	<b>H</b>	<b>W</b>	<b>H</b>				
			22	22	17	-	-	17	-	-				
			<b>RTA 00</b>											
 <p><b>Two Seater Bench</b> COM Yardage: 2.25 Freight Class: 250 Product Weight (lbs.): 42 Cubic Feet Per Carton: 11.5</p>	<p>No ganging hardware. Side(s) can be equipped with ganging brackets, model 7892. Does not gang to seating units.</p>	<b>S7893</b>	-	-	-	-	1539	1615	1756	1974	2146	2333	2720	3135
			<b>OVERALL DIMENSIONS</b>			<b>SEAT DIMENSIONS</b>			<b>BACK DIMENSIONS</b>					
			<b>W</b>	<b>D</b>	<b>H</b>	<b>W</b>	<b>D</b>	<b>H</b>	<b>W</b>	<b>H</b>				
			43	21.5	17	-	-	17	-	-				
			<b>RTA 00</b>											
 <p><b>Three Seater Bench</b> COM Yardage: 3.75 Freight Class: 250 Product Weight (lbs.): 62 Cubic Feet Per Carton: 16.75</p>	<p>No ganging hardware. Side(s) can be equipped with ganging brackets, model 7892. Does not gang to seating units.</p>	<b>S7894</b>	-	-	-	-	2191	2316	2546	2912	3195	3509	4155	4845
			<b>OVERALL DIMENSIONS</b>			<b>SEAT DIMENSIONS</b>			<b>BACK DIMENSIONS</b>					
			<b>W</b>	<b>D</b>	<b>H</b>	<b>W</b>	<b>D</b>	<b>H</b>	<b>W</b>	<b>H</b>				
			64.5	21.5	17	-	-	17	-	-				
			<b>RTA 00</b>											
 <p><b>Two Seater Bench - Single Cushion</b> COM Yardage: 2.25 Freight Class: 250 Product Weight (lbs.): 42 Cubic Feet Per Carton: 11.5</p>	<p>No ganging hardware. Side(s) can be equipped with ganging brackets, model 7892. Does not gang to seating units.</p>	<b>S7905</b>	-	-	-	-	1210	1286	1427	1645	1813	2004	2391	2806
			<b>OVERALL DIMENSIONS</b>			<b>SEAT DIMENSIONS</b>			<b>BACK DIMENSIONS</b>					
			<b>W</b>	<b>D</b>	<b>H</b>	<b>W</b>	<b>D</b>	<b>H</b>	<b>W</b>	<b>H</b>				
			43	21.5	17	-	-	17	-	-				
			<b>RTA 00</b>											

DESCRIPTION	FEATURES	MODEL#	STANDARD TEXTILE GRADES											
			1	2	3	4	5	6	7	8	9	10	11	12
 <p><b>Two Seater w/Arms - Single Cushion</b>                      COM Yardage: 6.5                      Freight Class: 250                      Product Weight (lbs.): 122                      Cubic Feet Per Carton: 36</p>	Free standing unit only.	<b>S7902</b>	-	-	-	-	2731	2937	3319	3931	4399	4923	6003	7152
			<b>OVERALL DIMENSIONS</b>			<b>SEAT DIMENSIONS</b>			<b>BACK DIMENSIONS</b>					
			<b>W</b>	<b>D</b>	<b>H</b>	<b>W</b>	<b>D</b>	<b>H</b>	<b>W</b>	<b>H</b>				
			51.25	31	30	42.5	19.5	17.5	42.5	12.5				
			<b>RTA 00</b>											
 <p><b>Two Seater w/Arms &amp; Lam. Tablet - Single Cushion</b>                      COM Yardage: 5.25                      Freight Class: 250                      Product Weight (lbs.): 114                      Cubic Feet Per Carton: 36</p>	Free standing unit only. Tablets are Right Hand Seated (RT) or Left Hand Seated (LT).	<b>S7902RT</b> <b>S7902LT</b>	-	-	-	-	3385	2684	2684	4631	2684	5667	6787	7983
			<b>OVERALL DIMENSIONS</b>			<b>SEAT DIMENSIONS</b>			<b>BACK DIMENSIONS</b>					
			<b>W</b>	<b>D</b>	<b>H</b>	<b>W</b>	<b>D</b>	<b>H</b>	<b>W</b>	<b>H</b>				
			48.75	33.5	30.75	42.5	19.5	17.5	42.5	13.25				
			<b>RTA 00</b>											
 <p><b>Two Seater w/Arms &amp; Lam. Tablets - Single Cushion</b>                      COM Yardage: 6.5                      Freight Class: 250                      Product Weight (lbs.): 127                      Cubic Feet Per Carton: 41.25</p>	Free standing unit only. With both Left and Right Tablets.	<b>S7902LRT</b>	-	-	-	-	4040	4250	4652	5286	5777	6322	7442	8638
			<b>OVERALL DIMENSIONS</b>			<b>SEAT DIMENSIONS</b>			<b>BACK DIMENSIONS</b>					
			<b>W</b>	<b>D</b>	<b>H</b>	<b>W</b>	<b>D</b>	<b>H</b>	<b>W</b>	<b>H</b>				
			54.25	33.5	30	42.5	19.5	17.5	42.5	12.5				
			<b>RTA 00</b>											
 <p><b>Two Seater w/One Arm - Single Cushion</b>                      COM Yardage: 5.25                      Freight Class: 250                      Product Weight (lbs.): 114                      Cubic Feet Per Carton: 36</p>	No ganging hardware. Armless side can be equipped with ganging brackets, model 7892. Arms are Right Hand Seated (RT) or Left Hand Seated (LT).	<b>S7902R</b> <b>S7902L</b>	-	-	-	-	2536	2707	3029	3543	3939	4381	5284	6251
			<b>OVERALL DIMENSIONS</b>			<b>SEAT DIMENSIONS</b>			<b>BACK DIMENSIONS</b>					
			<b>W</b>	<b>D</b>	<b>H</b>	<b>W</b>	<b>D</b>	<b>H</b>	<b>W</b>	<b>H</b>				
			47.25	31	30.75	42.5	19.5	17.5	42.5	13.25				
			<b>RTA 00</b>											
 <p><b>Two Seater w/One Arm &amp; Lam. Tablet - Single Cushion</b>                      COM Yardage: 5.25                      Freight Class: 250                      Product Weight (lbs.): 114                      Cubic Feet Per Carton: 36</p>	Free standing unit only. Tablets are Right Hand Seated (RT) or Left Hand Seated (LT).	<b>S7902RRT</b> <b>S7902LLT</b>	-	-	-	-	3189	3360	3682	4196	4592	5033	5937	6903
			<b>OVERALL DIMENSIONS</b>			<b>SEAT DIMENSIONS</b>			<b>BACK DIMENSIONS</b>					
			<b>W</b>	<b>D</b>	<b>H</b>	<b>W</b>	<b>D</b>	<b>H</b>	<b>W</b>	<b>H</b>				
			48.75	33.5	30.75	42.5	19.5	17.5	42.5	13.25				
			<b>RTA 00</b>											

DESCRIPTION FEATURES MODEL# STANDARD TEXTILE GRADES



**Armless Two Seater - Single Cushion**  
 COM Yardage: 6.5  
 Freight Class: 250  
 Product Weight (lbs.): 90  
 Cubic Feet Per Carton: 36

No ganging hardware.  
 Armless side(s) can be equipped with ganging brackets, model 7892.

	1	2	3	4	5	6	7	8	9	10	11	12
<b>S7902NA</b>	-	-	-	-	2536	2684	2962	3401	3740	4119	4894	5720

OVERALL DIMENSIONS			SEAT DIMENSIONS			BACK DIMENSIONS	
W	D	H	W	D	H	W	H
43.25	31	30.75	42.5	19.5	17.5	42.5	13.25

RTA 00

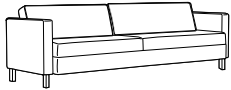

**Four Seater w/Arms - Duo Cushion**  
 COM Yardage: 10.25  
 Freight Class: 250  
 Product Weight (lbs.): 204  
 Cubic Feet Per Carton: 69

Free standing unit only.

	1	2	3	4	5	6	7	8	9	10	11	12
<b>S7904</b>	-	-	-	-	5201	5533	6162	7164	7935	8795	10562	12448

OVERALL DIMENSIONS			SEAT DIMENSIONS			BACK DIMENSIONS	
W	D	H	W	D	H	W	H
93.5	31	30	84	19.5	17.5	84	12.5

RTA 00

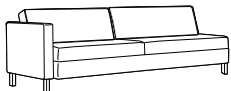

S7904R

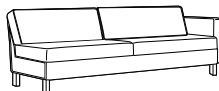

S7904L

**Four Seater w/One Arm - Duo Cushion**  
 COM Yardage: 9.5  
 Freight Class: 250  
 Product Weight (lbs.): 188  
 Cubic Feet Per Carton: 61.5

No ganging hardware.  
 Armless side can be equipped with ganging brackets, model 7892.  
 Arms are Right Hand Seated (RT) or Left Hand Seated (LT).

	1	2	3	4	5	6	7	8	9	10	11	12
<b>S7904R</b>	-	-	-	-	5089	5394	5979	6906	7624	8420	10057	11806
<b>S7904L</b>	-	-	-	-	5089	5394	5979	6906	7624	8420	10057	11806

OVERALL DIMENSIONS			SEAT DIMENSIONS			BACK DIMENSIONS	
W	D	H	W	D	H	W	H
89.5	31	30.75	84	19.5	17.5	84	12.5

RTA 00

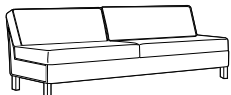

**Armless Four Seater - Single Cushion**  
 COM Yardage: 8.75  
 Freight Class: 250  
 Product Weight (lbs.): 172  
 Cubic Feet Per Carton: 61.5

No ganging hardware.  
 Armless side(s) can be equipped with ganging brackets, model 7892.

	1	2	3	4	5	6	7	8	9	10	11	12
<b>S7904NA</b>	-	-	-	-	5089	5370	5909	6767	7424	8158	9666	11277

OVERALL DIMENSIONS			SEAT DIMENSIONS			BACK DIMENSIONS	
W	D	H	W	D	H	W	H
85.5	31	30.75	84	19.5	17.5	84	12.5

RTA 00

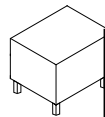

**Cube End Table**  
 COM Yardage: N/A  
 Freight Class: 100  
 Product Weight (lbs.): 51  
 Cubic Feet Per Carton: 5.5

Free standing unit only.  
 No ganging hardware.  
 For Power/USB module please see electrical placement chart.

	1	2	3	4	5	6	7	8	9	10	11	12
<b>S7911</b>	2021	-	-	-	-	-	-	-	-	-	-	-

OVERALL DIMENSIONS			SEAT DIMENSIONS			BACK DIMENSIONS	
W	D	H	W	D	H	W	H
20	24	16	-	-	-	-	-

RTA 00

NOT ON CONTRACT

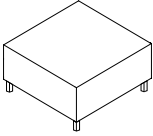
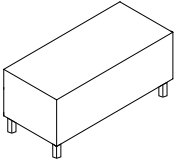
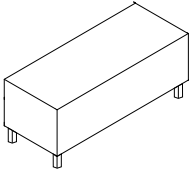
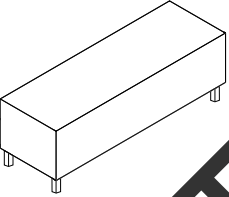
DESCRIPTION	FEATURES	MODEL#	STANDARD TEXTILE GRADES												
			1	2	3	4	5	6	7	8	9	10	11	12	
 <p><b>Cube Square Coffee Table</b> COM Yardage: N/A Freight Class: 100 Product Weight (lbs.): 86 Cubic Feet Per Carton: 10.75</p>	<p>Free standing unit only. No ganging hardware. For Power/USB module please see electrical placement chart.</p>	<b>S7912</b>	2567	-	-	-	-	-	-	-	-	-	-	-	
		<p><b>OVERALL DIMENSIONS</b></p> <p>W D H</p>			<p><b>SEAT DIMENSIONS</b></p> <p>W D H</p>			<p><b>BACK DIMENSIONS</b></p> <p>W H</p>							
		33	33	14	-	-	-	-	-	-	-	-	-	-	-
		<p>RTA 00</p>													
 <p><b>Cube 40" Coffee Table</b> COM Yardage: N/A Freight Class: 100 Product Weight (lbs.): 66 Cubic Feet Per Carton: 8</p>	<p>Free standing unit only. No ganging hardware. For Power/USB module please see electrical placement chart.</p>	<b>S7913</b>	2430	-	-	-	-	-	-	-	-	-	-		
		<p><b>OVERALL DIMENSIONS</b></p> <p>W D H</p>			<p><b>SEAT DIMENSIONS</b></p> <p>W D H</p>			<p><b>BACK DIMENSIONS</b></p> <p>W H</p>							
		40	20	14	-	-	-	-	-	-	-	-	-	-	
		<p>RTA 00</p>													
 <p><b>Cube Extended 60" Coffee Table</b> COM Yardage: N/A Freight Class: 125 Product Weight (lbs.): 93 Cubic Feet Per Carton: 12</p>	<p>Free standing unit only. No ganging hardware. For Power/USB module please see electrical placement chart.</p>	<b>S7915</b>	3174	-	-	-	-	-	-	-	-	-	-		
		<p><b>OVERALL DIMENSIONS</b></p> <p>W D H</p>			<p><b>SEAT DIMENSIONS</b></p> <p>W D H</p>			<p><b>BACK DIMENSIONS</b></p> <p>W H</p>							
		60	20	14	-	-	-	-	-	-	-	-	-	-	
		<p>RTA 00</p>													
 <p><b>Cube Extended 72" Coffee Table</b> COM Yardage: N/A Freight Class: 125 Product Weight (lbs.): 107 Cubic Feet Per Carton: 14.25</p>	<p>Free standing unit only. No ganging hardware. For Power/USB module please see electrical placement chart.</p>	<b>S7916</b>	3248	-	-	-	-	-	-	-	-	-	-		
		<p><b>OVERALL DIMENSIONS</b></p> <p>W D H</p>			<p><b>SEAT DIMENSIONS</b></p> <p>W D H</p>			<p><b>BACK DIMENSIONS</b></p> <p>W H</p>							
		72	20	14	-	-	-	-	-	-	-	-	-	-	
		<p>RTA 00</p>													

NOT ON CONTRACT

DRIFT



Wood Base model 8030  
Side Chair w/4 Leg



Side Chair, Sled Base  
Arm Patches model 8023P



Chrome Base model 8034  
Low Back Lounge Chair



Wood Base model 8037  
Mid Back Lounge Chair



Ottoman model 8026



Wood Base model 8052  
Counter Stool



For Drift tables, see page page 315

EXAMPLE OF TABLE ORDER CODE:

8030P	WA50	WA50	R11	NM	AAM
Model Number	Back/Arm Textile	Seat Textile	Patch Textile	Seat Height	Base Finish

NM	NBS	NSS	NB
Glide Type	Sealed Back Seams	Sealed Seat Seams	Moisture Barrier

5-Star Base Mechanism

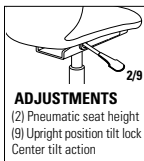

**ADJUSTMENTS**  
(2) Pneumatic seat height  
(9) Upright position tilt lock  
Center tilt action

**Ergonomic features:**  
B, C, S, U



**Flip Forward Seat**  
"F" suffix models





STANDARD FEATURES





- Drift's soft seat and contoured back and arms provide the perfect balance of style and comfort. Side chairs are available in six base types: sled, wood 4-leg, wood 4-prong swivel, chrome 4-prong swivel, high 4-star swivel and 5-star base on casters.
- Lounge chairs are available in four base types: sled, wood 4-leg, wood 4-star swivel and Chrome 4-prong swivel.
- Counter and bar height stools are available with three base types: sled, wood 4-leg, and Chrome 4-star swivel.
- Wood bases are made from Beechwood and are available in all standard wood finishes.
- Wood base seating models are standard with White non-marking polycarbonate glides. See Glide Type for additional glide options.
- Sled bases are standard in painted metal or Chrome finish. See Frame Finish for upcharges.
- Sled base models are standard with clear polycarbonate glides. See Glide Type for additional glide options.
- Chrome swivel bases are available in polished Chrome only. Lounge models with Chrome swivel bases swivel 360deg, available in swivel or self-centering swivel.
- Lounge seating is available with 17" seat height with a classic lounge angle or 18" seat height with a reduced back angle for ease of sitting and standing.
- Side chairs with 5-star base and casters swivel 360 degrees, are height adjustable with 4" range and include a tilting mechanism with upright tilt lock. Base is Polished Aluminum with C114 Carpet or C114R hard floor, dual wheel casters. See upcharges.
- Ottomans have a weighted bottom to maintain upright position. Specify Top and Side textile separately. Glides are White, non-marking.
- For increased durability on side and lounge seating, P and PH suffix models are available with arm and head patches. These high touch areas are covered in Global's Release vinyl. Specify Release color.
- For ease of cleaning, Side and Lounge Chair models with "F" suffix have flip-forward seats. Material under seat matches seat textile selection. (Stools and side chairs with high 4- star and 5-star bases have fixed seat cushions only.)
- Sealed seams are available on chair backs and/ or seats (with upcharge). For sealed seams on Ottoman, specify Ottoman (8026S), available only in sealed seam approved textiles.
- A moisture barrier may be added to seat cushions only (with upcharge). Not available with sealed seams.
- Upholstery options: fabric, vinyl, or leather.
- All Drift seating is assembled using tamper proof screws.
- Drift seating is available to specify with two textiles, one for the seat cushion and one for the back and arms (see model image).
- For pricing, start with the base price and add both back/arms graded textile upcharge and the seat graded textile upcharge.
- The Blended Textile matrix does not apply to this series.
- Drift seating is designed for 300lb capacity.
- Shipped fully assembled.
- See finishes section in Price List for solid wood/ laminate coordination chart.





Add option codes in the following order:





- **Model Number**  
Specify model number.
- **Back/Arm Textile**  
Specify textile code. See model grade upcharges.
- **Seat Textile**  
Specify textile code. See model grade upcharges.
- **Arm and Head Patch Textile** (For P and PH suffix models)  
Release Vinyl only

- **Seat Height** (lounge models only):  
(S17) 17" Seat height  
(S18) 18" Seat height
- **Base Finish** (wood base models)  
(AAM) Absolute (BKM) Black  
(ACM) Cherry (EOM) English Oak  
(ECM) Espresso Cafe (TFM) Fruitwood  
(HGM) Grey (AHM) Honey  
(TMM) Mahogany (AVM) Maple  
(NLW) Natural Walnut (MVM) Medium Walnut  
(ASM) Night (NBM) Noce Biondo  
(NGM) Noce Grigio (NEM) Noce Leggero  
(NMM) Noce Medio (SKM) Shaker Cherry  
(TWM) Walnut (WTM) WC Cream  
(WHM) White (WCM) Winter Cherry
- **Base Finish** (sled base models)  
(TBL) Black (TBZ) Buzz Blue  
(TCC) Cactus (TCR) Carrot  
(TDJ) Dijon (TDW) Designer White  
(TEG) Eggplant (TFO) Fog  
(TFR) Frost (TIN) Ink  
(TIV) Cloud (TKA) Kalua  
(TLA) Latte (TOA) Toast  
(TNE) Nevada (TSH) Shadow  
(TSN) Sand (TSR) Scarlet  
(TTU) Tungsten  
Metallics: Side/Lounge Counter Bar  
(CHM) Chrome. Add \$45 \$89 \$89
- **Base Finish** (5-star base only)  
(A7) Polish Aluminum
- **Cylinder Selection** (Chrome swivel lounge models):  
(DSC) Swivel cylinder  
(DAC) Self-centering cylinder
- **Glide Type** (wood base seating)  
(NM) White, non-marking nylon for most hard floor surfaces (standard)  
(SG) Steel cushioned glides for carpeted surfaces. Add \$36  
(RG) Non-slip, rubber glides for most hard floor surfaces. Add \$36  
(FG) Felt glides for most hard floor surfaces. Add \$36
- **Glide Type** (sled base seating)  
(CG) Clear, polycarbonate glide for most surfaces (standard)  
(XG) No glide for carpeted surfaces  
(FG) Felt glide for most hard surfaces. Add \$36  
(SG) Steel cushioned glide for carpeted surfaces. Add \$36  
(RG) Non-slip rubber glide for most hard surfaces. Add \$36
- **Glide Type** (High, 4-Star base side chairs)  
(NM) White Polyethylene non-marking glide for most surfaces  
(FG) Felt Glide for most hard floor surfaces. Add \$36
- **Caster Type** (5-star base side chairs)  
(DC) 2" Caster for carpeted surfaces  
(RC) 2" Caster for hard floor surfaces. Add \$53
- **Sealed Back Seams** (contact customer care for approved textiles)  
(NBS) No sealed back seam  
(SBS) Sealed back seams. See model for upcharge.
- **Sealed Seat Seams** (contact customer care for approved textiles)  
(NSS) No sealed seat seams  
(SSS) Sealed seat seams. See model for upcharge.
- **Moisture Barrier** (not available with sealed seams)  
(NB) No moisture barrier  
(MB) Moisture barrier (seat only). Add \$107





DESCRIPTION	MODEL#/ FEATURES	STANDARD TEXTILE GRADES												
		1/COM	2	3	4	5	6	7	8	9	10	11	12	
 <p><b>Ottoman</b> COM Yardage: Top: .5; Side: 1.5 Freight Class: 250 Product Weight (lbs.): 31 Cubic Feet Per Carton: 8.5</p>	8026	Base Price:	\$962											
	8026S	Base Price:	\$1162											
		Shell upcharge:	+0	+\$51	+\$91	+\$149	+\$232	+\$266	+\$338	+\$450	+\$534	+\$626	+\$817	+\$1019
		Seat upcharge:	+0	+\$17	+\$31	+\$50	+\$78	+\$89	+\$113	+\$150	+\$179	+\$209	+\$273	+\$340
			OVERALL DIMENSIONS			SEAT DIMENSIONS			BACK DIMENSIONS					
			W	D	H	W	D	H	W	H				
			18.5	18.5	18	-	-	-	-	-				
						RTA 00		1 per carton						
 <p><b>Side Chair, Sled Base</b> COM Yardage: Back/Arms: 1.25; Seat: .75 COM Yardage "F" Model: Back/Arms: 1.25; Seat 1 Freight Class: 250 Product Weight (lbs.): 31 Cubic Feet Per Carton: 13.25</p>	8023	Base Price:	\$1920											
		Back/Arm upcharge:	+0	+\$43	+\$76	+\$125	+\$194	+\$222	+\$282	+\$375	+\$446	+\$522	+\$681	+\$849
		Seat upcharge:	+0	+\$26	+\$46	+\$75	+\$117	+\$133	+\$169	+\$225	+\$267	+\$314	+\$409	+\$510
	8023F	Base Price:	\$2184											
		Back/Arm upcharge:	+0	+\$43	+\$76	+\$125	+\$194	+\$222	+\$282	+\$375	+\$446	+\$522	+\$681	+\$849
		Seat upcharge:	+0	+\$34	+\$61	+\$100	+\$155	+\$178	+\$225	+\$300	+\$356	+\$417	+\$545	+\$679
			OVERALL DIMENSIONS			SEAT DIMENSIONS			BACK DIMENSIONS					
			W	D	H	W	D	H	W	H				
			24.5	23	31	18	17.5	18	15	13				
						RTA 00		1 per carton						
 <p><b>Side Chair, Sled Base, Arm Patches</b> COM Yardage: Back/Arms: 1.25; Seat: .75 COM Yardage "F" Model: Back/Arms: 1.25; Seat 1 Freight Class: 250 Product Weight (lbs.): 31 Cubic Feet Per Carton: 13.25</p>	8023P	Base Price:	\$1946											
		Back/Arm upcharge:	+0	+\$43	+\$76	+\$125	+\$194	+\$222	+\$282	+\$375	+\$446	+\$522	+\$681	+\$849
		Seat upcharge:	+0	+\$26	+\$46	+\$75	+\$117	+\$133	+\$169	+\$225	+\$267	+\$314	+\$409	+\$510
	8023PF	Base Price:	\$2211											
		Back/Arm upcharge:	+0	+\$43	+\$76	+\$125	+\$194	+\$222	+\$282	+\$375	+\$446	+\$522	+\$681	+\$849
		Seat upcharge:	+0	+\$34	+\$61	+\$100	+\$155	+\$178	+\$225	+\$300	+\$356	+\$417	+\$545	+\$679
			OVERALL DIMENSIONS			SEAT DIMENSIONS			BACK DIMENSIONS					
			W	D	H	W	D	H	W	H				
			24.5	23	31	18	17.5	18	15	13				
						RTA 00		1 per carton						
 <p><b>Side Chair, 4 Leg Wood Base</b> COM Yardage: Back/Arms: 1.25; Seat: .75 COM Yardage "F" Model: Back/Arms: 1.25; Seat 1 Freight Class: 300 Product Weight (lbs.): 31 Cubic Feet Per Carton: 15.75</p>	8030	Base Price:	\$1712											
		Back/Arm upcharge:	+0	+\$43	+\$76	+\$125	+\$194	+\$222	+\$282	+\$375	+\$446	+\$522	+\$681	+\$849
		Seat upcharge:	+0	+\$26	+\$46	+\$75	+\$117	+\$133	+\$169	+\$225	+\$267	+\$314	+\$409	+\$510
	8030F	Base Price:	\$1970											
		Back/Arm upcharge:	+0	+\$43	+\$76	+\$125	+\$194	+\$222	+\$282	+\$375	+\$446	+\$522	+\$681	+\$849
		Seat upcharge:	+0	+\$34	+\$61	+\$100	+\$155	+\$178	+\$225	+\$300	+\$356	+\$417	+\$545	+\$679
			OVERALL DIMENSIONS			SEAT DIMENSIONS			BACK DIMENSIONS					
			W	D	H	W	D	H	W	H				
			24.5	23	31	18	17.5	18	15	13				
						RTA 00		1 per carton						





DESCRIPTION	MODEL#/ FEATURES	STANDARD TEXTILE GRADES													
		1/COM	2	3	4	5	6	7	8	9	10	11	12		
 <p><b>Side Chairs, 4 Leg Wood Base, Arm Patches</b>                      COM Yardage: Back/Arms: 1.25; Seat: .75                      COM Yardage "F" Model: Back/Arms: 1.25; Seat 1                      Freight Class: 250                      Product Weight (lbs.): 28                      Cubic Feet Per Carton: 13.25</p>	<b>8030P</b> Base Price: \$1738 Back/Arm upcharge: +0 Seat upcharge: +0														
	<b>8030PF</b> Base Price: \$1997 Back/Arm upcharge: +0 Seat upcharge: +0														
		<b>OVERALL DIMENSIONS</b>			<b>SEAT DIMENSIONS</b>			<b>BACK DIMENSIONS</b>							
		<b>W</b>	<b>D</b>	<b>H</b>	<b>W</b>	<b>D</b>	<b>H</b>	<b>W</b>	<b>H</b>						
		24.5	23	31	18	17.5	18	15	13						
		"F" model = Flip Forward Seat for ease of cleaning													
		Add \$57 for (SBS) Add \$29 for (SSS); \$47 (F model)													
				<b>RTA 00</b>									1 per carton		
	 <p><b>Side Chair, Wood Swivel Base</b>                      COM Yardage: Back/Arms: 1.25; Seat: .75                      COM Yardage "F" Model: Back/Arms: 1.25; Seat 1                      Freight Class: 300                      Product Weight (lbs.): 31                      Cubic Feet Per Carton: 15.75</p>	<b>8031</b> Base Price: \$1987 Back/Arm upcharge: +0 Seat upcharge: +0													
<b>8031F</b> Base Price: \$2246 Back/Arm upcharge: +0 Seat upcharge: +0															
		<b>OVERALL DIMENSIONS</b>			<b>SEAT DIMENSIONS</b>			<b>BACK DIMENSIONS</b>							
		<b>W</b>	<b>D</b>	<b>H</b>	<b>W</b>	<b>D</b>	<b>H</b>	<b>W</b>	<b>H</b>						
		24.5	23	31	18	17.5	18	15	13						
		"F" model = Flip Forward Seat for ease of cleaning													
		Add \$38 for (SBS) Add \$29 for (SSS); \$47 (F model)													
				<b>RTA 00</b>									1 per carton		
 <p><b>Side Chair, Wood Swivel Base, Arm Patches</b>                      COM Yardage: Back/Arms: 1.25; Seat: .75                      COM Yardage "F" Model: Back/Arms: 1.25; Seat 1                      Freight Class: 250                      Product Weight (lbs.): 33                      Cubic Feet Per Carton: 13.25</p>		<b>8031P</b> Base Price: \$2013 Back/Arm upcharge: +0 Seat upcharge: +0													
	<b>8031PF</b> Base Price: \$2272 Back/Arm upcharge: +0 Seat upcharge: +0														
		<b>OVERALL DIMENSIONS</b>			<b>SEAT DIMENSIONS</b>			<b>BACK DIMENSIONS</b>							
		<b>W</b>	<b>D</b>	<b>H</b>	<b>W</b>	<b>D</b>	<b>H</b>	<b>W</b>	<b>H</b>						
		24.5	23	31	18	17.5	18	15	13						
		"F" model = Flip Forward Seat for ease of cleaning													
		Add \$57 for (SBS) Add \$29 for (SSS); \$47 (F model)													
				<b>RTA 00</b>									1 per carton		
	 <p><b>Side Chair, Chrome Swivel Base</b>                      COM Yardage: Back/Arms: 1.25; Seat: .75                      COM Yardage "F" Model: Back/Arms: 1.25; Seat 1                      Freight Class: 300                      Product Weight (lbs.): 31                      Cubic Feet Per Carton: 15.75</p>	<b>8032</b> Base Price: \$2033 Back/Arm upcharge: +0 Seat upcharge: +0													
<b>8032F</b> Base Price: \$2292 Back/Arm upcharge: +0 Seat upcharge: +0															
		<b>OVERALL DIMENSIONS</b>			<b>SEAT DIMENSIONS</b>			<b>BACK DIMENSIONS</b>							
		<b>W</b>	<b>D</b>	<b>H</b>	<b>W</b>	<b>D</b>	<b>H</b>	<b>W</b>	<b>H</b>						
		24.5	23	31	18	17.5	18	15	13						
		"F" model = Flip Forward Seat for ease of cleaning													
		Add \$38 for (SBS) Add \$29 for (SSS); \$47 (F model)													
				<b>RTA 00</b>									1 per carton		

DESCRIPTION	MODEL#/ FEATURES	STANDARD TEXTILE GRADES											
		1/COM	2	3	4	5	6	7	8	9	10	11	12
 <p><b>Side Chair, Chrome Swivel Base, Arm Patches</b> COM Yardage: Back/Arms: 1.25; Seat: .75 COM Yardage "F" Model: Back/Arms: 1.25; Seat: 1 Freight Class: 250 Product Weight (lbs.): 33 Cubic Feet Per Carton: 13.25</p>	<b>8032P</b>	Base Price:	\$2060										
	Back/Arm upcharge:	+0	+\$26	+\$46	+\$75	+\$117	+\$133	+\$169	+\$225	+\$267	+\$314	+\$409	+\$510
	Seat upcharge:	+0	+\$43	+\$76	+\$125	+\$194	+\$222	+\$282	+\$375	+\$446	+\$522	+\$681	+\$849
	<b>8032PF</b>	Base Price:	\$2317										
	Back/Arm upcharge:	+0	+\$43	+\$76	+\$125	+\$194	+\$222	+\$282	+\$375	+\$446	+\$522	+\$681	+\$849
	Seat upcharge:	+0	+\$34	+\$61	+\$100	+\$155	+\$178	+\$225	+\$300	+\$356	+\$417	+\$545	+\$679
	<b>OVERALL DIMENSIONS</b>												
	W D H			24.5	23	31	18	17.5	18		15	13	
	<b>SEAT DIMENSIONS</b>												
	W D H												
<b>BACK DIMENSIONS</b>													
W H													
"F" model = Flip Forward Seat for ease of cleaning													
Add \$57 for (SBS) Add \$29 for (SSS); \$47 (F model)													
 <p><b>Side Chair, High 4 Star Swivel Base</b> COM Yardage: Back/Arms: 1.25; Seat: .75 Freight Class: 300 Product Weight (lbs.): 31 Cubic Feet Per Carton: 15.75</p>	<b>8021</b>	Base Price:	\$1999										
	Back/Arm upcharge:	+0	+\$43	+\$76	+\$125	+\$194	+\$222	+\$282	+\$375	+\$446	+\$522	+\$681	+\$849
	Seat upcharge:	+0	+\$26	+\$46	+\$75	+\$117	+\$133	+\$169	+\$225	+\$267	+\$314	+\$409	+\$510
	<b>OVERALL DIMENSIONS</b>												
	W D H			24.5	23	32	18	17.5	18.5		15	13	
	<b>SEAT DIMENSIONS</b>												
	W D H												
	<b>BACK DIMENSIONS</b>												
	W H												
	Fixed seat cushion only.												
Add \$38 for (SBS) Add \$29 for (SSS)													
 <p><b>Side Chair, High 4 Star Swivel Base, Arm Patches</b> COM Yardage: Back/Arms: 1.25; Seat: .75 Freight Class: 250 Product Weight (lbs.): 35.5 Cubic Feet Per Carton: 13.25</p>	<b>8021P</b>	Base Price:	\$2025										
	Back/Arm upcharge:	+0	+\$43	+\$76	+\$125	+\$194	+\$222	+\$282	+\$375	+\$446	+\$522	+\$681	+\$849
	Seat upcharge:	+0	+\$26	+\$46	+\$75	+\$117	+\$133	+\$169	+\$225	+\$267	+\$314	+\$409	+\$510
	<b>OVERALL DIMENSIONS</b>												
	W D H			24.5	23	32	18	17.5	18.5		15	13	
	<b>SEAT DIMENSIONS</b>												
	W D H												
	<b>BACK DIMENSIONS</b>												
	W H												
	Fixed seat cushion only.												
Add \$57 for (SBS) Add \$29 for (SSS)													
 <p><b>Side Chair, Swivel Tilt, 5 Star Base and Casters</b> COM Yardage: Back/Arms: 1.25; Seat: .75 Freight Class: 300 Product Weight (lbs.): 31 Cubic Feet Per Carton: 15.75</p>	<b>8022</b>	Base Price:	\$2179										
	Back/Arm upcharge:	+0	+\$43	+\$76	+\$125	+\$194	+\$222	+\$282	+\$375	+\$446	+\$522	+\$681	+\$849
	Seat upcharge:	+0	+\$26	+\$46	+\$75	+\$117	+\$133	+\$169	+\$225	+\$267	+\$314	+\$409	+\$510
	<b>OVERALL DIMENSIONS</b>												
	W D H			24.5	23	32.5	18	17.5	15		15	13	
	<b>SEAT DIMENSIONS</b>												
	W D H												
	<b>BACK DIMENSIONS</b>												
	W H												
	Tilting mechanism with tilt lock. Fixed seat cushion only.												
Add \$38 for (SBS) Add \$29 for (SSS)													

DESCRIPTION	MODEL#/ FEATURES	STANDARD TEXTILE GRADES												
		1/COM	2	3	4	5	6	7	8	9	10	11	12	
 <p><b>Side Chair, Swivel Tilt, 5 Star Base, Arm Patches and Casters</b> COM Yardage: Back/Arms: 1.25; Seat: .75 Freight Class: 250 Product Weight (lbs.): 37.5 Cubic Feet Per Carton: 15.75</p>	<b>8022P</b> Base Price: \$2205 Back/Arm upcharge: +0 Seat upcharge: +0													
	Tilting mechanism with tilt lock. Fixed seat cushion only.													
	Add \$57 for (SBS) Add \$29 for (SSS)													
 <p><b>Low Back Lounge Chair, Sled Base</b> COM Yardage: Back/Arms: 2.25; Seat: 1 COM Yardage "F" Model: Back/Arms: 2.25; Seat: 1.25 Freight Class: 250 Product Weight (lbs.): 52 Cubic Feet Per Carton: 19.25</p>	<b>8024</b> Base Price: \$2312 Back/Arm upcharge: +0 Seat upcharge: +0													
	"F" model = Flip Forward Seat for ease of cleaning													
	Add \$80 for (SBS) Add \$34 for (SSS); \$51 (F model)													
 <p><b>Low Back Lounge Chair, Sled Base, Arm Patches</b> COM Yardage: Back/Arms: 2.25; Seat: 1 COM Yardage "F" Model: Back/Arms: 2.25; Seat: 1.25 Freight Class: 250 Product Weight (lbs.): 52 Cubic Feet Per Carton: 19.25</p>	<b>8024P</b> Base Price: \$2338 Back/Arm upcharge: +0 Seat upcharge: +0													
	"F" model = Flip Forward Seat for ease of cleaning													
	Add \$99 for (SBS) Add \$34 for (SSS); \$51 (F model)													
 <p><b>Low Back Lounge Chair, 4 Leg Wood Base</b> COM Yardage: Back/Arms: 2.25; Seat: 1 COM Yardage "F" Model: Back/Arms: 2.75; Seat: 1.25 Freight Class: 250 Product Weight (lbs.): 53.5 Cubic Feet Per Carton: 19</p>	<b>8025</b> Base Price: \$3043 Back/Arm upcharge: +0 Seat upcharge: +0													
	"F" model = Flip Forward Seat for ease of cleaning													
	Add \$80 for (SBS) Add \$34 for (SSS); \$51 (F model)													





DESCRIPTION	MODEL#/ FEATURES	STANDARD TEXTILE GRADES											
		1/COM	2	3	4	5	6	7	8	9	10	11	12
 <p><b>Low Back Lounge Chair, Chrome Swivel Base, Arm Patches</b>                      COM Yardage: Back: 2.25; Seat: 1                      COM Yardage "F" Model: Back/Arms: 2.75; Seat: 1.25                      Freight Class: 250                      Product Weight (lbs.): 59                      Cubic Feet Per Carton: 19.25</p>	<b>8034P</b> Base Price: \$2825 Back/Arm upcharge: +0 Seat upcharge: +0												
	<b>8034PF</b> Base Price: \$3090 Back/Arm upcharge: +0 Seat upcharge: +0												
		<b>OVERALL DIMENSIONS</b> W D H			<b>SEAT DIMENSIONS</b> W D H			<b>BACK DIMENSIONS</b> W H					
	"F" model = Flip Forward Seat for ease of cleaning	29	30	33	21.5	20	17	21	16				
	Add \$99 for (SBS) Add \$34 for (SSS); \$51 (F model)	<b>RTA 00</b>			1 per carton								
 <p><b>Mid Back Lounge Chair, Sled Base</b>                      COM Yardage: Back: 2.5; Seat: 1                      COM Yardage "F" Model: Back/Arms: 3; Seat: 1.25                      Freight Class: 250                      Product Weight (lbs.): 52                      Cubic Feet Per Carton: 25.5</p>	<b>8016</b> Base Price: \$2572 Back/Arm upcharge: +0 Seat upcharge: +0												
	<b>8016F</b> Base Price: \$2836 Back/Arm upcharge: +0 Seat upcharge: +0												
		<b>OVERALL DIMENSIONS</b> W D H			<b>SEAT DIMENSIONS</b> W D H			<b>BACK DIMENSIONS</b> W H					
	"F" model = Flip Forward Seat for ease of cleaning	29	31.5	38.5	21.5	20	17	21	21.5				
	Add \$86 for (SBS) Add \$34 for (SSS); \$51 (F model)	<b>RTA 00</b>			1 per carton								
 <p><b>Mid Back Lounge Chair, Sled Base, Arm Patches</b>                      COM Yardage: Back: 2.5; Seat: 1                      COM Yardage "F" Model: Back/Arms: 3; Seat: 1.25                      Freight Class: 250                      Product Weight (lbs.): 52                      Cubic Feet Per Carton: 25.5</p>	<b>8016P</b> Base Price: \$2598 Back/Arm upcharge: +0 Seat upcharge: +0												
	<b>8016PF</b> Base Price: \$2863 Back/Arm upcharge: +0 Seat upcharge: +0												
		<b>OVERALL DIMENSIONS</b> W D H			<b>SEAT DIMENSIONS</b> W D H			<b>BACK DIMENSIONS</b> W H					
	"F" model = Flip Forward Seat for ease of cleaning	29	31.5	38.5	21.5	20	17	21	21.5				
	Add \$105 for (SBS) Add \$34 for (SSS); \$51 (F model)	<b>RTA 00</b>			1 per carton								
 <p><b>Mid Back Lounge Chair, 4 Leg Wood Base</b>                      COM Yardage: Back: 2.5; Seat: 1                      COM Yardage "F" Model: Back/Arms: 3; Seat: 1.25                      Freight Class: 250                      Product Weight (lbs.): 53.5                      Cubic Feet Per Carton: 25.5</p>	<b>8027</b> Base Price: \$3292 Back/Arm upcharge: +0 Seat upcharge: +0												
	<b>8027F</b> Base Price: \$3557 Back/Arm upcharge: +0 Seat upcharge: +0												
		<b>OVERALL DIMENSIONS</b> W D H			<b>SEAT DIMENSIONS</b> W D H			<b>BACK DIMENSIONS</b> W H					
	"F" model = Flip Forward Seat for ease of cleaning	29	31.5	38.5	21.5	20	17	21	21.5				
	Add \$86 for (SBS) Add \$34 for (SSS); \$51 (F model)	<b>RTA 00</b>			1 per carton								





DESCRIPTION	MODEL#/ FEATURES	STANDARD TEXTILE GRADES												
		1/COM	2	3	4	5	6	7	8	9	10	11	12	
 <p><b>Mid Back Lounge Chair, 4 Leg Wood Base, Arm Patches</b>                      COM Yardage: Back: 2.5; Seat: 1                      COM Yardage "F" Model: Back/Arms: 3; Seat: 1.25                      Freight Class: 250                      Product Weight (lbs.): 53.5                      Cubic Feet Per Carton: 25.5</p>	<b>8027P</b>	Base Price:	\$3318											
		Back/Arm upcharge:	<b>+0</b>	<b>+\$85</b>	<b>+151</b>	<b>+248</b>	<b>+386</b>	<b>+444</b>	<b>+563</b>	<b>+750</b>	<b>+890</b>	<b>+1043</b>	<b>+1361</b>	<b>+1697</b>
		Seat upcharge:	<b>+0</b>	<b>+\$34</b>	<b>+\$61</b>	<b>+\$100</b>	<b>+\$155</b>	<b>+\$178</b>	<b>+\$225</b>	<b>+\$300</b>	<b>+\$356</b>	<b>+\$417</b>	<b>+\$545</b>	<b>+\$679</b>
	<b>8027PF</b>	Base Price:	\$3583											
		Back/Arm upcharge:	<b>+0</b>	<b>+\$102</b>	<b>+181</b>	<b>+298</b>	<b>+463</b>	<b>+532</b>	<b>+675</b>	<b>+899</b>	<b>+1067</b>	<b>+1251</b>	<b>+1634</b>	<b>+2036</b>
		Seat upcharge:	<b>+0</b>	<b>+\$43</b>	<b>+\$76</b>	<b>+\$125</b>	<b>+\$194</b>	<b>+\$222</b>	<b>+\$282</b>	<b>+\$375</b>	<b>+\$446</b>	<b>+\$522</b>	<b>+\$681</b>	<b>+\$849</b>
		<b>OVERALL DIMENSIONS</b>												
		<b>W D H</b>	29	31.5	38.5							21	21.5	
		"F" model = Flip Forward Seat for ease of cleaning												
		Add \$105 for (SBS) Add \$34 for (SSS); \$51 (F model)												
 <p><b>Mid Back Lounge Chair, Wood Swivel Base</b>                      COM Yardage: Back: 2.5; Seat: 1                      COM Yardage "F" Model: Back/Arms: 3; Seat: 1.25                      Freight Class: 250                      Product Weight (lbs.): 54                      Cubic Feet Per Carton: 25.5</p>	<b>8035</b>	Base Price:	\$2896											
		Back/Arm upcharge:	<b>+0</b>	<b>+\$85</b>	<b>+151</b>	<b>+248</b>	<b>+386</b>	<b>+444</b>	<b>+563</b>	<b>+750</b>	<b>+890</b>	<b>+1043</b>	<b>+1361</b>	<b>+1697</b>
		Seat upcharge:	<b>+0</b>	<b>+\$34</b>	<b>+\$61</b>	<b>+\$100</b>	<b>+\$155</b>	<b>+\$178</b>	<b>+\$225</b>	<b>+\$300</b>	<b>+\$356</b>	<b>+\$417</b>	<b>+\$545</b>	<b>+\$679</b>
	<b>8035F</b>	Base Price:	\$3161											
		Back/Arm upcharge:	<b>+0</b>	<b>+\$102</b>	<b>+181</b>	<b>+298</b>	<b>+463</b>	<b>+532</b>	<b>+675</b>	<b>+899</b>	<b>+1067</b>	<b>+1251</b>	<b>+1634</b>	<b>+2036</b>
		Seat upcharge:	<b>+0</b>	<b>+\$43</b>	<b>+\$76</b>	<b>+\$125</b>	<b>+\$194</b>	<b>+\$222</b>	<b>+\$282</b>	<b>+\$375</b>	<b>+\$446</b>	<b>+\$522</b>	<b>+\$681</b>	<b>+\$849</b>
		<b>OVERALL DIMENSIONS</b>												
		<b>W D H</b>	29	31.5	38.5							21	21.5	
		"F" model = Flip Forward Seat for ease of cleaning												
		Add \$86 for (SBS) Add \$34 for (SSS); \$51 (F model)												
 <p><b>Mid Back Lounge Chair, Wood Swivel Base, Arm Patches</b>                      COM Yardage: Back: 2.5; Seat: 1                      COM Yardage "F" Model: Back/Arms: 3; Seat: 1.25                      Freight Class: 250                      Product Weight (lbs.): 54                      Cubic Feet Per Carton: 25.5</p>	<b>8035P</b>	Base Price:	\$2923											
		Back/Arm upcharge:	<b>+0</b>	<b>+\$85</b>	<b>+151</b>	<b>+248</b>	<b>+386</b>	<b>+444</b>	<b>+563</b>	<b>+750</b>	<b>+890</b>	<b>+1043</b>	<b>+1361</b>	<b>+1697</b>
		Seat upcharge:	<b>+0</b>	<b>+\$34</b>	<b>+\$61</b>	<b>+\$100</b>	<b>+\$155</b>	<b>+\$178</b>	<b>+\$225</b>	<b>+\$300</b>	<b>+\$356</b>	<b>+\$417</b>	<b>+\$545</b>	<b>+\$679</b>
	<b>8035PF</b>	Base Price:	\$3188											
		Back/Arm upcharge:	<b>+0</b>	<b>+\$102</b>	<b>+181</b>	<b>+298</b>	<b>+463</b>	<b>+532</b>	<b>+675</b>	<b>+899</b>	<b>+1067</b>	<b>+1251</b>	<b>+1634</b>	<b>+2036</b>
		Seat upcharge:	<b>+0</b>	<b>+\$43</b>	<b>+\$76</b>	<b>+\$125</b>	<b>+\$194</b>	<b>+\$222</b>	<b>+\$282</b>	<b>+\$375</b>	<b>+\$446</b>	<b>+\$522</b>	<b>+\$681</b>	<b>+\$849</b>
		<b>OVERALL DIMENSIONS</b>												
		<b>W D H</b>	29	31.5	38.5							21	21.5	
		"F" model = Flip Forward Seat for ease of cleaning												
		Add \$105 for (SBS) Add \$34 for (SSS); \$51 (F model)												
 <p><b>Mid Back Lounge Chair, Chrome Swivel Base</b>                      COM Yardage: Back: 2.5; Seat: 1                      COM Yardage "F" Model: Back/Arms: 3; Seat: 1.25                      Freight Class: 250                      Product Weight (lbs.): 60                      Cubic Feet Per Carton: 25.5</p>	<b>8036</b>	Base Price:	\$2914											
		Back/Arm upcharge:	<b>+0</b>	<b>+\$85</b>	<b>+151</b>	<b>+248</b>	<b>+386</b>	<b>+444</b>	<b>+563</b>	<b>+750</b>	<b>+890</b>	<b>+1043</b>	<b>+1361</b>	<b>+1697</b>
		Seat upcharge:	<b>+0</b>	<b>+\$34</b>	<b>+\$61</b>	<b>+\$100</b>	<b>+\$155</b>	<b>+\$178</b>	<b>+\$225</b>	<b>+\$300</b>	<b>+\$356</b>	<b>+\$417</b>	<b>+\$545</b>	<b>+\$679</b>
	<b>8036F</b>	Base Price:	\$3179											
		Back/Arm upcharge:	<b>+0</b>	<b>+\$102</b>	<b>+181</b>	<b>+298</b>	<b>+463</b>	<b>+532</b>	<b>+675</b>	<b>+899</b>	<b>+1067</b>	<b>+1251</b>	<b>+1634</b>	<b>+2036</b>
		Seat upcharge:	<b>+0</b>	<b>+\$43</b>	<b>+\$76</b>	<b>+\$125</b>	<b>+\$194</b>	<b>+\$222</b>	<b>+\$282</b>	<b>+\$375</b>	<b>+\$446</b>	<b>+\$522</b>	<b>+\$681</b>	<b>+\$849</b>
		<b>OVERALL DIMENSIONS</b>												
		<b>W D H</b>	29	31.5	38.5							21	21.5	
		"F" model = Flip Forward Seat for ease of cleaning												
		Add \$86 for (SBS) Add \$34 for (SSS); \$51 (F model)												

DESCRIPTION	MODEL#/ FEATURES	STANDARD TEXTILE GRADES												
		1/COM	2	3	4	5	6	7	8	9	10	11	12	
	<b>8036P</b> Base Price:	\$2941												
	Back/Arm upcharge:	+0	+\$85	+\$151	+\$248	+\$386	+\$444	+\$563	+\$750	+\$890	+\$1043	+\$1361	+\$1697	
	Seat upcharge:	+0	+\$34	+\$61	+\$100	+\$155	+\$178	+\$225	+\$300	+\$356	+\$417	+\$545	+\$679	
	<b>8036PF</b> Base Price:	\$3206												
	Back/Arm upcharge:	+0	+\$102	+\$181	+\$298	+\$463	+\$532	+\$675	+\$899	+\$1067	+\$1251	+\$1634	+\$2036	
	Seat upcharge:	+0	+\$43	+\$76	+\$125	+\$194	+\$222	+\$282	+\$375	+\$446	+\$522	+\$681	+\$849	
	<b>OVERALL DIMENSIONS</b>			<b>W</b>	<b>D</b>	<b>H</b>	<b>SEAT DIMENSIONS</b>			<b>W</b>	<b>D</b>	<b>H</b>	<b>BACK DIMENSIONS</b>	
			29		31.5	38.5	21.5	20	17			21	21.5	
	"F" model = Flip Forward Seat for ease of cleaning													
	COM Yardage: Back: 2.5; Seat: 1 COM Yardage "F" Model: Back/Arms: 3; Seat: 1.25 Freight Class: 250 Product Weight (lbs.): 60 Cubic Feet Per Carton: 25.5		Add \$105 for (SBS) Add \$34 for (SSS); \$51 (F model)		<b>RTA 00</b>	1 per carton								







DESCRIPTION	MODEL#/ FEATURES	STANDARD TEXTILE GRADES												
		1/COM	2	3	4	5	6	7	8	9	10	11	12	
	<b>8028</b> Base Price:	\$2931												
	Back/Arm upcharge:	+0	+\$93	+\$166	+\$274	+\$425	+\$488	+\$619	+\$824	+\$978	+\$1147	+\$1498	+\$1867	
	Seat upcharge:	+0	+\$34	+\$61	+\$100	+\$155	+\$178	+\$225	+\$300	+\$356	+\$417	+\$545	+\$679	
	<b>8028F</b> Base Price:	\$3196												
	Back/Arm upcharge:	+0	+\$110	+\$197	+\$323	+\$502	+\$577	+\$732	+\$974	+\$1157	+\$1355	+\$1770	+\$2205	
	Seat upcharge:	+0	+\$43	+\$76	+\$125	+\$194	+\$222	+\$282	+\$375	+\$446	+\$522	+\$681	+\$849	
	<b>OVERALL DIMENSIONS</b>			<b>W</b>	<b>D</b>	<b>H</b>	<b>SEAT DIMENSIONS</b>			<b>W</b>	<b>D</b>	<b>H</b>	<b>BACK DIMENSIONS</b>	
			29		31.5	44.5	21.5	20	17			21	27.5	
	"F" model = Flip Forward Seat for ease of cleaning													
	COM Yardage: Back: 2.75; Seat: 1 COM Yardage "F" Model: Back/Arms: 3.25; Seat: 1.25 Freight Class: 300 Product Weight (lbs.): 56 Cubic Feet Per Carton: 28.25		Add \$89 for (SBS) Add \$34 for (SSS); \$51 (F model)		<b>RTA 00</b>	1 per carton								

DESCRIPTION	MODEL#/ FEATURES	STANDARD TEXTILE GRADES												
		1/COM	2	3	4	5	6	7	8	9	10	11	12	
	<b>8028P</b> Base Price:	\$2985												
	Back/Arm upcharge:	+0	+\$93	+\$166	+\$274	+\$425	+\$488	+\$619	+\$824	+\$978	+\$1147	+\$1498	+\$1867	
	Seat upcharge:	+0	+\$34	+\$61	+\$100	+\$155	+\$178	+\$225	+\$300	+\$356	+\$417	+\$545	+\$679	
	<b>8028PF</b> Base Price:	\$3250												
	Back/Arm upcharge:	+0	+\$110	+\$197	+\$323	+\$502	+\$577	+\$732	+\$974	+\$1157	+\$1355	+\$1770	+\$2205	
	Seat upcharge:	+0	+\$43	+\$76	+\$125	+\$194	+\$222	+\$282	+\$375	+\$446	+\$522	+\$681	+\$849	
	<b>OVERALL DIMENSIONS</b>			<b>W</b>	<b>D</b>	<b>H</b>	<b>SEAT DIMENSIONS</b>			<b>W</b>	<b>D</b>	<b>H</b>	<b>BACK DIMENSIONS</b>	
			29		31.5	44.5	21.5	20	17			21	27.5	
	"F" model = Flip Forward Seat for ease of cleaning													
	COM Yardage: Back: 2.75; Seat: 1 COM Yardage "F" Model: Back/Arms: 3.25; Seat: 1.25 Freight Class: 300 Product Weight (lbs.): 56 Cubic Feet Per Carton: 28.25		Add \$108 for (SBS) Add \$34 for (SSS); \$51 (F model)		<b>RTA 00</b>	1 per carton								

DESCRIPTION	MODEL#/ FEATURES	STANDARD TEXTILE GRADES												
		1/COM	2	3	4	5	6	7	8	9	10	11	12	
	<b>8028PH</b> Base Price:	\$3038												
	Back/Arm upcharge:	+0	+\$93	+\$166	+\$274	+\$425	+\$488	+\$619	+\$824	+\$978	+\$1147	+\$1498	+\$1867	
	Seat upcharge:	+0	+\$34	+\$61	+\$100	+\$155	+\$178	+\$225	+\$300	+\$356	+\$417	+\$545	+\$679	
	<b>8028PHF</b> Base Price:	\$3303												
	Back/Arm upcharge:	+0	+\$110	+\$197	+\$323	+\$502	+\$577	+\$732	+\$974	+\$1157	+\$1355	+\$1770	+\$2205	
	Seat upcharge:	+0	+\$43	+\$76	+\$125	+\$194	+\$222	+\$282	+\$375	+\$446	+\$522	+\$681	+\$849	
	<b>OVERALL DIMENSIONS</b>			<b>W</b>	<b>D</b>	<b>H</b>	<b>SEAT DIMENSIONS</b>			<b>W</b>	<b>D</b>	<b>H</b>	<b>BACK DIMENSIONS</b>	
			29		31.5	44.5	21.5	20	17			21	27.5	
	"F" model = Flip Forward Seat for ease of cleaning													
	COM Yardage: Back: 2.75; Seat: 1 COM Yardage "F" Model: Back/Arms: 3.25; Seat: 1.25 Freight Class: 300 Product Weight (lbs.): 56 Cubic Feet Per Carton: 28.25		Add \$130 for (SBS) Add \$34 for (SSS); \$51 (F model)		<b>RTA 00</b>	1 per carton								

DESCRIPTION	MODEL#/ FEATURES	STANDARD TEXTILE GRADES											
		1/COM	2	3	4	5	6	7	8	9	10	11	12
	<b>8029</b> Base Price:	\$3669											
	Back/Arm upcharge:	<b>+0</b>	<b>+\$93</b>	<b>+166</b>	<b>+274</b>	<b>+425</b>	<b>+488</b>	<b>+619</b>	<b>+824</b>	<b>+978</b>	<b>+1147</b>	<b>+1498</b>	<b>+1867</b>
	Seat upcharge:	<b>+0</b>	<b>+\$34</b>	<b>+\$61</b>	<b>+\$100</b>	<b>+\$155</b>	<b>+\$178</b>	<b>+\$225</b>	<b>+\$300</b>	<b>+\$356</b>	<b>+\$417</b>	<b>+\$545</b>	<b>+\$679</b>
	<b>8029F</b> Base Price:	\$3934											
	Back/Arm upcharge:	<b>+0</b>	<b>+\$110</b>	<b>+197</b>	<b>+323</b>	<b>+502</b>	<b>+577</b>	<b>+732</b>	<b>+974</b>	<b>+1157</b>	<b>+1355</b>	<b>+1770</b>	<b>+2205</b>
	Seat upcharge:	<b>+0</b>	<b>+\$43</b>	<b>+\$76</b>	<b>+\$125</b>	<b>+\$194</b>	<b>+\$222</b>	<b>+\$282</b>	<b>+\$375</b>	<b>+\$446</b>	<b>+\$522</b>	<b>+\$681</b>	<b>+\$849</b>
	<b>OVERALL DIMENSIONS</b>		<b>SEAT DIMENSIONS</b>			<b>BACK DIMENSIONS</b>							
	W D H		W D H			W H							
	29 31.5 44.5		21.5 20 17			21 27.5							
	<p>"F" model = Flip Forward Seat for ease of cleaning</p> <p>Add \$89 for (SBS) Add \$34 for (SSS); \$51 (F model)</p>		<b>RTA 00</b>			1 per carton							
	<b>8029P</b> Base Price:	\$3721											
	Back/Arm upcharge:	<b>+0</b>	<b>+\$93</b>	<b>+166</b>	<b>+274</b>	<b>+425</b>	<b>+488</b>	<b>+619</b>	<b>+824</b>	<b>+978</b>	<b>+1147</b>	<b>+1498</b>	<b>+1867</b>
	Seat upcharge:	<b>+0</b>	<b>+\$34</b>	<b>+\$61</b>	<b>+\$100</b>	<b>+\$155</b>	<b>+\$178</b>	<b>+\$225</b>	<b>+\$300</b>	<b>+\$356</b>	<b>+\$417</b>	<b>+\$545</b>	<b>+\$679</b>
	<b>8029PF</b> Base Price:	\$3986											
	Back/Arm upcharge:	<b>+0</b>	<b>+\$110</b>	<b>+197</b>	<b>+323</b>	<b>+502</b>	<b>+577</b>	<b>+732</b>	<b>+974</b>	<b>+1157</b>	<b>+1355</b>	<b>+1770</b>	<b>+2205</b>
	Seat upcharge:	<b>+0</b>	<b>+\$43</b>	<b>+\$76</b>	<b>+\$125</b>	<b>+\$194</b>	<b>+\$222</b>	<b>+\$282</b>	<b>+\$375</b>	<b>+\$446</b>	<b>+\$522</b>	<b>+\$681</b>	<b>+\$849</b>
	<b>OVERALL DIMENSIONS</b>		<b>SEAT DIMENSIONS</b>			<b>BACK DIMENSIONS</b>							
	W D H		W D H			W H							
	29 31.5 44.5		21.5 20 17			21 27.5							
	<p>"F" model = Flip Forward Seat for ease of cleaning</p> <p>Add \$108 for (SBS) Add \$34 for (SSS); \$51 (F model)</p>		<b>RTA 00</b>			1 per carton							
	<b>8029PH</b> Base Price:	\$3774											
	Back/Arm upcharge:	<b>+0</b>	<b>+\$93</b>	<b>+166</b>	<b>+274</b>	<b>+425</b>	<b>+488</b>	<b>+619</b>	<b>+824</b>	<b>+978</b>	<b>+1147</b>	<b>+1498</b>	<b>+1867</b>
	Seat upcharge:	<b>+0</b>	<b>+\$34</b>	<b>+\$61</b>	<b>+\$100</b>	<b>+\$155</b>	<b>+\$178</b>	<b>+\$225</b>	<b>+\$300</b>	<b>+\$356</b>	<b>+\$417</b>	<b>+\$545</b>	<b>+\$679</b>
	<b>8029PHF</b> Base Price:	\$4039											
	Back/Arm upcharge:	<b>+0</b>	<b>+\$110</b>	<b>+197</b>	<b>+323</b>	<b>+502</b>	<b>+577</b>	<b>+732</b>	<b>+974</b>	<b>+1157</b>	<b>+1355</b>	<b>+1770</b>	<b>+2205</b>
	Seat upcharge:	<b>+0</b>	<b>+\$43</b>	<b>+\$76</b>	<b>+\$125</b>	<b>+\$194</b>	<b>+\$222</b>	<b>+\$282</b>	<b>+\$375</b>	<b>+\$446</b>	<b>+\$522</b>	<b>+\$681</b>	<b>+\$849</b>
	<b>OVERALL DIMENSIONS</b>		<b>SEAT DIMENSIONS</b>			<b>BACK DIMENSIONS</b>							
	W D H		W D H			W H							
	29 31.5 44.5		21.5 20 17			21 27.5							
	<p>"F" model = Flip Forward Seat for ease of cleaning</p> <p>Add \$130 for (SBS) Add \$34 for (SSS); \$51 (F model)</p>		<b>RTA 00</b>			1 per carton							
	<b>8037</b> Base Price:	\$3165											
	Back/Arm upcharge:	<b>+0</b>	<b>+\$93</b>	<b>+166</b>	<b>+274</b>	<b>+425</b>	<b>+488</b>	<b>+619</b>	<b>+824</b>	<b>+978</b>	<b>+1147</b>	<b>+1498</b>	<b>+1867</b>
	Seat upcharge:	<b>+0</b>	<b>+\$34</b>	<b>+\$61</b>	<b>+\$100</b>	<b>+\$155</b>	<b>+\$178</b>	<b>+\$225</b>	<b>+\$300</b>	<b>+\$356</b>	<b>+\$417</b>	<b>+\$545</b>	<b>+\$679</b>
	<b>8037F</b> Base Price:	\$3430											
	Back/Arm upcharge:	<b>+0</b>	<b>+\$110</b>	<b>+197</b>	<b>+323</b>	<b>+502</b>	<b>+577</b>	<b>+732</b>	<b>+974</b>	<b>+1157</b>	<b>+1355</b>	<b>+1770</b>	<b>+2205</b>
	Seat upcharge:	<b>+0</b>	<b>+\$43</b>	<b>+\$76</b>	<b>+\$125</b>	<b>+\$194</b>	<b>+\$222</b>	<b>+\$282</b>	<b>+\$375</b>	<b>+\$446</b>	<b>+\$522</b>	<b>+\$681</b>	<b>+\$849</b>
	<b>OVERALL DIMENSIONS</b>		<b>SEAT DIMENSIONS</b>			<b>BACK DIMENSIONS</b>							
	W D H		W D H			W H							
	29 31.5 44.5		21.5 20 17			21 27.5							
	<p>"F" model = Flip Forward Seat for ease of cleaning</p> <p>Add \$89 for (SBS) Add \$34 for (SSS); \$51 (F model)</p>		<b>RTA 00</b>			1 per carton							



DESCRIPTION	MODEL#/ FEATURES	STANDARD TEXTILE GRADES												
		1/COM	2	3	4	5	6	7	8	9	10	11	12	
 <p><b>High Back Lounge Chair, Chrome Swivel Base, Arm and Head Patches</b>                      COM Yardage: Back: 2.75; Seat: 1                      COM Yardage "F" Model: Back/Arms: 3.25; Seat: 1.25                      Freight Class: 250                      Product Weight (lbs.): 63                      Cubic Feet Per Carton: 28.25</p>	<b>8038PH</b>	Base Price:	\$3290											
	Back/Arm upcharge:	+0	+\$93	+\$166	+\$274	+\$425	+\$488	+\$619	+\$824	+\$978	+\$1147	+\$1498	+\$1867	
	Seat upcharge:	+0	+\$34	+\$61	+\$100	+\$155	+\$178	+\$225	+\$300	+\$356	+\$417	+\$545	+\$679	
	<b>8038PHF</b>	Base Price:	\$3555											
	Back/Arm upcharge:	+0	+\$110	+\$197	+\$323	+\$502	+\$577	+\$732	+\$974	+\$1157	+\$1355	+\$1770	+\$2205	
	Seat upcharge:	+0	+\$43	+\$76	+\$125	+\$194	+\$222	+\$282	+\$375	+\$446	+\$522	+\$681	+\$849	
	<b>OVERALL DIMENSIONS</b>			<b>SEAT DIMENSIONS</b>			<b>BACK DIMENSIONS</b>							
	W D H			W D H			W H							
	29 31.5 44.5			21.5 20 17			21 27.5							
	"F" model = Flip Forward Seat for ease of cleaning  Add \$130 for (SBS) Add \$34 for (SSS); \$51 (F model)			<b>RTA 00</b>			1 per carton							
 <p><b>Counter Stool, Sled Base</b>                      COM Yardage: Back: 1; Seat: 1                      Freight Class: 250                      Product Weight (lbs.): 32                      Cubic Feet Per Carton: 9</p>	<b>8051</b>	Base Price:	\$1339											
	Back/Arm upcharge:	+0	+\$34	+\$61	+\$100	+\$155	+\$178	+\$225	+\$300	+\$356	+\$417	+\$545	+\$679	
	Seat upcharge:	+0	+\$17	+\$31	+\$50	+\$78	+\$89	+\$113	+\$150	+\$179	+\$209	+\$273	+\$340	
	<b>OVERALL DIMENSIONS</b>			<b>SEAT DIMENSIONS</b>			<b>BACK DIMENSIONS</b>							
	W D H			W D H			W H							
	19.25 19 35			15.5 15.75 24.75			12.5 10							
	Add \$34 for (SBS) Add \$22 for (SSS)			<b>RTA 00</b>			1 per carton							
	 <p><b>Counter Stool, Wood Base</b>                      COM Yardage: Back: 1; Seat: 1                      Freight Class: 250                      Product Weight (lbs.): 28</p>	<b>8052</b>	Base Price:	\$2098										
		Back/Arm upcharge:	+0	+\$34	+\$61	+\$100	+\$155	+\$178	+\$225	+\$300	+\$356	+\$417	+\$545	+\$679
		Seat upcharge:	+0	+\$17	+\$31	+\$50	+\$78	+\$89	+\$113	+\$150	+\$179	+\$209	+\$273	+\$340
<b>OVERALL DIMENSIONS</b>			<b>SEAT DIMENSIONS</b>			<b>BACK DIMENSIONS</b>								
W D H			W D H			W H								
19.25 19 35			15.5 15.75 24.75			12.5 10								
Add \$34 for (SBS) Add \$22 for (SSS)			<b>RTA 00</b>			FedEx   1 per carton								
 <p><b>Counter Stool, Chrome Swivel Base</b>                      COM Yardage: Back: 1; Seat: 1                      Freight Class: 250                      Product Weight (lbs.): 43                      Cubic Feet Per Carton: 11.5</p>		<b>8053</b>	Base Price:	\$2553										
		Back/Arm upcharge:	+0	+\$34	+\$61	+\$100	+\$155	+\$178	+\$225	+\$300	+\$356	+\$417	+\$545	+\$679
		Seat upcharge:	+0	+\$17	+\$31	+\$50	+\$78	+\$89	+\$113	+\$150	+\$179	+\$209	+\$273	+\$340
	<b>OVERALL DIMENSIONS</b>			<b>SEAT DIMENSIONS</b>			<b>BACK DIMENSIONS</b>							
	W D H			W D H			W H							
	19.25 20 34.5			15.5 15.75 24.75			12.5 10							
	Add \$34 for (SBS) Add \$22 for (SSS)			<b>RTA 00</b>			1 per carton							
	 <p><b>Bar Stool, Sled Base</b>                      COM Yardage: Back: 1; Seat: 1                      Freight Class: 250                      Product Weight (lbs.): 34.5                      Cubic Feet Per Carton: 11</p>	<b>8054</b>	Base Price:	\$1442										
		Back/Arm upcharge:	+0	+\$34	+\$61	+\$100	+\$155	+\$178	+\$225	+\$300	+\$356	+\$417	+\$545	+\$679
		Seat upcharge:	+0	+\$17	+\$31	+\$50	+\$78	+\$89	+\$113	+\$150	+\$179	+\$209	+\$273	+\$340
<b>OVERALL DIMENSIONS</b>			<b>SEAT DIMENSIONS</b>			<b>BACK DIMENSIONS</b>								
W D H			W D H			W H								
19.25 20 40.25			15.5 15.75 30.25			12.5 10								
Add \$34 for (SBS) Add \$22 for (SSS)			<b>RTA 00</b>			1 per carton								

DESCRIPTION	MODEL#/ FEATURES	STANDARD TEXTILE GRADES														
		1/COM	2	3	4	5	6	7	8	9	10	11	12			
 <p><b>Bar Stool, Wood Base</b> COM Yardage: Back: 1; Seat: .5 Freight Class: 250 Product Weight (lbs.): 30 Cubic Feet Per Carton: 11</p>	8055	Base Price:	\$2199													
		Back/Arm upcharge:	+0	+\$34	+\$61	+\$100	+\$155	+\$178	+\$225	+\$300	+\$356	+\$417	+\$545	+\$679		
		Seat upcharge:	+0	+\$17	+\$31	+\$50	+\$78	+\$89	+\$113	+\$150	+\$179	+\$209	+\$273	+\$340		
		<b>OVERALL DIMENSIONS</b>	<b>W D H</b>			<b>SEAT DIMENSIONS</b>			<b>W D H</b>			<b>BACK DIMENSIONS</b>			<b>W H</b>	
			19.25	20	40	15.5	15.75	30	12.5	10						
		Add \$34 for (SBS) Add \$22 for (SSS)			<b>RTA 00</b>	<b>FedEx</b>	1 per carton									

 <p><b>Bar Stool, Chrome Swivel Base</b> COM Yardage: Back: 1; Seat: .5 Freight Class: 250 Product Weight (lbs.): 45.5 Cubic Feet Per Carton: 13.25</p>	8056	Base Price:	\$2653													
		Back/Arm upcharge:	+0	+\$34	+\$61	+\$100	+\$155	+\$178	+\$225	+\$300	+\$356	+\$417	+\$545	+\$679		
		Seat upcharge:	+0	+\$17	+\$31	+\$50	+\$78	+\$89	+\$113	+\$150	+\$179	+\$209	+\$273	+\$340		
		<b>OVERALL DIMENSIONS</b>	<b>W D H</b>			<b>SEAT DIMENSIONS</b>			<b>W D H</b>			<b>BACK DIMENSIONS</b>			<b>W H</b>	
			19.25	20	40	15.5	15.75	30	12.5	10						
		Add \$34 for (SBS) Add \$22 for (SSS)			<b>RTA 00</b>		1 per carton									

DRIFT TABLES



model 8041R2616C  
26"W x 16"H Round Table,  
Laminate Surface, Flat Edge,  
Chrome Base



model 8042SQ2816I  
28"W x 16"H Square Table,  
Laminate Surface, Flat Edge,  
Sled Base



Model 8042SQ2816W  
28"W x 16"H Square Table,  
Laminate Surface, Flat Edge  
Wood Base



For Drift seating, see page 302

EXAMPLE OF TABLE ORDER CODE:

8041R2616I	TFL	ACJ	TPL	CG
Model Number	Surface Type	Top HPL Finish	Base Finish (Sled Base)	Glide Type (Sled Base)

STANDARD FEATURES

- Tables are available in three shapes, multiple sizes, two edge styles, three top materials and three base types including: sled, wood and polished Chrome bases.
- Table bases are fixed and do not swivel.
- Wood bases are made from beechwood and are available in all standard wood finishes.
- Sled bases are standard in painted metal.
- Chrome base tables are available in polished Chrome only.
- All table tops are available with flat edge. High pressure laminate (HPL) and solid surface top tables are also available with knife edge.
- Laminate flat edge tops are available in either (TFL) 1" thick thermally fused laminate with 2mm edgeband or (HPL) 1-1/16" thick high pressure laminate with 2mm edgeband, with upcharge.
- Laminate knife edge tops are 1-3/16" thick with 2.5mm edgeband, available in high pressure laminate (HPL) only.
- Solid surface tabletops are 1.25" thick, available in models with flat or knife edge. For detailed material information, please reference WilsonArt's Solid Surface collection.
- Wood and Chrome bases are equipped with white non-marking polycarbonate glides suitable for most hard and carpeted floor surfaces.
- Sled bases are available with clear polycarbonate glides, standard.
- Wood and sled bases may be specified with a variety of optional glide types to suit various flooring materials. (See Glide Types for additional glide options and upcharges.)
- Tables are shipped fully assembled.

Add option codes in the following order:

- **Model Number**  
Specify model number
- **Surface Type** (Laminate, Flat Edge Tables)  
(TFL) Thermally fused laminate  
(HPL) High pressure laminate
- **Top Finish** (TFL or HPL laminate, flat edge tables and HPL laminate knife edge tables only). HPL upcharges apply -see model:  
(ACJ) Absolute Acajou (ASN) Asian Night  
(AWC) Avart Cherry (AWH) Avart Honey  
(BLK) Black (BRC) Brushed Cobalt  
(BZD) Blizzard (CGY) Custom Grey  
(CMB) Clear Maple (DES) Dark Espresso  
(DWT) Designer White (FAS) Fashionista  
(FCL) First Class (NBL) Noce Biondo  
(NGL) Noce Grigio (NEL) Noce Leggero  
(NML) Noce Medio  
(OTM) Quartered Mahogany  
(SBX) Sheer Beauty (SDT) Stonedust  
(SOG) Storm Grey (WHE) Walnut Heights  
(WHC) White Chocolate (WCR) Winter Cherry
- **Top Finish** (solid surface, flat and knife edge tables)  
Grade 1:  
(SWH) Designer White  
Grade 2, Upcharge applicable, see models.  
(SBT) Beige Tempest  
(SBX) Black Onyx Mirage  
(SMG) Milk Glass Spectra  
(SFW) Frosty White Mirage  
(SHS) Hot Stone  
(SNM) Northern Melange
- **Base finish** (sled base models only)  
Paint finishes:  
(TBL) Black (TTU) Tungsten  
(TSH) Shadow (TDW) Designer White  
(TNE) Nevada (TLA) Latte  
(TKA) Kalua (TMO) Mocha  
(TOA) Toast (TFO) Fog  
(TIV) Cloud (TSN) Sand  
(TFR) Frost (TDJ) Dijon  
(TCR) Carrot (TSR) Scarlet  
(TCC) Cactus (TBZ) Buzz Blue  
(TEG) Eggplant (TIN) Ink  
Metallic finish:  
(CHM) Chrome. Add \$45
- **Base Finish** (Chrome base only)  
(CHM) Chrome
- **Base finish** (wood base models only)  
(AAM) Absolute (BKM) Black  
(ACM) Cherry (EOM) English Oak  
(ECM) Espresso Cafe (TFM) Fruitwood  
(HGM) Gray (AHM) Honey  
(TMM) Mahogany (AVM) Maple  
(MWM) Medium Walnut (NLW) Natural Walnut  
(ASM) Night (NBM) Noce Biondo  
(NGM) Noce Grigio (NEM) Noce Leggero  
(NMM) Noce Medio (SKM) Shaker Cherry  
(TWM) Walnut (WTM) WC Cream  
(WHM) White (WCM) Winter Cherry
- **Glide Type** (sled base)  
(CG) Clear, polycarbonate glide for most floor surfaces (standard)  
(XG) No glide for carpeted surfaces, no charge  
(SG) Steel cushioned glide for carpeted surface. Add \$36  
(RG) Rubber, non-slip glide for most hard floor surfaces. Add \$36  
(FG) Felt glide for most hard floor surfaces. Add \$36
- **Glide Type** (wood base)  
(NM) White non-marking nylon glide for most surfaces (standard)  
(SG) Steel cushioned glides for carpeted surfaces. Add \$36.  
(RG) Non-slip rubber glides for most hard floor surfaces. Add \$36.  
(FG) Felt glides for most hard floor surfaces. Add \$36.

ROUND LAPTOP TABLES FOR OFFSET BASE



Round Table with Sled Base

MODEL# DIMENSIONS FREIGHT CLASS WT/LBS. CUBIC FT. LIST PRICE HP ADD GR. 2 ADD

D x W x H

Laminate, flat edge (TFL laminate)

8041R2616I	26 x 26 x 16	250	35	10.25	\$592	\$104	n/a
8041R3016I	30 x 30 x 16	250	44	13	\$624	\$122	n/a
8041R2120I	21 x 21 x 20	250	29	8.75	\$620	\$103	n/a

Laminate, knife edge (HPL laminate)

8041R2616IK	26 x 26 x 16	250	35	10.25	\$1265	n/a	n/a
8041R3016IK	30 x 30 x 16	250	44	13	\$1355	n/a	n/a
8041R2120IK	21 x 21 x 20	250	29	8.75	\$1051	n/a	n/a

Solid surface, flat edge

8041R2616ISF	26 x 26 x 16	150	48	10.25	\$2472	n/a	\$167
8041R3016ISF	30 x 30 x 16	150	61	13	\$2661	n/a	\$230
8041R2120ISF	21 x 21 x 20	150	37.5	8.75	\$2326	n/a	\$115

Solid surface, knife edge

8041R2616ISK	26 x 26 x 16	150	48	10.25	\$2529	n/a	\$179
8041R3016ISK	30 x 30 x 16	150	61	13	\$2747	n/a	\$247
8041R2120ISK	21 x 21 x 20	150	37.5	8.75	\$2429	n/a	\$122

Finished height will vary depending on material top. Shipped fully assembled in 1 carton.



Square Table with Sled Base

Laminate, flat edge (TFL laminate)

8042SQ2216I	22 x 22 x 16	150	34	8	\$592	\$104	n/a
8042SQ2816I	28 x 28 x 16	250	44	11.75	\$624	\$122	n/a
8042SQ1920I	19 x 19 x 20	250	29	7.75	\$600	\$93	n/a

Laminate, knife edge (HPL laminate)

8042SQ2216IK	22 x 22 x 16	150	34	8	\$1051	n/a	n/a
8042SQ2816IK	28 x 28 x 16	250	44	11.75	\$1317	n/a	n/a
8042SQ1920IK	19 x 19 x 20	250	29	7.75	\$1008	n/a	n/a

Solid surface, flat edge

8042SQ2216ISF	22 x 22 x 16	150	39.5	8	\$2179	n/a	\$144
8042SQ2816ISF	28 x 28 x 16	150	62.5	11.75	\$2496	n/a	\$230
8042SQ1920ISF	19 x 19 x 20	150	38	7.75	\$2085	n/a	\$174

Solid surface, knife edge

8042SQ2216ISK	22 x 22 x 16	150	39.5	8	\$2529	n/a	\$174
8042SQ2816ISK	28 x 28 x 16	150	62.5	11.75	\$2975	n/a	\$259
8042SQ1920ISK	19 x 19 x 20	150	38	7.75	\$2429	n/a	\$127

Finished height will vary depending on material top. Shipped fully assembled in 1 carton.

**ROUND LAPTOP TABLES FOR OFFSET BASE**



Oval Table with Sled Base

MODEL#	DIMENSIONS	FREIGHT CLASS	WT/LBS.	CUBIC FT.	LIST PRICE	HP ADD	GR. 2 ADD
<b>D x W x H</b>							
<b>Laminate, flat edge (TFL laminate)</b>							
80430V2616I	26 x 22 x 16	150	36.5	8.75	<b>\$592</b>	<b>\$104</b>	n/a
80430V3116I	31 x 26 x 16	250	46	11.75	<b>\$624</b>	<b>\$122</b>	n/a
80430V2220I	22 x 18 x 20	250	34	10.75	<b>\$620</b>	<b>\$103</b>	n/a
<b>Laminate, knife edge (HPL laminate)</b>							
80430V2616IK	26 x 22 x 16	150	36.5	8.75	<b>\$1265</b>	n/a	n/a
80430V3116IK	31 x 26 x 16	250	46	11.75	<b>\$1441</b>	n/a	n/a
80430V2220IK	22 x 18 x 20	250	34	10.75	<b>\$1175</b>	n/a	n/a
<b>Solid surface, flat edge</b>							
80430V2616ISF	26 x 22 x 16	150	42	8.75	<b>\$2472</b>	n/a	<b>\$167</b>
80430V3116ISF	31 x 26 x 16	150	60	11.75	<b>\$2661</b>	n/a	<b>\$230</b>
80430V2220ISF	22 x 18 x 20	250	38	10.75	<b>\$2325</b>	n/a	<b>\$115</b>
<b>Solid surface, knife edge</b>							
80430V2616ISK	26 x 22 x 16	150	42	8.75	<b>\$2529</b>	n/a	<b>\$179</b>
80430V3116ISK	31 x 26 x 16	150	60	11.75	<b>\$2747</b>	n/a	<b>\$247</b>
80430V2220ISK	22 x 18 x 20	250	38	10.75	<b>\$2429</b>	n/a	<b>\$122</b>

Finished height will vary depending on material top. Shipped fully assembled in 1 carton.



Round Table with Polished Chrome Base

<b>Laminate, flat edge (TFL laminate)</b>							
8041R2616C	26 x 26 x 16	250	38	10.75	<b>\$1117</b>	<b>\$104</b>	n/a
8041R3016C	30 x 30 x 16	250	45	13	<b>\$1148</b>	<b>\$122</b>	n/a
<b>Laminate, knife edge (HPL laminate)</b>							
8041R2616CK	26 x 26 x 16	250	38	10.75	<b>\$1790</b>	n/a	n/a
8041R3016CK	30 x 30 x 16	250	45	13	<b>\$1881</b>	n/a	n/a
<b>Solid surface, flat edge</b>							
8041R2616CSF	26 x 26 x 16	150	51	10.75	<b>\$2997</b>	n/a	<b>\$167</b>
8041R3016CSF	30 x 30 x 16	150	62.5	13	<b>\$3186</b>	n/a	<b>\$230</b>
<b>Solid surface, knife edge</b>							
8041R2616CSK	26 x 26 x 16	150	51	10.75	<b>\$3054</b>	n/a	<b>\$179</b>
8041R3016CSK	30 x 30 x 16	250	31.25	13	<b>\$3272</b>	n/a	<b>\$247</b>

Finished height will vary depending on material top. Shipped fully assembled in 1 carton.



Round Table with Wood Base

<b>Laminate, flat edge (TFL laminate)</b>							
8041R2616W	26 x 26 x 16	250	32	10.75	<b>\$1271</b>	<b>\$104</b>	n/a
8041R3016W	30 x 30 x 16	250	40	13	<b>\$1302</b>	<b>\$122</b>	n/a
<b>Laminate, knife edge (HPL laminate)</b>							
8041R2616WK	26 x 26 x 16	250	32	10.75	<b>\$1944</b>	n/a	n/a
8041R3016WK	30 x 30 x 16	250	40	13	<b>\$2033</b>	n/a	n/a
<b>Solid surface, flat edge</b>							
8041R2616WSF	26 x 26 x 16	150	45.5	10.75	<b>\$3150</b>	n/a	<b>\$167</b>
8041R3016WSF	30 x 30 x 16	150	57.5	13	<b>\$3340</b>	n/a	<b>\$230</b>
<b>Solid surface, knife edge</b>							
8041R2616WSK	26 x 26 x 16	150	45.5	10.75	<b>\$3208</b>	n/a	<b>\$179</b>
8041R3016WSK	30 x 30 x 16	150	57.5	13	<b>\$3425</b>	n/a	<b>\$247</b>

Finished height will vary depending on material top. Shipped fully assembled in 1 carton.

ROUND LAPTOP TABLES FOR OFFSET BASE



Square Table with Polished Chrome Base

MODEL# DIMENSIONS FREIGHT CLASS WT/LBS. CUBIC FT. LIST PRICE HP ADD GR. 2 ADD

D x W x H

Laminate, flat edge (TFL laminate)

8042SQ2216C	22.75 x 22.75 x 16	150	36	7.75	\$1117	\$104	n/a
8042SQ2816C	28.5 x 28.5 x 16	250	45	11.5	\$1148	\$122	n/a

Laminate, knife edge (HPL laminate)

8042SQ2216CK	22.75 x 22.75 x 16	150	36	7.75	\$1576	n/a	n/a
8042SQ2816CK	28.5 x 28.5 x 16	250	45	11.5	\$1676	n/a	n/a

Solid surface, flat edge

8042SQ2216CSF	22.75 x 22.75 x 16	150	41	7.75	\$2704	n/a	\$144
8042SQ2816CSF	28.5 x 28.5 x 16	150	57.5	11.5	\$3020	n/a	\$230

Solid surface, knife edge

8042SQ2216CSK	22.75 x 22.75 x 16	150	41	7.75	\$3054	n/a	\$174
8042SQ2816CSK	28.5 x 28.5 x 16	150	57.5	11.5	\$3499	n/a	\$259

Finished height will vary depending on material top. Shipped fully assembled in 1 carton.



Square Table with Wood Base

Laminate, flat edge (HPL laminate)

8042SQ2216W	22.75 x 22.75 x 16	250	30	7.75	\$1271	\$104	n/a
8042SQ2816W	28.5 x 28.5 x 16	250	39	11.5	\$1302	\$122	n/a

Laminate, knife edge (HPL laminate)

8042SQ2216WK	22.75 x 22.75 x 16	250	30	7.75	\$1730	n/a	n/a
8042SQ2816WK	28.5 x 28.5 x 16	250	39	11.5	\$1830	n/a	n/a

Solid surface, flat edge

8042SQ2216WSF	22.75 x 22.75 x 16	150	36	7.75	\$2857	n/a	\$144
8042SQ2816WSF	28.5 x 28.5 x 16	150	59	11.5	\$3174	n/a	\$230

Solid surface, knife edge

8042SQ2216WSK	22.75 x 22.75 x 16	150	36	7.75	\$3208	n/a	\$174
8042SQ2816WSK	28.5 x 28.5 x 16	150	59	11.5	\$3653	n/a	\$259

Finished height will vary depending on material top. Shipped fully assembled in 1 carton.

NOT ON CONTRACT

**ROUND LAPTOP TABLES FOR OFFSET BASE**      **MODEL#**      **DIMENSIONS**      **FREIGHT CLASS**      **WT./LBS.**      **CUBIC FT.**      **LIST PRICE**      **HP ADD**      **GR. 2 ADD**



**Oval Table with Polished Chrome Base**

D x W x H

**Laminate, flat edge**

80430V2616C	26 x 22 x 16	150	38	9.25	<b>\$1117</b>	<b>\$104</b>	n/a
80430V3116C	31 x 26 x 16	250	44	11.75	<b>\$1148</b>	<b>\$122</b>	n/a

**Laminate, knife edge**

80430V2616CK	26 x 22 x 16	150	38	9.25	<b>\$1790</b>	n/a	n/a
80430V3116CK	31 x 26 x 16	250	44	11.75	<b>\$1965</b>	n/a	n/a

**Solid surface, flat edge**

80430V2616CSF	26 x 22 x 16	150	49.5	9.25	<b>\$2997</b>	n/a	<del>\$167</del>
80430V3116CSF	31 x 26 x 16	150	61.5	11.75	<b>\$3186</b>	n/a	<b>\$230</b>

**Solid surface, knife edge**

80430V2616CSK	26 x 22 x 16	150	49.5	9.25	<del>\$3057</del>	n/a	<del>\$179</del>
80430V3116CSK	31 x 26 x 16	150	61.5	11.75	<del>\$3272</del>	n/a	<del>\$247</del>

Finished height will vary depending on material top. Shipped fully assembled in 1 carton.



**Oval Table with Wood Base**

**Laminate, flat edge**

80430V2616W	26 x 22 x 16	250	32	9.25	<b>\$1271</b>	<b>\$104</b>	n/a
80430V3116W	31 x 26 x 16	250	39	11.75	<b>\$1302</b>	<b>\$122</b>	n/a

**Laminate, knife edge**

80430V2616WK	26 x 22 x 16	250	32	9.25	<b>\$1944</b>	n/a	n/a
80430V3116WK	31 x 26 x 16	250	39	11.75	<b>\$2119</b>	n/a	n/a

**Solid surface, flat edge**

80430V2616WSF	26 x 22 x 16	150	44.5	9.25	<b>\$3150</b>	n/a	<b>\$167</b>
80430V3116WSF	31 x 26 x 16	150	56.5	11.75	<b>\$3340</b>	n/a	<b>\$230</b>

**Solid surface, knife edge**

80430V2616WSK	26 x 22 x 16	150	44.5	9.25	<b>\$3208</b>	n/a	<b>\$179</b>
80430V3116WSK	31 x 26 x 16	150	56.5	11.75	<b>\$3425</b>	n/a	<b>\$247</b>

Finished height will vary depending on material top. Shipped fully assembled in 1 carton.

NOT ON CONTRACT

JEO



model 8434



model 8433-4



Optional Quilted Stitch Back (Q).





Optional 5 prong base with glides (G).

STANDARD FEATURES

- Jeo is a contemporary, retro - inspired series with versatility for a variety of workplace applications.
- The tailored box styling functions well in lounge, conferencing, collaboration and side/guest environments.
- Three seating models: swivel tilter with a 5 prong caster base, a swivel self-centering return with a stationary round pedestal base or a matching four legged Arm Chair.
- Model 8433-4 is standard with a five prong Black nylon base with carpet casters (C1).
- Model 8437 is standard with Black four-legged frame.
- Upholstery options: fabric, vinyl, leather or a combination of two or more materials. The upholstery surfaces are seamed together with tailored double stitch detailing.
- Check textile availability prior to specifying upholstery material.

OPTIONAL FEATURES

- Chairs are available with an Optional Quilted Stitch back. Please specify (Q). Add \$212.
- Model 8433-4 has an optional five prong Aluminum base. specify (AL).
- Optional 5 prong Aluminum base with hard glides. Please specify (C7).
- Optional soft casters are available on the 5 prong base. Please specify (C9R) . Add \$76.
- Model 8434 round pedestal base available in Chrome (CHM) or Brushed Chrome (BCH). Please specify.
- Model 8437 has optional Chrome (CHM) or Brushed Chrome (BCH) four-legged frame.
- Occasional tables are available in the following laminate finishes to coordinate with Global Desking and wood seating: Absolute Acajou (ACJ), Asian Night (ASN), Avant Cherry (AWC), Avant Honey (AWH), Black (BLK), Blizzard (BZD), Brushed Cobalt (BRC), Clear Maple (CMB), Custom Grey (CGY), Dark Espresso (DES), Designer White (DWT), Fashionista (FAS), First Class (FCL), Noce Biondo (NBL), Noce Grigio (NGL), Noce Leggero (NEL), Noce Medio (NML), Quartered Mahogany (QTM), Sheer Beauty (SBY), Stonedust (SDT), Walnut Heights (WHE), White Chocolate (WHC), and Winter Cherry (WCR). Please Specify.

DESCRIPTION	FEATURES	MODEL#	STANDARD TEXTILE GRADES											
			1	2	3	4	5	6	7	8	9	10	11	12
 <p><b>Self-Centering Lounge Chair on Pedestal Base</b> COM Yardage: 2.75 Freight Class: 250 Product Weight (lbs.): 50 Cubic Feet Per Carton: 22</p> <p>Ergonomic Features: C</p>		<b>8434</b>	2474	2569	2643	2753	2909	2964	3100	3360	3487	3727	4055	4462
			<b>OVERALL DIMENSIONS</b>			<b>SEAT DIMENSIONS</b>			<b>BACK DIMENSIONS</b>					
				<b>W</b>	<b>D</b>	<b>H</b>	<b>W</b>	<b>D</b>	<b>H</b>	<b>W</b>	<b>H</b>			
			26	25	30-32.5	20	19	16.5-19	20	15				
 <p><b>Swivel Tilter Chair</b> COM Yardage: 2.75 Freight Class: 250 Product Weight (lbs.): 50 Cubic Feet Per Carton: 22</p> <p>Ergonomic Features: A, B, C, S</p>		<b>8433-4</b>	1679	1798	1887	2024	2218	2308	2483	2761	2978	3217	3709	4235
			<b>OVERALL DIMENSIONS</b>			<b>SEAT DIMENSIONS</b>			<b>BACK DIMENSIONS</b>					
				<b>W</b>	<b>D</b>	<b>H</b>	<b>W</b>	<b>D</b>	<b>H</b>	<b>W</b>	<b>H</b>			
			26	25	30-32.5	20	19	16.5-19	20	15				
 <p><b>Arm Chair</b> COM Yardage: 2.75 Freight Class: 250 Product Weight (lbs.): 50 Cubic Feet Per Carton: 22</p>		<b>8437</b>	1635	1741	1820	1940	2108	2189	2342	2587	2775	2984	3417	3876
			<b>OVERALL DIMENSIONS</b>			<b>SEAT DIMENSIONS</b>			<b>BACK DIMENSIONS</b>					
				<b>W</b>	<b>D</b>	<b>H</b>	<b>W</b>	<b>D</b>	<b>H</b>	<b>W</b>	<b>H</b>			
			26	25	34	20	19	18	20	15				

KATE®



model 2811-4







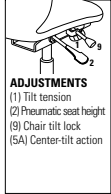

model 2811-8

STANDARD FEATURES

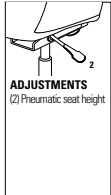
- A contemporary, yet retro series featuring sculpted seat and back cushions.
- Fully upholstered closed arms offer a unique style and function in the workplace.
- Models are standard with a five legged Polished Aluminum base.
- C10 casters are standard.
- Check textile availability prior to specifying upholstery material.

OPTIONAL FEATURES

- An optional Black injection molded base is available at no upcharge, please specify **(BK)**.
- There are no caster options for this series. **C7** glides can be specified at no upcharge.
- For hard surface flooring please specify **C10R**. Add \$70.
- For fully assembled in box, specify **SU**. Add \$81.

DESCRIPTION	FEATURES	MODEL#	STANDARD TEXTILE GRADES																																			
			1	2	3	4	5	6	7	8	9	10	11	12																								
 <p><b>MB Tilter</b> COM Yardage: 3.75 Freight Class: 250 Product Weight (lbs.): 47 Cubic Feet Per Carton: 15.75</p>	 <p><b>ADJUSTMENTS</b> (1) Tilt tension (2) Pneumatic seat height (9) Chair tilt lock (5A) Center-tilt action</p>	<p>Ergonomic Features: A, B, C, N</p>	<table border="1"> <thead> <tr> <th colspan="3">OVERALL DIMENSIONS</th> <th colspan="3">SEAT DIMENSIONS</th> <th colspan="2">BACK DIMENSIONS</th> </tr> <tr> <th>W</th><th>D</th><th>H</th> <th>W</th><th>D</th><th>H</th> <th>W</th><th>H</th> </tr> </thead> <tbody> <tr> <td>26</td><td>24.5</td><td>33</td> <td>17.5</td><td>18</td><td>17.5-21.50</td> <td>19</td><td>15.5</td> </tr> </tbody> </table>												OVERALL DIMENSIONS			SEAT DIMENSIONS			BACK DIMENSIONS		W	D	H	W	D	H	W	H	26	24.5	33	17.5	18	17.5-21.50	19	15.5
			OVERALL DIMENSIONS			SEAT DIMENSIONS			BACK DIMENSIONS																													
			W	D	H	W	D	H	W	H																												
			26	24.5	33	17.5	18	17.5-21.50	19	15.5																												
<p><b>RTA 00</b></p>																																						
<table border="1"> <thead> <tr> <th>1</th><th>2</th><th>3</th><th>4</th><th>5</th><th>6</th><th>7</th><th>8</th><th>9</th><th>10</th><th>11</th><th>12</th> </tr> </thead> <tbody> <tr> <td>2811-4</td><td>\$1490</td><td>\$1635</td><td>\$1752</td><td>\$1925</td><td>\$2169</td><td>\$2260</td><td>\$2472</td><td>\$2883</td><td>\$3079</td><td>\$3458</td><td>\$3975</td><td>\$4615</td> </tr> </tbody> </table>												1	2	3	4	5	6	7	8	9	10	11	12	2811-4	\$1490	\$1635	\$1752	\$1925	\$2169	\$2260	\$2472	\$2883	\$3079	\$3458	\$3975	\$4615		
1	2	3	4	5	6	7	8	9	10	11	12																											
2811-4	\$1490	\$1635	\$1752	\$1925	\$2169	\$2260	\$2472	\$2883	\$3079	\$3458	\$3975	\$4615																										
<p><b>FedEx</b> </p>																																						
 <p><b>MB Swivel</b> COM Yardage: 3.75 Freight Class: 250 Product Weight (lbs.): 43 Cubic Feet Per Carton: 15.75</p>	 <p><b>ADJUSTMENTS</b> (2) Pneumatic seat height</p>	<p>Ergonomic Features: C, N</p>	<table border="1"> <thead> <tr> <th colspan="3">OVERALL DIMENSIONS</th> <th colspan="3">SEAT DIMENSIONS</th> <th colspan="2">BACK DIMENSIONS</th> </tr> <tr> <th>W</th><th>D</th><th>H</th> <th>W</th><th>D</th><th>H</th> <th>W</th><th>H</th> </tr> </thead> <tbody> <tr> <td>26</td><td>24.5</td><td>33</td> <td>17.5</td><td>18</td><td>17.5-21.50</td> <td>19</td><td>15.5</td> </tr> </tbody> </table>												OVERALL DIMENSIONS			SEAT DIMENSIONS			BACK DIMENSIONS		W	D	H	W	D	H	W	H	26	24.5	33	17.5	18	17.5-21.50	19	15.5
			OVERALL DIMENSIONS			SEAT DIMENSIONS			BACK DIMENSIONS																													
			W	D	H	W	D	H	W	H																												
			26	24.5	33	17.5	18	17.5-21.50	19	15.5																												
<p><b>RTA 00</b></p>																																						
<table border="1"> <thead> <tr> <th>1</th><th>2</th><th>3</th><th>4</th><th>5</th><th>6</th><th>7</th><th>8</th><th>9</th><th>10</th><th>11</th><th>12</th> </tr> </thead> <tbody> <tr> <td>2811-8</td><td>\$1437</td><td>\$1587</td><td>\$1704</td><td>\$1874</td><td>\$2119</td><td>\$2210</td><td>\$2423</td><td>\$2833</td><td>\$3029</td><td>\$3407</td><td>\$3924</td><td>\$4566</td> </tr> </tbody> </table>												1	2	3	4	5	6	7	8	9	10	11	12	2811-8	\$1437	\$1587	\$1704	\$1874	\$2119	\$2210	\$2423	\$2833	\$3029	\$3407	\$3924	\$4566		
1	2	3	4	5	6	7	8	9	10	11	12																											
2811-8	\$1437	\$1587	\$1704	\$1874	\$2119	\$2210	\$2423	\$2833	\$3029	\$3407	\$3924	\$4566																										
<p><b>FedEx</b> </p>																																						
 <p><b>Armchair</b> COM Yardage: 3.75 Freight Class: 250 Product Weight (lbs.): 42 Cubic Feet Per Carton: 15.75</p>	<p>Ergonomic Features: N</p>	<table border="1"> <thead> <tr> <th colspan="3">OVERALL DIMENSIONS</th> <th colspan="3">SEAT DIMENSIONS</th> <th colspan="2">BACK DIMENSIONS</th> </tr> <tr> <th>W</th><th>D</th><th>H</th> <th>W</th><th>D</th><th>H</th> <th>W</th><th>H</th> </tr> </thead> <tbody> <tr> <td>26.5</td><td>26.5</td><td>33.5</td> <td>17.5</td><td>18</td><td>18</td> <td>19</td><td>15.5</td> </tr> </tbody> </table>												OVERALL DIMENSIONS			SEAT DIMENSIONS			BACK DIMENSIONS		W	D	H	W	D	H	W	H	26.5	26.5	33.5	17.5	18	18	19	15.5	
		OVERALL DIMENSIONS			SEAT DIMENSIONS			BACK DIMENSIONS																														
		W	D	H	W	D	H	W	H																													
		26.5	26.5	33.5	17.5	18	18	19	15.5																													
<p><b>RTA 00</b></p>																																						
<table border="1"> <thead> <tr> <th>1</th><th>2</th><th>3</th><th>4</th><th>5</th><th>6</th><th>7</th><th>8</th><th>9</th><th>10</th><th>11</th><th>12</th> </tr> </thead> <tbody> <tr> <td>2813</td><td>\$1628</td><td>\$1769</td><td>\$1881</td><td>\$2044</td><td>\$2277</td><td>\$2361</td><td>\$2565</td><td>\$2956</td><td>\$3143</td><td>\$3505</td><td>\$3996</td><td>\$4608</td> </tr> </tbody> </table>												1	2	3	4	5	6	7	8	9	10	11	12	2813	\$1628	\$1769	\$1881	\$2044	\$2277	\$2361	\$2565	\$2956	\$3143	\$3505	\$3996	\$4608		
1	2	3	4	5	6	7	8	9	10	11	12																											
2813	\$1628	\$1769	\$1881	\$2044	\$2277	\$2361	\$2565	\$2956	\$3143	\$3505	\$3996	\$4608																										
<p><b>FedEx</b> </p>																																						
 <p><b>Ottoman</b> COM Yardage: 1.5 Freight Class: 250 Product Weight (lbs.): 22 Cubic Feet Per Carton: 6</p>	<p>Ergonomic Features: N</p>	<table border="1"> <thead> <tr> <th colspan="3">OVERALL DIMENSIONS</th> <th colspan="3">SEAT DIMENSIONS</th> <th colspan="2">BACK DIMENSIONS</th> </tr> <tr> <th>W</th><th>D</th><th>H</th> <th>W</th><th>D</th><th>H</th> <th>W</th><th>H</th> </tr> </thead> <tbody> <tr> <td>23.5</td><td>18.75</td><td>17.75</td> <td>20.5</td><td>18.5</td><td>17-22</td> <td>20</td><td>21</td> </tr> </tbody> </table>												OVERALL DIMENSIONS			SEAT DIMENSIONS			BACK DIMENSIONS		W	D	H	W	D	H	W	H	23.5	18.75	17.75	20.5	18.5	17-22	20	21	
		OVERALL DIMENSIONS			SEAT DIMENSIONS			BACK DIMENSIONS																														
		W	D	H	W	D	H	W	H																													
		23.5	18.75	17.75	20.5	18.5	17-22	20	21																													
<p><b>RTA 00</b></p>																																						
<table border="1"> <thead> <tr> <th>1</th><th>2</th><th>3</th><th>4</th><th>5</th><th>6</th><th>7</th><th>8</th><th>9</th><th>10</th><th>11</th><th>12</th> </tr> </thead> <tbody> <tr> <td>2814</td><td>\$1020</td><td>\$1082</td><td>\$1125</td><td>\$1189</td><td>\$1282</td><td>\$1317</td><td>\$1398</td><td>\$1554</td><td>\$1630</td><td>\$1774</td><td>\$1971</td><td>\$2215</td> </tr> </tbody> </table>												1	2	3	4	5	6	7	8	9	10	11	12	2814	\$1020	\$1082	\$1125	\$1189	\$1282	\$1317	\$1398	\$1554	\$1630	\$1774	\$1971	\$2215		
1	2	3	4	5	6	7	8	9	10	11	12																											
2814	\$1020	\$1082	\$1125	\$1189	\$1282	\$1317	\$1398	\$1554	\$1630	\$1774	\$1971	\$2215																										
<p><b>FedEx</b> </p>																																						

LUX



model LX2426AC



model LX8033S

STANDARD FEATURES

- Contemporary styling featuring luxurious cushioning.
- Sofa cushions are removable.
- Fully upholstered. Wood legs with non marking clear glides.
- Cylindrical bolsters included with lounge chair models. One bolster on single seat lounge chair and two bolsters on two-seat and three-seat sofas.
- This item may require a longer lead time. Please contact your Global sales representative for further information.
- Check textile availability prior to specifying upholstery material.

OPTIONAL FEATURES

- Wood frames are available in Absolute (AAM), Black (BKM), Cherry (ACM), English Oak (EOM), Espresso Cafe (ECM), Fruitwood (TFM), Gray (HGM), Honey (AHM), Mahogany (TMM), Maple (AVM), Medium Walnut (MWM), Night (ASM), Natural Walnut (NLW), Noce Biondo (NBM), Noce Grigio (NGM), Noce Leggero (NEM), Noce Medio (NMM), Shaker Cherry (SKM), Walnut (TWM), WC Cream (WTM), White (WHM) and Winter Cherry (WCM). Please Specify. Genuine maple faced veneers and solids are used.

DESCRIPTION	FEATURES	MODEL#	STANDARD TEXTILE GRADES											
-------------	----------	--------	-------------------------	--	--	--	--	--	--	--	--	--	--	--



Side Chair

COM Yardage: 3  
 Freight Class: 150  
 Product Weight (lbs.): 36  
 Cubic Feet Per Carton: 17.75

	1	2	3	4	5	6	7	8	9	10	11	12
LX2226SC	1149	1270	1318	1394	1499	1534	1625	1798	1883	2045	2264	2538

OVERALL DIMENSIONS			SEAT DIMENSIONS			BACK DIMENSIONS	
W	D	H	W	D	H	W	H
25	27.75	36	19	19.5	19.5	19	18

RTA 00



Armchair

COM Yardage: 3  
 Freight Class: 250  
 Product Weight (lbs.): 40  
 Cubic Feet Per Carton: 17.75

	1	2	3	4	5	6	7	8	9	10	11	12
LX2426AC	1492	1618	1716	1861	2067	2165	2352	2652	2882	3137	3664	4226

OVERALL DIMENSIONS			SEAT DIMENSIONS			BACK DIMENSIONS	
W	D	H	W	D	H	W	H
26	27.75	36	19	19.5	19.5	19	18

RTA 00



Lounge Chair

COM Yardage: 8.50  
 Freight Class: 250  
 Product Weight (lbs.): 77  
 Cubic Feet Per Carton: 30.25

	1	2	3	4	5	6	7	8	9	10	11	12
LX3433CH	2906	3219	3468	3841	4371	4622	5099	5865	6456	7111	8459	9898

OVERALL DIMENSIONS			SEAT DIMENSIONS			BACK DIMENSIONS	
W	D	H	W	D	H	W	H
35	34	33	-	-	-	-	-

RTA 00



Ottoman

COM Yardage: 2.5  
 Freight Class: 250  
 Product Weight (lbs.): 48  
 Cubic Feet Per Carton: 18.25

	1	2	3	4	5	6	7	8	9	10	11	12
LX3636OTT	2775	3000	3069	3172	3325	3374	3508	3756	3876	4105	4420	4811

OVERALL DIMENSIONS			SEAT DIMENSIONS			BACK DIMENSIONS	
W	D	H	W	D	H	W	H
36	36	16	-	-	-	-	-

RTA 00

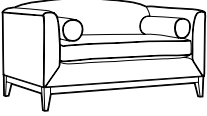
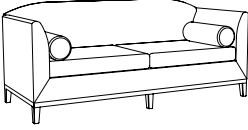
DESCRIPTION	FEATURES	MODEL#	STANDARD TEXTILE GRADES											
			1	2	3	4	5	6	7	8	9	10	11	12
 <p><b>Two Seat Sofa</b> w/Cylindrical bolsters. COM Yardage: 12 Freight Class: 250 Product Weight (lbs.): 105 Cubic Feet Per Carton: 50.25</p>		<b>LX6033S</b>	3000	3440	3793	4318	5065	5415	6094	7172	8003	8927	10829	12858
			<b>OVERALL DIMENSIONS</b>			<b>SEAT DIMENSIONS</b>			<b>BACK DIMENSIONS</b>					
			<b>W</b>	<b>D</b>	<b>H</b>	<b>W</b>	<b>D</b>	<b>H</b>	<b>W</b>	<b>H</b>				
			61	34	33	20	18.5	18.5	20	16				
			<b>RTA 00</b>											
 <p><b>Three Seat Sofa</b> w/Cylindrical bolsters. COM Yardage: 14.75 Freight Class: 300 Product Weight (lbs.): 125 Cubic Feet Per Carton: 66.25</p>														
		<b>LX8033S</b>	4318	5019	5409	6001	6832	7131	7860	9253	9922	11214	12967	15157
			<b>OVERALL DIMENSIONS</b>			<b>SEAT DIMENSIONS</b>			<b>BACK DIMENSIONS</b>					
			<b>W</b>	<b>D</b>	<b>H</b>	<b>W</b>	<b>D</b>	<b>H</b>	<b>W</b>	<b>H</b>				
		81	34	33	20	18.5	18.5	20	16					
			<b>RTA 00</b>											

ML™



model ML2630

**STANDARD FEATURES**

- Modern seating with a distinctive retro design.
- Features a steel tube frame, legs and arms.
- Fully upholstered continuous seat and back cushions.
- Standard with non marring, Black glides.
- Check textile availability prior to specifying upholstery material.

**OPTIONAL FEATURES**

- Available in five frame finish options. Please specify Chrome (**CHM**), Brushed Chrome (**BCH**), Black (**TBL**), Designer White (**TDW**) or Tungsten (**TTU**). No upcharge applies. Please specify.

DESCRIPTION	FEATURES	MODEL#	STANDARD TEXTILE GRADES											
-------------	----------	--------	-------------------------	--	--	--	--	--	--	--	--	--	--	--



**Counter Height Stool - 24" Seat Height**

COM Yardage: 1  
Freight Class: 250  
Product Weight (lbs.): 22  
Cubic Feet Per Carton: 5.75

	1	2	3	4	5	6	7	8	9	10	11	12
<b>ML171724</b>	1668	1693	1708	1735	1766	1781	1813	1862	1898	1942	2028	2120

OVERALL DIMENSIONS			SEAT DIMENSIONS			BACK DIMENSIONS	
W	D	H	W	D	H	W	H
18	19	24	17	16	23	-	-



**Bar Height Stool - 30" Seat Height**

COM Yardage: 1  
Freight Class: 250  
Product Weight (lbs.): 23  
Cubic Feet Per Carton: 8

	1	2	3	4	5	6	7	8	9	10	11	12
<b>ML171730</b>	1721	1744	1758	1783	1812	1825	1851	1902	1928	1976	2041	2123

OVERALL DIMENSIONS			SEAT DIMENSIONS			BACK DIMENSIONS	
W	D	H	W	D	H	W	H
18	20.5	30	17	16	29	-	-



**Bar Height Stool - 33" Seat Height**

COM Yardage: 1  
Freight Class: 250  
Product Weight (lbs.): 24  
Cubic Feet Per Carton: 9

	1	2	3	4	5	6	7	8	9	10	11	12
<b>ML171733</b>	1755	1860	1876	1896	1924	1936	1963	2011	2035	2081	2144	2223

OVERALL DIMENSIONS			SEAT DIMENSIONS			BACK DIMENSIONS	
W	D	H	W	D	H	W	H
18	21.5	33	17	16	32	-	-





**Ottoman**

COM Yardage: 1.25  
Freight Class: 150  
Product Weight (lbs.): 28  
Cubic Feet Per Carton: 5.75

	1	2	3	4	5	6	7	8	9	10	11	12
<b>ML2121</b>	1184	1279	1308	1350	1410	1431	1482	1582	1631	1720	1848	2004

OVERALL DIMENSIONS			SEAT DIMENSIONS			BACK DIMENSIONS	
W	D	H	W	D	H	W	H
21	21	17	-	-	-	-	-



DESCRIPTION	FEATURES	MODEL#	STANDARD TEXTILE GRADES											
			1	2	3	4	5	6	7	8	9	10	11	12
 <p><b>Dining Chair</b> COM Yardage: 1.75 Freight Class: 250 Product Weight (lbs.): 33 Cubic Feet Per Carton: 14.75</p>		<b>ML2326</b>	1390	1531	1587	1670	1789	1831	1937	2135	2230	2415	2666	2980
			<b>OVERALL DIMENSIONS</b>			<b>SEAT DIMENSIONS</b>			<b>BACK DIMENSIONS</b>					
			<b>W</b>	<b>D</b>	<b>H</b>	<b>W</b>	<b>D</b>	<b>H</b>	<b>W</b>	<b>H</b>				
			23.25	29.5	29.75	20	18.5	18.5	20	16				
			<b>RTA 00</b>											
 <p><b>Lounge Chair</b> COM Yardage: 2.5 Freight Class: 250 Product Weight (lbs.): 54 Cubic Feet Per Carton: 21.25</p>		<b>ML2630</b>	2085	2278	2347	2452	2598	2652	2785	3034	3151	3383	3696	4087
			<b>OVERALL DIMENSIONS</b>			<b>SEAT DIMENSIONS</b>			<b>BACK DIMENSIONS</b>					
			<b>W</b>	<b>D</b>	<b>H</b>	<b>W</b>	<b>D</b>	<b>H</b>	<b>W</b>	<b>H</b>				
			26	34.5	35	23	20	18.5	18.5	20.5				
			<b>RTA 00</b>											

ML PARK



model ML4634CH



model ML8634

STANDARD FEATURES

- Armless modern lounge seating with a distinctive retro design.
- Features beautiful aluminum legs with Black glides.
- Fully upholstered continuous seat and back cushions with distinctive seams.
- Check textile availability prior to specifying upholstery material.

OPTIONAL FEATURES

- Optional fixed back cushion (FC) is available on lounge models with upcharge. Please specify. Model ML4634, add \$193. Model ML6634, add \$255. Model ML8634, add \$316.
- Available in five leg finish options. Specify: Black (TBL), Brushed Aluminum (BAL), Designer White (TDW), Polished Aluminum (ALU) or Tungsten (TTU). No upcharge applies.

DESCRIPTION	FEATURES	MODEL#	STANDARD TEXTILE GRADES											
-------------	----------	--------	-------------------------	--	--	--	--	--	--	--	--	--	--	--

	1	2	3	4	5	6	7	8	9	10	11	12
ML2634	2297	2353	2397	2462	2554	2598	2682	2814	2916	3031	3266	3515



Ottoman

COM Yardage: 1.50  
 Freight Class: 150  
 Product Weight (lbs.): 28  
 Cubic Feet Per Carton: 5.75

OVERALL DIMENSIONS			SEAT DIMENSIONS			BACK DIMENSIONS	
W	D	H	W	D	H	W	H

21	26.75	18.25	26.75	-	20	-	-
----	-------	-------	-------	---	----	---	---

RTA 00



Lounge Chair

COM Yardage: 7.25  
 Freight Class: 250  
 Product Weight (lbs.): 54  
 Cubic Feet Per Carton: 21.25

	1	2	3	4	5	6	7	8	9	10	11	12
ML4634	3937	4183	4373	4658	5067	5255	5623	6211	6663	7165	8200	9304

OVERALL DIMENSIONS			SEAT DIMENSIONS			BACK DIMENSIONS	
W	D	H	W	D	H	W	H

26	34.5	35	42.75	22	19	27	13
----	------	----	-------	----	----	----	----

RTA 00

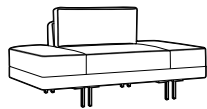

Two Seat Sofa

COM Yardage: 7.50  
 Freight Class: 250  
 Product Weight (lbs.): 132  
 Cubic Feet Per Carton: 52

	1	2	3	4	5	6	7	8	9	10	11	12
ML6634	4250	4739	4961	5299	5773	5947	6360	7155	7539	8275	9282	10531

OVERALL DIMENSIONS			SEAT DIMENSIONS			BACK DIMENSIONS	
W	D	H	W	D	H	W	H

66	36	32	66	22	19	27	13
----	----	----	----	----	----	----	----

RTA 00

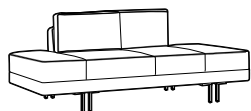

Three Seat Sofa

COM Yardage: 11  
 Freight Class: 250  
 Product Weight (lbs.): 132  
 Cubic Feet Per Carton: 52

	1	2	3	4	5	6	7	8	9	10	11	12
ML8634	5607	6265	6573	7034	7690	7925	8495	9589	10116	11130	12509	14231

OVERALL DIMENSIONS			SEAT DIMENSIONS			BACK DIMENSIONS	
W	D	H	W	D	H	W	H

66	36	32	86	22	19	52	13
----	----	----	----	----	----	----	----

RTA 00

## PRAIRIE™



model 3481



model 3482

### STANDARD FEATURES

- Featuring, gently barrel shaped arms that provide an attractive appearance.
- Fully upholstered. Tapered wood skirt and legs.
- Series includes lounge chair, two seat and three seat sofa.
- Check textile availability prior to specifying upholstery material.

### OPTIONAL FEATURES

- Tapered wood legs are available in Absolute (AAM), Black (BKM), Cherry (ACM), Espresso Cafe (ECM), English Oak (EOM), Fruitwood (TFM), Gray (HGM), Honey (AHM), Mahogany (TMM), Maple (AVM), Medium Walnut (MWVM), Natural Walnut (NLW), Night (ASM), Noce Biondo (NBM), Noce Grigio (NGM), Noce Leggero (NEM), Noce Medio (NMM), Shaker Cherry (SKM), Walnut (TWM), WC Cream (WTM), White (WHM) and Winter Cherry (WCM). Please specify. Genuine maple faced veneers and solids are used.

### STITCH DETAIL WHEN UPHOLSTERED IN ALL LEATHER - ILLUSTRATIONS BELOW

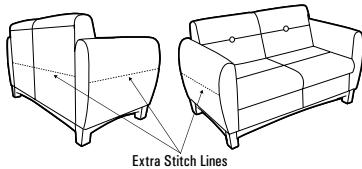

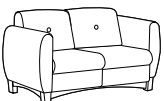
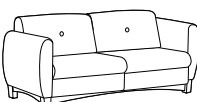
DESCRIPTION	FEATURES	MODEL#	STANDARD TEXTILE GRADES											
			1	2	3	4	5	6	7	8	9	10	11	12
 <b>Lounge Chair</b> COM Yardage: 4.25 Freight Class: 150 Product Weight (lbs.): 80 Cubic Feet Per Carton: 19.25		<b>3481</b>	2247	2442	2594	2819	3142	3256	3534	4068	4330	4823	5500	6340
			<b>OVERALL DIMENSIONS</b>			<b>SEAT DIMENSIONS</b>			<b>BACK DIMENSIONS</b>					
			<b>W</b>	<b>D</b>	<b>H</b>	<b>W</b>	<b>D</b>	<b>H</b>	<b>W</b>	<b>H</b>				
			32	29	30.5	21	19	16	21	14.5				
			<b>RTA 00</b>											
 <b>Two Seat Sofa</b> COM Yardage: 6.25 Freight Class: 250 Product Weight (lbs.): 106 Cubic Feet Per Carton: 41.25		<b>3482</b>	3188	3439	3634	3926	4347	4494	4856	5553	5884	6533	7410	8506
			<b>OVERALL DIMENSIONS</b>			<b>SEAT DIMENSIONS</b>			<b>BACK DIMENSIONS</b>					
			<b>W</b>	<b>D</b>	<b>H</b>	<b>W</b>	<b>D</b>	<b>H</b>	<b>W</b>	<b>H</b>				
			52.5	29	30.5	42	19	16	42	14.5				
			<b>RTA 00</b>											
 <b>Three Seat Sofa</b> COM Yardage: 9.5 Freight Class: 250 Product Weight (lbs.): 150 Cubic Feet Per Carton: 55.5		<b>3483</b>	4007	4355	4630	5044	5631	5908	6439	7287	7943	8668	10166	11762
			<b>OVERALL DIMENSIONS</b>			<b>SEAT DIMENSIONS</b>			<b>BACK DIMENSIONS</b>					
			<b>W</b>	<b>D</b>	<b>H</b>	<b>W</b>	<b>D</b>	<b>H</b>	<b>W</b>	<b>H</b>				
			73.5	29	30.5	63.5	19	16	63.5	14.5				
			<b>RTA 00</b>											

RAMBLER



Rectangular ottoman 26" x 52"  
RA2652RE



Square ottoman 39" x 39"  
RA3939SQ



Contrasting Textile Application.

STANDARD FEATURES





- The softened shapes of Ramble ottomans create mobile and stationary furniture landscapes for education, office and healthcare. This family of ottomans, available in numerous shapes and sizes, creates unique and inviting spaces for people to relax, socialize, work and study.
- These fully upholstered ottomans are available in square, rectangular and trapezoid shapes.
- Ottomans are standard at 17.5" seat height with 3" fixed legs or casters. A 15.5" seat height is achieved using the optional 1" leg.
- 3" and 1" poly legs are available in Night or Sand finish with white non-marking glides, standard. Various glide options are available to best suit flooring type and site conditions.
- For casters, select (CST) base type option and choose 2.5" black casters for either carpet or hard surfaces, see upcharge.
- An optional moisture barrier is available. Sealed seams are not available.
- Models do not gang.
- Upholstery options: fabric, coated textile or leather. Coated textile and leather models may feature stitch detail across the seat.
- Check textile availability prior to specifying upholstery material.
- Ottomans are available with contrasting textiles. Specify ottoman top separate from sides. For pricing, start with the base price and add applicable graded textile upcharges for the top and sides.
- Combining different material types (ex. coated textile and fabric) is not recommended due to different stretch resulting in potential for puckering.
- The blended textile matrix does not apply to this series.
- Active weight capacity 300 lbs.
- All models ship fully assembled.
- The series is designed for use across a range of facilities and is covered under Global's limited lifetime warranty for single-shift use.
- Model description dimensions are nominal. Actual dimensions are within .5 inches of nominal.





Please add option codes in the following order:

- **Model Number**  
Specify model number
- **Top Textile Back**  
Specify textile code
- **Side Textile**  
Specify textile code
- **Base Type**  
(1L) 1" Leg with 15.5" seat height  
(3L) 3" Leg with 17.5" seat height  
(CST) Casters with 17.5" seat height (please refer to upcharges below)
- **Leg Finish**  
(BLK) Night  
(SND) Sand
- **Caster Type**  
(C112) 2.5" Black caster for carpeted surfaces. No upcharge.  
(C112R) 2.5" Caster for most hard surfaces. Add \$57
- **Glide Type**  
(NM) White, non-marking nylon glides for most surfaces. No upcharge.  
(FG) Felt glides for most hard floor surfaces. Add \$34.  
(RG) Rubber non-slip glides for most hard floor surfaces. Add \$34.  
(SG) Steel cushioned glides for carpeted surfaces. Add \$34.
- **Moisture Barrier**  
(NB) No moisture barrier  
(MB) Moisture barrier. See model for upcharges.

EXAMPLE RAMBLER ORDER CODE:

RA2222SQ	WA50	VY20	3L	BLK	NM	NB
Model #	Top textile	Sides textile	Base type	Leg finish	Glide type	Moisture barrier

DESCRIPTION	FEATURES/ MODEL#	STANDARD TEXTILE GRADES												
		1/COM	2	3	4	5	6	7	8	9	10	11	12	
 <p><b>Square Ottoman 22" x 22"</b> COM Yardage: Top: 0.75; Side: 1 Freight Class: 150 Product Weight (lbs.): 38.5 Cubic Feet Per Carton: 6.5</p>	<b>RA2222SQ</b>	Base Price:	<b>\$716</b>											
		Top upcharge:	<b>+0</b>	<b>+\$24</b>	<b>+\$43</b>	<b>+\$71</b>	<b>+\$110</b>	<b>+\$126</b>	<b>+\$160</b>	<b>+\$213</b>	<b>+\$253</b>	<b>+\$297</b>	<b>+\$387</b>	<b>+\$483</b>
		Side upcharge:	<b>+0</b>	<b>+\$32</b>	<b>+\$57</b>	<b>+\$94</b>	<b>+\$146</b>	<b>+\$168</b>	<b>+\$213</b>	<b>+\$284</b>	<b>+\$337</b>	<b>+\$395</b>	<b>+\$516</b>	<b>+\$643</b>
			<b>OVERALL DIMENSIONS</b>			<b>SEAT DIMENSIONS</b>			<b>BACK DIMENSIONS</b>					
			<b>W</b>	<b>D</b>	<b>H</b>	<b>W</b>	<b>D</b>	<b>H</b>	<b>W</b>	<b>H</b>				
			22	22	17.5	-	-	-	-	-				
			Add \$107 for moisture barrier (MB).											
			Width and depth may vary by up to .05 in.											
			<b>RTA 00</b>	1 per carton										
 <p><b>Square Ottoman 26" x 26"</b> COM Yardage: Top: 0.75; Side: 1 Freight Class: 150 Product Weight (lbs.): 41 Cubic Feet Per Carton: 9.5</p>	<b>RA2626SQ</b>	Base Price:	<b>\$796</b>											
		Top upcharge:	<b>+0</b>	<b>+\$24</b>	<b>+\$43</b>	<b>+\$71</b>	<b>+\$110</b>	<b>+\$126</b>	<b>+\$160</b>	<b>+\$213</b>	<b>+\$253</b>	<b>+\$297</b>	<b>+\$387</b>	<b>+\$483</b>
		Side upcharge:	<b>+0</b>	<b>+\$32</b>	<b>+\$57</b>	<b>+\$94</b>	<b>+\$146</b>	<b>+\$168</b>	<b>+\$213</b>	<b>+\$284</b>	<b>+\$337</b>	<b>+\$395</b>	<b>+\$516</b>	<b>+\$643</b>
			<b>OVERALL DIMENSIONS</b>			<b>SEAT DIMENSIONS</b>			<b>BACK DIMENSIONS</b>					
			<b>W</b>	<b>D</b>	<b>H</b>	<b>W</b>	<b>D</b>	<b>H</b>	<b>W</b>	<b>H</b>				
			26.5	26.5	17.5	-	-	-	-	-				
			Add \$107 for moisture barrier (MB).											
			Width and depth may vary by up to .05 in.											
			<b>RTA 00</b>	1 per carton										
 <p><b>Square Ottoman 39" x 39"</b> COM Yardage: Top: 1.25; Side: 2.25 Freight Class: 250 Product Weight (lbs.): 74 Cubic Feet Per Carton: 19.5</p>	<b>RA3939SQ</b>	Base Price:	<b>\$1198</b>											
		Top upcharge:	<b>+0</b>	<b>+\$40</b>	<b>+\$72</b>	<b>+\$118</b>	<b>+\$183</b>	<b>+\$210</b>	<b>+\$267</b>	<b>+\$355</b>	<b>+\$422</b>	<b>+\$494</b>	<b>+\$645</b>	<b>+\$804</b>
		Side upcharge:	<b>+0</b>	<b>+\$72</b>	<b>+\$129</b>	<b>+\$212</b>	<b>+\$329</b>	<b>+\$378</b>	<b>+\$480</b>	<b>+\$639</b>	<b>+\$759</b>	<b>+\$889</b>	<b>+\$1161</b>	<b>+\$1447</b>
			<b>OVERALL DIMENSIONS</b>			<b>SEAT DIMENSIONS</b>			<b>BACK DIMENSIONS</b>					
			<b>W</b>	<b>D</b>	<b>H</b>	<b>W</b>	<b>D</b>	<b>H</b>	<b>W</b>	<b>H</b>				
			39	39	17.5	-	-	-	-	-				
			Add \$213 for moisture barrier (MB).											
			Width and depth may vary by up to .05 in.											
			<b>RTA 00</b>	1 per carton										
 <p><b>Rectangular Ottoman 26" x 39"</b> COM Yardage: Top: 1; Side: 1.5 Freight Class: 150 Product Weight (lbs.): 63 Cubic Feet Per Carton: 13.75</p>	<b>RA2639RE</b>	Base Price:	<b>\$1062</b>											
		Top upcharge:	<b>+0</b>	<b>+\$32</b>	<b>+\$57</b>	<b>+\$94</b>	<b>+\$146</b>	<b>+\$168</b>	<b>+\$213</b>	<b>+\$284</b>	<b>+\$337</b>	<b>+\$395</b>	<b>+\$516</b>	<b>+\$643</b>
		Side upcharge:	<b>+0</b>	<b>+\$48</b>	<b>+\$86</b>	<b>+\$141</b>	<b>+\$219</b>	<b>+\$252</b>	<b>+\$320</b>	<b>+\$426</b>	<b>+\$506</b>	<b>+\$593</b>	<b>+\$774</b>	<b>+\$965</b>
			<b>OVERALL DIMENSIONS</b>			<b>SEAT DIMENSIONS</b>			<b>BACK DIMENSIONS</b>					
			<b>W</b>	<b>D</b>	<b>H</b>	<b>W</b>	<b>D</b>	<b>H</b>	<b>W</b>	<b>H</b>				
			39.5	26.5	17.5	-	-	-	-	-				
			Add \$160 for moisture barrier (MB).											
			Width and depth may vary by up to .05 in.											
			<b>RTA 00</b>	1 per carton										

DESCRIPTION	FEATURES	MODEL#	STANDARD TEXTILE GRADES													
			1/COM	2	3	4	5	6	7	8	9	10	11	12		
 <p><b>Rectangular Ottoman 26" x 52"</b> COM Yardage: Top: 1; Side: 1.5 Freight Class: 150 Product Weight (lbs.): 75 Cubic Feet Per Carton: 17.75</p>	RA2652RE	Base Price:	<b>\$1186</b>													
		Top upcharge:	<b>+0</b>	<b>+\$32</b>	<b>+\$57</b>	<b>+\$94</b>	<b>+\$146</b>	<b>+\$168</b>	<b>+\$213</b>	<b>+\$284</b>	<b>+\$337</b>	<b>+\$395</b>	<b>+\$516</b>	<b>+\$643</b>		
		Side upcharge:	<b>+0</b>	<b>+\$48</b>	<b>+\$86</b>	<b>+\$141</b>	<b>+\$219</b>	<b>+\$252</b>	<b>+\$320</b>	<b>+\$426</b>	<b>+\$506</b>	<b>+\$593</b>	<b>+\$774</b>	<b>+\$965</b>		
			<b>OVERALL DIMENSIONS</b>	<b>SEAT DIMENSIONS</b>			<b>BACK DIMENSIONS</b>									
			<b>W</b>	<b>D</b>	<b>H</b>	<b>W</b>	<b>D</b>	<b>H</b>	<b>W</b>	<b>H</b>						
		52.5	26.5	17.5	-	-	-	-	-							
		Add \$160 for moisture barrier (MB).														
		Width and depth may vary by up to .05 in.	<b>RTA 00</b>	1 per carton												
 <p><b>Trapezoid Ottoman 26" x 26"</b> COM Yardage: Top: .75; Side: 1.5 Freight Class: 250 Product Weight (lbs.): 37.5 Cubic Feet Per Carton: 9.5</p>	RA2626TR	Base Price:	<b>\$796</b>													
		Top upcharge:	<b>+0</b>	<b>+\$24</b>	<b>+\$43</b>	<b>+\$71</b>	<b>+\$110</b>	<b>+\$126</b>	<b>+\$160</b>	<b>+\$213</b>	<b>+\$253</b>	<b>+\$297</b>	<b>+\$387</b>	<b>+\$483</b>		
		Side upcharge:	<b>+0</b>	<b>+\$48</b>	<b>+\$86</b>	<b>+\$141</b>	<b>+\$219</b>	<b>+\$252</b>	<b>+\$320</b>	<b>+\$426</b>	<b>+\$506</b>	<b>+\$593</b>	<b>+\$774</b>	<b>+\$965</b>		
			<b>OVERALL DIMENSIONS</b>	<b>SEAT DIMENSIONS</b>			<b>BACK DIMENSIONS</b>									
			<b>W</b>	<b>D</b>	<b>H</b>	<b>W</b>	<b>D</b>	<b>H</b>	<b>W</b>	<b>H</b>						
		27.5	27.5	17.5	-	-	-	-	-							
		Add \$160 for moisture barrier (MB).														
		Width and depth may vary by up to .05 in.	<b>RTA 00</b>	1 per carton												
 <p><b>Trapezoid Ottoman 26" x 39"</b> COM Yardage: Top: 1; Side: 1.5 Freight Class: 150 Product Weight (lbs.): 67 Cubic Feet Per Carton: 13.75</p>	RA2639TR	Base Price:	<b>\$1062</b>													
		Top upcharge:	<b>+0</b>	<b>+\$32</b>	<b>+\$57</b>	<b>+\$94</b>	<b>+\$146</b>	<b>+\$168</b>	<b>+\$213</b>	<b>+\$284</b>	<b>+\$337</b>	<b>+\$395</b>	<b>+\$516</b>	<b>+\$643</b>		
		Side upcharge:	<b>+0</b>	<b>+\$48</b>	<b>+\$86</b>	<b>+\$141</b>	<b>+\$219</b>	<b>+\$252</b>	<b>+\$320</b>	<b>+\$426</b>	<b>+\$506</b>	<b>+\$593</b>	<b>+\$774</b>	<b>+\$965</b>		
			<b>OVERALL DIMENSIONS</b>	<b>SEAT DIMENSIONS</b>			<b>BACK DIMENSIONS</b>									
			<b>W</b>	<b>D</b>	<b>H</b>	<b>W</b>	<b>D</b>	<b>H</b>	<b>W</b>	<b>H</b>						
		39	26	17.5	-	-	-	-	-							
		Add \$160 for moisture barrier (MB).														
		Width and depth may vary by up to .05 in.	<b>RTA 00</b>	1 per carton												
 <p><b>Trapezoid Ottoman 26" x 52"</b> COM Yardage: Top: 1; Side: 1.5 Freight Class: 250 Product Weight (lbs.): 67.5 Cubic Feet Per Carton: 17.75</p>	RA2652TR	Base Price:	<b>\$1186</b>													
		Top upcharge:	<b>+0</b>	<b>+\$32</b>	<b>+\$57</b>	<b>+\$94</b>	<b>+\$146</b>	<b>+\$168</b>	<b>+\$213</b>	<b>+\$284</b>	<b>+\$337</b>	<b>+\$395</b>	<b>+\$516</b>	<b>+\$643</b>		
		Side upcharge:	<b>+0</b>	<b>+\$48</b>	<b>+\$86</b>	<b>+\$141</b>	<b>+\$219</b>	<b>+\$252</b>	<b>+\$320</b>	<b>+\$426</b>	<b>+\$506</b>	<b>+\$593</b>	<b>+\$774</b>	<b>+\$965</b>		
			<b>OVERALL DIMENSIONS</b>	<b>SEAT DIMENSIONS</b>			<b>BACK DIMENSIONS</b>									
			<b>W</b>	<b>D</b>	<b>H</b>	<b>W</b>	<b>D</b>	<b>H</b>	<b>W</b>	<b>H</b>						
		52	26.5	17.5	-	-	-	-	-							
		Add \$160 for moisture barrier (MB).														
		Width and depth may vary by up to .05 in.	<b>RTA 00</b>	1 per carton												

## RIVER™



Sample Layout



Sample Layout

### STANDARD FEATURES

- A modular seating series that is composed of modular linking units in straight, curved and corner units. Soft seating models are available with standard height, high and extended high backs. All linking units can be used together in any combination to create a wide variety of layouts.
- The unique tapered legs (swaged legs) are made of welded steel, heavy duty construction, with each leg bolted directly to the frame. The extremely robust construction insures trouble free performance in any environment. All units except for the Laptop Tables have the same leg height of 6.5". The leg height makes it easier to clean under the product.
- Each leg is standard with adjustable black nylon leveling glides and are non-marking. Wood legs and casters are not available.
- All cushions are fixed and non-removable (cushions will not migrate). Perimeter seams feature a decorative single stitch detail, which makes seams lay flat and adds extra seam strength.
- Seating frames are heavy duty with interlocking plywood, puzzle box construction, made for rugged active environments. Seats are high density with highly resilient foam and are equipped with a synthetic rubberized webbing suspension system for extra comfort.
- Front edge or face of the seat, angles slightly inward, so feet have freedom of movement and shoe heels don't rub on the seat. This inward slanting matches the inward angles of the back. Benches and connecting end tables also reflect the inward angles on the front and back faces, so all units coordinate in visual appearance.
- For use in high traffic applications as well as 24/7 environments or for models with 600 lb. standard weight capacity, clean out space between seat and back and /or modular arms, please see the River+ series.
- Most units can be ganged together with a quick connect, disconnect feature. Ganging hardware is standard and is factory installed. Ganging hardware swivels out of sight when not in use.

### OPTIONAL FEATURES

- Most tables and seating units can be specified with Power/USB terminals, which includes two power outlets, two double USB terminals and a black 60" three-prong power cord. Each Power/USB module is set in predetermined locations, as shown in the electrical illustrations below. Electrical units must be factory installed.
- To add a Power/USB module: From the electrical illustrations below, please specify **J1, W1, J2, W2, J3, W4, J4, W4, J6** or **W6** after the product model number. Please note on seating units, if both right and left locations are required, add both **J1/J3** or **W1/W3** to the model number. Add \$997 for each module/location required.
- Power/USB modules are available with either Jet Black (**J**) face plate with black Power/USB receptacles or with a White (**W**) face plate with white Power/USB receptacles.
- Coffee, end and laptop tables are made with high pressure laminate and are offered in the following finishes: Absolute Acajou (**ACJ**), Asian Night (**ASN**), Avant Cherry (**AWC**), Avant Honey (**AWH**), Blizzard (**BZD**), Clear Maple (**CMB**), Custom Grey (**CGY**), Dark Espresso (**DES**), Designer White (**DWT**), Fashionista (**FAS**), First Class (**FCL**), Noce Biondo (**NBL**), Noce Grigio (**NGL**), Noce Leggero (**NEL**), Noce Medio (**NML**), Quartered Mahogany (**QTM**), Sheer Beauty (**SBY**), Stonedust (**SDT**), Walnut Heights (**WHE**), White Chocolate (**WHC**) and Winter Cherry (**WCR**). Please Specify. Custom High Pressure laminate finishes will be considered upon request.
- **Seating and Table Leg Finish**

<b>(CHM)</b> Chrome	<b>(TBL)</b> Black
<b>(TDW)</b> Designer White	<b>(TFO)</b> Fog
<b>(TFR)</b> Frost	<b>(TIV)</b> Cloud
<b>(TLA)</b> Latte	<b>(TMO)</b> Mocha
<b>(TNE)</b> Nevada	<b>(TOA)</b> Toast
<b>(TSH)</b> Shadow	<b>(TSN)</b> Sand
<b>(TTU)</b> Tungsten	<b>(TKA)</b> Kalua
- Check textile availability prior to specifying upholstery material. Leather not available on River series.
- If more than one fabric or a fabric/vinyl combination is required, please fill out a "Seating Multiple Textile" form, specifying each fabric location. Please contact Customer Care for more information.

### ELECTRICAL PLACEMENT

#### Soft Seating

Locations available on left side J1 (black) or W1 (white), right side J3 (black), or W3 (white) or both sides J1/J3 (black) or W1/W3 (white).

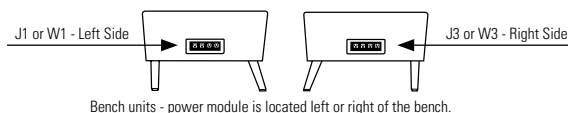
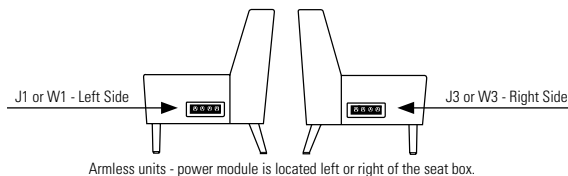
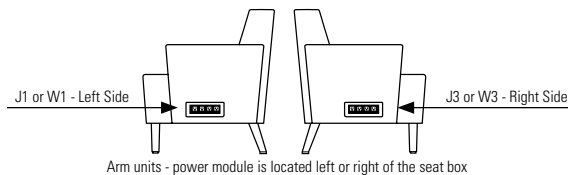

#### Coffee/End Tables

Primary location is on the top of the unit, centered J2 (black) or W2 (white). Secondary Location is end/side of the unit J1 (black) or W1 (white).

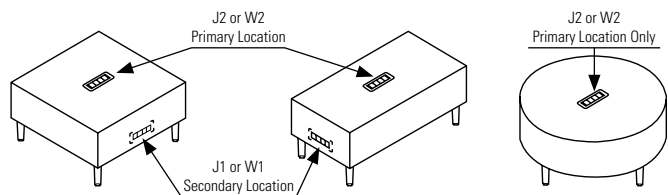

Primary location is on the top rear/edge of the unit J4 (black) or W4 (white). Secondary Location is the back side of the unit J6 (black) or W6 (white).

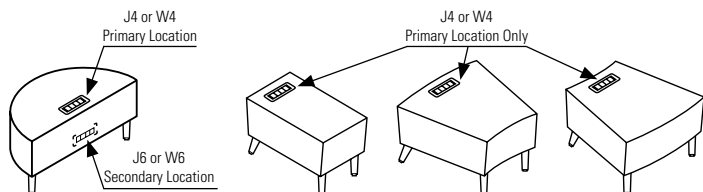

SAMPLE LAYOUTS

RVR101 (Layout 1)

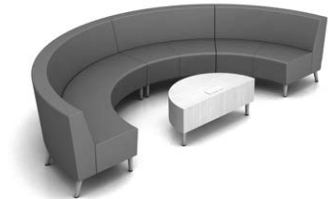

Qty	Model Number	Description	Dimensions	List Price
4	<b>7710NA</b>	Armless IS Curve - Two Seat - Standard Back	55 x 29.5 x 32	3438 x 4
1	<b>7737W6</b>	42" Half Round Laminate Coffee Table w/ W6 Rear Power/USB Module	42 x 21 x 17 upcharge	1461 997

**SAMPLE LAYOUT TOTAL (Starting at Grade 1) \$16,210**

RVR102 (Layout 2)



Qty	Model Number	Description	Dimensions	List Price
8	<b>7714NA</b>	Armless OS Curve - Two Seater - High Back	54x 29.5 x 41.5	4099 x 8

**SAMPLE LAYOUT TOTAL (Starting at Grade 1) \$32,792**

RVR103 (Layout 3)

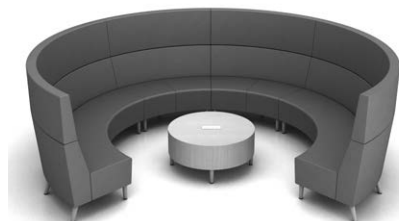

Qty	Model Number	Description	Dimensions	List Price
6	<b>7712NA</b>	Armless IS Curve - Two Seater - Extended Back	55 x 29.5 x 47	4804 x 6
1	<b>7734W2</b>	36" Dia - Round Laminate Coffee Table w/ W2 Center Power/USB Module	36 x 36 x 17 upcharge	1701 997

**SAMPLE LAYOUT TOTAL (Starting at Grade 1) \$31,522**

RVR104 (Layout 4)



Qty	Model Number	Description	Dimensions	List Price
2	<b>7712NA</b>	Armless IS Curve - Two Seater - Extended Back	55 x 29.5 x 47	4804 x 2
2	<b>7712NAW3</b>	Armless IS Curve - Two Seater - Extended Back w/ W3 Right Power/USB Module	55 x 29.5 x 47 upcharge	4804 x 2 997 x 2
2	<b>7726</b>	IS Curve - Two Seater Bench	54 x 28 x 17.5	2918 x 2
1	<b>7734</b>	36" Dia - Round Laminate Coffee Table	36 x 36 x 17	1701

**SAMPLE LAYOUT TOTAL (Starting at Grade 1) \$28,747**

RVR105 (Layout 5)



Qty	Model Number	Description	Dimensions	List Price
3	<b>7711NA</b>	Armless IS Curve - Two Seater - High Back	55 x 29.5 x 41.5	4365 x 3
3	<b>7712NAW3</b>	Armless IS Curve - Two Seater - Extended Back w/ W3 Right Power/USB Module	55 x 29.5 x 47 upcharge	4804 x 3 997 x 2
1	<b>7738</b>	Rectangular Laminate End Table	15 x 27.25 x 17	1381
2	<b>7743</b>	18" Dia. Round Laminate Laptop Table	18 x 18 x 25.25	836 x 2

**SAMPLE LAYOUT TOTAL (Starting at Grade 1) \$32,554**

## SAMPLE LAYOUTS

**RVR106 (Layout 6)**



Qty	Model Number	Description	Dimensions	List Price
1	<b>7709R</b>	Three Seater - Extended Back w/Right Arm	75 x 29.5 x 47	6540
1	<b>7709L</b>	Three Seater - Extended Back w/Left Arm	75 x 29.5 x 47	6540
1	<b>7718</b>	Armless Corner Unit - Extended Back	38 x 38 x 47	5633
1	<b>7732W2</b>	36" Square Laminate Coffee Table w/ W2 Center Power/USB Module	36 x 36 x 17 upcharge	1559 997

**SAMPLE LAYOUT TOTAL (Starting at Grade 1) \$21,217**

**RVR107 (Layout 7)**



Qty	Model Number	Description	Dimensions	List Price
1	<b>7704NA</b>	Armless Two Seater - Standard. Back	75x 29.5 x 47	2976
2	<b>7716</b>	Armless Corner Unit - Standard. Back	75 x 29.5 x 47	4199 x 2
1	<b>7725</b>	Two Seater Bench	75x 29.5 x 47	2148
1	<b>7728</b>	Square Single Seater Bench	75 x 29.5 x 17.5	1469
1	<b>7731</b>	30" Square Laminate Coffee Table	75 x 30 x 47	1372

**SAMPLE LAYOUT TOTAL (Starting at Grade 1) \$16,363**

**RVR108 (Layout 8)**



Qty	Model Number	Description	Dimensions	List Price
2	<b>7708NAW3</b>	Armless Three Seater - High Back w/ W3 Right Power/USB Module	75 x 29.5 x 41.5 upcharge	5639 x 2 997 x 2
2	<b>7708NAW1</b>	Armless Three Seater - High Back w/ W1 Left Power/USB Module	72.5 x 29.5 x 41.5 upcharge	5639 x 2 997 x 2
2	<b>7745</b>	16" Square Laminate Laptop Table	16 x 16 x 25.25	855 x 2

**SAMPLE LAYOUT TOTAL (Starting at Grade 1) \$28,248**

**RVR109 (Layout 9)**



Qty	Model Number	Description	Dimensions	List Price
2	<b>7702</b>	Lounge Chair - High Back w/Arms	29.5 x 29.5 x 41.5	3182 x 2
1	<b>7708NAW1</b>	Armless Three Seater - High Back w/ W1 Left Power/USB Module	72.5 x 29.5 x 41.5 upcharge	5639 945
1	<b>7708NAW3</b>	Armless Three Seater - High Back w/ W3 Right Power/USB Module	72.5 x 29.5 x 41.5 upcharge	5639 945
1	<b>7733</b>	Rectangular Laminate Coffee Table	40 x 20 x 17	1378

**SAMPLE LAYOUT TOTAL (Starting at Grade 1) \$21,014**

**RVR110 (Layout 10)**



Qty	Model Number	Description	Dimensions	List Price
1	<b>7705NAW3</b>	Armless Two Seater - High Back w/ W3 Right Power/USB Module	48.5 x 29.5 x 41.5 upcharge	3647 997
1	<b>7705NAW1</b>	Armless Two Seater - High Back w/ W1 Left Power/USB Module	48.5 x 29.5 x 41.5 upcharge	3647 997
1	<b>7708NA</b>	Armless Three Seater - High Back	72.5 x 29.5 x 41.5	5639
1	<b>7708NAW3</b>	Armless Three Seater - High Back w/ W3 Right Power/USB Module	72.5 x 29.5 x 41.5 upcharge	5639 997
1	<b>7708NAW1</b>	Armless Three Seater - High Back w/ W1 Left Power/USB Module	72.5 x 29.5 x 41.5 upcharge	5639 997
2	<b>7717</b>	Armless Corner Unit - High Back	38 x 38 x 41.5	5319 x 2
3	<b>7745</b>	16" Square Laminate Laptop Table	16 x 16 x 25.25	855 x 3

**SAMPLE LAYOUT TOTAL (Starting at Grade 1) \$41,402**

DESCRIPTION	FEATURES	MODEL#	STANDARD TEXTILE GRADES		
<b>RVR111 (Layout 11)</b> 	Qty	Model Number	Description	Dimensions	List Price
	2	<b>7701NA</b>	Armless One Seater - Standard Back	24.5 x 29.5x 32	1907 x 2
	4	<b>7710NA</b>	Armless IS Curve - Two Seat - Standard Back	55 x 29.5 x 32	3438 x 4
	2	<b>7743</b>	18" Dia. Round Laminate Laptop Table	18 x 18 x 25.25	836 x 2
<b>SAMPLE LAYOUT TOTAL (Starting at Grade 1)</b>					<b>\$19,238</b>

<b>RVR112 (Layout 12)</b> 	Qty	Model Number	Description	Dimensions	List Price
	2	<b>7711NA</b>	Armless IS Curve - Two Seater - High Back	55 x 29.5 x 41.5	4365 x 2
	6	<b>7712NA</b>	Armless IS Curve - Two Seater - Extended Back	55 x 29.5 x 47	4804 x 6
	1	<b>7709NA</b>	Armless Three Seater - Extended Back	72.5 x 29.5 x 47	6105
	2	<b>7734</b>	36" Dia - Round Laminate Coffee Table	36 x 36 x 17	1701 x 2
<b>SAMPLE LAYOUT TOTAL (Starting at Grade 1)</b>					<b>\$47,061</b>

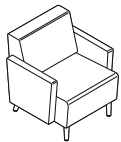

**Lounge Chair - Standard Back w/Arms**  
 COM Yardage: 4  
 Freight Class: 250  
 Product Weight (lbs.): 57  
 Cubic Feet Per Carton: 22.5

For Power/USB module please see electrical placement chart. No ganging hardware.

	1	2	3	4	5	6	7	8	9	10	11	12
<b>7701</b>	2776	2944	3077	3274	3554	3654	3899	4366	4591	5024	5614	6350

OVERALL DIMENSIONS			SEAT DIMENSIONS			BACK DIMENSIONS	
W	D	H	W	D	H	W	H
29.5	29.5	32	24	19	18	24	14

RTA 00

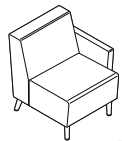

**7701L (Left Arm)**

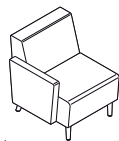

**7701R (Right Arm)**

**Lounge Chair - Standard w/One Arm**  
 COM Yardage: 3.25  
 Freight Class: 250  
 Product Weight (lbs.): 47  
 Cubic Feet Per Carton: 22.5

For Power/USB module please see electrical placement chart. Includes ganging hardware (1 side).

	1	2	3	4	5	6	7	8	9	10	11	12
<b>7701L</b>	2348	2488	2595	2757	2981	3066	3263	3644	3825	4179	4658	5256
<b>7701R</b>	2348	2488	2595	2757	2981	3066	3263	3644	3825	4179	4658	5256

OVERALL DIMENSIONS			SEAT DIMENSIONS			BACK DIMENSIONS	
W	D	H	W	D	H	W	H
27	29.5	32	24	19	18	24	14

RTA 00

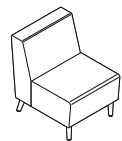

**Armless Lounge Chair - Standard Back**  
 COM Yardage: 2.5  
 Freight Class: 300  
 Product Weight (lbs.): 37  
 Cubic Feet Per Carton: 22.5

For Power/USB module please see electrical placement chart. Includes ganging hardware (2 sides).

	1	2	3	4	5	6	7	8	9	10	11	12
<b>7701NA</b>	1907	2016	2097	2221	2397	2460	2614	2903	3046	3316	3685	4145

OVERALL DIMENSIONS			SEAT DIMENSIONS			BACK DIMENSIONS	
W	D	H	W	D	H	W	H
24.5	29.5	32	24	19	18	24	14

RTA 00

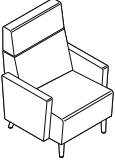
DESCRIPTION	FEATURES	MODEL#	STANDARD TEXTILE GRADES													
			1	2	3	4	5	6	7	8	9	10	11	12		
 <p><b>Lounge Chair - High Back w/Arms</b> COM Yardage: 4.5 Freight Class: 250 Product Weight (lbs.): 61 Cubic Feet Per Carton: 28.25</p>	<p>For Power/USB module please see electrical placement chart. No ganging hardware.</p>	<b>7702</b>	3182	3372	3521	3744	4058	4173	4445	4972	5226	5714	6377	7203		
		<b>OVERALL DIMENSIONS</b>			<b>SEAT DIMENSIONS</b>			<b>BACK DIMENSIONS</b>								
		<b>W</b>	<b>D</b>	<b>H</b>	<b>W</b>	<b>D</b>	<b>H</b>	<b>W</b>	<b>H</b>							
			29.5	29.5	41.5	24	19	18	24	24						
			<b>RTA 00</b>													

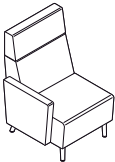
DESCRIPTION	FEATURES	MODEL#	STANDARD TEXTILE GRADES													
			1	2	3	4	5	6	7	8	9	10	11	12		
  <p><b>7702L (Left Arm)</b>      <b>7702R (Right Arm)</b></p> <p><b>Lounge Chair - High Back w/One Arm</b> COM Yardage: 4.5 Freight Class: 250 Product Weight (lbs.): 61 Cubic Feet Per Carton: 28.25</p>	<p>For Power/USB module please see electrical placement chart. Includes ganging hardware (1 side).</p>	<b>7702L</b>	2753	2914	3035	3223	3485	3577	3807	4245	4457	4863	5416	6106		
		<b>7702R</b>	2753	2914	3035	3223	3485	3577	3807	4245	4457	4863	5416	6106		
		<b>OVERALL DIMENSIONS</b>			<b>SEAT DIMENSIONS</b>			<b>BACK DIMENSIONS</b>								
			<b>W</b>	<b>D</b>	<b>H</b>	<b>W</b>	<b>D</b>	<b>H</b>	<b>W</b>	<b>H</b>						
			29.5	29.5	41.5	24	19	18	24	24						
			<b>RTA 00</b>													

DESCRIPTION	FEATURES	MODEL#	STANDARD TEXTILE GRADES													
			1	2	3	4	5	6	7	8	9	10	11	12		
 <p><b>Armless Lounge Chair - High Back</b> COM Yardage: 3 Freight Class: 300 Product Weight (lbs.): 41 Cubic Feet Per Carton: 28.25</p>	<p>For Power/USB module please see electrical placement chart. Includes ganging hardware (2 sides).</p>	<b>7702NA</b>	2314	2444	2541	2689	2898	2974	3160	3510	3678	4004	4446	4998		
		<b>OVERALL DIMENSIONS</b>			<b>SEAT DIMENSIONS</b>			<b>BACK DIMENSIONS</b>								
		<b>W</b>	<b>D</b>	<b>H</b>	<b>W</b>	<b>D</b>	<b>H</b>	<b>W</b>	<b>H</b>							
			24.5	29.5	41.5	24	19	18	24	24						
			<b>RTA 00</b>													

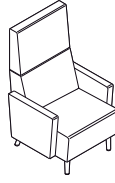
DESCRIPTION	FEATURES	MODEL#	STANDARD TEXTILE GRADES													
			1	2	3	4	5	6	7	8	9	10	11	12		
 <p><b>Lounge Chair - Extended Back w/Arms</b> COM Yardage: 4.75 Freight Class: 250 Product Weight (lbs.): 68 Cubic Feet Per Carton: 32.75</p>	<p>For Power/USB module please see electrical placement chart. No ganging hardware.</p>	<b>7703</b>	3687	3885	4043	4278	4611	4731	5021	5576	5844	6359	7057	7931		
		<b>OVERALL DIMENSIONS</b>			<b>SEAT DIMENSIONS</b>			<b>BACK DIMENSIONS</b>								
		<b>W</b>	<b>D</b>	<b>H</b>	<b>W</b>	<b>D</b>	<b>H</b>	<b>W</b>	<b>H</b>							
			29.5	29.5	47	24	19	18	24	29						
			<b>RTA 00</b>													

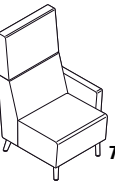
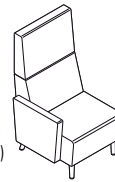
DESCRIPTION	FEATURES	MODEL#	STANDARD TEXTILE GRADES													
			1	2	3	4	5	6	7	8	9	10	11	12		
  <p><b>7703L (Left Arm)</b>      <b>7703R (Right Arm)</b></p> <p><b>Lounge Chair - Extended Back w/One Arm</b> COM Yardage: 4 Freight Class: 300 Product Weight (lbs.): 58 Cubic Feet Per Carton: 32.75</p>	<p>For Power/USB module please see electrical placement chart. Includes ganging hardware (1 side).</p>	<b>7703L</b>	3258	3426	3559	3756	4034	4135	4378	4847	5073	5506	6095	6832		
		<b>7703R</b>	3258	3426	3559	3756	4034	4135	4378	4847	5073	5506	6095	6832		
		<b>OVERALL DIMENSIONS</b>			<b>SEAT DIMENSIONS</b>			<b>BACK DIMENSIONS</b>								
			<b>W</b>	<b>D</b>	<b>H</b>	<b>W</b>	<b>D</b>	<b>H</b>	<b>W</b>	<b>H</b>						
			29.5	29.5	47	24	19	18	24	29						
			<b>RTA 00</b>													

DESCRIPTION FEATURES MODEL# STANDARD TEXTILE GRADES

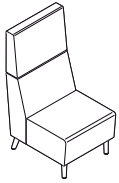

**Armless Lounge Chair - Extended Back**  
 COM Yardage: 3.25  
 Freight Class: 300  
 Product Weight (lbs.): 48  
 Cubic Feet Per Carton: 32.75

For Power/USB module please see electrical placement chart. Includes ganging hardware (2 sides).

MODEL#	1	2	3	4	5	6	7	8	9	10	11	12
7703NA	2819	2957	3065	3227	3452	3535	3734	4114	4295	4649	5127	5724

OVERALL DIMENSIONS			SEAT DIMENSIONS			BACK DIMENSIONS	
W	D	H	W	D	H	W	H
24.5	29.5	47	24	19	18	24	29

RTA 00

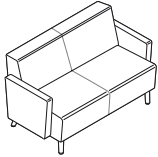

**Two Seater - Standard Back w/Arms**  
 COM Yardage: 5.5  
 Freight Class: 250  
 Product Weight (lbs.): 95  
 Cubic Feet Per Carton: 39

For Power/USB module please see electrical placement chart. No ganging hardware.

MODEL#	1	2	3	4	5	6	7	8	9	10	11	12
7704	3836	4066	4247	4517	4903	5041	5379	6024	6328	6926	7736	8746

OVERALL DIMENSIONS			SEAT DIMENSIONS			BACK DIMENSIONS	
W	D	H	W	D	H	W	H
53.5	29.5	32	48	19	18	48	14

RTA 00

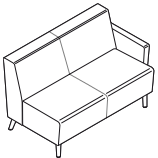

7704L (Left Arm)

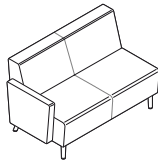

7704R (Right Arm)

**Two Seater - Standard Back w/One Arm**  
 COM Yardage: 4.75  
 Freight Class: 300  
 Product Weight (lbs.): 85  
 Cubic Feet Per Carton: 39

For Power/USB module please see electrical placement chart. Includes ganging hardware (1 side).

MODEL#	1	2	3	4	5	6	7	8	9	10	11	12
7704L	3413	3613	3771	4005	4339	4458	4749	5303	5571	6086	6786	7660
7704R	3413	3613	3771	4005	4339	4458	4749	5303	5571	6086	6786	7660

OVERALL DIMENSIONS			SEAT DIMENSIONS			BACK DIMENSIONS	
W	D	H	W	D	H	W	H
51	29.5	32	48	19	18	48	14

RTA 00

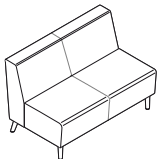

**Armless Two Seater - Standard Back**  
 COM Yardage: 4.25  
 Freight Class: 300  
 Product Weight (lbs.): 75  
 Cubic Feet Per Carton: 39

For Power/USB module please see electrical placement chart. Includes ganging hardware (2 sides).

MODEL#	1	2	3	4	5	6	7	8	9	10	11	12
7704NA	2976	3157	3298	3508	3805	3910	4171	4667	4907	5367	5995	6776

OVERALL DIMENSIONS			SEAT DIMENSIONS			BACK DIMENSIONS	
W	D	H	W	D	H	W	H
48.5	29.5	32	48	19	18	48	14

RTA 00

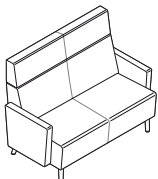

**Two Seater - High Back w/Arms**  
 COM Yardage: 6.5  
 Freight Class: 300  
 Product Weight (lbs.): 97  
 Cubic Feet Per Carton: 54

For Power/USB module please see electrical placement chart. No ganging hardware.

MODEL#	1	2	3	4	5	6	7	8	9	10	11	12
7705	4515	4789	5002	5325	5776	5940	6341	7099	7463	8169	9127	10320

OVERALL DIMENSIONS			SEAT DIMENSIONS			BACK DIMENSIONS	
W	D	H	W	D	H	W	H
53.5	29.5	41.5	48	19	18	48	24

RTA 00

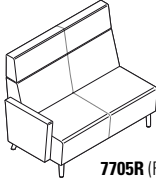
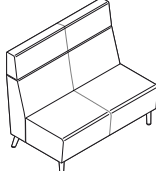
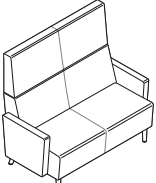
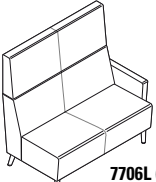
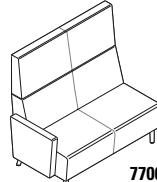
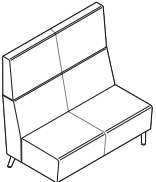
DESCRIPTION	FEATURES	MODEL#	STANDARD TEXTILE GRADES												
			1	2	3	4	5	6	7	8	9	10	11	12	
 <b>7705L (Left Arm)</b>	 <b>7705R (Right Arm)</b>														
		<b>7705L</b>	4084	4324	4514	4797	5201	5344	5698	6369	6692	7315	8163	9221	
<b>Two Seater - High Back w/One Arm</b> COM Yardage: 5.75 Freight Class: 300 Product Weight (lbs.): 87 Cubic Feet Per Carton: 54		For Power/USB module please see electrical placement chart. Includes ganging hardware (1 side).		<b>OVERALL DIMENSIONS</b> W    D    H			<b>SEAT DIMENSIONS</b> W    D    H			<b>BACK DIMENSIONS</b> W    H					
				51	29.5	41.5	48	19	18	48	24				
				<b>RTA 00</b>											
															
	<b>7705NA</b>	3647	3867	4041	4302	4667	4801	5121	5734	6031	6598	7372	8338		
<b>Armless Two Seater - High Back</b> COM Yardage: 5.25 Freight Class: 300 Product Weight (lbs.): 77 Cubic Feet Per Carton: 54		For Power/USB module please see electrical placement chart. Includes ganging hardware (2 sides).		<b>OVERALL DIMENSIONS</b> W    D    H			<b>SEAT DIMENSIONS</b> W    D    H			<b>BACK DIMENSIONS</b> W    H					
				48.5	29.5	41.5	48	19	18	48	24				
				<b>RTA 00</b>											
															
	<b>7706</b>	4765	5059	5289	5636	6125	6303	6728	7546	7940	8701	9730	11015		
<b>Two Seater - Extended Back w/Arms</b> COM Yardage: 7 Freight Class: 300 Product Weight (lbs.): 107 Cubic Feet Per Carton: 56.75		For Power/USB module please see electrical placement chart. No ganging hardware.		<b>OVERALL DIMENSIONS</b> W    D    H			<b>SEAT DIMENSIONS</b> W    D    H			<b>BACK DIMENSIONS</b> W    H					
				53.5	29.5	47	48	19	18	48	29				
				<b>RTA 00</b>											
 <b>7706L (Left Arm)</b>	 <b>7706R (Right Arm)</b>														
		<b>7706L</b>	4334	4596	4802	5110	5548	5702	6086	6818	7167	7848	8769	9915	
<b>Two Seater - Extended Back w/One Arm</b> COM Yardage: 6.25 Freight Class: 300 Product Weight (lbs.): 97 Cubic Feet Per Carton: 56.75		For Power/USB module please see electrical placement chart. Includes ganging hardware (1 side).		<b>OVERALL DIMENSIONS</b> W    D    H			<b>SEAT DIMENSIONS</b> W    D    H			<b>BACK DIMENSIONS</b> W    H					
				51	29.5	47	48	19	18	48	29				
				<b>RTA 00</b>											
															
	<b>7706NA</b>	3893	4134	4324	4608	5011	5154	5508	6179	6503	7125	7973	9031		
<b>Armless Two Seater - Extended Back</b> COM Yardage: 5.75 Freight Class: 300 Product Weight (lbs.): 87 Cubic Feet Per Carton: 56.75		For Power/USB module please see electrical placement chart. Includes ganging hardware (2 sides).		<b>OVERALL DIMENSIONS</b> W    D    H			<b>SEAT DIMENSIONS</b> W    D    H			<b>BACK DIMENSIONS</b> W    H					
				48.5	29.5	47	48	19	18	48	29				
				<b>RTA 00</b>											

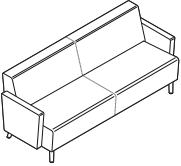
DESCRIPTION	FEATURES	MODEL#	STANDARD TEXTILE GRADES													
			1	2	3	4	5	6	7	8	9	10	11	12		
 <p><b>Three Seater - Standard Back w/Arms</b> COM Yardage: 8.25 Freight Class: 250 Product Weight (lbs.): 139 Cubic Feet Per Carton: 55.5</p>	<p>For Power/USB module please see electrical placement chart. No ganging hardware.</p>	<b>7707</b>	5704	6045	6321	6727	7304	7510	8015	8980	9444	10340	11556	13071		
		<b>OVERALL DIMENSIONS</b>			<b>SEAT DIMENSIONS</b>			<b>BACK DIMENSIONS</b>								
		<b>W</b>	<b>D</b>	<b>H</b>	<b>W</b>	<b>D</b>	<b>H</b>	<b>W</b>	<b>H</b>							
			77.5	29.5	32	72	19	18	72	14						
<b>RTA 00</b>																

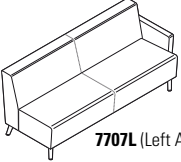
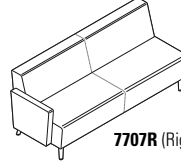
DESCRIPTION	FEATURES	MODEL#	STANDARD TEXTILE GRADES														
			1	2	3	4	5	6	7	8	9	10	11	12			
 <p><b>7707L (Left Arm)</b></p>  <p><b>7707R (Right Arm)</b></p> <p><b>Three Seater - Standard Back w/One Arm</b> COM Yardage: 7.75 Freight Class: 250 Product Weight (lbs.): 129 Cubic Feet Per Carton: 55.5</p>	<p>For Power/USB module please see electrical placement chart. Includes ganging hardware (1 side).</p>	<b>7707L</b>	5277	5599	5855	6238	6779	6976	7449	8353	8790	9630	10772	12196			
					<b>7707R</b>	5277	5599	5855	6238	6779	6976	7449	8353	8790	9630	10772	12196
		<b>OVERALL DIMENSIONS</b>			<b>SEAT DIMENSIONS</b>			<b>BACK DIMENSIONS</b>									
<b>W</b>	<b>D</b>	<b>H</b>	<b>W</b>	<b>D</b>	<b>H</b>	<b>W</b>	<b>H</b>										
			75	29.5	32	72	19	18	72	14							
<b>RTA 00</b>																	

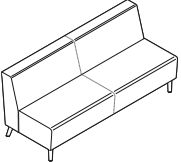
DESCRIPTION	FEATURES	MODEL#	STANDARD TEXTILE GRADES													
			1	2	3	4	5	6	7	8	9	10	11	12		
 <p><b>Armless Three Seater - Standard Back</b> COM Yardage: 7 Freight Class: 250 Product Weight (lbs.): 119 Cubic Feet Per Carton: 55.5</p>	<p>For Power/USB module please see electrical placement chart. Includes ganging hardware (2 sides).</p>	<b>7707NA</b>	4837	5132	5361	5709	6198	6374	6801	7620	8013	8773	9803	11092		
		<b>OVERALL DIMENSIONS</b>			<b>SEAT DIMENSIONS</b>			<b>BACK DIMENSIONS</b>								
		<b>W</b>	<b>D</b>	<b>H</b>	<b>W</b>	<b>D</b>	<b>H</b>	<b>W</b>	<b>H</b>							
			72.5	29.5	32	72	19	18	72	14						
<b>RTA 00</b>																

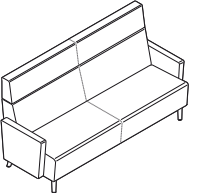
DESCRIPTION	FEATURES	MODEL#	STANDARD TEXTILE GRADES													
			1	2	3	4	5	6	7	8	9	10	11	12		
 <p><b>Three Seater - High Back w/Arms</b> COM Yardage: 10.5 Freight Class: 250 Product Weight (lbs.): 148 Cubic Feet Per Carton: 69.75</p>	<p>For Power/USB module please see electrical placement chart. No ganging hardware.</p>	<b>7708</b>	6501	6937	7282	7802	8534	8800	9441	10669	11261	12397	13947	15875		
		<b>OVERALL DIMENSIONS</b>			<b>SEAT DIMENSIONS</b>			<b>BACK DIMENSIONS</b>								
		<b>W</b>	<b>D</b>	<b>H</b>	<b>W</b>	<b>D</b>	<b>H</b>	<b>W</b>	<b>H</b>							
			77.5	29.5	41.5	72	19	18	72	24						
<b>RTA 00</b>																

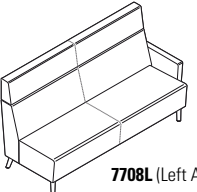
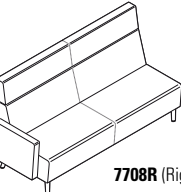
DESCRIPTION	FEATURES	MODEL#	STANDARD TEXTILE GRADES														
			1	2	3	4	5	6	7	8	9	10	11	12			
 <p><b>7708L (Left Arm)</b></p>  <p><b>7708R (Right Arm)</b></p> <p><b>Three Seater - High Back w/One Arm</b> COM Yardage: 9.75 Freight Class: 300 Product Weight (lbs.): 139 Cubic Feet Per Carton: 69.75</p>	<p>For Power/USB module please see electrical placement chart. Includes ganging hardware (1 side).</p>	<b>7708L</b>	6078	6485	6806	7285	7967	8214	8809	9948	10497	11554	12992	14784			
					<b>7708R</b>	6078	6485	6806	7285	7967	8214	8809	9948	10497	11554	12992	14784
		<b>OVERALL DIMENSIONS</b>			<b>SEAT DIMENSIONS</b>			<b>BACK DIMENSIONS</b>									
<b>W</b>	<b>D</b>	<b>H</b>	<b>W</b>	<b>D</b>	<b>H</b>	<b>W</b>	<b>H</b>										
			75	29.5	41.5	72	19	18	72	24							
<b>RTA 00</b>																	

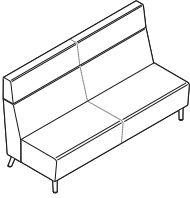
DESCRIPTION	FEATURES	MODEL#	STANDARD TEXTILE GRADES													
			1	2	3	4	5	6	7	8	9	10	11	12		
 <p><b>Armless Three Seater - High Back</b>                      COM Yardage: 9.25                      Freight Class: 300                      Product Weight (lbs.): 126                      Cubic Feet Per Carton: 69.75</p>	For Power/USB module please see electrical placement chart. Includes ganging hardware (2 sides).	<b>7708NA</b>	5639	6027	6329	6787	7434	7668	8231	9314	9835	10836	12199	13900		
		<b>OVERALL DIMENSIONS</b>			<b>SEAT DIMENSIONS</b>			<b>BACK DIMENSIONS</b>								
		<b>W</b>	<b>D</b>	<b>H</b>	<b>W</b>	<b>D</b>	<b>H</b>	<b>W</b>	<b>H</b>							
			72.5	29.5	41.5	72	19	18	72	24						
			<b>RTA 00</b>													

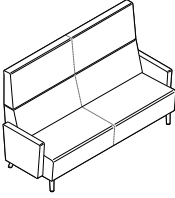
DESCRIPTION	FEATURES	MODEL#	STANDARD TEXTILE GRADES													
			1	2	3	4	5	6	7	8	9	10	11	12		
 <p><b>Three Seater - Extended Back w/Arms</b>                      COM Yardage: 11                      Freight Class: 300                      Product Weight (lbs.): 144                      Cubic Feet Per Carton: 78.75</p>	For Power/USB module please see electrical placement chart. No ganging hardware.	<b>7709</b>	6974	7432	7793	8338	9108	9383	10057	11341	11959	13154	14775	16795		
		<b>OVERALL DIMENSIONS</b>			<b>SEAT DIMENSIONS</b>			<b>BACK DIMENSIONS</b>								
		<b>W</b>	<b>D</b>	<b>H</b>	<b>W</b>	<b>D</b>	<b>H</b>	<b>W</b>	<b>H</b>							
			77.5	29.5	47	72	19	18	72	29						
			<b>RTA 00</b>													

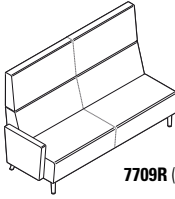
DESCRIPTION	FEATURES	MODEL#	STANDARD TEXTILE GRADES													
			1	2	3	4	5	6	7	8	9	10	11	12		
 <p><b>7709L (Left Arm)</b></p>  <p><b>7709R (Right Arm)</b></p> <p><b>Three Seater - Extended Back w/One Arm</b>                      COM Yardage: 10.5                      Freight Class: 300                      Product Weight (lbs.): 134                      Cubic Feet Per Carton: 78.75</p>	For Power/USB module please see electrical placement chart. Includes ganging hardware (1 side).	<b>7709L</b>	6540	6977	7321	7841	8576	8839	9483	10708	11296	12436	13984	15912		
		<b>7709R</b>	6540	6977	7321	7841	8576	8839	9483	10708	11296	12436	13984	15912		
		<b>OVERALL DIMENSIONS</b>			<b>SEAT DIMENSIONS</b>			<b>BACK DIMENSIONS</b>								
<b>W</b>	<b>D</b>	<b>H</b>	<b>W</b>	<b>D</b>	<b>H</b>	<b>W</b>	<b>H</b>									
			75	29.5	47	72	19	18	72	29						
			<b>RTA 00</b>													

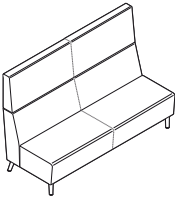
DESCRIPTION	FEATURES	MODEL#	STANDARD TEXTILE GRADES													
			1	2	3	4	5	6	7	8	9	10	11	12		
 <p><b>Armless Three Seater - Extended Back</b>                      COM Yardage: 9.75                      Freight Class: 300                      Product Weight (lbs.): 124                      Cubic Feet Per Carton: 78.75</p>	For Power/USB module please see electrical placement chart. Includes ganging hardware (2 sides).	<b>7709NA</b>	6105	6512	6833	7312	7994	8241	8835	9975	10524	11581	13020	14811		
		<b>OVERALL DIMENSIONS</b>			<b>SEAT DIMENSIONS</b>			<b>BACK DIMENSIONS</b>								
		<b>W</b>	<b>D</b>	<b>H</b>	<b>W</b>	<b>D</b>	<b>H</b>	<b>W</b>	<b>H</b>							
			72.5	29.5	47	72	19	18	72	29						
			<b>RTA 00</b>													

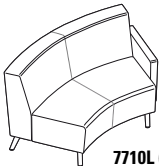
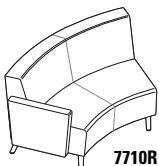
DESCRIPTION	FEATURES	MODEL#	STANDARD TEXTILE GRADES													
			1	2	3	4	5	6	7	8	9	10	11	12		
 <p><b>7710L (Left Arm)</b></p>  <p><b>7710R (Right Arm)</b></p> <p><b>IS Curve - Two Seater - Standard Back w/One Arm</b>                      COM Yardage: 5.25                      Freight Class: 250                      Product Weight (lbs.): 88                      Cubic Feet Per Carton: 43</p>	For Power/USB module please see electrical placement chart. Includes ganging hardware (1 side).	<b>7710L</b>	3879	4103	4273	4534	4901	5033	5354	5966	6264	6830	7604	8570		
		<b>7710R</b>	3879	4103	4273	4534	4901	5033	5354	5966	6264	6830	7604	8570		
		<b>OVERALL DIMENSIONS</b>			<b>SEAT DIMENSIONS</b>			<b>BACK DIMENSIONS</b>								
<b>W</b>	<b>D</b>	<b>H</b>	<b>W</b>	<b>D</b>	<b>H</b>	<b>W</b>	<b>H</b>									
			57	29.5	32	42	19	18	51	14						
			<b>RTA 00</b>													

## DESCRIPTION

## FEATURES

## MODEL#

## STANDARD TEXTILE GRADES

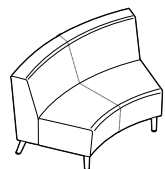
**Armless IS Curve - Two Seat - Standard Back**

COM Yardage: 4.5  
 Freight Class: 300  
 Product Weight (lbs.): 78  
 Cubic Feet Per Carton: 43

For Power/USB module please  
 see electrical placement chart.  
 Includes ganging hardware (2 sides).

	1	2	3	4	5	6	7	8	9	10	11	12
<b>7710NA</b>	3438	3627	3774	3999	4314	4427	4701	5228	5481	5968	6633	7458

**OVERALL DIMENSIONS**

W	D	H
55	29.5	32

**SEAT DIMENSIONS**

W	D	H
42	19	18

**BACK DIMENSIONS**

W	H
51	14

RTA 00

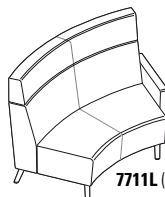
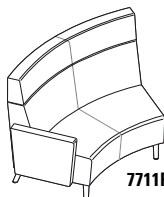
**7711L** (Left Arm)**7711R** (Right Arm)**IS Curve - Two Seater - High Back w/One Arm**

COM Yardage: 6.5  
 Freight Class: 300  
 Product Weight (lbs.): 94  
 Cubic Feet Per Carton: 54

For Power/USB module please  
 see electrical placement chart.  
 Includes ganging hardware (1 side).

	1	2	3	4	5	6	7	8	9	10	11	12
<b>7711L</b>	4804	5077	5291	5612	6065	6228	6625	7386	7751	8457	9413	10609

<b>7711R</b>	4804	5077	5291	5612	6065	6228	6625	7386	7751	8457	9413	10609
--------------	------	------	------	------	------	------	------	------	------	------	------	-------

**OVERALL DIMENSIONS**

W	D	H
57	29.5	41.5

**SEAT DIMENSIONS**

W	D	H
42	19	18

**BACK DIMENSIONS**

W	H
51	24

RTA 00

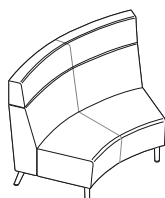
**Armless IS Curve - Two Seater - High Back**

COM Yardage: 6  
 Freight Class: 300  
 Product Weight (lbs.): 84  
 Cubic Feet Per Carton: 54

For Power/USB module please  
 see electrical placement chart.  
 Includes ganging hardware (2 sides).

	1	2	3	4	5	6	7	8	9	10	11	12
<b>7711NA</b>	4365	4618	4817	5112	5530	5683	6050	6753	7088	7738	8622	9726

**OVERALL DIMENSIONS**

W	D	H
55	29.5	41.5

**SEAT DIMENSIONS**

W	D	H
42	19	18

**BACK DIMENSIONS**

W	H
51	24

RTA 00

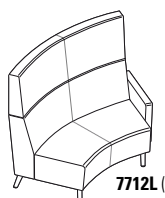
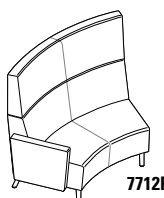
**7712L** (Left Arm)**7712R** (Right Arm)**IS Curve - Two Seater - Extended Back w/One Arm**

COM Yardage: 7  
 Freight Class: 300  
 Product Weight (lbs.): 99  
 Cubic Feet Per Carton: 62.75

For Power/USB module please  
 see electrical placement chart.  
 Includes ganging hardware (1 side).

	1	2	3	4	5	6	7	8	9	10	11	12
<b>7712L</b>	5241	5534	5764	6110	6600	6775	7203	8022	8415	9176	10206	11491

<b>7712R</b>	5241	5534	5764	6110	6600	6775	7203	8022	8415	9176	10206	11491
--------------	------	------	------	------	------	------	------	------	------	------	-------	-------

**OVERALL DIMENSIONS**

W	D	H
57	29.5	47

**SEAT DIMENSIONS**

W	D	H
42	19	18

**BACK DIMENSIONS**

W	H
51	29

RTA 00

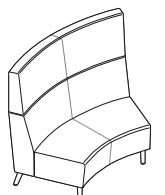
**Armless IS Curve - Two Seater - Extended Back**

COM Yardage: 6.75  
 Freight Class: 29.5  
 Product Weight (lbs.): 89  
 Cubic Feet Per Carton: 6.75

For Power/USB module please  
 see electrical placement chart.  
 Includes ganging hardware (2 sides).

	1	2	3	4	5	6	7	8	9	10	11	12
<b>7712NA</b>	4804	5085	5308	5641	6113	6283	6696	7486	7866	8599	9592	10832

**OVERALL DIMENSIONS**

W	D	H
55	29.5	47

**SEAT DIMENSIONS**

W	D	H
42	19	18

**BACK DIMENSIONS**

W	H
51	29

RTA 00

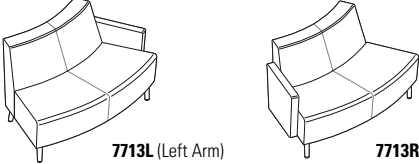
DESCRIPTION	FEATURES	MODEL#	STANDARD TEXTILE GRADES											
			1	2	3	4	5	6	7	8	9	10	11	12
 <p><b>7713L</b> (Left Arm)      <b>7713R</b> (Right Arm)</p> <p><b>OS Curve - Two Seater - Standard Back w/One Arm</b>                      COM Yardage: 5.25                      Freight Class: 300                      Product Weight (lbs.): 82                      Cubic Feet Per Carton: 43</p> <p>For Power/USB module please see electrical placement chart. Includes ganging hardware (1 side).</p>	<b>OVERALL DIMENSIONS</b>			<b>SEAT DIMENSIONS</b>			<b>BACK DIMENSIONS</b>							
	<b>W</b>	<b>D</b>	<b>H</b>	<b>W</b>	<b>D</b>	<b>H</b>	<b>W</b>	<b>H</b>						
	54.5	29.5	32	48	19	18	36	14						
<b>RTA 00</b>														

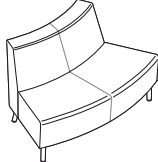
DESCRIPTION	FEATURES	MODEL#	STANDARD TEXTILE GRADES											
			1	2	3	4	5	6	7	8	9	10	11	12
 <p><b>7713NA</b></p> <p><b>Armless OS Curve - Two Seater - Standard Back</b>                      COM Yardage: 4.5                      Freight Class: 300                      Product Weight (lbs.): 72                      Cubic Feet Per Carton: 43</p> <p>For Power/USB module please see electrical placement chart. Includes ganging hardware (2 sides).</p>	<b>OVERALL DIMENSIONS</b>			<b>SEAT DIMENSIONS</b>			<b>BACK DIMENSIONS</b>							
	<b>W</b>	<b>D</b>	<b>H</b>	<b>W</b>	<b>D</b>	<b>H</b>	<b>W</b>	<b>H</b>						
	54	29.5	32	48	19	18	36	14						
<b>RTA 00</b>														

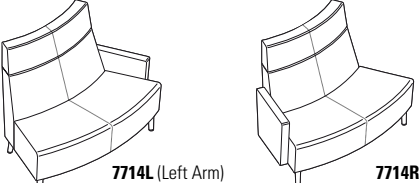
DESCRIPTION	FEATURES	MODEL#	STANDARD TEXTILE GRADES											
			1	2	3	4	5	6	7	8	9	10	11	12
 <p><b>7714L</b> (Left Arm)      <b>7714R</b> (Right Arm)</p> <p><b>OS Curve - Two Seater - High Back w/One Arm</b>                      COM Yardage: 6.5                      Freight Class: 300                      Product Weight (lbs.): 88                      Cubic Feet Per Carton: 54</p> <p>For Power/USB module please see electrical placement chart. Includes ganging hardware (1 side).</p>	<b>OVERALL DIMENSIONS</b>			<b>SEAT DIMENSIONS</b>			<b>BACK DIMENSIONS</b>							
	<b>W</b>	<b>D</b>	<b>H</b>	<b>W</b>	<b>D</b>	<b>H</b>	<b>W</b>	<b>H</b>						
	54.5	29.5	41.5	48	19	18	36	24						
<b>RTA 00</b>														

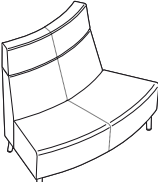
DESCRIPTION	FEATURES	MODEL#	STANDARD TEXTILE GRADES											
			1	2	3	4	5	6	7	8	9	10	11	12
 <p><b>7714NA</b></p> <p><b>Armless OS Curve - Two Seater - High Back</b>                      COM Yardage: 6                      Freight Class: 300                      Product Weight (lbs.): 78                      Cubic Feet Per Carton: 54</p> <p>For Power/USB module please see electrical placement chart. Includes ganging hardware (2 sides).</p>	<b>OVERALL DIMENSIONS</b>			<b>SEAT DIMENSIONS</b>			<b>BACK DIMENSIONS</b>							
	<b>W</b>	<b>D</b>	<b>H</b>	<b>W</b>	<b>D</b>	<b>H</b>	<b>W</b>	<b>H</b>						
	54	29.5	41.5	48	19	18	36	24						
<b>RTA 00</b>														

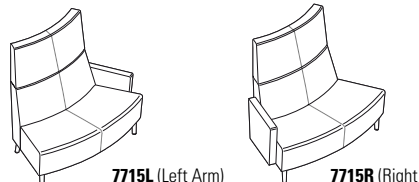
DESCRIPTION	FEATURES	MODEL#	STANDARD TEXTILE GRADES											
			1	2	3	4	5	6	7	8	9	10	11	12
 <p><b>7715L</b> (Left Arm)      <b>7715R</b> (Right Arm)</p> <p><b>OS Curve - Two Seater - Extended Back w/One Arm</b>                      COM Yardage: 7                      Freight Class: 300                      Product Weight (lbs.): 93                      Cubic Feet Per Carton: 62.75</p> <p>For Power/USB module please see electrical placement chart. Includes ganging hardware (1 side).</p>	<b>OVERALL DIMENSIONS</b>			<b>SEAT DIMENSIONS</b>			<b>BACK DIMENSIONS</b>							
	<b>W</b>	<b>D</b>	<b>H</b>	<b>W</b>	<b>D</b>	<b>H</b>	<b>W</b>	<b>H</b>						
	54.5	29.5	47	48	19	18	36	29						
<b>RTA 00</b>														

DESCRIPTION FEATURES MODEL# STANDARD TEXTILE GRADES

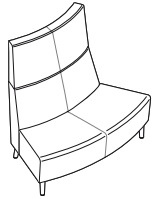

**Armless OS Curve - Two Seater - Ext. High Back**  
 COM Yardage: 6.75  
 Freight Class: 300  
 Product Weight (lbs.): 83  
 Cubic Feet Per Carton: 62.75

For Power/USB module please see electrical placement chart. Includes ganging hardware (2 sides).

	1	2	3	4	5	6	7	8	9	10	11	12
<b>7715NA</b>	4506	4787	5012	5343	5815	5985	6398	7189	7568	8301	9294	10536

OVERALL DIMENSIONS			SEAT DIMENSIONS			BACK DIMENSIONS	
W	D	H	W	D	H	W	H

54	29.5	47	48	19	18	36	28
----	------	----	----	----	----	----	----

RTA 00

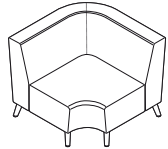

**Armless Corner Unit - Standard Back**  
 COM Yardage: 5.5  
 Freight Class: 300  
 Product Weight (lbs.): 75  
 Cubic Feet Per Carton: 49

For Power/USB module please see electrical placement chart. Includes ganging hardware (2 sides).

	1	2	3	4	5	6	7	8	9	10	11	12
<b>7716</b>	4199	4431	4614	4882	5270	5406	5743	6388	6695	7293	8104	9113

OVERALL DIMENSIONS			SEAT DIMENSIONS			BACK DIMENSIONS	
W	D	H	W	D	H	W	H

38	38	32	24	19	18	24	14
----	----	----	----	----	----	----	----

RTA 00

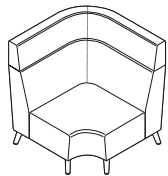

**Armless Corner Unit - High Back**  
 COM Yardage: 7.75  
 Freight Class: 300  
 Product Weight (lbs.): 82  
 Cubic Feet Per Carton: 49

For Power/USB module please see electrical placement chart. Includes ganging hardware (2 sides).

	1	2	3	4	5	6	7	8	9	10	11	12
<b>7717</b>	5319	5641	5897	6281	6824	7018	7491	8398	8833	9673	10815	12238

OVERALL DIMENSIONS			SEAT DIMENSIONS			BACK DIMENSIONS	
W	D	H	W	D	H	W	H

38	38	41.5	24	19	18	24	24
----	----	------	----	----	----	----	----

RTA 00

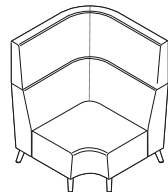

**Armless Corner Unit - Extended Back**  
 COM Yardage: 8.5  
 Freight Class: 300  
 Product Weight (lbs.): 88  
 Cubic Feet Per Carton: 49

For Power/USB module please see electrical placement chart. Includes ganging hardware (2 sides).

	1	2	3	4	5	6	7	8	9	10	11	12
<b>7718</b>	5633	5987	6266	6686	7280	7495	8015	9007	9486	10408	11661	13222

OVERALL DIMENSIONS			SEAT DIMENSIONS			BACK DIMENSIONS	
W	D	H	W	D	H	W	H

38	38	47	24	19	18	24	29
----	----	----	----	----	----	----	----

RTA 00

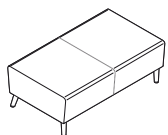

**Two Seater Bench**  
 COM Yardage: 2.25  
 Freight Class: 300  
 Product Weight (lbs.): 41  
 Cubic Feet Per Carton: 21.25

For Power/USB module please see electrical placement chart. Includes ganging hardware (2 sides).

	1	2	3	4	5	6	7	8	9	10	11	12
<b>7725</b>	2148	2247	2322	2430	2588	2646	2784	3047	3172	3418	3749	4161

OVERALL DIMENSIONS			SEAT DIMENSIONS			BACK DIMENSIONS	
W	D	H	W	D	H	W	H

48.5	28	17.5					
------	----	------	--	--	--	--	--

RTA 00

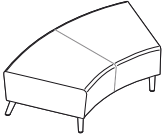
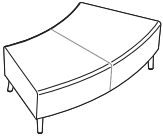
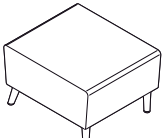
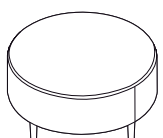
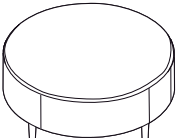
DESCRIPTION	FEATURES	MODEL#	STANDARD TEXTILE GRADES											
			1	2	3	4	5	6	7	8	9	10	11	12
 <p><b>IS Curve - Two Seater Bench</b> COM Yardage: 3 Freight Class: 300 Product Weight (lbs.): 41 Cubic Feet Per Carton: 21.25</p>	<p>For Power/USB module please see electrical placement chart. Includes ganging hardware (2 sides).</p>	<p><b>7726</b></p>	2918	3048	3146	3293	3502	3579	3764	4114	4282	4608	5050	5602
			<p><b>OVERALL DIMENSIONS</b></p> <p>W      D      H</p>			<p><b>SEAT DIMENSIONS</b></p> <p>W      D      H</p>			<p><b>BACK DIMENSIONS</b></p> <p>W      H</p>					
			54	28	17.5	<p><b>RTA 00</b></p>								
 <p><b>OS Curve - Two Seater Bench</b> COM Yardage: 3 Freight Class: 300 Product Weight (lbs.): 41 Cubic Feet Per Carton: 21.25</p>	<p>For Power/USB module please see electrical placement chart. Includes ganging hardware (2 sides).</p>	<p><b>7727</b></p>	2918	3048	3146	3293	3502	3579	3764	4114	4282	4608	5050	5602
			<p><b>OVERALL DIMENSIONS</b></p> <p>W      D      H</p>			<p><b>SEAT DIMENSIONS</b></p> <p>W      D      H</p>			<p><b>BACK DIMENSIONS</b></p> <p>W      H</p>					
			54	28	17.5	<p><b>RTA 00</b></p>								
 <p><b>Square Single Seater Bench</b> COM Yardage: 1.75 Freight Class: 250 Product Weight (lbs.): 30 Cubic Feet Per Carton: 9.25</p>	<p>For Power/USB module please see electrical placement chart. Includes ganging hardware (2 sides).</p>	<p><b>7728</b></p>	1469	1545	1602	1689	1810	1857	1962	2169	2266	2455	2714	3034
			<p><b>OVERALL DIMENSIONS</b></p> <p>W      D      H</p>			<p><b>SEAT DIMENSIONS</b></p> <p>W      D      H</p>			<p><b>BACK DIMENSIONS</b></p> <p>W      H</p>					
			24.5	28	17.5	<p><b>RTA 00</b></p>								
 <p><b>36" Dia. - Round Bench</b> COM Yardage: 3 Freight Class: 250 Product Weight (lbs.): 46 Cubic Feet Per Carton: 18.25</p>	<p>No Power/USB module. No ganging hardware.</p>	<p><b>7729</b></p>	2156	2286	2384	2533	2743	2820	3003	3352	3521	3846	4288	4840
			<p><b>OVERALL DIMENSIONS</b></p> <p>W      D      H</p>			<p><b>SEAT DIMENSIONS</b></p> <p>W      D      H</p>			<p><b>BACK DIMENSIONS</b></p> <p>W      H</p>					
			36	36	17.5	<p><b>RTA 00</b></p>								
 <p><b>42" Dia. - Round Bench</b> COM Yardage: 3.25 Freight Class: 250 Product Weight (lbs.): 50 Cubic Feet Per Carton: 22</p>	<p>No Power/USB module. No ganging hardware.</p>	<p><b>7730</b></p>	2481	2618	2726	2889	3112	3194	3393	3776	3957	4309	4787	5385
			<p><b>OVERALL DIMENSIONS</b></p> <p>W      D      H</p>			<p><b>SEAT DIMENSIONS</b></p> <p>W      D      H</p>			<p><b>BACK DIMENSIONS</b></p> <p>W      H</p>					
			42	42	17.5	<p><b>RTA 00</b></p>								

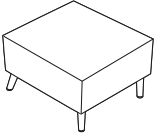
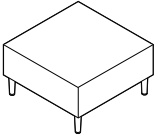
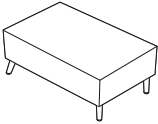
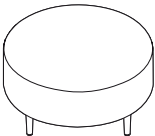
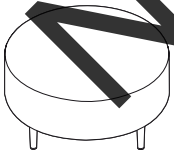
DESCRIPTION	FEATURES	MODEL#	STANDARD TEXTILE GRADES												
			1	2	3	4	5	6	7	8	9	10	11	12	
 <p><b>30" Square Laminate Coffee Table</b> COM Yardage: N/A Freight Class: 150 Product Weight (lbs.): 61 Cubic Feet Per Carton: 11.5</p>	<p>For Power/USB module please see electrical placement chart. No ganging hardware.</p>	7731	1372												
		<b>OVERALL DIMENSIONS</b>			<b>SEAT DIMENSIONS</b>			<b>BACK DIMENSIONS</b>							
		W	D	H	W	D	H	W	H						
		30	30	17											
			<b>RTA 00</b>												
 <p><b>36" Square Laminate Coffee Table</b> COM Yardage: N/A Freight Class: 150 Product Weight (lbs.): 85 Cubic Feet Per Carton: 16.5</p>	<p>For Power/USB module please see electrical placement chart. No ganging hardware.</p>	7732	1559												
		<b>OVERALL DIMENSIONS</b>			<b>SEAT DIMENSIONS</b>			<b>BACK DIMENSIONS</b>							
		W	D	H	W	D	H	W	H						
		36	36	17											
			<b>RTA 00</b>												
 <p><b>Rectangular Laminate Coffee Table</b> COM Yardage: N/A Freight Class: 150 Product Weight (lbs.): 55 Cubic Feet Per Carton: 11.5</p>	<p>For Power/USB module please see electrical placement chart. No ganging hardware.</p>	7733	1378												
		<b>OVERALL DIMENSIONS</b>			<b>SEAT DIMENSIONS</b>			<b>BACK DIMENSIONS</b>							
		W	D	H	W	D	H	W	H						
		40	20	17											
			<b>RTA 00</b>												
 <p><b>36" Dia. - Round Laminate Coffee Table</b> COM Yardage: N/A Freight Class: 250 Product Weight (lbs.): 63 Cubic Feet Per Carton: 16.5</p>	<p>For Power/USB module please see electrical placement chart. No ganging hardware.</p>	7734	1701												
		<b>OVERALL DIMENSIONS</b>			<b>SEAT DIMENSIONS</b>			<b>BACK DIMENSIONS</b>							
		W	D	H	W	D	H	W	H						
		36	36	17											
			<b>RTA 00</b>												
 <p><b>42" Dia. - Round Laminate Coffee Table</b> COM Yardage: N/A Freight Class: 250 Product Weight (lbs.): 85 Cubic Feet Per Carton: 22</p>	<p>For Power/USB module please see electrical placement chart. No ganging hardware.</p>	7735	1859												
		<b>OVERALL DIMENSIONS</b>			<b>SEAT DIMENSIONS</b>			<b>BACK DIMENSIONS</b>							
		W	D	H	W	D	H	W	H						
		42	42	17											
			<b>RTA 00</b>												

NOT ON CONTRACT

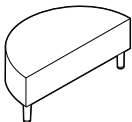
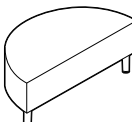
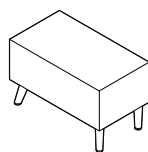
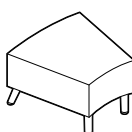
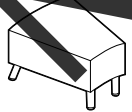
DESCRIPTION	FEATURES	MODEL#	STANDARD TEXTILE GRADES													
			1	2	3	4	5	6	7	8	9	10	11	12		
 <p><b>36" Half Round Laminate Coffee Table</b> COM Yardage: N/A Freight Class: 150 Product Weight (lbs.): 37 Cubic Feet Per Carton: 8.5</p>	<p>For Power/USB module please see electrical placement chart. No ganging hardware.</p>	7736	1206													
		<b>OVERALL DIMENSIONS</b>			<b>SEAT DIMENSIONS</b>			<b>BACK DIMENSIONS</b>								
		<b>W</b>	<b>D</b>	<b>H</b>	<b>W</b>	<b>D</b>	<b>H</b>	<b>W</b>	<b>H</b>							
		36	18	17												
		<b>RTA 00</b>														
 <p><b>42" Half Round Laminate Coffee Table</b> COM Yardage: N/A Freight Class: 150 Product Weight (lbs.): 48 Cubic Feet Per Carton: 11.5</p>	<p>For Power/USB module please see electrical placement chart. No ganging hardware.</p>	7737	1461													
		<b>OVERALL DIMENSIONS</b>			<b>SEAT DIMENSIONS</b>			<b>BACK DIMENSIONS</b>								
		<b>W</b>	<b>D</b>	<b>H</b>	<b>W</b>	<b>D</b>	<b>H</b>	<b>W</b>	<b>H</b>							
		42	21	17												
		<b>RTA 00</b>														
 <p><b>Rectangular Laminate End Table</b> COM Yardage: N/A Freight Class: 125 Product Weight (lbs.): 34 Cubic Feet Per Carton: 5.5</p>	<p>For Power/USB module please see electrical placement chart. Includes ganging hardware (2 sides).</p>	7738	1381													
		<b>OVERALL DIMENSIONS</b>			<b>SEAT DIMENSIONS</b>			<b>BACK DIMENSIONS</b>								
		<b>W</b>	<b>D</b>	<b>H</b>	<b>W</b>	<b>D</b>	<b>H</b>	<b>W</b>	<b>H</b>							
		15	27.25	17												
		<b>RTA 00</b>														
 <p><b>IS Curve Wide Wedge Laminate End Table</b> COM Yardage: N/A Freight Class: 150 Product Weight (lbs.): 50 Cubic Feet Per Carton: 9.5</p>	<p>For Power/USB module please see electrical placement chart. Includes ganging hardware (2 sides).</p>	7739	1824													
		<b>OVERALL DIMENSIONS</b>			<b>SEAT DIMENSIONS</b>			<b>BACK DIMENSIONS</b>								
		<b>W</b>	<b>D</b>	<b>H</b>	<b>W</b>	<b>D</b>	<b>H</b>	<b>W</b>	<b>H</b>							
		27.25	27.25	17												
		<b>RTA 00</b>														
 <p><b>IS Curve Narrow Wedge Laminate End Table</b> COM Yardage: N/A Freight Class: 150 Product Weight (lbs.): 34 Cubic Feet Per Carton: 6.5</p>	<p>For Power/USB module please see electrical placement chart. Includes ganging hardware (2 sides).</p>	7740	1477													
		<b>OVERALL DIMENSIONS</b>			<b>SEAT DIMENSIONS</b>			<b>BACK DIMENSIONS</b>								
		<b>W</b>	<b>D</b>	<b>H</b>	<b>W</b>	<b>D</b>	<b>H</b>	<b>W</b>	<b>H</b>							
		18.25	27.25	17												
		<b>RTA 00</b>														

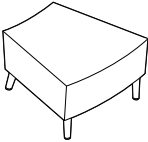
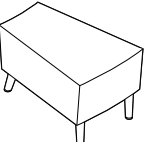
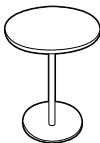
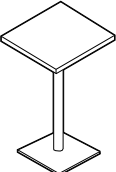
DESCRIPTION	FEATURES	MODEL#	STANDARD TEXTILE GRADES												
			1	2	3	4	5	6	7	8	9	10	11	12	
 <p><b>OS Curve - Wide Wedge Laminate End Table</b> COM Yardage: N/A Freight Class: 150 Product Weight (lbs.): 50 Cubic Feet Per Carton: 9.5</p>	<p>For Power/USB module please see electrical placement chart. Includes ganging hardware (2 sides).</p>	7741	1824												
		<b>OVERALL DIMENSIONS</b>			<b>SEAT DIMENSIONS</b>			<b>BACK DIMENSIONS</b>							
		<b>W</b>	<b>D</b>	<b>H</b>	<b>W</b>	<b>D</b>	<b>H</b>	<b>W</b>	<b>H</b>						
		27.25	27.25	17											
			RTA 00												
 <p><b>OS Curve - Narrow Wedge Laminate End Table</b> COM Yardage: N/A Freight Class: 150 Product Weight (lbs.): 34 Cubic Feet Per Carton: 6.5</p>	<p>For Power/USB module please see electrical placement chart. Includes ganging hardware (2 sides).</p>	7742	1477												
		<b>OVERALL DIMENSIONS</b>			<b>SEAT DIMENSIONS</b>			<b>BACK DIMENSIONS</b>							
		<b>W</b>	<b>D</b>	<b>H</b>	<b>W</b>	<b>D</b>	<b>H</b>	<b>W</b>	<b>H</b>						
		18.25	27.25	17											
			RTA 00												
 <p><b>18" Dia. Round Laminate Laptop Table</b> COM Yardage: N/A Freight Class: 150 Product Weight (lbs.): 32 Cubic Feet Per Carton: 6</p>	<p>No Power/USB module. No ganging hardware.</p>	7743	886												
		<b>OVERALL DIMENSIONS</b>			<b>SEAT DIMENSIONS</b>			<b>BACK DIMENSIONS</b>							
		<b>W</b>	<b>D</b>	<b>H</b>	<b>W</b>	<b>D</b>	<b>H</b>	<b>W</b>	<b>H</b>						
		18	18	25.25											
			RTA 00												
 <p><b>16" Square Laminate Laptop Table</b> COM Yardage: N/A Freight Class: 125 Product Weight (lbs.): 36 Cubic Feet Per Carton: 6</p>	<p>No Power/USB module. No ganging hardware.</p>	7745	855												
		<b>OVERALL DIMENSIONS</b>			<b>SEAT DIMENSIONS</b>			<b>BACK DIMENSIONS</b>							
		<b>W</b>	<b>D</b>	<b>H</b>	<b>W</b>	<b>D</b>	<b>H</b>	<b>W</b>	<b>H</b>						
		16	16	25.25											
			RTA 00												

NOT ON CONTRACT

# LOUNGE

## RIVER™ PERSONAL HARBOR



Sample Layout

### ELECTRICAL PLACEMENT

Locations available on left side J1 (black) or W1 (white), right side J3 (black) or W3 (white) or both sides J1/J3 (black) or W1/W3 (white).

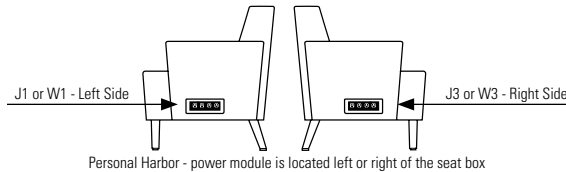

# RIVER™ PERSONAL HARBOR R

### STANDARD FEATURES

- River Personal Harbor is a line extension of the popular River modular seating series. For modular series see River price book pages.
- The freestanding soft seating models are available with standard height, high and extended high backs.
- The unique tapered legs (swaged legs) are made of welded steel, heavy duty construction, with each leg bolted directly to the frame. The extremely robust construction insures trouble free performance in any environment. All units have the same leg height of 6.5". The leg height makes it easier to clean under the product.
- Each leg is standard with adjustable black nylon leveling glides and are non-marking. Wood legs and casters are not available.
- All cushions are fixed and non-removable (cushions will not migrate). Perimeter seams feature a decorative single stitch detail, which makes seams lay flat and adds extra seam strength.
- Seating frames are heavy duty with interlocking plywood, puzzle box construction, made for rugged active environments. Seats are high density with highly resilient foam and are equipped with a synthetic rubberized webbing suspension system for extra comfort.
- Front edge of face of the seat, angles slightly inward, so feet have freedom of movement and shoe heels don't rub on the seat. This inward slanting matches the inward angles of the back. Benches and connecting end tables also reflect the inward angles on the front and back faces, so all units coordinate in visual appearance.
- High Traffic (HT) units are rated at 350 lbs. active load per seat and 24/7 use. These units have the same puzzle box frame construction except that the framing wood is 1" thick, rotary cut, birch plywood and all arms, seat and back cushions are made with Ultracell Foam.
- High Traffic (HT) models are recommend to be specified in textiles that meet or exceed 100,000 double rubs for added abrasion performance.

- Check textile availability prior to specifying upholstery material. Leather not available on River Personal Harbor.

### OPTIONAL FEATURES

- Seating units can be specified with Power/USB terminals, which includes two power outlets, two double USB terminals and a black 60" three-prong power cord. Each Power/USB module is set in predetermined locations, as shown in the electrical illustrations below. Electrical units must be factory installed.
- To add a Power/USB module: From the electrical illustrations below, please specify **J1, W1, J2, W2, J3, W4, J4, W4, J6 or W6** after the product model number. Please note on seating units, if both right and left locations are required, add both **J1/J3 or W1/W3** to the model number. Add \$997 for each module/location required.
- Power/USB modules are available with either Jet Black (**J**) face plate with black Power/USB receptacles or with a White (**W**) face plate with white Power/USB receptacles.
- **Leg finish**  

(CHM) Chrome	(TBL) Black
(TDW) Designer White	(TFO) Fog
(TFR) Frost	(TIV) Cloud
(TKA) Kalua	(TLA) Latte
(TMO) Mocha	(TNE) Nevada
(TOA) Toast	(TSH) Shadow
(TSN) Sand	(TTU) Tungsten
- If more than one fabric or a fabric/vinyl combination is required, please fill out a "Seating Multiple Textile" form, specifying each fabric location. Please contact Customer Care for more information.

### DESCRIPTION

### FEATURES

### MODEL#

### STANDARD TEXTILE GRADES

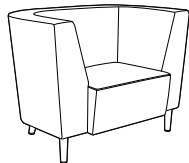

**Personal Harbor - Standard Back**  
 COM Yardage: 5.5  
 Freight Class: 150  
 Product Weight (lbs.): 50  
 Cubic Feet Per Carton: 9.5

For Power/USB module please see electrical placement chart. Freestanding unit only.

	1	2	3	4	5	6	7	8	9	10	11	12
<b>7746</b>	\$4079	\$4318	\$4507	\$4792	\$5194	\$5385	\$5749	\$6329	\$6777	\$7275	\$8301	\$9395

### OVERALL DIMENSIONS

### SEAT DIMENSIONS

### BACK DIMENSIONS

W	D	H	W	D	H	W	H
45	29.5	32	24	19	18	27	14

RTA 00

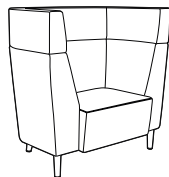

**Personal Harbor - High Back**  
 COM Yardage: 7.09  
 Freight Class: 150  
 Product Weight (lbs.): 86  
 Cubic Feet Per Carton: 9.5

For Power/USB module please see electrical placement chart. Freestanding unit only.

	1	2	3	4	5	6	7	8	9	10	11	12
<b>7747</b>	\$5734	\$6070	\$6336	\$6736	\$7303	\$7569	\$8082	\$8903	\$9534	\$10234	\$11682	\$13222

### OVERALL DIMENSIONS

### SEAT DIMENSIONS

### BACK DIMENSIONS

W	D	H	W	D	H	W	H
45	29.5	41.5	24	19	18	27	24

RTA 00

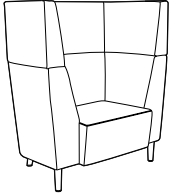
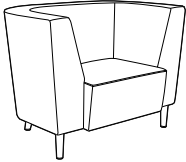
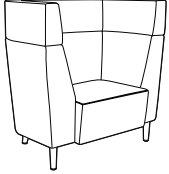
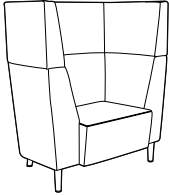

DESCRIPTION	FEATURES	MODEL#	STANDARD TEXTILE GRADES													
			1	2	3	4	5	6	7	8	9	10	11	12		
 <p><b>Personal Harbor - Extended Back</b> COM Yardage: 8.5 Freight Class: 150 Product Weight (lbs.): 102 Cubic Feet Per Carton: 9.5</p>	<p>For Power/USB module please see electrical placement chart. Freestanding unit only.</p>	7748	\$6451	\$6819	\$7111	\$7552	\$8171	\$8464	\$9028	\$9926	\$10619	\$11389	\$12972	\$14662		
			<b>OVERALL DIMENSIONS</b>			<b>SEAT DIMENSIONS</b>			<b>BACK DIMENSIONS</b>							
			<b>W</b>	<b>D</b>	<b>H</b>	<b>W</b>	<b>D</b>	<b>H</b>	<b>W</b>	<b>H</b>						
			45	29.5	47	24	19	18	27	29						
			<b>RTA 00</b>													
 <p><b>Personal Harbor - Standard Back</b> COM Yardage: 5.5 Freight Class: 150 Product Weight (lbs.): 50 Cubic Feet Per Carton: 9.5</p>	<p><b>High Traffic model</b> For Power/USB module please see electrical placement chart. Freestanding unit only.</p>	7786	\$4659	\$4899	\$5087	\$5372	\$5774	\$5965	\$6330	\$6912	\$7360	\$7857	\$8884	\$9978		
			<b>OVERALL DIMENSIONS</b>			<b>SEAT DIMENSIONS</b>			<b>BACK DIMENSIONS</b>							
			<b>W</b>	<b>D</b>	<b>H</b>	<b>W</b>	<b>D</b>	<b>H</b>	<b>W</b>	<b>H</b>						
			45	29.5	32	24	19	18	27	14						
			<b>RTA 00</b>													
 <p><b>Personal Harbor - High Back</b> COM Yardage: 7.09 Freight Class: 150 Product Weight (lbs.): 86 Cubic Feet Per Carton: 9.5</p>	<p><b>High Traffic model</b> For Power/USB module please see electrical placement chart. Freestanding unit only.</p>	7787	\$6482	\$6818	\$7084	\$7485	\$8051	\$8318	\$8831	\$9652	\$10282	\$10983	\$12430	\$13968		
			<b>OVERALL DIMENSIONS</b>			<b>SEAT DIMENSIONS</b>			<b>BACK DIMENSIONS</b>							
			<b>W</b>	<b>D</b>	<b>H</b>	<b>W</b>	<b>D</b>	<b>H</b>	<b>W</b>	<b>H</b>						
			45	29.5	41.5	24	19	18	27	24						
			<b>RTA 00</b>													
 <p><b>Personal Harbor - Extended Back</b> COM Yardage: 8.5 Freight Class: 150 Product Weight (lbs.): 102 Cubic Feet Per Carton: 9.5</p>	<p><b>High Traffic model</b> For Power/USB module please see electrical placement chart. Freestanding unit only.</p>	7788	\$7031	\$7400	\$7692	\$8132	\$8752	\$9047	\$9608	\$10507	\$11202	\$11970	\$13554	\$15245		
			<b>OVERALL DIMENSIONS</b>			<b>SEAT DIMENSIONS</b>			<b>BACK DIMENSIONS</b>							
			<b>W</b>	<b>D</b>	<b>H</b>	<b>W</b>	<b>D</b>	<b>H</b>	<b>W</b>	<b>H</b>						
			45	29.5	47	24	19	18	27	29						
			<b>RTA 00</b>													

# LOUNGE

## RIVER+ SEATING



Lounge Chair, High Back model R27802



120 Corner, Standard Back model R27824S



Loop arm R2770

### River+ Benches and Tables



For River+ benches, please see page 367  
For River+ tables, please see page 372

### EXAMPLE RIVER+ SEATING ORDER CODE:

R27802	-CE90	-FOG	-	-S6	-
Model number	Back, arm and seat textile	Connector finish	Shelf finish	Leg Selection	Counterweight

-CHM	-SSB
Leg finish	Bottom selection

Additional Options specify at end of order code.	SPECIFY CODE
<b>Additional weight</b> See each model for amount of added weight and upcharge.	<b>CW</b>
<b>Sealed back seams</b> Upcharges vary, see model.	<b>SBS</b>
<b>Sealed seat seams</b> Upcharges vary, see model.	<b>SSS</b>
<b>Power unit finish</b> Jet Black White	<b>J</b> <b>W</b>
<b>Power/USB unit position</b> (see electrical placement images, not available on corner units) Front left Front right Side left Side right Center back (models with shelf only)	\$698 per unit <b>F1</b> <b>F2</b> <b>S1</b> <b>S2</b> <b>CB</b>
<b>Tamperproof fasteners</b> Upcharges vary, see model.	<b>TP</b>
<b>Moisture barrier</b> Upcharges vary, see model.	<b>MB</b>
<b>Accessory hook finish</b> (for models with shelf) Night (BLK) Fog (FOG) Latte (LAB)	<b>NHK</b> <b>FHK</b> <b>LHK</b>

\*linking hardware is lowered to clear the staple strip.  
Units will only gang with other units with sealed bottom.  
\*\*cannot be combined with linking hardware or power units

# RIVER+ SEATING R

## STANDARD FEATURES

- A modular series that is composed of straight, curved and corner sections.
- Models with the same seat height can be ganged on ends with no upholstered arms. Ganging hardware is standard on armless ends of models (factory installed) and swivels out of the way when not in use.
- Seating frames are constructed of heavy duty plywood, and are made for active environments. Seats are high density with highly resilient foam.
- River+ seating is rated for an active weight up to 600 lbs. per seat and 24/7 use.
- For 24/7 use and/or heavy duty application use, Global's Heavy Duty warranty is only on models specified with performance textiles, rated for 150,000 double rubs or more.
- A clean-out gap is created by seat-to-back connector brackets available in three finishes.
- The standard, 6.5" tapered legs are made of welded steel. Front legs of River+ lounge models are straight. Back legs are angled.
- Models with a shelf are only available with 6.5" high legs. Back legs on these models are standard with (E6) EXTENDED legs.
- Legs include Black nylon, non-marking, height adjustable glides.
- Upholstery options include fabric or vinyl. Leather upholstery is not available.
- All units are shipped fully assembled.
- Arms on upholstered arm models are factory installed and not removable.
- Modular, aluminum loop arms are sold separately and available with or without nylon armcaps. These relocatable arms are field installed at any seat to back connector location.
- A 10" deep, 1" thick shelf is available on the back of select corner, curved, two and three seat models in many thermally fused laminate finishes with matching edge.
- Shelf supports are aluminum with accessory hook in three finishes. Weight capacity: Shelf - 50lbs per seat; Hook - 20lbs each.
- Back shelf heights align with the model's back height. See shelf heights diagrams for details.
- Check textile availability prior to specifying upholstery material.
- The series is available to specify with two textiles, one for the seat cushion and one for the back, arms and front rail (see model image).
- For pricing, start with the base price and add both back/arms graded textile upcharge and the seat graded textile upcharge.
- The blended textile matrix does not apply to this series.

## OPTIONAL FEATURES

- Optional 6.5" floor mount legs (F6) are available. Shelf back models are available with EXTENDED floor mount legs (F6).
- Optional 8" (S8) and 8" floor mount legs (F8) are available on models without shelves. Seat heights change to 19" high. Upcharges vary.
- To match back legs of shelf-back models with models without shelf, select (C6) leg with counterweight. Upcharges vary.
- Up to two power units are available on seating models, except 90 and 120 corner units. Add \$698 upcharge per unit.
- Each power unit includes one AC outlet and two USB-A, 10 watt charging ports. Location options include front or side. Back power location option available on models with back shelf (except corners). See electrical placement diagrams.
- Power units are available in either Jet Black (J) or White (W) with 120", three-prong matching cords.
- Tamperproof fasteners can be requested for a higher level of safety. Please specify (TP) - see each model for upcharge. Ganging brackets are not included when Tamper Proof (TP) option is selected.
- Sealed seams are available only for approved coated textiles. Specify (SSS) for sealed seat seams or (SBS) for sealed back and arm seams. Contact customer care

for details. See models for upcharge.

- To reduce ease of movement, counterweights can be added to any model. Specify (CW). See individual model for weight and upcharge.
- Underside of seat is standard with black lining (SB).
- For improved housekeeping and infection control practices, the underside of the seat can be finished with black vinyl and sealed to prevent penetration of liquids. Specify (SP) - see each model for upcharge.
- Steel bottom option provides tamperproof protection (includes tamperproof screws). Specify (BS). Upcharges vary. Note: electrical option and ganging are not available with steel bottom.
- Add option codes in the following order:
  - **Model number**  
Specify model number.
  - **Back/Arm Textile**  
Specify textile code. See model grade upcharges.
  - **Seat Textile**  
Specify textile code. See model grade upcharges.
  - **Seat to back connector finish**  
(NGT) Night (BLK). No upcharge.  
(FOG) Fog. No upcharge.  
(LAB) Latte. No upcharge.
  - **Back shelf finish** (for "S" models with shelf)  
See colors shown on website.
  - **Accessory hook finish** (for "S" models with shelf)  
(NHK) Night (BLK)  
(FHK) Fog (FOG)  
(LHK) Latte (LAB)
  - **Leg selection** (models without shelf):  
(S6) Standard seat height (17.5"), 6.5" leg w/adjustable glides. No upcharge.  
(S8) High seat (19"), 8" leg w/adjustable glides. No upcharge.  
(F6) Standard seat height (17.5"), 6.5" leg w/floor mount. Add \$106 for straight units; \$132 for curved, corner units.  
(F8) High seat (19"), 8" leg w/floor mount. Add \$106 for straight units; \$132 for curved, corner units.
  - **Leg selection** (For "S" models with shelf):  
(E6) Standard seat height (17.5"), 6.5" EXTENDED leg with adjustable glides.  
(C6) Standard seat height (17.5"), 6.5" leg, includes counterweight. Matches S6 leg. Upcharges vary, see model.  
(F6) Standard seat height (17.5"), 6.5" EXTENDED leg w/floor mount. Add \$106 for straight unit; \$132 for curved, corner units.
  - **Leg finish**

(CHM) Chrome	(TBL) Black
(TDW) Designer White	(TFO) Fog
(TFR) Frost	(TIV) Cloud
(TKA) Kalua	(TLA) Latte
(TMO) Mocha	(TNE) Nevada
(TOA) Toast	(TSH) Shadow
(TSN) Sand	(TTU) Tungsten
  - **Additional weight**  
(CU) No counterweight.  
(CW) Counterweight. Upcharges vary, see model.
  - **Bottom selection**  
(SSB) Standard seat bottom  
(SP) Vinyl sealed bottom with staple strip. Upcharges vary, see model.\*  
(BS) Steel bottom. Upcharges vary, see model.\*\*
  - **Sealed back and arm seams**  
(SBS) Sealed back seams. Upcharges vary, see model.
  - **Sealed seat seams**  
(SSS) Sealed seat seams. Upcharges vary, see model.
  - **Moisture barrier**  
(MB) Moisture Barrier. Upcharges vary, see model.
  - **Power/USB unit position. Add \$698 per unit.**  
(NP) No power (no upcharge)  
(F1) Front left (F2) Front right  
(S1) Side left (S2) Side right  
(CB) Center back (models with shelf only)
  - **Power unit finish**  
(J) Jet Black (W) White
  - **Tamperproof fasteners**  
(TP) Tamperproof fasteners. Upcharges vary, see model.

SHELF HEIGHTS

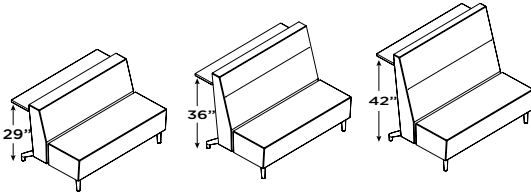

Standard height

High back

Extended high back

DIMENSIONS

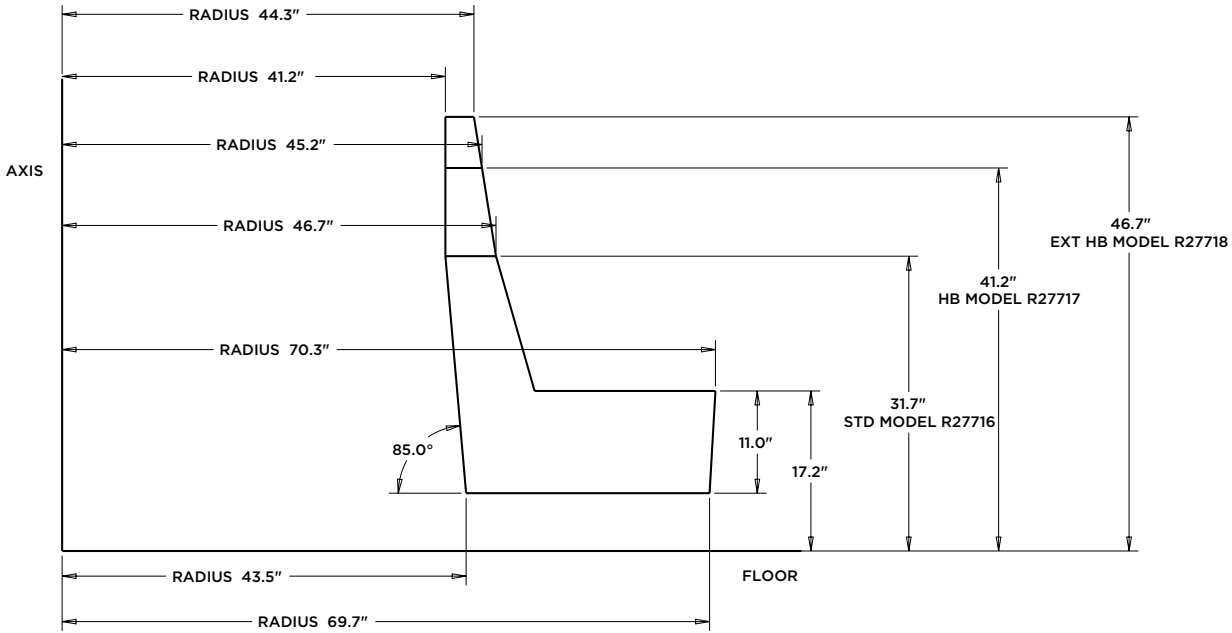



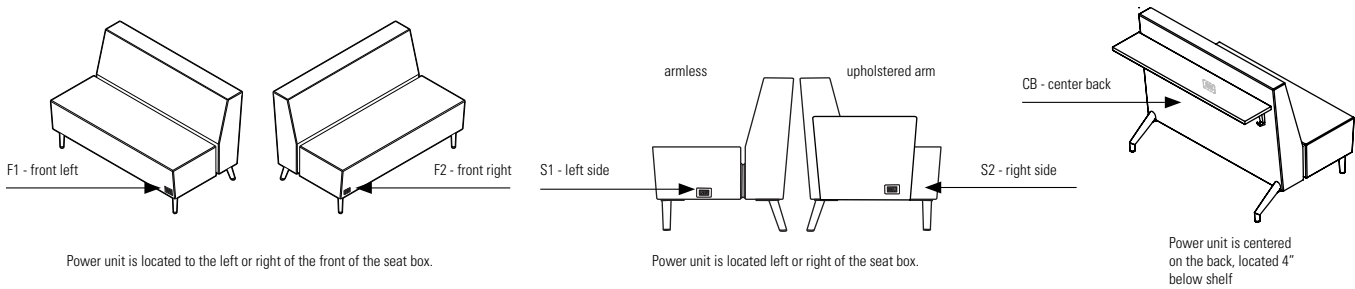

ELECTRICAL PLACEMENT







Power unit is located to the left or right of the front of the seat box.









Power unit is located left or right of the seat box.





Power unit is centered on the back, located 4" below shelf





DESCRIPTION	MODEL#/ FEATURES	STANDARD TEXTILE GRADES													
		1/COM	2	3	4	5	6	7	8	9	10	11	12		
 <p><b>R27801</b></p> <p><b>Lounge Chair - Standard Back</b> COM Yardage: Back: 2; Seat: 1.75 Freight class: 250 Product weight (lbs.): 61 Cubic feet per carton: 19.75</p>	<b>R27801</b>	Base Price:	<b>\$2178</b>												
	Back upcharge:	<b>+0</b>	<b>+\$68</b>	<b>+\$121</b>	<b>+\$199</b>	<b>+\$309</b>	<b>+\$355</b>	<b>+\$450</b>	<b>+\$600</b>	<b>+\$712</b>	<b>+\$834</b>	<b>+\$1089</b>	<b>+\$1357</b>		
	Seat upcharge:	<b>+0</b>	<b>+\$60</b>	<b>+\$106</b>	<b>+\$175</b>	<b>+\$271</b>	<b>+\$311</b>	<b>+\$394</b>	<b>+\$525</b>	<b>+\$623</b>	<b>+\$731</b>	<b>+\$953</b>	<b>+\$1188</b>		
	For power/USB unit, see electrical placement chart. Includes ganging hardware (2 sides). Add \$69 for (SSS), \$74 (SBS) Add \$667 for 36 lbs. (CW) Add \$109 for (SP) or \$513 for (BS) Add \$43 for (TP) Add \$134 for (MB)														
	<b>OVERALL DIMENSIONS</b>		<b>W</b>	<b>D</b>	<b>H</b>	<b>SEAT DIMENSIONS</b>			<b>BACK DIMENSIONS</b>		<b>W</b>	<b>H</b>			
			26	30	32	26	19	18	26	14					
			<b>RTA 00</b>	1 per carton											
	 <p><b>R27801B</b></p> <p><b>Lounge Chair - Standard Back</b> COM Yardage: Back: 4; Seat: 1.75 Freight class: 250 Product weight (lbs.): 82 Cubic feet per carton: 24.5</p>	<b>R27801B</b>	Base Price:	<b>\$2956</b>											
		Back/Arm upcharge:	<b>+0</b>	<b>+\$136</b>	<b>+\$241</b>	<b>+\$397</b>	<b>+\$617</b>	<b>+\$709</b>	<b>+\$899</b>	<b>+\$1199</b>	<b>+\$1423</b>	<b>+\$1667</b>	<b>+\$2178</b>	<b>+\$2714</b>	
		Seat upcharge:	<b>+0</b>	<b>+\$60</b>	<b>+\$106</b>	<b>+\$175</b>	<b>+\$271</b>	<b>+\$311</b>	<b>+\$394</b>	<b>+\$525</b>	<b>+\$623</b>	<b>+\$731</b>	<b>+\$953</b>	<b>+\$1188</b>	
For power/USB unit, see electrical placement chart. Ganging not available. Add \$69 for (SSS), \$130 (SBS) Add \$667 for 36 lbs. (CW) Add \$109 for (SP) or \$513 for (BS) Add \$43 for (TP) Add \$134 for (MB)															
<b>OVERALL DIMENSIONS</b>		<b>W</b>	<b>D</b>	<b>H</b>	<b>SEAT DIMENSIONS</b>			<b>BACK DIMENSIONS</b>		<b>W</b>	<b>H</b>				
		33	30	32	26	19	18	26	14						
		<b>RTA 00</b>	1 per carton												
 <p><b>R27801L</b>      <b>R27801R</b></p> <p><b>Lounge Chair - Standard Back</b> COM Yardage: Back: 3; Seat: 1.75 Freight class: 250 Product weight (lbs.): 72 Cubic feet per carton: 24.5</p>		<b>R27801L</b>	Base Price:	<b>\$2568</b>											
		<b>R27801R</b>	Base Price:	<b>\$2568</b>											
		Back/Arm upcharge:	<b>+0</b>	<b>+\$102</b>	<b>+\$181</b>	<b>+\$298</b>	<b>+\$463</b>	<b>+\$532</b>	<b>+\$675</b>	<b>+\$899</b>	<b>+\$1067</b>	<b>+\$1251</b>	<b>+\$1634</b>	<b>+\$2036</b>	
	Seat upcharge:	<b>+0</b>	<b>+\$60</b>	<b>+\$106</b>	<b>+\$175</b>	<b>+\$271</b>	<b>+\$311</b>	<b>+\$394</b>	<b>+\$525</b>	<b>+\$623</b>	<b>+\$731</b>	<b>+\$953</b>	<b>+\$1188</b>		
	For power/USB unit, see electrical placement chart. Includes ganging hardware (1 side). Add \$69 for (SSS), \$102 (SBS) Add \$667 for 36 lbs. (CW) Add \$109 for (SP) or \$513 for (BS) Add \$43 for (TP) Add \$134 for (MB)														
	<b>OVERALL DIMENSIONS</b>		<b>W</b>	<b>D</b>	<b>H</b>	<b>SEAT DIMENSIONS</b>			<b>BACK DIMENSIONS</b>		<b>W</b>	<b>H</b>			
			29.5	30	32	26	19	18	26	14					
			<b>RTA 00</b>	1 per carton											
	 <p><b>R27802</b></p> <p><b>Lounge Chair - High Back</b> COM Yardage: Back: 2.75; Seat: 1.75 Freight class: 250 Product weight: 71 Cubic feet per carton: 24.75</p>	<b>R27802</b>	Base Price:	<b>\$2554</b>											
		Back upcharge:	<b>+0</b>	<b>+\$93</b>	<b>+\$166</b>	<b>+\$274</b>	<b>+\$425</b>	<b>+\$488</b>	<b>+\$619</b>	<b>+\$824</b>	<b>+\$978</b>	<b>+\$1147</b>	<b>+\$1498</b>	<b>+\$1867</b>	
Seat upcharge:		<b>+0</b>	<b>+\$60</b>	<b>+\$106</b>	<b>+\$175</b>	<b>+\$271</b>	<b>+\$311</b>	<b>+\$394</b>	<b>+\$525</b>	<b>+\$623</b>	<b>+\$731</b>	<b>+\$953</b>	<b>+\$1188</b>		
For power/USB unit, see electrical placement chart. Includes ganging hardware (2 sides). Add \$69 for (SSS), \$105 for (SBS) Add \$667 for 36 lbs. (CW) Add \$109 for (SP) or \$513 for (BS) Add \$43 for (TP) Add \$134 for (MB)															
<b>OVERALL DIMENSIONS</b>		<b>W</b>	<b>D</b>	<b>H</b>	<b>SEAT DIMENSIONS</b>			<b>BACK DIMENSIONS</b>		<b>W</b>	<b>H</b>				
		26	30.5	41.5	26	19	18	26	23.5						
		<b>RTA 00</b>	1 per carton												
 <p><b>R27802B</b></p> <p><b>Lounge Chair - High Back</b> COM Yardage: Back: 4.75; Seat: 1.75 Freight class: 250 Product weight: 88.5 Cubic feet per carton: 31.25</p>		<b>R27802B</b>	Base Price:	<b>\$3330</b>											
		Back/Arm upcharge:	<b>+0</b>	<b>+\$161</b>	<b>+\$286</b>	<b>+\$472</b>	<b>+\$733</b>	<b>+\$842</b>	<b>+\$1068</b>	<b>+\$1424</b>	<b>+\$1690</b>	<b>+\$1981</b>	<b>+\$2586</b>	<b>+\$3224</b>	
		Seat upcharge:	<b>+0</b>	<b>+\$60</b>	<b>+\$106</b>	<b>+\$175</b>	<b>+\$271</b>	<b>+\$311</b>	<b>+\$394</b>	<b>+\$525</b>	<b>+\$623</b>	<b>+\$731</b>	<b>+\$953</b>	<b>+\$1188</b>	
	For power/USB unit, see electrical placement chart. Ganging not available. Add \$69 for (SSS), \$160 for (SBS) Add \$667 for 36 lbs. (CW) Add \$109 for (SP) or \$513 for (BS) Add \$43 for (TP) Add \$134 for (MB)														
	<b>OVERALL DIMENSIONS</b>		<b>W</b>	<b>D</b>	<b>H</b>	<b>SEAT DIMENSIONS</b>			<b>BACK DIMENSIONS</b>		<b>W</b>	<b>H</b>			
			33	30.5	41.5	26	19	18	26	23.5					
			<b>RTA 00</b>	1 per carton											















DESCRIPTION	MODEL#/ FEATURES	STANDARD TEXTILE GRADES											
		1/COM	2	3	4	5	6	7	8	9	10	11	12
 <p><b>R27804</b></p> <p><b>Two Seater - Standard Back</b> COM Yardage: Back: 2.75; Seat: 2 Freight class: 250 Product weight: 113   133 shelf model Cubic feet per carton: 37.5   51shelf model</p>	<p><b>R27804S</b></p> <p>Base Price: <b>\$3394</b></p> <p>Back upcharge: <b>+0</b></p> <p>Seat upcharge: <b>+0</b></p> <p>Shelf: 52W 10D 1H</p> <p>For power/USB unit, see electrical placement chart. Includes ganging hardware (2 sides). Add \$102 for (SSS), \$126 for (SBS) Add \$1330 for 72 lbs. (CW), (C6) Add \$207 for (SP) or \$816 for (BS) Add \$43 for (TP) Add \$266 for (MB)</p>												
		<b>OVERALL DIMENSIONS</b>			<b>SEAT DIMENSIONS</b>			<b>BACK DIMENSIONS</b>					
		<b>W</b>	<b>D</b>	<b>H</b>	<b>W</b>	<b>D</b>	<b>H</b>	<b>W</b>	<b>H</b>				
		52	30	32	52	19	18	52	14				
		<b>RTA 00</b>	1 per carton										
 <p><b>R27804B</b></p> <p><b>Two Seater - Standard Back</b> COM Yardage: Back: 4.75; Seat: 2 Freight class: 250 Product weight: 133   154 shelf model Cubic feet per carton: 42.5   57.5 shelf model</p>	<p><b>R27804SB</b></p> <p>Base Price: <b>\$4171</b></p> <p>Back/Arm upcharge: <b>+0</b></p> <p>Seat upcharge: <b>+0</b></p> <p>Shelf: 52W 10D 1H</p> <p>For power/USB unit, see electrical placement chart. Ganging not available. Add \$102 for (SSS), \$181 for (SBS) Add \$1330 for 72 lbs. (CW), (C6) Add \$207 for (SP) or \$816 for (BS) Add \$43 for (TP) Add \$266 for (MB)</p>												
		<b>OVERALL DIMENSIONS</b>			<b>SEAT DIMENSIONS</b>			<b>BACK DIMENSIONS</b>					
		<b>W</b>	<b>D</b>	<b>H</b>	<b>W</b>	<b>D</b>	<b>H</b>	<b>W</b>	<b>H</b>				
		59	30	32	52	19	18	52	14				
		<b>RTA 00</b>	1 per carton										
 <p><b>R27804L</b></p> <p><b>Two Seater - Standard Back</b> COM Yardage: Back: 3.75; Seat: 2 Freight class: 250 Product weight: 123 Cubic feet per carton: 42.5</p>	<p><b>R27804R</b></p> <p>Base Price: <b>\$3782</b></p> <p>Back/Arm upcharge: <b>+0</b></p> <p>Seat upcharge: <b>+0</b></p> <p>Shelf: 52W 10D 1H</p> <p>For power/USB unit, see electrical placement chart. Includes ganging hardware (1 side). Add \$102 for (SSS), \$153 for (SBS) Add \$1330 for 72 lbs. (CW), (C6) Add \$207 for (SP) or \$816 for (BS) Add \$43 for (TP) Add \$266 for (MB)</p>												
		<b>OVERALL DIMENSIONS</b>			<b>SEAT DIMENSIONS</b>			<b>BACK DIMENSIONS</b>					
		<b>W</b>	<b>D</b>	<b>H</b>	<b>W</b>	<b>D</b>	<b>H</b>	<b>W</b>	<b>H</b>				
		55.5	30	32	52	19	18	52	14				
		<b>RTA 00</b>	1 per carton										
 <p><b>R27804SL</b></p> <p><b>Two Seater - Standard Back</b> COM Yardage: Back: 3.75; Seat: 2 Freight class: 250 Product weight: 144 Cubic feet per carton: 57.5</p>	<p><b>R27804SR</b></p> <p>Base Price: <b>\$4549</b></p> <p>Back/Arm upcharge: <b>+0</b></p> <p>Seat upcharge: <b>+0</b></p> <p>Shelf: 52W 10D 1H</p> <p>For power/USB unit, see electrical placement chart. Includes ganging hardware (1 side). Add \$102 for (SSS), \$153 for (SBS) Add \$1330 for 72 lbs. (CW), (C6) Add \$207 for (SP) or \$816 for (BS) Add \$43 for (TP) Add \$266 for (MB)</p>												
		<b>OVERALL DIMENSIONS</b>			<b>SEAT DIMENSIONS</b>			<b>BACK DIMENSIONS</b>					
		<b>W</b>	<b>D</b>	<b>H</b>	<b>W</b>	<b>D</b>	<b>H</b>	<b>W</b>	<b>H</b>				
		55.5	40.5	32	52	19	18	52	14				
		<b>RTA 00</b>	1 per carton										

DESCRIPTION		MODEL#/ FEATURES	STANDARD TEXTILE GRADES																								
			1/COM	2	3	4	5	6	7	8	9	10	11	12													
 <p><b>R27805</b></p> <p><b>Two Seater - High Back</b> COM Yardage: Back: 3.50; Seat: 2 Freight class: 250 Product weight: 138   139 shelf model Cubic feet per carton: 47.25   64.75 shelf model</p>	 <p><b>R27805S</b></p> <p>For power/USB unit, see electrical placement chart. Includes ganging hardware (1 sides) Add \$102 for (SSS), \$166 for (SBS) Add \$1330 for 72 lbs. (CW), (C6) Add \$207 for (SP) or \$816 for (BS) Add \$43 for (TP) Add \$266 for (MB)</p>	<p><b>R27805</b> Base Price: <b>\$4130</b></p> <p><b>R27805S</b> Base Price: <b>\$4894</b></p> <p>Back upcharge: <b>+0</b> <b>+\$119</b> <b>+\$211</b> <b>+\$348</b> <b>+\$540</b> <b>+\$621</b> <b>+\$788</b> <b>+\$1049</b> <b>+\$1245</b> <b>+\$1460</b> <b>+\$1906</b> <b>+\$2375</b></p> <p>Seat upcharge: <b>+0</b> <b>+\$68</b> <b>+\$121</b> <b>+\$199</b> <b>+\$309</b> <b>+\$355</b> <b>+\$450</b> <b>+\$600</b> <b>+\$712</b> <b>+\$834</b> <b>+\$1089</b> <b>+\$1357</b></p> <p>Shelf: 52W 10D 1H</p>																									
		<p><b>OVERALL DIMENSIONS</b></p> <table border="1"> <thead> <tr> <th>W</th> <th>D</th> <th>H</th> </tr> </thead> <tbody> <tr> <td>52</td> <td>30.5</td> <td>41.5</td> </tr> </tbody> </table> <p><b>SEAT DIMENSIONS</b></p> <table border="1"> <thead> <tr> <th>W</th> <th>D</th> <th>H</th> </tr> </thead> <tbody> <tr> <td>52</td> <td>19</td> <td>18</td> </tr> </tbody> </table> <p><b>BACK DIMENSIONS</b></p> <table border="1"> <thead> <tr> <th>W</th> <th>H</th> </tr> </thead> <tbody> <tr> <td>52</td> <td>23.5</td> </tr> </tbody> </table> <p><b>RTA 00</b> 1 per carton</p>	W	D	H	52	30.5	41.5	W	D	H	52	19	18	W	H	52	23.5									
W	D	H																									
52	30.5	41.5																									
W	D	H																									
52	19	18																									
W	H																										
52	23.5																										
 <p><b>R27805B</b></p> <p><b>Two Seater - High Back</b> COM Yardage: Back: 5.50; Seat: 2 Freight class: 250 Product weight: 138   159 shelf model Cubic feet per carton: 54   73 shelf model</p>	 <p><b>R27805SB</b></p> <p>For power/USB unit, see electrical placement chart. Ganging not available. Add \$102 for (SSS), \$221 for (SBS) Add \$1330 for 72 lbs. (CW), (C6) Add \$207 for (SP) or \$816 for (BS) Add \$43 for (TP) Add \$266 for (MB)</p>	<p><b>R27805B</b> Base Price: <b>\$4907</b></p> <p><b>R27805SB</b> Base Price: <b>\$5672</b></p> <p>Back/Arm upcharge: <b>+0</b> <b>+\$186</b> <b>+\$332</b> <b>+\$546</b> <b>+\$848</b> <b>+\$975</b> <b>+\$1237</b> <b>+\$1648</b> <b>+\$1956</b> <b>+\$2293</b> <b>+\$2995</b> <b>+\$3732</b></p> <p>Seat upcharge: <b>+0</b> <b>+\$68</b> <b>+\$121</b> <b>+\$199</b> <b>+\$309</b> <b>+\$355</b> <b>+\$450</b> <b>+\$600</b> <b>+\$712</b> <b>+\$834</b> <b>+\$1089</b> <b>+\$1357</b></p> <p>Shelf: 52W 10D 1H</p>																									
		<p><b>OVERALL DIMENSIONS</b></p> <table border="1"> <thead> <tr> <th>W</th> <th>D</th> <th>H</th> </tr> </thead> <tbody> <tr> <td>59</td> <td>30.5</td> <td>41.5</td> </tr> </tbody> </table> <p><b>SEAT DIMENSIONS</b></p> <table border="1"> <thead> <tr> <th>W</th> <th>D</th> <th>H</th> </tr> </thead> <tbody> <tr> <td>52</td> <td>19</td> <td>18</td> </tr> </tbody> </table> <p><b>BACK DIMENSIONS</b></p> <table border="1"> <thead> <tr> <th>W</th> <th>H</th> </tr> </thead> <tbody> <tr> <td>52</td> <td>23.5</td> </tr> </tbody> </table> <p><b>RTA 00</b> 1 per carton</p>	W	D	H	59	30.5	41.5	W	D	H	52	19	18	W	H	52	23.5									
W	D	H																									
59	30.5	41.5																									
W	D	H																									
52	19	18																									
W	H																										
52	23.5																										
 <p><b>R27805L</b></p> <p><b>Two Seater - High Back</b> COM Yardage: Back: 4.50; Seat: 2 Freight class: 250 Product weight: 128 Cubic feet per carton: 54</p>	 <p><b>R27805R</b></p> <p>For power/USB unit, see electrical placement chart. Includes ganging hardware (1 side). Add \$102 for (SSS), \$221 for (SBS) Add \$1330 for 72 lbs. (CW), (C6) Add \$207 for (SP) or \$816 for (BS) Add \$43 for (TP) Add \$266 for (MB)</p>	<p><b>R27805L</b> Base Price: <b>\$4518</b></p> <p><b>R27805R</b> Base Price: <b>\$4518</b></p> <p>Back/Arm upcharge: <b>+0</b> <b>+\$152</b> <b>+\$272</b> <b>+\$447</b> <b>+\$694</b> <b>+\$798</b> <b>+\$1012</b> <b>+\$1349</b> <b>+\$1601</b> <b>+\$1876</b> <b>+\$2450</b> <b>+\$3054</b></p> <p>Seat upcharge: <b>+0</b> <b>+\$68</b> <b>+\$121</b> <b>+\$199</b> <b>+\$309</b> <b>+\$355</b> <b>+\$450</b> <b>+\$600</b> <b>+\$712</b> <b>+\$834</b> <b>+\$1089</b> <b>+\$1357</b></p> <p>Shelf: 52W 10D 1H</p>																									
		<p><b>OVERALL DIMENSIONS</b></p> <table border="1"> <thead> <tr> <th>W</th> <th>D</th> <th>H</th> </tr> </thead> <tbody> <tr> <td>55.5</td> <td>30.5</td> <td>41.5</td> </tr> </tbody> </table> <p><b>SEAT DIMENSIONS</b></p> <table border="1"> <thead> <tr> <th>W</th> <th>D</th> <th>H</th> </tr> </thead> <tbody> <tr> <td>52</td> <td>19</td> <td>18</td> </tr> </tbody> </table> <p><b>BACK DIMENSIONS</b></p> <table border="1"> <thead> <tr> <th>W</th> <th>H</th> </tr> </thead> <tbody> <tr> <td>52</td> <td>23.5</td> </tr> </tbody> </table> <p><b>RTA 00</b> 1 per carton</p>	W	D	H	55.5	30.5	41.5	W	D	H	52	19	18	W	H	52	23.5									
W	D	H																									
55.5	30.5	41.5																									
W	D	H																									
52	19	18																									
W	H																										
52	23.5																										
 <p><b>R27805SL</b></p> <p><b>Two Seater - High Back</b> COM Yardage: Back: 4.50; Seat: 2 Freight class: 250 Product weight: 149 Cubic feet per carton: 73</p>	 <p><b>R27805SR</b></p> <p>For power/USB unit, see electrical placement chart. Includes ganging hardware (1 side). Add \$102 for (SSS), \$221 for (SBS) Add \$1330 for 72 lbs. (CW), (C6) Add \$207 for (SP) or \$816 for (BS) Add \$43 for (TP) Add \$266 for (MB)</p>	<p><b>R27805SL</b> Base Price: <b>\$5283</b></p> <p><b>R27805SR</b> Base Price: <b>\$5283</b></p> <p>Back/Arm upcharge: <b>+0</b> <b>+\$152</b> <b>+\$272</b> <b>+\$447</b> <b>+\$694</b> <b>+\$798</b> <b>+\$1012</b> <b>+\$1349</b> <b>+\$1601</b> <b>+\$1876</b> <b>+\$2450</b> <b>+\$3054</b></p> <p>Seat upcharge: <b>+0</b> <b>+\$68</b> <b>+\$121</b> <b>+\$199</b> <b>+\$309</b> <b>+\$355</b> <b>+\$450</b> <b>+\$600</b> <b>+\$712</b> <b>+\$834</b> <b>+\$1089</b> <b>+\$1357</b></p> <p>Shelf: 52W 10D 1H</p>																									
		<p><b>OVERALL DIMENSIONS</b></p> <table border="1"> <thead> <tr> <th>W</th> <th>D</th> <th>H</th> </tr> </thead> <tbody> <tr> <td>55.5</td> <td>41</td> <td>41.5</td> </tr> </tbody> </table> <p><b>SEAT DIMENSIONS</b></p> <table border="1"> <thead> <tr> <th>W</th> <th>D</th> <th>H</th> </tr> </thead> <tbody> <tr> <td>52</td> <td>19</td> <td>18</td> </tr> </tbody> </table> <p><b>BACK DIMENSIONS</b></p> <table border="1"> <thead> <tr> <th>W</th> <th>H</th> </tr> </thead> <tbody> <tr> <td>52</td> <td>23.5</td> </tr> </tbody> </table> <p><b>RTA 00</b> 1 per carton</p>	W	D	H	55.5	41	41.5	W	D	H	52	19	18	W	H	52	23.5									
W	D	H																									
55.5	41	41.5																									
W	D	H																									
52	19	18																									
W	H																										
52	23.5																										





DESCRIPTION		MODEL#/ FEATURES		STANDARD TEXTILE GRADES											
				1/COM	2	3	4	5	6	7	8	9	10	11	12
	<p><b>R27806</b>      <b>R27806S</b></p> <p><b>Two Seater - Extended Back</b> COM Yardage: Back: 3.50; Seat: 2 Freight class: 250 Product weight: 131   152 shelf model Cubic feet per carton: 53.75   72.75 shelf model</p>	<p><b>R27806</b>      Base Price: <b>\$4701</b></p>	<p><b>R27806S</b>      Base Price: <b>\$5468</b></p>												
		<p>Back upcharge: <b>+0</b>    <b>+\$119</b>   <b>+\$211</b>   <b>+\$348</b>   <b>+\$540</b>   <b>+\$621</b>   <b>+\$788</b>   <b>+\$1049</b>   <b>+\$1245</b>   <b>+\$1460</b>   <b>+\$1906</b>   <b>+\$2375</b></p> <p>Seat upcharge: <b>+0</b>    <b>+\$68</b>    <b>+\$121</b>   <b>+\$199</b>   <b>+\$309</b>   <b>+\$355</b>   <b>+\$450</b>   <b>+\$600</b>   <b>+\$712</b>   <b>+\$834</b>   <b>+\$1089</b>   <b>+\$1357</b></p>													
				Shelf: 52W 10D 1H											
				<p><b>OVERALL DIMENSIONS</b></p> <p>W      D      H</p>			<p><b>SEAT DIMENSIONS</b></p> <p>W      D      H</p>			<p><b>BACK DIMENSIONS</b></p> <p>W      H</p>					
				52	31	47	52	19	18	52		29			
				<p><b>RTA 00</b></p>		1 per carton									
	<p><b>R27806B</b>      <b>R27806SB</b></p> <p><b>Two Seater - Extended Back</b> COM Yardage: Back: 6 Seat: 2 Freight class: 250 Product weight: 151   172 shelf model Cubic feet per carton: 60.5   82 shelf model</p>	<p><b>R27806B</b>      Base Price: <b>\$5479</b></p>	<p><b>R27806SB</b>      Base Price: <b>\$6244</b></p>												
		<p>Back/Arm upcharge: <b>+0</b>    <b>+\$203</b>   <b>+\$361</b>   <b>+\$596</b>   <b>+\$925</b>   <b>+\$1064</b>   <b>+\$1349</b>   <b>+\$1798</b>   <b>+\$2134</b>   <b>+\$2501</b>   <b>+\$3267</b>   <b>+\$4071</b></p> <p>Seat upcharge: <b>+0</b>    <b>+\$68</b>    <b>+\$121</b>   <b>+\$199</b>   <b>+\$309</b>   <b>+\$355</b>   <b>+\$450</b>   <b>+\$600</b>   <b>+\$712</b>   <b>+\$834</b>   <b>+\$1089</b>   <b>+\$1357</b></p>													
				Shelf: 52W 10D 1H											
				<p><b>OVERALL DIMENSIONS</b></p> <p>W      D      H</p>			<p><b>SEAT DIMENSIONS</b></p> <p>W      D      H</p>			<p><b>BACK DIMENSIONS</b></p> <p>W      H</p>					
				59	31	47	52	19	18	52		29			
				<p><b>RTA 00</b></p>		1 per carton									
	<p><b>R27806L</b>      <b>R27806R</b></p> <p><b>Two Seater - Extended Back</b> COM Yardage: Back: 5; Seat: 2 Freight class: 250 Product weight: 141 Cubic feet per carton: 60.5</p>	<p><b>R27806L</b>      Base Price: <b>\$5090</b></p>	<p><b>R27806R</b>      Base Price: <b>\$5857</b></p>												
		<p>Back/Arm upcharge: <b>+0</b>    <b>+\$169</b>   <b>+\$301</b>   <b>+\$496</b>   <b>+\$771</b>   <b>+\$887</b>   <b>+\$1124</b>   <b>+\$1499</b>   <b>+\$1778</b>   <b>+\$2084</b>   <b>+\$2722</b>   <b>+\$3392</b></p> <p>Seat upcharge: <b>+0</b>    <b>+\$68</b>    <b>+\$121</b>   <b>+\$199</b>   <b>+\$309</b>   <b>+\$355</b>   <b>+\$450</b>   <b>+\$600</b>   <b>+\$712</b>   <b>+\$834</b>   <b>+\$1089</b>   <b>+\$1357</b></p>													
				Shelf: 52W 10D 1H											
				<p><b>OVERALL DIMENSIONS</b></p> <p>W      D      H</p>			<p><b>SEAT DIMENSIONS</b></p> <p>W      D      H</p>			<p><b>BACK DIMENSIONS</b></p> <p>W      H</p>					
				55.5	31	47	52	19	18	52		29			
				<p><b>RTA 00</b></p>		1 per carton									
	<p><b>R27806SL</b>      <b>R27806SR</b></p> <p><b>Two Seater - Extended Back</b> COM Yardage: Back: 5; Seat: 2 Freight class: 250 Product weight: 162 Cubic feet per carton: 82</p>	<p><b>R27806SL</b>      Base Price: <b>\$5857</b></p>	<p><b>R27806SR</b>      Base Price: <b>\$5857</b></p>												
		<p>Back/Arm upcharge: <b>+0</b>    <b>+\$169</b>   <b>+\$301</b>   <b>+\$496</b>   <b>+\$771</b>   <b>+\$887</b>   <b>+\$1124</b>   <b>+\$1499</b>   <b>+\$1778</b>   <b>+\$2084</b>   <b>+\$2722</b>   <b>+\$3392</b></p> <p>Seat upcharge: <b>+0</b>    <b>+\$68</b>    <b>+\$121</b>   <b>+\$199</b>   <b>+\$309</b>   <b>+\$355</b>   <b>+\$450</b>   <b>+\$600</b>   <b>+\$712</b>   <b>+\$834</b>   <b>+\$1089</b>   <b>+\$1357</b></p>													
				Shelf: 52W 10D 1H											
				<p><b>OVERALL DIMENSIONS</b></p> <p>W      D      H</p>			<p><b>SEAT DIMENSIONS</b></p> <p>W      D      H</p>			<p><b>BACK DIMENSIONS</b></p> <p>W      H</p>					
				55.5	41.5	47	52	19	18	52		29			
				<p><b>RTA 00</b></p>		1 per carton									

DESCRIPTION		MODEL#/ FEATURES	STANDARD TEXTILE GRADES											
			1/COM	2	3	4	5	6	7	8	9	10	11	12
	<p><b>R27807</b></p> <p><b>Three Seater - Standard Back</b> COM Yardage: Back: 4.50; Seat: 3.50 Freight class: 250 Product weight: 152   173 shelf model Cubic feet per carton: 55.5   173 shelf model</p>	<p><b>R27807</b> Base Price: <b>\$5321</b></p> <p><b>R27807S</b> Base Price: <b>\$6333</b></p> <p>Back upcharge: <b>+0</b></p> <p>Seat upcharge: <b>+0</b></p>												
		<p>For power/USB unit, see electrical placement chart. Includes ganging hardware (2 sides). Add \$124 for (SSS), \$146 for (SBS) Add \$1330 for 72 lbs. (CW), (C6) Add \$311 for (SP) or \$1122 for (BS) Add \$43 for (TP) Add \$396 for (MB)</p>												
			Shelf: 52W 10D 1H											
			<p><b>OVERALL DIMENSIONS</b></p> <p>W D H</p>			<p><b>SEAT DIMENSIONS</b></p> <p>W D H</p>			<p><b>BACK DIMENSIONS</b></p> <p>W H</p>					
			78 30 32			78 19 18			78 14					
			<p><b>RTA 00</b> 1 per carton</p>											
	<p><b>R27807B</b></p> <p><b>Three Seater - Standard Back</b> COM Yardage: Back: 6.50; Seat: 3.50 Freight class: 250 Product weight: 170   193 shelf model Cubic feet per carton: 60.5   79.75 shelf model</p>	<p><b>R27807B</b> Base Price: <b>\$6099</b></p> <p><b>R27807SB</b> Base Price: <b>\$7111</b></p> <p>Back/Arm upcharge: <b>+0</b></p> <p>Seat upcharge: <b>+0</b></p>												
		<p>For power/USB unit, see electrical placement chart. Ganging not available. Add \$124 for (SSS), \$200 for (SBS) Add \$1330 for 72 lbs. (CW), (C6) Add \$311 for (SP) or \$1122 for (BS) Add \$43 for (TP) Add \$396 for (MB)</p>												
			Shelf: 52W 10D 1H											
			<p><b>OVERALL DIMENSIONS</b></p> <p>W D H</p>			<p><b>SEAT DIMENSIONS</b></p> <p>W D H</p>			<p><b>BACK DIMENSIONS</b></p> <p>W H</p>					
			85 30 32			78 19 18			78 14					
			<p><b>RTA 00</b> 1 per carton</p>											
	<p><b>R27807L</b></p> <p><b>Three Seater - Standard Back</b> COM Yardage: Back: 5.50; Seat: 3.50 Freight class: 250 Product weight: 160 Cubic feet per carton: 60.5</p>	<p><b>R27807L</b> Base Price: <b>\$5710</b></p> <p><b>R27807R</b> Base Price: <b>\$5710</b></p> <p>Back/Arm upcharge: <b>+0</b></p> <p>Seat upcharge: <b>+0</b></p>												
		<p>For power/USB unit, see electrical placement chart. Includes ganging hardware (2 sides). Add \$124 for (SSS), \$174 for (SBS) Add \$1330 for 72 lbs. (CW), (C6) Add \$311 for (SP) or \$1122 for (BS) Add \$43 for (TP) Add \$396 for (MB)</p>												
			Shelf: 52W 10D 1H											
			<p><b>OVERALL DIMENSIONS</b></p> <p>W D H</p>			<p><b>SEAT DIMENSIONS</b></p> <p>W D H</p>			<p><b>BACK DIMENSIONS</b></p> <p>W H</p>					
			81.5 30 32			78 19 18			78 14					
			<p><b>RTA 00</b> 1 per carton</p>											
	<p><b>R27807SL</b></p> <p><b>Three Seater - Standard Back</b> COM Yardage: Back: 5.50; Seat: 3.50 Freight class: 250 Product weight: 183 Cubic feet per carton: 79.75</p>	<p><b>R27807SL</b> Base Price: <b>\$6722</b></p> <p><b>R27807SR</b> Base Price: <b>\$6722</b></p> <p>Back/Arm upcharge: <b>+0</b></p> <p>Seat upcharge: <b>+0</b></p>												
		<p>For power/USB unit, see electrical placement chart. Includes ganging hardware (2 sides). Add \$124 for (SSS), \$174 for (SBS) Add \$1330 for 72 lbs. (CW), (C6) Add \$311 for (SP) or \$1122 for (BS) Add \$43 for (TP) Add \$396 for (MB)</p>												
			Shelf: 52W 10D 1H											
			<p><b>OVERALL DIMENSIONS</b></p> <p>W D H</p>			<p><b>SEAT DIMENSIONS</b></p> <p>W D H</p>			<p><b>BACK DIMENSIONS</b></p> <p>W H</p>					
			81.5 40.5 32			78 19 18			78 14					
			<p><b>RTA 00</b> 1 per carton</p>											

DESCRIPTION	MODEL#/ FEATURES	STANDARD TEXTILE GRADES																																	
		1/COM	2	3	4	5	6	7	8	9	10	11	12																						
 <p><b>R27808</b>                      <b>R27808S</b></p> <p><b>Three Seater - High Back</b> COM Yardage: Back: 5.75; Seat: 3.50 Freight class: 250 Product weight: 177   201 shelf model Cubic feet per carton: 69.75   95.5 shelf model</p>	<p><b>R27808</b>      Base Price:      <b>\$6206</b></p> <p><b>R27808S</b>      Base Price:      <b>\$7219</b></p> <p>Back upcharge:      <b>+0</b></p> <p>Seat upcharge:      <b>+0</b></p>	<b>\$6206</b>																																	
	<p>For power/USB unit, see electrical placement chart. Includes ganging hardware (2 sides). Add \$124 for (SSS), \$195 for (SBS) Add \$1330 for 72 lbs. (CW), (C6) Add \$311 for (SP) or \$1122 for (BS) Add \$43 for (TP) Add \$396 for (MB)</p>	<p>Shelf: 52W 10D 1H</p> <table border="1"> <thead> <tr> <th colspan="3">OVERALL DIMENSIONS</th> <th colspan="3">SEAT DIMENSIONS</th> <th colspan="2">BACK DIMENSIONS</th> </tr> <tr> <th>W</th> <th>D</th> <th>H</th> <th>W</th> <th>D</th> <th>H</th> <th>W</th> <th>H</th> </tr> </thead> <tbody> <tr> <td>78</td> <td>30.5</td> <td>41.5</td> <td>78</td> <td>19</td> <td>18</td> <td>78</td> <td>23.5</td> </tr> </tbody> </table> <p><b>RTA 00</b>                      1 per carton</p>	OVERALL DIMENSIONS			SEAT DIMENSIONS			BACK DIMENSIONS		W	D	H	W	D	H	W	H	78	30.5	41.5	78	19	18	78	23.5									
OVERALL DIMENSIONS			SEAT DIMENSIONS			BACK DIMENSIONS																													
W	D	H	W	D	H	W	H																												
78	30.5	41.5	78	19	18	78	23.5																												
 <p><b>R27808B</b>                      <b>R27808SB</b></p> <p><b>Three Seater - High Back</b> COM Yardage: Back: 7.75; Seat: 3.50 Freight class: 250 Product weight: 190.5   221.5 shelf model Cubic feet per carton: 69.75   101.5 shelf model</p>	<p><b>R27808B</b>      Base Price:      <b>\$6985</b></p> <p><b>R27808SB</b>      Base Price:      <b>\$7997</b></p> <p>Back/Arm upcharge:      <b>+0</b></p> <p>Seat upcharge:      <b>+0</b></p>	<b>\$6985</b>																																	
	<p>For power/USB unit, see electrical placement chart. Ganging not available. Add \$124 for (SSS), \$251 for (SBS) Add \$1330 for 72 lbs. (CW), (C6) Add \$311 for (SP) or \$1122 for (BS) Add \$43 for (TP) Add \$396 for (MB)</p>	<p>Shelf: 52W 10D 1H</p> <table border="1"> <thead> <tr> <th colspan="3">OVERALL DIMENSIONS</th> <th colspan="3">SEAT DIMENSIONS</th> <th colspan="2">BACK DIMENSIONS</th> </tr> <tr> <th>W</th> <th>D</th> <th>H</th> <th>W</th> <th>D</th> <th>H</th> <th>W</th> <th>H</th> </tr> </thead> <tbody> <tr> <td>85</td> <td>30.5</td> <td>41.5</td> <td>78</td> <td>19</td> <td>18</td> <td>78</td> <td>23.5</td> </tr> </tbody> </table> <p><b>RTA 00</b>                      1 per carton</p>	OVERALL DIMENSIONS			SEAT DIMENSIONS			BACK DIMENSIONS		W	D	H	W	D	H	W	H	85	30.5	41.5	78	19	18	78	23.5									
OVERALL DIMENSIONS			SEAT DIMENSIONS			BACK DIMENSIONS																													
W	D	H	W	D	H	W	H																												
85	30.5	41.5	78	19	18	78	23.5																												
 <p><b>R27808L</b>                      <b>R27808R</b></p> <p><b>Three Seater - High Back</b> COM Yardage: Back: 6.75; Seat: 3.50 Freight class: 250 Product weight: 180.5 Cubic feet per carton: 76.75</p>	<p><b>R27808L</b>      Base Price:      <b>\$6594</b></p> <p><b>R27808R</b>      Base Price:      <b>\$6594</b></p> <p>Back/Arm upcharge:      <b>+0</b></p> <p>Seat upcharge:      <b>+0</b></p>	<b>\$6594</b>																																	
	<p>For power/USB unit, see electrical placement chart. Includes ganging hardware (2 sides). Add \$124 for (SSS), \$251 for (SBS) Add \$1330 for 72 lbs. (CW), (C6) Add \$311 for (SP) or \$1122 for (BS) Add \$43 for (TP) Add \$396 for (MB)</p>	<p>Shelf: 52W 10D 1H</p> <table border="1"> <thead> <tr> <th colspan="3">OVERALL DIMENSIONS</th> <th colspan="3">SEAT DIMENSIONS</th> <th colspan="2">BACK DIMENSIONS</th> </tr> <tr> <th>W</th> <th>D</th> <th>H</th> <th>W</th> <th>D</th> <th>H</th> <th>W</th> <th>H</th> </tr> </thead> <tbody> <tr> <td>81.5</td> <td>30.5</td> <td>41.5</td> <td>78</td> <td>19</td> <td>18</td> <td>78</td> <td>23.5</td> </tr> </tbody> </table> <p><b>RTA 00</b>                      1 per carton</p>	OVERALL DIMENSIONS			SEAT DIMENSIONS			BACK DIMENSIONS		W	D	H	W	D	H	W	H	81.5	30.5	41.5	78	19	18	78	23.5									
OVERALL DIMENSIONS			SEAT DIMENSIONS			BACK DIMENSIONS																													
W	D	H	W	D	H	W	H																												
81.5	30.5	41.5	78	19	18	78	23.5																												
 <p><b>R27808SL</b>                      <b>R27808SR</b></p> <p><b>Three Seater - High Back</b> COM Yardage: Back: 6.75; Seat: 3.50 Freight class: 250 Product weight: 211.5 Cubic feet per carton: 101.5</p>	<p><b>R27808SL</b>      Base Price:      <b>\$7608</b></p> <p><b>R27808SR</b>      Base Price:      <b>\$7608</b></p> <p>Back/Arm upcharge:      <b>+0</b></p> <p>Seat upcharge:      <b>+0</b></p>	<b>\$7608</b>																																	
	<p>For power/USB unit, see electrical placement chart. Includes ganging hardware (2 sides). Add \$124 for (SSS), \$251 for (SBS) Add \$1330 for 72 lbs. (CW), (C6) Add \$311 for (SP) or \$1122 for (BS) Add \$43 for (TP) Add \$396 for (MB)</p>	<p>Shelf: 52W 10D 1H</p> <table border="1"> <thead> <tr> <th colspan="3">OVERALL DIMENSIONS</th> <th colspan="3">SEAT DIMENSIONS</th> <th colspan="2">BACK DIMENSIONS</th> </tr> <tr> <th>W</th> <th>D</th> <th>H</th> <th>W</th> <th>D</th> <th>H</th> <th>W</th> <th>H</th> </tr> </thead> <tbody> <tr> <td>81.5</td> <td>41</td> <td>41.5</td> <td>78</td> <td>19</td> <td>18</td> <td>78</td> <td>23.5</td> </tr> </tbody> </table> <p><b>RTA 00</b>                      1 per carton</p>	OVERALL DIMENSIONS			SEAT DIMENSIONS			BACK DIMENSIONS		W	D	H	W	D	H	W	H	81.5	41	41.5	78	19	18	78	23.5									
OVERALL DIMENSIONS			SEAT DIMENSIONS			BACK DIMENSIONS																													
W	D	H	W	D	H	W	H																												
81.5	41	41.5	78	19	18	78	23.5																												

DESCRIPTION		MODEL#/ FEATURES		STANDARD TEXTILE GRADES													
				1/COM	2	3	4	5	6	7	8	9	10	11	12		
		<b>R27809</b> Base Price: <b>\$6732</b> <b>R27809S</b> Base Price: <b>\$7744</b>  Back upcharge: <b>+0</b> Seat upcharge: <b>+0</b>	For power/USB unit, see electrical placement chart. Includes ganging hardware (2 sides). Add \$124 for (SSS), \$207 for (SBS) Add \$1330 for 72 lbs. (CW), (C6) Add \$311 for (SP) or \$1122 for (BS) Add \$43 for (TP) Add \$396 for (MB)	1/COM	2	3	4	5	6	7	8	9	10	11	12		
				+\$220 +\$119	+\$392 +\$211	+\$645 +\$348	+\$1002 +\$540	+\$1153 +\$621	+\$1462 +\$788	+\$1948 +\$1049	+\$2312 +\$1245	+\$2710 +\$1460	+\$3539 +\$1906	+\$4410 +\$2375	OVERALL DIMENSIONS W D H		SEAT DIMENSIONS W D H
<b>Three Seater - Extended Back</b> COM Yardage: Back: 6.50; Seat: 3.50 Freight class: 250 Product weight: 165   198 shelf model Cubic feet per carton: 79.25   108.5 shelf model				78	31	47	78	19	18	78	29	RTA 00		1 per carton			
		<b>R27809B</b> Base Price: <b>\$7509</b> <b>R27809SB</b> Base Price: <b>\$8521</b>  Back/Arm upcharge: <b>+0</b> Seat upcharge: <b>+0</b>	For power/USB unit, see electrical placement chart. Ganging not available. Add \$124 for (SSS), \$262 for (SBS) Add \$1330 for 72 lbs. (CW), (C6) Add \$311 for (SP) or \$1122 for (BS) Add \$43 for (TP) Add \$396 for (MB)	1/COM	2	3	4	5	6	7	8	9	10	11	12		
				+\$287 +\$119	+\$512 +\$211	+\$843 +\$348	+\$1310 +\$540	+\$1507 +\$621	+\$1911 +\$788	+\$2547 +\$1049	+\$3023 +\$1245	+\$3543 +\$1460	+\$4628 +\$1906	+\$5767 +\$2375	OVERALL DIMENSIONS W D H		SEAT DIMENSIONS W D H
<b>Three Seater - Extended Back</b> COM Yardage: Back: 7.50; Seat: 3.50 Freight class: 250 Product weight: 190   220 shelf model Cubic feet per carton: 86.25   114 shelf model				85	31	47	78	19	18	78	29	RTA 00		1 per carton			
		<b>R27809L</b> Base Price: <b>\$7121</b> <b>R27809R</b> Base Price: <b>\$7121</b>  Back/Arm upcharge: <b>+0</b> Seat upcharge: <b>+0</b>	For power/USB unit, see electrical placement chart. Includes ganging hardware (1 side). Add \$124 for (SSS), \$235 for (SBS) Add \$1330 for 72 lbs. (CW), (C6) Add \$311 for (SP) or \$1122 for (BS) Add \$43 for (TP) Add \$396 for (MB)	1/COM	2	3	4	5	6	7	8	9	10	11	12		
				+\$254 +\$119	+\$452 +\$211	+\$744 +\$348	+\$1156 +\$540	+\$1330 +\$621	+\$1686 +\$788	+\$2248 +\$1049	+\$2668 +\$1245	+\$3126 +\$1460	+\$4083 +\$1906	+\$5089 +\$2375	OVERALL DIMENSIONS W D H		SEAT DIMENSIONS W D H
<b>Three Seater - Extended Back</b> COM Yardage: Back: 7.50; Seat: 3.50 Freight class: 250 Product weight: 180 Cubic feet per carton: 86.25				81.5	31	47	78	19	18	78	29	RTA 00		1 per carton			
		<b>R27809SL</b> Base Price: <b>\$8132</b> <b>R27809SR</b> Base Price: <b>\$8132</b>  Back/Arm upcharge: <b>+0</b> Seat upcharge: <b>+0</b>	For power/USB unit, see electrical placement chart. Includes ganging hardware (1 side). Add \$124 for (SSS), \$235 for (SBS) Add \$1330 for 72 lbs. (CW), (C6) Add \$311 for (SP) or \$1122 for (BS) Add \$43 for (TP) Add \$396 for (MB)	1/COM	2	3	4	5	6	7	8	9	10	11	12		
				+\$254 +\$119	+\$452 +\$211	+\$744 +\$348	+\$1156 +\$540	+\$1330 +\$621	+\$1686 +\$788	+\$2248 +\$1049	+\$2668 +\$1245	+\$3126 +\$1460	+\$4083 +\$1906	+\$5089 +\$2375	OVERALL DIMENSIONS W D H		SEAT DIMENSIONS W D H
<b>Three Seater - Extended Back</b> COM Yardage: Back: 7.50; Seat: 3.50 Freight class: 250 Product weight: 210 Cubic feet per carton: 114				81.5	41.5	47	78	19	18	78	29	RTA 00		1 per carton			

Shelf: 52W 10D 1H

DESCRIPTION	MODEL#/ FEATURES	STANDARD TEXTILE GRADES											
		1/COM	2	3	4	5	6	7	8	9	10	11	12
 <p><b>R27810</b></p> <p><b>Bariatric Lounge Chair - Standard Back</b> COM Yardage: Back: 2.25; Seat: 2 Freight class: 250 Product weight: 90 Cubic feet per carton: 28.75</p>	<p><b>R27810</b> Base Price: <b>\$3324</b></p> <p>Back upcharge: <b>+0</b></p> <p>Seat upcharge: <b>+0</b></p>	<b>+0</b>	<b>+\$76</b>	<b>+\$137</b>	<b>+\$224</b>	<b>+\$348</b>	<b>+\$399</b>	<b>+\$507</b>	<b>+\$675</b>	<b>+\$801</b>	<b>+\$938</b>	<b>+\$1225</b>	<b>+\$1527</b>
	<p>For power/USB unit, see electrical placement chart. Includes ganging hardware (2 sides). Add \$74 for (SSS), \$91 for (SBS) Add \$667 for 36 lbs. (CW) Add \$146 for (SP) or \$716 for (BS) Add \$43 for (TP) Add \$199 for (MB)</p>	<p><b>OVERALL DIMENSIONS</b></p> <p>W D H</p>			<p><b>SEAT DIMENSIONS</b></p> <p>W D H</p>			<p><b>BACK DIMENSIONS</b></p> <p>W H</p>					
		39	30	32	39	19	18	39	14				
		<p><b>RTA 00</b> 1 per carton</p>											
 <p><b>R27810B</b></p> <p><b>Bariatric Lounge Chair - Standard Back</b> COM Yardage: Back: 4.25; Seat: 2 Freight class: 250 Product weight: 108 Cubic feet per carton: 33</p>	<p><b>R27810B</b> Base Price: <b>\$4100</b></p> <p>Back/Arm upcharge: <b>+0</b></p> <p>Seat upcharge: <b>+0</b></p>	<b>+0</b>	<b>+\$144</b>	<b>+\$257</b>	<b>+\$422</b>	<b>+\$656</b>	<b>+\$754</b>	<b>+\$956</b>	<b>+\$1274</b>	<b>+\$1512</b>	<b>+\$1772</b>	<b>+\$2314</b>	<b>+\$2884</b>
	<p>For power/USB unit, see electrical placement chart. Ganging not available. Add \$74 for (SSS), \$147 for (SBS) Add \$667 for 36 lbs. (CW) Add \$146 for (SP) or \$716 for (BS) Add \$43 for (TP) Add \$199 for (MB)</p>	<p><b>OVERALL DIMENSIONS</b></p> <p>W D H</p>			<p><b>SEAT DIMENSIONS</b></p> <p>W D H</p>			<p><b>BACK DIMENSIONS</b></p> <p>W H</p>					
		46	30	32	39	19	18	39	14				
		<p><b>RTA 00</b> 1 per carton</p>											
 <p><b>R27810L</b></p> <p><b>Bariatric Lounge Chair - Standard Back</b> COM Yardage: Back: 3.25; Seat: 2 Freight class: 250 Product weight: 98 Cubic feet per carton: 33</p>	<p><b>R27810L</b> Base Price: <b>\$3712</b></p> <p><b>R27810R</b> Base Price: <b>\$3712</b></p> <p>Back/Arm upcharge: <b>+0</b></p> <p>Seat upcharge: <b>+0</b></p>	<b>+0</b>	<b>+\$110</b>	<b>+\$197</b>	<b>+\$323</b>	<b>+\$502</b>	<b>+\$577</b>	<b>+\$732</b>	<b>+\$974</b>	<b>+\$1157</b>	<b>+\$1355</b>	<b>+\$1770</b>	<b>+\$2205</b>
	<p>For power/USB unit, see electrical placement chart. Includes ganging hardware (1 side). Add \$74 for (SSS), \$119 for (SBS) Add \$667 for 36 lbs. (CW) Add \$146 for (SP) or \$716 for (BS) Add \$43 for (TP) Add \$199 for (MB)</p>	<p><b>OVERALL DIMENSIONS</b></p> <p>W D H</p>			<p><b>SEAT DIMENSIONS</b></p> <p>W D H</p>			<p><b>BACK DIMENSIONS</b></p> <p>W H</p>					
		42.5	30	32	39	19	18	39	14				
		<p><b>RTA 00</b> 1 per carton</p>											
 <p><b>R27811</b></p> <p><b>Bariatric Lounge Chair - High Back</b> COM Yardage: Back: 2.75; Seat: 2 Freight class: 250 Product weight: 98 Cubic feet per carton: 36</p>	<p><b>R27811</b> Base Price: <b>\$3697</b></p> <p>Back upcharge: <b>+0</b></p> <p>Seat upcharge: <b>+0</b></p>	<b>+0</b>	<b>+\$93</b>	<b>+\$166</b>	<b>+\$274</b>	<b>+\$425</b>	<b>+\$488</b>	<b>+\$619</b>	<b>+\$824</b>	<b>+\$978</b>	<b>+\$1147</b>	<b>+\$1498</b>	<b>+\$4580</b>
	<p>For power/USB unit, see electrical placement chart. Includes ganging hardware (2 sides). Add \$74 for (SSS), \$117 for (SBS) Add \$667 for 36 lbs. (CW), (CG) Add \$146 for (SP) or \$716 for (BS) Add \$43 for (TP) Add \$199 for (MB)</p>	<p><b>OVERALL DIMENSIONS</b></p> <p>W D H</p>			<p><b>SEAT DIMENSIONS</b></p> <p>W D H</p>			<p><b>BACK DIMENSIONS</b></p> <p>W H</p>					
		39	30.5	41.5	39	19	18	39	23.5				
		<p><b>RTA 00</b> 1 per carton</p>											

DESCRIPTION MODEL#/ FEATURES STANDARD TEXTILE GRADES



R27811B

**Bariatric Lounge Chair - High Back**  
 COM Yardage: Back: 4.75; Seat: 2  
 Freight class: 250  
 Product weight: 117.5  
 Cubic feet per carton: 42.25

**R27811B** Base Price:  
 Back/Arm upcharge:  
 Seat upcharge:

For power/USB unit, see electrical placement chart.  
 Ganging not available.  
 Add \$74 for (SSS), \$171 for (SBS)  
 Add \$667 for 36 lbs. (CW), (C6)  
 Add \$146 for (SP) or \$716 for (BS)  
 Add \$43 for (TP)  
 Add \$199 for (MB)

1/COM	2	3	4	5	6	7	8	9	10	11	12

OVERALL DIMENSIONS			SEAT DIMENSIONS			BACK DIMENSIONS		
W	D	H	W	D	H	W	H	
46	30.5	41.5	39	19	18	39	23.5	
RTA 00			1 per carton					



R27811L

R27811R

**Bariatric Lounge Chair - High Back**  
 COM Yardage: Back: 3.75; Seat: 2  
 Freight class: 250  
 Product weight: 107.5  
 Cubic feet per carton: 42.25

**R27811L** Base Price:  
**R27811R** Base Price:  
 Back/Arm upcharge:  
 Seat upcharge:

For power/USB unit, see electrical placement chart.  
 Includes ganging hardware (1 side).  
 Add \$74 for (SSS), \$145 for (SBS)  
 Add \$667 for 36 lbs. (CW), (C6)  
 Add \$146 for (SP) or \$716 for (BS)  
 Add \$43 for (TP)  
 Add \$199 for (MB)

1/COM	2	3	4	5	6	7	8	9	10	11	12

OVERALL DIMENSIONS			SEAT DIMENSIONS			BACK DIMENSIONS		
W	D	H	W	D	H	W	H	
42.5	30.5	41.5	39	19	18	39	23.5	
RTA 00			1 per carton					



R27812

**Bariatric Lounge Chair - Extended Back**  
 COM Yardage: Back: 3.25; Seat: 2  
 Freight class: 250  
 Product weight: 115  
 Cubic feet per carton: 41

**R27812** Base Price:  
 Back upcharge:  
 Seat upcharge:

For power/USB unit, see electrical placement chart.  
 Includes ganging hardware (2 sides).  
 Add \$74 for (SSS), \$126 for (SBS)  
 Add \$667 for 36 lbs. (CW), (C6)  
 Add \$146 for (SP) or \$716 for (BS)  
 Add \$43 for (TP)  
 Add \$199 for (MB)

1/COM	2	3	4	5	6	7	8	9	10	11	12

OVERALL DIMENSIONS			SEAT DIMENSIONS			BACK DIMENSIONS		
W	D	H	W	D	H	W	H	
39	31	47	39	19	18	39	29	
RTA 00			1 per carton					



R27812B





**Bariatric Lounge Chair - Extended Back**  
 COM Yardage: Back: 5.25; Seat: 2  
 Freight class: 250  
 Product weight: 132.5  
 Cubic feet per carton: 47.25





**R27812B** Base Price:  
 Back/Arm upcharge:  
 Seat upcharge:





For power/USB unit, see electrical placement chart.  
 Ganging not available.  
 Add \$74 for (SSS), \$181 for (SBS)  
 Add \$667 for 36 lbs. (CW), (C6)  
 Add \$146 for (SP) or \$716 for (BS)  
 Add \$43 for (TP)  
 Add \$199 for (MB)





1/COM	2	3	4	5	6	7	8	9	10	11	12









OVERALL DIMENSIONS			SEAT DIMENSIONS			BACK DIMENSIONS		
W	D	H	W	D	H	W	H	
46	31	47	39	19	18	39	29	
RTA 00			1 per carton					





DESCRIPTION		MODEL#/ FEATURES		STANDARD TEXTILE GRADES																																							
				1/COM	2	3	4	5	6	7	8	9	10	11	12																												
	<p><b>R27812L</b></p> <p><b>Bariatric Lounge Chair - Extended Back</b> COM Yardage: Back: 4.25; Seat: 2 Freight class: 250 Product weight: 122.5 Cubic feet per carton: 47.25</p>	<p><b>R27812R</b></p> <p>For power/USB unit, see electrical placement chart. Includes ganging hardware (1 side). Add \$74 for (SSS), \$153 for (SBS) Add \$667 for 36 lbs. (CW), (C6) Add \$146 for (SP) or \$716 for (BS) Add \$43 for (TP) Add \$199 for (MB)</p>	<p>Base Price: <b>\$4304</b> Base Price: <b>\$4304</b></p> <p>Back/Arm upcharge: <b>+0</b> Seat upcharge: <b>+0</b></p>	<table border="1"> <tr> <td>1/COM</td><td>2</td><td>3</td><td>4</td><td>5</td><td>6</td><td>7</td><td>8</td><td>9</td><td>10</td><td>11</td><td>12</td> </tr> <tr> <td></td><td></td><td></td><td></td><td></td><td></td><td></td><td></td><td></td><td></td><td></td><td></td><td></td><td></td><td></td><td></td> </tr> </table>												1/COM	2	3	4	5	6	7	8	9	10	11	12																
				1/COM	2	3	4	5	6	7	8	9	10	11	12																												
				<p><b>OVERALL DIMENSIONS</b></p> <p>W D H</p>			<p><b>SEAT DIMENSIONS</b></p> <p>W D H</p>			<p><b>BACK DIMENSIONS</b></p> <p>W H</p>																																	
				42.5 31 47			39 19 18			39 29																																	
				<p><b>RTA 00</b> 1 per carton</p>																																							
	<p><b>R27815</b></p> <p><b>Inside Curve Two Seater - Standard Back</b> COM Yardage: Back: 3; Seat: 2 Freight class: 250 Product weight: 93   119 shelf model Cubic feet per carton: 42.75   63.5 shelf model</p>	<p><b>R27815S</b></p> <p>For power/USB unit, see electrical placement chart. Includes ganging hardware (2 sides). Add \$91 for (SSS), \$126 for (SBS) Add \$1330 for 72 lbs. (CW), (C6) Add \$184 for (SP) or \$816 for (BS) Add \$43 for (TP) Add \$266 for (MB)</p>	<p>Base Price: <b>\$3582</b> Base Price: <b>\$4692</b></p> <p>Back upcharge: <b>+0</b> Seat upcharge: <b>+0</b></p>	<table border="1"> <tr> <td>1/COM</td><td>2</td><td>3</td><td>4</td><td>5</td><td>6</td><td>7</td><td>8</td><td>9</td><td>10</td><td>11</td><td>12</td> </tr> <tr> <td></td><td></td><td></td><td></td><td></td><td></td><td></td><td></td><td></td><td></td><td></td><td></td><td></td><td></td><td></td><td></td> </tr> </table>												1/COM	2	3	4	5	6	7	8	9	10	11	12																
				1/COM	2	3	4	5	6	7	8	9	10	11	12																												
				<p><b>OVERALL DIMENSIONS</b></p> <p>W D H</p>			<p><b>SEAT DIMENSIONS</b></p> <p>W D H</p>			<p><b>BACK DIMENSIONS</b></p> <p>W H</p>																																	
				50.5 30 32			42 19 18			51 14																																	
				<p><b>RTA 00</b> 1 per carton</p>																																							
Shelf: 52W 10D 1H																																											
	<p><b>R27815L</b></p> <p><b>Inside Curve Two Seater - Standard Back</b> COM Yardage: Back: 4; Seat: 2 Freight class: 250 Product weight: 102 Cubic feet per carton: 43.5</p>	<p><b>R27815R</b></p> <p>For power/USB unit, see electrical placement chart. Includes ganging hardware (1 side). Add \$91 for (SSS), \$153 for (SBS) Add \$1330 for 72 lbs. (CW), (C6) Add \$184 for (SP) or \$816 for (BS) Add \$43 for (TP) Add \$266 for (MB)</p>	<p>Base Price: <b>\$3972</b> Base Price: <b>\$3972</b></p> <p>Back/Arm upcharge: <b>+0</b> Seat upcharge: <b>+0</b></p>	<table border="1"> <tr> <td>1/COM</td><td>2</td><td>3</td><td>4</td><td>5</td><td>6</td><td>7</td><td>8</td><td>9</td><td>10</td><td>11</td><td>12</td> </tr> <tr> <td></td><td></td><td></td><td></td><td></td><td></td><td></td><td></td><td></td><td></td><td></td><td></td><td></td><td></td><td></td><td></td> </tr> </table>												1/COM	2	3	4	5	6	7	8	9	10	11	12																
				1/COM	2	3	4	5	6	7	8	9	10	11	12																												
				<p><b>OVERALL DIMENSIONS</b></p> <p>W D H</p>			<p><b>SEAT DIMENSIONS</b></p> <p>W D H</p>			<p><b>BACK DIMENSIONS</b></p> <p>W H</p>																																	
				54 30 32			42 19 18			51 14																																	
				<p><b>RTA 00</b> 1 per carton</p>																																							
	<p><b>R27815SL</b></p> <p><b>Inside Curve Two Seater - Standard Back</b> COM Yardage: Back: 4; Seat: 2 Freight class: 250 Product weight: 102   128 shelf model Cubic feet per carton: 43.5   65 shelf model</p>	<p><b>R27815SR</b></p> <p>For power/USB unit, see electrical placement chart. Includes ganging hardware (1 side). Add \$91 for (SSS), \$153 for (SBS) Add \$1330 for 72 lbs. (CW), (C6) Add \$184 for (SP) or \$816 for (BS) Add \$43 for (TP) Add \$266 for (MB)</p>	<p>Base Price: <b>\$5081</b> Base Price: <b>\$5081</b></p> <p>Back/Arm upcharge: <b>+0</b> Seat upcharge: <b>+0</b></p>	<table border="1"> <tr> <td>1/COM</td><td>2</td><td>3</td><td>4</td><td>5</td><td>6</td><td>7</td><td>8</td><td>9</td><td>10</td><td>11</td><td>12</td> </tr> <tr> <td></td><td></td><td></td><td></td><td></td><td></td><td></td><td></td><td></td><td></td><td></td><td></td><td></td><td></td><td></td><td></td> </tr> </table>												1/COM	2	3	4	5	6	7	8	9	10	11	12																
				1/COM	2	3	4	5	6	7	8	9	10	11	12																												
				<p><b>OVERALL DIMENSIONS</b></p> <p>W D H</p>			<p><b>SEAT DIMENSIONS</b></p> <p>W D H</p>			<p><b>BACK DIMENSIONS</b></p> <p>W H</p>																																	
				61.5 40.5 32			42 19 18			51 14																																	
				<p><b>RTA 00</b> 1 per carton</p>																																							
Shelf: 52W 10D 1H																																											

DESCRIPTION		MODEL#/ FEATURES		STANDARD TEXTILE GRADES											
				1/COM	2	3	4	5	6	7	8	9	10	11	12
 <p><b>R27816</b></p> <p><b>Inside Curve Two Seater - High Back</b> COM Yardage: Back: 3.50; Seat: 2 Freight class: 300 Product weight: 106   132 shelf model Cubic feet per carton: 53.75   79.75 shelf model</p>	<p><b>R27816S</b></p> <p>For power/USB unit, see electrical placement chart. Includes ganging hardware (2 sides). Add \$91 for (SSS), \$166 for (SBS) Add \$1330 for 72 lbs. (CW), (C6) Add \$184 for (SP) or \$816 for (BS) Add \$43 for (TP) Add \$266 for (MB)</p>	<p><b>R27816</b> Base Price: <b>\$4663</b></p> <p><b>R27816S</b> Base Price: <b>\$5704</b></p> <p>Back upcharge: <b>+0</b></p> <p>Seat upcharge: <b>+0</b></p>	<p><b>\$4663</b></p> <p><b>\$5704</b></p> <p><b>+0</b></p> <p><b>+0</b></p>												
		Shelf: 52W 10D 1H				<b>OVERALL DIMENSIONS</b> W D H			<b>SEAT DIMENSIONS</b> W D H			<b>BACK DIMENSIONS</b> W H			
				51	30.5	41.5	42	19	18	51	23.5				
				<b>RTA 00</b>	1 per carton										
 <p><b>R27816L</b></p> <p><b>Inside Curve Two Seater - High Back</b> COM Yardage: Back: 4.50; Seat: 2 Freight class: 250 Product weight: 115 Cubic feet per carton: 55.5</p>	<p><b>R27816SR</b></p> <p>For power/USB unit, see electrical placement chart. Includes ganging hardware (1 side). Add \$91 for (SSS), \$194 for (SBS) Add \$1330 for 72 lbs. (CW), (C6) Add \$184 for (SP) or \$816 for (BS) Add \$43 for (TP) Add \$266 for (MB)</p>	<p><b>R27816L</b> Base Price: <b>\$5052</b></p> <p><b>R27816SR</b> Base Price: <b>\$5052</b></p> <p>Back/Arm upcharge: <b>+0</b></p> <p>Seat upcharge: <b>+0</b></p>	<p><b>\$5052</b></p> <p><b>\$5052</b></p> <p><b>+0</b></p> <p><b>+0</b></p>												
		Shelf: 52W 10D 1H				<b>OVERALL DIMENSIONS</b> W D H			<b>SEAT DIMENSIONS</b> W D H			<b>BACK DIMENSIONS</b> W H			
				54.5	30.5	41.5	42	19	18	51	23.5				
				<b>RTA 00</b>	1 per carton										
 <p><b>R27816SL</b></p> <p><b>Inside Curve Two Seater - High Back</b> COM Yardage: Back: 4.50; Seat: 2 Freight class: 250 Product weight: 141.5 Cubic feet per carton: 82.5</p>	<p><b>R27816SR</b></p> <p>For power/USB unit, see electrical placement chart. Includes ganging hardware (1 side). Add \$91 for (SSS), \$194 for (SBS) Add \$1330 for 72 lbs. (CW), (C6) Add \$184 for (SP) or \$816 for (BS) Add \$43 for (TP) Add \$266 for (MB)</p>	<p><b>R27816SL</b> Base Price: <b>\$6093</b></p> <p><b>R27816SR</b> Base Price: <b>\$6093</b></p> <p>Back/Arm upcharge: <b>+0</b></p> <p>Seat upcharge: <b>+0</b></p>	<p><b>\$6093</b></p> <p><b>\$6093</b></p> <p><b>+0</b></p> <p><b>+0</b></p>												
		Shelf: 52W 10D 1H				<b>OVERALL DIMENSIONS</b> W D H			<b>SEAT DIMENSIONS</b> W D H			<b>BACK DIMENSIONS</b> W H			
				62	41	41.5	42	19	18	51	23.5				
				<b>RTA 00</b>	1 per carton										
 <p><b>R27817</b></p> <p><b>Inside Curve Two Seater - Extended Back</b> COM Yardage: Back: 4; Seat: 2 Freight class: 300 Product weight: 118   139 shelf model Cubic feet per carton: 61   90.5 shelf model</p>	<p><b>R27817S</b></p> <p>For power/USB unit, see electrical placement chart. Includes ganging hardware (2 sides). Add \$91 for (SSS), \$178 for (SBS) Add \$1330 for 72 lbs. (CW), (C6) Add \$184 for (SP) or \$816 for (BS) Add \$43 for (TP) Add \$266 for (MB)</p>	<p><b>R27817</b> Base Price: <b>\$4939</b></p> <p><b>R27817S</b> Base Price: <b>\$5981</b></p> <p>Back upcharge: <b>+0</b></p> <p>Seat upcharge: <b>+0</b></p>	<p><b>\$4939</b></p> <p><b>\$5981</b></p> <p><b>+0</b></p> <p><b>+0</b></p>												
		Shelf: 52W 10D 1H				<b>OVERALL DIMENSIONS</b> W D H			<b>SEAT DIMENSIONS</b> W D H			<b>BACK DIMENSIONS</b> W H			
				51.5	31	47	42	19	18	51	29				
				<b>RTA 00</b>	1 per carton										

DESCRIPTION		MODEL#/ FEATURES		STANDARD TEXTILE GRADES															
				1/COM	2	3	4	5	6	7	8	9	10	11	12				
	<p><b>R27817L</b></p> <p><b>Inside Curve Two Seater - Extended Back</b> COM Yardage: Back: 5; Seat: 2 Freight class: 300 Product weight: 122 Cubic feet per carton: 62.25</p>	<p><b>R27817R</b></p> <p>For power/USB unit, see electrical placement chart. Includes ganging hardware (1 side). Add \$91 for (SSS), \$206 for (SBS) Add \$1330 for 72 lbs. (CW), (C6) Add \$184 for (SP) or \$816 for (BS) Add \$43 for (TP) Add \$266 for (MB)</p>	<p>Base Price: <b>\$5327</b></p> <p>Base Price: <b>\$5327</b></p> <p>Back/Arm upcharge: <b>+0</b></p> <p>Seat upcharge: <b>+0</b></p>	1/COM	2	3	4	5	6	7	8	9	10	11	12				
				<p><b>\$5327</b></p> <p><b>\$5327</b></p> <p><b>+0</b></p> <p><b>+0</b></p>	<b>+\$169</b>	<b>+\$301</b>	<b>+\$496</b>	<b>+\$771</b>	<b>+\$887</b>	<b>+\$1124</b>	<b>+\$1499</b>	<b>+\$1778</b>	<b>+\$2084</b>	<b>+\$2722</b>	<b>+\$3392</b>				
				<b>OVERALL DIMENSIONS</b>			<b>SEAT DIMENSIONS</b>			<b>BACK DIMENSIONS</b>									
				<b>W</b>	<b>D</b>	<b>H</b>	<b>W</b>	<b>D</b>	<b>H</b>	<b>W</b>	<b>H</b>								
				54	31	47	42	19	18	51	29								
				<b>RTA 00</b>	1 per carton														
	<p><b>R27817SL</b></p> <p><b>Inside Curve Two Seater - Extended Back</b> COM Yardage: Back: 5; Seat: 2 Freight class: 300 Product weight: 149 Cubic feet per carton: 92.75</p>	<p><b>R27817SR</b></p> <p>For power/USB unit, see electrical placement chart. Includes ganging hardware (1 side). Add \$91 for (SSS), \$206 for (SBS) Add \$1330 for 72 lbs. (CW), (C6) Add \$184 for (SP) or \$816 for (BS) Add \$43 for (TP) Add \$266 for (MB)</p>	<p>Base Price: <b>\$6371</b></p> <p>Base Price: <b>\$6371</b></p> <p>Back/Arm upcharge: <b>+0</b></p> <p>Seat upcharge: <b>+0</b></p>	1/COM	2	3	4	5	6	7	8	9	10	11	12				
				<p><b>\$6371</b></p> <p><b>\$6371</b></p> <p><b>+0</b></p> <p><b>+0</b></p>	<b>+\$169</b>	<b>+\$301</b>	<b>+\$496</b>	<b>+\$771</b>	<b>+\$887</b>	<b>+\$1124</b>	<b>+\$1499</b>	<b>+\$1778</b>	<b>+\$2084</b>	<b>+\$2722</b>	<b>+\$3392</b>				
				<b>OVERALL DIMENSIONS</b>			<b>SEAT DIMENSIONS</b>			<b>BACK DIMENSIONS</b>									
				<b>W</b>	<b>D</b>	<b>H</b>	<b>W</b>	<b>D</b>	<b>H</b>	<b>W</b>	<b>H</b>								
				62.5	41.5	47	42	19	18	51	29								
				<b>RTA 00</b>	1 per carton														
				Shelf: 52W 10D 1H															
	<p><b>R27818</b></p> <p><b>Outside Curve Two Seater - Standard Back</b> COM Yardage: Back: 2.25; Seat: 2 Freight class: 4.25 Product weight: 93   107 shelf model Cubic feet per carton: 42.75   63.5 shelf model</p>	<p><b>R27818S</b></p> <p>For power/USB unit, see electrical placement chart. Includes ganging hardware (2 sides). Add \$99 for (SSS), \$110 for (SBS) Add \$1330 for 72 lbs. (CW), (C6) Add \$184 for (SP) or \$919 for (BS) Add \$43 for (TP) Add \$266 for (MB)</p>	<p>Base Price: <b>\$3494</b></p> <p>Base Price: <b>\$4537</b></p> <p>Back upcharge: <b>+0</b></p> <p>Seat upcharge: <b>+0</b></p>	1/COM	2	3	4	5	6	7	8	9	10	11	12				
				<p><b>\$3494</b></p> <p><b>\$4537</b></p> <p><b>+0</b></p> <p><b>+0</b></p>	<b>+\$76</b>	<b>+\$137</b>	<b>+\$224</b>	<b>+\$348</b>	<b>+\$399</b>	<b>+\$507</b>	<b>+\$675</b>	<b>+\$801</b>	<b>+\$938</b>	<b>+\$1225</b>	<b>+\$1527</b>				
				<b>OVERALL DIMENSIONS</b>			<b>SEAT DIMENSIONS</b>			<b>BACK DIMENSIONS</b>									
				<b>W</b>	<b>D</b>	<b>H</b>	<b>W</b>	<b>D</b>	<b>H</b>	<b>W</b>	<b>H</b>								
				50	30	32	50	19	18	36	14								
				<b>RTA 00</b>	1 per carton														
				Shelf: 52W 10D 1H															
	<p><b>R27818L</b></p> <p><b>Outside Curve Two Seater - Standard Back</b> COM Yardage: Back: 3.25; Seat: 2 Freight class: 5.25 Product weight: 102 Cubic feet per carton: 43.5</p>	<p><b>R27818R</b></p> <p>For power/USB unit, see electrical placement chart. Includes ganging hardware (1 side). Add \$99 for (SSS), \$138 for (SBS) Add \$1330 for 72 lbs. (CW), (C6) Add \$184 for (SP) or \$919 for (BS) Add \$43 for (TP) Add \$266 for (MB)</p>	<p>Base Price: <b>\$3882</b></p> <p>Base Price: <b>\$3882</b></p> <p>Back/Arm upcharge: <b>+0</b></p> <p>Seat upcharge: <b>+0</b></p>	1/COM	2	3	4	5	6	7	8	9	10	11	12				
				<p><b>\$3882</b></p> <p><b>\$3882</b></p> <p><b>+0</b></p> <p><b>+0</b></p>	<b>+\$110</b>	<b>+\$197</b>	<b>+\$323</b>	<b>+\$502</b>	<b>+\$577</b>	<b>+\$732</b>	<b>+\$974</b>	<b>+\$1157</b>	<b>+\$1355</b>	<b>+\$1770</b>	<b>+\$2205</b>				
				<b>OVERALL DIMENSIONS</b>			<b>SEAT DIMENSIONS</b>			<b>BACK DIMENSIONS</b>									
				<b>W</b>	<b>D</b>	<b>H</b>	<b>W</b>	<b>D</b>	<b>H</b>	<b>W</b>	<b>H</b>								
				53.5	30	32	50	19	18	36	14								
				<b>RTA 00</b>	1 per carton														

DESCRIPTION	MODEL#/ FEATURES	STANDARD TEXTILE GRADES												
		1/COM	2	3	4	5	6	7	8	9	10	11	12	
 <p><b>R27819</b></p> <p><b>Outside Curve Two Seater - High Back</b> COM Yardage: Back 3.25; Seat: 2 Freight class: 300 Product weight: 101   115 shelf model Cubic feet per carton: 53.75   79.75 shelf model</p>	<p><b>R27819</b></p> <p>For power/USB unit, see electrical placement chart. Includes ganging hardware (2 sides). Add \$99 for (SSS), \$143 for (SBS) Add \$1330 for 72 lbs. (CW), (C6) Add \$184 for (SP) or \$919 for (BS) Add \$43 for (TP) Add \$266 for (MB)</p>	Base Price:	\$4159											
		Back Price:	\$5204											
		Back upcharge:	+0	+\$110	+\$197	+\$323	+\$502	+\$577	+\$732	+\$974	+\$1157	+\$1355	+\$1770	+\$2205
		Seat upcharge:	+0	+\$68	+\$121	+\$199	+\$309	+\$355	+\$450	+\$600	+\$712	+\$834	+\$1089	+\$1357
		Shelf: 52W 10D 1H												
		OVERALL DIMENSIONS			SEAT DIMENSIONS			BACK DIMENSIONS						
		W	D	H	W	D	H	W	H					
		50	30.5	41.5	50	19	18	32	23.5					
		RTA 00		1 per carton										
 <p><b>R27819L</b></p> <p><b>Outside Curve Two Seater - High Back</b> COM Yardage: Back 4.25; Seat: 2 Freight class: 300 Product weight: 110 Cubic feet per carton: 55.5</p>	<p><b>R27819L</b></p> <p>For power/USB unit, see electrical placement chart. Includes ganging hardware (1 side). Add \$99 for (SSS), \$170 for (SBS) Add \$1330 for 72 lbs. (CW), (C6) Add \$184 for (SP) or \$919 for (BS) Add \$43 for (TP) Add \$266 for (MB)</p>	Base Price:	\$4549											
		Back Price:	\$4549											
		Back/Arm upcharge:	+0	+\$144	+\$257	+\$422	+\$656	+\$754	+\$956	+\$1274	+\$1512	+\$1772	+\$2314	+\$2884
		Seat upcharge:	+0	+\$68	+\$121	+\$199	+\$309	+\$355	+\$450	+\$600	+\$712	+\$834	+\$1089	+\$1357
		Shelf: 52W 10D 1H												
		OVERALL DIMENSIONS			SEAT DIMENSIONS			BACK DIMENSIONS						
		W	D	H	W	D	H	W	H					
		53.5	30.5	41.5	50	19	18	32	23.5					
		RTA 00		1 per carton										
 <p><b>R27820</b></p> <p><b>Outside Curve Two Seater - Extended Back</b> COM Yardage: Back 4.25; Seat: 2 Freight class: 300 Product weight: 109   120 shelf Cubic feet per carton: 61   90.5 shelf</p>	<p><b>R27820S</b></p> <p>For power/USB unit, see electrical placement chart. Includes ganging hardware (2 sides). Add \$99 for (SSS), \$152 for (SBS) Add \$1330 for 72 lbs. (CW), (C6) Add \$184 for (SP) or \$919 for (BS) Add \$43 for (TP) Add \$266 for (MB)</p>	Base Price:	\$4581											
		Back Price:	\$5539											
		Back upcharge:	+0	+\$144	+\$257	+\$422	+\$656	+\$754	+\$956	+\$1274	+\$1512	+\$1772	+\$2314	+\$2884
		Seat upcharge:	+0	+\$68	+\$121	+\$199	+\$309	+\$355	+\$450	+\$600	+\$712	+\$834	+\$1089	+\$1357
		Shelf: 52W 10D 1H												
		OVERALL DIMENSIONS			SEAT DIMENSIONS			BACK DIMENSIONS						
		W	D	H	W	D	H	W	H					
		50	31	47	50	19	18	28	29					
		RTA 00		1 per carton										
 <p><b>R27820L</b></p> <p><b>Outside Curve Two Seater - Extended Back</b> COM Yardage: Back 5.25; Seat: 2 Freight class: 300 Product weight: 113 Cubic feet per carton: 62.25</p>	<p><b>R27820R</b></p> <p>For power/USB unit, see electrical placement chart. Includes ganging hardware (1 side). Add \$99 for (SSS), \$180 for (SBS) Add \$1330 for 72 lbs. (CW), (C6) Add \$184 for (SP) or \$919 for (BS) Add \$43 for (TP) Add \$266 for (MB)</p>	Base Price:	\$4970											
		Back Price:	\$4970											
		Back/Arm upcharge:	+0	+\$178	+\$317	+\$522	+\$810	+\$931	+\$1181	+\$1574	+\$1868	+\$2189	+\$2858	+\$3562
		Seat upcharge:	+0	+\$68	+\$121	+\$199	+\$309	+\$355	+\$450	+\$600	+\$712	+\$834	+\$1089	+\$1357
		Shelf: 52W 10D 1H												
		OVERALL DIMENSIONS			SEAT DIMENSIONS			BACK DIMENSIONS						
		W	D	H	W	D	H	W	H					
		53.5	31	47	50	19	18	28	29					
		RTA 00		1 per carton										

DESCRIPTION		MODEL#/ FEATURES		STANDARD TEXTILE GRADES												
				1/COM	2	3	4	5	6	7	8	9	10	11	12	
		<b>R27821</b>	Base Price:	<b>\$4620</b>												
		<b>R27821S</b>	Base Price:	<b>\$6084</b>												
				Back upcharge:	<b>+0</b>	<b>+\$136</b>	<b>+\$241</b>	<b>+\$397</b>	<b>+\$617</b>	<b>+\$709</b>	<b>+\$899</b>	<b>+\$1199</b>	<b>+\$1423</b>	<b>+\$1667</b>	<b>+\$2178</b>	<b>+\$2714</b>
				Seat upcharge:	<b>+0</b>	<b>+\$68</b>	<b>+\$121</b>	<b>+\$199</b>	<b>+\$309</b>	<b>+\$355</b>	<b>+\$450</b>	<b>+\$600</b>	<b>+\$712</b>	<b>+\$834</b>	<b>+\$1089</b>	<b>+\$1357</b>
				Shelf: 52W 10D 1H												
				<b>OVERALL DIMENSIONS</b>			<b>SEAT DIMENSIONS</b>			<b>BACK DIMENSIONS</b>						
				<b>W</b>	<b>D</b>	<b>H</b>	<b>W</b>	<b>D</b>	<b>H</b>	<b>W</b>	<b>D</b>	<b>H</b>	<b>W</b>	<b>H</b>		
				37.5	37.5	32	24	19	18	24	14					
				<div style="display: flex; justify-content: space-between; align-items: center;"> <span><b>RTA 00</b></span> <span>1 per carton</span> </div>												
<b>R27821</b>		<b>R27821S</b>														
<p><b>90 Corner - Standard Back</b>                      COM Yardage: Back 4; Seat: 2                      Freight class: 250                      Product weight: 105   137 shelf                      Cubic feet per carton: 35.5   63 shelf</p>																
		<b>R27822</b>	Base Price:	<b>\$5502</b>												
		<b>R27822S</b>	Base Price:	<b>\$6963</b>												
				Back upcharge:	<b>+0</b>	<b>+\$195</b>	<b>+\$347</b>	<b>+\$571</b>	<b>+\$887</b>	<b>+\$1020</b>	<b>+\$1293</b>	<b>+\$1723</b>	<b>+\$2045</b>	<b>+\$2397</b>	<b>+\$3131</b>	<b>+\$3902</b>
				Seat upcharge:	<b>+0</b>	<b>+\$68</b>	<b>+\$121</b>	<b>+\$199</b>	<b>+\$309</b>	<b>+\$355</b>	<b>+\$450</b>	<b>+\$600</b>	<b>+\$712</b>	<b>+\$834</b>	<b>+\$1089</b>	<b>+\$1357</b>
				Shelf: 52W 10D 1H												
				<b>OVERALL DIMENSIONS</b>			<b>SEAT DIMENSIONS</b>			<b>BACK DIMENSIONS</b>						
				<b>W</b>	<b>D</b>	<b>H</b>	<b>W</b>	<b>D</b>	<b>H</b>	<b>W</b>	<b>D</b>	<b>H</b>	<b>W</b>	<b>H</b>		
				38.5	38.5	41.5	24	19	18	24	23.5					
				<div style="display: flex; justify-content: space-between; align-items: center;"> <span><b>RTA 00</b></span> <span>1 per carton</span> </div>												
<b>R27822</b>		<b>R27822S</b>														
<p><b>90 Corner - High Back</b>                      COM Yardage: Back 5.75; Seat: 2                      Freight class: 250                      Product weight: 119   154 shelf                      Cubic feet per carton: 44.5   79.24 shelf</p>																
		<b>R27823</b>	Base Price:	<b>\$6051</b>												
		<b>R27823S</b>	Base Price:	<b>\$7514</b>												
				Back upcharge:	<b>+0</b>	<b>+\$211</b>	<b>+\$377</b>	<b>+\$621</b>	<b>+\$964</b>	<b>+\$1108</b>	<b>+\$1406</b>	<b>+\$1873</b>	<b>+\$2223</b>	<b>+\$2605</b>	<b>+\$3403</b>	<b>+\$2884</b>
				Seat upcharge:	<b>+0</b>	<b>+\$68</b>	<b>+\$121</b>	<b>+\$199</b>	<b>+\$309</b>	<b>+\$355</b>	<b>+\$450</b>	<b>+\$600</b>	<b>+\$712</b>	<b>+\$834</b>	<b>+\$1089</b>	<b>+\$1357</b>
				Shelf: 52W 10D 1H												
				<b>OVERALL DIMENSIONS</b>			<b>SEAT DIMENSIONS</b>			<b>BACK DIMENSIONS</b>						
				<b>W</b>	<b>D</b>	<b>H</b>	<b>W</b>	<b>D</b>	<b>H</b>	<b>W</b>	<b>D</b>	<b>H</b>	<b>W</b>	<b>H</b>		
				39	39	47	24	19	18	24	29					
				<div style="display: flex; justify-content: space-between; align-items: center;"> <span><b>RTA 00</b></span> <span>1 per carton</span> </div>												
<b>R27823</b>		<b>R27823S</b>														
<p><b>90 Corner - Extended Back</b>                      COM Yardage: Back 6.25; Seat: 2                      Freight class: 250                      Product weight: 128   160 shelf                      Cubic feet per carton: 50.5   90 shelf</p>																
		<b>R27824</b>	Base Price:	<b>\$4783</b>												
		<b>R27824S</b>	Base Price:	<b>\$6248</b>												
				Back upcharge:	<b>+0</b>	<b>+\$136</b>	<b>+\$241</b>	<b>+\$397</b>	<b>+\$617</b>	<b>+\$709</b>	<b>+\$899</b>	<b>+\$1199</b>	<b>+\$1423</b>	<b>+\$1667</b>	<b>+\$2178</b>	<b>+\$2714</b>
				Seat upcharge:	<b>+0</b>	<b>+\$68</b>	<b>+\$121</b>	<b>+\$199</b>	<b>+\$309</b>	<b>+\$355</b>	<b>+\$450</b>	<b>+\$600</b>	<b>+\$712</b>	<b>+\$834</b>	<b>+\$1089</b>	<b>+\$1357</b>
				Shelf: 52W 10D 1H												
				<b>OVERALL DIMENSIONS</b>			<b>SEAT DIMENSIONS</b>			<b>BACK DIMENSIONS</b>						
				<b>W</b>	<b>D</b>	<b>H</b>	<b>W</b>	<b>D</b>	<b>H</b>	<b>W</b>	<b>D</b>	<b>H</b>	<b>W</b>	<b>H</b>		
				52.5	30	32	52	19	18	52	14					
				<div style="display: flex; justify-content: space-between; align-items: center;"> <span><b>RTA 00</b></span> <span>1 per carton</span> </div>												
<b>R27824</b>		<b>R27824S</b>														
<p><b>120 Corner - Standard Back</b>                      COM Yardage: Back 4; Seat: 2                      Freight class: 250                      Product weight: 109   138 shelf                      Cubic feet per carton: 48.25   68.5 shelf</p>																

DESCRIPTION		MODEL#/ FEATURES		STANDARD TEXTILE GRADES													
				1/COM	2	3	4	5	6	7	8	9	10	11	12		
	<p><b>R27825</b></p> <p><b>R27825S</b></p>	<p>Base Price: <b>\$5596</b></p> <p>Base Price: <b>\$7062</b></p> <p>Back upcharge: <b>+0</b></p> <p>Seat upcharge: <b>+0</b></p>	<p>Shelf: 52W 10D 1H</p>														
				<p>No power/USB unit. Includes ganging hardware (2 sides). Add \$94 for (SSS), \$174 for (SBS) Add \$1330 for 36 lbs. (CW), (C6) Add \$228 for (SP) or \$1018 for (BS) Add \$43 for (TP) Add \$266 for (MB)</p>													
<p><b>120 Corner - High Back</b> COM Yardage: Back 5.75; Seat: 2 Freight class: 300 Product weight: 118   144 shelf Cubic feet per carton: 60.5   86 shelf</p>				<p><b>OVERALL DIMENSIONS</b></p> <p>W D H</p>			<p><b>SEAT DIMENSIONS</b></p> <p>W D H</p>			<p><b>BACK DIMENSIONS</b></p> <p>W H</p>							
				53.5	30.5	41.5	41	21	18	51	23.5						
				<p><b>RTA 00</b></p>		<p>1 per carton</p>											
	<p><b>R27826</b></p> <p><b>R27826S</b></p>	<p>Base Price: <b>\$6072</b></p> <p>Base Price: <b>\$7534</b></p> <p>Back upcharge: <b>+0</b></p> <p>Seat upcharge: <b>+0</b></p>	<p>Shelf: 52W 10D 1H</p>														
				<p>No power/USB unit. Includes ganging hardware (2 sides). Add \$94 for (SSS), \$185 for (SBS) Add \$1330 for 36 lbs. (CW), (C6) Add \$228 for (SP) or \$1018 for (BS) Add \$43 for (TP) Add \$266 for (MB)</p>													
<p><b>120 Corner - Extended Back</b> COM Yardage: Back 6.25; Seat: 2 Freight class: 300 Product weight: 123   144 shelf Cubic feet per carton: 68.75   97.75 shelf</p>				<p><b>OVERALL DIMENSIONS</b></p> <p>W D H</p>			<p><b>SEAT DIMENSIONS</b></p> <p>W D H</p>			<p><b>BACK DIMENSIONS</b></p> <p>W H</p>							
				54	31.5	47	41	21	18	51	29						
				<p><b>RTA 00</b></p>		<p>1 per carton</p>											
		<p>Attachment hardware included. Polished Aluminum arms sold separately (1 pc).</p>	<p>Armpcap finish options: (NGT) Night, (FOG) Fog, (LAB) Latte</p>	<p>List price</p>													
				<p><b>R2770</b> \$351</p>				<p><b>OVERALL DIMENSIONS</b></p> <p>W D H</p>			<p><b>SEAT DIMENSIONS</b></p> <p>W D H</p>			<p><b>BACK DIMENSIONS</b></p> <p>W H</p>			
<p><b>Loop Arm</b> COM Yardage: N/A Freight class: 92.5 Product weight (lbs.): 6.3 Cubic feet per carton: 0.6</p>				2.5	14	19.5	-	-	-	-	-						
				<p><b>RTA 1</b></p>		<p>FedEx UPS 1 per carton</p>											
		<p>Attachment hardware included. Polished Aluminum arms sold separately (1 pc).</p>	<p>Armpcap finish options: (NGT) Night, (FOG) Fog, (LAB) Latte</p>	<p>List price</p>													
				<p><b>R2771</b> \$399</p>				<p><b>OVERALL DIMENSIONS</b></p> <p>W D H</p>			<p><b>SEAT DIMENSIONS</b></p> <p>W D H</p>			<p><b>BACK DIMENSIONS</b></p> <p>W H</p>			
<p><b>Loop Arm w/Armpcap</b> COM Yardage: N/A Freight class: 92.5 Product weight (lbs.): 6.61 Cubic feet per carton: 0.6</p>				2.5	14	19.5	-	-	-	-	-						
				<p><b>RTA 1</b></p>		<p>FedEx UPS 1 per carton</p>											

# LOUNGE

## RIVER+ BENCHES

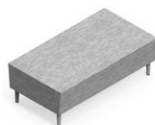

**Two Seater Bench**  
model R27832



**Y Bench**  
model R27842



**42" Round Bench**  
model R27845



**Inside Curve Boomerang Bench**  
model R27840

### River+ Seating, Tables



For River+ seating, please see page 349  
For River+ tables, please see page 372

### EXAMPLE RIVER+ BENCH ORDER CODE:

R27832	-CE90	-S6	-AS	-CH	-	-SP
Model number	Textile	Leg selection	Leg angle	Leg finish	Additional weight	Bottom selection

-	-	-F1	-W
Sealed Seams	Moisture barrier	Power/USB position	Power finish

Additional Options specify at end of order code.	SPECIFY CODE
<b>Tamperproof fasteners</b> Upcharges vary, see model.	<b>TP</b>
<b>Moisture barrier</b> Upcharges vary, see model.	<b>MB</b>

\*linking hardware is lowered to clear the staple strip.  
Units will only gang with other units with sealed bottom.  
\*\*cannot be combined with linking hardware or power units

### ELECTRICAL PLACEMENT

#### Straight benches

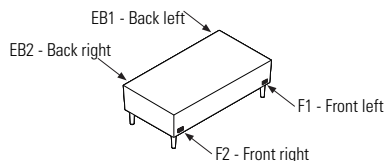

#### Y bench

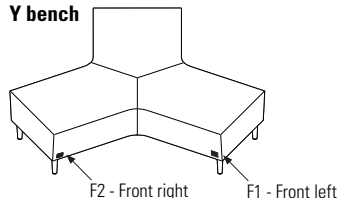

#### Curved benches

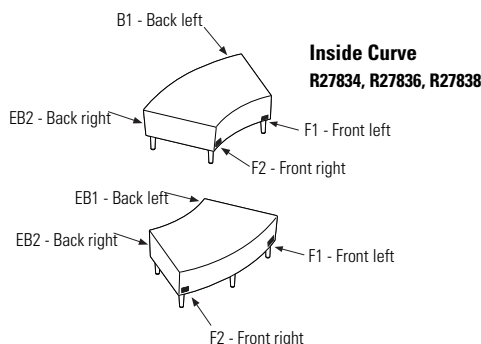

#### Boomerang benches

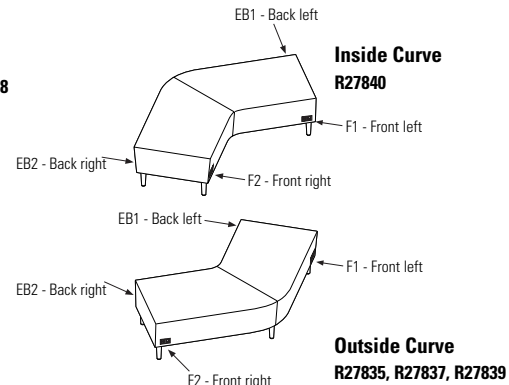

### STANDARD FEATURES

- A modular series that is composed of straight, and curved sections, as well as freestanding units.
- Linking units can be used together in any combination to create a wide variety of layouts. Ganging hardware is standard and is factory installed. Ganging hardware swivels out of the way when not in use.
- The standard, 6.5" tapered legs are made of welded steel.
- Legs are straight (vertical) as standard. Linking models are optionally available with angled back legs to match River+ seating units.
- Legs include Black nylon, non-marking, height adjustable glides.
- River+ is rated for an active weight up to 600 lbs. per seat and 24/7 use.
- For 24/7 use and/or heavy duty application use, Global's Heavy Duty warranty is applicable on models specified with performance textiles, rated for 150,000 double rubs.
- Check textile availability prior to specifying upholstery material. Leather not available on River+ series.
- All units are shipped fully assembled.

### OPTIONAL FEATURES



- Legs are available in 3" and 8" heights with no upcharge. All heights are available with fixed-to-floor option. Please specify. Add \$106. Fastening hardware not included.
- Steel bottom provides tamperproof protection (includes tamperproof screws). Specify **(BS)** - see each model for upcharge.\*\*
- Up to two power units are available on straight, Y, curved and boomerang benches.
- Each power unit includes one AC outlet and two USB-a, 10-watt charging ports.
- Power location options include front or back. See electrical placement diagrams. Electrical units must be factory installed. Add \$661 per unit.
- Power units are available in either Jet Black **(J)** or White **(W)** with 120", three-prong matching cords.
- To add sealed seams to your product, specify **(SLS)** - see each model for upcharge.
- To match leg angles with lounge seating, straight front and angled back 6.5" or 8" legs are available on straight, curved, corner, and boomerang units. Specify **(SA)**. No upcharge.
- Products can be weighted to reduce the ease of movement. For additional weight options, specify **(CW)** - see each model for available additional weight and upcharge.
- The underside of the seat can be finished with PVC (vinyl) and sealed to prevent penetration of liquids. Specify **(SP)** - see each model for upcharge.\*

Please add option codes in the following order:

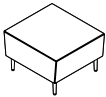
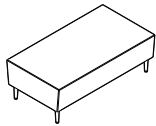
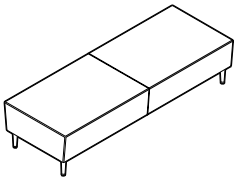
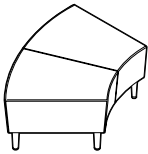
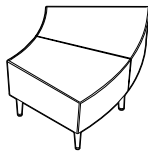

- Model number**  
R27831 to R27833 Straight benches  
R27834 to R27835 Curved benches  
R27836 to R27839 Corner benches  
R27840 to R27841 Boomerang benches  
R27842 Y bench  
R27843 to R27846 Round non-linking benches  
R27847 to R27850 Square non-linking benches
- Textile**  
Specify textile code.
- Leg selection**  
**(S6)** Standard seat height (17.5"), 6.5" leg w/ adjustable glides. No upcharge.  
**(S3)** Low seat (14"), 3" leg w/adjustable glides. No upcharge.  
**(S8)** High seat (19"), 8" leg w/adjustable glides. No upcharge.  
**(F6)** Standard seat height (17.5"), 6.5" leg, fixed to floor. Add \$106.  
**(F3)** Low seat (14"), 3" leg, fixed to floor. Add \$106.  
**(F8)** High seat (19"), 8" leg, fixed to floor. Add \$106.
- Leg angle**  
**(AST)** Straight legs. No upcharge.  
**(SA)** Straight front legs, angled back legs (available only for 6.5" and 8" high legs on straight, curved, corner and boomerang units). No upcharge.
- Leg finish**  
**(CHM)** Chrome  
**(TDW)** Designer White  
**(TFR)** Frost  
**(TLA)** Latte  
**(TNE)** Nevada  
**(TSH)** Shadow  
**(TTU)** Tungsten  
**(TBL)** Black  
**(TFO)** Fog  
**(TIV)** Cloud  
**(TMO)** Mocha  
**(TOA)** Toast  
**(TSN)** Sand
- Additional weight**  
**(CW)** Additional weight. Upcharges vary, see model.
- Bottom selection**  
**(SSB)** Standard bottom.  
**(SP)** Vinyl sealed bottom w/staple strip. Upcharges vary, see model.\*  
**(BS)** Steel bottom. Upcharges vary, see model.\*\*
- Sealed seams**  
**(SLS)** Sealed seams. Upcharges vary, see model.
- Moisture barrier**  
**(MB)** Upcharges vary, see model.
- Power/USB unit position** (straight, curved, boomerang and Y benches only, as shown below). Add \$661 per unit.  
**(NP)** No power (no upcharge)  
**(F1)** Front left  
**(F2)** Front right  
**(EB1)** Back left  
**(EB2)** Back right
- Power unit finish**  
**(J)** Jet Black  
**(W)** White
- Tamperproof fasteners**  
**(TP)** Upcharges vary, see model.

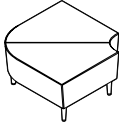
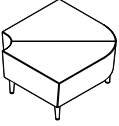
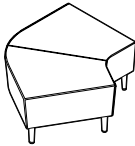
DESCRIPTION	FEATURES	MODEL#	STANDARD TEXTILE GRADES												
			1	2	3	4	5	6	7	8	9	10	11	12	
 <p><b>Single Seater Bench</b> COM Yardage: 1.75 Freight class: 1.75 Product weight: 48 Cubic feet per carton: 10.5</p>	<p>For power/USB unit, see electrical placement chart.</p> <p>Includes ganging hardware (2 sides).</p> <p>Add \$73 for <b>(SLS)</b> Add \$106 for <b>(F6, F3, or F8)</b> Add \$667 for 36 lbs. <b>(CW)</b> Add \$85 for <b>(SP)</b> or \$388 for <b>(BS)</b> Add \$43 for <b>(TP)</b> Add \$134 for <b>(MB)</b></p>	<p><b>R27831</b></p>	1469	1529	1575	1644	1740	1780	1863	1994	2092	2200	2422	2657	
			<p><b>OVERALL DIMENSIONS</b></p> <p>W D H</p>			<p><b>SEAT DIMENSIONS</b></p> <p>W D H</p>			<p><b>BACK DIMENSIONS</b></p> <p>W H</p>						
			26	28.5	17.5	-	-	-	-	-	-				
			<p><b>RTA 00</b></p>			1 per carton									
 <p><b>Two Seater Bench</b> COM Yardage: 2.75 Freight class: 2.50 Product weight: 65 Cubic feet per carton: 20.5</p>	<p>For power/USB unit, see electrical placement chart.</p> <p>Includes ganging hardware (2 sides).</p> <p>Add \$89 for <b>(SLS)</b> Add \$106 for <b>(F6, F3, or F8)</b> Add \$1330 for 72 lbs. <b>(CW)</b> Add \$132 for <b>(SP)</b> or \$641 for <b>(BS)</b> Add \$43 for <b>(TP)</b> Add \$266 for <b>(MB)</b></p>	<p><b>R27832</b></p>	2148	2241	2314	2422	2573	2636	2767	2972	3126	3295	3646	4015	
			<p><b>OVERALL DIMENSIONS</b></p> <p>W D H</p>			<p><b>SEAT DIMENSIONS</b></p> <p>W D H</p>			<p><b>BACK DIMENSIONS</b></p> <p>W H</p>						
			52	28.5	17.5	-	-	-	-	-	-				
			<p><b>RTA 00</b></p>			1 per carton									
 <p><b>Three Seater Bench</b> COM Yardage: 4.5 Freight class: 4.5 Product weight: 103 Cubic feet per carton: 30.25</p>	<p>For power/USB unit, see electrical placement chart.</p> <p>Includes ganging hardware (2 sides).</p> <p>Add \$130 for <b>(SLS)</b> Add \$106 for <b>(F6, F3, or F8)</b> Add \$1330 for 72 lbs. <b>(CW)</b> Add \$184 for <b>(SP)</b> or \$816 for <b>(BS)</b> Add \$43 for <b>(TP)</b> Add \$396 for <b>(MB)</b></p>	<p><b>R27833</b></p>	3379	3531	3651	3826	4073	4177	4391	4728	4980	5255	5829	6433	
			<p><b>OVERALL DIMENSIONS</b></p> <p>W D H</p>			<p><b>SEAT DIMENSIONS</b></p> <p>W D H</p>			<p><b>BACK DIMENSIONS</b></p> <p>W H</p>						
			78	28.5	17.5	-	-	-	-	-	-				
			<p><b>RTA 00</b></p>			1 per carton									
 <p><b>Inside Curve Two Seater Bench</b> COM Yardage: 3 Freight class: 2.50 Product weight: 60 Cubic feet per carton: 22.75</p>	<p>For power/USB unit, see electrical placement chart.</p> <p>Includes ganging hardware (2 sides).</p> <p>Add \$80 for <b>(SLS)</b> Add \$106 for <b>(F6, F3, or F8)</b> Add \$1332 for 72 lbs. <b>(CW)</b> Add \$132 for <b>(SP)</b> or \$513 for <b>(BS)</b> Add \$52 for <b>(TP)</b> Add \$266 for <b>(MB)</b></p>	<p><b>R27834</b></p>	2918	3020	3099	3216	3381	3450	3593	3817	3985	4169	4552	4954	
			<p><b>OVERALL DIMENSIONS</b></p> <p>W D H</p>			<p><b>SEAT DIMENSIONS</b></p> <p>W D H</p>			<p><b>BACK DIMENSIONS</b></p> <p>W H</p>						
			50	30.5	17.5	-	-	-	-	-	-				
			<p><b>RTA 00</b></p>			1 per carton									
 <p><b>Outside Curve Two Seater Bench</b> COM Yardage: 3 Freight class: 2.50 Product weight: 60 Cubic feet per carton: 22.75</p>	<p>For power/USB unit, see electrical placement chart.</p> <p>Includes ganging hardware (2 sides).</p> <p>Add \$80 for <b>(SLS)</b> Add \$106 for <b>(F6, F3, or F8)</b> Add \$1333 for 72 lbs. <b>(CW)</b> Add \$132 for <b>(SP)</b> or \$513 for <b>(BS)</b> Add \$52 for <b>(TP)</b> Add \$266 for <b>(MB)</b></p>	<p><b>R27835</b></p>	2918	3020	3099	3216	3381	3450	3593	3817	3985	4169	4552	4954	
			<p><b>OVERALL DIMENSIONS</b></p> <p>W D H</p>			<p><b>SEAT DIMENSIONS</b></p> <p>W D H</p>			<p><b>BACK DIMENSIONS</b></p> <p>W H</p>						
			50	30.5	17.5	-	-	-	-	-	-				
			<p><b>RTA 00</b></p>			1 per carton									

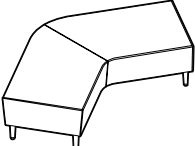
Options: **(SLS)** Sealed seams  
**(F6, F3, F8)** Floor mount legs  
**(CW)** Counterweight  
**(SP)** Vinyl sealed bottom  
**(BS)** Steel bottom  
**(TP)** Tamperproof  
**(MB)** Moisture barrier

DESCRIPTION	FEATURES	MODEL#	STANDARD TEXTILE GRADES											
			1	2	3	4	5	6	7	8	9	10	11	12
 <p><b>90° Inside Curve Corner Bench</b> COM Yardage: 3.25 Freight class: 250 Product weight: 60 Cubic feet per carton: 17.25</p>	<p>For power/USB unit, see electrical placement chart.</p> <p>Includes ganging hardware (2 sides).</p> <p>Add \$80 for <b>(SLS)</b> Add \$106 for <b>(F6, F3, or F8)</b> Add \$667 for 36 lbs. <b>(CW)</b> Add \$153 for <b>(SP)</b> or \$597 for <b>(BS)</b> Add \$52 for <b>(TP)</b> Add \$266 for <b>(MB)</b></p>	<b>R27836</b>	2910	3020	3107	3233	3412	3487	3642	3884	4067	4265	4680	5115
		<b>OVERALL DIMENSIONS</b>			<b>SEAT DIMENSIONS</b>			<b>BACK DIMENSIONS</b>						
		<b>W</b>	<b>D</b>	<b>H</b>	<b>W</b>	<b>D</b>	<b>H</b>	<b>W</b>	<b>H</b>					<b>H</b>
		36.5	36.5	17.5	-	-	-	-						-
			<b>RTA 00</b>	1 per carton										
 <p><b>90° Outside Curve Corner Bench</b> COM Yardage: 3.25 Freight class: 250 Product weight: 60 Cubic feet per carton: 17.25</p>	<p>For power/USB unit, see electrical placement chart.</p> <p>Includes ganging hardware (2 sides).</p> <p>Add \$80 for <b>(SLS)</b> Add \$106 for <b>(F6, F3, or F8)</b> Add \$668 for 36 lbs. <b>(CW)</b> Add \$153 for <b>(SP)</b> or \$597 for <b>(BS)</b> Add \$52 for <b>(TP)</b> Add \$266 for <b>(MB)</b></p>	<b>R27837</b>	2910	3020	3107	3233	3412	3487	3642	3884	4067	4265	4680	5115
		<b>OVERALL DIMENSIONS</b>			<b>SEAT DIMENSIONS</b>			<b>BACK DIMENSIONS</b>						
		<b>W</b>	<b>D</b>	<b>H</b>	<b>W</b>	<b>D</b>	<b>H</b>	<b>W</b>	<b>H</b>					<b>H</b>
		36.5	36.5	17.5	-	-	-	-						-
			<b>RTA 00</b>	1 per carton										
 <p><b>120° Inside Curve Corner Bench</b> COM Yardage: 3.5 Freight class: 250 Product weight: 57 Cubic feet per carton: 26.75</p>	<p>For power/USB unit, see electrical placement chart.</p> <p>Includes ganging hardware (2 sides).</p> <p>Add \$84 for <b>(SLS)</b> Add \$106 for <b>(F6, F3, or F8)</b> Add \$669 for 36 lbs. <b>(CW)</b> Add \$146 for <b>(SP)</b> or \$656 for <b>(BS)</b> Add \$52 for <b>(TP)</b> Add \$266 for <b>(MB)</b></p>	<b>R27838</b>	2910	3029	3121	3258	3450	3531	3698	3959	4155	4370	4816	5285
		<b>OVERALL DIMENSIONS</b>			<b>SEAT DIMENSIONS</b>			<b>BACK DIMENSIONS</b>						
		<b>W</b>	<b>D</b>	<b>H</b>	<b>W</b>	<b>D</b>	<b>H</b>	<b>W</b>	<b>H</b>					<b>H</b>
		36.5	51.5	17.5	-	-	-	-						-
			<b>RTA 00</b>	1 per carton										
 <p><b>120° Outside Curve Corner Bench</b> COM Yardage: 3.5 Freight class: 250 Product weight: 57 Cubic feet per carton: 26.75</p>	<p>For power/USB unit, see electrical placement chart.</p> <p>Includes ganging hardware (2 sides).</p> <p>Add \$84 for <b>(SLS)</b> Add \$106 for <b>(F6, F3, or F8)</b> Add \$671 for 36 lbs. <b>(CW)</b> Add \$146 for <b>(SP)</b> or \$656 for <b>(BS)</b> Add \$52 for <b>(TP)</b> Add \$266 for <b>(MB)</b></p>	<b>R27839</b>	2910	3029	3121	3258	3450	3531	3698	3959	4155	4370	4816	5285
		<b>OVERALL DIMENSIONS</b>			<b>SEAT DIMENSIONS</b>			<b>BACK DIMENSIONS</b>						
		<b>W</b>	<b>D</b>	<b>H</b>	<b>W</b>	<b>D</b>	<b>H</b>	<b>W</b>	<b>H</b>					<b>H</b>
		36.5	51.5	17.5	-	-	-	-						-
			<b>RTA 00</b>	1 per carton										
 <p><b>Inside Curve Boomerang Bench</b> COM Yardage: 5.25 Freight class: 250 Product weight: 126 Cubic feet per carton: 47.75</p>	<p>For power/USB unit, see electrical placement chart.</p> <p>Includes ganging hardware (2 sides).</p> <p>Add \$124 for <b>(SLS)</b> Add \$106 for <b>(F6, F3, or F8)</b> Add \$1330 for 72 lbs. <b>(CW)</b> Add \$214 for <b>(SP)</b> or \$1153 for <b>(BS)</b> Add \$52 for <b>(TP)</b> Add \$396 for <b>(MB)</b></p>	<b>R27840</b>	4501	4679	4818	5023	5311	5432	5682	6075	6369	6690	7359	8063
		<b>OVERALL DIMENSIONS</b>			<b>SEAT DIMENSIONS</b>			<b>BACK DIMENSIONS</b>						
		<b>W</b>	<b>D</b>	<b>H</b>	<b>W</b>	<b>D</b>	<b>H</b>	<b>W</b>	<b>H</b>					<b>H</b>
		82	45	17.5	-	-	-	-						-
			<b>RTA 00</b>	1 per carton										

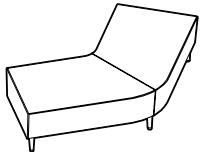
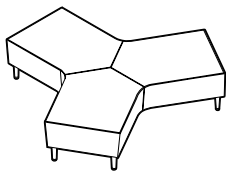
Options: **(SLS)** Sealed seams  
**(F6, F3, F8)** Floor mount legs  
**(CW)** Counterweight  
**(SP)** Vinyl sealed bottom  
**(BS)** Steel bottom  
**(TP)** Tamperproof  
**(MB)** Moisture barrier

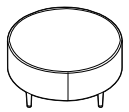
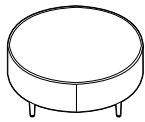
DESCRIPTION	FEATURES	MODEL#	STANDARD TEXTILE GRADES														
			1	2	3	4	5	6	7	8	9	10	11	12			
 <p><b>Outside Curve Boomerang Bench</b> COM Yardage: 5.25 Freight class: 250 Product weight: 126 Cubic feet per carton: 47.75</p>	<p>For power/USB unit, see electrical placement chart.</p> <p>Includes ganging hardware (2 sides).</p> <p>Add \$124 for (SLS) Add \$106 for (F6, F3, or F8) Add \$1330 for 72 lbs. (CW) Add \$214 for (SP) or \$1153 for (BS) Add \$52 for (TP) Add \$396 for (MB)</p>	<p><b>R27841</b></p>	4501	4679	4818	5023	5311	5432	5682	6075	6369	6690	7359	8063			
			<b>OVERALL DIMENSIONS</b>			<b>SEAT DIMENSIONS</b>			<b>BACK DIMENSIONS</b>								
			<b>W</b>	<b>D</b>	<b>H</b>	<b>W</b>	<b>D</b>	<b>H</b>	<b>W</b>	<b>H</b>							
			82	45	17.5	-	-	-	-	-							
			<b>RTA 00</b>	1 per carton													
 <p><b>Y Bench</b> COM Yardage: 8 Freight class: 250 Product weight: 203 Cubic feet per carton: 101.2</p>	<p>For power/USB unit, see electrical placement chart.</p> <p>Includes ganging hardware (2 sides).</p> <p>Add \$206 for (SLS) Add \$106 for (F6, F3, or F8) Add \$997 for 54 lbs. (CW) Add \$320 for (SP) or \$1429 for (BS) Add \$73 for (TP) Add \$529 for (MB)</p>	<p><b>R27842</b></p>	7248	7519	7730	8042	8481	8666	9046	9645	10093	10582	11604	12675			
			<b>OVERALL DIMENSIONS</b>			<b>SEAT DIMENSIONS</b>			<b>BACK DIMENSIONS</b>								
			<b>W</b>	<b>D</b>	<b>H</b>	<b>W</b>	<b>D</b>	<b>H</b>	<b>W</b>	<b>H</b>							
			82	70	17.5	-	-	-	-	-							
			<b>RTA 00</b>	1 per carton													
 <p><b>18" Dia. Round Bench</b> COM Yardage: 1 Freight class: 150 Product weight: 25 Cubic feet per carton: 4.7</p>	<p>No power/USB unit.</p> <p>Freestanding unit only.</p> <p>Add \$49 for (SLS) Add \$106 for (F6, F3, or F8) Not available (CW) Add \$124 for (SP), (BS) not available Add \$43 for (TP) Add \$134 for (MB)</p>	<p><b>R27843</b></p>	900	934	961	1000	1055	1078	1125	1200	1256	1317	1445	1579			
			<b>OVERALL DIMENSIONS</b>			<b>SEAT DIMENSIONS</b>			<b>BACK DIMENSIONS</b>								
			<b>W</b>	<b>D</b>	<b>H</b>	<b>W</b>	<b>D</b>	<b>H</b>	<b>W</b>	<b>H</b>							
			18	18	17.5	-	-	-	-	-							
			<b>RTA 00</b>	1 per carton													
 <p><b>36" Dia. Round Bench</b> COM Yardage: 3.25 Freight class: 250 Product weight: 50 Cubic feet per carton: 18.25</p>	<p>No power/USB unit.</p> <p>Freestanding unit only.</p> <p>Add \$73 for (SLS) Add \$106 for (F6, F3, or F8) Add \$667 for 36 lbs. (CW) Add \$193 for (SP) or \$656 for (BS) Add \$43 for (TP) Add \$134 for (MB)</p>	<p><b>R27844</b></p>	2156	2266	2353	2479	2658	2733	2888	3130	3313	3511	3926	4361			
			<b>OVERALL DIMENSIONS</b>			<b>SEAT DIMENSIONS</b>			<b>BACK DIMENSIONS</b>								
			<b>W</b>	<b>D</b>	<b>H</b>	<b>W</b>	<b>D</b>	<b>H</b>	<b>W</b>	<b>H</b>							
			36	36	17.5	-	-	-	-	-							
			<b>RTA 00</b>	1 per carton													
 <p><b>42" Dia. Round Bench</b> COM Yardage: 3.5 Freight class: 250 Product weight: 55 Cubic feet per carton: 23</p>	<p>No power/USB unit.</p> <p>Freestanding unit only.</p> <p>Add \$80 for (SLS) Add \$106 for (F6, F3, or F8) Add \$1330 for 72 lbs. (CW) Add \$214 for (SP) or \$724 for (BS) Add \$43 for (TP) Add \$266 for (MB)</p>	<p><b>R27845</b></p>	2481	2600	2692	2829	3021	3102	3269	3530	3726	3941	4387	4856			
			<b>OVERALL DIMENSIONS</b>			<b>SEAT DIMENSIONS</b>			<b>BACK DIMENSIONS</b>								
			<b>W</b>	<b>D</b>	<b>H</b>	<b>W</b>	<b>D</b>	<b>H</b>	<b>W</b>	<b>H</b>							
			42	42	17.5	-	-	-	-	-							
			<b>RTA 00</b>	1 per carton													

Options: (SLS) Sealed seams  
(F6, F3, F8) Floor mount legs  
(CW) Counterweight  
(SP) Vinyl sealed bottom  
(BS) Steel bottom  
(TP) Tamperproof  
(MB) Moisture barrier

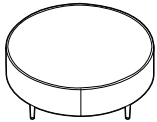
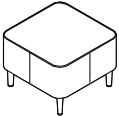
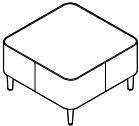
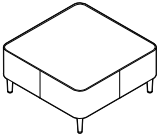
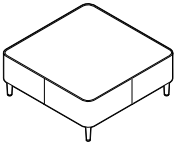
DESCRIPTION	FEATURES	MODEL#	STANDARD TEXTILE GRADES													
			1	2	3	4	5	6	7	8	9	10	11	12		
 <p><b>48" Dia. Round Bench</b> COM Yardage: 3.75 Freight class: 250 Product weight: 65 Cubic feet per carton: 30</p>	No power/USB unit.  Freestanding unit only.  Add \$89 for (SLS) Add \$106 for (F6, F3, or F8) Add \$1330 for 72 lbs. (CW) Add \$237 for (SP) or \$770 for (BS) Add \$43 for (TP) Add \$396 for (MB)	<b>R27846</b>	2797	2924	3023	3170	3376	3462	3640	3921	4131	4361	4839	5342		
		<b>OVERALL DIMENSIONS</b>			<b>SEAT DIMENSIONS</b>			<b>BACK DIMENSIONS</b>								
		<b>W</b>	<b>D</b>	<b>H</b>	<b>W</b>	<b>D</b>	<b>H</b>	<b>W</b>	<b>H</b>							
		48	48	17.5	-	-	-	-	-							
			<b>RTA 00</b>	1 per carton												
 <p><b>24" Square Bench</b> COM Yardage: 1.5 Freight class: 250 Product weight: 30 Cubic feet per carton: 8</p>	No power/USB unit.  Freestanding unit only.  Add \$64 for (SLS) Add \$106 for (F6, F3, or F8) Add \$667 for 36 lbs. (CW) Add \$132 for (SP) or \$297 for (BS) Add \$43 for (TP) Add \$134 for (MB)	<b>R27847</b>	1230	1281	1321	1379	1462	1496	1568	1680	1764	1856	2047	2249		
		<b>OVERALL DIMENSIONS</b>			<b>SEAT DIMENSIONS</b>			<b>BACK DIMENSIONS</b>								
		<b>W</b>	<b>D</b>	<b>H</b>	<b>W</b>	<b>D</b>	<b>H</b>	<b>W</b>	<b>H</b>							
		24	24	17.5	-	-	-	-	-							
			<b>RTA 00</b>	1 per carton												
 <p><b>30" Square Bench</b> COM Yardage: 2.75 Freight class: 250 Product weight: 40 Cubic feet per carton: 12.25</p>	No power/USB unit.  Freestanding unit only.  Add \$73 for (SLS) Add \$106 for (F6, F3, or F8) Add \$667 for 36 lbs. (CW) Add \$184 for (SP) or \$196 for (BS) Add \$43 for (TP) Add \$134 for (MB)	<b>R27848</b>	1623	1716	1789	1897	2048	2111	2242	2447	2601	2770	3121	3490		
		<b>OVERALL DIMENSIONS</b>			<b>SEAT DIMENSIONS</b>			<b>BACK DIMENSIONS</b>								
		<b>W</b>	<b>D</b>	<b>H</b>	<b>W</b>	<b>D</b>	<b>H</b>	<b>W</b>	<b>H</b>							
		30	30	17.5	-	-	-	-	-							
			<b>RTA 00</b>	1 per carton												
 <p><b>36" Square Bench</b> COM Yardage: 3 Freight class: 250 Product weight: 50 Cubic feet per carton: 18.25</p>	No power/USB unit.  Freestanding unit only.  Add \$80 for (SLS) Add \$106 for (F6, F3, or F8) Add \$1330 for 72 lbs. (CW) Add \$198 for (SP) or \$483 for (BS) Add \$43 for (TP) Add \$266 for (MB)	<b>R27849</b>	2023	2125	2204	2321	2486	2555	2698	2922	3090	3274	3657	4059		
		<b>OVERALL DIMENSIONS</b>			<b>SEAT DIMENSIONS</b>			<b>BACK DIMENSIONS</b>								
		<b>W</b>	<b>D</b>	<b>H</b>	<b>W</b>	<b>D</b>	<b>H</b>	<b>W</b>	<b>H</b>							
		36	36	17.5	-	-	-	-	-							
			<b>RTA 00</b>	1 per carton												
 <p><b>42" Square Bench</b> COM Yardage: 3.25 Freight class: 250 Product weight: 60 Cubic feet per carton: 23</p>	No power/USB unit.  Freestanding unit only.  Add \$91 for (SLS) Add \$106 for (F6, F3, or F8) Add \$1330 for 72 lbs. (CW) Add \$220 for (SP) or \$673 for (BS) Add \$43 for (TP) Add \$396 for (MB)	<b>R27850</b>	2458	2568	2655	2781	2960	3035	3190	3432	3615	3813	4228	4663		
		<b>OVERALL DIMENSIONS</b>			<b>SEAT DIMENSIONS</b>			<b>BACK DIMENSIONS</b>								
		<b>W</b>	<b>D</b>	<b>H</b>	<b>W</b>	<b>D</b>	<b>H</b>	<b>W</b>	<b>H</b>							
		42	42	17.5	-	-	-	-	-							
			<b>RTA 00</b>	1 per carton												

Options: (SLS) Sealed seams (F6, F3, F8) Floor mount legs (CW) Counterweight (SP) Vinyl sealed bottom (BS) Steel bottom (TP) Tamperproof (MB) Moisture barrier

## RIVER+ TABLES

Please add option codes in the following order:

- **Model number**  
**R27855 to R27858** Square coffee tables  
**R27859** Rectangular coffee table  
**R27860 to R27861** Round coffee tables  
**R27862 to R27864** Linking/end tables  
**7443 and 7745** Freestanding tables
- **Laminate finishes**  
**(ACJ)** Absolute Acajou **(ASN)** Asian Night  
**(AWC)** Avant Cherry **(AWH)** Avant Hone  
**(BLK)** Black **(BRC)** Brushed Cobalt  
**(BZD)** Blizzard **(CGY)** Custom Grey  
**(CMB)** Clear Maple **(DES)** Dark Espresso  
**(DWT)** Designer White **(FAS)** Faux  
**(FCL)** First Class  
**(NBL)** Noce Biondo **(NGL)** Noce Grigio  
**(NEL)** Noce Leggero **(NML)** Noce Medio  
**(QTM)** Quartered Mahogany  
**(SBY)** Sheer Beauty **(SDT)** Stone Dust  
**(SOG)** Storm Grey **(WCR)** Winter Cherry  
**(WHC)** White Chocolate **(WHE)** Walnut Heights  
(colors shown on website)
- **Leg selection**  
**(S6)** Standard height (6.5") w/adjustable glides. No upcharge.  
**(S3)** Low (3") w/adjustable glides. No upcharge.  
**(S8)** High (8") w/adjustable glides. No upcharge.  
**(F6)** Standard height (6.5"), fixed to floor. Add \$106.  
**(F3)** Low (3"), fixed to floor. Add \$106.  
**(F8)** High (8"), fixed to floor. Add \$106.
- **Leg angle** (linking/end tables only)  
**(AST)** Straight legs. No upcharge.  
**(SA)** Straight front legs, angled back legs. No upcharge.
- **Leg finish**  
**(CHM)** Chrome **(TBL)** Black  
**(TDW)** Designer White **(TFO)** Fog  
**(TFR)** Frost **(TIV)** Cloud  
**(TLA)** Latte **(TMO)** Mocha  
**(TNE)** Nevada **(TOA)** Toast  
**(TSH)** Shadow **(TSN)** Sand  
**(TTU)** Tungsten
- **Additional weight**  
**(CW)** Additional weight. Upcharges vary, see model.
- **Power/USB unit position** (coffee and linking/end tables only, as shown below).  
**Add \$661** per unit.  
**(NP)** No power (no upcharge)  
**(LE1)** Left end (coffee table only)  
**(LE2)** Right end (coffee table only)  
**(F3)** Front center (coffee table only)  
**(T1)** Top
- **Power unit finish**  
**(J)** Jet Black  
**(W)** White
- **(TP) Tamperproof fasteners.** Add \$169.

## STANDARD FEATURES

- A modular series that is composed of straight and curved sections, as well as freestanding units.
- Linking units can be used together in any combination with River+ seating and bench units to create a wide variety of layouts. Ganging hardware is standard and is factory installed. Ganging hardware swivels out of the way when not in use.
- Front and back faces of end (linking) tables angles slightly inwards. This inward slant matches the inward angles of River seating so all units coordinate in visual appearance.
- The standard 6.5", welded steel legs are straight (vertical) as standard. Linking models are optionally available with an angled back leg to visually align with River+ seating units.
- Legs include Black nylon, non-marking, height adjustable glides.
- Tables are made with high pressure laminate. Custom high pressure laminate finishes will be considered upon request.
- Laptop tables have 1" thick laminate tops.
- Laptop table painted metal base finishes are available in Black and Tungsten only.

## OPTIONAL FEATURES

- Legs of coffee and end (linking) tables are available in 3" (**S3**) and 8" (**S8**) heights. All leg heights are available with fixed-to-floor (**F3**) and (**F8**) options. Add \$106.
- To match adjacent lounge seating, straight front and angled back 6.5" or 8" legs are available on linking/end tables. Specify (**SA**). No upcharge.
- Power units are available on all tables except laptop tables. Each unit includes one AC outlet and two USB-a,10 watt charging ports. Add \$661 upcharge per unit.
- Power location options include top, front or end. See electrical placement diagrams. Electrical units must be factory installed.
- Power units are available in either Jet Black (**J**) or White (**W**), with 120", three-prong matching cords.
- Most products can be weighted to reduce the ease of movement. For additional weight options, specify (**CW**). See each model for available additional weight and upcharge.

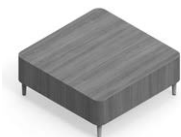

42" Square Coffee Table model R27858



Outside Curve End Table model R27864



18" Dia. Round Laptop Table model 7743

### River+ Seating and Benches

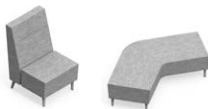

For River+ seating, please see page 349  
 For River+ benches, please see page 367

### EXAMPLE RIVER+ TABLE ORDER CODE:

R27858	-ACJ	-S6	-AS	-CM	-	-T1	-W	-
Model number	Laminate	Leg selection	Leg angle	Leg finish	Additional weight	Power/USB	Power finish	Fasteners

## ELECTRICAL PLACEMENT

### Coffee Tables

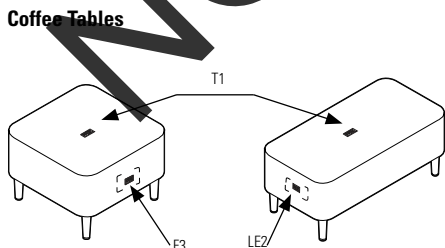

T1 location only

### Linking Tables

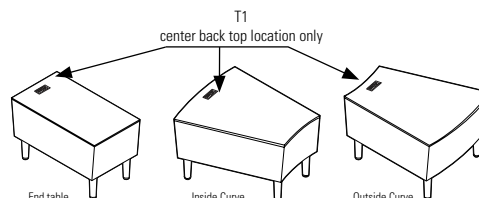

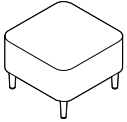
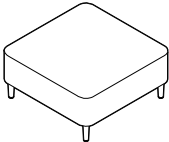
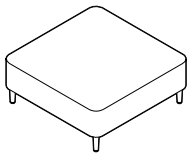
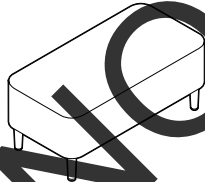
DESCRIPTION	FEATURES	MODEL#	STANDARD TEXTILE GRADES																											
 <p><b>24" Square Coffee Table</b> COM: N/A Freight class: 250 Product weight: 40 Cubic feet per carton: 10.7</p>	<p>For power/USB unit, see electrical placement chart.</p> <p>Freestanding unit only. Add \$511 for 36 lbs. (CW)</p>	List price																												
		R27855	1566																											
		<table border="1"> <thead> <tr> <th colspan="3">OVERALL DIMENSIONS</th> <th colspan="3">SEAT DIMENSIONS</th> <th colspan="2">BACK DIMENSIONS</th> </tr> <tr> <th>W</th> <th>D</th> <th>H</th> <th>W</th> <th>D</th> <th>H</th> <th>W</th> <th>H</th> </tr> </thead> <tbody> <tr> <td>24</td> <td>24</td> <td>17</td> <td>-</td> <td>-</td> <td>-</td> <td>-</td> <td>-</td> </tr> </tbody> </table>		OVERALL DIMENSIONS			SEAT DIMENSIONS			BACK DIMENSIONS		W	D	H	W	D	H	W	H	24	24	17	-	-	-	-	-	<table border="1"> <thead> <tr> <th colspan="2">RTA 00</th> </tr> </thead> <tbody> <tr> <td>1 per carton</td> </tr> </tbody> </table>		RTA 00
OVERALL DIMENSIONS			SEAT DIMENSIONS			BACK DIMENSIONS																								
W	D	H	W	D	H	W	H																							
24	24	17	-	-	-	-	-																							
RTA 00																														
1 per carton																														
 <p><b>30" Square Coffee Table</b> COM: N/A Freight class: 250 Product weight: 53 Cubic feet per carton: 15.3</p>	<p>For power/USB unit, see electrical placement chart.</p> <p>Freestanding unit only. Add \$383 for 27 lbs. (CW)</p>	List price																												
		R27856	1649																											
		<table border="1"> <thead> <tr> <th colspan="3">OVERALL DIMENSIONS</th> <th colspan="3">SEAT DIMENSIONS</th> <th colspan="2">BACK DIMENSIONS</th> </tr> <tr> <th>W</th> <th>D</th> <th>H</th> <th>W</th> <th>D</th> <th>H</th> <th>W</th> <th>H</th> </tr> </thead> <tbody> <tr> <td>30</td> <td>30</td> <td>17</td> <td>-</td> <td>-</td> <td>-</td> <td>-</td> <td>-</td> </tr> </tbody> </table>		OVERALL DIMENSIONS			SEAT DIMENSIONS			BACK DIMENSIONS		W	D	H	W	D	H	W	H	30	30	17	-	-	-	-	-	<table border="1"> <thead> <tr> <th colspan="2">RTA 00</th> </tr> </thead> <tbody> <tr> <td>1 per carton</td> </tr> </tbody> </table>		RTA 00
OVERALL DIMENSIONS			SEAT DIMENSIONS			BACK DIMENSIONS																								
W	D	H	W	D	H	W	H																							
30	30	17	-	-	-	-	-																							
RTA 00																														
1 per carton																														
 <p><b>36" Square Coffee Table</b> COM: N/A Freight class: 250 Product weight: 75 Cubic feet per carton: 20.6</p>	<p>For power/USB unit, see electrical placement chart.</p> <p>Freestanding unit only. No counterweight.</p>	List price																												
		R27857	1890																											
		<table border="1"> <thead> <tr> <th colspan="3">OVERALL DIMENSIONS</th> <th colspan="3">SEAT DIMENSIONS</th> <th colspan="2">BACK DIMENSIONS</th> </tr> <tr> <th>W</th> <th>D</th> <th>H</th> <th>W</th> <th>D</th> <th>H</th> <th>W</th> <th>H</th> </tr> </thead> <tbody> <tr> <td>36</td> <td>36</td> <td>17</td> <td>-</td> <td>-</td> <td>-</td> <td>-</td> <td>-</td> </tr> </tbody> </table>		OVERALL DIMENSIONS			SEAT DIMENSIONS			BACK DIMENSIONS		W	D	H	W	D	H	W	H	36	36	17	-	-	-	-	-	<table border="1"> <thead> <tr> <th colspan="2">RTA 00</th> </tr> </thead> <tbody> <tr> <td>1 per carton</td> </tr> </tbody> </table>		RTA 00
OVERALL DIMENSIONS			SEAT DIMENSIONS			BACK DIMENSIONS																								
W	D	H	W	D	H	W	H																							
36	36	17	-	-	-	-	-																							
RTA 00																														
1 per carton																														
 <p><b>42" Square Coffee Table</b> COM: N/A Freight class: 150 Product weight: 115 Cubic feet per carton: 26.7</p>	<p>For power/USB unit, see electrical placement chart.</p> <p>Freestanding unit only. No counterweight.</p>	List price																												
		R27858	2101																											
		<table border="1"> <thead> <tr> <th colspan="3">OVERALL DIMENSIONS</th> <th colspan="3">SEAT DIMENSIONS</th> <th colspan="2">BACK DIMENSIONS</th> </tr> <tr> <th>W</th> <th>D</th> <th>H</th> <th>W</th> <th>D</th> <th>H</th> <th>W</th> <th>H</th> </tr> </thead> <tbody> <tr> <td>42</td> <td>42</td> <td>17</td> <td>-</td> <td>-</td> <td>-</td> <td>-</td> <td>-</td> </tr> </tbody> </table>		OVERALL DIMENSIONS			SEAT DIMENSIONS			BACK DIMENSIONS		W	D	H	W	D	H	W	H	42	42	17	-	-	-	-	-	<table border="1"> <thead> <tr> <th colspan="2">RTA 00</th> </tr> </thead> <tbody> <tr> <td>1 per carton</td> </tr> </tbody> </table>		RTA 00
OVERALL DIMENSIONS			SEAT DIMENSIONS			BACK DIMENSIONS																								
W	D	H	W	D	H	W	H																							
42	42	17	-	-	-	-	-																							
RTA 00																														
1 per carton																														
 <p><b>Rectangular Coffee Table</b> COM: N/A Freight class: 250 Product weight: 55 Cubic feet per carton: 14.2</p>	<p>For power/USB unit, see electrical placement chart.</p> <p>Freestanding unit only. Add 256 for 18 lbs. (CW)</p>	List price																												
		R27859	1716																											
		<table border="1"> <thead> <tr> <th colspan="3">OVERALL DIMENSIONS</th> <th colspan="3">SEAT DIMENSIONS</th> <th colspan="2">BACK DIMENSIONS</th> </tr> <tr> <th>W</th> <th>D</th> <th>H</th> <th>W</th> <th>D</th> <th>H</th> <th>W</th> <th>H</th> </tr> </thead> <tbody> <tr> <td>40</td> <td>20</td> <td>17</td> <td>-</td> <td>-</td> <td>-</td> <td>-</td> <td>-</td> </tr> </tbody> </table>		OVERALL DIMENSIONS			SEAT DIMENSIONS			BACK DIMENSIONS		W	D	H	W	D	H	W	H	40	20	17	-	-	-	-	-	<table border="1"> <thead> <tr> <th colspan="2">RTA 00</th> </tr> </thead> <tbody> <tr> <td>1 per carton</td> </tr> </tbody> </table>		RTA 00
OVERALL DIMENSIONS			SEAT DIMENSIONS			BACK DIMENSIONS																								
W	D	H	W	D	H	W	H																							
40	20	17	-	-	-	-	-																							
RTA 00																														
1 per carton																														

Options: (CW) Counterweight

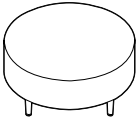
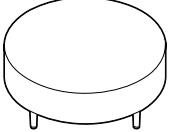
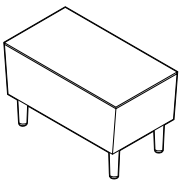
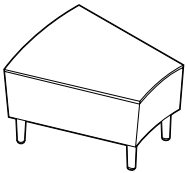
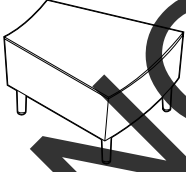
DESCRIPTION	FEATURES	MODEL#	STANDARD TEXTILE GRADES							
 <p><b>36" Dia. Round Coffee Table</b> COM: N/A Freight class: 150 Product weight: 63 Cubic feet per carton: 15.3</p>	<p>For power/USB unit, see electrical placement chart.</p> <p>Freestanding unit only. Add \$256 for 18 lbs. <b>(CW)</b></p>	<p>List price</p> <p><b>R27860</b> 2033</p>								
			<b>OVERALL DIMENSIONS</b>			<b>SEAT DIMENSIONS</b>			<b>BACK DIMENSIONS</b>	
			<b>W</b>	<b>D</b>	<b>H</b>	<b>W</b>	<b>D</b>	<b>H</b>	<b>W</b>	<b>H</b>
			36	36	17	-	-	-	-	-
			<b>RTA 00</b>	1 per carton						
 <p><b>42" Dia. Round Coffee Table</b> COM: N/A Freight class: 150 Product weight: 85 Cubic feet per carton: 20.6</p>	<p>For power/USB unit, see electrical placement chart.</p> <p>Freestanding unit only. No counterweight.</p>	<p>List price</p> <p><b>R27861</b> 2230</p>								
			<b>OVERALL DIMENSIONS</b>			<b>SEAT DIMENSIONS</b>			<b>BACK DIMENSIONS</b>	
			<b>W</b>	<b>D</b>	<b>H</b>	<b>W</b>	<b>D</b>	<b>H</b>	<b>W</b>	<b>H</b>
			42	42	17	-	-	-	-	-
			<b>RTA 00</b>	1 per carton						
 <p><b>Rectangular End Table</b> COM: N/A Freight class: 300 Product weight: 40 Cubic feet per carton: 20.6</p>	<p>For power/USB unit, see electrical placement chart.</p> <p>Includes ganging hardware (2 sides). Add \$511 for 36 lbs. <b>(CW)</b></p>	<p>List price</p> <p><b>R27862</b> 1665</p>								
			<b>OVERALL DIMENSIONS</b>			<b>SEAT DIMENSIONS</b>			<b>BACK DIMENSIONS</b>	
			<b>W</b>	<b>D</b>	<b>H</b>	<b>W</b>	<b>D</b>	<b>H</b>	<b>W</b>	<b>H</b>
			28	15	17	-	-	-	-	-
			<b>RTA 00</b>	1 per carton						
 <p><b>Inside Curve End Table</b> COM: N/A Freight class: 250 Product weight: 47 Cubic feet per carton: 13.3</p>	<p>For power/USB unit, see electrical placement chart.</p> <p>Includes ganging hardware (2 sides). Add \$511 for 36 lbs. <b>(CW)</b></p>	<p>List price</p> <p><b>R27863</b> 2188</p>								
			<b>OVERALL DIMENSIONS</b>			<b>SEAT DIMENSIONS</b>			<b>BACK DIMENSIONS</b>	
			<b>W</b>	<b>D</b>	<b>H</b>	<b>W</b>	<b>D</b>	<b>H</b>	<b>W</b>	<b>H</b>
			28	17	17	-	-	-	-	-
			<b>RTA 00</b>	1 per carton						
 <p><b>Outside Curve End Table</b> COM: N/A Freight class: 250 Product weight: 47 Cubic feet per carton: 13.3</p>	<p>For power/USB unit, see electrical placement chart.</p> <p>Includes ganging hardware (2 sides). Add \$511 for 36 lbs. <b>(CW)</b></p>	<p>List price</p> <p><b>R27864</b> 2188</p>								
			<b>OVERALL DIMENSIONS</b>			<b>SEAT DIMENSIONS</b>			<b>BACK DIMENSIONS</b>	
			<b>W</b>	<b>D</b>	<b>H</b>	<b>W</b>	<b>D</b>	<b>H</b>	<b>W</b>	<b>H</b>
			28	17	17	-	-	-	-	-
			<b>RTA 00</b>	1 per carton						

Options: **(CW)** Counterweight

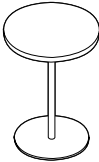
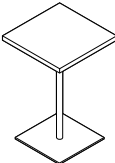
DESCRIPTION	FEATURES	MODEL#	STANDARD TEXTILE GRADES						
 <p><b>18" Dia. Round Laptop Table</b> COM: N/A Freight class: 150 Product weight: 32 Cubic feet per carton: 6</p>	No power/USB unit.	List price							
		7743	836						
		OVERALL DIMENSIONS			SEAT DIMENSIONS			BACK DIMENSIONS	
		W	D	H	W	D	H	W	H
18	18	25.25	-	-	-	-	-		
	<b>RTA 00</b>	1 per carton							
 <p><b>16" Square Laptop Table</b> COM: N/A Freight class: 125 Product weight: 36 Cubic feet per carton: 6</p>	No power/USB unit.	List price							
		7745	855						
		OVERALL DIMENSIONS			SEAT DIMENSIONS			BACK DIMENSIONS	
		W	D	H	W	D	H	W	H
16	16	25.25	-	-	-	-	-		
	<b>RTA 00</b>	1 per carton							

NOT ON CONTRACT

SIRENA™



models 3371 Lounge Chairs, 3373 Two Seat Sofa, 3400 Coffee Table, and 3402 End Table



model 3371



model 3372CRTL

STANDARD FEATURES

- Modern club style seating includes: lounge chair, two and three seat sofas.
- Complete with Modern tables for reception areas, meeting rooms, and private office use.
- Lounge seating distinctive round style feet are finished in Black Only.
- All models have fixed, non-removable seat cushions with arm height at 25" in the front.
- Casters are available on lounge chairs only. **C1M** casters are standard.
- Please note leather models offer additional stitch details.
- Check textile availability prior to specifying upholstery material.
- When ordering models with tablet, specify for left hand or for right hand tablet. See models below.
- Laminate Tops, are 1.5" thick.
- Table legs are 1.5" steel tubing, tapered toward the bottom to 7/8", equipped with self-leveling, pivoting steel glides.



OPTIONAL FEATURES

- Laminate tables, tablets and bookshelves are offered in the following laminate finishes: Absolute Acajou (**ACJ**), Asian Night (**ASN**), Avant Cherry (**AWC**), Avant Honey (**AWH**), Blizzard (**BZD**), Clear Maple (**CMB**), Custom Grey (**CGY**), Dark Espresso (**DES**), Designer White (**DWT**), Fashionista (**FAS**), First Class (**FCL**), Noce Biondo (**NBL**), Noce Grigio (**NGL**), Noce Leggero (**NEL**), Noce Medio (**NML**), Quartered Mahogany (**QTM**), Sheer Beauty (**SBY**), Stonedust (**SDT**), Walnut Heights (**WHE**), White Chocolate (**WHC**) and Winter Cherry (**WCR**). Please Specify.
- Table legs are available in Tungsten (**TTU**), Shadow (**TSH**), Black (**TBL**) at no upcharge. Not available in Chrome.

STITCH DETAIL WHEN UPHOLSTERED IN ALL LEATHER - ILLUSTRATIONS BELOW

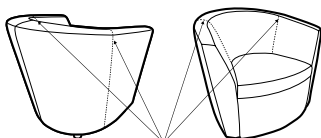

Extra Stitch Lines

Lounge Chair

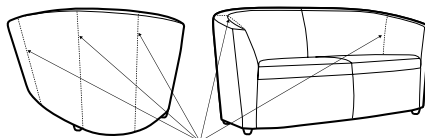

Extra Stitch Lines

Two and Three Seater Sofas

DESCRIPTION

FEATURES

MODEL#

STANDARD TEXTILE GRADES



**Lounge Chair** Fabric  
COM Yardage: 4.25  
Freight Class: 250  
Product Weight (lbs.): 52  
Cubic Feet Per Carton: 19.25

	1	2	3	4	5	6	7	8	9	10	11	12
<b>3371</b>	-	1826	1956	2140	2407	2505	2737	3174	3390	3795	4358	5054

OVERALL DIMENSIONS

W D H

30.5 29.5 28.5

SEAT DIMENSIONS

W D H

20 20 17.5

BACK DIMENSIONS

W H

19 11.5

RTA 00



**Lounge Chair w/Casters**  
COM Yardage: 4.25  
Freight Class: 250  
Product Weight (lbs.): 52  
Cubic Feet Per Carton: 19.25

	1	2	3	4	5	6	7	8	9	10	11	12
<b>3371C</b>	-	1964	2101	2296	2576	2680	2923	3380	3609	4033	4621	5351

OVERALL DIMENSIONS

W D H

30.5 29.5 29.5

SEAT DIMENSIONS

W D H







20 20 17.5

BACK DIMENSIONS

W H

19 11.5

RTA 00

DESCRIPTION	FEATURES	MODEL#	STANDARD TEXTILE GRADES											
			1	2	3	4	5	6	7	8	9	10	11	12
 <b>3371LTL</b>	 <b>3371RTL</b>	<b>3371LTL</b> 3371RTL	-	2635	2768	2967	3244	3348	3591	4050	4279	4700	5292	6022
			<b>OVERALL DIMENSIONS</b> W D H			<b>SEAT DIMENSIONS</b> W D H			<b>BACK DIMENSIONS</b> W H					
Lounge Chair w/Laminate Tablet COM Yardage: 4.25 Freight Class: 250 Product Weight (lbs.): 58 Cubic Feet Per Carton: 19.25			RTA 00											
 <b>3371CLTL</b>	 <b>3371CRTL</b>	<b>3371CLTL</b> 3371CRTL	-	2786	2922	3118	3395	3499	3745	4199	4430	4851	5443	6173
			<b>OVERALL DIMENSIONS</b> W D H			<b>SEAT DIMENSIONS</b> W D H			<b>BACK DIMENSIONS</b> W H					
Lounge Chair w/Casters & Laminate Tablet COM Yardage: 4.25 Freight Class: 250 Product Weight (lbs.): 62 Cubic Feet Per Carton: 19.25			RTA 00											
		<b>3372</b>	-	2431	2561	2745	3012	3110	3342	3779	3995	4400	4963	5659
	<b>OVERALL DIMENSIONS</b> W D H			<b>SEAT DIMENSIONS</b> W D H			<b>BACK DIMENSIONS</b> W H							
Lounge Chair w/Laminate Book Shelf COM Yardage: 4.25 Freight Class: 250 Product Weight (lbs.): 55 Cubic Feet Per Carton: 19.25			RTA 00											
		<b>3372C</b>	-	2665	2795	2979	3246	3344	3576	4013	4229	4634	5197	5893
	<b>OVERALL DIMENSIONS</b> W D H			<b>SEAT DIMENSIONS</b> W D H			<b>BACK DIMENSIONS</b> W H							
Lounge Chair w/Casters & Laminate Book Shelf COM Yardage: 4.25 Freight Class: 250 Product Weight (lbs.): 55 Cubic Feet Per Carton: 19.25			RTA 00											
 <b>3372LTL</b>	 <b>3372RTL</b>	<b>3372LTL</b> 3372RTL	-	3170	3300	3484	3751	3849	4081	4518	4734	5139	5702	6398
			<b>OVERALL DIMENSIONS</b> W D H			<b>SEAT DIMENSIONS</b> W D H			<b>BACK DIMENSIONS</b> W H					
Lounge Chair w/Laminate Tablet/Book Shelf COM Yardage: 4.25 Freight Class: 250 Product Weight (lbs.): 66 Cubic Feet Per Carton: 19.25			RTA 00											

DESCRIPTION	FEATURES	MODEL#	STANDARD TEXTILE GRADES											
			1	2	3	4	5	6	7	8	9	10	11	12



3372CLTL



3372CRTL

**Lounge Chair w/ Casters & Laminate Table/Book Shelf**  
 COM Yardage: 4.25  
 Freight Class: 250  
 Product Weight (lbs.): 66  
 Cubic Feet Per Carton: 19.25

3372CLTL	-	3326	3456	3640	3907	4005	4237	4674	4890	5296	5858	6554
3372CRTL												

OVERALL DIMENSIONS			SEAT DIMENSIONS			BACK DIMENSIONS	
W	D	H	W	D	H	W	H
32.5	29.5	28.5	20	20	17.5	19	11.5

RTA 00

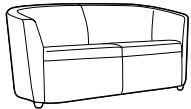

**Two Seat Sofa**  
 COM Yardage: 7  
 Freight Class: 300  
 Product Weight (lbs.): 92  
 Cubic Feet Per Carton: 48

3373	-	3426	3636	3945	4380	4544	4927	5641	6002	6670	7594	8736
------	---	------	------	------	------	------	------	------	------	------	------	------

OVERALL DIMENSIONS			SEAT DIMENSIONS			BACK DIMENSIONS	
W	D	H	W	D	H	W	H
62	29.5	28.5	53	20	17.5	53	11.5

RTA 00

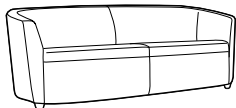

**Three Seat Sofa**  
 COM Yardage: 7.75  
 Freight Class: 300  
 Product Weight (lbs.): 107  
 Cubic Feet Per Carton: 55.5

3374	-	4119	4349	4689	5172	5357	5777	6571	6970	7706	8731	9996
------	---	------	------	------	------	------	------	------	------	------	------	------

OVERALL DIMENSIONS			SEAT DIMENSIONS			BACK DIMENSIONS	
W	D	H	W	D	H	W	H
81.5	29.5	28.5	72.5	20	17.5	72.5	11.5

RTA 00

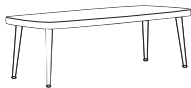

**Coffee Table - 48" Laminate Top**  
 COM Yardage: N/A  
 Freight Class: 250  
 Product Weight (lbs.): 52  
 Cubic Feet Per Carton: 17.25

3400	1959	-	-	-	-	-	-	-	-	-	-	-
------	------	---	---	---	---	---	---	---	---	---	---	---

OVERALL DIMENSIONS			SEAT DIMENSIONS			BACK DIMENSIONS	
W	D	H	W	D	H	W	H
48	22	14	-	-	-	-	-

RTA 00



**Coffee Table - 56" Laminate Top**  
 COM Yardage: N/A  
 Freight Class: 175  
 Product Weight (lbs.): 60  
 Cubic Feet Per Carton: 19

301	2165	-	-	-	-	-	-	-	-	-	-	-
-----	------	---	---	---	---	---	---	---	---	---	---	---

OVERALL DIMENSIONS			SEAT DIMENSIONS			BACK DIMENSIONS	
W	D	H	W	D	H	W	H
56	22	15	-	-	-	-	-

RTA 00

NOT ON CONTRACT

DESCRIPTION	FEATURES	MODEL#	STANDARD TEXTILE GRADES												
			1	2	3	4	5	6	7	8	9	10	11	12	
		3402	1571	-	-	-	-	-	-	-	-	-	-	-	-



**NOT ON CONTRACT**

**End Table - Laminate Top**  
 COM Yardage: N/A  
 Freight Class: Z50  
 Product Weight (lbs.): 26  
 Cubic Feet Per Carton: 7.75

OVERALL DIMENSIONS	SEAT DIMENSIONS	BACK DIMENSIONS
L	W	H
17	22	14.5



VENTURE



48\"/>



78\"/>



60\"/>

EXAMPLE VENTURE ORDER CODE:

8506-48	EL58	TBL
Model #	Textile	Leg Finish

STANDARD FEATURES

- Venture is a solid and durable banquette seating series.
- Banquettes are available with or without fully upholstered backs. Open back banquettes are intended to be placed against walls or in other layouts where the back will not be visible.
- Heavy duty frame has plywood construction suitable for public environments. For 24/7 use environments, must use approved textiles with 100,000 double-rubs and above.
- Cushions are made with highly resilient foam and seats are equipped with a synthetic rubberized webbing suspension system for extra comfort.
- Cushions are fixed and non-removable.
- Ganging bracket kit (8509) gangs single back models 'back to back' or side-by-side and double back models side-to-side..Standard in Black. Contains two brackets
- Legs are metal painted and Chrome with Black glides, suitable for carpet and hard surface flooring.Closed back models are fully upholstered for use in open settings and to support reconfiguration.
- Open back models have a black outer back protective dust cover, to be used against walls or for ganging back-to-back.

- Partial assembly (KD) packaging is optional on Double Back models to allow the unit to fit through standard doors. Assembly instructions are included.
- Check textile availability prior to specifying upholstery material.

**Note:** Double-sided models (8508-48 to 8508-78) measure 55" deep, 48" high and weigh over 100 lbs. They may require coordination for special handling and accommodation through doorway and elevators.

OPTIONAL FEATURES:

Add option codes in the following order

- **Model Number**
- **Back and seat textile**  
Specify textile code.
- **Leg Finish.** No upcharge  
(CHM) Chrome  
(TBL) Black  
(TLA) Latte  
(TTU) Tungsten
- **Package options.** No upcharge  
Available on Double Back models.  
(ST) Standard Fully assembled  
(KD) Knocked Down

DESCRIPTION

FEATURES

MODEL #

STANDARD TEXTILE GRADES

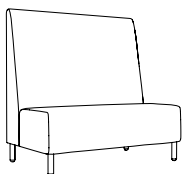

48\"/>

COM Yardage: 6.75  
Freight Class: 300  
Product weight (lbs): 104  
Cubic Feet Per Carton: 50.75

	1	2	3	4	5	6	7	8	9	10	11	12
<b>8506-48</b>	3168	3416	3608	3892	4293	4462	4809	5354	5763	6208	7138	8115

OVERALL DIMENSIONS			SEAT DIMENSIONS			BACK DIMENSIONS	
W	D	H	W	D	H	W	H
48	28	48	48	19	18	48	30

**RTA 00** 1 per carton

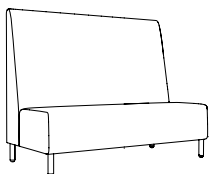

60\"/>

COM Yardage: 8  
Freight Class: 250  
Product weight (lbs): 127  
Cubic Feet Per Carton: 62.75

	1	2	3	4	5	6	7	8	9	10	11	12
<b>8506-60</b>	3776	4069	4297	4634	5108	5308	5719	6365	6849	7377	8481	9638

OVERALL DIMENSIONS			SEAT DIMENSIONS			BACK DIMENSIONS	
W	D	H	W	D	H	W	H
60	28	48	60	19	18	60	30

**RTA 00** 1 per carton

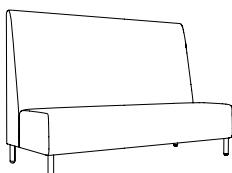

72\"/>

COM Yardage: 9  
Freight Class: 250  
Product weight (lbs): 153  
Cubic Feet Per Carton: 75

	1	2	3	4	5	6	7	8	9	10	11	12
<b>8506-72</b>	4023	4353	4609	4988	5522	5746	6208	6936	7480	8075	9315	10617

OVERALL DIMENSIONS			SEAT DIMENSIONS			BACK DIMENSIONS	
W	D	H	W	D	H	W	H
72	28	48	72	19	18	72	30

**RTA 00** 1 per carton

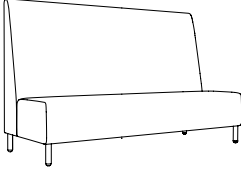
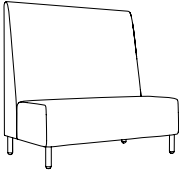
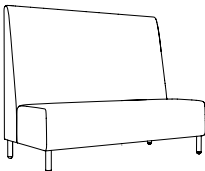
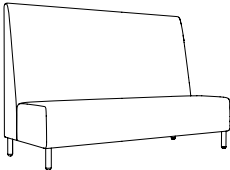
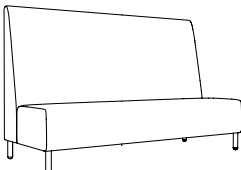
DESCRIPTION	FEATURES	MODEL#	STANDARD TEXTILE GRADES												
			1	2	3	4	5	6	7	8	9	10	11	12	
 <p><b>78\"W Three Seater Banquette, Closed Back</b>                      COM Yardage: 10                      Freight Class: 250                      Product weight (lbs): 163                      Cubic Feet Per Carton: 79.75</p>		<b>8506-78</b>	4413	4779	5063	5485	6077	6328	6841	7650	8254	8914	10293	11740	
	<b>OVERALL DIMENSIONS</b>			<b>SEAT DIMENSIONS</b>			<b>BACK DIMENSIONS</b>								
	<b>W</b>	<b>D</b>	<b>H</b>	<b>W</b>	<b>D</b>	<b>H</b>	<b>W</b>	<b>H</b>							
	78	28	48	78	19	18	78	30							
			<b>RTA 00</b>			1 per carton									
 <p><b>48\"W Two Seater Banquette, Open Back</b>                      COM Yardage: 5                      Freight Class: 250                      Product weight (lbs): 105                      Cubic Feet Per Carton: 50.75</p>		<b>8507-48</b>	2981	3164	3306	3517	3814	3939	4196	4600	4902	5232	5922	6646	
	<b>OVERALL DIMENSIONS</b>			<b>SEAT DIMENSIONS</b>			<b>BACK DIMENSIONS</b>								
	<b>W</b>	<b>D</b>	<b>H</b>	<b>W</b>	<b>D</b>	<b>H</b>	<b>W</b>	<b>H</b>							
	48	28	48	48	19	18	48	30							
			<b>RTA 00</b>			1 per carton									
 <p><b>60\"W Two Seater Banquette, Open Back</b>                      COM Yardage: 6                      Freight Class: 250                      Product weight (lbs): 127                      Cubic Feet Per Carton: 62.75</p>		<b>8507-60</b>	3394	3614	3786	4038	4394	4543	4853	5337	5700	6096	6922	7792	
	<b>OVERALL DIMENSIONS</b>			<b>SEAT DIMENSIONS</b>			<b>BACK DIMENSIONS</b>								
	<b>W</b>	<b>D</b>	<b>H</b>	<b>W</b>	<b>D</b>	<b>H</b>	<b>W</b>	<b>H</b>							
	60	28	48	60	19	18	60	30							
			<b>RTA 00</b>			1 per carton									
 <p><b>72\"W Three Seater Banquette, Open Back</b>                      COM Yardage: 7                      Freight Class: 250                      Product weight (lbs): 153                      Cubic Feet Per Carton: 75</p>		<b>8507-72</b>	3805	4061	4260	4556	4970	5146	5505	6072	6494	6957	7921	8935	
	<b>OVERALL DIMENSIONS</b>			<b>SEAT DIMENSIONS</b>			<b>BACK DIMENSIONS</b>								
	<b>W</b>	<b>D</b>	<b>H</b>	<b>W</b>	<b>D</b>	<b>H</b>	<b>W</b>	<b>H</b>							
	72	28	48	72	19	18	72	30							
			<b>RTA 00</b>			1 per carton									
 <p><b>78\"W Three Seater Banquette, Open Back</b>                      COM Yardage: 8                      Freight Class: 250                      Product weight (lbs): 163                      Cubic Feet Per Carton: 79.75</p>		<b>8507-78</b>	4179	4472	4701	5037	5511	5711	6123	6768	7253	7781	8884	10042	
	<b>OVERALL DIMENSIONS</b>			<b>SEAT DIMENSIONS</b>			<b>BACK DIMENSIONS</b>								
	<b>W</b>	<b>D</b>	<b>H</b>	<b>W</b>	<b>D</b>	<b>H</b>	<b>W</b>	<b>H</b>							
	78	28	48	78	19	18	78	30							
			<b>RTA 00</b>			1 per carton									

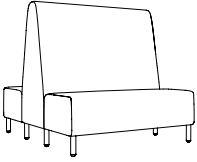
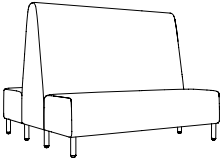
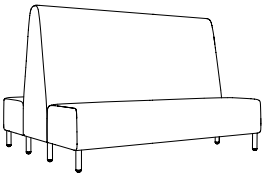
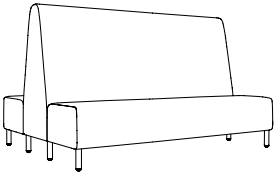
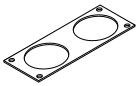
DESCRIPTION	FEATURES	MODEL#	STANDARD TEXTILE GRADES													
			1	2	3	4	5	6	7	8	9	10	11	12		
 <p><b>48"W Four Seater Banquette, Double Back</b> COM Yardage: 9 Freight Class: 300 Product weight (lbs): 163 Cubic Feet Per Carton: 89.75</p>	optional (KD) packaging (no upcharge)	<b>8508-48</b>	5749	6079	6336	6715	7249	7472	7935	8662	9207	9802	11041	12345		
			<b>OVERALL DIMENSIONS</b>			<b>SEAT DIMENSIONS</b>			<b>BACK DIMENSIONS</b>							
			<b>W</b>	<b>D</b>	<b>H</b>	<b>W</b>	<b>D</b>	<b>H</b>	<b>W</b>	<b>H</b>						
			48	55	48	48	19	18	48	30						
			<b>RTA 00</b>			1 per carton										
 <p><b>60"W Four Seater Banquette, Double Back</b> COM Yardage: 10 Freight Class: 300 Product weight (lbs): 198 Cubic Feet Per Carton: 111</p>	optional (KD) packaging (no upcharge)	<b>8508-60</b>	6661	7027	7311	7733	8325	8576	9089	9898	10502	11162	12541	13988		
			<b>OVERALL DIMENSIONS</b>			<b>SEAT DIMENSIONS</b>			<b>BACK DIMENSIONS</b>							
			<b>W</b>	<b>D</b>	<b>H</b>	<b>W</b>	<b>D</b>	<b>H</b>	<b>W</b>	<b>H</b>						
			60	55	48	60	19	18	60	30						
			<b>RTA 00</b>			1 per carton										
 <p><b>72"W Six Seater Banquette, Double Back</b> COM Yardage: 11 Freight Class: 300 Product weight (lbs): 242 Cubic Feet Per Carton: 132.5</p>	optional (KD) packaging (no upcharge)	<b>8508-72</b>	7909	8311	8626	9089	9741	10015	10581	11469	12135	12862	14378	15970		
			<b>OVERALL DIMENSIONS</b>			<b>SEAT DIMENSIONS</b>			<b>BACK DIMENSIONS</b>							
			<b>W</b>	<b>D</b>	<b>H</b>	<b>W</b>	<b>D</b>	<b>H</b>	<b>W</b>	<b>H</b>						
			72	55	48	72	19	18	72	30						
			<b>RTA 00</b>			1 per carton										
 <p><b>78"W Six Seater Banquette, Double Back</b> COM Yardage: 12 Freight Class: 300 Product weight (lbs): 255 Cubic Feet Per Carton: 141.7</p>	optional (KD) packaging (no upcharge)	<b>8508-78</b>	8838	9276	9619	10126	10837	11136	11752	12722	13448	14241	15894	17632		
			<b>OVERALL DIMENSIONS</b>			<b>SEAT DIMENSIONS</b>			<b>BACK DIMENSIONS</b>							
			<b>W</b>	<b>D</b>	<b>H</b>	<b>W</b>	<b>D</b>	<b>H</b>	<b>W</b>	<b>H</b>						
			78	55	48	78	19	18	78	30						
			<b>RTA 00</b>			1 per carton										
 <p><b>Ganging Bracket Kit</b> COM Yardage: n/a Freight Class: 70 Product weight (lbs): 0.5 Cubic Feet Per Carton: 0.1</p>	Includes two brackets	<b>8509</b>	List price													
			98													
			<b>OVERALL DIMENSIONS</b>			<b>SEAT DIMENSIONS</b>			<b>BACK DIMENSIONS</b>							
			<b>W</b>	<b>D</b>	<b>H</b>	<b>W</b>	<b>D</b>	<b>H</b>	<b>W</b>	<b>H</b>						
2.5	6	0.25	-	-	-	-	-									
			<b>RTA 00</b>			1 per carton										

VITROLA



Vitrola is offered in two back heights, standard lounge and high back lounge, along with two and three seat sofa models.



Matching ottoman and accent pillow to complete the offering.

STANDARD FEATURES

- Classic soft seating upholstery design with swooping arms.
- Available in standard Lounge, High Back Lounge along with Two and Three Seat Sofa models.
- Matching Ottoman and Accent Pillow complete the offering.
- Fully upholstered with piping details at the bottom of frame.
- Seat cushions are fixed or sewn tight.
- Standard in tapered maple wood legs. Standard in tapered maple wood legs. Legs are equipped with White non-marking glides as standard. Suitable for both carpet and hard surface flooring.
- Back upholstery is continuous without seams. In the event the textile cannot be railroaded, stitch lines will be required (one for 2 seater and two for 3 seater).
- All models ship fully assembled.
- Check textile availability prior to specifying upholstery material.

OPTION CODES





Please add option codes in the following order:

- **Model number**  
**8271** Lounge Chair  
**8272** Two Seat Sofa  
**8273** Three Seat Sofa  
**8274** Ottoman  
**8275** High Back Lounge Chair  
**8276** Accent Pillow
- **Fabric**  
Specify fabric code.
- **Wood Legs**  
**(AAM)** Absolute  
**(BKM)** Black  
**(ACM)** Cherry  
**(EOM)** English Oak  
**(ECM)** Espresso Café  
**(HGM)** Grey  
**(AHM)** Honey  
**(TMM)** Mahogany  
**(AVM)** Maple  
**(MWM)** Medium Walnut  
**(NLW)** Natural Walnut  
**(ASM)** Night  
**(NBM)** Noce Biondo  
**(NGM)** Noce Grigio  
**(NEM)** Noce Leggero  
**(NMM)** Noce Medio  
**(SKM)** Shaker Cherry  
**(TFM)** Fruitwood  
**(TWM)** Walnut  
**(WTM)** WC Cream  
**(WHM)** White  
**(WCM)** Winter Cherry  
(colors shown on website).

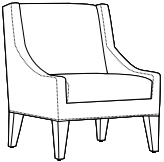
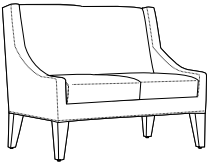
EXAMPLE OF ORDER CODE:

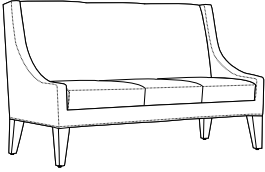
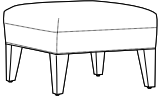
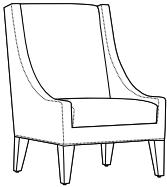
8271	WA50	HGM
Model Number	Fabric	Wood Legs

DESCRIPTION	FEATURES	MODEL#	STANDARD TEXTILE GRADES											
			1	2	3	4	5	6	7	8	9	10	11	12
 <b>Lounge Chair</b> COM Yardage: 5.25 Freight Class: 150 Product Weight (lbs.): 90 Cubic Feet Per Carton: 20.25		<b>8271</b>	\$1691	\$1895	\$2053	\$2290	\$2629	\$2791	\$3096	\$3585	\$3962	\$4380	\$5242	\$6163
			<b>OVERALL DIMENSIONS</b>			<b>SEAT DIMENSIONS</b>			<b>BACK DIMENSIONS</b>					
			<b>W</b>	<b>D</b>	<b>H</b>	<b>W</b>	<b>D</b>	<b>H</b>	<b>W</b>	<b>H</b>				
			28	31	34	22	21	17.5	22	18				
			<b>RTA 00</b>											
 <b>Two Seat Sofa</b> COM Yardage: 7.25 Freight Class: 250 Product Weight (lbs.): 107 Cubic Feet Per Carton: 36.5		<b>8272</b>	\$2774	\$3096	\$3349	\$3731	\$4274	\$4529	\$5020	\$5802	\$6404	\$7075	\$8457	\$9927
			<b>OVERALL DIMENSIONS</b>			<b>SEAT DIMENSIONS</b>			<b>BACK DIMENSIONS</b>					
			<b>W</b>	<b>D</b>	<b>H</b>	<b>W</b>	<b>D</b>	<b>H</b>	<b>W</b>	<b>H</b>				
			51	31	34	44	21	17.5	44	18				
			<b>RTA 00</b>											

DESCRIPTION	FEATURES	MODEL#	STANDARD TEXTILE GRADES												
			1	2	3	4	5	6	7	8	9	10	11	12	
 <p><b>Three Seat Sofa</b> COM Yardage: 9.25 Freight Class: 250 Product Weight (lbs.): 140 Cubic Feet Per Carton: 51.75</p>		<b>8273</b>	\$3608	\$4090	\$4473	\$5045	\$5858	\$6238	\$6976	\$8149	\$9052	\$10059	\$12130	\$14336	
			<b>OVERALL DIMENSIONS</b>			<b>SEAT DIMENSIONS</b>			<b>BACK DIMENSIONS</b>						
			<b>W</b>	<b>D</b>	<b>H</b>	<b>W</b>	<b>D</b>	<b>H</b>	<b>W</b>	<b>H</b>					
			74.25	31	34	66	21	17.5	66	18					
			<b>RTA 00</b>												
 <p><b>Ottoman</b> COM Yardage: 1.75 Freight Class: 250 Product Weight (lbs.): 20 Cubic Feet Per Carton: 8</p>		<b>8274</b>	\$972	\$1078	\$1157	\$1277	\$1445	\$1526	\$1679	\$1924	\$2112	\$2321	\$2754	\$3213	
			<b>OVERALL DIMENSIONS</b>			<b>SEAT DIMENSIONS</b>			<b>BACK DIMENSIONS</b>						
			<b>W</b>	<b>D</b>	<b>H</b>	<b>W</b>	<b>D</b>	<b>H</b>	<b>W</b>	<b>H</b>					
			24	24	17	-	-	-	-	-					
			<b>RTA 00</b>												
 <p><b>High Back Lounge Chair</b> COM Yardage: 6.25 Freight Class: 250 Product Weight (lbs.): 96 Cubic Feet Per Carton: 28.25</p>		<b>8275</b>	\$2035	\$2259	\$2433	\$2696	\$3068	\$3242	\$3581	\$4119	\$4534	\$4994	\$5944	\$6955	
			<b>OVERALL DIMENSIONS</b>			<b>SEAT DIMENSIONS</b>			<b>BACK DIMENSIONS</b>						
			<b>W</b>	<b>D</b>	<b>H</b>	<b>W</b>	<b>D</b>	<b>H</b>	<b>W</b>	<b>H</b>					
			28	31	42	22	21	17.5	22	26					
			<b>RTA 00</b>												
 <p><b>Accent Pillow</b> COM Yardage: 0.75 Freight Class: 150 Product Weight (lbs.): 4 Cubic Feet Per Carton: 1</p>		<b>8276</b>	\$202	\$230	\$252	\$282	\$327	\$348	\$387	\$451	\$500	\$555	\$668	\$786	
			<b>OVERALL DIMENSIONS</b>			<b>SEAT DIMENSIONS</b>			<b>BACK DIMENSIONS</b>						
			<b>W</b>	<b>D</b>	<b>H</b>	<b>W</b>	<b>D</b>	<b>H</b>	<b>W</b>	<b>H</b>					
			23	6	8	-	-	-	-	-					
			<b>RTA 00</b>	 		1 per carton									

WIND™



models 3361 Lounge chair & 3362 Two seat sofa, with 3357 Coffee table.

ADDITIONAL STITCH DETAIL - ILLUSTRATIONS BELOW

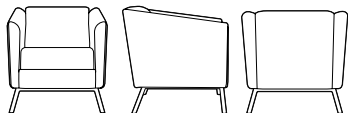

Standard Detailing - when upholstered in FABRIC or VINYL

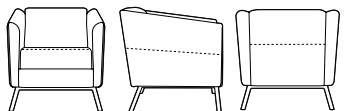

Additional Detailing - when upholstered in GENUINE LEATHER



Contrasting Textile Application



For Wind tables, see page 387

STANDARD FEATURES

- The Wind and Wind Linear series are compact, contemporary designed seating offering a raised, modern version of the traditional lounge chair; scaled down for smaller spaces.
- Wind is comprised of freestanding lounge chairs and tables.
- Wind Linear (see page 389 includes ganging seating and tables.
- Metal leg models (3361, 3362 and 3363) are available in plated and painted finishes noted.
- Wood leg models (3431, 3432 and 3433) are available in standard Global wood finishes.
- Wind tables are available with metal legs only.
- Metal legs are standard with Black glides and offer non-marking glides at no upcharge.
- Wood legs are standard with nonmarking glides and offer a variety of glide types for various flooring types. See list for types and upcharges.
- Casters are not available for Wind.
- Available with fabric, coated textile and leather upholstery; check approved textiles prior to ordering.
- The series is available with contrasting fabrics. Specify arms, back and front rail separate from seat cushion, see model image.
- For pricing, start with the base price and add both back/arms graded textile upcharge and the seat graded textile upcharge.
- For leather upholstery, note additional stitch details on seat and outside arm and back panels.
- Wind is covered under Global's Limited Lifetime Warranty.
- Wind seating has a 300 lb capacity.

Add option codes in the following order:

- **Model Number**  
Specify model number.  
3431 to 3433 Wood leg seating  
3361 to 3363 Metal leg seating
- **Back and Arm Textile** (includes front rail)  
Specify textile code.
- **Seat Textile**  
Specify textile code.
- **Leg Finish** (metal legs)
 

(TBL) Black	(TBZ) Buzz Blue
(TCC) Cactus	(TCR) Carrot
(TDJ) Dijon	(TDW) Designer White
(TEG) Eggplant	(TFO) Fog
(TFR) Frost	(TIN) Ink
(TIV) Cloud	(TKA) Kalua
(TLA) Latte	(TMO) Mocha
(TOA) Toast	(TNE) Nevada
(TSH) Shadow	(TSN) Sand
(TSR) Scarlet	(TTU) Tungsten

Metallics: Lounge 2 Seat 3 Seat  
(CHM) Chrome. No upcharge.  
(BCH) Brushed Chrome. Add \$165 \$200 \$224
- **Leg Finish** (wood legs)
 

(AAM) Absolute	(BKM) Black
(ACM) Cherry	(EOM) English Oak
(ECM) Espresso Cafe	(TFM) Fruitwood
(HGM) Grey	(AHM) Honey
(TMM) Mahogany	(AVM) Maple
(NLW) Natural Walnut	(MWM) Medium Walnut
(ASM) Night	(NBM) Noce Biondo
(NGM) Noce Grigio	(NEM) Noce Leggero
(NMM) Noce Medio	(SKM) Shaker Cherry
(TWM) Walnut	(WTM) WC Cream
(WHM) White	(WCM) Winter Cherry
- **Glide Type (metal legs)**  
(GL) Black Glide for most surfaces (standard).  
(NM) Non-Marking Glide for most surfaces. No upcharge.
- **Glide Type (wood legs)**  
(NM) Non-marking glides for most surfaces (standard).  
(SG) Steel cushioned glides for carpeted surfaces. Add \$36  
(RG) Rubber non-slip glides for most hard floor surfaces. Add \$36  
(FG) Felt glides for most hard floor surfaces. Add \$36

DESCRIPTION	FEATURES	MODEL#			STANDARD TEXTILE GRADES									
		1	2	3	4	5	6	7	8	9	10	11	12	
 <p><b>Lounge Chair, Wood Legs</b> COM Yardage: Back: 3.5 ; Seat: 1 Freight Class: 250 Product Weight (lbs.): 59 Cubic Feet Per Carton: 16.5</p>	3431	Base Price:	\$2950											
		Back/Arm upcharge:	+0	+0	\$93	\$229	\$421	\$503	\$669	\$931	\$1127	\$1341	\$1788	\$2257
		Seat upcharge:	+0	+0	\$27	\$66	\$121	\$144	\$191	\$266	\$322	\$383	\$511	\$645
		<b>OVERALL DIMENSIONS</b>			<b>SEAT DIMENSIONS</b>			<b>BACK DIMENSIONS</b>						
		<b>W</b>	<b>D</b>	<b>H</b>	<b>W</b>	<b>D</b>	<b>H</b>	<b>W</b>	<b>H</b>					
		27.5	29	28.5	19.5	29	28.5	19	12					

RTA 00

DESCRIPTION	FEATURES	MODEL#	STANDARD TEXTILE GRADES														
			1	2	3	4	5	6	7	8	9	10	11	12			
 <p><b>Two Seat Sofa, Wood Legs</b> COM Yardage: Back: 5 ; Seat: 1.75 Freight Class: 250 Product Weight (lbs.): 98 Cubic Feet Per Carton: 30</p>	3432	Base Price:	\$3833														
		Back/Arm upcharge:	+0	+0	\$132	\$328	\$602	\$718	\$955	\$1330	\$1609	\$1915	\$2554	\$3224			
		Seat upcharge:	+0	+0	\$47	\$115	\$211	\$252	\$335	\$466	\$564	\$671	\$894	\$1129			
		<b>OVERALL DIMENSIONS</b>	<b>W</b>	<b>D</b>	<b>H</b>	<b>SEAT DIMENSIONS</b>			<b>BACK DIMENSIONS</b>								
			54.5	29	28.5	46.5	29	28.5	46.5	12							
					RTA 00												
 <p><b>Three Seat Sofa, Wood Legs</b> COM Yardage: Back: 6 ; Seat: 3 Freight Class: 250 Product Weight (lbs.): 129 Cubic Feet Per Carton: 42.5</p>	3433	Base Price:	\$4713														
		Back/Arm upcharge:	+0	+0	\$159	\$393	\$722	\$861	\$1146	\$1596	\$1931	\$2298	\$3064	\$3868			
		Seat upcharge:	+0	+0	\$80	\$197	\$361	\$431	\$573	\$798	\$966	\$1149	\$1532	\$1934			
		<b>OVERALL DIMENSIONS</b>	<b>W</b>	<b>D</b>	<b>H</b>	<b>SEAT DIMENSIONS</b>			<b>BACK DIMENSIONS</b>								
			78	29	28.5	70.5	29	28.5	70.5	12							
					RTA 00												
 <p><b>Lounge Chair, Metal Legs</b> COM Yardage: Back: 2.75 ; Seat: 1.75 Freight Class: 250 Product Weight (lbs.): 62 Cubic Feet Per Carton: 16.5</p>	3361	Base Price:	\$2687														
		Back/Arm upcharge:	+0	+0	\$73	\$181	\$332	\$395	\$526	\$732	\$886	\$1054	\$1405	\$1774			
		Seat upcharge:	+0	+0	\$47	\$115	\$211	\$252	\$335	\$466	\$564	\$671	\$894	\$1129			
		<b>OVERALL DIMENSIONS</b>	<b>W</b>	<b>D</b>	<b>H</b>	<b>SEAT DIMENSIONS</b>			<b>BACK DIMENSIONS</b>								
			27.5	29	28.5	19.5	19	17	19	12							
					RTA 00												
 <p><b>Two Seat Sofa, Metal Legs</b> COM Yardage: Back: 3.5 ; Seat: 3.25 Freight Class: 250 Product Weight (lbs.): 102 Cubic Feet Per Carton: 250</p>	3362	Base Price:	\$3570														
		Back/Arm upcharge:	+0	+0	\$93	\$229	\$421	\$503	\$669	\$931	\$1127	\$1341	\$1788	\$2257			
		Seat upcharge:	+0	+0	\$87	\$214	\$392	\$467	\$622	\$865	\$1047	\$1245	\$1660	\$2096			
		<b>OVERALL DIMENSIONS</b>	<b>W</b>	<b>D</b>	<b>H</b>	<b>SEAT DIMENSIONS</b>			<b>BACK DIMENSIONS</b>								
			54.5	29	28.5	46.5	19	17	46.5	12							
					RTA 00												
 <p><b>Three Seat Sofa, Metal Legs</b> COM Yardage: Back: 4.5 ; Seat: 4.5 Freight Class: 250 Product Weight (lbs.): 135 Cubic Feet Per Carton: 250</p>	3363	Base Price:	\$4449														
		Back/Arm upcharge:	+0	+0	\$120	\$295	\$542	\$646	\$860	\$1197	\$1449	\$1724	\$2298	\$2902			
		Seat upcharge:	+0	+0	\$120	\$295	\$542	\$646	\$860	\$1197	\$1449	\$1724	\$2298	\$2902			
		<b>OVERALL DIMENSIONS</b>	<b>W</b>	<b>D</b>	<b>H</b>	<b>SEAT DIMENSIONS</b>			<b>BACK DIMENSIONS</b>								
			78	29	28.5	70.5	19	17	70.5	12							
					RTA 00												

WIND™ TABLES



models 3361 Lounge chair & 3362 Two seat sofa, with 3357 Coffee table.





For Wind seating, see page 385

STANDARD FEATURES

- Wind tables compliment the modern decor of many environments, pairing naturally with Wind and Wind Linear lounge seating and other contemporary seating, such as Kate, Erin, and Marche.
- Metal Legs are available in plated and painted finishes noted.
- Table tops are standard with Thermally Fused Laminate (LPL). High Pressure Laminate (HPL) surface is available at a 20% upcharge.

Add option codes in the following order:

- **Model Number**  
Specify model number.  
3366 to 3371 Metal leg tables
- **Laminate Tops (LPL)**  
(ACJ) Absolute Acajou (ASN) Asian Night  
(AWC) Avant Cherry (AWH) Avant Honey  
(BLK) Black (BRC) Brushed Cobalt  
(BZD) Blizzard (CGY) Custom Grey  
(CMB) Clear Maple (DES) Dark Espresso  
(DWT) Designer White (FAS) Fashionista  
(FCL) First Class (NBL) Noce Biondo  
(NGL) Noce Sergio (NEL) Noce Leggero  
(NML) Noce Medio  
(QTM) Quartered Mahogany  
(SBY) Sheen Beauty (SDT) Stonedust  
(SOG) Storm Grey (WHE) Walnut Heights  
(WHC) White Chocolate (WCR) Winter Cherry
- **Leg Finish (metal legs)**  
(TBL) Black (TBZ) Buzz Blue  
(TCC) Cactus (TCR) Carrot  
(TDJ) Dijon (TDW) Designer White  
(TEG) Eggplant (TFO) Fog  
(TFR) Frost (TIN) Ink  
(TIV) Cloud (TKA) Kalua  
(TLA) Latte (TMO) Mocha  
(TOA) Toast (TNE) Nevada  
(TSH) Shadow (TSN) Sand  
(TSR) Scarlet (TTU) Tungsten  
Metallics:  
(CHM) Chrome. No upcharge.  
(BCH) Brushed Chrome. Add \$224
- **Glide Type**  
(GL) Black Glide for most surfaces (standard).  
(NM) Non-Marking Glide for most surfaces. No upcharge.

DESCRIPTION	FEATURES	MODEL#	STANDARD TEXTILE GRADES												
			1	2	3	4	5	6	7	8	9	10	11	12	
 <b>End Table</b> COM Yardage: N/A Freight Class: 250 Product Weight (lbs.): 36 Cubic Feet Per Carton: 1.5	<b>3366</b> Laminate Top	List Price: \$985													
				<b>OVERALL DIMENSIONS</b> W D H			<b>SEAT DIMENSIONS</b> W D H			<b>BACK DIMENSIONS</b> W H					
			24	24	17	-	-	-	-	-					
			<b>RTA 00</b>												
 <b>Rectangular Coffee Table</b> COM Yardage: N/A Freight Class: 250 Product Weight (lbs.): 52 Cubic Feet Per Carton: 16	<b>3367</b> Laminate Top	List Price: \$1302													
				<b>OVERALL DIMENSIONS</b> W D H			<b>SEAT DIMENSIONS</b> W D H			<b>BACK DIMENSIONS</b> W H					
			48	20	15	-	-	-	-	-					
			<b>RTA 00</b>												

DESCRIPTION	FEATURES	MODEL#				STANDARD TEXTILE GRADES							
		1	2	3	4	5	6	7	8	9	10	11	12
	<b>3368</b> Laminate Top	List Price:	\$1762										
<b>Square Coffee Table</b> COM Yardage: N/A Freight Class: 250 Product Weight (lbs.): 66 Cubic Feet Per Carton: 22		<b>OVERALL DIMENSIONS</b>			<b>SEAT DIMENSIONS</b>			<b>BACK DIMENSIONS</b>					
		<b>W</b>	<b>D</b>	<b>H</b>	<b>W</b>	<b>D</b>	<b>H</b>	<b>W</b>	<b>H</b>				
		36	36	15	-	-	-	-	-	-	-	-	-
		<b>RTA 00</b>											

DESCRIPTION	FEATURES	MODEL#				STANDARD TEXTILE GRADES							
		1	2	3	4	5	6	7	8	9	10	11	12
	<b>3870</b> Laminate Top	List Price:	\$1077										
<b>Round Table</b> COM Yardage: N/A Freight Class: 250 Product Weight (lbs.): 35 Cubic Feet Per Carton: 11.5		<b>OVERALL DIMENSIONS</b>			<b>SEAT DIMENSIONS</b>			<b>BACK DIMENSIONS</b>					
		<b>W</b>	<b>D</b>	<b>H</b>	<b>W</b>	<b>D</b>	<b>H</b>	<b>W</b>	<b>H</b>				
		24	24	17	-	-	-	-	-	-	-	-	-
		<b>RTA 00</b>											

DESCRIPTION	FEATURES	MODEL#				STANDARD TEXTILE GRADES							
		1	2	3	4	5	6	7	8	9	10	11	12
	<b>3871</b> Laminate Top	List Price:	\$1584										
<b>Round Coffee Table</b> COM Yardage: N/A Freight Class: 250 Product Weight (lbs.): 57 Cubic Feet Per Carton: 22		<b>OVERALL DIMENSIONS</b>			<b>SEAT DIMENSIONS</b>			<b>BACK DIMENSIONS</b>					
		<b>W</b>	<b>D</b>	<b>H</b>	<b>W</b>	<b>D</b>	<b>H</b>	<b>W</b>	<b>H</b>				
		36	36	15	-	-	-	-	-	-	-	-	-
		<b>RTA 00</b>											

NOT ON CONTRACT

WIND™ LINEAR



models 3363R and 3363L with 3882 bridge table, 3360 table attaching bracket kit and two 3380 coffee tables



Contrasting Textile Application



For Wind Linear tables, see page 394

STANDARD FEATURES

- Wind Linear is an extension of the Wind lounge series with an emphasis on expansive, clean lines.
- Wind Linear tables complement the modern decor of many offices.
- This modular furniture series includes single arm and armless sofas and benches for use as freestanding or ganged seating. See ganging features below.
- Metal Leg models (3361L/R/NA, 3363L/R/NA, 3361B and 3363B ) are available in plated and painted finishes noted.
- Wood Leg models (3431L/R/NA, 3433L/R/NA, 3434B and 3435B ) are available in standard Global wood finishes, noted.
- Casters are not available on Wind Linear.
- Wind Linear tables are available with metal legs.
- A variety of glide types are available. Use glide chart for recommended glide use on various flooring types.
- Available with fabric, coated textile and leather upholstery; check approved textiles prior to ordering.
- The series is available with contrasting fabrics. Specify arms, back and front rail separate from seat cushion, see model image.
- For pricing, start with the base price and add both back/arms graded textile upcharge and the seat graded textile upcharge.
- For leather upholstery, note additional stitch details on seat and outside arm and back panels.
- Wind is covered under Global's Limited Lifetime Warranty.
- Wind Linear seating has a 300 lb capacity.

GANGING FEATURES

- Metal or wood leg seating gang to table 'bridges' and metal leg corner tables in-between seating units at armless ends. A table attaching bracket kit (3360) is required, specified separately and field installed. See Wind Linear Tables for details.
- Wood Leg seating models (only) offer a (GBS) ganging seat-to-seat option to gang seating together at armless ends (without tables). Option must be selected at the time of the order, the ganging bracket is factory installed and cannot be field installed. See above for ganging with tables.
- Benches and ottomans do not gang to seating models.

Add option codes in the following order:

- **Model Number**  
Specify model number.  
3361 to 3363 Metal leg seating  
3431 to 3435 Wood leg seating
- **Back and Arm Textile** (includes front rail)  
Specify textile code.
- **Seat Textile**  
Specify textile code.
- **Leg Finish** (metal legs)
 

(TBL) Black	(TBZ) Buzz Blue
(TCC) Cactus	(TCR) Carrot
(TDJ) Dijon	(TDW) Designer White
(TEG) Eggplant	(TFO) Fog
(TFR) Frost	(TIN) Ink
(TIV) Cloud	(TKA) Kalua
(TLA) Latte	(TMO) Mocha
(TOA) Toast	(TSH) Shadow
(TSN) Sand	(TSR) Scarlet

 Metallics: Lounge 2 Seat 3 Seat  
 (CHM) Chrome. No upcharge.  
 (BCH) Brushed Chrome. Add \$165 \$200 \$224
- **Leg Finish** (wood legs)
 

(AAM) Absolute	(BKM) Black
(ACM) Cherry	(EOM) English Oak
(ECM) Espresso Cafe	(TFM) Fruitwood
(HGM) Grey	(AHM) Honey
(TMM) Mahogany	(AVM) Maple
(NLW) Natural Walnut	(MWM) Medium Walnut
(ASM) Night	(NBM) Noce Biondo
(NGM) Noce Grigio	(NEM) Noce Leggero
(NMM) Noce Medio	(SKM) Shaker Cherry
(TWM) Walnut	(WTM) WC Cream
(WHM) White	(WCM) Winter Cherry
- **Glide Type** (metal legs)
  - (GL) Black Glide for most surfaces (standard)
  - (NM) Non-Marking Glide for most surfaces. No upcharge.
- **Glide Type** (wood legs)
  - (NM) Non-marking glides for most surfaces (standard).
  - (SG) Steel cushioned glides for carpeted surfaces.. Add \$36
  - (RG) Rubber non-slip glides for most hard floor surfaces. Add \$36
  - (FG) Felt glides for most hard floor surfaces. Add \$36
- **Ganging** (wood leg seating - for ganging seat to seat)
  - (NG) No ganging (Standard)
  - (GBS) Ganging seat to seat. Add \$No Match!

SAMPLE LAYOUTS

Layout A



Qty	Model Number	Description	Dimensions	List Price
1	<b>3361R</b>	Single Seater - Right Arm	39.5 x 29 x 28.5	2844
1	<b>3361L</b>	Single Seater - Left Arm	39.5 x 29 x 28.5	2844
1	<b>3363NA</b>	Single Sofa - Armless	72 x 29 x 28.5	3788
1	<b>3881R</b>	Bridge Corner Table - Right	25 x 25 x 12	1839
1	<b>3881L</b>	Bridge Corner Table - Left	25 x 25 x 12	1839
2	<b>3360</b>	Table Bracket Kit - 1 Kit per table		204 x 2

SAMPLE LAYOUT TOTAL IN STANDARD BLACK FRAME

\$12,852

Layout B

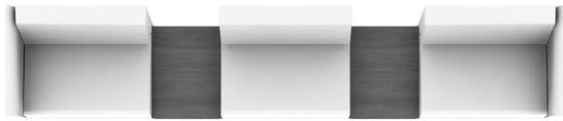

Qty	Model Number	Description	Dimensions	List Price
1	<b>3361R</b>	Single Seater - Right Arm	39.5 x 29 x 28.5	2844
1	<b>3361L</b>	Single Seater - Left Arm	39.5 x 29 x 28.5	2844
1	<b>3361NA</b>	Single Seater - Armless	36.5 x 29 x 28.5	2514
2	<b>3882</b>	Bridge End Table	25 x 20 x 12	1005 x 2
2	<b>3360</b>	Table Bracket Kit - 1 Kit per table		204 x 2

SAMPLE LAYOUT TOTAL IN STANDARD BLACK FRAME

\$10,062

DESCRIPTION	FEATURES	MODEL#	STANDARD TEXTILE GRADES											
			1	2	3	4	5	6	7	8	9	10	11	12

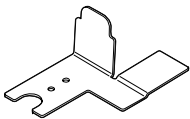

**3360** List Price: \$204

OVERALL DIMENSIONS			SEAT DIMENSIONS			BACK DIMENSIONS		
W	D	H	W	D	H	W	H	

-	-	-	-	-	-	-	-
---	---	---	---	---	---	---	---

**Table Bracket Kit**  
 COM Yardage: N/A  
 Freight Class: 70  
 Product Weight (lbs.): 1.5  
 Cubic Feet Per Carton: 0.03 ( 1 Kit per carton)

Includes 4 brackets and hardware.  
 Use with models 3381R, 3381L,  
 3436R, 3436L, 3882 and 3884



**3361R**      **3361L**





<b>3361R/3361L</b>	Base Price:	\$2844											
	Back/Arm upcharge:	<b>+0</b>	<b>+0</b>	<b>\$67</b>	<b>\$164</b>	<b>\$301</b>	<b>\$359</b>	<b>\$478</b>	<b>\$665</b>	<b>\$805</b>	<b>\$958</b>	<b>\$1277</b>	<b>\$1613</b>
	Seat upcharge:	<b>+0</b>	<b>+0</b>	<b>\$61</b>	<b>\$148</b>	<b>\$272</b>	<b>\$323</b>	<b>\$431</b>	<b>\$599</b>	<b>\$725</b>	<b>\$862</b>	<b>\$1149</b>	<b>\$1451</b>

OVERALL DIMENSIONS			SEAT DIMENSIONS			BACK DIMENSIONS		
W	D	H	W	D	H	W	H	

39.5	29	28.5	36	19	17	36	12
------	----	------	----	----	----	----	----



**Single Seater - w/ Left or Right Arm, Metal Legs**  
 COM Yardage: Back: 2.5 ; Seat: 2.25  
 Freight Class: 250  
 Product Weight (lbs.): 72  
 Cubic Feet Per Carton: 28.5

DESCRIPTION	FEATURES	MODEL#	STANDARD TEXTILE GRADES											
			1	2	3	4	5	6	7	8	9	10	11	12
 <p><b>3361NA</b>    Base Price: \$2514                      Back/Arm upcharge: +0    +0    \$41    \$99    \$181    \$216    \$287    \$399    \$484    \$575    \$766    \$968                      Seat upcharge: +0    +0    \$47    \$115    \$211    \$252    \$335    \$466    \$564    \$671    \$894    \$1129</p>	<b>OVERALL DIMENSIONS</b>			<b>SEAT DIMENSIONS</b>			<b>BACK DIMENSIONS</b>							
	<b>W</b>	<b>D</b>	<b>H</b>	<b>W</b>	<b>D</b>	<b>H</b>	<b>W</b>	<b>H</b>						
	36.5	29	28.5	36.5	19	17	36.5	12						
	<b>RTA 00</b>													
<p><b>Single Seater - Armless, Metal Legs</b>                      COM Yardage: Back: 1.5 ; Seat: 1.75                      Freight Class: 250                      Product Weight (lbs.): 58                      Cubic Feet Per Carton: 28.5</p>														
 <p><b>3363R/3363L</b>    Base Price: \$4257                      Back/Arm upcharge: +0    +0    \$93    \$229    \$421    \$503    \$669    \$931    \$1127    \$1341    \$1788    \$2257                      Seat upcharge: +0    +0    \$113    \$279    \$512    \$610    \$813    \$1130    \$1369    \$1628    \$2171    \$2740</p>	<b>OVERALL DIMENSIONS</b>			<b>SEAT DIMENSIONS</b>			<b>BACK DIMENSIONS</b>							
	<b>W</b>	<b>D</b>	<b>H</b>	<b>W</b>	<b>D</b>	<b>H</b>	<b>W</b>	<b>H</b>						
	75	29	28.5	17	19	17	71	12						
	<b>RTA 00</b>													
<p><b>Three Seat Sofa - w/ Left or Right Arm, Metal Legs</b>                      COM Yardage: Back: 3.5 ; Seat: 4.25                      Freight Class: 250                      Product Weight (lbs.): 120                      Cubic Feet Per Carton: 41</p>														
 <p><b>3363NA</b>    Base Price: \$3788                      Back/Arm upcharge: +0    +0    \$61    \$148    \$272    \$323    \$431    \$599    \$725    \$862    \$1149    \$1451                      Seat upcharge: +0    +0    \$113    \$279    \$512    \$610    \$813    \$1130    \$1369    \$1628    \$2171    \$2740</p>	<b>OVERALL DIMENSIONS</b>			<b>SEAT DIMENSIONS</b>			<b>BACK DIMENSIONS</b>							
	<b>W</b>	<b>D</b>	<b>H</b>	<b>W</b>	<b>D</b>	<b>H</b>	<b>W</b>	<b>H</b>						
	72	29	28.5	72	19	17	72	12						
	<b>RTA 00</b>													
<p><b>Three Seat Sofa - Armless, Metal Legs</b>                      COM Yardage: Back: 2.25 ; Seat: 4.25                      Freight Class: 250                      Product Weight (lbs.): 111                      Cubic Feet Per Carton: 39.25</p>														
 <p><b>3361B</b>    List Price: -    \$1869    \$1916    \$1984    \$2080    \$2121    \$2204    \$2335    \$2433    \$2540    \$2763    \$2998</p>	<b>OVERALL DIMENSIONS</b>			<b>SEAT DIMENSIONS</b>			<b>BACK DIMENSIONS</b>							
	<b>W</b>	<b>D</b>	<b>H</b>	<b>W</b>	<b>D</b>	<b>H</b>	<b>W</b>	<b>H</b>						
	35.5	20.5	17.5											
	<b>RTA 00</b>													
<p><b>Ottoman, Metal Legs</b>                      COM Yardage: 1.75                      Freight Class: 150                      Product Weight (lbs.): 50                      Cubic Feet Per Carton: 12.5</p>														
 <p><b>3363B</b>    List Price: -    \$2876    \$2969    \$3105    \$3297    \$3379    \$3545    \$3807    \$4003    \$4217    \$4664    \$5133</p>	<b>OVERALL DIMENSIONS</b>			<b>SEAT DIMENSIONS</b>			<b>BACK DIMENSIONS</b>							
	<b>W</b>	<b>D</b>	<b>H</b>	<b>W</b>	<b>D</b>	<b>H</b>	<b>W</b>	<b>H</b>						
	72	20.5	17.5											
	<b>RTA 00</b>													
<p><b>Bench, Metal Legs</b>                      COM Yardage: 3.5                      Freight Class: 150                      Product Weight (lbs.): 80                      Cubic Feet Per Carton: 18.75</p>														



DESCRIPTION	FEATURES	MODEL#			STANDARD TEXTILE GRADES								
		1	2	3	4	5	6	7	8	9	10	11	12
 <p><b>Bench, Wood Legs</b> COM Yardage: 3.5 Freight Class: 150 Product Weight (lbs.): 76 Cubic Feet Per Carton: 18.75</p>	<p><b>3435B</b> List Price:</p> <p>Specify (GBS) option for ganging seat-to-to seat. Add \$No Match!</p>	\$3140	\$3233	\$3369	\$3561	\$3643	\$3809	\$4071	\$4267	\$4481	\$4928	\$5397	
		<b>OVERALL DIMENSIONS</b>			<b>SEAT DIMENSIONS</b>			<b>BACK DIMENSIONS</b>					
		<b>W</b>	<b>D</b>	<b>H</b>	<b>W</b>	<b>D</b>	<b>H</b>	<b>W</b>	<b>H</b>				
		72	20.5	17.5									
		<b>RTA 00</b>											

DESCRIPTION	FEATURES	MODEL#			STANDARD TEXTILE GRADES									
		1	2	3	4	5	6	7	8	9	10	11	12	
<p><b>Bolster Cushion</b> COM Yardage: 1 Freight Class: 70 Product Weight (lbs.): 1.5 Cubic Feet Per Carton: 1.3</p>	<p><b>3885</b> List Price:</p> <p>1 Loose Cushion.</p>	-	\$263	\$290	\$329	\$384	\$407	\$454	\$529	\$585	\$646	\$774	\$908	
		<b>OVERALL DIMENSIONS</b>			<b>SEAT DIMENSIONS</b>			<b>BACK DIMENSIONS</b>						
		<b>W</b>	<b>D</b>	<b>H</b>	<b>W</b>	<b>D</b>	<b>H</b>	<b>W</b>	<b>H</b>					
		16	5	7										
		<b>RTA 00</b>												

WIND™ LINEAR TABLES



models 3363R and 3363L with 3882 bridge table, 3360 table attaching bracket kit and two 3380 coffee tables



For Wind Linear seating, see page 389

STANDARD FEATURES



- Wind Linear is an extension of the Wind lounge series with an emphasis on expansive, clean lines of seating and tables.
- Tables are available with metal legs.
- Table tops are standard with Thermally Fused Laminate (LPL)
- A variety of table 'bridges' are designed to mount between seating (at armless ends), or between benches or ottomans. See Ganging Features below.
- A variety of glide types are available. Use glide chart for recommended glide use on various flooring types.

GANGING FEATURES

- Corner bridge tables and bridge end tables, models 3881R/L, 3882, 3883 and 3436R/L mount between chairs and sofa units only at armless ends. Specify Table Attaching Bracket Kit 3360 separately. (Not usable with bench or ottoman models.)
- Bridge tables (model 3884) mount between ottoman models 3434B and 3361B and/or bench models 3435B and 3363B. Specify Table Attaching Bracket Kit 3360 separately.





Add option codes in the following order:

- **Model Number**  
Specify model number.
- **Laminate Tops (LPL)**  
(ACJ) Absolute Acajou (ASN) Asian Night  
(AWC) Avant Cherry (AWH) Avant Honey  
(BLK) Black (BRC) Brushed Cobalt  
(BZD) Blizzard (CGY) Custom Grey  
(CMB) Clear Maple (DES) Dark Espresso  
(DWT) Designer White (FAS) Fasaniista  
(FCL) First Class (NBL) Noce Blondo  
(NGL) Noce Grigio (NML) Noce Medico  
(QTM) Quartered Mahogany (SDT) Stone Dust  
(SBY) Sheer Beauty (SOG) Storm Grey (WHE) Walnut Heights  
(WHC) White Chocolate (WCR) Winter Cherry
- **Leg Finish (Metal Legs)**  
(TBL) Black (TBZ) Buzz Blue  
(TCC) Cactus (TCR) Carrot  
(DJ) Dijon (TDW) Designer White  
(EG) Eggplant (TFO) Fog  
(FRS) Frost (TIN) Ink  
(TIV) Cloud (TKA) Kalua  
(TLA) Latte (TMO) Mocha  
(TOA) Toast (TNE) Nevada  
(TSH) Shadow (TSN) Sand  
(TSR) Scarlet (TTU) Tungsten  
Metallics:  
(CHM) Chrome. No upcharge.  
(BCH) Brushed Chrome. Add \$224
- **Glide Type**  
(GL) Black Glide for most surfaces (standard).  
(NM) Non-Marking Glide for most surfaces. No upcharge.

DESCRIPTION	FEATURES	MODEL#	STANDARD TEXTILE GRADES												
			1	2	3	4	5	6	7	8	9	10	11	12	
 <p><b>Side Table - Rectangular, Metal Legs</b> COM Yardage: N/A Freight Class: 250 Product Weight (lbs.): 38 Cubic Feet Per Carton: 11.5</p>	<p>3878 Laminate Top</p> <p>Freestanding</p>	List Price: \$1408													
			<b>OVERALL DIMENSIONS</b>			<b>SEAT DIMENSIONS</b>			<b>BACK DIMENSIONS</b>						
			<b>W</b>	<b>D</b>	<b>H</b>	<b>W</b>	<b>D</b>	<b>H</b>	<b>W</b>	<b>H</b>					
			20	25	16	-	-	-	-	-					
			<b>RTA 00</b>												
 <p><b>Side Table - 25" Square, Metal Legs</b> COM Yardage: N/A Freight Class: 250 Product Weight (lbs.): 40 Cubic Feet Per Carton: 11.5</p>	<p>3879 Laminate Top</p> <p>Freestanding</p>	List Price: \$1536													
			<b>OVERALL DIMENSIONS</b>			<b>SEAT DIMENSIONS</b>			<b>BACK DIMENSIONS</b>						
			<b>W</b>	<b>D</b>	<b>H</b>	<b>W</b>	<b>D</b>	<b>H</b>	<b>W</b>	<b>H</b>					
			25	25	16	-	-	-	-	-					
			<b>RTA 00</b>												

# LOUNGE

# WIND LINEAR TABLES W

DESCRIPTION	FEATURES	MODEL#	STANDARD TEXTILE GRADES											
			1	2	3	4	5	6	7	8	9	10	11	12
 <p><b>Coffee Table - 54", Metal Legs</b> COM Yardage: N/A Freight Class: 250 Product Weight (lbs.): 36 Cubic Feet Per Carton: 11.5</p>	<p><b>3880</b> List Price: \$1713 Laminate Top</p>													
		<b>OVERALL DIMENSIONS</b>			<b>SEAT DIMENSIONS</b>			<b>BACK DIMENSIONS</b>						
		<b>W</b>	<b>D</b>	<b>H</b>	<b>W</b>	<b>D</b>	<b>H</b>	<b>W</b>	<b>D</b>	<b>H</b>	<b>W</b>	<b>D</b>	<b>H</b>	
		54	20	15	-	-	-	-	-	-	-	-	-	
<b>RTA 00</b>														
 <p><b>3881R</b>      <b>3881L</b></p> <p><b>Bridge Corner Table, Metal Legs</b> COM Yardage: N/A Freight Class: 250 Product Weight (lbs.): 33 Cubic Feet Per Carton: 11.5</p>	<p><b>3881R/3881L</b> List Price: \$1839 Laminate Top</p>													
		<b>OVERALL DIMENSIONS</b>			<b>SEAT DIMENSIONS</b>			<b>BACK DIMENSIONS</b>						
		<b>W</b>	<b>D</b>	<b>H</b>	<b>W</b>	<b>D</b>	<b>H</b>	<b>W</b>	<b>D</b>	<b>H</b>	<b>W</b>	<b>D</b>	<b>H</b>	
		25	25	12	-	-	-	-	-	-	-	-	-	
<b>RTA 00</b>														
 <p><b>Bridge End Table</b> COM Yardage: N/A Freight Class: 125 Product Weight (lbs.): 25 Cubic Feet Per Carton: 3.4</p>	<p><b>3882</b> List Price: \$1005 Laminate Top</p>													
		<b>OVERALL DIMENSIONS</b>			<b>SEAT DIMENSIONS</b>			<b>BACK DIMENSIONS</b>						
		<b>W</b>	<b>D</b>	<b>H</b>	<b>W</b>	<b>D</b>	<b>H</b>	<b>W</b>	<b>D</b>	<b>H</b>	<b>W</b>	<b>D</b>	<b>H</b>	
		20	25	5	-	-	-	-	-	-	-	-	-	
<b>RTA 00</b>														
 <p><b>Low Side Table, Metal Legs</b> COM Yardage: N/A Freight Class: 250 Product Weight (lbs.): 32 Cubic Feet Per Carton: 11.5</p>	<p><b>3883</b> List Price: \$1394 Laminate Top</p>													
		<b>OVERALL DIMENSIONS</b>			<b>SEAT DIMENSIONS</b>			<b>BACK DIMENSIONS</b>						
		<b>W</b>	<b>D</b>	<b>H</b>	<b>W</b>	<b>D</b>	<b>H</b>	<b>W</b>	<b>D</b>	<b>H</b>	<b>W</b>	<b>D</b>	<b>H</b>	
		20	25	12	-	-	-	-	-	-	-	-	-	
<b>RTA 00</b>														
 <p><b>Bridge Table - 20" Square</b> COM Yardage: N/A Freight Class: 125 Product Weight (lbs.): 23 Cubic Feet Per Carton: 3.4</p>	<p><b>3884</b> List Price: \$935 Laminate Top</p>													
		<b>OVERALL DIMENSIONS</b>			<b>SEAT DIMENSIONS</b>			<b>BACK DIMENSIONS</b>						
		<b>W</b>	<b>D</b>	<b>H</b>	<b>W</b>	<b>D</b>	<b>H</b>	<b>W</b>	<b>D</b>	<b>H</b>	<b>W</b>	<b>D</b>	<b>H</b>	
		20	20	5	-	-	-	-	-	-	-	-	-	
<b>RTA 00</b>														

NOT ON CONTRACT



# heavy duty/24hr

Concorde Executive 24HR ..... page 402

Malaga TS ..... page 399

Truform TS ..... page 401

Granada TS ..... page 398

ObusForme Comfort TS ..... page 400

Vion TS ..... page 407

Granada Deluxe TS ..... page 399

Robust ..... page 405

G1 Ergo Select TS ..... page 403

Saxon ..... page 406



model TS3140-3 Malaga

model TS5451-3 Truform



All models, except Truform, have outer back panels retained by trim screws for extra security.



All models, except Truform, have standard clear vinyl bumper guards around their outside backs.

STANDARD FEATURES

- The **TS** models are available within standard series. **TS** stands for “Three Shift” and each of the TS models are rated for 24-7 applications as well as weight rated up to 350 pounds.
- Multi-tilter models feature a heavy duty mechanism.
- All models are standard with either Ultracell or molded heavy duty seat foam.
- All models have a heavy duty 3” wide back upright.
- All models, except Truform, have outer back panels retained by trim screws for extra security.
- All models, except Truform have standard clear vinyl bumper guards around their outside backs.
- Multi-tilters standard with Pneumatic seat height and sliding seat depth adjustment. Forward and rearward seat tilt with infinite lock and free floating back angle control. Tilt tension control.
- Heavy duty height adjustable stools are standard with fixed back. Seat depth and pneumatic seat height adjustments. Swivels with adjustable chrome footring.
- Grade 2 and above textiles (or 100,000+ double rubs) are recommended for 24-7 applications.
- Check textile availability prior to specifying upholstery material.

OPTIONAL FEATURES

- An optional abrasion-resistant outer back fabric (polyester) is available (excludes Truform) (**BKB**). Resistant to impact damage. Available in Black only. Add \$25.

DESCRIPTION FEATURES MODEL# STANDARD TEXTILE GRADES



**LB Heavy Duty Multi-Tilter** Plain Back Ratchet Back  
COM Yardage: 1.50  
Freight Class: 150  
Product Weight (lbs.): 52  
Cubic Feet Per Carton: 9.25

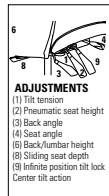

**Granada TS**

Ergonomic Features:  
A, B, C, D, E, F, G, H, M, N, Q, S

MODEL#	1	2	3	4	5	6	7	8	9	10	11	12
<b>TS3121</b>	1659	1724	1770	1838	1938	1972	2057	2222	2299	2453	2660	2917

OVERALL DIMENSIONS			SEAT DIMENSIONS			BACK DIMENSIONS	
W	D	H	W	D	H	W	H
26	24.5	37.75	20.5	17-19.5	16.5-20.5	19	19-22



**HB Heavy Duty Multi-Tilter** Plain Back Ratchet Back  
COM Yardage: 1.75  
Freight Class: 150  
Product Weight (lbs.): 55  
Cubic Feet Per Carton: 9.25

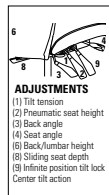

**Granada TS**

Ergonomic Features:  
A, B, C, D, E, F, G, H, M, N, Q, S

MODEL#	1	2	3	4	5	6	7	8	9	10	11	12
<b>TS3123</b>	1812	1883	1939	2019	2133	2172	2272	2463	2557	2734	2975	3273

OVERALL DIMENSIONS			SEAT DIMENSIONS			BACK DIMENSIONS	
W	D	H	W	D	H	W	H
26	24.5	39.75	20.5	17-19.5	16.5-20.5	19	19-22



**LB Heavy Duty Multi-Tilter** Plain Back  
COM Yardage: 1.50  
Freight Class: 125  
Product Weight (lbs.): 58  
Cubic Feet Per Carton: 9.25

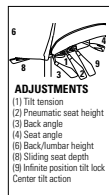











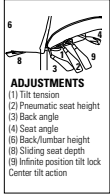



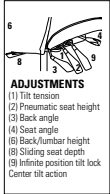

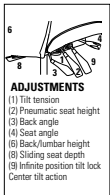

**Granada TS**



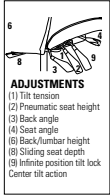

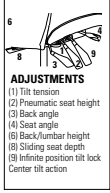

Ergonomic Features:  
A, B, C, D, E, F, G, H, M, N, Q, S

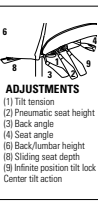

MODEL#	1	2	3	4	5	6	7	8	9	10	11	12
<b>TS3212</b>	1296	1361	1406	1474	1574	1607	1693	1857	1936	2089	2293	2550

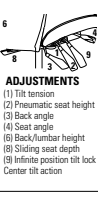
OVERALL DIMENSIONS			SEAT DIMENSIONS			BACK DIMENSIONS	
W	D	H	W	D	H	W	H
26	24	40.	20.5	17-19.5	17.5-21.5	19	21.5-25.5

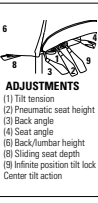

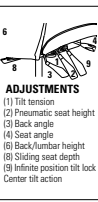
DESCRIPTION	FEATURES	MODEL#	STANDARD TEXTILE GRADES											
			1	2	3	4	5	6	7	8	9	10	11	12
 <p><b>HB Heavy Duty Multi-Tilter Plain Back</b> COM Yardage: 1.75 Freight Class: 150 Product Weight (lbs.): 57 Cubic Feet Per Carton: 10.50</p>	 <p><b>ADJUSTMENTS</b> (1) Tilt tension (2) Pneumatic seat height (3) Back angle (4) Seat angle (5) Back/lumbar height (6) Sliding seat depth (8) Infinite position tilt lock Center tilt action</p>	<b>TS3217</b>	1427	1500	1552	1633	1748	1787	1887	2081	2170	2349	2590	2887
			<b>OVERALL DIMENSIONS</b>			<b>SEAT DIMENSIONS</b>			<b>BACK DIMENSIONS</b>					
			<b>W</b>	<b>D</b>	<b>H</b>	<b>W</b>	<b>D</b>	<b>H</b>	<b>W</b>	<b>H</b>				
			26	24.5	43	20.5	17-19.5	17.5-21.5	19	21.5-25.5				
			<b>RTA 2</b>											
 <p><b>HB Heavy Duty Multi-Tilter</b> COM Yardage: 2 Freight Class: 125 Product Weight (lbs.): 65 Cubic Feet Per Carton: 9.25</p>	 <p><b>ADJUSTMENTS</b> (1) Tilt tension (2) Pneumatic seat height (3) Back angle (4) Seat angle (5) Back/lumbar height (6) Sliding seat depth (8) Infinite position tilt lock Center tilt action</p>	<b>TS1170-3</b>	1461	1532	1586	1667	1782	1822	1921	2112	2204	2383	2623	2921
			<b>OVERALL DIMENSIONS</b>			<b>SEAT DIMENSIONS</b>			<b>BACK DIMENSIONS</b>					
			<b>W</b>	<b>D</b>	<b>H</b>	<b>W</b>	<b>D</b>	<b>H</b>	<b>W</b>	<b>H</b>				
			26	23.5	45	21	18-20.5	17.5-21.5	20	23-28.25				
			<b>RTA 2</b>											
 <p><b>MB Heavy Duty Multi-Tilter</b> COM Yardage: 1.75 Freight Class: 125 Product Weight (lbs.): 63 Cubic Feet Per Carton: 9.25</p>	 <p><b>ADJUSTMENTS</b> (1) Tilt tension (2) Pneumatic seat height (3) Back angle (4) Seat angle (5) Back/lumbar height (6) Sliding seat depth (8) Infinite position tilt lock Center tilt action</p>	<b>TS1171-3</b>	\$1329	\$1396	\$1439	\$1507	\$1606	\$1640	\$1726	\$1891	\$1968	\$2122	\$2326	\$2583
			<b>OVERALL DIMENSIONS</b>			<b>SEAT DIMENSIONS</b>			<b>BACK DIMENSIONS</b>					
			<b>W</b>	<b>D</b>	<b>H</b>	<b>W</b>	<b>D</b>	<b>H</b>	<b>W</b>	<b>H</b>				
			26	23.5	41	21	18-20.5	17.5-21.5	20	19-24.25				
			<b>RTA 2</b>											
 <p><b>HB Heavy Duty Multi-Tilter</b> COM Yardage: 1.75 Freight Class: 125 Product Weight (lbs.): 63 Cubic Feet Per Carton: 9.25</p>	 <p><b>ADJUSTMENTS</b> (1) Tilt tension (2) Pneumatic seat height (3) Back angle (4) Seat angle (5) Back/lumbar height (6) Sliding seat depth (8) Infinite position tilt lock Center tilt action</p>	<b>TS3140-3</b>	\$1705	\$1776	\$1832	\$1912	\$2026	\$2065	\$2165	\$2359	\$2450	\$2628	\$2868	\$3165
			<b>OVERALL DIMENSIONS</b>			<b>SEAT DIMENSIONS</b>			<b>BACK DIMENSIONS</b>					
			<b>W</b>	<b>D</b>	<b>H</b>	<b>W</b>	<b>D</b>	<b>H</b>	<b>W</b>	<b>H</b>				
			26	25	44	20	17.5-20	16.5-20.5	18.5	25-27.25				
			<b>RTA 2</b>											
 <p><b>LB Heavy Duty Multi-Tilter</b> COM Yardage: 60 Freight Class: 125 Product Weight (lbs.): 60 Cubic Feet Per Carton: 9.25</p>	 <p><b>ADJUSTMENTS</b> (1) Tilt tension (2) Pneumatic seat height (3) Back angle (4) Seat angle (5) Back/lumbar height (6) Sliding seat depth (8) Infinite position tilt lock Center tilt action</p>	<b>TS3141-3</b>	\$1571	\$1633	\$1679	\$1748	\$1846	\$1881	\$1968	\$2131	\$2209	\$2362	\$2567	\$2827
			<b>OVERALL DIMENSIONS</b>			<b>SEAT DIMENSIONS</b>			<b>BACK DIMENSIONS</b>					
			<b>W</b>	<b>D</b>	<b>H</b>	<b>W</b>	<b>D</b>	<b>H</b>	<b>W</b>	<b>H</b>				
			25	24.5	39.75	20	17.5-20	16.5-20.5	18.5	20.5-22.75				
			<b>RTA 1</b>											

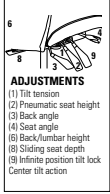
DESCRIPTION	FEATURES	MODEL#	STANDARD TEXTILE GRADES																																																																																																
			1	2	3	4	5	6	7	8	9	10	11	12																																																																																					
 <p><b>HB Heavy Duty Multi -Tilter</b> COM Yardage: 2.25 Freight Class: 125 Product Weight (lbs.): 74 Cubic Feet Per Carton: 11</p>	 <p><b>ADJUSTMENTS</b> (1) Tilt tension (2) Pneumatic seat height (3) Back angle (4) Seat angle (5) Back/lumbar height (6) Sliding seat depth (9) Infinite position tilt lock Center tilt action</p>	<p><b>ObusForme Comfort TS</b></p> <p>Ergonomic Features: A, C, E, F, H, M, N, S</p>	<table border="1"> <tr> <td colspan="12"> <table border="1"> <tr> <th colspan="3">OVERALL DIMENSIONS</th> <th colspan="3">SEAT DIMENSIONS</th> <th colspan="3">BACK DIMENSIONS</th> </tr> <tr> <th>W</th> <th>D</th> <th>H</th> <th>W</th> <th>D</th> <th>H</th> <th>W</th> <th>H</th> </tr> <tr> <td>26</td> <td>25</td> <td>48</td> <td>21</td> <td>17.5-20</td> <td>16-20</td> <td>19</td> <td>27</td> </tr> </table> </td> </tr> <tr> <td colspan="12"> <table border="1"> <tr> <th colspan="12">STANDARD TEXTILE GRADES</th> </tr> <tr> <td>1561</td> <td>1659</td> <td>1727</td> <td>1835</td> <td>1987</td> <td>2058</td> <td>2197</td> <td>2416</td> <td>2585</td> <td>2776</td> <td>3163</td> <td>3577</td> </tr> </table> </td> </tr> <tr> <td colspan="12"> <p>RTA 2      FedEx      ups</p> </td> </tr> </table>												<table border="1"> <tr> <th colspan="3">OVERALL DIMENSIONS</th> <th colspan="3">SEAT DIMENSIONS</th> <th colspan="3">BACK DIMENSIONS</th> </tr> <tr> <th>W</th> <th>D</th> <th>H</th> <th>W</th> <th>D</th> <th>H</th> <th>W</th> <th>H</th> </tr> <tr> <td>26</td> <td>25</td> <td>48</td> <td>21</td> <td>17.5-20</td> <td>16-20</td> <td>19</td> <td>27</td> </tr> </table>												OVERALL DIMENSIONS			SEAT DIMENSIONS			BACK DIMENSIONS			W	D	H	W	D	H	W	H	26	25	48	21	17.5-20	16-20	19	27	<table border="1"> <tr> <th colspan="12">STANDARD TEXTILE GRADES</th> </tr> <tr> <td>1561</td> <td>1659</td> <td>1727</td> <td>1835</td> <td>1987</td> <td>2058</td> <td>2197</td> <td>2416</td> <td>2585</td> <td>2776</td> <td>3163</td> <td>3577</td> </tr> </table>												STANDARD TEXTILE GRADES												1561	1659	1727	1835	1987	2058	2197	2416	2585	2776	3163	3577	<p>RTA 2      FedEx      ups</p>											
			<table border="1"> <tr> <th colspan="3">OVERALL DIMENSIONS</th> <th colspan="3">SEAT DIMENSIONS</th> <th colspan="3">BACK DIMENSIONS</th> </tr> <tr> <th>W</th> <th>D</th> <th>H</th> <th>W</th> <th>D</th> <th>H</th> <th>W</th> <th>H</th> </tr> <tr> <td>26</td> <td>25</td> <td>48</td> <td>21</td> <td>17.5-20</td> <td>16-20</td> <td>19</td> <td>27</td> </tr> </table>												OVERALL DIMENSIONS			SEAT DIMENSIONS			BACK DIMENSIONS			W	D	H	W	D	H	W	H	26	25	48	21	17.5-20	16-20	19	27																																																												
			OVERALL DIMENSIONS			SEAT DIMENSIONS			BACK DIMENSIONS																																																																																										
			W	D	H	W	D	H	W	H																																																																																									
26	25	48	21	17.5-20	16-20	19	27																																																																																												
<table border="1"> <tr> <th colspan="12">STANDARD TEXTILE GRADES</th> </tr> <tr> <td>1561</td> <td>1659</td> <td>1727</td> <td>1835</td> <td>1987</td> <td>2058</td> <td>2197</td> <td>2416</td> <td>2585</td> <td>2776</td> <td>3163</td> <td>3577</td> </tr> </table>												STANDARD TEXTILE GRADES												1561	1659	1727	1835	1987	2058	2197	2416	2585	2776	3163	3577																																																																
STANDARD TEXTILE GRADES																																																																																																			
1561	1659	1727	1835	1987	2058	2197	2416	2585	2776	3163	3577																																																																																								
<p>RTA 2      FedEx      ups</p>																																																																																																			
 <p><b>MB Heavy Duty Multi -Tilter</b> COM Yardage: 2 Freight Class: 125 Product Weight (lbs.): 71 Cubic Feet Per Carton: 10.50</p>	 <p><b>ADJUSTMENTS</b> (1) Tilt tension (2) Pneumatic seat height (3) Back angle (4) Seat angle (5) Back/lumbar height (6) Sliding seat depth (9) Infinite position tilt lock Center tilt action</p>	<p><b>ObusForme Comfort TS</b></p> <p>Ergonomic Features: A, C, E, F, H, M, N, S</p>	<table border="1"> <tr> <td colspan="12"> <table border="1"> <tr> <th colspan="3">OVERALL DIMENSIONS</th> <th colspan="3">SEAT DIMENSIONS</th> <th colspan="3">BACK DIMENSIONS</th> </tr> <tr> <th>W</th> <th>D</th> <th>H</th> <th>W</th> <th>D</th> <th>H</th> <th>W</th> <th>H</th> </tr> <tr> <td>26</td> <td>25</td> <td>44</td> <td>21</td> <td>17.5-20</td> <td>16-20</td> <td>19.5</td> <td>22-27.25</td> </tr> </table> </td> </tr> <tr> <td colspan="12"> <table border="1"> <tr> <th colspan="12">STANDARD TEXTILE GRADES</th> </tr> <tr> <td>1489</td> <td>1577</td> <td>1642</td> <td>1741</td> <td>1881</td> <td>1929</td> <td>2053</td> <td>2286</td> <td>2399</td> <td>2617</td> <td>2911</td> <td>3279</td> </tr> </table> </td> </tr> <tr> <td colspan="12"> <p>RTA 2      FedEx      ups</p> </td> </tr> </table>												<table border="1"> <tr> <th colspan="3">OVERALL DIMENSIONS</th> <th colspan="3">SEAT DIMENSIONS</th> <th colspan="3">BACK DIMENSIONS</th> </tr> <tr> <th>W</th> <th>D</th> <th>H</th> <th>W</th> <th>D</th> <th>H</th> <th>W</th> <th>H</th> </tr> <tr> <td>26</td> <td>25</td> <td>44</td> <td>21</td> <td>17.5-20</td> <td>16-20</td> <td>19.5</td> <td>22-27.25</td> </tr> </table>												OVERALL DIMENSIONS			SEAT DIMENSIONS			BACK DIMENSIONS			W	D	H	W	D	H	W	H	26	25	44	21	17.5-20	16-20	19.5	22-27.25	<table border="1"> <tr> <th colspan="12">STANDARD TEXTILE GRADES</th> </tr> <tr> <td>1489</td> <td>1577</td> <td>1642</td> <td>1741</td> <td>1881</td> <td>1929</td> <td>2053</td> <td>2286</td> <td>2399</td> <td>2617</td> <td>2911</td> <td>3279</td> </tr> </table>												STANDARD TEXTILE GRADES												1489	1577	1642	1741	1881	1929	2053	2286	2399	2617	2911	3279	<p>RTA 2      FedEx      ups</p>											
			<table border="1"> <tr> <th colspan="3">OVERALL DIMENSIONS</th> <th colspan="3">SEAT DIMENSIONS</th> <th colspan="3">BACK DIMENSIONS</th> </tr> <tr> <th>W</th> <th>D</th> <th>H</th> <th>W</th> <th>D</th> <th>H</th> <th>W</th> <th>H</th> </tr> <tr> <td>26</td> <td>25</td> <td>44</td> <td>21</td> <td>17.5-20</td> <td>16-20</td> <td>19.5</td> <td>22-27.25</td> </tr> </table>												OVERALL DIMENSIONS			SEAT DIMENSIONS			BACK DIMENSIONS			W	D	H	W	D	H	W	H	26	25	44	21	17.5-20	16-20	19.5	22-27.25																																																												
			OVERALL DIMENSIONS			SEAT DIMENSIONS			BACK DIMENSIONS																																																																																										
			W	D	H	W	D	H	W	H																																																																																									
26	25	44	21	17.5-20	16-20	19.5	22-27.25																																																																																												
<table border="1"> <tr> <th colspan="12">STANDARD TEXTILE GRADES</th> </tr> <tr> <td>1489</td> <td>1577</td> <td>1642</td> <td>1741</td> <td>1881</td> <td>1929</td> <td>2053</td> <td>2286</td> <td>2399</td> <td>2617</td> <td>2911</td> <td>3279</td> </tr> </table>												STANDARD TEXTILE GRADES												1489	1577	1642	1741	1881	1929	2053	2286	2399	2617	2911	3279																																																																
STANDARD TEXTILE GRADES																																																																																																			
1489	1577	1642	1741	1881	1929	2053	2286	2399	2617	2911	3279																																																																																								
<p>RTA 2      FedEx      ups</p>																																																																																																			
 <p><b>HB Heavy Duty Multi -Tilter with Schukra</b> COM Yardage: 2.25 Freight Class: 125 Product Weight (lbs.): 74 Cubic Feet Per Carton: 11</p>	 <p><b>ADJUSTMENTS</b> (1) Tilt tension (2) Pneumatic seat height (3) Back angle (4) Seat angle (5) Back/lumbar height (6) Sliding seat depth (9) Infinite position tilt lock Center tilt action</p>	<p><b>ObusForme Comfort TS</b></p> <p>Ergonomic Features: A, C, E, F, H, M, N, S</p>	<table border="1"> <tr> <td colspan="12"> <table border="1"> <tr> <th colspan="3">OVERALL DIMENSIONS</th> <th colspan="3">SEAT DIMENSIONS</th> <th colspan="3">BACK DIMENSIONS</th> </tr> <tr> <th>W</th> <th>D</th> <th>H</th> <th>W</th> <th>D</th> <th>H</th> <th>W</th> <th>H</th> </tr> <tr> <td>26</td> <td>25</td> <td>48</td> <td>21</td> <td>17.5-20</td> <td>16-20</td> <td>19.5</td> <td>27-32.25</td> </tr> </table> </td> </tr> <tr> <td colspan="12"> <table border="1"> <tr> <th colspan="12">STANDARD TEXTILE GRADES</th> </tr> <tr> <td>1729</td> <td>1827</td> <td>1900</td> <td>2010</td> <td>2168</td> <td>2226</td> <td>2365</td> <td>2628</td> <td>2753</td> <td>2997</td> <td>3330</td> <td>3742</td> </tr> </table> </td> </tr> <tr> <td colspan="12"> <p>RTA 2      FedEx      ups</p> </td> </tr> </table>												<table border="1"> <tr> <th colspan="3">OVERALL DIMENSIONS</th> <th colspan="3">SEAT DIMENSIONS</th> <th colspan="3">BACK DIMENSIONS</th> </tr> <tr> <th>W</th> <th>D</th> <th>H</th> <th>W</th> <th>D</th> <th>H</th> <th>W</th> <th>H</th> </tr> <tr> <td>26</td> <td>25</td> <td>48</td> <td>21</td> <td>17.5-20</td> <td>16-20</td> <td>19.5</td> <td>27-32.25</td> </tr> </table>												OVERALL DIMENSIONS			SEAT DIMENSIONS			BACK DIMENSIONS			W	D	H	W	D	H	W	H	26	25	48	21	17.5-20	16-20	19.5	27-32.25	<table border="1"> <tr> <th colspan="12">STANDARD TEXTILE GRADES</th> </tr> <tr> <td>1729</td> <td>1827</td> <td>1900</td> <td>2010</td> <td>2168</td> <td>2226</td> <td>2365</td> <td>2628</td> <td>2753</td> <td>2997</td> <td>3330</td> <td>3742</td> </tr> </table>												STANDARD TEXTILE GRADES												1729	1827	1900	2010	2168	2226	2365	2628	2753	2997	3330	3742	<p>RTA 2      FedEx      ups</p>											
			<table border="1"> <tr> <th colspan="3">OVERALL DIMENSIONS</th> <th colspan="3">SEAT DIMENSIONS</th> <th colspan="3">BACK DIMENSIONS</th> </tr> <tr> <th>W</th> <th>D</th> <th>H</th> <th>W</th> <th>D</th> <th>H</th> <th>W</th> <th>H</th> </tr> <tr> <td>26</td> <td>25</td> <td>48</td> <td>21</td> <td>17.5-20</td> <td>16-20</td> <td>19.5</td> <td>27-32.25</td> </tr> </table>												OVERALL DIMENSIONS			SEAT DIMENSIONS			BACK DIMENSIONS			W	D	H	W	D	H	W	H	26	25	48	21	17.5-20	16-20	19.5	27-32.25																																																												
			OVERALL DIMENSIONS			SEAT DIMENSIONS			BACK DIMENSIONS																																																																																										
			W	D	H	W	D	H	W	H																																																																																									
26	25	48	21	17.5-20	16-20	19.5	27-32.25																																																																																												
<table border="1"> <tr> <th colspan="12">STANDARD TEXTILE GRADES</th> </tr> <tr> <td>1729</td> <td>1827</td> <td>1900</td> <td>2010</td> <td>2168</td> <td>2226</td> <td>2365</td> <td>2628</td> <td>2753</td> <td>2997</td> <td>3330</td> <td>3742</td> </tr> </table>												STANDARD TEXTILE GRADES												1729	1827	1900	2010	2168	2226	2365	2628	2753	2997	3330	3742																																																																
STANDARD TEXTILE GRADES																																																																																																			
1729	1827	1900	2010	2168	2226	2365	2628	2753	2997	3330	3742																																																																																								
<p>RTA 2      FedEx      ups</p>																																																																																																			
 <p><b>MB Heavy Duty Multi -Tilter with Schukra</b> COM Yardage: 2 Freight Class: 125 Product Weight (lbs.): 69 Cubic Feet Per Carton: 10.50</p>	 <p><b>ADJUSTMENTS</b> (1) Tilt tension (2) Pneumatic seat height (3) Back angle (4) Seat angle (5) Back/lumbar height (6) Sliding seat depth (9) Infinite position tilt lock Center tilt action</p>	<p><b>ObusForme Comfort TS</b></p> <p>Ergonomic Features: A, C, E, F, H, M, N, S</p>	<table border="1"> <tr> <td colspan="12"> <table border="1"> <tr> <th colspan="3">OVERALL DIMENSIONS</th> <th colspan="3">SEAT DIMENSIONS</th> <th colspan="3">BACK DIMENSIONS</th> </tr> <tr> <th>W</th> <th>D</th> <th>H</th> <th>W</th> <th>D</th> <th>H</th> <th>W</th> <th>H</th> </tr> <tr> <td>26</td> <td>25</td> <td>44</td> <td>21</td> <td>17.5-20</td> <td>16-20</td> <td>19.5</td> <td>22</td> </tr> </table> </td> </tr> <tr> <td colspan="12"> <table border="1"> <tr> <th colspan="12">STANDARD TEXTILE GRADES</th> </tr> <tr> <td>1662</td> <td>1750</td> <td>1815</td> <td>1914</td> <td>2054</td> <td>2102</td> <td>2226</td> <td>2459</td> <td>2572</td> <td>2790</td> <td>3084</td> <td>3452</td> </tr> </table> </td> </tr> <tr> <td colspan="12"> <p>RTA 2      FedEx      ups</p> </td> </tr> </table>												<table border="1"> <tr> <th colspan="3">OVERALL DIMENSIONS</th> <th colspan="3">SEAT DIMENSIONS</th> <th colspan="3">BACK DIMENSIONS</th> </tr> <tr> <th>W</th> <th>D</th> <th>H</th> <th>W</th> <th>D</th> <th>H</th> <th>W</th> <th>H</th> </tr> <tr> <td>26</td> <td>25</td> <td>44</td> <td>21</td> <td>17.5-20</td> <td>16-20</td> <td>19.5</td> <td>22</td> </tr> </table>												OVERALL DIMENSIONS			SEAT DIMENSIONS			BACK DIMENSIONS			W	D	H	W	D	H	W	H	26	25	44	21	17.5-20	16-20	19.5	22	<table border="1"> <tr> <th colspan="12">STANDARD TEXTILE GRADES</th> </tr> <tr> <td>1662</td> <td>1750</td> <td>1815</td> <td>1914</td> <td>2054</td> <td>2102</td> <td>2226</td> <td>2459</td> <td>2572</td> <td>2790</td> <td>3084</td> <td>3452</td> </tr> </table>												STANDARD TEXTILE GRADES												1662	1750	1815	1914	2054	2102	2226	2459	2572	2790	3084	3452	<p>RTA 2      FedEx      ups</p>											
			<table border="1"> <tr> <th colspan="3">OVERALL DIMENSIONS</th> <th colspan="3">SEAT DIMENSIONS</th> <th colspan="3">BACK DIMENSIONS</th> </tr> <tr> <th>W</th> <th>D</th> <th>H</th> <th>W</th> <th>D</th> <th>H</th> <th>W</th> <th>H</th> </tr> <tr> <td>26</td> <td>25</td> <td>44</td> <td>21</td> <td>17.5-20</td> <td>16-20</td> <td>19.5</td> <td>22</td> </tr> </table>												OVERALL DIMENSIONS			SEAT DIMENSIONS			BACK DIMENSIONS			W	D	H	W	D	H	W	H	26	25	44	21	17.5-20	16-20	19.5	22																																																												
			OVERALL DIMENSIONS			SEAT DIMENSIONS			BACK DIMENSIONS																																																																																										
			W	D	H	W	D	H	W	H																																																																																									
26	25	44	21	17.5-20	16-20	19.5	22																																																																																												
<table border="1"> <tr> <th colspan="12">STANDARD TEXTILE GRADES</th> </tr> <tr> <td>1662</td> <td>1750</td> <td>1815</td> <td>1914</td> <td>2054</td> <td>2102</td> <td>2226</td> <td>2459</td> <td>2572</td> <td>2790</td> <td>3084</td> <td>3452</td> </tr> </table>												STANDARD TEXTILE GRADES												1662	1750	1815	1914	2054	2102	2226	2459	2572	2790	3084	3452																																																																
STANDARD TEXTILE GRADES																																																																																																			
1662	1750	1815	1914	2054	2102	2226	2459	2572	2790	3084	3452																																																																																								
<p>RTA 2      FedEx      ups</p>																																																																																																			

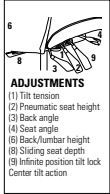
DESCRIPTION	FEATURES	MODEL#	STANDARD TEXTILE GRADES												
			1	2	3	4	5	6	7	8	9	10	11	12	
 <p><b>HB Heavy Duty Multi - Tilter</b> COM Yardage: 2 Freight Class: 125 Product Weight (lbs.): 63 Cubic Feet Per Carton: 10.50</p>	 <p><b>ADJUSTMENTS</b> (1) Tilt tension (2) Pneumatic seat height (3) Back angle (4) Seat angle (5) Back/lumbar height (6) Sliding seat depth (9) Infinite position tilt lock Center tilt action</p>	<b>TS5450-3</b>	1195	1274	1331	1421	1550	1594	1706	1917	2019	2217	2483	2818	
		<b>OVERALL DIMENSIONS</b>			<b>SEAT DIMENSIONS</b>			<b>BACK DIMENSIONS</b>							
		<b>W</b>	<b>D</b>	<b>H</b>	<b>W</b>	<b>D</b>	<b>H</b>	<b>W</b>	<b>H</b>						
		26	25	42	20	18-20.5	16.5-20.5	20	23.5-26						
		<b>Truform TS</b>													
Ergonomic Features: A, B, C, D, F, G, H, M, N, Q, S		<b>RTA 2</b>		FedEx		ups									
 <p><b>MB Heavy Duty Multi - Tilter</b> COM Yardage: 1.75 Freight Class: 150 Product Weight (lbs.): 60 Cubic Feet Per Carton: 10.50</p>	 <p><b>ADJUSTMENTS</b> (1) Tilt tension (2) Pneumatic seat height (3) Back angle (4) Seat angle (5) Back/lumbar height (6) Sliding seat depth (9) Infinite position tilt lock Center tilt action</p>	<b>TS5451-3</b>	1154	1224	1278	1354	1466	1507	1604	1791	1878	2051	2285	2576	
		<b>OVERALL DIMENSIONS</b>			<b>SEAT DIMENSIONS</b>			<b>BACK DIMENSIONS</b>							
		<b>W</b>	<b>D</b>	<b>H</b>	<b>W</b>	<b>D</b>	<b>H</b>	<b>W</b>	<b>H</b>						
		26	25	38.5	20	18-20.5	16.5-20.5	20	20-22.5						
		<b>Truform TS</b>													
Ergonomic Features: A, B, C, D, F, G, H, M, N, Q, S		<b>RTA 2</b>		FedEx		ups									

CONCORDE™ EXECUTIVE 24HR



model 2424



**Push Button**



Location within reach increases your adjustment. Promotes good posture as you move to various positions.

**STANDARD FEATURES**

- All adjustments are made with button controls that are conveniently located in full view, for easy use.
- Compound curved molded foam seat and back cushions.
- Seat cushion with Velcro attachment is easily removed and replaced.
- Rated for Multi-Shift use for persons up to 350 pounds.
- Standard with Allen-bolted width adjustable arms (Allen key included). Arms adjust 1 1/4" wider on each side, a total of 2 1/2" extra width.
- Pneumatic seat height adjustment and 5 - position tilt lock. Tilt tension control.
- Ratchet style back height adjustment.
- All models are standard with a reinforced five-legged, injection molded base with **C10** casters, Black (**BK**) Only.
- Check textile availability prior to specifying upholstery material.

**OPTIONAL FEATURES**

- Models are not available with **C7** glides.

DESCRIPTION	FEATURES	MODEL#	STANDARD TEXTILE GRADES											
			1	2	3	4	5	6	7	8	9	10	11	12
 <p><b>ADJUSTMENTS</b>                      (1) Tilt tension                      (2) Pneumatic seat height                      (6) Back height*                      (8) Seat depth                      (9) Chair tilt lock                      (5C) Synchro-tilt action                      Anti-kick back</p>	<p>Seat depth Adjust: 16" to 18"</p> <p>Ergonomic Features:                      A, B, C, D, E, L, M, N, Q, T</p>	<p><b>2424</b></p>	-	3375	3454	3568	3731	3790	3929	4194	4321	4570	4909	5331
			<p><b>OVERALL DIMENSIONS</b></p>			<p><b>SEAT DIMENSIONS</b></p>			<p><b>BACK DIMENSIONS</b></p>					
			W	D	H	W	D	H	W	H				
	28.5	27	50	21	17.5-19	18-22	21	28-31						
 <p><b>ADJUSTMENTS</b>                      (1) Tilt tension                      (2) Pneumatic seat height                      (6) Back height*                      (8) Seat depth                      (9) Chair tilt lock                      (5C) Synchro-tilt action                      Anti-kick back</p>	<p>Additional seat depth: 1"</p> <p>Ergonomic Features:                      A, B, C, D, E, L, M, N, Q, T</p>	<p><b>2424-18</b></p>	-	3430	3514	3626	3784	3846	3990	4250	4382	4630	4971	5392
			<p><b>OVERALL DIMENSIONS</b></p>			<p><b>SEAT DIMENSIONS</b></p>			<p><b>BACK DIMENSIONS</b></p>					
			W	D	H	W	D	H	W	H				
	28.5	27	50	21	17.5-19	18-22	21	28-31						

G1 ERGO SELECT™ TS



model TS7333

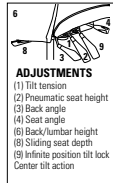

Ergonomic Features:  
 A, B, C, D, E, F, G, H, M, N,  
 O, R, S, U

**MECHANISM:**  
 Multi-tilter mechanism (-3)

**STANDARD FEATURES**

- TS models are available within the standard G1 Ergo Select series. TS stands for "three shift" and each TS model is rated for 24/7 applications as well as weight rated up to 350 lbs.
- Models feature a heavy duty multi-tilter mechanism, cylinder and molded heavy duty seat foam.
- Standard with pneumatic seat height, forward and rearward seat tilt with infinite lock, free floating back angle control, tilt tension control and side activated sliding seat depth.
- Available in three back heights and two seat sizes (standard or generous).
- Stitch detail on edges of seat and back is discrete, using matched thread as standard.
- Standard with height and width adjustable (G5) arms with sliding armcaps. Armcaps also articulate inwards and outwards to aim toward the keyboard or mouse area.
- Five prong, injection molded, fiberglass reinforced nylon Black base with (C82) dual wheel carpet casters.
- G1 Ergo Select is fully compliant with latest BIFMA G1, GSA, and CGSB specifications.
- For 24 hour applications, Global's Lifetime Warranty is applicable only on fabrics that are rated for 100,000 double rubs.
- Check textile availability prior to specifying upholstery material.

**OPTIONAL FEATURES**

- Upholstery is available with exaggerated top stitch detail (heavier thread). Fourteen coordinating or contrasting colors may be selected. Please specify.
- Optional Ergo Select arms are height (4") and width adjustable with sliding armcaps. Armcaps also articulate inwards (25°) and outwards (25°) to aim toward the keyboard or mouse area.



Please add option codes in the following order:

- **Model number**  
**TS7331** Medium back  
**TS7332** High back  
**TS7333** Extended high back
- **Textile**  
 Specify textile codes for back and seat
- **Mechanism**  
 (-3) Multi-tilter mechanism
- **Seat Size**  
**(STAN)** Standard seat  
**(GS)** Generous seat
- **Arms**  
**(G5)** G5 arms..... **Standard**  
**(H1)** Ergo Select arms..... **Add \$95**  
**(H2)** Ergo Select arms  
 w/wide armcaps..... **Add \$132**
- **Base**  
**(B7)** Black nylon B7B base ..... **Standard**  
**(A7)** Polished aluminum B7A base..... **Add \$177**
- **Casters**  
**(C82)** Dual wheel carpet casters..... **Standard**  
**(C82R)** Dual wheel  
 hard floor casters..... **Add \$100**
- **Stitch detail**  
**(MS)** Color matched stitching.  
 Decorative top stitch..... **No upcharge**  
**(XP)** Black                      **(XB)** Beige  
**(XG)** Copen                      **(XA)** Graphite  
**(XK)** Mahogany                **(XJ)** Natural  
**(XH)** Navy #3                    **(XD)** New Grey  
**(XF)** Nickel                      **(XN)** Off-White  
**(XL)** Rubytone                 **(XI)** Scarlett  
**(XC)** Smoke                     **(XE)** Taupe  
 (colors shown on website)

**EXAMPLE G1 ERGO SELECT TS ORDER CODE:**

TS7332	-WA53	-WA53	-3	-STAN	-H1	-B7	-C82	-MS
Model #	Back fabric	Seat fabric	Mechanism	Seat size	Arms	Base	Casters	Stitch detail

G1 Ergo Select TS dimensional information: based on measurements with heavy duty multi-tilter mechanism				
	Distance between arms	Standard arm height	Seat depth range	Standard seat height
<b>Standard seat (STAN)</b> Heavy duty 4" lift & (H1) arms	16.0" - 21.5" = 5.5" adjustment	7.3" - 11.4"	16.5" - 18.75"	17.5" - 21.5"
<b>Generous seat (GS)</b> Heavy duty 4" lift & (H1) arms	17.25" - 22.75" = 5.5" adjustment		17.25" - 19.5"	

DESCRIPTION	FEATURES	MODEL#	STANDARD TEXTILE GRADES													
			1	2	3	4	5	6	7	8	9	10	11	12		
 <p><b>Medium Back</b></p> <p>COM Yardage: 1.65 Freight Class: 125 Product Weight (lbs.): 66 Cubic Feet Per Carton: 10.50</p>	See series notes for mechanism options.	<b>TS7331</b>	1517	1584	1628	1702	1804	1851	1944	2090	2204	2332	2589	2866		
		<b>OVERALL DIMENSIONS</b>			<b>SEAT DIMENSIONS</b>			<b>BACK DIMENSIONS</b>								
		<b>W</b>	<b>D</b>	<b>H</b>	<b>W</b>	<b>D</b>	<b>H</b>	<b>W</b>	<b>H</b>							
		24	21.5	42	19.75	15.5-18.5	17.5-21.5	19	22							
					<b>RTA 1</b>			1 per carton								
 <p><b>High Back</b></p> <p>COM Yardage: 1.75 Freight Class: 125 Product Weight (lbs.): 68 Cubic Feet Per Carton: 10.50</p>	See series notes for mechanism options.	<b>TS7332</b>	1590	1659	1710	1786	1895	1946	2044	2202	2324	2458	2734	3032		
		<b>OVERALL DIMENSIONS</b>			<b>SEAT DIMENSIONS</b>			<b>BACK DIMENSIONS</b>								
		<b>W</b>	<b>D</b>	<b>H</b>	<b>W</b>	<b>D</b>	<b>H</b>	<b>W</b>	<b>H</b>							
		24.5	23	45.5	16.5-18.75	15.5-18.5	17.5-21.5	19	24.5							
					<b>RTA 1</b>			1 per carton								
 <p><b>Extended High Back</b></p> <p>COM Yardage: 2 Freight Class: 125 Product Weight (lbs.): 70 Cubic Feet Per Carton: 11</p>	See series notes for mechanism options.	<b>TS7333</b>	1663	1742	1800	1889	2014	2072	2186	2365	2506	2658	2979	3320		
		<b>OVERALL DIMENSIONS</b>			<b>SEAT DIMENSIONS</b>			<b>BACK DIMENSIONS</b>								
		<b>W</b>	<b>D</b>	<b>H</b>	<b>W</b>	<b>D</b>	<b>H</b>	<b>W</b>	<b>H</b>							
		26	24	51	16.5-18.75	15.5-18.5	17.5-21.5	19	27							
					<b>RTA 1</b>			1 per carton								

## ROBUST





model 2527

## STANDARD FEATURES

- Heavy duty chair rated for multi shift users up to 500 pounds.
- Standard with a six prong, oval tubular steel base (32" in diameter) in Black (BK) Only.
- Standard with a solid steel loop style arm. The arm is vinyl dipped to be warm to the touch and impact absorbent.
- Arms are width adjustable for an extra 2" on each side, providing additional room and comfort for users.
- There are no arm options for this series.
- Side tension adjustment can be reached from a seated position.
- Standard with Ultracell high density, high resilient foam on seat and back.
- Large diameter 3" black casters, providing easier mobility.
- Casters are suitable for hard surface flooring or carpet. There are no caster options for this series.
- Standard pneumatic seat height adjustment. Forward and rearward seat tilt with infinite lock and free floating back angle control. Tilt tension control.
- This series has a two-tone fabric combination as standard. Trim is always Dobby, Black (DB42) fabric.

## OPTIONAL FEATURES

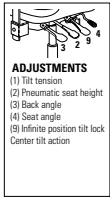
- Upholstered in fabric only. Check textile availability prior to specifying.
- An optional abrasion-resistant outer back fabric (polyester) is available (BKB). Resistant to impact damage. Available in Black only. Add \$25.

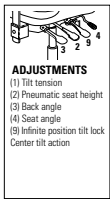
DESCRIPTION	FEATURES	MODEL#	STANDARD TEXTILE GRADES													
			1	2	3	4	5	6	7	8	9	10	11	12		
 <p><b>HB Heavy Duty Multi-Tilter</b> COM Yardage: 3.25 Freight Class: 250 Product Weight (lbs.): 118 Cubic Feet Per Carton: 33.50</p>	 <p><b>ADJUSTMENTS</b> (1) Tilt tension (2) Pneumatic seat height (3) Back angle (4) Seat angle (5) Infinite position tilt lock Center tilt action</p>	<b>2526</b>	-	2875	2973	3116	3321	3396	3572	3905	4071	4380	4811	5341		
		<b>OVERALL DIMENSIONS</b>			<b>SEAT DIMENSIONS</b>			<b>BACK DIMENSIONS</b>								
		<b>W</b>	<b>D</b>	<b>H</b>	<b>W</b>	<b>D</b>	<b>H</b>	<b>W</b>	<b>H</b>							
	29	27.5	50.5	25.5	20	16.5-20.5	22	30								
				<b>RTA 00</b>												
 <p><b>MB Heavy Duty Multi-Tilter</b> COM Yardage: 3 Freight Class: 250 Product Weight (lbs.): 114 Cubic Feet Per Carton: 29.50</p>	 <p><b>ADJUSTMENTS</b> (1) Tilt tension (2) Pneumatic seat height (3) Back angle (4) Seat angle (5) Infinite position tilt lock Center tilt action</p>	<b>2527</b>	-	2682	2773	2903	3091	3160	3326	3633	3787	4072	4470	4959		
		<b>OVERALL DIMENSIONS</b>			<b>SEAT DIMENSIONS</b>			<b>BACK DIMENSIONS</b>								
		<b>W</b>	<b>D</b>	<b>H</b>	<b>W</b>	<b>D</b>	<b>H</b>	<b>W</b>	<b>H</b>							
	29	26.5	42.5	25.5	20	16.5-20.5	22	24								
				<b>RTA 00</b>												

SAXON



model 2512-3



Back

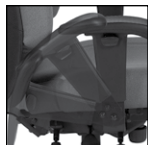

**Arm Feature**

Arms are designed to flip up and accommodate people wearing equipment belts.

**STANDARD FEATURES**

- A contoured molded, dual cushion, Ultracell foam seat and heavily padded back provides exceptional comfort.
- Rated for multi-shift use by persons up to 350lbs.
- Abrasion resistant outer back fabric (polyester) is standard. Resistant to impact damage. Available in Black only.
- Standard with a black nylon molded base with dual wheel carpet casters (C10). Select hard floor casters (C10R) for use on most hard surfaces, add \$70.
- Standard with VL fold-up arms to accommodate users' equipment belts.
- Arms standard with Vari-Width Adapter Plates (WA).
- Back upright is 3" standard, with 2.25", five-position, ratchet back height adjustment.
- Side activated sliding seat depth adjustment is standard.
- Saxon is covered under Global's Heavy Duty Warranty for 12 years, 24/7 use environments. Fabrics with a minimum of 100,000 double rubs required.
- Upholstery options: fabric and coated textiles only. Coated textiles may feature stitch detail across the seat and/or back cushions, if applicable.

**OPTIONAL FEATURES**

- **AC10** casters are standard. Please see page 414 for additional caster options. Optional caster may be priced higher than the standard casters and will incur an upcharge. Lower priced optional casters will not be credited.

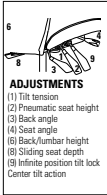
DESCRIPTION	FEATURES	MODEL#	STANDARD TEXTILE GRADES												
			1	2	3	4	5	6	7	8	9	10	11	12	
 <p><b>ADJUSTMENTS</b>                      (1) Tilt tension                      (2) Pneumatic seat height                      (3) Back angle                      (4) Seat angle                      (5) Back/lumbar height                      (6) Sliding seat depth                      (7) Infinite position tilt lock                      Center tilt action</p>	 <p>Ergonomic Features: A, B, C, M, N, S</p>	<b>2512-3</b>	-	1921	1995	2098	2247	2302	2431	2673	2796	3020	3333	3716	
		OVERALL DIMENSIONS			SEAT DIMENSIONS			BACK DIMENSIONS							
			W	D	H	W	D	H	W	H					
			27.5	25	39.5	22.5	19-21.5	18-22	20	19.5-22					
<p><b>HB Heavy Duty Multi-Tilter</b>                      COM Yardage: 2.25                      Freight Class: 150                      Product Weight (lbs.): 60                      Cubic Feet Per Carton: 13</p>			<b>RTA 2</b>												

## VION



model TS6321-3



model TS6331-3

VION FINISHES - TASK SEATING				
Back Frame	Base	Specify Code	Arm Option	Specify Code
Black	Black	BLK no upcharge	Adj. "T" arm ( <b>Black</b> ) Adj. "T" arm, fixed armcap ( <b>Black</b> ) Adj. "T" arm ( <b>Black</b> , Chrome accent) Adj. "T" arm, fixed armcap ( <b>Black</b> , Chrome accent)	AS AF AC A
Black	Polished Aluminum	BAU Add \$177	Fixed "C" arm ( <b>Black</b> ) Fixed "C" arm ( <b>Polished Aluminum</b> )	C CA - Add \$214
Shadow	Shadow	SHW Add \$81	Adj. "T" arm ( <b>Shadow</b> ) Adj. "T" arm, fixed armcap ( <b>Shadow</b> ) Adj. "T" arm ( <b>Shadow</b> , Chrome accent)	SHA SHF SHR
Shadow	Polished Aluminum	SAU Add \$255	Adj. "T" arm, fixed armcap ( <b>Shadow</b> , Chrome accent) Fixed "C" arm ( <b>Shadow</b> ) Fixed "C" arm ( <b>Polished Aluminum</b> )	SHD SHC CA - Add \$214
Fog	Fog	FOG Add \$81	Adj. "T" arm ( <b>Fog</b> ) Adj. "T" arm, fixed armcap ( <b>Fog</b> ) Adj. "T" arm ( <b>Fog</b> , Chrome accent)	FA FF FC
Fog	Polished Aluminum	FAU Add \$255	Adj. "T" arm, fixed armcap ( <b>Fog</b> , Chrome accent) Fixed "C" arm ( <b>Fog</b> ) Fixed "C" arm ( <b>Polished Aluminum</b> )	CF CC CA - Add \$214





\* All arms have Black SSU Armcaps.





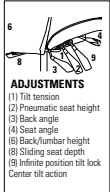

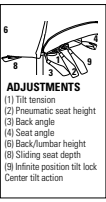

## STANDARD FEATURES

- The TS models are available within standard Vion series. TS stands for "Three Shift" and each of the TS models are rated for 24-7 applications as well as weight rated up to 350 pounds.
- Multi-Tilter models, feature a heavy duty mechanism.
- Multi-Tilters are standard with Pneumatic seat height and sliding seat depth adjustment. Forward and rearward seat tilt with infinite lock and free floating back angle control. Tilt tension control.
- Side activated sliding seat depth adjustment is standard on Multi-Tilter. Provides 2" of seat depth adjustment.
- Heavy duty height adjustable stools are standard with fixed back. Seat depth and pneumatic seat height adjustments. Swivels with adjustable chrome footring.
- All models are standard with either Ultracell or molded heavy duty seat foam.
- All models have a heavy duty 3" wide back upright.
- All models are standard with height and width adjustable arms (**AS**) that feature a front to back sliding armcap.
- Mesh back models are available in 10 standard Vion colors: Aqua (**MS75**), Black (**MS69**), Black Cherry (**MS76**), Blue (**MS72**), Dust (**MS77**), Ivory (**MS78**), Natural (**MS74**), Paprika (**MS79**), Rope (**MS73**) and Stone (**MS71**).
- Upholstered back models will always feature black fabric (Jenny **JN02**) on the back side.
- Check textile availability prior to specifying upholstery material. Materials must meet or exceed 100,000 double rubs to comply with Globals Heavy Duty seating textile warranty.

## OPTIONAL FEATURES

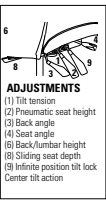
- Vion back frames, arms and bases are available in three colors: Black, Shadow and Fog. See Vion finishes chart for options and upcharges. Armcaps are always Black.
- Mesh back models are also available in 7 Dimension Mesh colors: Black (**DBK**), Fog (**DST**), Chalk (**DCL**), Shadow (**DGM**), Charcoal (**DCH**), Sand (**DSD**), Pool Blue (**DPB**). Add \$29
- Upholstered back models offer a Matching Outer (**MO**) upholstery option. Due to the additional material needed, these models are listed separately and are priced differently than the standard upholstered back models.
- Two featured "T" arm options that include height and width adjusting arms, one with sliding arm caps (**AS**) and one without sliding arm caps (**AF**). Also, available is a stylish fixed urethane arm (**C**) for conference/management environments.
- Optional Lumbar Pad can be added at the time of order. Please specify **LP**. Add \$43. Lumbar Pad can also be order after sale as a kit, specify model 6339 at \$46 list. The Lumbar Pad is adjustable up to 3".
- Optional Memory Foam available on Vion Seats. Please specify **MF**. Add \$124.
- B7A** Polished aluminum base and matching chrome arm accent on either **AS** or **AF** arms. Please specify **ALU** and **AC**. Add \$161.

DESCRIPTION	FEATURES	MODEL#	STANDARD TEXTILE GRADES																																	
			1	2	3	4	5	6	7	8	9	10	11	12																						
 <p><b>HB Heavy Duty Multi - Tilter - Mesh Back</b> COM Yardage: 1.75 Freight Class: 150 Product Weight (lbs.): 49 Cubic Feet Per Carton: 10.5</p>	 <p><b>ADJUSTMENTS</b> (1) Tilt tension (2) Pneumatic seat height (3) Back angle (4) Seat angle (5) Back/Lumbar height (6) Sliding seat depth (7) Infinite position tilt lock Center tilt action</p>	<p><b>Vion TS</b></p> <p>Ergonomic Features: A, B, C, E, F, G, H, M, N, Q, U, S</p>	<table border="1"> <tr> <td><b>TS6321-3</b></td><td>1365</td><td>1405</td><td>1434</td><td>1477</td><td>1540</td><td>1562</td><td>1616</td><td>1720</td><td>1772</td><td>1867</td><td>1998</td><td>2160</td> </tr> </table>												<b>TS6321-3</b>	1365	1405	1434	1477	1540	1562	1616	1720	1772	1867	1998	2160									
			<b>TS6321-3</b>	1365	1405	1434	1477	1540	1562	1616	1720	1772	1867	1998	2160																					
			<table border="1"> <thead> <tr> <th colspan="3">OVERALL DIMENSIONS</th> <th colspan="3">SEAT DIMENSIONS</th> <th colspan="3">BACK DIMENSIONS</th> </tr> <tr> <th>W</th><th>D</th><th>H</th> <th>W</th><th>D</th><th>H</th> <th>W</th><th>H</th> </tr> </thead> <tbody> <tr> <td>25.5</td><td>24</td><td>41</td> <td>20</td><td>17-19.5</td><td>17.5-21.5</td> <td>19</td><td>21.5-24</td> </tr> </tbody> </table>			OVERALL DIMENSIONS			SEAT DIMENSIONS			BACK DIMENSIONS			W	D	H	W	D	H	W	H	25.5	24	41	20	17-19.5	17.5-21.5	19	21.5-24	<p><b>RTA 2</b>            </p>					
			OVERALL DIMENSIONS			SEAT DIMENSIONS			BACK DIMENSIONS																											
W	D	H	W	D	H	W	H																													
25.5	24	41	20	17-19.5	17.5-21.5	19	21.5-24																													
<table border="1"> <tr> <th>1</th><th>2</th><th>3</th><th>4</th><th>5</th><th>6</th><th>7</th><th>8</th><th>9</th><th>10</th><th>11</th><th>12</th> </tr> <tr> <td><b>TS6322-3</b></td><td>1311</td><td>1352</td><td>1381</td><td>1424</td><td>1488</td><td>1509</td><td>1563</td><td>1667</td><td>1719</td><td>1814</td><td>1947</td><td>2108</td> </tr> </table>												1	2	3	4	5	6	7	8	9	10	11	12	<b>TS6322-3</b>	1311	1352	1381	1424	1488	1509	1563	1667	1719	1814	1947	2108
1	2	3	4	5	6	7	8	9	10	11	12																									
<b>TS6322-3</b>	1311	1352	1381	1424	1488	1509	1563	1667	1719	1814	1947	2108																								
<table border="1"> <thead> <tr> <th colspan="3">OVERALL DIMENSIONS</th> <th colspan="3">SEAT DIMENSIONS</th> <th colspan="3">BACK DIMENSIONS</th> </tr> <tr> <th>W</th><th>D</th><th>H</th> <th>W</th><th>D</th><th>H</th> <th>W</th><th>H</th> </tr> </thead> <tbody> <tr> <td>25.5</td><td>24</td><td>39</td> <td>20</td><td>17-19.5</td><td>17.5-21.5</td> <td>19</td><td>21.5-24</td> </tr> </tbody> </table>			OVERALL DIMENSIONS			SEAT DIMENSIONS			BACK DIMENSIONS			W	D	H	W	D	H	W	H	25.5	24	39	20	17-19.5	17.5-21.5	19	21.5-24	<p><b>RTA 2</b>            </p>								
OVERALL DIMENSIONS			SEAT DIMENSIONS			BACK DIMENSIONS																														
W	D	H	W	D	H	W	H																													
25.5	24	39	20	17-19.5	17.5-21.5	19	21.5-24																													

DESCRIPTION	FEATURES	MODEL#	STANDARD TEXTILE GRADES													
			1	2	3	4	5	6	7	8	9	10	11	12		
 <p><b>HB Heavy Duty Multi - Tilter - Upholstered Back</b> COM Yardage: 1.75 Freight Class: 150 Product Weight (lbs.): 49 Cubic Feet Per Carton: 10.5</p>	 <p><b>ADJUSTMENTS</b> (1) Tilt tension (2) Pneumatic seat height (3) Back angle (4) Seat angle (5) Back/lumbar height (6) Sliding seat depth (8) Infinite position tilt lock Center tilt action</p>	<b>TS6331-3</b>	1506	1557	1594	1647	1725	1755	1820	1953	2014	2135	2299	2501		
		<b>TS6331-3MO</b>	1565	1643	1701	1789	1915	1973	2086	2265	2403	2558	2876	3213		
		<b>OVERALL DIMENSIONS</b>			<b>SEAT DIMENSIONS</b>			<b>BACK DIMENSIONS</b>								
		<b>W</b>	<b>D</b>	<b>H</b>	<b>W</b>	<b>D</b>	<b>H</b>	<b>W</b>	<b>H</b>							
	25.5	24	41	20	17-19.5	17.5-21.5	19	21.5-24								
									  							
 <p><b>MB Heavy Duty Multi - Tilter - Upholstered Back</b> COM Yardage: 1.75 Freight Class: 150 Product Weight (lbs.): 49 Cubic Feet Per Carton: 10.5</p>	 <p><b>ADJUSTMENTS</b> (1) Tilt tension (2) Pneumatic seat height (3) Back angle (4) Seat angle (5) Back/lumbar height (6) Sliding seat depth (8) Infinite position tilt lock Center tilt action</p>	<b>TS6332-3</b>	1452	1502	1537	1592	1670	1699	1765	1898	1958	2079	2244	2446		
		<b>TS6332-3MO</b>	1515	1599	1663	1760	1893	1955	2081	2276	2426	2594	2939	3307		
		<b>OVERALL DIMENSIONS</b>			<b>SEAT DIMENSIONS</b>			<b>BACK DIMENSIONS</b>								
		<b>W</b>	<b>D</b>	<b>H</b>	<b>W</b>	<b>D</b>	<b>H</b>	<b>W</b>	<b>H</b>							
	25.5	24	41	20	17-19.5	17.5-21.5	19	21.5-24								
									  							

# arm and caster options



# HOW TO SELECT ARMRESTS

Global has a wide selection of armrest to suit almost every work task. Armrest are an important feature of a chair. They reduce stress an tension on the spine, neck and shoulder muscles by supporting the weight of your arms. This makes you more comfortable and ultimately more productive. Height, width and angle adjustable armrests enable you to position your arms at a comfortable working position, based on the task at hand.

## COMFORT TIPS

- Wrists should be in a straight or neutral position - avoid bending your wrists
- When mousing, use whole arm movements instead of flexing your wrist.
- Rest your palm on the mouse pad for support.

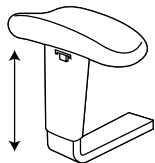

## HEIGHT ADJUSTABLE ARMS

- A full range of arms is available with armcaps in self-skinned urethane (SSU).
- Use the features available on Global's adjustable arms to accommodate your ergonomic requirements.

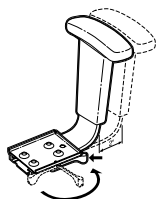

## VARI-WIDTH ARM

- Features maximum comfort while enabling you to maintain top productivity levels.
- Easy to use levers enable you to adjust the distance between armrests quickly and simply. An ergonomic feature, Vari-Width maximizes shoulder support as it accommodates the specific width requirements of each user.
- Metal adapter plates provide width adjustability. One adapter plate is attached under each side of the seat. Arms are inserted into the adapter plates.
- Arms extend outward up to 2" on each side. A lever locks each arm in any position.
- Vari-Width is available only with Global's height adjustable arms. The arm chart (on the following pages) specifies all arm options available for the Vari-Width series. Vari-Width is standard on many chairs; they can also be retroactively installed on chairs.
- When ordering, please specify series, arm and **(WA)** ie. Loover 2660-0 **(G5)** and **(WA)**. When ordering as retrofit, please specify **2660-0-WA**.

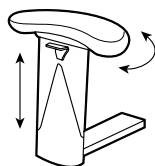

## ROTATING ARMCAPS

Rotating armcaps articulate inward and/or outward. This positions the arm to support mousing or keyboarding activities. Rotating armcaps can also be used to narrow the space between the arms for slender people seeking arm support while keyboarding.

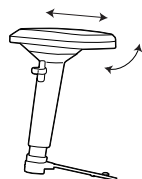

## SLIDING ARMCAPS

Select arms have sliding armcaps. They can slide over top of the seat to narrow the space between the arms for smaller users. Sliding armcaps also slide forward for arm support for larger users or slide to the rear allowing slender users to sit closer to their worksurface.

## OPTIONAL ARMS

Purchased separately from the chair. Cost listed below arm descriptions. Refer to chart for series compatibility.



**AS**

Height and width adjustable forward and backward sliding armcaps.

**\$289**

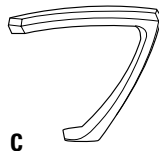

**C**

Fixed height and stylish "C" arm. Self-skinned urethane. Black only.

**\$289**

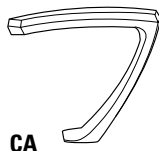

**CA**

Fixed height and stylish "C" arm. Polished Aluminum.

**\$454**

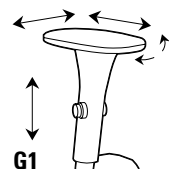

**G1**

Height and width adjustable forward and backward sliding armcaps. Self-skinned urethane pad rotates inward.

**\$289**



**G2**

Special low rise version of G3 arm, positions 1" lower but retains all G3 functions.

**\$289**

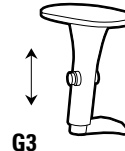

**G3**

Height and width adjustable forward and backward sliding armcaps. Self-skinned urethane pad rotates inward 30 degrees.

**\$289**



**G4**

Height adjustable "T" style Graphic arm. Self-Skinned Urethane (SSU) armcap. Slides forward and back.

**\$289**

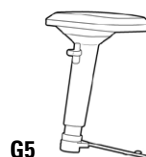

**G5**

Lockable, highly adjustable armcap slides forward and backward, cap slides over seat 3/4" each side, cap rotates inward & outward. Soft (SSU) arm pad.

**\$289**



**G6**

Special low rise version of G5 arm, positions 1" lower but retains all G5 arm functions.

**\$289**

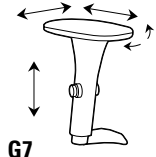

**G7**

Wider highly adjustable armcap slides forward and backward, cap slides over seat 3/4" each side. Cap rotates inward. Soft SSU arm pad. Curved corners and sides.

**\$289**

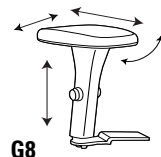

**G8**

Special low rise version of G7 arm, positions 1" lower but retains all G7 functions.

**\$289**

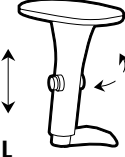

**GL**

Width adjustable forward and backward sliding armcaps.

**\$289**

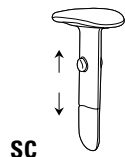

**SC**

Height adjustable forward swept arms with kidney shaped armcaps. Self-skinned urethane.

**\$252**

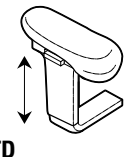

**TD**

Height adjustable "T" arms with teardrop shaped armcaps.

Self-skinned urethane.

**\$252**



**T6**

Height adj. T arm. Rotates 360. Self-skinned urethane.

**\$336**

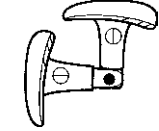

**ZT**

Height adjustable "T" arms, teardrop shaped. Swings away and folds. Self-skinned urethane.

**\$306**



**3B**

Height Adjustable "T" arm with soft touch Self-Skinned Urethane (SSU) armcap.

**\$252**

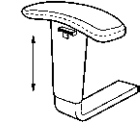

**3N**

Height adjustable "T" arms with curved shaped armcaps. Self-skinned urethane. Available in Black only.

**\$206**

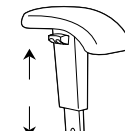

**3P**

Height adjustable "waterfall edge" arms. Self-skinned urethane. Available in Black Only.

**\$320**



**3R**

Hard durometer. Height Adjustable "T" arm with Concave Oval soft touch Self-Skinned Urethane (SSU) armcap.

**\$252**

# ARM SELECTIONS

SERIES \ ARM	STD	AS	C	CA	G1	G2	G3	G4	G5	G6	G7	G8
ASPEN	AS		NA	NA	0	NA	0	0	0	NA	0	0
ENTERPRISE	TD	102	NA	NA	46	46	46	6	46	46	NA	NA
GOAL	3N	NR	94	NA	NR	NR	NR	NR	NR	NR	NR	NR
GRAHAM	3N	102	NA	NA	95	95	95	95	95	95	NA	NA
GRANADA	3N	102	NA	NA	95	95	95	95	95	95	NR	NR
GRANADA DELUXE	3B	102	NA	NA	46	46	46	46	46	46	NA	NA
GRAPHIC	G4	0	0	NA	0	NA	0		0	NA	0	0
LOOVER	G5	0	0	153	0	0	0	0	STD	0	0	0
MALAGA	TD	96	NA	NA	46	46	46	46	46	46	NA	NA
OBUSFORME COMFORT	G3	0	NA	NA	0	0	STD	0	0	0	0	0
SAXON	VL	0	NA	NA	0	0	0	0	0	0	0	0
SUPRA X	SC	102	46	NA	46	46	46	46	46	46	NA	NA
SYNOPSIS	3B	102	46	NA	46	46	46	46	46	46	NA	NA
TRIUMPH	G1	0	NA	NA	STD	NA	0	0	0	NA	NA	NA
TRUFORM	SC	102	46	NA	46	46	46	46	46	46	46	NA
TYE	3N	102	NA	NA	95	95	95	95	95	95	95	NA
VION	AS/C	STD	STD	214	0	0	0	0	0	0	0	0
WEEV	GL	0	0	NA	0	0	0	0	0	0	0	0

**NOTE:** ARMCHAIRS HAVE FIXED ARMS WHICH ARE NOT INTERCHANGEABLE WITH ADJUSTABLE ARMS LISTED ABOVE.  
 \* INDICATES THAT ARMS CANNOT BE USED WITH "WA" ARM WIDTH ADAPTER.

**\$0** = AVAILABLE AT NO ADDITIONAL CHARGE

**NA** = NOT AVAILABLE

**NR** = OPTION NOT RECOMMENDED

SERIES \ ARMS	STD	GL	SC	TD	T6	ZT	3B	3N	3P	3R	WA
ASPEN	AS	0	NR	NR	NA	NA	NR	NR	NR	NR	STD
ENTERPRISE	TD	46	0	0	122	67	0	0	0	0	STD
GOAL	3N	NR	52	55	NR	117	52	STD	55	52	NA
GRAHAM	3N	95	55	55	171	117	52	STD	52	52	NA
GRANADA	3N	95	55	55	171	117	52	STD	52	52	STD
GRANADA DELUXE	3B	46	0	0	122	67	STD	0	0	0	STD
GRAPHIC	G4	0	0	NR	80	25	NR	NR	NR	NR	STD
LOOVER	G5	0	0	0	0	NA	0	0	0	0	0
MALAGA	TD	46	0	STD	117	67	0	0	0	0	STD
OBUSFORME COMFORT	G3	0	0	0	80	25	0	0	0	0	STD
SAXON	VL	0	0	NR	60	NR	0	0	0	0	NA
SUPRA X	SC	46	STD	0	117	67	0	0	0	0	STD
SYNOPSIS	3B	46	0	0	117	67	STD	0	0	0	STD
TRIUMPH	G1	0	NA	NA	NA	NA	NA	NA	NA	NA	NA
TRUFORM	SC	46	STD	0	117	67	0	0	0	0	NA
TYE	3N	95	55	55	171	117	55	STD	55	55	NA
VION	AS/C	0	0	0	80	NA	0	0	0	0	0
WEEV	GL	STD	0	0	80	25	0	0	0	0	STD

**NOTE:** ARMCHAIRS HAVE FIXED ARMS WHICH ARE NOT INTERCHANGEABLE WITH ADJUSTABLE ARMS LISTED ABOVE.  
 \* INDICATES THAT ARMS CANNOT BE USED WITH "WA" ARM WIDTH ADAPTER.

**\$0** = AVAILABLE AT NO ADDITIONAL CHARGE

**NA** = NOT AVAILABLE

**NR** = OPTION NOT RECOMMENDED

# CASTER SELECTIONS

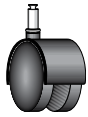

C1	2" Dual Wheel Caster	Black	Carpeted Floor	1 each set of 5	21 88
----	----------------------	-------	----------------	--------------------	----------

**Available on:** Softcurve and Traditional bases.



C7	Slipper Glide (allows chair to remain at caster height)	Black	Any surface	1 each set of 5	21 88
----	---	-------	-------------	--------------------	----------

**Available on:** All bases

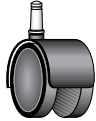

C9R	2 1/2" Dual Wheel Rubber Coated Caster	Black	Vinyl, Marble, Hardwood Floor	1 each set of 5	36 161
-----	---	-------	----------------------------------	--------------------	-----------

**Available on:** All bases



C10	2" Integrated Dual Wheel Caster	Black	Carpeted Floor	1 each set of 5	33 143
-----	------------------------------------	-------	----------------	--------------------	-----------

C10R	Integrated Dual Wheel Rubber Coated Caster	Black	Vinyl, Marble, Hardwood Floor	1 each set of 5	47 209
------	---	-------	----------------------------------	--------------------	-----------

**Available on:** Concorde, Graham, and Malaga bases only.



C14R	Automatic Locking Rubber Caster (while sitting)	Black	Any surface*	1 each set of 5	93 374
------	---	-------	--------------	--------------------	-----------

**Available on:** All bases



C15	Manual Locking Caster (individual)	Black	Carpeted Floor	1 each set of 5	43 194
-----	---------------------------------------	-------	----------------	--------------------	-----------

**Available on:** All bases

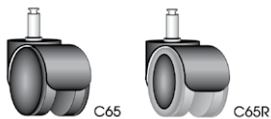











C65	2" Dual Wheel Caster	Black	Carpeted Floor	1 each set of 5	28 88
-----	----------------------	-------	----------------	--------------------	----------

C65R	2" Dual Wheel Rubber Coated Caster	Black	Vinyl, Marble, Hardwood Floor	1 each set of 5	40 161
------	---------------------------------------	-------	----------------------------------	--------------------	-----------

**Available on:** All bases (except wood base chairs).

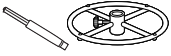
## CASTER NOTES:

- The casters shown above are sold in sets for replacement purposes. This price list can also be used to calculate the upcharge to change casters at time of ordering a chair. Optional casters may be priced higher than the standard casters for your chair and the difference will be charged. Lower priced casters will not be credited.
- All casters are not appropriate for all flooring surfaces. Please consult with your sales representative or Global Customer Service representative for special situations that can be verified with the caster manufacturer. Alternative casters, if needed, may require an upcharge.
- \*Recommended for use on hard surface floors.

	MODEL #	MODEL NAME
	3G	<b>3" cylinder, 360° swivel</b> Soft Descent™ pneumatic lift cylinder with 3 inch travel range. This lift cannot be used on synchro-tilter (-0) and multi-tilter (-3) mechanisms due to operational interference with controls.
	4F	<b>Fixed height 360° swivel spindle #4</b> Fixed height, swivel only. Seat height is determined by the spindle length which is preset at the factory and cannot be changed.
	4L	<b>4" cylinder, 360° swivel, low rise</b> Soft Descent™ low rise, pneumatic lift cylinder with 4 inch travel range.
	5F	<b>Fixed height 360° swivel spindle #5</b> Fixed height, swivel only. Seat height is determined by the spindle length which is preset at the factory and cannot be changed.
	5L	<b>5" cylinder, 360° swivel, low rise</b> Soft Descent™ low rise, pneumatic lift cylinder with 5 inch travel range.
	7G	<b>7" cylinder, 360° swivel</b> Soft Descent™ pneumatic lift cylinder with 7 inch travel range. Lift allows most users to sit at both desk and counter heights. Seats may be too tall for shorter users at desk height.
	7R	<b>7" cylinder, 360° swivel with 20" Chrome footrest</b> Soft Descent™ pneumatic lift cylinder with 7 inch travel range and adjustable footrest. Lift allows most users to sit at both desk and counter heights. Seats may be too tall for shorter users at desk height (refer to cylinder chart on page 416).
	SC	<b>Self-centering, height auto-return, 360° swivel</b> Return-to-center and return-to-height pneumatic height adjust cylinder with 2 inch travel range. Chair swivels back to face the original direction so groups of chairs remain aligned. The seat height may be lowered by occupant. Chair returns to the maximum seat height when user exits the chair.
	SH	<b>Height auto-return, 360° swivel</b> Return-to-height pneumatic height adjust cylinder with 2 inch travel range. The seat height may be lowered by occupant. Chair returns to the maximum seat height when user exits the chair.
	SN	<b>Height auto-return, non-swivel cylinder</b> Return-to-height pneumatic height adjust cylinder with 2 inch travel range. The seat height may be lowered by occupant. Chair returns to the maximum seat height when user exits the chair.

**CYLINDER NOTES:**

- All cylinders are not appropriate for all mechanisms. Please refer to the following chart for compatibility and effect on minimum seat height.
- For cylinder upcharges and replacement costs, please contact Customer Service.

# CYLINDER SELECTIONS

SERIES	CYLINDER	STD	3G	4L	4F	5L	5F	7G	7R	SC	SH	SN
	Mechanism											
ACCORD	-2	4L	NA	STD	NA	+1.5	NA	+1.0	NA	NA	NA	NA
	-4	4G*	NA	NA	+0.5	NA	+1.0	+1.0	NA	+1.5	+1.5	+1.5
ASPEN	-3	4L	-0.75	STD	NA	+1.5	NA	+2.0	NA	NA	NA	NA
G1 ERGO SELECT	-0	4L	N/A	STD	NA	+1.5	NA	NA	NA	NA	NA	NA
	-3	4L	N/A	STD	NA	+1.5	NA	+2.0	NA	NA	NA	NA
	-8	4L	N/A	STD	NA	+1.5	NA	+2.0	NA	NA	NA	NA
G20		5L	-2.25	-1.5	NA	STD	NA	+1.0	NA	NA	NA	NA
GRANADA DELUXE	-2, -3	4L	NA	STD	NA	+1.5	NA	+2.0	NA	NA	NA	NA
	-5	4L	-0.75	STD	NA	+1.5	NA	+2.0	NA	NA	NA	NA
LOOVER	-3	4L	-0.75	STD	NA	+1.5	NA	+2.0	NA	NA	NA	NA
	-4	5L	-2.25	-1.5	NA	STD	+1.0	+1.0	+1.0	+1.75	+1.75	+1.75
	-8	5L	-2.25	-1.5	NA	STD	+1.0	+1.0	+1.0	+2.0	+2.0	+2.0
LURAY	-2	4L	NA	STD	NA	+1.5	NA	NA	NA	NA	NA	NA
	-4	5L	NA	-1.5	+0.5	STD	+1.0	+1.0	NA	+1.5	+1.5	+1.5
MALAGA	-1, -4	5L	-2.25	-1.5	NA	STD	NA	+1.0	NA	NA	NA	NA
	-2, -3	5L	NA	-1.5	NA	STD	NA	+1.0	NA	NA	NA	NA
NOVELLO		5L	-2.25	-1.5	NA	STD	NA	+1.0	NA	NA	NA	NA
OBUSFORME COMFORT	-2, -3	4L	NA	STD	NA	+1.5	NA	+2.0	NA	NA	NA	NA
	-5	4L	-0.75	STD	NA	+1.5	NA	NA	NA	NA	NA	NA
PREFER		4G*	-1.75	-1.25	+0	+0.25	+1.0	+0.75	+0.75	NA	NA	NA
ROMA		4L*	-0.75	STD	NA	+1.5	+2.5	+2.0	NA	+2.0	+2.0	+2.0
SOFTCURVE LM	-1	5L	NA	-1.5	NA	STD	NA	NA	NA	NA	NA	NA
	-2, -3	4L	NA	STD	NA	+1.5	NA	NA	NA	NA	NA	NA
	-4	5L	NA	-1.5	NA	STD	+0.5	NA	NA	+2.0	+2.0	+2.0
SOLAR		4L*	NA	NA	+0.0	NA	+1.0	NA	NA	NA	NA	NA
SORA	-8	4L	-0.75	STD	NA	+1.5	NA	+2.0	+2.0	NA	NA	NA
SPREE		5L	-2.25	-1.5	NA	STD	NA	+1.0	NA	NA	NA	NA
SUPRA-X	-1, -4, -5	5L	-2.25	-1.5	NA	STD	NA	+1.0	NA	NA	NA	NA
	-3	5L	NA	-1.5	NA	STD	NA	+1.0	NA	NA	NA	NA
SYNOPSIS	-3	5L	NA	-1.5	NA	STD	NA	+1.0	NA	NA	NA	NA
	-4	5L	-2.25	-1.5	NA	STD	+1.0	+1.0	NA	+2.25	+2.25	+2.25
TRIUMPH	-3, -8	4L*	-0.75	STD	NA	+1.5	NA	+2.0	NA	NA	NA	NA
TRUFORM	-0	5L	NA	-1.5	NA	STD	NA	NA	NA	NA	NA	NA
	-3	5L	NA	-1.5	NA	STD	NA	+1.0	NA	NA	NA	NA
	-1, -4, -5	5L	NA	-1.5	NA	STD	NA	+1.0	NA	NA	NA	NA
	-8	5L	-2.25	-1.5	NA	STD	NA	+1.0	NA	NA	NA	NA
VION	-3	5L	-2.25	-1.5	NA	STD	NA	+1.0	+1.0	+1.75	+1.75	+1.5
	-4	5L	-2.25	-1.5	NA	STD	+1.0	+1.0	+1.0	+1.0	+1.0	+1.5
	-8	5L	-2.25	-1.5	NA	STD	+0.5	+1.0	NA	NA	NA	+1.5
WEEV	-3, -4, -8	5L	-2.25	-1.5	NA	STD	NA	+1.0	NA	NA	NA	NA

**NOTE:** CHART VALUES INDICATE CHANGE FROM STANDARD MINIMUM SEAT HEIGHT (IN INCHES).

3G AND 7G CYLINDERS ARE NOT AVAILABLE FOR USE WITH -0 SYNCHRO-TILT MECHANISM.

\*SPECIAL CYLINDER





# SWIVEL, FIXED HEIGHT BOARDROOM SEATING

SERIES	MODEL	DESCRIPTION	4" FIXED SPINDLE		5" FIXED SPINDLE		BACK MATERIAL
			SEAT HEIGHT	ARM HEIGHT CLEARANCE	SEAT HEIGHT	ARM HEIGHT CLEARANCE	
GLOBAL ACCORD	2670-4	Upholstered High Back Tilter	17"	26.25"	18"	27.25"	Upholstered
	2671-4	Upholstered Medium Back Tilter	17"	26.25"	18"	27.25"	Upholstered
AUBURN	3767	High Back Tilter	17.5"	25.75"	18.5"	26.75"	Upholstered
ENTERPRISE	4560	High Back Tilter	15.75"	24"	16.75"	25"	Upholstered
	4561	Medium Back Tilter	15.75"	24"	16.75"	25"	Upholstered
FACTOR (W / FIXED ARMS)	5540	High Back	16"	24.25"	17"	25.25"	Mesh
	5541	Medium Back	16"	24.25"	17"	25.25"	Mesh
LOOVER (W / FIXED ARMS)	2660-4	Extended High Back Tilter	16"	24.25"	17"	25.25"	Mesh
	2661-4	High Back Tilter	16"	24.25"	17"	25.25"	Mesh
	2662-4	Medium Back Tilter	16"	24.25"	17"	25.25"	Mesh
	2660-8	Extended High Back Weight Sensing Synchro-Tilter	16"	24.25"	17"	25.25"	Mesh
	2661-8	High Back Weight Sensing Synchro-Tilter	16"	24.25"	17"	25.25"	Mesh
	2662-8	Medium Back Weight Sensing Synchro-Tilter	16"	24.25"	17"	25.25"	Mesh
LURAY	2460-4	Extended High Back Tilter	17"	24.75"	18"	25.75"	Upholstered
	2461-4	High Back Tilter	17"	24.75"	18"	25.75"	Upholstered
NOETIC (W / FIXED ARMS)	6074	Mesh Back Weight Sensing Synchro-Tilter	18.25"	25"	19.25"	26"	Mesh
	6075	Upholstered Back Weight Sensing Synchro-Tilter	18.25"	25"	19.25"	26"	Upholstered
PREFER	8458	Multi-Task Chair, Asphalt Frame + Base	18"	26.75"	19"	27.75"	Mesh
	8459	Multi-Task Chair, Alabaster Frame + Base	18"	26.75"	19"	27.75"	Mesh
ROMA (W / FIXED ARMS)	1897	Honeycomb Poly Medium Back	16.5"	25.5"	17.5"	26.5"	Honeycomb Poly
	1906	Mesh Medium Back	16.5"	25.5"	17.5"	26.5"	Mesh
	1907	Poly Medium Back	16.5"	25.5"	17.5"	26.5"	Poly Flex
SUPRA	5330-4	High Back Tilter	16.5"	26.5"	17.5"	27.5"	Upholstered
	5331-4	High Back Tilter	16.5"	26.5"	17.5"	27.5"	Upholstered
SYNOPSIS	5090-4	High Back Tilter	16.5"	25.25"	17.5"	26.25"	Upholstered
	5091-4	Medium Back Tilter	16.5"	25.25"	17.5"	26.25"	Upholstered
VION (W / FIXED ARMS)	6321-4	Mesh High Back Tilter	16"	26"	17"	27"	Mesh
	6322-4	Mesh Medium Back Tilter	16"	26"	17"	27"	Mesh
	6331-4	Upholstered High Back Tilter	16"	26"	17"	27"	Upholstered
	6332-4	Upholstered Medium Back Tilter	16"	26"	17"	27"	Upholstered
	6321-8	Mesh High Back Weight Sensing Synchro-Tilter	16"	26"	17"	27"	Mesh
	6322-8	Mesh Medium Back Weight Sensing Synchro-Tilter	16"	26"	17"	27"	Mesh
	6331-8	Upholstered High Back Weight Sensing Synchro-Tilter	16"	26"	17"	27"	Upholstered
	6332-8	Upholstered Medium Back Weight Sensing Synchro-Tilter	16"	26"	17"	27"	Upholstered

## NOTE:

- SEATING MODELS CAN BE ORDERED WITH FIXED HEIGHT SPINDLES SHOWN TO ACHIEVE CONSISTENT BACK, SEAT AND ARM HEIGHTS. CONTACT CUSTOMER CARE FOR ORDERING DETAILS.
- DIMENSIONS SHOWN ARE FOR THE SPECIFIED MODEL, MECHANISM NOTED, WITH FIXED ARM OPTION AND STANDARD CASTERS.
- ARM HEIGHT CLEARANCE DIMENSIONS SHOWN INCLUDE OVERALL MAX. FIXED ARM HEIGHT WITH SELECTED SPINDLE PLUS A 1/4" ARM LIFT TOLERANCE FOR CHAIR TILT.
- HEIGHT ADJUST CONTROL HANDLE REMAINS WITH NO HEIGHT ADJUST FUNCTION. ALL OTHER MECHANISM FUNCTIONS REMAIN INCLUDING PUSH/PULL TILT LOCKS.

# DUET AND POPCORN GLIDE SELECTIONS

GLIDES	SURFACE	CARPET	VINYL SHEET	LVT	VCT	RUBBER	CORK	HARDWOOD	LAMINATE	CERAMIC TILE, STONE	MARBLE, GRANITE	CONCRETE
<b>NO GLIDE (XG):</b> The plain Chrome sled based frame slides easily and silently over carpeted surfaces. Note: do not use in damp areas.												
		●	NR	NR	NR	●	NR	NR	NR	NR	NR	NR
<b>CLEAR POLYCARBONATE GLIDE (CG):</b> The polycarbonate glide is easy to move over most flooring. It does not leave marks and it reduces noise on hard surfaces.												
		●	NR	NR	NR	●	NR	NR	NR	NR	NR	●
<b>STAINLESS STEEL PAD ON POLYCARBONATE GLIDE (SG):</b> The stainless steel bottomed glide slides easily. It is extremely durable, reduces floor contact and noise on hard surfaces.												
		●	NR	NR	NR	●	NR	NR	NR	NR	NR	NR
<b>FELT PAD ON POLY CARBONATE GLIDE (FG):</b> The felt bottomed glide moves silently and smoothly on hard surface flooring. Helps to prevent floor damage.												
		NR	●	●	●	NR	●	NR	●	NR	NR	NR
<b>RUBBER NO SLIP PAD ON POLY CARBONATE GLIDE (RG):</b> The rubber bottomed glide is slip-resistant. It grips flooring, reduces movement, scratching and eliminates noise.												
		NR	●	●	●	NR	NR	●	●	●	●	NR

**NOTE:** THE ABOVE IS ONLY A GUIDELINE BASED ON CLEAN AND PROPERLY FINISHED FLOORS. GLIDES THAT ARE NOT RECOMMENDED FOR USE WILL NOT BE COVERED BY GLOBAL'S LIFETIME WARRANTY. SITE CONDITIONS CAN DRAMATICALLY AFFECT HOW APPROPRIATE A GLIDE IS FOR ANY APPLICATION. REGULAR INSPECTION OF GLIDES IS CRITICAL TO PREVENTING FLOOR DAMAGE. SEE DESCRIPTIONS BELOW.

● = BEST FOR APPLICATION

NR = OPTION NOT RECOMMENDED

<b>NO GLIDE (XG):</b> The plain Chrome sled based frame slides easily and silently over carpeted surfaces. Note: do not use in damp areas.
<b>CLEAR POLYCARBONATE GLIDE (CG):</b> The polycarbonate glide is easy to move over most flooring. It does not leave marks and it reduces noise on hard surfaces.
<b>STAINLESS STEEL PAD ON POLYCARBONATE GLIDE (SG):</b> The stainless steel bottomed glide slides easily. It is extremely durable, reduces floor contact and noise on hard surfaces.
<b>FELT PAD ON POLYCARBONATE GLIDE (FG):</b> The felt bottomed glide moves silently and smoothly on hard surface flooring. Helps to prevent floor damage.
<b>RUBBER NO SLIP PAD ON POLYCARBONATE GLIDE (RG):</b> The rubber bottomed glide is slip-resistant. It grips flooring, reduces movement, scratching and eliminates noise.

# specialty

Industrial Seating ..... 421

Industrial Wipe Down ..... 426

Academic Arms + Casters ..... 429

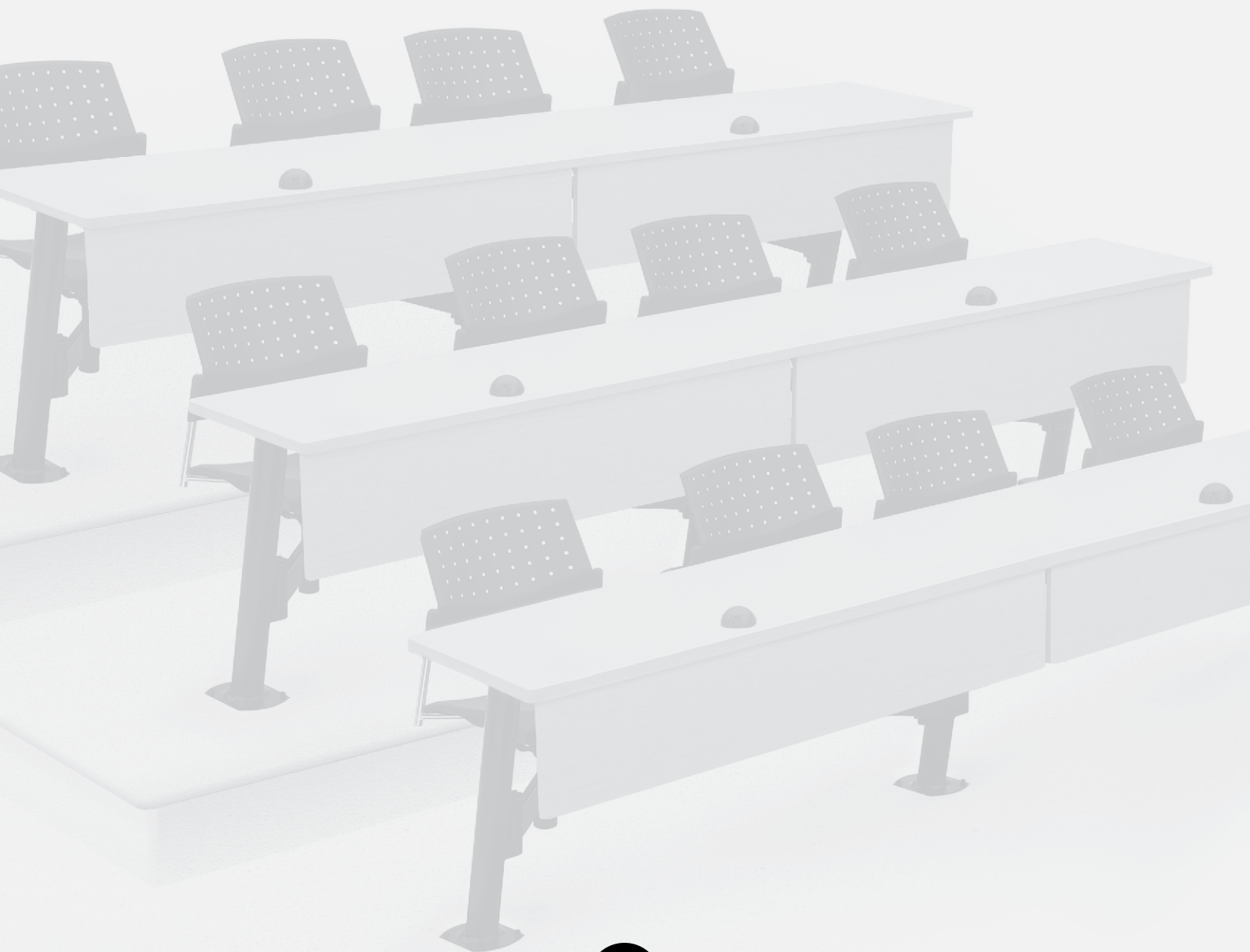

**EXPLANATION OF VARIOUS INDUSTRIAL APPLICATIONS**

This section presents only some of the possibilities that are available. Please contact your Sales Representative for additional information.



**50 - INDUSTRIAL**

Designed for heavier duty intensive environments such as those found in factories, assembly lines and dispatch offices. Seating features durable components including heavy gauge steel construction, chromed chip/corrosion/humidity resistant pneumatic lift cylinders and frames, heavy duty bases, weight activated interval safety casters for hard floors or encased levelling glides, wear resistant fabric or easy clean vinyl upholstery.



**64 - WIPE DOWN**

Furniture designed for dry food manufacturers, hospitals and forensic labs requiring regular and immediate clean up of dust,dirt or powder. Upholstery of any kind is unacceptable here. Features include comfortable Black self-skinned polyurethane seats and backs, chip/corroionn/humidity resistant pneumatic lift cylinders and frames,safety casters or glides. Some "Wipe Down" products may also be available with ESD.

**FABRIC APPLICATION GRID**

APPLICATION	FABRIC/VINYL
<b>50 - Industrial</b>	<p><b>Grade 1 (fabric):</b> Terrace, Waterfall</p> <p><b>Grade 2 (fabric):</b> Imprint</p> <p><b>Grade 2 (vinyl):</b> Allante FFree, Luxhide, MorCare™ Collection (Abbey, Arc, Aristo, Cinema, Nomad, Verve, Vitality)</p>
<b>Wipe Down - 64</b>	No upholstery required, seats are molded self-skinned urethane (SSU) foam.

9

INDUSTRIAL SEATING



model 3212-50 (3N)

model 3288-50 (3N)



**50 - Industrial**  
Designed for heavy duty environments found in factories, assembly lines and dispatch offices. See page 416 for available fabrics.





\* Images shown are for illustration purposes only.





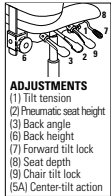

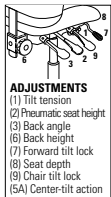

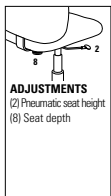
STANDARD FEATURES

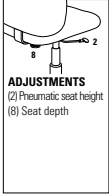

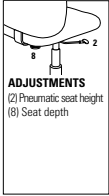

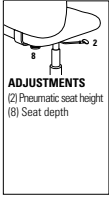
- \*Industrial models have a chrome back upright.
- Granada models feature a molded seat and contoured back with enhanced lumbar support.
- Standard with adjustable height T-arms with curved urethane armcaps (3N) in Black Only.
- Chrome chip/corrosion/humidity resistant pneumatic lift cylinders and frames.
- Chairs have a 5" chrome pneumatic cylinder, stools have a 10" chrome pneumatic cylinder.
- All chairs and stools have chrome back uprights.
- Clear protective back bumper (full surround) is standard on all models.
- Standard with a five-legged, heavy duty molded base in Black.
- C10R casters are standard on Granada models and Minotaur stools.
- Minotaur models are standard with a five-legged, heavy duty base with metal hub and C7R casters.
- Heavy Duty Bench Stools are standard with non-slip rubber glides.
- Check textile availability prior to specifying upholstery material.

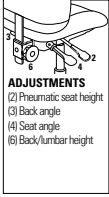
OPTIONAL FEATURES

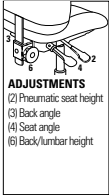

- See back of this section for additional arm or caster options.
- Optional casters may be priced higher than the standard casters for your chair and the difference will be charged. Lower priced optional casters will not be credited.

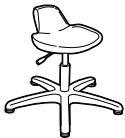
DESCRIPTION	FEATURES	MODEL#	STANDARD TEXTILE GRADES												
			1	2	3	4	5	6	7	8	9	10	11	12	
 <p><b>LB Multi-Tilter</b> COM Yardage: 1.5 Freight Class: 150 Product Weight (lbs.): 52 Cubic Feet Per Carton: 13</p>	 <p><b>ADJUSTMENTS</b> (1) Tilt tension (2) Pneumatic seat height (3) Back angle (6) Back height (7) Forward tilt lock (8) Seat depth (9) Chair tilt lock (5A) Center-tilt action</p>	<b>3212-50</b>	-	1909	1958	2023	2123	-	-	-	-	-	-	-	
		<b>OVERALL DIMENSIONS</b>			<b>SEAT DIMENSIONS</b>			<b>BACK DIMENSIONS</b>							
		<b>W</b>	<b>D</b>	<b>H</b>	<b>W</b>	<b>D</b>	<b>H</b>	<b>W</b>	<b>H</b>						
	25.5	24	40	20.5	17-19.5	18-23	19	17.5-21.5							
	Ergonomic Features: A, B, C, D, E, F, G, H, M, N, Q, S		<b>RTA 2</b>	FedEx		ups									
 <p><b>HB Multi-Tilter</b> COM Yardage: 1.75 Freight Class: 250 Product Weight (lbs.): 55 Cubic Feet Per Carton: 15.5</p>	 <p><b>ADJUSTMENTS</b> (1) Tilt tension (2) Pneumatic seat height (3) Back angle (6) Back height (7) Forward tilt lock (8) Seat depth (9) Chair tilt lock (5A) Center-tilt action</p>	<b>3217-50</b>	-	1970	2038	2126	2252	-	-	-	-	-	-	-	
		<b>OVERALL DIMENSIONS</b>			<b>SEAT DIMENSIONS</b>			<b>BACK DIMENSIONS</b>							
		<b>W</b>	<b>D</b>	<b>H</b>	<b>W</b>	<b>D</b>	<b>H</b>	<b>W</b>	<b>H</b>						
	25.5	24.5	43	20.5	17-19.5	18-23	19	21.5-25.5							
	Ergonomic Features: A, B, C, D, E, F, G, H, M, N, Q, S		<b>RTA 2</b>												
 <p><b>LB Task - Armless</b> COM Yardage: 1.5 Freight Class: 250 Product Weight (lbs.): 32 Cubic Feet Per Carton: 13</p>	 <p><b>ADJUSTMENTS</b> (2) Pneumatic seat height (8) Seat depth</p>	<b>3254-50</b>	-	1327	1376	1444	1544	-	-	-	-	-	-	-	
		<b>OVERALL DIMENSIONS</b>			<b>SEAT DIMENSIONS</b>			<b>BACK DIMENSIONS</b>							
		<b>W</b>	<b>D</b>	<b>H</b>	<b>W</b>	<b>D</b>	<b>H</b>	<b>W</b>	<b>H</b>						
	20.5	24	38	20.5	17-19.5	17-22	19	19							
	Ergonomic Features: C, E, M, N		<b>RTA 2</b>	FedEx		ups									

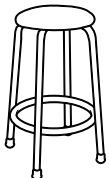
DESCRIPTION	FEATURES	MODEL#	STANDARD TEXTILE GRADES													
			1	2	3	4	5	6	7	8	9	10	11	12		
 <b>LB Task</b> - w/3N Arms COM Yardage: 1.5 Freight Class: 250 Product Weight (lbs.): 40 Cubic Feet Per Carton: 13	 <b>ADJUSTMENTS</b> (2) Pneumatic seat height (8) Seat depth	<b>Granada</b>  Ergonomic Features: C, E, M, N	3255-50	-	1519	1568	1639	1733	-	-	-	-	-	-	-	
			<b>OVERALL DIMENSIONS</b>			<b>SEAT DIMENSIONS</b>			<b>BACK DIMENSIONS</b>							
			<b>W</b>	<b>D</b>	<b>H</b>	<b>W</b>	<b>D</b>	<b>H</b>	<b>W</b>	<b>H</b>						
			25.5	24	38	20.5	17-19.5	17-22	19	19						
			<b>RTA 2</b>	<b>FedEx</b>	<b>ups</b>											
 <b>Stool Task</b> - Armless COM Yardage: 1.5 Freight Class: 250 Product Weight (lbs.): 37 Cubic Feet Per Carton: 13	 <b>ADJUSTMENTS</b> (2) Pneumatic seat height (8) Seat depth	<b>Granada</b>  Ergonomic Features: C, E, M, N	3256-50	-	1527	1577	1644	1741	-	-	-	-	-	-	-	
			<b>OVERALL DIMENSIONS</b>			<b>SEAT DIMENSIONS</b>			<b>BACK DIMENSIONS</b>							
			<b>W</b>	<b>D</b>	<b>H</b>	<b>W</b>	<b>D</b>	<b>H</b>	<b>W</b>	<b>H</b>						
			20.5	24	48	20.5	17.5-19	24-34	19	19						
			<b>RTA 2</b>	<b>FedEx</b>	<b>ups</b>											
 <b>Stool Task</b> - w/3N Arms COM Yardage: 1.5 Freight Class: 250 Product Weight (lbs.): 43 Cubic Feet Per Carton: 15.75	 <b>ADJUSTMENTS</b> (2) Pneumatic seat height (8) Seat depth	<b>Granada</b>  Ergonomic Features: C, E, H, M, N, Q	3257-50	-	1717	1766	1837	1930	-	-	-	-	-	-		
			<b>OVERALL DIMENSIONS</b>			<b>SEAT DIMENSIONS</b>			<b>BACK DIMENSIONS</b>							
			<b>W</b>	<b>D</b>	<b>H</b>	<b>W</b>	<b>D</b>	<b>H</b>	<b>W</b>	<b>H</b>						
			25.5	24	48	20.5	17.5-19	24-34	19	19						
			<b>RTA 2</b>													
 <b>Stool Operator</b> - Armless COM Yardage: 1.5 Freight Class: 250 Product Weight (lbs.): 44 Cubic Feet Per Carton: 13	 <b>ADJUSTMENTS</b> (2) Pneumatic seat height (3) Back angle (4) Seat angle (6) Back/lumbar height	<b>Granada</b>  Ergonomic Features: C, D, F, G, M, N	3278-50	-	1832	1880	1946	2046	-	-	-	-	-	-		
			<b>OVERALL DIMENSIONS</b>			<b>SEAT DIMENSIONS</b>			<b>BACK DIMENSIONS</b>							
			<b>W</b>	<b>D</b>	<b>H</b>	<b>W</b>	<b>D</b>	<b>H</b>	<b>W</b>	<b>H</b>						
			20.5	23.5	48	20.5	17.5	24-34	19	17.5-21						
			<b>RTA 2</b>	<b>FedEx</b>	<b>ups</b>											
 <b>Stool Operator</b> - w/3N Arms COM Yardage: 1.5 Freight Class: 250 Product Weight (lbs.): 52 Cubic Feet Per Carton: 15.75	 <b>ADJUSTMENTS</b> (2) Pneumatic seat height (3) Back angle (4) Seat angle (6) Back/lumbar height	<b>Granada</b>  Ergonomic Features: C, D, F, G, H, M, N, Q	3288-50	-	2020	2069	2137	2234	-	-	-	-	-	-		
			<b>OVERALL DIMENSIONS</b>			<b>SEAT DIMENSIONS</b>			<b>BACK DIMENSIONS</b>							
			<b>W</b>	<b>D</b>	<b>H</b>	<b>W</b>	<b>D</b>	<b>H</b>	<b>W</b>	<b>H</b>						
			25.5	23.5	48	20.5	17.5	24-34	19	17.5-21						
			<b>RTA 2</b>													

DESCRIPTION	FEATURES	MODEL#	STANDARD TEXTILE GRADES											
			1	2	3	4	5	6	7	8	9	10	11	12
 <p><b>Minotaur - Work Stool</b> COM Yardage: 0.75 Freight Class: 300 Product Weight (lbs.): 19 Cubic Feet Per Carton: 14.5</p>	5" Pneumatic  Ergonomic Features: C	<b>9602-50</b>	-	701	728	763	806	-	-	-	-	-	-	
		<b>OVERALL DIMENSIONS</b> W D H			<b>SEAT DIMENSIONS</b> W D H			<b>BACK DIMENSIONS</b> W H						
		14	14	17.5	14	-	15-20	-	-					
		RTA 00      FedEx      UPS												
 <p><b>Minotaur - Work Stool</b> COM Yardage: 0.75 Freight Class: 300 Product Weight (lbs.): 21 Cubic Feet Per Carton: 14.5</p>	10" Pneumatic  Ergonomic Features: C	<b>9604-50</b>	-	798	825	860	903	-	-	-	-	-		
		<b>OVERALL DIMENSIONS</b> W D H			<b>SEAT DIMENSIONS</b> W D H			<b>BACK DIMENSIONS</b> W H						
		14	14	26.5	14	-	21.5-31.5	-	-					
		RTA 00      FedEx      UPS												
 <p><b>Minotaur - Work Stool</b> COM Yardage: N/A Freight Class: 300 Product Weight (lbs.): 16 Cubic Feet Per Carton: 13</p>	5" Pneumatic  Ergonomic Features: C	<b>9611-50</b>	1002	-	-	-	-	-	-	-	-	-		
		<b>OVERALL DIMENSIONS</b> W D H			<b>SEAT DIMENSIONS</b> W D H			<b>BACK DIMENSIONS</b> W H						
		14	14	24.5	14	-	15-20	-	-					
		RTA 00      FedEx      UPS												
 <p><b>Minotaur - Work Stool</b> COM Yardage: N/A Freight Class: 300 Product Weight (lbs.): 22 Cubic Feet Per Carton: 14.5</p>	10" Pneumatic  Ergonomic Features: C	<b>9612-50</b>	1072	-	-	-	-	-	-	-	-	-		
		<b>OVERALL DIMENSIONS</b> W D H			<b>SEAT DIMENSIONS</b> W D H			<b>BACK DIMENSIONS</b> W H						
		14	14	31	14	-	21.5-31.5	-	-					
		RTA 00      FedEx      UPS												
 <p><b>Minotaur - Heavy Duty Work Stool</b> COM Yardage: N/A Freight Class: 300 Product Weight (lbs.): 22 Cubic Feet Per Carton: 14.5</p>		<b>9624-50</b>	-	550	577	612	655	-	-	-	-	-		
		<b>OVERALL DIMENSIONS</b> W D H			<b>SEAT DIMENSIONS</b> W D H			<b>BACK DIMENSIONS</b> W H						
		14	14	27.5	14	-	27.5	-	-					
		RTA 00      FedEx      UPS												

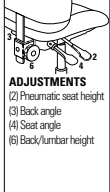

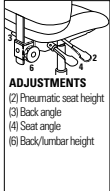
DESCRIPTION	FEATURES	MODEL#	STANDARD TEXTILE GRADES														
			1	2	3	4	5	6	7	8	9	10	11	12			
 <p><b>Minotaur - Stool Operator</b>                      COM Yardage: N/A                      Freight Class: 250                      Product Weight (lbs.): 34                      Cubic Feet Per Carton: 13</p>	 <p><b>ADJUSTMENTS</b>                      (2) Pneumatic seat height                      (3) Back angle                      (4) Seat angle                      (6) Back/lumbar height</p>	9666-50	1489	-	-	-	-	-	-	-	-	-	-				
		<b>OVERALL DIMENSIONS</b>			<b>SEAT DIMENSIONS</b>			<b>BACK DIMENSIONS</b>									
		<b>W</b>	<b>D</b>	<b>H</b>	<b>W</b>	<b>D</b>	<b>H</b>	<b>W</b>	<b>H</b>								
		18	20.5	32	18	17	15-20	16.5	12.5-19								
			<b>RTA 2</b>	<b>FedEx</b>		<b>ups</b>											
 <p><b>Minotaur - Stool Operator</b>                      COM Yardage: N/A                      Freight Class: 250                      Product Weight (lbs.): 35                      Cubic Feet Per Carton: 13</p>	 <p><b>ADJUSTMENTS</b>                      (2) Pneumatic seat height                      (3) Back angle                      (4) Seat angle                      (6) Back/lumbar height</p>	9667-50	1707	-	-	-	-	-	-	-	-	-	-				
		<b>OVERALL DIMENSIONS</b>			<b>SEAT DIMENSIONS</b>			<b>BACK DIMENSIONS</b>									
		<b>W</b>	<b>D</b>	<b>H</b>	<b>W</b>	<b>D</b>	<b>H</b>	<b>W</b>	<b>H</b>								
		18	20.5	42	18	17	21-31	16.5	12.5-19								
			<b>RTA 2</b>	<b>FedEx</b>		<b>ups</b>											

WIPE DOWN - SEATING



model 9632-64



model 9667-64



**64 - Wipe Down**  
Furniture designed for dry food manufacturers, hospitals and forensic labs requiring regular and immediate clean up of dust, dirt or powder.













\* Images shown are for illustration purposes only.





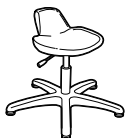





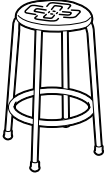

STANDARD FEATURES

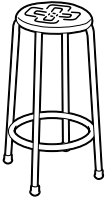





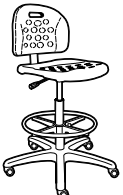







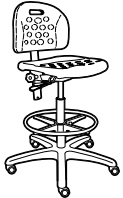

- \*Wipe Down models have a black pneumatic cylinder.
- Minotaur Wipe Down models have comfortable Black, self-skinned polyurethane seats and backs.
- Chip/corrosion/humidity resistant pneumatic lift cylinders and frames.
- Stools have a 5" or 10" black pneumatic cylinder.
- All chairs have a chrome back upright.
- Standard with a five-legged, heavy duty molded base in Black.
- No arms are available for any work stools.
- All Bench Stools have chrome frames.
- Work Stools are shipped fully set-up.

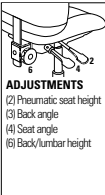
OPTIONAL FEATURES

- Work stools are available with optional **C5** casters at no charge. Please Specify.
- See back of this section for additional arm or caster options.
- Optional casters may be priced higher than the standard casters for your chair and the difference will be charged. Lower priced optional casters will not be credited

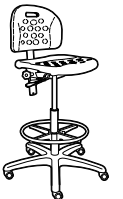
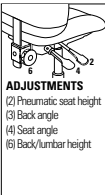
DESCRIPTION	FEATURES	MODEL#	STANDARD TEXTILE GRADES												
			1	2	3	4	5	6	7	8	9	10	11	12	
 <b>Minotaur - Work Stool</b> COM Yardage: N/A Freight Class: 250 Product Weight (lbs.): 14 Cubic Feet Per Carton: 6.5	5" Pneumatic  Ergonomic Features: C	<b>9602-64</b>	\$723	-	-	-	-	-	-	-	-	-	-	-	
		<b>OVERALL DIMENSIONS</b>			<b>SEAT DIMENSIONS</b>			<b>BACK DIMENSIONS</b>							
		<b>W</b>	<b>D</b>	<b>H</b>	<b>W</b>	<b>D</b>	<b>H</b>	<b>W</b>	<b>H</b>						
	14	14	17.5	14	-	15-20	-	-							
															
 <b>Minotaur - Work Stool</b> COM Yardage: N/A Freight Class: 250 Product Weight (lbs.): 20 Cubic Feet Per Carton: 9.5	10" Pneumatic  Ergonomic Features: C	<b>9604-64</b>	\$798	-	-	-	-	-	-	-	-	-	-	-	
		<b>OVERALL DIMENSIONS</b>			<b>SEAT DIMENSIONS</b>			<b>BACK DIMENSIONS</b>							
		<b>W</b>	<b>D</b>	<b>H</b>	<b>W</b>	<b>D</b>	<b>H</b>	<b>W</b>	<b>H</b>						
	14	14	26.5	14	-	21.5-31.5	-	-							
															
 <b>Minotaur - Work Stool</b> COM Yardage: N/A Freight Class: 250 Product Weight (lbs.): 19 Cubic Feet Per Carton: 9.5	5" Pneumatic  Ergonomic Features: C	<b>9611-64</b>	\$871	-	-	-	-	-	-	-	-	-	-	-	
		<b>OVERALL DIMENSIONS</b>			<b>SEAT DIMENSIONS</b>			<b>BACK DIMENSIONS</b>							
		<b>W</b>	<b>D</b>	<b>H</b>	<b>W</b>	<b>D</b>	<b>H</b>	<b>W</b>	<b>H</b>						
	14	14	24.5	14	-	15-20	-	-							
															

DESCRIPTION	FEATURES	MODEL#	STANDARD TEXTILE GRADES													
			1	2	3	4	5	6	7	8	9	10	11	12		
 <p><b>Minotaur - Work Stool</b> COM Yardage: N/A Freight Class: 250 Product Weight (lbs.): 22 Cubic Feet Per Carton: 13.75</p>	<p>10" Pneumatic</p> <p>Ergonomic Features: C</p>	9612-64	\$941	-	-	-	-	-	-	-	-	-	-	-		
			<b>OVERALL DIMENSIONS</b>			<b>SEAT DIMENSIONS</b>			<b>BACK DIMENSIONS</b>							
			<b>W</b>	<b>D</b>	<b>H</b>	<b>W</b>	<b>D</b>	<b>H</b>	<b>W</b>	<b>H</b>						
			14	14	31	14	-	21.5-31.5	-	-						
			<div style="display: flex; align-items: center; gap: 10px;"> <span>RTA 00</span>   </div>													
 <p><b>Minotaur - Heavy Duty Work Stool</b> COM Yardage: N/A Freight Class: 250 Product Weight (lbs.): 17 Cubic Feet Per Carton: 5.5</p>		9624-64	\$723	-	-	-	-	-	-	-	-	-	-	-		
			<b>OVERALL DIMENSIONS</b>			<b>SEAT DIMENSIONS</b>			<b>BACK DIMENSIONS</b>							
			<b>W</b>	<b>D</b>	<b>H</b>	<b>W</b>	<b>D</b>	<b>H</b>	<b>W</b>	<b>H</b>						
			16	16	27.5	14	-	27.5	-	-						
			<div style="display: flex; align-items: center; gap: 10px;"> <span>RTA 00</span>   </div>													
 <p><b>Minotaur - Heavy Duty Work Stool</b> COM Yardage: N/A Freight Class: 250 Product Weight (lbs.): 19 Cubic Feet Per Carton: 5.5</p>		9632-64	\$755	-	-	-	-	-	-	-	-	-	-	-		
			<b>OVERALL DIMENSIONS</b>			<b>SEAT DIMENSIONS</b>			<b>BACK DIMENSIONS</b>							
			<b>W</b>	<b>D</b>	<b>H</b>	<b>W</b>	<b>D</b>	<b>H</b>	<b>W</b>	<b>H</b>						
			16	16	32.5	14	-	32.5	-	-						
			<div style="display: flex; align-items: center; gap: 10px;"> <span>RTA 00</span>   </div>													
 <p><b>Minotaur - Work Stool Task</b> COM Yardage: N/A Freight Class: 250 Product Weight (lbs.): 26 Cubic Feet Per Carton: 13</p>	<p>5" Pneumatic</p> <p>Ergonomic Features: C, E</p>	9662-64	\$1015	-	-	-	-	-	-	-	-	-	-			
			<b>OVERALL DIMENSIONS</b>			<b>SEAT DIMENSIONS</b>			<b>BACK DIMENSIONS</b>							
			<b>W</b>	<b>D</b>	<b>H</b>	<b>W</b>	<b>D</b>	<b>H</b>	<b>W</b>	<b>H</b>						
			18	21	32	18	16.5-19	14-19	16.5	16						
			<div style="display: flex; align-items: center; gap: 10px;"> <span>RTA 00</span>   </div>													
 <p><b>Minotaur - Work Stool Task</b> COM Yardage: N/A Freight Class: 250 Product Weight (lbs.): 33 Cubic Feet Per Carton: 13</p>	<p>10" Pneumatic</p> <p>Ergonomic Features: C, E</p>	9663-64	\$1231	-	-	-	-	-	-	-	-	-	-			
			<b>OVERALL DIMENSIONS</b>			<b>SEAT DIMENSIONS</b>			<b>BACK DIMENSIONS</b>							
			<b>W</b>	<b>D</b>	<b>H</b>	<b>W</b>	<b>D</b>	<b>H</b>	<b>W</b>	<b>H</b>						
			18	20.5	42	18	16.5-19	20-30	16.5	16.5						
			<div style="display: flex; align-items: center; gap: 10px;"> <span>RTA 00</span>   </div>													

DESCRIPTION	FEATURES	MODEL#	STANDARD TEXTILE GRADES											
			1	2	3	4	5	6	7	8	9	10	11	12
 <b>Minotaur - Stool Posture Task</b> COM Yardage: N/A Freight Class: 250 Product Weight (lbs.): 30 Cubic Feet Per Carton: 13	5" Pneumatic  Ergonomic Features: C, D	<b>9664-64</b> \$1159	-	-	-	-	-	-	-	-	-	-	-	
			<b>OVERALL DIMENSIONS</b> W    D    H			<b>SEAT DIMENSIONS</b> W    D    H			<b>BACK DIMENSIONS</b> W    H					
			0	0	0	18	16	14-19	16.5	12.5-19				
			  											
 <b>Minotaur - Stool Posture Task</b> COM Yardage: N/A Freight Class: 250 Product Weight (lbs.): 33 Cubic Feet Per Carton: 13	10" Pneumatic  Ergonomic Features: C, D	<b>9665-64</b> \$1374	-	-	-	-	-	-	-	-	-	-		
			<b>OVERALL DIMENSIONS</b> W    D    H			<b>SEAT DIMENSIONS</b> W    D    H			<b>BACK DIMENSIONS</b> W    H					
			0	0	0	18	16	20.5-30.5	16.5	12.5-19				
			  											
 <b>Minotaur - Stool Operator</b> COM Yardage: N/A Freight Class: 250 Product Weight (lbs.): 34 Cubic Feet Per Carton: 13	 <b>ADJUSTMENTS</b> (2) Pneumatic seat height (3) Back angle (4) Seat angle (6) Back/lumbar height	<b>9666-64</b> \$1363	-	-	-	-	-	-	-	-	-	-		
			<b>OVERALL DIMENSIONS</b> W    D    H			<b>SEAT DIMENSIONS</b> W    D    H			<b>BACK DIMENSIONS</b> W    H					
			0	0	0	18	17	15-20	16.5	12.5-19				
			  											
 <b>Minotaur - Stool Operator</b> COM Yardage: N/A Freight Class: 250 Product Weight (lbs.): 35 Cubic Feet Per Carton: 13	 <b>ADJUSTMENTS</b> (2) Pneumatic seat height (3) Back angle (4) Seat angle (6) Back/lumbar height	<b>9667-64</b> \$1579	-	-	-	-	-	-	-	-	-	-		
			<b>OVERALL DIMENSIONS</b> W    D    H			<b>SEAT DIMENSIONS</b> W    D    H			<b>BACK DIMENSIONS</b> W    H					
			18	20.5	42	18	17	21-31	16.5	12.5-19				
			  											

**ACADEMIC REPLACEMENT ARMS**

(For Task Seating models ONLY)  
 Arms other than those provided as standard on your chair.  
 Refer to chart below for availability by series.

	STD	AL	F	O	OJ	TD	ZH	3N	4J	4M	4T	GL
<b>GOAL</b>	3N	NR	NR	42	106	42	NR	<b>STD</b>	139	77	77	NR
<b>GRANADA</b>	3N	83	201	42	106	42	0	<b>STD</b>	139	77	77	77

**\$0** = AVAILABLE AT NO ADDITIONAL CHARGE

**NR** = OPTION NOT RECOMMENDED

**INDUSTRIAL REPLACEMENT ARMS**

Optional arms for INDUSTRIAL and ESD seating ONLY.

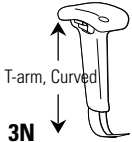
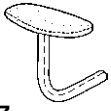
 <p>T-arm, Curved</p> <p><b>3N</b></p>	Industrial Seating Series	Options	*Replacement Arm Price	**Optional Arm Price
	Adjustable height	urethane	STD	\$241
 <p><b>2Z</b></p>	Industrial Seating Series	Options	*Replacement Arm Price	**Optional Arm Price
	Fixed height T-arm, Kidney Shaped	upholstered	STD (ESD Models)	\$122

Notes:

\* Use this column to select another arm other than the one provided on your chair.

\*\* Use this column to select arms for a chair that doesn't come with arms.

# INDUSTRIAL CASTER SELECTIONS SPECIALTY



<b>C5</b>	Large Ball Caster	Chrome Hood/ Black Ball	Hard Floor	1 each	<b>\$25</b>
-----------	-------------------	----------------------------	------------	--------	-------------

**Available as a substitute for C56 glides on Wipe Down Work stools at no charge.**



<b>C7R</b>	Slipper Glide		All surface except ESD	1 each	<b>\$27</b>
------------	---------------	--	---------------------------	--------	-------------

**Standard on Industrial and Wipe Down Minotaur Work stools.**

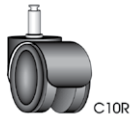

<b>C10R</b>	Integrated Dual Wheel Rubber Coated Caster	Black	Vinyl, Marble, Hardwood Floor	1 each	<b>\$47</b>
-------------	---	-------	----------------------------------	--------	-------------

**Standard on Industrial , Wipe Down Minotaur stools and Granada models**



<b>C39R</b>	Dual Wheel, Hard Floor Safety Caster w/Interval Brake	Galvanized Steel Axle w/Chrome Plated Hood Zinc die cast frame)	Hard Floor Surfaces	1 each	<b>\$71</b>
-------------	---	--	---------------------	--------	-------------

**Standard on Industrial chairs and stools. Weight activated release brake helps to prevent chair from moving when not in use.**



<b>C65R</b>	2" Dual Wheel Rubber Coated Caster	Black	All surfaces except ESD	1 each	<b>\$40</b>
-------------	---------------------------------------	-------	----------------------------	--------	-------------

## INDUSTRIAL CASTERS NOTES:

- Prices listed for Industrial Casters are upcharges when substituted on Industrial chair orders.
- Industrial Casters are not suitable for use on standard Global seating products.
- All casters are not appropriate for all flooring surfaces. Please consult with your Sales Representative or Global Customer Care for special situations that can be verified with the caster manufacturer. Alternate casters, if needed, may require an upcharge.

**PLEASE SPECIFY ALL SUBSTITUTIONS AND OPTIONS.**

# textiles and finishes

## Care and Cleaning

### TEXTILES

**Fabrics:** To extend the life of your seating upholstered in fabric, regularly dust the chair to prevent airborne particles from penetrating the fabric surface.

For light soiling, use a damp cloth and blot the spot with very slight pressure, taking care never to soak the fabric. Dry with a clean cloth by blotting - never rub fabric. More intense stains can be treated the same way, but with a mild detergent. Always test fabric first in an unseen area before using any cleaning method.

**Leather:** For regular cleaning, simply use a soft damp cloth, taking care not to soak the leather. For more thorough treatment, soak a soft cloth in mild soap solution and wipe surface in a light circular motion. Repeat with clean water. Allow to dry and polish with a soft dry cloth. Do not use detergents, aerosol sprays or other polishes.

### Various Care and Cleaning Methods

- **Water-Based Cleaner:** Spot clean, using the foam only from a water-based cleaning agent, such as a mild detergent or non-solvent upholstery shampoo product. Apply foam with a soft brush in a circular motion. Vacuum when dry. Pretest small area before proceeding.
- **Solvent Cleaner:** Spot clean, using a mild water-free solvent or dry cleaning product. Clean only in a well-ventilated room and avoid any product containing carbon tetrachloride or other toxic materials. Pre-test a small area before proceeding.
- **Water/Solvent Cleaner:** Spot clean with amid solvent, an upholstery shampoo, or the foam from a mild detergent. When using a solvent or dry cleaning product, follow instructions carefully and clean only in a well-ventilated room. Avoid any product that contains carbon tetrachloride or other toxic materials. With either method, pretest a small area before proceeding.
- **Vacuum Only:** Clean this fabric only by vacuuming or light brushing to prevent accumulation of dust and grime. Water-based foam cleaning agents of any kind may cause excessive shrinking, staining, or distortion of the surface pile and therefore, should not be used.
- **Crypton Cleaning:** Generally stains are removed with plain water and powdered enzyme detergent. Upholstery foam shampoo, water-based cleaning products and germicidal detergents can be used. Be sure to remove all residue from cleaning products with clean water. Do not use solvent-based cleaners or dry cleaning products.

---

### HARD SURFACES

**Wood Veneer Finishes:** Waxing or polishing catalyzed finishes is not recommended because this will give a greasy, cloudy or uneven appearance to the product and could void your warranty. Global's conversion varnish is best cleaned by wiping the surface with a damp cloth, followed by a soft dry cloth in the direction of the grain. If the surfaces are heavily soiled, a gentle product like "Windex" can be used, following the same instructions as above.

**Laminate & Painted Metal Finishes:** Using a soft cloth, simply wipe the surface with a mild soap solution or glass cleaner. Always use a dry cloth and circular motion to prevent streaks.

# TEXTILES & FINISHES

## Textile Price Grades - Global Textiles

Grade 1	Carrera, Dobby, Fusion, Illusion, Jenny, Quilt, Terrace, Trak, Urban, Waterfall, Wavelength
Grade 2	Allante FRee, Elevate, Etch, GC Linen, Imprint, Luxhide, Release
Grade 3	Non standard GLOBAL textiles
Grade 4	Non standard GLOBAL textiles
Grade 6	Novaro Genuine Leather, non standard GLOBAL textiles
Grade 7	Non standard GLOBAL textiles
Grade 8	Non standard GLOBAL textiles
Grade 9	Non standard GLOBAL textiles
Grade 11	Non standard GLOBAL textiles
Grade 10	Non standard GLOBAL textiles
Grade 12	Non standard GLOBAL textiles

Please refer to individual seating series for availability of a particular textile.

The charts above do not include Textiles offered by Alliance Partners: Architex, Arc-Com Fabrics, Designtex, Green Hides, LDI Interiors, Luum Textiles, Maharam, Mayer Fabrics, and Momentum.

## Blend Seating Textiles

The grid below outlines the grade structure for using multiple textiles on select seating series. Blended textiles occur when one textile is chosen for one part of the chair and a different textile is selected for another part of the chair, resulting in a revised "blended grade".

NOT FOR USE with Calidon, Drift, Erin, Noetic, River+ or Willow. See series price list pages for applicable pricing.

For specification and pricing for more than two different textiles, please contact Global CustomerCare for approval process and pricing.

### FIRST TEXTILE SELECTED

		FIRST TEXTILE SELECTED																	
		1	2	3	4	5	6	7	8	9	10	11	12	13	14	15	16	17	18
SECOND TEXTILE SELECTED	1	1																	
	2	2	2																
	3	3	3	3															
	4	3	4	4	4														
	5	4	4	5	5	5													
	6	5	5	5	6	6	6												
	7	5	6	6	6	7	7	7											
	8	6	6	7	7	7	8	8	8										
	9	7	7	7	8	8	8	9	9	9									
	10	8	8	8	8	9	9	9	10	10	10								
	11	9	9	9	9	9	10	10	10	11	11	11							
	12	10	10	10	10	10	10	11	11	11	12	12	12						
	13	11	11	11	11	11	11	12	12	12	12	13	13	13					
	14	11	12	12	12	12	12	12	13	13	13	13	14	14	14				
	15	12	12	13	13	13	13	13	13	14	14	14	14	15	15	15			
	16	13	13	13	14	14	14	14	14	14	15	15	15	15	16	16	16		
	17	14	14	14	14	15	15	15	15	15	15	16	16	16	16	17	17	17	
	18	15	15	15	15	15	16	16	16	16	16	16	17	17	17	17	18	18	18

## Textile and Color Listings

### Grade 1

#### Carrera 100% Polyester

CE84 Zest	CE85 Savannah	CE86 Slate	CE87 Rainforest	CE88 Aspen	CE89 Dune	CE90 Flannel
CE91 Azure	CE92 Chili	CE93 Jute	CE95 Ink	CE96 Sangria	CE97 Java	CE98 Charcoal

#### Dobby 96% Recycled Polyester / 4% Virgin Polyester

DB30 Snowcap	DB31 Bonsai	DB32 Cloud	DB33 Sand	DB34 Pewter	DB35 Santa Fe	DB36 Corfu
DB37 Medium Taupe	DB38 Charcoal	DB39 Berry	DB40 Royal	DB41 Titanium	DB42 Black	

#### Fusion 90% Virgin Polyester / 10% Post-Consumer Recycled Polyester

FU71 Tangerine	FU72 Fresh	FU73 Moss	FU74 Tomato	FU75 Aqua	FU76 Sandstone	FU77 Granite
FU78 Poppy	FU79 Cadet	FU80 Oasis	FU81 Graphite	FU82 Viola	FU83 Cobalt	FU84 Flax
FU85 Carbon						

#### Illusion 100% Virgin Polyester

II01 Cappuccino	II02 Paprika	II03 Tropic	II04 Wicker	II05 Hemp	II06 Cayenne	II07 Maui
II08 Dusk	II09 Smoke	II10 Currant	II11 Fiji	II12 Ozone	II13 Ebony	

#### Jenny 100% Polyester

JN01 Midnite	JN02 Ebony	JN03 Slate	JN07 Vermilion	JN08 Admiral	JN11 Charcoal	JN25 Silver Lining
JN26 Oatmeal	JN27 Sunflower	JN28 Cascade	JN29 Harvest	JN30 Melon	JN31 Berry	JN32 Green Grass
JN33 Roast						

#### Quilt 100% Polyester

QL10 Black	QL11 Charcoal Grey	QL14 Navy	QL16 Wine	QL19 Silver	QL20 Feather	QL21 Dune
QL22 Meadow	QL23 Cadet	QL24 Geranium	QL25 Daisy	QL26 Quest	QL27 Punch	QL28 Tangerine
QL29 Cocoa						

#### Terrace 70% Virgin Polyester / 30% Post-Consumer Recycled Polyester

TC61 Tigerlily	TC62 Shadow	TC63 Cobble	TC64 Cherry Blossom	TC65 Bluebell	TC66 Apple	TC67 Haze
TC68 Cerise	TC69 Twilight	TC70 Wintergreen	TC71 Ironwork	TC72 Pine Cone	TC73 Flirt	TC74 Echo
TC75 Glacier						

#### Trak 100% Recycled Polyester

TK40 Taupe	TK41 Mustard	TK42 Latte	TK43 Cement	TK44 Silver	TK45 Copper	TK46 Teal
TK47 Apple	TK48 Steel	TK49 Merlot	TK50 Midnight Sky	TK51 Mocha	TK52 Carbon	

#### Urban 62% Recycled Polyester / 32% Polyester

UR11 Ocean Blue	UR12 Blue Bayou	UR13 Green Grass	UR18 Brown Ridge	UR19 White Sand	UR20 Granite Rock	UR21 Gravel Road
UR22 Black Coal						

#### Waterfall 60% Virgin Polyester / 40% Post-Consumer Recycled Polyester

WA40 Trance	WA41 Tryst	WA42 Splash	WA43 Victoria	WA44 Imagine	WA45 Sky	WA46 Rainforest
WA47 Rumble	WA48 Prism	WA49 Tranquility	WA50 Grand	WA51 Rushing	WA52 Magestic	WA53 Pacific
WA54 Dance						

#### Wavelength 100% Virgin Polyester

WV01 Lime	WV02 Mint	WV03 Stone	WV04 Flame	WV05 Mykonos	WV06 Savannah	WV07 Mesa
WV08 Plasma	WV09 Cancun	WV10 Quartz	WV11 Moonrock	WV12 Rubine	WV13 Corfu	WV14 Bluejay
WV14 Panther						

### Grade 2

#### Elevate 80% Post-Consumer Recycled Polyester / 20% Rayon

EL51 Halo	EL52 Dove	EL53 Safari	EL54 Sunglow	EL55 Margarita	EL56 Fiji	EL57 Mist
EL58 Blaze	EL59 Wasabi	EL60 Mystic	EL61 Mica	EL62 Cherry	EL63 Scuba	EL64 Lapis
EL65 Onyx						

#### Etch 80% Post-Consumer Recycled Polyester / 20% Rayon

ET81 Drift	ET82 Citron	ET83 Calypso	ET84 Mandarin	ET85 Crisp	ET86 Iris	ET87 Nickel
ET88 Paprika	ET89 Nutmeg	ET90 Marine	ET91 Magnet	ET92 Infrared	ET93 Espresso	ET94 Indigo
ET95 Anthracite						

#### Imprint 100% Post-Consumer Polyester

IM70 Almond	IM71 Cork	IM72 Sand	IM73 Currie	IM74 Candy Apple	IM75 Ocean	IM76 Navy
IM77 Green Tea	IM78 Celery	IM79 Oregon	IM80 Walnut	IM81 Paprika	IM82 Graphite	IM83 Slate
IM84 Licorice						

# TEXTILES & FINISHES

**Grade 2 (Vinyl)** For availability of chair series in Vinyl, please contact a Global Sales Representative.

**Allante FRee** 100% Vinyl Face / 100% Polyester Backing

A01F Illusion	A02F Bright White	A03F White Crush	A04F Ivory	A05F Ice	A06F Bleached Sand	A07F Taupe Fawn
A08F Warm Smoke	A09F Autumn Rain	A10F Cookie	A11F Sierra Brick	A12F Gibraltar	A13F Chateau Grey	A14F Garden Green
A15F Oasis Green	A16F Ink Black	A17F Purple Impulse	A18F Italian Rose	A19F Mountain Sky	A20F Old Navy	A21F Galaxy
A22F Red Truffle	A23F Chocolate Sundae	A24F Province Blue	A25F Eclipse			

**GC Linen** 100% Vinyl Face

LE50 Potters Clay	LE51 Pearl	LE52 Tan	LE53 Storm	LE54 Butter	LE55 Haystack	LE56 Ganache
LE57 Sunset	LE58 Burnt Orange	LE59 Cayenne	LE60 Navy	LE61 Bamboo	LE62 Gray	LE63 Charcoal
LE64 Moss						

**Luxhide** 100% Vinyl Face / Bonded Leather Backing

BL20 Black	BL22 Parchment	BL23 Saddle	BL24 Dark Brown	BL26 Burgundy	BL27 Charcoal	BL28 White
BL34 Light Grey						

**Release** 100% Vinyl Face

RL11 White	RL12 Chalk	RL13 Stone	RL14 Taupe	RL15 Orange	RL16 Country	RL17 Tuscan
RL18 Cottage	RL19 Yellow	RL21 Red Barn	RL22 Brave Red	RL23 Gypsy Red	RL24 Cajun	RL25 Vineyard
RL26 Olive	RL27 Bonsai	RL28 Summer's Dream	RL29 Calico	RL31 Green	RL32 Blue	RL33 Black
RL34 Cool Grey	RL35 Thunder Grey	RL36 Navy	RL37 Dark Chocolate	RL38 Espresso		

**Grade 6**

**Novaro Genuine Leather** 100% Leather

NO50 Ash	NO51 Asphalt	NO52 Bison	NO53 Blueberry	NO54 Cloud	NO55 Clove	NO56 Cordovan
NO57 Doe	NO58 Linen	NO59 Marina	NO60 Phantom	NO61 Pigeon	NO62 Scarlet	NO63 Turtle
NO64 Wheat						

**Panel Fabrics**

**GRADE 2**

**Lola** 100% Polyester.

LL11 Medium Taupe	LL12 Caramel Cream	LL14 Blue Mist	LL35 Spray	LL36 Granite	LL37 Cinder	LL38 Sandstone
-------------------	--------------------	----------------	------------	--------------	-------------	----------------

**GRADE 3**

**Anchorage** 65% Pre-consumer Polyester / 35% Post-consumer Polyester

AN40 Birch	AN41 Green Apple	AN42 Lapis	AN43 Straw	AN44 Wolf	AN45 Goose	AN46 Angora
AN47 Cumin	AN48 Asteroid	AN49 Geranium	AN50 Thistle	AN51 Graphite	AN52 Slate	AN53 Quarry Blue
AN54 Onyx	AN55 Pumpkin	AN56 Red Delicious	AN57 Sunshine	AN59 Waterfall	AN61 Vanilla	AN62 Cobalt
AN64 Cloud						

**Merge** 100% Polyester / 75% Post-consumer Recycled Polyester

MG20 Fawn	MG21 Marshmallow	MG22 Driftwood	MG23 Dove	MG24 Graphite	MG25 Slate	MG26 Eucalyptus
MG27 Fire Engine	MG28 Mediterranean	MG29 Midnight				

## FINISHES

**Seating Finishes - Metal:** Please consult each Seating Series for finish availability.

Antique Copper (ACO)	Black (TBL)	Brushed Chrome (BCH)	Buzz Blue (TBZ)	Cactus (TCC)	Carrot (TCR)	Cloud (TIV)	Chrome (CHM)
Designer White (TDW)	Dijon (TDJ)	Eggplant (TEG)	Fog (TFO)	Frost (TFR)	Ink (TIN)	Kalua (TKA)	Shadow (TSH)
Latte (TLA)	Mocha (TMO)	Nevada (TNE)	Sand (TSN)	Satin Brass (SBR)	Scarlet (TSR)		
Toast	(TOA)	Tungsten (TT)					

**Seating Finishes - Plastic** (Duet, Popcorn, and Sonic)

Buzz Blue (BZB)	Cactus (CCT)	Carrot (CRO)	Cloud (IVC)	Dijon (DJN)	Eggplant (EGP)	Fog (FOG)
Frost (FRO)	Ink (INK)	Latte (LAB)	Night (BLK)	Sand (SND)	Scarlet (SAR)	Shadow (SHW)

**Seating Finishes - Wood** Seating finishes will not necessarily match Casegoods finishes. This is due to the fact that Seating and Casegoods finishes use different wood species and are manufactured at multiple locations.

Absolute (AAM)	Black (BKM)	Cherry (ACM)	Espresso Cafe (ECM)	English Oak (EOM)	Fruitwood (TFM)	Gray (HGM)
Honey (AHM)	Mahogany (TMM)	Maple (AVM)	Medium Walnut (MWM)	Natural Walnut (NLW)	Night (ASM)	Noce Biondo (NBM)
Noce Grigio (NGM)	Noce Leggero (NEM)	Noce Medio (NMM)	Shaker Cherry (SKM)	Walnut (TWM)	WC Cream (WTM)	White (WHM)
Winter Cherry (WCM)						

**Desks, Workstations, Tables and Accessories - Laminate**

Absolute Acajou (ACJ)	Asian Night (ASN)	Avant Cherry (AWC)	Avant Honey (AWH)	Black (BLK)	Blizzard (BZD)	Brushed Cobalt (BRC)
Clear Maple (CMB)	Custom Grey (CGY)	Dark Espresso (DES)	Designer White (DWT)	Fashionista (FAS)	First Class (FCL)	Noce Biondo (NBL)
Noce Grigio (NGL)	Noce Leggero (NEL)	Noce Medio (NML)	Quartered Mahogany (QTM)	Sheer Beauty (SBY)	Stonedust (SDT)	Storm Grey (SOG)
Walnut Heights (WHE)	White Chocolate (WHC)	Winter Cherry (WCR)				

**Desks, Workstations, Tables and Accessories - Wood Veneer**

Amber Cherry (ACW)	Almond Cherry (AMW)	Biscotti (BTW)	Cocoa Walnut (CAW)	Coral (CRW)	Dark Cherry (DCW)	Dark Walnut (DWW)
Espresso Walnut (EWW)	Evening Oak (EVW)	Grey on Oak (GRW)	Hazelnut (HAW)	Java (JAW)	Latte Walnut (LTW)	Mahogany on Walnut (MHW)
Milestone (MTW)	Natural Maple (MPW)	Natural Walnut (NLW)	Red Cherry (RCW)	Umber Walnut (ULW)	Vintage Cherry (VNW)	Walnut (WLW)
Warm Cherry (WCW)	White Maple (WMW)					

**Metal File + Storage Finishes**

Business Grey (BGR)	Black Coffee Textured (BKC)	Black (BLK)	Bone (BNE)	Blizzard Textured (BZD)	Charcoal (CHR)
Claret (CLT)	Dark Chocolate Textured (DCH)	Desert Putty (DPT)	Designer White (DWT)	Fog (FOG)	Grey (GRY)
Light Grey (LGR)	Ice (ICE)	Ivory (IVR)	Mocha Textured (MCH)	Metro (MET)	Moss (MOS)
Nevada (NEV)	Navy (NVY)	Oyster (OYS)	Stonedust Textured (SDT)	Storm Grey (SGR)	Silver (SIL)
Sky (SKY)	Stone (STN)	Taupe (TPE)	Tahiti Sand (TSA)	Tungsten (TUN)	Willow (WIL)

# TEXTILES & FINISHES

## Solid Wood and Laminate Coordinating Colors

### Solid Wood Colors

Absolute (AAM)  
 Black (BKM)  
 Cherry (ACM)  
 Espresso Cafe (ECM)  
 Fruitwood (TFM)  
 Gray (HGM)  
 Honey (AHM)  
 Mahogany (TMM)  
 Maple (AVM)  
 Medium Walnut (MWM)  
 Night (ASM)  
 Noce Biondo (NBM)  
 Noce Grigio (NGM)  
 Noce Leggero (NEM)  
 Noce Medio (NMM)  
 Walnut (TWM)  
 WC Cream (WTM)  
 White (WHM)  
 Winter Cherry (WCM)

### Laminate Colors

Absolute Acajou (ACJ)  
 Black (BLK)  
 Avant Cherry (AWC)  
 Dark Espresso (DES)  
  
 Avant Honey (AWH)  
 Quartered Mahogany (QTM)  
 Clear Maple (CMB)  
  
 Asian Night (ASN)  
 Noce Biondo (NBL)  
 Noce Leggero (NEL)  
 Noce Leggero (NEL)  
 Noce Medio (NML)  
  
 White Chocolate (WHC)  
 Designer White (DWT)  
 Winter Cherry (WCR)

DRIFT TABLE FINISHES COORDINATION CHART			
HPL TOP FINISH		COORDINATING WOOD BASE FINISH	
ACJ**	Absolute Acajou	AAM	Absolute
ASN**	Asian Night	ASM	Night
AWC**	Avant Cherry	ACM	Cherry
AWH**	Avant Honey	AHM	Honey
BLK**	Black	BKM	Black
CMB**	Clear Maple	AVM*	Maple
DES**	Dark Espresso	ECM	Espresso Cafe
DWT**	Designer White	WHM	White
NBL**	Noce Biondo	NBM	Noce Biondo
NEL**	Noce Leggero	NEM	Noce Leggero
NGL**	Noce Grigio	NGM	Noce Grigio
NML**	Noce Medio	NMM	Noce Medio
QTM**	Quartered Mahogany	TMM	Mahogany
WCR**	Winter Cherry	WCM	Winter Cherry
WHC**	White Chocolate	WTM	WC Cream
WHE**	Walnut Heights	MWM	Medium Walnut
HPL TOP FINISHES WITH NO COORDINATING WOOD BASE FINISHES		WOOD BASE FINISHES WITH NO COORDINATING HPL TOP FINISHES	
BRC**	Brushed Cobalt	EOM	English Oak
BZD**	Blizzard	NLW	Natural Walnut
CGY**	Custom Grey	SKM	Shaker Cherry
FAS**	Fashionista	TFM	Fruitwood
FCL**	First Class	TWM	Walnut
SBY**	Sheer Beauty	HGM	Grey
SDT**	Stone Dust		
SOG**	Storm Grey		

\*\*Chrome base models are available for all HPL Top Finishes

Please note that these finishes are coordinating and not exact matches. Please reach out to your Global Sales Representative for physical samples of finishes prior to ordering.

# METAL LEG, FRAME + BASE FINISH CHART

	paint finishes																			plated finishes				
	Black	Tungsten	Shadow	Latte	Mocha	Kalua	Toast	Designer White	Nevada	Fog	Cloud	Sand	Frost	Dijon	Carrot	Scarlet	Cactus	Buzz Blue	Eggplant	Ink	Chrome	Brushed Chrome		
OLD FINISH CODE	BLK	TUN	SHW	LAB	J52	KAL	TOA	DWT	NEV	FOG	IVC	-	-	-	-	-	-	-	-	-	CH	BSC		
NEW FINISH CODE	TBL	TTU	TSH	TLA	TMO	TKA	TOA	TDW	TNE	TFO	TIV	TSN	TFR	TDJ	TCR	TSR	TCC	TBZ	TEG	TIN	CHM	BCH		
<b>GUEST SEATING</b>																								
Caprice	●	●	●	●	●	●	●	●	●	●	●	●	●	●	●	●	●	●	●	●	●*	●*		
Comet	●	●	●	●	●	●	●	●	●	●	●	●	●	●	●	●	●	●	●	●	●*			
Diplomat	●	●	●																		●*			
Drift (sled bases)	●	●	●	●	●	●	●	●	●	●	●	●	●	●	●	●	●	●	●	●	●*			
Lite	●	●	●	●	●	●	●	●	●	●	●	●	●	●	●	●	●	●	●	●	●*	●*		
Marche	●	●*																			●*	●*		
Moda (four leg)	●*	●*	Also available in three woodgrain patterns																			●		
Sas	●	●																			●*			
Sidero	●	●	●	●	●	●	●	●	●	●	●	●									●*			
Solo (models 5225 + 5226)	●	●	●																		●*			
Supra (armchairs)	●	●																			●*			
Twilight	●	●																						
Tye (armchair)	●	●																			●*			
Willow	●	●	●	●	●	●	●	●	●	●	●	●	●	●	●	●	●	●	●	●	●*	●*		
<b>STACKING/NESTING CHAIRS</b>																								
Duet (sled bases)																					●			
Moda (stacking)																					●			
Popcorn (sled bases)																					●			
Rebound	●	●	●	●	●	●	●	●	●	●	●	●	●	●	●	●	●	●	●	●	●*	●*		
Roma Nester	●	●	●																		●*			
Sonic (four leg + sled bases)	●	●	●	●	●	●	●	●	●	●	●	●	●	●	●	●	●	●	●	●	●			
Spritz (four leg bases)	●	●	●																		●*			
Stream (multi-purpose)	●	●	●	●	●	●	●	●	●	●	●	●	●	●	●	●	●	●	●	●	●*	●*		
Vion (multi-purpose)	●	●	●							●											●*			
Zoma	●	●	●																		●*			
<b>LOUNGE SEATING</b>																								
Ballara	●	●						●													●*	●*		
Citi	●	●																			●*			
Citi Square	●	●	●	●	●	●	●	●	●	●	●	●	●	●	●	●	●	●	●	●	●*	●*		
Drift (sled bases)	●	●	●	●	●	●	●	●	●	●	●	●	●	●	●	●	●	●	●	●	●*			
Jeo (pedestal bases on chairs and tables)																					●	●		
Jeo (armchair, model 8437)	●	●						●													●*	●*		
ML	●	●						●													●	●		
ML Park	●	●						●	Also available in Polished Aluminum (ALU) and Brushed Aluminum (BAL)															
River	●	●	●	●	●	●	●	●	●	●	●	●	●								●			
River+ (legs)	●	●	●	●	●	●	●	●	●	●	●	●	●								●			
Sirena (table legs)	●	●																						
Venture	●	●		●																	●			
Wind	●	●	●	●	●	●	●	●	●	●	●	●	●	●	●	●	●	●	●	●	●	●*		
Wind Linear	●	●	●	●	●	●	●	●	●	●	●	●	●	●	●	●	●	●	●	●	●	●*		

\* Upcharge required for this finish selection.

# CUSTOMER'S OWN MATERIAL (C.O.M.) INSTRUCTIONS

## COM and Graded-In Textiles:

Global will evaluate the textile to determine its possible use on our furniture. An approved COM or Graded-In textile does not warrant or guarantee the appearance, durability, quality, behavior, colorfastness or any other attribute of the COM textile. Warranty claims for COM upholstery material will fall to the original vendor of the fabric, Global is not responsible for costs associated with recovering or replacement.

## COM Approval and Ordering Instructions

All COM requests must be submitted to Global for preliminary approval prior to acceptance of an order. Approval signifies only such material can be applied to the products they are intended. Approval does not constitute any responsibility nor any warranty on behalf of Global as to the appearance, behavior or durability of the COM.

To request review and approval of a COM textile:

1. Reference the [Global Textile Search](#) tool to verify if your COM is a pre-approved alliance partner textile.
2. Confirm the textile is FR and PFAS free. If not visible on supplier website, a written confirmation is required to be submitted with the request.
3. Complete the electronic COM Authorization at [Global COM Submittal Form](#).
4. An acknowledgment email will be sent which includes a COM request number. Check for emails from [webedi@globalfurnituregroup.com](mailto:webedi@globalfurnituregroup.com)
5. If the manufacturer of the textile is **NOT** part of our Alliance Textile Partnership, send a fabric memo sample (minimum 6" x 6") with the COM request number to:

Ship memo	Global Furniture Group
Sample with	COM Sample Review Department
Req. # to:	17 West Stow Road Marlton, NJ 08053

**Global Alliance partners** include ArcCom, Architex, CF Stinson, CTL Prescott Leather, DesignTex, EnviroLeather, Green Hides, Knoll Textiles, LUUM, Maharam, Momentum Textiles, Mayer, Morbern and Ultrafabrics

6. If approved, an email will be sent indicating the textile approval, the required yardage, the Global orderable textile code and the ship to address for sending the COM yardage for production. Check for emails from [webedi@globalfurnituregroup.com](mailto:webedi@globalfurnituregroup.com)
7. To order, submit furniture order with approved orderable textile code to Global Furniture Group.
8. Order required textile yardage from textile manufacturer:

Ship Fabric	<b>See Approval email</b>	Include on PO	<b>Global approved textile code XXXX. Use</b>
Yardage to:	<b>for shipping address</b>	to Mill:	<b>Trans American as inbound customs broker</b>
			<b>1-800-333-0465</b>

9. Upon receipt of textile yardage, a confirmation email will be sent. Check for emails from [webedi@globalfurnituregroup.com](mailto:webedi@globalfurnituregroup.com)
10. Email [comrequest@Globalfurnituregroup.com](mailto:comrequest@Globalfurnituregroup.com) with all inquiries.

COM orders will be scheduled for production only upon receipt of production yardage.

## COM Application

In the absence of any application instructions, Global will apply the textile in what it determines to be the best manner and cannot be held responsible after upholstering. Excess COM materials will be discarded at the discretion of Global unless otherwise instructed by the customer at the time the order is placed.

## COM Yardage Requirements

Upon approval of the submitted COM, Global will provide yardage requirements for the product model submitted. Yardage requirements shown in the List Price Book are based on plain, non-directional, 54" wide textile that is being cut up the roll. If the COM is to be railroaded, please note on the COM Authorization form.

The following chart is provided as a budgeting tool for our customers to estimate costs associated with yardage purchase. Final yardage requirement is evaluated and provided by Global on the final approval form. **Global is not responsible where additional materials must be ordered.**

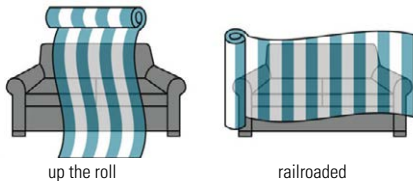

**For 2-way repeats, ranges are calculate by using the higher repeat . (i.e if the repeat is 13v x 15h you would use 15h to calculate the extra yardage needed).**

Repeat	Horizontal repeat	Vertical repeat	2-Way repeat in 2 directions
1/4" - 5"	Add 10%	Add 15%	Add 15%
6" - 9"	Add 15%	Add 18%	Add 20%
10" - 13"	Add 30%	Add 35%	Add 40%
14" - 19"	Add 45%	Add 55%	Add 60%

## Sealed Seams (Approved coated textiles only):

This process increases the strength and integrity of the seam for Vinyl textiles, providing additional protection against moisture penetration through the seam and can prevent insects from entering the interior of the upholstered piece through the seams.

Testing must be conducted on every coated textile and approval must be confirmed prior to acceptance of an order requesting sealed seams. When sealed seams are requested on the COM form, and if the coated textile is not an alliance partner, please contact Customer Care on where to submit the 1 yard of material needed for evaluation.

Note: Moisture barrier is not an option in conjunction with sealed seams.

## CUSTOMER INFORMATION (To be filled by the Dealer) Use one form per fabric

Note: Incomplete information may delay or prevent approval

Dealer/Company Name:  Email:

Address:  City:  Postal Code:

Contact Name:  Phone:

P.O.#:  Contract #:  Date:

Design Specifier of Record (often requested by Mill for Sales Commissions):

## FABRIC INFORMATION

1. Fabric Name (series/style#):   
Fabric color name and description (including specifically designed):

2. Mill/Manufacturer name:

3. Specified fabric's country of origin (if available):

4. Fabric Specification/data sheet (if available please upload and disregard step 5) Attached?  
 Yes, skip Step # 5,  No, complete Step # 5.

5. Fabric content (% Cotton, % Polyester, etc.):   
Fabric Width:  Pattern Repeat: Warp/Vertical  Fill/Horizontal

Railroaded?  Yes  No FR Chemical?  Yes  No PROP65 Compliant?  Yes  No Contains PFAS?  Yes  No

## FABRIC APPLICATION INFORMATION

Chair Model	Qty.	Multi Fabric	Special instructions for CS and buyer	Special Instruction (e.g. reverse side, off direction/railroad pattern, sealed seam, moisture barrier etc.)
<input type="text"/>	<input type="text"/>	Yes <input type="radio"/>	<input type="text"/>	Sealed seam: Yes <input type="radio"/> No <input type="radio"/>
<input type="text"/>	<input type="text"/>	(Drawing attached)	<input type="text"/>	Off Direction/rail road pattern: Yes <input type="radio"/> No <input type="radio"/>
<input type="text"/>	<input type="text"/>	No <input type="radio"/>	<input type="text"/>	No match repeat: Yes <input type="radio"/> No <input type="radio"/>
<input type="text"/>	<input type="text"/>		<input type="text"/>	Moisture barrier: Yes <input type="radio"/> No <input type="radio"/>
				Inside out: Yes <input type="radio"/> No <input type="radio"/>
				Random match: Yes <input type="radio"/> No <input type="radio"/>
				Excess material instructions: <input type="text"/>
				Other options: Yes <input type="radio"/> No <input type="radio"/>

## FABRIC DIRECTION



\*Please click on the image above to select the direction for the fabrics for the seat and back.

New fabric request

Attach textile sample (8" x 8" swatch) in correct direction and side

Previously approved fabric

Previous Global Approval/order #

Attach textile sample (8" x 8" swatch) in correct direction and side

USA CUSTOMER

Mail to: Customer Service Rep., 17 West Stow RD #3116 MARLTON, NJ 08053, USA

# THINK GLOBAL / THINK GREEN



**LEVEL 3 CERTIFIED**  
Many programs in various categories



**LEED PARTNERSHIP PROGRAM**  
Products can help you earn credits



**GREENGUARD CERTIFIED**  
Gold

**THE ENVIRONMENT** We believe now more than ever, that it is our responsibility to protect the environment and our precious natural resources for future generations. The growing importance of energy and environmental concerns continues to challenge us in this ever changing marketplace.

As an industry leader, Global continues to take proactive steps towards reducing the negative impacts on the environment. We are building "healthier" offices; investing in Research & Development and new technologies; reducing waste and the consumption of energy; and improving the quality of the air we breathe, all which can have a significant impact on our quality of life.



Epoxy Powder coating process is solvent free. No harmful VOC's or lead. No toxins are released into the atmosphere.

Global's recycled fabrics offer affordable, environmentally responsible alternatives to commercial textiles. We recycle 35,000 lbs of fabric offcuts weekly.



powder paint process:  
**98% paint recovery and reuse**

more recycled fabric  
**less to the landfill**

talk to us about our  
**leed partnership program**

we've diverted  
**90% of our wood waste from landfill in four years**



Global has the products and resources to help your projects achieve LEED certification.

New technology allows us to reduce glue usage by 50%. In addition, our polyurethane glue reduces emissions and requires less energy to apply.





# TERMS & CONDITIONS

This illustrated price list has been designed to facilitate fast reference and easy use. All products are categorized into "seating", "desks", "files", "panels", "tables" and "modular furniture", and are listed numerically within their categories. The line drawings match actual photographs (where possible) to aid in instant recognition of the total range within a series.

Sales of Global-The Total Office ("Global") products are made only on Global's standard terms and conditions of sale which are contained in this Price Book. These standard terms and conditions may be modified or supplemented only by a separately written document signed by Global's authorized personnel at its head office in Marlton, NJ. Any term or condition contained in any purchase order or other form used by dealer/purchaser to order goods (including standard, printed language) which is different from, in addition to, or in any way inconsistent with Global's standard terms and conditions shall be of no force or effect whatsoever.

All illustrations, specifications and prices in this book are based on the latest product information available at the time of publication. Global reserves the right to make changes, at any time and without prior notice, to prices, colors, materials, specifications and models offered.

## Description

Each product shown or described in this price list is standard Global product. Variations are noted at the beginning of each series. Any variations from what is standard may require additional delivery time and cost and may affect the warranty given. Sizes and weights shown are approximate and are subject to slight changes from time to time.

## Prices and Payment

The prices shown in this book, as well as those quoted by Global, are in United States dollars for orders shipped to destinations in the U.S. and Mexico.

If shipping date requested is more than 90 days from date of order, Global shall have the right to use published list prices effective at the time of shipment.

Orders are invoiced at the time of shipment. Terms of payment are net 30 days from date of invoice (1% 15 days) unless otherwise stated. The customer agrees that Global shall have the right to enforce a charge amounting to 1.5% per month (18% per year) on invoices outstanding more than 30 days.

If dealer/purchaser's most recent annual net volume is less than \$5,000.00, payment must be made in advance.

Any products sold by Global shall remain the personal property of Global until fully paid.

Prices are suggested list prices only and are subject to change without notice. Global will, however, attempt to keep dealer/purchasers up-to-date on all developments including price changes.

## Taxes

All prices shown in this book are exclusive of sales, use, excise and other applicable taxes and are the dealer/purchaser's responsibility as per the invoice issued by Global. If dealer/purchaser claims an exemption from such taxes, it shall be the dealer/purchaser's responsibility to furnish Global with an appropriate exemption certificate at time of order.

## Ordering Information

To avoid errors and/or duplication Global requires that all orders be submitted in writing. All orders submitted to Global in writing will be acknowledged on Global's acknowledgement forms governing the transaction. The details appearing

on this acknowledgement will describe the items to be shipped and the approximate shipping date. It is the dealer/purchaser's responsibility to determine that the information in the acknowledgement is correct. In the event of an error, the dealer/purchaser must notify Global immediately by telephone followed by written confirmation. Shipping dates are assigned to orders based on the item having the longest manufacturing lead time.

When ordering, please provide the following information:

- 1) Account number (if possible)
- 2) P.O. number
- 3) "Bill to" and "ship to" name and address
- 4) Complete model number
- 5) Description
- 6) Options:
  - a. Upholstery fabric type and color (specify by name and number)
  - b. Color of paint finish, laminate or wood (if applicable)
  - c. Trim options (frame)
  - d. Arms
  - e. Base, Casters
  - f. Mechanism
  - g. Accessories

Dealer/purchaser is responsible for providing correct information when placing an order. Orders with incorrect information (finish, etc.) will be scheduled for manufacturing upon receipt of complete information.

All phone orders must be confirmed in writing by the customer within 7 days.

To prevent a delay in processing orders, please specify delivery routing.

## Changes and Cancellations

After the date of Global's acknowledgement of a dealer/purchaser's order, the order may not be changed or cancelled by dealer/purchaser without the written consent of Global. Special order items, C.O.M. and fabric-covered items already in production are not subject to change or cancellation under any circumstances. Fabric-covered items are considered to be in production once the fabric is scheduled for cutting. Other standard items already in production are subject to a minimum 35% cancellation charge.

## Errors and Omissions

All quotations, acknowledgements and invoices are subject to corrections for any errors and omissions.

## FINISHES

### Wood Finishes

For custom stain requests, submit a special request for quotation. Non-standard wood finish orders will incur a one time charge of \$250 net to dealer per matching custom wood stain. This one time fee will be valid for 5 years from the time of matching. After 5 years, a new \$250 net to dealer charge will apply. All custom wood stain products will receive a 10% list per unit upcharge, included on the special quote. Requests with unit quantities of 30 or more, may be considered for reduced or eliminated upcharge. At time of order, a 3" x 3" color sample is required to be submitted with order. Extended order lead time is required for custom matching and approval process.

## File Finishes

All non-standard finishes must be approved by Global prior to acceptance of order and may be subject to an upcharge.

Laminated Tops - Pricing for all non-standard finishes and sizes must be provided by Global Customer Service and may be subject to an upcharge.

## Desk Finishes

Because the distinctive characteristics and the nature of wood products cause variations, exact matches are not always possible.

Global has launched a finishes program between marketing companies within the Global Group to match products as best as possible when same finishes are specified.

## C.O.M. (Customers Own Material)

Use of Customer's Own Material must be approved by Global prior to acceptance of order. Please refer to page 439 of the Price Book and fill out the Authorization Request Form. Photocopy and use this form as often as necessary. The customer must provide a 12" x 12" fabric sample and advise how the fabric is to be applied. **Fabric yardage requirement will be advised by the factory, and additional yardage may be required if pattern requires matching.** Yardage shown in the List Price Book does not allow for pattern repeat/matching. Send to the address provided on shipping document upon approval from Global. If C.O.M. is difficult to apply or if product shall be modified, extra charges shall be made. Global reserves the right to cancel an order at any time if C.O.M. is inadequate for any reason. Customer's Own Material must be shipped freight and duties paid to our factory. Such shipment must be fully identified with purchaser's order number, RGA # provided by Global, and the item for which material is intended. Performance of C.O.M. when applied to product is the sole responsibility of the purchaser. Global's standard product warranty shall not apply to C.O.M. Use of C.O.M. will not reduce the published list price.

## Textile Grading

All products are priced according to their standard fabric and fabric grade. Lower grade fabrics are available (unless otherwise specified) at same price as standard.

The listing of prices for each model indicates the prices for higher upholstery grades. Prices are based on yardage in imperial measurements.

## TEXTILE PRICE GRADES - GLOBAL TEXTILES

Grade	Upholstery (Seating Fabrics)
1	Carrera, Dobby, Fusion, Illusion, Jenny, Quilt, Terrace, Trak, Urban, Waterfall, Wavelength
2	Allante FRee, Elevate, Etch, GC Linen, Imprint, Luxhide, Release
6	Novaro Genuine Leather
Grade	Upholstery (Panel Fabrics)
2	Lola
3	Anchorage, Merge

The charts above do not include Textiles offered by Alliance Partners: Arc-Com Fabrics, CF Stinson, Designtex, Knoll Textiles, Green Hides, LDI Interiors, Luum Textiles, Maharam, Mayer Fabrics, Momentum, and Ultrafabrics.

## Upholstery Coverings

Slight variations in color may occur between dye lots. Although Global attempts to minimize these variances, they do occur and must be accepted as normal and will not be considered defects.

## Yardage

Required yardage (ydg) is based on unmatched materials with widths of 54" for seating, 63" for GPS panels. Yardage calculations are based on imperial measurements.

## Arms

A wide selection of arms are available for some series. See Arm Charts for details.

## Delays

Global's shipping confirmation will state a shipping date which is Global's best estimate at the time the order is acknowledged. However, Global shall not incur any obligation or liability to Purchaser for failure to ship by specified date unless Global has agreed to an unequivocal shipping date in a separately signed written document executed by its authorized personnel at its head office. In addition, Global shall not be liable for any loss or damage resulting from any delay or failure in shipment or other failure to perform all or any part of the agreement between the parties with respect to the goods shown on the face of the order acknowledgement where such delay, failure, loss or damage is the proximate result of any act of any governmental authority or political subdivision thereof, revolution, riot, civil disorder or disturbance, delay or default in transportation, strike disputes among or between labor unions or other labor disputes, delay or inability in obtaining materials and facilities, fire, flood, act of God or any cause not within the reasonable control of the company, whether of the class of causes enumerated or otherwise.

## F.O.B.

F.O.B. point is Global's Factory, Downsview, Ontario, Canada, or any Global Regional Distribution Center.

## FedEx and UPS Shipments

Seating products marked with a FedEx or UPS symbol are packaged for shipment via FedEx or UPS.

## Handling

Non-UPS/FedEx orders under \$10,000 list incur \$100 net handling fee. Small packages (FedEx, UPS) incur \$25 net handling fee per carton (up to four cartons).

## Special Delivery Requirements

Global's delivered pricing provides for dock delivery during normal business hours (considered to be 8 am to 4 pm Monday through Friday) to customer/end user only. Additional delivery requirements such as inside delivery, lift gate, limited access sites, installations and weekend deliveries will incur an additional expense and will be the responsibility of the dealer.

## Service

Service requests are normally the responsibility of Global's authorized dealers. Where this cannot be accomplished on a local level, service problems should be referred to Global's Customer Service Department in the nearest distribution center.

## Returns

No returns of goods will be accepted without written consent and shipping instruction of Global. A minimum re-stocking charge of 35% is made on all authorized returns for credit or refund, provided goods are received by Global in the condition in which they left the factory. This may increase depending on the type of product. Global's Return Goods Authorization (R.G.A.) numbers must appear prominently on all authorized

returns. Global will not be responsible for freight costs. No credit will be given if goods cannot be reused as new. Special order items, non-stock items and C.O.M. products are in no event subject to return. All returns must be approved and authorized in writing by Global Customer Service. Global reserves the right to refuse delivery of any unauthorized returns.

## Claims

All goods are sold F.O.B. plant or Global Distribution Center. Global is not responsible for damage which occurs in transit (or in storage). The carrier signs for all goods received in apparently good order. It is the dealer/purchaser's responsibility to examine goods upon receipt and to file any claims with the carrier for losses or damage to the product occurring during transit, including concealed damage.

Any claims made against Global for apparent defects, errors or shortages must be made by the dealer/purchaser, in writing, within 15 working days after any delivery. Failure by the dealer/purchaser to make any claim against Global within 15 days shall constitute acceptance of the goods and a waiver of any apparent defects, errors or shortages.

## Suspension

In the event that the dealer/purchaser defaults in the payment of any sum due to Global, or in the event the dealer/purchaser's financial condition becomes unsatisfactory to Global, Global shall have the right to defer or discontinue shipment of any goods until such time as the default is cured or the dealer/purchaser provides assurance of payment to Global.

## Copyright

All catalogs, photographs, drawings, price lists and other printed material are protected by copyright. All rights reserved.

## Trademarks

All trademarks are owned by GlobalFurniture Group other than OBUSFORME™ which is owned by OBUSFORME LTD. and are used under license. OBUSFORME® and the distinctive backrest design are registered trademarks of OBUSFORME LTD.

## Designs and Patents

Many of the products produced by Global are protected by design registrations, design patents and/or patents. Design and specifications are subject to change, discontinuance or additions without notice.

## Cubic Measure

The stated cubage is an approximate cubic foot measure to calculate freight costs. The figure shown is the volume for one carton and is subject to change without notice. It is most economical to purchase the specified number per carton.

## Combined Shipments

Global will make every effort to combine shipments and orders on written request. However, Global cannot be held responsible where such request is not complied with.

## Offer of Sale

Possession of this price list or any other literature shall not imply the company's willingness to sell to the holder and shall not be construed as a direct offer of sale.

If a conflict arises between: (i) prices found in software support packages furnished to the customer by Global or by any other source on behalf of Global; and (ii) Global's current printed price lists, then the most current shall prevail.

## Disclaimer

All dimensions are in inches. Prices shown are current manufacturer's suggested list prices at the time of printing. All applicable taxes are extra. Descriptions, specifications and prices are subject to change without notice. Errors and omissions are subject to correction.

## Flammability

The foam used in Global chairs meets the requirements of California TB117. In addition to the foam, upholstery materials must also meet the California TB117 smolder resistant requirements. Please contact Customer Care to determine if a selected textile meets the California TB117 requirement.

## This list price book is effective as of January 1, 2023.

For periodic updates, please check the PDF at [www.globalfurnituregroup.com/resources](http://www.globalfurnituregroup.com/resources). Global warrants that all commercial products are free from defects in material and workmanship, for the life of the product, to the original purchaser.

# LIFETIME WARRANTY

---

Global will repair or replace, at Global's option, as the sole remedy for any defect covered by the warranty. The warranty applies to products manufactured after March 22, 2016.

Global makes no warranty that any of its products are suitable for any particular purpose and makes no other warranties, express or implied, other than those set out here. As codes and standards vary from one jurisdiction to another, references to compliance are solely for convenience and without any representation as to accuracy or suitability. Users must verify the suitability of such information or product for their specific application. In no event shall Global be liable in either tort or contract for any loss or direct, special, incidental, consequential, or exemplary damages. The warranty applies to single shift, standard commercial usage, defined as a standard eight (8) hour day, forty (40) hour week for users weighing up to 300 pounds.

## General Commercial Seating

Global's warranty for general commercial seating covers all chair components including pneumatic cylinders, bases, casters, glides, frames, arms, plastic seats, backs and other structural components.

Exceptions to the warranty for general commercial seating are as follows:

- Foam, textiles (as sampled on Global branded and textile program cards), mesh material and electrical devices, are warranted for five (5) Years. Novaro Leather is warranted for 1 year.
- Control mechanisms are warranted for twelve (12) Years
- Heavy duty seating and Indoor/Outdoor Furniture are not defined as General commercial seating (see below for warranty exceptions)

## Heavy Duty Seating

Global offers products designed for multiple shift applications (24 hours a day / 7 days a week) and larger individuals weighing up to 400, 500 and/or 600 pounds (depending on series and/or model). Global warrants these products for twelve (12) years to the original purchaser. All components (including control mechanisms, pneumatic cylinders, bases, casters, glides, frames, arms, plastic seats/backs, etc.) are covered for 24/7 applications under the warranty. The exceptions are foam, upholstery and textiles, which are covered for five (5) years. Fabric or upholstery material on these products must exceed 100,000 double rubs for the textile portion of the warranty to apply. Heavy Duty product series that apply under this warranty can be found in the Heavy Duty section of this list price book.

## Outdoor Furniture

Global offers products designed for use indoors or outdoors. Global warrants these products for three (3) years to the original purchaser. This warranty applies to single shift (eight (8) hour day, forty (40) hour week) for users weighing up to 275 pounds, unless noted otherwise. Outdoor furniture must be stored indoors during inclement or extreme weather such as extreme cold, extreme heat, or excessive wind.

Exceptions to the warranty for indoor/outdoor furniture is as follows:

- Only Global branded textiles and Alliance Partner carded textile program materials expressly identified for outdoor application are covered for three (3) years when used outdoors.

## Global's Warranty does not apply (for any product category) to the following:

- Products not purchased directly from authorized Global resellers
- Nominal or normal amount of wear and tear that can occur over time
- Failures which result from negligence, abuse, accident or misuse
- Failure to apply, install or maintain products according to Global's written instructions and warnings
- Modifications, attachments or repair methods not approved by Global
- Damage caused by a carrier in transit, or delivery/installation contractors
- The matching of colors, grains or textures (wood, leather, etc.) of natural materials
- Products exposed to extreme hot or cold temperatures or excessively dry or humid environments
- Colorfastness or the matching of color of textiles, dye lots of textile can vary
- Damage by markings or staining; damage by sharp objects or imprinting from instruments
- Damage to textiles or laminate and wood surfaces/edges from exposure to sunlight (including UV rays)
- Products used for rental purposes
- Purchased parts are warranted for one (1) year
- Failure to follow specific cleaning and disinfecting instructions posted on [globalfurnituregroup.com](http://globalfurnituregroup.com)

## Seating Warranty Summary

Seating Type	Components Warranty For Original Purchaser	Use Time For Warranty Coverage	Exceptions
General Commercial Seating	Lifetime	8 Hours/5 Days Per Week	Foam/Upholstery/Textiles/Mesh/Electrical Devices - 5 Years Control Mechanisms - 12 Years
Heavy Duty Seating	12 Years	24 Hours/7 Days Per Week	Foam/Upholstery/Textiles - 5 Years
Indoor/Outdoor Furniture	3 Years	8 Hours/5 Days Per Week	Outdoor Use Textiles – 3 Years

## Textiles

Global warrants Global branded textiles and Alliance Partner carded textile programs inclusive of fabrics, vinyls and leather products for five (5) years, with the exception of Novaro Leather, which has a one (1) year warranty. Global does not warrant COM (Customer Own Materials) or graded-in materials (non-carded) and purchased by Global for a customer. For graded-in or COM products, please contact the textile supplier for performance information and warranty details. Please refer to our website at [globalfurnituregroup.com](http://globalfurnituregroup.com) for detailed information on cleaning and disinfecting procedures. Improper usage of disinfecting/cleaning products may void the warranty.

Global textiles and finishes are updated periodically to meet the demand and trends of the market. As a result, some textiles and finishes may be discontinued by Global or the manufacturer. In the event that a textile or finish is discontinued, Global will make every reasonable effort to provide an alternative product(s) of comparable function.

---

## Files, Desks, Modular Furniture, Tables, Panels & Accessories

Global warrants all components of metal storage and filing, laminate and wood veneer desks, laminate and wood veneer tables, metal leg components and panels for the lifetime of the product to the original purchaser.

The warranty applies to single shift, standard commercial usage, defined as a standard eight (8) hour day, forty (40) hour week. Load restrictions apply, refer to individual product descriptions.

Exceptions to the warranty for files/desks/tables and panels are as follows:

- Electrical devices, panel and tackboard textiles, adjustable keyboard mechanisms, non-electrical table mechanisms, monitor arms, lecterns, coat trees and task lights - five (5) years
- Laminate folding tables - one (1) year
- Motorized electrical components - two (2) years

## Files, Desks, Modular Furniture, Tables, Panels & Accessories Warranty Summary

Product Type	Components Warranty For Original Purchaser	Exceptions
Metal storage and filing	Lifetime	none
Laminate/wood veneer desks and modular furniture	Lifetime	tackboard textiles, electrical devices, task lights - 5 years
Boardroom, conference and training tables	Lifetime	electrical devices - 5 years moving parts - 5 years
Panels	Lifetime	panel textiles, electrical devices, task lights - 5 years
Coat racks and lecterns	5 years	none
Folding tables (laminate & molded)	1 year	none
Height adjustable tables	5 years	motorized parts (on electrical tables) - 2 years

## Global's Warranty does not apply (for any product category) to the following:

- Products not purchased directly from authorized Global resellers
- Nominal or normal amount of wear and tear that can occur over time
- Failures which result from negligence, abuse, accident or misuse
- Failure to apply, install or maintain products according to Global's written instructions and warnings
- Modifications, attachments or repair methods not approved by Global
- Damage caused by a carrier in transit, or delivery/installation contractors
- The matching of colors, grains or textures (wood, leather, etc.) of natural materials
- Products exposed to extreme hot or cold temperatures or excessively dry or humid environments
- Colorfastness or the matching of color of textiles, dye lots of textile can vary
- Damage by markings or staining; damage by sharp objects or imprinting from instruments
- Damage to textiles or laminate and wood surfaces/edges from exposure to sunlight (including UV rays)
- Products used for rental purposes
- Purchased parts are warranted for one (1) year
- Failure to follow specific cleaning and disinfecting instructions posted on [globalfurnituregroup.com](http://globalfurnituregroup.com)

Global's warranty does not cover the costs of transportation or labor. Repair or replacement will be at Global's option.

Global makes no warranty that any of its products are suitable for any particular purpose and makes no other warranties, express or implied, other than those set out here. As codes and standards vary from one jurisdiction to another, references to compliance are solely for convenience and without any representation as to accuracy or suitability. Users must verify the suitability of such information or product for their specific application. In no event shall Global be liable in either tort or contract for any loss or direct, special, incidental, consequential, or exemplary damages.

Global's warranty applies to products sold within the United States of America, Mexico, the Commonwealth of Puerto Rico and Canada.

## Global US Headquarters/Distribution Center

17 West Stow Road, P.O. Box 562  
Marlton, New Jersey U.S.A. 08053  
T (856) 596-3390  
T (800) 220-1900

---

### Showrooms

#### Atlanta

10 10th Street  
Suite 150  
Atlanta, GA 30309  
T (404) 879-0998

#### Boston

One Harbor Street  
Suite 104  
Boston, MA 02210  
T (617) 406-5435

#### Chicago

222 Merchandise  
Mart Plaza  
10th Floor, Suite 1035  
Chicago, IL 60654  
T (312) 755-0843

#### Irvine

18400 Von Karman Ave.  
Suite 100  
Irvine, CA 92618

#### Miami

112 NE 41st Street  
6th floor  
Miami, FL 33137

#### New York City

386 Park Avenue South  
7th floor  
New York, NY 10016  
T (212) 545-9900

#### Philadelphia

1735 Market Street  
38th Floor  
Philadelphia PA, 19103  
T (215) 861-0963

#### New Jersey (Southern)

119 West Greentree Road  
Marlton, NJ 08053  
T (856) 596-3390

#### Phoenix

4675 E Cotton Center Blvd.  
Suite 165  
Phoenix, AZ 85040  
T (602) 426-0666  
T (602) 426-0777

#### Washington, DC

1130 Connecticut Avenue  
10th Floor, Suite 1000  
Washington, DC 20036  
T (202) 659-0230  
T (202) 659-0236

### Distribution Centers

#### Atlanta Area

6715 Maple Ave.  
Suite 100  
Buford, GA 30518  
T (678) 602-4130

#### Baltimore Area

Troy Hill  
Corporate Center  
7030 Troy Hill Drive  
Elkridge, MD 21075  
T (410) 379-8021

#### Chicago Area

27W501 North Ave.  
Suite 300  
West Chicago, IL 60185  
T (630) 681-2818

#### Cincinnati Area

8712 LeSaint Drive  
Fairfield, OH 45014  
T (513) 777-0009

#### Dallas Area

2025 West Beltline Road  
#100  
Carrollton, TX 75006  
T (972) 236-1366

#### Denver Area

19080 E. 38th Ave.  
Unit # 30  
Aurora, CO 80011  
T (303) 340-1617

#### Ft. Lauderdale Area

560 Sawgrass  
Corporate Pkwy  
Sunrise, FL 33325  
T (954) 846-8888

#### Houston Area

7865 Northcourt Road  
Suite 200  
Houston, TX 77040  
T (713) 695-5777

#### Los Angeles Area

3629 Workman Mill Road  
Whittier, CA 90601  
T (562) 484-9686

#### Seattle Area

Oakesdale Commerce Ctr.  
820 Southwest 34th Street  
Building W7, Suite A  
Renton, WA 98057  
T (425) 291-9282

#### Kansas City Area

11617 West 81st Street  
Lenexa, KS 66214  
T (913) 310-9963

#### Tampa Area

10351 Windhorst Road  
Tampa, FL 33619  
T (813) 621-6272



globalfurnituregroup.com

