

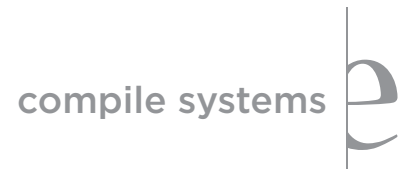

List Price Book
Effective July 14, 2025
Updated March 2, 2026



compile systems



PROTECTING THE ENVIRONMENT FOR FUTURE GENERATIONS

Our environmental success story began with the challenge to create an office system that would meet today's business requirements while maintaining a firm commitment to save and protect the environment.

Sustainability became a part of the creative focus and development of Compile that incorporates the latest technology and design features to provide excellent performance at a competitive price.

As government and industry environment ratings such as LEEDS & Greenguard become more prevalent, Compile offers designers and architects functional, attractive, and economical office designs that meet these standards.

Evolve Furniture Group is a leader in reducing waste in the manufacturing of its products as well as utilizing recycled materials wherever possible. We make extensive use of recycled plastic and wood waste from other Global factories.

Evolve Furniture Group is committed to the continuous improvement of our environmental systems, the prevention of pollution, and to comply with both the spirit and the letter of all relevant environmental legislation.

Compile Panels are 100% recyclable at the end of their lifespan. Nothing from an Evolve Panel needs to end up in a landfill.

SUSTAINABILITY INFORMATION

Compile offers fabrics that are made from 100% recycled polyester, which means less waste going to landfills. These fabrics also reduced the demand for petroleum products, and decrease the environmental impacts of processing those petroleum products into polyester.

Compile's epoxy powder coating process involves no liquids and is solvent free. It contains no harmful VOC's or lead. Up to 99% of over sprayed powdered is reclaimed, mixed with virgin powder and reused.

Compile's entire panel is up to 82% recycled.

Compile masonite is up to 85% recycled.

Compile's entire product line is up to 99% recyclable.

REFERENCES

Features, Benefits & General Information	3
Coding an Order	4
Textiles & Finishes	114
Panel COM Form	119
Panel Fabric Specification Sheet	120
Pedestal Cushions COM Form.....	121
Panel Fabric Sample.....	122
Appendix	123
Terms & Conditions.....	124

PANELS

Panels – Technical Information.....	8
Panel – Types	9
Panel Package – Configuration	15
Monolithic Panel Packages.....	16
Segmented Panel Packages.....	18
Acoustic Panel Packages	20
Monolithic Laminate Panel Packages	22
Segmented Laminate Panel Packages.....	26
Segmented Writeboard Panel Packages	30
Single Segmented Open Bottom Panel Packages	34
Glazed Panel Packages	36
Partly Glazed Panel Packages.....	38
12” Top Partly Glazed Panel Packages.....	40
Privacy Glass.....	42
Over Panels	44
Gallery Panels	48
Sliding Doors.....	55
Post Packages	56
Raceway & Knockout Covers	58
Posts & Trim Inserts	59
Post Covers	61
Panel Legs.....	62
Post Separator.....	63

ELECTRICAL

Electrical – Technical Information	66
Electrical – Wire Schematic	67
Electrical – Configuration.....	68
Power Distribution Housing	69
Cables.....	70
I Connector	71
Duplex Receptacle	71
Power Entry	72
Electrical Box.....	72
Post Extension.....	73

ELECTRICAL

Ceiling Feed.....	73
Cable Cover	73
Task Lights.....	74

WORKSURFACES

Worksurfaces – Technical Information	76
Worksurfaces – Configuration	77
Rectangular Worksurface	78
Straight Worksurfaces	79
Rectangular Worksurface for Height Adjustable Tables	80
Wedge Worksurfaces	81
Span a Post Rectangular Worksurfaces	81
Curvilinear Worksurface	82
Corner Worksurface	83
Extended Curved Corner.....	84
“D” Worksurface.....	85
Hatchet Worksurface	86
Straight Wedge Worksurfaces	86
Quarter Round Panel Worksurface	86
Transaction Worksurface	87
Accessories.....	88

STORAGE

Storage – Technical Information	94
Storage – Configuration	95
Pedestals.....	96
Overhead Storage	98
Lateral File.....	100
Storage Towers	103
Key Alike Form	105

ACCESSORIES

Tack Board.....	108
White Marker Board	108
Load Bars.....	109
Rail Accessories.....	109



PANELS

- Panel Fabric modules consist of Module Frames, Module Interiors and Fabric Skins.

Fabric

- Fabric offerings include selections woven with 100% recycled yarn.

Panel Frame

- Typical workstation contains up to 62.2% recycled material.
- Panel is made of 82.3% recycled material.
- Acoustic panels are light tackable with 0.70 NRC and a 26 STC rating.
- Non Acoustic panels are not tackable with 0.17 NRC and a 28 STC rating.
- Raceway covers are aluminum.
- Plastic top cap vs Aluminum top cap.

Metal Components/Raceway Finish

- All aluminum components are painted with environmentally friendly epoxy powder.
- Raceway interiors are coated with recycled epoxy powder.
- The entire Compile Panel and the processes used to manufacture it are designed to save and protect the environment. Compile Panels are made from recycled materials and are 99% recyclable.

Panel Options

- Compile Panels come in 5 heights: 30", 42", 48" 54" and 66".
- Panel widths come in 7 sizes including: 24", 30", 36", 42", 48", 54" and 60".
- Panels conform to CGSB and ANSI/BIFMA standards.
 - This is your assurance that the quality, and performance level of these Panels have been tested to equal or exceed the requirements of the US government.
- Rigid, aluminum Panel Frame is 2 3/8" thick.
- Aluminum Panel Frame combined with easy to assemble "Quick Connect" clips, create a rigid Panel Wall.
- Levelling glides extend 2". Enables the client to deal with severe undulations in the flooring levels of a building.
- Compile makes it easy to select a Panel function that is suitable for your application.
- Compile makes it easy to select a Panel type and height that is suitable for your application.

VOICE/DATA AND ELECTRICAL POWER

- Voice/data cables can be inserted at the base. 8 wire, 4 circuit electrical capability, 2 utility + 2 dedicated circuits, each with 10 gauge (oversized) neutrals. All circuits can support up to 20 amps (15 CSA).
- Raceway Cover opening sizes conform to the ANSI/TIA/EIA Furniture Opening Standard of 1.345" x 2.680".
- Panels 24" wide include raceway covers with 2 knockouts.
- Panels 30" – 60" wide include raceway covers with 3 knockouts.

- Panels and electrical components are CSA/UL approved.
- Compile panel raceway is roughly 2.13" x 4.6" without power distribution housing installed. With power distribution housing installed, the dimension is reduced to roughly 2.13" x 2.13
- The base raceway cavity accommodates 50 .25" diameter communication cables without power installed or 30 .25" diameter communication cables with power installed.
- 90-degree posts accommodate 25 .25" diameter communication cables without a ceiling infeed or 20 .25" diameter communication cables with a ceiling infeed installed.
- 120-degree posts may not be utilized for power infeeds or communication cables. 90-degree posts may be utilized at the end of a 120-degree configuration if ceiling infeed of power and/or data cables is required.
- No tools are required to install electrical in the Compile Panel System.

WORKSURFACES

- 1" thick worksurfaces come in a variety of shapes and sizes. Essentially, they are 24" or 30" deep and are available in 6" increments from 24" to 84" wide.
- Cable scoops located at the back of each Worksurface provide routing of power and data cables.
- This convenient feature, together with a 3/8" gap between the Worksurface and the Panel, allows access to cables without having grommet holes in the Worksurface.
- With this choice of product, we can tailor each installation to your requirements. The addition of custom sizes shows a commitment to client satisfaction that not every manufacturer offers.
- Thermally fused laminate tops are standard.
- All Worksurfaces utilize balanced construction.
- Predrilled holes in worksurfaces enable installer to properly align worksurface.

STORAGE

- 19", 23" and 29" deep Pedestals. Freestanding and Worksurface supporting options available.
- Drawer divider and pencil tray included in all Freestanding Pedestals containing box drawers. Drawer divider and pencil tray not included in Worksurface Supporting Pedestals.
- Adjustable glides are accessible from the inside of the cabinet.
- Positive and secure locking system on all Pedestals is standard.
- Full height drawer sides are standard on all file drawers. This enables you to hang files from the drawer side so no extra hardware is necessary. File drawers accept letter sized files. Optional file bars are available to file legal and metric sized files.
- Steel construction guarantees the performance of the product over the long term. Welded joints with a full top, back and base ensure that the Pedestal will sit square and adequately support the Worksurface where necessary.

- Worksurface supporting Pedestals are standard with Compile.
- Shelves feature all metal construction.
- All storage components as well as the Panel Frames are epoxy powder coated.
- Glides enable you to level the cabinet to the floor and or Worksurface. The convenient adjustment feature allows the installer to adjust the height of the cabinet while it is under the Worksurface. This saves time in the installation process.
- For additional security and peace of mind, locks can be keyed alike or master keyed for additional convenience. Standard recessed handle offers uncluttered aesthetic.
- "Environmentally friendly" epoxy powder coat is 15 times more durable in independent testing than a wet paint spray. This helps maintain the look of the product over its many years of service.

WARRANTIES AND PERFORMANCE

- A Lifetime Warranty
- Non Obsolescence Warranty
- Reduced cost of assembly and reconfiguration
- ISO9001:2008 Registered
- ISO14001:2004 Registered
- GreenGuard Certified
- Level 3 Certified
- ANSI/BIFMA CGSB testing on all products
- For piece of mind over the long term, we cover you with a comprehensive warranty that is supported by our dealer network.
- Some installation companies claim that the Compile Panels System can be installed in half the time it takes to install most of our competitor's segmented panels. This cost saving can amount to thousands of dollars over the lifetime of our furniture.
- Your assurance of consistent quality to an international standard. Evolve Furniture Group is committed to design, manufacture and distribute superior quality office furniture, which meets or exceeds the requirements of our customers.
- Confirmation that Evolve Furniture Group is committed (1) to providing product that, through their entire life cycle, minimize negative environmental impacts on the environment, (2) to continuous improvement to our environmental systems and programs and (3) to comply to all relevant environmental legislation and regulations.
- Compile Panel System can help a company meet LEED requirements for office furniture.
- Compile components are tested to the highest standard in the industry. This is your assurance of quality and longevity.
- Panel textiles, adjustable keyboard mechanisms, task lights and electrical devices = five (5) Years
- Other parts = Lifetime Warranty

Compile products have been coded using alphas that correspond with the product name. This creates an easy-to-remember code. The following breaks down the coding logic and highlights the required code components needed to order within each product category.

Panels

Example: **Product:** Compile Fabric Monolithic Panel

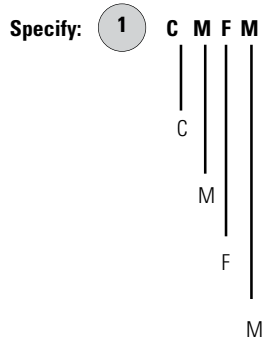

Base Code found on the product page to the left of the product name and a simple product illustration.

CoMpile product line

Fabric-covered Panel

Monolithic panel category

2 CMFM**6648**

Panel size offering. Listed on every product page with price listing.

Note: Additional dimensions are provided for most products on the far right hand side of each page. These dimensions are not required in the ordering code.

3 CMFM6648-**BK**

Standard paint code for frame. See the Fabric & Finish listing in this section.

To specify fabric for a Compile Panel, please note:

4 CMFM6648-BK-**B84A**

Fabric code for all modules on both sides of the Panel*. See the Fabric & Finish listing in this section.

* **NOTE:** If different fabrics are to be included on a Compile Panel, please use the following ordering format. **Start at the bottom** of one side of a Panel and work to the top module of that Panel. Then start the process over on the other side of the Panel. As an example:

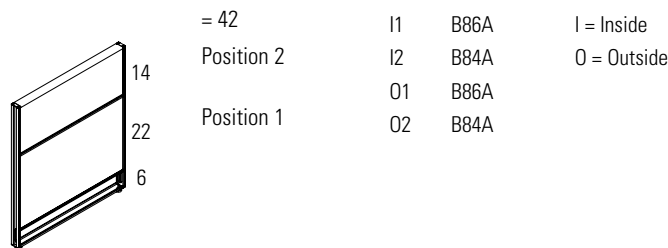

Electrical

Example: **Product:** Flexible Mesh Jumper Cable

Specify: **1** **C E 8 C P 1 7**

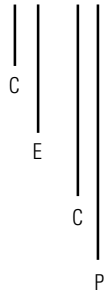

2 CE8CP17

Base Code found on the product page to the left of the product name and a simple product illustration.

Compile product line.

Electrical category.

Cable Panel.

Pass-Through.

Product size offering – length. Listed on every product page with price listing. Note: Additional dimensions are provided for most products on the far right hand side of each page. These dimensions are not required in the ordering code.

Worksurfaces

Example: **Product:** Curvilinear Worksurface – Left

Specify: **1** **C W V L**



2 CWVL3042

3 CWVL3042–T431

4 CWVL3042–T890–CR

Base Code found on the product page to the left of the product name and a simple product illustration.

Compile product line.

Worksurface category.

Cur**V**ilinear shape.

Left hand configuration.

Worksurface size offering. Listed on every product page with price listing. Note: Additional dimensions are provided for most products on the far right hand side of each page. These dimensions are not required in the ordering code.

Laminate code for surface. See the Fabric & Finish listing in this section.

PVC code for trim. See the Fabric & Finish listing in this section.

Worksurfaces – Hardware

Example: **Product:** End Panel

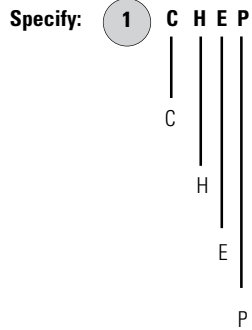

Base Code found on the product page to the left of the product name and a simple product illustration.

Compile product line.

Hardware category.

End Panel.

End **P**anel.

2 CHEP-T431

Laminte code for End Panel. See the Fabric & Finish listing in this section.

Storage

Example: **Product:** Box, Box, File Pedestal

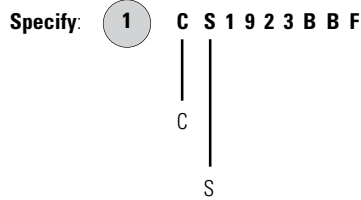

Base Code found on the product page to the left of the product name and a simple product illustration.

Compile product line.

Storage category.

2 CS1923BBF

19 Product Series.

3 CS1923BBF

23" Pedestal depth in inches.

4 CS1923BBF

Box drawer, **B**ox drawer, **F**ile drawer.



panels

THE INFORMATION LISTED BELOW PROVIDES YOU WITH BASIC FEATURES OF COMPILE PANELS:

- Compile Panels are:
 - Available in five (5) heights: 30", 42", 48", 54" and 66"; and seven (7) widths: 24", 30" 36", 42", 48", 54" and 60".
 - 2 3/8" thick.
 - Monolithic, Segmented, Acoustic, and Glazed.
- Acoustic panels are lightly tackable with 0.70 NRC rating and a 26 STC rating.
- Compile Non - Acoustic panels are not tackable.
- Raceway openings are 1.375" x 2.680".
- Panels 24" wide include raceway covers with 2 knockouts.
- Panels 30" – 60" wide include raceway covers with 3 knockouts.
- Opposite sides of each Module may have a different fabric within the same grade at no upcharge.
- If different grades of fabric are used on one panel, the entire panel must be priced at the highest grade.
- Standard with aluminum frame.
- Individual fabric covered acoustic modules incorporated into an aluminum frame.
- Reinforced aluminum raceway covers are included when ordering panel packages or may be ordered and shipped separately. Raceway covers can be replaced in the field to change a panel from non-powered to powered (or vice versa).
- Base raceway lifts up and locks in an upright 90-degree position, or can be removed for open access to base raceway.
- Electric knockouts in the raceway have black plastic covers that snap into place from the outside of the cover, when a duplex is not required. Electric knockout covers must be specified separately. Available in standard paint finishes.
- 3 panel connector brackets per side for 30"h, 42"h and 54"h come installed on panels and universal posts.
- 4 panel connector brackets per side for 66"h panels come installed on panels and universal posts.
- Panel connector brackets are opposite direction of each other per panel side, and can be removed with one screw per bracket.

MONOLITHIC PANEL PACKAGES - PAGES 16 & 17, 22-25

Non-Powered Compile Monolithic Fabric Panel Package

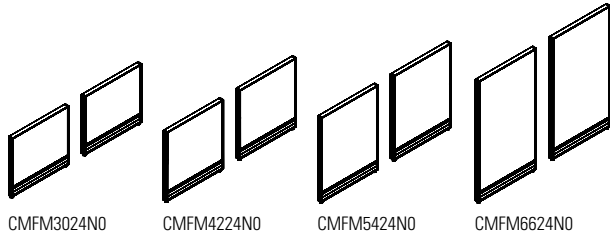

Powered Compile Monolithic Fabric Panel Package

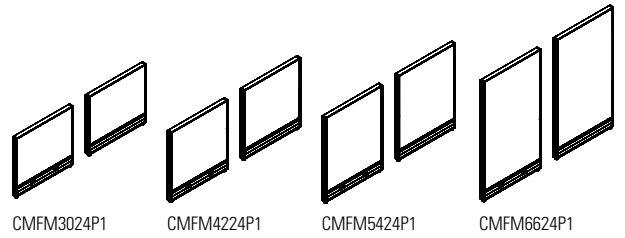

Non-Powered Compile Monolithic Fabric Panel Package

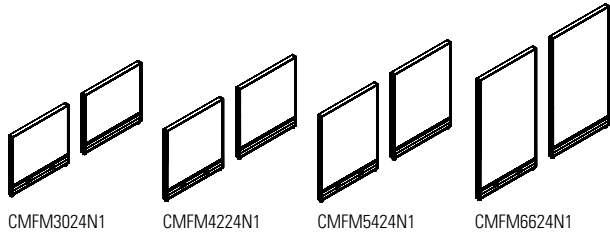

Powered Compile Monolithic Fabric Panel Package

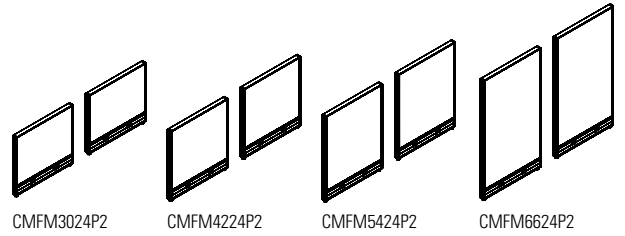

Non-Powered Compile Monolithic Fabric Panel Package

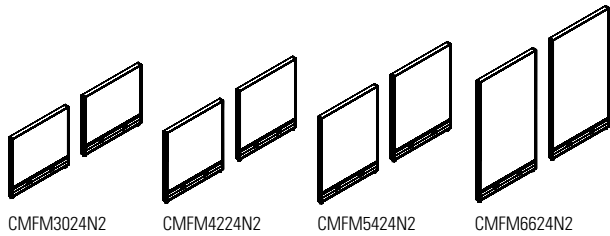

Non-Powered Compile Monolithic Laminate Panel Package

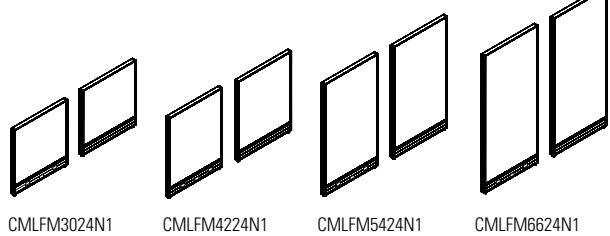

Non-Powered Compile Monolithic Laminate Panel Package

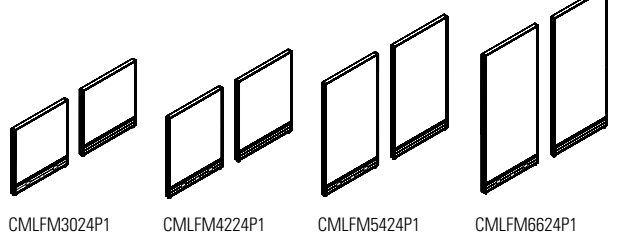

Model Definitions:

- N0 = No punch outs on raceways.
- N1 = Raceway punch out on one side.
- N2 = Raceway punch out on both sides.
- P1 = Power harness and raceway punch out on one side.
- P2 = Power harness and raceway punch outs on two sides.

RACEWAY COVER OPTIONS (Suffix)

- (N0) No Knockouts Side 1 and Side 2
- (N1) Knockouts Side 1 – No Knockout Side 2
- (N2) Knockouts Side 1 and Side
- (P1) Knockouts Side 1 – No Knockout Side 2
- (P2) Knockouts Side 1 and Side 2

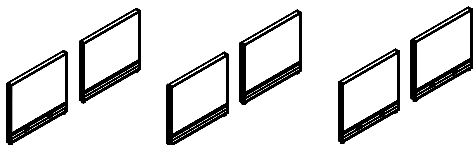

SEGMENTED - PANEL PACKAGES - PAGES 18 & 19, 26-35

Non-Powered Compile Single Segmented Fabric Panel Package

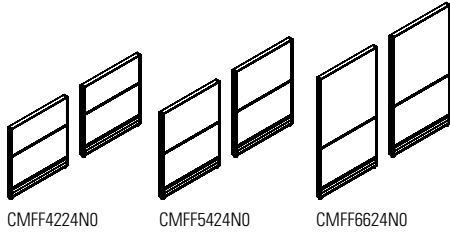

Powered Compile Single Segmented Fabric Panel Package

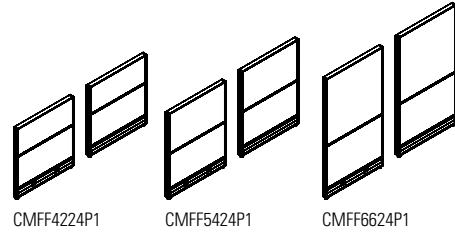

Non-Powered Compile Single Segmented Fabric Panel Package

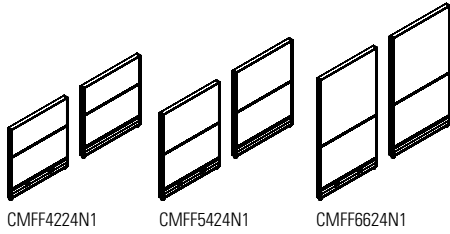

Powered Compile Single Segmented Fabric Panel Package

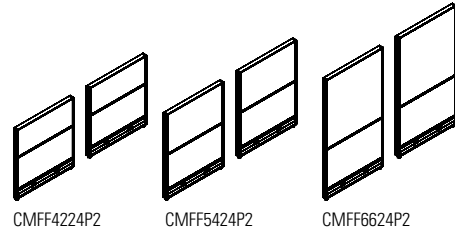

Non-Powered Compile Single Segmented Fabric Panel Package

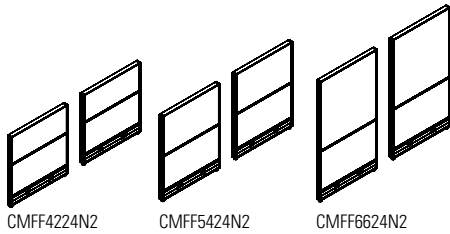

ACOUSTIC PANEL PACKAGES - PAGES 20 & 21

Non-Powered Compile Monolithic Acoustic Panel Package

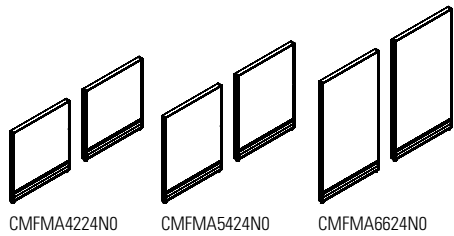

CMFMA4224N0

CMFMA5424N0

CMFMA6624N0

Powered Compile Monolithic Acoustic Panel Package

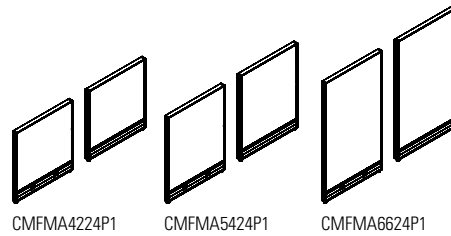

CMFMA4224P1

CMFMA5424P1

CMFMA6624P1

Non-Powered Compile Monolithic Acoustic Panel Package

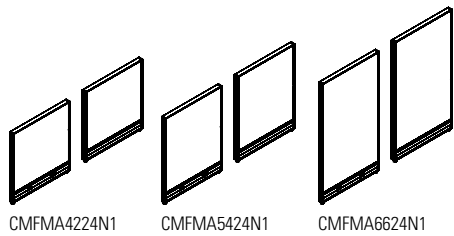

CMFMA4224N1

CMFMA5424N1

CMFMA6624N1

Powered Compile Monolithic Acoustic Panel Package

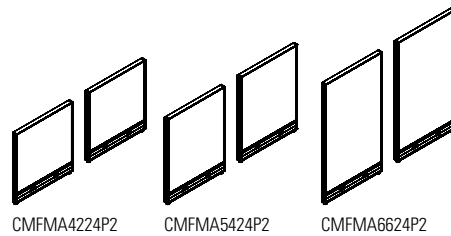

CMFMA4224P2

CMFMA5424P2

CMFMA6624P2

Non-Powered Compile Monolithic Acoustic Panel Package

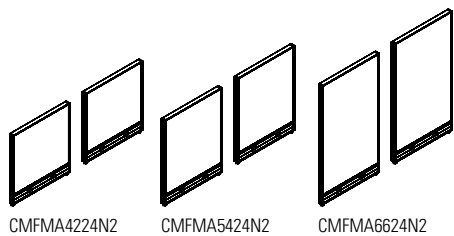

CMFMA4224N2

CMFMA5424N2

CMFMA6624N2

SINGLE SEGMENTED OPEN BOTTOM PANEL PACKAGES - PAGES 34-35

Non-Powered Compile Single Segmented Open Bottom Panel Package

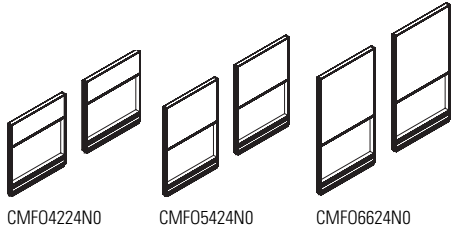

Powered Compile Single Segmented Open Bottom Panel Package

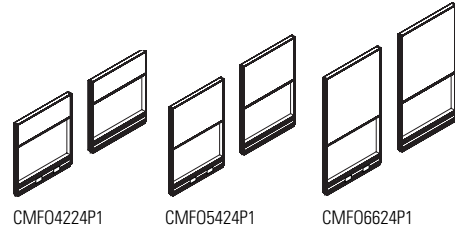

Non-Powered Compile Single Segmented Open Bottom Panel Package

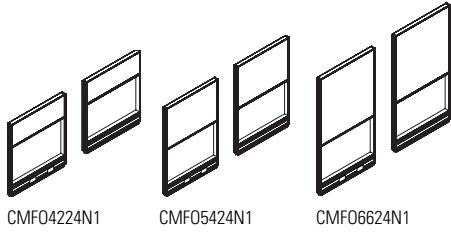

Powered Compile Single Segmented Open Bottom Panel Package

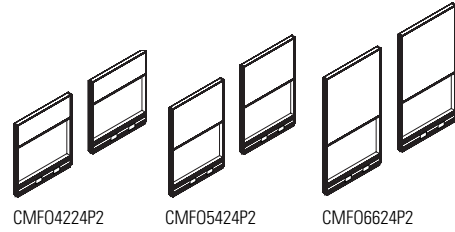

Non-Powered Compile Single Segmented Open Bottom Panel Package

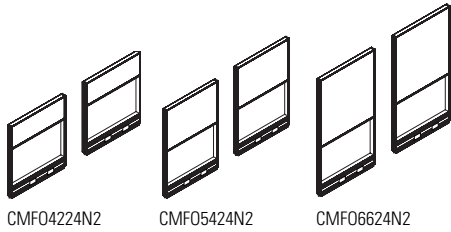

DOOR PANELS - PAGE 55

Sliding Door

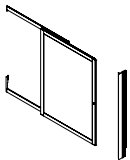

CMPDPS6636/42



GLAZED PANEL PACKAGES - PAGES 36-37

Non-Powered Compile Glazed Panel Package

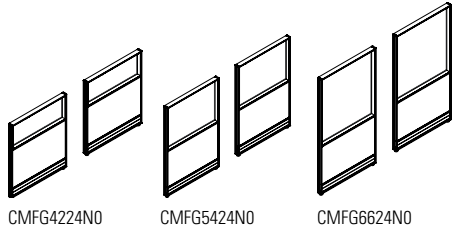

Powered Compile Glazed Panel Package

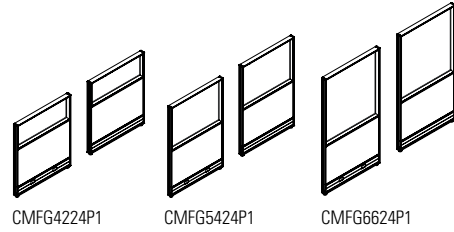

Non-Powered Compile Glazed Panel Package

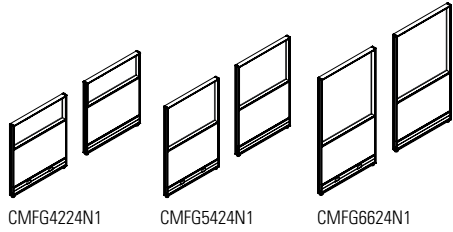

Powered Compile Glazed Panel Package

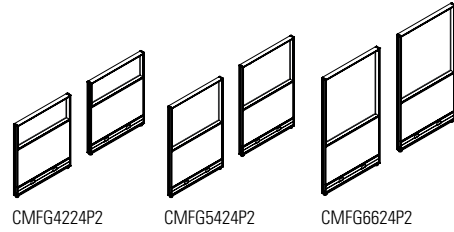

Non-Powered Compile Glazed Panel Package

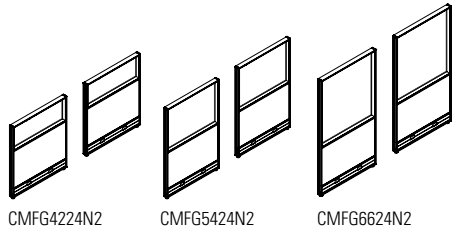

PARTLY GLAZED PANEL PACKAGES - PAGES 38-41

Non-Powered Compile Partly Glazed Panel Package

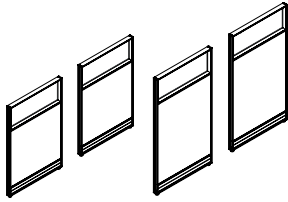

CMPG5424N0 CMPG6624N0

Powered Compile Partly Glazed Panel Package

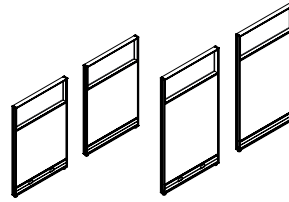

CMPG5424P1 CMPG6624P1

Non-Powered Compile Partly Glazed Panel Package

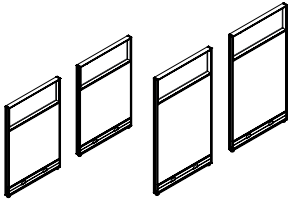

CMPG5424N1 CMPG6624N1

Powered Compile Partly Glazed Panel Package

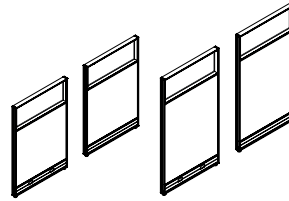

CMPG5424P2 CMPG6624P2

Non-Powered Compile Partly Glazed Panel Package

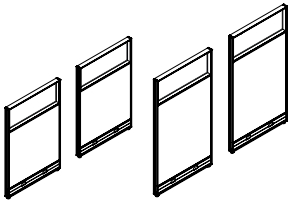

CMPG5424N2 CMPG6624N2

Compile Privacy Glass

Available in widths from 24" to 60".

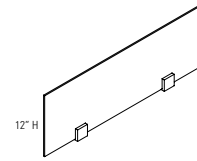

CMPS30

MINI PANEL KIT - PAGE 43

Mini Panel Kit

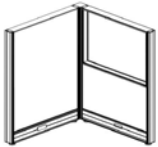

CMFMA2418KIT1



This page provides an exploded view of a sample Panel Package highlighting each **Panel** component included within the package.

Package Components

Package 1 CMFM6636N0

- A. (1) 66" h x 36" w Monolithic Fabric Panel
- B. (2) 36" w Raceway Covers Without Knockouts

Package 2 CMFF6636P2

- C. (1) 66" h x 36" w Single Segmented Fabric Panel
- D. (2) 36" w Raceway Covers With Knockouts
- E. (1) 36" w Power Distribution Housing

Package 3 CHP66-2

- F. (1) 66" h Universal Corner Post
- G. (2) Trim Inserts for 66" Universal Corner Post
- H. (1) Post Base Cover for 2-Way Application
- I. "Quick Connect" comes standard with Panels and Universal Corner Post

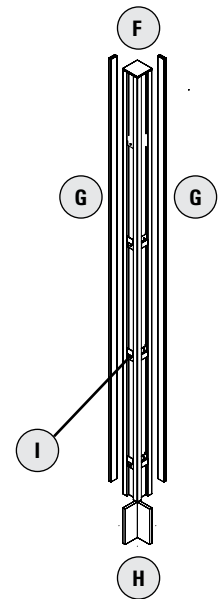
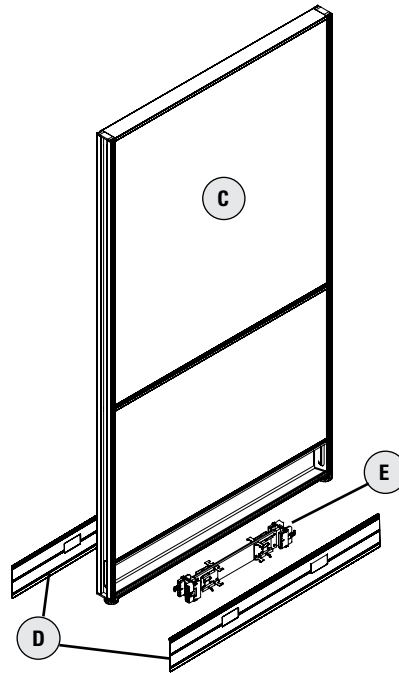
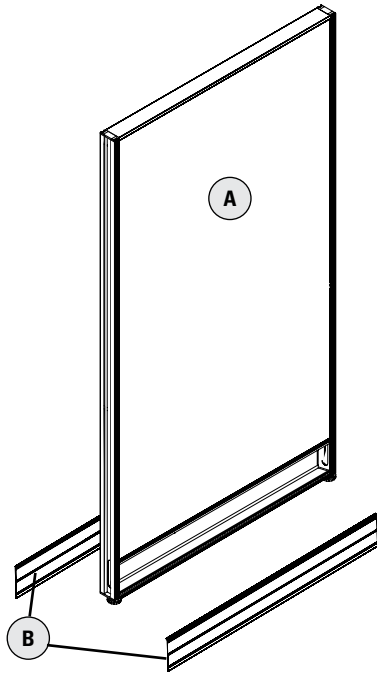

CMFMXXYYN - NON-POWERED COMPILE FABRIC MONOLITHIC PANEL PACKAGE

- Non powered.
- Includes one panel and two raceway covers with no punchouts.
- Individual fabric-covered modules incorporated into an aluminum frame.
- Opposite sides of each module may have a different fabric within the same grade at no upcharge.
- If different grades of fabric are used on one panel, the entire panel must be priced at highest grade.
- Panels are not tackable or acoustical.
- Note: Trim is not required at a straight connection between two panels of the same height.
- 3 Panel connector brackets per side come standard with 30”h, 42”h, 48”h and 54”h panels.
- 4 Panel connector brackets per side come standard with 66”h panels.
- Panels contain leveling glides. Maximum extension of glides is 2”.

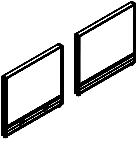
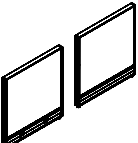
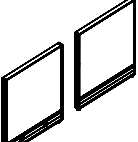
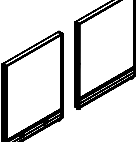
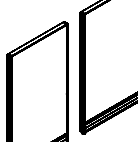
	DESCRIPTION	PRODUCT CODE	LIST PRICE		DIMENSIONS/INCHES		
			Gr1	Gr2	H	W	D
	Non-Powered Compile Fabric Monolithic Panel Package - 30"	CMFM3024N_	391	427	30	24	2 3/8
		CMFM3030N_	441	476	30	30	2 3/8
		CMFM3036N_	479	548	30	36	2 3/8
		CMFM3042N_	529	598	30	42	2 3/8
		CMFM3048N_	562	631	30	48	2 3/8
		CMFM3054N_	622	691	30	54	2 3/8
		CMFM3060N_	656	724	30	60	2 3/8
	Non-Powered Compile Fabric Monolithic Panel Package - 42"	CMFM4224N_	391	427	42	24	2 3/8
		CMFM4230N_	441	476	42	30	2 3/8
		CMFM4236N_	479	548	42	36	2 3/8
		CMFM4242N_	529	598	42	42	2 3/8
		CMFM4248N_	562	631	42	48	2 3/8
		CMFM4254N_	622	691	42	54	2 3/8
		CMFM4260N_	656	724	42	60	2 3/8
	Non-Powered Compile Fabric Monolithic Panel Package - 48"	CMFM4824N_	407	448	48	24	2 3/8
		CMFM4830N_	462	503	48	30	2 3/8
		CMFM4836N_	513	593	48	36	2 3/8
		CMFM4842N_	571	652	48	42	2 3/8
		CMFM4848N_	600	682	48	48	2 3/8
		CMFM4854N_	650	732	48	54	2 3/8
		CMFM4860N_	710	789	48	60	2 3/8
	Non-Powered Compile Fabric Monolithic Panel Package - 54"	CMFM5424N_	408	450	54	24	2 3/8
		CMFM5430N_	462	504	54	30	2 3/8
		CMFM5436N_	514	596	54	36	2 3/8
		CMFM5442N_	571	653	54	42	2 3/8
		CMFM5448N_	601	684	54	48	2 3/8
		CMFM5454N_	651	734	54	54	2 3/8
		CMFM5460N_	710	792	54	60	2 3/8
	Non-Powered Compile Fabric Monolithic Panel Package - 66"	CMFM6624N_	456	511	66	24	2 3/8
		CMFM6630N_	524	579	66	30	2 3/8
		CMFM6636N_	598	698	66	36	2 3/8
		CMFM6642N_	671	771	66	42	2 3/8
		CMFM6648N_	726	826	66	48	2 3/8
		CMFM6654N_	808	908	66	54	2 3/8
		CMFM6660N_	888	990	66	60	2 3/8

Raceway Cover Options (1) Shown

- **RACEWAY COVER OPTIONS (Suffix)**
 - (0) No Knockouts Side 1 and Side 2
 - (1) Knockouts Side 1 – No Knockout Side 2
 - (2) Knockouts Side 1 and Side 2



CMFMXXYP - POWERED COMPILE FABRIC MONOLITHIC PANEL PACKAGE

- With power distribution harness.
- Includes one panel, power harness, one raceway cover with punchout and one raceway cover with no punchout.
- Individual fabric-covered modules incorporated into an aluminum frame.
- Opposite sides of each module may have a different fabric within the same grade at no upcharge.
- If different grades of fabric are used on one panel, the entire panel must be priced at highest grade.
- Panels are not tackable or acoustical.
- Note: Trim is not required at a straight connection between two panels of the same height.
- 3 Panel connector brackets per side come standard with 30”h, 42”h, 48”h and 54”h panels.
- 4 Panel connector brackets per side come standard with 66”h panels.
- Panels contain leveling glides. Maximum extension of glides is 2”.

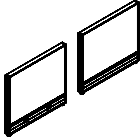
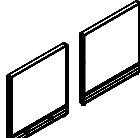
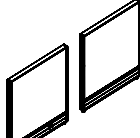
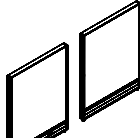
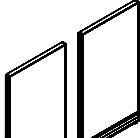
	DESCRIPTION	PRODUCT CODE	LIST PRICE		DIMENSIONS/INCHES		
			Gr1	Gr2	H	W	D
	Powered Compile Fabric Monolithic Panel Package - 30"	CMFM3024P_	556	592	30	24	2 3/8
		CMFM3030P_	663	698	30	30	2 3/8
		CMFM3036P_	712	781	30	36	2 3/8
		CMFM3042P_	766	835	30	42	2 3/8
		CMFM3048P_	818	887	30	48	2 3/8
		CMFM3054P_	878	947	30	54	2 3/8
		CMFM3060P_	914	982	30	60	2 3/8
	Powered Compile Fabric Monolithic Panel Package - 42"	CMFM4224P_	556	592	42	24	2 3/8
		CMFM4230P_	663	698	42	30	2 3/8
		CMFM4236P_	712	781	42	36	2 3/8
		CMFM4242P_	766	835	42	42	2 3/8
		CMFM4248P_	818	887	42	48	2 3/8
		CMFM4254P_	878	947	42	54	2 3/8
		CMFM4260P_	914	982	42	60	2 3/8
	Powered Compile Fabric Monolithic Panel Package - 48"	CMFM4824P_	571	613	48	24	2 3/8
		CMFM4830P_	680	721	48	30	2 3/8
		CMFM4836P_	742	823	48	36	2 3/8
		CMFM4842P_	806	887	48	42	2 3/8
		CMFM4848P_	858	939	48	48	2 3/8
		CMFM4854P_	904	986	48	54	2 3/8
		CMFM4860P_	966	1047	48	60	2 3/8
	Powered Compile Fabric Monolithic Panel Package - 54"	CMFM5424P_	571	613	54	24	2 3/8
		CMFM5430P_	680	722	54	30	2 3/8
		CMFM5436P_	745	827	54	36	2 3/8
		CMFM5442P_	807	889	54	42	2 3/8
		CMFM5448P_	858	941	54	48	2 3/8
		CMFM5454P_	905	988	54	54	2 3/8
		CMFM5460P_	966	1048	54	60	2 3/8
	Powered Compile Fabric Monolithic Panel Package - 66"	CMFM6624P_	619	674	66	24	2 3/8
		CMFM6630P_	745	800	66	30	2 3/8
		CMFM6636P_	830	930	66	36	2 3/8
		CMFM6642P_	907	1007	66	42	2 3/8
		CMFM6648P_	983	1083	66	48	2 3/8
		CMFM6654P_	1065	1165	66	54	2 3/8
		CMFM6660P_	1144	1246	66	60	2 3/8

Raceway Cover Options (1) Shown

- **RACEWAY COVER OPTIONS (Suffix)**
 - (1) Knockouts Side 1 – No Knockout Side 2
 - (2) Knockouts Side 1 and Side 2

CMFFXXYYN - NON-POWERED COMPILE SINGLE SEGMENTED FABRIC PANEL PACKAGE

- Non powered.
- Includes one panel, two raceway covers with no punchouts.
- Individual fabric-covered modules incorporated into an aluminum frame.
- Opposite sides of each module may have a different fabric within the same grade at no upcharge.
- If different grades of fabric are used on one panel, the entire panel must be priced at highest grade.
- Panels are not tackable or acoustical.
- Note: Trim is not required at a straight connection between two panels of the same height.
- 3 Panel connector brackets per side come standard with 42”h, 48”h and 54”h panels.
- 4 Panel connector brackets per side come standard with 66”h panels.
- Panels contain leveling glides. Maximum extension of glides is 2”.

	DESCRIPTION	PRODUCT CODE	LIST PRICE		DIMENSIONS/INCHES		
			Gr1	Gr2	H	W	D
	Non-Power Compile Single Segmented Fabric Panel Package - 42”	CMFF4224N_	409	445	42	24	2 3/8
		CMFF4230N_	462	498	42	30	2 3/8
		CMFF4236N_	488	556	42	36	2 3/8
		CMFF4242N_	557	626	42	42	2 3/8
		CMFF4248N_	594	663	42	48	2 3/8
		CMFF4254N_	660	729	42	54	2 3/8
		CMFF4260N_	706	775	42	60	2 3/8
		CMFF4266N_	832	965	42	66	2 3/8
		CMFF4272N_	877	1010	42	72	2 3/8
			Non-Powered Compile Single Segmented Fabric Panel Package - 48”	CMFF4824N_	446	487	48
CMFF4830N_	494			535	48	30	2 3/8
CMFF4836N_	558			639	48	36	2 3/8
CMFF4842N_	632			713	48	42	2 3/8
CMFF4848N_	682			763	48	48	2 3/8
CMFF4854N_	726			806	48	54	2 3/8
CMFF4860N_	781			862	48	60	2 3/8
	Non-Powered Compile Single Segmented Fabric Panel Package - 54”	CMFF5424N_	447	488	54	24	2 3/8
		CMFF5430N_	495	537	54	30	2 3/8
		CMFF5436N_	559	641	54	36	2 3/8
		CMFF5442N_	632	714	54	42	2 3/8
		CMFF5448N_	683	765	54	48	2 3/8
		CMFF5454N_	726	808	54	54	2 3/8
		CMFF5460N_	781	863	54	60	2 3/8
	Non-Powered Compile Single Segmented Fabric Panel Package - 66”	CMFF6624N_	523	578	66	24	2 3/8
		CMFF6630N_	596	651	66	30	2 3/8
		CMFF6636N_	663	763	66	36	2 3/8
		CMFF6642N_	756	856	66	42	2 3/8
		CMFF6648N_	801	901	66	48	2 3/8
		CMFF6654N_	868	968	66	54	2 3/8
		CMFF6660N_	922	1022	66	60	2 3/8

Raceway Cover Options (1) Shown

- **RACEWAY COVER OPTIONS (Suffix)**
 - (0) No Knockouts Side 1 and Side 2
 - (1) Knockouts Side 1 – No Knockout Side 2
 - (2) Knockouts Side 1 and Side 2



CMFFXXYY_P - POWERED COMPILE SINGLE SEGMENTED FABRIC PANEL PACKAGE

- With power distribution harness.
- Includes one panel, power harness, one raceway cover with punchout and one raceway cover with no punchout.
- Individual fabric-covered modules incorporated into an aluminum frame.
- Opposite sides of each module may have a different fabric within the same grade at no upcharge.
- If different grades of fabric are used on one panel, the entire panel must be priced at highest grade.
- Panels are not tackable or acoustical.
- Note: Trim is not required at a straight connection between two panels of the same height.
- 3 Panel connector brackets per side come standard with 42”h, 48”h and 54”h panels.
- 4 Panel connector brackets per side come standard with 66”h panels.
- Panels contain leveling glides. Maximum extension of glides is 2”.

	DESCRIPTION	PRODUCT CODE	LIST PRICE		DIMENSIONS/INCHES		
			Gr1	Gr2	H	W	D
	Powered Compile Single Segmented Fabric Panel Package - 42"	CMFF4224P_	572	608	42	24	2 3/8
		CMFF4230P_	680	716	42	30	2 3/8
		CMFF4236P_	721	789	42	36	2 3/8
		CMFF4242P_	794	863	42	42	2 3/8
		CMFF4248P_	847	916	42	48	2 3/8
		CMFF4254P_	917	986	42	54	2 3/8
		CMFF4260P_	962	1031	42	60	2 3/8
		CMFF4266P_	1111	1243	42	66	2 3/8
CMFF4272P_	1171	1303	42	72	2 3/8		
	Powered Compile Single Segmented Fabric Panel Package - 48"	CMFF4824P_	610	650	48	24	2 3/8
		CMFF4830P_	715	756	48	30	2 3/8
		CMFF4836P_	791	870	48	36	2 3/8
		CMFF4842P_	868	949	48	42	2 3/8
		CMFF4848P_	939	1020	48	48	2 3/8
		CMFF4854P_	984	1064	48	54	2 3/8
		CMFF4860P_	1039	1118	48	60	2 3/8
	Powered Compile Single Segmented Fabric Panel Package - 54"	CMFF5424P_	611	652	54	24	2 3/8
		CMFF5430P_	715	757	54	30	2 3/8
		CMFF5436P_	793	875	54	36	2 3/8
		CMFF5442P_	869	951	54	42	2 3/8
		CMFF5448P_	940	1022	54	48	2 3/8
		CMFF5454P_	985	1067	54	54	2 3/8
		CMFF5460P_	1041	1123	54	60	2 3/8
	Powered Compile Single Segmented Fabric Panel Package - 66"	CMFF6624P_	685	740	66	24	2 3/8
		CMFF6630P_	817	872	66	30	2 3/8
		CMFF6636P_	893	993	66	36	2 3/8
		CMFF6642P_	992	1092	66	42	2 3/8
		CMFF6648P_	1054	1154	66	48	2 3/8
		CMFF6654P_	1123	1223	66	54	2 3/8
		CMFF6660P_	1177	1277	66	60	2 3/8

Raceway Cover Options (1) Shown

- **RACEWAY COVER OPTIONS (Suffix)**
 - (1) Knockouts Side 1 – No Knockout Side 2
 - (2) Knockouts Side 1 and Side 2

CMFMAXYYN_ - NON-POWERED COMPILE MONOLITHIC ACOUSTIC PANEL PACKAGE

- Non powered.
- Includes one panel and two raceway covers with no punchouts.
- Individual fabric-covered acoustic modules incorporated into an aluminum frame.
- Opposite sides of each module may have a different fabric within the same grade at no upcharge.
- If different grades of fabric are used on one panel, the entire panel must be priced at highest grade.
- Panels are lightly tackable.
- Note: Trim is not required at a straight connection between two panels of the same height.
- 3 Panel connector brackets per side come standard with 42”h, 48”h and 54”h panels.
- 4 Panel connector brackets per side come standard with 66”h panels.
- Panels contain leveling glides. Maximum extension of glides is 2”.

	DESCRIPTION	PRODUCT CODE	LIST PRICE		DIMENSIONS/INCHES		
			Gr1	Gr2	H	W	D
	Non-Powered Compile Monolithic Acoustic Panel Package - 42"	CMFMA4224N_	465	500	42	24	2 3/8
		CMFMA4230N_	523	558	42	30	2 3/8
		CMFMA4236N_	569	638	42	36	2 3/8
		CMFMA4242N_	624	693	42	42	2 3/8
		CMFMA4248N_	664	733	42	48	2 3/8
		CMFMA4254N_	735	804	42	54	2 3/8
		CMFMA4260N_	773	841	42	60	2 3/8
	Non-Powered Compile Monolithic Acoustic Panel Package - 48"	CMFMA4824N_	485	526	48	24	2 3/8
		CMFMA4830N_	546	570	48	30	2 3/8
		CMFMA4836N_	603	684	48	36	2 3/8
		CMFMA4842N_	675	756	48	42	2 3/8
		CMFMA4848N_	712	793	48	48	2 3/8
		CMFMA4854N_	763	844	48	54	2 3/8
		CMFMA4860N_	834	916	48	60	2 3/8
	Non-Powered Compile Monolithic Acoustic Panel Package - 54"	CMFMA5424N_	485	527	54	24	2 3/8
		CMFMA5430N_	547	589	54	30	2 3/8
		CMFMA5436N_	603	686	54	36	2 3/8
		CMFMA5442N_	675	758	54	42	2 3/8
		CMFMA5448N_	712	794	54	48	2 3/8
		CMFMA5454N_	764	847	54	54	2 3/8
		CMFMA5460N_	834	917	54	60	2 3/8
	Non-Powered Compile Monolithic Acoustic Panel Package - 66"	CMFMA6624N_	541	596	66	24	2 3/8
		CMFMA6630N_	621	676	66	30	2 3/8
		CMFMA6636N_	710	810	66	36	2 3/8
		CMFMA6642N_	798	898	66	42	2 3/8
		CMFMA6648N_	862	962	66	48	2 3/8
		CMFMA6654N_	956	1058	66	54	2 3/8
		CMFMA6660N_	1050	1150	66	60	2 3/8

Raceway Cover Options (1) Shown

- **RACEWAY COVER OPTIONS (Suffix)**
 - (0) No Knockouts Side 1 and Side 2
 - (1) Knockouts Side 1 – No Knockout Side 2
 - (2) Knockouts Side 1 and Side 2



CMFMAXYYYP - POWERED COMPILE MONOLITHIC ACOUSTIC PANEL PACKAGE

- With power distribution harness.
- Includes one panel, power harness, one raceway cover with punchout and one raceway cover with no punchout.
- Individual fabric-covered acoustic modules incorporated into an aluminum frame.
- Opposite sides of each module may have a different fabric within the same grade at no upcharge.
- If different grades of fabric are used on one panel, the entire panel must be priced at highest grade.
- Panels are lightly tackable.
- Note: Trim is not required at a straight connection between two panels of the same height.
- 3 Panel connector brackets per side come standard with 42”h, 48”h and 54”h panels.
- 4 Panel connector brackets per side come standard with 66”h panels.
- Panels contain leveling glides. Maximum extension of glides is 2”.

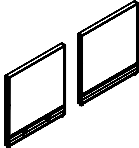
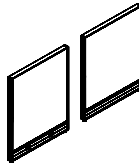
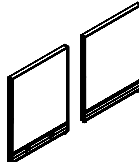
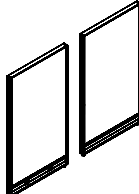
	DESCRIPTION	PRODUCT CODE	LIST PRICE		DIMENSIONS/INCHES		
			Gr1	Gr2	H	W	D
	Powered Compile Monolithic Acoustic Panel Package - 42”	CMFMA4224P_	629	664	42	24	2 3/8
		CMFMA4230P_	742	777	42	30	2 3/8
		CMFMA4236P_	801	870	42	36	2 3/8
		CMFMA4242P_	863	932	42	42	2 3/8
		CMFMA4248P_	919	988	42	48	2 3/8
		CMFMA4254P_	989	1058	42	54	2 3/8
		CMFMA4260P_	1029	1097	42	60	2 3/8
	Powered Compile Monolithic Acoustic Panel Package - 48”	CMFMA4824P_	647	688	48	24	2 3/8
		CMFMA4830P_	764	805	48	30	2 3/8
		CMFMA4836P_	835	917	48	36	2 3/8
		CMFMA4842P_	910	992	48	42	2 3/8
		CMFMA4848P_	966	1047	48	48	2 3/8
		CMFMA4854P_	1021	1103	48	54	2 3/8
		CMFMA4860P_	1091	1173	48	60	2 3/8
	Powered Compile Monolithic Acoustic Panel Package - 54”	CMFMA5424P_	650	692	54	24	2 3/8
		CMFMA5430P_	766	808	54	30	2 3/8
		CMFMA5436P_	835	918	54	36	2 3/8
		CMFMA5442P_	911	994	54	42	2 3/8
		CMFMA5448P_	966	1048	54	48	2 3/8
		CMFMA5454P_	1021	1104	54	54	2 3/8
		CMFMA5460P_	1092	1175	54	60	2 3/8
	Powered Compile Monolithic Acoustic Panel Package - 66”	CMFMA6624P_	706	761	66	24	2 3/8
		CMFMA6630P_	843	898	66	30	2 3/8
		CMFMA6636P_	941	1041	66	36	2 3/8
		CMFMA6642P_	1031	1131	66	42	2 3/8
		CMFMA6648P_	1115	1215	66	48	2 3/8
		CMFMA6654P_	1212	1314	66	54	2 3/8
		CMFMA6660P_	1305	1405	66	60	2 3/8

Raceway Cover Options (1) Shown

- **RACEWAY COVER OPTIONS (Suffix)**
 - (1) Knockouts Side 1 – No Knockout Side 2
 - (2) Knockouts Side 1 and Side 2

CMLFMXXYYN - MONOLITHIC LAMINATE SINGLE SIDED PANEL – NON-POWERED

- Individual modules, one in fabric and one in laminate, incorporated into an aluminum frame.
- Modules have laminate on one side and fabric on the other.
- Opposite sides of each module may have a different laminate within the same grade at no upcharge.
- Panels are not tackable.
- 3 panel connector brackets per side come standard with 30”h, 42”h, 48”h and 54”h panels.
- 4 panel connector brackets per side come standard with 66”h panels.
- 24” wide panels have two punchouts, one for electrical and one for data.
- 30” wide panels and wider have three punchouts, two for electrical and one for data.
- Note: Trim is not required at a straight connection between two panels of the same height.

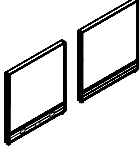
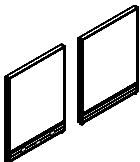
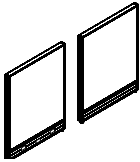
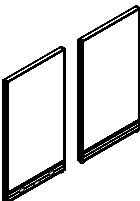
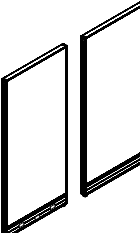
	DESCRIPTION	PRODUCT CODE	LIST PRICE		DIMENSIONS/INCHES		
			Gr1	Gr2	H	W	D
	Non-Powered Compile Monolithic Single Sided Panel Package - 30”	CMLFM3024N_	475	495	30	24	2 3/8
		CMLFM3030N_	550	564	30	30	2 3/8
		CMLFM3036N_	628	646	30	36	2 3/8
		CMLFM3042N_	712	726	30	42	2 3/8
		CMLFM3048N_	775	793	30	48	2 3/8
		CMLFM3054N_	855	876	30	54	2 3/8
		CMLFM3060N_	939	962	30	60	2 3/8
	Non-Powered Compile Monolithic Single Sided Panel Package - 42”	CMLFM4224N_	560	578	42	24	2 3/8
		CMLFM4230N_	656	677	42	30	2 3/8
		CMLFM4236N_	749	774	42	36	2 3/8
		CMLFM4242N_	850	875	42	42	2 3/8
		CMLFM4248N_	926	953	42	48	2 3/8
		CMLFM4254N_	1024	1057	42	54	2 3/8
		CMLFM4260N_	1124	1158	42	60	2 3/8
	Non-Powered Compile Monolithic Single Sided Panel Package - 48”	CMLFM4824N_	663	691	48	24	2 3/8
		CMLFM4830N_	777	798	48	30	2 3/8
		CMLFM4836N_	892	918	48	36	2 3/8
		CMLFM4842N_	1011	1043	48	42	2 3/8
		CMLFM4848N_	1103	1137	48	48	2 3/8
		CMLFM4854N_	1227	1264	48	54	2 3/8
		CMLFM4860N_	1347	1387	48	60	2 3/8
	Non-Powered Compile Monolithic Single Sided Panel Package - 54”	CMLFM5424N_	664	688	54	24	2 3/8
		CMLFM5430N_	777	804	54	30	2 3/8
		CMLFM5436N_	892	918	54	36	2 3/8
		CMLFM5442N_	1012	1045	54	42	2 3/8
		CMLFM5448N_	1103	1139	54	48	2 3/8
		CMLFM5454N_	1227	1264	54	54	2 3/8
		CMLFM5460N_	1347	1388	54	60	2 3/8
	Non-Powered Compile Monolithic Single Sided Panel Package - 66”	CMLFM6624N_	819	846	66	24	2 3/8
		CMLFM6630N_	959	992	66	30	2 3/8
		CMLFM6636N_	1106	1141	66	36	2 3/8
		CMLFM6642N_	1258	1295	66	42	2 3/8
		CMLFM6648N_	1368	1412	66	48	2 3/8
		CMLFM6654N_	1522	1571	66	54	2 3/8
		CMLFM6660N_	1675	1728	66	60	2 3/8

Raceway Cover Options (1) Shown

- **RACEWAY COVER OPTIONS (Suffix)**
 - (0) No Knockouts Side 1 and Side 2
 - (1) Knockouts Side 1 – No Knockout Side 2
 - (2) Knockouts Side 1 and Side 2



CMLFMXXYP - MONOLITHIC LAMINATE SINGLE SIDED PANEL – POWERED

- Individual modules, one in fabric and one in laminate, incorporated into an aluminum frame.
- Modules have laminate on one side and fabric on the other.
- Opposite sides of each module may have a different laminate within the same grade at no upcharge.
- Panels are not tackable.
- 3 panel connector brackets per side come standard with 30”h, 42”h, 48”h and 54”h panels.
- 4 panel connector brackets per side come standard with 66”h panels.
- 24” wide panels have two punchouts, one for electrical and one for data.
- 30” wide panels and wider have three punchouts, two for electrical and one for data.
- Note: Trim is not required at a straight connection between two panels of the same height.

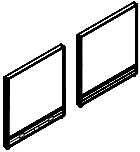
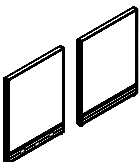
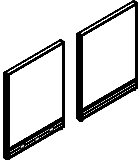
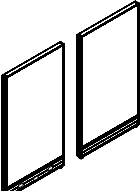
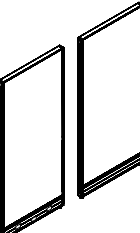
	DESCRIPTION	PRODUCT CODE	LIST PRICE		DIMENSIONS/INCHES		
			Gr1	Gr2	H	W	D
	Non-Powered Compile Monolithic Single Sided Panel Package - 30”	CMLFM3024P_	638	657	30	24	2 3/8
		CMLFM3030P_	770	846	30	30	2 3/8
		CMLFM3036P_	859	947	30	36	2 3/8
		CMLFM3042P_	949	1044	30	42	2 3/8
		CMLFM3048P_	1029	1133	30	48	2 3/8
		CMLFM3054P_	1111	1230	30	54	2 3/8
		CMLFM3060P_	1196	1325	30	60	2 3/8
	Non-Powered Compile Monolithic Single Sided Panel Package - 42”	CMLFM4224P_	724	805	42	24	2 3/8
		CMLFM4230P_	877	971	42	30	2 3/8
		CMLFM4236P_	983	1092	42	36	2 3/8
		CMLFM4242P_	1089	1210	42	42	2 3/8
		CMLFM4248P_	1182	1314	42	48	2 3/8
		CMLFM4254P_	1281	1431	42	54	2 3/8
		CMLFM4260P_	1384	1546	42	60	2 3/8
	Non-Powered Compile Monolithic Single Sided Panel Package - 48”	CMLFM4824P_	828	845	48	24	2 3/8
		CMLFM4830P_	998	1022	48	30	2 3/8
		CMLFM4836P_	1123	1151	48	36	2 3/8
		CMLFM4842P_	1246	1278	48	42	2 3/8
		CMLFM4848P_	1357	1387	48	48	2 3/8
		CMLFM4854P_	1481	1521	48	54	2 3/8
		CMLFM4860P_	1604	1799	48	60	2 3/8
	Non-Powered Compile Monolithic Single Sided Panel Package - 54”	CMLFM5424P_	829	926	54	24	2 3/8
		CMLFM5430P_	998	1114	54	30	2 3/8
		CMLFM5436P_	1123	1252	54	36	2 3/8
		CMLFM5442P_	1246	1395	54	42	2 3/8
		CMLFM5448P_	1357	1518	54	48	2 3/8
		CMLFM5454P_	1482	1659	54	54	2 3/8
		CMLFM5460P_	1604	1800	54	60	2 3/8
	Non-Powered Compile Monolithic Single Sided Panel Package - 66”	CMLFM6624P_	985	1106	66	24	2 3/8
		CMLFM6630P_	1177	1319	66	30	2 3/8
		CMLFM6636P_	1338	1500	66	36	2 3/8
		CMLFM6642P_	1492	1675	66	42	2 3/8
		CMLFM6648P_	1623	1824	66	48	2 3/8
		CMLFM6654P_	1780	2002	66	54	2 3/8
		CMLFM6660P_	1934	2175	66	60	2 3/8

Raceway Cover Options (1) Shown

- **RACEWAY COVER OPTIONS (Suffix)**
 - (0) No Knockouts Side 1 and Side 2
 - (1) Knockouts Side 1 – No Knockout Side 2
 - (2) Knockouts Side 1 and Side 2

CMLLMXXYYN - MONOLITHIC LAMINATE DOUBLE SIDED PANEL - NON-POWERED

- Individual laminate modules incorporated into an aluminum frame.
- Modules have laminate on both sides.
- Opposite sides of each module may have a different laminate within the same grade at no upcharge.
- 3 panel connector brackets per side come standard with 30”h, 42”h, 48”h and 54”h panels.
- 4 panel connector brackets per side come standard with 66”h panels.
- 24” wide panels have two punchouts, one for electrical and one for data.
- 30” wide panels and wider have three punchouts, two for electrical and one for data.
- Note: Trim is not required at a straight connection between two panels of the same height.

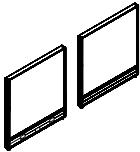
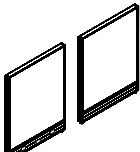
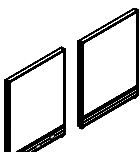
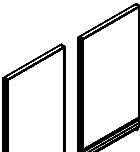
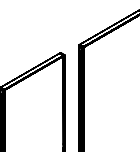
	DESCRIPTION	PRODUCT CODE	LIST PRICE Gr1	DIMENSIONS/INCHES		
				H	W	D
	Non-Powered Compile Monolithic	CMLLM3024N_	537	30	24	2 3/8
	Double Sided Laminate Panel Package - 30”	CMLLM3030N_	636	30	30	2 3/8
		CMLLM3036N_	726	30	36	2 3/8
		CMLLM3042N_	829	30	42	2 3/8
		CMLLM3048N_	925	30	48	2 3/8
		CMLLM3054N_	1023	30	54	2 3/8
		CMLLM3060N_	1106	30	60	2 3/8
	Non-Powered Compile Monolithic	CMLLM4224N_	636	42	24	2 3/8
	Double Sided Laminate Panel Package - 42”	CMLLM4230N_	748	42	30	2 3/8
		CMLLM4236N_	871	42	36	2 3/8
		CMLLM4242N_	993	42	42	2 3/8
		CMLLM4248N_	1112	42	48	2 3/8
		CMLLM4254N_	1222	42	54	2 3/8
		CMLLM4260N_	1329	42	60	2 3/8
	Non-Powered Compile Monolithic	CMLLM4824N_	752	48	24	2 3/8
	Double Sided Laminate Panel Package - 48”	CMLLM4830N_	891	48	30	2 3/8
		CMLLM4836N_	1033	48	36	2 3/8
		CMLLM4842N_	1181	48	42	2 3/8
		CMLLM4848N_	1327	48	48	2 3/8
		CMLLM4854N_	1462	48	54	2 3/8
		CMLLM4860N_	1546	48	60	2 3/8
	Non-Powered Compile Monolithic	CMLLM5424N_	752	54	24	2 3/8
	Double Sided Laminate Panel Package - 54”	CMLLM5430N_	891	54	30	2 3/8
		CMLLM5436N_	1034	54	36	2 3/8
		CMLLM5442N_	1182	54	42	2 3/8
		CMLLM5448N_	1328	54	48	2 3/8
		CMLLM5454N_	1462	54	54	2 3/8
		CMLLM5460N_	1592	54	60	2 3/8
	Non-Powered Compile Monolithic	CMLLM6624N_	952	66	24	2 3/8
	Double Sided Laminate Panel Package - 66”	CMLLM6630N_	1124	66	30	2 3/8
		CMLLM6636N_	1304	66	36	2 3/8
		CMLLM6642N_	1493	66	42	2 3/8
		CMLLM6648N_	1675	66	48	2 3/8
		CMLLM6654N_	1847	66	54	2 3/8
		CMLLM6660N_	2020	66	60	2 3/8

Raceway Cover Options (1) Shown

- **RACEWAY COVER OPTIONS (Suffix)**
 - (0) No Knockouts Side 1 and Side 2
 - (1) Knockouts Side 1 – No Knockout Side 2
 - (2) Knockouts Side 1 and Side 2



CMLLMXXYP_ - MONOLITHIC LAMINATE DOUBLE SIDED PANEL – POWERED

- Individual laminate modules incorporated into an aluminum frame.
- Modules have laminate on both sides.
- Opposite sides of each module may have a different laminate within the same grade at no upcharge.
- 3 panel connector brackets per side come standard with 30”h, 42”h, 48”h and 54”h panels.
- 4 panel connector brackets per side come standard with 66”h panels.
- 24” wide panels have two punchouts, one for electrical and one for data.
- 30” wide panels and wider have three punchouts, two for electrical and one for data.
- Note: Trim is not required at a straight connection between two panels of the same height.

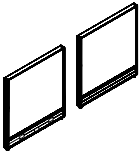
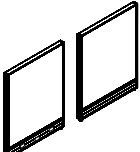
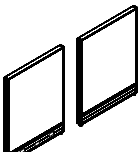
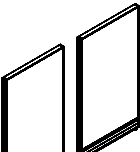
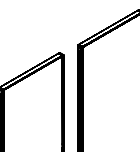
	DESCRIPTION	PRODUCT CODE	LIST PRICE Gr1	DIMENSIONS/INCHES		
				H	W	D
	Powered Compile Monolithic	CMLLM3024P_	703	30	24	2 3/8
	Double Sided Laminate Panel Package - 30”	CMLLM3030P_	858	30	30	2 3/8
		CMLLM3036P_	959	30	36	2 3/8
		CMLLM3042P_	1064	30	42	2 3/8
		CMLLM3048P_	1177	30	48	2 3/8
		CMLLM3054P_	1280	30	54	2 3/8
		CMLLM3060P_	1364	30	60	2 3/8
	Powered Compile Monolithic	CMLLM4224P_	801	42	24	2 3/8
	Double Sided Laminate Panel Package - 42”	CMLLM4230P_	970	42	30	2 3/8
		CMLLM4236P_	1105	42	36	2 3/8
		CMLLM4242P_	1231	42	42	2 3/8
		CMLLM4248P_	1366	42	48	2 3/8
		CMLLM4254P_	1480	42	54	2 3/8
		CMLLM4260P_	1587	42	60	2 3/8
	Powered Compile Monolithic	CMLLM4824P_	915	48	24	2 3/8
	Double Sided Laminate Panel Package - 48”	CMLLM4830P_	1111	48	30	2 3/8
		CMLLM4836P_	1266	48	36	2 3/8
		CMLLM4842P_	1418	48	42	2 3/8
		CMLLM4848P_	1583	48	48	2 3/8
		CMLLM4854P_	1719	48	54	2 3/8
		CMLLM4860P_	1796	48	60	2 3/8
	Powered Compile Monolithic	CMLLM5424P_	915	54	24	2 3/8
	Double Sided Laminate Panel Package - 54”	CMLLM5430P_	1112	54	30	2 3/8
		CMLLM5436P_	1266	54	36	2 3/8
		CMLLM5442P_	1418	54	42	2 3/8
		CMLLM5448P_	1584	54	48	2 3/8
		CMLLM5454P_	1721	54	54	2 3/8
		CMLLM5460P_	1848	54	60	2 3/8
	Powered Compile Monolithic	CMLLM6624P_	1115	66	24	2 3/8
	Double Sided Laminate Panel Package - 66”	CMLLM6630P_	1347	66	30	2 3/8
		CMLLM6636P_	1536	66	36	2 3/8
		CMLLM6642P_	1731	66	42	2 3/8
		CMLLM6648P_	1929	66	48	2 3/8
		CMLLM6654P_	2104	66	54	2 3/8
		CMLLM6660P_	2277	66	60	2 3/8

Raceway Cover Options (1) Shown

- **RACEWAY COVER OPTIONS (Suffix)**
 - (0) No Knockouts Side 1 and Side 2
 - (1) Knockouts Side 1 – No Knockout Side 2
 - (2) Knockouts Side 1 and Side 2

CMFLXXYYN - SEGMENTED LAMINATE SINGLE SIDED PANEL – NON-POWERED

- Individual fabric or laminate covered modules incorporated into an aluminum frame.
- Modules have laminate on one side and fabric on the other.
- Opposite sides of each module may have a different laminate within the same grade at no upcharge.
- If different grades of fabric are used on one panel, the entire panel must be priced at highest grade.
- Panels are not tackable.
- Note: Trim is not required at a straight connection between two panels of the same height.
- 3 Panel connector brackets per side come standard with 42”h, 48h” and 54”h panels.
- 4 Panel connector brackets per side come standard with 66”h panels.
- 24” wide panels have two punchouts, one for electrical and one for data.
- 30” wide panels and wider have three punchouts, two for electrical and one for data.

	DESCRIPTION	PRODUCT CODE	LIST PRICE		DIMENSIONS/INCHES		
			Gr1	Gr2	H	W	D
	Non-Powered Compile Single Segmented Laminate Panel Package - 42"	CMFL4224N_	560	579	42	24	2.38
		CMFL4230N_	656	677	42	30	2.38
		CMFL4236N_	749	775	42	36	2.38
		CMFL4242N_	850	876	42	42	2.38
		CMFL4248N_	926	954	42	48	2.38
		CMFL4254N_	1024	1057	42	54	2.38
		CMFL4260N_	1124	1158	42	60	2.38
	Non-Powered Compile Single Segmented Laminate Panel Package - 48"	CMFL4824N_	663	684	48	24	2.38
		CMFL4830N_	777	798	48	30	2.38
		CMFL4836N_	892	919	48	36	2.38
		CMFL4842N_	1011	1044	48	42	2.38
		CMFL4848N_	1103	1136	48	48	2.38
		CMFL4854N_	1227	1468	48	54	2.38
		CMFL4860N_	1347	1389	48	60	2.38
	Non-Powered Compile Single Segmented Laminate Panel Package - 54"	CMFL5424N_	664	688	54	24	2.38
		CMFL5430N_	777	804	54	30	2.38
		CMFL5436N_	892	919	54	36	2.38
		CMFL5442N_	1012	1045	54	42	2.38
		CMFL5448N_	1103	1139	54	48	2.38
		CMFL5454N_	1227	1265	54	54	2.38
		CMFL5460N_	1347	1389	54	60	2.38
	Non-Powered Compile Single Segmented Lmainate Panel Package - 66"	CMFL6624N_	819	847	66	24	2.38
		CMFL6630N_	959	992	66	30	2.38
		CMFL6636N_	1106	1141	66	36	2.38
		CMFL6642N_	1258	1293	66	42	2.38
		CMFL6648N_	1368	1413	66	48	2.38
		CMFL6654N_	1522	1572	66	54	2.38
		CMFL6660N_	1675	1729	66	60	2.38

Raceway Cover Options (1) Shown

- **RACEWAY COVER OPTIONS (Suffix)**
 - (0) No Knockouts Side 1 and Side 2
 - (1) Knockouts Side 1 – No Knockout Side 2
 - (2) Knockouts Side 1 and Side 2



CMFLXXYP_ - SEGMENTED LAMINATE SINGLE SIDED PANEL – POWERED

- Individual fabric or laminate covered modules incorporated into an aluminum frame.
- Modules have laminate on one side and fabric on the other.
- Opposite sides of each module may have a different laminate within the same grade at no upcharge.
- If different grades of fabric are used on one panel, the entire panel must be priced at highest grade.
- Panels are not tackable.
- Note: Trim is not required at a straight connection between two panels of the same height.
- 3 Panel connector brackets per side come standard with 42”h, 48h” and 54”h panels.
- 4 Panel connector brackets per side come standard with 66”h panels.
- 24” wide panels have two punchouts, one for electrical and one for data.
- 30” wide panels and wider have three punchouts, two for electrical and one for data.

	DESCRIPTION	PRODUCT CODE	LIST PRICE		DIMENSIONS/INCHES		
			Gr1	Gr2	H	W	D
	Powered Compile Single Segmented Laminate Panel Package - 42”	CMFL4224P_	724	805	42	24	2 3/8
		CMFL4230P_	877	971	42	30	2 3/8
		CMFL4236P_	983	1093	42	36	2 3/8
		CMFL4242P_	1089	1211	42	42	2 3/8
		CMFL4248P_	1182	1315	42	48	2 3/8
		CMFL4254P_	1281	1431	42	54	2 3/8
		CMFL4260P_	1384	1546	42	60	2 3/8
	Powered Compile Single Segmented Laminate Panel Package - 48”	CMFL4824P_	828	848	48	24	2 3/8
		CMFL4830P_	998	1021	48	30	2 3/8
		CMFL4836P_	1123	1151	48	36	2 3/8
		CMFL4842P_	1246	1276	48	42	2 3/8
		CMFL4848P_	1357	1392	48	48	2 3/8
		CMFL4854P_	1481	1520	48	54	2 3/8
		CMFL4860P_	1604	1648	48	60	2 3/8
	Powered Compile Single Segmented Laminate Panel Package - 54”	CMFL5424P_	829	927	54	24	2 3/8
		CMFL5430P_	998	1114	54	30	2 3/8
		CMFL5436P_	1123	1252	54	36	2 3/8
		CMFL5442P_	1246	1395	54	42	2 3/8
		CMFL5448P_	1357	1519	54	48	2 3/8
		CMFL5454P_	1482	1659	54	54	2 3/8
		CMFL5460P_	1604	1801	54	60	2 3/8
	Powered Compile Single Segmented Laminate Panel Package - 66”	CMFL6624P_	985	1107	66	24	2 3/8
		CMFL6630P_	1177	1319	66	30	2 3/8
		CMFL6636P_	1297	1502	66	36	2 3/8
		CMFL6642P_	1492	1675	66	42	2 3/8
		CMFL6648P_	1623	1821	66	48	2 3/8
		CMFL6654P_	1780	2003	66	54	2 3/8
		CMFL6660P_	1934	2177	66	60	2 3/8

Raceway Cover Options (1) Shown

- **RACEWAY COVER OPTIONS (Suffix)**
 - (1) Knockouts Side 1 – No Knockout Side 2
 - (2) Knockouts Side 1 and Side 2

CMLLXXYYN - SEGMENTED LAMINATE DOUBLE SIDED PANEL – NON-POWERED

- Individual laminate covered modules incorporated into an aluminum frame. same height.
- Modules have laminate on one side and fabric on the other.
- Opposite sides of each module may have a different laminate within the same grade at no upcharge.
- If different grades of fabric are used on one panel, the entire panel must be priced at highest grade.
- Note: Trim is not required at a straight connection between two panels of the
- 3 Panel connector brackets per side come standard with 42”h, 48h” and 54”h panels.
- 4 Panel connector brackets per side come standard with 66”h panels.
- 24” wide panels have two punchouts, one for electrical and one for data.
- 30” wide panels and wider have three punchouts, two for electrical and one for data.

	DESCRIPTION	PRODUCT CODE	LIST PRICE Gr1	DIMENSIONS/INCHES		
				H	W	D
	Non-Powered Compile Single Segmented	CMLL4224N_	636	42	24	2 3/8
	Double Sided Laminate Panel Package - 42”	CMLL4230N_	748	42	30	2 3/8
		CMLL4236N_	871	42	36	2 3/8
		CMLL4242N_	993	42	42	2 3/8
		CMLL4248N_	1112	42	48	2 3/8
		CMLL4254N_	1222	42	54	2 3/8
		CMLL4260N_	1329	42	60	2 3/8
	Non-Powered Compile Single Segmented	CMLL4824N_	752	48	24	2 3/8
	Double Sided Laminate Panel Package - 48”	CMLL4830N_	891	48	30	2 3/8
		CMLL4836N_	1033	48	36	2 3/8
		CMLL4842N_	1181	48	42	2 3/8
		CMLL4848N_	1327	48	48	2 3/8
		CMLL4854N_	1462	48	54	2 3/8
		CMLL4860N_	1589	48	60	2 3/8
	Non-Powered Compile Single Segmented	CMLL5424N_	752	54	24	2 3/8
	Double Sided Laminate Panel Package - 54”	CMLL5430N_	891	54	30	2 3/8
		CMLL5436N_	1034	54	36	2 3/8
		CMLL5442N_	1182	54	42	2 3/8
		CMLL5448N_	1328	54	48	2 3/8
		CMLL5454N_	1462	54	54	2 3/8
		CMLL5460N_	1592	54	60	2 3/8
	Non-Powered Compile Single Segmented	CMLL6624N_	952	66	24	2 3/8
	Double Sided Laminate Panel Package - 66”	CMLL6630N_	1124	66	30	2 3/8
		CMLL6636N_	1304	66	36	2 3/8
		CMLL6642N_	1493	66	42	2 3/8
		CMLL6648N_	1675	66	48	2 3/8
		CMLL6654N_	1847	66	54	2 3/8
		CMLL6660N_	2020	66	60	2 3/8

Raceway Cover Options (1) Shown

- **RACEWAY COVER OPTIONS (Suffix)**
 - (0) No Knockouts Side 1 and Side 2
 - (1) Knockouts Side 1 – No Knockout Side 2
 - (2) Knockouts Side 1 and Side 2



CMLLXXYP_ - SEGMENTED LAMINATE DOUBLE SIDED PANEL – POWERED

- Individual laminate covered modules incorporated into an aluminum frame.
- Modules have laminate on one side and fabric on the other.
- Opposite sides of each module may have a different laminate within the same grade at no upcharge.
- If different grades of fabric are used on one panel, the entire panel must be priced at highest grade.
- Note: Trim is not required at a straight connection between two panels of the same height.
- 3 Panel connector brackets per side come standard with 42”h, 48h” and 54”h panels.
- 4 Panel connector brackets per side come standard with 66” panels.
- 24” wide panels have two punchouts, one for electrical and one for data.
- 30” wide panels and wider have three punchouts, two for electrical and one for data.



	DESCRIPTION	PRODUCT CODE	LIST PRICE Gr1	DIMENSIONS/INCHES		
				H	W	D
	Powered Compile Single Segmented	CMLL4224P_	801	42	24	2.38
	Double Sided Laminate Panel Package - 42”	CMLL4230P_	970	42	30	2.38
		CMLL4236P_	1105	42	36	2.38
		CMLL4242P_	1231	42	42	2.38
		CMLL4248P_	1366	42	48	2.38
		CMLL4254P_	1480	42	54	2.38
		CMLL4260P_	1587	42	60	2.38
	Powered Compile Single Segmented	CMLL4824P_	915	48	24	2.38
	Double Sided Laminate Panel Package - 48”	CMLL4830P_	1111	48	30	2.38
		CMLL4836P_	1266	48	36	2.38
		CMLL4842P_	1418	48	42	2.38
		CMLL4848P_	1583	48	48	2.38
		CMLL4854P_	1719	48	54	2.38
		CMLL4860P_	1848	48	60	2.38
	Powered Compile Single Segmented	CMLL5424P_	915	54	24	2.38
	Double Sided Laminate Panel Package - 54”	CMLL5430P_	1112	54	30	2.38
		CMLL5436P_	1266	54	36	2.38
		CMLL5442P_	1418	54	42	2.38
		CMLL5448P_	1584	54	48	2.38
		CMLL5454P_	1721	54	54	2.38
		CMLL5460P_	1848	54	60	2.38
	Powered Compile Single Segmented	CMLL6624P_	1115	66	24	2.38
	Double Sided Laminate Panel Package - 66”	CMLL6630P_	1347	66	30	2.38
		CMLL6636P_	1536	66	36	2.38
		CMLL6642P_	1731	66	42	2.38
		CMLL6648P_	1929	66	48	2.38
		CMLL6654P_	2104	66	54	2.38
		CMLL6660P_	2277	66	60	2.38

Raceway Cover Options (1) Shown

- **RACEWAY COVER OPTIONS (Suffix)**
 - (0) No Knockouts Side 1 and Side 2
 - (1) Knockouts Side 1 – No Knockout Side 2
 - (2) Knockouts Side 1 and Side 2

CMFWXXYYN_ - SEGMENTED WRITE BOARD SINGLE SIDED PANEL – NON-POWERED

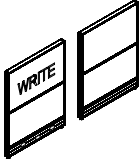
- Individual fabric or write board covered modules incorporated into an aluminum frame.
- Modules have write board on one side and fabric on the other at the top and fabric on two sides at the bottom.
- Opposite sides of each module may have a different fabric within the same grade at no upcharge.
- If different grades of fabric are used on one panel, the entire panel must be priced at highest grade.
- Panels are not tackable.
- Note: Trim is not required at a straight connection between two panels of the same height.
- 3 Panel connector brackets per side come standard with 48”h. and 54”h. panels.
- 4 Panel connector brackets per side come standard with 66”h. panels.
- 24” wide panels have two punchouts, one for electrical and one for data.
- 30” wide panels and wider have three punchouts, two for electrical and one for data.

	DESCRIPTION	PRODUCT CODE	LIST PRICE		DIMENSIONS/INCHES		
			Gr1	Gr2	H	W	D
	Non-Powered Compile Write Board Single Sided Panel Package - 48” No punchouts	CMFW4824N_	594	623	48	24	2 3/8
		CMFW4830N_	717	752	48	30	2 3/8
		CMFW4836N_	796	835	48	36	2 3/8
		CMFW4842N_	897	752	48	42	2 3/8
		CMFW4848N_	1008	1060	48	48	2 3/8
		CMFW4854N_	1121	1161	48	54	2 3/8
		CMFW4860N_	1233	1300	48	60	2 3/8
	Non-Powered Compile Write Board Single Sided Panel Package - 54”	CMFW5424N_	595	619	54	24	2 3/8
		CMFW5430N_	718	745	54	30	2 3/8
		CMFW5436N_	797	823	54	36	2 3/8
		CMFW5442N_	898	931	54	42	2 3/8
		CMFW5448N_	1010	1046	54	48	2 3/8
		CMFW5454N_	1121	1159	54	54	2 3/8
		CMFW5460N_	1234	1276	54	60	2 3/8
	Non-Powered Compile Write Board Single Sided Panel Package - 66”	CMFW6624N_	749	777	66	24	2 3/8
		CMFW6630N_	891	924	66	30	2 3/8
		CMFW6636N_	992	1027	66	36	2 3/8
		CMFW6642N_	1122	1160	66	42	2 3/8
		CMFW6648N_	1251	1296	66	48	2 3/8
		CMFW6654N_	1391	1439	66	54	2 3/8
		CMFW6660N_	1536	1588	66	60	2 3/8

Raceway Cover Options (1) Shown

- **RACEWAY COVER OPTIONS (Suffix)**
 - (0) No Knockouts Side 1 and Side 2
 - (1) Knockouts Side 1 – No Knockout Side 2
 - (2) Knockouts Side 1 and Side 2



CMFWXXYYP_ - SEGMENTED WRITE BOARD SINGLE SIDED PANEL – POWERED

- Individual fabric or write board covered modules incorporated into an aluminum frame.
- Modules have write board on one side and fabric on the other at the top and fabric on two sides at the bottom.
- Opposite sides of each module may have a different fabric within the same grade at no upcharge.
- If different grades of fabric are used on one panel, the entire panel must be priced at highest grade.
- Panels are not tackable.
- Note: Trim is not required at a straight connection between two panels of the same height.
- 3 Panel connector brackets per side come standard with 48”h. and 54”h. panels.
- 4 Panel connector brackets per side come standard with 66”h. panels.
- 24” wide panels have two punchouts, one for electrical and one for data.
- 30” wide panels and wider have three punchouts, two for electrical and one for data.

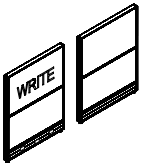
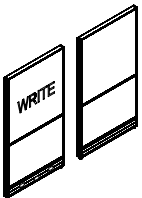

	DESCRIPTION	PRODUCT CODE	LIST PRICE		DIMENSIONS/INCHES		
			Gr1	Gr2	H	W	D
	Powered Compile Write Board Single Sided Panel Package - 48” Punchouts on one side	CMFW4824P_	757	786	48	24	2 3/8
		CMFW4830P_	939	974	48	30	2 3/8
		CMFW4836P_	1027	1066	48	36	2 3/8
		CMFW4842P_	1133	1183	48	42	2 3/8
		CMFW4848P_	1263	1313	48	48	2 3/8
		CMFW4854P_	1378	1417	48	54	2 3/8
		CMFW4860P_	1491	1557	48	60	2 3/8
	Powered Compile Write Board Single Sided Panel Package - 54”	CMFW5424P_	759	783	54	24	2 3/8
		CMFW5430P_	940	967	54	30	2 3/8
		CMFW5436P_	1027	1054	54	36	2 3/8
		CMFW5442P_	1134	1167	54	42	2 3/8
		CMFW5448P_	1263	1299	54	48	2 3/8
		CMFW5454P_	1380	1418	54	54	2 3/8
		CMFW5460P_	1491	1536	54	60	2 3/8
	Powered Compile Write Board Single Sided Panel Package - 66”	CMFW6624P_	914	941	66	24	2 3/8
		CMFW6630P_	1112	1145	66	30	2 3/8
		CMFW6636P_	1222	1257	66	36	2 3/8
		CMFW6642P_	1358	1396	66	42	2 3/8
		CMFW6648P_	1507	1549	66	48	2 3/8
		CMFW6654P_	1647	1697	66	54	2 3/8
		CMFW6660P_	1795	1849	66	60	2 3/8

Raceway Cover Options (1) Shown

- **RACEWAY COVER OPTIONS (Suffix)**
 - (0) No Knockouts Side 1 and Side 2
 - (1) Knockouts Side 1 – No Knockout Side 2
 - (2) Knockouts Side 1 and Side 2

CMWWXXYYN_ - SEGMENTED WRITE BOARD DOUBLE SIDED PANEL – NON-POWERED

- Individual fabric or write board covered modules incorporated into an aluminum frame.
- Modules have write board on two sides at the top and fabric on two sides at the bottom.
- Opposite sides of each module may have a different fabric within the same grade at no upcharge.
- If different grades of fabric are used on one panel, the entire panel must be priced at highest grade.
- Panels are not tackable.
- Note: Trim is not required at a straight connection between two panels of the same height.
- 3 Panel connector brackets per side come standard with 48”h. and 54”h. panels.
- 4 Panel connector brackets per side come standard with 66”h. panels.
- 24” wide panels have two punchouts, one for electrical and one for data.
- 30” wide panels and wider have three punchouts, two for electrical and one for data.

	DESCRIPTION	PRODUCT CODE	LIST PRICE		DIMENSIONS/INCHES		
			Gr1	Gr2	H	W	D
	Non-Powered Compile Write Board	CMWW4824N_	651	670	48	24	2.38
	Single Segmented Panel Package - 48"	CMWW4830N_	808	831	48	30	2.38
	No Punchouts	CMWW4836N_	875	907	48	36	2.38
		CMWW4842N_	992	1025	48	42	2.38
		CMWW4848N_	1161	1197	48	48	2.38
		CMWW4854N_	1289	1329	48	54	2.38
		CMWW4860N_	1420	1461	48	60	2.38
	Non-Powered Compile Write Board	CMWW5424N_	652	688	54	24	2.38
	Single Segmented Panel Package - 54"	CMWW5430N_	808	844	54	30	2.38
		CMWW5436N_	875	944	54	36	2.38
		CMWW5442N_	993	1062	54	42	2.38
		CMWW5448N_	1161	1230	54	48	2.38
		CMWW5454N_	1290	1359	54	54	2.38
		CMWW5460N_	1420	1489	54	60	2.38
	Non-Powered Compile Write Board	CMWW6624N_	804	840	66	24	2.38
	Single Segmented Panel Package - 66"	CMWW6630N_	985	1021	66	30	2.38
		CMWW6636N_	992	1061	66	36	2.38
		CMWW6642N_	1218	1288	66	42	2.38
		CMWW6648N_	1400	1469	66	48	2.38
		CMWW6654N_	1563	1632	66	54	2.38
		CMWW6660N_	1723	1792	66	60	2.38



Raceway Cover Options (1) Shown

- **RACEWAY COVER OPTIONS (Suffix)**
 - (0) No Knockouts Side 1 and Side 2
 - (1) Knockouts Side 1 – No Knockout Side 2
 - (2) Knockouts Side 1 and Side 2



CMWWXYYP_ - SEGMENTED WRITE BOARD DOUBLE SIDED PANEL – POWERED

- Individual fabric or write board covered modules incorporated into an aluminum frame.
- Modules have write board on two sides at the top and fabric on two sides at the bottom.
- Opposite sides of each module may have a different fabric within the same grade at no upcharge.
- If different grades of fabric are used on one panel, the entire panel must be priced at highest grade.
- Panels are not tackable.
- Note: Trim is not required at a straight connection between two panels of the same height.
- 3 Panel connector brackets per side come standard with 48”h. and 54”h. panels.
- 4 Panel connector brackets per side come standard with 66”h. panels.
- 24” wide panels have two punchouts, one for electrical and one for data.
- 30” wide panels and wider have three punchouts, two for electrical and one for data.

	DESCRIPTION	PRODUCT CODE	LIST PRICE		DIMENSIONS/INCHES		
			Gr1	Gr2	H	W	D
	Powered Compile Write Board	CMWW4824P_	815	835	48	24	2 3/8
	Single Segmented Panel Package - 48"	CMWW4830P_	1029	1052	48	30	2 3/8
	Punchouts on one side	CMWW4836P_	1107	1136	48	36	2 3/8
		CMWW4842P_	1230	1262	48	42	2 3/8
		CMWW4848P_	1415	1451	48	48	2 3/8
		CMWW4854P_	1546	1586	48	54	2 3/8
		CMWW4860P_	1678	1718	48	60	2 3/8
	Powered Compile Write Board	CMWW5424P_	815	851	54	24	2 3/8
	Single Segmented Panel Package - 54"	CMWW5430P_	1029	1065	54	30	2 3/8
		CMWW5436P_	1107	1176	54	36	2 3/8
		CMWW5442P_	1231	1300	54	42	2 3/8
		CMWW5448P_	1415	1484	54	48	2 3/8
		CMWW5454P_	1547	1616	54	54	2 3/8
		CMWW5460P_	1678	1747	54	60	2 3/8
	Powered Compile Write Board	CMWW6624P_	966	1002	66	24	2 3/8
	Single Segmented Panel Package - 66"	CMWW6630P_	1204	1240	66	30	2 3/8
		CMWW6636P_	1305	1374	66	36	2 3/8
		CMWW6642P_	1454	1523	66	42	2 3/8
		CMWW6648P_	1656	1725	66	48	2 3/8
		CMWW6654P_	1819	1888	66	54	2 3/8
		CMWW6660P_	1981	2050	66	60	2 3/8

Raceway Cover Options (1) Shown

- **RACEWAY COVER OPTIONS (Suffix)**
 - (0) No Knockouts Side 1 and Side 2
 - (1) Knockouts Side 1 – No Knockout Side 2
 - (2) Knockouts Side 1 and Side 2

CMFOXXYYN_ - COMPILE SINGLE SEGMENTED OPEN BOTTOM PANEL PACKAGE – NON-POWERED

- Non powered.
- Includes one panel and two raceways covers with no punchouts and a integrated aluminum top cap.
- Individual fabric-covered module in upper position incorporated into an aluminum frame. Bottom is open.
- Opposite sides of each module may have a different fabric within the same grade at no upcharge.
- If different grades of fabric are used on one panel, the entire panel must be priced at highest grade.
- Panels are not tackable or acoustical.
- Trim is not required at a straight connection between two panels of the same height.
- 3 Panel connector brackets per side come standard with 42”h, 48”h and 54”h panels.
- 4 Panel connector brackets per side come standard with 66”h panels.
- Panels contain leveling glides. Maximum extension of glides is 2”.

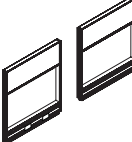
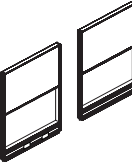
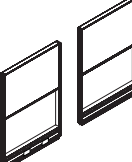
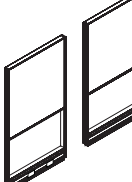
	DESCRIPTION	PRODUCT CODE	LIST PRICE		DIMENSIONS/INCHES		
			Gr1	Gr2	H	W	D
	Non-Powered Compile Single Segmented Open Bottom Panel Package - 42"	CMFO4224N_	380	398	42	24	2 3/8
		CMFO4230N_	426	441	42	30	2 3/8
		CMFO4236N_	452	481	42	36	2 3/8
		CMFO4242N_	516	545	42	42	2 3/8
		CMFO4248N_	549	578	42	48	2 3/8
		CMFO4254N_	613	628	42	54	2 3/8
	Non-Powered Compile Single Segmented Open Bottom Panel Package - 48"	CMFO4824N_	410	433	48	24	2 3/8
		CMFO4830N_	460	480	48	30	2 3/8
		CMFO4836N_	516	537	48	36	2 3/8
		CMFO4842N_	586	626	48	42	2 3/8
		CMFO4848N_	632	673	48	48	2 3/8
		CMFO4854N_	671	712	48	54	2 3/8
	Non-Powered Compile Single Segmented Open Bottom Panel Package - 54"	CMFO5424N_	411	435	54	24	2 3/8
		CMFO5430N_	460	484	54	30	2 3/8
		CMFO5436N_	517	541	54	36	2 3/8
		CMFO5442N_	586	627	54	42	2 3/8
		CMFO5448N_	632	673	54	48	2 3/8
		CMFO5454N_	671	713	54	54	2 3/8
	Non-Powered Compile Single Segmented Open Bottom Panel Package - 66"	CMFO6624N_	482	517	66	24	2 3/8
		CMFO6630N_	553	588	66	30	2 3/8
		CMFO6636N_	615	676	66	36	2 3/8
		CMFO6642N_	699	762	66	42	2 3/8
		CMFO6648N_	740	803	66	48	2 3/8
		CMFO6654N_	804	865	66	54	2 3/8
CMFO6660N_	852	913	66	60	2 3/8		



Raceway Cover Options (1) Shown

- **RACEWAY COVER OPTIONS (Suffix)**
 - (0) No Knockouts Side 1 and Side 2
 - (1) Knockouts Side 1 – No Knockout Side 2
 - (2) Knockouts Side 1 and Side 2

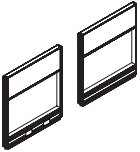
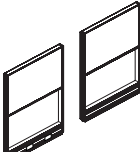
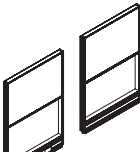

CMFOXXYP - COMPILE SINGLE SEGMENTED - OPEN BOTTOM PANEL PACKAGE – POWERED

- With power distribution harness.
- Includes one panel, power harness, one raceway cover with punchout, one raceway cover without punchout and a integrated aluminum top cap.
- Individual fabric-covered module in upper position incorporated into an aluminum frame. Bottom is open.
- Opposite sides of each module may have a different fabric within the same grade at no upcharge.
- If different grades of fabric are used on one panel, the entire panel must be priced at highest grade.
- Panels are not tackable or acoustical.
- Trim is not required at a straight connection between two panels of the same height.
- 3 Panel connector brackets per side come standard with 42”h, 48”h and 54”h panels.
- 4 Panel connector brackets per side come standard with 66”h panels.
- Panels contain leveling glides. Maximum extension of glides is 2”.
- 24” wide panels have one punchout, 30” wide panels or wider have two punchouts.

	DESCRIPTION	PRODUCT CODE	LIST PRICE		DIMENSIONS/INCHES		
			Gr1	Gr2	H	W	D
	Powered Compile Single Segmented Open Bottom Panel Package - 42”	CMFO4224P_	529	547	42	24	2 3/8
		CMFO4230P_	630	648	42	30	2 3/8
		CMFO4236P_	664	693	42	36	2 3/8
		CMFO4242P_	733	762	42	42	2 3/8
		CMFO4248P_	782	811	42	48	2 3/8
		CMFO4254P_	847	862	42	54	2 3/8
	Powered Compile Single Segmented Open Bottom Panel Package - 48”	CMFO4824P_	562	585	48	24	2 3/8
		CMFO4830P_	660	681	48	30	2 3/8
		CMFO4836P_	732	753	48	36	2 3/8
		CMFO4842P_	803	844	48	42	2 3/8
		CMFO4848P_	866	907	48	48	2 3/8
		CMFO4854P_	907	948	48	54	2 3/8
	Powered Compile Single Segmented Open Bottom Panel Package - 54”	CMFO5424P_	562	586	54	24	2 3/8
		CMFO5430P_	663	686	54	30	2 3/8
		CMFO5436P_	732	756	54	36	2 3/8
		CMFO5442P_	804	846	54	42	2 3/8
		CMFO5448P_	868	910	54	48	2 3/8
		CMFO5454P_	910	951	54	54	2 3/8
	Powered Compile Single Segmented Open Bottom Panel Package - 66”	CMFO6624P_	633	667	66	24	2 3/8
		CMFO6630P_	754	789	6	30	2 3/8
		CMFO6636P_	828	891	66	36	2 3/8
		CMFO6642P_	915	976	66	42	2 3/8
		CMFO6648P_	972	1035	66	48	2 3/8
		CMFO6654P_	1039	1100	66	54	2 3/8
CMFO6660P_	1091	1154	66	60	2 3/8		

Raceway Cover Options (1) Shown

- **RACEWAY COVER OPTIONS (Suffix)**
 - (1) Knockouts Side 1 – No Knockout Side 2
 - (2) Knockouts Side 1 and Side 2

CMFGXXYYN - COMPILE GLAZED PANEL PACKAGE – NON-POWERED

- Non powered.
- Includes one panel and two raceway covers with no punchouts.
- Individual fabric-covered module in lower position incorporated into a solid steel frame.
- Opposite sides of each module may have a different fabric within the same grade at no upcharge.
- If different grades of fabric are used on one panel, the entire panel must be priced at highest grade.
- Panels are not tackable or acoustical.
- Trim is not required at a straight connection between two panels of the same height.
- 3 Panel connector brackets per side come standard with 42”h, 48”h and 54”h panels.
- 4 Panel connector brackets per side come standard with 66”h panels.
- Panels contain leveling glides. Maximum extension of glides is 2”.
- Standard clear (CLR) plexi.
- Optional Frosted Plexi with 10% upcharge.
- PVC glass retainer in matching paint color.
- Glazing starts at 29” high to the top of the panel.

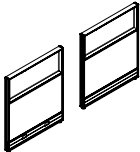
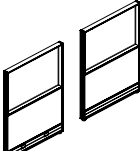
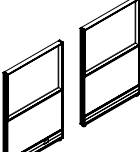
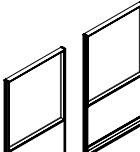
	DESCRIPTION	PRODUCT CODE	LIST PRICE		DIMENSIONS/INCHES		
			Gr1	Gr2	H	W	D
	Non-Powered Compile Glazed Panel Package - 42"	CMFG4224N_	514	534	42	24	2.38
		CMFG4230N_	586	609	42	30	2.38
		CMFG4236N_	655	683	42	36	2.38
		CMFG4242N_	732	764	42	42	2.38
		CMFG4248N_	801	834	42	48	2.38
		CMFG4254N_	900	935	42	54	2.38
		CMFG4260N_	992	1032	42	60	2.38
	Non-Powered Compile Glazed Panel Package - 48"	CMFG4824N_	553	573	48	24	2.38
		CMFG4830N_	647	670	48	30	2.38
		CMFG4836N_	736	763	48	36	2.38
		CMFG4842N_	824	853	48	42	2.38
		CMFG4848N_	899	932	48	48	2.38
		CMFG4854N_	1047	1083	48	54	2.38
		CMFG4860N_	1184	1226	48	60	2.38
	Non-Powered Compile Glazed Panel Package - 54"	CMFG5424N_	554	577	54	24	2.38
		CMFG5430N_	650	674	54	30	2.38
		CMFG5436N_	736	764	54	36	2.38
		CMFG5442N_	828	857	54	42	2.38
		CMFG5448N_	900	934	54	48	2.38
		CMFG5454N_	1048	1084	54	54	2.38
		CMFG5460N_	1185	1227	54	60	2.38
	Non-Powered Compile Glazed Panel Package - 66"	CMFG6624N_	694	723	66	24	2.38
		CMFG6630N_	806	840	66	30	2.38
		CMFG6636N_	919	955	66	36	2.38
		CMFG6642N_	1034	1081	66	42	2.38
		CMFG6648N_	1122	1173	66	48	2.38
		CMFG6654N_	1298	1353	66	54	2.38
		CMFG6660N_	1465	1523	66	60	2.38

Raceway Cover Options (1) Shown

- **RACEWAY COVER OPTIONS (Suffix)**
 - (0) No Knockouts Side 1 and Side 2
 - (1) Knockouts Side 1 – No Knockout Side 2
 - (2) Knockouts Side 1 and Side 2



CMFGXXYP - COMPILE GLAZED PANEL PACKAGE – POWERED

- With power distribution harness.
- Includes one panel, power harness, one raceway cover with punchout and one raceway cover with no punchout.
- Individual fabric-covered modules incorporated into an aluminum frame.
- Opposite sides of each module may have a different fabric within the same grade at no upcharge.
- If different grades of fabric are used on one panel, the entire panel must be priced at highest grade.
- Panels are not tackable or acoustical.
- Trim is not required at a straight connection between two panels of the same height.
- 3 Panel connector brackets per side come standard with 42”h, 48”h and 54”h panels.
- 4 Panel connector brackets per side come standard with 66”h panels.
- Panels contain leveling glides. Maximum extension of glides is 2”.
- Standard clear (CLR) plexi.
- Optional Frosted Plexi with 10% upcharge.
- PVC glass retainer in matching paint color.
- Glazing starts at 29” high to the top of the panel.

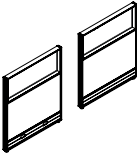
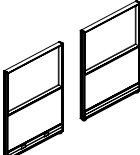
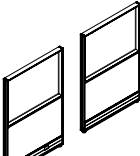
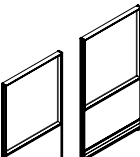
	DESCRIPTION	PRODUCT CODE	LIST PRICE		DIMENSIONS/INCHES		
			Gr1	Gr2	H	W	D
	Powered Compile Glazed Panel Package - 42"	CMFG4224P_	677	697	42	24	2 3/8
		CMFG4230P_	806	829	42	30	2 3/8
		CMFG4236P_	888	916	42	36	2 3/8
		CMFG4242P_	966	998	42	42	2 3/8
		CMFG4248P_	1054	1087	42	48	2 3/8
		CMFG4254P_	1154	1189	42	54	2 3/8
		CMFG4260P_	1247	1287	42	60	2 3/8
	Powered Compile Glazed Panel Package - 48"	CMFG4824P_	715	736	48	24	2 3/8
		CMFG4830P_	866	889	48	30	2 3/8
		CMFG4836P_	966	994	48	36	2 3/8
		CMFG4842P_	1062	1090	48	42	2 3/8
		CMFG4848P_	1152	1186	48	48	2 3/8
		CMFG4854P_	1302	1338	48	54	2 3/8
		CMFG4860P_	1442	1483	48	60	2 3/8
	Powered Compile Glazed Panel Package - 54"	CMFG5424P_	715	738	54	24	2 3/8
		CMFG5430P_	868	892	54	30	2 3/8
		CMFG5436P_	966	994	54	36	2 3/8
		CMFG5442P_	1062	1091	54	42	2 3/8
		CMFG5448P_	1153	1187	54	48	2 3/8
		CMFG5454P_	1303	1339	54	54	2 3/8
		CMFG5460P_	1443	1485	54	60	2 3/8
	Powered Compile Glazed Panel Package - 66"	CMFG6624P_	858	887	66	24	2 3/8
		CMFG6630P_	1027	1061	66	30	2 3/8
		CMFG6636P_	1151	1187	66	36	2 3/8
		CMFG6642P_	1271	1318	66	42	2 3/8
		CMFG6648P_	1380	1431	66	48	2 3/8
		CMFG6654P_	1552	1607	66	54	2 3/8
		CMFG6660P_	1725	1783	66	60	2 3/8

Raceway Cover Options (1) Shown

- **RACEWAY COVER OPTIONS (Suffix)**
 - (1) Knockouts Side 1 – No Knockout Side 2
 - (2) Knockouts Side 1 and Side 2

CMPGXXYYN_ - COMPILE PARTLY GLAZED PANEL PACKAGE – NON-POWERED

- Non powered.
- Includes one panel and two raceway covers with no punchouts.
- Individual fabric-covered module in lower position incorporated into a solid steel frame.
- Opposite sides of each module may have a different fabric within the same grade at no upcharge.
- If different grades of fabric are used on one panel, the entire panel must be priced at highest grade.
- Panels are not tackable or acoustical.
- Trim is not required at a straight connection between two panels of the same height.
- 3 Panel connector brackets per side come standard with 48”h and 54”h panels.
- 4 Panel connector brackets per side come standard with 66”h panels.
- Panels contain leveling glides. Maximum extension of glides is 2”.
- Standard clear (CLR) plexi.
- Optional Frosted Plexi with 10% upcharge.
- PVC glass retainer in matching paint color.
- Glazing is 14” nominal from the top of the panel.

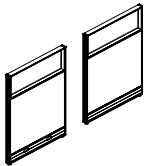
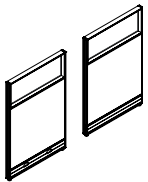
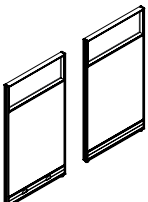
	DESCRIPTION	PRODUCT CODE	LIST PRICE		DIMENSIONS/INCHES		
			Gr1	Gr2	H	W	D
	Non-Powered Compile Partly Glazed Panel Package - 48"	CMPG4824N_	589	634	48	24	2 3/8
		CMPG4830N_	679	737	48	30	2 3/8
		CMPG4836N_	757	816	48	36	2 3/8
		CMPG4842N_	843	918	48	42	2 3/8
		CMPG4848N_	929	1018	48	48	2 3/8
		CMPG4854N_	1027	1118	48	54	2 3/8
		CMPG4860N_	1115	1216	48	60	2 3/8
	Non-Powered Compile Partly Glazed Panel Package - 54"	CMPG5424N_	589	636	54	24	2 3/8
		CMPG5430N_	679	738	54	30	2 3/8
		CMPG5436N_	759	820	54	36	2 3/8
		CMPG5442N_	844	918	54	42	2 3/8
		CMPG5448N_	929	1018	54	48	2 3/8
		CMPG5454N_	1027	1120	54	54	2 3/8
		CMPG5460N_	1117	1219	54	60	2 3/8
	Non-Powered Compile Partly Glazed Panel Package - 66"	CMPG6624N_	647	698	66	24	2 3/8
		CMPG6630N_	741	802	66	30	2 3/8
		CMPG6636N_	831	987	66	36	2 3/8
		CMPG6642N_	925	999	66	42	2 3/8
		CMPG6648N_	1022	1110	66	48	2 3/8
		CMPG6654N_	1126	1216	66	54	2 3/8
		CMPG6660N_	1227	1325	66	60	2 3/8

Raceway Cover Options (1) Shown

- **RACEWAY COVER OPTIONS (Suffix)**
 - (0) No Knockouts Side 1 and Side 2
 - (1) Knockouts Side 1 – No Knockout Side 2
 - (2) Knockouts Side 1 and Side 2



CMPGXXYP_ - COMPILER PARTLY GLAZED PANEL PACKAGE – POWERED

- With power distribution harness.
- Includes one panel, power harness, one raceway cover with punchout and one raceway cover with no punchout.
- Individual fabric-covered modules incorporated into an aluminum frame.
- Opposite sides of each module may have a different fabric within the same grade at no upcharge.
- If different grades of fabric are used on one panel, the entire panel must be priced at highest grade.
- Panels are not tackable or acoustical.
- Trim is not required at a straight connection between two panels of the same height.
- 3 Panel connector brackets per side come standard with 48”h and 54”h panels.
- 4 Panel connector brackets per side come standard with 66”h panels.
- Panels contain leveling glides. Maximum extension of glides is 2”.
- Standard clear (CLR) plexi.
- Optional Frosted Plexi with 10% upcharge.
- PVC glass retainer in matching paint color.
- Glazing is 14” nominal from the top of the panel.

	DESCRIPTION	PRODUCT CODE	LIST PRICE		DIMENSIONS/INCHES		
			Gr1	Gr2	H	W	D
	Powered Compile Partly Glazed Panel Package - 48"	CMPG4824P_	754	800	48	24	2 3/8
		CMPG4830P_	900	958	48	2 3/8	
		CMPG4836P_	988	1047	48	36	2 3/8
		CMPG4842P_	1079	1152	48	42	2 3/8
		CMPG4848P_	1185	1273	48	48	2 3/8
		CMPG4854P_	1281	1374	48	54	2 3/8
		CMPG4860P_	1372	1474	48	60	2 3/8
	Powered Compile Partly Glazed Panel Package - 54"	CMPG5424P_	754	801	54	24	2 3/8
		CMPG5430P_	901	960	54	30	2 3/8
		CMPG5436P_	989	1050	54	36	2 3/8
		CMPG5442P_	1079	1153	54	42	2 3/8
		CMPG5448P_	1186	1275	54	48	2 3/8
		CMPG5454P_	1282	1375	54	54	2 3/8
		CMPG5460P_	1372	1474	54	60	2 3/8
	Powered Compile Partly Glazed Panel Package - 66"	CMPG6624P_	808	859	66	24	2 3/8
		CMPG6630P_	961	1022	66	30	2 3/8
		CMPG6636P_	1062	1218	66	36	2 3/8
		CMPG6642P_	1161	1235	66	42	2 3/8
		CMPG6648P_	1276	1364	66	48	2 3/8
		CMPG6654P_	1384	1474	66	54	2 3/8
		CMPG6660P_	1484	1582	66	60	2 3/8

Raceway Cover Options (1) Shown

- **RACEWAY COVER OPTIONS (Suffix)**
 - (1) Knockouts Side 1 – No Knockout Side 2
 - (2) Knockouts Side 1 and Side 2

CMPLGXXYYN - SINGLE 12" GLAZED AT TOP PANEL - NON-POWERED

- Individual fabric-covered module in lower position with 12" H glazed module in upper position incorporated into an aluminum frame.
- Opposite sides of each module may have a different fabric within the same grade at no upcharge.
- If different grades of fabric are used on one panel, the entire panel must be priced at highest grade.
- Panels are not tackable.
- Note: Trim is not required at a straight connection between two panels of the same height.
- 3 Panel connector brackets per side come standard with 42"h, 48"h and 54"h

- panels.
- 4 Panel connector brackets per side come standard with 66"h. panels.
- Standard clear (CLR) plexi.
- Optional Frosted Plexi with 10% upcharge.
- 24" wide panels have two punchouts, one for electrical and one for data.
- 30" wide panels and wider have three punchouts, two for electrical and one for data.
- Glazing is 12" nominal from the top of the panel.

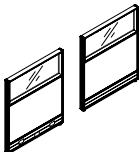
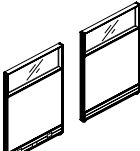
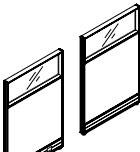
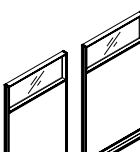
	DESCRIPTION	PRODUCT CODE	LIST PRICE		DIMENSIONS/INCHES		
			Gr1	Gr2	H	W	D
	Non-Powered Compile 12" Top Glazed Single Segmented Panel Package - 42"	CMPLG4224N_	564	585	42	24	2 3/8
		CMPLG4230N_	660	681	42	30	2 3/8
		CMPLG4236N_	757	798	42	36	2 3/8
		CMPLG4242N_	843	883	42	42	2 3/8
		CMPLG4248N_	915	956	42	48	2 3/8
		CMPLG4254N_	1022	1063	42	54	2 3/8
	Non-Powered Compile 12" Top Glazed Single Segmented Panel Package - 48"	CMPLG4824N_	577	596	48	24	2 3/8
		CMPLG4830N_	665	685	48	30	2 3/8
		CMPLG4836N_	742	781	48	36	2 3/8
		CMPLG4842N_	824	863	48	42	2 3/8
		CMPLG4848N_	903	942	48	48	2 3/8
		CMPLG4854N_	1008	1044	48	54	2 3/8
	Non-Powered Compile 12" Top Glazed Single Segmented Panel Package - 54"	CMPLG5424N_	580	603	54	24	2 3/8
		CMPLG5430N_	665	686	54	30	2 3/8
		CMPLG5436N_	745	785	54	36	2 3/8
		CMPLG5442N_	828	869	54	42	2 3/8
		CMPLG5448N_	914	955	54	48	2 3/8
		CMPLG5454N_	1010	1051	54	54	2 3/8
	Non-Powered Compile 12" Top Glazed Single Segmented Panel Package - 66"	CMPLG6624N_	632	673	66	24	2 3/8
		CMPLG6630N_	726	767	66	30	2 3/8
		CMPLG6636N_	831	912	66	36	2 3/8
		CMPLG6642N_	907	988	66	42	2 3/8
		CMPLG6648N_	1004	1084	66	48	2 3/8
		CMPLG6654N_	1106	1187	66	54	2 3/8
		CMPLG6660N_	1203	1284	66	60	2 3/8

Raceway Cover Options (1) Shown

- **RACEWAY COVER OPTIONS (Suffix)**
 - (0) No Knockouts Side 1 and Side 2
 - (1) Knockouts Side 1 – No Knockout Side 2
 - (2) Knockouts Side 1 and Side 2



CMPLGXXYP_ - SINGLE 12" GLAZED AT TOP PANEL – POWERED

- Individual fabric-covered module in lower position with 12" H glazed module in upper position incorporated into an aluminum frame.
- Opposite sides of each module may have a different fabric within the same grade at no upcharge.
- If different grades of fabric are used on one panel, the entire panel must be priced at highest grade.
- Panels are not tackable.
- Note: Trim is not required at a straight connection between two panels of the same height.
- 3 Panel connector brackets per side come standard with 42"h, 48"h and 54"h panels.
- 4 Panel connector brackets per side come standard with 66"h panels.
- Standard clear (CLR) plexi.
- Optional Frosted Plexi with 10% upcharge.
- 24" wide panels have two punchouts, one for electrical and one for data.
- 30" wide panels and wider have three punchouts, two for electrical and one for data.
- Please specify duplex receptacles separately.
- Glazing is 12" nominal from the top of the panel.

	DESCRIPTION	PRODUCT CODE	LIST PRICE		DIMENSIONS/INCHES		
			Gr1	Gr2	H	W	D
	Powered Compile 12" Top Glazed Single Segmented Panel Package - 42"	CMPLG4224P_	728	751	42	24	2 3/8
		CMPLG4230P_	880	903	42	30	2 3/8
		CMPLG4236P_	988	1028	42	36	2 3/8
		CMPLG4242P_	1078	1119	42	42	2 3/8
		CMPLG4248P_	1171	1212	42	48	2 3/8
		CMPLG4254P_	1278	1318	42	54	2 3/8
		CMPLG4260P_	1382	1422	42	60	2 3/8
	Powered Compile 12" Top Glazed Single Segmented Panel Package - 48"	CMPLG4824P_	741	764	48	24	2 3/8
		CMPLG4830P_	886	905	48	30	2 3/8
		CMPLG4836P_	975	1013	48	36	2 3/8
		CMPLG4842P_	1062	1098	48	42	2 3/8
		CMPLG4848P_	1149	1187	48	48	2 3/8
		CMPLG4854P_	1264	1302	48	54	2 3/8
		CMPLG4860P_	1354	1392	48	60	2 3/8
	Powered Compile 12" Top Glazed Single Segmented Panel Package - 54"	CMPLG5424P_	742	763	54	24	2 3/8
		CMPLG5430P_	888	909	54	30	2 3/8
		CMPLG5436P_	975	1016	54	36	2 3/8
		CMPLG5442P_	1062	1103	54	42	2 3/8
		CMPLG5448P_	1169	1210	54	48	2 3/8
		CMPLG5454P_	1264	1305	54	54	2 3/8
		CMPLG5460P_	1354	1395	54	60	2 3/8
	Powered Compile 12" Top Glazed Single Segmented Panel Package - 66"	CMPLG6624P_	798	838	66	24	2 3/8
		CMPLG6630P_	949	990	66	30	2 3/8
		CMPLG6636P_	1048	1128	66	36	2 3/8
		CMPLG6642P_	1144	1224	66	42	2 3/8
		CMPLG6648P_	1259	1340	66	48	2 3/8
		CMPLG6654P_	1363	1444	66	54	2 3/8
		CMPLG6660P_	1460	1540	66	60	2 3/8

Raceway Cover Options (1) Shown

- **RACEWAY COVER OPTIONS (Suffix)**
 - (1) Knockouts Side 1 – No Knockout Side 2
 - (2) Knockouts Side 1 and Side 2

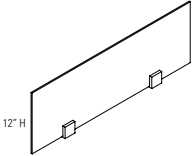
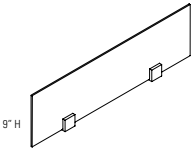
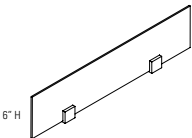

CMPSXX - COMPILE PRIVACY GLASS

- Attaches on top of Compile Panels to add privacy or divide space.
- Standard in clear (CLR) or frosted (FRST) glass.
- Clamps available in satin chrome finish only.
- Width dimensions given are width of glass only.
- Attachment hardware is provided for attaching to panels.
- Please note Privacy Glass in 24" - 54" widths includes 2 clamps and a Privacy Glass in 60" width includes 3 clamps.
- Square profile on clamps and glass corners.

	DESCRIPTION	PRODUCT CODE	LIST PRICE		DIMENSIONS/INCHES		
			CLR	FRST ADD	H	W	D
 <p>12" H</p>	Compile Privacy Glass	CMPS24	316	68	12	24	6
		CMPS30	335	50	12	30	6
		CMPS36	354	40	12	36	6
		CMPS42	365	61	12	42	6
		CMPS48	375	83	12	48	6
		CMPS54	386	100	12	54	6
		CMPS60	403	124	12	60	6
 <p>9" H</p>		CMPS0924	316	68	9	24	6
		CMPS0930	335	54	9	30	6
		CMPS0936	354	40	9	36	6
		CMPS0942	365	64	9	42	6
		CMPS0948	375	83	9	48	6
		CMPS0954	386	100	9	54	6
		CMPS0960	403	124	9	60	6
 <p>6" H</p>		CMPS0624	316	68	6	24	6
		CMPS0630	335	54	6	30	6
		CMPS0636	354	40	6	36	6
		CMPS0642	365	64	6	42	6
		CMPS0648	375	83	6	48	6
		CMPS0654	386	100	6	54	6
		CMPS0660	403	124	6	60	6

CMPSGXX - COMPILE PRIVACY GLASS PANEL WIDTH

- Attaches on top of Compile Panels to add privacy or divide space.
- Standard in clear (CLR) or frosted (FRST) glass.
- Width dimensions given are width of glass only.
- Attachment hardware is provided for attaching to panels.

	DESCRIPTION	PRODUCT CODE	LIST PRICE		DIMENSIONS/INCHES		
			CLR	FRST ADD	H	W	D
	Compile Privacy Glass	CMPSEG0624	283	62.26	6	24	2.41
		CMPSEG0630	309	48	6	30	2.41
		CMPSEG0636	328	32.8	6	36	2.41
		CMPSEG0642	342	56	6	42	2.41
		CMPSEG0648	363	72.6	6	48	2.41
		CMPSEG0654	377	93	6	54	2.41
		CMPSEG0660	386	120	6	60	2.41
		CMPSEG0924	283	62.26	9	24	2.41
		CMPSEG0930	309	48	9	30	2.41
		CMPSEG0936	328	32.8	9	36	2.41
		CMPSEG0942	342	56	9	42	2.41
		CMPSEG0948	363	72.6	9	48	2.41
		CMPSEG0954	377	93	9	54	2.41
		CMPSEG0960	386	120	9	60	2.41
		CMPSEG1224	283	62.26	12	24	2.41
		CMPSEG1230	309	48	12	30	2.41
		CMPSEG1236	328	32.8	12	36	2.41
		CMPSEG1242	342	56	12	42	2.41
		CMPSEG1248	363	72.6	12	48	2.41
		CMPSEG1254	377	93	12	54	2.41
		CMPSEG1260	386	120	12	60	2.41



CMPMP-GI-W - PRIVACY GLASS FOR 1" LAMINATE GALLERY PANELS

- Privacy glass integrated with aluminum top trim.
- Attaches on top of gallery panels to add privacy or divide space.
- Includes aluminum trim with channel, end caps and glass tile.
- Top rail may also be used to hang accessories.
- Glass and attachment hardware ship separately.
- Please specify standard paint finish for the channel.
- Standard in clear (CLR) or frosted (FRST).

	DESCRIPTION	PRODUCT CODE	LIST PRICE		DIMENSIONS/INCHES		
			Clear	FRST ADD	H	W	D
	6" H Privacy Glass w/ Aluminum Trim	CMPMP24GI6W	311	71	6	24	1
		CMPMP30GI6W	338	50	6	30	1
		CMPMP36GI6W	359	36	6	36	1
		CMPMP42GI6W	375	59	6	42	1
		CMPMP48GI6W	395	76	6	48	1
	9" H Privacy Glass w/ Aluminum Trim	CMPMP24GI9W	311	71	9	24	1
		CMPMP30GI9W	338	50	9	30	1
		CMPMP36GI9W	359	36	9	36	1
		CMPMP42GI9W	375	59	9	42	1
		CMPMP48GI9W	395	76	9	48	1
	12" H Privacy Glass w/ Aluminum Trim	CMPMP24GIW	311	66	12	24	1
		CMPMP30GIW	338	50	12	30	1
		CMPMP36GIW	359	36	12	36	1
		CMPMP42GIW	375	59	12	42	1
		CMPMP48GIW	395	76	12	48	1



CMPFD-W - PRIVACY FELT FOR 1" LAMINATE GALLERY PANELS

- Privacy felt integrated with aluminum top trim.
- Attaches on top of gallery panels to add privacy or divide space.
- Includes aluminum trim with channel, end caps and felt tile.
- Top rail may also be used to hang accessories.
- Felt and attachment hardware ship separately.
- Please specify standard paint finish for the channel.
- Please specify standard felt finish.

	DESCRIPTION	PRODUCT CODE	LIST PRICE	DIMENSIONS/INCHES		
				H	W	D
	6" H Felt w/ Aluminum Trim	CMPFD0624W	125	6	24	1
		CMPFD0630W	145	6	30	1
		CMPFD0636W	172	6	36	1
		CMPFD0642W	193	6	42	1
		CMPFD0648W	283	6	48	1
		CMPFD0654W	310	6	54	1
		CMPFD0660W	332	6	60	1
		CMPFD0666W	350	6	66	1
		CMPFD0672W	395	6	72	1
		9" H Felt w/ Aluminum Trim	CMPFD0924W	125	9	24
		CMPFD0930W	145	9	30	1
		CMPFD0936W	172	9	36	1
		CMPFD0942W	193	9	42	1
		CMPFD0948W	283	9	48	1
		CMPFD0954W	310	9	54	1
		CMPFD0960W	332	9	60	1
		CMPFD0966W	350	9	66	1
		CMPFD0972W	395	9	72	1
		12" H Felt w/ Aluminum Trim	CMPFD1224W	125	12	24
		CMPFD1230W	145	12	30	1
		CMPFD1236W	172	12	36	1
		CMPFD1242W	193	12	42	1
		CMPFD1248W	283	12	48	1
		CMPFD1254W	310	12	54	1
		CMPFD1260W	332	12	60	1
		CMPFD1266W	350	12	66	1
		CMPFD1272W	395	12	72	1

CMPSEF - EMBEDDED FELT DIVIDER OVER PANEL

- Privacy felt panel intergrated with aluminum top trim.
- Attaches on top of panels to add privacy or divide space.
- Includes aluminum trim with channel and felt tile.
- Felt and attachment hardware to ship separately
- 9mm Felt material is tackable and comes in 12 different colors. Please specify color.

	DESCRIPTION	PRODUCT CODE	LIST PRICE	DIMENSIONS/INCHES		
				H	W	D
	6" Integrated Felt Divider, Panel Width	CMPSEF0624	115	6	24	2.41
		CMPSEF0630	133	6	30	2.41
		CMPSEF0636	159	6	36	2.41
		CMPSEF0642	175	6	42	2.41
		CMPSEF0648	262	6	48	2.41
		CMPSEF0654	282	6	54	2.41
		CMPSEF0660	305	6	60	2.41
	9" Integrated Felt Divider, Panel Width	CMPSEF0924	115	9	24	2.41
		CMPSEF0930	133	9	30	2.41
		CMPSEF0936	159	9	36	2.41
		CMPSEF0942	175	9	42	2.41
		CMPSEF0948	262	9	48	2.41
		CMPSEF0954	282	9	54	2.41
		CMPSEF0960	305	9	60	2.41
	12" Integrated Felt Divider, Panel Width	CMPSEF1224	115	12	24	2.41
		CMPSEF1230	133	12	30	2.41
		CMPSEF1236	159	12	36	2.41
		CMPSEF1242	175	12	42	2.41
		CMPSEF1248	262	12	48	2.41
		CMPSEF1254	282	12	54	2.41
		CMPSEF1260	305	12	60	2.41

CMOF - COMPILE FABRIC OVER PANEL

- Fabric-covered modules incorporated into an aluminum frame.
- Opposite sides of each module may have a different fabric within the same grade at no upcharge.
- If different grades of fabric are used on one panel, the entire panel must be priced at highest grade.
- One CHSD Slider Kit for Over Panel included
- Note: Trim is not required at a straight connection between two panels of the same height.
- Maximum stacking one high. Not load bearing.

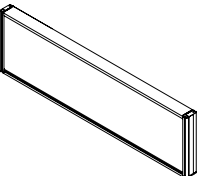
	DESCRIPTION	PRODUCT CODE	LIST PRICE		DIMENSIONS/INCHES		
			Gr1	Gr2	H	W	D
	Compile Fabric Over Panel	CMOF1224	220	248	12	24	2.3
		CMOF1230	257	285	12	30	2.3
		CMOF1236	286	315	12	36	2.3
		CMOF1242	324	353	12	42	2.3
		CMOF1248	374	403	12	48	2.3
		CMOF1254	388	417	12	54	2.3
		CMOF1260	460	488	12	60	2.3
		CMOF1624	256	289	16	24	2.3
		CMOF1630	298	332	16	30	2.3
		CMOF1636	315	348	16	36	2.3
		CMOF1642	375	409	16	42	2.3
		CMOF1648	430	464	16	48	2.3
		CMOF1654	450	483	16	54	2.3
		CMOF1660	526	560	16	60	2.3
		CMOF2424	330	377	24	24	2.3
		CMOF2430	381	428	24	30	2.3
		CMOF2436	426	473	24	36	2.3
		CMOF2442	478	525	24	42	2.3
		CMOF2448	515	562	24	48	2.3
		CMOF2454	572	619	24	54	2.3
CMOF2460	657	704	24	60	2.3		



CMOLF - COMPILE LAMINATE ONE SIDE, FABRIC ONE SIDE OVER PANEL

- One side in fabric and one side in laminate, incorporated into an aluminum frame.
- Opposite sides of each module may have a different fabric within the same grade at no upcharge.
- If different grades of fabric are used on one panel, the entire panel must be priced at highest grade.
- One CHSD Slider Kit for Over Panel included
- Note: Trim is not required at a straight connection between two panels of the same height.
- Maximum stacking one high. Not load bearing.

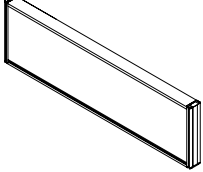
DESCRIPTION	PRODUCT CODE	LIST PRICE		DIMENSIONS/INCHES		
		Gr1	Gr2	H	W	D
 Compile Laminate One Side, Fabric One Side Over Panel	CMOLF1224	246	264	12	24	2.3
	CMOLF1230	289	307	12	30	2.3
	CMOLF1236	328	343	12	36	2.3
	CMOLF1242	372	387	12	42	2.3
	CMOLF1248	427	442	12	48	2.3
	CMOLF1254	451	466	12	54	2.3
	CMOLF1260	527	542	12	60	2.3
	CMOLF1624	294	314	16	24	2.3
	CMOLF1630	351	371	16	30	2.3
	CMOLF1636	388	408	16	36	2.3
	CMOLF1642	440	460	16	42	2.3
	CMOLF1648	502	522	16	48	2.3
	CMOLF1654	530	550	16	54	2.3
	CMOLF1660	617	637	16	60	2.3
	CMOLF2424	385	411	24	24	2.3
	CMOLF2430	460	484	24	30	2.3
	CMOLF2436	510	534	24	36	2.3
	CMOLF2442	573	599	24	42	2.3
	CMOLF2448	623	649	24	48	2.3
	CMOLF2454	695	719	24	54	2.3
CMOLF2460	794	818	24	60	2.3	

CMOLL - COMPILE LAMINATE TWO SIDES OVER PANEL

- Laminate modules incorporated into an aluminum frame.
- One CHSD Slider Kit for Over Panel included
- Note: Trim is not required at a straight connection between two panels of the same height.
- Maximum stacking one high. Not load bearing.

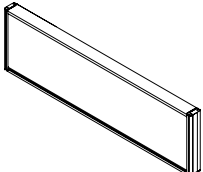
DESCRIPTION	PRODUCT CODE	LIST PRICE	DIMENSIONS/INCHES		
			H	W	D
 Compile Laminate Two Sides Over Panel	CMOLL1224	273	12	24	2.3
	CMOLL1230	310	12	30	2.3
	CMOLL1236	365	12	36	2.3
	CMOLL1242	416	12	42	2.3
	CMOLL1248	478	12	48	2.3
	CMOLL1254	507	12	54	2.3
	CMOLL1260	589	12	60	2.3
	CMOLL1624	327	16	24	2.3
	CMOLL1630	385	16	30	2.3
	CMOLL1636	438	16	36	2.3
	CMOLL1642	498	16	42	2.3
	CMOLL1648	570	16	48	2.3
	CMOLL1654	606	16	54	2.3
	CMOLL1660	699	16	60	2.3
	CMOLL2424	435	24	24	2.3
	CMOLL2430	513	24	30	2.3
	CMOLL2436	585	24	36	2.3
	CMOLL2442	663	24	42	2.3
	CMOLL2448	724	24	48	2.3
	CMOLL2454	806	24	54	2.3
CMOLL2460	917	24	60	2.3	

CMOG - COMPILE GLAZED OVER PANEL

- Glazed module incorporated into an aluminum frame.
- One CHSD Slider Kit for Over Panel included
- Note: Trim is not required at a straight connection between two panels of the same height.
- Maximum stacking one high. Not load bearing.

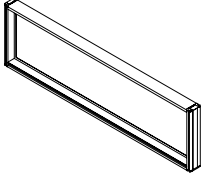
DESCRIPTION	PRODUCT CODE	LIST PRICE		DIMENSIONS/INCHES		
		CLR	FRST ADD	H	W	D
 <p>Compile Glazed Over Panel</p>	CMOG1224	196	10	12	24	2.3
	CMOG1230	228	10	12	30	2.3
	CMOG1236	255	11	12	36	2.3
	CMOG1242	285	11	12	42	2.3
	CMOG1248	327	12	12	48	2.3
	CMOG1254	340	14	12	54	2.3
	CMOG1260	407	15	12	60	2.3
	CMOG1624	228	10	16	24	2.3
	CMOG1630	258	11	16	30	2.3
	CMOG1636	294	12	16	36	2.3
	CMOG1642	328	12	16	42	2.3
	CMOG1648	377	14	16	48	2.3
	CMOG1654	389	15	16	54	2.3
	CMOG1660	460	18	16	60	2.3
	CMOG2424	292	12	24	24	2.3
	CMOG2430	315	12	24	30	2.3
	CMOG2436	371	14	24	36	2.3
	CMOG2442	416	15	24	42	2.3
	CMOG2448	443	18	24	48	2.3
	CMOG2454	491	19	24	54	2.3
	CMOG2460	569	19	24	60	2.3

CMOFW - COMPILE ONE SIDE WRITE BOARD OVER PANEL

- Fabric or write board covered modules incorporated into an aluminum frame.
- One CHSD Slider Kit for Over Panel included
- Note: Trim is not required at a straight connection between two panels of the same height.
- Maximum stacking one high. Not load bearing.

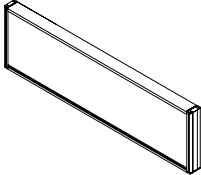
DESCRIPTION	PRODUCT CODE	LIST PRICE		DIMENSIONS/INCHES		
		Gr1	Gr2	H	W	D
 <p>Compile Fabric or Write Board Over Panel</p>	CMOFW1224	277	292	12	24	2.3
	CMOFW1230	328	343	12	30	2.3
	CMOFW1236	372	387	12	36	2.3
	CMOFW1242	423	438	12	42	2.3
	CMOFW1248	468	483	12	48	2.3
	CMOFW1254	516	531	12	54	2.3
	CMOFW1260	601	616	12	60	2.3
	CMOFW1624	333	353	16	24	2.3
	CMOFW1630	392	412	16	30	2.3
	CMOFW1636	448	467	16	36	2.3
	CMOFW1642	510	529	16	42	2.3
	CMOFW1648	583	603	16	48	2.3
	CMOFW1654	621	640	16	54	2.3
	CMOFW1660	714	733	16	60	2.3
	CMOFW2424	430	456	24	24	2.3
	CMOFW2430	495	519	24	30	2.3
	CMOFW2436	606	630	24	36	2.3
	CMOFW2442	678	704	24	42	2.3
	CMOFW2448	713	737	24	48	2.3
	CMOFW2454	852	876	24	54	2.3
	CMOFW2460	946	970	24	60	2.3



CMOWW - COMPILE WRITE BOARD TWO SIDES OVER PANEL

- Write board covered modules incorporated into an aluminum frame.
- One CHSD Slider Kit for Over Panel included
- Note: Trim is not required at a straight connection between two panels of the same height.
- Maximum stacking one high. Not load bearing.

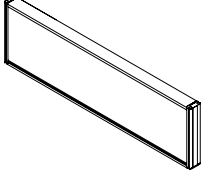
DESCRIPTION	PRODUCT CODE	LIST PRICE	DIMENSIONS/INCHES		
			H	W	D
 <p>Compile Write Board Over Panel</p>	CMOWW1224	336	12	24	2.3
	CMOWW1230	389	12	30	2.3
	CMOWW1236	463	12	36	2.3
	CMOWW1242	516	12	42	2.3
	CMOWW1248	606	12	48	2.3
	CMOWW1254	638	12	54	2.3
	CMOWW1260	738	12	60	2.3
	CMOWW1624	411	16	24	2.3
	CMOWW1630	492	16	30	2.3
	CMOWW1636	568	16	36	2.3
	CMOWW1642	650	16	42	2.3
	CMOWW1648	740	16	48	2.3
	CMOWW1654	800	16	54	2.3
	CMOWW1660	913	16	60	2.3
	CMOWW2424	562	24	24	2.3
	CMOWW2430	671	24	30	2.3
	CMOWW2436	776	24	36	2.3
	CMOWW2442	888	24	42	2.3
CMOWW2448	982	24	48	2.3	
CMOWW2454	1095	24	54	2.3	
CMOWW2460	1241	24	60	2.3	

CHSD - SLIDER KIT FOR OVER PANEL

- One kit required for installation of each Over Panel
- Included with each NEW Over Panel Kit

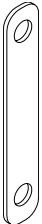
DESCRIPTION	PRODUCT CODE	LIST PRICE	DIMENSIONS/INCHES		
			H	W	D
 <p>One kit required for installation of each Over Panel</p>	CHSDKIT	7	.09	2.28	.43

CMLEPXXXXNC - END OF RUN GALLERY PANEL WITH NO END CONNECTION

- Provides floor standing support while enclosing the end of a panel run.
- Attached at the end of a straight panel run with connectors to form a T configuration.
- No connections at both ends, connection is at the center interior face.
- Includes all attachment hardware and glides.
- Total height is inclusive of panel glides extended to their full height.
- 51" wide gallery panel accommodates two 24" deep surface while the 63" wide accommodates two 30" deep surfaces.
- Please specify LP laminate finish and PVC edge finish.
- If a wood grain laminate is chosen, grain direction run horizontally.
- Gallery panel is edged in PVC on exposed edges and self edged on bottom.

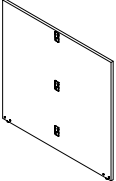
DESCRIPTION	PRODUCT CODE	LIST PRICE	DIMENSIONS/INCHES		
			H	W	D
 End of Run Gallery Panel	CMLEP4227NC	466	42	26.25	1
	CMLEP4251NC	845	42	50.30	1
	CMLEP4263NC	982	42	62.30	1
	CMLEP4827NC	513	48	26.25	1
	CMLEP4851NC	928	48	50.30	1
	CMLEP4863NC	1078	48	62.30	1
	CMLEP5427NC	559	54	26.25	1
	CMLEP5451NC	1012	54	50.30	1
	CMLEP5463NC	1176	54	62.30	1

CMLMPXXXXNC - MIDDLE OF RUN GALLERY PANEL WITH NO END CONNECTION

- Provides floor standing support in the middle of a panel run.
- Attached in the middle of a straight panel run with connectors to form an X configuration.
- No connections at both ends, connection is at center on both faces.
- Includes all attachment hardware and glides.
- Total height is inclusive of panel glides extended to their full height.
- 51" wide gallery panel accommodates two 24" deep surface while the 63" wide accommodates two 30" deep surfaces.
- Please specify LP laminate finish and PVC edge finish.
- If a wood grain laminate is chosen, grain direction run horizontally.
- Gallery panel is edged in PVC on exposed edges and self edged on bottom.

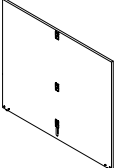
DESCRIPTION	PRODUCT CODE	LIST PRICE	DIMENSIONS/INCHES		
			H	W	D
 Middle of Run Gallery Panel	CMLMP4251NC	983	42	50.30	1
	CMLMP4263NC	1118	42	62.30	1
	CMLMP4851NC	1066	48	50.30	1
	CMLMP4863NC	1216	48	62.30	1
	CMLMP5451NC	1150	54	50.30	1
	CMLMP5463NC	1314	54	62.30	1



CMLSEPLXXXNC - SINGLE END OF RUN GALLERY PANEL WITH NO END CONNECTION

- Provides floor standing support while enclosing the end of a panel run.
- Attached at the end of a straight panel run with connectors to form an L configuration.
- No connections at both ends, connection is at center on both faces.
- Includes all attachment hardware and glides.
- Total height is inclusive of panel glides extended to their full height.
- 27" wide gallery panel accommodate two 24" deep surface while the 33" wide accommodates two 30" deep surfaces.
- Please specify LP laminate finish and PVC edge finish.
- If a wood grain laminate is chosen, grain direction run horizontally.
- Gallery panel is edged in PVC on exposed edges and self edged on bottom.

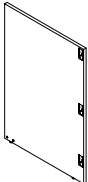
	DESCRIPTION	PRODUCT CODE	LIST PRICE	DIMENSIONS/INCHES		
				H	W	D
	Single End of Run Gallery Panel	CMLSEPL4215NC	350	42	14.25	1
		CMLSEPR4215NC	350	42	14.25	1
		CMLSEPL4227NC	644	42	26.30	1
		CMLSEPR4227NC	644	42	26.30	1
		CMLSEPL4815NC	381	48	14.25	1
		CMLSEPR4815NC	381	48	14.25	1
		CMLSEPL4827NC	703	48	26.30	1
		CMLSEPR4827NC	703	48	26.30	1
		CMLSEPL5415NC	410	54	14.25	1
		CMLSEPR5415NC	410	54	14.25	1
		CMLSEPL5427NC	763	54	26.30	1
CMLSEPR5427NC	763	54	26.30	1		
	Single End of Run Gallery Panel	CMLSEPL4233NC	664	42	32.33	1
		CMLSEPR4233NC	664	42	32.33	1
		CMLSEPL4833NC	725	48	32.33	1
		CMLSEPR4833NC	725	48	32.33	1
		CMLSEPL5433NC	786	54	32.33	1
		CMLSEPR5433NC	786	54	32.33	1

CMLSMPXXXNC - SINGLE MIDDLE OF RUN GALLERY PANEL WITH NO END CONNECTION

- Provides floor standing support at the middle of a panel run.
- Attached in the middle of a straight panel run with connectors to form a T configuration.
- No connections at the exposed end, connection is at both the interior and exterior face near the opposite end.
- Includes all attachment hardware and glides.
- Total height is inclusive of panel glides extended to their full height.
- 27" wide gallery panel accommodates a 24" deep surface while the 33" wide accommodates a 30" deep surface.
- Please specify LP laminate finish and PVC edge finish.
- If a wood grain laminate is chosen, grain direction run horizontally.
- Gallery panel is edged in PVC on exposed edges and self edged on bottom.

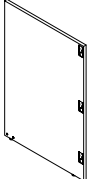
	DESCRIPTION	PRODUCT CODE	LIST PRICE	DIMENSIONS/INCHES		
				H	W	D
	Single Middle of Run Gallery Panel	CMLSMP4227NC	782	42	26.30	1
		CMLSMP4827NC	842	48	26.30	1
		CMLSMP5427NC	901	54	26.30	1
		CMLSMP4233NC	805	42	32.30	1
		CMLSMP4833NC	865	48	32.30	1
		CMLSMP5433NC	927	54	32.30	1

CMLEPXXXX - END OF RUN GALLERY PANEL WITH END CONNECTIONS

- Provides floor standing support while enclosing the end of a panel run.
- Attached at the end of a straight panel run with connectors to form a T configuration.
- Connections at both ends as well as the center on the interior face.
- Includes all attachment hardware and glides.
- Total height is inclusive of panel glides extended to their full height.
- 51" wide gallery panel accommodates two 24" deep surface while the 63" wide accommodates two 30" deep surfaces.
- Please specify LP laminate finish and PVC edge finish.
- If a wood grain laminate is chosen, grain direction run horizontally.
- Gallery panel is edged in PVC on exposed edges and self edged on edge connecting to panel and bottom edge.

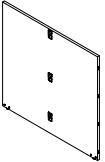
DESCRIPTION	PRODUCT CODE	LIST PRICE	DIMENSIONS/INCHES		
			H	W	D
 End of Run Gallery Panel	CMLEP4251	879	42	50.30	1
	CMLEP4263	1013	42	62.30	1
	CMLEP4851	961	48	50.30	1
	CMLEP4863	1111	48	62.30	1
	CMLEP5451	1045	54	50.30	1
	CMLEP5463	1210	54	62.30	1

CMLMPXXXX - MIDDLE OF RUN GALLERY PANEL WITH END CONNECTIONS

- Provides floor standing support in the middle of a panel run.
- Attached in the middle of a straight panel run with connectors to form an X configuration.
- Connections at both ends as well as the center on the interior face.
- Includes all attachment hardware and glides.
- Total height is inclusive of panel glides extended to their full height.
- 51" wide gallery panel accommodates two 24" deep surface while the 63" wide accommodates two 30" deep surfaces.
- Please specify LP laminate finish and PVC edge finish.
- If a wood grain laminate is chosen, grain direction run horizontally.
- Gallery panel is edged in PVC on exposed edges and self edged on edge connecting to panel and bottom edge.

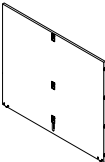
DESCRIPTION	PRODUCT CODE	LIST PRICE	DIMENSIONS/INCHES		
			H	W	D
 Middle of Run Gallery Panel	CMLMP4251	988	42	50.30	1
	CMLMP4263	1123	42	62.30	1
	CMLMP4851	1072	48	50.30	1
	CMLMP4863	1221	48	62.30	1
	CMLMP5451	1154	54	50.30	1
	CMLMP5463	1322	54	62.30	1

CMLSEPLXXXX - SINGLE END PANEL WITH END CONNECTIONS

- Provides floor standing support while enclosing the end of a panel run.
- Attached at the end of a straight panel run with connectors to form an L configuration.
- Connections are at the exposed end on one side and near the end on the other interior face.
- Total height is inclusive of panel glides extended to their full height.
- 27" wide gallery panel accommodates a 24" deep surface while the 33" wide accommodates a 30" deep surface.
- Please specify LP laminate finish and PVC edge finish.
- If a wood grain laminate is chosen, grain direction run horizontally.
- Gallery panel is edged in PVC on exposed edges and self edged on edge connecting to panel and bottom edge.

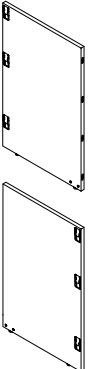
DESCRIPTION	PRODUCT CODE	LIST PRICE	DIMENSIONS/INCHES		
			H	W	D
 Single End of Run Gallery Panel	CMLSEPL4227	659	42	26.30	1
	CMLSEPR4227	659	42	26.30	1
	CMLSEPL4827	721	48	26.30	1
	CMLSEPR4827	721	48	26.30	1
	CMLSEPL5427	779	54	26.30	1
	CMLSEPR5427	779	54	26.30	1
	CMLSEPL4233	680	42	32.33	1
	CMLSEPR4233	680	42	32.33	1
	CMLSEPL4833	740	48	32.33	1
	CMLSEPR4833	740	48	32.33	1
	CMLSEPL5433	803	54	32.33	1
	CMLSEPR5433	803	54	32.33	1



CMLSMPXXXX - SINGLE MIDDLE OF RUN GALLERY PANEL WITH END CONNECTIONS

- Provides floor standing support at the middle of a panel run.
- Attached in the middle of a straight panel run with connectors to form a T configuration
- Connections are at the exposed end and at the interior and exterior near the opposite end.
- Includes all attachment hardware and glides.
- Total height is inclusive of panel glides extended to their full height.
- 27" wide gallery panel accommodates a 24" deep surface while the 33" wide accommodates a 30" deep surface.
- Please specify LP laminate finish and PVC edge finish.
- If a wood grain laminate is chosen, grain direction run horizontally.
- Gallery panel is edged in PVC on exposed edges and self edged on edge connecting to panel and bottom edge.

	DESCRIPTION	PRODUCT CODE	LIST PRICE	DIMENSIONS/INCHES		
				H	W	D
	Single Middle of Run Gallery Panel	CMLSMP4227	797	42	26.30	1
		CMLSMP4827	858	48	26.30	1
		CMLSMP5427	915	54	26.30	1
		CMLSMP4233	821	42	32.30	1
		CMLSMP4833	882	48	32.30	1
		CMLSMP5433	944	54	32.30	1

CML2PLXXXX - LEFT TWO WAY RETURN END OF RUN GALLERY PANEL WITH END CONNECTIONS

- Provides floor standing support while enclosing the end of a panel run.
- Attached at the end of a gallery panel with connectors to form an L configuration.
- Connections are at one exposed end.
- Includes all attachment hardware and glides.
- Total height is inclusive of panel glides extended to their full height.
- 25" wide gallery panel accommodates a 24" deep surface while the 31" wide accommodates a 30" deep surface.
- Please specify LP laminate finish and PVC edge finish.
- If a wood grain laminate is chosen, grain direction run horizontally.
- Gallery panel is edged in PVC on exposed edges and self edged on edge connecting to panel and bottom edge.

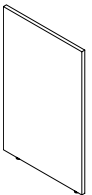
	DESCRIPTION	PRODUCT CODE	LIST PRICE	DIMENSIONS/INCHES		
				H	W	D
	Two Way Return	CML2PL4213	240	42	13	1
	End of Run Gallery Panel	CML2PL4225	523	42	25	1
		CML2PL4231	537	42	31	1
		CML2PL4813	269	48	13	1
		CML2PL4825	582	48	25	1
		CML2PL4831	598	48	31	1
		CML2PL5413	299	54	13	1
		CML2PL5425	640	54	25	1
		CML2PL5431	659	54	31	1

CML2PRXXXX - RIGHT TWO WAY RETURN END OF RUN GALLERY PANEL WITH END CONNECTIONS

- Provides floor standing support while enclosing the end of a panel run.
- Attached at the end of a gallery panel with connectors to form an L configuration.
- Connections are at one exposed end.
- Includes all attachment hardware and glides.
- Total height is inclusive of panel glides extended to their full height.
- 25" wide gallery panel accommodates a 24" deep surface while the 31" wide accommodates a 30" deep surface.
- Please specify LP laminate finish and PVC edge finish.
- If a wood grain laminate is chosen, grain direction run horizontally.
- Gallery panel is edged in PVC on exposed edges and self edged on edge connecting to panel and bottom edge.

	DESCRIPTION	PRODUCT CODE	LIST PRICE	DIMENSIONS/INCHES		
				H	W	D
	Two Way Return	CML2PR4213	240	42	13	1
	End of Run Gallery Panel	CML2PR4225	523	42	25	1
		CML2PR4231	537	42	31	1
		CML2PR4813	269	48	13	1
		CML2PR4825	582	48	25	1
		CML2PR4831	598	48	31	1
		CML2PR5413	299	54	13	1
		CML2PR5425	640	54	25	1
		CML2PR5431	659	54	31	1

CML3PLXXXX - LEFT THREE WAY RETURN END OF RUN GALLERY PANEL

- Provides floor standing support while enclosing the end of a gallery panel run.
- Attached at the end of a gallery panel with connectors to form a T configuration.
- There are no connections at the exposed ends. Connection is at the center of the interior face.
- Connects to CMLXPLxxxx or CMLSEPLxxxx.
- Includes all attachment hardware and glides.
- Total height is inclusive of panel glides extended to their full height.
- 49" wide gallery panel accommodates two 24" deep surface while the 61" wide accommodates two 30" deep surfaces.
- Please specify LP laminate finish and PVC edge finish.
- If a wood grain laminate is chosen, grain direction run horizontally.
- Gallery panel is edged in PVC on exposed edges and self edged on edge connecting to panel and bottom edge.

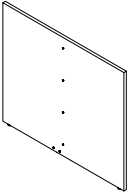
DESCRIPTION	PRODUCT CODE	LIST PRICE	DIMENSIONS/INCHES		
			H	W	D
 <p>Three Way Return End of Run Gallery Panel</p>	CML3PL4225	357	42	25	1
	CML3PL4249	724	42	49	1
	CML3PL4261	859	42	61	1
	CML3PL4825	401	48	25	1
	CML3PL4849	807	48	49	1
	CML3PL4861	957	48	61	1
	CML3PL5425	447	54	25	1
	CML3PL5449	889	54	49	1
	CML3PL5461	1054	54	61	1

CML3PRXXXX - RIGHT THREE WAY RETURN END OF RUN GALLERY PANEL

- Provides floor standing support while enclosing the end of a gallery panel run.
- Attached at the end of a gallery panel with connectors to form a T configuration.
- There are no connections at the exposed ends. Connection is at the center of the interior face.
- Connects to CMLXPRxxxx or CMLSEPRxxxx.
- Includes all attachment hardware and glides.
- Total height is inclusive of panel glides extended to their full height.
- 49" wide gallery panel accommodates two 24" deep surface while the 61" wide accommodates two 30" deep surfaces.
- Please specify LP laminate finish and PVC edge finish.
- If a wood grain laminate is chosen, grain direction run horizontally.
- Gallery panel is edged in PVC on exposed edges and self edged on edge connecting to panel and bottom edge.

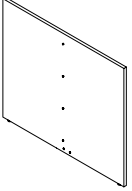
DESCRIPTION	PRODUCT CODE	LIST PRICE	DIMENSIONS/INCHES		
			H	W	D
 <p>Three Way Return End of Run Gallery Panel</p>	CML3PR4225	357	42	25	1
	CML3PR4249	724	42	49	1
	CML3PR4261	859	42	61	1
	CML3PR4825	401	48	25	1
	CML3PR4849	807	48	49	1
	CML3PR4861	957	48	61	1
	CML3PR5425	447	54	25	1
	CML3PR5449	889	54	49	1
	CML3PR5461	1054	54	61	1



CMLXPLXXXX - LEFT EXTENSION END OF RUN RETURN GALLERY PANEL WITH END CONNECTION

- Provides floor standing support while enclosing the end of a gallery panel run.
- Attached at the end of a panel to allow for extending the gallery panel run.
- Connections at both exposed ends, one to connect to the panel and one to connect to another gallery panel.
- Includes all attachment hardware and glides.
- Total height is inclusive of panel glides extended to their full height.
- Please specify LP laminate finish and PVC edge finish.
- If a wood grain laminate is chosen, grain direction run horizontally.
- Gallery panel is edged in PVC on exposed edges and self edges on edge connecting to panel.

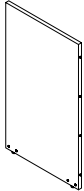
DESCRIPTION	PRODUCT CODE	LIST PRICE	DIMENSIONS/INCHES		
			H	W	D
 Extension End of Run Return Gallery Panel	CMLXPL4224	846	42	12.3	1
	CMLXPL4224	846	42	24	1
	CMLXPL4230	509	42	30	1
	CMLXPL4236	586	42	35	1
	CMLXPL4242	736	42	42	1
	CMLXPL4248	756	42	48	1
	CMLXPL4812	248	48	12.3	1
	CMLXPL4824	448	48	24	1
	CMLXPL4830	526	48	30	1
	CMLXPL4836	601	48	36	1
	CMLXPL4842	756	48	42	1
	CMLXPL4848	779	48	48	1
	CMLXPL5412	277	54	12.3	1
	CMLXPL5424	478	54	24	1
	CMLXPL5430	560	54	30	1
	CMLXPL5436	644	54	36	1
	CMLXPL5442	726	54	42	1
	CMLXPL5448	892	54	48	1

CMLXPRXXXX - RIGHT EXTENSION END OF RUN RETURN GALLERY PANEL WITH END CONNECTION

- Provides floor standing support while enclosing the end of a gallery panel run.
- Attached at the end of a panel to allow for extending the gallery panel run.
- Connections at both exposed ends, one to connect to the panel and one to connect to another gallery panel.
- Includes all attachment hardware and glides.
- Total height is inclusive of panel glides extended to their full height.
- Please specify LP laminate finish and PVC edge finish.
- If a wood grain laminate is chosen, grain direction run horizontally.
- Gallery panel is edged in PVC on exposed edges and self edges on edge connecting to panel.

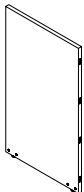
DESCRIPTION	PRODUCT CODE	LIST PRICE	DIMENSIONS/INCHES		
			H	W	D
 Extension End of Run Return Gallery Panel	CMLXPL4212	222	42	12.3	1
	CMLXPR4224	846	42	24	1
	CMLXPR4230	509	42	30	1
	CMLXPR4236	586	42	35	1
	CMLXPR4242	736	42	42	1
	CMLXPR4248	756	42	48	1
	CMLXPL4812	248	48	12.3	1
	CMLXPR4824	448	48	24	1
	CMLXPR4830	526	48	30	1
	CMLXPR4836	601	48	36	1
	CMLXPR4842	756	48	42	1
	CMLXPR4848	779	48	48	1
	CMLXPL5412	277	54	12.3	1
	CMLXPR5424	478	54	24	1
	CMLXPR5430	560	54	30	1
	CMLXPR5436	644	54	36	1
	CMLXPR5442	726	54	42	1
	CMLXPR5448	892	54	48	1

CMLXPLXXXNC - EXTENSION END OF RUN, LEFT, NO CONNECTION

- Provides floor standing support while enclosing the end of a gallery panel run.
- Attached at the end of a gallery panel to extend the gallery panel run.
- Connections only at one exposed end.
- Includes all attachment hardware and glides.
- Total height is inclusive of panel glides extended to their full height.
- Please specify LP laminate finish and PVC edge finish.
- If a wood grain laminate is chosen, grain direction run horizontally.
- Gallery panel is edged in PVC on exposed edges and self edged on edge connecting to panel.

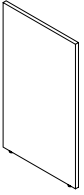
DESCRIPTION	PRODUCT CODE	LIST PRICE	DIMENSIONS/INCHES		
			H	W	D
 Extension End of Run Gallery Panel	CMLXPL4224NC	432	42	24	1
	CMLXPL4230NC	506	42	30	1
	CMLXPL4236NC	582	42	35	1
	CMLXPL4242NC	732	42	42	1
	CMLXPL4248NC	753	42	48	1
	CMLXPL4824NC	445	48	24	1
	CMLXPL4830NC	523	48	30	1
	CMLXPL4836NC	598	48	36	1
	CMLXPL4842NC	753	48	42	1
	CMLXPL4848NC	776	48	48	1
	CMLXPL5424NC	476	54	24	1
	CMLXPL5430NC	558	54	30	1
	CMLXPL5436NC	640	54	36	1
	CMLXPL5442NC	724	54	42	1
	CMLXPL5448NC	889	54	48	1

CMLXPLXXXNC • EXTENSION END OF RUN, RIGHT, NO CONNECTION

- Provides floor standing support while enclosing the end of a gallery panel run.
- Attached at the end of a gallery panel to extend the gallery panel run.
- Connections only at one exposed end.
- Includes all attachment hardware and glides.
- Total height is inclusive of panel glides extended to their full height.
- Please specify LP laminate finish and PVC edge finish.
- If a wood grain laminate is chosen, grain direction run horizontally.
- Gallery panel is edged in PVC on exposed edges and self edged on edge connecting to panel.

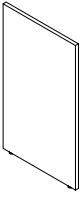
DESCRIPTION	PRODUCT CODE	LIST PRICE	DIMENSIONS/INCHES		
			H	W	D
 Extension End of Run Gallery Panel	CMLXPR4224NC	432	42	24	1
	CMLXPR4230NC	506	42	30	1
	CMLXPR4236NC	582	42	35	1
	CMLXPR4242NC	732	42	42	1
	CMLXPR4248NC	753	42	48	1
	CMLXPR4824NC	445	48	24	1
	CMLXPR4830NC	523	48	30	1
	CMLXPR4836NC	598	48	36	1
	CMLXPR4842NC	753	48	42	1
	CMLXPR4848NC	776	48	48	1
	CMLXPR5424NC	476	54	24	1
	CMLXPR5430NC	558	54	30	1
	CMLXPR5436NC	640	54	36	1
	CMLXPR5442NC	724	54	42	1
	CMLXPR5448NC	889	54	48	1

CMHLPBB01 - GALLERY PANEL BRACKET

- Gallery panel bottom bracket connects two gallery end panels at bottom with screws.
- Available in standard paint colors.
- Screws are included with the bracket.

DESCRIPTION	PRODUCT CODE	LIST PRICE	DIMENSIONS/INCHES		
			H	W	D

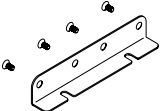
 Bracket	CMHLPBB01	50	1.5	8	1
--	-----------	----	-----	---	---



CMHLPCB01 - GALLERY PANEL CORNER BRACKET

- Gallery panel corner bottom bracket connects two laminate panels at 90 degrees.
- Screws are included with the bracket.
- Available in standard paint colors.

DESCRIPTION	PRODUCT CODE	LIST PRICE	DIMENSIONS/INCHES		
			H	W	D
 <p>Corner Bracket</p>	CMHLPCB01	48	1.5	4	4

CMPDPS - SLIDING DOOR

- Sliding Door provides privacy in an open plan environment.
- Complete Sliding Door kit includes aluminum door panel, rails, and capture extrusion.
- Door is non-handed (Can be assembled to slide left or right).
- 36" wide door spans 36" opening. Sliding Door rails must be installed on adjacent 42" panel.
- 42" wide door spans 42" opening. Privacy screen rails must be installed on adjacent 48" panel.
- Available in Clear (CLR) or Frosted (FRST) acrylic glazing.
- Available in all Panel Frame Finishes.
- Metal Finish - standard panel frame finishes.
- Lockable - key option - key alike, W series or random

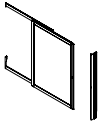
DESCRIPTION	PRODUCT CODE	LIST PRICE	DIMENSIONS/INCHES		
			H	W	D
 <p>Sliding Door</p>	CMPDPS6636	2981	66	43	3
	CMPDPS6642	3126	66	49	3

CMPDPSF - SLIDING DOOR

- Sliding Door provides privacy in an open plan environment.
- Complete Sliding Door kit includes aluminum door panel, rails, and capture extrusion.
- Door is non-handed (Can be assembled to slide left or right).
- 36" wide door spans 36" opening. Sliding Door rails must be installed on adjacent 42" panel.
- 42" wide door spans 42" opening. Privacy screen rails must be installed on adjacent 48" panel.
- Available in standard felt finishes.
- Available in all Panel Frame Finishes.
- Metal Finish - standard panel frame finishes.
- Lockable - key option - key alike, W series or random

DESCRIPTION	PRODUCT CODE	LIST PRICE	DIMENSIONS/INCHES		
			H	W	D
 <p>Felt Sliding Door</p>	CMPDPSF6636	2159	66	43	3
	CMPDPSF6642	2265	66	49	3



CMFMA - MINI PANEL KIT

- The Compile mini panel is an excellent sales tool featuring two panel and samples of various hardware and electrical components and consists of the following:
 - One Monolithic Mini Panel (Laminate side one / Acoustic side two).
 - One Segmented Glazed Mini panel.
 - One 2-way Universal Corner Post Kit.
 - Two 24" Raceway Cover with Punch Out.
 - Two 24" Raceway Cover with out Punch Out.
 - One Raceway Cut Out Cover.
- One 3-way Post Base Cover.
- One End of Run Trim.
- One Pair of Corner Brackets.
- One Mid span Worksurface Support Bracket.
- One Duplex.
- One Power Distribution Harness.
- One Mesh jumper.
- One Carry Bag.

DESCRIPTION	PRODUCT CODE	LIST PRICE	DIMENSIONS/INCHES		
			H	W	D
 <p>Mini Panel Kit</p>	CMFMA2418KIT1	2605	30	24	2 7/8

CHP POST PACKAGE

- Universal Post with all "Quick-Connection" clips.
- Post trim(s)
- Post base and top cap

	DESCRIPTION	PRODUCT CODE	LIST PRICE	DIMENSIONS/INCHES		
				H	W	D
	2 - Way Post	CHP30-2	124	30	2.3	2.3
		CHP42-2	124	42	2.3	2.3
		CHP46-2	179	46	2.3	2.3
		CHP48-2	146	48	2.3	2.3
		CHP54-2	152	54	2.3	2.3
		CHP58-2	224	58	2.3	2.3
		CHP60-2	224	60	2.3	2.3
		CHP64-2	265	64	2.3	2.3
		CHP66-2	179	66	2.3	2.3
		CHP70-2	258	70	2.3	2.3
		CHP72-2	258	72	2.3	2.3
		CHP78-2	294	78	2.3	2.3
		CHP82-2	309	82	2.3	2.3
		CHP90-2	309	90	2.3	2.3
	3 - Way Post	CHP30-3	109	30	2.3	2.3
		CHP42-3	109	42	2.3	2.3
		CHP46-3	162	46	2.3	2.3
		CHP48-3	162	48	2.3	2.3
		CHP54-3	135	54	2.3	2.3
		CHP58-3	203	58	2.3	2.3
		CHP60-3	203	60	2.3	2.3
		CHP64-3	216	64	2.3	2.3
		CHP66-3	162	66	2.3	2.3
		CHP70-3	233	70	2.3	2.3
		CHP72-3	233	72	2.3	2.3
		CHP78-3	265	78	2.3	2.3
		CHP82-3	277	82	2.3	2.3
		CHP90-3	307	90	2.3	2.3
	4 - Way Post *No trim or base. Includes top cap only.	CHP30-4	88	30	2.3	2.3
		CHP42-4	88	42	2.3	2.3
		CHP46-4	148	46	2.3	2.3
		CHP48-4	109	48	2.3	2.3
		CHP54-4	114	54	2.3	2.3
		CHP58-4	165	58	2.3	2.3
		CHP60-4	165	60	2.3	2.3
		CHP64-4	175	64	2.3	2.3
		CHP66-4	135	66	2.3	2.3
		CHP70-4	193	70	2.3	2.3
		CHP72-4	193	72	2.3	2.3
		CHP78-4	219	78	2.3	2.3
		CHP82-4	228	82	2.3	2.3
		CHP90-4	255	90	2.3	2.3





CHPXW - 90 DEGREE CORNER POST KIT FOR OVER PANELS

- Specify the corner post height that matches the height of the over panel
- 2-way kits include 2 trims (CMETPxx), 2 way post base (CMPCxx) and post cap (CMPC).
- 3-way kits include 2 trim (CMETPxx), 3 way post base (CMPCxx) and post cap (CMPC).
- 4-way kits include post cap (CMPC) only.

DESCRIPTION	PRODUCT CODE	LIST PRICE	DIMENSIONS/INCHES		
			H	W	D
	90 Degree Corner Post Kit for Over Panels				
	CHOP12-2	81	12	2.3	2.3
	CHOP12-3	69	12	2.3	2.3
	CHOP12-4	48	12	2.3	2.3
	CHOP16-2	81	16	2.3	2.3
	CHOP16-3	81	16	2.3	2.3
	CHOP16-4	69	16	2.3	2.3
	CHOP24-2	90	24	2.3	2.3
	CHOP24-3	81	24	2.3	2.3
	CHOP24-4	68	24	2.3	2.3

CHPXW - 60 DEGREE POST PACKAGE

- Universal Post with all "Quick-Connection" clips.
- Post trim is incorporated into 2 - Way aluminum post extrusion.
- Post top cap
- Outer part of the post is the full panel height and the inner part of the post is 6" shorter.
- 3 - Way post is 6" shorter than panel height to accommodate electric and base.
- PVC post trims can not be added to 60 degree posts.

DESCRIPTION	PRODUCT CODE	LIST PRICE	DIMENSIONS/INCHES		
			H	W	D
	2 - Way - 60 Degree Post Package				
	CHP2W30	88	30	2.3	2.3
	CHP2W42	88	42	2.3	2.3
	CHP2W46	114	46	2.3	2.3
	CHP2W54	114	54	2.3	2.3
	CHP2W58	156	58	2.3	2.3
	CHP2W60	171	60	2.3	2.3
	CHP2W64	185	64	2.3	2.3
	CHP2W66	135	66	2.3	2.3
	CHP2W70	196	70	2.3	2.3
	CHP2W72	196	72	2.3	2.3
	CHP2W78	219	78	2.3	2.3
	CHP2W82	228	82	2.3	2.3
	CHP2W90	251	90	2.3	2.3
		3 - Way - 60 Degree Post Package			
CHP3W30		88	30	2.3	2.3
CHP3W42		88	42	2.3	2.3
CHP3W46		125	46	2.3	2.3
CHP3W54		114	54	2.3	2.3
CHP3W58		156	58	2.3	2.3
CHP3W60		171	60	2.3	2.3
CHP3W64		185	64	2.3	2.3
CHP3W66		135	66	2.3	2.3
CHP3W70		196	70	2.3	2.3
CHP3W72		196	72	2.3	2.3
CHP3W78		219	78	2.3	2.3
CHP3W82		228	82	2.3	2.3
CHP3W90		251	90	2.3	2.3

CMRCXXNP - COMPILE RACEWAY COVER - WITHOUT KNOCKOUTS

- No electrical knockouts included.
- Note: Made of reinforced aluminum.

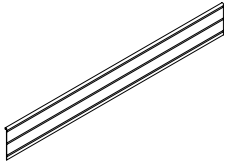
	DESCRIPTION	PRODUCT CODE	LIST PRICE	DIMENSIONS/INCHES		
				H	W	D
	Compile Raceway Cover Without Knockouts	CMRC24NP	20	24		
		CMRC30NP	24	30		
		CMRC36NP	27	36		
		CMRC42NP	29	42		
		CMRC48NP	33	48		
		CMRC54NP	40	54		
		CMRC60NP	42	60		

CMRCXXPO - COMPILE RACEWAY COVER - WITH KNOCKOUTS

- Contains one knockout for 24" w and three knockouts for 30" w+.
- Raceway Knockout Cover must be added to openings where duplex receptacles are not used.
- Note: Made of reinforced aluminum.

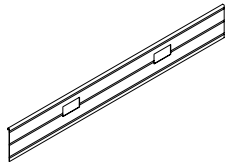
	DESCRIPTION	PRODUCT CODE	LIST PRICE	DIMENSIONS/INCHES		
				H	W	D
	Compile Raceway Cover With Knockouts	CMRC24PO	20	24		
		CMRC30PO	24	30		
		CMRC36PO	27	36		
		CMRC42PO	29	42		
		CMRC48PO	33	48		
		CMRC54PO	40	54		
				CMRC60PO	42	60

CMRCB01 - COMPILE RACEWAY KNOCKOUT COVER

- Fills knockout when duplex is not used.
- Available in Black, White, Nevada, and Fog.
- Note: Knockout covers are made of plastic.

	DESCRIPTION	PRODUCT CODE	LIST PRICE	DIMENSIONS/INCHES		
				H	W	D
	Compile Raceway Knockout Cover	CMRCB01	19			



CHP - 90-DEGREE UNIVERSAL CORNER POST

- Available in 42", 54" and 66"h.
- Standard Compile paint options.
- Specify the corner post height that matches the tallest or smallest panel connection.
- Can be used for any variation of 90-degree connections: 2-way, 3-way or 4-way.
- Requires post trim inserts to finish off post where there are no panel connections. Post trim inserts are specified separately.
- 6" shorter than panel height to accommodate electric in base.
- Requires a post basecover to finish off post at the base (for 2- or 3-way). Refer to CMPC.
- See Panel Configuration Tips for application.
- Made of aluminum.

	DESCRIPTION	PRODUCT CODE	LIST PRICE	DIMENSIONS/INCHES		
				H	W	D
	90-Degree Universal Corner Post	CHP30	82	30		
		CHP42	82	36		
		CHP54	106	48		
		CHP66	130	60		

CMET - END OF RUN TRIM INSERT FOR PANEL

- Trim inserts are not included with panels.
- Cannot be used for a universal post application.
- Used at the end of each panel run and cannot be used to attach a panel run to a fixed wall.
- Vertical trims must be specified separately. Trim snaps in the panel at the end of run.
- Standard Compile paint options.
- See Panel Configuration Tips for application.
- Trims are PVC.

	DESCRIPTION	PRODUCT CODE	LIST PRICE	DIMENSIONS/INCHES		
				H	W	D
	End of Run Trim Insert for Panel	CMET16	20	16	2.3	0.5
		CMET30	23	30	2.3	0.5
		CMET42	23	42	2.3	0.5
		CMET46	24	46	2.3	0.5
		CMET48	27	48	2.3	0.5
		CMET54	27	54	2.3	0.5
		CMET58	28	58	2.3	0.5
		CMET60	28	60	2.3	0.5
		CMET64	29	64	2.3	0.5
		CMET66	29	66	2.3	0.5
		CMET70	32	70	2.3	0.5
		CMET72	32	72	2.3	0.5
		CMET78	34	78	2.3	0.5
		CMET82	35	82	2.3	0.5
		CMET90	41	90	2.3	0.5

CMETP - TRIM INSERT FOR UNIVERSAL CORNER POST

- Does not come with a post.
- Trim installs on all exposed sides of a Universal Corner Post.
- Specify to equal post height.
- Trims must be specified separately. Trim snaps in the post.
- Available in standard Compile paint options.
- 6" shorter than Universal Corner Post to accommodate Post Base Cover (must be specified separate)
- See Panel Configuration Tips for application.

DESCRIPTION	PRODUCT CODE	LIST PRICE	DIMENSIONS/INCHES			
			H	W	D	
	Trim Insert for Universal Corner Post	CMETP30	19	30	2.3	0.5
		CMETP42	19	42	2.3	0.5
		CMETP46	24	46	2.3	0.5
		CMETP48	15	48	2.3	0.5
		CMETP54	20	54	2.3	0.5
		CMETP58	26	58	2.3	0.5
		CMETP60	28	60	2.3	0.5
		CMETP64	29	64	2.3	0.5
		CMETP66	21	66	2.3	0.5
		CMETP70	33	70	2.3	0.5
		CMETP72	33	72	2.3	0.5
		CMETP78	34	78	2.3	0.5
		CMETP82	36	82	2.3	0.5
		CMETP90	41	90	2.3	0.5

CMET - TRIM INSERT FOR STEP DOWN

- Does not come with a post. Trim inserts are not included with Universal Corner Posts.
- Specify to meet the taller post.
- Trim snaps in the post or end of run at a change in height.
- Available in standard Compile paint options.
- Can not be applied to 60 degree posts.
- See Panel Configuration Tips for application.

DESCRIPTION	PRODUCT CODE	LIST PRICE	DIMENSIONS/INCHES		
			H	W	D
	Trim Insert for Step Down	CMET06	12	6	
		CMET12	15	12	
		CMET18	20	18	
		CMET24	26	24	
		CMET36	32	36	

CHWAXX - WALL ADAPTER

- Same profile as vertical extrusion.
- Wall attachment hardware not provided.
- Made of aluminum.

DESCRIPTION	PRODUCT CODE	LIST PRICE	DIMENSIONS/INCHES			
			H	W	D	
	Wall Adapter	CHWA30	51	30	2.36	.79
		CHWA42	69	42	2.36	.79
		CHWA46	69	46	2.36	.79
		CHWA48	69	48	2.36	.79
		CHWA54	87	54	2.36	.79
		CHWA58	87	58	2.36	.79
		CHWA60	101	60	2.36	.79
		CHWA64	101	64	2.36	
		CHWA66	101	66	2.36	.79
		CHWA70	116	70	2.36	.79
		CHWA72	116	72	2.36	.79
		CHWA78	130	78	2.36	.79
		CHWA82	146	82	2.36	.79
		CHWA90	160	90	2.36	.79



CWMA - VERTICAL CHANNEL

- Used to attach system components to fixed wall.
- Panel frame finish.
- Comes in 60" length only.
- Care should be taken to mount adapters only to wall studs using correct fasteners.
- Does not include mounting hardware. Mounting hardware selection to be based on wall material.
- Failure to do this may result in collapse of the unit and subsequent possible personal injury.
- Compile vertical channels cannot be shared.

	DESCRIPTION	PRODUCT CODE	LIST PRICE	DIMENSIONS/INCHES		
				H	W	D
	Vertical Channel Sold in pairs	CWMA60	42	60	0.6	0.7

CMPC - UNIVERSAL POST CAP

- Comes standard with universal post.
- Specified separately for reconfiguration purposes.
- Available in standard Compile paint options.
- Made of PVC.

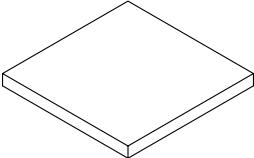
	DESCRIPTION	PRODUCT CODE	LIST PRICE	DIMENSIONS/INCHES		
				H	W	D
	Universal Post Cap	CMPC	9	2 3/8		

CMPC - POST BASE COVER

- Post Base Covers are not included with Universal Corner Posts.
- Base trim for universal post. These are connected with screws at the base and the trims at the post will slide to meet.
- Available for 2-way and 3-way configurations.
- Finish is smooth plastic.
- Available in standard Compile paint options.

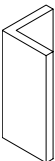
	DESCRIPTION	PRODUCT CODE	LIST PRICE	DIMENSIONS/INCHES		
				H	W	D
	Post Base Cover - 3-Way Connection	CMPC1	14	6		
	Post Base Cover - 2-Way Connection	CMPC2	15	6		

CMHLPF - FLAT LEG FOR FREESTANDING PANELS

- Not intended to add to a run of panels in conjunction with Leveling Glides. panel and replace it with the legs.
- Kit will contains one legs and all attachment hardware. • Please specify paint finish.
- For the installation the customer will have to remove the existing levelers on the

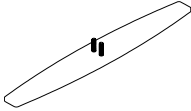
	DESCRIPTION	PRODUCT CODE	LIST PRICE	DIMENSIONS/INCHES		
				H	W	D
	Single Flat Leg	CMHLPF01	135	.31	21	3

CMHLPF - FLAT LEG FOR FREESTANDING PANELS

- Double kit for freestanding applications. • Please specify paint finish.
- Kit will contains two legs and all attachment hardware. • Note: Leg is on available for freestanding panels 42" to 60" wide.
- For the installation the customer will have to remove the existing levelers on the panel and replace it with the legs.

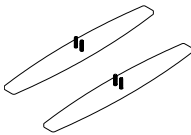
	DESCRIPTION	PRODUCT CODE	LIST PRICE	DIMENSIONS/INCHES		
				H	W	D
	Double Flat Leg	CMHLPF02	267	.31	21	3

CMHLLP01 - LOW PROFILE FOOT

- Provides added support to a panel under load. • Made of powder coated steel.
- Adjustable glides and connectors included.

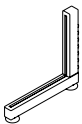
	DESCRIPTION	PRODUCT CODE	LIST PRICE	DIMENSIONS/INCHES		
				H	W	D
	Low Profile Foot	CMHLLP01	200	12	11	1.1

CMHLLP02 - LOW PROFILE FOOT

- Provides added support to a panel under load. • Made of powder coated steel.
- Adjustable glides and connectors included. • Set includes 2 complete legs.

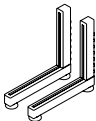
	DESCRIPTION	PRODUCT CODE	LIST PRICE	DIMENSIONS/INCHES		
				H	W	D
	Double Low Profile Foot	CMHLLP02	397	12	11	1.1



CMPS - POST SEPARATOR

- Creates a diagonal division within a compile post.
- Please specify post height.

	DESCRIPTION	PRODUCT CODE	LIST PRICE	DIMENSIONS/INCHES		
				H	W	D
	Post Separator	CMPS01	165	96	3.25	14

electrical

STEP-BY-STEP SPECIFICATION – 8-WIRE ELECTRICAL SYSTEM

Step **1** **Determine the location of the source power entering the Panel Run.**

1. At the base of the Panel.
 - (a) Use CE8FR1 Reversible Floor Power Entry (default to CE8FR1).
 - (b) Select the Panel to which the Floor Power Entry will be attached.
 - (c) Select the side of the Panel and the receptacle outlet to which the Floor Power Entry is to be attached.

Note: When using Pass Through Connectors in conditions other than a straight line, you must use a CE8CI-1 I-Connector along with a CE8CP17 Flexible Mesh Jumper Cable through the corner post.

Step **2** **Determine which Panels are to be powered.**

1. Use CE8PD Power Distribution Housing that corresponds with the width of the Panel.

Step **3** **Connect power to the powered Panels.**

1. Use CE8CP17 Flexible Mesh Jumper Cable between two adjacent powered Panels.
2. Use CE8CP17 Flexible Mesh Jumper Cable between two adjacent powered Panels separated by a post.
3. Use CE8CP17 Flexible Mesh cable (to turn the post) and a CE8CI-1 "I" Connector to attach the CE8CP Pass Through Cable.
 - (a) The length of the Pass-Through Cable is calculated by adding together the widths of the non-powered Panels that separate the two powered Panels and applying an additional 16" to the total. (CE8PD Power Distribution Housing is positioned 8" in from the ends of the powered Panel.)
 - (b) An additional 3" must be added to the Pass-Through Cable for each post that the cable passes through.
 - (c) Subtract 17" from the total length to find the pass through cable length required.
4. From the price list, select the CE8CP Pass-Through Cable that matches the calculated length. If the length is between listed sizes, use the next size up.

Step **4** **Determine the location and circuitry of the receptacles.**

1. Each powered Panel has four (4) potential locations for CE8RD Duplex Receptacles – 2 per side. (Exception: 24" wide Panel has only two potential locations – 1 per side.)
2. At each receptacle location there is a choice of four circuit options. Select a circuit option for each location. Circuits one & two are utility circuits; circuits A & B are dedicated circuits.

COMPILE'S 8-WIRE ELECTRICAL SYSTEM

Electrical

This modification allows for the integration of the commonly required "2+2" configuration (2 utility circuits, 2 dedicated circuits) found in the source power of most of today's North American buildings.

This system is rated for connection to:

1. A grounded 120/240V, single phase, 20 A, 60Hz
2. A 120/208V, 3 phase, 20 A, 60Hz branch circuit

EQUIPMENT AMPERAGE

Calculator	0.25
Electric Eraser	0.50
Pencil Sharpener.....	1.00
Radio	0.05
Paper Shredder.....	4.40 - 13.00
Electric Typewriter	1.20
Personal Computer	2.00 - 4.00
Video Display Terminal	0.08
Draft / Letter Quality Printer	1.20 - 3.00
Laser Printer.....	5.00 - 8.00
Processor / Disk Unit.....	1.00 - 10.00

Data/Comm

Compile's duplex receptacle openings (1.345 x 2.80) will conform to the ANSI/TIA/EIA Furniture Opening Standard of 1.38 +/- .035 x 2.71 +/- .04

Desk Top Plotter	1.50
Fan	1.00
Heater	8.50 - 12.50
Coffee Pot.....	15.00
Task Light	1.00
Slide Projector	2.00 - 6.00

Since some equipment, such as large copiers, printers, plotters, heaters and coffee makers would occupy most of the circuit capacity, it is recommended that such devices be supplied with the power directly from the wall or building receptacle.



Wiring Schematic

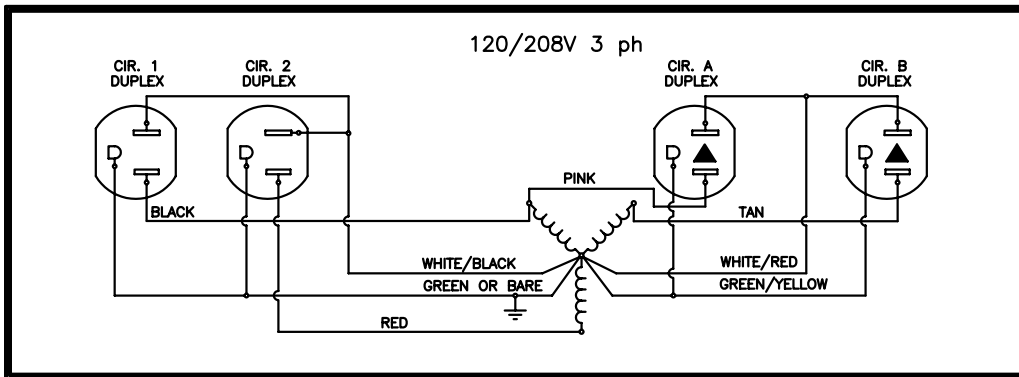
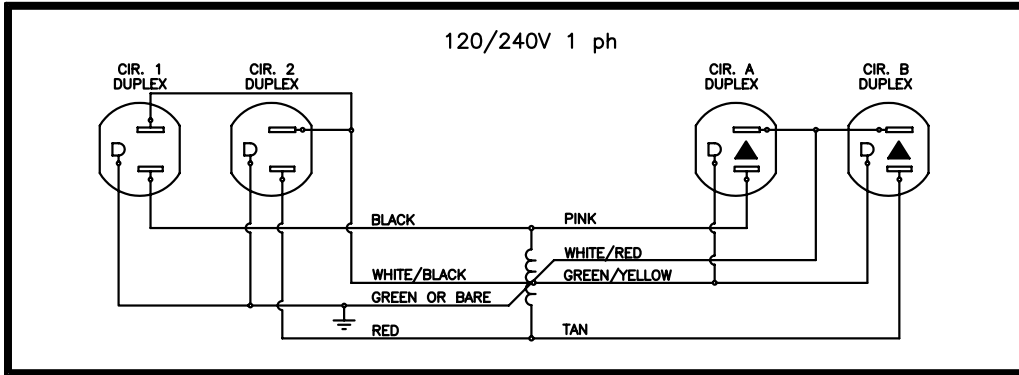

Defining "2 + 2" Wiring Configurations

2 + 2 Configuration (8 wire, 4 circuit)

Two Utility Circuits [Compile's new #1 & #2 circuits] share one neutral wire and one ground wire.
 (2 hot [circuit] wires + 1 neutral wire*** + 1 green ground wire* = 4 wires)

Two Dedicated Circuits [Compile's new "A" & "B" circuits] share one neutral wire and one ground wire.
 (2 hot [circuit] wires + 1 neutral wire*** + 1 green/yellow ground wire** = 4 wires)

Note:

It is the ground wire that makes the difference between "Utility" and "Dedicated" circuits. Refer to Wiring Schematics found above.

* A Green ground wire is a "system" ground. This means it could be grounded to any piece of metal, including the Panel.

** A Green/Yellow ground wire is isolated, within the wiring conduit, all the way back to the box at the source (building ground).

*** All Neutral Wires are 10 gauge rather than 12 gauge meaning they are larger than normal, allowing greater protection against "noise" or interference on the circuit.

This page provides an exploded view of a sample configuration highlighting each **Electrical** component required when specifying this configuration.

Components

- A. CE8PD36 Power Distribution Housing
Note: 8 wire, 4 circuits, 2+2 configuration
- B. CE8CP17 Flexible Mesh Jumper Cable (connects two panels side by side or separated by a post)
- C. CE8RD Duplex Receptacle
- D. CE8CI-1 "I" Connector
- E. CE8CP Pass-Through Cable
Note: Must run in a straight line application only
Note: Pass-Through Extension Cable (CE8CPF154) available – extends power capability beyond 208".

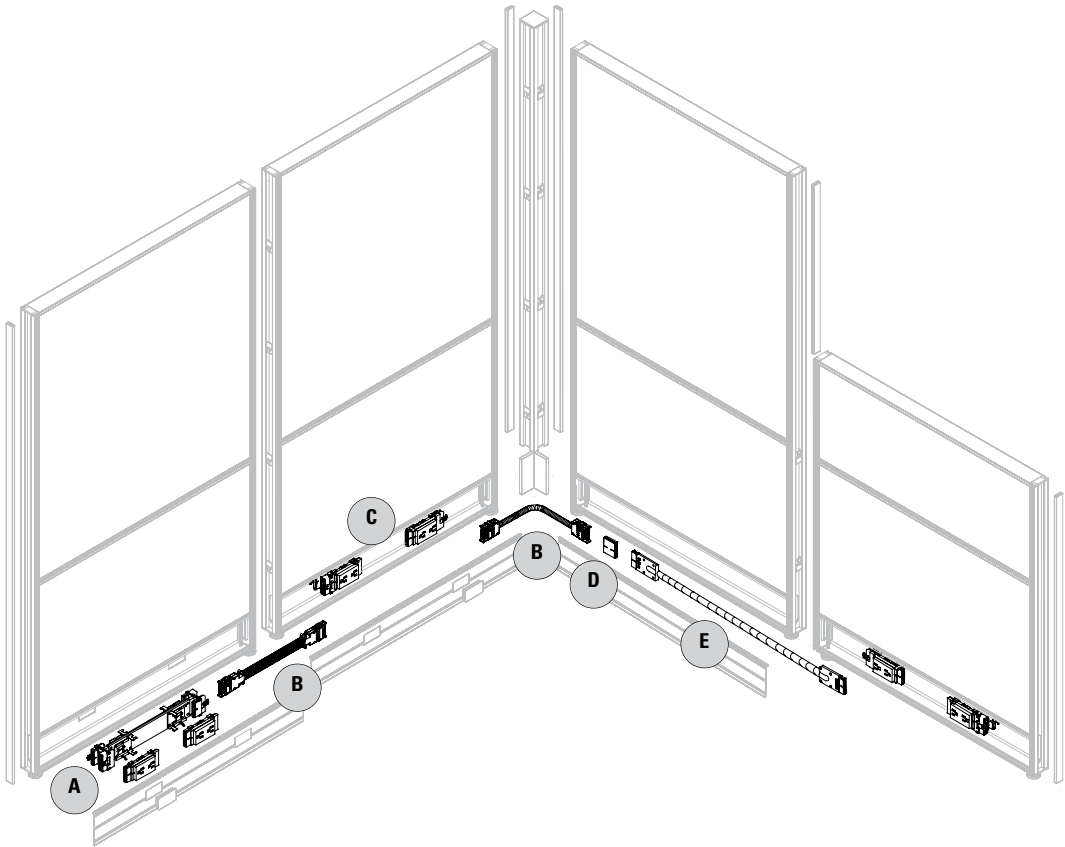

ELECTRICAL

CE8PD - POWER DISTRIBUTION HOUSING

- Power housing is specified per panel size (e.g. CE8PD36 is for use in a 36" panel).
- 8 wire, 4 circuits (4th circuit dedicated).
- Power distribution housing is required for each powered panel, the power distribution housing should equal the width of the panel that it is specified in.
- Provides two duplex receptacle ports per panel side on all panel widths except the 24" wide panel.
- 24" wide panel allows for only one (1) duplex receptacle on one panel side.
- Each power distribution housing supports 15-20 amps.
- Must specify Raceway Cover with Knockouts on panels, where Power Distribution Housings will be utilized.

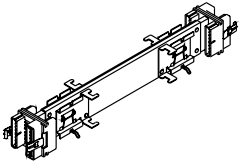
	DESCRIPTION	PRODUCT CODE	LIST PRICE	DIMENSIONS/INCHES		
				H	W	D
	Power Distribution Housing	CE8PD24	165	6 1/4		
		CE8PD30	224	11 1/2		
		CE8PD36	235	17 1/2		
		CE8PD42	240	23 1/2		
		CE8PD48	258	29 1/2		
		CE8PD60	262	41 1/2		

CE8CP17 - FLEXIBLE MESH JUMPER CABLE

- 17" mesh jumper.
- Jumper cable is used to pass through a post or connect two panels together.

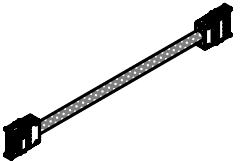
	DESCRIPTION	PRODUCT CODE	LIST PRICE	DIMENSIONS/INCHES		
				H	W	D
	Flexible Mesh Jumper Cable	CE8CP17	129		17	

ELECTRICAL

CE8CP - PASS THROUGH CABLE

- Flexible metal conduit is used to distribute electrical power through non-powered panels.
- Metal conduit pass through cables should be in used in a straight runs. Metal conduit pass through cables cannot pass through a post.
- Flexible conduit is required to turn a post. This only comes as 17" w. If panels at the posts do not all have power distribution housings, they must be added even if duplexes are not specified.
- To calculate the length of a Pass-Through Cable, add the widths of the non-powered panels separating the powered panels (panels with distribution housing attached). To this add 16" (distance from the edge of the panel to the distribution housing x 2).
- Add additional 3" when passing through a corner post. See the Tips at the beginning of the section for more details.

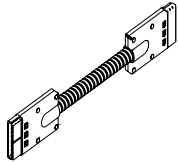
DESCRIPTION	PRODUCT CODE	LIST PRICE	DIMENSIONS/INCHES		
			H	W	D
 Pass Through Cable	CE8CP28	171		28 1/2	
	CE8CP40	179		40 1/2	
	CE8CP46	185		46 1/2	
	CE8CP52	191		52 1/2	
	CE8CP58	201		58 1/2	
	CE8CP64	211		64 1/2	
	CE8CP70	217		70 1/2	
	CE8CP76	220		76 1/2	
	CE8CP82	228		82 1/2	
	CE8CP88	235		88 1/2	
	CE8CP94	241		94 1/2	
	CE8CP100	248		100 1/2	

CE8CP-H - HYBRID PASS THROUGH CABLES WITH WIRE MESH

- Flexible metal conduit with wire mesh distributes electrical power through non powered panels.
- Hybrid Pass through cables with wire mesh allows to connect at 90 degree post at one end.
- To calculate the length of a Pass-Through Cable, add the widths of the non-powered panels separating the powered panels (panels with distribution housing attached). To this, add 16" (distance from the edge of the panel to the distribution housing x 2).
- Add additional 3" when passing through a post. See tips at the beginning of the section for more details.
- Hybrid pass-through cables with wire mesh allows connection at 90 degree post at one end for panels.

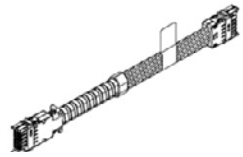
DESCRIPTION	PRODUCT CODE	LIST PRICE	DIMENSIONS/INCHES		
			H	W	D
 Hybrid Pass Through Cable	CE8CP40-H	111	2	40 1/2	.5
	CE8CP46-H	118	2	46 1/2	.5
	CE8CP52-H	127	2	52 1/2	.5
	CE8CP58-H	135	2	58 1/2	.5
	CE8CP64-H	143	2	64 1/2	.5
	CE8CP70-H	154	2	70 1/2	.5
	CE8CP76-H	162	2	76 1/2	.5
	CE8CP82-H	171	2	82 1/2	.5
	CE8CP88-H	178	2	88 1/2	.5
	CE8CP94-H	187	2	94 1/2	.5
	CE8CP100-H	195	2	100 1/2	.5
	CE8CP106-H	204	2	106 1/2	.5
	CE8CP118-H	222	2	118 1/2	.5
	CE8CP130-H	238	2	130 1/2	.5
	CE8CP142-H	255	2	142 1/2	.5



ELECTRICAL

CE8CI-1 - "I" CONNECTOR

- Female - Female connector connects two Pass-Through Cables.
- Connects 17" Flexible Jumper Cable or ceiling feeds to pass through cables.

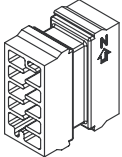
	DESCRIPTION	PRODUCT CODE	LIST PRICE	DIMENSIONS/INCHES		
				H	W	D
	"I" Connector	CE8CI-1	95			

CE8RD - DUPLEX RECEPTACLE

- Up to 3 receptacles per circuit
- Up to 6 receptacles per circuit (24 per infeed), not to exceed total of 15 Amps per circuit.
- Duplex Receptacles standard in Black (BLK).
- CE8RD1 = Circuit #1 (utility circuit)
- CE8RD2 = Circuit #2 (utility circuit)
- CE8RDA = Circuit A (dedicated)
- CE8RDB = Circuit B (dedicated)
- CE8RD1 and CE8RD2 (#1 and #2 share common ground)
- CE8RDA and CE8RDB (A and B share common ground)

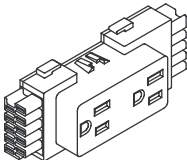
	DESCRIPTION	PRODUCT CODE	LIST PRICE	DIMENSIONS/INCHES		
				H	W	D
	Duplex Receptacle	CE8RD1	36			
		CE8RD2	36			
		CE8RDA	36			
		CE8RDB	36			

CE8RDxca - CONTROLLED DUPLEX RECEPTACLE

- Meets California Title 24, Federal and LEED certification guidelines
- Allows circuit to be controlled or switched off when utility is not in use.
- Duplex receptacles are rated for 15 Amps.
- CE8RD1CA = Circuit #1 (utility circuit)
- CE8RD2CA = Circuit #2 (utility circuit)
- CE8RDACA = Circuit A (dedicated)
- CE8RDBCA = Circuit B (dedicated)

NOTE:

- CE8RD1CA and CE8RD2CA (#1 and #2 share common ground)
- CE8RDACA and CE8RDBCA (A and B share common ground)
- Up to 6 receptacles per circuit (24 per infeed), not to exceed total of 15 Amps per circuit.
- Available in BLK finish only.
- Duplexes are stamped with Power Logo in Upper left corner.

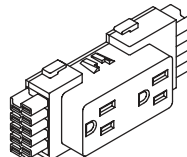
	DESCRIPTION	PRODUCT CODE	LIST PRICE	DIMENSIONS/INCHES		
				H	W	D
	Duplex Receptacle	CE8RD1CA	41	2	4 5/8	1 1/4
		CE8RD2CA	41	2	4 5/8	1 1/4
		CE8RDACA	41	2	4 5/8	1 1/4
		CE8RDBCA	41	2	4 5/8	1 1/4

ELECTRICAL

CE8FR1 - REVERSIBLE FLOOR POWER ENTRY

- Takes the place of a duplex receptacle by snapping into the base power way.
- Includes 72" long flexible vinyl conduit.
- Must be hard wired to source power by a licensed electrician.
- Diameter is 0.85"

CE8FR2 - REVERSIBLE FLOOR POWER ENTRY

- Takes the place of a duplex receptacle by snapping into the base power way.
- Includes 144" long flexible vinyl conduit.
- Must be hard wired to source power by a licensed electrician.

DESCRIPTION	PRODUCT CODE	LIST PRICE	DIMENSIONS/INCHES		
			H	W	D

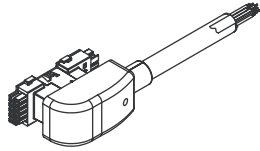

Reversible Floor Power Entry

CE8FR1
CE8FR2

372
479

72
144

CE8F - FLOOR POWER ENTRY

- Snaps in end of power distribution housing.
- Includes flexible vinyl conduit.

- Must be hard wired to source power by a licensed electrician.
- Diameter is 0.85"

DESCRIPTION	PRODUCT CODE	LIST PRICE	DIMENSIONS/INCHES		
			H	L	D

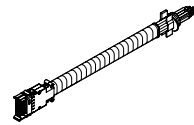

Reversible Floor Power Entry

CE8F1P
CE8F2P

382
494

72
144

CMEB01 - ELECTRICAL BOX - CHICAGO

- Can be retrofitted in any size of panel at the receptacle location.
- Gives access from one side only at each location.
- Customer to supply conduit, wiring, receptacle, and face plate.

- 2 per panel ,except 24" panel only one
- Note: A licensed electrician must provide hardware connection with the junction box.

DESCRIPTION	PRODUCT CODE	LIST PRICE	DIMENSIONS/INCHES		
			H	W	D

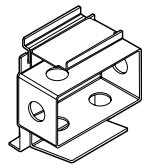

Electrical Box - Chicago

CMEB01

109

CMEB02NY - ELECTRICAL BOX - NEW YORK

- Shipped assembled.
- Comes with pig tail electric.
- Use with 30" wide Panel of larger

- Post extension cable capacities: without electric, 30 with electric, 20
- Includes ceiling bezel and screws.

DESCRIPTION	PRODUCT CODE	LIST PRICE	DIMENSIONS/INCHES		
			H	W	D

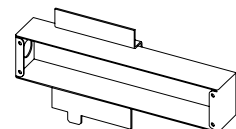

Electrical Box - New York

CMEB02NY

476



ELECTRICAL

CEPEXX - POST EXTENSION

- Same profile as post.
- Includes two post extension brackets, four screws and four trim inserts.
- Includes ceiling bezel and screws.

	DESCRIPTION	PRODUCT CODE	LIST PRICE	DIMENSIONS/INCHES		
				H	W	D
	Post Extension	CEPE64	206	64		
		CEPE82	258	82		

CE8ECX - CEILING FEED

- Snaps into the end of a Power Distribution Housing.
- Flexible metal conduit extends into the ceiling through a corner post and post extension.
- Must be hard wired to source power by a licensed electrician.
- 4" junction box included.
- Post extension ordered separately

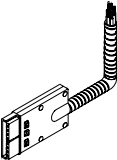
	DESCRIPTION	PRODUCT CODE	LIST PRICE	DIMENSIONS/INCHES		
				H	W	D
	Ceiling Feed	CE8EC1	286	132		
		CE8EC2	502	144		
		CE8EC3	568	180		

CMECC - CABLE COVER

- Attaches to panels vertically between modules to provide enclosures for power or data cords.
- Available in Steel (STL), Black (BLK), Nevada (NEV) only.
- Available in 21" and 36" lengths, 6 per pack.

	DESCRIPTION	PRODUCT CODE	LIST PRICE	DIMENSIONS/INCHES		
				H	W	D
	Cord Cover	CMECC21	35	21	0.5	1
		CMECC36	54	36	0.5	1

ELECTRICAL

CMLEDES - STARTER LED TASK LIGHT

- Undercabinet slim profile LED linear light fixture with lens and On/Off switch.
- May be used as stand-alone or extended with add-on section below (CMLEDES_DSC).
- Plug-in power supply with 72" cord length plus 78" DC cable.
- Includes magnet mounting bracket with optional adhesive metal plate.
- Light enclosure in clear anodizing finish. Color temperature cool white 4000K.
- Lifespan rated 30,000 hours.

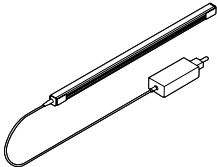
DESCRIPTION	PRODUCT CODE	LIST PRICE	DIMENSIONS/INCHES		
			H	W	D
 Led Task Light	CMLEDES24	297	1	22.9	1
	CMLEDES36	341	1	33.5	1
	CMLEDES48	379	1	45.5	1

CMLEDES - ADD-ON LED TASK LIGHT

- Undercabinet slim profile LED linear add-on light fixture with lens.
- Daisy chain unit with 39" linking cable, no power supply.
- Add-on units can only be linked up to a total of 48 watts per power supply; this is equivalent to 10 feet of nominal length of light per power supply.
- Includes magnet mounting bracket with optional adhesive metal plate. Light enclosure in clear anodizing finish. Color temperature cool white 4000K. Lifespan rated 30,000 hours.

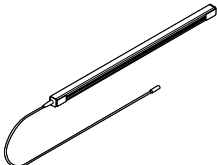
DESCRIPTION	PRODUCT CODE	LIST PRICE	DIMENSIONS/INCHES		
			H	W	D
 Led Task Light	CMLEDES24DSC	243	1	24	39
	CMLEDES36DSC	286	1	36	39
	CMLEDES48DSC	325	1	48	39

CMLEDESOS - OCCUPANCY SENSOR

- Inline add-on controller for dimming and occupancy sensor.
- Sensor bypass switch.

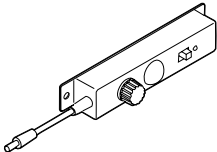
DESCRIPTION	PRODUCT CODE	LIST PRICE	DIMENSIONS/INCHES		
			H	W	D
 Occupancy Sensor	CMLEDESOS	122	6	2.4	2



worksurfaces

The information listed below provides you with basic features of Compile Worksurfaces.

- Compile thermally fused Worksurfaces are 1" thick and are finished with 3 mm PVC edging on all sides.
- Worksurfaces are predrilled to enable proper alignment with worksurface supports.
- Standard laminate offerings are available in thermally-fused (T). See laminate listings for details.
- Wood grain laminates on corner Worksurfaces up to 42" available in laminate run diagonally for an upcharge. Otherwise, standard horizontal application of laminate will be used.
- Most wood grain laminate Worksurfaces will have matching woodgrain trim unless specified otherwise.
- Depth of the Worksurface scoops are 1 1/8" when measured from the Panel the Worksurface is attached to.
- All Worksurfaces require support items. These are priced separately within this section.
- Grain Direction for Worksurfaces are as follows:

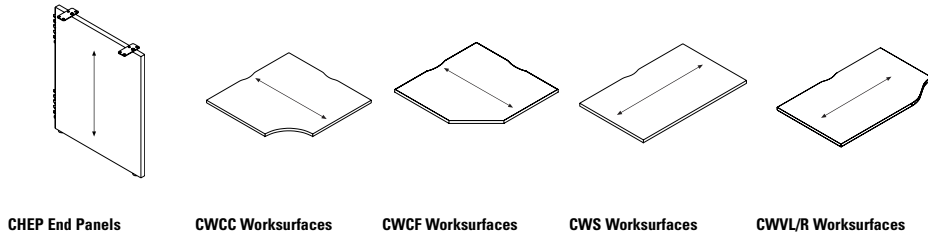

- Communication and electrical wires are routed through a cable scoop located at the back of the Worksurface. When specifying a Straight Worksurface (CWS) or a Curvilinear Worksurface (CWVL), note that the number of cable scoops depends upon the width of the Worksurface. All other Worksurface shapes have one scoop on Panel edges.

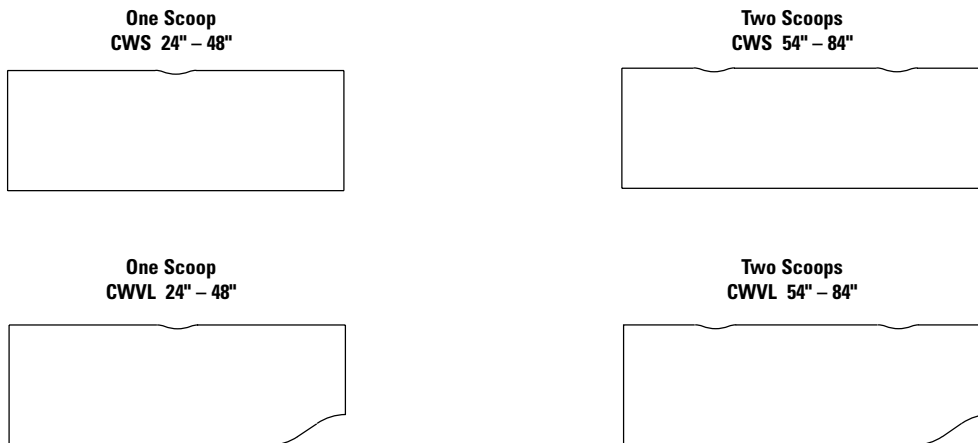

This page provides a three dimensional view of a sample configuration highlighting each **Worksurface** component required when specifying this configuration.

Components

- A.** CWVL2436 Curvilinear Worksurface – Left
 Note: When deepest end equals 24", opposite depth is 18"
 When deepest end equals 30", opposite depth is 24"
- B.** CWCC3618 Corner Curved Worksurface
- C.** CWVR2436 Curvilinear Worksurface – Right

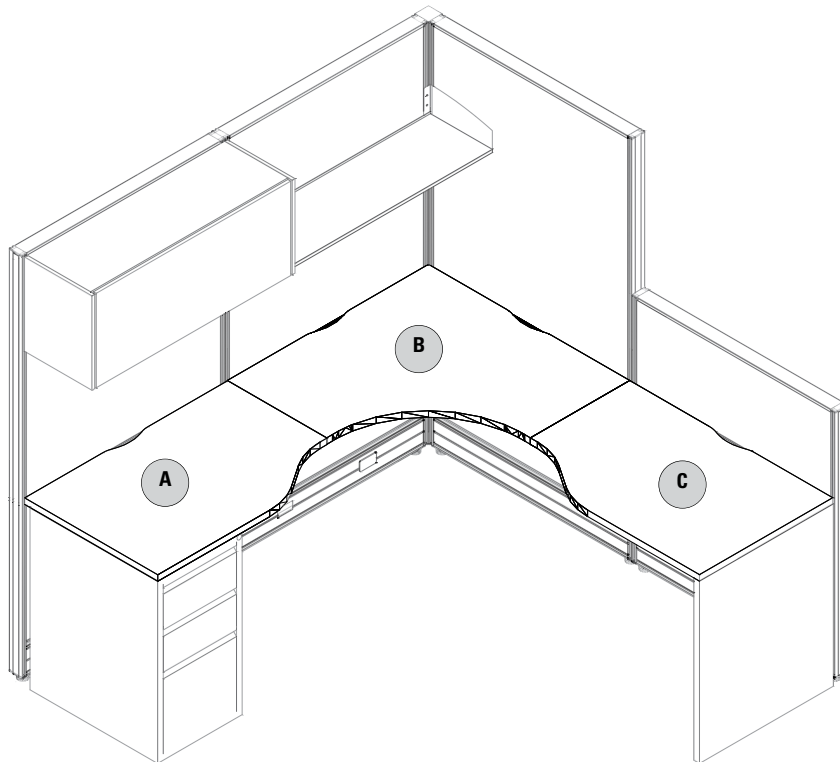

WORKSURFACES

CWS - RECTANGULAR WORKSURFACES

- All tops are thermally fused 1" thick with pilot holes to enable proper alignment with worksurface supports. Wood screws must be used.
- Compile worksurfaces feature a 3mm edge.
- Support hardware must be ordered separately. See the listings in this section.
- Width and depth dimensions listed include a nominal measurement (3/8") to account for wire management between the worksurface and adjoining panel.
- All surfaces over 48" will have two scoops, all others have one.
- Worksurfaces greater than 48" wide require additional structural support.

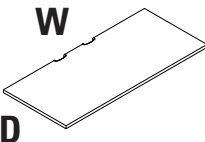
	DESCRIPTION	PRODUCT CODE	LIST PRICE	DIMENSIONS/INCHES		
				D	W	
	Rectangular Worksurfaces - 24" Deep	CWS2424P	149	24	24	
		CWS2430P	160	24	30	
		CWS2436P	179	24	36	
		CWS2442P	229	24	42	
		CWS2448P	277	24	48	
		CWS2454P	323	24	54	
		CWS2460P	363	24	60	
		CWS2466P	379	24	66	
		CWS2472P	393	24	72	
		CWS2478P	632	24	78	
		CWS2484P	639	24	84	
		CWS2490P	670	24	90	
		CWS2496P	715	24	96	
		Rectangular Worksurfaces - 30" Deep	CWS3024P	175	30	24
			CWS3030P	186	30	30
			CWS3036P	220	30	36
CWS3042P	309		30	42		
CWS3048P	323		30	48		
CWS3054P	354		30	54		
CWS3060P	379		30	60		
CWS3066P	392		30	66		
CWS3072P	416		30	72		
CWS3078P	786		30	78		
CWS3084P	801	30	84			



WORKSURFACES

CWSNSC - STRAIGHT WORKSURFACE NO SCOOP

- There is no scoop on this worksurface.
- Worksurface depth is exact, not nominal.
- Support hardware must be ordered separately. See listing in this section of the price book.
- For use with Bridges II or Princeton style legs.
- Surfaces not available in HPW.
- Worksurfaces greater than 48" wide require additional structural support.

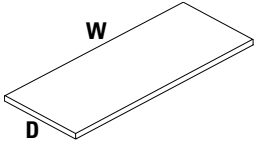
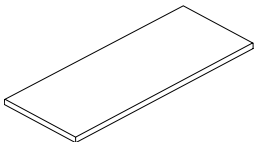
	DESCRIPTION	PRODUCT CODE	LIST PRICE	DIMENSIONS/INCHES	
				D	W
	Straight Worksurface No Scoops - 24" Deep	CWS2424NSC	149	24	24
		CWS2430NSC	160	24	30
		CWS2436NSC	179	24	36
		CWS2442NSC	229	24	42
		CWS2448NSC	277	24	48
		CWS2454NSC	323	24	54
		CWS2460NSC	363	24	60
		CWS2466NSC	379	24	66
		CWS2472NSC	393	24	72
		CWS2478NSC	632	24	78
		CWS2484NSC	639	24	84
		CWS2490NSC	752	24	90
CWS2496NSC	715	24	96		
	Straight Worksurface No Scoops - 30" Deep	CWS3024NSC	175	30	24
		CWS3030NSC	186	30	30
		CWS3036NSC	220	30	36
		CWS3042NSC	309	30	42
		CWS3048NSC	323	30	48
		CWS3054NSC	354	30	54
		CWS3060NSC	379	30	60
		CWS3066NSC	392	30	66
		CWS3072NSC	416	30	72
		CWS3078NSC	786	30	78
		CWS3084NSC	801	30	84

WORKSURFACES

CWSNSCP - RECTANGULAR WORKSURFACE, NO SCOOPS FOR HEIGHT ADJUSTABLE TABLES

- There is no scoop on this work surface.
- Worksurface depth is exact, not nominal.
- Support hardware must be ordered separately. See listing in this section of the price book.
- For use with Height Adjustable Tables
- Surfaces not available in HPW.

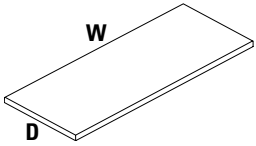
	DESCRIPTION	PRODUCT CODE	LIST PRICE	DIMENSIONS/INCHES		
				H	D	W
	Rectangular Worksurface No Scoops for Height Adjustable Tables	CWS2346NSCP	277	1	23	46
		CWS2352NSCP	323	1	23	52
		CWS2358NSCP	363	1	23	58
		CWS2364NSCP	379	1	23	64
		CWS2370NSCP	393	1	23	70
		CWS2946NSCP	323	1	29	46
		CWS2952NSCP	354	1	29	52
		CWS2958NSCP	379	1	29	58
		CWS2964NSCP	392	1	29	64
		CWS2970NSCP	416	1	29	70

WORKSURFACES

CWSWNSC - WEDGE WORKSURFACE NO SCOOP

- There is no scoop on this worksurface.
- Worksurface depth is exact, not nominal.
- Support hardware must be ordered separately. See listing in this section of the price book.
- For use with Bridges II or Princeton style legs.
- Surfaces not available in HPW.
- Worksurfaces greater than 48" wide require additional structural support.

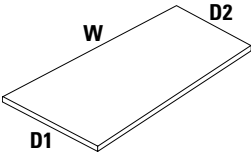
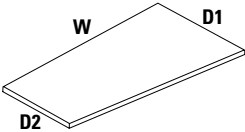
	DESCRIPTION	PRODUCT CODE	LIST PRICE	DIMENSIONS/INCHES		
				D1	D2	W
	Straight Wedge Worksurface No Scoops - Left	CWSW241848NSC	385	24	18	48
		CWSW241854NSC	434	24	18	54
		CWSW241860NSC	478	24	18	36
		CWSW241866NSC	529	24	18	42
		CWSW241872NSC	576	24	18	48
		CWSW302448NSC	478	30	24	60
		CWSW302454NSC	540	30	24	66
		CWSW302460NSC	600	30	24	72
		CWSW302466NSC	659	30	24	78
		CWSW302472NSC	722	30	24	84
	Straight Wedge Worksurface No Scoops - Right	CWSW182448NSC	385	24	18	24
		CWSW182454NSC	434	24	18	30
		CWSW182460NSC	478	24	18	36
		CWSW182466NSC	529	24	18	42
		CWSW182472NSC	576	24	18	48
		CWSW243048NSC	478	30	24	60
		CWSW243054NSC	540	30	24	66
		CWSW243060NSC	600	30	24	72
		CWSW243066NSC	659	30	24	78
		CWSW243072NSC	722	30	24	84

CWSP - RECTANGULAR WORKSURFACES - SPAN A POST

- All tops are thermally fused 1" thick with pilot holes to enable proper alignment with worksurface supports. Wood screws must be used.
- Compile worksurfaces feature a 3mm edge.
- Support hardware must be ordered separately. See the listings in this section.
- Note: Width and depth dimensions listed include a nominal measurement (3/8") to account for wire management between the worksurface and adjoining panel.

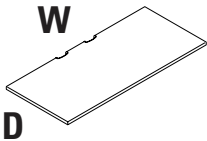
	DESCRIPTION	PRODUCT CODE	LIST PRICE	DIMENSIONS/INCHES		
				D	W	
	Rectangular Worksurfaces - 24" Deep Span a Post	CWSP2426P	179	24	26	
		CWSP2432P	216	24	32	
		CWSP2438P	251	24	38	
		CWSP2444P	283	24	44	
		CWSP2450P	320	24	50	
		CWSP2456P	354	24	56	
		CWSP2462P	468	24	62	
		CWSP2468P	510	24	68	
		CWSP2474P	554	24	74	
		CWSP2480P	595	24	80	
		CWSP2486P	679	24	86	
		Rectangular Worksurfaces - 30" Deep Span a Post	CWSP3026P	224	30	26
			CWSP3032P	268	30	32
			CWSP3038P	317	30	38
CWSP3044P	354		30	44		
CWSP3050P	400		30	50		
CWSP3056P	443		30	56		
CWSP3062P	585		30	62		
CWSP3068P	636		30	68		
CWSP3074P	692		30	74		
CWSP3080P	742		30	80		
CWSP3086P	847	30	86			

WORKSURFACES

CWVR - CURVILINEAR WORKSURFACES - RIGHT

- All tops are thermally fused 1" thick with pilot holes to enable proper alignment with worksurface supports. Wood screws must be used.
- Compile worksurfaces feature a 3mm edge.
- When deepest end equals 24", the opposite depth is 18". When deepest end equals 30", the opposite depth is 24"
- Support hardware must be ordered separately. See the listings in this section.
- Note: Width and depth dimensions listed include a nominal measurement (3/8") to account for wire management between the worksurface and adjoining panel.
- Worksurfaces greater than 48" wide require additional structural support.

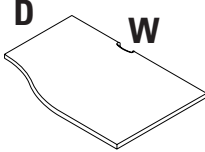
	DESCRIPTION	PRODUCT CODE	LIST PRICE	DIMENSIONS/INCHES		
				D	W	
	Curvilinear Worksurfaces - 24" Deep	CWVR2424P	192	24	24	
		CWVR2430P	198	24	30	
		CWVR2436P	239	24	36	
		CWVR2442P	277	24	42	
		CWVR2448P	316	24	48	
		CWVR2454P	354	24	54	
		CWVR2460P	384	24	60	
		CWVR2466P	424	24	66	
		CWVR2472P	456	24	72	
		CWVR2478P	632	24	78	
		CWVR2484P	639	24	84	
		Curvilinear Worksurfaces - 30" Deep	CWVR3024P	198	30	24
			CWVR3030P	210	30	30
CWVR3036P	248		30	36		
CWVR3042P	340		30	42		
CWVR3048P	354		30	48		
CWVR3054P	392		30	54		
CWVR3060P	424		30	60		
CWVR3066P	456		30	66		
CWVR3072P	485		30	72		
CWVR3078P	786		30	78		
CWVR3084P	801		30	84		

CWVL - CURVILINEAR WORKSURFACES - LEFT

- All tops are thermally fused 1" thick with pilot holes to enable proper alignment with worksurface supports. Wood screws must be used.
- Compile worksurfaces feature a 3mm edge.
- When deepest end equals 24", the opposite depth is 18". When deepest end equals 30", the opposite depth is 24"
- Support hardware must be ordered separately. See the listings in this section.
- Note: Width and depth dimensions listed include a nominal measurement (3/8") to account for wire management between the worksurface and adjoining panel.

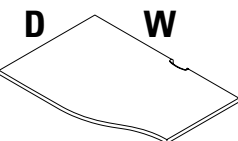
	DESCRIPTION	PRODUCT CODE	LIST PRICE	DIMENSIONS/INCHES		
				D	W	
	Curvilinear Worksurfaces - 24" Deep	CWVL2424P	192	24	24	
		CWVL2430P	198	24	30	
		CWVL2436P	239	24	36	
		CWVL2442P	277	24	42	
		CWVL2448P	316	24	48	
		CWVL2454P	354	24	54	
		CWVL2460P	384	24	60	
		CWVL2466P	424	24	66	
		CWVL2472P	456	24	72	
		CWVL2478P	632	24	78	
		CWVL2484P	639	24	84	
		Curvilinear Worksurfaces - 30" Deep	CWVL3024P	198	30	24
			CWVL3030P	210	30	30
CWVL3036P	248		30	36		
CWVL3042P	340		30	42		
CWVL3048P	354		30	48		
CWVL3054P	392		30	54		
CWVL3060P	424		30	60		
CWVL3066P	456		30	66		
CWVL3072P	485		30	72		
CWVL3078P	786		30	78		
CWVL3084P	801		30	84		



WORKSURFACES

CWCC - CORNER CURVED WORKSURFACES

- All tops are thermally fused 1" thick with pilot holes to enable proper alignment with worksurface supports. Wood screws must be used.
- Compile worksurfaces feature a 3mm edge.
- Support hardware must be ordered separately. See the listings in this section.
- Note: Width and depth dimensions listed include a nominal measurement (3/8") to account for wire management between the worksurface and adjoining panel.
- Note: Wood grain laminates do not run diagonally on corner worksurfaces.
- Worksurfaces greater than 48" wide require additional structural support.

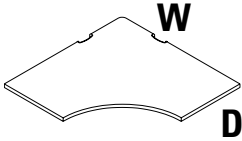
	DESCRIPTION	PRODUCT CODE	LIST PRICE	DIMENSIONS/INCHES	
				D	W
	Corner Curved Worksurfaces - 36"	CWCC3618P	499	18	36
		CWCC3624P	547	24	36
	Corner Curved Worksurfaces - 42"	CWCC4224P	738	24	42
		CWCC4230P	803	30	42
	Corner Curved Worksurfaces - 48"	CWCC4824P	863	24	48
		CWCC4830P	904	30	48

CWCF - FIVE SIDED WORKSURFACES

- All tops are thermally fused 1" thick with pilot holes to enable proper alignment with worksurface supports. Wood screws must be used.
- Compile worksurfaces feature a 3mm edge.
- Support hardware must be ordered separately. See the listings in this section.
- Note: Width and depth dimensions listed include a nominal measurement (3/8") to account for wire management between the worksurface and adjoining panel.
- Note: Wood grain laminates do not run diagonally on corner worksurfaces.

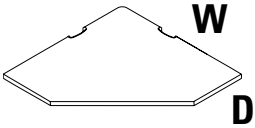
	DESCRIPTION	PRODUCT CODE	LIST PRICE	DIMENSIONS/INCHES	
				D	W
	Five Sided Worksurface - 36"	CWCF3618P	494	18	36
		CWCF3624P	547	24	36
	Five Sided Worksurface - 42"	CWCF4224P	738	24	42
		CWCF4230P	803	30	42
	Five Sided Worksurface - 48"	CWCF4824P	863	24	48
		CWCF4830P	904	30	48

WORKSURFACES

CWC6 - CURVED CORNER WORKSURFACE FOR 60° POST

- All tops are thermally fused 1" thick with pilot holes to enable proper alignment with worksurface supports. Wood screws must be used.
- Compile worksurfaces feature a 3mm edge.
- Support hardware must be ordered separately. See the listings in this section.
- Note: Width and depth dimensions listed include a nominal measurement (3/8") to account for wire management between the worksurface and adjoining panel.
- Note: Wood grain laminates do not run diagonally on corner worksurfaces.
- Worksurfaces greater than 48" wide require additional structural support.

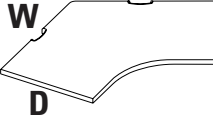
DESCRIPTION	PRODUCT CODE	LIST PRICE TF	DIMENSIONS/INCHES	
			D	W
 Curved Corner Worksurface for 60° Post - 24"	CWC62424P	466	24	24
	CWC62430P	828	24	30
	CWC62436P	929	24	36
	CWC62442P	1420	24	42
	CWC62448P	1549	24	48
Curved Corner Worksurface for 60° Post - 30"	CWC63024P	466	30	24
	CWC63030P	828	30	30
	CWC63036P	929	30	36
	CWC63042P	1420	30	42
	CWC63048P	1549	30	48

CWC6L - EXTENDED CURVED CORNER - LEFT

- There are three cable scoops on this worksurface
- Support hardware must be ordered separately. See listing in this section of the price list
- Note: Wood Grain Laminates do not run diagonally on Extended Curved Corners

DESCRIPTION	PRODUCT CODE	LIST PRICE	DIMENSIONS/INCHES		
			D1	D2	W
 Extended Curved Corner - 36" x 24"	CWC6L362448P	675	36	24	48
	CWC6L362460P	736	36	24	60
	CWC6L362466P	807	36	24	66
	CWC6L362472P	893	36	24	72
	CWC6L362478P	954	36	24	78
	CWC6L362484P	1027	36	24	84
Extended Curved Corner - 42" x 24"	CWC6L422460P	774	42	24	60
	CWC6L422466P	848	42	24	66
	CWC6L422472P	941	42	24	72
	CWC6L422478P	1004	42	24	78
	CWC6L422484P	1083	42	24	84
Extended Curved Corner - 42" x 30"	CWC6L423060P	870	42	30	60
	CWC6L423066P	954	42	30	66
	CWC6L423072P	1044	42	30	72
	CWC6L423078P	1118	42	30	78
	CWC6L423084P	1191	42	30	84
Extended Curved Corner - 48" x 24"	CWC6L482460P	915	48	24	60
	CWC6L482466P	989	48	24	66
	CWC6L482472P	1062	48	24	72
	CWC6L482478P	1169	48	24	78
	CWC6L482484P	1215	48	24	84
Extended Curved Corner - 48" x 30"	CWC6L483060P	969	48	30	60
	CWC6L483066P	1054	48	30	66
	CWC6L483072P	1144	48	30	72
	CWC6L483078P	1231	48	30	78
	CWC6L483084P	1286	48	30	84



WORKSURFACES

CWCER - EXTENDED CURVED CORNER - RIGHT

- There are three cable scoops on this worksurface
- Support hardware must be ordered separately. See listing in this section of the price list
- Note: Wood Grain Laminates do not run diagonally on Extended Curved Corners
- Worksurfaces greater than 48" wide require additional structural support.

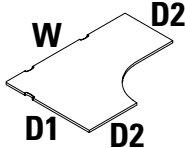
	DESCRIPTION	PRODUCT CODE	LIST PRICE	DIMENSIONS/INCHES		
				D1	D2	W
	Extended Curved Corner - 36" x 24"	CWCER362448P	675	36	24	48
		CWCER362460P	736	36	24	60
		CWCER362466P	807	36	24	66
		CWCER362472P	893	36	24	72
		CWCER362478P	954	36	24	78
		CWCER362484P	1027	36	24	84
	Extended Curved Corner - 42" x 24"	CWCER422460P	774	42	24	60
		CWCER422466P	848	42	24	66
		CWCER422472P	941	42	24	72
		CWCER422478P	1004	42	24	78
		CWCER422484P	1083	42	24	84
	Extended Curved Corner - 42" x 30"	CWCER423060P	870	42	30	60
		CWCER423066P	954	42	30	66
		CWCER423072P	1044	42	30	72
		CWCER423078P	1118	42	30	78
		CWCER423084P	1191	42	30	84
	Extended Curved Corner - 48" x 24"	CWCER482460P	915	48	24	60
		CWCER482466P	989	48	24	66
		CWCER482472P	1062	48	24	72
		CWCER482478P	1169	48	24	78
		CWCER482484P	1215	48	24	84
	Extended Curved Corner - 48" x 30"	CWCER483060P	969	48	30	60
		CWCER483066P	1054	48	30	66
		CWCER483072P	1144	48	30	72
		CWCER483078P	1231	48	30	78
		CWCER483084P	1286	48	30	84

CWD - "D" WORKSURFACE

- Support hardware must be ordered separately. See listing in this section of the price list
- Monoleg is included

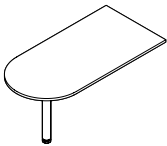
	DESCRIPTION	PRODUCT CODE	LIST PRICE	DIMENSIONS/INCHES	
				D	W
	"D" Worksurface - 24"	CWD2442P	553	24	42
		CWD2448P	568	24	48
		CWD2460P	595	24	60
		CWD2472P	636	24	72
	"D" Worksurface - 30"	CWD3042P	599	30	42
		CWD3048P	606	30	48
		CWD3060P	636	30	60
		CWD3072P	706	30	72

WORKSURFACES

CWH - HATCHET WORKSURFACE (LEFT SHOWN)

- Cable scoop is in the center of the 36" wide edge.
- Support hardware must be ordered separately. See listing in this section of the price list
- Monoleg is included
- Must be specified either left or right handed.
- Note: Wood Grain Laminates do not run diagonally on Hatchet Corners
- Worksurfaces greater than 48" wide require additional structural support.

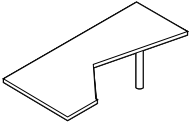
	DESCRIPTION	PRODUCT CODE	LIST PRICE	DIMENSIONS/INCHES		
				D1	D2	W
	Hatchet Worksurface - Left	CWHL3672P	1213	36	30	72
	Hatchet Worksurface - Right	CWHR3672P	1213	36	30	72

Right Shown

CWSW - STRAIGHT WEDGE WORKSURFACES

- Support hardware must be ordered separately. See the listings in this section.
- Must be specified either left or right handed.

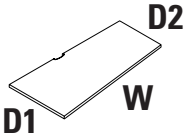
	DESCRIPTION	PRODUCT CODE	LIST PRICE	DIMENSIONS/INCHES		
				D1	D2	W
	Straight Wedge Worksurface - Left	CWSW241848P	385	24	18	48
		CWSW241854P	434	24	18	54
		CWSW241860P	478	24	18	60
		CWSW241866P	529	24	18	66
		CWSW241872P	576	24	18	72
		CWSW302448P	478	30	24	48
	Straight Wedge Worksurface - Right	CWSW302454P	540	30	24	54
		CWSW302460P	600	30	24	60
		CWSW302466P	659	30	24	66
		CWSW302472P	722	30	24	72
		CWSW182448P	385	18	24	48
		CWSW182454P	434	18	24	54
		CWSW182460P	478	18	24	60
		CWSW182466P	529	18	24	66
CWSW182472P	576	18	24	72		
Straight Wedge Worksurface - Right	CWSW243048P	478	24	30	48	
	CWSW243054P	540	24	30	54	
	CWSW243060P	600	24	30	60	
	CWSW243066P	659	24	30	66	
	CWSW243072P	722	24	30	72	

CWQR - QUARTER ROUND PANEL WORKSURFACE

- The worksurface edge running along the panel is a slightly different length than that of the worksurface end, causing the surface to be handed.
- Left hand surface shown.
- Support hardware must be ordered separately. See the listings in this section.

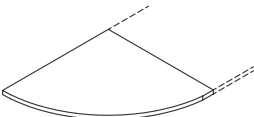
	DESCRIPTION	PRODUCT CODE	LIST PRICE	DIMENSIONS/INCHES	
				D	W
	Quarter Round Panel Worksurface - Left	CWQRL2424	229	24	24
		CWQRL3030	303	30	30
	Quarter Round Panel Worksurface - Right	CWQRR2424	229	24	24
		CWQRR3030	303	30	30



WORKSURFACES

CWQRC - QUARTER ROUND PANEL CORNER WORKSURFACE

- Wraps around a 90° corner post.
- Support hardware must be ordered separately. See the listing in this section.
- Worksurfaces greater than 48" wide require additional structural support.

DESCRIPTION	PRODUCT CODE	LIST PRICE	DIMENSIONS/INCHES	
			D	W
Quarter Round Panel Corner Worksurface	CWQRC2424	275	24	24
	CWQRC3030	339	30	30

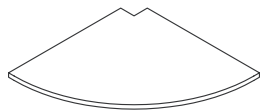

CWT - STRAIGHT TRANSACTION WORKSURFACE

- Support hardware must be ordered separately. See the listings in this section.
- Compile worksurfaces feature a 3mm edge.

DESCRIPTION	PRODUCT CODE	LIST PRICE	DIMENSIONS/INCHES	
			D	W
Straight Transaction Worksurface	CWT1512	69	15	12
	CWT1518	91	15	18
	CWT1524	109	15	24
	CWT1530	130	15	30
	CWT1536	148	15	36
	CWT1542	165	15	42
	CWT1548	188	15	48
	CWT1554	205	15	54
	CWT1560	227	15	60
	CWT1566	243	15	66
	CWT1572	265	15	72
	CWT1578	283	15	78
	CWT1584	302	15	84

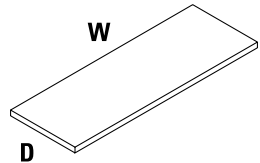

CWTE - END TRANSACTION SURFACE

- Support hardware must be ordered separately. See the listings in this section.
- Extends 1.5" past end of run.
- Compile worksurfaces feature a 3mm edge.

DESCRIPTION	PRODUCT CODE	LIST PRICE	DIMENSIONS/INCHES	
			D	W
End Transaction Surface	CWTE1512	91	15	14
	CWTE1518	109	15	20
	CWTE1524	130	15	26
	CWTE1530	148	15	32
	CWTE1536	165	15	38
	CWTE1542	188	15	44
	CWTE1548	205	15	50
	CWTE1554	227	15	56
	CWTE1560	243	15	62
	CWTE1566	265	15	68
	CWTE1572	283	15	74

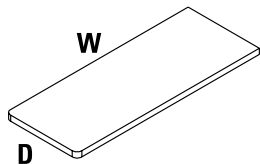

WORKSURFACES

CWTCL - "L" CORNER TRANSACTION SURFACE

- Support hardware must be ordered separately. See the listings in this section.
- When specifying this item along with a straight surface, deduct 12" from each return side.
- Worksurfaces greater than 48" wide require additional structural support.

DESCRIPTION	PRODUCT CODE	LIST PRICE	DIMENSIONS/INCHES	
			D	W
"L" Corner Transaction Surface	CWTCL90	193	15	21

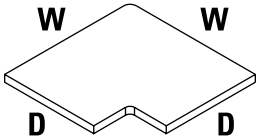

CW9T - CORNER TRANSACTION SURFACE FOR 90° POST

- Support hardware must be ordered separately. See the listing in this section.

DESCRIPTION	PRODUCT CODE	LIST PRICE	DIMENSIONS/INCHES	
			D	W
Corner Transaction Surface for 90° Post	CW9T1524	263	15	32.861
	CW9T1530	313	15	38.861
	CW9T1536	362	15	44.861
	CW9T1542	410	15	50.861
	CW9T1548	465	15	56.861

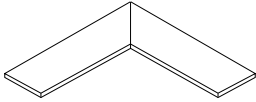

CHCB2 - CORNER BRACKET

- Attaches the corner of any worksurface to a panel connector.
- Priced and shipped in pairs.
- Available in standard paint colors.
- Cannot be used off modular.
- Can be used when a panel is the same depth as the worksurface in the front and back application.

DESCRIPTION	PRODUCT CODE	LIST PRICE	DIMENSIONS/INCHES	
			D	W
Corner Bracket	CHCB2	24	2.5	

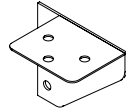

CHWB1 - MID SPAN SUPPORT BRACKET

- Does not need to be on module.
- Used when a panel exceeds the depth of the adjacent worksurface.
- Can only be used with a Segmented Panel.
- Comes in unfinished zinc.

DESCRIPTION	PRODUCT CODE	LIST PRICE	DIMENSIONS/INCHES	
			D	W
Mid Span Support Bracket	CHWB1	15		

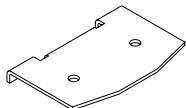

WORKSURFACES

CHC15 & CHC22- CANTILEVER

- Attaches a worksurface to a panel.
- Use one cantilever to support two convergent worksurfaces when specified with 3 Flat Brackets or two cantilevers with one flat bracket to support two convergent worksurfaces.
- Does not include Flat Brackets.
- Priced individually
- Specify handedness of each cantilever
- Available in standard paint colors.
- Right and left Cantilever needs to be specified unless flat brackets are also specified.

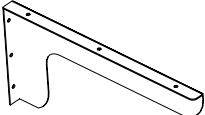
	DESCRIPTION	PRODUCT CODE	LIST PRICE	DIMENSIONS/INCHES	
				D	W
	Cantilever - 15"	CHC15L	54	15	6
		CHC15R	54	15	6
	Cantilever - 22"	CHC22L	83	22	6
		CHC22R	83	22	6

CMHC - WORKSURFACE SUPPORT CHANNEL

- Support channel attaches to underside of worksurface with screws
- Support channel should be 14" shorter than top length.
- Screws are included.
- Only available in Black.
- Tops with post legs should be specified with support channel for structural reinforcement.

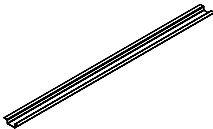
	DESCRIPTION	PRODUCT CODE	LIST PRICE	DIMENSIONS/INCHES	
				L	D
	Worksurface Support Channel	CMHC40 - for 54" wide table	90	40	5
		CMHC46 - for 60" wide table	98	46	5
		CMHC52 - for 66" wide table	109	52	5
		CMHC58 - for 72" wide table	122	58	5
		CMHC64 - for 78" wide table	133	64	5
		CMHC70 - for 84" wide table	148	70	5

CHFB1 - FLAT BRACKET

- Use in conjunction with Cantilever to make it a shared Cantilever to support convergent worksurfaces.
- Used at the front of 2 convergent worksurfaces to keep worksurfaces flush at seams.
- Available in Black only.

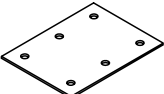
	DESCRIPTION	PRODUCT CODE	LIST PRICE	DIMENSIONS/INCHES	
				D	W
	Flat Bracket	CHFB1	23	3	4

CHTB2 - TRANSACTION TOP BRACKETS

- Securely attaches a transaction surface to the top of a panel.
- One pair must be on each side of transaction surface.
- Priced and shipped in pairs.
- Available in Anodized Aluminum only.

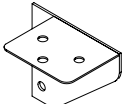
	DESCRIPTION	PRODUCT CODE	LIST PRICE	DIMENSIONS/INCHES	
				D	W
	Flat Bracket	CHTB2	24	2.5	

WORKSURFACES

CHEP - END PANEL

- Supports the worksurface and enhances the stability of connected panels.
- Provides solid support at the end of a run of worksurfaces.
- Finished in thermally-fused laminate.
- Includes flat brackets and hardware.
- End panel height is inclusive of panel glides extended to their fullest height.
- If wood grains is selected, grain runs vertically.

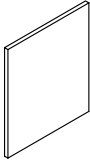
	DESCRIPTION	PRODUCT CODE	LIST PRICE	DIMENSIONS/INCHES	
				D	W
	End Panel - 28"High	CHEP2924	283	28	24
		CHEP2930	333	28	30

CHMSL - MID SUPPORT LEG

- Provides support for a worksurface.
- Includes leveling glide, PVC Sleeve and 4.8" x 4.8" attachment plate.
- 1.5" diameter.
- Available in standard paint colors.

	DESCRIPTION	PRODUCT CODE	LIST PRICE	DIMENSIONS/INCHES
				H
	Mid Support Leg - Round	CHMSL1	98	28
	Mid Support Leg - Square	CHMSL2	98	28

CMHCL & CHHCL - CORNER LEG WITH LEVELER

- Provides support for a worksurface.
- Includes leveling glide, PVC Sleeve and attachment plate.
- 1.5" diameter
- Available in standard paint colors.
- Legs can be used in the corner of a single worksurface or be rotated 45 degrees to support the corners of two worksurfaces.

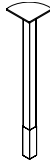
	DESCRIPTION	PRODUCT CODE	LIST PRICE	DIMENSIONS/INCHES
				H
 	Corner Leg Round	CMHCL1	136	28
	Corner Leg Square	CMHCL2	136	28

CHWS - 5" SURFACE TO STORAGE SUPPORT LEG

- Provides support for a worksurface.
- Includes leveling glide, PVC Sleeve and 4.8" x 4.8" attachment plate.
- 1.5" diameter.
- Available in standard paint colors.

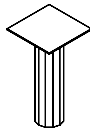
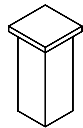
	DESCRIPTION	PRODUCT CODE	LIST PRICE	DIMENSIONS/INCHES
				H
 	5" Surface to Storage Support Leg - Round	CHWSRL01	64	4.5
	5" Surface to Storage Support Leg - Square	CHWSSL01	64	4.5

Round Square



WORKSURFACES

CHMEGR - METAL END GABLE ROUND LEG, NON-HANDED

- Supports the worksurface and enhances the stability of connected panels.
- Includes a levelling glide and decorative PVC sleeve to cover the glide.
- Attaches to Compile panel connectors. The mounting bracket is universal and attaches with screws to the back of the leg.
- Available in standard paint colors.
- NOTE: Cannot be used to support worksurfaces side by side. Please use EVHMSRL12 for supporting adjoining worksurfaces.

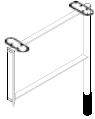
	DESCRIPTION	PRODUCT CODE	LIST PRICE	DIMENSIONS/INCHES		
				H	D	W
	Metal End Gable Round Leg	CHMEGR24	329	29	2	23
	Non-handed	CHMEGR30	345	29	2	29

CHMSRL - METAL MID SUPPORT ROUND LEG

- Supports two adjoining worksurface and enhances the stability of connected panels.
- Includes a levelling glide and decorative PVC sleeve to cover the glide.
- Attaches to Compile panels.
- Available in standard paint colors.

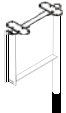
	DESCRIPTION	PRODUCT CODE	LIST PRICE	DIMENSIONS/INCHES		
				H	D	W
	Metal Mid Support Round Leg	CHMSRL12	279	29	2	11

CHMEGS - METAL END GABLE SQUARE LEG, NON-HANDED

- Supports the worksurface and enhances the stability of connected panels.
- Includes a levelling glide and decorative PVC sleeve to cover the glide.
- Attaches to Compile panel connectors. The mounting bracket is universal and attaches with screws to the back of the leg.
- Available in standard paint colors.
- NOTE: Cannot be used to support worksurfaces side by side. Please use EVHMSRL12 for supporting adjoining worksurfaces.

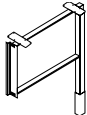
	DESCRIPTION	PRODUCT CODE	LIST PRICE	DIMENSIONS/INCHES		
				H	D	W
	Metal End Gable Square Leg	CHMEGS24	317	29	2	23
	Non-handed	CHMEGS30	352	29	2	29

CHMSSL - METAL MID SUPPORT SQUARE LEG

- Supports two adjoining worksurface and enhances the stability of connected panels.
- Includes a levelling glide and decorative PVC sleeve to cover the glide.
- Attaches to Compile panels.
- Available in standard paint colors.

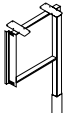
	DESCRIPTION	PRODUCT CODE	LIST PRICE	DIMENSIONS/INCHES		
				H	D	W
	Metal End Gable Square Leg	CHMSSL12	286	29	2	11

WORKSURFACES

PEDESTAL FILLER BRACKET

- Screws to back of pedestal
- Fills the gap between the pedestal and panel when wing pnael is not used.

DESCRIPTION	PRODUCT CODE	LIST PRICE	DIMENSIONS/INCHES		
			D	W	

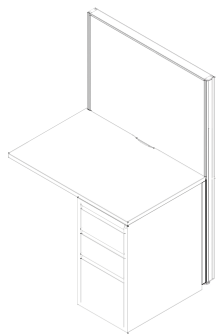

Pedestal Filler Bracket-	CHPBF	65	26.875	1.375	
--------------------------	-------	----	--------	-------	--

CHPEDB - FLUSH PEDESTAL BRACKET

- Attaches metal or laminate storage or desking, to Compile panels for additional panel support
- Used in flush mount applications only
- Use CHPBF Pedestal Filler Bracket with CS19xx Pedestals and standard depth worksurfaces

DESCRIPTION	PRODUCT CODE	LIST PRICE	DIMENSIONS/INCHES		
			H	W	D



Flush Pedestal Bracket	CHPEDB	32	8	1	1
------------------------	--------	----	---	---	---



storage

LATERAL FILE FEATURES

DRAWERS/SHELVES

- Drawer interlocking system
- Three-stage, anti-bounceback suspension
- Pre-installed, side-to-side file bars for letter, legal and A4
- Front-to-back file bars – optional
- Full-height dividers – optional
- Angled full pull

CONSTRUCTION

- Top stiffener bar
- Corner gussets
- Four (4) ganging drill points are marked to ensure correct positioning
- Cam lock included
- Leveling glides
- Counterweights are included in 2, 3 and 4 drawer cabinets. BIFMA does not require counterweight in 5 drawer cabinets.

PEDESTAL FEATURES

DRAWERS/SHELVES

- All drawer fronts feature a recessed, angled full pull.
- Drawers feature ball bearing suspension.

CONSTRUCTION

- Central Core removable cam locks.
- Pedestals are 15" wide.
- Counterweight is standard on all Freestanding models.
- Worksurfaces supporting models have holes drilled in top to attach underneath a worksurface.

STANDARD PAINT COLORS

BLACK	BLK
DESIGNER WHITE	DWT
NEVADA	NEV
STEEL	STL

TEXTURED PAINT COLORS

Only available on Compile Storage.

BLIZZARD	BZD
STONE DUST	SDT

GENERAL WARRANTY INFORMATION

- Evolve warrants all components of metal storage and filing for the lifetime of the product to the original purchaser.



This page provides a three dimensional view of a sample configuration highlighting each storage component required when specifying this configuration.

Components

- A. CSOF13XX KD Overhead
- B. CSSL13XX Low-Profile Shelf
- C. CM19XXBBF Worksurface Supporting Box, Box, File Pedestal

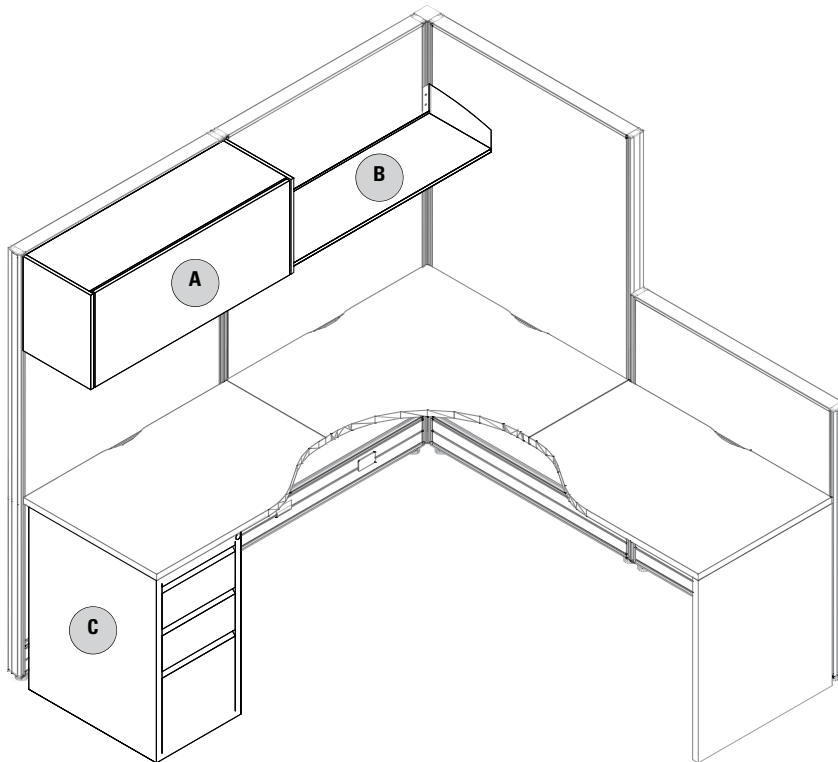

STORAGE

CS19XXBBF - WORKSURFACE SUPPORTING BOX/BOX/FILE 15" PEDESTAL

- Worksurface supporting, with predrilled holes in the top.
- Also available as freestanding with finished top.
- All drawer fronts feature a recessed, angled full pull.
- Pedestal height shown includes glide.
- Pencil tray and Lock included.
- File Bars are not included with Compile pedestals. To order file bars, use product code CSPEDHFB at \$32.00 each list.

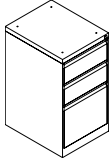
	DESCRIPTION	PRODUCT CODE	LIST PRICE	DIMENSIONS/INCHES		
				H	D	W
	Worksurface Supporting Box/Box/File 15" Pedestal	CS1919BBF	588	27 5/8	18 5/8	15
		CS1923BBF	605	27 5/8	22 5/8	15
		CS1929BBF	686	27 5/8	29 5/8	15

CS19XXFF - WORKSURFACE SUPPORTING FILE/FILE 15" PEDESTAL

- Worksurface supporting, with predrilled holes in the top.
- Also available as freestanding with finished top.
- All drawer fronts feature a recessed, angled full pull.
- Pedestal height shown includes glide.
- Lock included.
- File Bars are not included with Compile pedestals. To order file bars, use product code CSPEDHFB at \$32.00 each list.

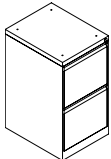
	DESCRIPTION	PRODUCT CODE	LIST PRICE	DIMENSIONS/INCHES		
				H	D	W
	Worksurface Supporting File/File 15" Pedestal	CS1919FF	588	27 5/8	18 5/8	15
		CS1923FF	605	27 5/8	22 5/8	15
		CS1929FF	686	27 5/8	29 5/8	15

CS19FXBBF - FREESTANDING BOX/BOX/FILE 15" PEDESTAL

- All drawer fronts feature a recessed, angled full pull.
- Pedestal height shown includes glide.
- Finished top.
- Counterweight, Pencil tray and Lock included.
- File Bars are not included with Compile pedestals. To order file bars, use product code CSPEDHFB at \$32.00 each list.

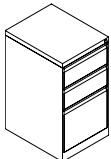
	DESCRIPTION	PRODUCT CODE	LIST PRICE	DIMENSIONS/INCHES		
				H	D	W
	Freestanding Box/Box/File 15" Pedestal	CS19F19BBF	605	27 5/8	18 5/8	15
		CS19F23BBF	623	27 5/8	22 5/8	15
		CS19F29BBF	701	27 5/8	29 5/8	15

CS19FXFF - FREESTANDING FILE/FILE 15" PEDESTAL

- All drawer fronts feature a recessed, angled full pull.
- Pedestal height shown includes glide.
- Finished top.
- Counterweight and Lock included.
- File Bars are not included with Compile pedestals. To order file bars, use product code CSPEDHFB at \$32.00 each list.

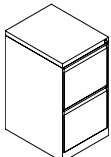
	DESCRIPTION	PRODUCT CODE	LIST PRICE	DIMENSIONS/INCHES		
				H	D	W
	Freestanding File/File 15" Pedestal	CS19F19FF	605	27 5/8	18 5/8	15
		CS19F23FF	623	27 5/8	22 5/8	15
		CS19F29FF	701	27 5/8	29 5/8	15



STORAGE

CS19MPXXBBF - MOBILE BOX/BOX/FILE PEDESTAL

- All drawer fronts feature a recessed, angled full pull.
- Pedestal height shown includes glide.
- Finished top.
- Counterweight, Pencil tray, and Lock included.
- File Bars are not included with Compile pedestals. To order file bars, use product code CSPEDHFB at \$32.00 each list.

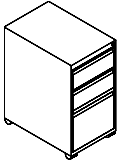
	DESCRIPTION	PRODUCT CODE	LIST PRICE	DIMENSIONS/INCHES		
				H	D	W
	Mobile Box/Box/File Pedestal	CS19MP19BBF	801	27 7/8	18 5/8	15
		CS19MP23BBF	843	27 7/8	22 5/8	15

CS19MPXXFF - MOBILE FILE/FILE PEDESTAL

- All drawer fronts feature a recessed, angled full pull.
- Pedestal height shown includes glide.
- Finished top.
- Counterweight and Lock included.
- File Bars are not included with Compile pedestals. To order file bars, use product code CSPEDHFB at \$32.00 each list.

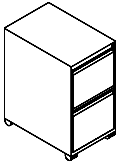
	DESCRIPTION	PRODUCT CODE	LIST PRICE	DIMENSIONS/INCHES		
				H	D	W
	Mobile File/File Pedestal	CS19MP19FF	801	27 7/8	18 5/8	15
		CS19MP23FF	843	27 7/8	22 5/8	15

CSMCPXXBFNC - MOBILE BOX/FILE PEDESTAL WITH 60MM CASTERS

- Mobile pedestal that includes one pencil tray.
- Includes factory installed counterweight.
- Lock is standard.
- 60mm high castors.
- For use with pedestal seat cushion. See model below.
- Casters do not lock.
- File Bars are not included with Compile pedestals. To order file bars, use product code CSPEDHFB at \$32.00 each list.

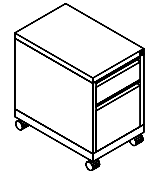
	DESCRIPTION	PRODUCT CODE	LIST PRICE	DIMENSIONS/INCHES		
				H	D	W
	Mobile Box/File Pedestal with 60mm Castors	CSMCP19BFNC	870	23.7/8	18.5/8	15
		CSMCP23BFNC	888	23.7/8	22.5/8	15

STORAGE

CSCUSH15 - PEDESTAL SEAT CUSHIONS

- Cushions will have single stitching at the seams.
- Velcro included for quick attachment to pedestal file.
- 1" Cushion will have a rectilinear design on all sides.
- 2" Cushion will have waterfall edges Front and Back,
- Cushions are for use on CSMCPXXBFNC Mobile Pedestals.
- Please choose a fabric from the standard cushion textiles on pages 94-96

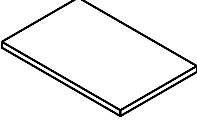
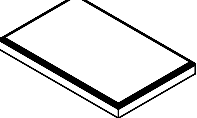
	DESCRIPTION	PRODUCT CODE	LIST PRICE/GRADES														DIM./INCH			YRDS			
			1	2	3	4	5	6	7	8	9	10	11	12	13	14	15	16	17		H	D	W
	Pedestal Seat	CSCUSH15X18-5/8X1	220	256	283	319	374	397	445	524	583	650	785	932	1037	1180	1367	1633	1901	1	18.625	15	1
	Cushions - 1" Thick	CSCUSH15X22-5/8X1	246	282	309	345	400	423	471	550	609	676	811	958	1060	1202	1389	1655	1924	1	22.625	15	1
	Pedestal Seat	CSCUSH15X18-5/8X2	243	278	303	341	397	420	468	545	605	671	805	955	1334	1523	1777	2131	2490	2	18.625	15	2
	Cushions - 2" Thick	CSCUSH15X22-5/8X2	273	309	340	389	456	489	552	651	726	812	988	1174	1361	1551	1802	2158	2514	2	22.625	15	2

CSSL13 - LOW PROFILE SHELF

- 13" deep panel-mounted storage shelf with backlip.
- Mounting brackets are included.

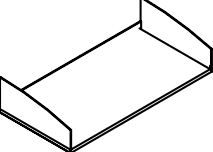
	DESCRIPTION	PRODUCT CODE	LIST PRICE	DIMENSIONS/INCHES		
				H	D	W
	Low Profile Shelf - 13"	CSSL1324	146	5	13	24
		CSSL1330	161	5	13	30
		CSSL1336	175	5	13	36
		CSSL1342	188	5	13	42
		CSSL1348	197	5	13	48
		CSSL1354	206	5	13	54
		CSSL1360	212	5	13	60

CSOF13 - KD OVERHEAD

- Mounting brackets are included.
- Door retracts up and over the cabinet.
- Ready for quick assembly on site.
- Quality steel construction.
- 60" unit is reinforced for proper weight distribution.
- Inside dimensions: 12" h x 12.75" d

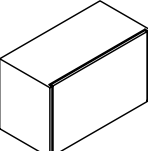
	DESCRIPTION	PRODUCT CODE	LIST PRICE	DIMENSIONS/INCHES		
				H	D	W
	KD Overhead - 13"	CSOF1324	382	14.5	13	24
		CSOF1330	420	14.5	13	30
		CSOF1336	463	14.5	13	36
		CSOF1342	489	14.5	13	42
		CSOF1348	517	14.5	13	48
		CSOF1354	586	14.5	13	54
		CSOF1360	633	14.5	13	60

CMSLK13 - LOCK FOR KD OVERHEAD

- Must be specified separately.

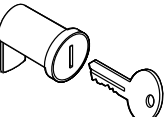
	DESCRIPTION	PRODUCT CODE	LIST PRICE	DIMENSIONS/INCHES		
				H	D	W
	Lock for KD Overhead	CMSLK13	48			



STORAGE

CSLOCKKEY - CORE AND KEY

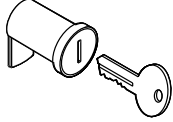
	DESCRIPTION	PRODUCT CODE	LIST PRICE	DIMENSIONS/INCHES		
				H	D	W
	LOCKKEY - Core and Key	CSLOCKKEY	45			

CMEK93 - EXTRA KEY

- Must be specified at time of order.

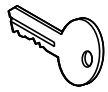
	DESCRIPTION	PRODUCT CODE	LIST PRICE	DIMENSIONS/INCHES		
				H	D	W
	Extra Key	CMEK93	21			

CMDAOHXX - CENTER MOUNT OVERHEAD

- Inside dimensions 13" high x 13" deep.
- Laminate Overhead. No doors.
- Available in standard Compile laminate finishes.
- Top mount on panels.
- Overhead Support Brackets are included.

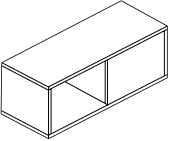
	DESCRIPTION	PRODUCT CODE	LIST PRICE	DIMENSIONS/INCHES		
				H	D	W
	Center Mount Overhead - 13"	CMDAOH36	1200	15	13	36
		CMDAOH42	1302	15	13	42
		CMDAOH48	1363	15	13	48
		CMDAOH54	1465	15	13	54
		CMDAOH60	1523	15	13	60

CMADAXPM - ADA COMPLIANT OVERHEAD STORAGE UNIT

- Panel Mounted Overhead Storage with metal sides and opaque door that retracts on top of the unit
- Meets CSA B651 Barrier Free Design & ADA (American Disabilities Act).
- 16" high units accept standard and A4 binders.
- All shelves are reinforced for proper weight distribution.
- Inside dimensions: 14.25" high x 12" deep.
- Unit includes attachment hardware, lock and mounting brackets. Back not included.
- Shipped partially assembled.
- Available in standard Compile paint colors only. Door made of opaque plastic. **add 10% upcharge for Fog.

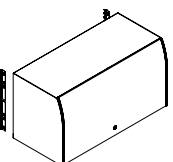
	DESCRIPTION	PRODUCT CODE	LIST PRICE	DIMENSIONS/INCHES		
				H	D	W
	ADA Compliant Overhead Storage Unit	CMADA30PM	1219	16	14.2	30
		CMADA36PM	1317	16	14.2	36
		CMADA42PM	1406	16	14.2	42
		CMADA48PM	1502	16	14.2	48
		CMADA54PM	1595	16	14.2	54
		CMADA60PM	1523	16	14.2	60

STORAGE

CWMA - VERTICAL CHANNEL

- Used to attach system components to fixed wall.
- Panel frame finish.
- Comes in 60" length only.
- Care should be taken to mount adapters only to wall studs using correct fasteners.
- Does not include mounting hardware. Mounting hardware selection to be based on wall material.
- Failure to do this may result in collapse of the unit and subsequent possible personal injury.
- Compile vertical channels cannot be shared.

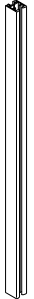
	DESCRIPTION	PRODUCT CODE	LIST PRICE	DIMENSIONS/INCHES		
				H	W	D
	Vertical Channel Sold in pairs	CWMA60	42	60	0.6	0.7

CS19XX-1X1FH - ONE 1/2 HEIGHT FIXED FRONT & ONE 12" FIXED FRONT LATERAL FILE

- 1/2 Height Box Drawer.
- 1 Fixed Drawer Front.
- Includes Lock.
- Lateral File Top is required when not installed under a worksurface.
- Counterweights must be specified on lateral files with pull out drawers, unless worksurface supporting, ganged together or anchored to the floor or wall.

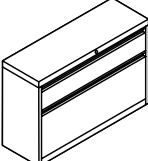
	DESCRIPTION	PRODUCT CODE	LIST PRICE	DIMENSIONS/INCHES		
				H	D	W
	One 1/2 Height Fixed Front &	CS1930P-1X1FH	1328	21.1875	19.25	30
	One 12" Fixed Front Lateral File	CS1936P-1X1FH	1418	21.1875	19.25	36
		CS1942P-1X1FH	1506	21.1875	19.25	42

CS19XX-1XSND - ONE 1/2 HEIGHT OPEN SHELF & ONE 12" OPEN SHELF LATERAL CABINET

- 1/2 Height Open Shelf.
- Bottom Open Shelf.

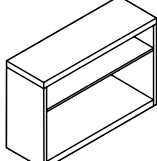
	DESCRIPTION	PRODUCT CODE	LIST PRICE	DIMENSIONS/INCHES		
				H	D	W
	One 1/2 Height Open Shelf &	CS1930-1XSND	666	21.1875	19.25	30
	One 12" Open Shelf Lateral Cabinet	CS1936-1XSND	757	21.1875	19.25	36
		CS1942-1XSND	843	21.1875	19.25	42



STORAGE

CSCUSH19 - LATERAL SEAT CUSHIONS

- Cushions will have single stitching at the seams,
- Velcro included for quick attachment to lateral file.
- 1" Cushion will have a rectilinear design on all sides.
- 2" Cushion will have waterfall edges Front and Back.
- Please choose a fabric from the standard cushion textiles on pages 244-246.

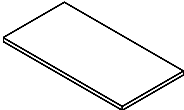
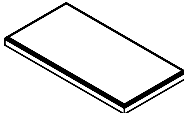
	DESCRIPTION	PRODUCT CODE	LIST PRICE/GRADES														DIM./INCH			YRDS			
			1	2	3	4	5	6	7	8	9	10	11	12	13	14	15	16	17		H	D	W
	Lateral Seat	CSCUSH19-25X30X1	401	446	481	530	605	638	705	809	889	979	1163	1358	1518	1710	1951	2306	2661	1	19	30	1
	Cushions - 1" Thick	CSCUSH19-25X36X1	416	461	496	547	620	653	720	824	904	994	1178	1372	1529	1720	1962	2317	2675	1	19	36	1
		CSCUSH19-25X42X1	431	475	511	560	634	667	733	836	917	1008	1191	1387	1466	1657	1902	2257	2613	1	19	42	1
	Lateral Seat	CSCUSH19-25X30X2	445	490	525	574	649	682	747	850	931	1022	1205	1401	1478	1669	1914	2268	2626	2	19	30	2
	Cushions - 2" Thick	CSCUSH19-25X36X2	456	501	536	585	659	693	758	861	942	1033	1216	1412	1489	1678	1924	2277	2634	2	19	36	2
		CSCUSH19-25X42X2	473	518	553	604	677	710	775	881	959	1050	1233	1429	1500	1691	1933	2290	2645	2	18	42	2

CWFT - LATERAL FILE TOPS

- Available in standard Compile finishes.

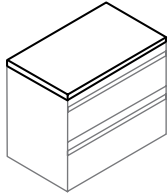
	DESCRIPTION	PRODUCT CODE	LIST PRICE	DIMENSIONS/INCHES		
			LP	H	D	W
	Lateral File Tops	CWFT1930	175	1	19.25	30
		CWFT1936	179	1	19.25	36
		CWFT1942	229	1	19.25	42
	2 Lateral Files SBS Top	CWFT1960	363	1	19.25	60
		CWFT1972	393	1	19.25	72
		CWFT1984	639	1	19.25	84
	4 Lateral File BTB Top	CWFT3860	721	1	38.75	60
		CWFT3872	819	1	38.75	72
		CWFT3884	971	1	38.75	84

CS19XXP - 2F12 - LATERAL FILES - 2 DRAWERS WITH COUNTERWEIGHT

- Counterweight is standard. Two fixed front drawers.
- Side-to-side hanging file bars included.
- Drawers are 12.25" high.
- File cannot be used to store standard three ring binders.
- Lock included.

	DESCRIPTION	PRODUCT CODE	LIST PRICE	DIMENSIONS/INCHES		
				H	D	W
	Lateral Files - 2 Drawers with Counterweight	CS1930P-2F12	1054	27.14	19.25	30
		CS1936P-2F12	1136	27.14	19.25	36
		CS1942P-2F12	1181	27.14	19.25	42

STORAGE

CS19XXP - 3F12 - LATERAL FILES - 3 DRAWERS WITH COUNTERWEIGHT

- Counterweight is standard. Three fixed front drawers.
- Side-to-side hanging file bars included.
- Drawers are 12.25" high.
- File cannot be used to store standard three ring binders.
- Lock included.

	DESCRIPTION	PRODUCT CODE	LIST PRICE	DIMENSIONS/INCHES		
				H	D	W
	Lateral Files - 3 Drawers with Counterweight	CS1930P-3F12	1312	39.52	19.25	30
		CS1936P-3F12	1383	39.52	19.25	36
		CS1942P-3F12	1444	39.52	19.25	42

CS19XXP - 4F12 - LATERAL FILES - 4 DRAWERS WITH COUNTERWEIGHT

- Counterweight is standard. Four fixed front drawers.
- Side-to-side hanging file bars included.
- Drawers are 12.25" high.
- File cannot be used to store standard three ring binders.
- Posting shelf option NOT available.
- Lock included.

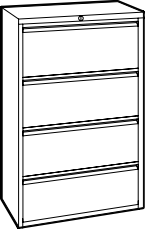
	DESCRIPTION	PRODUCT CODE	LIST PRICE	DIMENSIONS/INCHES		
				H	D	W
	Lateral Files - 4 Drawers with Counterweight	CS1930P-4F12	1675	51.89	19.25	30
		CS1936P-4F12	1754	51.89	19.25	36
		CS1942P-4F12	1888	51.89	19.25	42

CS19XXP - 5F12 - LATERAL FILES - 5 DRAWERS

- Four fixed front drawers plus top drawer with receding door and roll-out shelf.
- Side-to-side hanging file bars included.
- Drawers are 12.25" high.
- File cannot be used to store standard three ring binders.
- Posting shelf option NOT available.
- Lock included.

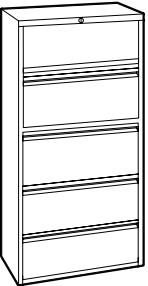
	DESCRIPTION	PRODUCT CODE	LIST PRICE	DIMENSIONS/INCHES		
				H	D	W
	Lateral Files - 5 Drawers	CS1930P-5F12	1994	66.39	19.25	30
		CS1936P-5F12	2082	66.39	19.25	36
		CS1942P-5F12	2196	66.39	19.25	42



STORAGE

CSPT - STORAGE TOWERS

- Model CSPT3-2BFL has wardrobe section on the left and drawers on the right. compartment, 2 box drawers and 1 file drawer. Locker compartment has one fixed shelf.
- Model CSPT3-2BFR has wardrobe section on the right and drawers on the left.
- Includes ventilated 24"D wardrobe section (ventilated on bottom of cabinet), locker • Locking.

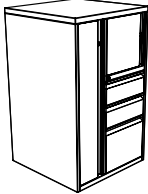
	DESCRIPTION	PRODUCT CODE	LIST PRICE	DIMENSIONS/INCHES		
				H	D	W
	Storage Tower - 2 Box/1 File Drawer	CSPT3-2BFL	2969	39.52	24	24
		CSPT3-2BFR	2969	39.52	24	24

CSPT - STORAGE TOWERS

- Model CSPT3-2FL has wardrobe section on the left and drawers on the right. compartment, 2 box drawers and 1 file drawer. Locker compartment has one fixed shelf.
- Model CSPT3-2FR has wardrobe section on the right and drawers on the left.
- Includes ventilated 24"D wardrobe section (ventilated on bottom of cabinet), locker • Locking.

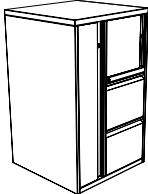
	DESCRIPTION	PRODUCT CODE	LIST PRICE	DIMENSIONS/INCHES		
				H	D	W
	Storage Tower - 2 File Drawers	CSPT3-2FL	2969	39.52	24	24
		CSPT3-2FR	2969	39.52	24	24

CSPT - STORAGE TOWERS

- Model CSPT4-2BFL has wardrobe section on the left and drawers on the right. compartment, 2 box drawers and 1 file drawer. Locker compartment has one fixed shelf.
- Model CSPT4-2BFR has wardrobe section on the right and drawers on the left.
- Includes ventilated 24"D wardrobe section (ventilated on bottom of cabinet), locker • Locking.

	DESCRIPTION	PRODUCT CODE	LIST PRICE	DIMENSIONS/INCHES		
				H	D	W
	Storage Tower - 2 Box/1 File Drawer	CSPT4-2BFL	2985	51.89	24	24
		CSPT4-2BFR	2985	51.89	24	24

STORAGE

CSPT - STORAGE TOWERS

- Model CSPT4-2FL has wardrobe section on the left and drawers on the right. compartment, 2 box drawers and 1 file drawer. Locker compartment has one fixed shelf.
- Model CSPT4-2FR has wardrobe section on the right and drawers on the left.
- Includes ventilated 24"D wardrobe section (ventilated on bottom of cabinet), locker • Locking.

DESCRIPTION	PRODUCT CODE	LIST PRICE	DIMENSIONS/INCHES		
			H	D	W
Storage Tower - 2 File Drawers	CSPT4-2FL	2985	51.89	24	24
	CSPT4-2FR	2985	51.89	24	24

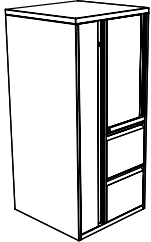

CSPT - STORAGE TOWERS

- Model CSPT5-2BFL has wardrobe section on the left and drawers on the right. compartment, 2 box drawers and 1 file drawer. Locker compartment has one fixed shelf.
- Model CSPT5-2BFR has wardrobe section on the right and drawers on the left.
- Includes ventilated 24"D wardrobe section (ventilated on bottom of cabinet), locker • Locking.

DESCRIPTION	PRODUCT CODE	LIST PRICE	DIMENSIONS/INCHES		
			H	D	W
Storage Tower - 2 Box/1 File Drawe	CSPT5-2BFL	3063	66.39	24	24
	CSPT5-2BFR	3063	66.39	24	24

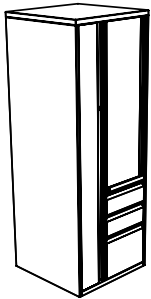

CSPT - STORAGE TOWERS

- Model CSPT5-2FL has wardrobe section on the left and drawers on the right. compartment, 2 box drawers and 1 file drawer. Locker compartment has one fixed shelf.
- Model CSPT5-2FR has wardrobe section on the right and drawers on the left.
- Includes ventilated 24"D wardrobe section (ventilated on bottom of cabinet), locker • Locking.

DESCRIPTION	PRODUCT CODE	LIST PRICE	DIMENSIONS/INCHES		
			H	D	W
Storage Tower - 2 File Drawers	CSPT5-2FL	3063	66.39	24	24
	CSPT5-2FR	3063	66.39	24	24

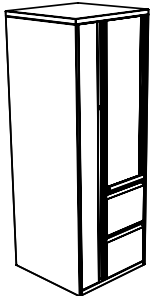

SO# _____ PO# _____ TAG# _____ Date _____

KEY#	SETS REQ'D	KEY#	SETS REQ'D	KEY#	SETS REQ'D	KEY#	SETS REQ'D	KEY#	SETS REQ'D
401		431		461		491		521	
402		432		462		492		522	
403		433		463		493		523	
404		434		464		494		524	
405		435		465		495		525	
406		436		466		496		526	
407		437		467		497		527	
408		438		468		498		528	
409		439		469		499		529	
410		440		470		500		530	
411		441		471		501		531	
412		442		472		502		532	
413		443		473		503		533	
414		444		474		504		534	
415		445		475		505		535	
416		446		476		506		536	
417		447		477		507		537	
418		448		478		508		538	
419		449		479		509		539	
420		450		480		510		540	
421		451		481		511		541	
422		452		482		512		542	
423		453		483		513		543	
424		454		484		514		544	
425		455		485		515		545	
426		456		486		516		546	
427		457		487		517		547	
428		458		488		518		548	
429		459		489		519		549	
430		460		490		520		550	

401-430 =	431-460 =	461-490 =	491-520 =	521-550 =
-----------	-----------	-----------	-----------	-----------

Total: _____

NOTE : If Key Alike Instructions are not submitted to EVOLVE with the Customer's Purchase Order, all components will be keyed randomly.

accessories

ACCESSORIES

CATB - TACK BOARD

- Provide a tackable surface for notes and memos in a work area.
- Includes two pairs of panel-mounting brackets.
- Only fabric must be specified.
- 10" to be installed on 42" h panels.
- 21" specified for use under overhead shelf or storage bin.
- 24" for use without any overheads.

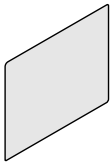
	DESCRIPTION	PRODUCT CODE	LIST PRICE		DIMENSIONS/INCHES		
			Gr1	Gr2	H	W	D
	Tack Board - 10" High	CATB1024	197	209	10	24	
		CATB1030	210	225	10	30	
		CATB1036	232	247	10	36	
		CATB1042	255	275	10	42	
		CATB1048	280	300	10	48	
		CATB1054	309	333	10	54	
	CATB1060	329	355	10	60		
	Tack Board - 21" High	CATB2124	285	297	21	24	
		CATB2130	310	325	21	30	
		CATB2136	351	363	21	36	
CATB2142		403	423	21	42		
CATB2148		450	468	21	48		
CATB2154		492	516	21	54		
Tack Board - 24" High	CATB2424	285	297	21	24		
	CATB2430	310	325	24	30		
	CATB2436	351	363	24	36		
	CATB2442	403	423	24	42		
	CATB2448	450	468	24	48		
	CATB2454	492	516	24	54		
CATB2460	540	566	24	60			

CAWB - WHITE MARKER BOARD

- Provides a writing surface within a work area.
- Includes two pairs of panel-mounting brackets.
- 10" to be installed on 42" h panels.
- 21" specified for use under overhead shelf or storage bin.
- 24" for use without any overheads.

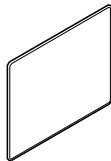
	DESCRIPTION	PRODUCT CODE	LIST PRICE	DIMENSIONS/INCHES		
				H	W	D
	White Marker Board - 10" High	CAWB1030	191	10	30	
		CAWB1036	214	10	36	
		CAWB1042	238	10	42	
		CAWB1048	273	10	48	
White Marker Board - 21" High	White Marker Board - 21" High	CAWB2130	330	21	30	
		CAWB2136	372	21	36	
		CAWB2142	419	21	42	
		CAWB2148	487	21	48	
White Marker Board - 24" High	White Marker Board - 24" High	CAWB2430	330	24	30	
		CAWB2436	372	24	36	
		CAWB2442	419	24	42	
		CAWB2448	487	24	48	



ACCESSORIES

CALB - LOAD BAR

- Frame available in Steel (STL), Black (BLK), and Nevada (NEV) only.
- Mounting brackets and clear end caps are included.

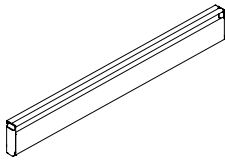
	DESCRIPTION	PRODUCT CODE	LIST PRICE	DIMENSIONS/INCHES		
				H	W	D
	Load Bar	CALB24	161	2.25	24	1
		CALB30	177	2.25	30	1
		CALB36	193	2.25	36	1
		CALB42	224	2.25	42	1
		CALB48	258	2.25	48	1
		CALB54	275	2.25	54	1
		CALB60	295	2.25	60	1

CSABB01 - BINDER BIN

- Must be ordered in conjunction with a load bar option.
- Available in standard and premium paint selections. See "Textile & Finish Listings" in Introduction for complete list of offerings and conditions.

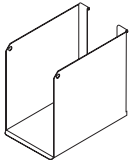
	DESCRIPTION	PRODUCT CODE	LIST PRICE	DIMENSIONS/INCHES		
				H	W	D
	Binder Bin	CSABB01	87	9	4	10.25

CSALT01 - LETTER TRAY

- Must be ordered in conjunction with a load bar option.
- Available in standard and premium paint selections. See "Textile & Finish Listings" in Introduction for complete list of offerings and conditions.

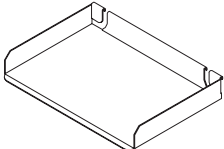
	DESCRIPTION	PRODUCT CODE	LIST PRICE	DIMENSIONS/INCHES		
				H	W	D
	Letter Tray	CSALT01	74	2	13.5	9.25

CSASS01 - SLANT SORTER

- Must be ordered in conjunction with a load bar option.
- Available in standard and premium paint selections. See "Textile & Finish Listings" in Introduction for complete list of offerings and conditions.

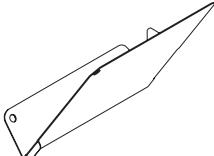
	DESCRIPTION	PRODUCT CODE	LIST PRICE	DIMENSIONS/INCHES		
				H	W	D
	Slant Sorter	CSASS01L	55	9.5	5	10.25
		CSASS01R	55	9.5	5	10.25

ACCESSORIES

EVAMB01 - MEDIA BIN

- Must be ordered in conjunction with a load bar option.
- Available in standard and premium paint selections. See "Textile & Finish Listings" in Introduction for complete list of offerings and conditions.

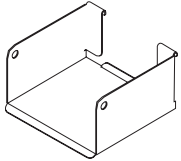
	DESCRIPTION	PRODUCT CODE	LIST PRICE	DIMENSIONS/INCHES		
				H	W	D
	Media Bin	CSAMB01	68	3	5.75	5.25

CSAUT01 - UTILITY TRAY

- Must be ordered in conjunction with a load bar option.
- Available in standard and premium paint selections. See "Textile & Finish Listings" in Introduction for complete list of offerings and conditions.

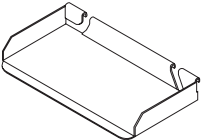
	DESCRIPTION	PRODUCT CODE	LIST PRICE	DIMENSIONS/INCHES		
				H	W	D
	Utility Tray	CSAUT01	47	1	8.5	3.75

CSAFS01 - FLIP SORTER

- Must be ordered in conjunction with a load bar option. in Introduction for complete list of offerings and conditions.
- Comes with nickel plated wire.
- Available in standard and premium paint selections. See "Textile & Finish Listings"

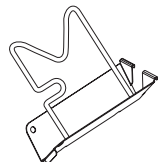
	DESCRIPTION	PRODUCT CODE	LIST PRICE	DIMENSIONS/INCHES		
				H	W	D
	Flip Sorter	CSAFS01	64	9.25	2.75	9.25

CSAPP01 - MAIL BOX

- Must be ordered in conjunction with a load bar option.
- Available in standard and premium paint selections. See "Textile & Finish Listings" in Introduction for complete list of offerings and conditions.

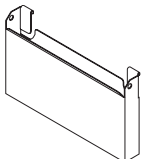
	DESCRIPTION	PRODUCT CODE	LIST PRICE	DIMENSIONS/INCHES		
				H	W	D
	Mail Box	CSAPP01	109	9	12	2.75



ACCESSORIES

CSATH01 - TELEPHONE HOLDER

- Must be ordered in conjunction with a load bar option.
- Available in standard and premium paint selections. See "Textile & Finish Listings" in Introduction for complete list of offerings and conditions.

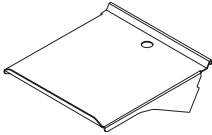
	DESCRIPTION	PRODUCT CODE	LIST PRICE	DIMENSIONS/INCHES		
				H	W	D
	Telephone Holder	CSATH01	103	2	9	10

CPNP01 - NAME PLATE

- Name Plate attached to 1" increment slots.
- Available in single sided (parallel to panel) or double sided (perpendicular to panel) for isle application displaying name on both sides.
- Injection molded frame and die cast base with black rubberized finish.
- Includes two slide-in name cards, steel brackets and fasteners.
- Available in black only.
- Free template for additional slide-in name cards are available at http://www.evolvefurnituregroup.com/Product_Sheets.html

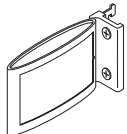
	DESCRIPTION	PRODUCT CODE	LIST PRICE	DIMENSIONS/INCHES		
				H	W	D
	Name Plate	CPNP01	158	3.30	5.3	1.25

CMCH01 - COAT HOOK

- Coat hook for Compile panels.
- Available in standard Compile paint finishes: DWT, BLK, STL, NEV.

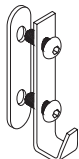
	DESCRIPTION	PRODUCT CODE	LIST PRICE	DIMENSIONS/INCHES		
				H	W	D
	Coat Hook	CMCH01	68	5.5	0.65	1

CATP91 - TOUCH-UP PAINT KIT

- Available in standard paint colors to facilitate easy touch-ups.
- 1/2 fl. ounce bottle (spray not available).
- Specify color.

	DESCRIPTION	PRODUCT CODE	LIST PRICE	DIMENSIONS/INCHES		
				H	W	D
	Touch-Up Paint Kit	CATP91	54			

textiles and finishes

Care and Cleaning

The following guide encompasses the Compile System line.

The guide was compiled using information from our "raw" material suppliers and is relevant only to our standard offering finishes and textiles.

FABRICS

To extend the life of your upholstered panels, regularly dust the panel to prevent airborne particles from penetrating the fabric surface.

For light soiling, use a damp cloth and blot the spot with very slight pressure, taking care never to soak the fabric. Dry with a clean cloth by blotting - never rub fabric. More intense stains can be treated the same way, but with a mild detergent. Always test fabric first in an unseen area before using any cleaning method.

PANEL FRAMES

The panel frames are manufactured out of sturdy aluminum with a powder coated enamel paint finish. To clean the frames of the panels, and all hardware associated with the Evolve line, simply utilize a clean, damp cloth. For stubborn stains on the panel frames, you may consider adding a mild detergent.

GLAZED PANELS

Cleaning of the glazing in panels should only be done with a damp lint-free cloth. A mild detergent can be used if necessary. Do not use paper towels in combination with a window cleaner-this may cause scratches to the glazing.

WORKSURFACES

The worksurfaces are manufactured using primarily Nevamar Brand laminates as the exposed surface. To properly clean these areas, it is best to use a clean, damp cloth and circular motion to prevent streaks. For stubborn stains, you are able to add a mild detergent to the water. Be certain not to use an ammonia-based solution. It will react with the PVC, or wood edge trim, causing permanent damage to the contacted areas.

ACCESSORIES

The accessories sold with the Evolve product line can be simply cleaned with a clean, damp cloth. If they are really dirty, a mild, non-abrasive solution may be added. Wipe with a damp cloth after the solution, and finally, a dry cloth.

LAMINATES – THERMALLY FUSED & HIGH PRESSURE

Absolute Acajou*	ACJ
Asian Night*	ASN
Avant Cherry*	AWC
Avant Honey*	AWH
Black	BLK
Blizzard Matrix	BMX
Brushed Cobalt*	BRC
Clear Maple*	CMB
Custom Grey	CGY
Dark Espresso*	DES
Designer White	DWT
Fashionista	FAS
First Class	FCL
Noce Biondo	NBL
Noce Grigio	NGL
Noce Leggero	NEL
Noce Medio	NML
Quartered Mahogany*	QTM
Sheer Beauty	SBY
Stone Dust	SDT
Storm Grey	SOG
Walnut Heights*	WHE
Winter Cherry	WCR
White Chocolate*	WHC

Additional paint and laminates may be available. Contact Evolve Customer Care for details.

* Matching Wood Grain PVC edge available.

PVC EDGE TRIM

Absolute Acajou	AAE
Asian Night	ASE
Avant Cherry	ACE
Avant Honey	AHE
Black	BLK
Blizzard	BZD
Brushed Cobalt	BRC
Charcoal	CHR
Clear Maple	CMB
Dark Espresso*	DES
Designer White	DWE
Fashionista	FAS
First Class	FCL
Nevada	NEV
Noce Biondo	NBL
Noce Grigio	NGL
Noce Leggero	NEL
Noce Medio	NML
Quartered Mahogany	QTM
Sheer Beauty	SBY
Silver	SIL
Taupe	TPE
Tungsten	TUN
Walnut Heights	WHE
White Chocolate*	CBE
Winter Cherry	WCR

*1-7/16" HPW PVC Trim for Worksurfaces is not available in Dark Espresso (DES).

PAINT & FRAME COLORS

(for application to trim, steel components, PVC, vertical and horizontal members)

Black	BLK
Designer White	DWT
Fog	FOG
Nevada	NEV

WOOD VENEER WORKSURFACES*

Almond Cherry	AMW
Amber Cherry	ACW
Biscotti	BTW
Cocoa Walnut	CAW
Coral	CRW
Dark Cherry	DCW
Dark Walnut	DWW
Espresso Walnut	EWW
Evening Oak	EVW
Grey on Oak	GRW
Hazelnut	HAW
Java	JAW
Latte Walnut	LTW
Mahogany on Walnut	MHW
Milestone	MTW
Natural Maple	MPW
Natural Walnut	NLW
Red Cherry	RCW
Umber Walnut	ULW
Vintage Cherry	VNW
Walnut	WLW
Warm Cherry	WCW
White Maple	WMW

All wood veneer worksurfaces are 1.38" thick.

*Note: Wood veneer options for worksurfaces are available at an upcharge and with an extended lead time. Contact Evolve Customer Care for details.



PANEL FABRICS – GRADE 1

Anchorage - 35% Post - consumer Recycled Polyester and 65% Pre -consumer Recycled Polyester

Birch	AN40
Green Apple	AN41
Lapis	AN42
Straw	AN43
Wolf	AN44
Goose	AN45
Angora	AN46
Cumin	AN47
Asteroid	AN48
Geranium	AN49
Thistle	AN50
Graphite	AN51
Slate	AN52
Quarry Blue	AN53
Onyx	AN54
Pumpkin	AN55
Red Delicious	AN56
Sunshine	AN57
Waterfall	AN59
Vanilla	AN61
Vanilla	AN61
Cobalt	AN62
Cloud	AN64

Aurora - 100% Polyester, 80% minimum Post-Consumer Recycled Polyester

Cloud	AU20
Seal	AU21
Fog	AU22
Pewter	AU23
Granite	AU24
Oat	AU25
Coconut	AU26
Latte	AU27
Lake	AU28
Frost	AU29

Ease - 100% Recycled Polyester,

Stratus	EZ24
Pebble	EZ25
Glow	EZ26
Bloom	EZ27
Earthbound	EZ28
Nebula	EZ29
Terrain	EZ30
Fog	EZ32
Glacial	EZ33
Evening	EZ34

Expanse - 100% Post-Consumer Recycled Biodegradable Polyester

Sand	AX42
Vapor	AX43
Steel	AX44
Cinder	AX45
Morel	AX46
Driftwood	AX47
Hazel	AX48
Seed	AX49
Mineral	AX50
Breeze	AX51

Linea - 100% Post Consumer Recycled Polyester

Queue	LN41
Cord	LN42
Twine	LN43
Thread	LN44
Contour	LN45
Silhouette	LN46
Cable	LN47
Route	LN48

Lisbon - 80% Polyester, 20% Post-Consumer Recycled Polyester

Gesso	LS11
Dusk	LS12
Grey	LS13
Ivory	LS14
Henna	LS15
Nocturnal	LS16
Moss	LS17
Navy	LS18
Buff	LS19
Spa	LS20

Loopy - 100% Recycled Polyester

Oyster	LP60
Putty	LP61
Marble	LP62
Hazelnut	LP63
Latte	LP64
Bay	LP65
Wild Rice	LP66
Harbor	LP67

Melody - 100% Recycled Polyester

Spray	ME40
Pond	ME41
Sand Bar	ME42
Silt	ME43
Pebble	ME44
Lake	ME45
Gravel	ME46
Boulder	ME47

Merge - 100% Polyester, 75% minimum Post-Consumer Recycled Polyester

Fawn	MG20
Marshmallow	MG21
Driftwood	MG22
Dove	MG23
Graphite	MG24
Slate	MG25
Eucalyptus	MG26
Fire Engine	MG27
Mediterranean	MG28
Midnight	MG29

Pinpoint - 100% Post-Consumer Recycled Polyester

Bliss	PN11
Delight	PN12
Dune	PN13
Infusion	PN14
Ebony	PN15
Fresh	PN16
Carrot	PN17
Splash	PN18
Vibe	PN19
Gala	PN20

Streak - 100% Recycled Polyester

Beach	SR81
Shade	SR86
Stretch	SR88
Sprint	SR89
Roll	SR91
Dart	SR92
Zoom	SR93
Splash	SR94
Whiz	SR95
Flash	SR96

Tek - 100% Recycled Polyester

Finesse	TX60
Grain	TX61
Essence	TX62
Warp	TX64
Mesh	TX67
Form	TX69
Spice	TX71
Glacier	TX72
Spring	TX73
Harmony	TX74
Smoke	TX75
Pebble	TX76

Terrace - 100% Post-Consumer Recycled Polyester

Lotus	TC60
Tigerlily	TC61
Shadow	TC62
Cobble	TC63
Cherry Blossom	TC64
Bluebell	TC65
Apple	TC66
Haze	TC67
Cerise	TC68
Twilight	TC69
Wintergreen	TC70
Ironwork	TC71
Flirt	TC73
Echo	TC74
Glacier	TC75

PANEL FABRICS— GRADE 2

Cyclone - 56% post-consumer recycled polyester and 44% polyester.

Stove Pipe	IM37
Stainless.....	IM40
Polished Pewter	IM41
Welded Steel	IM43
Etched Bronze.....	IM44
Fired Titanium.....	IM46
Chrome.....	IM49
Dark Annealed.....	IM50
Karat.....	IM54
Red Metal.....	IM55
Oxidized Bronze.....	IM56
Bright Ray.....	IM57
Bismuth Crystal	IM58
Gallium Blue.....	IM59

Dashing -100% Post-Consumer Recycled Polyester

Classic Silver.....	DS21
Refined Marble.....	DS22
Antique Sage.....	DS23
Polished Slate	DS24
Genteel Beige	DS25
Bespoke Tan	DS26
Dapper Grey.....	DS27

PET PANEL FABRICS

Amethyst	GPH
Apricot.....	APR
Black.....	BLK
Blue Smoke	BSK
Brick.....	BRI
Carnation.....	CNN
Denim	DEN
Emerald	EMD
Graphite.....	GPH
Harvest.....	HVT
Lapis	LAP
Mist	MTS
Navy	NVY
Pewter	PWT
Ruby.....	RBV
Shamrock.....	SHR
Sunflower	SFR
White.....	WHT



GRADE 1

Dobby - 96% Recycled Polyester / 4% Virgin Polyester

Snowcap.....	DB30
Bonsai.....	DB31
Cloud.....	DB32
Sand.....	DB33
Pewter.....	DB34
Sante Fe.....	DB35
Corfu.....	DB36
Medium Taupe.....	DB37
Charcoal.....	DB38
Berry.....	DB39
Royal.....	DB40
Titanium.....	DB41
Black.....	DB42

Fusion - 90% Virgin Polyester/ 10% Post-Consumer Recycled Polyester

Tangerine.....	FU71
Fresh.....	FU72
Moss.....	FU73
TomatoF.....	FU74
Aqua.....	FU75
Sandstone.....	FU76
Granite.....	FU77
Poppy.....	FU78
Cadet.....	FU79
Oasis.....	FU80
Graphite.....	FU81
Viola.....	FU82
Cobalt.....	FU83
Flax.....	FU84
Carbon.....	FU85

Illusion - 100% Virgin Polyester

Cappuccino.....	II01
Paprika.....	II02
Tropic.....	II03
Wicker.....	II04
Hemp.....	II05
Cayenne.....	II06
Maui.....	II07
Dusk.....	II08
Smoke.....	II09
Currant.....	II10
Fiji.....	II11
Ozone.....	II12
Ebony.....	II13

Jenny - 100% Polyester

Midnite.....	JN01
Ebony.....	JN02
Slate.....	JN03
Vermilion.....	JN07
Admiral.....	JN08
Charcoal.....	JN11
Silver Lining.....	JN25
Oatmeal.....	JN26
Sunflower.....	JN27
Cascade.....	JN28
Harvest.....	JN29
Mellon.....	JN30
Berry.....	JN31
Green Grass.....	JN32
Roast.....	JN33

Quilt - 100% Polyester

Black.....	QL10
Charcoal Grey.....	QL11
Navy.....	QL14
Wine.....	QL16
Silver.....	QL19
Feather.....	QL20
Dune.....	QL21
Meadow.....	QL22
Cadet.....	QL23
Geranium.....	QL24
Daisy.....	QL25
Quest.....	QL26
Punch.....	QL27
Tangerine.....	QL28
Cocoa.....	QL29

Terrace - 100% Post-Consumer Recycled Polyester

Lotus.....	TC60
Tigerlily.....	TC61
Shadow.....	TC62
Cobble.....	TC63
Cherry Blossom.....	TC64
Bluebell.....	TC65
Apple.....	TC66
Haze.....	TC67
Cerise.....	TC68
Twilight.....	TC69
Wintergreen.....	TC70
Ironwork.....	TC71
Pine Cone.....	TC72
Flirt.....	TC73
Echo.....	TC74

Trak - 100% Recycled Polyester

Taupe.....	TK40
Mustard.....	TK41
Latte.....	TK42
Cement.....	TK43
Silver.....	TK44
Copper.....	TK45
Teal.....	TK46
Apple.....	TK47
Steel.....	TK48
Merlot.....	TK49
Midnight Sky.....	TK50
Mocha.....	TK51
Carbon.....	TK52

Urban - 62% Recycled Polyester / 32% Polyester

Ocean Blue.....	UR11
Blue Bayou.....	UR12
Green Grass.....	UR13
Brown Ridge.....	UR18
White Sand.....	UR19
Granite Rock.....	UR20
Gravel Road.....	UR21
Black Coal.....	UR22

Waterfall - 60% Virgin Polyester /40% Post - Consumer Recycled Polyester

Trance.....	WA40
Tryst.....	WA41
Splash.....	WA42
Victoria.....	WA43
Imagine.....	WA44
Sky.....	WA45
Rainforest.....	WA46
Rumble.....	WA47
Prism.....	WA48
Tranquility.....	WA49
Grand.....	WA50
Rushing.....	WA51
Majestic.....	WA52
Pacific.....	WA53
Dance.....	WA54

Waterfall - 60% Virgin Polyester /40% Post - Consumer Recycled Polyester

Lime.....	WV01
Mint.....	WV02
Stone.....	WV03
Flame.....	WV04
Mykonos.....	WV05
Savannah.....	WV06
Mesa.....	WV07
Plasma.....	WV08
Cancun.....	WV09
Quartz.....	WV10
Moonrock.....	WV11
Rubine.....	WV12
Corfu.....	WV13
Bluejay.....	WV14

GRADE 2 (FABRIC)

Imprint - 100% Post-Consumer Polyester

Almond.....	IM70
Cork.....	IM71
Sand.....	IM72
Currie.....	IM73
Candy Apple.....	IM74
Ocean.....	IM75
Navy.....	IM76
Green Tea.....	IM77
Celery.....	IM78
Oregano.....	IM79
Walnut.....	IM80
Paprika.....	IM81
Graphite.....	IM82
Slate.....	IM83
Licorice.....	IM84

GRADE 2 (VINYL)

For availability of chair series in Vinyl, please contact a Global Sales Representative.

Allante FRee - 100% Vinyl Face / 100% Polyester Backing

Illusion	A01F
Bright White	A02F
White Crush	A03F
Ivory	A04F
Ice	A05F
Bleached Sand	A06F
Taupe Fawn	A07F
Warm Smoke	A08F
Autumn Rain	A09F
Cookie	A10F
Sierra Brick	A11F
Gibraltar	A12F
Chateau Grey	A13F
Golden Green	A14F
Oasis Green	A15F
Ink Black	A16F
Purple impulse	A17F
Italian Rose	A18F
Mountain Sky	A19F
Old Navy	A20F
Galaxy	A21F
Red Truffle	A22F
Chocolate Sundae	A23F
Province Blue	A24F
Eclipse	A25F



PANEL COM REQUEST FOR APPLICATION TEST

SEND COMPLETED FORM AND FABRIC TO:

Compile Customer Service
565 Petrolia Road, Doors 6-13
Toronto, Ontario M3J2X8
Phone: 416.739.5000
Attn: Eric Sam

Requested By: _____

Phone #: _____

Fax #: _____

Project Name _____

Dealer/Specifier _____

Dealer Contact: _____

Evolve CSR: _____

Phone #: _____

Fax #: _____

FABRIC INFORMATION

Fabric Manufacturer: _____

Color Name: _____

Color #: _____

Pattern Name: _____

Pattern #: _____

Content: _____

Weight: _____

Width: _____

Repeat Horizontal: _____

Repeat Vertical: _____

Other Comments: _____

REQUEST FOR APPLICATION TEST (THIS REQUIRES 2 YARDS OF FABRIC)

_____ Compile Panel

_____ Compile Tackboard

Total Number of yards for testing: _____

Please Note:

Compile is not responsible for the duty and brokerage fees for C.O.M. Fabric to clear customs. These charges will be billed to the dealer on a separate invoice.

PANEL FABRIC SPECIFICATION SHEET

SEND COMPLETED FORM TO:

Compile Customer Service
 565 Petrolia Road, Doors 6-13
 Toronto, Ontario M3J2X8
 Phone: 416.739.5000
 Attn: Eric Sam

SUPPLIER PATTERN WIDTH CONTENT	REMARKS: _____ _____ _____ _____	
LIGHT FASTNESS FLAMMABILITY TUNNER TEST	REMARKS: _____ _____ _____ _____	
CUT PRICE 1 - 3 ROLLS 4 ROLLS	REMARKS: _____ _____ _____ _____	
DIRECTIONAL PANELS CORNERS RACEWAY COVER RACEWAY CORNERS STRETCH	REMARKS: _____ _____ _____ _____	EASY HARD X-HARD
<p> APPROVED <input type="checkbox"/> NOT APPROVED <input type="checkbox"/> CONDITIONAL APPROVAL <input type="checkbox"/> </p> <p> REMARKS: _____ _____ _____ </p> <p> * This fabric is approved for upholster-ability only. The approval does not account for the durability of the fabric at the time of, and after installation of the product </p> <p> APPROVAL SIGNATURE: _____ DATE: _____ </p>		



C.O.M AUTHORIZATION FORM FOR COMPILE PEDESTAL CUSHIONS

CUSTOMER INFORMATION

To be completed by the dealer/design firm. Use one form per textile. Incomplete information may delay or prevent approval.

A+D/Dealer/Company Name:	Contact:	Date:
Billing Address:	Phone:	
City:	State:	Zip:
	Fax:	
End-User/Project Name:	End-User/Project Registered?	YES NO If YES, The Evolve Quote#:

TEXTILE APPLICATION INFORMATION

MODEL NUMBER	QUANTITY	SPECIAL INSTRUCTIONS

Textile Name (Series/Style #):		
Textile Color Name and Description:		
Country of Origin:		
Mill or Manufacturer's Name:		
Textile Content (% Cotton, % Poly, % Wool, etc.):		
Textile Width:	Pattern Repeat: VERTICAL HORIZONTAL	Rail Roaded? YES NO

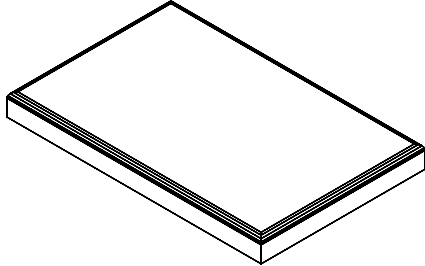
TEXTILE DIRECTION	NEW TEXTILE	PREVIOUSLY APPROVED TEXTILE
 <p>STAPLE FABRIC TO THIS FORM IN THE DIRECTION IN WHICH THE FABRIC IS TO BE UPHOLSTERED WITH THE LEFT SIDE OF THIS PAGE BEING THE SAME LEFT AS THE CUSHION.</p>	Attached textile sample (Minimum 5" x 5" Max 12" x 12") In correct DIRECTION and SIDE.	Fax completed form to: 856.596.5684
	MAIL FORM AND TEXTILE SAMPLE ONLY TO: GLOBAL - COM Department 17 West Stow Road Marlton, NJ 08053 856.596.3390	
	<p>Please contact your local EVOLVE CustomerCare representative for status of all COM requests. When textile is approved and an authorization number issued, a set of shipping instructions will be faxed or e-mailed to you.</p> <p>Approved textiles are to be shipped to the address that will be included with instructions. Do not ship textiles to the address on this form. Dealer is responsible for the shipping expenses. Brokerage fees will be paid for by Global. However, duties imposed by North American Governments related to textile materials, content and Country of Origin, additional fees may apply and will be billed separately.</p> <p>Please Note: C.O.M Textiles may not be shipped without shipping documents. GLOBAL is not responsible for any material shipped without the authorization number.</p> <p>Please be advised that Global has phased out the use of textiles that contain certain Phthalates, including but not limited to: DEHP (di (2-ethylhexyl) phthalate), DBP (di-n-butyl phthalate), BBP (butyl benzyl phthalate) and DINP (di-isononyl phthalate) (collectively the "Listed Chemicals"). The Listed Chemicals are used in certain types of vinyls. Global cannot accept orders for textiles that contain the Listed Chemicals, if such orders are to be shipped to the U.S.A. or are intended for customer in the U.S.A. If you are not sure if the C.O.M you have selected contains the Listed Chemicals, please contact the manufacturer or supplier of the fabric to verify.</p>	

EVOLVE AUTHORIZATION FORM (TO BE COMPLETED BY CUSTOMERCARE REP.)

CAN#:	TEXTILE YARDAGE (REQUIRED FOR THE ORDER):	GU CODE:
SIGNATURE: _____	PRINT NAME: _____	DATE: _____

TOP

**STAPLE
MINIMUM 6" X 6"
FABRIC SAMPLE HERE
IN THE DIRECTION IT IS TO BE
APPLIED TO THE PRODUCT**

BOTTOM



APPENDIX

The Evolve Furniture Group has partnered with the software vendors listed below to provide you with an online source for viewing the 2019 Compile Electronic Catalog. Please visit their websites for additional information and download details.

2020 Technologies

www.2020technologies.com
5503 Mile Road NW
Grand Rapids, MI 49544
Phone: 800-638-6002

Ice Edge Business Solutions

www.ice-edge.com
4001 S 700 East, Suite 450
Salt Lake City, UT 84107
Phone: 801-747-0373

KISP

www.kisp.com
Customer Support: 416-499-2457
Cad Services Team: 416-499-2457 x3
Customer Service e-mail: tellmemore@kisp.com
CAD Services requests CadServices@kispstech.com

Project Matrix

www.projectmatrix.com
11655 Lebanon Rd.
Cincinnati, OH 45241
Tech Support Instant Messenger: projectmatrixtech@yahoo.com
Phone: 513.554.1665
Fax: 513.554.1255

Quintero-Smith Incorporated/Midnight Oil

www.midnight-oil.com
10469 Kinnard Avenue
Los Angeles, CA 90024
voice: 800-350-7434 (US Only)
international: 310-478-5140
fax: 310-478-4572
e-mail: jimrsr@q-si.com



TERMS & CONDITIONS

APPLICATION OF STANDARD TERMS

Sales of Evolve products are made only on Evolve standard terms and conditions of sale which are contained in the Price Book and in Evolve's order acknowledgments. These standard terms and conditions may be modified or supplemented only by a separately written document signed by Evolve's authorized personnel at its head office in Marlton, New Jersey. An offer by Purchaser of said terms and conditions shall not be binding until accepted by Evolve in writing.

All illustrations, specifications and prices in this Price List are based on the latest product information available at the time of publication. Evolve reserves the right to make changes, at any time and without prior notice, to prices, colors, materials, specifications and models offered.

PRICES AND PAYMENT

The prices shown in this Price List, as well as those quoted by Evolve, shall be in US dollars for orders shipped to destinations within the continental United States.

Prices listed herein are for standard product. Quotations for special product are available through Evolve Customer Support Department in Marlton, New Jersey.

If shipping date requested is more than 90 days from date of order Evolve shall use published list prices effective at the time of shipment.

Not included in the list price are special or export packing, unpacking and installation. Orders are invoiced at the time of shipment. The Customer agrees to pay a charge of 2% per month of invoices outstanding more than 30 days.

FOR PAYMENTS ONLY, MAIL TO:

Evolve Furniture Group, a division of:
Global Industries, Inc.
17 West Stow Road
P.O. Box 562
Marlton, New Jersey 08053

Any products sold shall remain the property of Evolve until fully paid for in cash. The Purchaser agrees to perform all acts which may be necessary to perfect and assure retention of title to such products to Evolve until such time as the goods have been paid for in full.

Free freight applies to orders dock delivered to one commercial business location in the contiguous United States during normal business hours. Residential deliveries will incur additional delivery charges.

Please note exception below:

All showroom and mock-up orders will be subject to actual freight charges.

Evolve shall, in its sole discretion, determine the most appropriate method of shipment routing and carrier. Shipments of less than a full trailer load (LTL) shall ship via common carrier. **These LTL shipments are not subject to specific delivery days or times.** Full trailer loads will provide for dedicated delivery time and schedule. Purchaser may request special packaging or method of shipment at Purchaser's sole expense.

TAXES

All sales, use, excise and other applicable taxes and the collection and reporting thereof (excluding only taxes on the net income of Evolve) are the Purchaser's responsibility and will be invoiced to the Purchaser. If Purchaser claims an exemption from such taxes, it shall be the Purchaser's responsibility to furnish an appropriate exemption certificate to Evolve.

ORDER INFORMATION

Evolve requires that **all orders be submitted in writing** to avoid errors and/or duplication. Orders will be acknowledged with Evolve's acknowledgement forms governing the transaction. The details appearing on the acknowledgement will describe the items to be shipped to Purchaser who must ascertain that they are correct. If not correct, Purchaser should notify Evolve immediately by telephone or fax followed by written confirmation. Acknowledgment shows approximate shipping date of items ordered. **Shipping dates are assigned to orders based on the item having the longest manufacturing lead time.** Orders with Customer's Own Material (C.O.M.), or missing or incorrect information (finish selections, fabric selections, etc.) will be scheduled for manufacturing upon receipt of COM or correct complete information. Purchaser must indicate if multiple shipping schedules are required including noting if the shipping date requested is longer than standard posted lead time. Each shipment will be invoiced at time of shipping and will be subject to payment terms described herein.

C.O.M. CUSTOMER'S OWN MATERIAL

Should Purchaser request a fabric, not standard to the Evolve upholstery line, Purchaser shall submit a sample of not less than two yards for approval. Evolve will determine whether fabric is suitable to manufacturing process and applicable UL or code requirements. Should Evolve be required to test such fabric, it shall so advise Purchaser, and Purchaser shall be responsible for all costs associated therewith. This includes all duty and brokerage fees.

Fabric yardage requirement will be determined by Evolve. An additional charge may be made to cover the cost of cutting, matching or sewing unusual or directional patterns. Evolve shall have no responsibility for condition, quality, performance, physical properties or any other aspect of C.O.M. For panels, price as if grade 1 fabric is used.

Evolve reserves the right to reject any C.O.M. deemed unsuitable.

Evolve reserves the right to cancel an order at any time if C.O.M. is, in the sole judgement of Evolve, inadequate for any reason.

CHANGES AND CANCELLATION

The order may not be changed or cancelled by Purchaser without the written consent of Evolve. This charge can be as much as 100% based upon proximity to scheduled shipment date. Special order items and fabric-covered items already in production are not subject to change or cancellation under any circumstances. Fabric-covered items are considered to be in production once the fabric has been cut.

DEPOSIT ON SPECIAL ORDERS

Orders for nonstandard products may, at Evolve's discretion, require deposit prior to scheduling of production, the amount of the deposit being credited against the total price of the project.

SUSPENSION

In the event that the Purchaser defaults in the payment of any sum due Evolve, or in the event the Purchaser's financial condition becomes unsatisfactory to Evolve, Evolve shall have the right at its option, upon written notice to the Purchaser, to cancel shipment of any goods, unless within ten (10) days of Purchaser's receipt of such notice Purchaser provides assurance of payment to Evolve in such form, content and/or amounts as Evolve, in its sole discretion, deems adequate.

COMBINED SHIPMENTS

Evolve will make every effort to combine shipments and orders on written request. However, acceptance of such request shall be with Evolve's sole discretion.

CODE RESTRICTIONS

Evolve portable furniture may be subject to local fire, electrical and/or building codes applicable to portable furniture. It shall be Purchaser's sole responsibility for the proper application of Evolve items within the limitations of such local codes, which may be different from area to area.

SERVICE

Service problems shall be handled by the authorized Evolve dealer. Where this cannot be accomplished on a local level, service problems should be referred to:

Evolve Furniture Group
Customer Support
17 West Stow Road
Marlton, New Jersey USA 08053
856-552-4000 888-827-2500
Attention: Evolve Operations Manager



TERMS & CONDITIONS

STORAGE

In the event Purchaser requests postponement of delivery beyond the acknowledged shipping date, Evolve may transfer the goods to storage on Purchaser's account and at Purchaser's risk and expense subject to a daily storage rate. Such transfer to storage shall be deemed shipment to Purchaser for all purposes, including invoicing and payment.

DELAYS

Evolve's order acknowledgement will state a shipping date which is Evolve's best estimate at the time the order is acknowledged. However, Evolve shall not incur any obligation or liability to Purchaser for failure to ship by a specified date. In addition, Evolve shall not be liable for any loss or damage resulting from any delay or failure in shipment or other failure to perform all or any part of the agreement between the parties with respect to the goods shown on the face of the order acknowledgement where such delay, failure, loss or damage is the proximate result of any act of any governmental authority or political subdivision thereof, revolution, riot, civil disorder or disturbance, act of enemies, delay or default in transportation, strike disputes among or between unions or other labor disputes, delay or inability in obtaining materials and facilities, fire, flood, act of God or any cause not within the reasonable control of Evolve, whether of the class of causes enumerated or otherwise. Without limiting the generality of the foregoing, Evolve may, without causing any breach or incurring liability, allocate goods which are in short supply, regardless of the reasons therefore, among purchasers, in any manner which Evolve, in its sole discretion, deems advisable.

BACK CHARGES

Evolve will not accept charges for expense incurred by the Purchaser in expediting shipments or otherwise. Evolve will not accept charges for the repair of damage by others.

CLAIMS

All goods are sold F.O.B. Toronto, Canada, unless otherwise agreed to in writing by Evolve. Evolve is not responsible for damage which occurs in transit or in storage. The carrier signs for all goods received in good order. It is the Purchaser's responsibility to examine goods upon receipt and to file any claims with the carrier. Any claims made against Evolve for apparent defects, errors or shortages must be made by the Purchaser in writing, within fifteen (15) working days after any delivery. Failure by the Purchaser to make any claim against Evolve within the above-described fifteen days shall constitute acceptance of the goods and a waiver of any apparent defects, errors or shortages.

RETURNS

No returns of goods will be accepted without written consent and shipping instructions, including Evolve's Return Goods Authorization (R.G.A.) numbers, to Evolve. A minimum restocking charge of 35% is made on all authorized returns for credit or refund, provided goods are received by Evolve in the condition in which they left the factory. No credit will be given if goods cannot be reused. Special order items and fabric-covered items are in no event subject to return. All returns must be approved and authorized in writing by Evolve Customer Support, Marlton, New Jersey.

LIFETIME WARRANTY

Evolve warrants that all commercial products are free from defects in material and workmanship, for the life of the product, to the original purchaser. This warranty is made by Evolve only to original customers acquiring the product directly from Evolve's authorized dealers. The customer's sole remedy pursuant to this warranty is limited to repair or replacement of parts or product at Evolve's option. Consent from Evolve must be obtained before any warranty work is performed. This warranty shall not apply to any products which must be replaced because of normal wear and tear, negligence, abuse or "accident", shipping damage, or product use and installation other than in accordance with written instructions or warnings. It shall also not apply when product has been modified or altered, repaired or refurbished by someone other than Evolve or an authorized dealer or because of natural variations over which Evolve has no control. In the event of repair and/or replacement of any defective product, Evolve does not warrant matching color, grain, texture or dye lots. Evolve's warranty does not cover the cost of transportation or labor. Repair or replacement will be at Evolve's option. Evolve makes no warranty that any of its products are suitable for any particular purpose and makes no other warranties, expressed or implied, other than those set forth in this Price List. As codes and standards vary from one jurisdiction to another, references to compliance are solely for convenience and without any representation as to accuracy or suitability. Users must verify the suitability of such information or product for their specific application. In no event shall Evolve be liable in either tort or contract for any loss or direct, special, incidental, consequential, or exemplary damages.

This Lifetime Warranty is NOT applicable to customers who use Evolve products for rental purposes and is effective only for products, parts or components manufactured after January 1, 2011.

Exceptions to this warranty include:

- Global fabrics and wood veneers, which are warranted for five years from date of delivery.
- Electrical components, which are warranted for ten years from the date of delivery.
- Moving parts such as glides, slides, casters, user-adjustable worksurface mechanisms, which are warranted for five years from date of delivery.

- Fading on fabric and wood veneers can be caused by exposure to U.V. rays/sunlight. Natural wood veneer, being a natural material, will have shade differences between veneer sheers, the difference will be more apparent between dye lots.

Evolve does not warrant color fastness on Customer's Own Material.

Because of natural variations over which Evolve has no control, this warranty does not extend to color, grain or texture of wood, and Evolve does not warrant matching of color, grain or texture.

Evolve makes no warranties, including implied warranties of merchantability and fitness for a particular purpose, other than the express warranties contained herein.

LIMITATION OF REMEDY

Purchaser's sole and exclusive remedy (excluding the repair or replacement of goods for breach of the express warranty above) for any matter or claim arising under or relating to these terms and conditions, the goods covered hereby and any transaction involving or relating to such goods, whether in contract, tort (including negligence) or otherwise, shall be payment of the lesser of the cost to repair or replace said product or the purchase price for the goods to which the claim relates. In no event shall Evolve be liable for any special, indirect, consequential, or incidental damages, including without limitation, damages for loss of business profits, business interruptions, or loss of information.

EVOLVE'S WARRANTY DOES NOT APPLY (FOR ANY PRODUCT CATEGORY) TO THE FOLLOWING:

- Failures due to wear and tear
- Failures which result from negligence, abuse, accident or misuse
- Failure to apply, install or maintain products according to Evolve's written instructions and warnings
- Modifications, attachments or repair methods not approved by Evolve
- Damage caused by a carrier in transit, or delivery/installation contractors
- The matching of colors, grains or textures (wood, leather, etc.) of natural materials and color matching of textiles
- Products exposed to extreme hot or cold temperatures or excessively dry or humid environments
- Colorfastness or the matching of color of textiles
- Damage by markings or staining; damage by sharp objects or imprinting from instruments
- Damage to textiles or laminate and wood surfaces/edges from exposure to sunlight (including UV rays)
- Products used for rental purposes

Evolve's warranty applies to products sold within the United States of America, Mexico, the Commonwealth of Puerto Rico and Canada.

showrooms and distribution centers throughout the united states

SHOWROOMS

Atlanta

10 10th Street
Suite 150
Atlanta, GA 30309
T 404.879.0998

Chicago

The Merchandise Mart
10th Floor, Suite 1035
Chicago, IL 60654
T 312.755.0843

Miami

112 NE 41st Street
6th floor
Miami, FL 33137

New York City

386 Park Avenue South,
7th floor
New York, NY 10016
T 212.545.9900

Phoenix

4675 East Cotton
Center Boulevard,
Suite 165
Phoenix, AZ 85040
T 602.426.0666

Boston

One Harbor Street,
Suite 104
Boston, MA 02210
T 617.406.5435

Irvine

18400 Von Karman Ave.
Suite 100
Irvine, CA 92618

New Jersey (Southern)

119 Greentree Road
Marlton, NJ 08053
T 856.596.3390

Philadelphia

1735 Market Street
38th Floor
Philadelphia PA, 19103
215.861.0963

Washington, DC

1130 Connecticut
Avenue
Washington, DC 20036
T 202.659.0230

SHOWROOMS + DISTRIBUTION CENTERS

Atlanta Area

6715 Maple Ave.
Suite 100
Buford, GA 30518
T 678.602.4130

Cincinnati Area

8712 LeSaint Drive
Fairfield, OH 45014
T 513.777.0009

Ft. Lauderdale Area

560 Sawgrass
Corporate Parkway
Sunrise, FL 33325
T 954.846.8888

Los Angeles Area

12320 Bloomfield
Avenue, Unit A
Santa Fe Springs, CA
90670
T 562.484.9686

Baltimore Area

Troy Hill Corporate
Center
7030 Troy Hill Drive
Elkridge, MD 21075
T 410.379.8021

Dallas Area

2025 W. Beltline Rd.,
#100
Carrollton, TX 75006
T 972.236.1366

Houston

7865 Northcourt Road,
Building D, Suite 200
Houston, TX 77040
T 713.695.5777

Seattle Area

Oakesdale Commerce
Center
820 Southwest 34th St.
Building W7, Suite A
Renton, WA 98057
T 425.291.9282

Chicago Area

27W501 North Avenue
West Chicago, IL 60185
T 630.681.2818

Denver Area

19080 E 38th Ave.,
#30
Aurora, CO 80011
T 303.340.1617

Kansas Area

11617 West 81st Street
Lenexa, KS 66214
T 913.310.9963

Tampa Area

10351 Windhorst Road
Tampa, FL 33619
T 813.621.6272

Global - USA Headquarters

17 West Stow Road P.O. Box 562
Marlton, New Jersey U.S.A. 08053
Tel (856) 596-3390 (800) 220-1900
Fax (856) 596-5684
www.globalfurnituregroup.com

Global - Canada Headquarters

1350 Flint Road
Downsview, ON Canada M3J 2J7
Sales & Marketing: Tel (1-877) 446-2251
Customer Service: Fax (800) 361-3182
Government Customer Service: Fax (416) 739-6319



Association of Canadian Ergonomists
Association Canadienne d'Ergonomie