

Wood Veneer

Effective July 14, 2025 – USA

March 2, 2026



PRICE LIST
wood veneer



think global

THE GLOBAL EDGE

ERGONOMICS IN THE TOTAL OFFICE

- One stop shopping for a full range of office furniture.
- Seating, desks, tables, files, modular furniture, panels and accessories.
- Ergonomics, competitive pricing and built-in value.

STRENGTH AND STABILITY

- Established in 1966.
- One of North America's largest office furniture manufacturers.
- Manufacturing and showrooms worldwide.

QUICK SHIP - INSTOCK

- Hundreds of products in stock for immediate delivery.

STRONG LOCAL REPRESENTATION

- Service and expert advice where you are, when you need it!

MANUFACTURING CAPABILITY

- Vertical integration ensures "start to finish" control.
- Ongoing research and investment in new, innovative production technology.

QUALITY ASSURANCE

- Quality Assurance Program is qualified by C.G.S.B. ISO9001 standards.
- On-site furniture testing facility.
- Product and components are tested to ANSI/BIFMA standards.

ENVIRONMENTAL COMMITMENT

- Continuous development of "earth friendly" programs.
- One of the first molded foam manufacturers to create ozone-friendly, CFC and HFC-free process.
- Seat and back pans are made from recyclable plastics and wood waste, enabling little waste and cost effective products.

SYMBOL IDENTIFICATION



Global's Certified Products are in compliance with the stringent emission guidelines set by the GREENGUARD Environmental Institute and include all Upholstered Seating. To obtain a GREENGUARD Certificate for any product, please go to the product page on our website www.globaltotaloffice.com and click on "View GREENGUARD Certificate".



level™ certification, based on the ANSI/BIFMA e3-2012 furniture sustainability standard, sets furniture manufacturers on a path toward greater sustainability over time. Based on environmental and social criteria set forth in the standard, a product's entire supply chain is assessed.



Certification assessment includes an evaluation of specific corporate policies and guidelines and an assessment of associated company manufacturing facilities. Products must meet quantifiable milestones of environmental and social performance at every step of development.

The quantitative assessment addresses four categories: material use, energy and atmosphere impacts, human and ecosystem health and social responsibility.

Manufacturers earn points in each of the four categories. The level™ brand and its numeric rating of 1, 2 or 3 indicate what threshold of certification a product has achieved. level™ 3 is the highest rating.

TABLE OF CONTENTS

WOOD VENEER DESKS

Corby.....	4
Dufferin.....	62
Foundations.....	146
Kingston.....	208
Lufton.....	272
Philadelphia.....	334

WOOD VENEER TABLES

Boardroom Tables.....	382
-----------------------	-----

REFERENCE

Care and Maintenance Guide.....	435
Custom Grommet Location Forms.....	432
Terms + Conditions.....	436
Textiles + Finishes.....	428
Warranty.....	438

WOOD VENEER DESK NOTES

The following applies to all VENEER Series - Corby, Dufferin, Foundations, Kingston, Lufton and Philadelphia (unless otherwise noted).

CONSTRUCTION:

- "Number one select, architectural grade A" oak, American black walnut, American black cherry, and hard maple. Wood worksurface moulded edges are solid oak, walnut, cherry, or maple (except where square self-edges exist, i.e. credenza and computer worksurface back edges that are most commonly against walls).

FINISH:

- Conversion varnish (similar to catalyzed lacquer, but tougher), 25 degree sheen. Finishes are not buffed or rubbed.
- All Global wood casegood products are veneered and finished on the back sides (360 degree finishing), except modular under-surface storage - tops and backs are unfinished.
- Touch up kits available, includes a touch up marker and fill crayon. Order **VTOUCHUPKIT, \$164** list. Specify finish when ordering.

PEDESTALS:

- Pedestals are fully assembled units. Undersurface storage units provide standard locks.
- All drawers are standard as vinyl-wrapped black embossed with V-groove construction.
- Drawers are "5-sided". The drawer front is an applied element to a four-sided drawer. Drawer fronts can be removed or replaced in the field.
- Pedestal drawers and lateral file drawers are supported by steel ball bearing suspensions. All suspensions carry a full lifetime warranty against defects.
- All drawers have full extension.

HARDWARE:

- All necessary hardware items for attaching furniture items are included in the shipment. Actual wall attachment fasteners for wall cabinets, tackboards and visualboards are not included due to variation between site conditions.
- **Leveling glides** are shipped installed on the unit. Levelers have a 1" range of adjustment.
- **Hanging file rails** are pre-installed on file drawer perimeters with additional front-to-back rails found in the bottom of the filing drawers. These rails hang onto plastic clips and do not require any tools to install. Legal filing can be achieved either as side-to-side or front-to-back. Letter filing can be achieved as front-to-back filing only.
- **Flat plates** for attaching bridge and return to desk are shipped pre-attached to the bottom of the bridge or return. **Mini flat plates** for securing bridge modesty panels to desk or credenza end panels, and **quick connectors** for securing modular corner units to adjacent pieces (Dufferin Series) are shipped along with screws in a plastic bag attached to the bottom of the bridge or return. CAUTION: using screws other than those supplied by Global could result in damage to finished tops.

INSTALLATION:

Wall-mounted cabinets and visual boards are pre-attached with horizontal wall rails to the back of each unit. The wall-side components need to be detached from the unit and fastened to the wall accordingly. Wall fasteners are not included due to variation between site conditions. Securing the wall rail to a vertical structural member is the required manner of installation. The cabinet or visualboard is then lowered on to the wall rail. It is important to level the wall rail before installation. Wall cabinets are equipped with levelers at the bottoms of the side panels for proper cabinet alignment. It is recommended to use a single drywall screw through the back of the cabinet and the wall-mounted rail, to further secure the wall attachment.

Wall-mounted tackboards have vertical grooves in the back for tasklight wiring. Horizontal wall rails are provided. Fasteners are not included due to variation between site conditions. The site installer need to position the wall rail and determine the type of screw to be used for the application. The tackboard is hung on the wall rail. Using a level will also aid in the tackboard installation.

Hutches are installed with double-faced tape applied on the bottom of the end panels. Global utilizes a non-marring method of hutch attachment. The tape is shipped in a plastic bag found in the hutch. Removal of the hutch requires moderate pressure to be applied on the top of the unit towards the wall for at least a minute for the pressure-sensitive tape to release. At the dealer or installer's discretion, additional support may be added by installing flat plates along the back of the attached units. These flat plates are not included in the shipment.

Hutch tackboards are factory installed.

Modular storage units have pre-drilled holes through the tops for securing to the bottom of the worksurfaces. Disassemble the modular unit first before relocating the entire unit to avoid damage or body injuries.

5-Sided corner tables and adjoining bridge and credenza run-offs are attached with MP-53 mending plates. Accurate leveling is critical for these units to align and connect properly.

NOTE: Leveling wood office furniture properly is the most important procedure to ensure proper functioning and alignment of drawers, locks and doors. Upon completing installation, wipe furniture with a damp cloth, followed with a dry soft cloth - always in the direction of the grain.

corby





Introducing the Corby Collection of wood veneer and laminate desks, tables and storage elements. Christopher Wright has reflected on the mid-century modern vernacular to design a unique series of workplace furnishings that reward a new generation of pioneers and nation builders.

Corby is suited for any office environment, private office, boardrooms, open desking and collaborative areas. Its timeless design is expressed in subtle details - flared legs that elevate storage off the floor, tapered aprons on the bottom of storage pieces which reflect the knife edge detail of the worksurface. Standard height and counter height tables combined with tiered storage pieces offer a reprieve from formal boardrooms and deliver a more casual style for meeting areas.

Corby is a fresh take on desking, blending the warmth and comfort of residential-style furniture with the features and long lasting quality you'd expect from Global.

Features and Benefits

- Tapered solid wood legs in two heights
- Modesty panel in two heights
- Drawers are standard vinyl-wrapped construction with black drawer sides and bottom.
- 75 lb box - 150 lb. file drawer weight capacity with full height sides with pencil tray included in box drawer
- Lateral file drawers can accommodate legal or letter documents
- Premium full extension progressive ball bearing slides on file drawers
- Box drawers mounted on 3/4 extension premium ball bearing slides.
- Power / data accessories are available to be factory installed
- Designed by Christopher Wright



Overlapping worksurface with knife edge



Pedestal with optional cushion (shown with low base)



Rectangular grommet in tungsten

GENERAL INFORMATION

- Corby detailing is new century modern with a knife edge on table tops.
- Solid walnut, cherry, oak and maple edging on 1-3/8" tops (veneer).
- 3mm matching PVC edge on laminate surfaces.
- Tapered, solid wood legs are used to support the peninsula, work, collaboration and occasional tables.
- Pedestal, credenza and bookcase bottoms include 1 3/8" thick painted, beveled profile and tapered solid wood legs (4"H or 11 1/2"H).
- Productivity Solutions by Global offers multiple desktop power options that can be retrofitted into grommets, or clamp mounting on the edge of worksurfaces. Under mount options provide a clean way to power accessories in storage cabinets.
- For environmental certifications, please visit globalfurnituregroup.com.

WORKSURFACES

- Standard with 1 3/8" top thickness
- Veneer surfaces constructed from grade "A" veneers
- When laminate is specified, all surfaces constructed using high pressure laminate.
- Peninsula tables, freestanding work tables, collaboration tables and coffee tables feature a contemporary 2" overhang knife edge on all sides. All other surfaces feature a self-edge veneer.

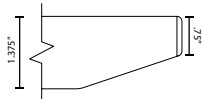
**CONSTRUCTION**

- "Number one select, architectural grade A" oak, American black walnut, American black cherry, and hard maple. Wood worksurface moulded edges are solid oak, walnut, cherry or maple (except where square self-edges exist, i.e. credenza and computer worksurface back edges that are most commonly against walls).
- Stack-on unit back panels are a solid thermally fused laminate color.
- When veneer is specified, tapered, solid wood legs (walnut, cherry, oak and maple) are used to support the Peninsula, Work, Collaboration and Occasional Tables.
- When laminate is specified, tapered, solid poplar legs are used to support the Peninsula, Work, Collaboration and Occasional Tables.
- Pedestal, Credenza and Bookcase bottoms include 1 3/8" thick painted, beveled profile and tapered solid wood legs.

FINISHES

- Conversion varnish (similar to catalyzed lacquer, but tougher), 25 degree sheen. Finishes are not buffed or rubbed.
- Global Corby Wood Veneer Desking products are veneered and finished on the back sides (360° finishing)
- Touch up kits available, includes a touch up marker and fill crayon. Order **VTOUCHUPKIT, \$175** list. Specify finish when ordering.
- Global standard finish, on oak and walnut, is open pore and on cherry and maple is semi-closed pore. If a full finish is required for walnut, cherry, anigre and maple tops, Add the suffix "2" to the finish code and Add 5% to the base pricing for each product.

CUSTOM FINISH IS AVAILABLE.**PEDESTALS, STORAGE CABINETS, CREDENZAS AND BOOKCASES**

- All units are elevated 4" (xxLB = Low Base), or 11.5" (xxHB = High Base) off the floor by tapered, solid wood legs.

HANDLES

- All box and lateral drawers have one vertical handle PL89 (chrome finish) installed. Doors are equipped with touch latch mechanism with no handles.
- Handles can be purchased separately and installed in the field - no template is provided.

**STACK-ON BOOKCASES AND STORAGE CABINETS**

- Stack-on units are designed to be placed and installed on top of the credenzas with low and high base

LOCKS

- Front locking is standard on the Pedestals with box/file and file drawers, credenzas with box/lateral and lateral drawers. Box/box drawer units are non-locking. Optional locking on doors is available. Specify **LO, add \$429**.

DRAWER SUSPENSIONS

- Pedestal drawer suspensions are metal ball-bearing type. Both box and file drawers are full extension.

HANGING FILE RAILS

- Pre-installed on file drawer perimeters. The back rail in a lateral file drawer is designed for both legal and letter size filing. Legal filing can be achieved either as side-to-side or front-to-back. Letter filing can be achieved as front-to-back filing only.

DRAWER CONSTRUCTION

- Drawers are standard vinyl-wrapped construction with black drawer sides and bottom

DRAWER FRONTS

- The drawer front is an applied element to a four sided drawer. Drawer fronts are veneered on all surfaces. Drawer fronts can be removed or replaced in the field.

LEVELING GLIDES

- Levelers have a 1" range of adjustment

HARDWARE

- All necessary hardware for attaching furniture is included in the shipment

1. SPECIFY MODEL NUMBER

2. SPECIFY FINISH

VEENER FINISHES - Top, Chassis, Doors and Fronts:

Code	Finish	Veneer Type	Cut
AMW	Almond Cherry	Cherry	Flat Sliced
ACW	Amber Cherry	Cherry	Flat Sliced
BTW	Biscotti	White Oak	Rift
CAW	Cocoa Walnut	Walnut	Flat Sliced
CRW	Coral	White Oak	Rift
DCW	Dark Cherry	Cherry	Flat Sliced
DWW	Dark Walnut	Walnut	Flat Sliced
EWV	Espresso Walnut	Walnut	Flat Sliced
EWV	Evening Oak	White Oak	Rift
GRW	Grey on Oak	White Oak	Rift
HAW	Hazelnut	Maple	Flat Sliced
JAW	Java	White Oak	Rift
LTW	Latte Walnut	Walnut	Flat Sliced
MHW	Mahogany on Walnut	Walnut	Flat Sliced
MTW	Milestone	White Oak	Rift
MPW	Natural Maple	Maple	Flat Sliced
NLW	Natural Walnut	Walnut	Flat Sliced
RCW	Red Cherry	Cherry	Flat Sliced
VNW	Vintage Cherry	Cherry	Flat Sliced
ULW	Umber Walnut	Walnut	Flat Sliced
WLW	Walnut	Walnut	Flat Sliced
WCW	Warm Cherry	Cherry	Flat Sliced
WMW	White Maple	Maple	Flat Sliced

LAMINATE FINISHES - Top, Chassis, Doors and Fronts:

ACJ	Absolute Acajou	NBL	Noce Biondo
ASN	Asian Night	NGL	Noce Grigio
BLK	Black	NEL	Noce Leggero
BZD	Blizzard	NML	Noce Medio
CMB	Clear Maple	SBY	Sheer Beauty
CGY	Custom Grey	SDT	Stonedust
DES	Dark Espresso	SOG	Storm Grey
DWT	Designer White	WHE	Walnut Heights
FAS	Fashionista	WCR	Winter Cherry
FCL	First Class		

LAMINATE FINISHES - Back Panel*, Painted Legs and Base**:

BLK	Black	BZD	Blizzard
CGY	Custom Grey	DWT	Designer White
SOG	Storm Grey	MSM	Moss
SDT	Stonedust	SEM	Sienna
SPM	Spice	SRM	Surf

*Back panel only when unit is specified in veneer.

**Back panel, painted legs + base when unit is specified in laminate.

3. SPECIFY OPTIONS

Grommets

- Standard grommet on all components is GM5C. Grommet is included with products where shown in line drawings in price book.
- Optional grommets may be ordered along the centerline of Peninsula, Work and Collaboration tables. Order as GM5CTL, GM5CTC, GM5CTR. **Add \$103.**
- Grommet hole dimensions are 3.4" x 1.85". GM5C metal chrome grommet is available exclusively on Corby. Order as G5CTL, G5CTC, G5CTR. **Add \$103.**
- Components that come standard with grommet may be ordered without a grommet. Order as **RSG - Add \$57.**

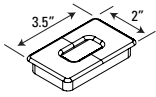

Cushions

- Cushions are standard in Global Grade 2 seating textiles. Please refer to the website for the current offering at globalfurnituregroup.com.

Wood Back Panel

- For units that come with a laminate back panel (all stack-on and freestanding bookcases), an option is available for veneer back panel. Specify **WBP. Add \$732.**

Custom Cut-out

- Optional custom sized cut-out available in standard locations - **CCUTL** (left), **CCUTC** (center) and **CCUTR** (right) for all CBYRTxxxx and CBYRTCxxxx tables. Submit appropriate form (beginning on page 432) with order. **Add \$320** for each cut-out.

CUT-OUTS FOR GROMMETS

OPTIONAL GM5C GROMMET SPECIFICATION



Work and Collaboration Table
From 32" to 42" deep tops

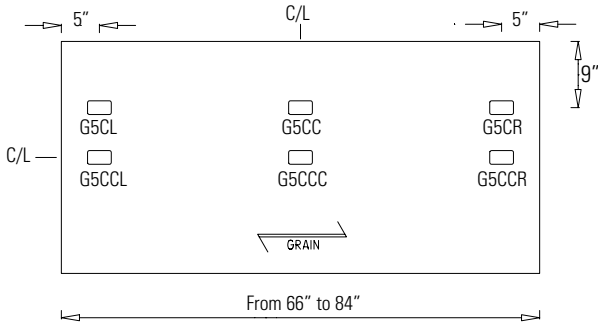

Peninsula Table
For 32" deep tops

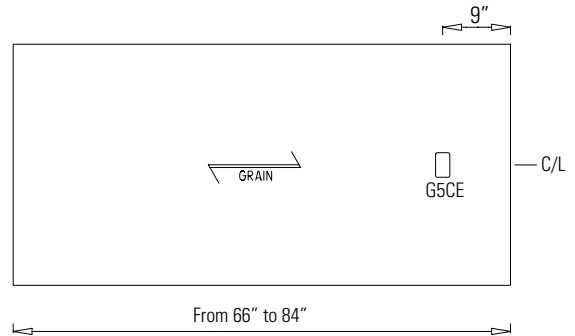

Executive Returns

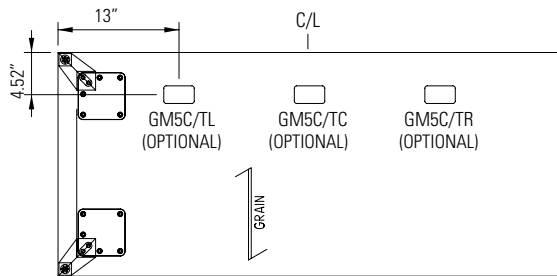

Executive Bridges

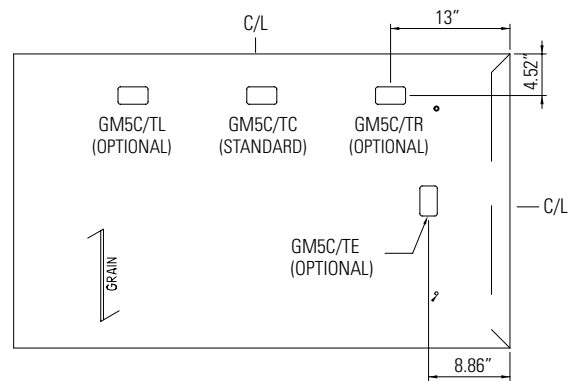

CUT-OUTS FOR POWER BLOCKS

Power Blocks sold separately, see page 57.

PRTMCS401 / PRTMCS421



PRTMCD602 / PRTMCD622 / PRTMCD642



Work and Collaboration Table
From 32" to 42" deep tops

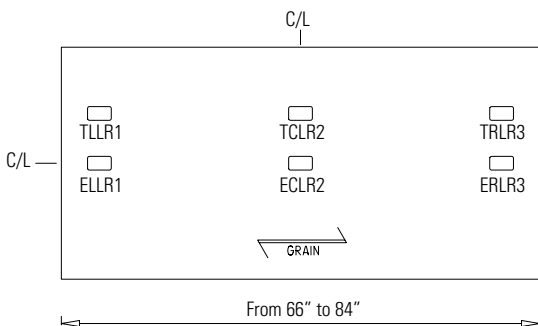

Work and Collaboration Table
From 32" to 42" deep tops

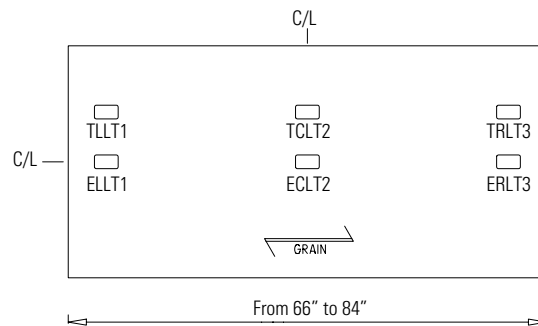

CREDENZA WIRE MANAGEMENT CUT-OUT

- Option C275

Cut-out Specification

- Available on all 27.5"H credenzas, above open positions only (not available on door or drawer positions).
- Use in conjunction with CBYRxxxx Peninsula Tops that have G5CE grommet specified to provide a means of wire management from the surface, thru the credenza top and out the credenza back.
- When specified, the C275 includes a 5.90"w x 3.90"d cut-out in the credenza top and a standard GM5C grommet in the back, upper section of the open cavity.
- Order as **C275L**, **C275C**, **C275R**. Add **\$429** list.

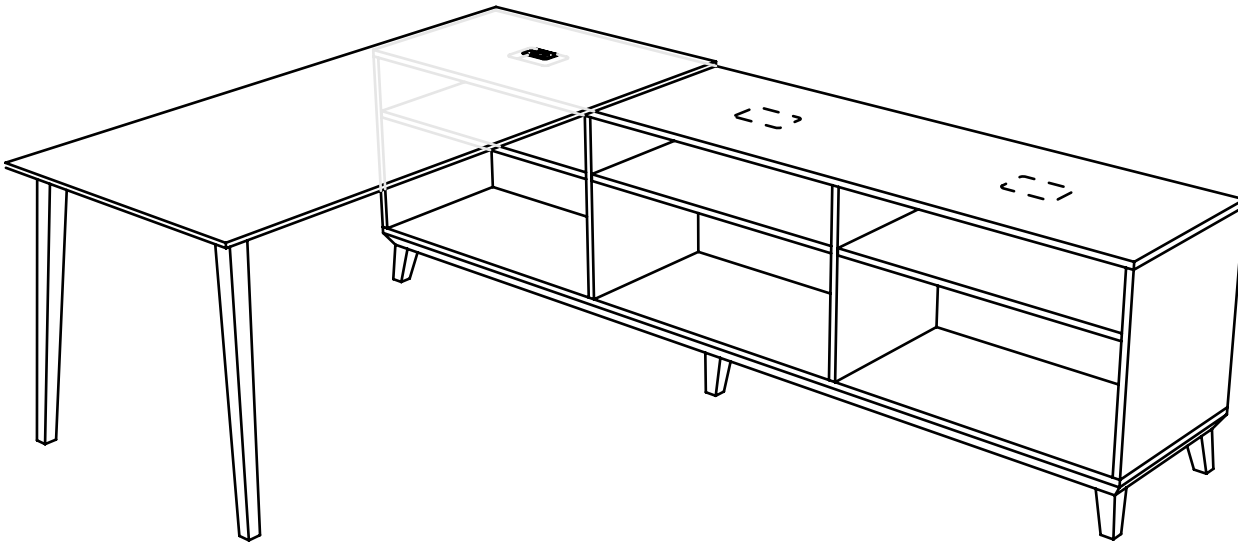
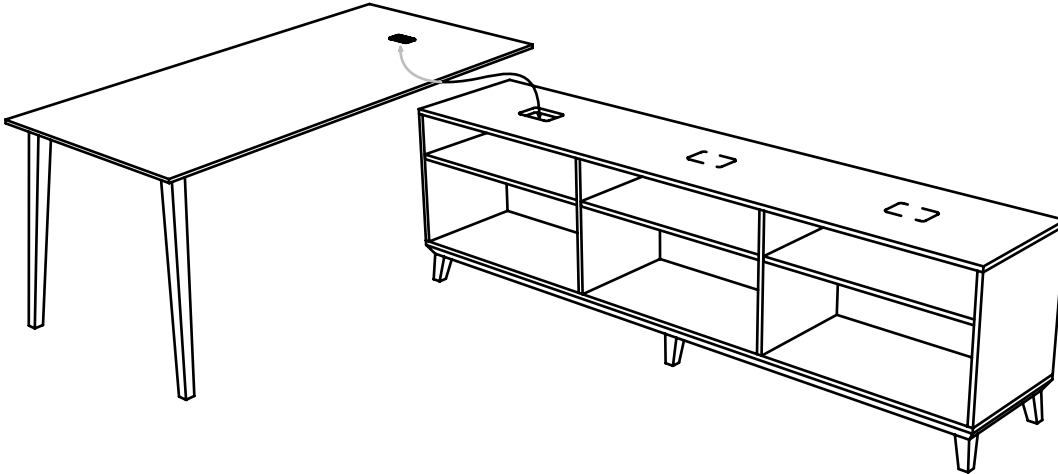

MODESTY PANEL OPTIONS

- Wood Modesty Panels are available in 15" and 22" height.
- To be used on Work Tables and on the Peninsula Table with and without the Riser Box.
- Recommended position for installation is 6" inset.

PENINSULA TABLE WITH HIGH BASE PEDESTAL**MODESTY SIZES:**

CBYCMPW44H15 - 44" x 15" x 0.75"

CBYCMPW50H15 - 50" x 15" x 0.75"

CBYCMPW56H15 - 56" x 15" x 0.75"

CBYCMPW62H15 - 62" x 15" x 0.75"

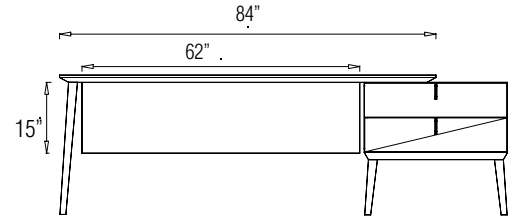
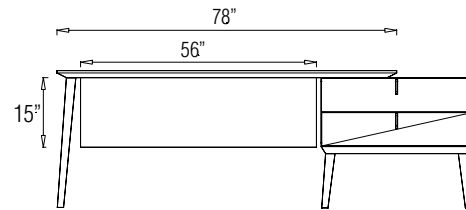
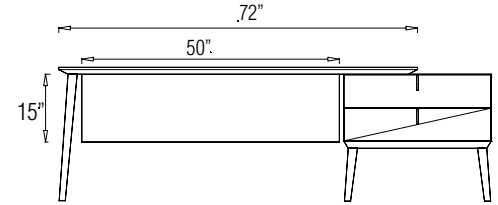
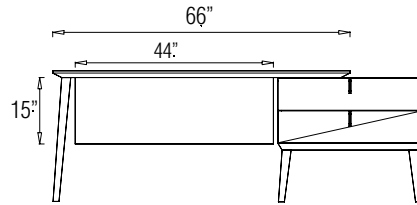
**PENINSULA TABLE WITH LOW BASE PEDESTAL****MODESTY SIZES:**

CBYCMPW44H22 - 44" x 22" x 0.75"

CBYCMPW50H22 - 50" x 22" x 0.75"

CBYCMPW56H22 - 56" x 22" x 0.75"

CBYCMPW62H22 - 62" x 22" x 0.75"

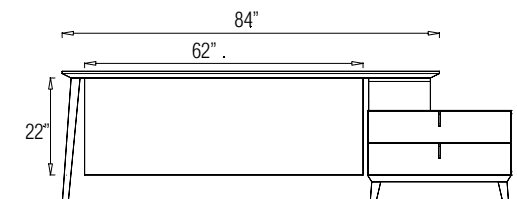
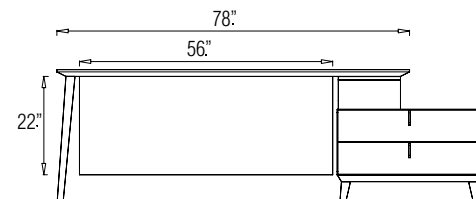
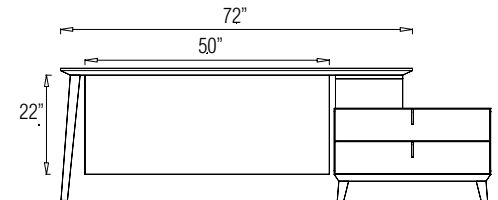
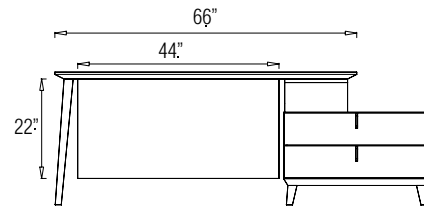
**PENINSULA TABLE WITH HIGH BASE CREDENZA****MODESTY SIZES:**

CBYCMPW38H15 - 38" x 15" x 0.75"

CBYCMPW44H15 - 44" x 15" x 0.75"

CBYCMPW50H15 - 50" x 15" x 0.75"

CBYCMPW56H15 - 56" x 15" x 0.75"

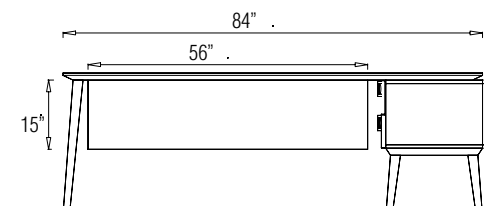
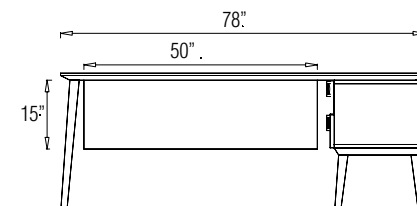
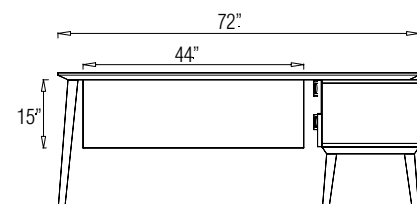
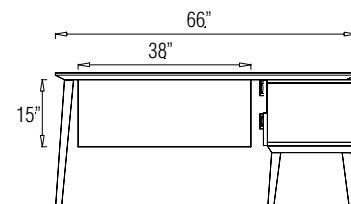

**MODESTY PANEL OPTIONS
PENINSULA TABLE WITH
LOW BASE CREDENZA**

MODESTY SIZES:

- CBYCMWPW38H22 - 38" x 22" x 0.75"
- CBYCMWPW44H22 - 44" x 22" x 0.75"
- CBYCMWPW50H22 - 50" x 22" x 0.75"
- CBYCMWPW56H22 - 56" x 22" x 0.75"

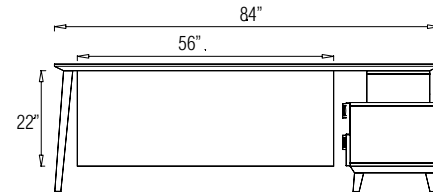
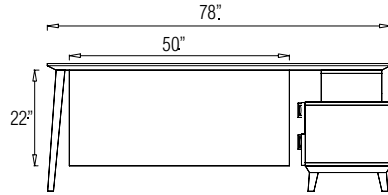
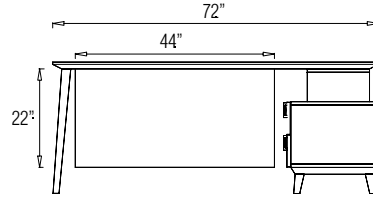
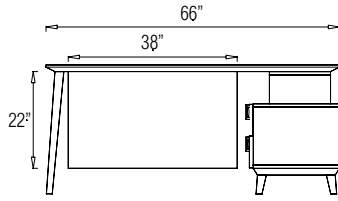

**FREESTANDING WORK TABLES
& COLLABORATION TABLES**

MODESTY SIZES:

- CBYCMWPW56H15 - 56" x 15" x 0.75"
- CBYCMWPW62H15 - 62" x 15" x 0.75"
- CBYCMWPW68H15 - 68" x 15" x 0.75"
- CBYCMWPW74H15 - 74" x 15" x 0.75"

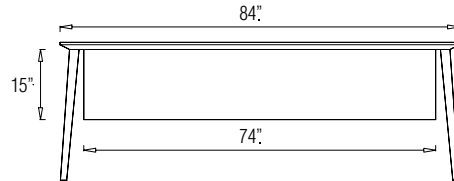
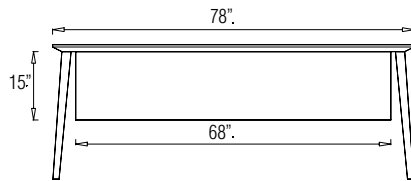
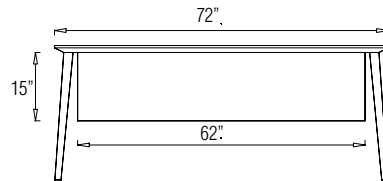
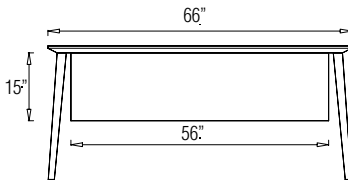

RISER BOX

- Riser Box is to be used as a spacer between the peninsula table and 20"H pedestals and credenzas
- CBYSPBOX2814 to be used with 32"D peninsula tables and executive bridges
- CBYSPBOX2014 to be used with 24"D executive bridges

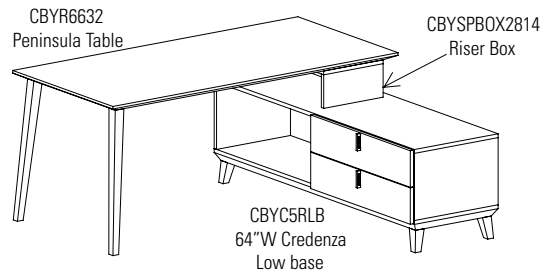
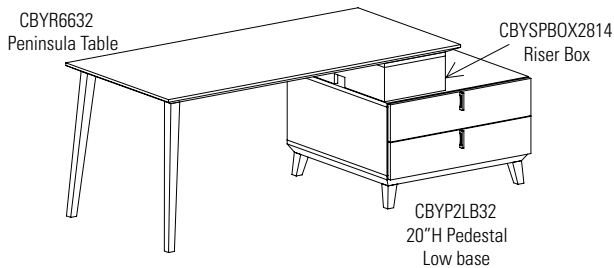

- On Peninsula Table, the Riser Box can be installed as below:

Riser Box opening is on the outside.

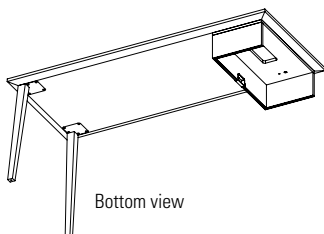

Riser Box opening is on the inside.

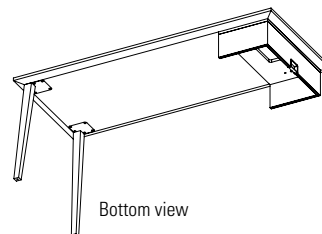

HEIGHT GRID - FLOOR UNITS, LOW BASE

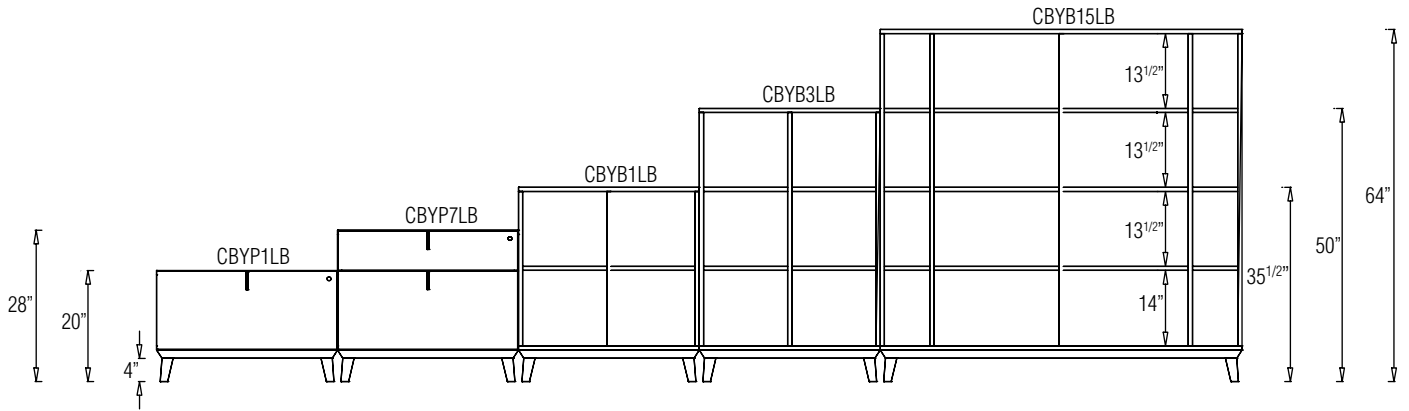

HEIGHT GRID - FLOOR UNITS, HIGH BASE

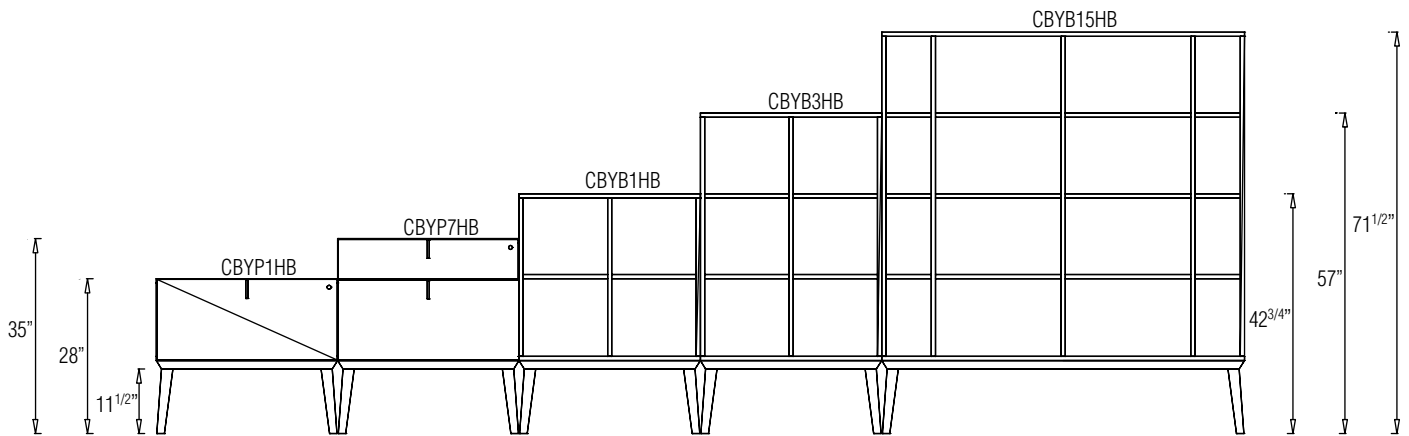

HEIGHT GRID - STACK-ON UNITS

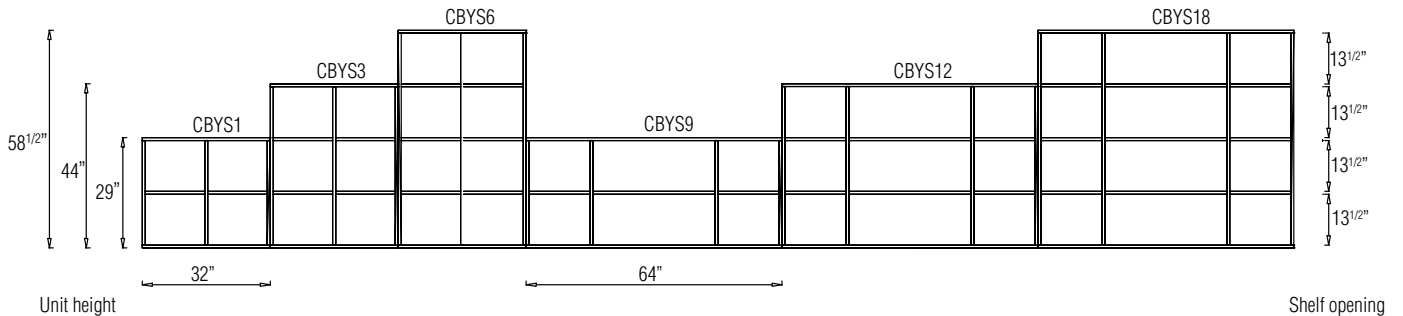

TABLES

D x W x H

- All tables are shipped Knock Down (KD). Please see assembly instructions included with product.
- Available modesty panels are 15" and 22" height
- Peninsula table has metal inserts installed for quick assembly to the pedestal or pedestal with riser box

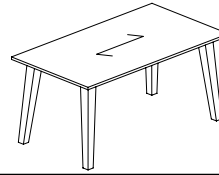

Note - Arrow indicates grain direction

TABLES + RETURNS

MODEL# DIMENSIONS FREIGHT CLASS WT/LBS. CUBIC FT. LAMINATE VENEER

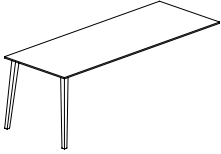

Peninsula Table

CBYR8432	32 x 84 x 29	100	119	12	\$3141	\$3925
CBYR7832	32 x 78 x 29	92.5	112	12	\$2984	\$3731
CBYR7232	32 x 72 x 29	100	105	11	\$2843	\$3555
CBYR6632	32 x 66 x 29	100	98	10	\$2697	\$3373

Table with two legs. Connects to 27.5"H storage. Must be supported by 32"D storage on one side (sold separately).



Round Table

CBY42H29	42 x 42 x 29	300	89	38	\$4458	\$5574
CBY36H29	36 x 36 x 29	300	77	31	\$4204	\$5256
CBY30H29	30 x 30 x 29	300	65	22	\$3896	\$4872

Round table with four legs.

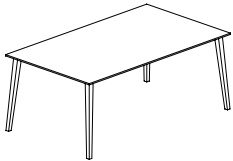

Freestanding Work Table*

CBYRT8442	42 x 84 x 29	65	170	15	\$4867	\$6084
CBYRT7842	42 x 78 x 29	92.5	161	14	\$4663	\$5828
CBYRT7242	42 x 72 x 29	65	152	13	\$4478	\$5599
CBYRT6642	42 x 66 x 29	70	142	13	\$4291	\$5364
CBYRT8432	32 x 84 x 29	65	139	12	\$4229	\$5288
CBYRT7832	32 x 78 x 29	92.5	132	12	\$4074	\$5095
CBYRT7232	32 x 72 x 29	65	125	11	\$3930	\$4914
CBYRT6632	32 x 66 x 29	65	118	10	\$3791	\$4738

Freestanding work table with four legs.



Conference Tables*

CBYRT16848	48 x 168 x 29	85	400	30	\$23637	\$29546
CBYRT14448	48 x 144 x 29	85	356	28	\$21844	\$27305
CBYRT12048	48 x 120 x 29	92.5	284	24	\$20051	\$25063
CBYRT9648	48 x 96 x 29	92.5	240	21	\$18256	\$22821
CBYRT16842	42 x 168 x 29	85	360	27	\$22069	\$27585
CBYRT14442	42 x 144 x 29	85	324	25	\$20498	\$25623
CBYRT12042	42 x 120 x 29	85	260	21	\$18931	\$23663
CBYRT9642	42 x 96 x 29	92.5	219	19	\$17361	\$21701
CBYRT16832	32 x 168 x 29	85	296	21	\$19601	\$24502
CBYRT14432	32 x 144 x 29	85	268	19	\$18256	\$22821
CBYRT12032	32 x 120 x 29	85	212	17	\$17136	\$21420
CBYRT9632	32 x 96 x 29	85	183	15	\$15792	\$19738

Freestanding conference table with six legs. 96" tables shipped in 4 cartons.

- 120", 144" and 168" tables are in two sections. Shipped in 5 cartons.

Required Specifications

Finish

Optional Specifications

Grommet
Custom cut-out*

MODESTY PANELS

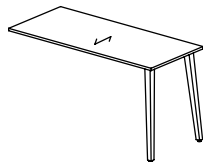
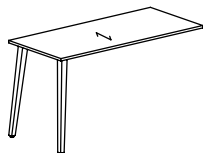
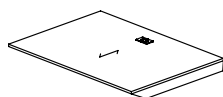
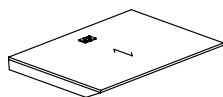
**Executive Return****Executive Bridge**

MODEL#	DIMENSIONS	FREIGHT CLASS	WT/LBS.	CUBIC FT.	LAMINATE	veneer
--------	------------	---------------	---------	-----------	----------	--------

D x W x H

Left:

CBYERL6024CG	24 x 60 x 29	70	56	3.30	\$2312	\$2891
CBYERL5424CG	24 x 54 x 29	70	50	3	\$2197	\$2746
CBYERL4824CG	24 x 48 x 29	70	45	2.60	\$2080	\$2601
CBYERL4224CG	24 x 42 x 29	70	39	2.30	\$1964	\$2456
CBYERL3624CG	24 x 36 x 29	70	34	2	\$1850	\$2314

Right:

CBYERR6024CG	24 x 60 x 29	70	56	3.30	\$2312	\$2891
CBYERR5424CG	24 x 54 x 29	70	50	3	\$2197	\$2746
CBYERR4824CG	24 x 48 x 29	70	45	2.60	\$2080	\$2601
CBYERR4224CG	24 x 42 x 29	70	39	2.30	\$1964	\$2456
CBYERR3624CG	24 x 36 x 29	70	34	2	\$1850	\$2314

Executive return with two legs. Coped edge on opposite side to connect to a freestanding work table, creating an "L" workstation. CBYERRxxxxCG has legs on right side. CBYERLxxxxCG has legs on left side.

Left:

CBY6024TLCG	24 x 60 x 29	70	56	3.30	\$1646	\$2059
CBY5424TLCG	24 x 54 x 29	70	50	3	\$1487	\$1858
CBY4824TLCG	24 x 48 x 29	70	45	2.60	\$1321	\$1654
CBY4224TLCG	24 x 42 x 29	70	39	2.30	\$1159	\$1448
CBY3624TLCG	24 x 36 x 29	70	34	2	\$992	\$1241

CBY6032TLCG	32 x 60 x 29	70	75	4.20	\$2197	\$2746
CBY5432TLCG	32 x 54 x 29	70	68	3.80	\$1983	\$2479
CBY4832TLCG	32 x 48 x 29	70	60	3.40	\$1762	\$2203
CBY4232TLCG	32 x 42 x 29	70	53	3	\$1542	\$1928
CBY3632TLCG	32 x 36 x 29	70	45	1	\$1321	\$1654

Right:

CBY6024TRCG	24 x 60 x 29	70	56	3.30	\$1646	\$2059
CBY5424TRCG	24 x 54 x 29	70	50	3	\$1487	\$1858
CBY4824TRCG	24 x 48 x 29	70	45	2.60	\$1321	\$1654
CBY4224TRCG	24 x 42 x 29	70	39	2.30	\$1159	\$1448
CBY3624TRCG	24 x 36 x 29	70	34	2	\$992	\$1241

CBY6032TRCG	32 x 60 x 29	70	75	4.20	\$2197	\$2746
CBY5432TRCG	32 x 54 x 29	70	68	3.80	\$1983	\$2479
CBY4832TRCG	32 x 48 x 29	70	60	3.40	\$1762	\$2203
CBY4232TRCG	32 x 42 x 29	70	53	3	\$1542	\$1928
CBY3632TRCG	32 x 36 x 29	70	45	1	\$1321	\$1654

Executive return with coped edge on one side to connect to a freestanding work table, overlapping a 27.5" h or 20" h storage piece (using "Riser Box", sold separately) on the opposite side. Standard with grommet.

- Available in 32" d to match cavity opening on credenzas and storage, or 24" d for a narrower workspace
- CBYxxxxTLCG units have a coped edge on the **left, forming a right return**
- CBYxxxxTRCG units have a coped edge on the **right, forming a left return**

Required Specifications

Finish

Optional SpecificationsAdditional grommet
Custom cut-out*

HEIGHT ADJUSTABLE TOPS

MODEL#	DIMENSIONS	FREIGHT CLASS	WT/LBS.	CUBIC FT.	LAMINATE	veneer
D x W x H						
CBYRE8226T	26 x 82 x 1.5	85	105	8	\$1911	\$2389
CBYRE8026T	26 x 80 x 1.5	85	103	7.5	\$1864	\$2330
CBYRE7626T	26 x 76 x 1.5	85	98	7	\$1773	\$2217
CBYRE6426T	26 x 64 x 1.5	85	84	6	\$1494	\$1867
CBYRE5226T	26 x 52 x 1.5	85	70	5	\$1215	\$1518
CBYRE4626T	26 x 46 x 1.5	85	63	4.5	\$1072	\$1340
CBYRE4026T	26 x 40 x 1.5	85	56	4	\$911	\$1168
CBYRE8229T	29 x 82 x 1.5	85	116	9	\$2131	\$2663
CBYRE7629T	29 x 76 x 1.5	85	113	8.5	\$1976	\$2470
CBYRE6429T	29 x 64 x 1.5	85	93	6.5	\$1667	\$2083
CBYRE5229T	29 x 52 x 1.5	85	77	5.5	\$1352	\$1690
CBYRE4629T	29 x 46 x 1.5	85	70	5	\$1198	\$1497
CBYRE4029T	29 x 40 x 1.5	70	62	4	\$1043	\$1303
CBYRE8235T	35 x 82 x 1.5	85	138	10	\$2574	\$3218
CBYRE7635T	35 x 76 x 1.5	85	135	9.5	\$2384	\$2980
CBYRE6435T	35 x 64 x 1.5	85	110	8	\$2011	\$2513
CBYRE5235T	35 x 52 x 1.5	85	91	6.5	\$1633	\$2040
CBYRE4635T	35 x 46 x 1.5	85	82	6	\$1441	\$1802
CBYRE4035T	35 x 40 x 1.5	85	73	5	\$1257	\$1571

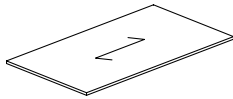

Height Adjustable Top

Corby tops with Corby edge on all sides, for use with FreeFit height adjustable table mechanisms, sold separately (FTxxxxx, see page 713 of the Desking price list for information).

- 26" deep tops accommodate FTxxx24 mechanisms. Depth is exact to accommodate the Corby edge + the Freefit mechanism. *Cannot be made smaller.*
- 29" and 35" deep tops accommodate FTxxx30 mechanisms



HA Return Tops

Left:

CBYRE6026CGCOPLT	26 x 60 x 1.5	85	80	5.5	\$1399	\$1749
CBYRE5426CGCOPLT	26 x 54 x 1.5	85	73	5	\$1262	\$1577
CBYRE4826CGCOPLT	26 x 48 x 1.5	85	66	4.5	\$1120	\$1400
CBYRE4226CGCOPLT	26 x 42 x 1.5	85	59	4	\$978	\$1222

Right:

CBYRE6026CGCOPRT	26 x 60 x 1.5	85	80	5.5	\$1399	\$1749
CBYRE5426CGCOPRT	26 x 54 x 1.5	85	73	5	\$1262	\$1577
CBYRE4826CGCOPRT	26 x 48 x 1.5	85	66	4.5	\$1120	\$1400
CBYRE4226CGCOPRT	26 x 42 x 1.5	85	59	4	\$978	\$1222

Corby return tops with Corby edge on three sides, for use with FreeFit height adjustable table mechanisms, sold separately (FTxxxxx, see page 713 of the Desking price list for information).

- 26" deep tops accommodate FTxxx24 mechanisms. Depth is exact to accommodate the Corby edge + the Freefit mechanism. *Cannot be made smaller.*

Required Specifications
Finish

Optional Specifications
Grommet

COLLABORATION TABLE

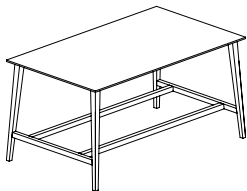

Freestanding Collaboration Table*

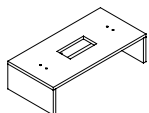

Riser Box

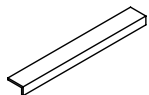

Footrest Cover

MODEL#	DIMENSIONS	FREIGHT CLASS	WT/LBS.	CUBIC FT.	LAMINATE	veneer
--------	------------	---------------	---------	-----------	----------	--------

D x W x H

CBYRTC8442	42 x 84 x 36	250	230	79	\$5957	\$7448
CBYRTC7842	42 x 78 x 36	250	211	73	\$5759	\$7199
CBYRTC7242	42 x 72 x 36	250	192	68	\$5571	\$6965
CBYRTC6642	42 x 66 x 36	250	172	62	\$5382	\$6729
CBYRTC8432	32 x 84 x 36	250	189	61	\$5318	\$6649
CBYRTC7832	32 x 78 x 36	250	172	56	\$5161	\$6453
CBYRTC7232	32 x 72 x 36	250	155	52	\$5023	\$6279
CBYRTC6632	32 x 66 x 36	250	138	48	\$4882	\$6103

Freestanding collaboration table with four legs and foot rests. Long footrests are steel and available in Brushed Chrome (**BCH**) or Black (**BLK**). Short footrests are wood and stained to match the veneer surface. Footrest covers are available as an option - please see page 15. Ships assembled.

CBYSPBOX2814	14 x 28 x 7.5	150	14	3	\$236	\$296
CBYSPBOX2014	14 x 20 x 7.5	250	2	1	\$433	\$542

Riser box for 20"H storage to support peninsula table. For wire pass through grommets, both top and back are included.

- CBYSPBOX2814 for use with 32"D peninsula tables and executive bridges.
- CBYSPBOX2014 for use with 24"D executive bridges

FRC8442	--	70	--	--	\$1216
FRC7842	--	70	--	--	\$1148
FRC7242	--	70	--	--	\$1081
FRC6642	--	70	--	--	\$1014
FRC8432	--	70	--	--	\$1081
FRC7832	--	70	--	--	\$1014
FRC7232	--	70	--	--	\$947
FRC6632	--	70	--	--	\$879

Factory installed.

Required Specifications

Finish

Optional Specifications

Lock*
Handles*

MODESTY PANELS

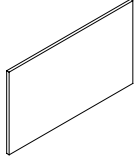

Hanging Wood Modesty Panel

MODEL#	DIMENSIONS D x W x H	FREIGHT CLASS	WT/LBS.	CUBIC FT.	LAMINATE	VENEER
CBYCMWP62H22	.75 x 62 x 22	100	28	3	\$892	\$1116
CBYCMWP56H22	.75 x 56 x 22	100	26	3	\$831	\$1040
CBYCMWP50H22	.75 x 50 x 22	100	24	3	\$783	\$980
CBYCMWP44H22	.75 x 44 x 22	92.5	22	2	\$719	\$900
CBYCMWP38H22	.75 x 38 x 22	92.5	20	2	\$660	\$826

22" hanging wood modesty panel.

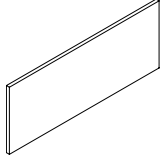

Hanging Wood Modesty Panel

CBYCMWP74H15	.75 x 74 x 15	100	24	3	\$917	\$1148
CBYCMWP68H15	.75 x 68 x 15	125	23	3	\$864	\$1081
CBYCMWP62H15	.75 x 62 x 15	92.5	21	2	\$864	\$1081
CBYCMWP56H15	.75 x 56 x 15	92.5	20	2	\$805	\$1007
CBYCMWP50H15	.75 x 50 x 15	100	18	2	\$756	\$947
CBYCMWP44H15	.75 x 44 x 15	100	17	2	\$691	\$865
CBYCMWP38H15	.75 x 38 x 15	125	15	2	\$633	\$791

15" hanging wood modesty panel.

Required Specifications

Veneer finish
Long footrest finish*

Optional Specifications

Additional grommet
Custom cut-out*

COLLABORATION MEDIA TABLES

D x W x H

COLLABORATION MEDIA TABLE (CBYxx32) AND WALL MOUNT MEDIA STORAGE (CBYFO-GM)

32" Wide, Wall Mount Media Storage

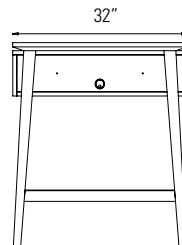
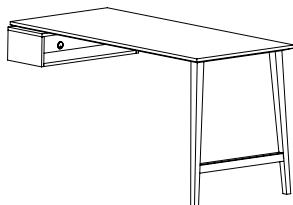

64" Wide, Wall Mount Media Storage

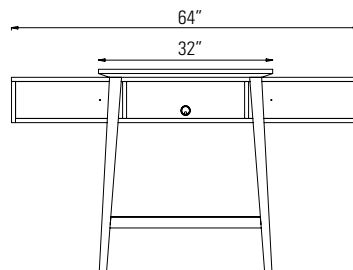
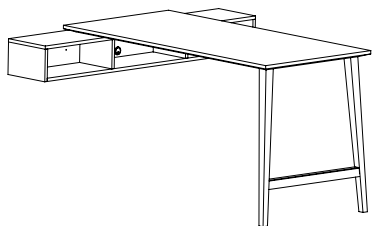

96" Wide, Wall Mount Media Storage

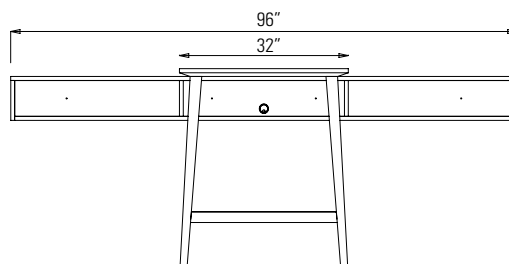
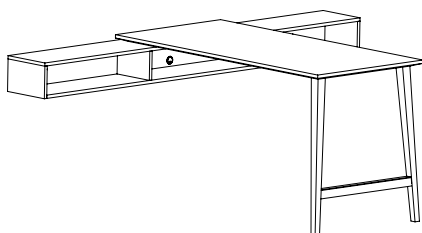

COLLABORATION MEDIA TABLES

MODEL#

DIMENSIONS

FREIGHT CLASS

WT./LBS.

CUBIC FT.

LAMINATE

VENEER

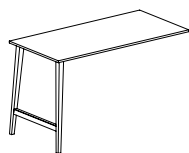

Collaboration Media Table

CBYRC8432	32 x 84 x 36	250	140	57	\$4391	\$5490
CBYRC7832	32 x 78 x 36	250	124	52	\$4228	\$5286
CBYRC7232	32 x 72 x 36	250	117	49	\$4081	\$5103
CBYRC6632	32 x 66 x 36	250	110	45	\$3930	\$4914

Table with two legs. To be used with Wall Mount Media Storage (CBYFOxxD12H8-GM).

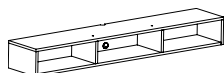

Wall Mounted Media Storage

CBYFO96D12H8-GM	12 x 96 x 8	125	78	10	\$2373	\$2967
CBYFO64D12H8-GM	12 x 64 x 8	125	50	8	\$1582	\$1979
CBYFO32D12H8-GM	12 x 32 x 8	100	35	4	\$1447	\$1810

To be used with Collaboration Media Table (CBYxx32). GM grommet on the back panel is included. For wire pass through, scoop cutouts on both top and bottom are included. Pre-drilled insert holes on top panel.

Required Specifications

Veneer finish

OCCASIONAL TABLES

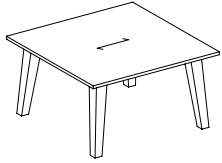

Square Occasional Table

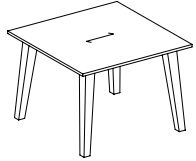

Square Occasional Table

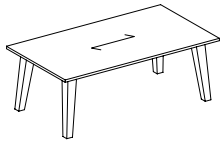

Rectangular Occasional Table

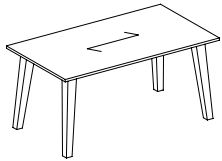

Rectangular Occasional Table



Round Occasional Table

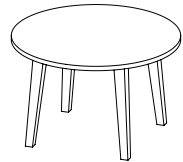

Round Occasional Table

MODEL#	DIMENSIONS D x W x H	FREIGHT CLASS	WT/LBS.	CUBIC FT.	LAMINATE	VENEER
CBYCT3636H13	36 x 36 x 13	125	73	8	\$2545	\$3181
CBYCT3030H13	30 x 30 x 13	125	59	6	\$2245	\$2809
CBYCT2424H13	24 x 24 x 13	125	47	5	\$1999	\$2500

13"H square occasional table.

CBYCT3636H17	36 x 36 x 17	150	78	9	\$2855	\$3569
CBYCT3030H17	30 x 30 x 17	150	64	7	\$2557	\$3197
CBYCT2424H17	24 x 24 x 17	125	52	6	\$2312	\$2891

17"H square occasional table.

CBYCT4820H13	48 x 20 x 13	125	61	7	\$2295	\$2869
CBYCT4220H13	42 x 20 x 13	125	57	6	\$2190	\$2738
CBYCT3620H13	36 x 20 x 13	125	52	6	\$2107	\$2634

13"H rectangular occasional table.

CBYCT4820H17	48 x 20 x 17	125	66	8	\$2608	\$3260
CBYCT4220H17	42 x 20 x 17	125	62	7	\$2498	\$3124
CBYCT3620H17	36 x 20 x 17	125	57	7	\$2421	\$3026

17"H rectangular occasional table.

CBY36H13	36 x 36 x 13	150	73	16	\$3532	\$4417
CBY30H13	30 x 30 x 13	150	59	12	\$2901	\$3627
CBY24H13	24 x 24 x 13	150	47	8	\$2643	\$3304

13"H round occasional table.

CBY36H17	36 x 36 x 17	250	78	20	\$3811	\$4766
CBY30H17	30 x 30 x 17	150	64	14	\$3224	\$4030
CBY24H17	24 x 24 x 17	150	52	10	\$2967	\$3710

17"H round occasional table.

Required Specifications

Veneer finish

32"W FREESTANDING PEDESTALS + STORAGE

D x W x H

- All pedestals and storage units are shipped assembled
- Freestanding Pedestals and Storage may be used as stand alone units or as the Peninsula Table Support (20" and 27.5" height units).
- To support the Peninsula Table with 20"H Pedestal, the Riser Box is required (see Tables / Accessories section).
- Pedestal and Storage units are available in two base heights: 4" (xxLB = Low Base) or 11.5" (xxHB = High Base)
- All drawer fronts have one vertical handle (PL89) installed.
- Front locking is standard on the Pedestals with box/file and file drawers.
- Optional locking on doors (Storage units) is available (see Accessories section).
- Optional Cushions (32" x 14") for Pedestal tops are available (see Accessories section).

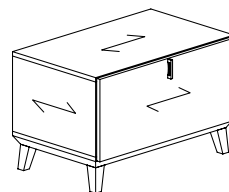
**Note** - Arrow indicates grain direction

32"W PEDESTALS - LOW BASE

MODEL#	DIMENSIONS	FREIGHT CLASS	WT/LBS.	CUBIC FT.	LAMINATE	veneer
--------	------------	---------------	---------	-----------	----------	--------

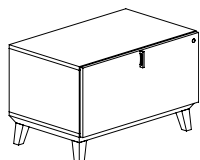
**Pedestal**

CBYP1LB	20 x 32 x 20	92.5	106	9	\$2530	\$3164
---------	--------------	------	-----	---	--------	--------

20"H freestanding pedestal with front locking lateral drawer. Low base.

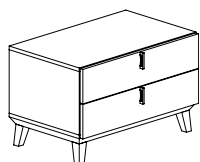
**Pedestal**

CBYP2LB	20 x 32 x 20	92.5	105	9	\$2514	\$3143
---------	--------------	------	-----	---	--------	--------

20"H freestanding pedestal with two box drawers. Low base.

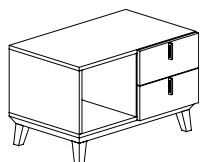
**Pedestal**

CBYP3LB	20 x 32 x 20	92.5	105	9	\$2672	\$3341
---------	--------------	------	-----	---	--------	--------

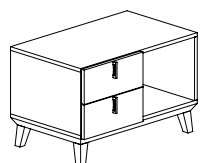
20"H freestanding pedestal with open cabinet on **left**, two box drawers on **right**. Low base.**Pedestal**

CBYP4LB	20 x 32 x 20	92.5	105	9	\$2672	\$3341
---------	--------------	------	-----	---	--------	--------

20"H freestanding pedestal with open cabinet on **right**, two box drawers on **left**. Low base.**Required Specifications**

Veneer finish

32"W PEDESTALS - LOW BASE

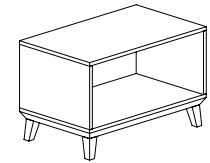

Pedestal

MODEL#	DIMENSIONS D x W x H	FREIGHT CLASS	WT/LBS.	CUBIC FT.	LAMINATE	veneer
CBYP5LB	20 x 32 x 20	100	86	9	\$2190	\$2738

20"H freestanding pedestal with open cabinet. Low base.

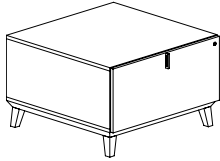

Pedestal

CBYP1LB32	32 x 32 x 20	100	136	14	\$2687	\$3360
-----------	--------------	-----	-----	----	---------------	---------------

20"H freestanding pedestal with front locking lateral drawer. Can be used to support peninsula table in conjunction with optional riser box ("CBYSPBOX2814"). Low base.

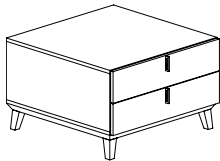

Pedestal

CBYP2LB32	32 x 32 x 20	100	135	14	\$2672	\$3341
-----------	--------------	-----	-----	----	---------------	---------------

20"H freestanding pedestal with two box drawers. Can be used to support peninsula table in conjunction with optional riser box ("CBYSPBOX2814"). Low base.

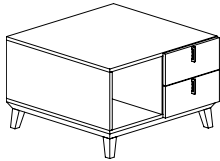

Pedestal

CBYP3LB32	32 x 32 x 20	100	135	14	\$2826	\$3534
-----------	--------------	-----	-----	----	---------------	---------------

20"H freestanding pedestal with open cabinet on **left**, two box drawers on **right**. Can be used to support peninsula table in conjunction with optional riser box ("CBYSPBOX2814"). Low base.

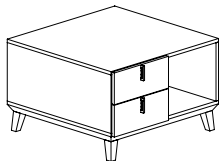

Pedestal

CBYP4LB32	32 x 32 x 20	100	135	14	\$2826	\$3534
-----------	--------------	-----	-----	----	---------------	---------------

20"H freestanding pedestal with open cabinet on **right**, two box drawers on **left**. Can be used to support peninsula table in conjunction with optional riser box ("CBYSPBOX2814"). Low base.

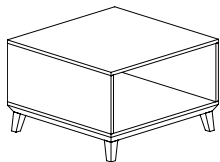

Pedestal

CBYP5LB32	32 x 32 x 20	100	135	14	\$2342	\$2929
-----------	--------------	-----	-----	----	---------------	---------------

20"H freestanding pedestal with open cabinet. Can be used to support peninsula table in conjunction with optional riser box ("CBYSPBOX2814"). Low base.

Required Specifications
Veneer finish

Optional Specifications

32"W PEDESTALS - LOW BASE

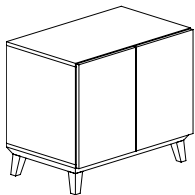

Pedestal*

MODEL#	DIMENSIONS	FREIGHT CLASS	WT/LBS.	CUBIC FT.	LAMINATE	VENEER
	D x W x H					
CBYP6LB	20 x 32 x 27.5	100	117	12	\$2655	\$3320

27.5"H freestanding storage cabinet with two doors, one adjustable shelf. Low base.

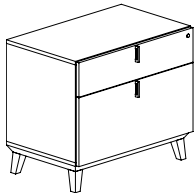

Pedestal

CBYP7LB	20 x 32 x 27.5	92.5	124	12	\$3388	\$4235
---------	----------------	------	-----	----	--------	--------

27.5"H freestanding pedestal with front locking lateral and box drawer. Low base.

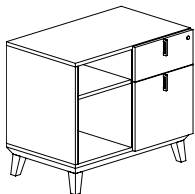

Pedestal

CBYP8LB	20 x 32 x 27.5	92.5	124	12	\$3541	\$4427
---------	----------------	------	-----	----	--------	--------

27.5"H freestanding pedestal with open fixed shelf on **left**, front locking box file drawer on **right**. Low base.

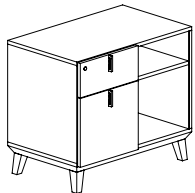

Pedestal

CBYP9LB	20 x 32 x 27.5	92.5	124	12	\$3541	\$4427
---------	----------------	------	-----	----	--------	--------

27.5"H freestanding pedestal with open fixed shelf on **right**, front locking box file drawer on **left**. Low base.

32"W PEDESTALS - HIGH BASE

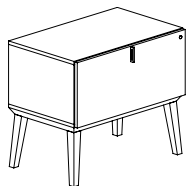

Pedestal

CBYP1HB	20 x 32 x 27.5	100	111	12	\$2843	\$3555
---------	----------------	-----	-----	----	--------	--------

27.5"H freestanding pedestal with front locking lateral drawer. High base.

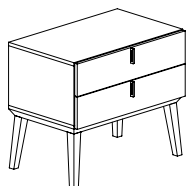

Pedestal

CBYP2HB	20 x 32 x 27.5	100	111	12	\$2826	\$3534
---------	----------------	-----	-----	----	--------	--------

27.5"H freestanding pedestal with two box drawers. High base.

Required Specifications

Veneer finish

Optional Specifications

Lock*
Handles*

32"W PEDESTALS - HIGH BASE

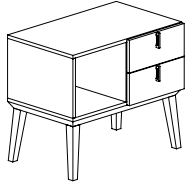

Pedestal

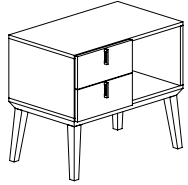

Pedestal

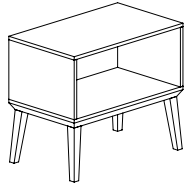

Pedestal

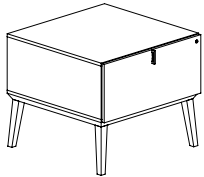

Pedestal

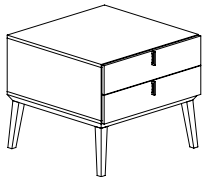

Pedestal

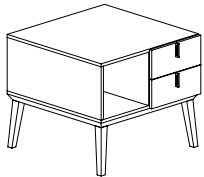

Pedestal

MODEL#	DIMENSIONS D x W x H	FREIGHT CLASS	WT/LBS.	CUBIC FT.	LAMINATE	veneer
CBYP3HB	20 x 32 x 27.5	100	111	12	\$2672	\$3341

27.5"H freestanding pedestal with open cabinet on **left**, two box drawers on **right**. High base.

CBYP4HB	20 x 32 x 27.5	100	110	12	\$2672	\$3341
---------	----------------	-----	-----	----	---------------	---------------

27.5"H freestanding pedestal with open cabinet on **right**, two box drawers on **left**. High base.

CBYP5HB	20 x 32 x 27.5	125	91	12	\$2190	\$2738
---------	----------------	-----	----	----	---------------	---------------

27.5"H freestanding pedestal with open cabinet. High base.

CBYP1HB32	32 x 32 x 27.5	125	141	18	\$2998	\$3749
-----------	----------------	-----	-----	----	---------------	---------------

27.5"H freestanding pedestal with front locking lateral drawer. Can be used to support peninsula table. High base.

CBYP2HB32	32 x 32 x 27.5	125	140	18	\$2909	\$3731
-----------	----------------	-----	-----	----	---------------	---------------

27.5"H freestanding pedestal with two box drawers. Can be used to support peninsula table. High base.

CBYP3HB32	32 x 32 x 27.5	125	140	18	\$2826	\$3534
-----------	----------------	-----	-----	----	---------------	---------------

27.5"H freestanding pedestal with open cabinet on **left**, two box drawers on **right**. Can be used to support peninsula table. High base.

Required Specifications
Veneer finish

Optional Specifications

64"W AND 96"W FREESTANDING CREDENZAS

MODEL#	DIMENSIONS	FREIGHT CLASS	WT./LBS.	CUBIC FT.	LAMINATE	VENEER
	D x W x H					
CBYP4HB32	32 x 32 x 27.5	125	140	18	\$2826	\$3534
CBYP5HB32	32 x 32 x 27.5	125	121	18	\$2342	\$2929
CBYP6HB	20 x 32 x 35	100	129	15	\$2967	\$3710
CBYP7HB	20 x 32 x 35	100	129	15	\$3700	\$4625
CBYP8HB	20 x 32 x 35	100	132	15	\$3855	\$4819
CBYP9HB	20 x 32 x 35	100	132	15	\$3855	\$4819

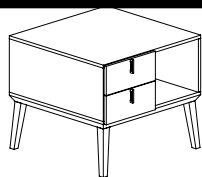
**Pedestal**

27.5"H freestanding pedestal with open cabinet on **right**, two box drawers on **left**. Can be used to support peninsula table. High base.

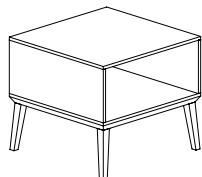
**Pedestal**

27.5"H freestanding pedestal with open cabinet. Can be used to support peninsula table. High base.

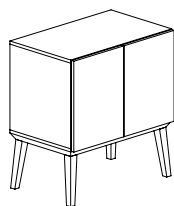
**Pedestal***

35"H freestanding storage cabinet with two doors, one adjustable shelf. High base.

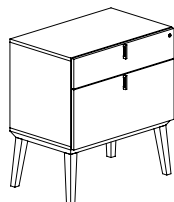
**Pedestal**

35"H freestanding pedestal with front locking lateral and box drawer. High base.

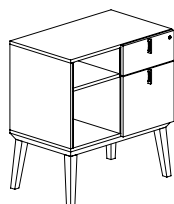
**Pedestal**

35"H freestanding pedestal open with fixed shelf on **left**, front locking box file drawer on **right**. High base.

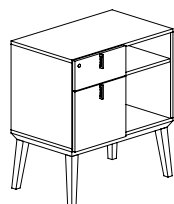
**Pedestal**

35"H freestanding pedestal open with fixed shelf on **right**, front locking box file drawer on **left**. High base.

Required Specifications

Veneer finish

Optional SpecificationsLock*
Handles*

64"W AND 96"W FREESTANDING CREDENZAS

D x W x H

- All Credenzas are shipped assembled.
- Freestanding Credenzas may be used as stand alone units or as the Peninsula Table Support (20" and 27.5" Height units)
- To support the Peninsula Table with 20"H Credenza, the Riser Box is required (see Tables or Accessories section).
- Credenza units are available in two base heights: 4" (xxLB = Low Base), or 11.5" (xxHB = High Base).
- All drawer fronts have vertical handle (PL89) installed where indicated.
- Front locking is standard on the Credenzas with box/lateral and lateral drawers.
- Optional locking on doors (Storage units) is available (see Accessories section).
- Optional Cushions (32" x 14") for Credenza tops are available (see Accessories section).

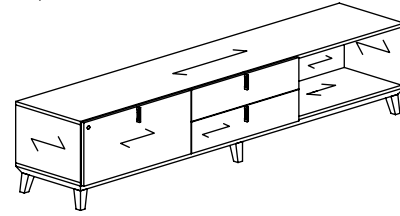

Note - Arrow indicates grain direction

64"W FREESTANDING CREDENZAS - LOW BASE

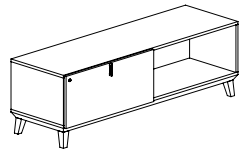

Credenza

MODEL#	DIMENSIONS	FREIGHT CLASS	WT/LBS.	CUBIC FT.	LAMINATE	VENEER
CBYC1LLB	20 x 64 x 20	125	161	17	\$4478	\$5599

Freestanding credenza with front locking lateral drawer on **left**, open on **right**. Low base.

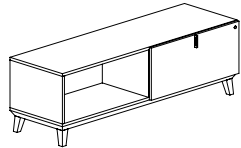

Credenza

CBYC1RLB	20 x 64 x 20	125	161	17	\$4478	\$5599
----------	--------------	-----	-----	----	--------	--------

Freestanding credenza with front locking lateral drawer on **right**, open on **left**. Low base.

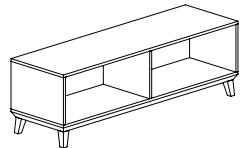

Credenza

CBYC2LB	20 x 64 x 20	100	141	17	\$3822	\$4779
---------	--------------	-----	-----	----	--------	--------

Freestanding credenza, open on left and right. Low base.

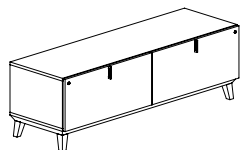

Credenza

CBYC3LB	20 x 64 x 20	92.5	180	17	\$4977	\$6224
---------	--------------	------	-----	----	--------	--------

Freestanding credenza, two front locking lateral drawers. Low base.

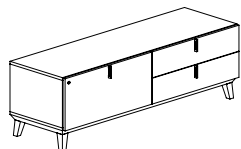

Credenza

CBYC4LLB	20 x 64 x 20	92.5	179	17	\$4964	\$6205
----------	--------------	------	-----	----	--------	--------

Freestanding credenza, front locking lateral drawer on **left**, two box drawers **right**. Low base.

Required Specifications

Veneer finish

Optional Specifications

64"W FREESTANDING CREDENZAS - LOW BASE

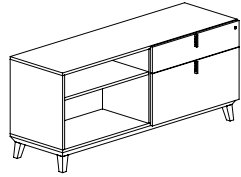

Credenza**

MODEL#	DIMENSIONS D x W x H	FREIGHT CLASS	WT/LBS.	CUBIC FT.	LAMINATE	VENEER
CBYC8RLB	20 x 64 x 27.5	100	194	23	\$5337	\$6671

Freestanding credenza, front locking lateral drawer with box drawer on **right**, open with fixed shelf on **left**. Low base.

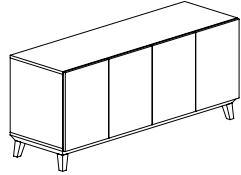

Credenza*

CBYC9LB	20 x 64 x 27.5	100	189	23	\$5306	\$6635
---------	----------------	-----	-----	----	--------	--------

Freestanding storage credenza, four doors with two adjustable shelves. Low base.

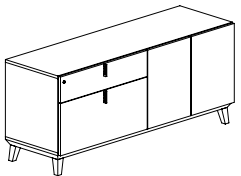

Credenza*

CBYC10LLB	20 x 64 x 27.5	100	206	23	\$5644	\$7057
-----------	----------------	-----	-----	----	--------	--------

Freestanding credenza, front locking lateral drawer with box drawer on **left**, two doors with adjustable shelf on **right**. Low base.

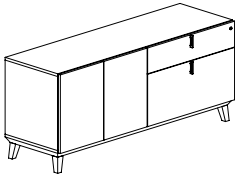

Credenza*

CBYC10RLB	20 x 64 x 27.5	100	206	23	\$5644	\$7057
-----------	----------------	-----	-----	----	--------	--------

Freestanding credenza, front locking lateral drawer with box drawer on **right**, two doors with adjustable shelf on **left**. Low base.

64"W FREESTANDING CREDENZAS - HIGH BASE

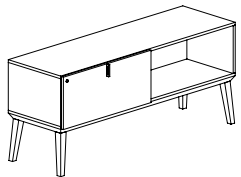

Credenza**

MODEL#	DIMENSIONS	FREIGHT CLASS	WT/LBS.	CUBIC FT.	LAMINATE	VENEER
CBYC1LHB	20 x 64 x 27.5	125	166	23	\$4791	\$5990

Freestanding credenza with front locking lateral drawer on **left**, open on **right**. High base.

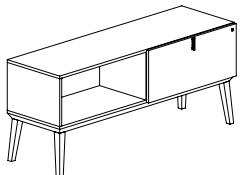

Credenza**

CBYC1RHB	20 x 64 x 27.5	125	166	23	\$4791	\$5990
----------	----------------	-----	-----	----	--------	--------

Freestanding credenza with front locking lateral drawer on **right**, open on **left**. High base.

Required Specifications
Veneer finish

Optional Specifications
Lock*
Handles*
Wire management (C275)**

64"W FREESTANDING CREDENZAS - HIGH BASE

MODEL#	DIMENSIONS	FREIGHT CLASS	WT/LBS.	CUBIC FT.	LAMINATE	veneer
--------	------------	---------------	---------	-----------	----------	--------

D x W x H

MODEL#	D x W x H	FREIGHT CLASS	WT/LBS.	CUBIC FT.	LAMINATE	veneer
--------	-----------	---------------	---------	-----------	----------	--------

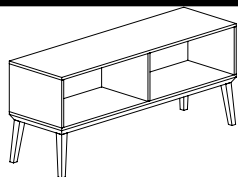

Credenza*

Freestanding credenza open on **left** and **right**. High base.

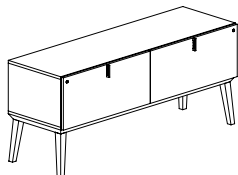

Credenza

MODEL#	D x W x H	FREIGHT CLASS	WT/LBS.	CUBIC FT.	LAMINATE	veneer
--------	-----------	---------------	---------	-----------	----------	--------

Freestanding credenza, two front locking lateral drawers. High base.

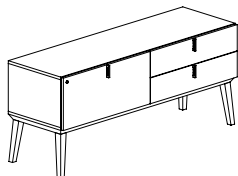

Credenza

MODEL#	D x W x H	FREIGHT CLASS	WT/LBS.	CUBIC FT.	LAMINATE	veneer
--------	-----------	---------------	---------	-----------	----------	--------

Freestanding credenza, front locking lateral drawer on **left**, two box drawers on **right**. High base.

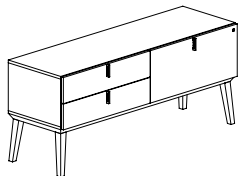

Credenza

MODEL#	D x W x H	FREIGHT CLASS	WT/LBS.	CUBIC FT.	LAMINATE	veneer
--------	-----------	---------------	---------	-----------	----------	--------

Freestanding credenza, front locking lateral drawer on **right**, two box drawers on **left**. High base.

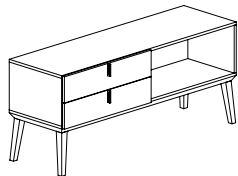

Credenza*

MODEL#	D x W x H	FREIGHT CLASS	WT/LBS.	CUBIC FT.	LAMINATE	veneer
--------	-----------	---------------	---------	-----------	----------	--------

Freestanding credenza, two box drawers on **left**, open on **right**. High base.

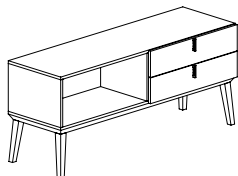

Credenza*

MODEL#	D x W x H	FREIGHT CLASS	WT/LBS.	CUBIC FT.	LAMINATE	veneer
--------	-----------	---------------	---------	-----------	----------	--------

Freestanding credenza, two box drawers on **right**, open on **left**. High base.

Required Specifications

Veneer finish
Laminate finish

Optional Specifications

Lock*
Handles*

64"W FREESTANDING CREDENZAS - HIGH BASE

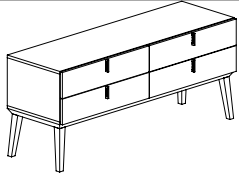

Credenza

MODEL#	DIMENSIONS D x W x H	FREIGHT CLASS	WT/LBS.	CUBIC FT.	LAMINATE	VENEER
CBYC6HB	20 x 64 x 27.5	100	184	23	\$5104	\$6380

Freestanding credenza with four box drawers. High base.

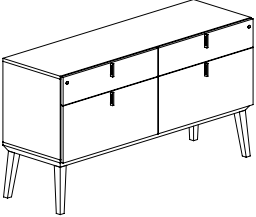

Credenza

CBYC7HB	20 x 64 x 35	125	218	29	\$6320	\$7901
---------	--------------	-----	-----	----	---------------	---------------

Freestanding credenza, front locking lateral drawer with box drawer on **left** and **right**. High base.

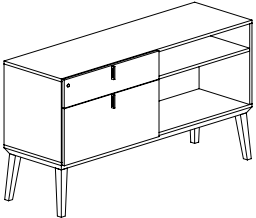

Credenza

CBYC8LHB	20 x 64 x 35	125	199	29	\$5644	\$7057
----------	--------------	-----	-----	----	---------------	---------------

Freestanding credenza, front locking lateral with box drawer on **left**, open with fixed shelf on **right**. High base.

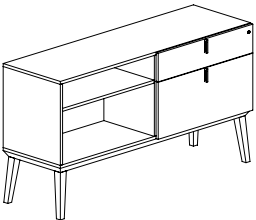

Credenza

CBYC8RHB	20 x 64 x 35	125	199	29	\$5644	\$7057
----------	--------------	-----	-----	----	---------------	---------------

Freestanding credenza, front locking lateral with box drawer on **right**, open with fixed shelf on **left**. High base.

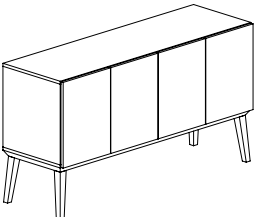

Credenza*

CBYC9HB	20 x 64 x 35	125	194	29	\$5614	\$7017
---------	--------------	-----	-----	----	---------------	---------------

Freestanding storage credenza, four doors with two adjustable shelves. High base.

Required Specifications

Veneer finish
Laminate finish

Optional Specifications

Lock*
Handles*

64"W FREESTANDING CREDENZAS - HIGH BASE

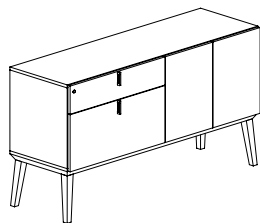

Credenza*

MODEL#	DIMENSIONS	FREIGHT CLASS	WT/LBS.	CUBIC FT.	LAMINATE	VENEER
	D x W x H					
CBYC10LHB	20 x 64 x 35	125	211	29	\$5957	\$7448

Freestanding credenza, front locking lateral with box drawer on **left**, two doors with adjustable shelf on **right**. High base.

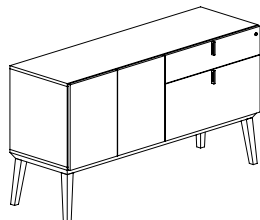

Credenza*

CBYC10RHB	20 x 64 x 35	125	211	29	\$5957	\$7448
-----------	--------------	-----	-----	----	--------	--------

Freestanding credenza, front locking lateral with box drawer on **right**, two doors with adjustable shelf on **left**. High base.

96"W FREESTANDING CREDENZAS - LOW BASE

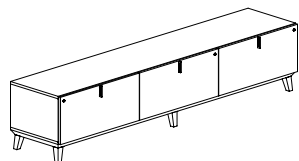

Credenza

MODEL#	DIMENSIONS	FREIGHT CLASS	WT/LBS.	CUBIC FT.	LAMINATE	VENEER
CBYC11LB	20 x 96 x 20	92.5	259	25	\$7427	\$9284

Freestanding credenza, three front locking lateral drawers. Low base.

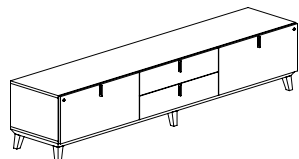

Credenza

CBYC12LB	20 x 96 x 20	92.5	258	25	\$7411	\$9265
----------	--------------	------	-----	----	--------	--------

Freestanding credenza, front locking lateral drawer on **left**, two box drawers **center**, and front locking lateral drawer on **right**. Low base.

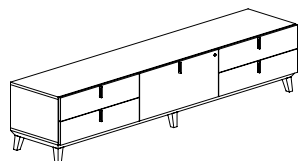

Credenza

CBYC13LB	20 x 96 x 20	92.5	258	25	\$7394	\$9243
----------	--------------	------	-----	----	--------	--------

Freestanding credenza, two box drawers on **left**, front locking lateral drawer **center**, and two box drawers on **right**. Low base.

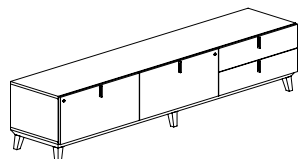

Credenza

CBYC14LB	20 x 96 x 20	92.5	258	25	\$7411	\$9265
----------	--------------	------	-----	----	--------	--------

Freestanding credenza, front locking lateral drawers **left** and **center**, and two box drawers on **right**. Low base.

Required Specifications

Veneer finish
Laminate finish

Optional Specifications

Lock*
Handles*

96"W FREESTANDING CREDENZAS - LOW BASE

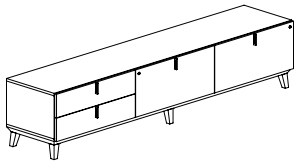

Credenza

MODEL#	DIMENSIONS D x W x H	FREIGHT CLASS	WT/LBS.	CUBIC FT.	LAMINATE	ENEER
CBYC15LB	20 x 96 x 20	92.5	258	25	\$7411	\$9265

Freestanding credenza, two box drawers on **left**, front locking lateral drawer **center** and **right**. Low base.

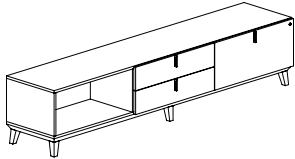

Credenza

CBYC16LB	20 x 96 x 20	100	239	25	\$6911	\$8640
----------	--------------	-----	-----	----	---------------	---------------

Freestanding credenza, open on **left**, two box drawers **center**, and front locking lateral drawer on **right**. Low base.

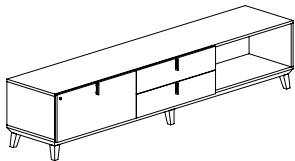

Credenza

CBYC17LB	20 x 96 x 20	100	239	25	\$6911	\$8640
----------	--------------	-----	-----	----	---------------	---------------

Freestanding credenza, front locking lateral drawer on **left**, two box drawers **center**, and open on **right**. Low base.

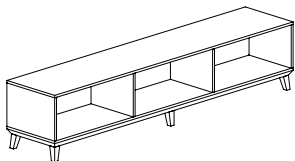

Credenza

CBYC18LB	20 x 96 x 20	100	201	25	\$5927	\$7409
----------	--------------	-----	-----	----	---------------	---------------

Freestanding credenza, open **left**, **center** and **right**. Low base.

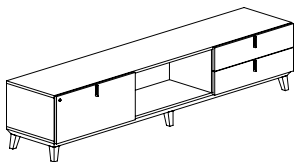

Credenza

CBYC19LB	20 x 96 x 20	100	239	25	\$6911	\$8640
----------	--------------	-----	-----	----	---------------	---------------

Freestanding credenza, front locking lateral drawer on **left**, open **center**, and two box drawers on **right**. Low base.

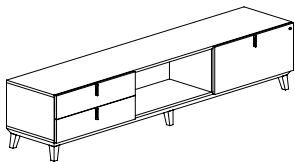

Credenza

CBYC20LB	20 x 96 x 20	100	239	25	\$6911	\$8640
----------	--------------	-----	-----	----	---------------	---------------

Freestanding credenza, two box drawers on **left**, open **center**, and front locking lateral drawer on **right**. Low base.

Required Specifications

- Veneer finish
- Laminate finish

96"W FREESTANDING CREDENZAS - LOW BASE

MODEL#	DIMENSIONS	FREIGHT CLASS	WT/LBS.	CUBIC FT.	LAMINATE	VENEER
	D x W x H					
CBYC21LB	20 x 96 x 20	100	225	25	\$6549	\$8188
CBYC22LB	20 x 96 x 20	100	217	25	\$6393	\$7992
CBYC23LB	20 x 96 x 20	92.5	256	25	\$7377	\$9222
CBYC24LB	20 x 96 x 27.5	100	304	34	\$8158	\$10199
CBYC25LB	20 x 96 x 27.5	100	284	34	\$7411	\$9265
CBYC26LB	20 x 96 x 27.5	100	296	34	\$7566	\$9459

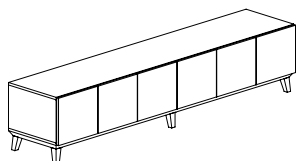

Credenza*

Freestanding storage credenza with six doors. Low base.

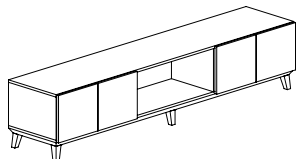

Credenza*

Freestanding storage credenza with two doors on **left**, open **center**, and two doors on **right**. Low base.

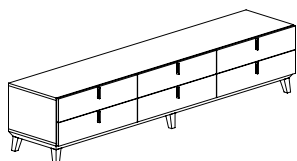

Credenza

Freestanding credenza with six box drawers. Low base.

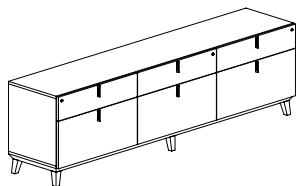

Credenza

Freestanding credenza, front locking lateral drawer with box drawer **left**, **center** and **right**. Low base.

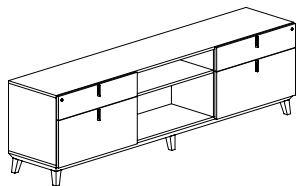

Credenza**

Freestanding credenza, front locking lateral drawer with box drawer on **left**, open with fixed shelf **center**, and front locking lateral drawer with box drawer on **right**. Low base.

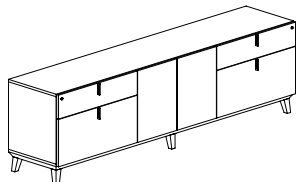

Credenza*

Freestanding credenza, front locking lateral drawer with box drawer on **left**, two door storage with adjustable shelf **center**, and front locking lateral drawer with box drawer on **right**. Low base.

Required Specifications

Veneer finish
Laminate finish

Optional Specifications

Lock
Handles
Wire management (C275)*

96"W FREESTANDING CREDENZAS - LOW BASE

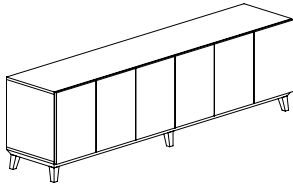

Credenza

MODEL#	DIMENSIONS D x W x H	FREIGHT CLASS	WT/LBS.	CUBIC FT.	LAMINATE	veneer
CBYC27LB	20 x 96 x 27.5	100	281	34	\$7018	\$8773

Freestanding storage credenza, six doors with three adjustable shelves. Low base.

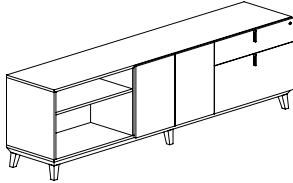

Credenza*

CBYC28LB	20 x 96 x 27.5	100	277	34	\$6818	\$8524
----------	----------------	-----	-----	----	---------------	---------------

Freestanding credenza, open with fixed shelf on **left**, two door storage with adjustable shelf **center**, and front locking lateral drawer with box drawer on **right**. Low base.

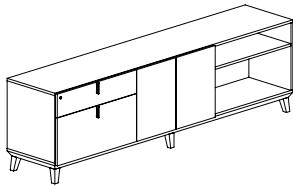

Credenza*

CBYC29LB	20 x 96 x 27.5	100	277	34	\$6818	\$8524
----------	----------------	-----	-----	----	---------------	---------------

Freestanding credenza, front locking lateral drawer with box drawer on **left**, two door storage with adjustable shelf **center**, and open with fixed shelf on **right**. Low base.

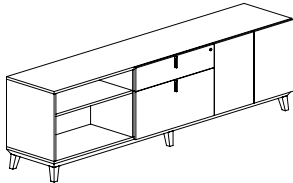

Credenza*

CBYC30LB	20 x 96 x 27.5	100	277	34	\$6818	\$8524
----------	----------------	-----	-----	----	---------------	---------------

Freestanding credenza, open with fixed shelf on **left**, front locking lateral drawer with box drawer **center**, and two door storage with adjustable shelf on **right**. Low base.

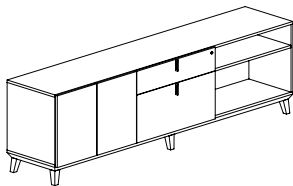

Credenza*

CBYC31LB	20 x 96 x 27.5	100	277	34	\$6818	\$8524
----------	----------------	-----	-----	----	---------------	---------------

Freestanding credenza, two door storage with adjustable shelf on **left**, front locking lateral drawer with box drawer **center**, and open with fixed shelf on **right**. Low base.

Required Specifications

Veneer finish
Laminate finish

Optional Specifications

Lock
Handles
Wire management (C275)*

96"W FREESTANDING CREDENZAS - LOW BASE

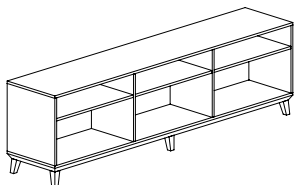

Credenza*

MODEL#	DIMENSIONS	FREIGHT CLASS	WT/LBS.	CUBIC FT.	LAMINATE	VENEER
--------	------------	---------------	---------	-----------	----------	--------

D x W x H						
CBYC32LB	20 x 96 x 27.5	125	277	34	\$6549	\$8188

Freestanding credenza, open with fixed shelf **left, center** and **right**. Low base.

96"W FREESTANDING CREDENZAS - HIGH BASE

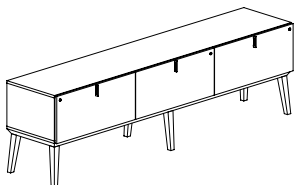

Credenza

MODEL#	DIMENSIONS	FREIGHT CLASS	WT/LBS.	CUBIC FT.	LAMINATE	VENEER
--------	------------	---------------	---------	-----------	----------	--------

CBYC11HB	20 x 96 x 27.5	125	264	34	\$7739	\$9675
----------	----------------	-----	-----	----	--------	--------

Freestanding credenza, three front locking lateral drawers. High base.

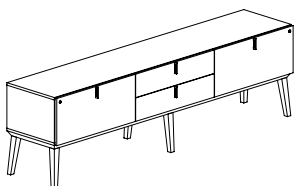

Credenza

CBYC12HB	20 x 96 x 27.5	125	263	34	\$7723	\$9654
----------	----------------	-----	-----	----	--------	--------

Freestanding credenza, front locking lateral drawer on **left**, two box drawers **center**, and front locking lateral drawer on **right**. High base.

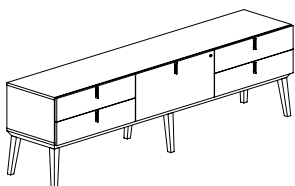

Credenza

CBYC13HB	20 x 96 x 27.5	125	263	34	\$7706	\$9634
----------	----------------	-----	-----	----	--------	--------

Freestanding credenza, two box drawers on **left**, front locking lateral drawer **center**, and two box drawers on **right**. High base.

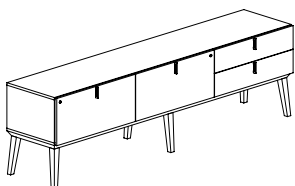

Credenza

CBYC14HB	20 x 96 x 27.5	125	263	34	\$7723	\$9654
----------	----------------	-----	-----	----	--------	--------

Freestanding credenza, front locking lateral drawer on **left** and **center**, two box drawers on **right**. High base.

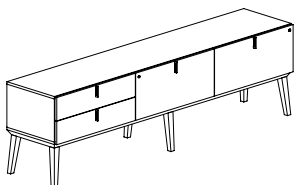

Credenza

CBYC15HB	20 x 96 x 27.5	125	263	34	\$7723	\$9654
----------	----------------	-----	-----	----	--------	--------

Freestanding credenza, two box drawers on **left** and front locking lateral drawer **center** and **right**. High base.

Required Specifications

Veneer finish
Laminate finish

Optional Specifications

Wire management (C275)*

96"W FREESTANDING CREDENZAS - HIGH BASE

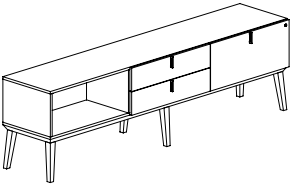

Credenza*

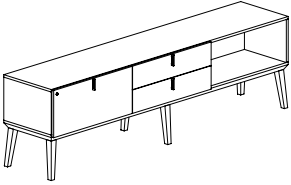

Credenza*

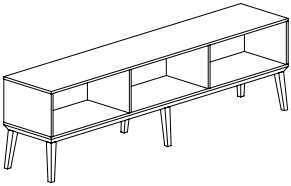

Credenza*

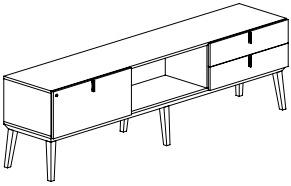

Credenza*

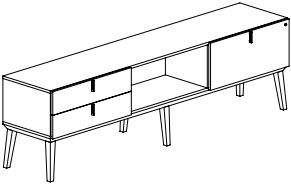

Credenza*

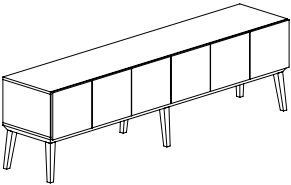

Credenza**

MODEL#	DIMENSIONS D x W x H	FREIGHT CLASS	WT/LBS.	CUBIC FT.	LAMINATE	VENEER
CBYC16HB	20 x 96 x 27.5	125	244	34	\$7223	\$9030
Freestanding credenza, open on left , two box drawers center , and front locking lateral drawer on right . High base.						
CBYC17HB	20 x 96 x 27.5	125	244	34	\$7223	\$9030
Freestanding credenza, front locking lateral drawer on left , two box drawers center , and open on right . High base.						
CBYC18HB	20 x 96 x 27.5	125	206	34	\$6236	\$7797
Freestanding credenza, open left , center and right . High base.						
CBYC19HB	20 x 96 x 27.5	125	244	34	\$7223	\$9030
Freestanding credenza, front locking lateral drawer on left , open center , and two box drawers on right . High base.						
CBYC20HB	20 x 96 x 27.5	125	244	34	\$7223	\$9030
Freestanding credenza, two box drawers on left , open center , and front locking lateral drawer on right . High base.						
CBYC21HB	20 x 96 x 27.5	125	230	34	\$6863	\$8578
Freestanding storage credenza, six doors. High base.						

Required Specifications

Veneer finish
Laminate finish

Optional Specifications

Wire management (C275)*
Lock**
Handles**

96"W FREESTANDING CREDENZAS - HIGH BASE

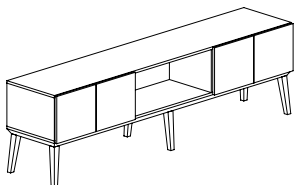

Credenza**

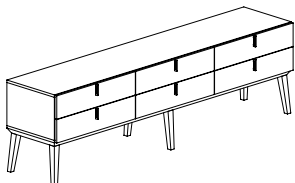

Credenza

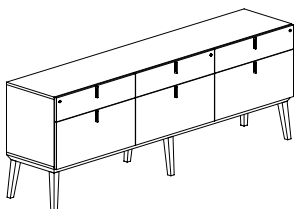

Credenza

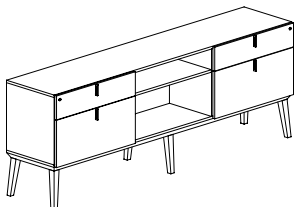

Credenza

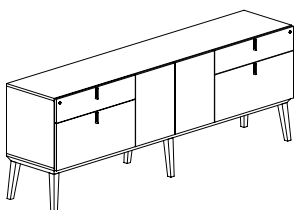

Credenza*

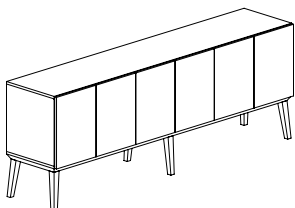

Credenza*

MODEL#	DIMENSIONS	FREIGHT CLASS	WT/LBS.	CUBIC FT.	LAMINATE	VENEER
--------	------------	---------------	---------	-----------	----------	--------

D x W x H

CBYC22HB	20 x 96 x 27.5	125	222	34	\$6705	\$8382
----------	----------------	-----	-----	----	--------	--------

Freestanding storage credenza with two doors on **left**, open **center**, and two doors on **right**. High base.

CBYC23HB	20 x 96 x 27.5	125	261	34	\$7690	\$9613
----------	----------------	-----	-----	----	--------	--------

Freestanding credenza with six box drawers. High base.

CBYC24HB	20 x 96 x 35	125	309	43	\$8469	\$10587
----------	--------------	-----	-----	----	--------	---------

Freestanding credenza, front locking lateral drawer with box drawer **left**, **center** and **right**. High base.

CBYC25HB	20 x 96 x 35	125	289	43	\$7723	\$9654
----------	--------------	-----	-----	----	--------	--------

Freestanding credenza, front locking lateral drawer with box drawer on **left**, open with fixed shelf **center**, and front locking lateral drawer with box drawer on **right**. High base.

CBYC26HB	20 x 96 x 35	125	301	43	\$7876	\$9847
----------	--------------	-----	-----	----	--------	--------

Freestanding credenza, front locking lateral drawer with box drawer on **left**, two door storage with adjustable shelf **center**, and front locking lateral drawer with box drawer on **right**. High base.

CBYC27HB	20 x 96 x 35	125	286	43	\$7331	\$9164
----------	--------------	-----	-----	----	--------	--------

Freestanding storage credenza, six doors with three adjustable shelves. High base.

Required Specifications

Veneer finish
Laminate finish

Optional Specifications

Lock*
Handles*
Wire management (C275)**

96"W FREESTANDING CRENZAS - HIGH BASE

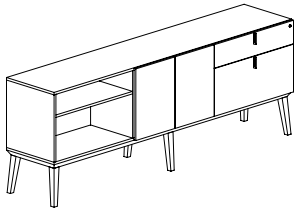

Credenza*

MODEL#	DIMENSIONS D x W x H	FREIGHT CLASS	WT/LBS.	CUBIC FT.	LAMINATE	veneer
CBYC28HB	20 x 96 x 35	125	282	43	\$7131	\$8915

Freestanding credenza, open with fixed shelf on **left**, two door storage with adjustable shelf **center**, and front locking lateral drawer with box drawer on **right**. High base.

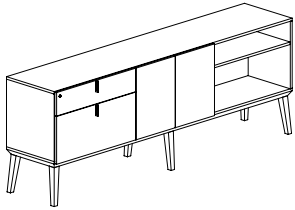

Credenza*

CBYC29HB	20 x 96 x 35	125	282	43	\$7131	\$8915
----------	--------------	-----	-----	----	---------------	---------------

Freestanding credenza, front locking lateral drawer with box drawer on **left**, two door storage with adjustable shelf **center**, and open with fixed shelf on **right**. High base.

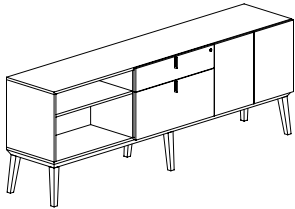

Credenza*

CBYC30HB	20 x 96 x 35	125	282	43	\$7131	\$8915
----------	--------------	-----	-----	----	---------------	---------------

Freestanding credenza, open with fixed shelf on **left**, front locking lateral drawer with box drawer **center**, and two door storage with adjustable shelf on **right**. High base.

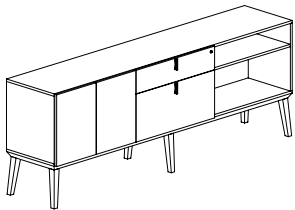

Credenza*

CBYC31HB	20 x 96 x 35	125	282	43	\$7131	\$8915
----------	--------------	-----	-----	----	---------------	---------------

Freestanding credenza, two door storage with adjustable shelf on **left**, front locking lateral drawer with box drawer **center**, and open with fixed shelf on **right**. High base.

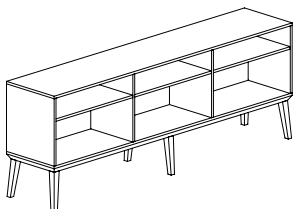

Credenza

CBYC32HB	20 x 96 x 35	150	250	43	\$6862	\$8578
----------	--------------	-----	-----	----	---------------	---------------

Freestanding credenza, open with fixed shelf **left, center** and **right**. High base.

Required Specifications

Veneer finish
Laminate finish

Optional Specifications

Veneer back panel

32"W AND 64"W STACK-ON BOOKCASES AND STORAGE CABINETS

D x W x H

- All Stack-on Bookcases and Storage Cabinets are shipped assembled.
- Stack-on units are designed to be placed and installed on top of the Credenzas with Low or High Base.
- Stack on Units are available in three heights 29.5", 44" and 58.5". For the overall height, please see page A.7.
- Back Panels of the Stack-on units are made of LP solid color laminate.
- Optional locking on doors (Storage units) is available (see Accessories section)

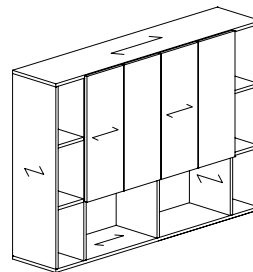

Note - Arrow indicates grain direction

32"W STACK-ON BOOKCASES

MODEL# **DIMENSIONS** **FREIGHT CLASS** **WT/LBS.** **CUBIC FT.** **LAMINATE** **VENEER**

D x W x H

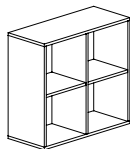

Stack-on Bookcase

CBYS1 14.5 x 32 x 29.5 125 69 9 **\$2107** **\$2634**

Two-high stack-on bookcase with symmetrical 16" wide openings, fixed shelves. LP laminate back.

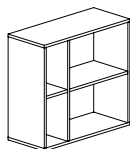

Stack-on Bookcase

CBYS2L 14.5 x 32 x 29.5 125 69 9 **\$2107** **\$2634**

Two-high stack-on bookcase with asymmetrical openings - **8" left / 24" right**, fixed shelves. LP laminate back.

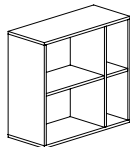

Stack-on Bookcase

CBYS2R 14.5 x 32 x 29.5 125 69 9 **\$2107** **\$2634**

Two-high stack-on bookcase with asymmetrical openings - **24" left / 8" right**, fixed shelves. LP laminate back.

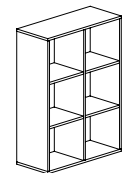

Stack-on Bookcase

CBYS3 14.5 x 32 x 44 125 95 14 **\$2886** **\$3608**

Three-high stack-on bookcase with symmetrical 16" wide openings, fixed shelves. LP laminate back.

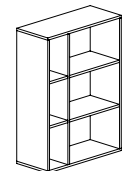

Stack-on Bookcase

CBYS4L 14.5 x 32 x 44 125 95 14 **\$2886** **\$3608**

Three-high stack-on bookcase with asymmetrical openings - **8" left / 24" right**, fixed shelves. LP laminate back.

Required Specifications

Veneer finish
Laminate finish

Optional Specifications

Veneer back panel

32"W STACK-ON BOOKCASES

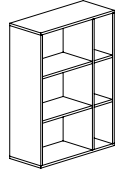

Stack-on Bookcase

MODEL#	DIMENSIONS D x W x H	FREIGHT CLASS	WT./LBS.	CUBIC FT.	LAMINATE	VENEER
CBYS4R	14.5 x 32 x 44	125	95	14	\$2886	\$3608

Three-high stack-on bookcase with asymmetrical openings - **24" left / 8" right**, fixed shelves. LP laminate back.

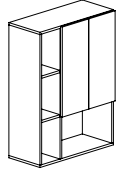

Stack-on Bookcase*

CBYS5L	14.5 x 32 x 44	125	106	14	\$3417	\$4274
--------	----------------	-----	-----	----	--------	--------

Three-high stack-on bookcase with asymmetrical openings - **8" left / 24" right**, fixed shelves, two door storage upper right with one adjustable shelf. LP laminate back.

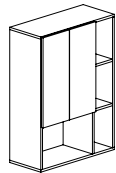

Stack-on Bookcase*

CBYS5R	14.5 x 32 x 44	125	106	14	\$3417	\$4274
--------	----------------	-----	-----	----	--------	--------

Three-high stack-on bookcase with asymmetrical openings - **24" left / 8" right**, fixed shelves, two door storage upper left with one adjustable shelf. LP laminate back.

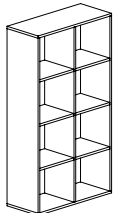

Stack-on Bookcase

CBYS6	14.5 x 32 x 58.5	125	111	18	\$3822	\$4779
-------	------------------	-----	-----	----	--------	--------

Four-high stack-on bookcase with symmetrical 16" wide openings, fixed shelves. LP laminate back.

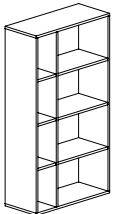

Stack-on Bookcase

CBYS7L	14.5 x 32 x 58.5	125	111	18	\$3822	\$4779
--------	------------------	-----	-----	----	--------	--------

Four-high stack-on bookcase with asymmetrical openings - **8" left / 24" right**, fixed shelves. LP laminate back.

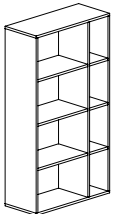

Stack-on Bookcase

CBYS7R	14.5 x 32 x 58.5	125	111	18	\$3822	\$4779
--------	------------------	-----	-----	----	--------	--------

Four-high stack-on bookcase with asymmetrical openings - **24" left / 8" right**, fixed shelves. LP laminate back.

Required Specifications

Veneer finish
Laminate finish

Optional Specifications

Lock*
Handles*
Veneer back panel

32"W STACK-ON BOOKCASES

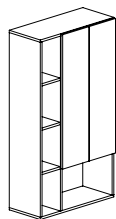

Stack-on Bookcase*

MODEL#	DIMENSIONS	FREIGHT CLASS	WT/LBS.	CUBIC FT.	LAMINATE	VENEER
--------	------------	---------------	---------	-----------	----------	--------

D x W x H

CBYS8L	14.5 x 32 x 58.5	125	129	18	\$4634	\$5795
--------	------------------	-----	-----	----	--------	--------

Four-high stack-on bookcase with asymmetrical openings - **8" left / 24" right**, fixed shelves. two door storage upper right with two adjustable shelves. LP laminate back.

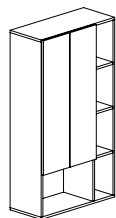

Stack-on Bookcase*

CBYS8R	14.5 x 32 x 58.5	125	129	18	\$4634	\$5795
--------	------------------	-----	-----	----	--------	--------

Four-high stack-on bookcase with asymmetrical openings - **24" left / 8" right**, fixed shelves. two door storage upper left with two adjustable shelves. LP laminate back.

64"W STACK-ON BOOKCASES

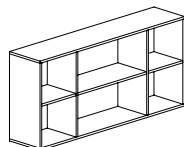

Stack-on Bookcase

MODEL#	DIMENSIONS	FREIGHT CLASS	WT/LBS.	CUBIC FT.	LAMINATE	VENEER
--------	------------	---------------	---------	-----------	----------	--------

CBYS9	14.5 x 64 x 29.5	125	119	18	\$3666	\$4584
-------	------------------	-----	-----	----	--------	--------

Two-high stack-on bookcase, 32" open fixed shelf center, 16" open fixed shelves on either side. LP laminate back.

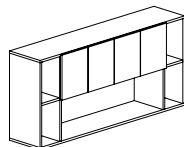

Stack-on Bookcase*

CBYS10	14.5 x 64 x 29.5	125	134	18	\$4336	\$5422
--------	------------------	-----	-----	----	--------	--------

Two-high stack-on bookcase, four door storage upper center, 48" open fixed shelf lower center, and 8" open fixed shelves on either side. LP laminate back.

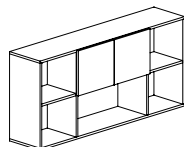

Stack-on Bookcase*

CBYS11	14.5 x 64 x 29.5	125	127	18	\$4074	\$5095
--------	------------------	-----	-----	----	--------	--------

Two-high stack-on bookcase, two door storage upper center, 32" open fixed shelves center, and 16" open fixed shelves on either side. LP laminate back.

Required Specifications

Veneer finish
Laminate finish

Optional Specifications

Lock*
Handles*
Veneer back panel

64"W STACK-ON BOOKCASES

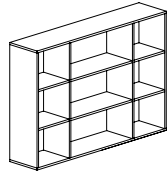

Stack-on Bookcase

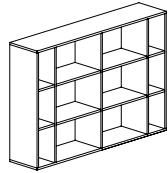

Stack-on Bookcase

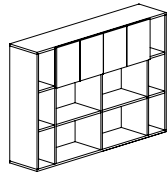

Stack-on Bookcase*

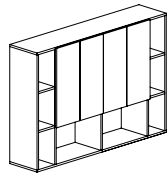

Stack-on Bookcase*

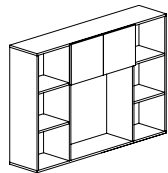

Stack-on Bookcase*

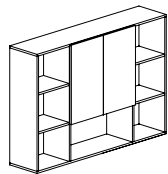

Stack-on Bookcase*

MODEL#	DIMENSIONS	FREIGHT CLASS	WT/LBS.	CUBIC FT.	LAMINATE	VENEER
--------	------------	---------------	---------	-----------	----------	--------

	D x W x H					
CBYS12	14.5 x 64 x 44	125	164	27	\$5153	\$6441

Three-high stack-on bookcase, 32" open fixed shelves center, 16" open fixed shelves on either side. LP laminate back.

CBYS13	14.5 x 64 x 44	125	174	27	\$5433	\$6791
--------	----------------	-----	-----	----	---------------	---------------

Three-high stack-on bookcase, two 24" open fixed shelves center, 8" open fixed shelves on either side. LP laminate back.

CBYS14	14.5 x 64 x 44	125	186	27	\$6180	\$7725
--------	----------------	-----	-----	----	---------------	---------------

Three-high stack-on bookcase, four door storage upper center, two 24" open fixed shelves lower center, 8" open fixed shelves on either side. LP laminate back.

CBYS15	14.5 x 64 x 44	125	198	27	\$6564	\$8207
--------	----------------	-----	-----	----	---------------	---------------

Three-high stack-on bookcase, four door storage upper center, two 24" open fixed shelves lower center, 8" open fixed shelves on either side. LP laminate back.

CBYS16	14.5 x 64 x 44	125	172	27	\$5554	\$6944
--------	----------------	-----	-----	----	---------------	---------------

Three-high stack-on bookcase, two door storage upper center, 32" open shelf lower center, 16" open fixed shelves on either side. LP laminate back.

CBYS17	14.5 x 64 x 44	125	172	27	\$5817	\$7273
--------	----------------	-----	-----	----	---------------	---------------

Three-high stack-on bookcase, two door storage upper center with adjustable shelf, 32" open fixed shelf lower center, 16" open fixed shelves on either side. LP laminate back.

Required Specifications

Veneer finish
Laminate finish

Optional Specifications

Lock*
Handles*
Veneer back panel

64"W STACK-ON BOOKCASES

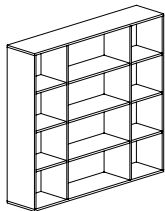

Stack-on Bookcase

MODEL#	DIMENSIONS D x W x H	FREIGHT CLASS	WT/LBS.	CUBIC FT.	LAMINATE	VENEER
CBYS18	14.5 x 64 x 58.5	150	208	35	\$6629	\$8288

Four-high stack-on bookcase, 32" open fixed shelves center, 16" open fixed shelves on either side. LP laminate back.

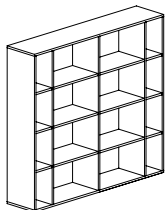

Stack-on Bookcase

CBYS19	14.5 x 64 x 58.5	125	222	35	\$7099	\$8874
--------	------------------	-----	-----	----	--------	--------

Four-high stack-on bookcase, two 24" open fixed shelves center, 8" open fixed shelves on either side. LP laminate back.

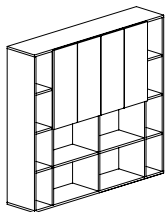

Stack-on Bookcase*

CBYS20	14.5 x 64 x 58.5	125	245	35	\$8158	\$10199
--------	------------------	-----	-----	----	--------	---------

Four-high stack-on bookcase, four door storage upper center, with adjustable shelves, two 24" open fixed shelves lower center, 8" open fixed shelves on either side. LP laminate back.

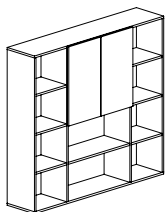

Stack-on Bookcase*

CBYS21	14.5 x 64 x 58.5	125	224	35	\$7158	\$8948
--------	------------------	-----	-----	----	--------	--------

Four-high stack-on bookcase, two door storage upper center, with adjustable shelf, 32" open fixed shelf lower center, 16" open fixed shelves on either side. LP laminate back.

Required Specifications

Veneer finish
Laminate finish

Optional Specifications

Lock*
Handles*
Veneer back panel

32"W AND 64"W FREESTANDING BOOKCASES AND STORAGE CABINETS

D x W x H

- All Bookcases and Storage cabinets are shipped assembled.
- Bookcases and Storage cabinets are available in two base heights: 4" (xxLB = Low Base) or 11.5" (xxHB = High Base)
- Back Panels of the Bookcases and storage cabinets are made of LP solid color laminate.
- Optional locking on doors (Storage units) is available (see Accessories section).

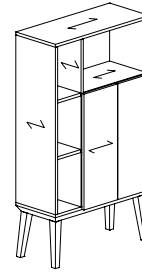

Note - Arrow indicates grain direction

32"W FREESTANDING BOOKCASES - LOW BASE

MODEL#	DIMENSIONS	FREIGHT CLASS	WT/LBS.	CUBIC FT.	LAMINATE	veneer
--------	------------	---------------	---------	-----------	----------	--------

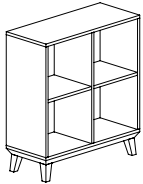

Freestanding Bookcase

CBYB1LB	14.5 x 32 x 35.5	100	101	11	\$2731	\$3414
---------	------------------	-----	-----	----	---------------	---------------

Freestanding two-high bookcase with symmetrical 16" wide openings, fixed shelves. Low base. LP Laminate back.

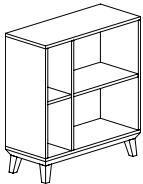

Freestanding Bookcase

CBYB2LLB	14.5 x 32 x 35.5	100	101	11	\$2731	\$3414
----------	------------------	-----	-----	----	---------------	---------------

Freestanding two-high bookcase with asymmetrical openings - **8" left / 24" right**, fixed shelves. Low base. LP laminate back.

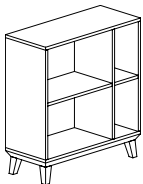

Freestanding Bookcase

CBYB2RLB	14.5 x 32 x 35.5	100	101	11	\$2731	\$3414
----------	------------------	-----	-----	----	---------------	---------------

Freestanding two-high bookcase with asymmetrical openings - **24" left / 8" right**, fixed shelves. Low base. LP laminate back.

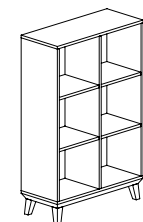

Freestanding Bookcase

CBYB3LB	14.5 x 32 x 50	125	119	15	\$3512	\$4390
---------	----------------	-----	-----	----	---------------	---------------

Freestanding three-high bookcase with symmetrical 16" wide openings, fixed shelves. Low base. LP Laminate back.

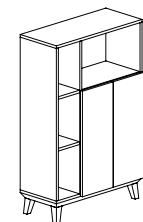

Freestanding Bookcase*

CBYB4LLB	14.5 x 32 x 50	100	138	15	\$4044	\$5055
----------	----------------	-----	-----	----	---------------	---------------

Freestanding three-high bookcase with asymmetrical openings - **8" left / 24" right**, fixed shelves, two door storage lower right with one adjustable shelf. Low base. LP Laminate back.

Required Specifications

Veneer finish
Laminate finish

Optional Specifications

Lock*
Handles*
Veneer back panel

32"W FREESTANDING BOOKCASES - LOW BASE

MODEL#

DIMENSIONS

FREIGHT CLASS

WT/LBS.

CUBIC FT.

LAMINATE

VENEER

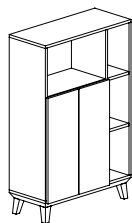

Freestanding Bookcase*

	D x W x H						
CBYB4RLB	14.5 x 32 x 50	100	138	15	\$4044	\$5055	

Freestanding three-high bookcase with asymmetrical openings - **24" left / 8" right**, fixed shelves, two door storage lower left with one adjustable shelf. Low base. LP Laminate back.

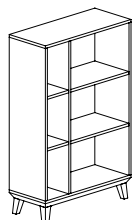

Freestanding Bookcase

CBYB5LLB	14.5 x 32 x 50	100	126	15	\$3512	\$4390	
----------	----------------	-----	-----	----	--------	--------	--

Freestanding three-high bookcase with asymmetrical openings - **8" left / 24" right**, fixed shelves. Low base. LP Laminate back.

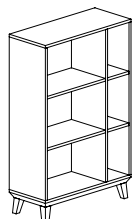

Freestanding Bookcase

CBYB5RLB	14.5 x 32 x 50	100	126	15	\$3512	\$4390	
----------	----------------	-----	-----	----	--------	--------	--

Freestanding three-high bookcase with asymmetrical openings - **24" left / 8" right**, fixed shelves. Low base. LP Laminate back.

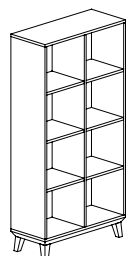

Freestanding Bookcase

CBYB6LB	14.5 x 32 x 64	125	152	20	\$4448	\$5559	
---------	----------------	-----	-----	----	--------	--------	--

Freestanding four-high bookcase with symmetrical 16" wide openings, fixed shelves. Low base. LP Laminate back.

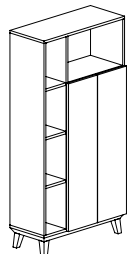

Freestanding Bookcase*

CBYB7LLB	14.5 x 32 x 64	100	169	20	\$5259	\$6575	
----------	----------------	-----	-----	----	--------	--------	--

Freestanding four-high bookcase with asymmetrical openings - **8" left / 24" right**, fixed shelves, two door storage lower right with two adjustable shelves. Low base. LP Laminate back.

Required Specifications

Veneer finish
Laminate finish

Optional Specifications

Lock*
Handles*
Veneer back panel

32"W FREESTANDING BOOKCASES - LOW BASE

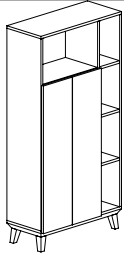

Freestanding Bookcase*

MODEL#	DIMENSIONS D x W x H	FREIGHT CLASS	WT/LBS.	CUBIC FT.	LAMINATE	veneer
CBYB7RLB	14.5 x 32 x 64	100	169	20	\$5259	\$6575

Freestanding four-high bookcase with asymmetrical openings - **24" left / 8" right**, fixed shelves, two door storage lower left with two adjustable shelves. Low base. LP Laminate back.

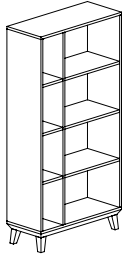

Freestanding Bookcase

CBYB8LLB	14.5 x 32 x 64	125	152	20	\$4448	\$5559
----------	----------------	-----	-----	----	--------	--------

Freestanding four-high bookcase with asymmetrical openings - **8" left / 24" right**, fixed shelves. Low base. LP Laminate back.

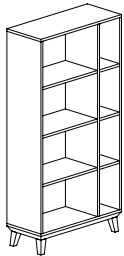

Freestanding Bookcase

CBYB8RLB	14.5 x 32 x 64	125	152	20	\$4448	\$5559
----------	----------------	-----	-----	----	--------	--------

Freestanding four-high bookcase with asymmetrical openings - **24" left / 8" right**, fixed shelves. Low base. LP Laminate back.

32"W FREESTANDING BOOKCASES - HIGH BASE

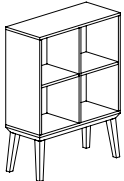

Freestanding Bookcase

MODEL#	DIMENSIONS	FREIGHT CLASS	WT/LBS.	CUBIC FT.	LAMINATE	veneer
CBYB1HB	14.5 x 32 x 42.75	100	106	13	\$3043	\$3804

Freestanding two-high bookcase with symmetrical 16" wide openings, fixed shelves. High base. LP Laminate back.

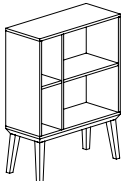

Freestanding Bookcase

CBYB2LHB	14.5 x 32 x 42.75	100	106	13	\$3043	\$3804
----------	-------------------	-----	-----	----	--------	--------

Freestanding two-high bookcase with asymmetrical openings - **8" left / 24" right**, fixed shelves. High base. LP laminate back.

Required Specifications

Veneer finish
Laminate finish

Optional Specifications

Lock*
Handles*
Veneer back panel

32"W FREESTANDING BOOKCASES - HIGH BASE

MODEL#

DIMENSIONS

FREIGHT CLASS

WT/LBS.

CUBIC FT.

LAMINATE

VENEER

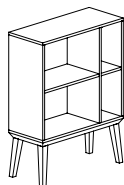

Freestanding Bookcase

	D x W x H						
CBYB2RHB	14.5 x 32 x 42.75	100	106	13	\$3043	\$3804	

Freestanding two-high bookcase with asymmetrical openings - **24" left / 8" right**, fixed shelves. High base. LP laminate back.

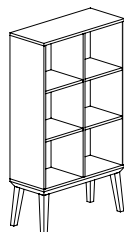

Freestanding Bookcase

CBYB3HB	14.5 x 32 x 57	125	119	18	\$3822	\$4779	
---------	----------------	-----	-----	----	--------	--------	--

Freestanding three-high bookcase with symmetrical 16" wide openings, fixed shelves. High base. LP Laminate back.

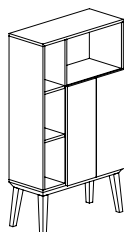

Freestanding Bookcase*

CBYB4LHB	14.5 x 32 x 57	125	143	18	\$4355	\$5444	
----------	----------------	-----	-----	----	--------	--------	--

Freestanding three-high bookcase with asymmetrical openings - **8" left / 24" right**, fixed shelves, two door storage lower right with one adjustable shelf. High base. LP Laminate back.

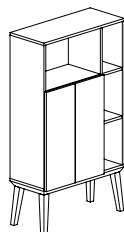

Freestanding Bookcase*

CBYB4RHB	14.5 x 32 x 57	125	143	18	\$4355	\$5444	
----------	----------------	-----	-----	----	--------	--------	--

Freestanding three-high bookcase with asymmetrical openings - **24" left / 8" right**, fixed shelves, two door storage lower right with one adjustable shelf. High base. LP Laminate back.

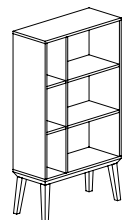

Freestanding Bookcase

CBYB5LHB	14.5 x 32 x 57	125	131	18	\$3822	\$4779	
----------	----------------	-----	-----	----	--------	--------	--

Freestanding three-high bookcase with asymmetrical openings - **8" left / 24" right**, fixed shelves. High base. LP Laminate back.

Required Specifications

Veneer finish
Laminate finish

Optional Specifications

Lock*
Handles*
Veneer back panel

32"W FREESTANDING BOOKCASES - HIGH BASE

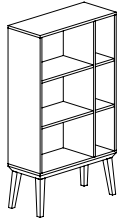

Freestanding Bookcase

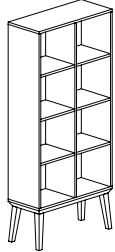

Freestanding Bookcase

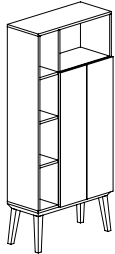

Freestanding Bookcase*

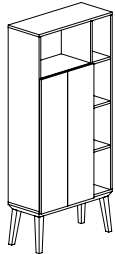

Freestanding Bookcase*

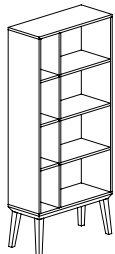

Freestanding Bookcase

MODEL#	DIMENSIONS	FREIGHT CLASS	WT/LBS.	CUBIC FT.	LAMINATE	veneer
--------	------------	---------------	---------	-----------	----------	--------

	D x W x H					
CBYB5RHB	14.5 x 32 x 57	125	131	18	\$3822	\$4779

Freestanding three-high bookcase with asymmetrical openings - **24" left / 8" right**, fixed shelves. High base. LP Laminate back.

CBYB6HB	14.5 x 32 x 71.5	125	157	22	\$4759	\$5949
---------	------------------	-----	-----	----	---------------	---------------

Freestanding four-high bookcase with symmetrical 16" wide openings, fixed shelves. High base. LP Laminate back.

CBYB7LHB	14.5 x 32 x 71.5	125	174	22	\$5571	\$6965
----------	------------------	-----	-----	----	---------------	---------------

Freestanding four-high bookcase with asymmetrical openings - **8" left / 24" right**, fixed shelves, two door storage lower right with two adjustable shelves. High base. LP Laminate back.

CBYB7RHB	14.5 x 32 x 71.5	125	174	22	\$5571	\$6965
----------	------------------	-----	-----	----	---------------	---------------

Freestanding four-high bookcase with asymmetrical openings - **24" left / 8" right**, fixed shelves, two door storage lower left with two adjustable shelves. High base. LP Laminate back.

CBYB8LHB	14.5 x 32 x 71.5	125	157	22	\$4759	\$5949
----------	------------------	-----	-----	----	---------------	---------------

Freestanding four-high bookcase with asymmetrical openings - **8" left / 24" right**, fixed shelves. High base. LP Laminate back.

Required Specifications

- Veneer finish
- Laminate finish

Optional Specifications

- Lock*
- Handles*
- Veneer back panel

32"W FREESTANDING BOOKCASES - HIGH BASE

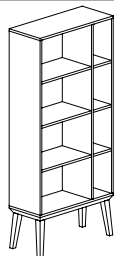

Freestanding Bookcase

MODEL# DIMENSIONS FREIGHT CLASS WT/LBS. CUBIC FT. LAMINATE VENEER

MODEL#	DIMENSIONS D x W x H	FREIGHT CLASS	WT/LBS.	CUBIC FT.	LAMINATE	VENEER
CBYB8RHB	14.5 x 32 x 71.5	125	157	22	\$4759	\$5949

Freestanding four-high bookcase with asymmetrical openings - **24" left / 8" right**, fixed shelves. High base. LP Laminate back.

64"W FREESTANDING BOOKCASES - LOW BASE

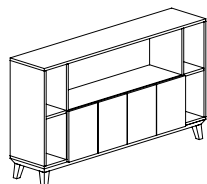

Freestanding Bookcase*

MODEL# DIMENSIONS FREIGHT CLASS WT/LBS. CUBIC FT. LAMINATE VENEER

CBYB9LB	14.5 x 64 x 35.5	100	177	21	\$4964	\$6205
---------	------------------	-----	-----	----	--------	--------

Freestanding two-high bookcase with four door storage lower center, 48" open fixed upper shelf and 8" open fixed shelves on either side. Low base. LP Laminate back.

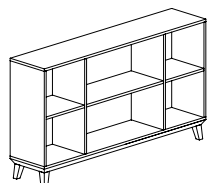

Freestanding Bookcase

CBYB10LB	14.5 x 64 x 35.5	125	162	21	\$4291	\$5364
----------	------------------	-----	-----	----	--------	--------

Freestanding two-high bookcase, 32" open fixed shelf center, and 16" open fixed shelves on either side. Low base. LP Laminate back.

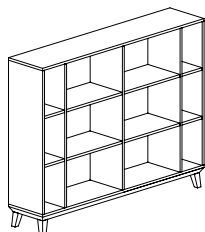

Freestanding Bookcase

CBYB11LB	14.5 x 64 x 50	125	217	30	\$4570	\$5713
----------	----------------	-----	-----	----	--------	--------

Freestanding three-high bookcase, two 24" open fixed shelves center, and 8" open fixed shelves on either side. Low base. LP Laminate back.

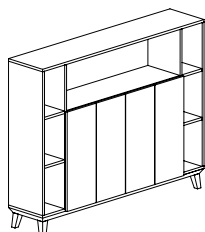

Freestanding Bookcase*

CBYB12LB	14.5 x 64 x 50	125	237	30	\$7190	\$8988
----------	----------------	-----	-----	----	--------	--------

Freestanding three-high bookcase, four door storage lower center with adjustable shelves, 48" open fixed shelf upper, and 8" open fixed shelves on either side. Low base. LP Laminate back.

Required Specifications

Veneer finish
Laminate finish

Optional Specifications

Lock*
Handles*
Veneer back panel

64"W FREESTANDING BOOKCASES - LOW BASE

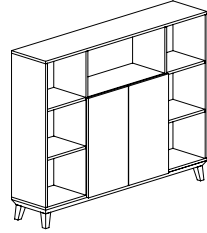

Freestanding Bookcase*

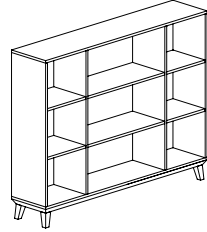

Freestanding Bookcase

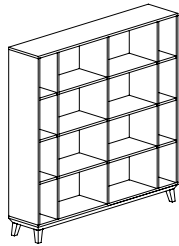

Freestanding Bookcase

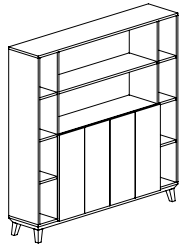

Freestanding Bookcase*

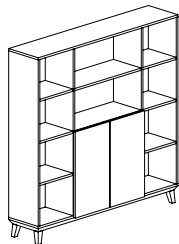

Freestanding Bookcase*

MODEL#	DIMENSIONS	FREIGHT CLASS	WT/LBS.	CUBIC FT.	LAMINATE	veneer
--------	------------	---------------	---------	-----------	----------	--------

CBYB13LB	14.5 x 64 x 50	125	223	30	\$6443	\$8054
----------	----------------	-----	-----	----	---------------	---------------

Freestanding three-high bookcase, two door storage lower center with adjustable shelves, 32" open fixed shelf upper, and 16" open fixed shelves on either side. Low base. LP laminate back.

CBYB14LB	14.5 x 64 x 50	125	207	30	\$5769	\$7213
----------	----------------	-----	-----	----	---------------	---------------

Freestanding three-high bookcase, 32" open fixed shelves center, and 16" open fixed shelves on either side. Low base. LP laminate back.

CBYB15LB	14.5 x 64 x 64	125	265	38	\$7723	\$9654
----------	----------------	-----	-----	----	---------------	---------------

Freestanding four-high bookcase, two 24" open fixed shelves center, and 8" open fixed shelves on either side. Low base. LP laminate back.

CBYB16LB	14.5 x 64 x 64	125	281	38	\$8780	\$10977
----------	----------------	-----	-----	----	---------------	----------------

Freestanding four-high bookcase, four door storage lower center with adjustable shelves, 48" open fixed upper shelves, and 8" open fixed shelves on either side. Low base. LP laminate back.

CBYB17LB	14.5 x 64 x 64	125	267	38	\$7780	\$9727
----------	----------------	-----	-----	----	---------------	---------------

Freestanding four-high bookcase, two door storage lower center with adjustable shelves, 32" open fixed upper shelves, and 16" open fixed shelves on either side. Low base. LP laminate back.

Required Specifications

Veneer finish
Laminate finish

Optional Specifications

Lock*
Handles*
Veneer back panel

64"W FREESTANDING BOOKCASES - LOW BASE

MODEL#

DIMENSIONS

FREIGHT CLASS

WT/LBS.

CUBIC FT.

LAMINATE

VENEER

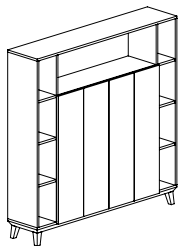

Freestanding Bookcase*

	D x W x H						
CBYB18LB	14.5 x 64 x 64	125	295	38	\$8937	\$11172	

Freestanding four-high bookcase, four door storage lower center with adjustable shelves, 48" open fixed upper shelf, and 8" open fixed shelves on either side. Low base. LP Laminate back.

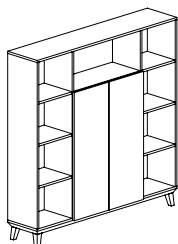

Freestanding Bookcase*

CBYB19LB	14.5 x 64 x 64	125	275	38	\$7938	\$9923	
----------	----------------	-----	-----	----	--------	--------	--

Freestanding four-high bookcase, four door storage lower center with adjustable shelves, 32" open fixed upper shelf, and 16" open fixed shelves on either side. Low base. LP Laminate back.

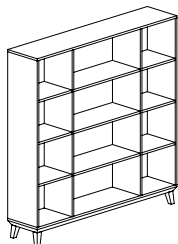

Freestanding Bookcase

CBYB20LB	14.5 x 64 x 64	125	251	38	\$7256	\$9070	
----------	----------------	-----	-----	----	--------	--------	--

Freestanding four-high bookcase, 32" open fixed shelves center, and 16" open fixed shelves on either side. Low base. LP Laminate back.

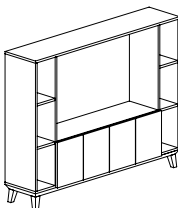

Freestanding Media Cabinet*

CBYTV1LB	14.5 x 64 x 50	125	222	30	\$6803	\$8503	
----------	----------------	-----	-----	----	--------	--------	--

Freestanding media cabinet, 48" wide two high opening can accommodate up to a 50" monitor, four door storage lower center, 8" open fixed shelf center on either side. Monitor mount is optional. Please see accessories. Low base. LP Laminate back.

64"W FREESTANDING BOOKCASES - HIGH BASE

MODEL#

DIMENSIONS

FREIGHT CLASS

WT/LBS.

CUBIC FT.

LAMINATE

VENEER

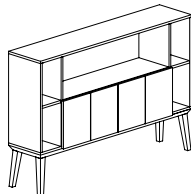

Freestanding Bookcase*

CBYB9HB	14.5 x 64 x 42.75	125	182	26	\$5276	\$6595	
---------	-------------------	-----	-----	----	--------	--------	--

Freestanding two-high bookcase with four door storage lower center, 48" open fixed upper shelf and 8" open fixed shelves on either side. High base. LP Laminate back.

Required Specifications

Veneer finish
Laminate finish

Optional Specifications

Lock*
Handles*
Veneer back panel

64"W FREESTANDING BOOKCASES - HIGH BASE

MODEL# DIMENSIONS FREIGHT CLASS WT/LBS. CUBIC FT. LAMINATE VENEER

D x W x H



Freestanding Bookcase

CBYB10HB	14.5 x 64 x 42.75	125	167	26	\$4603	\$5755
----------	-------------------	-----	-----	----	---------------	---------------

Freestanding two-high bookcase, 32" open fixed shelf center, and 16" open fixed shelves on either side. High base. LP Laminate back.

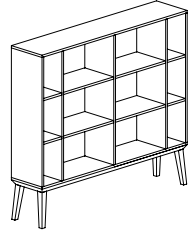

Freestanding Bookcase

CBYB11HB	14.5 x 64 x 57	125	222	34	\$4882	\$6103
----------	----------------	-----	-----	----	---------------	---------------

Freestanding three-high bookcase, two 24" open fixed shelves center, and 8" open fixed shelves on either side. High base. LP Laminate back.

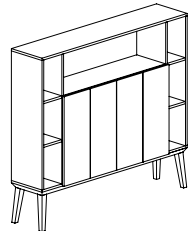

Freestanding Bookcase*

CBYB12HB	14.5 x 64 x 57	125	242	34	\$7502	\$9379
----------	----------------	-----	-----	----	---------------	---------------

Freestanding three-high bookcase, four door storage lower center with adjustable shelves, 48" open fixed shelf upper, and 8" open fixed shelves on either side. High base. LP Laminate back.

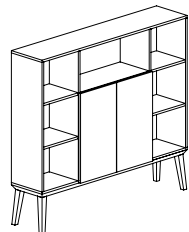

Freestanding Bookcase*

CBYB13HB	14.5 x 64 x 57	125	228	34	\$6753	\$8443
----------	----------------	-----	-----	----	---------------	---------------

Freestanding three-high bookcase, two door storage lower center with adjustable shelves, 32" open fixed shelf upper, and 16" open fixed shelves on either side. High base. LP laminate back.

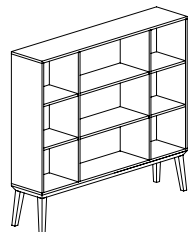

Freestanding Bookcase

CBYB14HB	14.5 x 64 x 57	125	212	34	\$6083	\$7604
----------	----------------	-----	-----	----	---------------	---------------

Freestanding three-high bookcase, 32" open fixed shelves center, and 16" open fixed shelves on either side. High base. LP Laminate back.

Required Specifications

Veneer finish
Laminate finish

Optional Specifications

Lock*
Handles*
Veneer back panel

64"W FREESTANDING BOOKCASES - HIGH BASE

MODEL#

DIMENSIONS

FREIGHT CLASS

WT/LBS.

CUBIC FT.

LAMINATE

VENEER

D x W x H

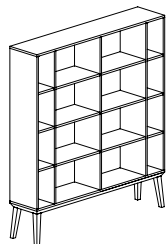

Freestanding Bookcase

MODEL#	DIMENSIONS (D x W x H)	FREIGHT CLASS	WT/LBS.	CUBIC FT.	LAMINATE	VENEER
CBYB15HB	14.5 x 64 x 71.5	125	270	43	\$8035	\$10045

Freestanding four-high bookcase, two 24" open fixed shelves center, and 8" open fixed shelves on either side. High base. LP Laminate back.

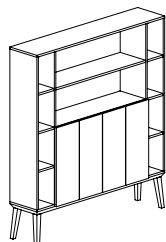

Freestanding Bookcase*

CBYB16HB	14.5 x 64 x 71.5	125	286	43	\$9095	\$11369
----------	------------------	-----	-----	----	--------	---------

Freestanding four-high bookcase, four door storage lower center with adjustable shelves, 48" open fixed upper shelves, and 8" open fixed shelves on either side. High base. LP Laminate back.

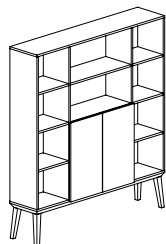

Freestanding Bookcase*

CBYB17HB	14.5 x 64 x 71.5	125	272	43	\$8094	\$10118
----------	------------------	-----	-----	----	--------	---------

Freestanding four-high bookcase, two door storage lower center with adjustable shelves, 32" open fixed upper shelves, and 16" open fixed shelves on either side. High base. LP laminate back.

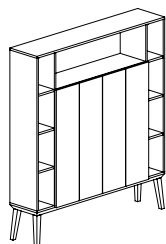

Freestanding Bookcase*

CBYB18HB	14.5 x 64 x 71.5	125	300	43	\$9249	\$11563
----------	------------------	-----	-----	----	--------	---------

Freestanding four-high bookcase, four door storage lower center with adjustable shelves, 48" open fixed upper shelf, and 8" open fixed shelves on either side. High base. LP laminate back.

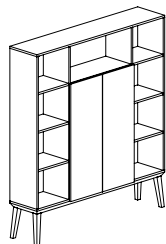

Freestanding Bookcase*

CBYB19HB	14.5 x 64 x 71.5	125	280	43	\$8251	\$10314
----------	------------------	-----	-----	----	--------	---------

Freestanding four-high bookcase, four door storage lower center with adjustable shelves, 32" open fixed upper shelf, and 16" open fixed shelves on either side. High base. LP Laminate back.

Required Specifications

Veneer finish
Laminate finish

Optional Specifications

Lock*
Handles*
Veneer back panel

64"W FREESTANDING BOOKCASES - HIGH BASE

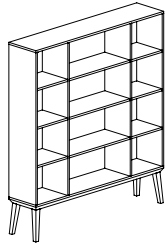

Freestanding Bookcase

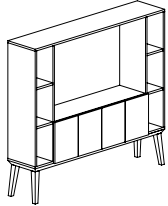

Freestanding Media Cabinet*

MODEL#	DIMENSIONS	FREIGHT CLASS	WT/LBS.	CUBIC FT.	LAMINATE	VENEER
--------	------------	---------------	---------	-----------	----------	--------

D x W x H						
CBYB20HB	14.5 x 64 x 71.5	150	256	43	\$7566	\$9459

Freestanding four-high bookcase, 32" open fixed shelves center, and 16" open fixed shelves on either side. High base. LP Laminate back.

CBYTV1HB	14.5 x 64 x 57	125	227	34	\$7115	\$8892
----------	----------------	-----	-----	----	--------	--------

Freestanding media cabinet, 48" wide two high opening can accommodate up to a 50" monitor, four door storage lower center, 8" open fixed shelf center on either side. Monitor mount is optional. Please see accessories. High base. LP Laminate back.

ROOM DIVIDING BOOKCASES - LOW BASE

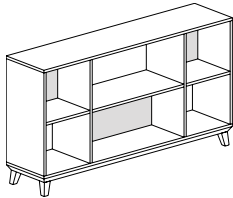

Freestanding Bookcase

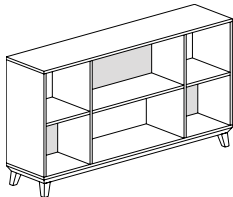

Freestanding Bookcase



Freestanding Bookcase

MODEL#	DIMENSIONS	FREIGHT CLASS	WT/LBS.	CUBIC FT.	LAMINATE	VENEER
--------	------------	---------------	---------	-----------	----------	--------

CBYB28LB	15 x 64 x 35	125	162	21	\$6141	\$7678
----------	--------------	-----	-----	----	--------	--------

Shaded areas indicate closed cavities.

Freestanding two-high bookcase for use in open plan areas as space division. Low base. LP laminate back.

- Two 32" fixed shelves in center. Top cavity is open as a pass-through, bottom cavity is closed.
- 16" fixed shelves on either side. Top cavity is closed, bottom is open as a pass-through.

CBYB29LB	15 x 64 x 35	125	162	21	\$6141	\$7678
----------	--------------	-----	-----	----	--------	--------

Shaded areas indicate closed cavities.

Freestanding two-high bookcase for use in open plan areas as space division. Low base. LP laminate back.

- Two 32" fixed shelves in center. Top cavity is closed, bottom cavity is open as a pass-through.
- 16" fixed shelves on either side. Top cavity is open as a pass-through, bottom is closed.

CBYB26LB	15 x 64 x 49	125	217	30	\$7076	\$8847
----------	--------------	-----	-----	----	--------	--------

Shaded areas indicate closed cavities.

Freestanding three-high bookcase for use in open plan areas as space division. Low base. LP laminate back.

- Three 32" fixed shelves in center. Top and bottom cavities are closed, middle is open as a pass-through.
- Three 16" fixed shelves on either side. Top and bottom cavities are open as a pass-through, middle is closed.

Required Specifications

Veneer finish
Laminate finish

Optional Specifications

Lock*
Handles*
Veneer back panel

ROOM DIVIDING BOOKCASES - LOW BASE

MODEL#	DIMENSIONS	FREIGHT CLASS	WT/LBS.	CUBIC FT.	LAMINATE	VENEER
--------	------------	---------------	---------	-----------	----------	--------

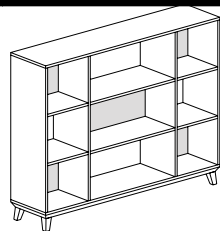

Freestanding Bookcase

	D x W x H					
CBYB27LB	15 x 64 x 49	125	217	30	\$7076	\$8847

Shaded areas indicate closed cavities.

Freestanding three-high bookcase for use in open plan areas as space division. Low base. LP laminate back.

- Three 32" fixed shelves in center. Top and bottom cavities are open as a pass-through, middle is closed.
- Three 16" fixed shelves on either side. Top and bottom cavities are closed, middle is open as a pass-through.

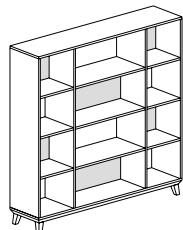

Freestanding Bookcase

CBYB22LB	15 x 64 x 64	125	265	38	\$8921	\$11152
----------	--------------	-----	-----	----	--------	---------

Shaded areas indicate closed cavities.

Freestanding four-high bookcase for use in open plan areas as space division. Low base. LP laminate back.

- Four 32" fixed shelves in center. Cavities alternate from top to bottom: open/closed/open/closed.
- Four 16" fixed shelves on either side. Cavities alternate from top to bottom: closed/open/closed/open.

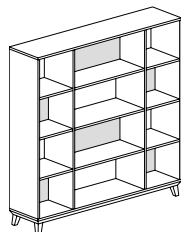

Freestanding Bookcase

CBYB23LB	15 x 64 x 64	125	265	38	\$8921	\$11152
----------	--------------	-----	-----	----	--------	---------

Shaded areas indicate closed cavities.

Freestanding four-high bookcase for use in open plan areas as space division. Low base. LP laminate back.

- Four 32" fixed shelves in center. Cavities alternate from top to bottom: closed/open/closed/open.
- Four 16" fixed shelves on either side. Cavities alternate from top to bottom: open/closed/open/closed.

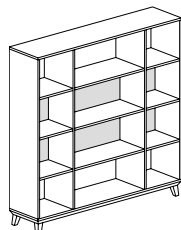

Freestanding Bookcase

CBYB24LB	15 x 64 x 64	125	265	38	\$8921	\$11152
----------	--------------	-----	-----	----	--------	---------

Shaded areas indicate closed cavities.

Freestanding four-high bookcase for use in open plan areas as space division. Low base. LP laminate back.

- Four 32" fixed shelves in center. Top and bottom cavities are open as a pass-through. Two middle cavities are closed.
- Four 16" fixed shelves on either side. Top and bottom cavities are closed. Two middle cavities are open as a pass-through.

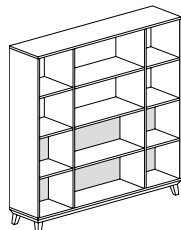

Freestanding Bookcase

CBYB25LB	15 x 64 x 64	125	265	38	\$8921	\$11152
----------	--------------	-----	-----	----	--------	---------

Shaded areas indicate closed cavities.

Freestanding four-high bookcase for use in open plan areas as space division. Low base. LP laminate back.

- Four 32" fixed shelves in center. Top two cavities are open as a pass-through. Bottom two cavities are closed.
- Four 16" fixed shelves on either side. Top two cavities are open as a pass-through. Bottom two cavities are closed.

Required Specifications

Veneer finish
Laminate finish

Optional Specifications

Veneer back panel

ROOM DIVIDING BOOKCASES - HIGH BASE

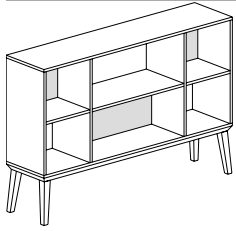

Freestanding Bookcase

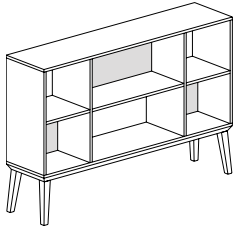

Freestanding Bookcase

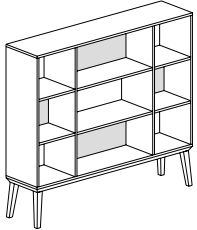

Freestanding Bookcase

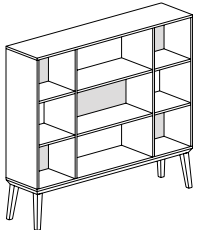

Freestanding Bookcase

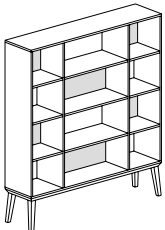

Freestanding Bookcase

MODEL#	DIMENSIONS	FREIGHT CLASS	WT./LBS.	CUBIC FT.	LAMINATE	veneer
--------	------------	---------------	----------	-----------	----------	--------

	D x W x H					
CBYB28HB	15 x 64 x 43	125	167	26	\$6443	\$8054

Shaded areas indicate closed cavities.

Freestanding two-high bookcase for use in open plan areas as space division. High base. LP laminate back.

- Two 32" fixed shelves in center. Top cavity is open as a pass-through, bottom cavity is closed.
- 16" fixed shelves on either side. Top cavity is closed, bottom is open as a pass-through.

CBYB29HB	15 x 64 x 43	125	167	26	\$6443	\$8054
----------	--------------	-----	-----	----	--------	--------

Shaded areas indicate closed cavities.

Freestanding two-high bookcase for use in open plan areas as space division. High base. LP laminate back.

- Two 32" fixed shelves in center. Top cavity is closed, bottom cavity is open as a pass-through.
- 16" fixed shelves on either side. Top cavity is open as a pass-through, bottom is closed.

CBYB26HB	15 x 64 x 57	125	222	34	\$7374	\$9219
----------	--------------	-----	-----	----	--------	--------

Shaded areas indicate closed cavities.

Freestanding three-high bookcase for use in open plan areas as space division. High base. LP laminate back.

- Three 32" fixed shelves in center. Top and bottom cavities are closed, middle is open as a pass-through.
- Three 16" fixed shelves on either side. Top and bottom cavities are open as a pass-through, middle is closed.

CBYB27HB	15 x 64 x 57	125	222	34	\$7374	\$9219
----------	--------------	-----	-----	----	--------	--------

Shaded areas indicate closed cavities.

Freestanding three-high bookcase for use in open plan areas as space division. High base. LP laminate back.

- Three 32" fixed shelves in center. Top and bottom cavities are open as a pass-through, middle is closed.
- Three 16" fixed shelves on either side. Top and bottom cavities are closed, middle is open as a pass-through.

CBYB22HB	15 x 64 x 72	125	270	43	\$9281	\$11603
----------	--------------	-----	-----	----	--------	---------

Shaded areas indicate closed cavities.

Freestanding four-high bookcase for use in open plan areas as space division. High base. LP laminate back.

- Four 32" fixed shelves in center. Cavities alternate from top to bottom: open/closed/open/closed.
- Four 16" fixed shelves on either side. Cavities alternate from top to bottom: closed/open/closed/open.

Required Specifications

- Veneer finish
- Laminate finish

Optional Specifications

- Veneer back panel

ROOM DIVIDING BOOKCASES - HIGH BASE

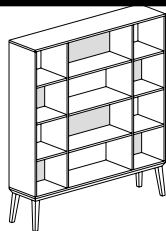

Freestanding Bookcase

MODEL#	DIMENSIONS	FREIGHT CLASS	WT/LBS.	CUBIC FT.	LAMINATE	VENEER
--------	------------	---------------	---------	-----------	----------	--------

	D x W x H					
CBYB23HB	15 x 64 x 72	125	270	43	\$9281	\$11603

Shaded areas indicate closed cavities.

Freestanding four-high bookcase for use in open plan areas as space division. High base. LP laminate back.

- Four 32" fixed shelves in center. Cavities alternate from top to bottom: closed/open/closed/open.
- Four 16" fixed shelves on either side. Cavities alternate from top to bottom: open/closed/open/closed.

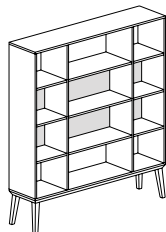

Freestanding Bookcase

CBYB24HB	15 x 64 x 72	125	270	43	\$9281	\$11603
----------	--------------	-----	-----	----	--------	---------

Shaded areas indicate closed cavities.

Freestanding four-high bookcase for use in open plan areas as space division. High base. LP laminate back.

- Four 32" fixed shelves in center. Top and bottom cavities are open as a pass-through. Two middle cavities are closed.
- Four 16" fixed shelves on either side. Top and bottom cavities are closed. Two middle cavities are open as a pass-through.

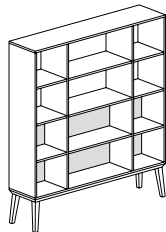

Freestanding Bookcase

CBYB25HB	15 x 64 x 72	125	270	43	\$9281	\$11603
----------	--------------	-----	-----	----	--------	---------

Shaded areas indicate closed cavities.

Freestanding four-high bookcase for use in open plan areas as space division. High base. LP laminate back.

- Four 32" fixed shelves in center. Top two cavities are open as a pass-through. Bottom two cavities are closed.
- Four 16" fixed shelves on either side. Top two cavities are open as a pass-through. Bottom two cavities are closed.

FLOATING SHELF

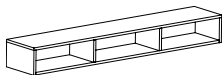

Wall Mounted Open Storage

MODEL#	DIMENSIONS	FREIGHT CLASS	WT/LBS.	CUBIC FT.	LAMINATE	VENEER
--------	------------	---------------	---------	-----------	----------	--------

CBYF096D12H8	12 x 96 x 8	125	78	10	\$2291	\$2863
CBYF064D12H8	12 x 64 x 8	125	50	8	\$1496	\$1873
CBYF032D12H8	12 x 32 x 8	100	35	4	\$1356	\$1697

To be used as a stand alone unit.

Required Specifications

Veneer finish
Laminate finish

Optional Specifications

Veneer back panel

ACCESSORIES

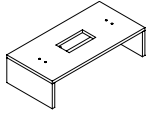

Riser Box*

MODEL#	DIMENSIONS D x W x H	FREIGHT CLASS	WT/LBS.	CUBIC FT.	LAMINATE	VENEER
CBYSPBOX2814	14 x 28 x 7.5	150	14	3	\$236	\$296
CBYSPBOX2014	14 x 20 x 7.5	250	2	1	\$433	\$542

Riser box for 20"H storage to support peninsula table. For wire pass through grommets, both top and back are included.

- CBYSPBOX2814 for use with 32"D peninsula tables and executive bridges.
- CBYSPBOX2014 for use with 24"D executive bridges

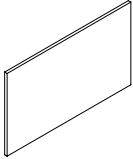

Hanging Wood Modesty Panel*

CBYCMWP62H22	.75 x 62 x 22	100	28	3	\$892	\$1116
CBYCMWP56H22	.75 x 56 x 22	100	26	3	\$831	\$1040
CBYCMWP50H22	.75 x 50 x 22	100	24	3	\$783	\$980
CBYCMWP44H22	.75 x 44 x 22	92.5	22	2	\$719	\$900
CBYCMWP38H22	.75 x 38 x 22	92.5	20	2	\$660	\$826

22" hanging wood modesty panel.

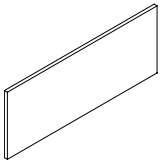

Hanging Wood Modesty Panel*

CBYCMWP74H15	.75 x 74 x 15	100	24	3	\$917	\$1148
CBYCMWP68H15	.75 x 68 x 15	125	23	3	\$864	\$1081
CBYCMWP62H15	.75 x 62 x 15	92.5	21	2	\$864	\$1081
CBYCMWP56H15	.75 x 56 x 15	92.5	20	2	\$805	\$1007
CBYCMWP50H15	.75 x 50 x 15	100	18	2	\$756	\$947
CBYCMWP44H15	.75 x 44 x 15	100	17	2	\$691	\$865
CBYCMWP38H15	.75 x 38 x 15	125	15	2	\$633	\$791

15" hanging wood modesty panel.

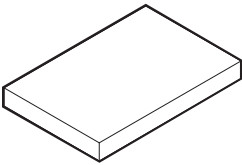

Cushion**

CU3020	20 x 30 x 2.5	150	6	1.30	1	\$248	7	\$535
	2				\$294	8	\$634	
	3				\$325	9	\$711	
	4				\$374	10	\$794	
	5				\$440	11	\$967	
	6				\$474	12	\$1157	

Cushion attaches with Velcro strips. For use on cabinets of coordinating size..

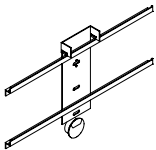

Flat Screen Monitor Mount

FVMED	2 x 28 x 17	70	14	.70	\$783
-------	-------------	----	----	-----	--------------

Flat screen monitor mount up to 50". To be used on CBYTV1LB and CBYTV1HB media cabinets. GM1K (tungsten) grommet on the back panel is included.

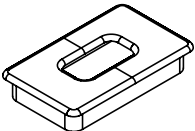

Grommet

GM5C	2 x 3.5 x --	70	--	--	\$114
------	--------------	----	----	----	--------------

Rectangular grommet in metal, tungsten finish.

Required Specifications

- Finish
- Fabric (cushion)**

POWER/DATA



Single Sided Recessed Power Block

MODEL# DIMENSIONS FREIGHT CLASS WT/LBS. CUBIC FT. LIST PRICE

D x W x H

PRTMCS401B	4.22 x 10.78 x 4.86	100	4.3	0.51	\$486
PRTMCS401T	4.22 x 10.78 x 4.86	100	4.3	0.51	\$486
PRTMCS401W	4.22 x 10.78 x 4.86	100	4.3	0.51	\$486

Single-sided recessed power block with **one regular duplex and one telecom knockout on top; one power duplex on bottom**. 10' power cord with straight plug. Specify telecom options separately, see page 58. Available in Black (**B**), Tungsten (**T**) or Designer White (**W**) as indicated by the last letter of model number. Duplexes always Grey. Corresponding cut-out options are **R1, R2** or **R3**. Units are not approved for daisy chaining. UL listed: UL 1363.



Single Sided Recessed Power Block - USB-A + USB-C

PRTMCS421B	4.22 x 10.78 x 4.86	100	4.3	0.51	\$638
PRTMCS421T	4.22 x 10.78 x 4.86	100	4.3	0.51	\$638
PRTMCS421W	4.22 x 10.78 x 4.86	100	4.3	0.51	\$638

Single-sided recessed power block with **one power/USB-A/USB-C duplex and one telecom knockout on top; one power duplex on bottom**. USB-A port charges max 2.4 amps at 5V and USB-C port charges max 3 amps at 5V. 10' power cord with straight plug. Specify telecom options separately, see page 58. Available in Black (**B**), Tungsten (**T**) or Designer White (**W**) as indicated by the last letter of model number. Duplexes always Grey (duplex with USB ports is glossy finish). Corresponding cut-out options are **R1, R2** or **R3**. Units are not approved for daisy chaining. UL listed: UL 1363.



Double Sided Recessed Power Block

PRTMCD602B	6.22 x 10.78 x 4.86	92.5	5.9	0.51	\$555
PRTMCD602T	6.22 x 10.78 x 4.86	92.5	5.9	0.51	\$555
PRTMCD602W	6.22 x 10.78 x 4.86	92.5	5.9	0.51	\$555

Double-sided recessed power block with **two regular power duplexes and two telecom knockouts on top; one power duplex on bottom**. 10' power cord with straight plug. Specify telecom options separately, see page 58. Available in Black (**B**), Tungsten (**T**) or Designer White (**W**) as indicated by last letter of model number. Duplexes always Grey. Corresponding cut-out options are **T1, T2** or **T3**. Units are not approved for daisy chaining. UL listed: UL 1363.



Double Sided Recessed Power Block - USB-A + USB-C

PRTMCD622B	6.22 x 10.78 x 4.86	92.5	6.1	0.51	\$699
PRTMCD622T	6.22 x 10.78 x 4.86	92.5	6.1	0.51	\$699
PRTMCD622W	6.22 x 10.78 x 4.86	92.5	6.1	0.51	\$699

Double-sided recessed power block with **one regular power duplex, one power/USB-A/USB-C duplex and two telecom knockouts on top; one power duplex on bottom**. USB-A port charges max 2.4 amps at 5V and USB-C port charges max 3 amps at 5V. 10' power cord with straight plug. Specify telecom options separately, see page 58. Available in Black (**B**), Tungsten (**T**) or Designer White (**W**) as indicated by last letter of model number. Duplexes always Grey (duplex with USB ports is glossy finish). Corresponding cut-out options are **T1, T2** or **T3**. Units are not approved for daisy chaining. UL listed: UL 1363.



Double Sided Recessed Power Block - USB-A + USB-C

PRTMCD642B	6.22 x 10.78 x 4.86	85	6.3	0.51	\$842
PRTMCD642T	6.22 x 10.78 x 4.86	85	6.3	0.51	\$842
PRTMCD642W	6.22 x 10.78 x 4.86	85	6.3	0.51	\$842

Double-sided recessed power block with **two power/USB-A/USB-C duplexes and two telecom knockouts on top; one power duplex on bottom**. USB-A port charges max 2.4 amps at 5V and USB-C port charges max 3 amps at 5V. 10' power cord with straight plug. Specify telecom options separately, see page 58. Available in Black (**B**), Tungsten (**T**) or Designer White (**W**) as indicated by last letter of model number. Duplexes always Grey (duplex with USB ports is glossy finish). Corresponding cut-out options are **T1, T2** or **T3**. Units are not approved for daisy chaining. UL listed: UL 1363.

Required Specifications

Finish

POWER / DATA

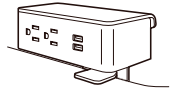

Edge Mounted 2 Power/USB

MODEL#	DIMENSIONS D x W x H	FREIGHT CLASS	WT/LBS.	CUBIC FT.	LIST PRICE
PS305057	5.5 x 3.2 x 3	60	3.01	0.05	\$412
PS305002	5.5 x 3.2 x 3	60	3.01	0.05	\$412

Edge mounted power module with two power outlets and two 2.1 amp USB ports. Edge clamp accommodates worksurfaces 0.5" to 1.5" thick; fastened with thumb screws. 6' cord.

PS305057 - White module with Silver bracket. PS305002 - Black module with Silver bracket

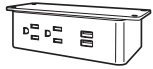

Under Mounted 2 Power/USB*

PS305157	5.5 x 2.8 x 1.8	60	3.2	0.05	\$357
PS305102	5.5 x 2.8 x 1.8	60	3.2	0.05	\$357

Under mount power module with two power outlets and two 2.1 amp USB ports. Mountable under most worksurfaces. Installation template provided. 6' cord.

PS305157 - White module with Silver bracket. PS305102 - Black module with Silver bracket.

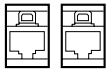

Telecom Plate - 2 x 6

PTEL01	- x - x -	70	0.01	0.05	\$175
--------	-----------	----	------	------	--------------

Includes 2 x RJ45 cat 6 data. Black telecom plate. To be hardwired by data contractor.



Telecom Plate - 3 x 6

PTEL02	- x - x -	70	0.01	0.05	\$237
--------	-----------	----	------	------	--------------

Includes 2 x RJ45 cat 6 data and 1 RJ11 cat phone. Black telecom plate. To be hardwired by data contractor.

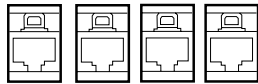

Telecom Plate - 4 x 6

PTEL03	- x - x -	70	0.01	0.05	\$363
--------	-----------	----	------	------	--------------

Includes 4 x RJ45 cat 6 data. Black telecom plate. To be hardwired by data contractor.



Telecom Plate - 3TSV

PTEL04	- x - x -	70	0.01	0.05	\$309
--------	-----------	----	------	------	--------------

Includes 1 x RJ45 cat 6 data, mini stereo and 15 pin HD VGA. Black telecom plate. To be hardwired by data contractor.

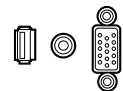

Telecom Plate - 3SVH

PTEL05	- x - x -	70	0.01	0.05	\$428
--------	-----------	----	------	------	--------------

Includes mini stereo, 15 pin HD VGA and HDMI. Black telecom plate.

Required Specifications

Finish*

ACCESSORIES

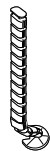

Cable Snake

MODEL#	DIMENSIONS	FREIGHT CLASS	WT/LBS.	CUBIC FT.	LIST PRICE
--------	------------	---------------	---------	-----------	------------

D x W x H

BRTCS	2 x 8 x 30	70	3	.19	\$162
-------	------------	----	---	-----	--------------

Flexible cable management trough. Two pathways within the snake, one for data/communication and one for routing power cables. Translucent White finish only.



Cable Snake

PCSN01	-- x -- x --	92.5	2.10	.20	\$144
--------	--------------	------	------	-----	--------------

Flexible cable management. Provides access to power/data from floor to underside of worksurface where it attaches. Two pathways within Cable Snake. Length under desk is 31.25". Silver (SIL) plastic only.



Cable Snake Extension

PCSN01E	- x - x -	92.5	2.1	0.2	\$116
---------	-----------	------	-----	-----	--------------

Extension kit to use with cable snake PCSN01. Additional 8 links extend cable snake up to 49" in length. Ideal for height adjustable tables. Silver plastic only.

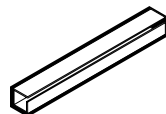

Wire Management Track - Single

C2M72	2 x 72 x 2	70	0.10	0.10	\$89
C2M60	2 x 60 x 2	70	0.10	0.10	\$74
C2M48	2 x 48 x 2	70	0.10	0.10	\$61
C2M36	2 x 36 x 2	70	0.10	0.10	\$45
C2M24	2 x 24 x 2	70	0.10	0.10	\$34
C2M12	2 x 12 x 2	70	0.10	0.10	\$19

To conceal and organize wires and cords. Attaches to Modesty Panel with double sided tape. Plastic.

• Available in Black Plastic Only.

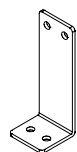

L Bracket

BAR526	--	70	.25	.10	\$140
--------	----	----	-----	-----	--------------

Set of two. For securing the stack-on units to the credenza.

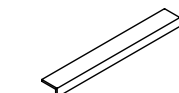

Foot Rest Cover

FRC8442	--	70	--	.10	\$1216
FRC7842	--	70	--	.10	\$1148
FRC7242	--	70	--	.10	\$1081
FRC6642	--	70	--	.10	\$1014
FRC8432	--	70	--	.10	\$1081
FRC7832	--	70	--	.10	\$1014
FRC7232	--	70	--	.10	\$947
FRC6632	--	70	--	.10	\$879

Factory installed.

ACCESSORIES



Handle

MODEL#	DIMENSIONS D x W x H	FREIGHT CLASS	WT/LBS.	CUBIC FT.	LIST PRICE
PL89	--	70	--	--	\$65

Chrome finish.

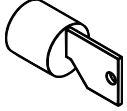

Lock Assembly

LO/C	--	70	--	--	\$113
------	----	----	----	----	--------------

Tungsten.

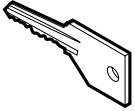

Extra Key

LOCK	--	70	--	--	\$46
------	----	----	----	----	-------------

Specify key #. Key range 401 - 420.

dufferin





The **Dufferin** series is a unique entity in that it integrates wood veneer and laminate. Worksurfaces, drawer and cabinet fronts use genuine wood veneer while the chassis and cabinets are finished in your choice of laminate or wood veneer. The result is a rich, two tone appearance to coordinate with any contemporary business interior.

Key features include a two inch knife edge providing clean, crisp detailing, grommets, a reverse profile/self edge edge on connecting worksurfaces, square or round post leg on islands, base and modesty panel upgrades and endless electrical options.

Storage options are available in 29", 48", 54", 66", 72" and 84" heights. Various models include storage cabinets, file modules, mixed storage cabinets, open shelving, wardrobe cabinets and personal towers.

Above worksurface storage selections include overhead storage and hutches with or without pigeon-hole storage. Hutch doors are available in a choice of veneer or glass with an aluminum frame. Tackboards are offered in all fabric or with a built-in accessory rail for organizing folders, binders, cds and more!



Contemporary **two inch overhang knife edge** on user and guest sides. Self-edge veneer on ends and wall sides.



Optional **base upgrades** include a rectangular two tone base (shown) and elliptical base. Available on most islands.

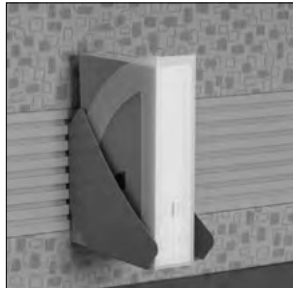

Tackboards with **accessory rails** accommodate letter trays, binder bins and file holders.



Features and Benefits

- Choice of ten handle options on every door/drawer that features handles
- Modesty panel options include veneer and straight glass (translucent) tungsten frame.
- Base upgrades to replace standard monopost on islands are available in four styles
- Drawers are standard vinyl-wrapped construction with black drawer sides and bottom.
- 75 lb box - 150 lb. file drawer weight capacity with full height sides with pencil tray included in box drawer
- Lateral file drawers can accommodate legal or letter documents
- Premium full extension progressive ball bearing slides on file drawers
- Box drawers mounted on 3/4 extension premium ball bearing slides.
- Power / Data accessories are available to be factory installed on any Dufferin unit, including Boardroom Tables, to meet all today's technological requirements
- A full array of complementary Boardroom and Reception area furnishings are available to coordinate the entire office

GENERAL INFORMATION

- Dufferin is a veneer and laminate desking system composed of hundreds of models, capable of furnishing executive suites, boardrooms and reception areas.
- 1 3/16" thick worksurfaces utilizing pedestal and panel construction with top over side panel design.
- Full modesty panels on desks are available in either a straight or breakfront style
- For environmental certification, please visit globalfurnituregroup.com

WORKSURFACES

- Standard with 1 3/16" top thickness
- All surfaces constructed from grade "A" veneers
- All top surfaces feature a contemporary 2" overhang knife edge on user and guest sides. Self-edge veneer on ends and wall sides.

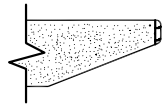

Contemporary 2" overhanging knife edge

CONSTRUCTION

- "Number one select, architectural grade A" oak, American black walnut, American black cherry, hard maple and lyptus. Wood worksurface molded edges are solid oak, walnut, cherry, maple or lyptus (except where square self-edges exist, i.e. credenza and computer worksurface back edges that are most commonly against walls).

FINISHES

- Conversion varnish (similar to catalyzed lacquer, but tougher), 35 to 40 degree sheen. Finishes are not buffed or rubbed.
- All Global wood casegood products are veneered and finished on the back sides (360° finishing), except modular under-surface storage - tops and backs are unfinished.
- Touch up kits available, includes a touch up marker and fill crayon. Order **VTUCHUPKIT, \$175** list. Specify finish when ordering.
- Global standard finish, on oak and walnut, is open pore and on cherry and maple is semi-closed pore. If a full finish is required for walnut, cherry, anigre and maple tops, Add the suffix "2" to the finish code and Add 5% to the base pricing for each product. **CUSTOM FINISH IS AVAILABLE.**
- High Pressure laminate inlays are available at no upcharge. Contact Customer Care for specification information.

PEDESTALS

- Black embossed vinyl-wrapped construction drawer sides and bottom are standard.
- All pedestals are full to floor and locking.
- Double pedestal models feature a choice of four drawer configurations: two file/file pedestals (EE), two box/box/file pedestals (DD), file/file on left, box/box/file on right (ED), or file/file on right, box/box/file on left (DE).
- Single pedestal models feature a choice of two drawer configurations: one file/file pedestal (E) or one box/box/file pedestal (D) on the left or right.

HARDWARE

- All necessary hardware items for attaching furniture items are included in the shipment. Actual wall attachment fasteners for wall cabinets, tackboards and visualboards are not included due to variation between site conditions.
- **Leveling glides** are shipped in a plastic bag attached to the bottom of the item or inside the pedestal. It is important to install leveling glides to ensure the unit is level. Levelers have a 1" range of adjustment.

- **Hanging file rails** are pre-installed on file drawer perimeters with additional front-to-back rails found in the bottom of the filing drawers. These rails hang onto plastic clips and do not require any tools to install. Legal filing can be achieved either as side-to-side or front-to-back. Letter filing can be achieved as front-to-back filing only.
- **Flat plates** for attaching bridge and return to desk are shipped pre-attached to the bottom of the bridge or return. **Mini flat plates** for securing bridge modesty panels to desk or credenza end panels, and quick connectors for securing modular corner units to adjacent pieces (Dufferin Series) are shipped along with screws in a plastic bag attached to the bottom of the bridge or return. **CAUTION:** using screws other than those supplied by Global could result in damage to finished tops.

LOCKS

- Locks are standard on all "below worksurface level" drawer and door storage units with the exception of the stationary organizer, pull-out tray units and single lateral file drawer combination tray/slot units. Combination storage unit comes with lock for file and lateral file drawer only, box drawers cannot lock.
- Optional locks may be ordered on all "above worksurface level" closed storage, Factory Installed. Please specify **LO, add \$143.**

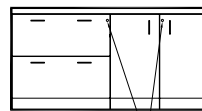
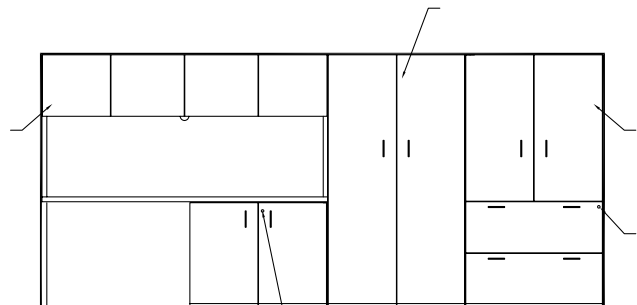

DCF7224

Style Credenza: File lock is on the inside gable behind the bookcase door. Lock for doors is on the front.

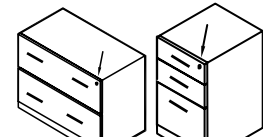

DWF

DWD

Modular Furniture: Lock is on the front

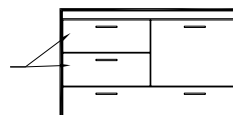

DZ3622

Combination storage unit Z comes with lock for file and lateral file drawer only, box drawers cannot lock.

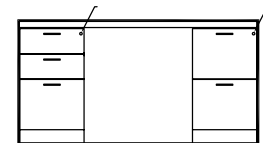

DD7236DE

Fully assembled furniture: Lock for D and E pedestals are inside the gable.

1. SPECIFY MODEL NUMBER

2. SPECIFY FINISH

WORKSURFACE TOP & DRAWER/DOOR FRONTS, BODY FINISHES (including pedestals)

veneer:

Code	Finish	Veneer Type	Cut
AMW	Almond Cherry	Cherry	Flat Sliced
ACW	Amber Cherry	Cherry	Flat Sliced
BTW	Biscotti	White Oak	Rift
CAW	Cocoa Walnut	Walnut	Flat Sliced
CRW	Coral	White Oak	Rift
DCW	Dark Cherry	Cherry	Flat Sliced
DWW	Dark Walnut	Walnut	Flat Sliced
EWV	Espresso Walnut	Walnut	Flat Sliced
EVW	Evening Oak	White Oak	Rift
GRW	Grey on Oak	White Oak	Rift
HAW	Hazelnut	Maple	Flat Sliced
JAW	Java	White Oak	Rift
LTW	Latte Walnut	Walnut	Flat Sliced
MHW	Mahogany on Walnut	Walnut	Flat Sliced
MTW	Milestone	White Oak	Rift
MPW	Natural Maple	Maple	Flat Sliced
NLW	Natural Walnut	Walnut	Flat Sliced
RCW	Red Cherry	Cherry	Flat Sliced
VNW	Vintage Cherry	Cherry	Flat Sliced
ULW	Umber Walnut	Walnut	Flat Sliced
WLW	Walnut	Walnut	Flat Sliced
WCW	Warm Cherry	Cherry	Flat Sliced
WMW	White Maple	Maple	Flat Sliced

BODY FINISHES (INCLUDING PEDESTALS) - LAMINATE:

BLK	Black
BZD	Blizzard
CGY	Custom Grey
DWT	Designer White
SDT	Stonedust
SOG	Storm Grey

MONOPOST FINISHES:

E	Black
K	Tungsten

3. SPECIFY OPTIONS

Handles

- Handles are standard on most drawers/storage modules. Each handle is identified by letters: **PL33, PL34, PL64, PL66, PL92, PL93, PL94, PL95, PL96, PL97, PL98, PL99, PLS7, and PLS8**. To specify a handle, specify the code after the model number and finish selections.

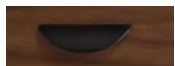

PL33 Black Moon Pull



PL34 Nickel Moon Pull



PL64 Contemporary Nickel



PL66 Transitional Nickel



PL92 Silver Bar



PL93 Black Bar



PL94 Silver Rectangular

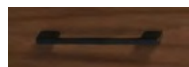

PL95 Black Rectangular

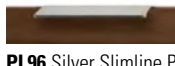

PL96 Silver Slimline Pull

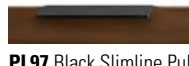

PL97 Black Slimline Pull



PL98 Silver Princeton Bar



PL99 Black Princeton Bar



PLS7 Black Spaghetti



PLS8 Silver Spaghetti

Grommets

- Standard grommet on all components is GM1. Grommet is included with products where shown in line drawings in price book.
- Optional grommets may be ordered in standard worksurface locations (left, center or right). Order as **GM1TL, GM1TC or GM1TR**. Add \$103.
- Grommet hole dimensions are 2.36" in diameter. Specify **GM1E** for **Black** or **GM1K** for **Tungsten**.



- Components that come standard with grommet may be ordered without a grommet. Order as RSG - Add \$57.

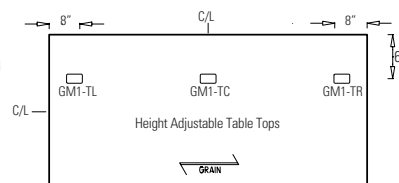
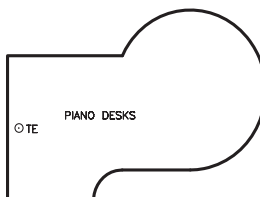
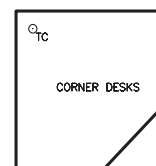
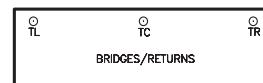
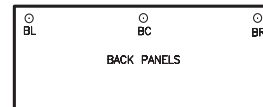
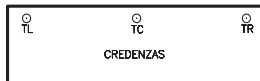
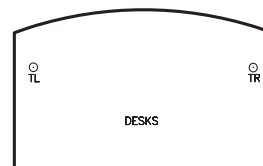

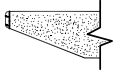

● Molding Edge

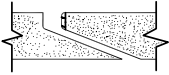

■ Reverse Profile / Molding Edge



▼ Self Edge Joint

- D - Desks and Credenzas
- B - Executive Bridges
- E - Executive Returns
- C - Corner Components
- L - Linking Bridges
- P - Piano Desks

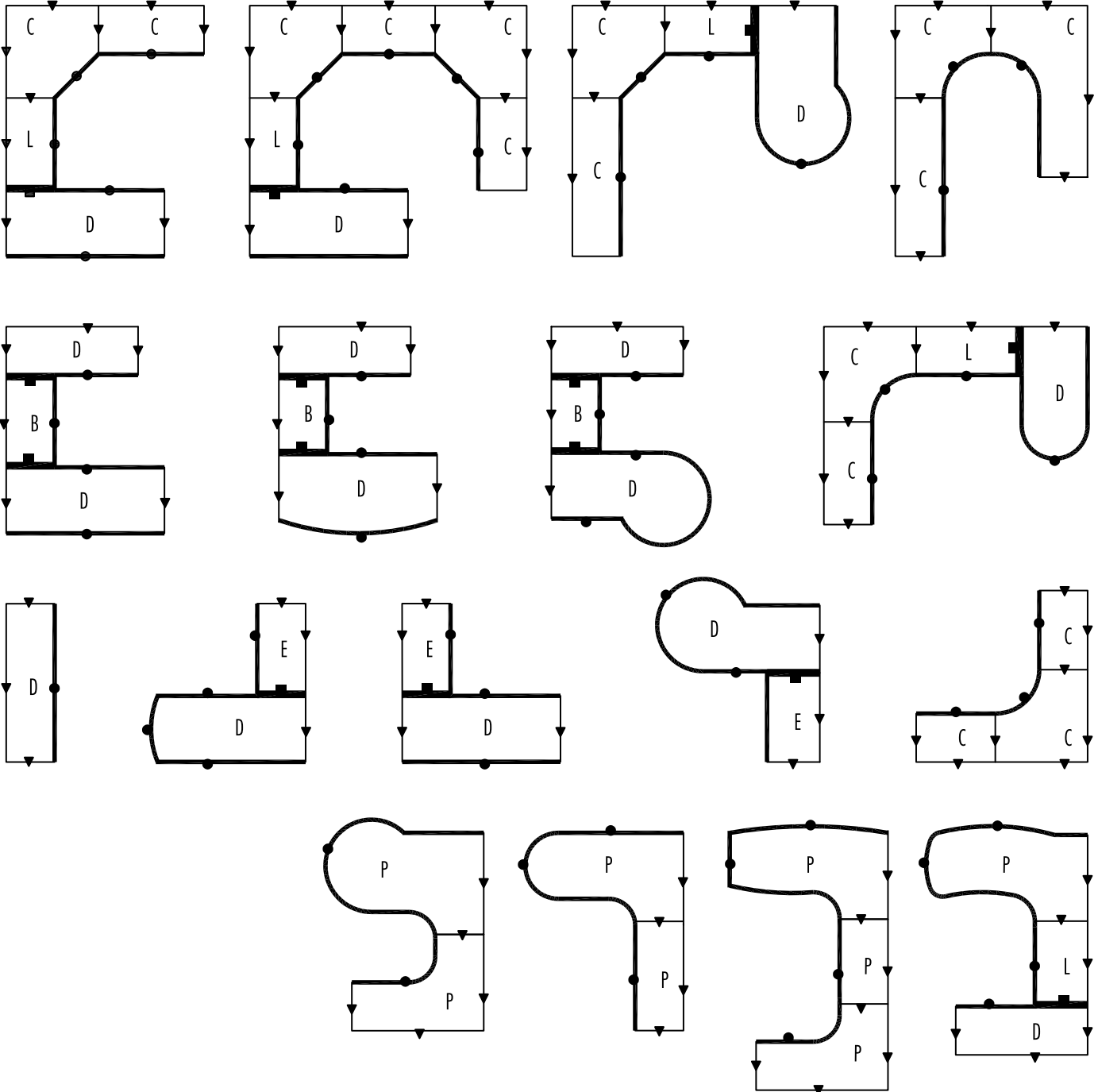

D DUFFERIN

DOUBLE PEDESTAL DESKS

MODEL#

DIMENSIONS

FREIGHT CLASS

WT/LBS.

CUBIC FT.

VENEER/LAMINATE

ALL VENEER

D x W x H

- Can be ordered as a shell or with pedestals.
- Grommets are available an option on Desks and most Credenzas.
- Hand of Rectangular Desk is determined by location of pedestal from user side.
- Hand of "P" Top is determined by outward orientation of conference end from user projection.

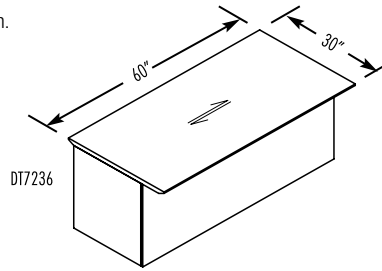
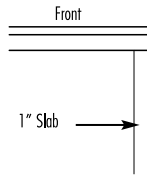
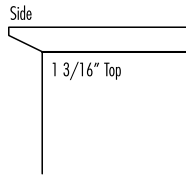
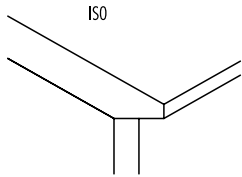

MODESTY PANEL CLEARANCE:

DT7236

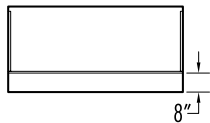

DT7230

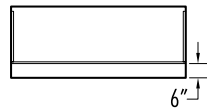

DMT7242

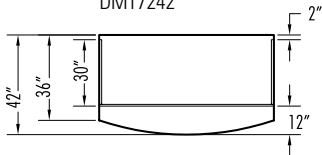

DMT6636

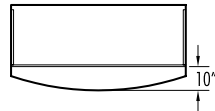

DISR8442D

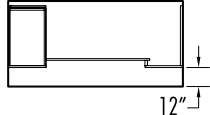

DISR7230D

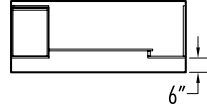

DDD7236



DDDBE7236

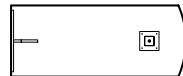

DDDBS7236



DTPL7242 (left shown)

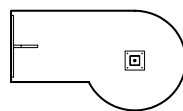

DESK MODESTY OPTIONS:

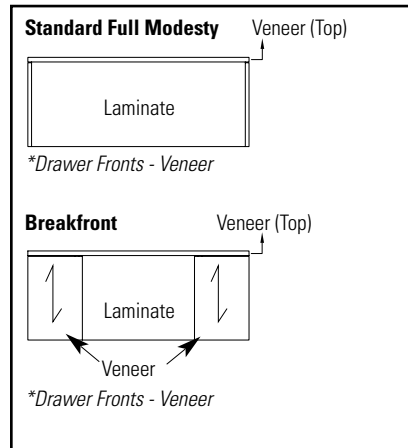

Breakfront Style - Modesty

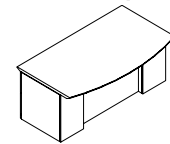

view from guest side

Standard Full Modesty

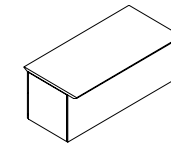

view from guest side

DOUBLE PEDESTAL DESKS - RECESSED FRONT MODESTY

DIMENSIONS

FREIGHT CLASS

WT/LBS.

CUBIC FT.

VENEER/LAMINATE

ALL VENEER

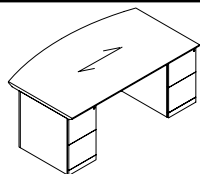

Double Pedestal Bow Top Desk

MODEL#	DIMENSIONS	FREIGHT CLASS	WT/LBS.	CUBIC FT.	VENEER/LAMINATE	ALL VENEER
DMD8442EE	42 x 84 x 29	125	443	59	\$6531	\$7838
DMD7842EE	42 x 78 x 29	125	412	55	\$6061	\$7273
DMD7242EE	42 x 72 x 29	125	380	51	\$5598	\$6716
DMD6636EE	36 x 66 x 29	125	240	40	\$5430	\$6514

Standard with full to floor **file/file** pedestals on **left and right**. Bow top. Pedestals lock. Refer to the Desks and Credenzas Notes above for overhang dimensions. Shipped assembled in 1 carton.

Required Specifications

Veneer Finish
Laminate Finish
Handle Style

Optional Specifications

Grommet

DOUBLE PEDESTAL DESKS

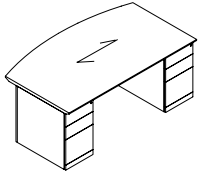

Double Pedestal Bow Top Desk

MODEL#	DIMENSIONS	FREIGHT CLASS	WT./LBS.	CUBIC FT.	VENEER/LAMINATE	ALL VENEER
D x W x H						
DMD8442DD	42 x 84 x 29	125	443	59	\$6531	\$7838
DMD7842DD	42 x 78 x 29	125	412	55	\$6061	\$7273
DMD7242DD	42 x 72 x 29	125	380	51	\$5598	\$6716
DMD6636DD	36 x 66 x 29	125	240	40	\$5430	\$6514

Standard with full to floor **box/box/file** pedestals on **left** and **right**. Bow top. Pedestals lock. One pencil tray. Refer to the Desks and Credenzas Notes Section on previous page for overhang dimensions. Shipped assembled in 1 carton.

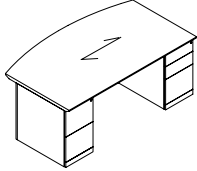

Double Pedestal Bow Top Desk

DMD8442ED	42 x 84 x 29	125	443	59	\$6531	\$7838
DMD7842ED	42 x 78 x 29	125	412	55	\$6061	\$7273
DMD7242ED	42 x 72 x 29	125	380	51	\$5598	\$6716
DMD6636ED	36 x 66 x 29	125	240	40	\$5430	\$6514

Standard with full to floor **file/file** pedestal on **left** and **box/box/file** pedestal on **right**. Bow top. Pedestals lock. One pencil tray. Refer to the Desks and Credenzas Notes Section on previous page for overhang dimensions. Shipped assembled in 1 carton.

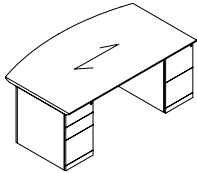

Double Pedestal Bow Top Desk

DMD8442DE	42 x 84 x 29	125	443	59	\$6531	\$7838
DMD7842DE	42 x 78 x 29	125	412	55	\$6061	\$7273
DMD7242DE	42 x 72 x 29	125	380	51	\$5598	\$6716
DMD6636DE	36 x 66 x 29	125	240	40	\$5430	\$6514

Standard with full to floor **box/box/file** pedestal on **left** and **file/file** pedestal on **right**. Bow top. Pedestals lock. One pencil tray. Refer to the Desks and Credenzas Notes Section on previous page for overhang dimensions. Shipped assembled in 1 carton.

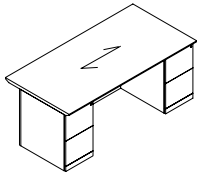

Double Pedestal Desk

DD8442EE	42 x 84 x 29	125	432	59	\$5552	\$6662
DD7842EE	42 x 78 x 29	125	401	55	\$5158	\$6186
DD7236EE	36 x 72 x 29	100	370	44	\$4761	\$5711
DD7230EE	30 x 72 x 29	100	349	36	\$4685	\$5624
DD6636EE	36 x 66 x 29	100	339	40	\$4685	\$5624
DD6630EE	30 x 66 x 29	100	320	33	\$4612	\$5534
DD6030EE	30 x 60 x 29	92.5	305	30	\$4468	\$5363

Standard with full to floor **file/file** pedestals on **left** and **right**. Pedestals lock. Refer to the Desks and Credenzas Notes Section on previous page for overhang dimensions. Shipped assembled in 1 carton.

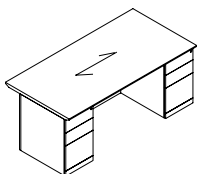

Double Pedestal Desk

DD8442DD	42 x 84 x 29	125	432	59	\$5552	\$6662
DD7842DD	42 x 78 x 29	125	401	55	\$5158	\$6186
DD7236DD	36 x 72 x 29	100	370	44	\$4761	\$5711
DD7230DD	30 x 72 x 29	100	349	36	\$4685	\$5624
DD6636DD	36 x 66 x 29	100	339	40	\$4685	\$5624
DD6630DD	30 x 66 x 29	100	320	33	\$4612	\$5534
DD6030DD	30 x 60 x 29	92.5	305	30	\$4468	\$5363

Standard with full to floor **box/box/file** pedestals on **left** and **right**. Pedestals lock. Refer to the Desks and Credenzas Notes Section on previous page for overhang dimensions. Shipped assembled in 1 carton.

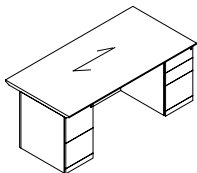

Double Pedestal Desk

DD8442ED	42 x 84 x 29	125	432	59	\$5552	\$6662
DD7842ED	42 x 78 x 29	125	401	55	\$5158	\$6186
DD7236ED	36 x 72 x 29	100	370	44	\$4761	\$5711
DD7230ED	30 x 72 x 29	100	349	36	\$4685	\$5624
DD6636ED	36 x 66 x 29	100	339	40	\$4685	\$5624
DD6630ED	30 x 66 x 29	100	320	33	\$4612	\$5534
DD6030ED	30 x 60 x 29	92.5	305	30	\$4468	\$5363

Standard with full to floor **file/file** pedestal on **left** and **box/box/file** pedestal on **right**. Pedestals lock. Refer to the Desks and Credenzas Notes Section on previous page for overhang dimensions. Shipped assembled in 1 carton.

Required Specifications

Veneer Finish
Laminate Finish
Handle Style

Optional Specifications

Grommet

DOUBLE PEDESTAL DESKS

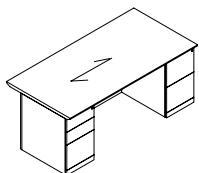

Double Pedestal Desk

MODEL#	DIMENSIONS D x W x H	FREIGHT CLASS	WT/LBS.	CUBIC FT.	VENEER/LAMINATE	ALL VENEER
DD8442DE	42 x 84 x 29	125	432	59	\$5552	\$6662
DD7842DE	42 x 78 x 29	125	401	55	\$5158	\$6186
DD7236DE	36 x 72 x 29	100	370	44	\$4761	\$5711
DD7230DE	30 x 72 x 29	100	349	36	\$4685	\$5624
DD6636DE	36 x 66 x 29	100	339	40	\$4685	\$5624
DD6630DE	30 x 66 x 29	100	320	33	\$4612	\$5534
DD6030DE	30 x 60 x 29	92.5	305	30	\$4468	\$5363

Standard with full to floor **box/box/file** pedestal on **left** and **file/file** pedestal on **right**. Pedestals lock. Refer to the Desks and Credenzas Notes Section on page 66 for overhang dimensions. Shipped assembled in 1 carton.

DOUBLE PEDESTAL DESKS - BREAKFRONT STYLE

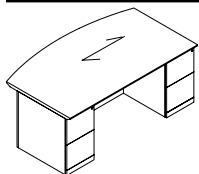

Double Pedestal Bow Top Desk Breakfront Style

MODEL#	DIMENSIONS	FREIGHT CLASS	WT/LBS.	CUBIC FT.	VENEER/LAMINATE	ALL VENEER
DMID8442EE	42 x 84 x 29	125	443	59	\$7753	\$9301
DMID7842EE	42 x 78 x 29	125	412	55	\$7198	\$8639
DMID7242EE	42 x 72 x 29	125	380	51	\$6647	\$7975
DMID6636EE	36 x 66 x 29	125	240	40	\$5974	\$7169

Standard with full to floor **file/file** pedestals on **left** and **right**. Bow top. Pedestals lock. Refer to the Desks and Credenzas Notes Section on page 66. for overhang dimensions. Shipped assembled in 1 carton.

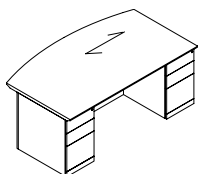

Double Pedestal Bow Top Desk Breakfront Style

DMID8442DD	42 x 84 x 29	125	443	59	\$7753	\$9301
DMID7842DD	42 x 78 x 29	125	412	55	\$7198	\$8639
DMID7242DD	42 x 72 x 29	125	380	51	\$6647	\$7975
DMID6636DD	36 x 66 x 29	125	240	40	\$5974	\$7169

Standard with full to floor **box/box/file** pedestals on **left** and **right**. Bow top. Pedestals lock. Refer to the Desks and Credenzas Notes Section on page 66. for overhang dimensions. Shipped assembled in 1 carton.

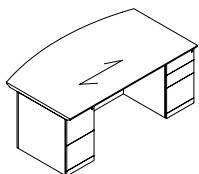

Double Pedestal Bow Top Desk Breakfront Style

DMID8442ED	42 x 84 x 29	125	443	59	\$7753	\$9301
DMID7842ED	42 x 78 x 29	125	412	55	\$7198	\$8639
DMID7242ED	42 x 72 x 29	125	380	51	\$6647	\$7975
DMID6636ED	36 x 66 x 29	125	240	40	\$5974	\$7169

Standard with full to floor **file/file** pedestal on **left** and **box/box/file** pedestal on **right**. Bow top. Pedestals lock. One pencil tray. Refer to the Desks and Credenzas Notes Section on page 66 for overhang dimensions. Shipped assembled in 1 carton.

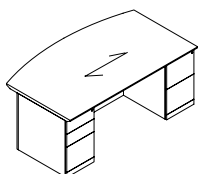

Double Pedestal Bow Top Desk Breakfront Style

DMID8442DE	42 x 84 x 29	125	443	59	\$7753	\$9301
DMID7842DE	42 x 78 x 29	125	412	55	\$7198	\$8639
DMID7242DE	42 x 72 x 29	125	380	51	\$6993	\$8394
DMID6636DE	36 x 66 x 29	125	240	40	\$5974	\$7169

Standard with full to floor **box/box/file** pedestal on **left** and **file/file** pedestal on **right**. Bow top. Pedestals lock. One pencil tray. Refer to the Desks and Credenzas Notes Section on page 66 for overhang dimensions. Shipped assembled in 1 carton.

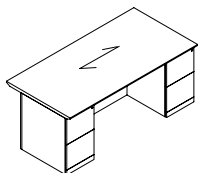

Double Pedestal Desk, Breakfront Style

DID8442EE	42 x 84 x 29	125	432	59	\$7626	\$9150
DID7842EE	42 x 78 x 29	125	401	55	\$7075	\$8494
DID7236EE	36 x 72 x 29	100	370	44	\$5654	\$6782
DID7230EE	30 x 72 x 29	100	349	36	\$5567	\$6677
DID6636EE	36 x 66 x 29	100	339	40	\$5567	\$6677
DID6630EE	30 x 66 x 29	100	320	33	\$5477	\$6572
DID6030EE	30 x 60 x 29	92.5	305	30	\$5306	\$6365

Standard with full to floor **file/file** pedestals on **left** and **right**. Pedestals lock. Refer to the Desks and Credenzas Notes Section on page 66 for overhang dimensions. Shipped assembled in 1 carton.

Required Specifications

Veneer Finish
Laminate Finish
Handle Style

Optional Specifications

Grommet

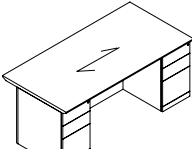
DOUBLE PEDESTAL DESKS - BREAKFRONT STYLE	MODEL#	DIMENSIONS	FREIGHT CLASS	WT./LBS.	CUBIC FT.	veneer/LAMINATE	ALL VENEER
		D x W x H					
	DID8442DD	42 x 84 x 29	125	432	59	\$7626	\$9150
	DID7842DD	42 x 78 x 29	125	401	55	\$7075	\$8494
	DID7236DD	36 x 72 x 29	100	370	44	\$5654	\$6782
	DID7230DD	30 x 72 x 29	100	349	36	\$5567	\$6677
	DID6636DD	36 x 66 x 29	100	339	40	\$5567	\$6677
	DID6630DD	30 x 66 x 29	100	320	33	\$5477	\$6572
DID6030DD	30 x 60 x 29	92.5	305	30	\$5306	\$6365	

Double Pedestal Desk, Breakfront Style

Standard with full to floor **box/box/file** pedestals on **left** and **right**. Pedestals lock. Refer to the Desks and Credenzas Notes Section on page 66 for overhang dimensions. Shipped assembled in 1 carton.

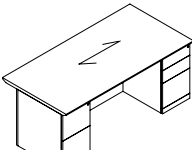
	DID8442ED	42 x 84 x 29	125	432	59	\$7626	\$9150
	DID7842ED	42 x 78 x 29	125	401	55	\$7075	\$8494
	DID7236ED	36 x 72 x 29	100	370	44	\$5654	\$6782
	DID7230ED	30 x 72 x 29	100	349	36	\$5567	\$6677
	DID6636ED	36 x 66 x 29	100	339	40	\$5654	\$6782
	DID6630ED	30 x 66 x 29	100	320	33	\$5477	\$6572
	DID6030ED	30 x 60 x 29	92.5	305	30	\$5306	\$6365

Double Pedestal Desk, Breakfront Style

Standard with full to floor **file/file** pedestal on **left** and **box/box/file** pedestal on **right**. Pedestals lock. Refer to the Desks and Credenzas Notes Section on page 66 for overhang dimensions. Shipped assembled in 1 carton.

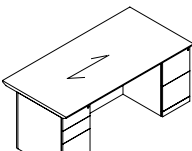
	DID8442DE	42 x 84 x 29	125	432	59	\$7626	\$9150
	DID7842DE	42 x 78 x 29	125	401	55	\$7075	\$8494
	DID7236DE	36 x 72 x 29	100	370	44	\$5654	\$6782
	DID7230DE	30 x 72 x 29	100	349	36	\$5567	\$6677
	DID6636DE	36 x 66 x 29	100	339	40	\$5567	\$6677
	DID6630DE	30 x 66 x 29	100	320	33	\$5477	\$6572
	DID6030DE	30 x 60 x 29	92.5	305	30	\$5306	\$6365

Double Pedestal Desk, Breakfront Style

Standard with full to floor **box/box/file** pedestal on **left** and **file/file** pedestal on **right**. Pedestals lock. Refer to the Desks and Credenzas Notes Section on page 66 for overhang dimensions. Shipped assembled in 1 carton.

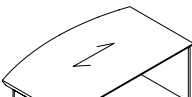
SINGLE PEDESTAL DESKS - RECESSED FRONT MODESTY		DIMENSIONS	FREIGHT CLASS	WT./LBS.	CUBIC FT.	veneer/LAMINATE	ALL VENEER
	DMSL8442E	42 x 84 x 29	125	432	59	\$6144	\$7372
	DMSL7842E	42 x 78 x 29	125	401	55	\$5709	\$6853
	DMSL7242E	42 x 72 x 29	125	370	51	\$5270	\$6324
	DMSL6636E	36 x 66 x 29	150	230	40	\$5069	\$6080

Single Pedestal Bow Top Desk - LEFT

Standard with full to floor **file/file** pedestal on **left**. Bow top. Pedestal locks. Refer to the Desks and Credenzas Notes Section on page 66 for overhang dimensions. Shipped assembled in 1 carton.

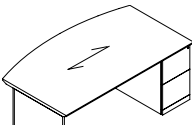
	DMSR8442E	42 x 84 x 29	125	432	59	\$6144	\$7372
	DMSR7842E	42 x 78 x 29	125	401	55	\$5709	\$6853
	DMSR7242E	42 x 72 x 29	125	370	51	\$5270	\$6324
	DMSR6636E	36 x 66 x 29	150	230	40	\$5069	\$6080

Single Pedestal Bow Top Desk - RIGHT

Standard with full to floor **file/file** pedestal on **right**. Bow top. Pedestal locks. Refer to the Desks and Credenzas Notes Section on page 66 for overhang dimensions. Shipped assembled in 1 carton.

Required Specifications

Veneer Finish
Laminate Finish
Handle Style

Optional Specifications

Grommet

SINGLE PEDESTAL DESKS

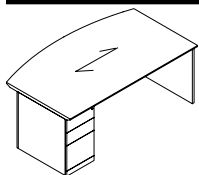

Single Pedestal Bow Top Desk - LEFT

MODEL#	DIMENSIONS D x W x H	FREIGHT CLASS	WT/LBS.	CUBIC FT.	VENEER/LAMINATE	ALL VENEER
DMSL8442D	42 x 84 x 29	125	432	59	\$6144	\$7372
DMSL7842D	42 x 78 x 29	125	401	55	\$5709	\$6853
DMSL7242D	42 x 72 x 29	125	370	51	\$5270	\$6324
DMSL6636D	36 x 66 x 29	150	230	40	\$5069	\$6080

Standard with full to floor **box/box/file** pedestal on **left**. Bow top. Pedestal locks. Refer to the Desks and Credenzas Notes Section on page 66 for overhang dimensions. Shipped assembled in 1 carton.

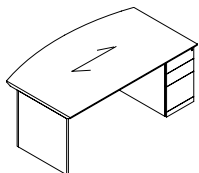

Single Pedestal Bow Top Desk - RIGHT

DMSR8442D	42 x 84 x 29	125	432	59	\$6144	\$7372
DMSR7842D	42 x 78 x 29	125	401	55	\$5709	\$6853
DMSR7242D	42 x 72 x 29	125	370	51	\$5270	\$6324
DMSR6636D	36 x 66 x 29	150	230	40	\$5069	\$6080

Standard with full to floor **box/box/file** pedestal on **right**. Bow top. Pedestal locks. Refer to the Desks and Credenzas Notes Section on page 66 for overhang dimensions. Shipped assembled in 1 carton.

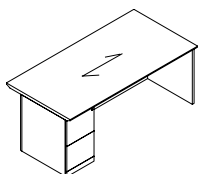

Single Pedestal Desk - LEFT

DSL8442E	42 x 84 x 29	125	463	59	\$4938	\$5923
DSL7842E	42 x 78 x 29	125	430	55	\$4584	\$5501
DSL7236E	36 x 72 x 29	125	340	44	\$3629	\$4352
DSL7230E	30 x 72 x 29	125	283	36	\$3470	\$4164
DSL6636E	36 x 66 x 29	125	312	40	\$3470	\$4164
DSL6630E	30 x 66 x 29	100	295	33	\$3312	\$3974
DSL6030E	30 x 60 x 29	100	265	30	\$3162	\$3795

Standard with full to floor **file/file** pedestal on **left**. Pedestal locks. Refer to the Desks and Credenzas Notes Section on page 66 for overhang dimensions. Shipped assembled in 1 carton.

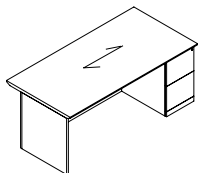

Single Pedestal Desk - RIGHT

DSR8442E	42 x 84 x 29	125	463	59	\$4938	\$5923
DSR7842E	42 x 78 x 29	125	430	55	\$4584	\$5501
DSR7236E	36 x 72 x 29	125	340	44	\$3629	\$4352
DSR7230E	30 x 72 x 29	125	283	36	\$3470	\$4164
DSR6636E	36 x 66 x 29	125	312	40	\$3470	\$4164
DSR6630E	30 x 66 x 29	100	295	33	\$3312	\$3974
DSR6030E	30 x 60 x 29	100	265	30	\$3162	\$3795

Standard with full to floor **file/file** pedestal on **right**. Pedestal locks. Refer to the Desks and Credenzas Notes Section on page 66 for overhang dimensions. Shipped assembled in 1 carton.

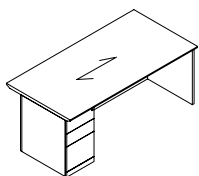

Single Pedestal Desk - LEFT

DSL8442D	42 x 84 x 29	125	463	59	\$4938	\$5923
DSL7842D	42 x 78 x 29	125	430	55	\$4584	\$5501
DSL7236D	36 x 72 x 29	125	340	44	\$3629	\$4352
DSL7230D	30 x 72 x 29	125	283	36	\$3470	\$4164
DSL6636D	36 x 66 x 29	125	312	40	\$3470	\$4164
DSL6630D	30 x 66 x 29	100	295	33	\$3312	\$3974
DSL6030D	30 x 60 x 29	100	265	30	\$3162	\$3795

Standard with full to floor **box/box/file** pedestal on **left**. Pedestal locks. Refer to the Desks and Credenzas Notes Section on page 66 for overhang dimensions. Shipped assembled in 1 carton.

Required Specifications

- Veneer Finish
- Laminate Finish
- Handle Style

Optional Specifications

- Grommet

SINGLE PEDESTAL DESKS	MODEL#	DIMENSIONS	FREIGHT CLASS	WT/LBS.	CUBIC FT.	VENEER/LAMINATE	ALL VENEER
		D x W x H					
	DSR8442D	42 x 84 x 29	125	463	59	\$4938	\$5923
	DSR7842D	42 x 78 x 29	125	430	55	\$4584	\$5501
	DSR7236D	36 x 72 x 29	125	340	44	\$3629	\$4352
	DSR7230D	30 x 72 x 29	125	283	36	\$3470	\$4164
	DSR6636D	36 x 66 x 29	125	312	40	\$3470	\$4164
	DSR6630D	30 x 66 x 29	100	295	33	\$3312	\$3974
DSR6030D	30 x 60 x 29	100	265	30	\$3162	\$3795	

Single Pedestal Desk - RIGHT

Standard with full to floor **box/box/file** pedestal on **right**. Pedestal locks. Refer to the Desks and Credenzas Notes Section on page 66 for overhang dimensions. Shipped assembled in 1 carton.

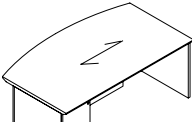
SINGLE PEDESTAL DESKS - BREAKFRONT STYLE	MODEL#	DIMENSIONS	FREIGHT CLASS	WT/LBS.	CUBIC FT.	VENEER/LAMINATE	ALL VENEER
	DMISL8442E	42 x 84 x 29	125	432	59	\$6144	\$7372
	DMISL7842E	42 x 78 x 29	125	401	55	\$5706	\$6847
	DMISL7242E	42 x 72 x 29	125	370	51	\$5268	\$6322
	DMISL6636E	36 x 66 x 29	150	230	40	\$5068	\$6078

**Single Pedestal Bow Top Desk - LEFT
Breakfront Style**

Standard with full to floor **file/file** pedestal on **left**. Bow top. Pedestal locks. Refer to the Desks and Credenzas Notes Section on page 66 for overhang dimensions. Shipped assembled in 1 carton.

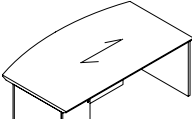
	DMISR8442E	42 x 84 x 29	125	432	59	\$6144	\$7372
	DMISR7842E	42 x 78 x 29	125	401	55	\$5706	\$6847
	DMISR7242E	42 x 72 x 29	125	370	51	\$5268	\$6322
	DMISR6636E	36 x 66 x 29	150	230	40	\$5068	\$6078

**Single Pedestal Bow Top Desk - RIGHT
Breakfront Style**

Standard with full to floor **file/file** pedestal on **right**. Bow top. Pedestal locks. Refer to the Desks and Credenzas Notes Section on page 66 for overhang dimensions. Shipped assembled in 1 carton.

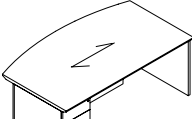
	DMISL8442D	42 x 84 x 29	125	432	59	\$6144	\$7372
	DMISL7842D	42 x 78 x 29	125	401	55	\$5706	\$6847
	DMISL7242D	42 x 72 x 29	125	370	51	\$5268	\$6322
	DMISL6636D	36 x 66 x 29	150	230	40	\$5068	\$6078

**Single Pedestal Bow Top Desk - LEFT
Breakfront Style**

Standard with full to floor **box/box/file** pedestal on **left**. Bow top. Pedestal locks. Refer to the Desks and Credenzas Notes Section on page 66 for overhang dimensions. Shipped assembled in 1 carton.

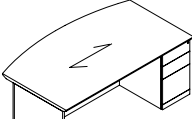
	DMISR8442D	42 x 84 x 29	125	432	59	\$6144	\$7372
	DMISR7842D	42 x 78 x 29	125	401	55	\$5706	\$6847
	DMISR7242D	42 x 72 x 29	125	370	51	\$5268	\$6322
	DMISR6636D	36 x 66 x 29	150	230	40	\$5068	\$6078

**Single Pedestal Bow Top Desk - RIGHT
Breakfront Style**

Standard with full to floor **box/box/file** pedestal on **right**. Bow top. Pedestal locks. Refer to the Desks and Credenzas Notes Section on page 66 for overhang dimensions. Shipped assembled in 1 carton.

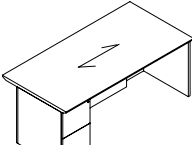
	DISL8442E	42 x 84 x 29	125	463	59	\$5862	\$7035
	DISL7842E	42 x 78 x 29	125	430	55	\$5444	\$6533
	DISL7236E	36 x 72 x 29	125	340	44	\$4311	\$5172
	DISL7230E	30 x 72 x 29	125	283	36	\$4119	\$4941
	DISL6636E	36 x 66 x 29	125	312	40	\$4119	\$4941
	DISL6630E	30 x 66 x 29	100	295	33	\$3930	\$4717
	DISL6030E	30 x 60 x 29	100	265	30	\$3758	\$4511

**Single Pedestal Desk - LEFT
Breakfront Style**

Standard with full to floor **file/file** pedestal on **left**. Pedestal locks. Refer to the Desks and Credenzas Notes Section on page 66 for overhang dimensions. Shipped assembled in 1 carton.

Required Specifications

Veneer Finish
Laminate Finish
Handle Style

Optional Specifications

Grommet

ELECTRIC HEIGHT ADJUSTABLE UNITS - NOTES

D x W x H

- All Height Adjustable (HA) units are shipped fully assembled.
- Simple Up / Down function enables the height adjustment of the worksurface.
- The height adjustment range for desks is 29" to 45", for table and bridge top 26" to 43" (including worksurface).
- Single stage HA mechanism with an electric motor in each column is used.
- The height adjustable mechanism operates at 1.5" per second.
- Max. weight / lift is 265 lbs.
- All columns are integrated into fully functional pedestals, or pedestal bases with the exception of the HA table and the HA bridge top.
- Height adjustable bases are available in three colors: **Black (BLK)**, **Tungsten (TUN)**, and **Designer White (DWT)**
- All desks include two (2) PVC wire management channels (L & R side) allowing for cabling through the pedestals.
- Hanging wood modesty panel on desk is standard. Hanging glass (aluminum framed) modesty panel is optional.
- To avoid risk of pinching:
 - 4.9" / 124mm gap is kept between the pedestal and the lowest point of the worksurface.
 - Wood spacer HASP must be used to attach height adjustable unit in the "U" or "L" configuration. See assembly instructions.
 - 2" gap is required between the worksurfaces when using the HA Table or the HA Bridge Top.
 - Includes collision detector
- Optional grommet locations: **TL** - Top Left or **TR** - Top Right

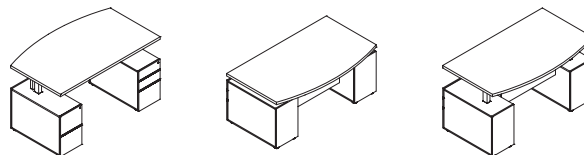
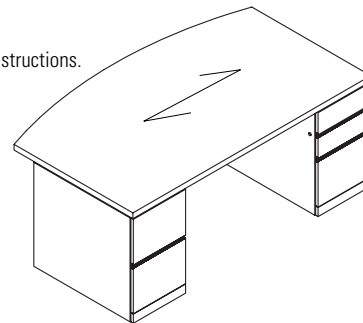

Note: Arrow indicates direction of grain.

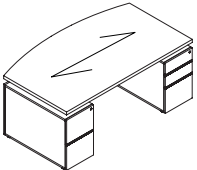
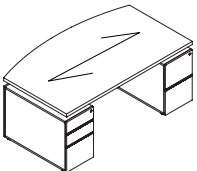
HEIGHT ADJUSTABLE DOUBLE PEDESTAL DESKS	MODEL#	DIMENSIONS	FREIGHT CLASS	WT/LBS.	CUBIC FT.	VENEER/LAMINATE	ALL VENEER
		D x W x H					
 <p>Height Adj. Double Ped. Bow Top Desk Breakfront Style</p>	DHAMID8442ED	42 x 84 x 29	150	450	81	\$13124	\$14581
	DHAMID7842ED	42 x 78 x 29	150	430	72	\$12569	\$13965
	DHAMID7242ED	42 x 72 x 29	125	410	67	\$12015	\$13347
	DHAMID6636ED	36 x 66 x 29	125	390	54	\$11396	\$12662
		Built-in electric height adjustable double pedestal, standard with full to floor box/box/file pedestal on right and file/file pedestal on left . Bow top. Pedestals lock. One pencil tray. Refer to the Desks and Credenzas Notes Section on page 66 for overhang dimensions. Shipped RTA (ready to assemble).					
 <p>Height Adj. Double Ped. Bow Top Desk Breakfront Style</p>	DHAMID8442DE	42 x 84 x 29	150	450	81	\$13124	\$14581
	DHAMID7842DE	42 x 78 x 29	150	430	72	\$12569	\$13965
	DHAMID7242DE	42 x 72 x 29	125	410	67	\$12015	\$13347
	DHAMID6636DE	36 x 66 x 29	125	390	54	\$11396	\$12662
		Built-in electric height adjustable double pedestal, standard with full to floor box/box/file pedestal on left and file/file pedestal on right . Bow top. Pedestals lock. One pencil tray. Refer to the Desks and Credenzas Notes Section on page 66 for overhang dimensions. Shipped RTA (ready to assemble).					

Required Specifications

- Top Finish
- Edge
- Base finish
- Handle style

Optional Specifications

- Grommet
- Glass modesty

HEIGHT ADJUSTABLE DOUBLE PEDESTAL DESKS **MODEL#** **DIMENSIONS** **FREIGHT CLASS** **WT./LBS.** **CUBIC FT.** **VENEER/LAMINATE** **ALL VENEER**

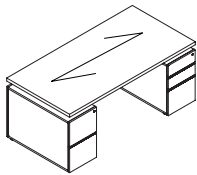

Height Adj. Double Ped. Desk
Breakfront Style

	D x W x H						
DHAID8436ED	36 x 84 x 29	125	440	68	\$11174	\$12416	
DHAID7836ED	36 x 78 x 29	125	420	63	\$11100	\$12332	
DHAID7236ED	36 x 72 x 29	125	400	58	\$11018	\$12243	
DHAID7230ED	30 x 72 x 29	125	390	49	\$10937	\$12152	
DHAID6630ED	30 x 66 x 29	100	380	46	\$10786	\$11983	

Built-in electric height adjustable double pedestal, standard with full to floor **box/box/file** pedestal on **right** and **file/file** pedestal on **left**. Pedestals lock. One pencil tray. Refer to the Desks and Credenzas Notes Section on page 66 for overhang dimensions. Shipped RTA (ready to assemble).

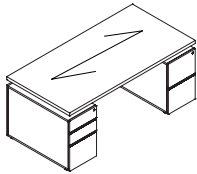

Height Adj. Double Ped. Desk
Breakfront Style

DHAID8436DE	36 x 84 x 29	125	440	68	\$11174	\$12416	
DHAID7836DE	36 x 78 x 29	125	420	63	\$11100	\$12332	
DHAID7236DE	36 x 72 x 29	125	400	58	\$11018	\$12243	
DHAID7230DE	30 x 72 x 29	125	390	49	\$10937	\$12152	
DHAID6630DE	30 x 66 x 29	100	380	46	\$10786	\$11983	

Built-in electric height adjustable double pedestal, standard with full to floor **box/box/file** pedestal on **left** and **file/file** pedestal on **right**. Pedestals lock. One pencil tray. Refer to the Desks and Credenzas Notes Section on page 66 for overhang dimensions. Shipped RTA (ready to assemble).

HEIGHT ADJUSTABLE SINGLE PEDESTAL DESKS **MODEL#** **DIMENSIONS** **FREIGHT CLASS** **WT./LBS.** **CUBIC FT.** **VENEER/LAMINATE** **ALL VENEER**

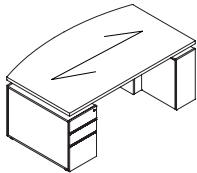

Height Adj. Single Ped. Bow Top Desk
Breakfront Style - LEFT

DHAMISL8442D	42 x 84 x 29	150	440	59	\$11511	\$12787	
DHAMISL7842D	42 x 78 x 29	150	420	55	\$11075	\$12306	
DHAMISL7242D	42 x 72 x 29	150	400	51	\$10638	\$11823	
DHAMISL6636D	36 x 66 x 29	125	390	40	\$10098	\$11220	

Built-in electric height adjustable single pedestal bow top desk. Standard with full to floor locking **box/box/file** pedestal on **left** and support pedestal on **right**. Refer to the Desks and Credenzas Notes Section on page 66 for overhang dimensions. Shipped RTA (ready to assemble).

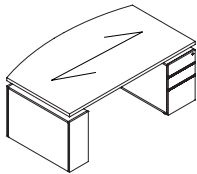

Height Adj. Single Ped. Bow Top Desk
Breakfront Style - RIGHT

DHAMISR8442D	42 x 84 x 29	150	440	59	\$11511	\$12787	
DHAMISR7842D	42 x 78 x 29	150	420	55	\$11075	\$12306	
DHAMISR7242D	42 x 72 x 29	150	400	51	\$10638	\$11823	
DHAMISR6636D	36 x 66 x 29	125	390	40	\$10098	\$11220	

Built-in electric height adjustable single pedestal bow top desk. Standard with full to floor locking **box/box/file** pedestal on **right** and support pedestal on **left**. Refer to the Desks and Credenzas Notes Section on page 66 for overhang dimensions. Shipped RTA (ready to assemble).

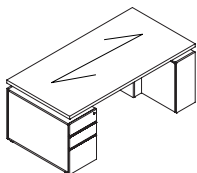

Height Adjustable Single Ped. Desk
Breakfront Style - LEFT

DHAISL8436D	36 x 84 x 29	125	430	55	\$9834	\$10924	
DHAISL7836D	36 x 78 x 29	125	410	50	\$9794	\$10883	
DHAISL7236D	36 x 72 x 29	125	390	44	\$9676	\$10751	
DHAISL7230D	30 x 72 x 29	125	380	40	\$9486	\$10684	
DHAISL6630D	30 x 66 x 29	125	360	36	\$9240	\$10266	
DHAISL6030D	30 x 60 x 29	100	340	35	\$9064	\$10071	

Built-in electric height adjustable single pedestal desk. Standard with full to floor locking **box/box/file** pedestal on **left** and support pedestal on **right**. Refer to the Desks and Credenzas Notes Section on page 66 for overhang dimensions. Shipped RTA (ready to assemble).

Required Specifications

Top Finish
Edge
Base finish
Handle style

Optional Specifications

Grommet
Glass modesty

HEIGHT ADJUSTABLE SINGLE PEDESTAL DESKS

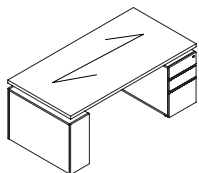

Height Adjustable Single Ped. Desk*
Breakfront Style - RIGHT

MODEL#	DIMENSIONS D x W x H	FREIGHT CLASS	WT/LBS.	CUBIC FT.	VENEER/LAMINATE	ALL VENEER
DHAISR8436D	36 x 84 x 29	125	430	55	\$9834	\$10924
DHAISR7836D	36 x 78 x 29	125	410	50	\$9794	\$10883
DHAISR7236D	36 x 72 x 29	125	390	44	\$9676	\$10751
DHAISR7230D	30 x 72 x 29	125	380	40	\$9486	\$10541
DHAISR6630D	30 x 66 x 29	125	360	36	\$9240	\$10266
DHAISR6030D	30 x 60 x 29	100	340	35	\$9064	\$10071

Built-in electric height adjustable single pedestal desk. Standard with full to floor locking **box/box/file** pedestal on **right** and support pedestal on **left**. Refer to the Desks and Credenzas Notes Section on page 66 for overhang dimensions. Shipped RTA (ready to assemble).

HEIGHT ADJUSTABLE DESK SHELLS

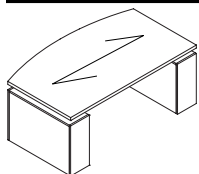

Height Adjustable Bow Top Desk Shell
Breakfront Style

MODEL#	DIMENSIONS	FREIGHT CLASS	WT/LBS.	CUBIC FT.	VENEER/LAMINATE	ALL VENEER
DHAMIT8442	42 x 84 x 29	150	350	59	\$11151	\$12389
DHAMIT7842	42 x 78 x 29	150	330	55	\$10911	\$12122
DHAMIT7242	42 x 72 x 29	150	310	51	\$10665	\$11851
DHAMIT6636	36 x 66 x 29	150	280	40	\$9624	\$10694

Built-in electric height adjustable bow top desk shell. Shipped RTA (ready to assemble). Refer to the Desks and Credenzas Notes Section on page 66 for overhang dimensions.

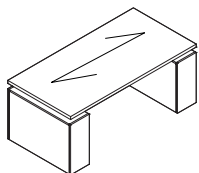

Height Adjustable Desk Shell
Breakfront Style

DHAIT8436	36 x 84 x 29	150	330	68	\$9921	\$11022
DHAIT7836	36 x 78 x 29	150	310	63	\$9738	\$10819
DHAIT7236	36 x 72 x 29	150	290	44	\$9544	\$10605
DHAIT7230	30 x 72 x 29	150	280	40	\$8944	\$9939
DHAIT6636	36 x 66 x 29	150	260	36	\$9164	\$10183
DHAIT6630	30 x 66 x 29	150	250	35	\$8944	\$9939
DHAIT6030	30 x 60 x 29	150	240	42	\$8787	\$9762

Built-in electric height adjustable desk shell. Shipped RTA (ready to assemble). Refer to the Desks and Credenzas Notes Section on page 66 for overhang dimensions.

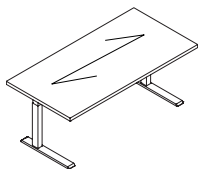

Height Adjustable Table

DHA8436	36 x 84 x 29	250	160	68	\$8030	\$8921
DHA7836	36 x 78 x 29	250	150	63	\$7847	\$8716
DHA7236	36 x 72 x 29	250	140	58	\$7649	\$8501
DHA7230	30 x 72 x 29	250	130	49	\$7052	\$7835
DHA6636	36 x 66 x 29	250	140	54	\$7273	\$8081
DHA6630	30 x 66 x 29	250	120	46	\$7052	\$7835
DHA6030	30 x 60 x 29	250	115	42	\$6895	\$7660

Electric height adjustable table. Shipped RTA (ready to assemble).

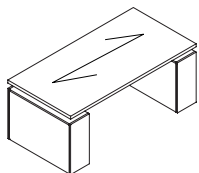

Height Adjustable Desk

DHA8436TP	36 x 84 x 29	150	320	68	\$9607	\$10688
DHA7836TP	36 x 78 x 29	150	300	63	\$9424	\$10469
DHA7236TP	36 x 72 x 29	150	280	58	\$9228	\$10253
DHA7230TP	30 x 72 x 29	150	270	49	\$8628	\$9587
DHA6636TP	36 x 66 x 29	150	250	54	\$8850	\$9832
DHA6630TP	30 x 66 x 29	150	240	46	\$8628	\$9587
DHA6030TP	30 x 60 x 29	150	230	42	\$8470	\$9412

Built-in electric height adjustable desk on TP bases. Shipped RTA (ready to assemble).

Required Specifications

- Top Finish
- Edge
- Base finish
- Handle style

Optional Specifications

- Grommet
- Glass modesty

HEIGHT ADJUSTABLE **MODEL#** **DIMENSIONS** **FREIGHT CLASS** **WT/LBS.** **CUBIC FT.** **veneer/LAMINATE** **ALL VENEER**

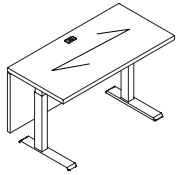

Height Adjustable Bridge Top

	D x W x H						
DHABT6024	24 x 60 x 29	150	150	35	\$7482	\$8313	
DHABT5424	24 x 54 x 29	150	140	31	\$7260	\$8067	
DHABT4824	24 x 48 x 29	150	130	28	\$7040	\$7822	
DHABT4224	24 x 42 x 29	300	29	26	\$6812	\$7567	

Electric height adjustable executive bridge top. Grommet in worksurface. Shipped RTA (ready to assemble).

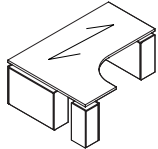

Height Adj. Right Extended Corner Desk*

DHAEKR60842436	24-36 x 60-84 x 29	150	450	108	\$14875	\$16528	
DHAEKR60782436	24-36 x 60-78 x 29	150	430	100	\$14839	\$16488	
DHAEKR60722436	24-36 x 60-72 x 29	150	410	93	\$14512	\$16124	
DHAEKR60662436	24-36 x 60-66 x 29	150	390	86	\$14088	\$15655	
DHAEKR60602436	24-36 x 60-60 x 29	150	370	79	\$13667	\$15183	

Built-in electric height adjustable right extended corner table desk with a 24" return connection. Extended worksurface on **right. Full end panel on right, narrow end panel on left.** Connects to Linking Bridges, Extended Corners and Connectable Tables. Shipped RTA (ready to assemble).

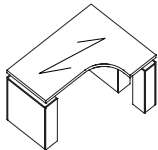

Height Adj. Left Extended Corner Desk*

DHAEKL84603624	24-36 x 60-84 x 29	150	450	108	\$14875	\$16528	
DHAEKL78603624	24-36 x 60-78 x 29	150	430	100	\$14839	\$16488	
DHAEKL72603624	24-36 x 60-72 x 29	150	410	93	\$14512	\$16124	
DHAEKL66603624	24-36 x 60-66 x 29	150	390	86	\$14088	\$15655	
DHAEKL60603624	24-36 x 60-60 x 29	150	370	79	\$13667	\$15183	

Built-in electric height adjustable right extended corner table desk with a 24" return connection. Extended worksurface on **left. Full end panel on left, narrow end panel on right.** Connects to Linking Bridges, Extended Corners and Connectable Tables. Shipped RTA (ready to assemble).



Spacer

DHASP	2 x 8 x 23	70	15	.75	\$538	\$598	
-------	------------	----	----	-----	--------------	--------------	--

Connects height adjustable desks with linking bridges and returns.

Required Specifications

Top Finish
Edge
Base finish

Optional Specifications

Grommet*
Glass modesty

HEIGHT ADJUSTABLE TOPS

MODEL# DIMENSIONS FREIGHT CLASS WT/LBS. CUBIC FT. LIST PRICE

D x W x H

DRE8226T	26 x 82 x 1.18	92.5	89	8	\$2389
DRE8026T	26 x 80 x 1.18	92.5	87	7.5	\$2330
DRE7626T	26 x 76 x 1.18	85	97	8	\$2217
DRE6426T	26 x 64 x 1.18	92.5	70	6	\$1867
DRE5226T	26 x 52 x 1.18	92.5	57	5.5	\$1518
DRE4626T	26 x 46 x 1.18	92.5	44	4	\$1340
DRE4026T	26 x 40 x 1.18	92.5	44	4	\$1168
DRE8229T	29 x 82 x 1.18	92.5	99	8.5	\$2663
DRE7629T	29 x 76 x 1.18	85	97	8	\$2470
DRE7029T	29 x 70 x 1.18	85	92	7.5	\$2276
DRE6429T	29 x 64 x 1.18	85	78	6.5	\$2083
DRE5229T	29 x 52 x 1.18	92.5	63	6	\$1690
DRE4629T	29 x 46 x 1.18	92.5	56	5	\$1497
DRE4029T	29 x 40 x 1.18	92.5	49	4.5	\$1303
DRE8235T	35 x 82 x 1.18	85	120	10	\$3218
DRE7635T	35 x 76 x 1.18	85	117	9.5	\$2980
DRE7235T	35 x 72 x 1.18	85	111	9	\$2825
DRE6435T	35 x 64 x 1.18	85	94	7.5	\$2513
DRE5235T	35 x 52 x 1.18	92.5	76	7	\$2040
DRE4635T	35 x 46 x 1.18	92.5	67	6	\$1802
DRE4035T	35 x 40 x 1.18	92.5	59	5	\$1571

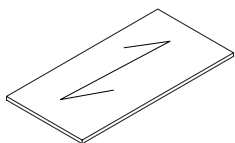

Height Adjustable Top

Dufferin tops with Dufferin edge on three sides, for use with FreeFit height adjustable table mechanisms, sold separately (FTxxxxx, see page 713 of the Desking price list for information).

- 26" deep tops accommodate FTxxxx24 mechanisms. Depth is exact to accommodate the Dufferin edge + the Freefit mechanism. *Cannot be made smaller.*
- 29" and 35" deep tops accommodate FTxxxx30 mechanisms.



HA Return Tops

Left:

DRE6026CGCOPLT	26 x 60 x 1.18	85	75	5.5	\$1749
DRE5426CGCOPLT	26 x 54 x 1.18	85	69	5	\$1577
DRE4826CGCOPLT	26 x 48 x 1.18	85	62	4.5	\$1400
DRE4226CGCOPLT	26 x 42 x 1.18	85	56	4	\$1222

Right:

DRE6026CGCOPRT	26 x 60 x 1.18	85	75	5.5	\$1749
DRE5426CGCOPRT	26 x 54 x 1.18	85	69	5	\$1577
DRE4826CGCOPRT	26 x 48 x 1.18	85	62	4.5	\$1400
DRE4226CGCOPRT	26 x 42 x 1.18	85	56	4	\$1222

Dufferin return tops with Dufferin edge on three sides, for use with FreeFit height adjustable table mechanisms, sold separately (FTxxxxx, see page 713 of the Desking price list for information).

- 26" deep tops accommodate FTxxxx24 mechanisms. Depth is exact to accommodate the Dufferin edge + the Freefit mechanism. *Cannot be made smaller.*

Required Specifications

Veneer finish
Edge

Optional Specifications

Grommet

MODESTY PANEL OPTIONS

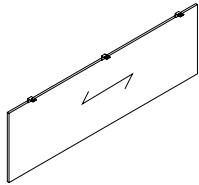

Veneer Modesty Panel Upgrade*

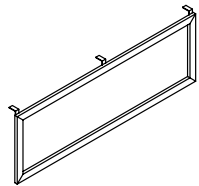

Glass Modesty Panel Upgrade

MODEL#	DIMENSIONS D x W x H	FREIGHT CLASS	WT/LBS.	CUBIC FT.	LIST PRICE
CMP72W	0.75 x 67 x 18	--	20	1	\$1728
CMP66W	0.75 x 61 x 18	--	18	1	\$1673
CMP60W	0.75 x 55 x 18	--	16	1	\$1647
CMP54W	0.75 x 49 x 18	--	14	1	\$1619
CMP48W	0.75 x 43 x 18	--	13	1	\$1594

Straight modesty panel. Attaches to underside of worksurface. **Cannot be retrofitted in the field *Not sold individually - to be ordered as an upgrade option only.***

- CMP72W - Specify on "P" Top Islands or 96" x 48" Islands for Piano Desks.
- CMP66W - Specify on 84" x 36" "D" Top Islands.
- CMP60W - Specify on 84" x 42" "P" Top Islands or 84" x 48" Islands for Piano Desks.
- CMP54W - Specify on 72" x 30" "D" Top Islands.
- CMP48W - Specify on 66" x 36" , 60" x 30" "D" Top Islands, 72" x 42" "P" Top Islands or 72" x 48" Islands for Piano Desks.

CMP72G	0.75 x 67 x 18	--	20	1	\$2647
CMP66G	0.75 x 61 x 18	--	18	1	\$2504
CMP60G	0.75 x 55 x 18	--	16	1	\$2289
CMP54G	0.75 x 49 x 18	--	14	1	\$2132
CMP48G	0.75 x 43 x 18	--	13	1	\$2036

Straight modesty panel. Translucent, screened glass. Aluminum box frame construction in Tungsten Only. Attaches to underside of worksurface. **Cannot be retrofitted in the field. *Not sold individually - to be ordered as an upgrade option only.***

- CMP72G - Specify on "P" Top Islands or 96" x 48" Islands for Piano Desks.
- CMP66G - Specify on 84" x 36" "D" Top Islands.
- CMP60G - Specify on 84" x 42" "P" Top Islands or 84" x 48" Islands for Piano Desks.
- CMP54G - Specify on 72" x 30" "D" Top Islands.
- CMP48G - Specify on 66" x 36" , 60" x 30" "D" Top Islands, 72" x 42" "P" Top Islands or 72" x 48" Islands for Piano Desks.
- Tungsten finish on the aluminum box frame closely resembles the existing Tungsten finish.

SINGLE PEDESTAL DESKS - BREAKFRONT STYLE

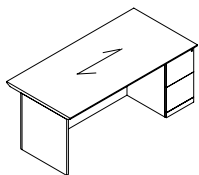

**Single Pedestal Desk - RIGHT
Breakfront Style**

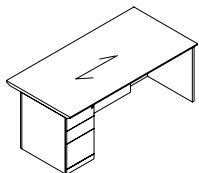

**Single Pedestal Desk - LEFT
Breakfront Style**

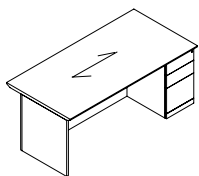

**Single Pedestal Desk - RIGHT
Breakfront Style**

MODEL#	DIMENSIONS D x W x H	FREIGHT CLASS	WT/LBS.	CUBIC FT.	VENEER/LAMINATE	ALL VENEER
DISR8442E	42 x 84 x 29	125	463	59	\$5862	\$7035
DISR7842E	42 x 78 x 29	125	430	55	\$5444	\$6533
DISR7236E	36 x 72 x 29	125	340	44	\$4311	\$5172
DISR7230E	30 x 72 x 29	125	283	36	\$4119	\$4941
DISR6636E	36 x 66 x 29	125	312	40	\$4119	\$4941
DISR6630E	30 x 66 x 29	100	295	33	\$3930	\$4717
DISR6030E	30 x 60 x 29	100	265	30	\$3758	\$4511

Standard with full to floor **file/file** pedestal on **right**. Pedestal locks. Refer to the Desks and Credenzas Notes Section on page 66 for overhang dimensions. Shipped assembled in 1 carton.

DISL8442D	42 x 84 x 29	125	463	59	\$5862	\$7035
DISL7842D	42 x 78 x 29	125	430	55	\$5444	\$6533
DISL7236D	36 x 72 x 29	125	340	44	\$4311	\$5172
DISL7230D	30 x 72 x 29	125	283	36	\$4119	\$4941
DISL6636D	36 x 66 x 29	125	312	40	\$4119	\$4941
DISL6630D	30 x 66 x 29	100	295	33	\$3930	\$4717
DISL6030D	30 x 60 x 29	100	265	30	\$3758	\$4511

Standard with full to floor **box/box/file** pedestal on **left**. Pedestal locks. Refer to the Desks and Credenzas Notes Section on page 66 for overhang dimensions. Shipped assembled in 1 carton.

DISR8442D	42 x 84 x 29	125	463	59	\$5862	\$7035
DISR7842D	42 x 78 x 29	125	430	55	\$5444	\$6533
DISR7236D	36 x 72 x 29	125	340	44	\$4311	\$5172
DISR7230D	30 x 72 x 29	125	283	36	\$4119	\$4941
DISR6636D	36 x 66 x 29	125	312	40	\$4119	\$4941
DISR6630D	30 x 66 x 29	100	295	33	\$3930	\$4717
DISR6030D	30 x 60 x 29	100	265	30	\$3758	\$4511

Standard with full to floor **box/box/file** pedestal on **right**. Pedestal locks. Refer to the Desks and Credenzas Notes Section on page 66 for overhang dimensions. Shipped assembled in 1 carton.

DESK SHELLS WITH RECESSED FRONT

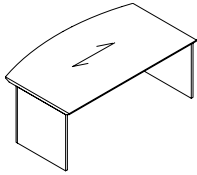

Bow Top Desk Shell

MODEL#	DIMENSIONS	FREIGHT CLASS	WT/LBS.	CUBIC FT.	veneer/LAMINATE	ALL VENEER
D x W x H						
DMT8442	42 x 84 x 29	125	380	59	\$4725	\$5667
DMT7842	42 x 78 x 29	125	353	55	\$4385	\$5261
DMT7242	42 x 72 x 29	125	331	51	\$4051	\$4861
DMT6636	36 x 66 x 29	125	287	40	\$3862	\$4634

Bow top and recessed modesty panel. Refer to the Desks and Credenzas Notes Section on page 66 for overhang dimensions. Shipped assembled in 1 carton.

DT8436	36 x 84 x 29	125	362	51	\$3766	\$4520
DT7836	36 x 78 x 29	125	336	47	\$3498	\$4199
DT7236	36 x 72 x 29	125	315	44	\$3229	\$3874
DT6636	36 x 66 x 29	125	271	40	\$3041	\$3652

DT7230	30 x 72 x 29	125	271	36	\$3041	\$3652
DT6630	30 x 66 x 29	100	265	33	\$2855	\$3428
DT6030	30 x 60 x 29	100	241	30	\$2613	\$3136

DT4824	24 x 48 x 29	125	123	20	\$1720	\$2064
DT4224	24 x 42 x 29	150	98	17	\$1441	\$1729
DT3624	24 x 36 x 29	150	82	14	\$1387	\$1666
DT3024	24 x 30 x 29	125	76	12	\$1362	\$1634

DT4822	22 x 48 x 29	150	105	18	\$1578	\$1893
DT4222	22 x 42 x 29	150	90	16	\$1321	\$1585
DT3622	22 x 36 x 29	150	75	13	\$1275	\$1530
DT3022	22 x 30 x 29	150	65	11	\$1250	\$1499

DT4820	20 x 48 x 29	125	105	18	\$1435	\$1722
DT4220	20 x 42 x 29	125	90	16	\$1200	\$1439
DT3620	20 x 36 x 29	125	75	13	\$1162	\$1392
DT3020	20 x 30 x 29	125	65	11	\$1135	\$1362

Recessed modesty panel. Refer to the Desks and Credenzas Notes Section on page 66 for overhang dimensions. Shipped assembled in 1 carton.

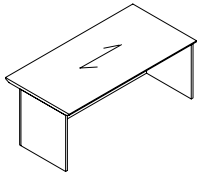

Desk Shell

Required Specifications

- Veneer Finish
- Laminate Finish
- Handle Style (Single Pedestal Desks)

Optional Specifications

- Grommet

D DUFFERIN

RETURNS

D x W x H

- An Executive Return is used to attach to a Single Pedestal Desk, Single Pedestal Credenza, Desk Shell or Credenza Shell.
- Grommets are available as an option.
- Hand of Executive Return is determined by location of full end panel from user side.
- Hand of Desk or Credenza is determined by location of pedestal from user side.
- To remove cross grain veneer pattern on top, delete suffix "CG" from the model number. Available as a special - no upcharge.

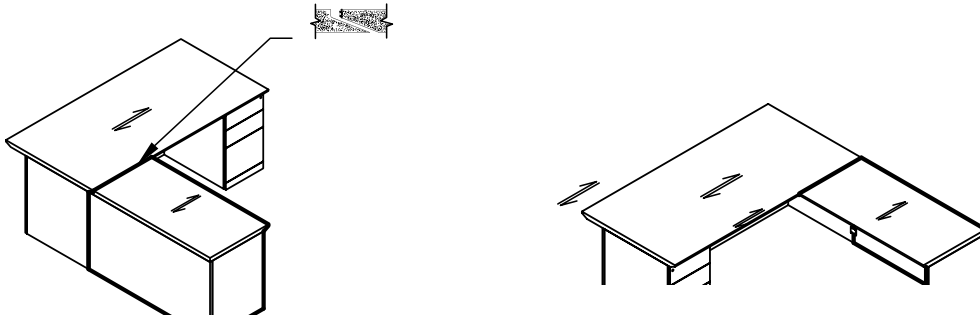

RETURNS

MODEL# DIMENSIONS FREIGHT CLASS WT/LBS. CUBIC FT. VENEER/LAMINATE ALL VENEER

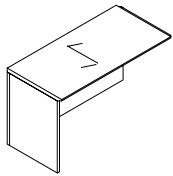

Flush Return - LEFT 24" Deep

DERL7224CG	24 x 72 x 29	150	135	29	\$2488	\$2986
DERL6624CG	24 x 66 x 29	150	127	27	\$2276	\$2733
DERL6024CG	24 x 60 x 29	150	120	24	\$2072	\$2487
DERL5424CG	24 x 54 x 29	150	112	22	\$1871	\$2246
DERL4824CG	24 x 48 x 29	150	105	19	\$1660	\$1990
DERL4224CG	24 x 42 x 29	150	97	17	\$1456	\$1746

Return has **no pedestal**. For use with right handed single pedestal desks, credenzas, desk shells, credenza shells, "D" islands or "P" islands. Shipped assembled in 1 carton.

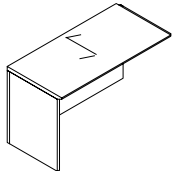

Flush Return - LEFT 22" Deep

DERL7222CG	22 x 72 x 29	150	130	27	\$2372	\$2846
DERL6622CG	22 x 66 x 29	150	122	24	\$1987	\$2384
DERL6022CG	22 x 60 x 29	150	115	22	\$1812	\$2172
DERL5422CG	22 x 54 x 29	150	105	20	\$1740	\$2086
DERL4822CG	22 x 48 x 29	150	100	18	\$1456	\$1746
DERL4222CG	22 x 42 x 29	150	90	16	\$1272	\$1528

Return has **no pedestal**. For use with right handed single pedestal desks, credenzas, desk shells, credenza shells, "D" islands or "P" islands. Shipped assembled in 1 carton.

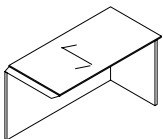

Flush Return - RIGHT 24" Deep

DERR7224CG	24 x 72 x 29	150	135	29	\$2488	\$2986
DERR6624CG	24 x 66 x 29	150	127	27	\$2276	\$2733
DERR6024CG	24 x 60 x 29	150	120	24	\$2072	\$2487
DERR5424CG	24 x 54 x 29	150	112	22	\$1871	\$2246
DERR4824CG	24 x 48 x 29	150	105	19	\$1660	\$1990
DERR4224CG	24 x 42 x 29	150	97	17	\$1456	\$1746

Return has **no pedestal**. For use with left handed single pedestal desks, credenzas, desk shells, credenza shells, "D" islands or "P" islands. Shipped assembled in 1 carton.

Required Specifications

Veneer Finish
Laminate Finish

Optional Specifications

Grommet

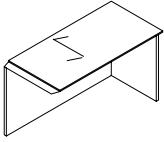
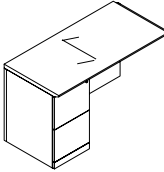
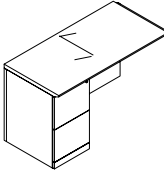
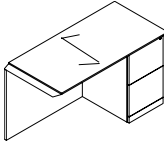
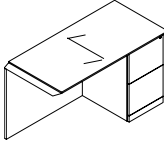
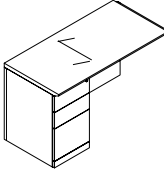
RETURNS	MODEL#	DIMENSIONS	FREIGHT CLASS	WT/LBS.	CUBIC FT.	veneer/LAMINATE	ALL VENEER
 <p>Flush Return - RIGHT 22" Deep</p>	D x W x H						
	DERR7222CG	22 x 72 x 29	150	130	27	\$2372	\$2846
	DERR6622CG	22 x 66 x 29	150	122	24	\$1987	\$2384
	DERR6022CG	22 x 60 x 29	150	115	22	\$1812	\$2172
	DERR5422CG	22 x 54 x 29	150	105	20	\$1629	\$1955
	DERR4822CG	22 x 48 x 29	150	100	18	\$1448	\$1739
DERR4222CG	22 x 42 x 29	150	90	16	\$1266	\$1517	
<p>Return has no pedestal. For use with left handed single pedestal desks, credenzas, desk shells, credenza shells, "D" islands or "P" islands. Shipped assembled in 1 carton.</p>							
 <p>Flush Return - LEFT* 24" Deep</p>	DERL7224ECG	24 x 72 x 29	100	250	29	\$4391	\$5268
	DERL6624ECG	24 x 66 x 29	100	236	27	\$4222	\$5068
	DERL6024ECG	24 x 60 x 29	100	227	24	\$3843	\$4611
	DERL5424ECG	24 x 54 x 29	100	205	22	\$3706	\$4446
	DERL4824ECG	24 x 48 x 29	100	185	19	\$3289	\$3946
	DERL4224ECG	24 x 42 x 29	92.5	178	17	\$3173	\$3807
<p>Return has file/file pedestal on the left. Pedestal locks. For use with right handed single pedestal desks, credenzas, desk shells, credenza shells, "D" islands or "P" islands. Shipped assembled in 1 carton.</p>							
 <p>Flush Return - LEFT* 22" Deep</p>	DERL7222ECG	22 x 72 x 29	100	240	27	\$4222	\$5068
	DERL6622ECG	22 x 66 x 29	100	231	24	\$3726	\$4473
	DERL6022ECG	22 x 60 x 29	92.5	222	22	\$3393	\$4071
	DERL5422ECG	22 x 54 x 29	92.5	200	20	\$3268	\$3922
	DERL4822ECG	22 x 48 x 29	92.5	180	18	\$2905	\$3485
	DERL4222ECG	22 x 42 x 29	92.5	173	16	\$2795	\$3353
<p>Return has file/file pedestal on the left. Pedestal locks. For use with right handed single pedestal desks, credenzas, desk shells, credenza shells, "D" islands or "P" islands. Shipped assembled in 1 carton.</p>							
 <p>Flush Return - RIGHT* 24" Deep</p>	DERR7224ECG	24 x 72 x 29	100	250	29	\$4391	\$5268
	DERR6624ECG	24 x 66 x 29	100	236	27	\$4222	\$5068
	DERR6024ECG	24 x 60 x 29	100	227	24	\$3843	\$4611
	DERR5424ECG	24 x 54 x 29	100	205	22	\$3706	\$4446
	DERR4824ECG	24 x 48 x 29	100	185	19	\$3289	\$3946
	DERR4224ECG	24 x 42 x 29	92.5	178	17	\$3173	\$3807
<p>Return has file/file pedestal on the right. Pedestal locks. For use with right handed single pedestal desks, credenzas, desk shells, credenza shells, "D" islands or "P" islands. Shipped assembled in 1 carton.</p>							
 <p>Flush Return - RIGHT 22" Deep</p>	DERR7222ECG	22 x 72 x 29	100	240	27	\$4222	\$5068
	DERR6622ECG	22 x 66 x 29	100	231	24	\$3726	\$4473
	DERR6022ECG	22 x 60 x 29	92.5	222	22	\$3393	\$4071
	DERR5422ECG	22 x 54 x 29	92.5	200	20	\$3268	\$3922
	DERR4822ECG	22 x 48 x 29	92.5	180	18	\$2905	\$3485
	DERR4222ECG	22 x 42 x 29	92.5	173	16	\$2795	\$3353
<p>Return has file/file pedestal on the right. Pedestal locks. For use with right handed single pedestal desks, credenzas, desk shells, credenza shells, "D" islands or "P" islands. Shipped assembled in 1 carton.</p>							
 <p>Flush Return - LEFT 24" Deep</p>	DERL7224DCG	24 x 72 x 29	100	250	29	\$4391	\$5268
	DERL6624DCG	24 x 66 x 29	100	236	27	\$4222	\$5068
	DERL6024DCG	24 x 60 x 29	100	227	24	\$3843	\$4611
	DERL5424DCG	24 x 54 x 29	100	205	22	\$3706	\$4446
	DERL4824DCG	24 x 48 x 29	100	185	19	\$3289	\$3946
	DERL4224DCG	24 x 42 x 29	92.5	178	17	\$3173	\$3807
<p>Return has box/box/file pedestal on the left. Pedestal locks. For use with right handed single pedestal desks, credenzas, desk shells, credenza shells, "D" islands or "P" islands. Shipped assembled in 1 carton.</p>							

Required Specifications

Veneer Finish
Laminate Finish
Handle Style*

Optional Specifications

Grommet

RETURNS

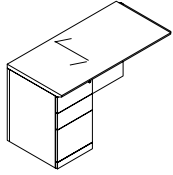

Flush Return - LEFT
22" Deep

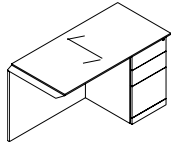

Flush Return - RIGHT
24" Deep

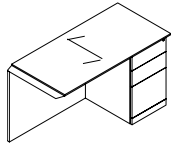

Flush Return - RIGHT
22" Deep

MODEL#	DIMENSIONS D x W x H	FREIGHT CLASS	WT/LBS.	CUBIC FT.	VENEER/LAMINATE	ALL VENEER
DERL7222DCG	22 x 72 x 29	100	240	27	\$4222	\$5068
DERL6622DCG	22 x 66 x 29	100	231	24	\$3726	\$4473
DERL6022DCG	22 x 60 x 29	92.5	222	22	\$3393	\$4071
DERL5422DCG	22 x 54 x 29	92.5	200	20	\$3268	\$3922
DERL4822DCG	22 x 48 x 29	150	180	18	\$2905	\$3485
DERL4222DCG	22 x 42 x 29	92.5	173	16	\$2795	\$3353

Return has **box/box/file** pedestal on the **left**. Pedestal locks. For use with right handed single pedestal desks, credenzas, desk shells, credenza shells, "D" islands or "P" islands. Shipped assembled in 1 carton.

DERR7224DCG	24 x 72 x 29	100	250	29	\$4391	\$5268
DERR6624DCG	24 x 66 x 29	100	236	27	\$4222	\$5068
DERR6024DCG	24 x 60 x 29	100	227	24	\$3843	\$4611
DERR5424DCG	24 x 54 x 29	100	205	22	\$3706	\$4446
DERR4824DCG	24 x 48 x 29	100	185	19	\$3289	\$3946
DERR4224DCG	24 x 42 x 29	92.5	178	17	\$3173	\$3807

Return has **box/box/file** pedestal on the **right**. Pedestal locks. For use with right handed single pedestal desks, credenzas, desk shells, credenza shells, "D" islands or "P" islands. Shipped assembled in 1 carton.

DERR7222DCG	22 x 72 x 29	100	240	27	\$4222	\$5068
DERR6622DCG	22 x 66 x 29	100	231	24	\$3726	\$4473
DERR6022DCG	22 x 60 x 29	92.5	222	22	\$3393	\$4071
DERR5422DCG	22 x 54 x 29	92.5	200	20	\$3268	\$3922
DERR4822DCG	22 x 48 x 29	92.5	180	18	\$2905	\$3485
DERR4222DCG	22 x 42 x 29	92.5	173	16	\$2795	\$3353

Return has **box/box/file** pedestal on the **right**. Pedestal locks. For use with right handed single pedestal desks, credenzas, desk shells, credenza shells, "D" islands or "P" islands. Shipped assembled in 1 carton.

Required Specifications

Veneer Finish
Laminate Finish
Handle Style

Optional Specifications

Grommet

BRIDGES - EXECUTIVE **MODEL#** **DIMENSIONS** **FREIGHT CLASS** **WT./LBS.** **CUBIC FT.** **VENEER/LAMINATE** **ALL VENEER**

D x W x H

- An Executive Bridge is used to connect a Desk to a Credenza.
- Not to be used with Corner Components or Piano Desks,
- Three Modesty Panel options - Full Modesty, 8" Modesty and No Modesty (Flush Bridge Top).
- Modesty panel flush with end panels of Desk and Credenza.
- Includes GM1 grommet in the top center position.
- Both connecting sides of executive bridges feature a reverse profile edge

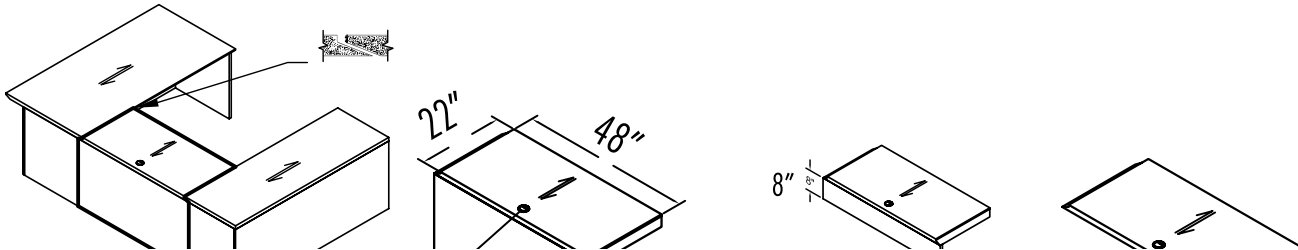

BRIDGES - LINKING

- A linking bridge is used to connect corner components to a single pedestal desk, HA desk, single pedestal credenza, desk shell or credenza shell.
- When connecting HA desk, must specify DHASP spacer.
- Two modesty panel options - full modesty and 8" modesty.
- Includes GM1 grommet in the top center position.
- Hand of linking bridge is determined by location of half end panel from user side.
- Linking bridges are handed **left and right** (handedness is determined by connecting side with the self edge). The opposite connecting side features a reverse profile edge.

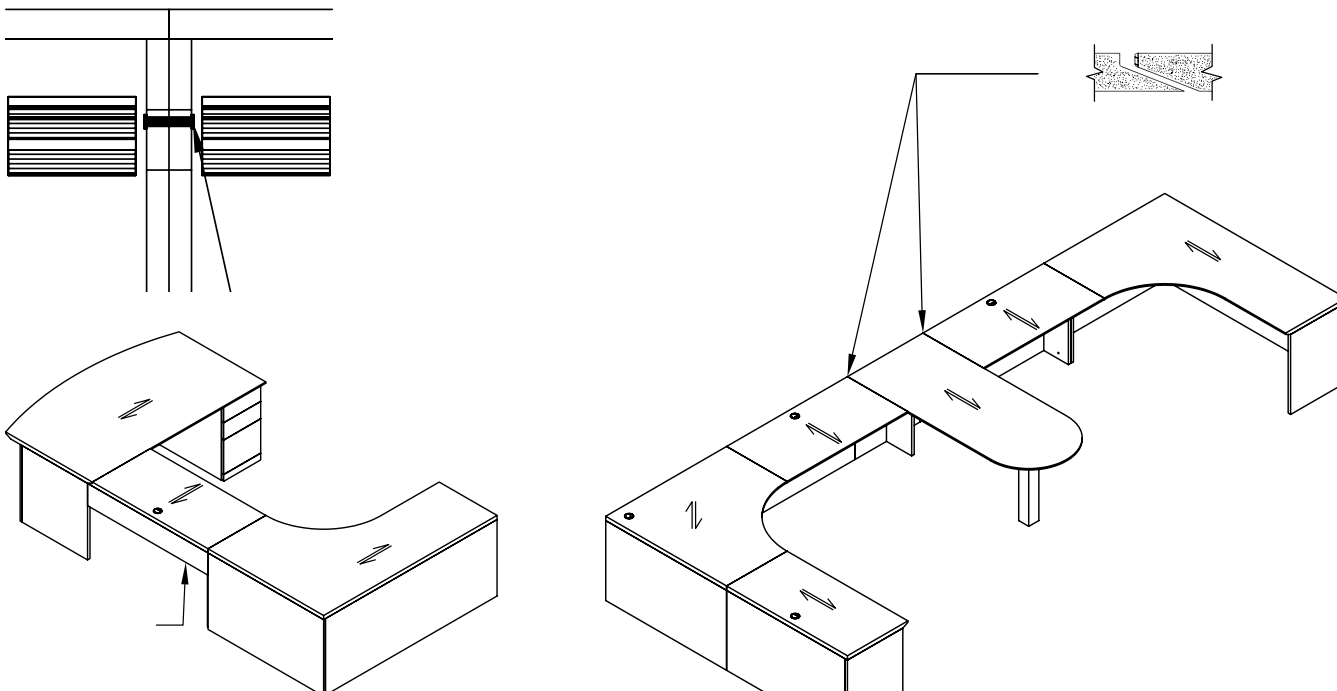

BRIDGES - FLUSH

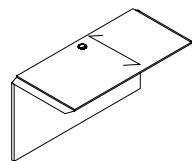

Flush Bridge

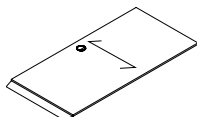

Flush Bridge Top

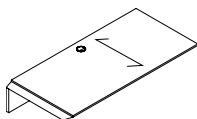

Flush Bridge Top, 8" Modesty Panel

MODEL#	DIMENSIONS D x W x H	FREIGHT CLASS	WT./LBS.	CUBIC FT.	VENEER/LAMINATE	ALL VENEER
DBT6024CG	24 x 60 x 29	70	144	10	\$1779	\$2138
DBT5424CG	24 x 54 x 29	70	129	9	\$1608	\$1926
DBT4824CG	24 x 48 x 29	70	120	8	\$1425	\$1711
DBT4224CG	24 x 42 x 29	85	105	7	\$1249	\$1496
DBT6022CG	22 x 60 x 29	70	138	9	\$1458	\$1749
DBT5422CG	22 x 54 x 29	70	124	8	\$1444	\$1730
DBT4822CG	22 x 48 x 29	85	115	7	\$1281	\$1539
DBT4222CG	22 x 42 x 29	85	101	6	\$1124	\$1351
DBT6020CG	20 x 60 x 29	70	131	8	\$1458	\$1749
DBT5420CG	20 x 54 x 29	85	118	8	\$1316	\$1578
DBT4820CG	20 x 48 x 29	85	110	7	\$1169	\$1402
DBT4220CG	20 x 42 x 29	85	96	6	\$1004	\$1201

Top surface, back panel and hardware to create a "U" configuration with a single pedestal desk or credenza. **Cannot be used with corners.** Grommet in worksurface. Shipped assembled in 1 carton.

- If linking to bookcase or open storage, add **/S** to end of model number

DBT5424TCG	24 x 54 x --	70	129	9	N/A	\$1203
DBT4824TCG	24 x 48 x --	70	120	8	N/A	\$1070
DBT4224TCG	24 x 42 x --	70	105	7	N/A	\$937
DBT5422TCG	22 x 54 x --	70	124	8	N/A	\$966
DBT4822TCG	22 x 48 x --	70	115	7	N/A	\$860
DBT4222TCG	22 x 42 x --	70	101	6	N/A	\$753
DBT5420TCG	20 x 54 x --	70	118	8	N/A	\$883
DBT4820TCG	20 x 48 x --	70	110	7	N/A	\$783
DBT4220TCG	20 x 42 x --	70	96	6	N/A	\$674

Top surface only to create a "U" configuration with a single pedestal desk or credenza. **Cannot be used with corners.** Grommet in worksurface. Shipped assembled in 1 carton.

- If linking to bookcase or open storage, add **/S** to end of model number

DBT6024Q8CG	24 x 60 x --	70	144	10	\$1600	\$1921
DBT5424Q8CG	24 x 54 x --	70	129	9	\$1444	\$1730
DBT4824Q8CG	24 x 48 x --	70	120	8	\$1282	\$1540
DBT4224Q8CG	24 x 42 x --	70	105	7	\$1122	\$1350
DBT6022Q8CG	22 x 60 x --	70	138	9	\$1444	\$1730
DBT5422Q8CG	22 x 54 x --	70	124	8	\$1299	\$1559
DBT4822Q8CG	22 x 48 x --	70	115	7	\$1153	\$1381
DBT4222Q8CG	22 x 42 x --	70	101	6	\$1012	\$1216
DBT6020Q8CG	20 x 60 x --	70	131	8	\$1316	\$1578
DBT5420Q8CG	20 x 54 x --	70	118	8	\$1181	\$1418
DBT4820Q8CG	20 x 48 x --	70	110	7	\$1052	\$1263
DBT4220Q8CG	20 x 42 x --	70	96	6	\$901	\$1081

Top surface with 8" modesty panel for utility access. Create a "U" configuration with a single pedestal desk or credenza. **Cannot be used with corners.** Grommet in worksurface. Shipped assembled in 1 carton.

- If linking to bookcase or open storage, add **/S** to end of model number

Required Specifications

Veneer finish
Laminate finish

Optional Specifications

Additional grommet

BRIDGES - LINKING

MODEL# DIMENSIONS FREIGHT CLASS WT/LBS. CUBIC FT. VENEER/LAMINATE ALL VENEER

D x W x H

DBT6024NLLCG	24 x 60 x 29	125	145	24	\$1766	\$2117
DBT5424NLLCG	24 x 54 x 29	150	131	22	\$1591	\$1908
DBT4824NLLCG	24 x 48 x 29	125	116	19	\$1414	\$1697
DBT4224NLLCG	24 x 42 x 29	125	102	17	\$1145	\$1374
DBT3624NLLCG	24 x 36 x 29	150	87	15	\$1042	\$1251
DBT3024NLLCG	24 x 30 x 29	125	73	12	\$1017	\$1219

DBT6022NLLCG	22 x 60 x 29	150	131	22	\$1681	\$2018
DBT5422NLLCG	22 x 54 x 29	150	118	20	\$1516	\$1821
DBT4822NLLCG	22 x 48 x 29	125	110	18	\$1346	\$1613
DBT4222NLLCG	22 x 42 x 29	150	95	16	\$1093	\$1310
DBT3622NLLCG	22 x 36 x 29	125	80	13	\$990	\$1189
DBT3022NLLCG	22 x 30 x 29	150	65	11	\$968	\$1163

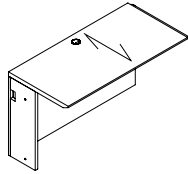

Linking Bridge - LEFT

Top surface, back panel and hardware. **Left side** connects to a 5-Sided Corner, Extended Corner or Connectable Table. Right side connects to a single pedestal desk or credenza, "D" island, Boat shaped island, "P" island and Delta island with a "T" base. Grommet in worksurface. Shipped assembled in 1 carton.

DBT6024NLRCG	24 x 60 x 29	125	145	24	\$1766	\$2117
DBT5424NLRCG	24 x 54 x 29	150	131	22	\$1591	\$1908
DBT4824NLRCG	24 x 48 x 29	125	116	19	\$1414	\$1697
DBT4224NLRCG	24 x 42 x 29	125	102	17	\$1145	\$1374
DBT3624NLRCG	24 x 36 x 29	150	87	15	\$1042	\$1251
DBT3024NLRCG	24 x 30 x 29	125	73	12	\$1017	\$1219

DBT6022NLRCG	22 x 60 x 29	150	131	22	\$1681	\$2018
DBT5422NLRCG	22 x 54 x 29	150	118	20	\$1516	\$1821
DBT4822NLRCG	22 x 48 x 29	125	110	18	\$1346	\$1613
DBT4222NLRCG	22 x 42 x 29	150	95	16	\$1093	\$1310
DBT3622NLRCG	22 x 36 x 29	125	80	13	\$990	\$1189
DBT3022NLRCG	22 x 30 x 29	150	65	11	\$968	\$1163

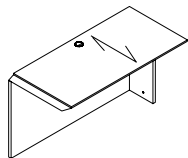

Linking Bridge - RIGHT

Top surface, back panel and hardware. **Right side** connects to a 5-Sided Corner, Extended Corner or Connectable Table. Left side connects to a single pedestal desk or credenza, "D" island, Boat shaped island, "P" island and Delta island with a "T" base. Grommet in worksurface. Shipped assembled in 1 carton.

DBT6024NLLQ8CG	24 x 60 x 29	125	145	24	\$1943	\$2331
DBT5424NLLQ8CG	24 x 54 x 29	150	131	22	\$1752	\$2104
DBT4824NLLQ8CG	24 x 48 x 29	125	116	19	\$1558	\$1870
DBT4224NLLQ8CG	24 x 42 x 29	125	102	17	\$1401	\$1678
DBT3624NLLQ8CG	24 x 36 x 29	150	87	15	\$1145	\$1374
DBT3024NLLQ8CG	24 x 30 x 29	125	73	12	\$1121	\$1346

DBT6022NLLQ8CG	22 x 60 x 29	150	131	22	\$1851	\$2221
DBT5422NLLQ8CG	22 x 54 x 29	150	118	20	\$1667	\$2002
DBT4822NLLQ8CG	22 x 48 x 29	125	110	18	\$1482	\$1776
DBT4222NLLQ8CG	22 x 42 x 29	150	95	16	\$1199	\$1436
DBT3622NLLQ8CG	22 x 36 x 29	125	80	13	\$1090	\$1309
DBT3022NLLQ8CG	22 x 30 x 29	150	65	11	\$1065	\$1277

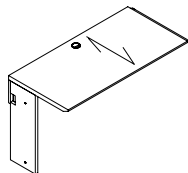

Linking Bridge, 8" Modesty Panel - LEFT

Top surface with 8" modesty panel for utility access and hardware. **Left side** connects to a 5-Sided Corner, Extended Corner or Connectable Table. Right side connects to a single pedestal desk or credenza, "D" island, Boat shaped island, "P" island and Delta island with a "T" base. Grommet in worksurface. Shipped assembled in 1 carton.

Required Specifications

Veneer finish
Laminate finish

Optional Specifications

Additional grommet

BRIDGES - LINKING

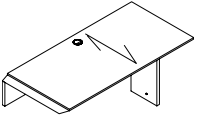

Linking Bridge, 8" Modesty Panel - RIGHT

MODEL#	DIMENSIONS	FREIGHT CLASS	WT/LBS.	CUBIC FT.	VENEER/LAMINATE	ALL VENEER
D x W x H						
DBT6024NLRQ8CG	24 x 60 x 29	125	145	24	\$1943	\$2331
DBT5424NLRQ8CG	24 x 54 x 29	150	131	22	\$1752	\$2104
DBT4824NLRQ8CG	24 x 48 x 29	125	116	19	\$1558	\$1870
DBT4224NLRQ8CG	24 x 42 x 29	125	102	17	\$1401	\$1678
DBT3624NLRQ8CG	24 x 36 x 29	150	87	15	\$1145	\$1374
DBT3024NLRQ8CG	24 x 30 x 29	125	73	12	\$1121	\$1346
DBT6022NLRQ8CG	22 x 60 x 29	150	131	22	\$1851	\$2221
DBT5422NLRQ8CG	22 x 54 x 29	150	118	20	\$1667	\$2002
DBT4822NLRQ8CG	22 x 48 x 29	125	110	18	\$1482	\$1776
DBT4222NLRQ8CG	22 x 42 x 29	150	95	16	\$1199	\$1436
DBT3622NLRQ8CG	22 x 36 x 29	125	80	13	\$1090	\$1309
DBT3022NLRQ8CG	22 x 30 x 29	150	65	11	\$1065	\$1277

Top surface with 8" modesty panel for utility access and hardware. **Right side** connects to a 5-Sided Corner, Extended Corner or Connectable Table. Right side connects to a single pedestal desk or credenza, "D" island, Boat shaped island, "P" island and Delta island with a "T" base. Grommet in worksurface. Shipped assembled in 1 carton.

CREDENZAS

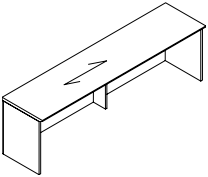

sizes 96" and larger

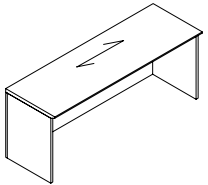

sizes less than 96"

Credenza Shell*

MODEL#	DIMENSIONS	FREIGHT CLASS	WT/LBS.	CUBIC FT.	VENEER/LAMINATE	ALL VENEER
DC12024	24 x 120 x 29	100	387	48	\$4440	\$5329
DC11424	24 x 114 x 29	125	367	46	\$4218	\$5064
DC10824	24 x 108 x 29	125	348	44	\$3999	\$4795
DC10224	24 x 102 x 29	100	329	41	\$3776	\$4530
DC9624	24 x 96 x 29	125	309	39	\$3552	\$4262
DC9024	24 x 90 x 29	100	290	36	\$3332	\$3999
DC8424	24 x 84 x 29	125	271	34	\$3110	\$3733
DC7824	24 x 78 x 29	100	251	31	\$2888	\$3464
DC7224	24 x 72 x 29	100	232	29	\$2665	\$3198
DC6624	24 x 66 x 29	125	213	27	\$2565	\$3080
DC6024	24 x 60 x 29	100	193	24	\$2332	\$2798
DC5424	24 x 54 x 29	125	174	22	\$2211	\$2656
DC4824	24 x 48 x 29	100	155	19	\$2089	\$2506
DC4224	24 x 42 x 29	125	135	17	\$1769	\$2123
DC12022	22 x 120 x 29	100	358	44	\$4071	\$4884
DC11422	22 x 114 x 29	100	340	42	\$3866	\$4639
DC10822	22 x 108 x 29	100	323	40	\$3662	\$4397
DC10222	22 x 102 x 29	100	305	38	\$3456	\$4152
DC9622	22 x 96 x 29	100	287	35	\$3260	\$3910
DC9022	22 x 90 x 29	100	269	33	\$3055	\$3666
DC8422	22 x 84 x 29	100	251	31	\$2853	\$3426
DC7822	22 x 78 x 29	100	233	29	\$2646	\$3177
DC7222	22 x 72 x 29	125	215	27	\$2446	\$2934
DC6622	22 x 66 x 29	100	197	24	\$2357	\$2829
DC6022	22 x 60 x 29	100	179	22	\$2140	\$2565
DC5422	22 x 54 x 29	100	161	20	\$2027	\$2433
DC4822	22 x 48 x 29	125	143	18	\$1920	\$2303
DC4222	22 x 42 x 29	125	125	16	\$1621	\$1948

Standard with **no pedestals**. Flush full modesty panel. 96"w and larger includes a center support leg. If using storage component shells underneath to support the worksurface, **no more than 72" may be left unsupported**. Shipped assembled in 1 carton.

Required Specifications

Veneer finish
Laminated finish

Optional Specifications

Additional grommet

Accessories

Modular Storage*

CREDENZAS

MODEL# DIMENSIONS FREIGHT CLASS WT/LBS. CUBIC FT. VENEER/LAMINATE ALL VENEER

D x W x H

DCK8424EE	24 x 84 x 29	92.5	348	34	\$6580	\$7895
DCK7824EE	24 x 78 x 29	92.5	319	31	\$6114	\$7336
DCK7224EE	24 x 72 x 29	100	280	29	\$5646	\$6774
DCK6624EE	24 x 66 x 29	100	261	27	\$5560	\$6673
DCK6024EE	24 x 60 x 29	100	238	24	\$5172	\$6205

DCK8422EE	22 x 84 x 29	92.5	320	34	\$6032	\$7238
DCK7822EE	22 x 78 x 29	92.5	298	31	\$5605	\$6724
DCK7222EE	22 x 72 x 29	92.5	280	29	\$5173	\$6206
DCK6622EE	22 x 66 x 29	92.5	257	27	\$5095	\$6116
DCK6022EE	22 x 60 x 29	92.5	233	24	\$4739	\$5687

Standard with full to floor **file/file** pedestals on **left and right. Center is open** Pedestals lock. Shipped assembled in 1 carton.

DCK8424DD	24 x 84 x 29	92.5	348	34	\$6580	\$7895
DCK7824DD	24 x 78 x 29	92.5	319	31	\$6114	\$7336
DCK7224DD	24 x 72 x 29	100	280	29	\$5646	\$6774
DCK6624DD	24 x 66 x 29	100	261	27	\$5560	\$6673
DCK6024DD	24 x 60 x 29	100	238	24	\$5172	\$6205

DCK8422DD	22 x 84 x 29	92.5	320	34	\$6032	\$7238
DCK7822DD	22 x 78 x 29	92.5	298	31	\$5605	\$6724
DCK7222DD	22 x 72 x 29	92.5	280	29	\$5173	\$6206
DCK6622DD	22 x 66 x 29	92.5	257	27	\$5095	\$6116
DCK6022DD	22 x 60 x 29	92.5	233	24	\$4739	\$5687

Standard with full to floor **box/box/file** pedestals on **left and right. Center is open** Pedestals lock. One pencil tray. Shipped assembled in 1 carton.

DCK8424ED	24 x 84 x 29	92.5	348	34	\$6580	\$7895
DCK7824ED	24 x 78 x 29	92.5	319	31	\$6114	\$7336
DCK7224ED	24 x 72 x 29	100	280	29	\$5646	\$6774
DCK6624ED	24 x 66 x 29	100	261	27	\$5560	\$6673
DCK6024ED	24 x 60 x 29	100	238	24	\$5172	\$6205

DCK8422ED	22 x 84 x 29	92.5	320	34	\$6032	\$7238
DCK7822ED	22 x 78 x 29	92.5	298	31	\$5605	\$6724
DCK7222ED	22 x 72 x 29	92.5	280	29	\$5173	\$6206
DCK6622ED	22 x 66 x 29	92.5	257	27	\$5095	\$6116
DCK6022ED	22 x 60 x 29	92.5	233	24	\$4739	\$5687

Standard with full to floor **file/file** pedestal on **left and box/box/file** pedestal on **right. Center is open** Pedestals lock. One pencil tray. Shipped assembled in 1 carton.

DCK8424DE	24 x 84 x 29	92.5	348	34	\$6580	\$7895
DCK7824DE	24 x 78 x 29	92.5	319	31	\$6114	\$7336
DCK7224DE	24 x 72 x 29	100	280	29	\$5646	\$6774
DCK6624DE	24 x 66 x 29	100	261	27	\$5560	\$6673
DCK6024DE	24 x 60 x 29	100	238	24	\$5172	\$6205

DCK8422DE	22 x 84 x 29	92.5	320	34	\$6032	\$7238
DCK7822DE	22 x 78 x 29	92.5	298	31	\$5605	\$6724
DCK7222DE	22 x 72 x 29	92.5	280	29	\$5173	\$6206
DCK6622DE	22 x 66 x 29	92.5	257	27	\$5095	\$6116
DCK6022DE	22 x 60 x 29	92.5	233	24	\$4739	\$5687

Standard with full to floor **box/box/file** pedestal on **left and file/file** pedestal on **right. Center is open** Pedestals lock. One pencil tray. Shipped assembled in 1 carton.

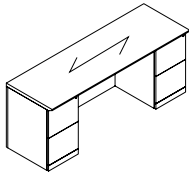

Kneespace Credenza

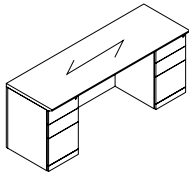

Kneespace Credenza

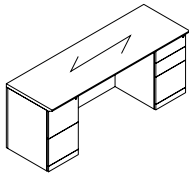

Kneespace Credenza

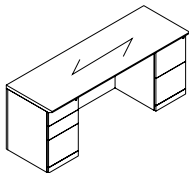

Kneespace Credenza

Required Specifications

- Veneer Finish
- Laminate Finish
- Handle style

Optional Specifications

- Grommet

CREENZAS

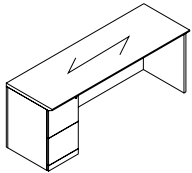

Single Pedestal Credenza - LEFT

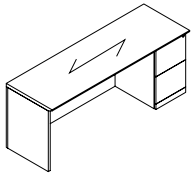

Single Pedestal Credenza - RIGHT

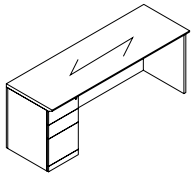

Single Pedestal Credenza - LEFT

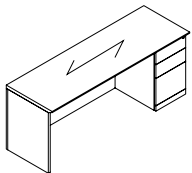

Single Pedestal Credenza - RIGHT

MODEL#	DIMENSIONS D x W x H	FREIGHT CLASS	WT/LBS.	CUBIC FT.	VENEER/LAMINATE	ALL VENEER
DCL8424E	24 x 84 x 29	100	315	34	\$4977	\$5973
DCL7824E	24 x 78 x 29	100	292	31	\$4623	\$5544
DCL7224E	24 x 72 x 29	100	270	29	\$4268	\$5120
DCL6624E	24 x 66 x 29	100	247	27	\$4108	\$4930
DCL6024E	24 x 60 x 29	100	225	24	\$3735	\$4481
DCL8422E	22 x 84 x 29	100	286	34	\$4563	\$5475
DCL7822E	22 x 78 x 29	100	265	31	\$4239	\$5088
DCL7222E	22 x 72 x 29	100	250	29	\$3915	\$4694
DCL6622E	22 x 66 x 29	100	229	27	\$3767	\$4521
DCL6022E	22 x 60 x 29	100	208	24	\$3426	\$4108

Standard with full to floor **file/file** pedestal on **left**. Pedestal locks. Shipped assembled in 1 carton.

DCR8424E	24 x 84 x 29	100	315	34	\$4977	\$5973
DCR7824E	24 x 78 x 29	100	292	31	\$4623	\$5544
DCR7224E	24 x 72 x 29	100	270	29	\$4268	\$5120
DCR6624E	24 x 66 x 29	100	247	27	\$4108	\$4930
DCR6024E	24 x 60 x 29	100	225	24	\$3735	\$4481
DCR8422E	22 x 84 x 29	100	286	34	\$4563	\$5475
DCR7822E	22 x 78 x 29	100	265	31	\$4239	\$5088
DCR7222E	22 x 72 x 29	100	250	29	\$3915	\$4694
DCR6622E	22 x 66 x 29	100	229	27	\$3767	\$4521
DCR6022E	22 x 60 x 29	100	208	24	\$3426	\$4108

Standard with full to floor **file/file** pedestal on **right**. Pedestal locks. Shipped assembled in 1 carton.

DCL8424D	24 x 84 x 29	100	315	34	\$4977	\$5973
DCL7824D	24 x 78 x 29	100	292	31	\$4623	\$5544
DCL7224D	24 x 72 x 29	100	270	29	\$4268	\$5120
DCL6624D	24 x 66 x 29	100	247	27	\$4108	\$4930
DCL6024D	24 x 60 x 29	100	225	24	\$3735	\$4481
DCL8422D	22 x 84 x 29	100	286	34	\$4563	\$5475
DCL7822D	22 x 78 x 29	100	265	31	\$4239	\$5088
DCL7222D	22 x 72 x 29	100	250	29	\$3915	\$4694
DCL6622D	22 x 66 x 29	100	229	27	\$3767	\$4521
DCL6022D	22 x 60 x 29	100	208	24	\$3426	\$4108

Standard with full to floor **box/box/file** pedestal on **left**. Pedestal locks. Shipped assembled in 1 carton.

DCR8424D	24 x 84 x 29	100	315	34	\$4977	\$5973
DCR7824D	24 x 78 x 29	100	292	31	\$4623	\$5544
DCR7224D	24 x 72 x 29	100	270	29	\$4268	\$5120
DCR6624D	24 x 66 x 29	100	247	27	\$4108	\$4930
DCR6024D	24 x 60 x 29	100	225	24	\$3735	\$4481
DCR8422D	22 x 84 x 29	100	286	34	\$4563	\$5475
DCR7822D	22 x 78 x 29	100	265	31	\$4239	\$5088
DCR7222D	22 x 72 x 29	100	250	29	\$3915	\$4694
DCR6622D	22 x 66 x 29	100	229	27	\$3767	\$4521
DCR6022D	22 x 60 x 29	100	208	24	\$3426	\$4108

Standard with full to floor **box/box/file** pedestal on **right**. Pedestal locks. Shipped assembled in 1 carton.

Required Specifications

Veneer Finish
Laminate Finish
Handle style

Optional Specifications

Grommet

CREDENZAS

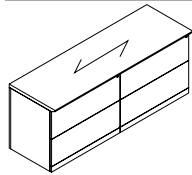

Lateral File Credenza

MODEL#	DIMENSIONS D x W x H	FREIGHT CLASS	WT/LBS.	CUBIC FT.	veneer/LAMINATE	ALL VENEER
DC7224FF	24 x 72 x 29	92.5	328	29	\$6864	\$8241
DC7222FF	22 x 72 x 29	92.5	300	27	\$6297	\$7553
DC6024NN	24 x 60 x 29	92.5	273	24	\$6296	\$7552
DC6022NN	22 x 60 x 29	100	218	22	\$5775	\$6932

Two 2-drawer lateral files side-by-side. Locking drawers. Anti-lock tilt suspension. **Not for stacking materials on lateral file drawer bottom.** Shipped assembled in 1 carton.

- "FF" models use two 36" wide lateral files, "NN" models use 30" wide.

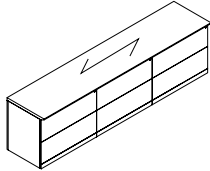

Lateral File Credenza

DC10824FFF	24 x 108 x 29	92.5	457	44	\$12077	\$14491
DC10822FFF	22 x 108 x 29	92.5	435	40	\$11069	\$13283
DC9024NNN	24 x 90 x 29	92.5	381	36	\$10067	\$12079
DC9022NNN	22 x 90 x 29	92.5	372	33	\$9230	\$11076

Three 2-drawer lateral files side-by-side. Locking drawers. Anti-lock tilt suspension. **Not for stacking materials on lateral file drawer bottom.** Shipped assembled in 1 carton.

- "FFF" models use two 36" wide lateral files, "NNN" models use 30" wide.

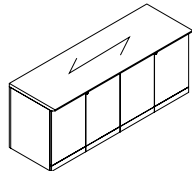

Storage Cabinet Credenza

DC7224GG	24 x 72 x 29	92.5	300	29	\$5097	\$6118
DC7222GG	22 x 72 x 29	92.5	277	27	\$4673	\$5607
DC6024MM	24 x 60 x 29	92.5	254	24	\$4673	\$5607
DC6022MM	22 x 60 x 29	92.5	232	22	\$4285	\$5142

Two 2-door storage cabinets side-by-side. Locking doors. Self-closing hinged doors cover one adjustable shelf. Shipped assembled in 1 carton.

- "GG" models use two 36" wide storage cabinets, "MM" models use 30" wide.

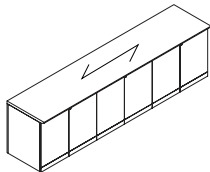

Storage Cabinet Credenza

DC10824GGG	24 x 108 x 29	100	392	44	\$9629	\$11555
DC10822GGG	22 x 108 x 29	100	348	40	\$8826	\$10591
DC9024MMM	24 x 90 x 29	100	326	36	\$8025	\$9630
DC9022MMM	22 x 90 x 29	100	302	33	\$7360	\$8830

Three 2-door storage cabinets side-by-side. Locking doors. Self-closing hinged doors cover one adjustable shelf. Shipped assembled in 1 carton.

- "GGG" models use two 36" wide storage cabinets, "MMM" models use 30" wide.

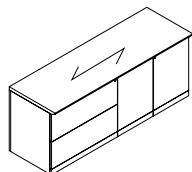

Lateral File/Storage Cabinet Credenza

DCF7224	24 x 72 x 29	92.5	305	29	\$5372	\$6447
DCF7222	22 x 72 x 29	92.5	285	27	\$4925	\$5911
DCF6024	24 x 60 x 29	92.5	254	24	\$4478	\$5372
DCF6022	22 x 60 x 29	92.5	233	22	\$4104	\$4923

One 2-drawer lateral file and one storage cabinet. Locking door/drawers. Storage cabinet includes one adjustable shelf. Anti-lock tilt suspension. **Not for stacking materials on lateral file drawer bottom.** Shipped assembled in 1 carton.

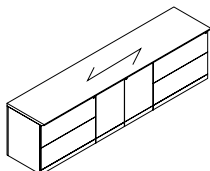

Lateral File/Storage Cabinet Credenza

DC10824FGF	24 x 108 x 29	92.5	392	44	\$11264	\$13517
DC10822FGF	22 x 108 x 29	92.5	348	40	\$10321	\$12388
DC9024NMN	24 x 90 x 29	92.5	326	36	\$9386	\$11264
DC9022NMN	22 x 90 x 29	92.5	302	33	\$8606	\$10327

One 2-drawer lateral file and one storage cabinet. Locking door/drawers. Storage cabinet includes one adjustable shelf. Anti-lock tilt suspension. **Not for stacking materials on lateral file drawer bottom.** Shipped assembled in 1 carton.

- "FGF" models use two 36" wide lateral files and one 36" wide storage cabinet, "NMN" models use 30" wide.

Required Specifications

- Veneer Finish
- Laminate Finish
- Handle style

CREDENZAS

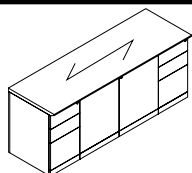

Vertical File/Storage Cabinet Credenza

MODEL#	DIMENSIONS D x W x H	FREIGHT CLASS	WT./LBS.	CUBIC FT.	VENEER/LAMINATE	ALL VENEER
DCD7224D	24 x 72 x 29	92.5	319	29	\$6297	\$7553
DCD7222D	22 x 72 x 29	92.5	298	24	\$5775	\$6932
DCD6024D	24 x 60 x 29	92.5	266	24	\$5775	\$6932
DCD6022D	22 x 60 x 29	92.5	246	20	\$5292	\$6353

Two box/box/file vertical files and one storage cabinet. Locking door/drawers. Storage cabinet includes one adjustable shelf. One pencil tray. Shipped assembled in 1 carton.

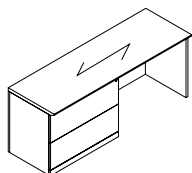

Kneespace Lateral File Credenza - LEFT*

DCL8424F	24 x 84 x 29	100	305	34	\$5782	\$6939
DCL7824F	24 x 78 x 29	100	285	31	\$5370	\$6446
DCL7224F	24 x 72 x 29	100	261	29	\$4956	\$5947
DCL6624F	24 x 66 x 29	100	239	27	\$4772	\$5725
DCL6024F	24 x 60 x 29	100	218	24	\$4335	\$5202
DCL8422F	22 x 84 x 29	100	266	31	\$5306	\$6365
DCL7822F	22 x 78 x 29	100	245	29	\$4923	\$5909
DCL7222F	22 x 72 x 29	100	230	27	\$4548	\$5458
DCL6622F	22 x 66 x 29	100	209	24	\$4377	\$5253
DCL6022F	22 x 60 x 29	100	188	22	\$3975	\$4769

One 2-drawer lateral file on the **left**. Locking drawers. Anti-lock tilt suspension. **Not for stacking materials on lateral file drawer bottom.** Shipped assembled in 1 carton.

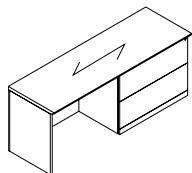

Kneespace Lateral File Credenza - RIGHT*

DCR8424F	24 x 84 x 29	100	305	34	\$5782	\$6939
DCR7824F	24 x 78 x 29	100	285	31	\$5370	\$6446
DCR7224F	24 x 72 x 29	100	261	29	\$4956	\$5947
DCR6624F	24 x 66 x 29	100	239	27	\$4772	\$5725
DCR6024F	24 x 60 x 29	100	218	24	\$4335	\$5202
DCR8422F	22 x 84 x 29	100	266	31	\$5306	\$6365
DCR7822F	22 x 78 x 29	100	245	29	\$4923	\$5909
DCR7222F	22 x 72 x 29	100	230	27	\$4548	\$5458
DCR6622F	22 x 66 x 29	100	209	24	\$4377	\$5253
DCR6022F	22 x 60 x 29	100	188	22	\$3975	\$4769

One 2-drawer lateral file on the **right**. Locking drawers. Anti-lock tilt suspension. **Not for stacking materials on lateral file drawer bottom.** Shipped assembled in 1 carton.

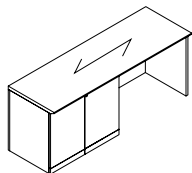

Kneespace Storage Cabinet * Credenza - LEFT

DCL8424G	24 x 84 x 29	100	338	34	\$5189	\$6229
DCL7824G	24 x 78 x 29	92.5	314	31	\$4822	\$5787
DCL7224G	24 x 72 x 29	92.5	290	29	\$4450	\$5340
DCL6624G	24 x 66 x 29	100	266	27	\$4284	\$5140
DCL6024G	24 x 60 x 29	92.5	242	24	\$3897	\$4677
DCL8422G	22 x 84 x 29	100	266	31	\$4765	\$5720
DCL7822G	22 x 78 x 29	100	245	29	\$4423	\$5310
DCL7222G	22 x 72 x 29	100	230	27	\$4082	\$4896
DCL6622G	22 x 66 x 29	92.5	209	24	\$3927	\$4712
DCL6022G	22 x 60 x 29	92.5	188	22	\$3576	\$4288

One storage cabinet on **left**. Locking doors. Storage cabinet has one adjustable shelf. Shipped assembled in 1 carton.

Required Specifications

Veneer Finish
Laminate Finish
Handle style

Optional Specifications

Grommet*

CREDENZAS

MODEL# DIMENSIONS FREIGHT CLASS WT/LBS. CUBIC FT. VENEER/LAMINATE ALL VENEER

D x W x H

DCR8424G	24 x 84 x 29	100	338	34	\$5189	\$6229
DCR7824G	24 x 78 x 29	92.5	314	31	\$4822	\$5787
DCR7224G	24 x 72 x 29	92.5	290	29	\$4450	\$5340
DCR6624G	24 x 66 x 29	100	266	27	\$4284	\$5140
DCR6024G	24 x 60 x 29	92.5	242	24	\$3897	\$4677

DCR8422G	22 x 84 x 29	100	266	31	\$4765	\$5720
DCR7822G	22 x 78 x 29	100	245	29	\$4423	\$5310
DCR7222G	22 x 72 x 29	100	230	27	\$4082	\$4896
DCR6622G	22 x 66 x 29	92.5	209	24	\$3927	\$4712
DCR6022G	22 x 60 x 29	92.5	188	22	\$3576	\$4288

One storage cabinet on **right**. Locking doors. Storage cabinet has one adjustable shelf. Shipped assembled in 1 carton.

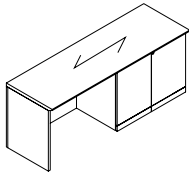

Kneespace Storage Cabinet Credenza - RIGHT

DCL8424Z	24 x 84 x 29	100	338	34	\$6315	\$7579
DCL7824Z	24 x 78 x 29	92.5	314	31	\$5864	\$7036
DCL7224Z	24 x 72 x 29	92.5	290	29	\$5415	\$6496
DCL6624Z	24 x 66 x 29	100	266	27	\$5212	\$6254
DCL6024Z	24 x 60 x 29	92.5	242	24	\$4737	\$5682

DCL8422Z	22 x 84 x 29	92.5	309	31	\$5788	\$6947
DCL7822Z	22 x 78 x 29	100	287	29	\$5376	\$6451
DCL7222Z	22 x 72 x 29	92.5	270	27	\$4964	\$5956
DCL6622Z	22 x 66 x 29	92.5	248	24	\$4778	\$5732
DCL6022Z	22 x 60 x 29	92.5	225	22	\$4343	\$5212

Standard with two box drawers, one file drawer, and one 36"W lateral file drawer on the **left**. File drawer and lateral file drawer lock. Front-to-back and side-to-side filing. **Not for stacking materials on lateral file drawer bottom.** Shipped assembled in 1 carton.

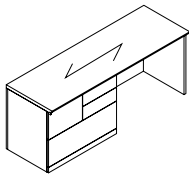

Mixed Storage Credenza - LEFT

DCR8424Z	24 x 84 x 29	100	338	34	\$6315	\$7579
DCR7824Z	24 x 78 x 29	92.5	314	31	\$5864	\$7036
DCR7224Z	24 x 72 x 29	92.5	290	29	\$5415	\$6496
DCR6624Z	24 x 66 x 29	100	266	27	\$5212	\$6254
DCR6024Z	24 x 60 x 29	92.5	242	24	\$4737	\$5682

DCR8422Z	22 x 84 x 29	92.5	309	31	\$5788	\$6947
DCR7822Z	22 x 78 x 29	100	287	29	\$5377	\$6452
DCR7222Z	22 x 72 x 29	92.5	270	27	\$4964	\$5956
DCR6622Z	22 x 66 x 29	92.5	248	24	\$4778	\$5732
DCR6022Z	22 x 60 x 29	92.5	225	22	\$4343	\$5212

Standard with two box drawers, one file drawer, and one 36"W lateral file drawer on the **right**. File drawer and lateral file drawer lock. Front-to-back and side-to-side filing. **Not for stacking materials on lateral file drawer bottom.** Shipped assembled in 1 carton.

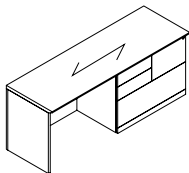

Mixed Storage Credenza - RIGHT

Required Specifications

- Veneer Finish
- Laminate Finish
- Handle style

Optional Specifications

- Grommet

D DUFFERIN

CORNERS	MODEL#	DIMENSIONS	FREIGHT CLASS	WT./LBS.	CUBIC FT.	VENEER/LAMINATE	ALL VENEER
---------	--------	------------	---------------	----------	-----------	-----------------	------------

D x W x H

- A Corner Desk is used to connect to a Linking Bridge and Linking Credenza, or Connectable Table
- Cable management tray is included.
- Full Modesty Panel option.
- 5-Sided Corners include a GM1 grommet in the top center position. Grommets are available as an option on Extended Corners.
- Hand of Linking Credenza is determined by location of full end panel from user side.
- Hand of Extended Corner is determined by location of long narrow end from user side.
- Connecting sides feature a self edge.

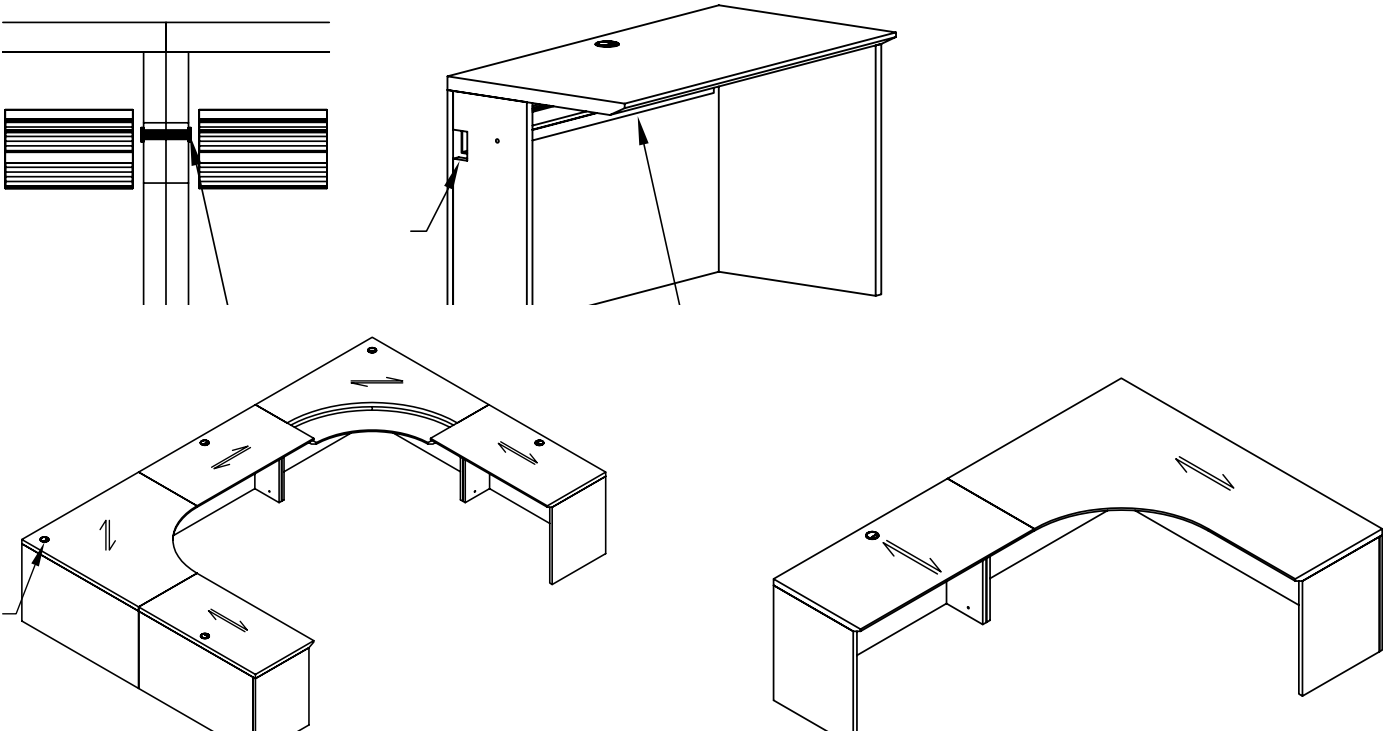

5-SIDED CORNERS	MODEL#	DIMENSIONS	FREIGHT CLASS	WT./LBS.	CUBIC FT.	VENEER/LAMINATE	ALL VENEER
-----------------	--------	------------	---------------	----------	-----------	-----------------	------------

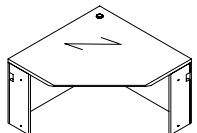

5-Sided Corner

DE484824	48 x 48 x 29	150	201	39	\$3017	\$3619
DE424224	42 x 42 x 29	150	155	30	\$2314	\$2774
DE363624	36 x 36 x 29	125	135	22	\$2199	\$2639

Connects to **24"D** connectables, returns, extended corners, storage/lateral file credenzas, credenzas and bridges. Includes grommet and installed horizontal wire management. Narrow end panels on left and right. Shipped assembled in 1 carton.

- *Not freestanding*

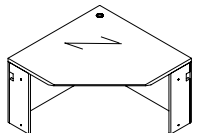

5-Sided Corner

DE484822	48 x 48 x 29	150	196	39	\$3017	\$3619
DE424222	42 x 42 x 29	150	150	30	\$2314	\$2774
DE363622	36 x 36 x 29	150	130	22	\$2199	\$2639

Connects to **22"D** connectables, returns, extended corners, storage/lateral file credenzas, credenzas and bridges. Includes grommet and installed horizontal wire management. Narrow end panels on left and right. Shipped assembled in 1 carton.

- *Not freestanding*

Required Specifications

Veneer Finish
Laminate Finish

Optional Specifications

Additional grommet

LEFT EXTENDED CORNERS

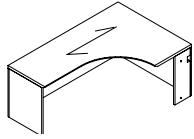

Left Extended Corner

MODEL#	DIMENSIONS	FREIGHT CLASS	WT./LBS.	CUBIC FT.	veneer/LAMINATE	ALL VENEER
D x W x H						
DEKL964824	24-48 x 96 x 29	150	387	77	\$5021	\$6022
DEKL904824	24-48 x 90 x 29	150	363	73	\$4669	\$5602
DEKL844824	24-48 x 84 x 29	150	338	68	\$4663	\$5597
DEKL784824	24-48 x 78 x 29	150	314	63	\$4589	\$5505
DEKL724824	24-48 x 72 x 29	150	290	58	\$4302	\$5163
DEKL664824	24-48 x 66 x 29	150	266	52	\$4069	\$4881
DEKL604824	24-48 x 60 x 29	150	242	48	\$3770	\$4522

Extended worksurface on **left. Full end panel on left, narrow end panel on right.** Connects to Linking Bridges, Extended Corners and Connectable Tables. Shipped assembled in 1 carton.

RIGHT EXTENDED CORNERS

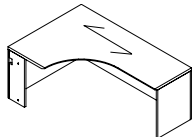

Right Extended Corner

MODEL#	DIMENSIONS	FREIGHT CLASS	WT./LBS.	CUBIC FT.	veneer/LAMINATE	ALL VENEER
DEKR489624	24-48 x 96 x 29	150	387	77	\$5021	\$6022
DEKR489024	24-48 x 90 x 29	150	363	73	\$4669	\$5602
DEKR488424	24-48 x 84 x 29	150	338	68	\$4663	\$5597
DEKR487824	24-48 x 78 x 29	150	314	63	\$4589	\$5505
DEKR487224	24-48 x 72 x 29	150	290	58	\$4302	\$5163
DEKR486624	24-48 x 66 x 29	150	266	52	\$4069	\$4881
DEKR486024	24-48 x 60 x 29	150	242	48	\$3770	\$4522

Extended worksurface on **right. Full end panel on right, narrow end panel on left.** Connects to Linking Bridges, Extended Corners and Connectable Tables. Shipped assembled in 1 carton.

FREESTANDING TABLES

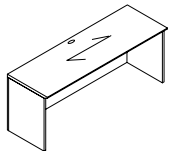

24" Deep Freestanding Table

MODEL#	DIMENSIONS	FREIGHT CLASS	WT./LBS.	CUBIC FT.	veneer/LAMINATE	ALL VENEER
DVT9624	24 x 96 x 29	150	213	39	\$2993	\$3591
DVT9024	24 x 90 x 29	150	199	36	\$2805	\$3366
DVT8424	24 x 84 x 29	150	186	34	\$2619	\$3143
DVT7824	24 x 78 x 29	150	173	31	\$2433	\$2920
DVT7224	24 x 72 x 29	150	160	29	\$2246	\$2693
DVT6624	24 x 66 x 29	150	146	27	\$2111	\$2534
DVT6024	24 x 60 x 29	150	133	24	\$1977	\$2372
DVT5424	24 x 54 x 29	150	128	22	\$1870	\$2242
DVT4824	24 x 48 x 29	125	120	19	\$1757	\$2109
DVT4224	24 x 42 x 29	125	104	17	\$1488	\$1788
DVT3624	24 x 36 x 29	150	88	15	\$1441	\$1729
DVT3024	24 x 30 x 29	125	82	12	\$1414	\$1697
DVT2424	24 x 24 x 29	125	65	10	\$1188	\$1425

Two full end panels. **Cannot be connected on left or right side.** Shipped assembled in 1 carton.

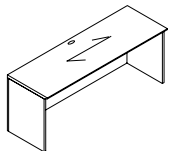

22" Deep Freestanding Table

DVT9622	22 x 96 x 29	150	193	35	\$2852	\$3423
DVT9022	22 x 90 x 29	150	181	33	\$2670	\$3207
DVT8422	22 x 84 x 29	150	169	31	\$2498	\$2996
DVT7822	22 x 78 x 29	150	157	29	\$2316	\$2779
DVT7222	22 x 72 x 29	150	145	27	\$2140	\$2565
DVT6622	22 x 66 x 29	150	138	24	\$2010	\$2411
DVT6022	22 x 60 x 29	150	130	22	\$1883	\$2261
DVT5422	22 x 54 x 29	125	123	20	\$1777	\$2137
DVT4822	22 x 48 x 29	125	115	18	\$1676	\$2013
DVT4222	22 x 42 x 29	125	100	16	\$1418	\$1702
DVT3622	22 x 36 x 29	125	85	13	\$1374	\$1647
DVT3022	22 x 30 x 29	125	80	11	\$1346	\$1613
DVT2422	22 x 24 x 29	125	64	9	\$1130	\$1357

Two full end panels. **Cannot be connected on left or right side.** Shipped assembled in 1 carton.

Required Specifications

Veneer Finish
Laminate Finish

Optional Specifications

Grommet

CONNECTABLE TABLES

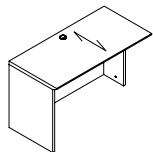

24" Deep Connectable Table - LEFT

MODEL#	DIMENSIONS D x W x H	FREIGHT CLASS	WT./LBS.	CUBIC FT.	VENEER/LAMINATE	ALL VENEER
DVL9624CG	24 x 96 x 29	150	200	39	\$3312	\$3974
DVL9024CG	24 x 90 x 29	150	187	36	\$3101	\$3721
DVL8424CG	24 x 84 x 29	150	174	34	\$2896	\$3476
DVL7824CG	24 x 78 x 29	150	162	31	\$2686	\$3221
DVL7224CG	24 x 72 x 29	150	149	29	\$2482	\$2978
DVL6624CG	24 x 66 x 29	150	141	27	\$2328	\$2794
DVL6024CG	24 x 60 x 29	150	132	24	\$2176	\$2613
DVL5424CG	24 x 54 x 29	150	121	22	\$2054	\$2460
DVL4824CG	24 x 48 x 29	125	115	19	\$1928	\$2315
DVL4224CG	24 x 42 x 29	150	99	17	\$1629	\$1955
DVL3624CG	24 x 36 x 29	150	83	15	\$1569	\$1886
DVL3024CG	24 x 30 x 29	125	77	12	\$1542	\$1850
DVL2424CG	24 x 24 x 29	125	61	10	\$1296	\$1553

Full end panel on left. Right narrow end panel connects to 24"D center/right connectable table; 24"D extended corners, 24"D 5-sided corners; Grommet in worksurface. Shipped assembled in 1 carton.

- To remove cross grain veneer pattern on top, **delete suffix "CG"** from the model number. Available as a special - no upcharge.

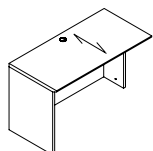

22" Deep Connectable Table - LEFT

DVL9622CG	22 x 96 x 29	150	187	39	\$3151	\$3780
DVL9022CG	22 x 90 x 29	150	175	36	\$2957	\$3549
DVL8422CG	22 x 84 x 29	150	163	34	\$2760	\$3312
DVL7822CG	22 x 78 x 29	150	152	31	\$2560	\$3070
DVL7222CG	22 x 72 x 29	150	140	29	\$2364	\$2836
DVL6622CG	22 x 66 x 29	150	133	27	\$2221	\$2664
DVL6022CG	22 x 60 x 29	150	125	24	\$2074	\$2490
DVL5422CG	22 x 54 x 29	150	113	22	\$1960	\$2351
DVL4822CG	22 x 48 x 29	125	110	19	\$1842	\$2209
DVL4222CG	22 x 42 x 29	150	95	17	\$1555	\$1863
DVL3622CG	22 x 36 x 29	125	80	15	\$1495	\$1795
DVL3022CG	22 x 30 x 29	125	75	12	\$1469	\$1766
DVL2422CG	22 x 24 x 29	125	60	10	\$1236	\$1483

Full end panel on left. Right narrow end panel connects to 22"D center/right connectable table; 22"D 5-sided corners; Grommet in worksurface. Shipped assembled in 1 carton.

- To remove cross grain veneer pattern on top, **delete suffix "CG"** from the model number. Available as a special - no upcharge.

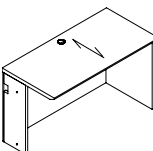

24" Deep Connectable Table - RIGHT

DVR9624CG	24 x 96 x 29	150	200	39	\$3312	\$3974
DVR9024CG	24 x 90 x 29	150	187	36	\$3101	\$3721
DVR8424CG	24 x 84 x 29	150	174	34	\$2896	\$3476
DVR7824CG	24 x 78 x 29	150	162	31	\$2686	\$3221
DVR7224CG	24 x 72 x 29	150	149	29	\$2482	\$2978
DVR6624CG	24 x 66 x 29	150	141	27	\$2328	\$2794
DVR6024CG	24 x 60 x 29	150	132	24	\$2173	\$2609
DVR5424CG	24 x 54 x 29	150	121	22	\$2054	\$2460
DVR4824CG	24 x 48 x 29	125	115	19	\$1930	\$2316
DVR4224CG	24 x 42 x 29	150	99	17	\$1629	\$1955
DVR3624CG	24 x 36 x 29	150	83	15	\$1569	\$1886
DVR3024CG	24 x 30 x 29	125	77	12	\$1542	\$1850
DVR2424CG	24 x 24 x 29	125	61	10	\$1296	\$1553

Full end panel on right. Left narrow end panel connects to 24"D center/left connectable table; 24"D extended corners, 24"D 5-sided corners; Grommet in worksurface. Shipped assembled in 1 carton.

- To remove cross grain veneer pattern on top, **delete suffix "CG"** from the model number. Available as a special - no upcharge.

Required Specifications

Veneer Finish
Laminate Finish

Optional Specifications

Additional grommet

CONNECTABLE TABLES

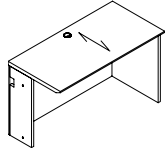

22" Deep Connectable Table - RIGHT

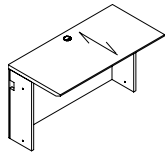

24" Deep Connectable Table

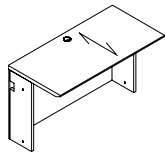

22" Deep Connectable Table

MODEL#	DIMENSIONS D x W x H	FREIGHT CLASS	WT./LBS.	CUBIC FT.	veneer/LAMINATE	ALL VENEER
DVR9622CG	22 x 96 x 29	150	187	39	\$3151	\$3780
DVR9022CG	22 x 90 x 29	150	175	36	\$2957	\$3549
DVR8422CG	22 x 84 x 29	150	163	34	\$2760	\$3312
DVR7822CG	22 x 78 x 29	150	152	31	\$2560	\$3070
DVR7222CG	22 x 72 x 29	150	140	29	\$2364	\$2836
DVR6622CG	22 x 66 x 29	150	133	27	\$2221	\$2664
DVR6022CG	22 x 60 x 29	150	125	24	\$2074	\$2490
DVR5422CG	22 x 54 x 29	150	113	22	\$1960	\$2351
DVR4822CG	22 x 48 x 29	125	110	19	\$1842	\$2209
DVR4222CG	22 x 42 x 29	150	95	17	\$1555	\$1863
DVR3622CG	22 x 36 x 29	125	80	15	\$1495	\$1795
DVR3022CG	22 x 30 x 29	125	75	12	\$1469	\$1766
DVR2422CG	22 x 24 x 29	125	60	10	\$1236	\$1483

Full end panel on right. Left narrow end panel connects to 22"D center/left connectable table; 22"D 5-sided corners; Grommet in worksurface. Shipped assembled in 1 carton.

- To remove cross grain veneer pattern on top, delete suffix "CG" from the model number. Available as a special - no upcharge.

DV9624CG	24 x 96 x 29	150	197	39	\$3233	\$3877
DV9024CG	24 x 90 x 29	150	185	36	\$3034	\$3641
DV8424CG	24 x 84 x 29	150	173	34	\$2831	\$3398
DV7824CG	24 x 78 x 29	150	160	31	\$2629	\$3154
DV7224CG	24 x 72 x 29	150	145	29	\$2424	\$2908
DV6624CG	24 x 66 x 29	150	136	27	\$2453	\$2945
DV6024CG	24 x 60 x 29	150	123	24	\$2117	\$2539
DV5424CG	24 x 54 x 29	150	119	22	\$1992	\$2392
DV4824CG	24 x 48 x 29	150	107	19	\$1871	\$2246
DV4224CG	24 x 42 x 29	150	91	17	\$1569	\$1886
DV3624CG	24 x 36 x 29	150	76	15	\$1514	\$1815
DV3024CG	24 x 30 x 29	150	70	12	\$1483	\$1777
DV2424CG	24 x 24 x 29	150	53	10	\$1245	\$1494

Narrow end panels on left and right connects to 24"D connectable table; 24"D extended corners, 24"D 5-sided corners; Grommet in worksurface. Shipped assembled in 1 carton.

- To remove cross grain veneer pattern on top, delete suffix "CG" from the model number. Available as a special - no upcharge.

DV9622CG	22 x 96 x 29	150	181	35	\$3079	\$3694
DV9022CG	22 x 90 x 29	150	169	33	\$2891	\$3468
DV8422CG	22 x 84 x 29	150	157	31	\$2693	\$3233
DV7822CG	22 x 78 x 29	150	145	29	\$2503	\$3004
DV7222CG	22 x 72 x 29	150	133	27	\$2305	\$2767
DV6622CG	22 x 66 x 29	150	126	24	\$2162	\$2594
DV6022CG	22 x 60 x 29	150	118	22	\$2022	\$2428
DV5422CG	22 x 54 x 29	150	111	20	\$1898	\$2276
DV4822CG	22 x 48 x 29	150	103	18	\$1780	\$2139
DV4222CG	22 x 42 x 29	150	88	16	\$1490	\$1790
DV3622CG	22 x 36 x 29	150	73	13	\$1440	\$1728
DV3022CG	22 x 30 x 29	125	68	11	\$1412	\$1693
DV2422CG	22 x 24 x 29	150	52	9	\$1184	\$1420

Narrow end panels on left and right connects to 22"D connectable table; 22"D extended corners, 22"D 5-sided corners; Grommet in worksurface. Shipped assembled in 1 carton.

- To remove cross grain veneer pattern on top, delete suffix "CG" from the model number. Available as a special - no upcharge.

Required Specifications

Veneer Finish
Laminate Finish

Optional Specifications

Additional grommet

DUFFERIN

"D" ISLANDS

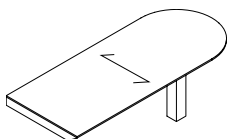

"D" Island with Monopost

MODEL#	DIMENSIONS D x W x H	FREIGHT CLASS	WT./LBS.	CUBIC FT.	VENEER/LAMINATE	ALL VENEER
DRD8436CG	36 x 84 x 29	250	135	51	N/A	\$3052
DRD7236CG	36 x 72 x 29	250	121	44	N/A	\$2613
DRD7230CG	30 x 72 x 29	250	99	36	N/A	\$2446
DRD6636CG	36 x 66 x 29	250	99	40	N/A	\$2446
DRD6030CG	30 x 60 x 29	250	83	30	N/A	\$2276

Attaches to edge of worksurfaces with Dufferin knife (molding) edge. Attaching hardware included. Shipped RTA (ready to assemble).

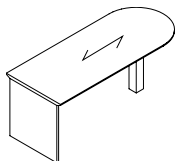

"D" Island - Full End Panel* (T-Base) & Monopost

DDD8436	36 x 84 x 29	125	343	51	\$4843	\$5813
DDD7236	36 x 72 x 29	125	294	44	\$4151	\$4978
DDD7230	30 x 72 x 29	125	264	36	\$3858	\$4628
DDD6636	36 x 66 x 29	125	245	40	\$3858	\$4628
DDD6030	30 x 60 x 29	125	225	30	\$3709	\$4448

Connects to Linking Bridges or Executive Returns. Attaching hardware included. **Not freestanding.** Shipped RTA (ready to assemble).

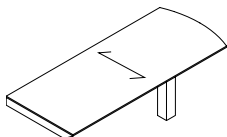

"D" Island with Monopost, Bow End

DRDBE8436CG	36 x 84 x 29	250	135	51	N/A	\$3052
DRDBE7236CG	36 x 72 x 29	250	121	44	N/A	\$2613
DRDBE7230CG	30 x 72 x 29	250	99	36	N/A	\$2446
DRDBE6636CG	36 x 66 x 29	250	99	40	N/A	\$2446
DRDBE6030CG	30 x 60 x 29	250	83	30	N/A	\$2276

Attaches to edge of worksurfaces with Dufferin knife (molding) edge. Attaching hardware included. Shipped RTA (ready to assemble).

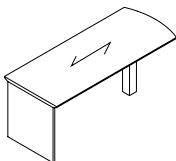

"D" Island - Full End Panel, Bow End (T-Base) & Monopost

DDDBE8436	36 x 84 x 29	125	343	51	\$4842	\$5810
DDDBE7236	36 x 72 x 29	125	294	44	\$4151	\$4978
DDDBE7230	30 x 72 x 29	125	264	36	\$3857	\$4627
DDDBE6636	36 x 66 x 29	125	245	40	\$3857	\$4627
DDDBE6030	30 x 60 x 29	125	225	30	\$3706	\$4446

Connects to Linking Bridges or Executive Returns. Attaching hardware included. **Not freestanding.** Shipped RTA (ready to assemble).

BOAT SHAPED ISLANDS

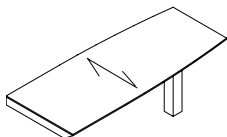

Boat Shaped Island with Monopost

MODEL#	DIMENSIONS	FREIGHT CLASS	WT./LBS.	CUBIC FT.	VENEER/LAMINATE	ALL VENEER
DRDBS8442CG	42 x 84 x 29	250	179	59	N/A	\$3552
DRDBS8436CG	36 x 84 x 29	250	155	51	N/A	\$3052
DRDBS7236CG	36 x 72 x 29	250	141	44	N/A	\$2613
DRDBS7230CG	30 x 72 x 29	250	119	36	N/A	\$2446
DRDBS6636CG	36 x 66 x 29	250	119	40	N/A	\$2446
DRDBS6030CG	30 x 60 x 29	250	103	30	N/A	\$2276

Attaches to edge of worksurfaces with Dufferin knife (molding) edge. Attaching hardware included. Shipped RTA (ready to assemble).

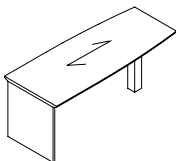

Boat Shaped Island - Full End Panel* (T-Base) & Monopost

DDDBS8442	42 x 84 x 29	125	414	59	\$5732	\$6880
DDDBS8436	36 x 84 x 29	125	343	51	\$4842	\$5810
DDDBS7236	36 x 72 x 29	125	314	44	\$4151	\$4978
DDDBS7230	30 x 72 x 29	125	284	36	\$3857	\$4627
DDDBS6636	36 x 66 x 29	125	265	40	\$3857	\$4627
DDDBS6030	30 x 60 x 29	100	245	30	\$3706	\$4446

Connects to Linking Bridges or Executive Returns. Attaching hardware included. **Not freestanding.** Shipped RTA (ready to assemble).

Required Specifications

Veneer finish
Laminate finish*
Monopost finish

Optional Specifications

Grommet
Modesty panel
Monopost (Base) upgrade

"P" ISLANDS

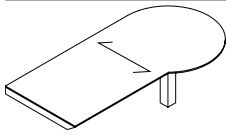

"P" Island - LEFT with Monopost

MODEL#	DIMENSIONS D x W x H	FREIGHT CLASS	WT./LBS.	CUBIC FT.	veneer/LAMINATE	ALL VENEER
DRPL9642CG	42 x 96 x 29	250	239	68	N/A	\$4695
DRPL8442CG	42 x 84 x 29	250	209	59	N/A	\$4106
DRPL7242CG	42 x 72 x 29	250	143	51	N/A	\$3525

Attaches to edge of worksurfaces with Dufferin knife (molding) edge. Attaching hardware included. Shipped RTA (ready to assemble).

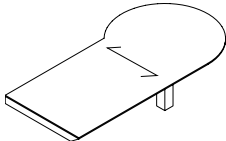

"P" Island - RIGHT with Monopost

DRPR9642CG	42 x 96 x 29	250	239	68	N/A	\$4695
DRPR8442CG	42 x 84 x 29	250	209	59	N/A	\$4106
DRPR7242CG	42 x 72 x 29	250	143	51	N/A	\$3525

Attaches to edge of worksurfaces with Dufferin knife (molding) edge. Attaching hardware included. Shipped RTA (ready to assemble).

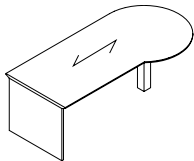

"P" Island - LEFT with Monopost (T-Base) & Monopost*

DTPL9642	42 x 96 x 29	125	440	68	\$4434	\$5318
DTPL8442	42 x 84 x 29	125	385	59	\$3878	\$4656
DTPL7242	42 x 72 x 29	125	319	51	\$3535	\$4241

Connects to Linking Bridges or Executive Returns. Attaching hardware included. **Not freestanding.** Shipped RTA (ready to assemble).

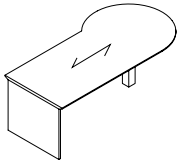

"P" Island - RIGHT with Monopost (T-Base) & Monopost*

DTPR9642	42 x 96 x 29	125	440	68	\$4434	\$5318
DTPR8442	42 x 84 x 29	125	385	59	\$3878	\$4656
DTPR7242	42 x 72 x 29	125	319	51	\$3535	\$4241

Connects to Linking Bridges or Executive Returns. Attaching hardware included. **Not freestanding.** Shipped RTA (ready to assemble).

Required Specifications

Veneer finish
Laminate finish*
Monopost finish

Optional Specifications

Grommet
Modesty panel
Monopost (Base) upgrade

DUFFERIN

PIANO DESKS	MODEL#	DIMENSIONS D x W x H	FREIGHT CLASS	WT./LBS.	CUBIC FT.	VENEER/LAMINATE	ALL VENEER
-------------	--------	-------------------------	---------------	----------	-----------	-----------------	------------

- Can be ordered as a shell or with pedestals.
- Components include a GM1 grommet in the top center position.
- Hand of Rectangular Desk is determined by location of pedestal from user side.
- Hand of "D" Top is determined by outward orientation of curved end from user projection.
- Hand of "P" Top is determined by outward orientation of conference end from user projection.
- Connectable Tables and Bridges - To remove cross grain veneer pattern on top, delete suffix "CG" from the model number. Available as a special - no upcharge.

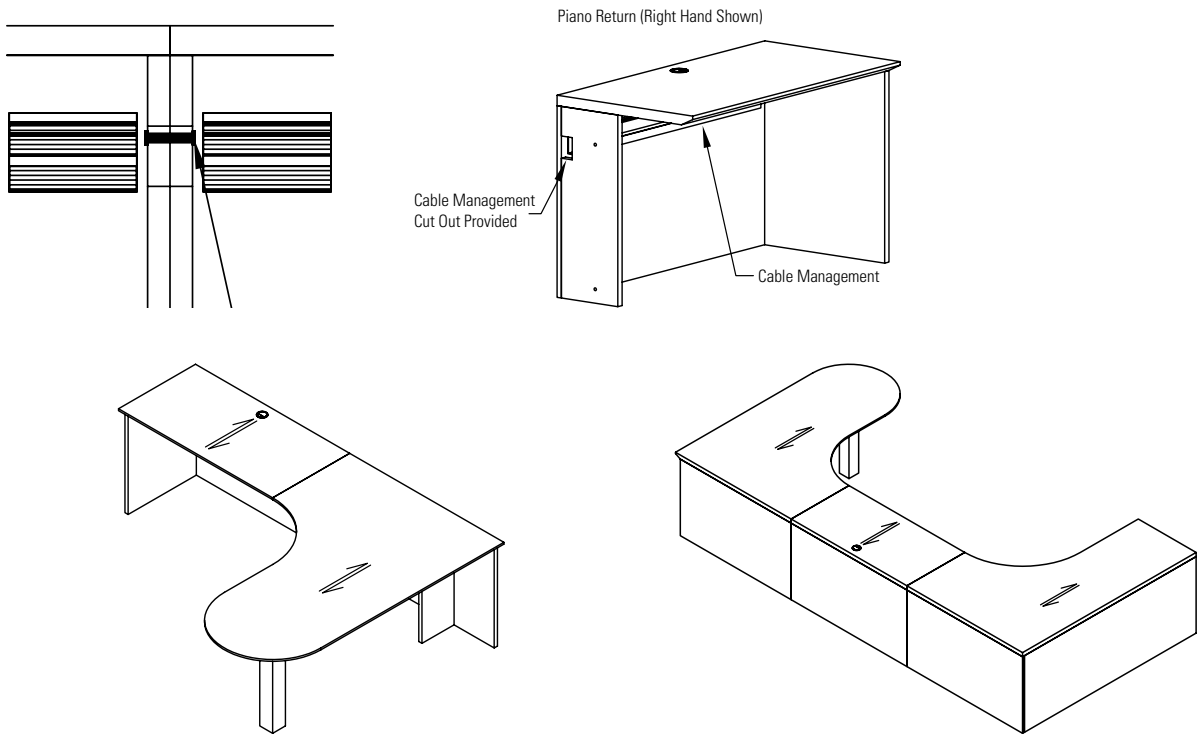

"D" ISLANDS (PIANO DESKS)	MODEL#	DIMENSIONS	FREIGHT CLASS	WT./LBS.	CUBIC FT.	VENEER/LAMINATE	ALL VENEER
---------------------------	--------	------------	---------------	----------	-----------	-----------------	------------

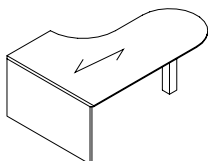

"D" Island LEFT - Full End Panel & Monopost, Piano Desk

DTDPL96304824	48 x 96 x 29	125	464	77	\$4598	\$5516
DTDPL84304824	48 x 84 x 29	150	406	68	\$4093	\$4913
DTDPL72304824	48 x 72 x 29	125	348	58	\$3585	\$4302

Extended island worksurface on the **left**. Narrow end panel on right connects to **24"D** returns or bridges **for Piano Desks Only** (see above). **Not freestanding**. Includes installed horizontal wire management. Shipped RTA (ready to assemble).

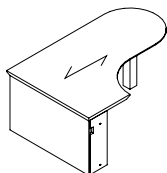

"D" Island RIGHT - Full End Panel & Monopost, Piano Desk

DTDPR96304824	48 x 96 x 29	125	464	77	\$4598	\$5516
DTDPR84304824	48 x 84 x 29	150	406	68	\$4093	\$4913
DTDPR72304824	48 x 72 x 29	125	348	58	\$3585	\$4302

Extended island worksurface on the **right**. Narrow end panel on left connects to **24"D** returns or bridges **for Piano Desks Only** (see above). **Not freestanding**. Includes installed horizontal wire management. Shipped RTA (ready to assemble).

Required Specifications

- Veneer finish
- Laminate finish
- Monopost finish

Optional Specifications

- Grommet
- Modesty panel
- Monopost (Base) upgrade

BOAT SHAPED ISLANDS (PIANO DESKS)	MODEL#	DIMENSIONS	FREIGHT CLASS	WT./LBS.	CUBIC FT.	VENEER/LAMINATE	ALL VENEER
		D x W x H					
	DTBPL96304824	48 x 96 x 29	125	522	87	\$5465	\$6558
	DTBPL84304824	48 x 84 x 29	125	457	76	\$5465	\$6558
	DTBPL72304824	48 x 72 x 29	125	392	65	\$4772	\$5725

Boat Shaped Island LEFT - Full End Panel & Monopost, Piano Desk

Extended island worksurface on the **left**. Narrow end panel on right connects to **24"D** returns or bridges **for Piano Desks Only** (see pg. 35). **Not freestanding**. Includes installed horizontal wire management. Shipped RTA (ready to assemble).

	DTBPR96304824	48 x 96 x 29	125	522	87	\$5465	\$6558
	DTBPR84304824	48 x 84 x 29	125	457	76	\$5465	\$6558
	DTBPR72304824	48 x 72 x 29	125	392	65	\$4769	\$5724

Boat Shaped Island RIGHT - Full End Panel & Monopost, Piano Desk

Extended island worksurface on the **right**. Narrow end panel on left connects to **24"D** returns or bridges **for Piano Desks Only** (see pg. 35). **Not freestanding**. Includes installed horizontal wire management. Shipped RTA (ready to assemble).

"P" ISLANDS (PIANO DESKS)	MODEL#	DIMENSIONS	FREIGHT CLASS	WT./LBS.	CUBIC FT.	VENEER/LAMINATE	ALL VENEER
	DTPPL96424824	60 x 96 x 29	150	580	97	\$5245	\$6296
	DTPPL84424824	60 x 84 x 29	150	508	85	\$4692	\$5629
	DTPPL72424824	60 x 72 x 29	150	435	73	\$4350	\$5220

"P" Shaped Island LEFT - Full End Panel & Monopost, Piano Desk

Extended island worksurface on the **left**. Narrow end panel on right connects to **24"D** returns or bridges **for Piano Desks Only** (see pg. 35). **Not freestanding**. Includes installed horizontal wire management. Shipped RTA (ready to assemble).

	DTPPR96424824	60 x 96 x 29	150	580	97	\$5241	\$6289
	DTPPR84424824	60 x 84 x 29	150	508	85	\$4692	\$5629
	DTPPR72424824	60 x 72 x 29	150	435	73	\$4350	\$5220

Boat Shaped Island RIGHT - Full End Panel & Monopost, Piano Desk

Extended island worksurface on the **right**. Narrow end panel on left connects to **24"D** returns or bridges **for Piano Desks Only** (see pg. 35). **Not freestanding**. Includes installed horizontal wire management. Shipped RTA (ready to assemble).

DELTA ISLANDS (PIANO DESKS)	MODEL#	DIMENSIONS	FREIGHT CLASS	WT./LBS.	CUBIC FT.	VENEER/LAMINATE	ALL VENEER
	DBTHPL96304824	54 x 96 x 29	125	531	87	\$4973	\$5968
	DBTHPL84304824	54 x 84 x 29	125	464	76	\$4421	\$5306
	DBTHPL72304824	54 x 72 x 29	125	398	65	\$4081	\$4894

Delta Island LEFT - Full End Panel & Monopost, Piano Desk

Extended island worksurface on the **left**. Narrow end panel on right connects to **24"D** returns or bridges **for Piano Desks Only** (see pg. 35). **Not freestanding**. Includes installed horizontal wire management. Shipped RTA (ready to assemble).

	DBTHPR96304824	54 x 96 x 29	125	531	87	\$4973	\$5968
	DBTHPR84304824	54 x 84 x 29	125	464	76	\$4421	\$5306
	DBTHPR72304824	54 x 72 x 29	125	398	65	\$4081	\$4894

Delta Island RIGHT - Full End Panel & Monopost, Piano Desk

Extended island worksurface on the **right**. Narrow end panel on left connects to **24"D** returns or bridges **for Piano Desks Only** (see pg. 35). **Not freestanding**. Includes installed horizontal wire management. Shipped RTA (ready to assemble).

Required Specifications

Veneer finish
Laminate finish
Monopost finish

Optional Specifications

Grommet
Modesty panel
Monopost (Base) upgrade

CONNECTABLE TABLES - LEFT (FOR PIANO DESKS)

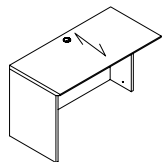

24" Deep Connectable Table - LEFT
For Piano Desk

MODEL#	DIMENSIONS D x W x H	FREIGHT CLASS	WT/LBS.	CUBIC FT.	veneer/LAMINATE	ALL VENEER
DVEL9624CG	24 x 96 x 29	150	200	39	\$3436	\$4124
DVEL9024CG	24 x 90 x 29	150	187	36	\$3224	\$3871
DVEL8424CG	24 x 84 x 29	150	174	34	\$3006	\$3607
DVEL7824CG	24 x 78 x 29	150	162	31	\$2795	\$3353
DVEL7224CG	24 x 72 x 29	150	149	29	\$2583	\$3100
DVEL6624CG	24 x 66 x 29	150	141	27	\$2416	\$2900
DVEL6024CG	24 x 60 x 29	150	132	24	\$2265	\$2716
DVEL5424CG	24 x 54 x 29	150	121	22	\$2132	\$2559
DVEL4824CG	24 x 48 x 29	125	115	19	\$2008	\$2410
DVEL4224CG	24 x 42 x 29	150	99	17	\$1690	\$2025
DVEL3624CG	24 x 36 x 29	150	83	15	\$1638	\$1963
DVEL3024CG	24 x 30 x 29	125	77	12	\$1752	\$2104
DVEL2424CG	24 x 24 x 29	125	61	10	\$1346	\$1613

Full end panel on left. Right narrow end panel connects to 24"D right connectable table, "D" islands, Boat shaped islands, "P" islands or Delta islands with "T" bases **for Piano Desks Only.** Grommet in worksurface. Shipped assembled in 1 carton.

- To remove cross grain veneer pattern on top, **delete suffix "CG"** from the model number. Available as a special - no upcharge.

CONNECTABLE TABLES - RIGHT (FOR PIANO DESKS)

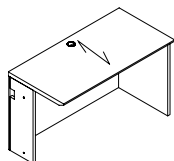

24" Deep Connectable Table - RIGHT
For Piano Desk

MODEL#	DIMENSIONS	FREIGHT CLASS	WT/LBS.	CUBIC FT.	veneer/LAMINATE	ALL VENEER
DVER9624CG	24 x 96 x 29	150	200	39	\$3436	\$4124
DVER9024CG	24 x 90 x 29	150	187	36	\$3224	\$3871
DVER8424CG	24 x 84 x 29	150	174	34	\$3006	\$3607
DVER7824CG	24 x 78 x 29	150	162	31	\$2795	\$3353
DVER7224CG	24 x 72 x 29	150	149	29	\$2583	\$3100
DVER6624CG	24 x 66 x 29	150	141	27	\$2416	\$2900
DVER6024CG	24 x 60 x 29	150	132	24	\$2265	\$2716
DVER5424CG	24 x 54 x 29	150	121	22	\$2132	\$2559
DVER4824CG	24 x 48 x 29	125	115	19	\$2008	\$2410
DVER4224CG	24 x 42 x 29	150	99	17	\$1690	\$2025
DVER3624CG	24 x 36 x 29	150	83	15	\$1638	\$1963
DVER3024CG	24 x 30 x 29	125	77	12	\$1621	\$1948
DVER2424CG	24 x 24 x 29	125	61	10	\$1346	\$1613

Full end panel on right. Left narrow end panel connects to 24"D left connectable table, "D" islands, Boat shaped islands, "P" islands or Delta islands with "T" bases **for Piano Desks Only.** Grommet in worksurface. Shipped assembled in 1 carton..

- To remove cross grain veneer pattern on top, **delete suffix "CG"** from the model number. Available as a special - no upcharge.

BRIDGES (FOR PIANO DESKS)

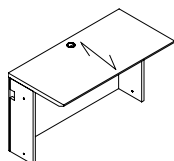

Flush Bridge

MODEL#	DIMENSIONS	FREIGHT CLASS	WT/LBS.	CUBIC FT.	veneer/LAMINATE	ALL VENEER
DBTN4824CG	24 x 48 x 29	125	116	19	\$1723	\$2068
DBTN4224CG	24 x 42 x 29	92.5	102	17	\$1448	\$1739
DBTN3624CG	24 x 36 x 29	150	87	15	\$1387	\$1666
DBTN3024CG	24 x 30 x 29	125	73	12	\$1359	\$1633
DBTN2424CG	24 x 24 x 29	150	58	10	\$1143	\$1371
DBTN1824CG	24 x 18 x 29	150	43	8	\$858	\$1029
DBTN1224CG	24 x 12 x 29	150	29	5	\$572	\$690

Full end panel on both sides connects to 24"D worksurfaces, "D" islands, Boat shaped islands, "P" islands or Delta islands with "T" bases **for Piano Desks Only.** Grommet in worksurface. Shipped assembled in 1 carton.

- To remove cross grain veneer pattern on top, **delete suffix "CG"** from the model number. Available as a special - no upcharge.

Required Specifications

Veneer finish
Laminate finish

Optional Specifications

Additional grommet

TABLE DESK	MODEL#	DIMENSIONS	FREIGHT CLASS	WT/LBS.	CUBIC FT.	VENEER/LAMINATE	ALL VENEER
		D x W x H					
	DTB8442	42 x 84 x 29	150	272	59	N/A	\$8189
	DTB7842	42 x 78 x 29	150	253	55	N/A	\$7606
	DTB7236	36 x 72 x 29	150	205	44	N/A	\$6019
	DTB7230	30 x 72 x 29	150	192	36	N/A	\$5905
	DTB6636	36 x 66 x 29	150	192	40	N/A	\$5905
	DTB6630	30 x 66 x 29	150	188	33	N/A	\$5790
DTB6030	30 x 60 x 29	150	171	30	N/A	\$5517	

Table Desk**

Four 4" square metal legs. Includes centered pencil drawer. Shipped RTA (ready to assemble).

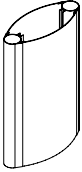
MONOPOST (BASE) UPGRADES	MODEL#	DIMENSIONS	FREIGHT CLASS	WT/LBS.	CUBIC FT.	VENEER/LAMINATE	ALL VENEER
	TE18	5 x 18 x 28	70	30	2	N/A	\$1375

Elliptical Base Upgrade

To replace one standard monopost on Islands ONLY. Must specify at time of order. **Cannot be retrofitted in the field.**

	TPML18	8 x 18 x 28	70	36	2	N/A	\$1440
---	--------	-------------	----	----	---	-----	---------------

Rectangular Base Upgrade

To replace one standard monopost on Islands ONLY. Must specify at time of order. **Cannot be retrofitted in the field. Not sold individually - to be ordered as an upgrade option only.**

Required Specifications

Veneer Finish
Laminate Finish
Metal finish*

Optional Specifications

Lock**
Veneer top**

MODESTY PANEL OPTIONS

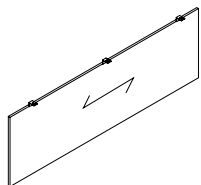

Veneer Modesty Panel Upgrade*

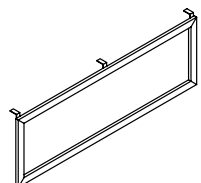

Glass Modesty Panel Upgrade

MODEL#	DIMENSIONS D x W x H	FREIGHT CLASS	WT/LBS.	CUBIC FT.	LIST PRICE
CMP72W	0.75 x 67 x 18	--	20	1	\$1728
CMP66W	0.75 x 61 x 18	--	18	1	\$1673
CMP60W	0.75 x 55 x 18	--	16	1	\$1647
CMP54W	0.75 x 49 x 18	--	14	1	\$1619
CMP48W	0.75 x 43 x 18	--	13	1	\$1594

Straight modesty panel. Attaches to underside of worksurface. **Cannot be retrofitted in the field *Not sold individually - to be ordered as an upgrade option only.***

- CMP72W - Specify on "P" Top Islands or 96" x 48" Islands for Piano Desks.
- CMP66W - Specify on 84" x 36" "D" Top Islands.
- CMP60W - Specify on 84" x 42" "P" Top Islands or 84" x 48" Islands for Piano Desks.
- CMP54W - Specify on 72" x 30" "D" Top Islands.
- CMP48W - Specify on 66" x 36" , 60" x 30" "D" Top Islands, 72" x 42" "P" Top Islands or 72" x 48" Islands for Piano Desks.

CMP72G	0.75 x 67 x 18	--	20	1	\$2647
CMP66G	0.75 x 61 x 18	--	18	1	\$2504
CMP60G	0.75 x 55 x 18	--	16	1	\$2289
CMP54G	0.75 x 49 x 18	--	14	1	\$2132
CMP48G	0.75 x 43 x 18	--	13	1	\$2036

Straight modesty panel. Translucent, screened glass. Aluminum box frame construction in Tungsten Only. Attaches to underside of worksurface. **Cannot be retrofitted in the field. *Not sold individually - to be ordered as an upgrade option only.***

- CMP72G - Specify on "P" Top Islands or 96" x 48" Islands for Piano Desks.
- CMP66G - Specify on 84" x 36" "D" Top Islands.
- CMP60G - Specify on 84" x 42" "P" Top Islands or 84" x 48" Islands for Piano Desks.
- CMP54G - Specify on 72" x 30" "D" Top Islands.
- CMP48G - Specify on 66" x 36" , 60" x 30" "D" Top Islands, 72" x 42" "P" Top Islands or 72" x 48" Islands for Piano Desks.
- Tungsten finish on the aluminum box frame closely resembles the existing Tungsten finish.

SIDE BY SIDE COMPONENTS

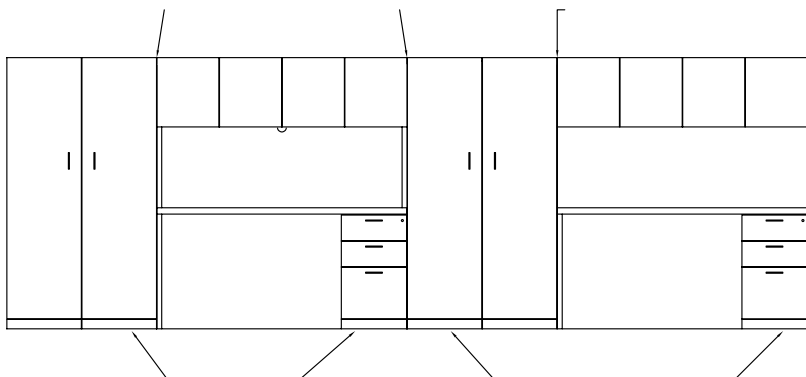

Required Specifications

Veneer finish

STORAGE SHELLS - NOTES

D x W x H

- When using Storage Shells, laminate gables will show.
- Credenza shell cannot be completely filled up with storage shells to create a full storage credenza.
- Handle style must be specified.

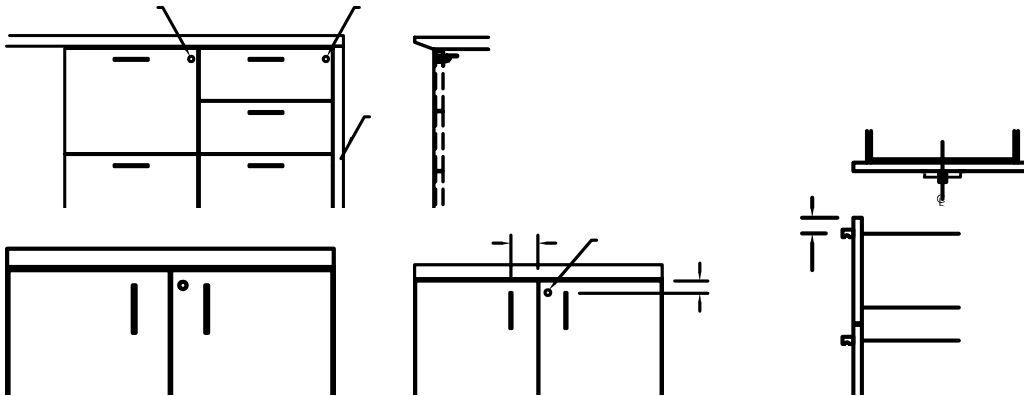

STORAGE SHELLS	MODEL#	DIMENSIONS	FREIGHT CLASS	WT./LBS.	CUBIC FT.	VENEER/LAMINATE	ALL VENEER
----------------	--------	------------	---------------	----------	-----------	-----------------	------------

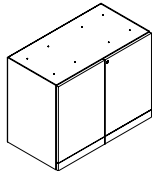

Storage Shell

DWG	19.1 x 36.75 x 28	92.5	115	11	\$1685	\$2020
DWM	19.1 x 31.625 x 28	92.5	96	9	\$1490	\$1790

For use **under a freestanding worksurface (22", 24", 30" or 36"D)**. Top drilled to attach to worksurface. One adjustable shelf. **Standard with lock**. Shipped assembled in 1 carton.

- **Unfinished top and back**

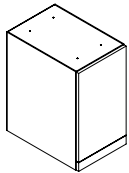

Storage Shell - LEFT

DWWIL	23 x 15.6 x 28	100	53	6	\$1498	\$1797
DWIL	19.1 x 15.6 x 28	100	45	5	\$1238	\$1484

For use **under a freestanding worksurface (22", 24", 30" or 36"D)**. Top drilled to attach to worksurface. One adjustable shelf. Handle is on the **right**, door opens to the **left**. Shipped assembled in 1 carton.

- For 22" or 24"D worksurface, order **DWIL**. For 30" or 36"D worksurface, order **DWWIL**.

- **Unfinished top and back**

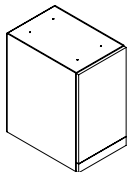

Storage Shell - RIGHT

DWWIR	23 x 15.6 x 28	100	53	6	\$1498	\$1797
DWIR	19.1 x 15.6 x 28	100	45	5	\$1238	\$1484

For use **under a freestanding worksurface (22", 24", 30" or 36"D)**. Top drilled to attach to worksurface. One adjustable shelf. Handle is on the **left**, door opens to the **right**. Shipped assembled in 1 carton.

- For 22" or 24"D worksurface, order **DWIR**. For 30" or 36"D worksurface, order **DWWIR**.

- **Unfinished top and back**

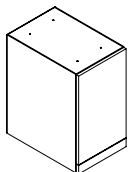

Storage Shell - LEFT
Eight Storage Slot Shelves

DWWIL8S	23 x 15.6 x 28	125	45	6	\$2047	\$2456
DWIL8S	19.1 x 15.6 x 28	125	37	5	\$1779	\$2138

For use **under a freestanding worksurface (22", 24", 30" or 36"D)**. Top drilled to attach to worksurface. Eight adjustable storage slot shelves. Handle is on the **right**, door opens to the **left**. Shipped assembled in 1 carton.

- For 22" or 24"D worksurface, order **DWIL8S**. For 30" or 36"D worksurface, order **DWWIL8S**.

- **Unfinished top and back**

Required Specifications

Veneer Finish (doors)
Laminate Finish (body)
Handle Style

Optional Specifications

Lock

STORAGE SHELLS

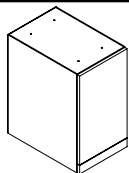

Storage Shell - RIGHT
Eight Storage Slot Shelves

MODEL#	DIMENSIONS D x W x H	FREIGHT CLASS	WT/LBS.	CUBIC FT.	VENEER/LAMINATE	ALL VENEER
DWWIR8S	23 x 15.6 x 28	125	45	6	\$2047	\$2456
DWIR8S	19.1 x 15.6 x 28	125	37	5	\$1779	\$2138

For use under a freestanding worksurface (22", 24", 30" or 36"D). Top drilled to attach to worksurface. Eight adjustable storage slot shelves. Handle is on the left, door opens to the right. Shipped assembled in 1 carton.

- For 22" or 24"D worksurface, order **DWIR8S**. For 30" or 36"D worksurface, order **DWWIR8S**.
- Unfinished top and back

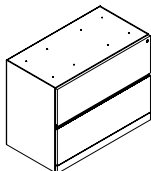

File/File Shell - Lateral

DWF	19.1 x 36.75 x 28	92.5	115	11	\$2412	\$2896
DWN	19.1 x 31.625 x 28	92.5	96	9	\$2112	\$2535

For use under a freestanding worksurface (22", 24", 30" or 36"D). Top drilled to attach to worksurface. Two lateral file drawers. Lock secures all drawers. Side-to-side file bars included. Shipped assembled in 1 carton.

- Unfinished top and back

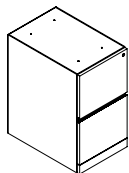

File/File Shell - Vertical*

LETTER						
DWWE	23 x 15.6 x 28	85	72	6	\$1859	\$2233
DWE	19.1 x 15.6 x 28	85	70	5	\$1620	\$1944
LEGAL						
DWWLE	23 x 18.5 x 28	85	85	7	\$2235	\$2682
DWLE	19.1 x 18.5 x 28	85	83	6	\$1944	\$2332

For use under a freestanding worksurface (22", 24", 30" or 36"D). Top drilled to attach to worksurface. Two file drawers. Lock secures all drawers. Shipped assembled in 1 carton.

- For 22" or 24"D worksurface, order **DWE** or **DWLE**. For 30" or 36"D worksurface, order **DWWE** or **DWWLE**.
- Unfinished top and back

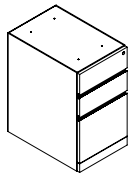

Box/Box/File Shell - Vertical*

LETTER						
DWWD	23 x 15.6 x 28	85	72	6	\$1859	\$2233
DWD	19.1 x 15.6 x 28	85	70	5	\$1620	\$1944
LEGAL						
DWWLD	23 x 18.5 x 28	85	85	7	\$2235	\$2682
DWLD	19.1 x 18.5 x 28	85	83	6	\$1944	\$2332

For use under a freestanding worksurface (22", 24", 30" or 36"D). Top drilled to attach to worksurface. Two box and one file drawers. One pencil tray. Lock secures all drawers. Shipped assembled in 1 carton.

- For 22" or 24"D worksurface, order **DWD** or **DWLD**. For 30" or 36"D worksurface, order **DWWD** or **DWWLD**.
- Unfinished top and back

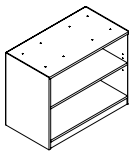

Open Shelving Shell

DWOB36	19.1 x 36.75 x 28	100	92	11	\$1274	\$1529
DWOB30	19.1 x 31.625 x 28	100	77	9	\$1128	\$1354

For use under a freestanding worksurface (22", 24", 30" or 36"D). Top drilled to attach to worksurface. One adjustable veneer shelf. Shipped assembled in 1 carton.

- Unfinished top and back

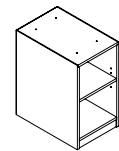

Open Shelving Shell

DWWQ	23 x 15.6 x 28	125	45	6	\$1319	\$1581
DWQ	19.1 x 15.6 x 28	125	37	5	\$1090	\$1309

For use under a freestanding worksurface (22", 24", 30" or 36"D). Top drilled to attach to worksurface. One adjustable veneer shelf. Shipped assembled in 1 carton.

- For 22" or 24"D worksurface, order **DWQ**. For 30" or 36"D worksurface, order **DWWQ**.
- Unfinished top and back

Required Specifications

Veneer Finish (doors, drawer fronts, open shelves)
Laminate Finish (body)
Handle Style

Optional Specifications

Additional Lock*

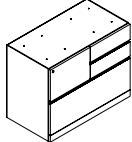
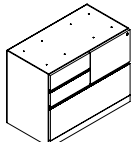
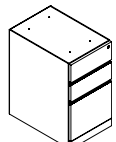
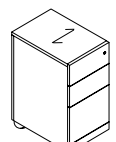
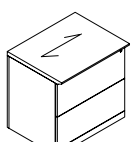
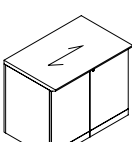
STORAGE SHELLS	MODEL#	DIMENSIONS	FREIGHT CLASS	WT/LBS.	CUBIC FT.	veneer/LAMINATE	ALL VENEER
 Mixed Storage Shell - LEFT	DWZL	19.1 x 36.75 x 28	92.5	115	11	\$2800	\$3362
	For use under a freestanding worksurface (22", 24", 30" or 36"D) . Top drilled to attach to worksurface. One file drawer on left , two box drawers on right and one lateral file drawer on bottom. File drawer and lateral file drawer lock. One pencil tray. Not for stacking materials on lateral file drawer bottom . Shipped assembled in 1 carton. • Unfinished top and back						
 Mixed Storage Shell - RIGHT	DWZR	19.1 x 36.75 x 28	92.5	115	11	\$2800	\$3362
	For use under a freestanding worksurface (22", 24", 30" or 36"D) . Top drilled to attach to worksurface. One file drawer on right , two box drawers on left and one lateral file drawer on bottom. File drawer and lateral file drawer lock. One pencil tray. Not for stacking materials on lateral file drawer bottom . Shipped assembled in 1 carton. • Unfinished top and back						
STORAGE MODULES - (FREESTANDING)	MODEL#	DIMENSIONS	FREIGHT CLASS	WT/LBS.	CUBIC FT.	veneer/LAMINATE	ALL VENEER
 Box/Box/File Freestanding Pedestal	DWDB	19.8 x 15.5 x 28	85	70	5	\$1756	\$2108
	DWWDB	23.8 x 15.5 x 28	300	75	6	\$2022	\$2428
Two box and one file drawer. One pencil tray. Lock secures all drawers. Finished back. Shipped assembled in 1 carton.							
 Box/Box/File Module, Mobile	DWDM	19.8 x 15.5 x 28	85	70	5	\$1890	\$2267
	DWWDM	23.8 x 15.5 x 28	300	75	6	\$2171	\$2607
Two box and one file drawer. One pencil tray. Lock secures all drawers. Casters. Shipped assembled in 1 carton.							
 File/File Module, Lateral	DF3624	24 x 36 x 29	85	184	15	\$3358	\$4029
	DN3024	24 x 30 x 29	85	153	12	\$2941	\$3530
	DF3622	22 x 36 x 29	85	170	13	\$3078	\$3693
	DN3022	22 x 30 x 29	85	142	11	\$2697	\$3237
Two lateral file drawers. Lock secures all drawers. Side-to-side file bars included. Shipped assembled in 1 carton.							
 Storage Cabinet w/Doors	DBD3624	24 x 36 x 29	92.5	152	15	\$2101	\$2519
	DBD3024	24 x 30 x 29	92.5	127	12	\$1838	\$2203
	DBD3622	22 x 36 x 29	92.5	140	13	\$1924	\$2306
	DBD3022	22 x 30 x 29	92.5	117	11	\$1685	\$2020
Includes one adjustable shelf. Standard with lock. Shipped assembled in 1 carton.							

Required Specifications

Veneer Finish (doors, drawer fronts, open shelves)
 Laminate Finish (top/body)
 Handle Style

STORAGE MODULES - FREESTANDING

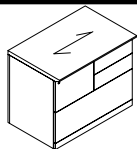

Mixed Storage Cabinet - LEFT

MODEL#	DIMENSIONS D x W x H	FREIGHT CLASS	WT/LBS.	CUBIC FT.	VENEER/LAMINATE	ALL VENEER
DZL3624	24 x 36 x 29	85	184	15	\$3342	\$4009
DZL3622	22 x 36 x 29	85	170	13	\$3063	\$3678

One file drawer on the **left**, two box drawers on the **right** and one lateral file drawer on the bottom. File drawer and lateral file drawer lock. One pencil tray. Not for stacking materials on lateral file drawer bottom. Shipped assembled in 1 carton.

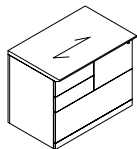

Mixed Storage Cabinet - RIGHT

DZR3624	24 x 36 x 29	85	184	15	\$3342	\$4009
DZR3622	22 x 36 x 29	85	170	13	\$3063	\$3678

One file drawer on the **right**, two box drawers on the **left** and one lateral file drawer on the bottom. File drawer and lateral file drawer lock. One pencil tray. Not for stacking materials on lateral file drawer bottom. Shipped assembled in 1 carton.

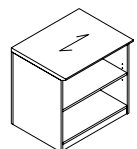

Open Storage Cabinet

DOB3624	24 x 36 x 29	100	123	15	\$1620	\$1944
DOB3024	24 x 30 x 29	100	103	12	\$1420	\$1703
DOB3622	22 x 36 x 29	100	115	13	\$1488	\$1788
DOB3022	22 x 30 x 29	100	96	11	\$1303	\$1563

One fixed and **one** adjustable veneer shelf. Shelves are 3/4" thick. Shipped assembled in 1 carton.

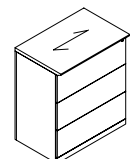

Three File Module

DF36243	24 x 36 x 42	92.5	231	21	\$4057	\$4871
DN30243	24 x 30 x 42	92.5	193	18	\$3559	\$4271
DF36223	22 x 36 x 42	92.5	212	19	\$3757	\$4507
DN30223	22 x 30 x 42	92.5	176	16	\$3297	\$3954

Three lateral file drawers. Lock secures all drawers. Shipped assembled in 1 carton.

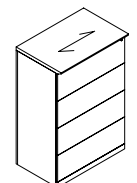

Four File Module

DF36244	24 x 36 x 54	92.5	297	27	\$5369	\$6443
DN30244	24 x 30 x 54	92.5	248	23	\$4584	\$5501
DF36224	22 x 36 x 54	92.5	270	25	\$4577	\$5492
DN30224	22 x 30 x 54	92.5	225	21	\$4010	\$4814

Four lateral file drawers. Lock secures all drawers. Shipped assembled in 1 carton.

STORAGE MODULES - 48" HIGH (FREESTANDING)

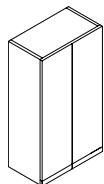

Storage Cabinet w/Doors*

MODEL#	DIMENSIONS	FREIGHT CLASS	WT/LBS.	CUBIC FT.	VENEER/LAMINATE	ALL VENEER
D1D22H48	22 x 36 x 48	150	107	22	\$3238	\$3885
D1D22W30H48	22 x 30 x 48	150	90	19	\$3162	\$3795
D1D22W24H48	22 x 24 x 48	150	72	15	\$3101	\$3721
D1D20H48	20 x 36 x 48	150	97	20	\$2946	\$3533
D1D20W30H48	20 x 30 x 48	150	81	17	\$2882	\$3456
D1D20W24H48	20 x 24 x 48	150	63	13	\$2820	\$3382

Includes four adjustable shelves. Optional lock available. Shipped assembled in 1 carton.

Required Specifications

Veneer finish
Laminate finish (body)
Handle Style

Optional Specifications

Lock*
Veneer Top*

STORAGE MODULES - 48" HIGH (FREESTANDING) MODEL# DIMENSIONS FREIGHT CLASS WT/LBS. CUBIC FT. VENEER/LAMINATE ALL VENEER

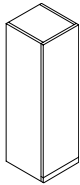

Storage Cabinet w/Door - LEFT*

	D x W x H						
D1D22W18H48L	22 x 18 x 48	150	60	11	\$2044	\$2454	
D1D22W16H48L	22 x 16 x 48	150	54	10	\$1818	\$2184	
D1D20W18H48L	20 x 18 x 48	125	60	10	\$1861	\$2236	
D1D20W16H48L	20 x 16 x 48	125	54	9	\$1650	\$1980	

Includes three adjustable shelves. Handle is on the **right**, door opens to the **left**. Optional lock available. Shipped assembled in 1 carton.

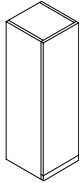

Storage Cabinet w/Door - RIGHT*

D1D22W18H48R	22 x 18 x 48	150	60	11	\$2044	\$2454	
D1D22W16H48R	22 x 16 x 48	150	54	10	\$1818	\$2184	
D1D20W18H48R	20 x 18 x 48	125	60	10	\$1861	\$2236	
D1D20W16H48R	20 x 16 x 48	125	54	9	\$1650	\$1980	

Includes three adjustable shelves. Handle is on the **left**, door opens to the **right**. Optional lock available. Shipped assembled in 1 carton.

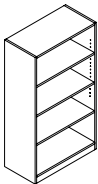

Open Storage Cabinet

D7D22W36H48	22 x 36 x 48	150	118	22	\$2554	\$3066	
D7D22W30H48	22 x 30 x 48	150	98	19	\$1898	\$2276	
D7D22W24H48	22 x 24 x 48	150	78	15	\$1514	\$1815	
D7D22W18H48	22 x 18 x 48	150	59	11	\$1272	\$1528	
D7D20W36H48	20 x 36 x 48	150	108	20	\$2322	\$2787	
D7D20W30H48	20 x 30 x 48	150	90	17	\$1723	\$2068	
D7D20W24H48	20 x 24 x 48	100	72	13	\$1687	\$2022	
D7D20W18H48	20 x 18 x 48	150	54	10	\$1215	\$1457	

One fixed and **three** adjustable veneer shelves. Shelves are 3/4" thick. Shipped assembled in 1 carton.

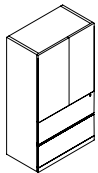

Two File Module w/Doors*

D13D22H48	22 x 36 x 48	150	117	23	\$3450	\$4138	
D13D22W30H48	22 x 30 x 48	150	101	19	\$3123	\$3746	
D13H48	20 x 36 x 48	150	107	23	\$3304	\$3968	
D13W30H48	20 x 30 x 48	150	91	19	\$4040	\$4846	

Two lateral file drawers on bottom. Includes two adjustable shelves. Lower lock secures two file drawers. Optional lock available for upper storage. **Not for stacking materials on lateral file drawer bottom.** Shipped assembled in 1 carton.

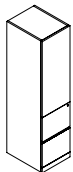

Two File Module w/Door - LEFT*

D17D22H48L	22 x 16 x 48	125	97	13	\$2561	\$3073	
D17D20H48L	20 x 16 x 48	125	88	13	\$2336	\$2803	

Two file drawers on bottom. Includes two adjustable shelves. Lower lock secures two file drawers. Optional lock available for upper storage. Handle is on the right, door opens to the left. Shipped assembled in 1 carton.

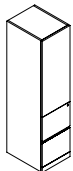

Two File Module w/Door - RIGHT*

D17D22H48R	22 x 16 x 48	125	97	13	\$2561	\$3073	
D17D20H48R	20 x 16 x 48	125	88	13	\$2336	\$2803	

Two file drawers on bottom. Includes two adjustable shelves. Lower lock secures two file drawers. Optional lock available for upper storage. Handle is on the left, door opens to the right. Shipped assembled in 1 carton.

Required Specifications

Veneer finish (doors, drawer fronts)
Laminate finish (top/body)
Handle Style*

Optional Specifications

Lock*
Veneer top

STORAGE MODULES - 48" HIGH (FREESTANDING)		MODEL#	DIMENSIONS	FREIGHT CLASS	WT/LBS.	CUBIC FT.	VENEER/LAMINATE	ALL VENEER
			D x W x H					
		D18D22H48L	22 x 16 x 48	125	64	9	\$2561	\$3073
	D18D20H48L	20 x 16 x 48	125	59	9	\$2336	\$2803	
Box/Box/File Module w/Door - LEFT*		Two box drawers and one file drawer on bottom. Includes two adjustable shelves. Lower lock secures all drawers. Optional lock available for upper storage. Handle is on the right , door opens to the left . Shipped assembled in 1 carton.						
		D18D22H48R	22 x 16 x 48	125	64	9	\$2561	\$3073
	D18D20H48R	20 x 16 x 48	125	59	9	\$2336	\$2803	
Box/Box/File Module w/Door - RIGHT*		Two box drawers and one file drawer on bottom. Includes two adjustable shelves. Lower lock secures all drawers. Optional lock available for upper storage. Handle is on the left , door opens to the right . Shipped assembled in 1 carton.						
		D12D22H48	22 x 36 x 48	150	117	23	\$3239	\$3888
		D12D22W30H48	22 x 30 x 48	150	101	19	\$2800	\$3362
		D12H48	20 x 36 x 48	150	107	23	\$3109	\$3731
	D12W30H48	20 x 30 x 48	150	91	19	\$3793	\$4550	
Two File Module w/Open Shelf		Two open veneer shelves and two lateral file drawers on bottom. Includes one adjustable shelf. Lock secures all drawers. Not for stacking materials on lateral file drawer bottom. Shipped assembled in 1 carton.						
		D22D22H48	22 x 36 x 48	150	117	23	\$2924	\$3506
		D22D22W30H48	22 x 30 x 48	150	101	19	\$2002	\$2400
		D22D20H48	20 x 36 x 48	150	107	23	\$2301	\$2760
	D22D20W30H48	20 x 30 x 48	150	91	19	\$1912	\$2295	
Storage Module w/Open Shelf		Two open veneer shelves and storage cabinet on bottom. Includes one adjustable shelf in upper compartment and one adjustable shelf in storage cabinet. Lock secures storage cabinet. Shipped assembled in 1 carton.						

WARDROBE CABINETS - 48" HIGH		MODEL#	DIMENSIONS	FREIGHT CLASS	WT/LBS.	CUBIC FT.	VENEER/LAMINATE	ALL VENEER
		D2D22H48	22 x 36 x 48	150	107	22	\$2647	\$3181
		D2D22W30H48	22 x 30 x 48	150	107	19	\$2592	\$3109
		D2D22W24H48	22 x 24 x 48	150	85	15	\$3101	\$3721
		D2H48	20 x 36 x 48	150	102	20	\$2408	\$2891
		D2W30H48	20 x 30 x 48	150	89	17	\$2357	\$2829
		D2W24H48	20 x 24 x 48	150	72	13	\$2305	\$2767
Wardrobe Cabinet*		Includes full length hanging rod and fixed hat shelf. Optional lock available. Shipped assembled in 1 carton.						
		D2D22W24H48L	22 x 24 x 48	150	80	15	\$2539	\$3051
		D2D22W18H48L	22 x 18 x 48	150	60	11	\$2044	\$2454
		D2D22W12H48L	22 x 12 x 48	150	40	7	\$1952	\$2342
		D2D20W24H48L	20 x 24 x 48	150	72	13	\$2305	\$2767
		D2D20W18H48L	20 x 18 x 48	150	54	10	\$1861	\$2236
	D2D20W12H48L	20 x 12 x 48	125	36	7	\$2165	\$2596	
Wardrobe Cabinet - LEFT*		Includes full length hanging rod and fixed hat shelf. Handle is on the right , door opens to the left . Optional lock available. Shipped assembled in 1 carton.						

Required Specifications

Veneer Finish (doors, drawer fronts)
Laminate Finish (top/body)
Handle Style

Optional Specifications

Lock*
Veneer Top

WARDROBE CABINETS - 48" HIGH

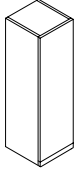

Wardrobe Cabinet - RIGHT*

MODEL#	DIMENSIONS	FREIGHT CLASS	WT/LBS.	CUBIC FT.	VENEER/LAMINATE	ALL VENEER
D x W x H						
D2D22W24H48R	22 x 24 x 48	150	80	15	\$2539	\$3051
D2D22W18H48R	22 x 18 x 48	150	60	11	\$2044	\$2454
D2D22W12H48R	22 x 12 x 48	150	40	7	\$1952	\$2342
D2D20W24H48R	20 x 24 x 48	150	72	13	\$2305	\$2767
D2D20W18H48R	20 x 18 x 48	150	54	10	\$1861	\$2236
D2D20W12H48R	20 x 12 x 48	125	36	7	\$2165	\$2596

Includes full length hanging rod and fixed hat shelf. Handle is on the **left**, door opens to the **right**. Optional lock available. Shipped assembled in 1 carton.

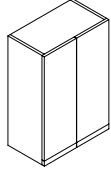

Wardrobe Cabinet/Shelving Combo*

D25D22H48	22 x 36 x 48	150	117	23	\$2818	\$3381
D25D22W30H48	22 x 30 x 48	150	101	19	\$2765	\$3318
D25D20H48	20 x 36 x 48	150	107	23	\$2699	\$3239
D25D20W30H48	20 x 30 x 48	60	91	19	\$2647	\$3181

Wardrobe compartment on **left** includes hanging rod and fixed hat shelf. Storage compartment on **right** includes three adjustable shelves. Optional lock available. Shipped assembled in 1 carton.

STORAGE MODULES - 54" HIGH (FREESTANDING)

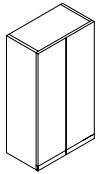

Storage Cabinet w/Doors*

MODEL#	DIMENSIONS	FREIGHT CLASS	WT/LBS.	CUBIC FT.	VENEER/LAMINATE	ALL VENEER
D1D22H54	22 x 36 x 54	150	120	22	\$2867	\$3442
D1D22W30H54	22 x 30 x 54	150	102	19	\$2853	\$3426
D1D22W24H54	22 x 24 x 54	150	81	17	\$3485	\$4185
D1D20H54	20 x 36 x 54	150	110	20	\$2709	\$3248
D1D20W30H54	20 x 30 x 54	150	92	17	\$2647	\$3181
D1D20W24H54	20 x 24 x 54	150	71	13	\$2599	\$3116

Includes four adjustable shelves. Optional lock available. Shipped assembled in 1 carton.

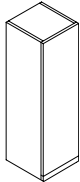

Storage Cabinet w/Door - LEFT*

D1D22W18H54L	22 x 18 x 54	150	68	12	\$2305	\$2767
D1D22W16H54L	22 x 16 x 54	150	61	11	\$2044	\$2454
D1D20W18H54L	20 x 18 x 54	125	68	11	\$2089	\$2506
D1D20W16H54L	20 x 16 x 54	125	61	10	\$1861	\$2236

Includes three adjustable shelves. Handle is on the **right**, door opens to the **left**. Optional lock available. Shipped assembled in 1 carton.

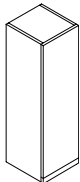

Storage Cabinet w/Door - RIGHT*

D1D22W18H54R	22 x 18 x 54	150	68	12	\$2305	\$2767
D1D22W16H54R	22 x 16 x 54	150	61	11	\$2044	\$2454
D1D20W18H54R	20 x 18 x 54	125	68	11	\$2089	\$2506
D1D20W16H54R	20 x 16 x 54	125	61	10	\$1861	\$2236

Includes three adjustable shelves. Handle is on the **left**, door opens to the **right**. Optional lock available. Shipped assembled in 1 carton.

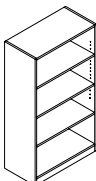

Open Storage Cabinet

D7D22W36H54	22 x 36 x 54	150	132	25	\$2876	\$3450
D7D22W30H54	22 x 30 x 54	150	110	21	\$2132	\$2559
D7D22W24H54	22 x 24 x 54	150	88	17	\$1711	\$2054
D7D22W18H54	22 x 18 x 54	150	67	12	\$1336	\$1608
D7D20W36H54	20 x 36 x 54	150	122	23	\$2613	\$3136
D7D20W30H54	20 x 30 x 54	150	102	19	\$1943	\$2331
D7D20W24H54	20 x 24 x 54	150	81	15	\$1550	\$1858
D7D20W18H54	20 x 18 x 54	150	61	11	\$1257	\$1510

One fixed and **three** adjustable veneer shelves. Shelves are 3/4" thick. Shipped assembled in 1 carton.

Required Specifications

Veneer Finish (doors)
Laminate Finish (top/body)
Handle Style*

Optional Specifications

Lock*
Veneer Top

STORAGE MODULES - 54" HIGH (FREESTANDING) MODEL# DIMENSIONS FREIGHT CLASS WT/LBS. CUBIC FT. VENEER/LAMINATE ALL VENEER

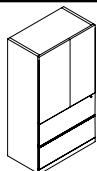

Two File Module w/Doors

	D x W x H						
D13D22H54	22 x 36 x 54	150	130	24	\$4739	\$5687	
D13D22W30H54	22 x 30 x 54	150	112	20	\$3508	\$4212	
D13H54	20 x 36 x 54	125	120	19	\$3721	\$4466	
D13W30H54	20 x 30 x 54	150	102	21	\$3365	\$4035	

Two lateral file drawers on bottom. Includes two adjustable shelves. Lower lock secures two file drawers. Optional lock available for upper storage. Front-to-back and side-to-side filing. **Not for stacking materials on lateral file drawer bottom.** Shipped assembled in 1 carton.



Two File Module w/Door - LEFT

D17D22H54L	22 x 16 x 54	100	110	13	\$2891	\$3468	
D17D20H54L	20 x 16 x 54	125	99	13	\$2629	\$3154	

Two file drawers on bottom. Includes two adjustable shelves. Lower lock secures two file drawers. Optional lock available for upper storage. Handle is on the right, door opens to the left. Shipped assembled in 1 carton.



Two File Module w/Door - RIGHT

D17D22H54R	22 x 16 x 54	100	110	13	\$2891	\$3468	
D17D20H54R	20 x 16 x 54	125	99	13	\$2629	\$3154	

Two file drawers on bottom. Includes two adjustable shelves. Lower lock secures two file drawers. Optional lock available for upper storage. Handle is on the left, door opens to the right. Shipped assembled in 1 carton.

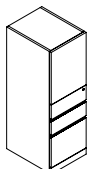

Box/Box/File Module w/Door - LEFT

D18D22H54L	22 x 16 x 54	125	71	10	\$2891	\$3468	
D18D20H54L	20 x 16 x 54	125	66	10	\$2629	\$3154	

Two box drawers and one file drawer on bottom. Includes two adjustable shelves. Lower lock secures all drawers. Optional lock available for upper storage. Handle is on the **right**, door opens to the **left**. Shipped assembled in 1 carton.

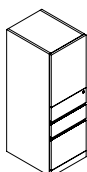

Box/Box/File Module w/Door - RIGHT

D18D22H54R	22 x 16 x 54	125	71	10	\$2891	\$3468	
D18D20H54R	20 x 16 x 54	125	66	10	\$2629	\$3154	

Two box drawers and one file drawer on bottom. Includes two adjustable shelves. Lower lock secures all drawers. Optional lock available for upper storage. Handle is on the **left**, door opens to the **right**. Shipped assembled in 1 carton.

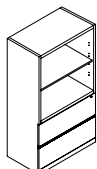

Two File Module w/Open Shelf

D12D22H54	22 x 36 x 54	150	130	24	\$3878	\$4656	
D12D22W30H54	22 x 30 x 54	150	112	20	\$3151	\$3780	
D12H54	20 x 36 x 54	125	120	19	\$3878	\$4656	
D12W30H54	20 x 30 x 54	150	102	21	\$3020	\$3627	

Two open veneer shelves and two lateral file drawers on bottom. Includes one adjustable shelf. Lock secures all drawers. Front-to-back and side-to-side filing. **Not for stacking materials on lateral file drawer bottom.** Shipped assembled in 1 carton.

Required Specifications

Veneer Finish (doors, drawer fronts, open shelves)
Laminate Finish (top/body)
Handle Style

Optional Specifications

Additional Lock (storage compartments)
Veneer Top

STORAGE MODULES - 54" HIGH (FREESTANDING) MODEL# DIMENSIONS FREIGHT CLASS WT/LBS. CUBIC FT. VENEER/LAMINATE ALL VENEER

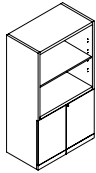

Storage Module w/Open Shelf

	D x W x H					
D22D22H54	22 x 36 x 54	150	130	24	\$2693	\$3233
D22D22W30H54	22 x 30 x 54	150	112	20	\$2248	\$2698
D22D20H54	20 x 36 x 54	150	120	24	\$2583	\$3100
D22D20W30H54	20 x 30 x 54	150	102	20	\$2153	\$2585

Two open veneer shelves and storage cabinet on bottom. Includes one adjustable shelf in upper compartment and one adjustable shelf in storage cabinet. Lock secures storage cabinet. Shipped assembled in 1 carton.

WARDROBE CABINETS - 54" HIGH MODEL# DIMENSIONS FREIGHT CLASS WT/LBS. CUBIC FT. VENEER/LAMINATE ALL VENEER

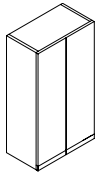

Wardrobe Cabinet*

D2D22H54	22 x 36 x 54	150	120	25	\$2867	\$3442
D2D22W30H54	22 x 30 x 54	150	120	21	\$2853	\$3426
D2D22W24H54	22 x 24 x 54	150	95	17	\$3485	\$4185
D2H54	20 x 36 x 54	150	119	23	\$2709	\$3248
D2W30H54	20 x 30 x 54	150	101	19	\$2647	\$3181
D2W24H54	20 x 24 x 54	150	81	15	\$2599	\$3116

Includes full length hanging rod and fixed hat shelf. Optional lock available. Shipped assembled in 1 carton.

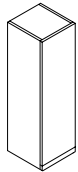

Wardrobe Cabinet - LEFT*

D2D22W24H54L	22 x 24 x 54	150	90	17	\$2853	\$3426
D2D22W18H54L	22 x 18 x 54	150	68	12	\$2301	\$2760
D2D22W12H54L	22 x 12 x 54	150	45	8	\$2190	\$2629
D2D20W24H54L	20 x 24 x 54	150	81	15	\$3168	\$3804
D2D20W18H54L	20 x 18 x 54	150	61	11	\$2089	\$2506
D2D20W12H54L	20 x 12 x 54	150	41	8	\$2435	\$2922

Includes full length hanging rod and fixed hat shelf. Handle is on the **right**, door opens to the **left**. Optional lock available. Shipped assembled in 1 carton.

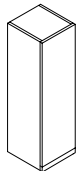

Wardrobe Cabinet - RIGHT*

D2D22W24H54R	22 x 24 x 54	150	90	17	\$2853	\$3426
D2D22W18H54R	22 x 18 x 54	150	68	12	\$2301	\$2760
D2D22W12H54R	22 x 12 x 54	150	45	8	\$2190	\$2629
D2D20W24H54R	20 x 24 x 54	150	81	15	\$3168	\$3804
D2D20W18H54R	20 x 18 x 54	150	61	11	\$2089	\$2506
D2D20W12H54R	20 x 12 x 54	150	41	8	\$2435	\$2922

Includes full length hanging rod and fixed hat shelf. Handle is on the **left**, door opens to the **right**. Optional lock available. Shipped assembled in 1 carton.

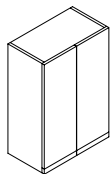

Wardrobe Cabinet/Shelving Combo*

D25D22H54	22 x 36 x 54	150	130	24	\$3166	\$3798
D25D22W30H54	22 x 30 x 54	150	112	20	\$3109	\$3731
D25D20H54	20 x 36 x 54	150	120	24	\$3034	\$3641
D25D20W30H54	20 x 30 x 54	150	102	20	\$2985	\$3580

Wardrobe compartment on **left** includes hanging rod and fixed hat shelf. Storage compartment on **right** includes three adjustable shelves. Optional lock available. Shipped assembled in 1 carton.

STORAGE MODULES - 66" HIGH (FREESTANDING) MODEL# DIMENSIONS FREIGHT CLASS WT/LBS. CUBIC FT. VENEER/LAMINATE ALL VENEER

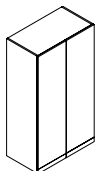

Storage Cabinet w/Doors*

D1D22	22 x 36 x 66	100	259	30	\$3545	\$4252
D1D22W30	22 x 30 x 66	100	259	25	\$3104	\$3724
D1D22W24	22 x 24 x 66	125	173	22	\$2664	\$3197
D1	20 x 36 x 66	100	245	28	\$3380	\$4053
D1W30	20 x 30 x 66	100	202	23	\$2818	\$3381
D1W24	20 x 24 x 66	125	163	18	\$2249	\$2699

Includes four adjustable shelves. Optional lock available. Shipped assembled in 1 carton.

Required Specifications

Veneer Finish (doors, drawer fronts, open shelves)
Laminate Finish (top/body)
Handle Style

Optional Specifications

Lock*
Veneer Top

STORAGE MODULES - 66" HIGH (FREESTANDING)

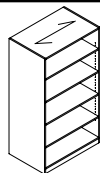

Open Storage Cabinet

MODEL#	DIMENSIONS D x W x H	FREIGHT CLASS	WT/LBS.	CUBIC FT.	VENEER/LAMINATE	ALL VENEER
D7D24	24 x 36 x 66	100	281	33	\$3262	\$3915
D7D24W30	24 x 30 x 66	100	234	28	\$2853	\$3426
D7	20 x 36 x 66	100	234	28	\$2703	\$3244
D7W30	20 x 30 x 66	100	193	23	\$2372	\$2846

Includes one fixed and **four** adjustable veneer shelves. Shelves are 3/4" thick. Shipped assembled in 1 carton.

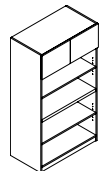

Open Storage Cabinet w/Doors*

D9D22	22 x 36 x 66	92.5	308	30	\$3052	\$3660
D9D22W30	22 x 30 x 66	92.5	257	25	\$2669	\$3205
D9	20 x 36 x 66	92.5	294	28	\$2904	\$3484
D9W30	20 x 30 x 66	92.5	243	23	\$2424	\$2908

Storage compartment with fixed shelf. One fixed and **two** adjustable veneer shelves. Fixed shelf is at 29" high. Shelves are 3/4" thick. Optional lock available for upper storage. Shipped assembled in 1 carton.

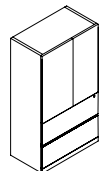

Two File Module w/Doors*

D13D22	22 x 36 x 66	92.5	313	30	\$4386	\$5264
D13D22W30	22 x 30 x 66	92.5	261	25	\$3843	\$4611
D13	20 x 36 x 66	92.5	299	28	\$4178	\$5015
D13W30	20 x 30 x 66	92.5	247	23	\$3484	\$4181

Two lateral file drawers on bottom. Includes **two** adjustable shelves. Lower lock secures two file drawers. Optional lock available for upper storage. Front-to-back and side-to-side filing. **Not for stacking materials on lateral file drawer bottom.** Shipped assembled in 1 carton.



Two File Module w/Door - LEFT*

D17D22L	22 x 16 x 66	125	91	13	\$3052	\$3660
D17D20L	20 x 16 x 66	125	83	12	\$2772	\$3326

Two file drawers on bottom. Includes two adjustable shelves. Lower lock secures two file drawers. Optional lock available for upper storage. Handle is on the **right**, door opens to the **left**. Shipped assembled in 1 carton.



Two File Module w/Door - RIGHT*

D17D22R	22 x 16 x 66	125	91	13	\$3052	\$3660
D17D20R	20 x 16 x 66	125	83	12	\$2772	\$3326

Two file drawers on bottom. Includes two adjustable shelves. Lower lock secures two file drawers. Optional lock available for upper storage. Handle is on the **left**, door opens to the **right**. Shipped assembled in 1 carton.

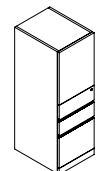

Box/Box/File Module w/Door - LEFT*

D18D22L	22 x 16 x 66	125	91	13	\$3052	\$3660
D18D20L	20 x 16 x 66	125	83	12	\$2772	\$3326

Two box drawers and one file drawer on bottom. Includes two adjustable shelves. Lower lock secures all drawers. Optional lock available for upper storage. Handle is on the **right**, door opens to the **left**. Shipped assembled in 1 carton.

Required Specifications

Veneer Finish (doors, drawer fronts, open shelves)
Laminate Finish (top/body)
Handle Style

Optional Specifications

Lock*
Veneer Top

PERSONAL TOWERS - 66" HIGH (FREESTANDING) MODEL# DIMENSIONS FREIGHT CLASS WT./LBS. CUBIC FT. VENEER/LAMINATE ALL VENEER

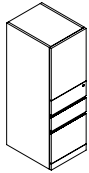

Box/Box/File Module w/Door - RIGHT*

	D x W x H						
D18D22R	22 x 16 x 66	125	91	13	\$3052	\$3660	
D18D20R	20 x 16 x 66	125	83	12	\$2772	\$3326	

Two box drawers and one file drawer on bottom. Includes two adjustable shelves. Lower lock secures all drawers. Optional lock available for upper storage. Handle is on the left, door opens to the right. Shipped assembled in 1 carton.

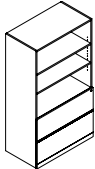

Two File Module w/Open Shelves

D12D22	22 x 36 x 66	92.5	303	30	\$3850	\$4625	
D12D22W30	22 x 30 x 66	92.5	253	25	\$3372	\$4049	
D12	20 x 36 x 66	92.5	289	28	\$3666	\$4398	
D12W30	20 x 30 x 66	92.5	239	23	\$3058	\$3673	

Three open veneer shelves and two lateral file drawers on bottom. Includes two adjustable shelves. Lock secures all drawers. Front-to-back and side-to-side filing. **Not for stacking materials on lateral file drawer bottom.** Shipped assembled in 1 carton.

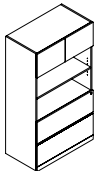

Two File Module w/Doors* and Open Shelves

D10D22	22 x 36 x 66	92.5	308	30	\$4262	\$5116	
D10D22W30	22 x 30 x 66	92.5	257	25	\$3733	\$4478	
D10	20 x 36 x 66	92.5	294	28	\$4056	\$4870	
D10W30	20 x 30 x 66	92.5	243	23	\$3384	\$4059	

Storage compartment with fixed shelf. Two open veneer shelves and two lateral file drawers on bottom. Includes one adjustable shelf. Lock secures all drawers. Optional lock available for upper storage. Front-to-back and side-to-side filing. **Not for stacking materials on lateral file drawer bottom.** Shipped assembled in 1 carton.

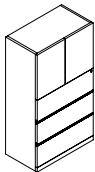

Three File Module w/Doors*

D14D22	22 x 36 x 66	100	286	30	\$4717	\$5662	
D14D22W30	22 x 30 x 66	100	238	25	\$4132	\$4958	
D14	20 x 36 x 66	100	272	28	\$4495	\$5393	
D14W30	20 x 30 x 66	100	224	23	\$3743	\$4494	

Three lateral file drawers on bottom. Includes one adjustable shelf. Lock secures all drawers. Optional lock available for upper storage. Front-to-back and side-to-side filing. **Not for stacking materials on lateral file drawer bottom.** Shipped assembled in 1 carton.

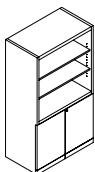

Storage Module w/Open Shelves

D22D22	22 x 36 x 66	100	275	30	\$3233	\$3877	
D22D22W30	22 x 30 x 66	100	243	25	\$2828	\$3394	
D22	20 x 36 x 66	100	278	28	\$3080	\$3695	
D22W30	20 x 30 x 66	100	229	23	\$2563	\$3078	

Three open veneer shelves and storage cabinet on bottom. Includes two adjustable shelves in upper compartment and one adjustable shelf in storage cabinet. Lock secures storage cabinet. Shipped assembled in 1 carton.

WARDROBE CABINETS - 66" HIGH (FREESTANDING) MODEL# DIMENSIONS FREIGHT CLASS WT./LBS. CUBIC FT. VENEER/LAMINATE ALL VENEER

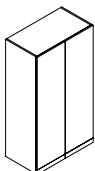

Wardrobe Cabinet*

D2D22	22 x 36 x 66	100	259	30	\$3080	\$3695	
D2D22W30	22 x 30 x 66	100	216	30	\$2693	\$3233	
D2D22W24	22 x 24 x 66	100	198	22	\$2307	\$2769	
D2	20 x 36 x 66	100	245	28	\$2932	\$3521	
D2W30	20 x 30 x 66	100	202	23	\$2443	\$2931	
D2W24	20 x 24 x 66	125	163	18	\$1955	\$2347	

Includes full length hanging rod and fixed hat shelf. Optional lock available. Shipped assembled in 1 carton.

Required Specifications

Veneer Finish (doors, drawer fronts)
Laminate Finish (top/body)
Handle Style

Optional Specifications

Lock*
Veneer Top

WARDROBE CABINETS - 66" HIGH (FREESTANDING) MODEL# DIMENSIONS FREIGHT CLASS WT/LBS. CUBIC FT. VENEER/LAMINATE ALL VENEER

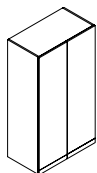

Wardrobe Cabinet/Shelving Combo*

	D x W x H						
D25D22	22 x 36 x 66	100	292	30	\$3977	\$4772	
D25D22W30	22 x 30 x 66	100	243	25	\$3480	\$4176	
D25D22W24	22 x 24 x 66	100	195	22	\$2981	\$3578	
D25	20 x 36 x 66	100	278	28	\$3784	\$4543	
D25W30	20 x 30 x 66	100	229	23	\$3157	\$3789	
D25W24	20 x 24 x 66	100	185	18	\$2526	\$3031	

Wardrobe compartment on **left** includes hanging rod and fixed hat shelf. Storage compartment on **right** includes three adjustable shelves. Optional lock available. Shipped assembled in 1 carton.

PERSONAL TOWERS - 66" HIGH (FREESTANDING) MODEL# DIMENSIONS FREIGHT CLASS WT/LBS. CUBIC FT. VENEER/LAMINATE ALL VENEER

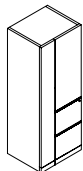

Personal Tower - LEFT

D29D22W24L	22 x 24 x 66	125	141	20	\$4140	\$4971	
D29W24L	20 x 24 x 66	125	128	18	\$3924	\$4709	

Two file drawers on bottom. Wardrobe compartment on **left** includes hanging rod. Storage compartment on **right** includes one adjustable shelf. Lower lock secures all drawers. Optional lock available for upper storage and wardrobe. Shipped assembled in 1 carton.

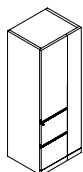

Personal Tower - RIGHT

D29D22W24R	22 x 24 x 66	125	141	20	\$4140	\$4971	
D29W24R	20 x 24 x 66	125	128	18	\$3924	\$4709	

Two file drawers on bottom. Wardrobe compartment on **right** includes hanging rod. Storage compartment on **left** includes one adjustable shelf. Lower lock secures all drawers. Optional lock available for upper storage and wardrobe. Shipped assembled in 1 carton.

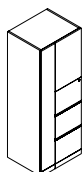

Personal Tower - LEFT

D27D22W24L	22 x 24 x 66	125	141	20	\$4710	\$5654	
D27W24L	20 x 24 x 66	125	128	18	\$4485	\$5382	

Three file drawers on bottom. Wardrobe compartment on **left** includes hanging rod. Storage compartment on **right** includes one adjustable shelf. Lower lock secures all drawers. Optional lock available for upper storage and wardrobe. Shipped assembled in 1 carton.

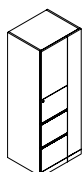

Personal Tower - RIGHT

D27D22W24R	22 x 24 x 66	125	141	20	\$4710	\$5654	
D27W24R	20 x 24 x 66	125	128	18	\$4485	\$5382	

Three file drawers on bottom. Wardrobe compartment on **right** includes hanging rod. Storage compartment on **left** includes one adjustable shelf. Lower lock secures all drawers. Optional lock available for upper storage and wardrobe. Shipped assembled in 1 carton.

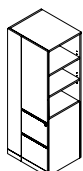

Personal Tower w/Open Bookcase - LEFT

D30D22W24L	22 x 24 x 66	125	141	20	\$4140	\$4971	
D30W24L	20 x 24 x 66	125	128	18	\$3924	\$4709	

Two file drawers on bottom. Wardrobe compartment on **left** includes hanging rod. Storage compartment on **right** includes one adjustable shelf. Open bookcase on **right** includes two adjustable shelves. Lower lock secures all drawers. Optional lock available for wardrobe. Shipped assembled in 1 carton.

Required Specifications

Veneer Finish (doors, drawer fronts)
Laminate Finish (top/body)
Handle Style

Optional Specifications

Lock
Veneer Top

PERSONAL TOWERS - 66" HIGH (FREESTANDING)		MODEL#	DIMENSIONS	FREIGHT CLASS	WT/LBS.	CUBIC FT.	VENEER/LAMINATE	ALL VENEER
			D x W x H					
	D30D22W24R	22 x 24 x 66	125	141	20	\$4140	\$4971	
	D30W24R	20 x 24 x 66	125	128	18	\$3924	\$4709	
Two file drawers on bottom. Wardrobe compartment on right includes hanging rod. Storage compartment on left includes one adjustable shelf. Open bookcase on left includes two adjustable shelves. Lower lock secures all drawers. Optional lock available for wardrobe. Shipped assembled in 1 carton.								
	D26D22W24L	22 x 24 x 66	125	141	20	\$5705	\$6845	
	D26W24L	20 x 24 x 66	125	128	18	\$5434	\$6520	
Three file drawers on bottom. Wardrobe compartment on left includes hanging rod. Storage compartment on right includes one adjustable shelf. Open bookcase on right includes one adjustable shelf. Lower lock secures all drawers. Optional lock available for wardrobe. Shipped assembled in 1 carton.								
	D26D22W24R	22 x 24 x 66	125	141	20	\$5705	\$6845	
	D26W24R	20 x 24 x 66	125	128	18	\$5434	\$6520	
Three file drawers on bottom. Wardrobe compartment on right includes hanging rod. Storage compartment on left includes one adjustable shelf. Open bookcase on left includes one adjustable shelf. Lower lock secures all drawers. Optional lock available for wardrobe. Shipped assembled in 1 carton.								

STORAGE MODULES - 72" HIGH (FREESTANDING)		MODEL#	DIMENSIONS	FREIGHT CLASS	WT/LBS.	CUBIC FT.	VENEER/LAMINATE	ALL VENEER
	D1D22H72	22 x 36 x 72	100	283	33	\$3870	\$4643	
	D1D22W30H72	22 x 30 x 72	100	283	28	\$3384	\$4059	
	D1D22W24H72	22 x 24 x 72	125	255	24	\$2902	\$3482	
	D1H72	20 x 36 x 72	100	269	30	\$3686	\$4422	
	D1W30H72	20 x 30 x 72	100	233	25	\$3070	\$3684	
	D1W24H72	20 x 24 x 72	125	179	20	\$2457	\$2949	
Includes four adjustable shelves. Optional lock available. Shipped assembled in 1 carton.								
	D7D24H72	24 x 36 x 72	100	306	36	\$3559	\$4271	
	D7D24W30H72	24 x 30 x 72	100	255	30	\$3113	\$3738	
	D7H72	20 x 36 x 72	100	257	30	\$2951	\$3543	
	D7W30H72	20 x 30 x 72	100	223	25	\$2459	\$2952	
Includes one fixed and four adjustable veneer shelves. Shelves are 3/4" thick. Shipped assembled in 1 carton.								
	D9D22H72	22 x 36 x 72	92.5	336	33	\$3326	\$3993	
	D9D22W30H72	22 x 30 x 72	92.5	294	28	\$2910	\$3495	
	D9H72	20 x 36 x 72	92.5	322	30	\$3166	\$3798	
	D9W30H72	20 x 30 x 72	92.5	280	25	\$2642	\$3168	
Storage compartment with fixed shelf. One fixed and two adjustable veneer shelves. Fixed shelf is at 29" high. Shelves are 3/4" thick. Optional lock available on upper storage. Shipped assembled in 1 carton.								

Required Specifications

Veneer Finish (doors, drawer fronts, open shelves)
Laminate Finish (top/body)
Handle Style

Optional Specifications

Lock*
Veneer Top

STORAGE MODULES - 72" HIGH (FREESTANDING) MODEL# DIMENSIONS FREIGHT CLASS WT/LBS. CUBIC FT. VENEER/LAMINATE ALL VENEER

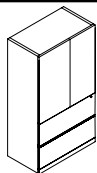

Two File Module w/Doors*

	D x W x H						
D13D22H72	22 x 36 x 72	92.5	341	33	\$4789	\$5747	
D13D22W30H72	22 x 30 x 72	125	299	28	\$4188	\$5024	
D13H72	20 x 36 x 72	92.5	327	30	\$4560	\$5470	
D13W30H72	20 x 30 x 72	92.5	285	25	\$3798	\$4560	

Two lateral file drawers on bottom. Includes **two** adjustable shelves. Lower lock secures two file drawers. Optional lock available on upper storage. Front-to-back and side-to-side filing. **Not for stacking materials on lateral file drawer bottom.** Shipped assembled in 1 carton.



Two File Module w/Door - LEFT*

D17D22H72L	22 x 16 x 72	125	99	15	\$3333	\$4001	
D17D20H72L	20 x 16 x 72	125	90	13	\$3029	\$3634	

Two file drawers on bottom. Includes two adjustable shelves. Lower lock secures two file drawers. Optional lock available on upper storage. Handle is on the **right**, door opens to the **left**. Shipped assembled in 1 carton.



Two File Module w/Door - RIGHT*

D17D22H72R	22 x 16 x 72	125	99	15	\$3333	\$4001	
D17D20H72R	20 x 16 x 72	125	90	13	\$3029	\$3634	

Two file drawers on bottom. Includes two adjustable shelves. Lower lock secures two file drawers. Optional lock available on upper storage. Handle is on the **left**, door opens to the **right**. Shipped assembled in 1 carton.

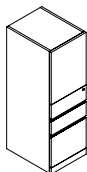

Box/Box/File Module w/Door - LEFT*

D18D22H72L	22 x 16 x 72	125	99	15	\$3333	\$4001	
D18D20H72L	20 x 16 x 72	125	90	13	\$3029	\$3634	

Two box drawers and one file drawer on bottom. Includes two adjustable shelves. Lower lock secures all drawers. Optional lock available on upper storage. Handle is on the **right**, door opens to the **left**. Shipped assembled in 1 carton.

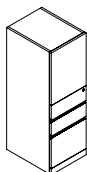

Box/Box/File Module w/Door - RIGHT*

D18D22H72R	22 x 16 x 72	125	99	15	\$3333	\$4001	
D18D20H72R	20 x 16 x 72	125	90	13	\$3029	\$3634	

Two box drawers and one file drawer on bottom. Includes two adjustable shelves. Lower lock secures all drawers. Optional lock available on upper storage. Handle is on the **left**, door opens to the **right**. Shipped assembled in 1 carton.

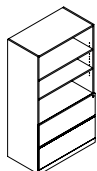

Two File Module w/Open Shelves

D12D22H72	22 x 36 x 72	92.5	331	33	\$4204	\$5044	
D12D22W30H72	22 x 30 x 72	92.5	289	28	\$3678	\$4413	
D12H72	20 x 36 x 72	92.5	317	30	\$4002	\$4802	
D12W30H72	20 x 30 x 72	92.5	275	25	\$3502	\$4202	

Three open veneer shelves and two lateral file drawers on bottom. Includes two adjustable shelves. Lock secures all drawers. Front-to-back and side-to-side filing. **Not for stacking materials on lateral file drawer bottom.** Shipped assembled in 1 carton.

Required Specifications

Veneer Finish (doors, drawer fronts, open shelves)
Laminate Finish (top/body)
Handle Style

Optional Specifications

Lock*
Veneer Top

STORAGE MODULES - 72" HIGH (FREESTANDING) MODEL# DIMENSIONS FREIGHT CLASS WT/LBS. CUBIC FT. VENEER/LAMINATE ALL VENEER

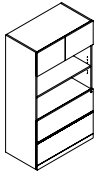

Two File Module w/Doors* and Open Shelves

	D x W x H						
D10D22H72	22 x 36 x 72	92.5	336	33	\$4649	\$5579	
D10D22W30H72	22 x 30 x 72	92.5	294	28	\$4069	\$4881	
D10H72	20 x 36 x 72	92.5	322	30	\$4425	\$5311	
D10W30H72	20 x 30 x 72	92.5	280	25	\$3689	\$4426	

Storage compartment with fixed shelf. Two open veneer shelves and two lateral file drawers on bottom. Includes one adjustable shelf. Lower lock secures all drawers. Optional lock available on upper storage. Front-to-back and side-to-side filing. **Not for stacking materials on lateral file drawer bottom.** Shipped assembled in 1 carton.

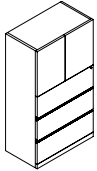

Three File Module w/Doors*

D14D22H72	22 x 36 x 72	100	312	33	\$5147	\$6174
D14D22W30H72	22 x 30 x 72	100	273	28	\$4503	\$5405
D14H72	20 x 36 x 72	100	298	30	\$4899	\$5881
D14W30H72	20 x 30 x 72	92.5	259	25	\$4085	\$4901

Three lateral file drawers on bottom. Includes one adjustable shelf. Lower lock secures all drawers. Optional lock available on upper storage. Front-to-back and side-to-side filing. **Not for stacking materials on lateral file drawer bottom.**

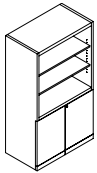

Storage Module w/Open Shelves

D22D22H72	22 x 36 x 72	100	300	33	\$3529	\$4233
D22D22W30H72	22 x 30 x 72	100	279	28	\$3088	\$3706
D22H72	20 x 36 x 72	100	305	30	\$3354	\$4026
D22W30H72	20 x 30 x 72	100	265	25	\$2798	\$3358

Three open veneer shelves and storage cabinet on bottom. Includes two adjustable shelves in upper compartment and one adjustable shelf in storage cabinet. Lower lock secures storage cabinet. Optional lock available on upper storage. Shipped assembled in 1 carton.

WARDROBE CABINETS - 72" HIGH (FREESTANDING) MODEL# DIMENSIONS FREIGHT CLASS WT/LBS. CUBIC FT. VENEER/LAMINATE ALL VENEER

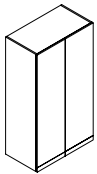

Wardrobe Cabinet*

D2D22H72	22 x 36 x 72	100	283	33	\$3354	\$4026
D2D22W30H72	22 x 30 x 72	100	247	33	\$2936	\$3525
D2D22W24H72	22 x 24 x 72	125	216	24	\$2494	\$2992
D2H72	20 x 36 x 72	100	269	30	\$3197	\$3838
D2W30H72	20 x 30 x 72	100	233	25	\$2664	\$3197
D2W24H72	20 x 24 x 72	125	179	20	\$2132	\$2559

Includes full length hanging rod and fixed hat shelf. Optional lock available. Shipped assembled in 1 carton.

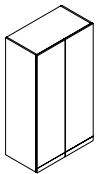

Wardrobe Cabinet/ Shelving Combo*

D25D22H72	22 x 36 x 72	100	319	33	\$4339	\$5206
D25D22W30H72	22 x 30 x 72	100	279	28	\$3794	\$4552
D25D22W24H72	22 x 24 x 72	100	213	24	\$3253	\$3902
D25H72	20 x 36 x 72	92.5	305	30	\$5053	\$6061
D25W30H72	20 x 30 x 72	92.5	265	25	\$3447	\$4134
D25W24H72	20 x 24 x 72	100	203	20	\$2757	\$3306

Wardrobe compartment on **left** includes hanging rod and fixed hat shelf. Storage compartment on **right** includes three adjustable shelves. Optional lock available. Shipped assembled in 1 carton.

PERSONAL TOWERS - 72" HIGH (FREESTANDING) MODEL# DIMENSIONS FREIGHT CLASS WT/LBS. CUBIC FT. VENEER/LAMINATE ALL VENEER

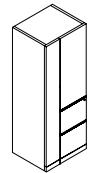

Personal Tower - LEFT*

D29D22W24H72L	22 x 24 x 72	125	154	22	\$4566	\$5477
D29W24H72L	20 x 24 x 72	125	140	20	\$5283	\$6338

Two file drawers on bottom. Wardrobe compartment on **left** includes hanging rod. Storage compartment on **right** includes one adjustable shelf. Lower lock secures all drawers. Optional lock available on upper storage and wardrobe. Shipped assembled in 1 carton.

Required Specifications

Veneer Finish (doors, drawer fronts, open shelves)
Laminate Finish (top/body)
Handle Style

Optional Specifications

Lock*
Veneer Top

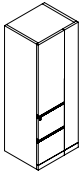
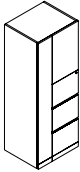
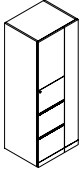
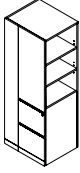
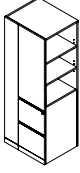
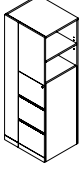
PERSONAL TOWERS - 72" HIGH (FREESTANDING)	MODEL#	DIMENSIONS	FREIGHT CLASS	WT/LBS.	CUBIC FT.	VENEER/LAMINATE	ALL VENEER
 <p>Personal Tower - RIGHT*</p>		D x W x H					
	D29D22W24H72R	22 x 24 x 72	125	154	22	\$4566	\$5477
	D29W24H72R	20 x 24 x 72	125	140	20	\$4323	\$5188
<p>Two file drawers on bottom. Wardrobe compartment on right includes hanging rod. Storage compartment on left includes one adjustable shelf. Lower lock secures all drawers. Optional lock available on upper storage and wardrobe. Shipped assembled in 1 carton.</p>							
 <p>Personal Tower - LEFT*</p>							
	D27D22W24H72L	22 x 24 x 72	125	154	22	\$5136	\$6165
	D27W24H72L	20 x 24 x 72	125	140	20	\$4894	\$5873
<p>Three file drawers on bottom. Wardrobe compartment on left includes hanging rod. Storage compartment on right includes one adjustable shelf. Lower lock secures all drawers. Optional lock available on upper storage and wardrobe. Shipped assembled in 1 carton.</p>							
 <p>Personal Tower - RIGHT*</p>							
	D27D22W24H72R	22 x 24 x 72	125	154	22	\$5136	\$6165
	D27W24H72R	20 x 24 x 72	125	140	20	\$4894	\$5873
<p>Three file drawers on bottom. Wardrobe compartment on right includes hanging rod. Storage compartment on left includes one adjustable shelf. Lower lock secures all drawers. Optional lock available on upper storage and wardrobe. Shipped assembled in 1 carton.</p>							
 <p>Personal Tower w/Open Bookcase - LEFT</p>							
	D30D22W24H72L	22 x 24 x 72	125	154	22	\$4566	\$5477
	D30W24H72L	20 x 24 x 72	125	140	20	\$4323	\$5188
<p>Two file drawers on bottom. Wardrobe compartment on left includes hanging rod. Storage compartment on right includes one adjustable shelf. Open bookcase on right includes two adjustable shelves. Lower lock secures all drawers. Shipped assembled in 1 carton.</p>							
 <p>Personal Tower w/Open Bookcase - RIGHT</p>							
	D30D22W24H72R	22 x 24 x 72	125	154	22	\$4566	\$5477
	D30W24H72R	20 x 24 x 72	125	140	20	\$4323	\$5188
<p>Two file drawers on bottom. Wardrobe compartment on right includes hanging rod. Storage compartment on left includes one adjustable shelf. Open bookcase on left includes two adjustable shelves. Lower lock secures all drawers. Shipped assembled in 1 carton.</p>							
 <p>Personal Tower w/Open Bookcase - LEFT</p>							
	D26D22W24H72L	22 x 24 x 72	125	154	22	\$5089	\$6106
	D26W24H72L	20 x 24 x 72	125	140	20	\$5924	\$7109
<p>Three file drawers on bottom. Wardrobe compartment on left includes hanging rod. Storage compartment on right includes one adjustable shelf. Open bookcase on right includes one adjustable shelf. Lower lock secures all drawers. Shipped assembled in 1 carton.</p>							

Required Specifications

Veneer Finish (doors, drawer fronts, open shelves)
 Laminate Finish (top/body)
 Handle Style

Optional Specifications

Lock*
 Veneer Top

PERSONAL TOWERS - 72" HIGH (FREESTANDING) MODEL# DIMENSIONS FREIGHT CLASS WT/LBS. CUBIC FT. VENEER/LAMINATE ALL VENEER

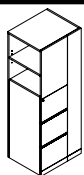

Personal Tower w/Open Bookcase RIGHT*

	D x W x H						
D26D22W24H72R	22 x 24 x 72	125	154	22	\$5089	\$6106	
D26W24H72R	20 x 24 x 72	125	140	20	\$5924	\$7109	

Three file drawers on bottom. Wardrobe compartment on **right** includes hanging rod. Storage compartment on **left** includes one adjustable shelf. Open bookcase on **left** includes one adjustable shelf. Lower lock secures all drawers. Optional lock available on wardrobe. Shipped assembled in 1 carton.

STORAGE MODULES - 84" HIGH (FREESTANDING) MODEL# DIMENSIONS FREIGHT CLASS WT/LBS. CUBIC FT. VENEER/LAMINATE ALL VENEER

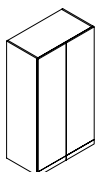

Storage Cabinet w/Doors*

D1D22H84	22 x 36 x 84	125	304	42	\$4470	\$5364	
D1D22W30H84	22 x 30 x 84	100	304	35	\$3908	\$4691	
D1D22W24H84	22 x 24 x 84	92.5	320	28	\$3347	\$4016	
D1H84	20 x 36 x 84	100	297	35	\$4259	\$5108	
D1W30H84	20 x 30 x 84	100	257	29	\$3545	\$4252	
D1W24H84	20 x 24 x 84	100	198	23	\$2840	\$3405	

Includes four adjustable shelves. Optional lock available. Shipped assembled in 1 carton.

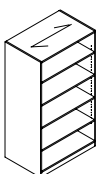

Open Storage Cabinet

D7D24H84	24 x 36 x 84	125	331	43	\$4151	\$4978	
D7D24W30H84	24 x 30 x 84	125	280	36	\$3632	\$4362	
D7H84	20 x 36 x 84	100	282	35	\$3627	\$4350	
D7W30H84	20 x 30 x 84	100	248	29	\$3020	\$3627	

Includes one fixed and **four** adjustable veneer shelves. Shelves are 3/4" thick. Shipped assembled in 1 carton.

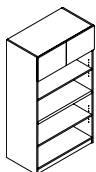

Open Storage Cabinet w/Doors*

D9D22H84	22 x 36 x 84	92.5	364	36	\$3878	\$4656	
D9D22W30H84	22 x 30 x 84	92.5	330	31	\$3400	\$4081	
D9H84	20 x 36 x 84	92.5	348	33	\$3690	\$4427	
D9W30H84	20 x 30 x 84	92.5	317	28	\$3079	\$3694	

Storage compartment with fixed shelf. One fixed and **two** adjustable veneer shelves. Fixed shelf is at 29" high. Shelves are 3/4" thick. Optional lock available on upper storage. Shipped assembled in 1 carton.

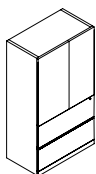

Two File Module w/Doors*

D13D22H84	22 x 36 x 84	92.5	364	36	\$5533	\$6640	
D13D22W30H84	22 x 30 x 84	92.5	330	31	\$4842	\$5810	
D13H84	20 x 36 x 84	92.5	365	35	\$5265	\$6317	
D13W30H84	20 x 30 x 84	92.5	305	29	\$4807	\$5764	

Two lateral file drawers on bottom. Includes **two** adjustable shelves. Lower lock secures two file drawers. Optional lock available on upper storage. Front-to-back and side-to-side filing. **Not for stacking materials on lateral file drawer bottom.** Shipped assembled in 1 carton.



Two File Module w/Door - LEFT*

D17D22H84L	22 x 16 x 84	125	116	17	\$3999	\$4795	
D17D20H84L	20 x 16 x 84	125	105	15	\$3632	\$4362	

Two file drawers on bottom. Includes two adjustable shelves. Lower lock secures two file drawers. Optional lock available on upper storage. Handle is on the **right**, door opens to the **left**. Shipped assembled in 1 carton.

Required Specifications

Veneer Finish (doors, drawer fronts, open shelves)
Laminate Finish (top/body)
Handle Style

Optional Specifications

Lock*
Veneer Top

STORAGE MODULES - 84" HIGH (FREESTANDING) MODEL# DIMENSIONS FREIGHT CLASS WT/LBS. CUBIC FT. VENEER/LAMINATE ALL VENEER

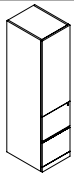

Two File Module w/Door - RIGHT

	D x W x H						
D17D22H84R	22 x 16 x 84	125	116	17	\$3999	\$4795	
D17D20H84R	20 x 16 x 84	125	105	15	\$3632	\$4362	

Two file drawers on bottom. Includes two adjustable shelves. Lower lock secures two file drawers. Handle is on the **left**, door opens to the **right**. Shipped assembled in 1 carton.

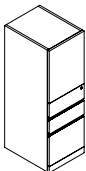

Box/Box/File Module w/Door - LEFT

D18D22H84L	22 x 16 x 84	125	116	17	\$3999	\$4795	
D18D20H84L	20 x 16 x 84	125	105	15	\$3632	\$4362	

Two box drawers and one file drawer on bottom. Includes two adjustable shelves. Lower lock secures all drawers. Handle is on the **right**, door opens to the **left**. Shipped assembled in 1 carton.

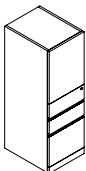

Box/Box/File Module w/Door - RIGHT

D18D22H84R	22 x 16 x 84	125	116	17	\$3999	\$4795	
D18D20H84R	20 x 16 x 84	125	105	15	\$3632	\$4362	

Two box drawers and one file drawer on bottom. Includes two adjustable shelves. Lower lock secures all drawers. Handle is on the **left**, door opens to the **right**. Shipped assembled in 1 carton.

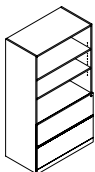

Two File Module w/Open Shelves

D12D22H84	22 x 36 x 84	92.5	364	36	\$4858	\$5828	
D12D22W30H84	22 x 30 x 84	92.5	330	31	\$4252	\$5103	
D12H84	20 x 36 x 84	92.5	348	33	\$4675	\$5608	
D12W30H84	20 x 30 x 84	92.5	317	28	\$4049	\$4858	

Three open veneer shelves and two lateral file drawers on bottom. Includes two adjustable shelves. Lock secures all drawers. Front-to-back and side-to-side filing. **Not for stacking materials on lateral file drawer bottom.** Shipped assembled in 1 carton.

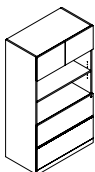

Two File Module w/Doors and Open Shelves

D10D22H84	22 x 36 x 84	92.5	364	36	\$5373	\$6449	
D10D22W30H84	22 x 30 x 84	92.5	330	31	\$4706	\$5646	
D10H84	20 x 36 x 84	92.5	348	33	\$5118	\$6141	
D10W30H84	20 x 30 x 84	92.5	317	28	\$4268	\$5120	

Storage compartment with fixed shelf. Two open veneer shelves and two lateral file drawers on bottom. Includes one adjustable shelf. Lock secures all drawers. Front-to-back and side-to-side filing. **Not for stacking materials on lateral file drawer bottom.** Shipped assembled in 1 carton.

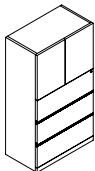

Three File Module w/Doors

D14D22H84	22 x 36 x 84	100	340	42	\$5970	\$7166	
D14D22W30H84	22 x 30 x 84	100	308	35	\$5206	\$6249	
D14H84	20 x 36 x 84	100	330	35	\$5665	\$6799	
D14W30H84	20 x 30 x 84	92.5	298	29	\$4725	\$5667	

Three lateral file drawers on bottom. Includes one adjustable shelf. Lock secures all drawers. Front-to-back and side-to-side filing. **Not for stacking materials on lateral file drawer bottom.** Shipped assembled in 1 carton.

Required Specifications

Veneer Finish (doors, drawer fronts, open shelves)
Laminate Finish (top/body)
Handle Style

Optional Specifications

Additional Lock (storage compartments)
Veneer Top

STORAGE MODULES - 84" HIGH (FREESTANDING) MODEL# DIMENSIONS FREIGHT CLASS WT/LBS. CUBIC FT. VENEER/LAMINATE ALL VENEER

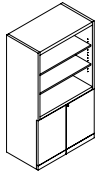

Storage Module w/Open Shelves

	D x W x H						
D22D22H84	22 x 36 x 84	125	325	42	\$4076	\$4891	
D22D22W30H84	22 x 30 x 84	100	304	35	\$3565	\$4281	
D22H84	20 x 36 x 84	100	327	33	\$3878	\$4656	
D22W30H84	20 x 30 x 84	92.5	301	28	\$3239	\$3888	

Three open veneer shelves and storage cabinet on bottom. Includes two adjustable shelves in upper compartment and one adjustable shelf in storage cabinet. Lock secures storage cabinet.

WARDROBE CABINETS - 84" HIGH (FREESTANDING) MODEL# DIMENSIONS FREIGHT CLASS WT/LBS. CUBIC FT. VENEER/LAMINATE ALL VENEER

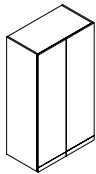

Wardrobe Cabinet*

D2D22H84	22 x 36 x 84	125	307	42	\$3878	\$4656	
D2D22W30H84	22 x 30 x 84	125	260	42	\$3400	\$4081	
D2D22W24H84	22 x 24 x 84	100	242	28	\$2910	\$3495	
D2H84	20 x 36 x 84	100	297	35	\$3690	\$4427	
D2W30H84	20 x 30 x 84	100	257	29	\$3079	\$3694	
D2W24H84	20 x 24 x 84	100	198	23	\$2466	\$2958	

Includes full length hanging rod and fixed hat shelf. Optional lock available. Shipped assembled in 1 carton.

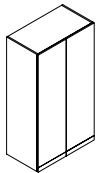

Wardrobe Cabinet/Shelving Combo*

D25D22H84	22 x 36 x 84	100	348	42	\$5019	\$6020	
D25D22W30H84	22 x 30 x 84	100	307	35	\$4382	\$5259	
D25D22W24H84	22 x 24 x 84	100	254	28	\$3757	\$4507	
D25H84	20 x 36 x 84	100	330	35	\$4776	\$5731	
D25W30H84	20 x 30 x 84	92.5	300	29	\$3981	\$4778	
D25W24H84	20 x 24 x 84	92.5	235	23	\$3190	\$3825	

Wardrobe compartment on **left** includes hanging rod and fixed hat shelf. Storage compartment on **right** includes three adjustable shelves. Optional lock available. Shipped assembled in 1 carton.

PERSONAL TOWERS - 84" HIGH (FREESTANDING) MODEL# DIMENSIONS FREIGHT CLASS WT/LBS. CUBIC FT. VENEER/LAMINATE ALL VENEER

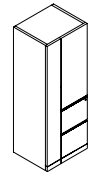

Personal Tower - LEFT*

D29D22W24H84L	22 x 24 x 84	125	167	24	\$5417	\$6498	
D29W24H84L	20 x 24 x 84	125	152	22	\$5132	\$6158	

Two file drawers on bottom. Wardrobe compartment on **left** includes hanging rod. Storage compartment on **right** includes one adjustable shelf. Lower lock secures all drawers. Optional lock available on upper storage and wardrobe. Shipped assembled in 1 carton.

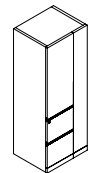

Personal Tower - RIGHT*

D29D22W24H84R	22 x 24 x 84	125	167	24	\$5417	\$6498	
D29W24H84R	20 x 24 x 84	125	152	22	\$5132	\$6158	

Two file drawers on bottom. Wardrobe compartment on **right** includes hanging rod. Storage compartment on **left** includes one adjustable shelf. Lower lock secures all drawers. Optional lock available on upper storage and wardrobe. Shipped assembled in 1 carton.

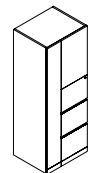

Personal Tower - LEFT*

D27D22W24H84L	22 x 24 x 84	125	167	24	\$7258	\$8712	
D27W24H84L	20 x 24 x 84	125	152	22	\$6910	\$8293	

Three file drawers on bottom. Wardrobe compartment on **left** includes hanging rod. Storage compartment on **right** includes one adjustable shelf. Lower lock secures all drawers. Optional lock available on upper storage and wardrobe. Shipped assembled in 1 carton.

Required Specifications

Veneer Finish (doors, drawer fronts, open shelves)
Laminate Finish (top/body)
Handle Style

Optional Specifications

Lock*
Veneer Top

PERSONAL TOWERS - 84" HIGH (FREESTANDING) MODEL# DIMENSIONS FREIGHT CLASS WT/LBS. CUBIC FT. VENEER/LAMINATE ALL VENEER

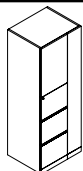

Personal Tower - RIGHT

	D x W x H					
D27D22W24H84R	22 x 24 x 84	125	167	24	\$7258	\$8712
D27W24H84R	20 x 24 x 84	125	152	22	\$6910	\$8293

Three file drawers on bottom. Wardrobe compartment on **right** includes hanging rod. Storage compartment on **left** includes one adjustable shelf. Lower lock secures all drawers. Optional lock available on upper storage and wardrobe. Shipped assembled in 1 carton.

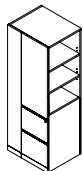

Personal Tower w/Open Bookcase - LEFT

D30D22W24H84L	22 x 24 x 84	125	167	24	\$5417	\$6498
D30W24H84L	20 x 24 x 84	125	152	22	\$5132	\$6158

Two file drawers on bottom. Wardrobe compartment on **left** includes hanging rod. Storage compartment on **right** includes one adjustable shelf. Open bookcase on **right** includes two adjustable shelves. Lower lock secures all drawers. Optional lock available on wardrobe. Shipped assembled in 1 carton.

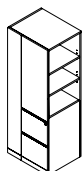

Personal Tower w/Open Bookcase - RIGHT

D30D22W24H84R	22 x 24 x 84	125	167	24	\$5417	\$6498
D30W24H84R	20 x 24 x 84	125	152	22	\$5132	\$6158

Two file drawers on bottom. Wardrobe compartment on **right** includes hanging rod. Storage compartment on **left** includes one adjustable shelf. Open bookcase on **left** includes two adjustable shelves. Lower lock secures all drawers. Optional lock available on wardrobe. Shipped assembled in 1 carton.

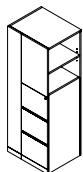

Personal Tower w/Open Bookcase - LEFT

D26D22W24H84L	22 x 24 x 84	125	167	24	\$7258	\$8712
D26W24H84L	20 x 24 x 84	125	152	22	\$6910	\$8293

Three file drawers on bottom. Wardrobe compartment on **left** includes hanging rod. Storage compartment on **right** includes one adjustable shelf. Open bookcase on **right** includes one adjustable shelf. Lower lock secures all drawers. Optional lock available on wardrobe. Shipped assembled in 1 carton.

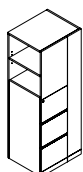

Personal Tower w/Open Bookcase - RIGHT

D26D22W24H84R	22 x 24 x 84	125	167	24	\$7258	\$8712
D26W24H84R	20 x 24 x 84	125	152	22	\$6910	\$8293

Three file drawers on bottom. Wardrobe compartment on **right** includes hanging rod. Storage compartment on **left** includes one adjustable shelf. Open bookcase on **left** includes one adjustable shelf. Lower lock secures all drawers. Optional lock available on wardrobe. Shipped assembled in 1 carton.

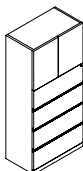

Four File Module w/Doors

D6W30H84	20 x 30 x 84	85	351	29	\$5757	\$6906
----------	--------------	----	-----	----	---------------	---------------

Four lateral file drawers on bottom. Includes one adjustable shelf. Lock secures all drawers. Optional lock available on upper storage. Front-to-back and side-to-side filing. **Not for stacking materials on lateral file drawer bottom.** Shipped assembled in 1 carton.

Required Specifications

Veneer Finish (doors, drawer fronts, open shelves)
Laminate Finish (top/body)
Handle Style

Optional Specifications

Lock*
Veneer Top

TOPS FOR STORAGE MODELS	MODEL#	DIMENSIONS	FREIGHT CLASS	WT./LBS.	CUBIC FT.	VENEER/LAMINATE	ALL VENEER
		D x W x H					
	D12024T	24 x 120 x 1	60	115	2	N/A	\$2453
	D11824T	24 x 118 x 1	60	109	2	N/A	\$2416
	D11624T	24 x 116 x 1	60	107	2	N/A	\$2381
	D11424T	24 x 114 x 1	60	105	2	N/A	\$2350
	D11224T	24 x 112 x 1	60	103	2	N/A	\$2292
	D11024T	24 x 110 x 1	60	102	2	N/A	\$2248
	D10824T	24 x 108 x 1	60	100	2	N/A	\$2206
	D10624T	24 x 106 x 1	60	98	2	N/A	\$2167
	D10424T	24 x 104 x 1	60	96	2	N/A	\$2124
	D10224T	24 x 102 x 1	60	94	2	N/A	\$2089
	D10024T	24 x 100 x 1	60	92	2	N/A	\$2044
	D9824T	24 x 98 x 1	60	90	2	N/A	\$2002
	D9624T	24 x 96 x 1	60	88	2	N/A	\$1963
	D9424T	24 x 94 x 1	60	86	2	N/A	\$1921
	D9224T	24 x 92 x 1	60	85	2	N/A	\$1883
	D9024T	24 x 90 x 1	60	83	2	N/A	\$1842
	D8824T	24 x 88 x 1	60	81	2	N/A	\$1804
	D8624T	24 x 86 x 1	60	80	2	N/A	\$1760
	D8424T	24 x 84 x 1	60	78	2	N/A	\$1716
	D8224T	24 x 82 x 1	60	75	2	N/A	\$1678
	D8024T	24 x 80 x 1	60	74	2	N/A	\$1638
	D7824T	24 x 78 x 1	60	72	2	N/A	\$1615
	D7624T	24 x 76 x 1	60	70	2	N/A	\$1558
	D7424T	24 x 74 x 1	60	69	2	N/A	\$1518
	D7224T	24 x 72 x 1	60	66	2	N/A	\$1477
	D7024T	24 x 70 x 1	60	64	2	N/A	\$1433
	D6824T	24 x 68 x 1	60	62	2	N/A	\$1399
	D6624T	24 x 66 x 1	60	61	2	N/A	\$1353
	D6424T	24 x 64 x 1	60	59	1	N/A	\$1308
	D6224T	24 x 62 x 1	60	57	1	N/A	\$1272
	D6024T	24 x 60 x 1	60	55	1	N/A	\$1227
	D5824T	24 x 58 x 1	60	54	1	N/A	\$1184
	D5624T	24 x 56 x 1	60	52	1	N/A	\$1148
	D5424T	24 x 54 x 1	60	50	1	N/A	\$1106
	D5224T	24 x 52 x 1	60	48	1	N/A	\$1067
	D5024T	24 x 50 x 1	60	46	1	N/A	\$1024
	D4824T	24 x 48 x 1	60	44	1	N/A	\$981
	D4224T	24 x 42 x 1	60	39	1	N/A	\$953
	D4024T	24 x 40 x 1	60	37	1	N/A	\$909
	D3824T	24 x 38 x 1	60	35	1	N/A	\$864
	D3624T	24 x 36 x 1	60	33	1	N/A	\$813
	D3424T	24 x 34 x 1	60	31	1	N/A	\$761
	D3224T	24 x 32 x 1	65	29	1	N/A	\$719
	D3024T	24 x 30 x 1	65	28	1	N/A	\$616
	D2424T	24 x 24 x 1	65	23	1	N/A	\$616
	D1824T	24 x 18 x 1	70	17	1	N/A	\$448
	D1624T	24 x 16 x 1	70	15	1	N/A	\$434
	D1224T	24 x 12 x 1	92.5	11	1	N/A	\$325

EXAMPLE:

(1) D9024T
Veneer Top

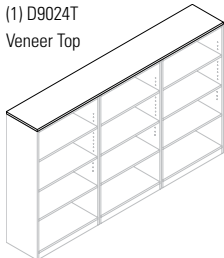

(3) D7D22W30H48 - Open Storage Cabinet

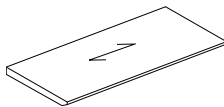

Tops - 24" Deep

For use with 22" deep units. Tops are 1" thick.

- **This is an OPTION for Storage Modules, Wardrobe Cabinets and Personal Towers.**
Specify a Veneer Top from the listing above (either a single model or straight run).

Required Specifications

Veneer finish

TOPS FOR STORAGE MODELS

MODEL#	DIMENSIONS	FREIGHT CLASS	WT/LBS.	CUBIC FT.	VENEER/LAMINATE	ALL VENEER
D x W x H						
D12022T	22 x 120 x 1	60	101	2	N/A	\$2248
D11822T	22 x 118 x 1	60	100	2	N/A	\$2211
D11622T	22 x 116 x 1	60	97	2	N/A	\$2173
D11422T	22 x 114 x 1	60	96	2	N/A	\$2140
D11222T	22 x 112 x 1	60	95	2	N/A	\$2104
D11022T	22 x 110 x 1	60	92	2	N/A	\$2059
D10822T	22 x 108 x 1	60	91	2	N/A	\$2022
D10622T	22 x 106 x 1	60	89	2	N/A	\$1987
D10422T	22 x 104 x 1	60	87	2	N/A	\$1952
D10222T	22 x 102 x 1	60	86	2	N/A	\$1912
D10022T	22 x 100 x 1	60	84	2	N/A	\$1877
D9822T	22 x 98 x 1	60	83	2	N/A	\$1832
D9622T	22 x 96 x 1	60	81	2	N/A	\$1797
D9422T	22 x 94 x 1	60	79	2	N/A	\$1760
D9222T	22 x 92 x 1	60	77	2	N/A	\$1723
D9022T	22 x 90 x 1	60	76	2	N/A	\$1723
D8822T	22 x 88 x 1	60	74	2	N/A	\$1650
D8622T	22 x 86 x 1	60	73	2	N/A	\$1615
D8422T	22 x 84 x 1	60	71	2	N/A	\$1578
D8222T	22 x 82 x 1	60	69	2	N/A	\$1542
D8022T	22 x 80 x 1	60	67	2	N/A	\$1499
D7822T	22 x 78 x 1	60	66	2	N/A	\$1461
D7622T	22 x 76 x 1	60	65	2	N/A	\$1425
D7422T	22 x 74 x 1	60	63	2	N/A	\$1387
D7222T	22 x 72 x 1	60	61	2	N/A	\$1387
D7022T	22 x 70 x 1	65	59	2	N/A	\$1318
D6822T	22 x 68 x 1	65	57	2	N/A	\$1280
D6622T	22 x 66 x 1	65	55	2	N/A	\$1245
D6422T	22 x 64 x 1	65	54	1	N/A	\$1200
D6222T	22 x 62 x 1	60	52	1	N/A	\$1166
D6022T	22 x 60 x 1	60	50	1	N/A	\$1125
D5822T	22 x 58 x 1	60	49	1	N/A	\$1089
D5622T	22 x 56 x 1	60	47	1	N/A	\$1055
D5422T	22 x 54 x 1	60	46	1	N/A	\$1018
D5222T	22 x 52 x 1	60	44	1	N/A	\$981
D5022T	22 x 50 x 1	60	42	1	N/A	\$937
D4822T	22 x 48 x 1	60	40	1	N/A	\$901
D4222T	22 x 42 x 1	60	36	1	N/A	\$873
D4022T	22 x 40 x 1	60	34	1	N/A	\$828
D3822T	22 x 38 x 1	60	32	1	N/A	\$791
D3622T	22 x 36 x 1	60	30	1	N/A	\$749
D3422T	22 x 34 x 1	65	28	1	N/A	\$703
D3222T	22 x 32 x 1	65	27	1	N/A	\$662
D3022T	22 x 30 x 1	65	25	1	N/A	\$616
D2422T	22 x 24 x 1	70	20	1	N/A	\$594
D1822T	22 x 18 x 1	70	15	1	N/A	\$448
D1622T	22 x 16 x 1	85	14	1	N/A	\$397
D1222T	22 x 12 x 1	92.5	10	1	N/A	\$298

EXAMPLE:

(1) D9022T
Veneer Top

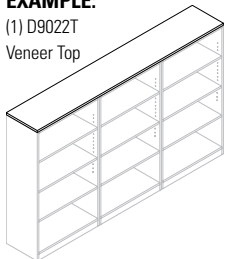

(3) D7D20W30H48 - Open Storage Cabinet

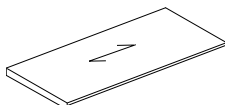

Tops - 22" Deep

For use with 20" deep units. Tops are 1" thick.

• **This is an OPTION for Storage Modules, Wardrobe Cabinets and Personal Towers.**
Specify a Veneer Top from the listing above (either a single model or straight run).

FLOATING SHELF

MODEL#	DIMENSIONS	FREIGHT CLASS	WT/LBS.	CUBIC FT.	LIST PRICE
CBYF096D12H8	12 x 96 x 8	125	78	10	\$2863
CBYF064D12H8	12 x 64 x 8	125	50	8	\$1873
CBYF032D12H8	12 x 32 x 8	100	35	4	\$1697

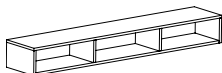

Wall Mounted Open Storage*

To be used as a stand alone unit. Shipped assembled in 1 carton.

Required Specifications

Veneer finish

OVERHEAD STORAGE **MODEL#** **DIMENSIONS** **FREIGHT CLASS** **WT./LBS.** **CUBIC FT.** **VENEER/LAMINATE** **ALL VENEER**

sizes 48" and larger

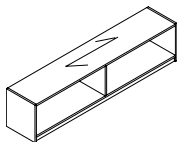

sizes less than 48"

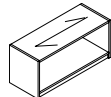

Open Front Overhead Storage

MODEL#	DIMENSIONS	FREIGHT CLASS	WT./LBS.	CUBIC FT.	VENEER/LAMINATE	ALL VENEER
DCSF072	14.5 x 72 x 16.5	125	100	10	\$1733	\$2082
DCSF066	14.5 x 66 x 16.5	125	83	9	\$1592	\$1909
DCSF060	14.5 x 60 x 16.5	100	75	8	\$1446	\$1733
DCSF054	14.5 x 54 x 16.5	100	68	7	\$1303	\$1563
DCSF048	14.5 x 48 x 16.5	100	60	7	\$1159	\$1390
DCSF042	14.5 x 42 x 16.5	100	55	6	\$1071	\$1283
DCSF036	14.5 x 36 x 16.5	100	50	5	\$1060	\$1270
DCSF030	14.5 x 30 x 16.5	100	45	4	\$1036	\$1245

Includes pre-mounted "J" brackets for wall mount applications. Shipped assembled in 1 carton.

- **NOTE:** Care should be taken to mount the units. Units should be mounted to wall studs using correct fasteners. Failure to do so may result in collapse of the unit and subsequent personal injury. **Mounting hardware not included.** Mounting hardware used should be based on wall material. Consult an installation professional for proper wall mounting.

sizes 48" and larger

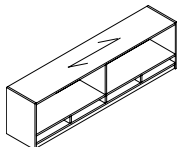

sizes less than 48"

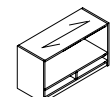

Open Front Overhead Storage - Pigeon-Hole Storage

DCSFOP72	14.5 x 72 x 19.5	125	100	12	\$2082	\$2498
DCSFOP66	14.5 x 66 x 19.5	125	83	11	\$1908	\$2290
DCSFOP60	14.5 x 60 x 19.5	125	75	10	\$1733	\$2082
DCSFOP54	14.5 x 54 x 19.5	125	68	9	\$1565	\$1878
DCSFOP48	14.5 x 48 x 19.5	125	60	8	\$1386	\$1664
DCSFOP42	14.5 x 42 x 19.5	125	55	7	\$1303	\$1563
DCSFOP36	14.5 x 36 x 19.5	125	50	6	\$1263	\$1515
DCSFOP30	14.5 x 30 x 19.5	125	45	5	\$1248	\$1495

Includes pre-mounted "J" brackets for wall mount applications. Horizontal pigeon-hole storage on bottom of overhead.

- **NOTE:** Care should be taken to mount the units. Units should be mounted to wall studs using correct fasteners. Failure to do so may result in collapse of the unit and subsequent personal injury. **Mounting hardware not included.** Mounting hardware used should be based on wall material. Consult an installation professional for proper wall mounting. Shipped assembled in 1 carton.

sizes 48" and larger

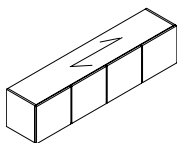

sizes less than 48"

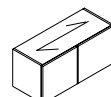

Closed Front Overhead Storage with Hinge Doors*

DSF72	14.5 x 72 x 16.5	92.5	100	10	\$2242	\$2690
DSF66	14.5 x 66 x 16.5	100	83	9	\$2059	\$2471
DSF60	14.5 x 60 x 16.5	100	75	8	\$1871	\$2246
DSF54	14.5 x 54 x 16.5	100	68	7	\$1678	\$2014
DSF48	14.5 x 48 x 16.5	60	60	7	\$1650	\$1980
DSF42	14.5 x 42 x 16.5	100	55	6	\$1375	\$1649
DSF36	14.5 x 36 x 16.5	92.5	50	5	\$1346	\$1613
DSF30	14.5 x 30 x 16.5	92.5	45	4	\$1322	\$1588

Includes pre-mounted "J" brackets for wall mount applications. Shipped assembled in 1 carton.

- **NOTE:** Care should be taken to mount the units. Units should be mounted to wall studs using correct fasteners. Failure to do so may result in collapse of the unit and subsequent personal injury. **Mounting hardware not included.** Mounting hardware used should be based on wall material. Consult an installation professional for proper wall mounting.

sizes 48" and larger

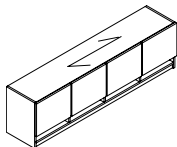

sizes less than 48"

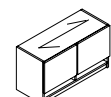

Closed Front Overhead Storage with Hinge Doors & Pigeon-Hole Storage*

DSFP72	14.5 x 72 x 19.5	100	100	12	\$2693	\$3233
DSFP66	14.5 x 66 x 19.5	125	83	11	\$2466	\$2958
DSFP60	14.5 x 60 x 19.5	125	75	10	\$2248	\$2698
DSFP54	14.5 x 54 x 19.5	125	68	9	\$2022	\$2428
DSFP48	14.5 x 48 x 19.5	125	60	8	\$1791	\$2146
DSFP42	14.5 x 42 x 19.5	125	55	7	\$1711	\$2054
DSFP36	14.5 x 36 x 19.5	100	50	6	\$1615	\$1938
DSFP30	14.5 x 30 x 19.5	100	45	5	\$1593	\$1910

Includes pre-mounted "J" brackets for wall mount applications. Horizontal pigeon-hole storage on bottom of overhead. Shipped assembled in 1 carton.

- **NOTE:** Care should be taken to mount the units. Units should be mounted to wall studs using correct fasteners. Failure to do so may result in collapse of the unit and subsequent personal injury. **Mounting hardware not included.** Mounting hardware used should be based on wall material. Consult an installation professional for proper wall mounting.

Required Specifications

Veneer Finish
Laminate Finish (top/body)

Optional Specifications

Lock*
Handle style*

OVERHEAD STORAGE

sizes 48" and larger

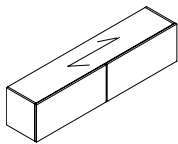

sizes less than 48"

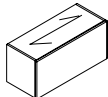

Closed Front Overhead Storage - with Flipper Doors

sizes 48" and larger

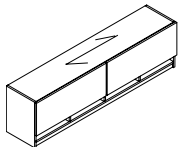

sizes less than 48"

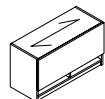

Closed Front Overhead Storage with Flipper Doors & Pigeon-Hole Storage

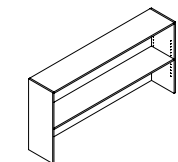

Open Hutch with Closed Back

MODEL#	DIMENSIONS	FREIGHT CLASS	WT/LBS.	CUBIC FT.	VENEER/LAMINATE	ALL VENEER
	D x W x H					
DSFF72	14.5 x 72 x 16.5	92.5	100	10	\$2431	\$2916
DSFF66	14.5 x 66 x 16.5	100	83	9	\$2225	\$2670
DSFF60	14.5 x 60 x 16.5	100	75	8	\$2022	\$2428
DSFF54	14.5 x 54 x 16.5	100	68	7	\$1826	\$2191
DSFF48	14.5 x 48 x 16.5	100	60	7	\$1621	\$1948
DSFF42	14.5 x 42 x 16.5	100	55	6	\$1506	\$1805
DSFF36	14.5 x 36 x 16.5	92.5	50	5	\$1477	\$1773
DSFF30	14.5 x 30 x 16.5	92.5	45	4	\$1456	\$1746

Includes pre-mounted "J" brackets for wall mount applications. Horizontal pigeon-hole storage on bottom of overhead. Shipped assembled in 1 carton.

- **NOTE:** Care should be taken to mount the units. Units should be mounted to wall studs using correct fasteners. Failure to do so may result in collapse of the unit and subsequent personal injury. **Mounting hardware not included.** Mounting hardware used should be based on wall material. Consult an installation professional for proper wall mounting.

DSFFP72	14.5 x 72 x 19.5	100	100	12	\$3187	\$3824
DSFFP66	14.5 x 66 x 19.5	125	83	11	\$2669	\$3205
DSFFP60	14.5 x 60 x 19.5	125	75	10	\$2431	\$2916
DSFFP54	14.5 x 54 x 19.5	125	68	9	\$2185	\$2618
DSFFP48	14.5 x 48 x 19.5	125	60	8	\$1943	\$2331
DSFFP42	14.5 x 42 x 19.5	125	55	7	\$1804	\$2165
DSFFP36	14.5 x 36 x 19.5	100	50	6	\$1768	\$2121
DSFFP30	14.5 x 30 x 19.5	100	45	5	\$1740	\$2086

Includes pre-mounted "J" brackets for wall mount applications. Horizontal pigeon-hole storage on bottom of overhead. Shipped assembled in 1 carton.

- **NOTE:** Care should be taken to mount the units. Units should be mounted to wall studs using correct fasteners. Failure to do so may result in collapse of the unit and subsequent personal injury. **Mounting hardware not included.** Mounting hardware used should be based on wall material. Consult an installation professional for proper wall mounting.

D72CL36	16 x 72 x 36	125	155	23	\$1936	\$2322
D66CL36	16 x 66 x 36	125	140	21	\$1795	\$2152
D60CL36	16 x 60 x 36	125	130	19	\$1593	\$1910
D48CL36	16 x 48 x 36	125	110	15	\$1516	\$1821
D42CL36	16 x 42 x 36	125	95	13	\$1375	\$1649
D36CL36	16 x 36 x 36	125	80	11	\$1293	\$1550
D30CL36	16 x 30 x 36	125	67	9	\$1074	\$1293

One adjustable shelf. Closed back. Shipped assembled in 1 carton.

- **A Tackboard cannot be used with this hutch.**

CLOSED HUTCHES

sizes 120"-108"w

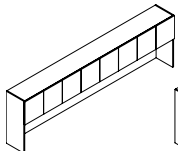

sizes 102"-84"w

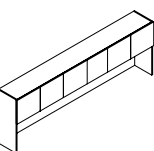

sizes 78"-60"w

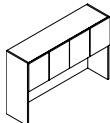

sizes 36"-30"w

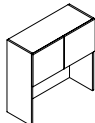

Closed Hutch w/Veneer Doors 36" High*

MODEL#	DIMENSIONS	FREIGHT CLASS	WT/LBS.	CUBIC FT.	VENEER/LAMINATE	ALL VENEER
D120SH36	16 x 120 x 36	125	295	38	\$5230	\$6277
D114SH36	16 x 114 x 36	125	281	36	\$4967	\$5960
D108SH36	16 x 108 x 36	125	268	34	\$4707	\$5647
D102SH36	16 x 102 x 36	125	254	32	\$4446	\$5335
D96SH36	16 x 96 x 36	100	241	30	\$4186	\$5022
D90SH36	16 x 90 x 36	100	227	28	\$3922	\$4707
D84SH36	16 x 84 x 36	100	214	26	\$3660	\$4393
D78SH36	16 x 78 x 36	100	200	24	\$3400	\$4081
D72SH36	16 x 72 x 36	125	187	23	\$3139	\$3767
D66SH36	16 x 66 x 36	100	173	21	\$3025	\$3628
D60SH36	16 x 60 x 36	100	160	19	\$2877	\$3452
D36SH36	16 x 36 x 36	100	94	11	\$1964	\$2358
D30SH36	16 x 30 x 36	100	78	9	\$1718	\$2061

One fixed shelf. Closed back features one grommet. Shipped assembled in 1 carton.

- Models 120"w- 108"w have three fixed shelf dividers.
- Models 84"w- 102"w have two fixed shelf dividers.
- Models 60"w - 78"w have one fixed shelf divider.
- *Clearance from worksurface to valance is 19.5".*

Required Specifications

Veneer Finish
Laminate Finish (top/body)

Optional Specifications

Lock (models with doors)
Handle Style (models with doors)

Accessories

Tackboard*
Tasklight*

CLOSED HUTCHES

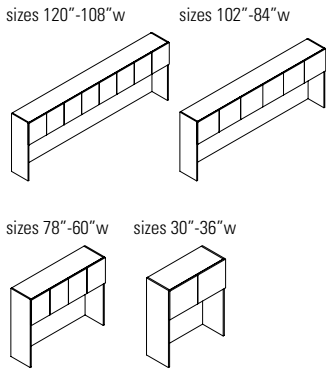

Closed Hutch w/Veneer Doors 42" H

MODEL#	DIMENSIONS	FREIGHT CLASS	WT./LBS.	CUBIC FT.	veneer/LAMINATE	ALL VENEER
D x W x H						
D120SH42	16 x 120 x 42	125	341	44	\$6100	\$7318
D114SH42	16 x 114 x 42	125	324	42	\$5791	\$6951
D108SH42	16 x 108 x 42	125	307	39	\$5766	\$6920
D102SH42	16 x 102 x 42	125	290	37	\$5184	\$6221
D96SH42	16 x 96 x 42	125	273	35	\$4880	\$5856
D90SH42	16 x 90 x 42	125	256	33	\$4575	\$5490
D84SH42	16 x 84 x 42	125	239	31	\$4485	\$5382
D78SH42	16 x 78 x 42	125	222	38	\$3968	\$4760
D72SH42	16 x 72 x 42	125	205	26	\$3660	\$4393
D66SH42	16 x 66 x 42	125	188	24	\$3526	\$4232
D60SH42	16 x 60 x 42	125	171	22	\$3354	\$4026
D36SH42	16 x 36 x 42	125	102	13	\$2291	\$2747
D30SH42	16 x 30 x 42	125	85	11	\$2006	\$2406

One fixed shelf. Closed back features one grommet. Shipped assembled in 1 carton.

- Models 120" w- 108" w have three fixed shelf dividers.
- Models 84" w- 102" w have two fixed shelf dividers.
- Models 60" w - 78" w have one fixed shelf divider.
- Clearance from worksurface to valance is 19.5".

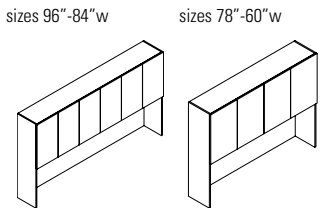

Closed Hutch w/Veneer Doors 54" H

D962SH54	15 x 96 x 54	125	351	45	\$6268	\$7522
D902SH54	15 x 90 x 54	125	329	42	\$5881	\$7056
D842SH54	15 x 84 x 54	125	307	39	\$5488	\$6582
D782SH54	15 x 78 x 54	125	285	37	\$5095	\$6116
D722SH54	15 x 72 x 54	300	263	34	\$4706	\$5646
D662SH54	15 x 66 x 54	125	241	31	\$4530	\$5436
D602SH54	15 x 60 x 54	125	219	28	\$4315	\$5176

One fixed shelf and one adjustable shelf (per compartment). Closed back features one grommet. Shipped assembled in 1 carton.

- Clearance from worksurface to valance is 25.5".

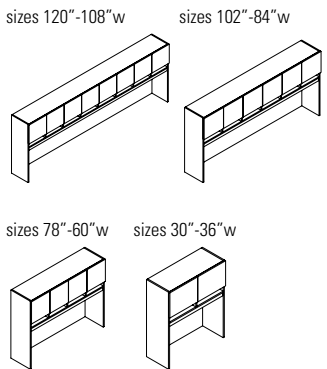

Closed Hutch w/Veneer Doors Pigeon-Hole Storage, 42" High

D120SHP42	15 x 120 x 42	125	341	44	\$7318	\$8782
D114SHP42	15 x 114 x 42	125	324	42	\$6952	\$8344
D108SHP42	15 x 108 x 42	125	307	39	\$6590	\$7904
D102SHP42	15 x 102 x 42	125	290	37	\$6221	\$7465
D96SHP42	15 x 96 x 42	125	273	35	\$5856	\$7026
D90SHP42	15 x 90 x 42	125	256	33	\$5490	\$6590
D84SHP42	15 x 84 x 42	125	239	31	\$5124	\$6148
D78SHP42	15 x 78 x 42	125	222	38	\$4759	\$5709
D72SHP42	15 x 72 x 42	125	205	26	\$4599	\$5517
D66SHP42	15 x 66 x 42	125	188	24	\$4440	\$5329
D60SHP42	15 x 60 x 42	125	171	22	\$4232	\$5077
D36SHP42	15 x 36 x 42	125	102	13	\$2747	\$3298
D30SHP42	15 x 30 x 42	125	85	11	\$2406	\$2889

One fixed shelf. Closed back features one grommet. Horizontal pigeon-hole storage top mounted to hutch. Shipped assembled in 1 carton.

- Models 120" w- 108" w have three fixed shelf dividers.
- Models 84" w- 102" w have two fixed shelf dividers.
- Models 60" w - 78" w have one fixed shelf divider.
- Clearance from worksurface to valance is 21.5".

Required Specifications

Veneer Finish (doors)
Laminate Finish (top/body)

Optional Specifications

Lock
Handle Style

Accessories

Tackboard
Tasklight

CLOSED HUTCHES

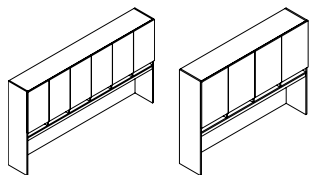

Closed Hutch w/Veneer Doors
Pigeon-Hole Storage, 54" H*

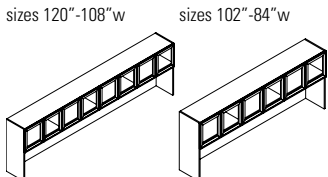

sizes 120"-108"w sizes 102"-84"w

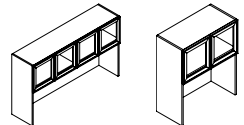

sizes 78"-60"w sizes 30"-36"w

Closed Hutch w/Glass Doors 36" H**

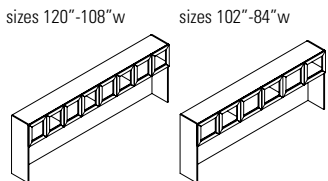

sizes 120"-108"w sizes 102"-84"w

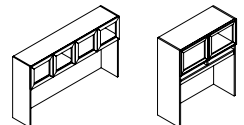

sizes 78"-60"w sizes 30"-36"w

Closed Hutch w/Glass Doors 42" H**

MODEL#	DIMENSIONS	FREIGHT CLASS	WT./LBS.	CUBIC FT.	VENEER/LAMINATE	ALL VENEER
	D x W x H					
D962SHP54	15 x 96 x 54	125	351	45	\$7527	\$9033
D902SHP54	15 x 90 x 54	125	329	42	\$7053	\$8462
D842SHP54	15 x 84 x 54	125	307	39	\$6580	\$7895
D782SHP54	15 x 78 x 54	125	285	37	\$6114	\$7336
D722SHP54	15 x 72 x 54	125	263	34	\$5646	\$6774
D662SHP54	15 x 66 x 54	125	241	31	\$5434	\$6520
D602SHP54	15 x 60 x 54	125	219	28	\$5174	\$6208

One fixed shelf and one adjustable shelf (per compartment). Closed back features one grommet. Horizontal pigeon-hole storage top mounted to hutch. Shipped assembled in 1 carton.

- Clearance from worksurface to valance is 21.5".

D120SH36G	15 x 120 x 36	125	295	38	\$7822	\$9384
D114SH36G	15 x 114 x 36	125	281	36	\$7508	\$9009
D108SH36G	15 x 108 x 36	125	268	34	\$7202	\$8642
D102SH36G	15 x 102 x 36	125	254	32	\$6466	\$7759
D96SH36G	15 x 96 x 36	85	241	30	\$6168	\$7401
D90SH36G	15 x 90 x 36	100	227	28	\$5862	\$7035
D84SH36G	15 x 84 x 36	100	214	26	\$5563	\$6675
D78SH36G	15 x 78 x 36	85	200	24	\$5271	\$6326
D72SH36G	15 x 72 x 36	100	187	23	\$4580	\$5495
D66SH36G	15 x 66 x 36	100	173	21	\$4382	\$5259
D60SH36G	15 x 60 x 36	100	160	19	\$4187	\$5023
D36SH36G	15 x 36 x 36	100	94	11	\$2663	\$3194
D30SH36G	15 x 30 x 36	100	78	9	\$2381	\$2854

One fixed shelf. Closed back features one grommet. Aluminum frame available in Tungsten finish only. Shipped assembled in 1 carton. Translucent, screened glass.

- Models 120"w- 108"w have three fixed shelf dividers.
- Models 84"w- 102"w have two fixed shelf dividers.
- Models 60"w - 78"w have one fixed shelf divider.
- Clearance from worksurface to valance is 19.5".
- **Locks are not available on hutches with Glass Doors.**

D120SH42G	15 x 120 x 42	125	341	44	\$8222	\$9868
D114SH42G	15 x 114 x 42	125	324	42	\$7887	\$9464
D108SH42G	15 x 108 x 42	125	307	39	\$7560	\$9071
D102SH42G	15 x 102 x 42	125	290	37	\$6814	\$8180
D96SH42G	15 x 96 x 42	125	273	35	\$6495	\$7793
D90SH42G	15 x 90 x 42	125	256	33	\$6254	\$7506
D84SH42G	15 x 84 x 42	125	239	31	\$5840	\$7008
D78SH42G	15 x 78 x 42	150	222	38	\$5518	\$6622
D72SH42G	15 x 72 x 42	125	205	26	\$4763	\$5713
D66SH42G	15 x 66 x 42	125	188	24	\$4595	\$5514
D60SH42G	15 x 60 x 42	125	171	22	\$4434	\$5318
D36SH42G	15 x 36 x 42	125	102	13	\$3462	\$4154
D30SH42G	15 x 30 x 42	125	85	11	\$2517	\$3025

One fixed shelf. Closed back features one grommet. Aluminum frame available in Tungsten finish only. Shipped assembled in 1 carton. Translucent, screened glass.

- Models 120"w- 108"w have three fixed shelf dividers.
- Models 84"w- 102"w have two fixed shelf dividers.
- Models 60"w - 78"w have one fixed shelf divider.
- Clearance from worksurface to valance is 25.5".
- **Locks are not available on hutches with Glass Doors.**

Required Specifications

Veneer finish*
Laminate finish (body)**
Handle Style

Optional Specifications

Lock*
Veneer top*

Accessories

Tackboard
Tasklight

CLOSED HUTCHES

sizes 96"-84"w

sizes 78"-60"w

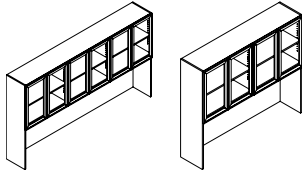

Closed Hutch w/Glass Doors 54"H

MODEL#	DIMENSIONS	FREIGHT CLASS	WT./LBS.	CUBIC FT.	veneer/LAMINATE	ALL VENEER
D x W x H						
D962SH54G	15 x 96 x 54	125	351	45	\$8295	\$9953
D902SH54G	15 x 90 x 54	125	329	42	\$7697	\$9238
D842SH54G	15 x 84 x 54	125	307	39	\$7151	\$8582
D782SH54G	15 x 78 x 54	125	285	37	\$6575	\$7891
D722SH54G	15 x 72 x 54	125	263	34	\$6007	\$7207
D662SH54G	15 x 66 x 54	125	241	31	\$5797	\$6957
D602SH54G	15 x 60 x 54	125	219	28	\$5541	\$6649

One fixed shelf and one adjustable shelf (per compartment). Closed back features one grommet. Aluminum frame available in Tungsten finish only. Shipped assembled in 1 carton. Translucent, screened glass.

- Clearance from worksurface to valance is 25.5".
- Locks are not available on hutches with Glass Doors.

sizes 120"-108"w

sizes 102"-84"w

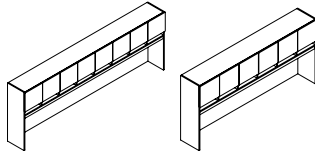

sizes 78"-60"w

sizes 30"-36"w

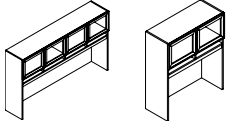

Closed Hutch w/Glass Doors Pigeon-Hole Storage, 42"H

D120SHP42G	15 x 120 x 42	125	341	44	\$9371	\$11247
D114SHP42G	15 x 114 x 42	125	324	42	\$8967	\$10758
D108SHP42G	15 x 108 x 42	125	307	39	\$8593	\$10313
D102SHP42G	15 x 102 x 42	125	290	37	\$7798	\$9359
D96SHP42G	15 x 96 x 42	125	273	35	\$7436	\$8924
D90SHP42G	15 x 90 x 42	125	256	33	\$7413	\$8896
D84SHP42G	15 x 84 x 42	125	239	31	\$6642	\$7967
D78SHP42G	15 x 78 x 42	150	222	38	\$6262	\$7513
D72SHP42G	15 x 72 x 42	125	205	26	\$5462	\$6552
D66SHP42G	15 x 66 x 42	125	188	24	\$5286	\$6344
D60SHP42G	15 x 60 x 42	125	171	22	\$5030	\$6037
D36SHP42G	15 x 36 x 42	125	102	13	\$3268	\$3922
D30SHP42G	15 x 30 x 42	125	85	11	\$2918	\$3502

One fixed shelf. Closed back features one grommet. Aluminum frame available in Tungsten finish only. Horizontal pigeon-hole storage top mounted to hutch. Shipped assembled in 1 carton. Translucent, screened glass.

- Models 120"w- 108"w have three fixed shelf dividers.
- Models 84"w- 102"w have two fixed shelf dividers.
- Models 60"w - 78"w have one fixed shelf divider.
- Clearance from worksurface to valance is 21.5".
- Locks are not available on hutches with Glass Doors.

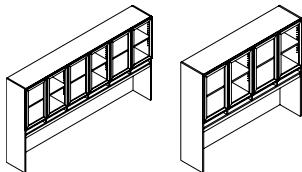

Closed Hutch w/Glass Doors Pigeon-Hole Storage, 54"H

D962SHP54G	15 x 96 x 54	125	351	45	\$9532	\$11441
D902SHP54G	15 x 90 x 54	125	329	42	\$8885	\$10661
D842SHP54G	15 x 84 x 54	125	307	39	\$8235	\$9884
D782SHP54G	15 x 78 x 54	125	285	37	\$7589	\$9105
D722SHP54G	15 x 72 x 54	125	263	34	\$6940	\$8328
D662SHP54G	15 x 66 x 54	125	241	31	\$6692	\$8028
D602SHP54G	15 x 60 x 54	125	219	28	\$6393	\$7673

One fixed shelf and one adjustable shelf (per compartment). Closed back features one grommet. Aluminum frame available in Tungsten finish only. Horizontal pigeon-hole storage top mounted to hutch. Shipped assembled in 1 carton. Translucent, screened glass.

- Clearance from worksurface to valance is 21.5".
- Locks are not available on hutches with Glass Doors.

Required Specifications
Laminate Finish (body)

Accessories
Tackboard
Task Light

CLOSED HUTCHES

MODEL# DIMENSIONS FREIGHT CLASS WT/LBS. CUBIC FT. GR. 1-3 GR. 4-5

D x W x H

TACKBOARD Notes: Tackboards can be upholstered in all of the following fabrics:

Grade 1: Jenny, Quilt, Terrace, Urban, Waterfall

Grade 2: Imprint, Lola

Grade 3: Anchorage, Merge

WALL MOUNTED TACKBOARDS FOR OVERHEAD STORAGE

GR. 1-3 GR. 4-5

TS120	1 x 120 x 20	70	26	2	\$1621	\$2026
TS114	1 x 114 x 20	70	25	2	\$1544	\$1932
TS108	1 x 108 x 20	70	23	2	\$1460	\$1825
TS102	1 x 102 x 20	85	19	2	\$1383	\$1729
TS96	1 x 96 x 20	70	17	1	\$1293	\$1619
TS90	1 x 90 x 20	70	15	1	\$1216	\$1521
TS84	1 x 84 x 20	70	14	1	\$1139	\$1422
TS78	1 x 78 x 20	70	13	1	\$1055	\$1319
TS72	1 x 72 x 20	70	12	1	\$594	\$744
TS66	1 x 66 x 20	85	11	1	\$546	\$686
TS60	1 x 60 x 20	85	10	1	\$502	\$631
TS54	1 x 54 x 20	85	10	1	\$455	\$572
TS48	1 x 48 x 20	85	10	1	\$407	\$511
TS42	1 x 42 x 20	85	10	1	\$360	\$453
TS36	1 x 36 x 20	100	8	1	\$322	\$408
TS30	1 x 30 x 20	150	5	1	\$268	\$337

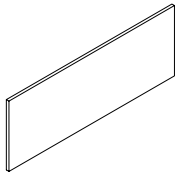

Tackboard

For use on **16.5"H** overhead storage (DCSFO_, DSF_, DSFF_) at a finished height of **66"**. See Tackboard Notes above for exact fabric availability. List Price shown applies for all fabric grades.

- NOTE:** Care should be taken to mount the units. Units should be mounted to wall studs using correct fasteners. Failure to do so may result in collapse of the unit and subsequent personal injury. **Mounting hardware not included.** Mounting hardware used should be based on wall material. Consult an installation professional for proper wall mounting.

TS120H26	1 x 120 x 26	70	34	2	\$2108	\$2635
TS114H26	1 x 114 x 26	70	32	2	\$2003	\$2504
TS108H26	1 x 108 x 26	70	30	2	\$1898	\$2374
TS102H26	1 x 102 x 26	85	24	2	\$1788	\$2235
TS96H26	1 x 96 x 26	92.5	22	2	\$1691	\$2116
TS90H26	1 x 90 x 26	92.5	20	2	\$1585	\$1980
TS84H26	1 x 84 x 26	100	18	2	\$1473	\$1842
TS78H26	1 x 78 x 26	100	17	2	\$1370	\$1714
TS72H26	1 x 72 x 26	70	16	1	\$761	\$956
TS66H26	1 x 66 x 26	85	14	1	\$701	\$879
TS60H26	1 x 60 x 26	85	13	1	\$641	\$805
TS54H26	1 x 54 x 26	85	13	1	\$588	\$737
TS48H26	1 x 48 x 26	85	13	1	\$520	\$653
TS42H26	1 x 42 x 26	85	13	1	\$462	\$573
TS36H26	1 x 36 x 26	100	8	1	\$403	\$506
TS30H26	1 x 30 x 26	150	5	1	\$338	\$428

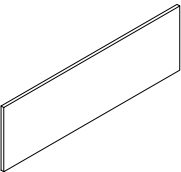

Tackboard

For use on **16.5"H** overhead storage (DCSFO_, DSF_, DSFF_) at a finished height of **72"**. See Tackboard Notes above for exact fabric availability. List Price shown applies for all fabric grades.

- NOTE:** Care should be taken to mount the units. Units should be mounted to wall studs using correct fasteners. Failure to do so may result in collapse of the unit and subsequent personal injury. **Mounting hardware not included.** Mounting hardware used should be based on wall material. Consult an installation professional for proper wall mounting.

Required Specifications

Fabric

TACKBOARDS FOR OVERHEAD STORAGE & HUTCHES **MODEL#** **DIMENSIONS** **FREIGHT CLASS** **WT/LBS.** **CUBIC FT.** **GR. 1-3** **GR. 4-5**

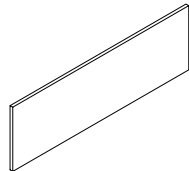

Tackboard

	D x W x H						
TSP120H23	1 x 120 x 23	70	34	2	\$1830	\$2288	
TSP114H23	1 x 114 x 23	70	32	2	\$1739	\$2172	
TSP108H23	1 x 108 x 23	70	30	2	\$1704	\$2045	
TSP102H23	1 x 102 x 23	85	24	2	\$1625	\$1951	
TSP96H23	1 x 96 x 23	92.5	20	2	\$1467	\$1832	
TSP90H23	1 x 90 x 23	92.5	20	1	\$1370	\$1714	
TSP84H23	1 x 84 x 23	70	18	1	\$1280	\$1599	
TSP78H23	1 x 78 x 23	70	17	1	\$1047	\$1273	
TSP72H23	1 x 72 x 23	70	16	1	\$973	\$1222	
TSP66H23	1 x 66 x 23	85	14	1	\$884	\$1109	
TSP60H23	1 x 60 x 23	85	13	1	\$641	\$805	
TSP54H23	1 x 54 x 23	85	13	1	\$812	\$1018	
TSP48H23	1 x 48 x 23	85	13	1	\$642	\$653	
TSP42H23	1 x 42 x 23	85	13	1	\$565	\$573	
TSP36H23	1 x 36 x 23	100	8	1	\$488	\$505	
TSP30H23	1 x 30 x 23	150	5	1	\$404	\$430	

For use on **19.5"H** overhead storage (**DCSFOP_**, **DSFP_**, **DSFFP_**) with Pigeon-Hole Storage **at a finished height of 72"**. See *Tackboard Notes* above for exact fabric availability. List Price shown applies for all fabric grades.

- **NOTE:** Care should be taken to mount the units. Units should be mounted to wall studs using correct fasteners. Failure to do so may result in collapse of the unit and subsequent personal injury. **Mounting hardware not included.** Mounting hardware used should be based on wall material. Consult an installation professional for proper wall mounting.

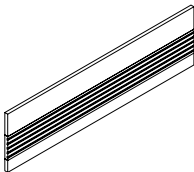

Tackboard - Accessory Rail

TSA120	1 x 120 x 20	85	26	2	\$2854	\$3567
TSA114	1 x 114 x 20	85	25	2	\$2715	\$3395
TSA108	1 x 108 x 20	92.5	23	2	\$2569	\$3210
TSA102	1 x 102 x 20	100	19	2	\$2436	\$3045
TSA96	1 x 96 x 20	70	15	1	\$2283	\$2854
TSA90	1 x 90 x 20	70	15	1	\$2142	\$2678
TSA84	1 x 84 x 20	85	14	1	\$1996	\$2498
TSA78	1 x 78 x 20	85	13	1	\$1857	\$2322
TSA72	1 x 72 x 20	85	12	1	\$1711	\$2139
TSA66	1 x 66 x 20	92.5	11	1	\$1570	\$1964
TSA60	1 x 60 x 20	92.5	10	1	\$1425	\$1783
TSA54	1 x 54 x 20	92.5	10	1	\$1286	\$1610
TSA48	1 x 48 x 20	92.5	10	1	\$1146	\$1434
TSA42	1 x 42 x 20	92.5	10	1	\$999	\$1250
TSA36	1 x 36 x 20	125	6	1	\$854	\$1070
TSA30	1 x 30 x 20	150	4	1	\$665	\$831

For use on **16.5"H** overhead storage (**DCSFO_**, **DSF_**, **DSFF_**) **at a finished height of 66"**. See *Tackboard Notes* above for exact fabric availability. List Price shown applies for all fabric grades.

- **Must Specify Black (E) or Tungsten (K) Accessory Rail finish.**
- **NOTE:** Care should be taken to mount the units. Units should be mounted to wall studs using correct fasteners. Failure to do so may result in collapse of the unit and subsequent personal injury. **Mounting hardware not included.** Mounting hardware used should be based on wall material. Consult an installation professional for proper wall mounting.

Required Specifications

- Fabric
- Accessory Rail Finish

WALL MOUNTED TACKBOARDS FOR OVERHEAD STORAGE MODEL# DIMENSIONS FREIGHT CLASS WT/LBS. CUBIC FT. GR. 1-3 GR. 4-5

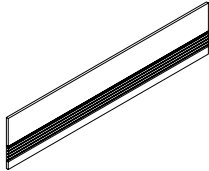

Tackboard - Accessory Rail

	D x W x H						
TSA120H26	1 x 120 x 26	85	26	2	\$3427	\$4283	
TSA114H26	1 x 114 x 26	85	25	2	\$3252	\$4065	
TSA108H26	1 x 108 x 26	92.5	23	2	\$3092	\$3864	
TSA102H26	1 x 102 x 26	100	19	2	\$2916	\$3647	
TSA96H26	1 x 96 x 26	70	15	1	\$2582	\$3229	
TSA90H26	1 x 90 x 26	70	15	1	\$2576	\$3221	
TSA84H26	1 x 84 x 26	85	14	1	\$2373	\$2967	
TSA78H26	1 x 78 x 26	85	13	1	\$2226	\$2785	
TSA72H26	1 x 72 x 26	85	12	1	\$2025	\$2533	
TSA66H26	1 x 66 x 26	92.5	11	1	\$1893	\$2365	
TSA60H26	1 x 60 x 26	92.5	10	1	\$1711	\$2139	
TSA54H26	1 x 54 x 26	92.5	10	1	\$1544	\$1932	
TSA48H26	1 x 48 x 26	92.5	10	1	\$1376	\$1720	
TSA42H26	1 x 42 x 26	92.5	10	1	\$1210	\$1511	
TSA36H26	1 x 36 x 26	125	6	1	\$1028	\$1286	
TSA30H26	1 x 30 x 26	150	4	1	\$860	\$1076	

For use on **16.5" H** overhead storage (**DCSF0_**, **DSF_**, **DSFF_**) at a finished height of **72"**. See Tackboard Notes above for exact fabric availability. List Price shown applies for all fabric grades.

- **Must Specify Black (E) or Tungsten (K) Accessory Rail finish.**
- **NOTE:** Care should be taken to mount the units. Units should be mounted to wall studs using correct fasteners. Failure to do so may result in collapse of the unit and subsequent personal injury. **Mounting hardware not included.** Mounting hardware used should be based on wall material. Consult an installation professional for proper wall mounting.

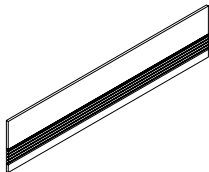

Tackboard - Accessory Rail

TSPA120H23	1 x 120 x 23	70	34	2	\$3120	\$3899
TSPA114H23	1 x 114 x 23	70	32	2	\$2952	\$3694
TSPA108H23	1 x 108 x 23	70	30	2	\$2784	\$3482
TSPA102H23	1 x 102 x 23	85	24	2	\$2652	\$3315
TSPA96H23	1 x 96 x 23	92.5	20	2	\$2484	\$3108
TSPA90H23	1 x 90 x 23	70	20	2	\$2332	\$2915
TSPA84H23	1 x 84 x 23	100	18	2	\$2171	\$2714
TSPA78H23	1 x 78 x 23	100	17	2	\$2019	\$2525
TSPA72H23	1 x 72 x 23	70	16	1	\$1863	\$2331
TSPA66H23	1 x 66 x 23	85	14	1	\$1711	\$2139
TSPA60H23	1 x 60 x 23	85	13	1	\$1551	\$1940
TSPA54H23	1 x 54 x 23	85	13	1	\$1370	\$1714
TSPA48H23	1 x 48 x 23	85	13	1	\$1242	\$1555
TSPA42H23	1 x 42 x 23	85	13	1	\$1090	\$1364
TSPA36H23	1 x 36 x 23	100	6	1	\$937	\$1170
TSPA30H23	1 x 30 x 23	150	4	1	\$777	\$973

For use on **19.5" H** overhead storage (**DCSF0P_**, **DSFP_**, **DSFFP_**) with Pigeon-Hole Storage at a finished height of **72"**. See Tackboard Notes above for exact fabric availability. List Price shown applies for all fabric grades.

- **Must Specify Black (E) or Tungsten (K) Accessory Rail finish.**
- **NOTE:** Care should be taken to mount the units. Units should be mounted to wall studs using correct fasteners. Failure to do so may result in collapse of the unit and subsequent personal injury. **Mounting hardware not included.** Mounting hardware used should be based on wall material. Consult an installation professional for proper wall mounting.

Required Specifications

Fabric
Accessory Rail Finish

WALL MOUNTED TACKBOARDS FOR OVERHEAD STORAGE **MODEL#** **DIMENSIONS** **FREIGHT CLASS** **WT/LBS.** **CUBIC FT.** **GR. 1-3** **GR. 4-5**

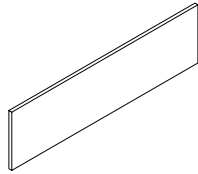

Tackboard

	D x W x H						
DTS120	1 x 118 x 20	70	26	2	\$963	\$1207	
DTS114	1 x 112 x 20	70	25	2	\$914	\$1145	
DTS108	1 x 106 x 20	70	23	2	\$870	\$1091	
DTS102	1 x 100 x 20	85	19	2	\$824	\$1032	
DTS96	1 x 94 x 20	70	15	1	\$776	\$973	
DTS90	1 x 88 x 20	70	15	1	\$734	\$924	
DTS84	1 x 82 x 20	70	14	1	\$690	\$864	
DTS78	1 x 76 x 20	70	13	1	\$641	\$805	
DTS72	1 x 70 x 20	70	12	1	\$594	\$744	
DTS66	1 x 64 x 20	85	11	1	\$546	\$686	
DTS60	1 x 58 x 20	85	10	1	\$502	\$631	
DTS36	1 x 34 x 20	100	6	1	\$322	\$408	
DTS30	1 x 28 x 20	150	4	1	\$268	\$337	

For use on **36" H** hutches (**D_SH36, D_SH36G, D_SH36DGD, D_SH36GDG**). **Factory installed**, with velcro tape. Please specify hutch to be installed on. *See Tackboard Notes above for exact fabric availability.* List Price shown applies for all fabric grades.

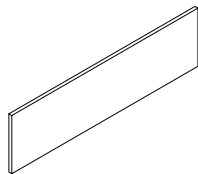

Tackboard

DTS120H26	1 x 118 x 26	70	34	2	\$1245	\$1559
DTS114H26	1 x 112 x 26	70	32	2	\$1184	\$1483
DTS108H26	1 x 106 x 26	70	30	2	\$1122	\$1405
DTS102H26	1 x 100 x 26	85	24	2	\$1063	\$1335
DTS96H26	1 x 94 x 26	92.5	20	2	\$1005	\$1259
DTS90H26	1 x 88 x 26	92.5	20	2	\$941	\$1181
DTS84H26	1 x 82 x 26	100	18	2	\$882	\$1107
DTS78H26	1 x 76 x 26	100	17	2	\$824	\$1032
DTS72H26	1 x 70 x 26	70	16	1	\$761	\$956
DTS66H26	1 x 64 x 26	85	14	1	\$701	\$879
DTS60H26	1 x 58 x 26	85	13	1	\$641	\$805
DTS36H26	1 x 34 x 26	100	8	1	\$403	\$506
DTS30H26	1 x 28 x 26	150	5	1	\$338	\$428

For use on **42" H and 54" H** hutches (**D_SH42/54, D_SH42/54G, D_SH42/54DGD, D_SH42/54GDG**). **Factory installed**, with velcro tape. Please specify hutch to be installed on. *See Tackboard Notes above for exact fabric availability.* List Price shown applies for all fabric grades.

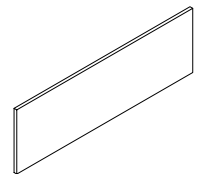

Tackboard

DTSP120H23	1 x 118 x 23	70	34	2	\$1245	\$1559
DTSP114H23	1 x 112 x 23	70	32	2	\$1184	\$1483
DTSP108H23	1 x 106 x 23	70	30	2	\$1122	\$1405
DTSP102H23	1 x 100 x 23	85	24	2	\$1063	\$1335
DTSP96H23	1 x 94 x 23	92.5	20	2	\$1005	\$1259
DTSP90H23	1 x 88 x 23	92.5	20	1	\$941	\$1181
DTSP84H23	1 x 82 x 23	70	18	1	\$882	\$1107
DTSP78H23	1 x 76 x 23	70	17	1	\$824	\$1032
DTSP72H23	1 x 70 x 23	70	16	1	\$761	\$956
DTSP66H23	1 x 64 x 23	85	14	1	\$701	\$879
DTSP60H23	1 x 58 x 23	85	13	1	\$641	\$805
DTSP54H23	1 x 52 x 23	85	13	1	\$588	\$737
DTSP48H23	1 x 46 x 23	85	13	1	\$520	\$653
DTSP42H23	1 x 40 x 23	85	13	1	\$462	\$581
DTSP36H23	1 x 34 x 23	100	8	1	\$403	\$506
DTSP30H23	1 x 28 x 23	150	5	1	\$338	\$428

For use on **42" H and 54" H** hutches (**D_SHP42/54, D_SHP42/54G, D_SHP42/54DGD, D_SHP42/54GDG**) with Pigeon-Hole Storage. **Factory installed**, with velcro tape. Please specify hutch to be installed on. *See Tackboard Notes above for exact fabric availability.* List Price shown applies for all fabric grades.

Required Specifications

Fabric

TACKBOARDS FOR HUTCHES

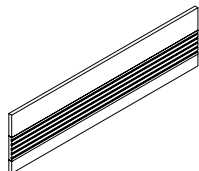

Tackboard - Accessory Rail

MODEL#	DIMENSIONS	FREIGHT CLASS	WT/LBS.	CUBIC FT.	GR. 1-3	GR. 4-5
D x W x H						
DTSA120	1 x 118 x 20	85	26	2	\$1678	\$2103
DTSA114	1 x 112 x 20	85	25	2	\$1599	\$2004
DTSA108	1 x 106 x 20	92.5	23	2	\$1511	\$1892
DTSA102	1 x 100 x 20	100	19	2	\$1432	\$1793
DTSA96	1 x 94 x 20	70	15	1	\$1346	\$1684
DTSA90	1 x 88 x 20	70	15	1	\$1271	\$1594
DTSA84	1 x 82 x 20	85	14	1	\$1184	\$1483
DTSA78	1 x 76 x 20	85	13	1	\$1105	\$1384
DTSA72	1 x 70 x 20	85	12	1	\$1023	\$1281
DTSA66	1 x 64 x 20	92.5	11	1	\$936	\$1173
DTSA60	1 x 58 x 20	92.5	10	1	\$856	\$1074
DTSA54	1 x 52 x 20	92.5	10	1	\$776	\$973
DTSA48	1 x 46 x 20	92.5	10	1	\$695	\$871
DTSA42	1 x 40 x 20	92.5	10	1	\$615	\$773
DTSA36	1 x 34 x 20	125	6	1	\$528	\$664
DTSA30	1 x 28 x 20	150	4	1	\$445	\$561

For use on 36" H hutches (D_SH36, D_SH36G, D_SH36DGD, D_SH36GDG). Factory installed, with velcro tape. Please specify hutch to be installed on. See Tackboard Notes above for exact fabric availability. List Price shown applies for all fabric grades.

- Must Specify Black (E) or Tungsten (K) Accessory Rail finish.

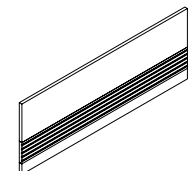

Tackboard - Accessory Rail

DTSA120H26	1 x 118 x 26	85	26	2	\$2007	\$2513
DTSA114H26	1 x 112 x 26	85	25	2	\$1908	\$2390
DTSA108H26	1 x 106 x 26	92.5	23	2	\$1813	\$2272
DTSA102H26	1 x 100 x 26	100	19	2	\$1714	\$2145
DTSA96H26	1 x 94 x 26	70	15	1	\$1612	\$2019
DTSA90H26	1 x 88 x 26	70	15	1	\$1518	\$1900
DTSA78H26	1 x 76 x 26	85	13	1	\$1319	\$1652
DTSA72H26	1 x 70 x 26	85	12	1	\$1198	\$1501
DTSA66H26	1 x 64 x 26	92.5	11	1	\$1122	\$1405
DTSA60H26	1 x 58 x 26	92.5	10	1	\$1023	\$1281
DTSA54H26	1 x 52 x 26	92.5	10	1	\$924	\$1157
DTSA48H26	1 x 46 x 26	92.5	10	1	\$828	\$1039
DTSA42H26	1 x 40 x 26	92.5	10	1	\$729	\$913
DTSA36H26	1 x 34 x 26	125	6	1	\$627	\$785
DTSA30H26	1 x 28 x 26	150	4	1	\$534	\$671

For use on 42" H and 54" H hutches (D_SH42/54, D_SH42/54G, D_SH42/54DGD, D_SH42/54GDG). Factory installed, with velcro tape. Please specify hutch to be installed on. See Tackboard Notes above for exact fabric availability. List Price shown applies for all fabric grades.

- Must Specify Black (E) or Tungsten (K) Accessory Rail finish.

Required Specifications

- Fabric
- Accessory Rail finish

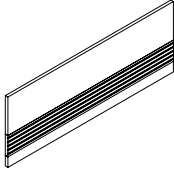
TACKBOARDS FOR HUTCHES	MODEL#	DIMENSIONS	FREIGHT CLASS	WT/LBS.	CUBIC FT.	GR. 1-3	GR. 4-5
 <p>Tackboard - Accessory Rail*</p>		D x W x H					
	DTSPA120H23	1 x 118 x 23	70	34	2	\$2088	\$2612
	DTSPA114H23	1 x 112 x 23	70	32	2	\$1988	\$2489
	DTSPA108H23	1 x 106 x 23	70	30	2	\$1879	\$2351
	DTSPA102H23	1 x 100 x 23	85	24	2	\$1795	\$2249
	DTSPA96H23	1 x 94 x 23	92.5	20	2	\$1678	\$2103
	DTSPA90H23	1 x 88 x 23	92.5	20	2	\$1580	\$1981
	DTSPA84H23	1 x 82 x 23	100	18	2	\$1472	\$1845
	DTSPA78H23	1 x 76 x 23	100	17	2	\$1373	\$1720
	DTSPA72H23	1 x 70 x 23	70	16	1	\$1271	\$1594
	DTSPA66H23	1 x 64 x 23	85	14	1	\$1166	\$1462
	DTSPA60H23	1 x 58 x 23	85	13	1	\$1063	\$1335
	DTSPA54H23	1 x 52 x 23	85	13	1	\$963	\$1207
	DTSPA48H23	1 x 46 x 23	85	13	1	\$856	\$1074
	DTSPA42H23	1 x 40 x 23	85	13	1	\$756	\$948
	DTSPA36H23	1 x 34 x 23	100	8	1	\$653	\$823
	DTSPA30H23	1 x 28 x 23	150	5	1	\$555	\$698

For use on **42"H** and **54"H** hutches (**D_SHP42/54, D_SHP42/54G, D_SHP42/54DGD, D_SHP42/54GDG**) with Pigeon-Hole Storage. **Factory installed**, with velcro tape. Please specify hutch to be installed on. See *Tackboard Notes above* for exact fabric availability. List Price shown applies for all fabric grades.

- **Must Specify Black (E) or Tungsten (K) Accessory Rail finish.**

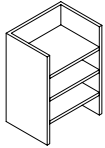
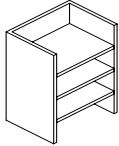
HUTCH ACCESSORIES	MODEL#	DIMENSIONS	FREIGHT CLASS	WT/LBS.	CUBIC FT.	veneer/LAMINATE	ALL VENEER
 <p>Vertical Pigeon-Hole Storage, Letter**</p>	DCPH131226	12 x 13 x 26	100	16	2	\$613	\$733
	DCPH131223	12 x 13 x 23	125	15	2	\$520	\$625
	DCPH131219	12 x 13 x 19	125	12	2	\$392	\$472
 <p>Vertical Pigeon-Hole Storage, Legal**</p>	DCPH161226	12 x 16 x 26	125	20	3	\$753	\$906
	DCPH161223	12 x 16 x 23	125	18	3	\$638	\$766
	DCPH161219	12 x 16 x 19	125	15	2	\$485	\$579

Used in conjunction with overhead storage units and hutches that incorporate horizontal pigeon-hole storage. Not freestanding. Shipped RTA (ready to assemble).



Required Specifications

- Fabric*
- Accessory Rail finish*
- Veneer finish**
- Laminate finish**

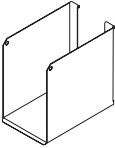
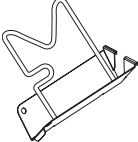
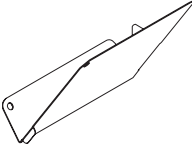
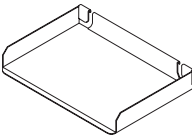
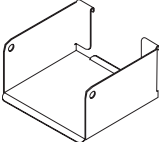
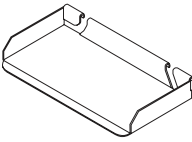
ACCESSORY RAIL/PANEL ORGANIZERS	MODEL#	DIMENSIONS		FREIGHT CLASS	WT/LBS.	CUBIC FT.	LIST PRICE
Available Finishes:		D x W x H					
	BLK	Black	SIL	Silver			
	CHR	Charcoal	TPE	Taupe			
	DWT	Designer White	TUN	Tungsten			
	NEV	Nevada					

	MODEL#	DIMENSIONS	FREIGHT CLASS	WT/LBS.	CUBIC FT.	LIST PRICE
 <p>Binder Bin</p>	BABB01	10.25 x 4 x 9	100	2	.21	\$75
Load bar/accessory rail mounted metal binder bin.						
 <p>Flip Sorter</p>	BAFS01	9.25 x 2.75 x 9.25	70	.06	.14	\$58
Load bar/accessory rail mounted metal flip sorter. Comes with chrome wire.						
 <p>Slant Sorter</p>	BASS01L (Left)	10.25 x 5 x 9.5	70	1	.28	\$47
	BASS01R (Right)	10.25 x 5 x 9.5	70	1	.28	\$47
Load bar/accessory rail mounted metal slant sorter.						
 <p>Letter Tray</p>	BALTO1	9.25 x 13.5 x 2	70	.50	.15	\$62
Load bar/accessory rail mounted metal letter tray.						
 <p>Media Bin</p>	BAMB01	5.25 x 5.75 x 3	70	.08	.05	\$62
Load bar/accessory rail mounted metal media bin.						
 <p>Utility Tray</p>	BAUT01	3.75 x 5.75 x 3	70	.05	.02	\$41
Load bar/accessory rail mounted metal utility tray.						

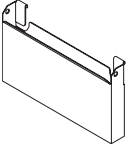
Required Specifications
Metal finish

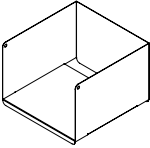
ACCESSORY RAIL/PANEL ORGANIZERS	MODEL#	DIMENSIONS	FREIGHT CLASS	WT./LBS.	CUBIC FT.	LIST PRICE
 <p>Mail Box*</p>  <p>Telephone Holder*</p>  <p>Elevated Shelf Binder Bin*</p>		D x W x H				
	BAPP01	2.75 x 16 x 9	100	2	.25	\$94
	Load bar/accessory rail mounted metal mail box.					
	BATH01	10 x 9 x 2	125	2	.26	\$91
	Load bar/accessory rail mounted metal telephone holder.					
	BRTESBBIN	12 x 12 x 8	100	6	.66	\$193
	Load bar/accessory rail mounted elevated shelf binder bin.					

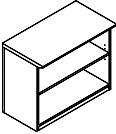
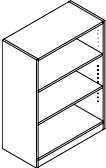
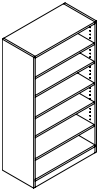
BOOKCASES	MODEL#	DIMENSIONS	FREIGHT CLASS	WT./LBS.	CUBIC FT.	VENEER/LAMINATE	ALL VENEER
 <p>Bookcase - 29" High**</p>	DB23615	15 x 36 x 29	92.5	90	9	\$1350	\$1617
	DB23015	15 x 30 x 29	92.5	90	8	\$1179	\$1416
	Includes one adjustable veneer shelf. Shelf is ¾" thick. Shipped assembled in 1 carton.						
 <p>Bookcase - 48" High**</p>	DB43615	15 x 36 x 48	100	140	15	\$1684	\$2019
	DB43015	15 x 30 x 48	92.5	140	13	\$1474	\$1768
	Includes two adjustable veneer shelves. Shelf is ¾" thick. Shipped assembled in 1 carton.						
 <p>Bookcase - 66" High**</p>	DB53615	15 x 36 x 66	100	188	21	\$2042	\$2451
	DB53015	15 x 30 x 66	92.5	188	17	\$1788	\$2143
	Includes five adjustable veneer shelves. Shelf is ¾" thick. Shipped assembled in 1 carton.						

Required Specifications

- Metal finish*
- Veneer finish (shelves)**
- Laminate finish (top/body)**

BOOKCASES

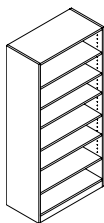

Bookcase - 72" High

MODEL#	DIMENSIONS D x W x H	FREIGHT CLASS	WT/LBS.	CUBIC FT.	VENEER/LAMINATE	ALL VENEER
DB63615	15 x 36 x 72	100	210	23	\$2214	\$2658
DB63015	15 x 30 x 72	92.5	210	19	\$1939	\$2326

Includes **six adjustable** veneer shelves. Shelf is 3/4" thick. Shipped assembled in 1 carton.

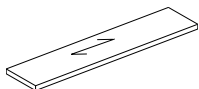

Tops 15" Deep

DT3617D	17 x 36 x 1	65	27	1	N/A	\$663
DT3017D	17 x 30 x 1	65	23	1	N/A	\$551

For use with 15" deep bookcases. Tops are 1" thick. Shipped assembled in 1 carton.

END SHELVES

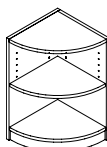

End Shelf - 29" High

MODEL#	DIMENSIONS	FREIGHT CLASS	WT/LBS.	CUBIC FT.	VENEER/LAMINATE	ALL VENEER
DB2R1515	15 x 15 x 29	100	37	4	\$1063	\$1275

For use at end of **worksurfaces or storage modules**. Includes one adjustable veneer shelf. Shipped assembled in 1 carton..

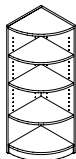

End Shelf - 48" High

DB4R1515	15 x 15 x 48	100	59	6	\$1323	\$1589
----------	--------------	-----	----	---	--------	--------

For use at end of **storage modules or wardrobe cabinets**. Includes **three adjustable** veneer shelves. Shipped assembled in 1 carton.

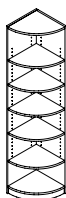

End Shelf - 66" High

DB5R1515	15 x 15 x 66	100	81	9	\$1610	\$1930
----------	--------------	-----	----	---	--------	--------

For use at end of **storage modules, wardrobe cabinets or personal towers**. Includes **five adjustable** veneer shelves. Shipped assembled in 1 carton.

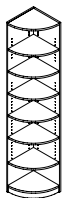

End Shelf - 72" High

DB6R1515	15 x 15 x 72	100	83	9	\$1748	\$2096
----------	--------------	-----	----	---	--------	--------

For use at end of **storage modules, wardrobe cabinets or personal towers**. Includes **six adjustable** veneer shelves. Shipped assembled in 1 carton.

Required Specifications

- Veneer finish (shelves)
- Laminate finish (top/body)

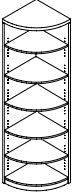
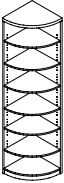
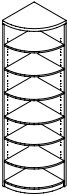
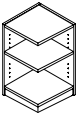
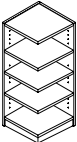
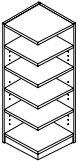
END SHELVES	MODEL#	DIMENSIONS	FREIGHT CLASS	WT/LBS.	CUBIC FT.	veneer/LAMINATE	ALL VENEER
 <p>End Shelf - 66" High</p>	D x W x H						
	DB7R2424	24 x 24 x 66	100	187	22	\$2934	\$3522
	DB7R2222	22 x 22 x 66	100	157	18	\$2554	\$3066
	DB7R2020	20 x 20 x 66	100	130	15	\$2436	\$2925
<p>For use at end of storage modules, wardrobe cabinets or personal towers. Includes five adjustable veneer shelves. Shipped assembled in 1 carton.</p>							
 <p>End Shelf - 72" High</p>	DB7R2424H72	24 x 24 x 72	125	204	28	\$3203	\$3843
	DB7R2222H72	22 x 22 x 72	100	171	20	\$2791	\$3346
	DB7R2020H72	20 x 20 x 72	100	142	17	\$2658	\$3190
	<p>For use at end of storage modules, wardrobe cabinets or personal towers. Includes six adjustable veneer shelves. Shipped assembled in 1 carton.</p>						
 <p>End Shelf - 84" High</p>	DB7R2424H84	24 x 24 x 84	100	234	28	\$3735	\$4481
	DB7R2222H84	22 x 22 x 84	100	189	20	\$3423	\$4106
	DB7R2020H84	20 x 20 x 84	100	163	19	\$3262	\$3915
	<p>For use at end of storage modules, wardrobe cabinets or personal towers. Includes seven adjustable veneer shelves. Shipped assembled in 1 carton.</p>						
 <p>End Shelf - 29" High - Square</p>	DB2S1515	15 x 15 x 29	100	37	4	\$1119	\$1345
<p>For use at end of worksurfaces or storage modules. Includes one adjustable veneer shelf. Shipped assembled in 1 carton.</p>							
 <p>End Shelf - 48" High - Square</p>	DB4S1515	15 x 15 x 48	100	59	6	\$1399	\$1674
<p>For use at end of storage modules or wardrobe cabinets. Includes three adjustable veneer shelves. Shipped assembled in 1 carton.</p>							
 <p>End Shelf - 66" High - Square</p>	DB5S1515	15 x 15 x 66	100	81	9	\$1695	\$2035
<p>For use at end of storage modules, wardrobe cabinets or personal towers. Includes five adjustable veneer shelves. Shipped assembled in 1 carton.</p>							

Required Specifications

- Veneer finish (shelves)
- Laminate finish (top/body)

D DUFFERIN

END SHELVES

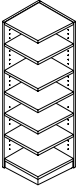

End Shelf - 72" High - Square

MODEL#	DIMENSIONS D x W x H	FREIGHT CLASS	WT./LBS.	CUBIC FT.	VENEER/LAMINATE	ALL VENEER
DB6S1515	15 x 15 x 72	100	83	9	\$1842	\$2209

For use at end of **storage modules, wardrobe cabinets or personal towers**. Includes **six adjustable** veneer shelves. Shipped assembled in 1 carton.

RECEPTION DESKS

- To add storage use storage shells. See pages 40-42.
- Includes GM1 grommet.
- Transaction tops to be specified separately, handed by square edge from user side.
- Decorative Front Panels should be specified separately. Size chosen should be 12" less than desk dimensions. Available in Reverse Diamond, Vertical Rib, Vertical Grain and Horizontal Grain Patterns.

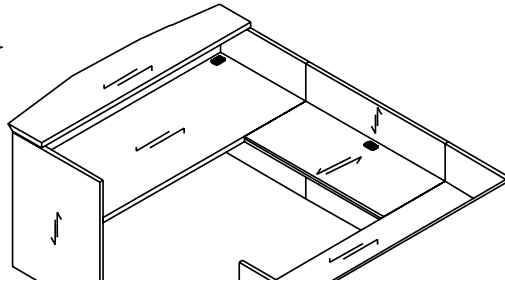
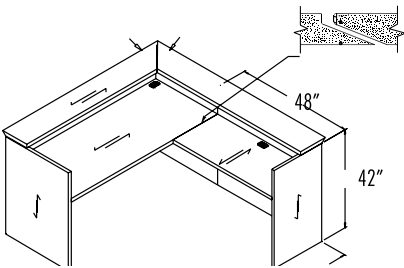

OPTION DETAILS

Decorative Front Panel (Reverse Diamond Pattern)
DGFDP5430F

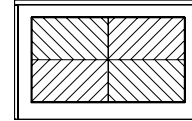

Decorative Front Panel (Vertical Rib Pattern)
DGFDP5430RIB

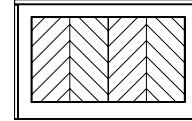

MODEL#	DIMENSIONS	FREIGHT CLASS	WT./LBS.	CUBIC FT.	VENEER/LAMINATE	ALL VENEER
DGC10836	36 x 108 x 42	150	533	95	\$6883	\$8257
DGC10236	36 x 102 x 42	150	503	89	\$6498	\$7798
DGC9636	36 x 96 x 42	150	473	84	\$6118	\$7340
DGC9036	36 x 90 x 42	150	444	79	\$5736	\$6884
DGC8436	36 x 84 x 42	150	414	74	\$5352	\$6420
DGC7236	36 x 72 x 42	150	355	63	\$4589	\$5505
DGC7230	30 x 72 x 42	150	315	53	\$4439	\$5327
DGC6630	30 x 66 x 42	125	295	48	\$4001	\$4799
DGC6030	30 x 60 x 42	125	275	44	\$4329	\$5192

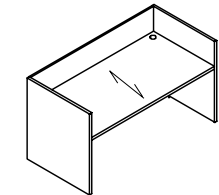

Gallery/Reception Desk Shell*

No pedestals. Two grommets in worksurface. For use with modular storage components. Shipped assembled in 1 carton.

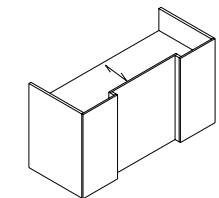

**Gallery/Reception Desk Shell
Breakfront Style**

DGIC10836	36 x 108 x 42	150	533	95	\$8454	\$10146
DGIC10236	36 x 102 x 42	150	503	89	\$7986	\$9582
DGIC9636	36 x 96 x 42	150	473	84	\$7517	\$9020
DGIC9036	36 x 90 x 42	150	444	79	\$7048	\$8457
DGIC8436	36 x 84 x 42	150	414	74	\$6578	\$7894
DGIC7236	36 x 72 x 42	150	355	63	\$5640	\$6768
DGIC7230	30 x 72 x 42	150	315	53	\$5455	\$6545
DGIC6630	30 x 66 x 42	125	295	48	\$5318	\$6383
DGIC6030	30 x 60 x 42	125	275	44	\$5019	\$6020

No pedestals. Two grommets in worksurface. For use with modular storage components. Shipped assembled in 1 carton.

Required Specifications

Veneer Finish
Laminate Finish

Optional Specifications

Additional Grommet (Reception Desks)
Decorative Panel*

Accessories

Storage Shells (Reception Desks)

RECEPTION DESKS

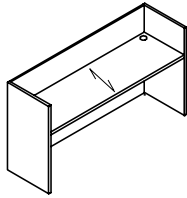

Gallery/Reception Credenza Shell*

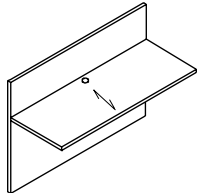

Bridge

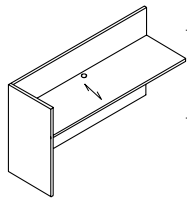

Reception Return - LEFT

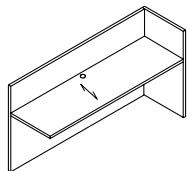

Reception Return - RIGHT

MODEL#	DIMENSIONS D x W x H	FREIGHT CLASS	WT/LBS.	CUBIC FT.	VENEER/LAMINATE	ALL VENEER
DGC10824	24 x 108 x 42	150	353	63	\$5394	\$6473
DGC10224	24 x 102 x 42	150	333	60	\$5095	\$6116
DGC9624	24 x 96 x 42	150	314	56	\$4794	\$5755
DGC9024	24 x 90 x 42	150	294	53	\$4495	\$5393
DGC8424	24 x 84 x 42	150	274	49	\$4193	\$5035
DGC7224	24 x 72 x 42	150	235	42	\$3599	\$4317
DGC6624	24 x 66 x 42	150	216	39	\$3382	\$4057
DGC6024	24 x 60 x 42	150	196	35	\$3167	\$3801

No pedestals. Two grommets in worksurface. For use with modular storage components. Shipped assembled in 1 carton.

DGBT5624CG	24 x 56 x 42	150	178	32	\$3018	\$3625
DGBT5424CG	24 x 54 x 42	150	169	29	\$3018	\$3625
DGBT5024CG	24 x 50 x 42	150	151	27	\$2682	\$3217
DGBT4824CG	24 x 48 x 42	150	142	26	\$2682	\$3217
DGBT4424CG	24 x 44 x 42	150	134	23	\$2348	\$2815
DGBT4224CG	24 x 42 x 42	150	127	22	\$2348	\$2815
DGBT3824CG	24 x 38 x 42	150	119	20	\$2115	\$2537
DGBT3624CG	24 x 36 x 42	150	112	19	\$2115	\$2537

Attaches between **Gallery Desk and Gallery Credenza Only**. One grommet in center of worksurface. Shipped assembled in 1 carton.

- To remove cross-grain veneer pattern on top, **delete "CG"** from model number. Available as a special - no upcharge.

DGRL7224	24 x 72 x 42	125	273	42	\$4530	\$5436
DGRL6624	24 x 66 x 42	125	250	39	\$4153	\$4984
DGRL6024	24 x 60 x 42	125	228	35	\$3778	\$4531
DGRL5424	24 x 54 x 42	125	205	32	\$3400	\$4081
DGRL4824	24 x 48 x 42	125	182	28	\$3025	\$3628
DGRL4224	24 x 42 x 42	125	159	25	\$2644	\$3173
DGRL3624	24 x 36 x 42	125	137	21	\$2381	\$2854

No pedestal. One grommet in center of worksurface. For use with modular storage components. Shipped assembled in 1 carton.

DGRR7224	24 x 72 x 42	125	273	42	\$4530	\$5436
DGRR6624	24 x 66 x 42	125	250	39	\$4153	\$4984
DGRR6024	24 x 60 x 42	125	228	35	\$3778	\$4531
DGRR5424	24 x 54 x 42	125	205	32	\$3400	\$4081
DGRR4824	24 x 48 x 42	125	182	28	\$3025	\$3628
DGRR4224	24 x 42 x 42	125	159	25	\$2644	\$3173
DGRR3624	24 x 36 x 42	125	137	21	\$2381	\$2854

No pedestal. One grommet in center of worksurface. For use with modular storage components. Shipped assembled in 1 carton.

Required Specifications

Veneer Finish
Laminate Finish

Optional Specifications

Additional grommet*
Decorative panel*

Accessories

Storage shells*

TRANSACTION TOPS

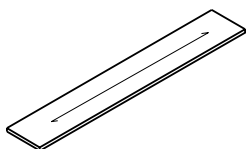

Transaction Counter Top

MODEL#	DIMENSIONS D x W x H	FREIGHT CLASS	WT./LBS.	CUBIC FT.	VENEER/LAMINATE	ALL VENEER
DGTT10810	10 x 108 x 1.50	100	78	8	N/A	\$1276
DGTT10210	10 x 102 x 1.50	92.5	72	7	N/A	\$1207
DGTT9610	10 x 96 x 1.50	100	66	7	N/A	\$1137
DGTT9010	10 x 90 x 1.50	92.5	60	6	N/A	\$1065
DGTT8410	10 x 84 x 1.50	100	54	6	N/A	\$994
DGTT7210	10 x 72 x 1.50	100	48	5	N/A	\$854
DGTT6610	10 x 66 x 1.50	100	42	5	N/A	\$780
DGTT6010	10 x 60 x 1.50	100	36	4	N/A	\$712

Rectangular top for main reception desk. Counter sits on top of Gallery panels. Does not overhang. **Factory installed - specify Gallery to be used on.** Size must match dimension of desk front or combined desk side and return length. Hardware included.

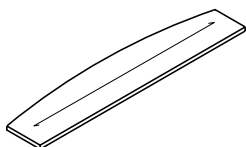

Bow Front Transaction Counter Top

DGTTM1081013	10-13 x 108 x 1.50	125	78	10	N/A	\$2551
DGTTM1021013	10-13 x 102 x 1.50	100	72	9	N/A	\$2831
DGTTM961013	10-13 x 96 x 1.50	125	66	9	N/A	\$2268
DGTTM901013	10-13 x 90 x 1.50	125	60	8	N/A	\$2126
DGTTM841013	10-13 x 84 x 1.50	125	54	8	N/A	\$1986
DGTTM721013	10-13 x 72 x 1.50	125	48	7	N/A	\$1702
DGTTM661013	10-13 x 66 x 1.50	125	42	6	N/A	\$1562
DGTTM601013	10-13 x 60 x 1.50	125	36	5	N/A	\$1418

Bow top for main reception desk. Counter sits on top of Gallery panels. Bow front overhangs 3". **Factory installed - specify Gallery to be used on.** Size must match dimension of desk front or combined desk side and return length. Hardware included.

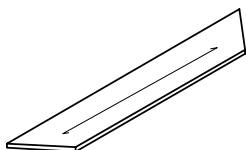

Trapezoid Transaction Counter Top

DGTTA10810	10 x 108 x 1.50	100	78	8	N/A	\$1449
DGTTA10210	10 x 102 x 1.50	92.5	72	7	N/A	\$1378
DGTTA9610	10 x 96 x 1.50	100	66	7	N/A	\$1307
DGTTA9010	10 x 90 x 1.50	92.5	60	6	N/A	\$1236
DGTTA8410	10 x 84 x 1.50	100	54	6	N/A	\$1168
DGTTA7210	10 x 72 x 1.50	100	48	5	N/A	\$1024
DGTTA6610	10 x 66 x 1.50	100	42	5	N/A	\$956
DGTTA6010	10 x 60 x 1.50	100	36	4	N/A	\$882

Trapezoid top for main reception desk. 45° mitered ends on left and right. For use with left and right 45° mitered return transaction counters. Counter sits on top of Gallery panels. Does not overhang. **Factory installed - specify Gallery to be used on.** Width must match dimension of desk front. Hardware included.

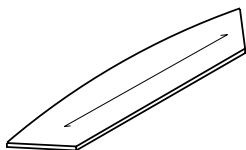

Bow Front Trapezoid Transaction Counter Top

DGTTMA1081013	10-13 x 108 x 1.50	125	78	10	N/A	\$2718
DGTTMA1021013	10-13 x 102 x 1.50	100	72	9	N/A	\$2578
DGTTMA961013	10-13 x 96 x 1.50	125	66	9	N/A	\$2437
DGTTMA901013	10-13 x 90 x 1.50	125	60	8	N/A	\$2296
DGTTMA841013	10-13 x 84 x 1.50	125	54	8	N/A	\$2158
DGTTMA721013	10-13 x 72 x 1.50	125	48	7	N/A	\$1872
DGTTMA661013	10-13 x 66 x 1.50	125	42	6	N/A	\$1729
DGTTMA601013	10-13 x 60 x 1.50	125	36	5	N/A	\$1591

Trapezoid bow top for main reception desk. 45° mitered ends on left and right. For use with left and right 45° mitered return transaction counters. Counter sits on top of Gallery panels. Bow front overhangs 3". **Factory installed - specify Gallery to be used on.** Width must match dimension of desk front. Hardware included.

Required Specifications
Veneer Finish

TRANSACTION TOPS	MODEL#	DIMENSIONS	FREIGHT CLASS	WT/LBS.	CUBIC FT.	VENEER/LAMINATE	ALL VENEER
		D x W x H					
	DGTTAL12010	10 x 120 x 1.50	92.5	84	8	N/A	\$1531
	DGTTAL11410	10 x 114 x 1.50	92.5	81	8	N/A	\$1455
	DGTTAL10810	10 x 108 x 1.50	100	78	8	N/A	\$1390
	DGTTAL10210	10 x 102 x 1.50	92.5	72	7	N/A	\$1321
	DGTTAL9610	10 x 96 x 1.50	100	66	7	N/A	\$1251
	DGTTAL9010	10 x 90 x 1.50	92.5	60	6	N/A	\$1178
	DGTTAL8410	10 x 84 x 1.50	100	54	6	N/A	\$1110
	DGTTAL7210	10 x 72 x 1.50	100	48	5	N/A	\$966
	DGTTAL6610	10 x 66 x 1.50	100	42	5	N/A	\$898
	DGTTAL6010	10 x 60 x 1.50	100	36	4	N/A	\$827
	DGTTAL3610	10 x 36 x 1.50	100	24	3	N/A	\$497
	DGTTAL3010	10 x 30 x 1.50	92.5	20	2	N/A	\$417
	DGTTAL2410	10 x 24 x 1.50	100	16	2	N/A	\$366

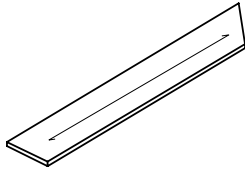

Transaction Counter Top - LEFT

Rectangular top for main reception desk with 45° mitered end on **left**. For use with rectangular or bow front transaction counters with miters at both ends. Width must match dimension of Gallery Desk end and Return width. Counter sits on top of Gallery panels. Does not overhang. **Factory installed - specify Gallery to be used on.** Hardware included.

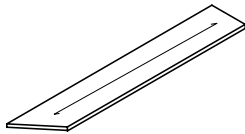

Transaction Counter Top - RIGHT

DGTTAR12010	10 x 120 x 1.50	92.5	84	8	N/A	\$1531
DGTTAR11410	10 x 114 x 1.50	92.5	81	8	N/A	\$1455
DGTTAR10810	10 x 108 x 1.50	100	78	8	N/A	\$1390
DGTTAR10210	10 x 102 x 1.50	92.5	72	7	N/A	\$1321
DGTTAR9610	10 x 96 x 1.50	100	66	7	N/A	\$1251
DGTTAR9010	10 x 90 x 1.50	92.5	60	6	N/A	\$1178
DGTTAR8410	10 x 84 x 1.50	100	54	6	N/A	\$1110
DGTTAR7210	10 x 72 x 1.50	100	48	5	N/A	\$966
DGTTAR6610	10 x 66 x 1.50	100	42	5	N/A	\$898
DGTTAR6010	10 x 60 x 1.50	100	36	4	N/A	\$827
DGTTAR3610	10 x 36 x 1.50	100	24	3	N/A	\$497
DGTTAR3010	10 x 30 x 1.50	92.5	20	2	N/A	\$417
DGTTAR2410	10 x 24 x 1.50	100	16	2	N/A	\$366

Rectangular top for main reception desk with 45° mitered end on **right**. For use with rectangular or bow front transaction counters with miters at both ends. Width must match dimension of Gallery Desk end and Return width. Counter sits on top of Gallery panels. Does not overhang. **Factory installed - specify Gallery to be used on.** Hardware included.

Required Specifications
Veneer Finish

RECEPTION DESKS

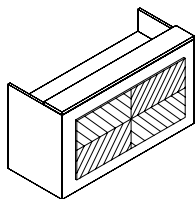

**Decorative Front Panel
Reverse Diamond Pattern**

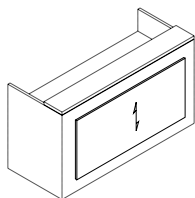

**Decorative Front Panel
Vertical Grain Pattern**

MODEL#	DIMENSIONS D x W x H	FREIGHT CLASS	WT./LBS.	CUBIC FT.	VENEER/LAMINATE	ALL VENEER
DGFDP9630F	1 x 96 x 30	92.5	81	8	N/A	\$2539
DGFDP9030F	1 x 90 x 30	100	78	8	N/A	\$2377
DGFDP8430F	1 x 84 x 30	92.5	72	7	N/A	\$2222
DGFDP7230F	1 x 72 x 30	100	66	7	N/A	\$1904
DGFDP6030F	1 x 60 x 30	92.5	60	6	N/A	\$1591
DGFDP5430F	1 x 54 x 30	100	54	6	N/A	\$1429
DGFDP4830F	1 x 48 x 30	100	48	5	N/A	\$1272

Raised decorative front panel for a reception desk. Size should be 12" less than desk dimensions. **Factory installed.** Hardware included.

DGFDP9630V	1 x 96 x 30	92.5	81	8	N/A	\$2210
DGFDP9030V	1 x 90 x 30	100	78	8	N/A	\$2069
DGFDP8430V	1 x 84 x 30	92.5	72	7	N/A	\$1936
DGFDP7230V	1 x 72 x 30	100	66	7	N/A	\$1657
DGFDP6030V	1 x 60 x 30	92.5	60	6	N/A	\$1381
DGFDP5430V	1 x 54 x 30	100	54	6	N/A	\$1249
DGFDP4830V	1 x 48 x 30	100	48	5	N/A	\$1105

Raised decorative front panel for a reception desk. Size should be 12" less than desk dimensions. **Factory installed.** Hardware included.

Required Specifications

Veneer finish

foundations





Contemporary. Minimal. Inspirational. **Foundations** desking draws upon a contemporary minimal aesthetic, paring down furniture structure and surface to its essence to reveal an architecture of simple horizontal and vertical planar elements.

Each piece is designed to serve the needs of a changing office landscape, elevating the look and function of the private office and taking into account the diverse uses of meeting rooms in the modern work environment. Designed by Christopher Wright.

Foundations components for the private office include modular desks, credenzas and wall storage units punctuated by niches set into the vertical plane of the unit. Personal items or work tools can be stored in niches, desks and storage components that combine to suit individual work styles.

Features and Benefits

- Workwalls support configurations or function as display backdrops
- Niches are designed to accept tackboards, remote-controlled LED lighting and flat screen monitors
- Wall units can be specified with LED lighting.
- Power, data and cable management accessories are available on any Foundations unit, including boardroom tables to meet exact requirements.
- A full array of complementary conference room furnishings are available to coordinate the entire office.



Open frame leg

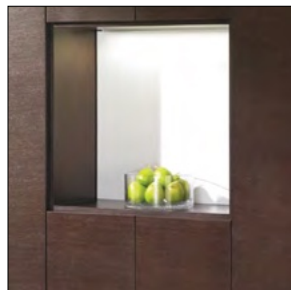

Workwall niche offers a surface, storage or display.

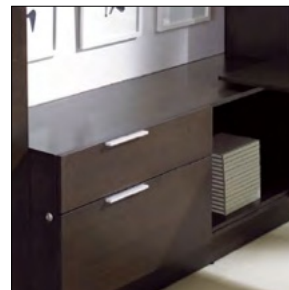

Workwall with integrated storage credenza.

GENERAL INFORMATION

- Foundations includes workwalls, single- and double-pedestal desks and executive desk extensions, bridges and transaction counters
- Storage components include credenzas, bench storage, wall-mounted and freestanding storage
- Two- or three-tone finish options allow for a distinctive aesthetic
- Executive desk extensions are supported by an open frame leg or elevated pedestals
- Modular wall units, pedestals and credenzas allow for scalable storage solutions; components accommodate L- and U-shaped configurations, as well as desk and workwall/credenza combinations.
- For environmental certification, please visit globalfurnituregroup.com

CONSTRUCTION

- Engineered veneer is real wood that through a manufacturing process of slicing, dyeing, gluing and re-slicing achieves consistent wood grain and color structure.
- Veneer is purchased by the block and sliced into a rift cut slip matched pattern to a thickness of 0.6mm (1/42"). Global lays up rift cut veneers in a slip match method.

FINISHES

- Conversion varnish (similar to catalyzed lacquer, but tougher), 25 degree sheen. Finishes are not buffed or rubbed.
- All Global wood casegood products are veneered and finished on the back sides (360° finishing), except modular under-surface storage - tops and backs are unfinished.
- Touch up kits available, includes a touch up marker and fill crayon. Order **VTOUCHUPKIT, \$175** list. Specify finish when ordering.
- Global standard finish, on oak and walnut, is open pore and on cherry and maple is semi-closed pore. If a full finish is required for walnut, cherry, anigre and maple tops, Add the suffix "2" to the finish code and Add 5% to the base pricing for each product.

CUSTOM FINISH IS AVAILABLE.

PEDESTALS AND CREDENZAS

- Suspended 7.5" off the floor by an open framed aluminum leg
- Locks are always located on the side panel.
- Handle placement is offset from the center, towards the lock
- Overall height is 26.5"
- Pedestal drawer suspensions are metal ball bearing type. Both box and file drawers are full extension.
- Hanging file rails are pre-installed on file drawer perimeters. The back rail in a lateral file drawer is designed for both letter and legal size filing.
- Drawer sides and bottoms are wrapped black vinyl.
- Drawer front is an applied element to a four sided drawer. Drawer fronts are veneered on all surfaces. Drawer fronts can be removed or replaced in the field.
- Leveling glides have 1" range of adjustment.

HARDWARE

- All necessary hardware to assemble the furniture is included in the shipment. Actual wall-attachment fasteners for wall cabinets and tackboards are not included due to variable site conditions.
- Hanging file rails are pre-installed on file drawer perimeters and accommodate both legal and letter size filing. Legal filing can be achieved either as side-to-side or front-to-back. Letter filing can be achieved as front-to-back filing only.
- Connecting brackets are used to attached bridges and returns to desk, and are shipped pre-attached to the bottom of the bridge or return. Additional screws are shipped in a plastic bag.

INSTALLATION

- **Wall-mounted cabinets and tackboards** are shipped with preattached horizontal wall rails at the back of each unit. The wall-side components must be detached from the unit and fastened to the wall accordingly. Wall fasteners are not included due to the variable site conditions. Securing the wall rail to a vertical structural member is the required manner of installation. The cabinet or tackboard is then lowered on to the wall rail. It is important to level the wall rail before installation. Wall cabinets are equipped with levelers at the bottom of the back panels for proper cabinet alignment. Units with doors are equipped with adjustable European door hinges to assist in door alignment. It is required to use a #8 wood screw through the back of the cabinet and the wall-mounted rail, to further secure the wall attachment. Tackboards have vertical grooves in the back for tasklight wiring.
- **Transaction counter and decorative panels** are shipped knock down. To assemble it follow the assembly instruction sheet included. To secure the transaction counter to the desk, double sided tape is applied to the bottom of the end panels. Included screws must be used to attach the decorative panel to the desk.
- **Modular storage units:** Have pre-drilled holes through the tops for securing to the bottom of the work surfaces. Screws and lock keys are included in a plastic bag fastened inside the pedestal. Pedestals may be installed flush or offset. Disassemble the modular unit first before relocating the entire unit to avoid damage or bodily injuries.
- **Work Walls:** Incorporate storage units, credenzas and niches of different sizes, attached to the base with connecting bolts. Upper units are installed with plastic dowels. Small connectors are supplied to secure the units thru the side panels. Complete assembly instruction is included with the wall unit. All necessary connectors and dowels are shipped in a plastic bag.
- **Credenza backpanels and display walls:** Optional credenza backpanels and display walls are attached to the units with supplied quick connectors. To assemble the display wall follow the assembly instructions included. All connectors and screws are shipped in a plastic bag.
- **Tables:** All table components are shipped in multiple boxes. Screws and table connectors are packed in a separate box identified with the label "Hardware Enclosed". Assembly instructions for specific tables are included.

F FOUNDATIONS - HOW TO SPECIFY

1. SPECIFY MODEL NUMBER

2. SPECIFY FINISH

WORKSURFACE TOP & DRAWER/DOOR FRONTS, BODY FINISHES (INCLUDING PEDESTALS) - VENEER

Foundations Engineered Veneer Finishes (Horizontal Grain Standard):

Code	Finish	Veneer Type	Cut
NTF	Natural	Maple Reconstituted	Rift
TLF	Twilight	Maple Reconstituted	Rift
CIF	Chai	White Oak Reconstituted	Rift
FGF	Fig	White Oak Reconstituted	Rift
STF	Sumatra	White Oak Reconstituted	Rift
MTF	Metro	White Oak Reconstituted	Rift
MSF	Mesa	White Oak Reconstituted	Rift
CHF	Cashmere	White Oak Reconstituted	Rift
SNF	Sienna	White Oak Reconstituted	Rift
WIF	Winter	White Oak Reconstituted	Rift

METAL LEG FINISH (Casegoods):

SGR Silver Glimmer

METAL LEG FINISHES (Conference Tables):

BLKT Black Textured
 TUNT Tungsten Textured
 DWTT Designer White Textured

3. SPECIFY OPTIONS

Handle

- Handles are standard on most drawers/storage modules.

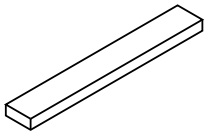

PL83 Anodized Aluminum, 7.2"

Edges

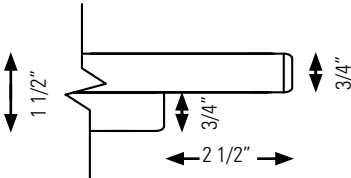

Edge Detail - Casegoods

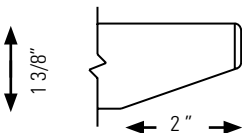

Edge Detail - Conference Tables

Grommets

- Standard grommet on all components is **GM5**. Grommets are included with products where shown in product line drawings.
- Optional grommets may be ordered in standard worksurface locations (left, center or right). Order as **GM5L, GM5C or GM5R**. **Add \$103.**
- Grommet hole dimensions are 3.5" x 2"
- Grommets available in Tungsten only

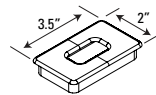

- Components that come standard with grommet may be ordered without a grommet. Order as **RSG** - **Add \$57.**
- View diagrams on the following pages for additional details.

For tops up to 24"D

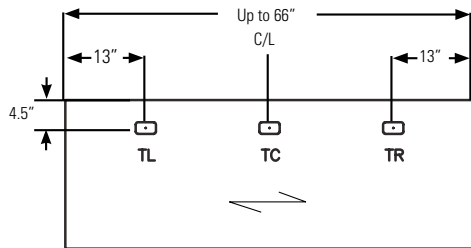
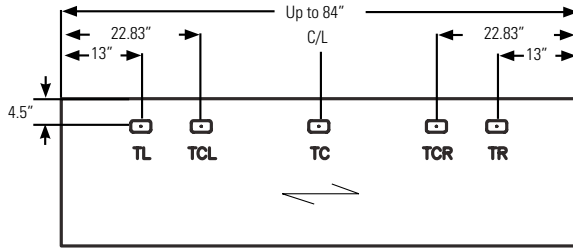

For tops 30" to 36"D

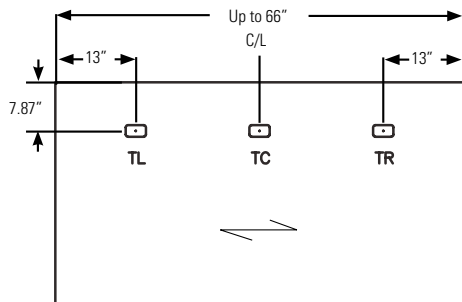
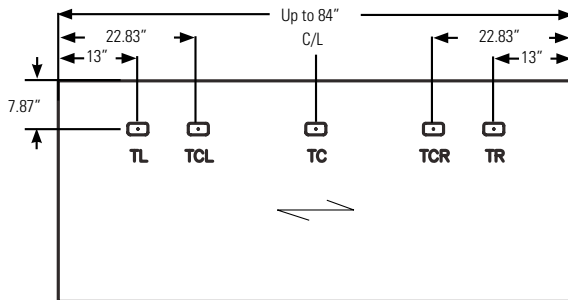

F FOUNDATIONS - NOTES

Optional Grommet Locations on Work Walls

Grommets and Grommet Locations must be specified.

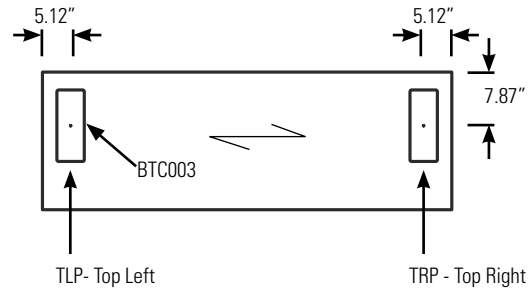
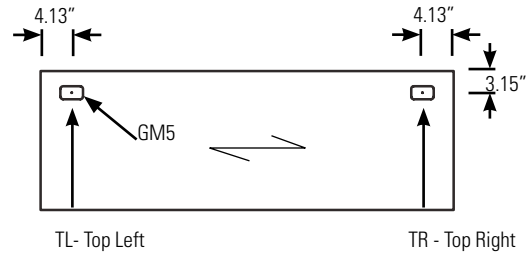
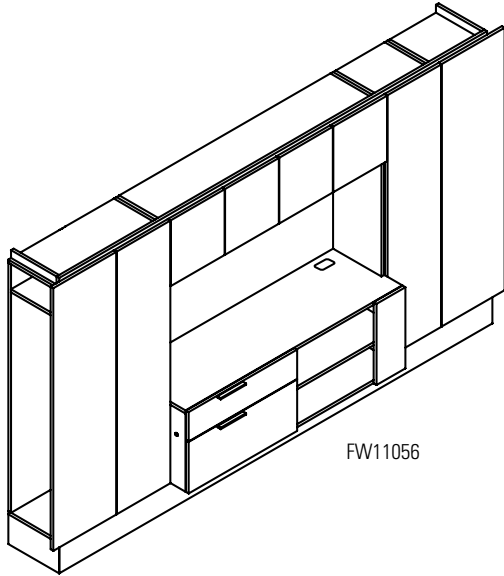

Standard Grommet Locations on Work Walls

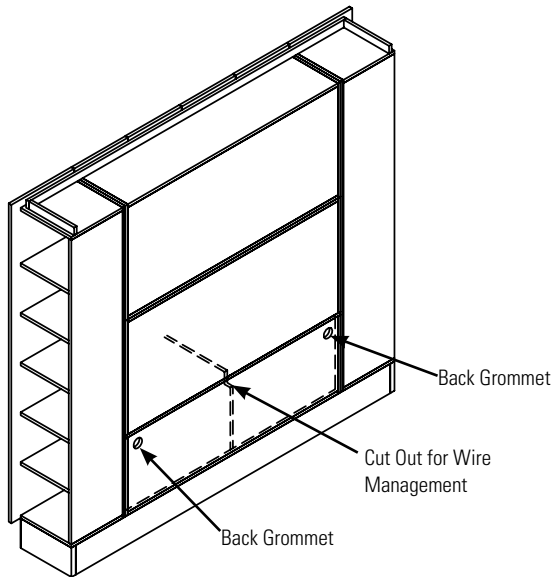

FW9570-IR Back View

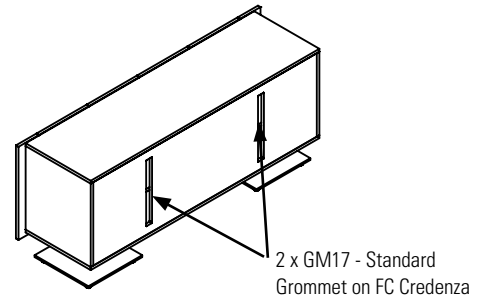
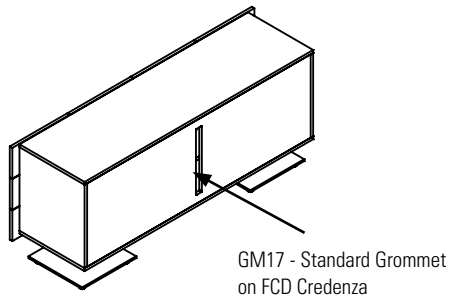
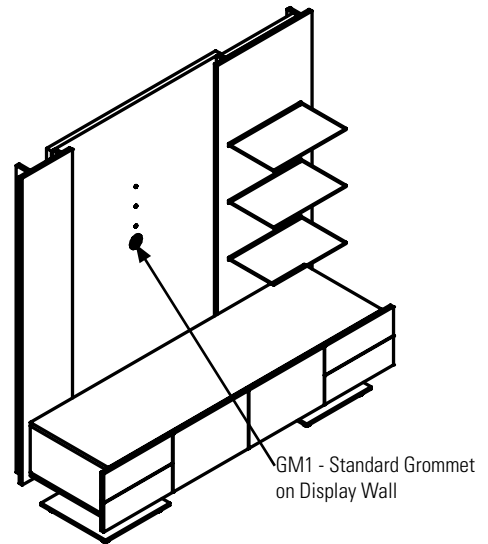

Work Wall Display Niches

- Available widths 15", 30", 45", 60" wide.
- Available heights 14", 28", 42" high.
- Maximum niche dimension 60" wide is 42" high.
- Maximum niche dimension 75" wide is 28" high.

When a niche is placed on 20" cantilevered storage there is no bottom. When a niche is placed between storage components it always has a bottom.

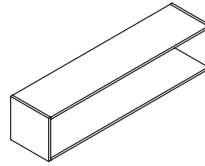
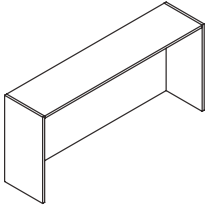

Work Wall Lighting

- LED lights for niches must be specified at time of manufacture. When more than one LED light is required in a work wall configuration, a single remote switch is included. Up to four LED lights can work off a single transformer.

Four sided niche with routed upper panel for LED light.

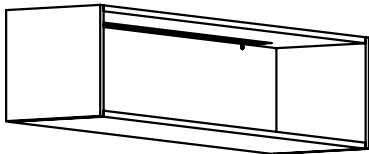

Niche is routed on inside top panel & back is drilled for wire pass through.

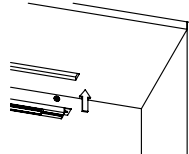

Open bottom niche with routed upper panel for LED light.

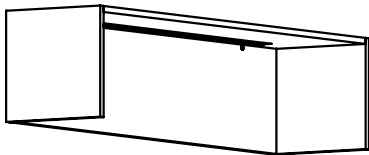

LED lights available in 12", 24", 36" and 48" widths.

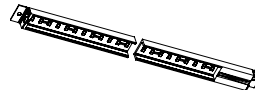

F FOUNDATIONS - NOTES

CONFERENCE TABLES DETAILS

Optional Grommet Locations for Conference Table Tops

Grommets and Grommet Locations must be specified.

For tables that are 48" wide and 96", 120", 144" or 168" long:

TCL - Top Center Left

TCR - Top Left

TC - Top Center

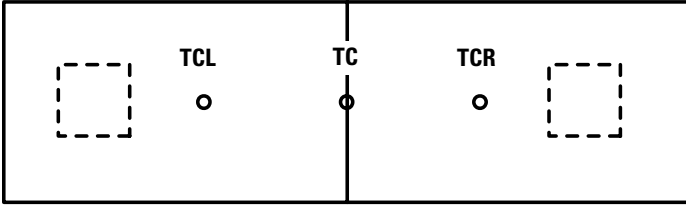

For tables that are 48" wide and 192" or 216" long and tables that are 60" wide and 168", 192", 216" or 240" long:

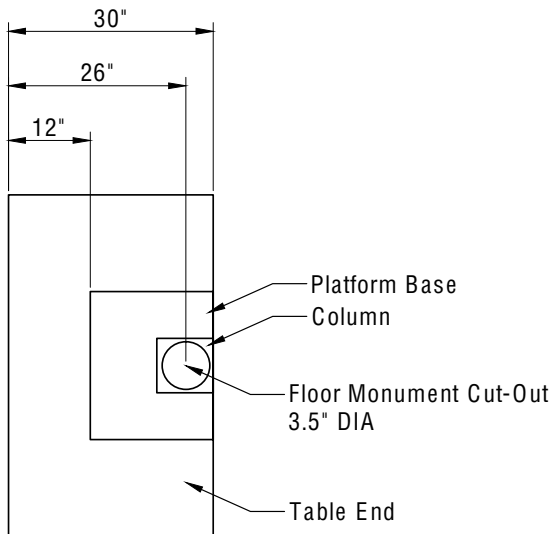
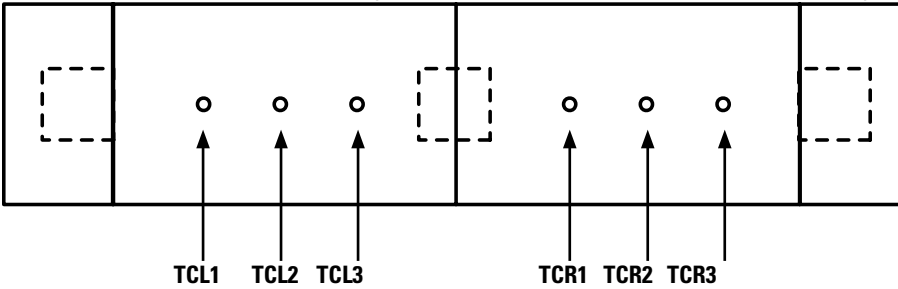

Conference Table Top and Base Guide

Conference Table, two piece Top with 3 Bases

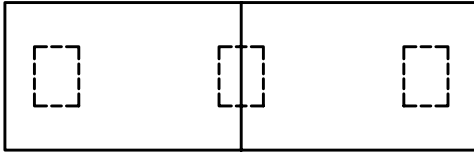

Sectional Conference Table with 3 Bases

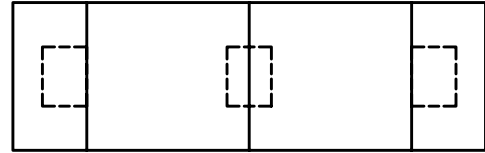

Conference Table, two piece Top with 2 Bases



Sectional Conference Table with 2 Bases



Conference Table, one piece Top with 2 Bases



Square Table Top with Mono Base

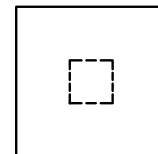

Sectional Conference Table with Technology Trough and 3 Bases

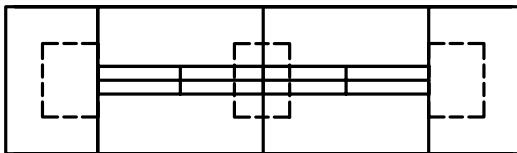

Round Table Top with Mono Base

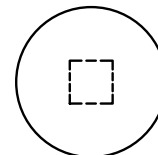

Sectional Conference Table with Technology Trough and 2 Bases

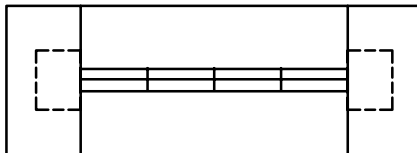

Sectional Conference Table with Technology Trough and 2 Bases



Note: Different Table Shapes are available.

Technology Trough Details

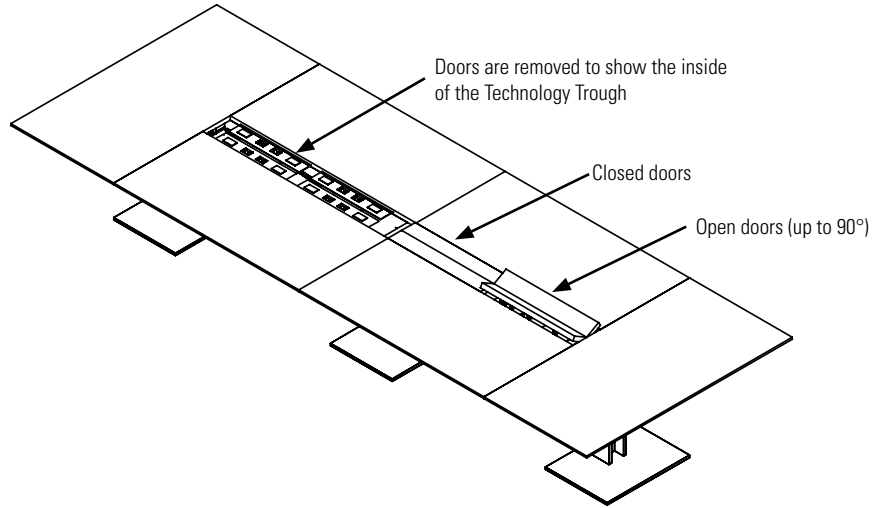

Side View

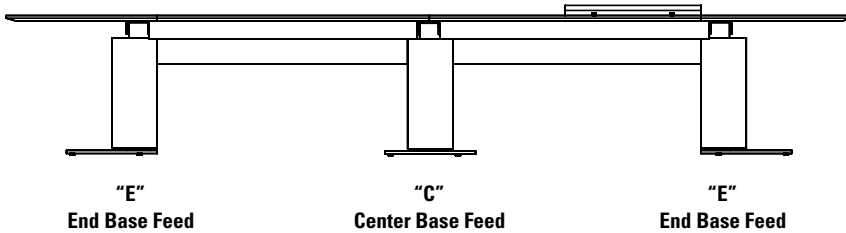

End View

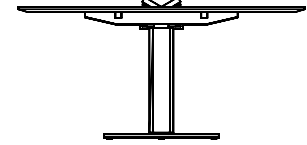

Power kits are included.

Two power receptacles and two telecom knockouts per door are standard.

Telecom plates will be shipped separately. If no telecom plate is specified, blank coverplate will be included.

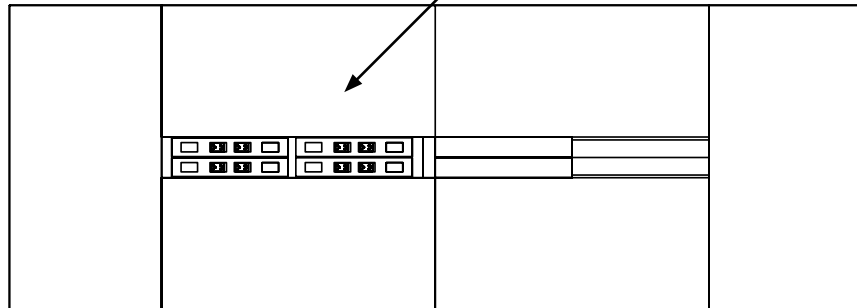
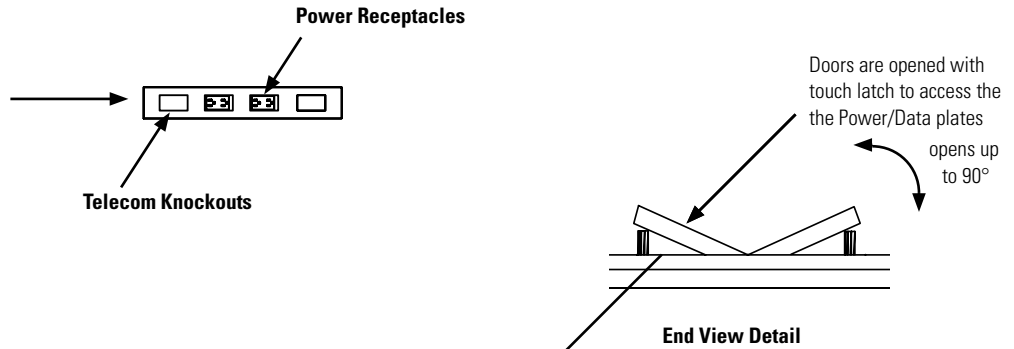

FINISH SPECIFICATIONS

Double and Single Pedestal Desks

- For desks two finishes can be specified.
- The first finish in the product string, indicated as #1.
- The second finish in the product string indicated as #2.
- If only one finish is indicated, the entire unit will be monotone.
- **Note:** Horizontal grain direction is standard on all engineered finishes. If natural veneer is required, the grain direction will be vertical. Arrow indicates direction of grain.

User Side

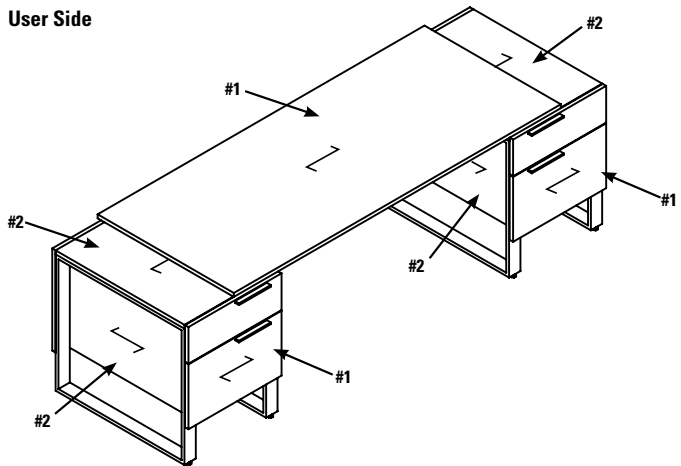

Back View

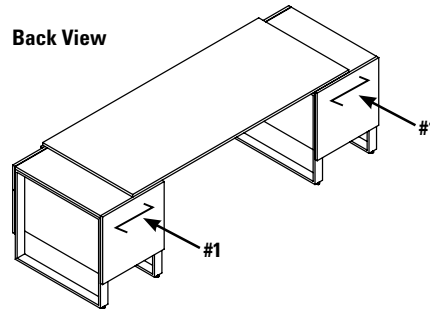

Transaction Counter and Decorative Panel

- For Transaction Counter and Decorative Panel, only one finish can be specified.
- Arrow indicates direction of grain

User Side

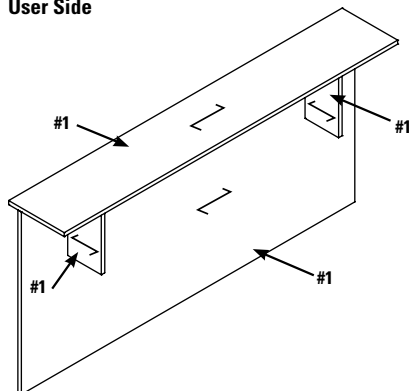

Back View

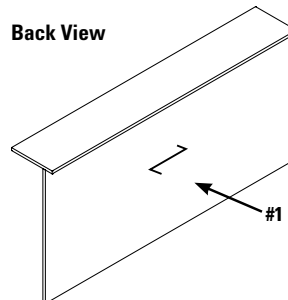

Pedestals

- For Pedestals, two finishes can be specified.
- The first finish in the product string, indicated as #1.
- The second finish in the product string indicated as #2.
- If only one finish is indicated, the entire unit will be monotone.

User Side

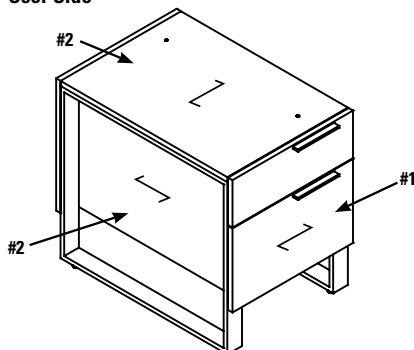

Back View

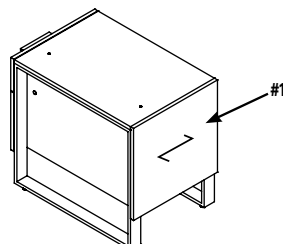

F FOUNDATIONS - NOTES

Lateral Files

- For Lateral Files two finishes can be specified.
- The first finish in the product string, indicated as **#1**.
- The second finish in the product string indicated as **#2**.
- If only one finish is indicated, the entire unit will be monotone.
- Arrow indicates direction of grain

User Side

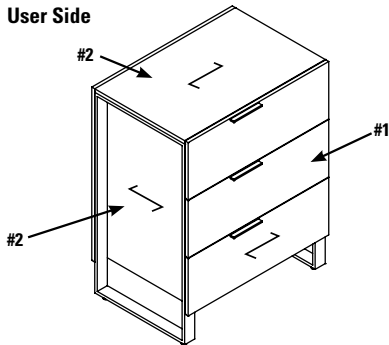

Back View

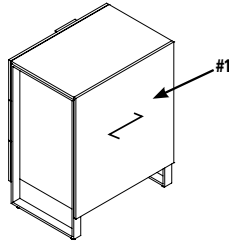

Mobile Pedestals

- For Mobile Pedestals, two finishes can be specified.
- The first finish in the product string, indicated as **#1**.
- The second finish in the product string indicated as **#2**.
- If only one finish is indicated, the entire unit will be monotone.
- Arrow indicates direction of grain

User Side

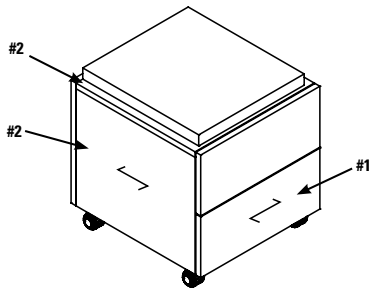

Back View

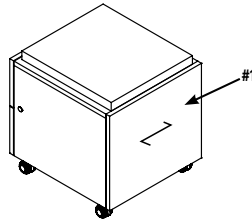

Benches

- For Benches, two finishes can be specified.
- The first finish in the product string, indicated as **#1**.
- The second finish in the product string indicated as **#2**.
- If only one finish is indicated, the entire unit will be monotone.
- Arrow indicates direction of grain

User Side

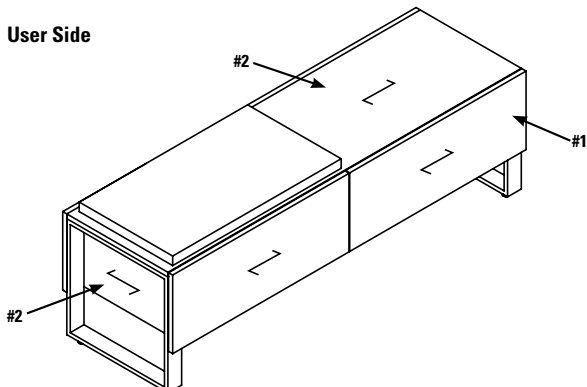

Back View

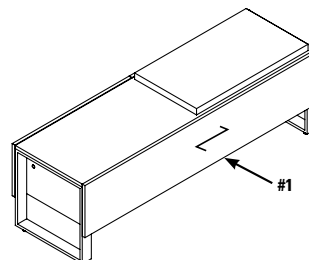

Credenzas

- For Credenzas, two finishes can be specified.
- The first finish in the product string, indicated as **#1**.
- The second finish in the product string indicated as **#2**.
- If only one finish is indicated, the entire unit will be monotone.
- Arrow indicates direction of grain

User Side

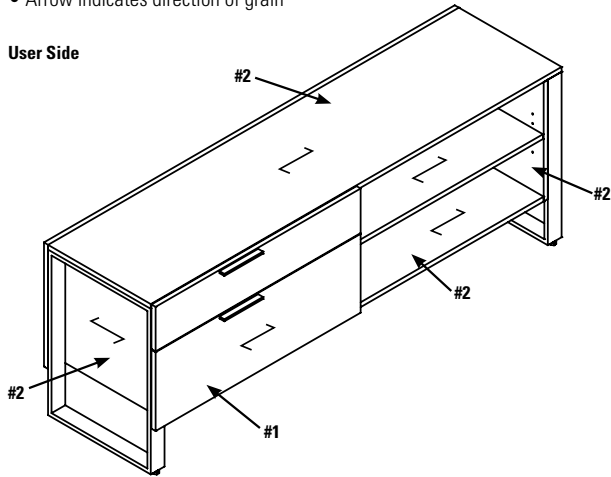

Back View

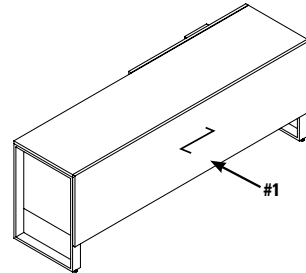

Modular Tops

- For Modular Tops, only one finish can be specified.
- Arrow indicates direction of grain

Isometric View

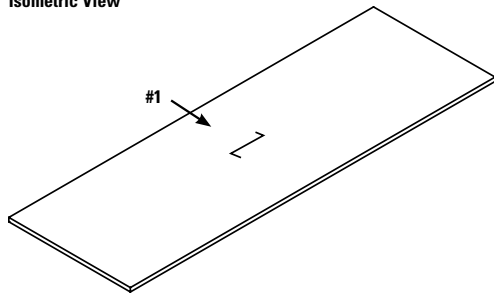

End View

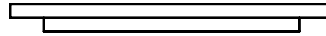

Wall Mounted Overheads

- For wall mounted overheads, two finishes can be specified.
- The first finish in the product string, indicated as **#1**.
- The second finish in the product string indicated as **#2**.
- If only one finish is indicated, the entire unit will be monotone.
- Arrow indicates direction of grain

User Side

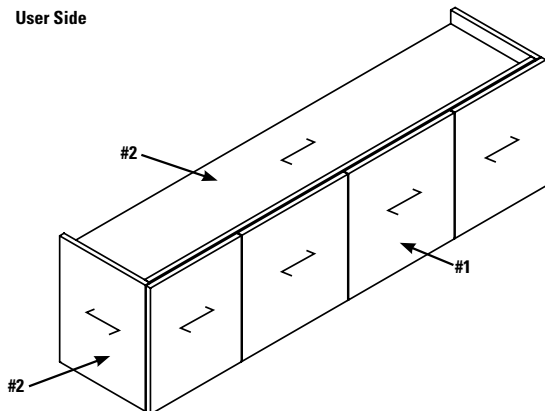

Back View

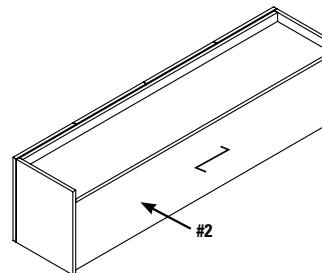

F FOUNDATIONS - NOTES

Work Wall Credenzas

- Two finishes can be specified.
- The first finish in the product string, indicated as **#1**.
- The second finish in the product string indicated as **#2**.
- If only one finish is indicated, the entire unit will be monotone.
- Arrow indicates direction of grain

User Side

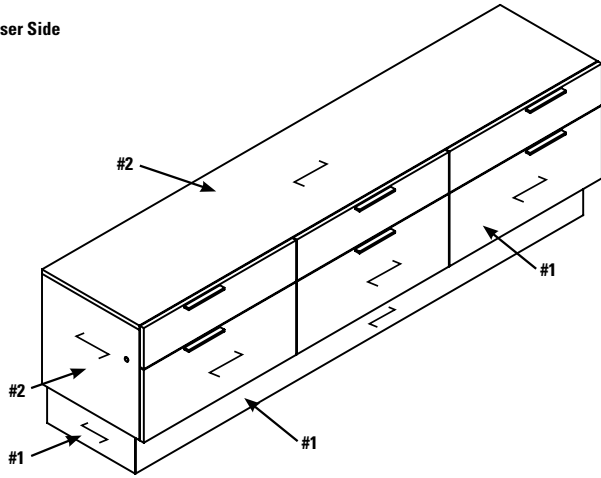

Back View

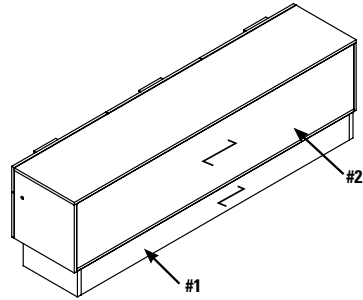

Work Wall Credenzas

- Three finishes can be specified.
- The first finish in the product string, indicated as **#1**.
- The second finish in the product string indicated as **#2**.
- The third finish in the product string indicated as **#3**.
- If only one finish is indicated, the entire unit will be monotone.
- Horizontal grain direction is standard on all engineered finishes. If natural veneer is required, the grain direction will be vertical. Arrow indicates direction of grain

Front View

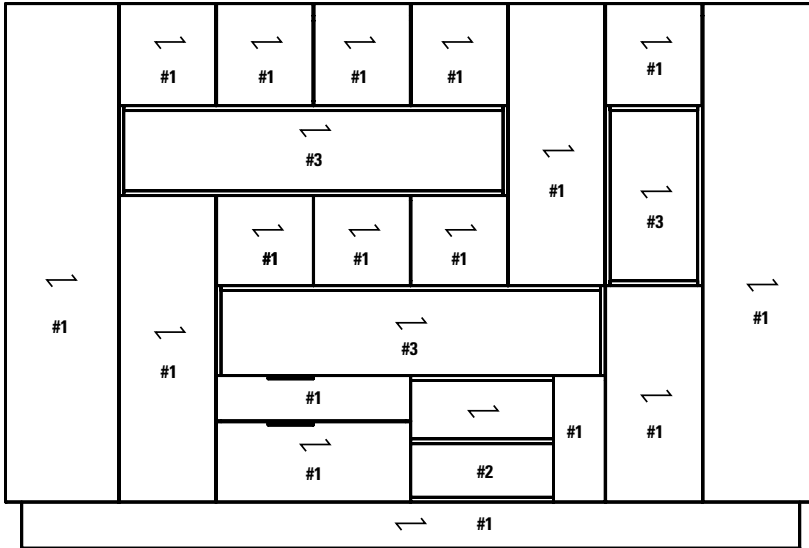

Side View

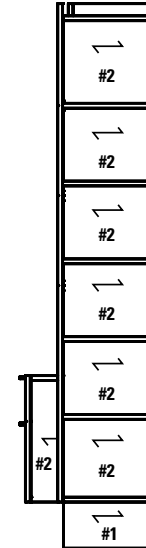

Isometric View

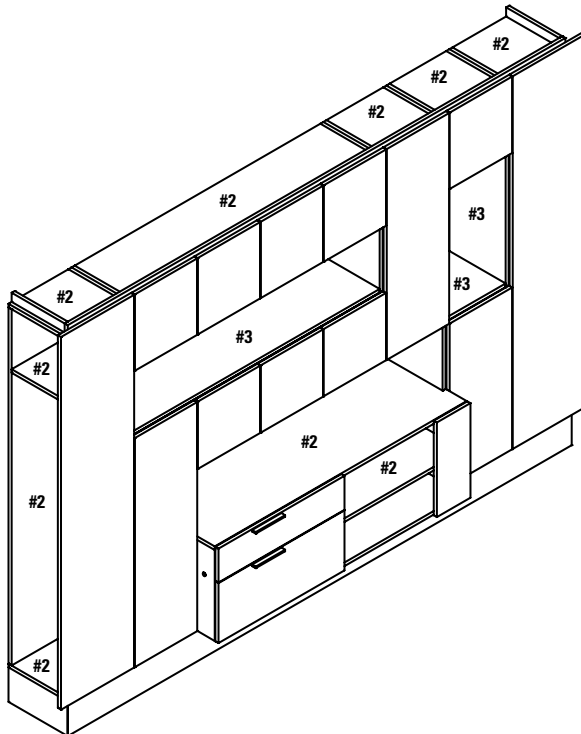

F FOUNDATIONS - NOTES

Sectional Top with two bases

- Two finishes can be specified.
- The first finish in the product string, indicated as #1.
- The second finish in the product string indicated as #2.
- If only one finish is indicated, the entire unit will be monotone.
- Arrow indicates direction of grain

Top View

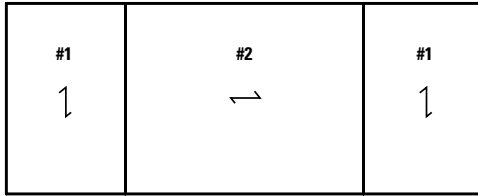

Side View

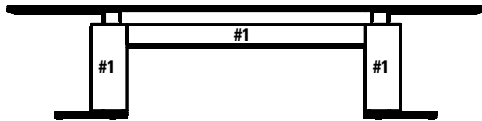

End View

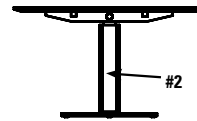

Sectional Top with Technology Trough and bases

- Three finishes can be specified.
- The first finish in the product string, indicated as #1.
- The second finish in the product string indicated as #2.
- The third finish in the product string indicated as #3.
- If only one finish is indicated, the entire unit will be monotone.
- Arrow indicates direction of grain

Top View

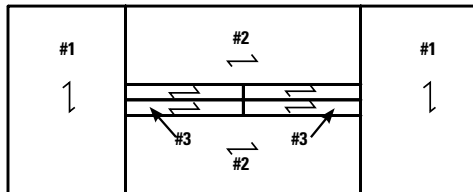

Side View

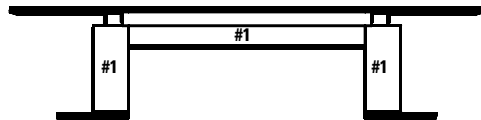

End View

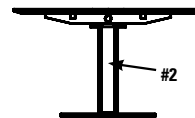

Full Storage Credenza with two sets of Storage Cabinets and Display Wall

- Two finishes can be specified.
- The first finish in the product string, indicated as #1.
- The second finish in the product string indicated as #2.
- If only one finish is indicated, the entire unit will be monotone.
- Arrow indicates direction of grain

Front View

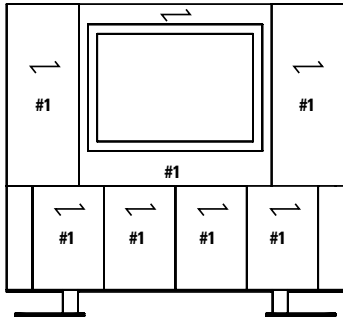

Side View

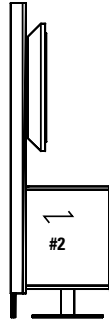

Top View

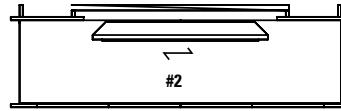

Full Storage Credenza with BBB, Storage Cabinet, BBB and Display Wall

- Two finishes can be specified.
- The first finish in the product string, indicated as #1.
- The second finish in the product string indicated as #2.
- If only one finish is indicated, the entire unit will be monotone.
- Arrow indicates direction of grain

Front View

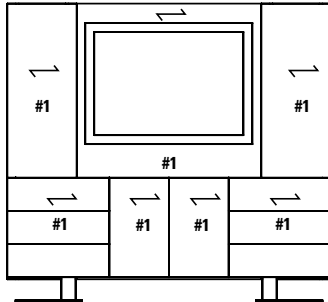

Side View

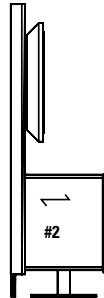

Top View

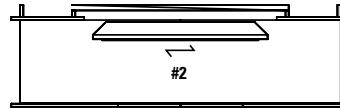

Full Storage Credenza with BB, Storage Cabinet, BB and Display Wall

- Two finishes can be specified.
- The first finish in the product string, indicated as #1.
- The second finish in the product string indicated as #2.
- If only one finish is indicated, the entire unit will be monotone.
- Arrow indicates direction of grain

Front View

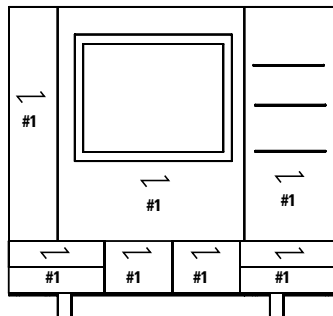

Side View

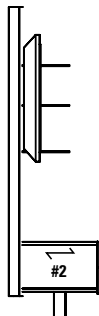

Top View

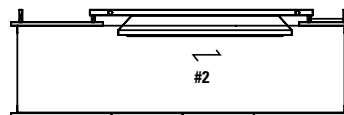

F FOUNDATIONS - NOTES

Lectern

- Two finishes can be specified.
- The first finish in the product string, indicated as **#1**.
- The second finish in the product string indicated as **#2**.
- If only one finish is indicated, the entire unit will be monotone.
- Arrow indicates direction of grain

FLEC-36 Lectern

Front View

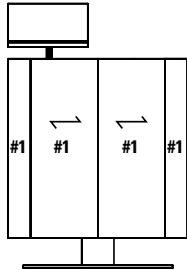

Side View

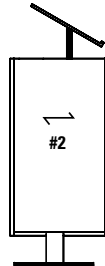

Top View

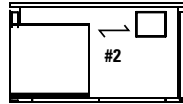

FLEC-24 Lectern

Front View

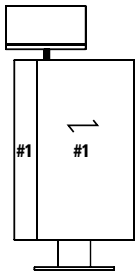

Side View

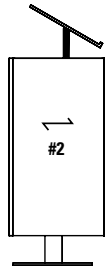

Top View

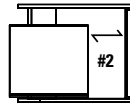

Mobile Units

- Two finishes can be specified.
- The first finish in the product string, indicated as **#1**.
- The second finish in the product string indicated as **#2**.
- If only one finish is indicated, the entire unit will be monotone.
- Arrow indicates direction of grain

Mobile Lectern

Front View

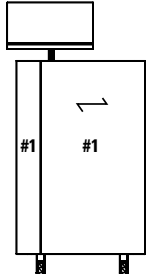

Side View

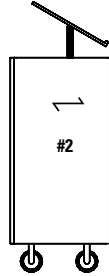

Top View

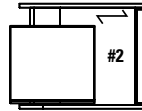

Mobile Tech Cart

Front View

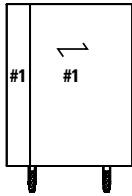

Side View

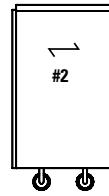

Top View

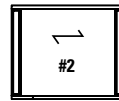

Mobile Server

Front View

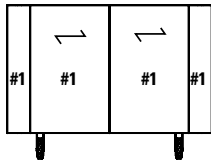

Side View

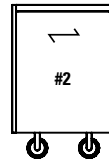

Top View

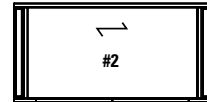

DESKS - NOTES

- Horizontal grain direction is standard on all engineered finishes.
- Tops are constructed with two 3/4" thick panels, laminated together to create a total thickness of 1.5".
- All pedestals are suspended 7.5" off the floor by an open framed leg, and can be installed flush or offset
- Pedestals are handed:
 - Left pedestals have the handle offset from the center to the right, and the lock is placed on the right end panel
 - Right pedestals have the handle offset from the center to the left, and the lock is placed on the left end panel
- Modesty panels are available as an optional upgrade in wood or glass on Desks
- Grommets are available as an option on Desks and most Credenzas.
- **NOTE:** Arrow indicates direction of grain

Double Pedestal Desk with Box/File installed flush.

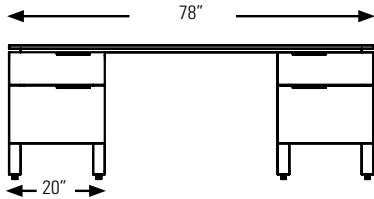

Double Pedestal Desk with Box/File installed offset.
Add 20" to the overall width of the top.

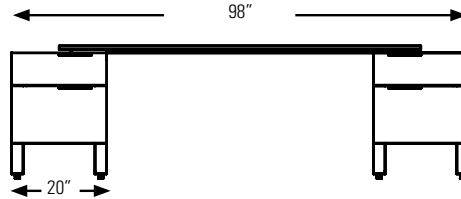

Single Pedestal Desk with Box/File installed flush.

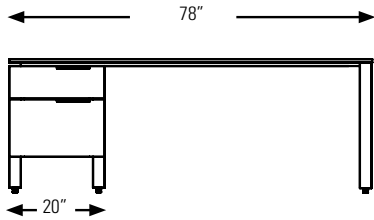

Single Pedestal Desk with Box/File installed offset.
Add 10" to the overall width of the top.

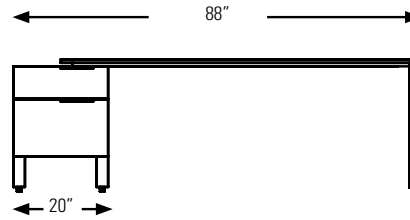

By adding a Transaction Counter Top with Decorative Front Panel (**FGTT**) to a Desk, the Desk can be used as a Reception Desk:

User View

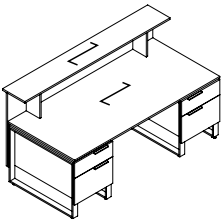

Guest View

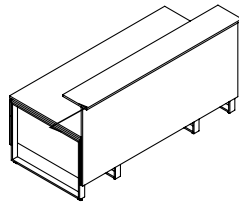

Required Specifications

Veneer Finish
Edge

Optional Specifications

Grommet

DOUBLE PEDESTAL DESKS

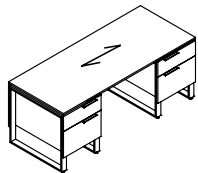

Double Pedestal Desk

MODEL#	DIMENSIONS D x W x H	FREIGHT CLASS	WT./LBS.	CUBIC FT.	LIST PRICE
FD8436BB	36 x 84 x 28	85	201	15	\$12195
FD7836BB	36 x 78 x 28	85	192	15	\$11957
FD7236BB	36 x 72 x 28	92.5	177	15	\$11660
FD8430BB	30 x 84 x 28	85	184	15	\$11587
FD7830BB	30 x 78 x 28	92.5	176	15	\$11397
FD7230BB	30 x 72 x 28	92.5	163	14	\$11125

Standard with **flush box/file** pedestals on **left** and **right**.

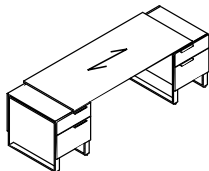

Double Pedestal Desk

FD8436BBOS	36 x 104 x 28	85	201	15	\$12578
FD7836BBOS	36 x 98 x 28	85	192	15	\$12344
FD7236BBOS	36 x 92 x 28	92.5	177	15	\$12042
FD8430BBOS	30 x 104 x 28	85	184	15	\$11975
FD7830BBOS	30 x 98 x 28	92.5	176	15	\$11783
FD7230BBOS	30 x 92 x 28	92.5	163	14	\$11511

Standard with **offset box/file** pedestals on **left** and **right**. Model # represents worksurface dimension only.

SINGLE PEDESTAL DESKS

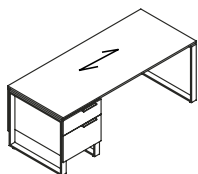

Single Pedestal Desk - LEFT

MODEL#	DIMENSIONS	FREIGHT CLASS	WT./LBS.	CUBIC FT.	LIST PRICE
FSL8436B	36 x 84 x 28	85	201	15	\$8872
FSL7836B	36 x 78 x 28	85	192	15	\$8634
FSL7236B	36 x 72 x 28	92.5	177	15	\$8310
FSL8430B	30 x 84 x 28	85	184	15	\$8265
FSL7830B	30 x 78 x 28	92.5	176	15	\$8071
FSL7230B	30 x 72 x 28	92.5	163	14	\$7803

Standard with **flush box/file** pedestal on **left**.

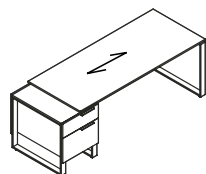

Single Pedestal Desk - LEFT

FSL8436BOS	36 x 94 x 28	85	201	15	\$9259
FSL7836BOS	36 x 88 x 28	85	192	15	\$9020
FSL7236BOS	36 x 82 x 28	92.5	177	15	\$8693
FSL8430BOS	30 x 94 x 28	85	184	15	\$8650
FSL7830BOS	30 x 88 x 28	92.5	176	15	\$8461
FSL7230BOS	30 x 82 x 28	92.5	163	14	\$8188

Standard with **offset box/file** pedestal on **left**. Model # represents worksurface dimension only.

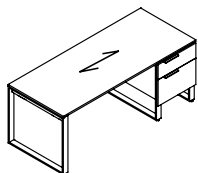

Single Pedestal Desk - RIGHT

FSR8436B	36 x 84 x 28	85	201	15	\$8872
FSR7836B	36 x 78 x 28	85	192	15	\$8634
FSR7236B	36 x 72 x 28	92.5	177	15	\$8310
FSR8430B	30 x 84 x 28	85	184	15	\$8265
FSR7830B	30 x 78 x 28	92.5	176	15	\$8071
FSR7230B	30 x 72 x 28	92.5	163	14	\$7803

Standard with **flush box/file** pedestal on **right**.

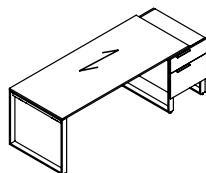

Single Pedestal Desk - RIGHT

FSR8436BOS	36 x 94 x 28	85	201	15	\$9259
FSR7836BOS	36 x 88 x 28	85	192	15	\$9020
FSR7236BOS	36 x 82 x 28	92.5	177	15	\$8693
FSR8430BOS	30 x 94 x 28	85	184	15	\$8650
FSR7830BOS	30 x 88 x 28	92.5	176	15	\$8461
FSR7230BOS	30 x 82 x 28	92.5	163	14	\$8188

Standard with **offset box/file** pedestal on **right**. Model # represents worksurface dimension only.

Required Specifications

Top finish
Body finish

Optional Specifications

Grommet
Modesty Panel

F FOUNDATIONS

DESK SHELL

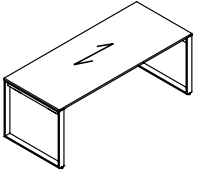

Desk Shell*

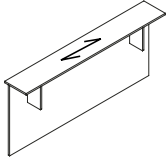

Transaction Counter

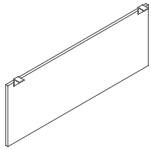

Hanging Wood Modesty Panel

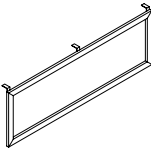

Hanging Glass Modesty Panel

MODEL#	DIMENSIONS	FREIGHT CLASS	WT/LBS.	CUBIC FT.	LIST PRICE
--------	------------	---------------	---------	-----------	------------

D x W x H

FT7236	36 x 72 x 28	85	201	15	\$5851
FT6636	36 x 66 x 28	85	192	15	\$5585
FT6036	36 x 60 x 28	92.5	177	15	\$5337
FT7230	30 x 72 x 28	85	184	15	\$5142
FT6630	30 x 66 x 28	92.5	176	15	\$4938
FT6030	30 x 60 x 28	92.5	163	14	\$4738

FGTT8412	12 x 84 x 42	250	73	21	\$3905
FGTT7812	12 x 78 x 42	250	68	19	\$3743
FGTT7212	12 x 72 x 42	250	63	18	\$3495

Rectangular transaction counter with decorative panel.

FCMP70W	0.75 x 70 x 18	--	25	1	\$1746
FCMP66W	0.75 x 66 x 18	--	24	1	\$1707
FCMP64W	0.75 x 64 x 18	--	23	1	\$1693
FCMP62W	0.75 x 62 x 18	--	22	1	\$1674
FCMP60W	0.75 x 60 x 18	--	22	1	\$1504
FCMP58W	0.75 x 58 x 18	--	21	1	\$1652
FCMP56W	0.75 x 56 x 18	--	20	1	\$1646
FCMP54W	0.75 x 54 x 18	--	20	1	\$1637
FCMP50W	0.75 x 50 x 18	--	18	1	\$1621
FCMP48W	0.75 x 48 x 18	--	18	1	\$1613
FCMP42W	0.75 x 42 x 18	--	16	1	\$1504
FCMP36W	0.75 x 36 x 18	--	14	1	\$1292
FCMP30W	0.75 x 30 x 18	--	12	1	\$1080

Hanging wood modesty panel. Attaches to underside of worksurface. **Cannot be retrofitted in the field.**

Not sold individually - to be ordered as an upgrade option only.

FCMP70G	0.75 x 70 x 18	--	25	1	\$2812
FCMP66G	0.75 x 66 x 18	--	24	1	\$2722
FCMP64G	0.75 x 64 x 18	--	23	1	\$2659
FCMP62G	0.75 x 62 x 18	--	22	1	\$2511
FCMP60G	0.75 x 60 x 18	--	22	1	\$2141
FCMP58G	0.75 x 58 x 18	--	21	1	\$2367
FCMP56G	0.75 x 56 x 18	--	20	1	\$2348
FCMP54G	0.75 x 54 x 18	--	20	1	\$2266
FCMP50G	0.75 x 50 x 18	--	18	1	\$2205
FCMP48G	0.75 x 48 x 18	--	18	1	\$2165
FCMP42G	0.75 x 42 x 18	--	16	1	\$2141
FCMP36G	0.75 x 36 x 18	--	14	1	\$2124
FCMP30G	0.75 x 30 x 18	--	12	1	\$2101

Aluminum framed glass modesty panel with frosted glass (standard). Attaches to underside of worksurface. **Cannot be retrofitted in the field. Not sold individually - to be ordered as an upgrade option only.**

• For white back painted glass, please contact Customer Care for pricing.

Required Specifications

Top finish
Body finish

Optional Specifications

Grommet
Modesty Panel*

CRENZAS - NOTES

D x W x H

- Horizontal grain direction is standard on all engineered finishes.
- Tops are constructed with two 3/4" thick panels, laminated together to create a total thickness of 1.5".
- All pedestals are suspended 7.5" off the floor by an open framed leg, and can be installed flush or offset
- Pedestals are handed:
 - Left pedestals have the handle offset from the center to the right, and the lock is placed on the right end panel
 - Right pedestals have the handle offset from the center to the left, and the lock is placed on the left end panel
- Modesty panels are available in wood or glass
- Grommets can be specified on Credenza Tops.
- **NOTE:** Arrow indicates direction of grain

Single Pedestal Credenza with 35" Lat. Box/File installed flush

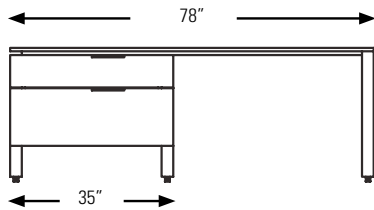

Single Pedestal Credenza with 35" Lat. Box/File installed offset
Adds 10" to overall width

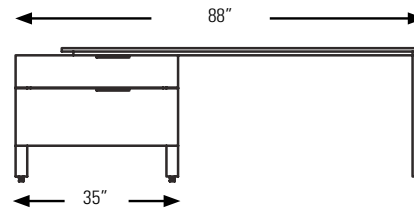

Single Pedestal Credenza with 40" Lat. Box/File installed flush.

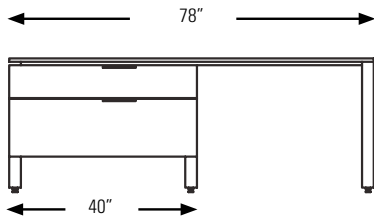

Double Pedestal Credenza with 40" Lat. Box/File installed offset.
Adds 10" to overall width

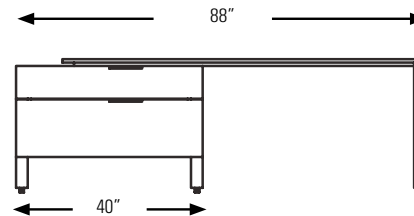

SINGLE PEDESTAL CRENZAS	MODEL#	DIMENSIONS	FREIGHT CLASS	WT/LBS.	CUBIC FT.	LIST PRICE
-------------------------	--------	------------	---------------	---------	-----------	------------

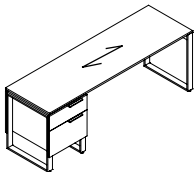

Single Pedestal Credenza - LEFT

FCCL7824B	24 x 78 x 28	85	160	12	\$8009
FCCL7224B	24 x 72 x 28	85	151	12	\$7753
FCCL7820B	20 x 78 x 28	85	153	11	\$7520
FCCL7220B	20 x 72 x 28	85	144	11	\$7284

Standard with **flush box/file** pedestal on **left**.

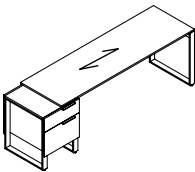

Single Pedestal Credenza - LEFT

FCCL7824BOS	24 x 88 x 28	85	160	12	\$8059
FCCL7224BOS	24 x 82 x 28	85	151	12	\$7753
FCCL7820BOS	20 x 88 x 28	85	153	11	\$7573
FCCL7220BOS	20 x 82 x 28	85	144	11	\$7284

Standard with **offset box/file** pedestal on **left**. Model # represents worksurface dimension only.

Required Specifications

Top finish
Body finish

Optional Specifications

Grommet

F FOUNDATIONS

SINGLE PEDESTAL CREDENZAS

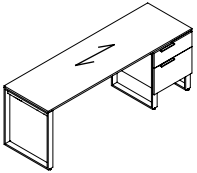

Single Pedestal Credenza - RIGHT

MODEL#	DIMENSIONS D x W x H	FREIGHT CLASS	WT./LBS.	CUBIC FT.	LIST PRICE
FCCR7824B	24 x 78 x 28	85	160	12	\$8009
FCCR7224B	24 x 72 x 28	85	151	12	\$7753
FCCR7820B	20 x 78 x 28	85	153	11	\$7520
FCCR7220B	20 x 72 x 28	85	144	11	\$7284

Standard with **flush box/file** pedestal on **right**.

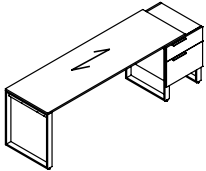

Single Pedestal Credenza - RIGHT

FCCR7824BOS	24 x 88 x 28	85	160	12	\$8059
FCCR7224BOS	24 x 82 x 28	85	151	12	\$7753
FCCR7820BOS	20 x 88 x 28	85	153	11	\$7573
FCCR7220BOS	20 x 82 x 28	85	144	11	\$7284

Standard with **offset box/file** pedestal on **right**. Model # represents worksurface dimension only.

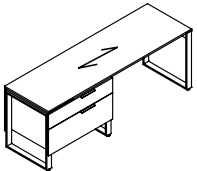

Single Pedestal Credenza - LEFT

FCC35L7824H	24 x 78 x 28	92.5	188	18	\$8639
FCC35L7224H	24 x 72 x 28	100	179	18	\$8381
FCC35L7820H	20 x 78 x 28	92.5	179	15	\$8106
FCC35L7220H	20 x 72 x 28	92.5	170	15	\$7868

Standard with **flush 35" lateral box/file** pedestal on **left**.

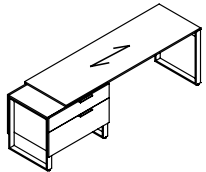

Single Pedestal Credenza - LEFT

FCC35L7824HOS	24 x 88 x 28	92.5	188	18	\$8985
FCC35L7224HOS	24 x 82 x 28	100	179	18	\$8725
FCC35L7820HOS	20 x 88 x 28	92.5	179	15	\$8454
FCC35L7220HOS	20 x 82 x 28	92.5	170	15	\$8215

Standard with **offset 35" lateral box/file** pedestal on **left**. Model # represents worksurface dimension only.

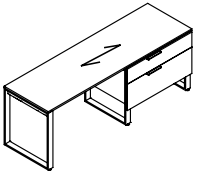

Single Pedestal Credenza - RIGHT

FCC35R7824H	24 x 78 x 28	92.5	188	18	\$8639
FCC35R7224H	24 x 72 x 28	100	179	18	\$8381
FCC35R7820H	20 x 78 x 28	92.5	179	15	\$8106
FCC35R7220H	20 x 72 x 28	92.5	170	15	\$7868

Standard with **flush 35" lateral box/file** pedestal on **right**.

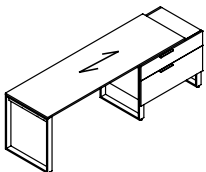

Single Pedestal Credenza - RIGHT

FCC35R7824HOS	24 x 88 x 28	92.5	188	18	\$8985
FCC35R7224HOS	24 x 82 x 28	100	179	18	\$8725
FCC35R7820HOS	20 x 88 x 28	92.5	179	15	\$8454
FCC35R7220HOS	20 x 82 x 28	92.5	170	15	\$8215

Standard with **offset 35" lateral box/file** pedestal on **right**. Model # represents worksurface dimension only.

Required Specifications

Top finish
Body finish

Optional Specifications

Grommet

SINGLE PEDESTAL CREDENZAS

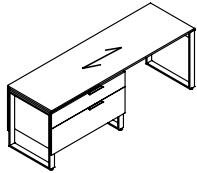

Single Pedestal Credenza - LEFT

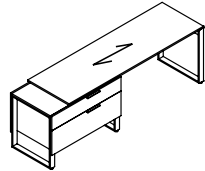

Single Pedestal Credenza - LEFT

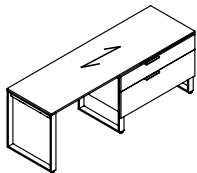

Single Pedestal Credenza - RIGHT

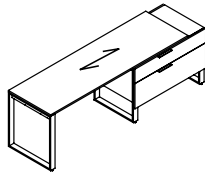

Single Pedestal Credenza - RIGHT

MODEL#	DIMENSIONS D x W x H	FREIGHT CLASS	WT/LBS.	CUBIC FT.	LIST PRICE
FCC40L7824H	24 x 78 x 28	100	198	20	\$8939
FCC40L7224H	24 x 72 x 28	100	189	20	\$9029
FCC40L7820H	20 x 78 x 28	92.5	188	17	\$8493
FCC40L7220H	20 x 72 x 28	92.5	179	17	\$8252

Standard with **flush 40" lateral box/file** pedestal on **left**.

FCC40L7824HOS	24 x 88 x 28	100	198	20	\$9284
FCC40L7224HOS	24 x 82 x 28	100	189	20	\$9029
FCC40L7820HOS	20 x 88 x 28	92.5	188	17	\$8837
FCC40L7220HOS	20 x 82 x 28	92.5	179	17	\$8599

Standard with **offset 40" lateral box/file** pedestal on **left**. Model # represents worksurface dimension only.

FCC40R7824H	24 x 78 x 28	100	198	20	\$8939
FCC40R7224H	24 x 72 x 28	100	189	20	\$9029
FCC40R7820H	20 x 78 x 28	92.5	188	17	\$8493
FCC40R7220H	20 x 72 x 28	92.5	179	17	\$8252

Standard with **flush 40" lateral box/file** pedestal on **right**.

FCC40R7824HOS	24 x 88 x 28	100	198	20	\$9284
FCC40R7224HOS	24 x 82 x 28	100	189	20	\$9029
FCC40R7820HOS	20 x 88 x 28	92.5	188	17	\$8837
FCC40R7220HOS	20 x 82 x 28	92.5	179	17	\$8599

Standard with **offset 40" lateral box/file** pedestal on **right**. Model # represents worksurface dimension only.

Required Specifications

Top finish
Body finish

Optional Specifications

Grommet

FULL STORAGE CREDENZAS - NOTES

D x W x H

- Horizontal grain direction is standard on all engineered finishes.
- Tops are 3/4" thick with flat edge.
- All pedestals are suspended 7.5" off the floor by an open framed leg, and can be installed flush or offset.
- Handles are standard on all drawer fronts.
- Doors will open with touch latch.
- Units placed on the left have the handle offset from the center to the left, and the lock is placed on the left side panel.
- Units placed on the right have the handle offset from the center to the right, and the lock is placed on the right side panel.
- Units intended to be used with overlapping bridges or returns.
- **NOTE:** Arrow indicates direction of grain

FULL STORAGE CREDENZAS

MODEL# DIMENSIONS FREIGHT CLASS WT/LBS. CUBIC FT. LIST PRICE

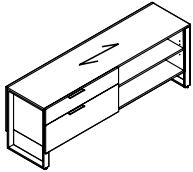

Storage Credenza

FCC7424HO	24 x 74.5 x 26.75	125	203	29	\$7809
FCC6424HO	24 x 64.5 x 26.75	125	186	25	\$6884
FCC7420HO	20 x 74.5 x 26.75	125	187	24	\$7440
FCC6420HO	20 x 64.5 x 26.75	100	171	21	\$6545

Standard with **lateral box/file** on **left** and **open storage** on **right**. Handle and lock on left.

- If using in a freestanding application, must specify modular top.

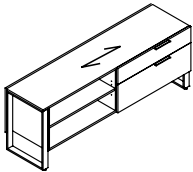

Storage Credenza

FCC7424OH	24 x 74.5 x 26.75	125	203	29	\$7809
FCC6424OH	24 x 64.5 x 26.75	125	186	25	\$6884
FCC7420OH	20 x 74.5 x 26.75	125	187	24	\$7440
FCC6420OH	20 x 64.5 x 26.75	100	171	21	\$6545

Standard with **open storage** on **left** and **lateral box/file** on **right**. Handle and lock on right.

- If using in a freestanding application, must specify modular top.

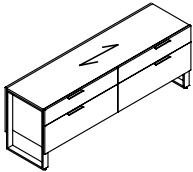

Storage Credenza

FCC7424HH	24 x 74.5 x 26.75	100	265	29	\$8862
FCC6424HH	24 x 64.5 x 26.75	100	238	25	\$7765
FCC7420HH	20 x 74.5 x 26.75	92.5	251	24	\$8440
FCC6420HH	20 x 64.5 x 26.75	92.5	226	21	\$7399

Standard with **lateral box/file** on **left** and **right**. Handles and locks on left and right.

- If using in a freestanding application, must specify modular top.

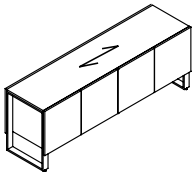

Storage Credenza

FCC7424GG	24 x 74.5 x 26.75	150	171	29	\$7756
FCC6424MM	24 x 64.5 x 26.75	125	152	25	\$7028
FCC7420GG	20 x 74.5 x 26.75	125	153	24	\$7126
FCC6420MM	20 x 64.5 x 26.75	125	136	21	\$6463

Standard with **four doors and adjustable shelves** on **left** and **right**.

- If using in a freestanding application, must specify modular top.

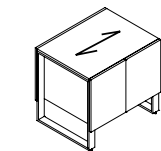

Storage Credenza

FCC3624G	24 x 36 x 26.75	150	171	29	\$4849
FCC3024M	24 x 30 x 26.75	125	152	25	\$4042
FCC3620G	20 x 36 x 26.75	125	153	24	\$4334
FCC3020M	20 x 30 x 26.75	125	136	21	\$3612

Standard with **two doors and adjustable shelves**.

- If using in a freestanding application, must specify modular top.

Required Specifications

Top finish
Body finish

Optional Specifications

Grommet

MODULAR STORAGE - NOTES

D x W x H

- Horizontal grain direction is standard on all engineered finishes.
- All pedestals are suspended 7.5" off the floor by an open framed leg, and can be installed flush or offset
- Pedestals are handed:
 - Left pedestals have the handle offset from the center to the right, and the lock is placed on the right gable
 - Right pedestals have the handle offset from the center to the left, and the lock is placed on the left gable
- All modular pedestals have pre-drilled holes on the top for easy connection to worksurface.
- **NOTE:** Arrow indicates direction of grain

MODULAR STORAGE	MODEL#	DIMENSIONS	FREIGHT CLASS	WT./LBS.	CUBIC FT.	LIST PRICE
-----------------	--------	------------	---------------	----------	-----------	------------

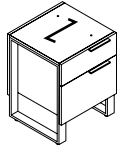

Box/File Pedestal - LEFT

F2036BL	36 x 20.5 x 26.75	100	99	11	\$4669
F2030BL	30 x 20.5 x 26.75	100	90	10	\$4449
F2024BL	24 x 20.5 x 26.75	92.5	83	8	\$4192
F2020BL	20 x 20.5 x 26.75	92.5	78	7	\$3988

For use under a freestanding desk or credenza. Top pre-drilled to attach to worksurface. One **box/file** drawer.

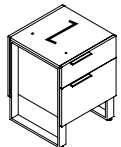

Box/File Pedestal - RIGHT

F2036BR	36 x 20.5 x 26.75	100	99	11	\$4669
F2030BR	30 x 20.5 x 26.75	100	90	10	\$4449
F2024BR	24 x 20.5 x 26.75	92.5	83	8	\$4192
F2020BR	20 x 20.5 x 26.75	92.5	78	7	\$3988

For use under a freestanding desk or credenza. Top pre-drilled to attach to worksurface. One **box/file** drawer.

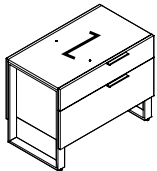

Lateral Box/File Pedestal - LEFT

F4024HL	24 x 40 x 26.75	125	121	16	\$5490
F3524HL	24 x 35 x 26.75	125	111	14	\$5186
F4020HL	20 x 40 x 26.75	100	113	13	\$5325
F3520HL	20 x 35 x 26.75	100	104	11	\$4938

For use under a freestanding desk or credenza. Top pre-drilled to attach to worksurface. One **lateral box/file** drawer.

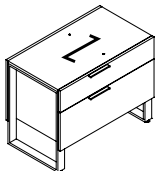

Lateral Box/File Pedestal - RIGHT

F4024HR	24 x 40 x 26.75	125	121	16	\$5490
F3524HR	24 x 35 x 26.75	125	111	14	\$5186
F4020HR	20 x 40 x 26.75	100	113	13	\$5325
F3520HR	20 x 35 x 26.75	100	104	11	\$4938

For use under a freestanding desk or credenza. Top pre-drilled to attach to worksurface. One **lateral box/file** drawer.

Required Specifications

Front finish
Top/body finish

Optional Specifications

Grommet

F FOUNDATIONS

MODULAR STORAGE

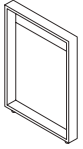

Frame Leg

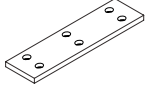

Top Connecting Bracket

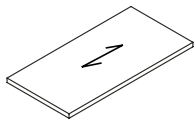

Modular Top*

MODEL#	DIMENSIONS D x W x H	FREIGHT CLASS	WT/LBS.	CUBIC FT.	LIST PRICE
FLEG36	2.5 x 36 x 27.5	250	6	3	\$1260
FLEG30	2.5 x 30 x 27.5	250	6	3	\$1155
FLEG24	2.5 x 24 x 27.5	250	5	2	\$1070
FLEG20	2.5 x 20 x 27.5	250	5	2	\$979

FCON36	31 x 10 x .75	150	4	1	\$266
FCON30	25 x 10 x .75	150	4	1	\$245
FCON24	19 x 10 x .75	250	3	1	\$240
FCON20	15 x 10 x .75	250	3	1	\$222

F8436T	36 x 84 x 1.5	60	95	3	\$3463
F7836T	36 x 78 x 1.5	65	88	3	\$3222
F7236T	36 x 72 x 1.5	65	82	3	\$2973
F8430T	30 x 84 x 1.5	65	80	3	\$2897
F7830T	30 x 78 x 1.5	65	73	3	\$2701
F7230T	30 x 72 x 1.5	60	67	2	\$2472
F6630T	30 x 66 x 1.5	60	62	2	\$2289
F6030T	30 x 60 x 1.5	65	56	2	\$2088
F5430T	30 x 54 x 1.5	65	51	2	\$1887
F8424T	24 x 84 x 1.5	60	67	2	\$2575
F7824T	24 x 78 x 1.5	60	62	2	\$2390
F7424T	24 x 74 x 1.5	65	58	2	\$2268
F7224T	24 x 72 x 1.5	65	53	2	\$2136
F6624T	24 x 66 x 1.5	65	51	2	\$2055
F6424T	24 x 64 x 1.5	65	49	2	\$1925
F6024T	24 x 60 x 1.5	65	47	2	\$1799
F5424T	24 x 54 x 1.5	70	42	2	\$1668
F4824T	24 x 48 x 1.5	60	38	1	\$1542
F4224T	24 x 42 x 1.5	60	34	1	\$1352
F8420T	20 x 84 x 1.5	60	64	2	\$2371
F7820T	20 x 78 x 1.5	60	60	2	\$2199
F7420T	20 x 74 x 1.5	65	51	2	\$2088
F7220T	20 x 72 x 1.5	65	51	2	\$1961
F6620T	20 x 66 x 1.5	65	49	2	\$1898
F6420T	20 x 64 x 1.5	65	47	2	\$1790
F6020T	20 x 60 x 1.5	65	45	2	\$1663
F5420T	20 x 54 x 1.5	60	40	1	\$1538
F4820T	20 x 48 x 1.5	60	36	1	\$1415
F4220T	20 x 42 x 1.5	60	31	1	\$1239

3/4" top with flat edge. 3/4" subtop inset 2.5" all around. For crossgrain veneer pattern, add (CG) to the end of the product code. When connecting two tops together, a connecting bracket must be specified. Use the width of the smallest top to determine the correct bracket size (i.e. for a 20"D top, order FCON20). Optional grommet may be specified.



Required Specifications
Top finish*

Optional Specifications
Grommet*

FREESTANDING STORAGE - NOTES

D x W x H

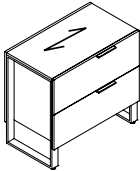
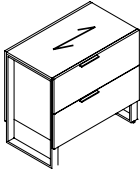
- Horizontal grain direction is standard on all engineered finishes.
- All pedestals are suspended 7.5" off the floor by an open framed leg, and can be installed flush or offset
- Pedestals are handed:
 - Left pedestals have the handle offset from the center to the right, and the lock is placed on the right gable
 - Right pedestals have the handle offset from the center to the left, and the lock is placed on the left gable
- Bench drawers do not come with a handle. They open by pulling the bottom edge of the drawer.
- Cushions will be field installed. On double width benches, the cushion can either be installed left or right.
- On mobile pedestals, the lock will be placed on the right gable.
- **NOTE:** Arrow indicates direction of grain

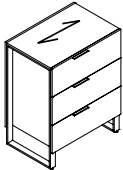
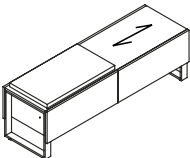
FREESTANDING STORAGE	MODEL#	DIMENSIONS	FREIGHT CLASS	WT./LBS.	CUBIC FT.	LIST PRICE
 <p>2H Lateral File Pedestal - LEFT</p>	FN3524L	24 x 35 x 32	100	152	17	\$5696
	FN3520L	20 x 35 x 32	100	144	15	\$5420
 <p>2H Lateral File Pedestal - RIGHT</p>	FN3524R	24 x 35 x 32	100	152	17	\$5696
	FN3520R	20 x 35 x 32	100	144	15	\$5420
 <p>3H Lateral File Pedestal - LEFT</p>	FN35243L	24 x 35 x 44.5	92.5	220	22	\$7251
	FN35203L	20 x 35 x 44.5	92.5	212	19	\$6929
 <p>3H Lateral File Pedestal - RIGHT</p>	FN35243R	24 x 35 x 44.5	92.5	220	22	\$7251
	FN35203R	20 x 35 x 44.5	92.5	212	19	\$6929
 <p>Bench, Two File Drawers w/Cushion*</p>	FBENKK6420	20 x 64.5 x 21	100	167	17	\$6216
<p>With two file drawers and cushion. Standard in grade 2 seating fabric. Locks on left and right.</p>						

Required Specifications

Front finish
Top/body finish
Fabric*

F FOUNDATIONS

FREESTANDING STORAGE

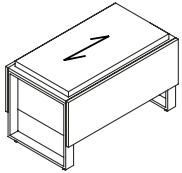

Bench, One File Drawer w/Cushion

MODEL#	DIMENSIONS	FREIGHT CLASS	WT/LBS.	CUBIC FT.	LIST PRICE
	D x W x H				
FBENK3520	20 x 35 x 21	92.5	99	9	\$4515

With **one file drawer** and **cushion**. Standard in grade 2 seating fabric. Lock on right.

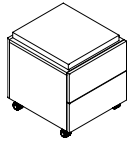

Mobile Box/Box Pedestal w/Cushion

F20BMCU	20 x 20.5 x 20.5	70	87	5	\$3066
---------	------------------	----	----	---	---------------

With **two box drawers** and **cushion**. Standard in grade 2 seating fabric. Lock on right. Casters are locking.

Required Specifications

Front finish
 Top/body finish
 Fabric

RETURNS - NOTES

D x W x H

- Horizontal grain direction is standard on all engineered finishes.
- Tops are constructed with two 3/4" thick panels, laminated together to create a total thickness of 1.5".
- Returns can be connected to wall credenzas and single pedestal desks
- All pedestals are suspended 7.5" off the floor by an open framed leg, and can be installed flush or offset
- Pedestals are handed:
 - Left pedestals have the handle offset from the center to the right, and the lock is placed on the left gable.
 - Right pedestals have the handle offset from the center to the left, and the lock is placed on the right gable.
- The standard grain direction on return tops is cross grain (**CG**). To remove cross grain veneer pattern on top, delete suffix "**CG**" from the model number (no upcharge)
- One Connecting Bracket is included.
- **NOTE:** Arrow indicates direction of grain

RETURNS

MODEL#

DIMENSIONS

FREIGHT CLASS

WT./LBS.

CUBIC FT.

LIST PRICE

D x W x H

FERL6624CG	24 x 66 x 28	85	59	4	\$3838
FERL6024CG	24 x 60 x 28	85	55	4	\$3580
FERL5424CG	24 x 54 x 28	85	50	4	\$3384
FERL4824CG	24 x 48 x 28	70	46	3	\$3246
FERL4224CG	24 x 42 x 28	85	42	3	\$2675

FERL6620CG	20 x 66 x 28	85	57	4	\$3489
FERL6020CG	20 x 60 x 28	85	53	4	\$3255
FERL5420CG	20 x 54 x 28	70	48	3	\$3075
FERL4820CG	20 x 48 x 28	85	44	3	\$2951
FERL4220CG	20 x 42 x 28	85	39	3	\$2430

Return has **no pedestal**. For use with right handed single pedestal desks, credenzas, or desk shells.

FERR6624CG	24 x 66 x 28	85	59	4	\$3838
FERR6024CG	24 x 60 x 28	85	55	4	\$3580
FERR5424CG	24 x 54 x 28	85	50	4	\$3384
FERR4824CG	24 x 48 x 28	70	46	3	\$3246
FERR4224CG	24 x 42 x 28	85	42	3	\$2675

FERR6620CG	20 x 66 x 28	85	57	4	\$3489
FERR6020CG	20 x 60 x 28	85	53	4	\$3255
FERR5420CG	20 x 54 x 28	70	48	3	\$3075
FERR4820CG	20 x 48 x 28	85	44	3	\$2951
FERR4220CG	20 x 42 x 28	85	39	3	\$2430

Return has **no pedestal**. For use with left handed single pedestal desks, credenzas, or desk shells.

FERL6624BCG	24 x 66 x 28	85	137	10	\$6405
FERL6024BCG	24 x 60 x 28	85	133	10	\$6157
FERL5424BCG	24 x 54 x 28	85	128	10	\$6024
FERL4824BCG	24 x 48 x 28	85	124	9	\$5897
FERL4224BCG	24 x 42 x 28	85	120	9	\$5711

FERL6620BCG	20 x 66 x 28	85	130	9	\$6102
FERL6020BCG	20 x 60 x 28	85	126	9	\$5867
FERL5420BCG	20 x 54 x 28	70	121	8	\$5739
FERL4820BCG	20 x 48 x 28	85	117	8	\$5618
FERL4220BCG	20 x 42 x 28	85	112	8	\$5441

Return has **flush box/file pedestal** on the **left**. For use with right handed single pedestal desks, credenzas, or desk shells.

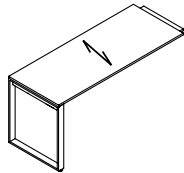

Executive Return - LEFT

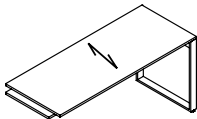

Executive Return - RIGHT

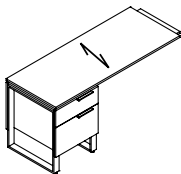

Executive Return - LEFT

Required Specifications

Top finish
Body finish

Optional Specifications

Grommet

EXECUTIVE RETURNS

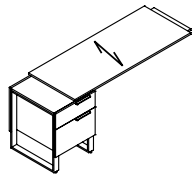

Executive Return - LEFT

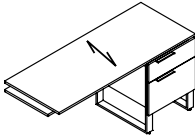

Executive Return - RIGHT

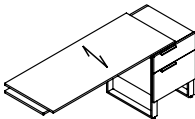

Executive Return - RIGHT

MODEL#	DIMENSIONS D x W x H	FREIGHT CLASS	WT/LBS.	CUBIC FT.	LIST PRICE
FERL6624BOSCG	24 x 76 x 28	85	137	10	\$7094
FERL6024BOSCG	24 x 70 x 28	85	133	10	\$6157
FERL5424BOSCG	24 x 64 x 28	85	128	10	\$6024
FERL4824BOSCG	24 x 58 x 28	85	124	9	\$5897
FERL4224BOSCG	24 x 52 x 28	85	120	9	\$5711
FERL6620BOSCG	20 x 76 x 28	85	130	9	\$6447
FERL6020BOSCG	20 x 70 x 28	85	126	9	\$5867
FERL5420BOSCG	20 x 64 x 28	70	121	8	\$5739
FERL4820BOSCG	20 x 58 x 28	85	117	8	\$5618
FERL4220BOSCG	20 x 52 x 28	85	112	8	\$5441

Return has **offset box/file pedestal** on the **left**. For use with right handed single pedestal desks, credenzas, or desk shells.
Model # represents worksurface dimension only.

FERR6624BCG	24 x 66 x 28	85	137	10	\$6405
FERR6024BCG	24 x 60 x 28	85	133	10	\$6157
FERR5424BCG	24 x 54 x 28	85	128	10	\$6024
FERR4824BCG	24 x 48 x 28	85	124	9	\$5897
FERR4224BCG	24 x 42 x 28	85	120	9	\$5711
FERR6620BCG	20 x 66 x 28	85	130	9	\$6102
FERR6020BCG	20 x 60 x 28	85	126	9	\$5867
FERR5420BCG	20 x 54 x 28	70	121	8	\$5739
FERR4820BCG	20 x 48 x 28	85	117	8	\$5618
FERR4220BCG	20 x 42 x 28	85	112	8	\$5441

Return has **flush box/file pedestal** on the **right**. For use with left-handed single pedestal desks, credenzas, or desk shells.

FERR6624BOSCG	24 x 76 x 28	85	137	10	\$7094
FERR6024BOSCG	24 x 70 x 28	85	133	10	\$6157
FERR5424BOSCG	24 x 64 x 28	85	128	10	\$6024
FERR4824BOSCG	24 x 58 x 28	85	124	9	\$5897
FERR4224BOSCG	24 x 52 x 28	85	120	9	\$5711
FERR6620BOSCG	20 x 76 x 28	85	130	9	\$6447
FERR6020BOSCG	20 x 70 x 28	85	126	9	\$5867
FERR5420BOSCG	20 x 64 x 28	70	121	8	\$5739
FERR4820BOSCG	20 x 58 x 28	85	117	8	\$5618
FERR4220BOSCG	20 x 52 x 28	85	112	8	\$5441

Return has **offset box/file pedestal** on the **right**. For use with left-handed single pedestal desks, credenzas, or desk shells.
Model # represents worksurface dimension only.

Required Specifications

Top finish
Body finish

Optional Specifications

Grommet

DESKS	MODEL#	DIMENSIONS	FREIGHT CLASS	WT/LBS.	CUBIC FT.	LIST PRICE
-------	--------	------------	---------------	---------	-----------	------------

D x W x H

- Horizontal grain direction is standard on all engineered finishes.
- Tops are constructed with two 3/4" thick panels, laminated together to create a total thickness of 1.5".
- All pedestals are suspended 7.5" off the floor by an open framed leg, and can be installed flush or offset
- The standard grain direction on Bridge tops is cross grain (**CG**). To remove cross grain veneer pattern on top, delete suffix "**CG**" from the model number (no upcharge)
- Two Connecting Brackets are included.
- GM5K (Tungsten) TC grommet location is standard
- **NOTE:** Arrow indicates direction of grain

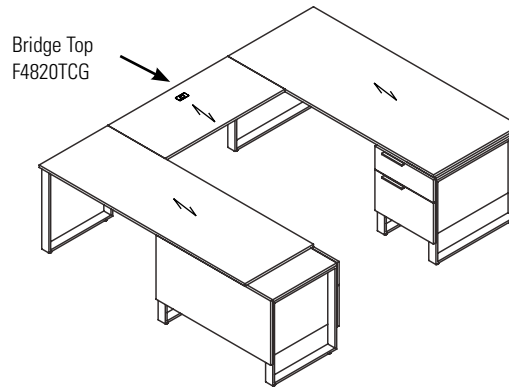

BRIDGES	MODEL#	DIMENSIONS	FREIGHT CLASS	WT/LBS.	CUBIC FT.	LIST PRICE
---------	--------	------------	---------------	---------	-----------	------------

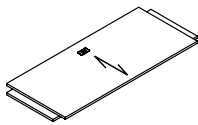

Bridge Top

FBT6624CG	24 x 66 x 1.5	65	57	2	\$3067
FBT6024CG	24 x 60 x 1.5	65	53	2	\$2810
FBT5424CG	24 x 54 x 1.5	65	48	2	\$2665
FBT4824CG	24 x 48 x 1.5	60	44	1	\$2162
FBT4224CG	24 x 42 x 1.5	60	40	1	\$1960
FBT6620CG	20 x 66 x 1.5	65	55	2	\$2788
FBT6020CG	20 x 60 x 1.5	65	51	2	\$2552
FBT5420CG	20 x 54 x 1.5	60	46	1	\$2428
FBT4820CG	20 x 48 x 1.5	60	42	1	\$1960
FBT4220CG	20 x 42 x 1.5	60	37	1	\$1780

Top surface only to create a "U" configuration with a single pedestal desk or credenza. **Cannot be used with corners.** Grommet in worksurface. Shipped RTA (ready to assemble).

Required Specifications
Top finish

Optional Specifications
Grommet

F FOUNDATIONS

WALL-MOUNTED STORAGE - NOTES

D x W x H

- Horizontal grain direction is standard on all engineered finishes.
- Wall Mount Overheads have a 2" deep valance on top and bottom and it can accommodate LED or T5 lighting in either location
- Tackboards are installed flush.
- Standard Heights for Tackboards are:
 - 19.2" (overall height above worksurface = 36.5")
 - 26" (overall height above worksurface = 42.5")
- **NOTE:** Arrow indicates direction of grain

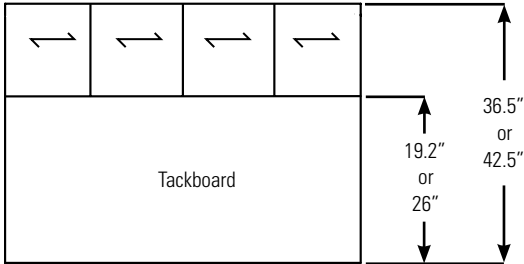

WALL-MOUNTED STORAGE	MODEL#	DIMENSIONS	FREIGHT CLASS	WT/LBS.	CUBIC FT.	LIST PRICE
----------------------	--------	------------	---------------	---------	-----------	------------

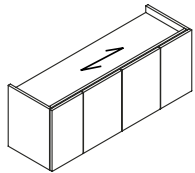

Wall Mount Storage w/Doors

FSF74	15 x 74.5 x 18.5	125	103	13	\$4158
FSF72	15 x 72 x 18.5	100	101	12	\$3990
FSF66	15 x 66 x 18.5	100	94	11	\$3752
FSF64	15 x 64.5 x 18.5	100	92	11	\$3674
FSF60	15 x 60 x 18.5	100	87	10	\$3519
FSF54	15 x 54 x 18.5	100	80	9	\$3353
FSF48	15 x 48 x 18.5	100	74	8	\$3049

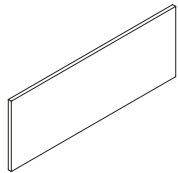

Wall Mount Tackboard*

FTS74H26	.75 x 74.5 x 26	100	17	2	\$1260
FTS72H26	.75 x 72 x 26	70	16	1	\$1163
FTS66H26	.75 x 66 x 26	85	14	1	\$1070
FTS64H26	.75 x 64.5 x 26	85	13	1	\$1036
FTS60H26	.75 x 60 x 26	85	13	1	\$969
FTS54H26	.75 x 54 x 26	85	13	1	\$874
FTS48H26	.75 x 48 x 26	85	13	1	\$777
FTS74	.75 x 74.5 x 19.2	85	13	1	\$968
FTS72	.75 x 72 x 19.2	85	12	1	\$894
FTS66	.75 x 66 x 19.2	92.5	11	1	\$815
FTS64	.75 x 64.5 x 19.2	92.5	11	1	\$774
FTS60	.75 x 60 x 19.2	92.5	10	1	\$745
FTS54	.75 x 54 x 19.2	92.5	10	1	\$675
FTS48	.75 x 48 x 19.2	92.5	10	1	\$601

Required Specifications

Front finish
Top/body finish
Fabric*

WORK WALLS - NOTES

D x W x H

- Horizontal grain direction is standard on all engineered finishes.
- Tackboards and tasklights must be specified
- When the tackboard option is specified, the price includes a tackboard for each niche of the Work Wall.
- When the Task Light option is specified, the price includes LED Tasklight installed in the top of each niche. If more than one niche is needed in the configuration, remote on/off switch is included for simultaneous operation.
- All Storage Doors open with touch latch
- Side access to open storage or wardrobe - front panels are fixed.
- Standard heights are 26.5", 56", 70" and 84"
- Walls are available in 15" increments starting at 95" (i.e. 110", 125" 140", 155")
- Wall credenzas are only available in 90" width
- Cantilevered storage units are side locking
- For modifications to the wall configurations, size or finish, please contact customer care.

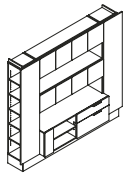
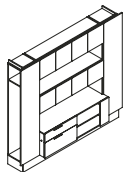
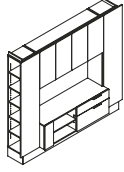
WORK WALLS - 84" H	MODEL#	DIMENSIONS	FREIGHT CLASS	WT/LBS.	CUBIC FT.	LIST PRICE
 <p>Work Wall - 95"W</p>	FW9584-1L	20 x 95 x 84	100	634	79	\$27605
 <p>Work Wall - 95"W</p>	FW9584-1R	20 x 95 x 84	100	634	79	\$27605
 <p>Work Wall - 95"W</p>	FW9584-2L	20 x 95 x 84	125	568	77	\$24269

Vertical storage with 5 adjustable shelves, 60" wide wall credenza with adjustable shelf and box/file, 60" wide niche, 60" wide single height storage, 60" wide niche, 60" wide single height storage, wardrobe with coat hook and hat shelf.

- To add tackboard to niche, add **TB** to end of product code. **Add \$2056** to list price for grades 1-3. Add **\$2467** for grades 4-5.
- To add LED light to niche, add **LT** to end of product code. **Add \$2159** to list price.

Wardrobe with coat hook and hat shelf, 60" wide wall credenza with box/file and adjustable shelf, 60" wide niche, 60" wide single height storage, 60" wide niche, 60" wide single height storage, vertical storage with 5 adjustable shelves..

- To add tackboard to niche, add **TB** to end of product code. **Add \$2056** to list price for grades 1-3. Add **\$2467** for grades 4-5.
- To add LED light to niche, add **LT** to end of product code. **Add \$2159** to list price.

Vertical storage with 5 adjustable shelves, 60" wide wall credenza with adjustable shelf and box/file, 60" wide double height niche, 60" wide double height storage, wardrobe with coat hook and hat shelf.

- To add tackboard to niche, add **TB** to end of product code. **Add \$1276** to list price for grades 1-3. Add **\$1532** for grades 4-5.
- To add LED light to niche, add **LT** to end of product code. **Add \$873** to list price.

Required Specifications

- Front finish
- Top/body finish
- Cubby interior finish

Optional Specifications

- Grommet
- LED light
- Tackboard

WORK WALLS - 84" H

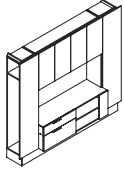

Work Wall - 95" W

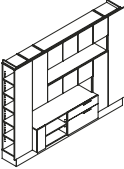

Work Wall - 110" W

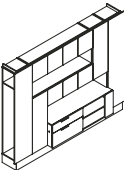

Work Wall - 110" W

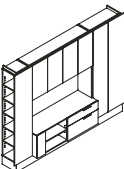

Work Wall - 110" W

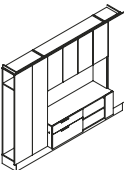

Work Wall - 110" W

MODEL#	DIMENSIONS	FREIGHT CLASS	WT/LBS.	CUBIC FT.	LIST PRICE
--------	------------	---------------	---------	-----------	------------

D x W x H

FW9584-2R	20 x 95 x 84	125	568	77	\$24269
-----------	--------------	-----	-----	----	----------------

Wardrobe with coat hook and hat shelf, 60" wide wall credenza with box/file and adjustable shelf, 60" wide double height niche, 60" wide double height storage, vertical storage with 5 adjustable shelves.

- To add tackboard to niche, add **TB** to end of product code. **Add \$1276** to list price for grades 1-3. Add **\$1532** for grades 4-5.
- To add LED light to niche, add **LT** to end of product code. **Add \$873** to list price.

FW11084-1L	20 x 110 x 84	100	741	91	\$31430
------------	---------------	-----	-----	----	----------------

Vertical storage with 5 adjustable shelves, 60" wide wall credenza with adjustable shelf and box/file, 60" wide niche, triple height storage, 45" wide single height storage, 60" wide niche, 60" wide single height storage, triple height storage, wardrobe with coat hook and hat shelf.

- To add tackboard to niche, add **TB** to end of product code. **Add \$2050** to list price for grades 1-3. Add **\$2460** for grades 4-5.
- To add LED light to niche, add **LT** to end of product code. **Add \$2162** to list price.

FW11084-1R	20 x 110 x 84	100	741	91	\$31430
------------	---------------	-----	-----	----	----------------

Wardrobe with coat hook and hat shelf, triple height storage, 60" wide niche, 60" wide single height storage, 60" wide wall credenza with box/file and adjustable shelf, 60" wide niche, 45" wide single height storage, triple height storage, vertical storage with 5 adjustable shelves.

- To add tackboard to niche, add **TB** to end of product code. **Add \$2050** to list price for grades 1-3. Add **\$2460** for grades 4-5.
- To add LED light to niche, add **LT** to end of product code. **Add \$2162** to list price.

FW11084-2L	20 x 110 x 84	125	628	88	\$26823
------------	---------------	-----	-----	----	----------------

Vertical storage with 5 adjustable shelves, 60" wide wall credenza with adjustable shelf and box/file, 60" wide double height niche, 60" wide double height storage, double depth wardrobe with coat rod and hat shelf.

- To add tackboard to niche, add **TB** to end of product code. **Add \$1274** to list price for grades 1-3. Add **\$1529** for grades 4-5.
- To add LED light to niche, add **LT** to end of product code. **Add \$873** to list price.

FW11084-2R	20 x 110 x 84	125	628	88	\$26823
------------	---------------	-----	-----	----	----------------

Double depth wardrobe with coat rod and hat shelf, 60" wide wall credenza with adjustable shelf and box/file, 60" wide double height niche, 60" wide double height storage, vertical storage with 5 adjustable shelves.

- To add tackboard to niche, add **TB** to end of product code. **Add \$1274** to list price for grades 1-3. Add **\$1529** for grades 4-5.
- To add LED light to niche, add **LT** to end of product code. **Add \$873** to list price.

Required Specifications

Front finish
Top/body finish
Cubby interior finish

Optional Specifications

Grommet
LED light
Tackboard

WORK WALLS - 84"H

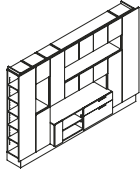

Work Wall - 125"W

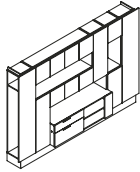

Work Wall - 125"W

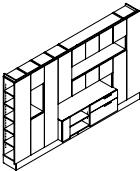

Work Wall - 140"W

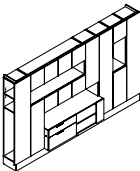

Work Wall - 140"W

MODEL#	DIMENSIONS	FREIGHT CLASS	WT/LBS.	CUBIC FT.	LIST PRICE
--------	------------	---------------	---------	-----------	------------

D x W x H

FW12584-1L	20 x 125 x 84	100	858	103	\$35286
------------	---------------	-----	-----	-----	----------------

Vertical storage with 5 adjustable shelves, 15" wide double height niche, single height storage, 60" wide wall credenza with adjustable shelf and box/file, 60" wide niche, triple height storage, 45" wide single height storage, 60" wide niche, 60" wide single height storage, triple height storage, wardrobe with coat hook and hat shelf.

- To add tackboard to niche, add **TB** to end of product code. **Add \$2503** to list price for grades 1-3. Add **\$3005** for grades 4-5.
- To add LED light to niche, add **LT** to end of product code. **Add \$2512** to list price.

FW12584-1R	20 x 125 x 84	100	858	103	\$35286
------------	---------------	-----	-----	-----	----------------

Wardrobe with coat hook and hat shelf, triple height storage, 60" wide niche, 60" wide single height storage, 60" wide wall credenza with box/file and adjustable shelf, 60" wide niche, 45" wide single height storage, triple height storage, 15" wide double height niche, single height storage, vertical storage with 5 adjustable shelves.

- To add tackboard to niche, add **TB** to end of product code. **Add \$2503** to list price for grades 1-3. Add **\$3005** for grades 4-5.
- To add LED light to niche, add **LT** to end of product code. **Add \$2512** to list price.

FW14084-1L	20 x 140 x 84	100	936	115	\$38055
------------	---------------	-----	-----	-----	----------------

Vertical storage with 5 adjustable shelves, triple height storage, 15" wide double height niche, single height storage, vertical storage with 5 adjustable shelves, 60" wide wall credenza with adjustable shelf and box/file, 60" wide niche, triple height storage cabinet, 45" wide single height storage, 60" wide niche, 60" wide single height storage, double depth wardrobe with coat rod and two shelves.

- To add tackboard to niche, add **TB** to end of product code. **Add \$2503** to list price for grades 1-3. Add **\$3005** for grades 4-5.
- To add LED light to niche, add **LT** to end of product code. **Add \$2511** to list price.

FW14084-1R	20 x 125 x 84	100	936	115	\$38055
------------	---------------	-----	-----	-----	----------------

Double depth wardrobe with coat rod and two shelves, 60" wide niche, 60" wide single height storage, 60" wide wall credenza with box/file and adjustable shelf, 60" wide niche, 45" wide single height storage, triple height storage, vertical storage with 5 adjustable shelves, triple height storage, 15" wide double height niche, single height storage, vertical storage with 5 adjustable shelves.

- To add tackboard to niche, add **TB** to end of product code. **Add \$2503** to list price for grades 1-3. Add **\$3005** for grades 4-5.
- To add LED light to niche, add **LT** to end of product code. **Add \$2511** to list price.

Required Specifications

Front finish
Top/body finish
Cubby interior finish

Optional Specifications

Grommet
LED light
Tackboard

WORK WALLS - 70"H

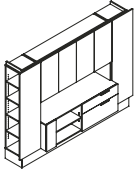

Work Wall - 95"W

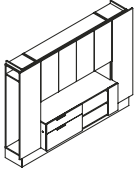

Work Wall - 95"W

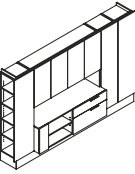

Work Wall - 110"W

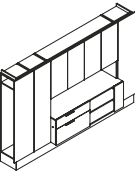

Work Wall - 110"W

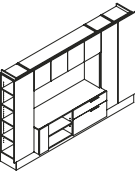

Work Wall - 110"W

MODEL#	DIMENSIONS	FREIGHT CLASS	WT./LBS.	CUBIC FT.	LIST PRICE
--------	------------	---------------	----------	-----------	------------

D x W x H

FW9570-1L	20 x 95 x 70	125	523	66	\$23169
-----------	--------------	-----	-----	----	----------------

Vertical storage with 4 adjustable shelves, 60" wide wall credenza with adjustable shelf and box/file, 60" wide niche, 60" wide double height storage, wardrobe with coat hook and hat shelf.

- To add tackboard to niche, add **TB** to end of product code. **Add \$1029** to list price for grades 1-3. Add **\$1236** for grades 4-5.
- To add LED light to niche, add **LT** to end of product code. **Add \$871** to list price.

FW9570-1R	20 x 95 x 70	125	523	66	\$23169
-----------	--------------	-----	-----	----	----------------

Wardrobe with coat hook and hat shelf, 60" wide wall credenza with box/file and adjustable shelf, 60" wide niche, 60" wide double height storage, vertical storage with 4 adjustable shelves.

- To add tackboard to niche, add **TB** to end of product code. **Add \$1029** to list price for grades 1-3. Add **\$1236** for grades 4-5.
- To add LED light to niche, add **LT** to end of product code. **Add \$871** to list price.

FW11070-1L	20 x 110 x 70	100	618	76	\$25296
------------	---------------	-----	-----	----	----------------

Vertical storage with 4 adjustable shelves, 60" wide wall credenza with adjustable shelf and box/file, 60" wide niche, 60" wide double height storage, vertical storage with 4 adjustable shelves, wardrobe with coat hook and hat shelf.

- To add tackboard to niche, add **TB** to end of product code. **Add \$1026** to list price for grades 1-3. Add **\$1231** for grades 4-5.
- To add LED light to niche, add **LT** to end of product code. **Add \$871** to list price.

FW11070-1R	20 x 110 x 70	100	618	76	\$25296
------------	---------------	-----	-----	----	----------------

Wardrobe with coat hook and hat shelf, vertical storage with 4 adjustable shelves, 60" wide wall credenza with box/file and adjustable shelf, 60" wide niche, 60" wide double height storage, vertical storage with 4 adjustable shelves.

- To add tackboard to niche, add **TB** to end of product code. **Add \$1026** to list price for grades 1-3. Add **\$1231** for grades 4-5.
- To add LED light to niche, add **LT** to end of product code. **Add \$871** to list price.

FW11070-2L	20 x 110 x 70	125	586	76	\$23839
------------	---------------	-----	-----	----	----------------

Vertical storage with 4 adjustable shelves, 60" wide wall credenza with adjustable shelf and box/file, 60" wide double height niche, 60" wide single height storage, vertical storage with 4 adjustable shelves, wardrobe with coat hook and hat shelf.

- To add tackboard to niche, add **TB** to end of product code. **Add \$1271** to list price for grades 1-3. Add **\$1526** for grades 4-5.
- To add LED light to niche, add **LT** to end of product code. **Add \$873** to list price.

Required Specifications

Front finish
Top/body finish
Cubby interior finish

Optional Specifications

Grommet
LED light
Tackboard

WORK WALLS - 70"H

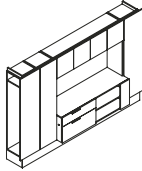

Work Wall - 110"W

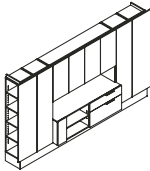

Work Wall - 125"W

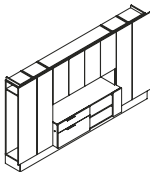

Work Wall - 125"W

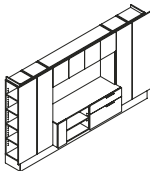

Work Wall - 125"W

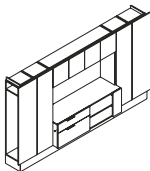

Work Wall - 125"W

MODEL#	DIMENSIONS	FREIGHT CLASS	WT/LBS.	CUBIC FT.	LIST PRICE
--------	------------	---------------	---------	-----------	------------

D x W x H

FW11070-2R	20 x 110 x 70	125	586	76	\$23839
------------	---------------	-----	-----	----	----------------

Wardrobe with coat hook and hat shelf, vertical storage with 4 adjustable shelves, 60" wide wall credenza with box/file and adjustable shelf, 60" wide double height niche, 60" wide single height storage, vertical storage with 4 adjustable shelves.

- To add tackboard to niche, add **TB** to end of product code. **Add \$1271** to list price for grades 1-3. Add **\$1526** for grades 4-5.
- To add LED light to niche, add **LT** to end of product code. **Add \$873** to list price.

FW12570-1L	20 x 125 x 70	100	713	85	\$26578
------------	---------------	-----	-----	----	----------------

Vertical storage with 4 adjustable shelves, vertical storage with 4 adjustable shelves, 60" wide wall credenza with adjustable shelf and box/file, 60" wide niche, 60" wide double height storage, vertical storage with 4 adjustable shelves, wardrobe with coat hook and hat shelf.

- To add tackboard to niche, add **TB** to end of product code. **Add \$1029** to list price for grades 1-3. Add **\$1236** for grades 4-5.
- To add LED light to niche, add **LT** to end of product code. **Add \$873** to list price.

FW12570-1R	20 x 125 x 70	100	713	85	\$26578
------------	---------------	-----	-----	----	----------------

Wardrobe with coat hook and hat shelf, vertical storage with 4 adjustable shelves, 60" wide wall credenza with box/file and adjustable shelf, 60" wide niche, 60" wide double height storage, vertical storage with 4 adjustable shelves, vertical storage with 4 adjustable shelves.

- To add tackboard to niche, add **TB** to end of product code. **Add \$1029** to list price for grades 1-3. Add **\$1236** for grades 4-5.
- To add LED light to niche, add **LT** to end of product code. **Add \$873** to list price.

FW12570-2L	20 x 125 x 70	100	681	85	\$25117
------------	---------------	-----	-----	----	----------------

Vertical storage with 4 adjustable shelves, vertical storage with 4 adjustable shelves, 60" wide wall credenza with adjustable shelf and box/file, 60" wide double height niche, 60" wide single height storage, vertical storage with 4 adjustable shelves, wardrobe with coat hook and hat shelf.

- To add tackboard to niche, add **TB** to end of product code. **Add \$1274** to list price for grades 1-3. Add **\$1529** for grades 4-5.
- To add LED light to niche, add **LT** to end of product code. **Add \$873** to list price.

FW12570-2R	20 x 125 x 70	100	681	85	\$25117
------------	---------------	-----	-----	----	----------------

Wardrobe with coat hook and hat shelf, vertical storage with 4 adjustable shelves, 60" wide wall credenza with box/file and adjustable shelf, 60" wide double height niche, 60" wide single height storage, vertical storage with 4 adjustable shelves, vertical storage with 4 adjustable shelves.

- To add tackboard to niche, add **TB** to end of product code. **Add \$1274** to list price for grades 1-3. Add **\$1529** for grades 4-5.
- To add LED light to niche, add **LT** to end of product code. **Add \$873** to list price.

Required Specifications

Front finish
Top/body finish
Cubby interior finish

Optional Specifications

Grommet
LED light
Tackboard

WORK WALLS - 70"H

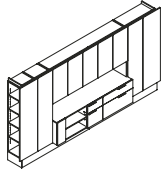

Work Wall - 140"W

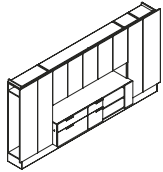

Work Wall - 140"W

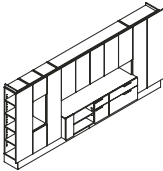

Work Wall - 155"W

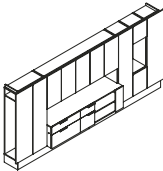

Work Wall - 155"W

MODEL#	DIMENSIONS	FREIGHT CLASS	WT/LBS.	CUBIC FT.	LIST PRICE
--------	------------	---------------	---------	-----------	------------

D x W x H

FW14070-1L	20 x 140 x 70	125	750	95	\$28753
------------	---------------	-----	-----	----	----------------

Vertical storage with 4 adjustable shelves, vertical storage with 4 adjustable shelves, 75" wide wall credenza with adjustable shelf, narrow box/file and box file, 75" wide single height niche, 75" wide double height storage, double depth wardrobe with coat rod and hat shelf.

- To add tackboard to niche, add **TB** to end of product code. **Add \$1289** to list price for grades 1-3. Add **\$1547** for grades 4-5.
- To add LED light to niche, add **LT** to end of product code. **Add \$1972** to list price.

FW14070-1R	20 x 140 x 70	125	750	95	\$28753
------------	---------------	-----	-----	----	----------------

Double depth wardrobe with coat rod and hat shelf, 75" wide wall credenza with box/file, narrow box/file and adjustable shelf, 75" wide single height niche, 75" wide double height storage, vertical storage with 4 adjustable shelves, vertical storage with 4 adjustable shelves.

- To add tackboard to niche, add **TB** to end of product code. **Add \$1289** to list price for grades 1-3. Add **\$1547** for grades 4-5.
- To add LED light to niche, add **LT** to end of product code. **Add \$1972** to list price.

FW15570-1L	20 x 155 x 70	125	849	107	\$34732
------------	---------------	-----	-----	-----	----------------

Vertical storage with 4 adjustable shelves, double height storage, 15" wide double height niche, single height storage, vertical storage with 4 adjustable shelves, 75" wide wall credenza with adjustable shelf, narrow box/file and box file, 75" wide niche, 75" wide double height storage, double depth wardrobe with coat rod and hat shelf.

- To add tackboard to niche, add **TB** to end of product code. **Add \$1736** to list price for grades 1-3. Add **\$2084** for grades 4-5.
- To add LED light to niche, add **LT** to end of product code. **Add \$2318** to list price.

FW15570-1R	20 x 155 x 70	125	849	107	\$34732
------------	---------------	-----	-----	-----	----------------

Double depth wardrobe with coat rod and hat shelf, 75" wide wall credenza with box/file, narrow box/file and adjustable shelf, 75" wide niche, 75" wide double height storage, vertical storage with 4 adjustable shelves, double height storage, 15" wide double height niche, single height storage, vertical storage with 4 adjustable shelves.

- To add tackboard to niche, add **TB** to end of product code. **Add \$1736** to list price for grades 1-3. Add **\$2084** for grades 4-5.
- To add LED light to niche, add **LT** to end of product code. **Add \$2318** to list price.

Required Specifications

Front finish
Top/body finish
Cubby interior finish

Optional Specifications

Grommet
LED light
Tackboard

WORK WALLS - 56"H

MODEL#	DIMENSIONS	FREIGHT CLASS	WT/LBS.	CUBIC FT.	LIST PRICE
--------	------------	---------------	---------	-----------	------------

D x W x H

FW9556-1	20 x 95 x 56	100	488	55	\$21467
----------	--------------	-----	-----	----	----------------

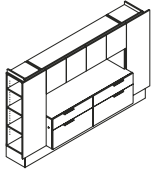

Work Wall - 95"W

Vertical storage with 3 adjustable shelves, 60" wide wall credenza with two box/files, 60" wide single height niche, 60" wide single height storage, vertical storage with 3 adjustable shelves.

- To add tackboard to niche, add **TB** to end of product code. **Add \$1028** to list price for grades 1-3. Add **\$1235** for grades 4-5.
- To add LED light to niche, add **LT** to end of product code. **Add \$871** to list price.

FW9556-2	20 x 95 x 56	125	420	55	\$19338
----------	--------------	-----	-----	----	----------------

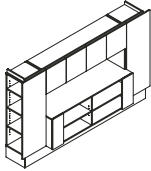

Work Wall - 95"W

Vertical storage with 3 adjustable shelves, 60" wide wall open credenza with two adjustable shelves, 60" wide single height niche, 60" wide single height storage, vertical storage with 3 adjustable shelves.

- To add tackboard to niche, add **TB** to end of product code. **Add \$1028** to list price for grades 1-3. Add **\$1235** for grades 4-5.
- To add LED light to niche, add **LT** to end of product code. **Add \$873** to list price.

FW11056-1L	20 x 110 x 56	100	533	63	\$21040
------------	---------------	-----	-----	----	----------------

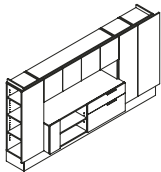

Work Wall - 110"W

Vertical storage with 3 adjustable shelves, 60" wide wall credenza with adjustable shelf and box/file, 60" wide niche, 60" wide single height storage, vertical storage with 3 adjustable shelves, wardrobe with coat hook and hat shelf.

- To add tackboard to niche, add **TB** to end of product code. **Add \$1028** to list price for grades 1-3. Add **\$1235** for grades 4-5.
- To add LED light to niche, add **LT** to end of product code. **Add \$871** to list price.

FW11056-1R	20 x 110 x 56	100	533	63	\$21040
------------	---------------	-----	-----	----	----------------

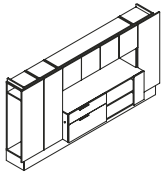

Work Wall - 110"W

Wardrobe with coat hook and hat shelf, vertical storage with 3 adjustable shelves, 60" wide wall credenza with box/file and adjustable shelf, 60" wide single height niche, 60" wide single height storage, vertical storage with 3 adjustable shelves.

- To add tackboard to niche, add **TB** to end of product code. **Add \$1028** to list price for grades 1-3. Add **\$1235** for grades 4-5.
- To add LED light to niche, add **LT** to end of product code. **Add \$871** to list price.

FW11056-2L	20 x 110 x 56	100	549	62	\$23168
------------	---------------	-----	-----	----	----------------

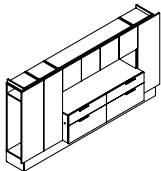

Work Wall - 110"W

Wardrobe with coat hook and hat shelf, vertical storage with 3 adjustable shelves, 60" wide wall credenza with two box/files, 60" wide niche, 60" wide single height storage, vertical storage with 3 adjustable shelves.

- To add tackboard to niche, add **TB** to end of product code. **Add \$1028** to list price for grades 1-3. Add **\$1236** for grades 4-5.
- To add LED light to niche, add **LT** to end of product code. **Add \$871** to list price.

Required Specifications

Front finish
Top/body finish
Cubby interior finish

Optional Specifications

Grommet
LED light
Tackboard

WORK WALLS - 56"H

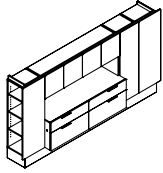

Work Wall - 110"W*

MODEL#	DIMENSIONS D x W x H	FREIGHT CLASS	WT/LBS.	CUBIC FT.	LIST PRICE
FW11056-2R	20 x 110 x 56	100	549	62	\$23168

Vertical storage with 3 adjustable shelves, 60" wide wall credenza with two box/files, 60" wide niche, 60" wide single height storage, vertical storage with 3 adjustable shelves, wardrobe with coat hook and hat shelf.

- To add tackboard to niche, add **TB** to end of product code. **Add \$1028** to list price for grades 1-3. Add **\$1236** for grades 4-5.
- To add LED light to niche, add **LT** to end of product code. **Add \$871** to list price.

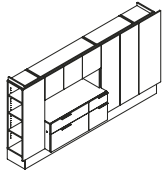

Work Wall - 110"W*

FW11056-3L	20 x 110 x 56	100	538	62	\$22960
------------	---------------	-----	-----	----	----------------

Vertical storage with 3 adjustable shelves, 45" wide wall credenza with box/file and narrow box/file, 45" wide niche, 45" wide single height storage, double width vertical storage with 3 adjustable shelves, wardrobe with coat hook and hat shelf.

- To add tackboard to niche, add **TB** to end of product code. **Add \$1031** to list price for grades 1-3. Add **\$1238** for grades 4-5.
- To add LED light to niche, add **LT** to end of product code. **Add \$708** to list price.

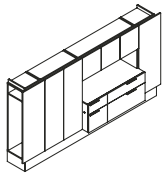

Work Wall - 110"W*

FW11056-3R	20 x 110 x 56	100	538	62	\$22960
------------	---------------	-----	-----	----	----------------

Wardrobe with coat hook and hat shelf, double width vertical storage with 3 adjustable shelves, 45" wide wall credenza with narrow box/file and box/file, 45" wide niche, 45" wide single height storage, vertical storage with 3 adjustable shelves.

- To add tackboard to niche, add **TB** to end of product code. **Add \$1031** to list price for grades 1-3. Add **\$1238** for grades 4-5.
- To add LED light to niche, add **LT** to end of product code. **Add \$708** to list price.

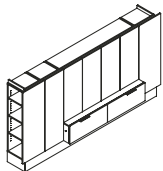

Work Wall - 110"W

FW11056-4L	20 x 110 x 56	100	530	61	\$22036
------------	---------------	-----	-----	----	----------------

Vertical storage with 3 adjustable shelves, vertical storage with 3 adjustable shelves, 60" wide single height wall credenza with two files, 60" wide triple height storage with 2 adjustable shelves, wardrobe with coat hook and hat shelf.

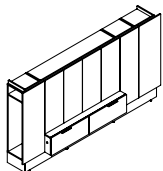

Work Wall - 110"W

FW11056-4R	20 x 110 x 56	100	530	61	\$22036
------------	---------------	-----	-----	----	----------------

Wardrobe with coat hook and hat shelf, single height 60" wide wall credenza with two files, 60" wide triple height storage with 2 adjustable shelves, vertical storage with 3 adjustable shelves, vertical storage with 3 adjustable shelves.

Required Specifications

Front finish
Top/body finish
Cubby interior finish

Optional Specifications

Grommet
LED light*
Tackboard*

WORK WALLS - 84"H

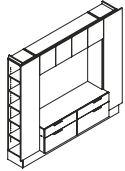

Work Wall - 95"W

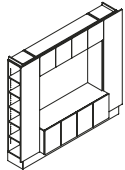

Work Wall - 95"W

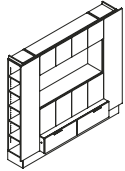

Work Wall - 95"W

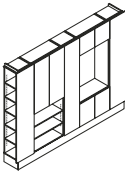

Work Wall - 110"W

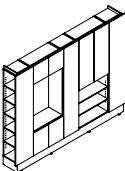

Work Wall - 110"W

MODEL#	DIMENSIONS	FREIGHT CLASS	WT/LBS.	CUBIC FT.	LIST PRICE
--------	------------	---------------	---------	-----------	------------

D x W x H

FW9584-20	20 x 95 x 84	125	565	77	\$26820
-----------	--------------	-----	-----	----	----------------

Vertical storage with 5 adjustable shelves, 60" wide wall credenza with two box/files, 60" wide triple height niche, 60" wide single height storage, vertical storage with 5 adjustable shelves.

- To add tackboard to niche, add **TB** to end of product code. **Add \$1910** to list price for grades 1-3. Add **\$2292** for grades 4-5.
- To add LED light to niche, add **LT** to end of product code. **Add \$871** to list price.

FW9584-21	20 x 95 x 84	125	512	77	\$24690
-----------	--------------	-----	-----	----	----------------

Vertical storage with 5 adjustable shelves, 60" wide wall credenza with two cabinets with adjustable shelves, 60" wide triple height niche, 60" wide single height storage, vertical storage with 5 adjustable shelves.

- To add tackboard to niche, add **TB** to end of product code. **Add \$1910** to list price for grades 1-3. Add **\$2292** for grades 4-5.
- To add LED light to niche, add **LT** to end of product code. **Add \$874** to list price.

FW9584-22	20 x 95 x 84	125	611	77	\$25754
-----------	--------------	-----	-----	----	----------------

Vertical storage with 5 adjustable shelves, 60" wide single height wall credenza with two files, 60" wide double height storage, 60" wide double height niche, 60" wide single height storage, vertical storage with 5 adjustable shelves.

- To add tackboard to niche, add **TB** to end of product code. **Add \$1271** to list price for grades 1-3. Add **\$1526** for grades 4-5.
- To add LED light to niche, add **LT** to end of product code. **Add \$871** to list price.

FW11084-20L	15 x 110 x 84	125	659	87	\$25226
-------------	---------------	-----	-----	----	----------------

Vertical storage with 5 adjustable shelves, 30" wide triple height open bookcase, 30" wide triple height double width storage, vertical storage with 5 adjustable shelves, 30" wide and double height storage, 30" triple height niche, 30" wide single height storage, vertical storage with 5 adjustable shelves.

- To add tackboard to niche, add **TB** to end of product code. **Add \$956** to list price for grades 1-3. Add **\$1146** for grades 4-5.
- To add LED light to niche, add **LT** to end of product code. **Add \$533** to list price.

FW11084-20R	15 x 110 x 84	125	659	87	\$25226
-------------	---------------	-----	-----	----	----------------

Vertical storage with 5 adjustable shelves, 30" wide double height storage, 30" wide triple height niche, 30" wide single height storage, vertical storage with 5 adjustable shelves, 30" wide triple height open bookcase, 30" wide triple height double width storage, vertical storage with 5 adjustable shelves.

- To add tackboard to niche, add **TB** to end of product code. **Add \$956** to list price for grades 1-3. Add **\$1146** for grades 4-5.
- To add LED light to niche, add **LT** to end of product code. **Add \$533** to list price.

Required Specifications

Front finish
Top/body finish
Cubby interior finish

Optional Specifications

Grommet
LED light
Tackboard

WORK WALLS - 84"H

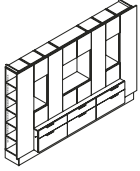

Work Wall - 125"W

MODEL#	DIMENSIONS D x W x H	FREIGHT CLASS	WT/LBS.	CUBIC FT.	LIST PRICE
FW12584-20	20 x 125 x 84	100	962	101	\$38990

Vertical storage with 5 adjustable shelves, 90" wide wall credenza with three box/files, single height storage, 15" wide double height niche, single height storage, four-fold height vertical storage with 3 adjustable shelves, double width single height storage, 30" wide double height niche, double width single height storage, fourfold height vertical storage with 3 adjustable shelves, single height storage, 15" wide double height niche, single height storage, vertical storage with 5 adjustable shelves.

- To add tackboard to niche, add **TB** to end of product code. **Add \$1736** to list price for grades 1-3. **Add \$2084** for grades 4-5.
- To add LED light to niche, add **LT** to end of product code. **Add \$1742** to list price.

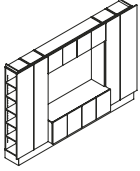

Work Wall - 125"W

FW12584-21	20 x 125 x 84	125	738	100	\$29584
------------	---------------	-----	-----	-----	----------------

Vertical storage with 5 adjustable shelves, vertical storage with 5 adjustable shelves, 60" wide wall credenza with two cabinets and adjustable shelf, 60" wide triple height niche, 60" wide single height storage, vertical storage with 5 adjustable shelves, vertical storage with 5 adjustable shelves.

- To add tackboard to niche, add **TB** to end of product code. **Add \$1905** to list price for grades 1-3. **Add \$2287** for grades 4-5.
- To add LED light to niche, add **LT** to end of product code. **Add \$873** to list price.

WORK WALLS - 70"H

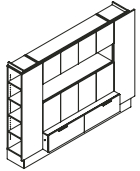

Work Wall - 95"W

MODEL#	DIMENSIONS	FREIGHT CLASS	WT/LBS.	CUBIC FT.	LIST PRICE
FW9570-20	20 x 95 x 70	100	563	66	\$23169

Vertical storage with 4 adjustable shelves, 60" wide single height wall credenza with two files, 60" wide double height storage, 60" wide niche, 60" wide single height storage, vertical storage with 4 adjustable shelves.

- To add tackboard to niche, add **TB** to end of product code. **Add \$1029** to list price for grades 1-3. **Add \$1236** for grades 4-5.
- To add LED light to niche, add **LT** to end of product code. **Add \$871** to list price.

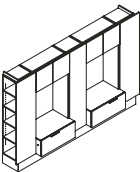

Work Wall - 110"W

FW11070-20	20 x 110 x 70	125	602	78	\$26602
------------	---------------	-----	-----	----	----------------

Vertical storage with 4 adjustable shelves, 30" wide single height wall credenza with file, 30" wide triple height niche, 30" wide single height storage, vertical storage with 4 adjustable shelves, 30" wide single height wall credenza with file, 30" wide triple height niche, 30" wide single height storage, vertical storage with 4 adjustable shelves.

- To add tackboard to niche, add **TB** to end of product code. **Add \$1908** to list price for grades 1-3. **Add \$2289** for grades 4-5.
- To add LED light to niche, add **LT** to end of product code. **Add \$1381** to list price.

Required Specifications

Front finish
Top/body finish
Cubby interior finish

Optional Specifications

Grommet
LED light
Tackboard

WORK WALLS - 70"H

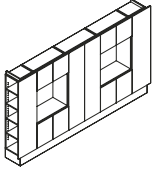

Work Wall - 125"W

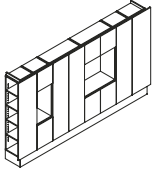

Work Wall - 125"W

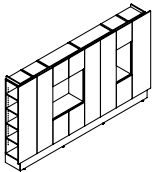

Work Wall - 125"W

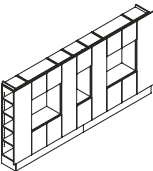

Work Wall - 140"W

MODEL#	DIMENSIONS	FREIGHT CLASS	WT/LBS.	CUBIC FT.	LIST PRICE
--------	------------	---------------	---------	-----------	------------

D x W x H

FW12570-20	20 x 125 x 70	125	645	84	\$26823
------------	---------------	-----	-----	----	----------------

Vertical storage with 4 adjustable shelves, 30" wide double height storage, 30" wide double height niche, 30" wide single height storage, double width vertical storage with 4 adjustable shelves, 30" wide double height storage, 30" wide double height niche, 30" wide single height storage, vertical storage with 4 adjustable shelves.

- To add tackboard to niche, add **TB** to end of product code. **Add \$1274** to list price for grades 1-3. Add **\$1529** for grades 4-5.
- To add LED light to niche, add **LT** to end of product code. **Add \$1380** to list price.

FW12570-21L	20 x 125 x 70	100	685	84	\$28121
-------------	---------------	-----	-----	----	----------------

Vertical storage with 4 adjustable shelves, 15" wide double height storage, 15" wide double height niche, 15" wide single height storage, double width vertical storage with 4 adjustable shelves, 30" wide double height storage, 30" wide double height niche, 30" wide single height storage, vertical storage with 4 adjustable shelves, vertical storage with 4 adjustable shelves.

- To add tackboard to niche, add **TB** to end of product code. **Add \$871** to list price for grades 1-3. Add **\$1045** for grades 4-5.
- To add LED light to niche, add **LT** to end of product code. **Add \$1045** to list price.

FW12570-21R	20 x 125 x 70	100	685	84	\$28121
-------------	---------------	-----	-----	----	----------------

Vertical storage with 4 adjustable shelves, vertical storage with 4 adjustable shelves, 30" wide double height storage, 30" wide double height niche, 30" wide single height storage, double width vertical storage with 4 adjustable shelves, 15" wide double height storage, 15" wide double height niche, 15" wide single height storage, vertical storage with 4 adjustable shelves.

- To add tackboard to niche, add **TB** to end of product code. **Add \$871** to list price for grades 1-3. Add **\$1045** for grades 4-5.
- To add LED light to niche, add **LT** to end of product code. **Add \$1045** to list price.

FW14070-20	20 x 140 x 70	100	779	96	\$31741
------------	---------------	-----	-----	----	----------------

Vertical storage with 4 adjustable shelves, 30" wide double height storage, 30" wide double height niche, 30" wide single height storage, vertical storage cabinet with 4 adjustable shelves, 15" wide double height storage, 15" wide double height niche, 15" wide single height storage, vertical storage with 4 adjustable shelves, 30" wide double height storage, 30" wide double height niche, 30" wide single height storage, vertical storage with 4 adjustable shelves.

- To add tackboard to niche, add **TB** to end of product code. **Add \$1722** to list price for grades 1-3. Add **\$2066** for grades 4-5.
- To add LED light to niche, add **LT** to end of product code. **Add \$1745** to list price.

Required Specifications

Front finish
Top/body finish
Cubby interior finish

Optional Specifications

Grommet
LED light
Tackboard

WORK WALLS - 70"H

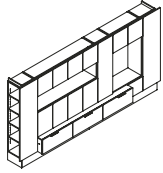

Work Wall - 140"W

MODEL#	DIMENSIONS D x W x H	FREIGHT CLASS	WT/LBS.	CUBIC FT.	LIST PRICE
FW14070-21L	20 x 140 x 70	100	832	96	\$31741

Vertical storage with 4 adjustable shelves, 60" wide double height storage, 60" wide niche, 60" wide single height storage, 15" wide triple height storage, 15" wide single height storage, 30" wide double height niche, 30" wide single height storage, 90" wide single height wall credenza with three files, vertical storage with 4 adjustable shelves.

- To add tackboard to niche, add **TB** to end of product code. **Add \$2025** to list price for grades 1-3. Add **\$2431** for grades 4-5.
- To add LED light to niche, add **LT** to end of product code. **Add \$1814** to list price.

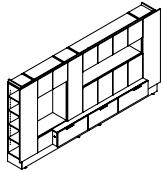

Work Wall - 140"W

FW14070-21R	20 x 140 x 70	100	832	96	\$31741
-------------	---------------	-----	-----	----	----------------

Vertical storage with 4 adjustable shelves, 15" wide single height storage, 30" wide double height niche, 30" wide single height storage, 90" wide single height wall credenza with three files, 15" wide triple height storage, 60" wide double height storage, 60" wide niche, 60" wide single height storage, vertical storage with 4 adjustable shelves.

- To add tackboard to niche, add **TB** to end of product code. **Add \$2025** to list price for grades 1-3. Add **\$2431** for grades 4-5.
- To add LED light to niche, add **LT** to end of product code. **Add \$1814** to list price.

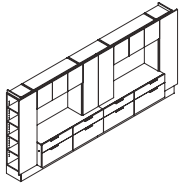

Work Wall - 155"W

FW15570-20	20 x 155 x 70	100	900	108	\$31741
------------	---------------	-----	-----	-----	----------------

Vertical storage with 4 adjustable shelves, 60" wide wall credenza with two box/files, 45" wide double height niche, 45" wide single height storage, 30" wide double width storage with 2 adj. shelves, 60" wide wall credenza with two box/files, 45" wide double height niche, 45" wide single height storage, vertical storage with 4 adjustable

- To add tackboard to niche, add **TB** to end of product code. **Add \$2595** to list price for grades 1-3. Add **\$3113** for grades 4-5.
- To add LED light to niche, add **LT** to end of product code. **Add \$1858** to list price.

WORK WALLS - 84"H

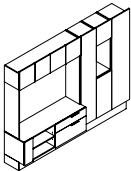

Work Wall - 107"W

MODEL#	DIMENSIONS	FREIGHT CLASS	WT/LBS.	CUBIC FT.	LIST PRICE
FW10784L	20 x 95 x 84	100	832	96	\$29442

60" wide wall credenza with adjustable shelf and box/file, 60" wide triple height niche, 60" wide single height storage, vertical storage with 5 adjustable shelves, triple height storage, 15" wide double height niche, single height storage, vertical storage with 5 adjustable shelves.

- To add tackboard to niche, add **TB** to end of product code. **Add \$1298** to list price for grades 1-3. Add **\$1558** for grades 4-5.
- To add LED light to niche, add **LT** to end of product code. **Add \$1298** to list price.

Required Specifications

Front finish
Top/body finish
Cubby interior finish

Optional Specifications

Grommet
LED light
Tackboard

OPEN KNEE SPACE WORK WALLS

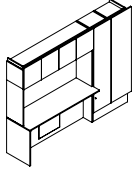

Open Knee Space Work Wall - 92"W

MODEL#	DIMENSIONS D x W x H	FREIGHT CLASS	WT/LBS.	CUBIC FT.	LIST PRICE
FW927002R	20 x 92.5 x 84	100	832	96	\$17358

60" wide work surface wall credenza, 60" wide double height niche, 60" wide single height storage, vertical storage with 4 adjustable shelves, wardrobe with coat hook and hat shelf.

- To add tackboard to niche, add **TB** to end of product code. **Add \$1298** to list price for grades 1-3. Add **\$1558** for grades 4-5.
- To add LED light to niche, add **LT** to end of product code. **Add \$1298** to list price.

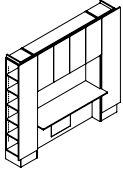

Open Knee Space Work Wall - 95"W

FW95840WR	20 x 95 x 84	100	832	96	\$18129
-----------	--------------	-----	-----	----	----------------

Vertical storage with 5 adjustable shelves, 60" wide work surface wall credenza, 60" wide double height niche, 60" wide double height storage, wardrobe with coat hook and hat shelf.

- To add tackboard to niche, add **TB** to end of product code. **Add \$1298** to list price for grades 1-3. Add **\$1558** for grades 4-5.
- To add LED light to niche, add **LT** to end of product code. **Add \$889** to list price.

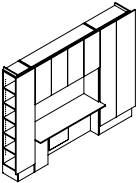

Open Knee Space Work Wall - 110"W

FW110840W2R	20 x 110 x 84	100	832	96	\$20763
-------------	---------------	-----	-----	----	----------------

Vertical storage with 5 adjustable shelves, 60" wide work surface wall credenza, 60" wide double height niche, 60" wide double height storage, double depth wardrobe with coat rod and hat shelf.

- To add tackboard to niche, add **TB** to end of product code. **Add \$1299** to list price for grades 1-3. Add **\$1559** for grades 4-5.
- To add LED light to niche, add **LT** to end of product code. **Add \$894** to list price.

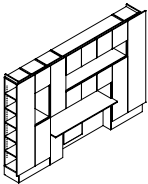

Open Knee Space Work Wall - 125"W

FW125840IL	20 x 110 x 84	100	832	96	\$29257
------------	---------------	-----	-----	----	----------------

Vertical storage with 5 adjustable shelves, triple height storage, 15" wide triple height storage, 15" wide double height niche, single high storage, 60" wide work surface wall credenza, 60" wide single height niche, triple height storage, 45" wide single height storage, 60" wide single height niche, 60" wide single height storage, triple height storage, wardrobe with coat hook and hat shelf.

- To add tackboard to niche, add **TB** to end of product code. **Add \$2554** to list price for grades 1-3. Add **\$3067** for grades 4-5.
- To add LED light to niche, add **LT** to end of product code. **Add \$2563** to list price.

Required Specifications

Front finish
Top/body finish
Cubby interior finish

Optional Specifications

Grommet
LED light
Tackboard

F FOUNDATIONS

WORK WALL CREDENZAS

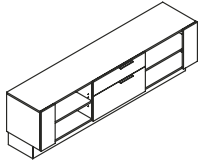

Work Wall Credenza

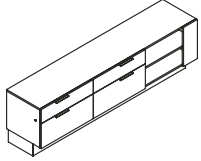

Work Wall Credenza

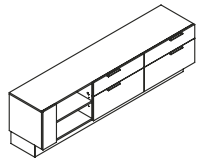

Work Wall Credenza

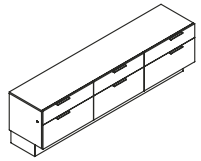

Work Wall Credenza

MODEL#	DIMENSIONS	FREIGHT CLASS	WT/LBS.	CUBIC FT.	LIST PRICE
--------	------------	---------------	---------	-----------	------------

D x W x H

FW9026-1	20 x 90 x 26	100	254	27	\$10008
----------	--------------	-----	-----	----	----------------

Standard with adjustable shelf, box/file and adjustable shelf.

FW9026-2	20 x 90 x 26	92.5	270	27	\$10435
----------	--------------	------	-----	----	----------------

Standard with box/file, box/file and adjustable shelf.

FW9026-3	20 x 90 x 26	92.5	270	27	\$10735
----------	--------------	------	-----	----	----------------

Standard with adjustable shelf, box/file and box/file.

FW9026-4	20 x 90 x 26	92.5	310	27	\$11071
----------	--------------	------	-----	----	----------------

Standard with three box/file drawers. Center pedestal does not lock.

Required Specifications

Front finish
Top/body finish

Optional Specifications

Grommet

CONFERENCE ROOM FURNITURE - NOTES

D x W x H

- Horizontal grain direction is standard on all engineered finishes.
- Full Storage Credenza backs include GM17 vertical cut out
- Optional decorative credenza back panels (**FBP**) are available as a factory installed upgrade on FC/FCD models only.
- Doors open with touch latch
- To open the drawer, pull drawer front overhang - no handles available
- Display Wall can be purchased with optional monitor mount installed
- Mobile and stationary lecterns are available.
- Two Connecting Brackets are included.
- **Metal Leg finishes (conference furniture):**
 - BLKT Black Textured
 - TUNT Tungsten Textured
 - DWTT Designer White Textured
- **NOTE:** Arrow indicates direction of grain

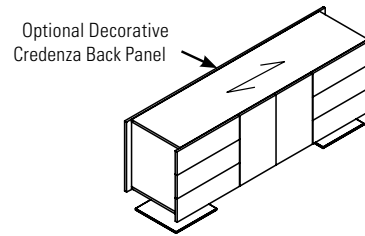

CONFERENCE ROOM FURNITURE	MODEL#	DIMENSIONS	FREIGHT CLASS	WT./LBS.	CUBIC FT.	LIST PRICE
---------------------------	--------	------------	---------------	----------	-----------	------------

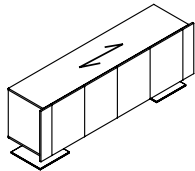

Full Storage Credenza

FC9020GG	20 x 90 x 29	125	241	36	\$11284
FC8420GG	20 x 84 x 29	125	232	33	\$10837
FC7820GG	20 x 78 x 29	125	223	31	\$10059
FC7220GG	20 x 72 x 29	125	213	29	\$9787
FC6020MM	20 x 60 x 29	125	194	26	\$9083

Standard with two sets of storage cabinets.

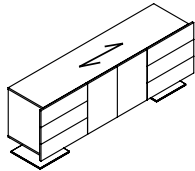

Full Storage Credenza

FCD9020A	20 x 90 x 29	125	249	36	\$11956
FCD8420A	20 x 84 x 29	125	240	33	\$11512
FCD7820A	20 x 78 x 29	125	230	31	\$10689
FCD7220A	20 x 72 x 29	125	221	29	\$10459
FCD6020A	20 x 60 x 29	125	202	26	\$9763

Standard with three box drawers on left, storage cabinets in center, and three box drawers on right.

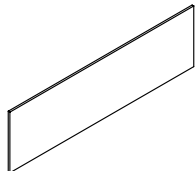

Decorative Back Panel

FBP9020	20 x 90 x 29	92.5	41	4	\$1924
FBP8420	20 x 84 x 29	100	38	4	\$1827
FBP7820	20 x 78 x 29	85	36	3	\$1701
FBP7220	20 x 72 x 29	92.5	33	3	\$1482
FBP6020	20 x 60 x 29	100	27	3	\$1254

For FC/FCD credenza models only. Not sold individually. Must be ordered as an upgrade option only.

Required Specifications

- Front finish
- Top/body finish
- Leg finish

CONFERENCE ROOM FURNITURE

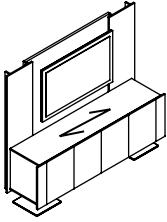

Display Wall Storage Credenza

MODEL#	DIMENSIONS D x W x H	FREIGHT CLASS	WT/LBS.	CUBIC FT.	LIST PRICE
FC9024GGTWH72	24 x 90 x 72	100	463	47	\$17489
FC8424GGTWH72	24 x 84 x 72	92.5	460	45	\$16659
FC7824GGTWH72	24 x 78 x 72	125	286	41	\$15471
FC7224GGTWH72	24 x 72 x 72	92.5	418	39	\$15004
FC9024GGTWH66	24 x 90 x 66	100	444	48	\$16882
FC8424GGTWH66	24 x 84 x 66	100	422	45	\$16218
FC7824GGTWH66	24 x 78 x 66	100	402	42	\$15057
FC7224GGTWH66	24 x 72 x 66	100	381	39	\$14592

With two sets of storage cabinets and display wall. Monitors and TV mounts are not included. Display wall includes GM1 grommet.

Monitor size chart based on display wall size:

Display Wall Width	Monitor Size
90"	54"
84"	50"
78"	46"
72"	42"

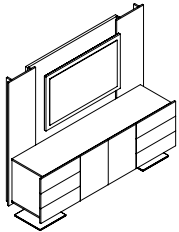

Display Wall Storage Credenza

FCD9024ATWH72	24 x 90 x 72	92.5	481	48	\$17757
FCD8424ATWH72	24 x 84 x 72	92.5	460	45	\$16929
FCD7824ATWH72	24 x 78 x 72	92.5	439	42	\$14121
FCD7224ATWH72	24 x 72 x 72	100	381	39	\$15223
FCD9024ATWH66	24 x 90 x 66	100	444	48	\$17153
FCD8424ATWH66	24 x 84 x 66	100	422	45	\$16486
FCD7824ATWH66	24 x 78 x 66	100	402	42	\$15330
FCD7224ATWH66	24 x 72 x 66	100	381	39	\$14863

With three box drawers on left, storage cabinets in center, and three box drawers on right, and display wall. Monitors and TV mounts are not included. Display wall includes GM1 grommet.

Monitor size chart based on display wall size:

Display Wall Width	Monitor Size
90"	54"
84"	50"
78"	46"
72"	42"

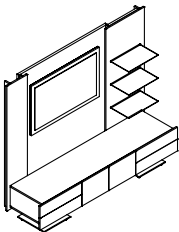

Display Wall Storage Credenza

FFTWA90WH72	24 x 90 x 72	92.5	482	41	\$18588
FFTWA84WH72	24 x 84 x 72	85	462	38	\$17953
FFTWA78WH72	24 x 78 x 72	85	442	35	\$17026
FFTWA72WH72	24 x 72 x 72	85	421	32	\$16007
FFTWA90WH66	24 x 90 x 66	92.5	462	40	\$17985
FFTWA84WH66	24 x 84 x 66	92.5	443	37	\$17349
FFTWA78WH66	24 x 78 x 66	85	424	34	\$16458
FFTWA72WH66	24 x 72 x 66	85	404	31	\$15535

With two box drawers on left, storage cabinets in center, and two box drawers on right, and display wall with shelves. Monitors and TV mounts are not included. Display wall includes GM1 grommet.

Monitor size chart based on display wall size:

Display Wall Width	Monitor Size
90"	54"
84"	50"
78"	46"
72"	42"

Required Specifications

Front/wall finish
Top/body finish
Leg finish

CONFERENCE ROOM ACCESSORIES

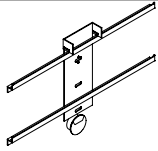

Flat Screen Monitor Mount

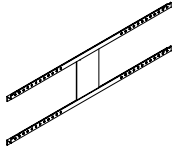

Flat Screen Monitor Mount

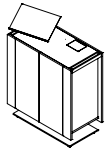

Lectern

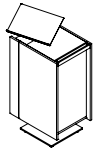

Lectern

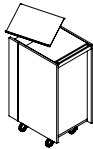

Mobile Lectern

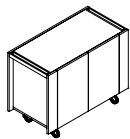

Mobile Server

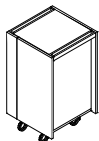

Mobile Tech Cart

MODEL#	DIMENSIONS	FREIGHT CLASS	WT/LBS.	CUBIC FT.	LIST PRICE
--------	------------	---------------	---------	-----------	------------

D x W x H

FVMED	2 x 28 x 17	70	14	0.7	\$783
-------	-------------	----	----	-----	--------------

Flat screen monitor mount up to 50". To be used on Foundations display wall storage credenzas. GM1K (tungsten) grommet on the back panel is included.

FVLRG	2 x 38 x 21	60	25	0.75	\$651
-------	-------------	----	----	------	--------------

Flat screen monitor mount for over 50". To be used on Foundations display wall storage credenzas.

FLEC36	20 x 36 x 42	125	166	22	\$10800
--------	--------------	-----	-----	----	----------------

With pop-up door to reveal concealed power/data monument (power duplex, 15 pin VGA, data and telephone connectors). Metal finish on base, book rest and handles must be specified. Includes 1 adjustable shelf.

FLEC24	20 x 24 x 42	100	135	15	\$8911
--------	--------------	-----	-----	----	---------------

With laptop pull-out tray to reveal concealed power/data monument (power duplex, 15 pin VGA, data and telephone connectors). Metal finish on base, book rest and handles must be specified. Includes 1 adjustable shelf.

FLEC24M	20 x 24 x 42	100	135	15	\$6601
---------	--------------	-----	-----	----	---------------

With laptop pull-out tray. Metal finish on base, book rest and handles must be specified. Includes 1 adjustable shelf. Locking casters (Tungsten only).

FSM4020	20 x 40 x 30	150	108	21	\$7192
---------	--------------	-----	-----	----	---------------

With cutlery drawer and adjustable shelf. Metal finish on handles must be specified. Locking casters (Tungsten only).

FTCM2020H42	20 x 20 x 42	150	67	13.5	\$5241
-------------	--------------	-----	----	------	---------------

FTCM2020H36	20 x 20 x 36	150	54	10.5	\$4494
-------------	--------------	-----	----	------	---------------

Metal finish on handles must be specified. Includes 1 adjustable shelf. Locking casters (Tungsten only).

Required Specifications

Front finish
Top/body finish
Metal finish*

BOARDROOM TABLES - NOTES

D x W x H

- Table tops are 1.5" thick with a 2" undercut knife edge.

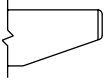

- All tops have a 1/8" (3mm) solid edge of walnut, cherry, maple and oak
- See notes section for optional grommet locations on tables without technology trough
- See "Technology Trough Details" on page 154
- For tables with 3 bases and technology trough, add **C** (for center base feed) or **E** (for end base feed) to the end of the model number (Example: FRESTCT19298**C**)
- Extended leveling capabilities below the top surface; interior column of base can be raised an additional 4" over the 0.5" of leveling glide adjustment at the floor if required. See installation instructions for further information.
- **NOTE:** Arrow indicates direction of grain

BOARDROOM TABLES - RECTANGULAR

MODEL# DIMENSIONS FREIGHT CLASS WT/LBS. CUBIC FT. LIST PRICE

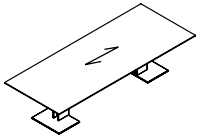

Rectangular Table

FRE12048	48 x 120 x 29	100	450	54	\$15293
FRE9648	48 x 96 x 29	125	390	49	\$13847

One piece top. Two bases.

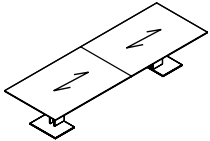

Rectangular Table

FRE16848	48 x 168 x 29	100	571	65	\$18681
FRE14448	48 x 144 x 29	100	511	60	\$16913
FRE12048-2	48 x 120 x 29	100	450	56	\$15495

Two piece top. Two bases.

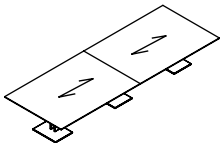

Rectangular Table

FRE24060	60 x 240 x 29	100	965	109	\$29818
FRE21660	60 x 216 x 29	100	893	104	\$28146
FRE19260	60 x 192 x 29	100	821	99	\$26418
FRE16860	60 x 168 x 29	100	748	93	\$24710
FRE21648	48 x 216 x 29	92.5	872	87	\$25829
FRE19248	48 x 192 x 29	100	744	82	\$24295

Two piece top. Three bases.

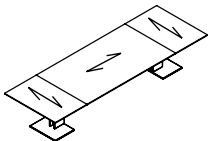

Rectangular Table, Sectional*

FREST16848	48 x 168 x 29	100	571	65	\$19037
FREST14448	48 x 144 x 29	100	511	60	\$17529
FREST12048	48 x 120 x 29	100	450	54	\$16009

Three piece top. Two bases.

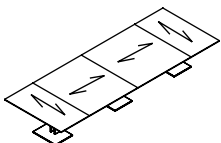

Rectangular Table, Sectional*

FREST24060	60 x 240 x 29	100	965	109	\$27693
FREST21660	60 x 216 x 29	100	893	104	\$28753
FREST19260	60 x 192 x 29	100	821	99	\$26836
FREST16860	60 x 168 x 29	100	748	93	\$25000
FREST21648	48 x 216 x 29	92.5	872	87	\$26533
FREST19248	48 x 192 x 29	100	744	82	\$24898

Four piece top. Three bases.

- 168"W table - midsection is one piece

Required Specifications

Top finish/base side finish
Base end finish
Metal finish

Optional Specifications

Grommet

BOARDROOM TABLES - RECTANGULAR

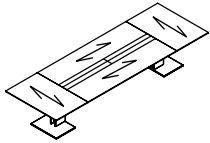

Rectangular Table, Sectional

MODEL#	DIMENSIONS	FREIGHT CLASS	WT/LBS.	CUBIC FT.	LIST PRICE
--------	------------	---------------	---------	-----------	------------

D x W x H

FRESTCT16848	48 x 168 x 29	100	659	69	\$29049
FRESTCT14448	48 x 144 x 29	100	584	63	\$23273
FRESTCT12048	48 x 120 x 29	100	508	57	\$21576

Four piece top. Two bases / power kit included.

- 168"W table includes technology trough with 8 doors
- 144"W and 120" tables include technology trough with 4 doors

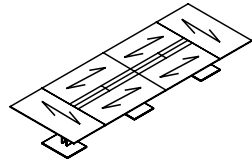

Rectangular Table, Sectional

FRESTCT24060	60 x 240 x 29	100	1113	116	\$42464
FRESTCT21660	60 x 216 x 29	100	1021	109	\$40210
FRESTCT19260	60 x 192 x 29	100	920	103	\$37770
FRESTCT16860	60 x 168 x 29	100	836	96	\$35253
FRESTCT21648	48 x 216 x 29	92.5	1000	92	\$38096
FRESTCT19248	48 x 192 x 29	100	843	87	\$35881

Six piece top. Three bases. Add **C** or **E** to end of model number to specify base feed location. Includes technology trough with 8 doors.

- 168"W table - midsection is one piece

BOARDROOM TABLES - BOW END

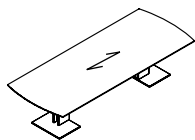

Bow End Table

MODEL#	DIMENSIONS	FREIGHT CLASS	WT/LBS.	CUBIC FT.	LIST PRICE
--------	------------	---------------	---------	-----------	------------

FREBE12048	48 x 120 x 29	100	450	54	\$16056
FREBE9648	48 x 96 x 29	125	390	49	\$14539

One piece top. Two bases.

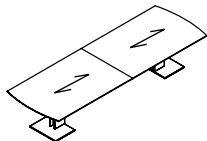

Bow End Table

FREBE16848	48 x 168 x 29	100	571	65	\$19611
FREBE14448	48 x 144 x 29	100	511	60	\$17758
FREBE12048-2	48 x 120 x 29	100	450	56	\$16271

Two piece top. Two bases.

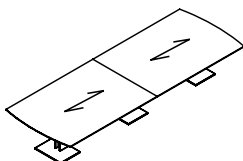

Bow End Table

FREBE24060	60 x 240 x 29	100	965	109	\$31307
FREBE21660	60 x 216 x 29	100	893	104	\$29552
FREBE19260	60 x 192 x 29	100	821	99	\$27738
FREBE16860	60 x 168 x 29	100	748	93	\$25945
FREBE21648	48 x 216 x 29	92.5	872	87	\$27120
FREBE19248	48 x 192 x 29	100	744	82	\$25508

Two piece top. Three bases.

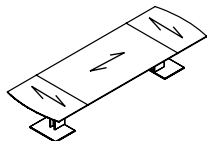

Bow End Table, Sectional

FREBEST16848	48 x 168 x 29	100	571	65	\$19991
FREBEST14448	48 x 144 x 29	100	511	60	\$18405
FREBEST12048	48 x 120 x 29	100	450	54	\$16810

Three piece top. Two bases.

Required Specifications

Top finish/base side finish
Base end finish
Metal finish

Optional Specifications

Grommet

F FOUNDATIONS

BOARDROOM TABLES - BOW END

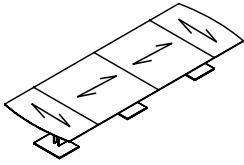

Bow End Table, Sectional

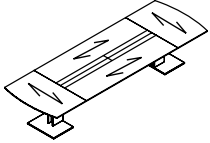

Bow End Table, Sectional

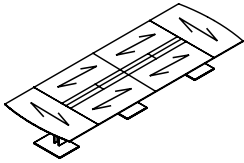

Bow End Table, Sectional

MODEL#	DIMENSIONS D x W x H	FREIGHT CLASS	WT/LBS.	CUBIC FT.	LIST PRICE
FREBEST24060	60 x 240 x 29	100	965	109	\$31982
FREBEST21660	60 x 216 x 29	100	893	104	\$30192
FREBEST19260	60 x 192 x 29	100	821	99	\$28179
FREBEST16860	60 x 168 x 29	100	748	93	\$26248
FREBEST21648	48 x 216 x 29	92.5	872	87	\$27861
FREBEST19248	48 x 192 x 29	100	744	82	\$26141

Four piece top. Three bases.
 • 168"W table - midsection is one piece

FREBESTCT16848	48 x 168 x 29	100	659	69	\$30502
FREBESTCT14448	48 x 144 x 29	100	584	63	\$24434
FREBESTCT12048	48 x 120 x 29	100	508	57	\$22654

Four piece top. Two bases / power kit included.
 • 168"W table includes technology trough with 8 doors
 • 144"W and 120" tables include technology trough with 4 doors

FREBESTCT24060	60 x 240 x 29	100	1113	116	\$44585
FREBESTCT21660	60 x 216 x 29	100	1021	109	\$42217
FREBESTCT19260	60 x 192 x 29	100	920	103	\$39659
FREBESTCT16860	60 x 168 x 29	100	836	96	\$37015
FREBESTCT21648	48 x 216 x 29	92.5	1000	92	\$40000
FREBESTCT19248	48 x 192 x 29	100	843	87	\$37673

Six piece top. Three bases. Add **C** or **E** to end of model number to specify base feed location. Includes technology trough with 8 doors.
 • 168"W table - midsection is one piece

BOARDROOM TABLES - BOAT SHAPED

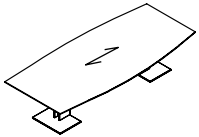

Boat Shaped Table

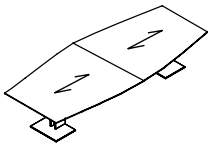

Boat Shaped Table

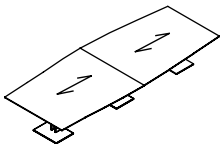

Boat Shaped Table

MODEL#	DIMENSIONS	FREIGHT CLASS	WT/LBS.	CUBIC FT.	LIST PRICE
FBO12048	48 x 120 x 29	100	450	54	\$16856
FBO9648	48 x 96 x 29	125	390	49	\$15264

One piece top. Two bases.

FBO16848	48 x 168 x 29	100	571	65	\$20590
FBO14448	48 x 144 x 29	100	511	60	\$18644
FBO12048-2	48 x 120 x 29	100	450	56	\$17081

Two piece top. Two bases.

FBO24060	60 x 240 x 29	100	965	109	\$32871
FBO21660	60 x 216 x 29	100	893	104	\$31028
FBO19260	60 x 192 x 29	100	821	99	\$29124
FBO16860	60 x 168 x 29	100	748	93	\$27237
FBO21648	48 x 216 x 29	92.5	872	87	\$28473
FBO19248	48 x 192 x 29	100	744	82	\$26784

Two piece top. Three bases.

Required Specifications

Top finish/base side finish
 Base end finish
 Metal finish

Optional Specifications

Grommet

BOARDROOM TABLES - BOAT SHAPED

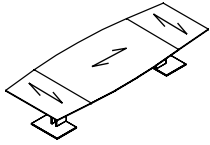

Boat Shaped Table, Sectional

MODEL#	DIMENSIONS	FREIGHT CLASS	WT./LBS.	CUBIC FT.	LIST PRICE
--------	------------	---------------	----------	-----------	------------

D x W x H

FBOST16848	48 x 168 x 29	100	571	65	\$20991
FBOST14448	48 x 144 x 29	100	511	60	\$19325
FBOST12048	48 x 120 x 29	100	450	54	\$17650

Three piece top. Two bases.

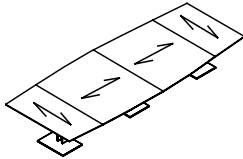

Boat Shaped Table, Sectional

FBOST24060	60 x 240 x 29	100	965	109	\$33582
FBOST21660	60 x 216 x 29	100	893	104	\$31700
FBOST19260	60 x 192 x 29	100	821	99	\$29587
FBOST16860	60 x 168 x 29	100	748	93	\$27558
FBOST21648	48 x 216 x 29	92.5	872	87	\$29250
FBOST19248	48 x 192 x 29	100	744	82	\$27447

Four piece top. Three bases.

- 168"W table - midsection is one piece

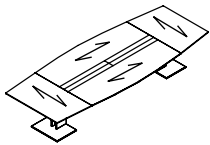

Boat Shaped Table, Sectional

FBOSTCT16848	48 x 168 x 29	100	659	69	\$32027
FBOSTCT14448	48 x 144 x 29	100	584	63	\$25652
FBOSTCT12048	48 x 120 x 29	100	508	57	\$23787

Four piece top. Two bases / power kit included.

- 168"W table includes technology trough with 8 doors
- 144"W and 120" tables include technology trough with 4 doors

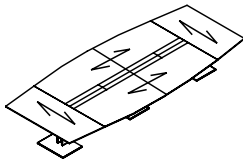

Boat Shaped Table, Sectional

FBOSTCT24060	60 x 240 x 29	100	1113	116	\$46812
FBOSTCT21660	60 x 216 x 29	92.5	1021	91	\$44325
FBOSTCT19260	60 x 192 x 29	100	920	103	\$41641
FBOSTCT16860	60 x 168 x 29	100	836	96	\$38863
FBOSTCT21648	48 x 216 x 29	92.5	1000	92	\$41456
FBOSTCT19248	48 x 192 x 29	100	843	87	\$39556

Six piece top. Three bases. Add **C** or **E** to end of model number to specify base feed location. Includes technology trough with 8 doors.

- 168"W table - midsection is one piece

BOARDROOM TABLES - BOAT SHAPED, BOW END

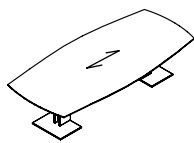

Boat Shaped Table, Bow End

MODEL#	DIMENSIONS	FREIGHT CLASS	WT./LBS.	CUBIC FT.	LIST PRICE
--------	------------	---------------	----------	-----------	------------

FBOBE12048	48 x 120 x 29	100	450	54	\$17426
FBOBE9648	48 x 96 x 29	125	390	49	\$15757

One piece top. Two bases.

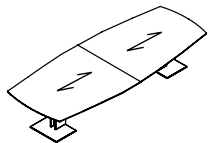

Boat Shaped Table, Bow End

FBOBE16848	48 x 168 x 29	100	571	65	\$21347
FBOBE14448	48 x 144 x 29	100	511	60	\$19309
FBOBE12048-2	48 x 120 x 29	100	450	56	\$17664

Two piece top. Two bases.

Required Specifications

Top finish/base side finish
Base end finish
Metal finish

Optional Specifications

Grommet

F FOUNDATIONS

BOARDROOM TABLES - BOAT SHAPED, BOW END

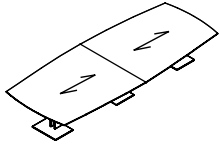

Boat Shaped Table, Bow End

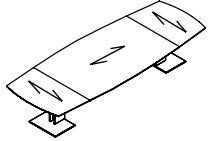

Boat Shaped Table, Bow End, Sectional

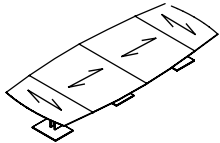

Boat Shaped Table, Bow End, Sectional

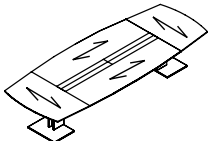

Boat Shaped Table, Bow End, Sectional

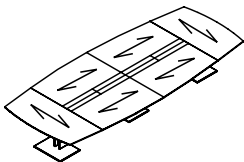

Boat Shaped Table, Bow End, Sectional

MODEL#	DIMENSIONS D x W x H	FREIGHT CLASS	WT/LBS.	CUBIC FT.	LIST PRICE
FBOBE24060	60 x 240 x 29	100	965	109	\$34246
FBOBE21660	60 x 216 x 29	100	893	104	\$32304
FBOBE19260	60 x 192 x 29	100	821	99	\$30309
FBOBE16860	60 x 168 x 29	100	748	93	\$28329
FBOBE21648	48 x 216 x 29	92.5	872	87	\$29622
FBOBE19248	48 x 192 x 29	100	744	82	\$27852

Two piece top. Three bases.

FBOBEST16848	48 x 168 x 29	100	571	65	\$21767
FBOBEST14448	48 x 144 x 29	100	511	60	\$20020
FBOBEST12048	48 x 120 x 29	100	450	54	\$18249

Three piece top. Two bases.

FBOBEST24060	60 x 240 x 29	100	965	109	\$34992
FBOBEST21660	60 x 216 x 29	100	893	104	\$33011
FBOBEST19260	60 x 192 x 29	100	821	99	\$30513
FBOBEST16860	60 x 168 x 29	100	748	93	\$28667
FBOBEST21648	48 x 216 x 29	92.5	872	87	\$30444
FBOBEST19248	48 x 192 x 29	100	744	82	\$28545

Four piece top. Three bases.

- 168"W table - midsection is one piece

FBOBESTCT16848	48 x 168 x 29	100	659	69	\$33356
FBOBESTCT14448	48 x 144 x 29	100	584	63	\$26666
FBOBESTCT12048	48 x 120 x 29	100	508	57	\$24704

Four piece top. Two bases / power kit included.

- 168"W table includes technology trough with 8 doors
- 144"W and 120" tables include technology trough with 4 doors

FBOBESTCT24060	60 x 240 x 29	100	1113	116	\$48881
FBOBESTCT21660	60 x 216 x 29	100	1021	109	\$46270
FBOBESTCT19260	60 x 192 x 29	100	920	103	\$43449
FBOBESTCT16860	60 x 168 x 29	100	836	96	\$40550
FBOBESTCT21648	48 x 216 x 29	92.5	1000	92	\$43259
FBOBESTCT19248	48 x 192 x 29	100	843	87	\$41260

Six piece top. Three bases. Add **C** or **E** to end of model number to specify base feed location. Includes technology trough with 8 doors.

- 168"W table - midsection is one piece

Required Specifications

Top finish/base side finish
Base end finish
Metal finish

Optional Specifications

Grommet

BOARDROOM TABLES - RACETRACK

MODEL#	DIMENSIONS	FREIGHT CLASS	WT/LBS.	CUBIC FT.	LIST PRICE
--------	------------	---------------	---------	-----------	------------

D x W x H

FRA12048	48 x 120 x 29	100	450	54	\$17700
FRA9648	48 x 96 x 29	125	390	49	\$16029

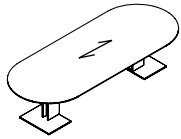

Racetrack Table

One piece top. Two bases.

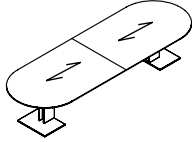

Racetrack Table

FRA16848	48 x 168 x 29	100	571	65	\$21618
FRA14448	48 x 144 x 29	100	511	60	\$19575
FRA12048-2	48 x 120 x 29	100	450	56	\$17935

Two piece top. Two bases.

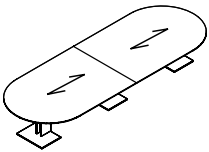

Racetrack Table

FRA24060	60 x 240 x 29	100	965	109	\$34516
FRA21660	60 x 216 x 29	100	893	104	\$32576
FRA19260	60 x 192 x 29	100	821	99	\$30580
FRA16860	60 x 168 x 29	100	748	93	\$28597
FRA21648	48 x 216 x 29	92.5	872	87	\$29895
FRA19248	48 x 192 x 29	100	744	82	\$28121

Two piece top. Three bases.

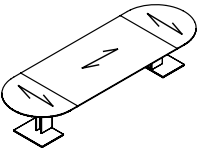

Racetrack Table, Sectional

FRAST16848	48 x 168 x 29	100	571	65	\$22034
FRAST14448	48 x 144 x 29	100	511	60	\$20291
FRAST12048	48 x 120 x 29	100	450	54	\$18522

Three piece top. Two bases.

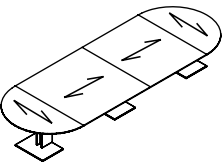

Racetrack Table, Sectional

FRAST24060	60 x 240 x 29	100	965	109	\$35261
FRAST21660	60 x 216 x 29	100	893	104	\$33285
FRAST19260	60 x 192 x 29	100	821	99	\$30783
FRAST16860	60 x 168 x 29	100	748	93	\$28937
FRAST21648	48 x 216 x 29	92.5	872	87	\$30714
FRAST19248	48 x 192 x 29	100	744	82	\$28817

Four piece top. Three bases.

- 168"W table - midsection is one piece

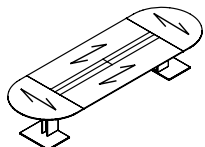

Racetrack Table, Sectional

FRASTCT16848	48 x 168 x 29	100	659	69	\$33627
FRASTCT14448	48 x 144 x 29	100	584	63	\$26935
FRASTCT12048	48 x 120 x 29	100	508	57	\$24974

Four piece top. Two bases / power kit included.

- 168"W table includes technology trough with 8 doors
- 144"W and 120" tables include technology trough with 4 doors

Required Specifications

Top finish/base side finish
Base end finish
Metal finish

Optional Specifications

Grommet

F FOUNDATIONS

BOARDROOM TABLES - RACETRACK

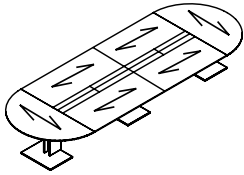

Racetrack Table, Sectional

MODEL#	DIMENSIONS D x W x H	FREIGHT CLASS	WT/LBS.	CUBIC FT.	LIST PRICE
FRASTCT24060	60 x 240 x 29	100	1113	116	\$49152
FRASTCT21660	60 x 216 x 29	100	1021	109	\$46539
FRASTCT19260	60 x 192 x 29	100	920	103	\$43721
FRASTCT16860	60 x 168 x 29	100	836	96	\$40802
FRASTCT21648	48 x 216 x 29	92.5	1000	92	\$43529
FRASTCT19248	48 x 192 x 29	100	843	87	\$41533

Six piece top. Three bases. Add **C** or **E** to end of model number to specify base feed location. Includes technology trough with 8 doors.

- 168"W table - midsection is one piece

BOARDROOM TABLES - WEDGE

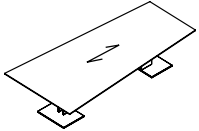

Wedge Table

MODEL#	DIMENSIONS	FREIGHT CLASS	WT/LBS.	CUBIC FT.	LIST PRICE
FWE1206048	60-48 x 120 x 29	100	511	60	\$15560

One piece top. Two bases.

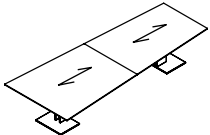

Wedge Table

FWE1446048	48 x 144 x 29	100	571	65	\$18950
FWE1206048-2	48 x 120 x 29	100	511	60	\$17183

Two piece top. Two bases.

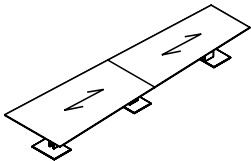

Wedge Table

FWE2406048	60-48 x 240 x 29	100	1037	114	\$30089
FWE2166048	60-48 x 216 x 29	100	965	109	\$28414
FWE1926048	60-48 x 192 x 29	100	893	104	\$26687
FWE1686048	60-48 x 168 x 29	100	630	70	\$24977

Two piece top. Three bases.

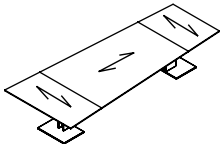

Wedge Table, Sectional

FWEST1446048	60-48 x 144 x 29	100	571	65	\$19311
FWEST1206048	60-48 x 120 x 29	100	511	60	\$17803

Three piece top. Two bases.

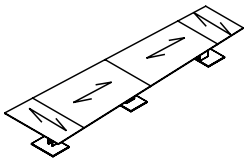

Wedge Table, Sectional

FWEST2406048	60-48 x 240 x 29	100	1037	114	\$30194
FWEST2166048	60-48 x 216 x 29	100	965	109	\$29026
FWEST1926048	60-48 x 192 x 29	100	893	104	\$28179
FWEST1686048	60-48 x 168 x 29	100	630	70	\$25269

Four piece top. Three bases.

- 168"W table - midsection is one piece

Required Specifications

Top finish/base side finish
Base end finish
Metal finish

Optional Specifications

Grommet

BOARDROOM TABLES - WEDGE

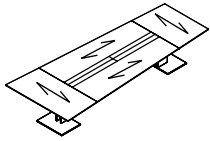

Wedge Table, Sectional*

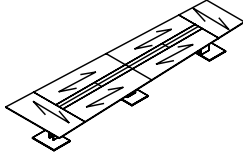

Wedge Table, Sectional*

MODEL#	DIMENSIONS	FREIGHT CLASS	WT/LBS.	CUBIC FT.	LIST PRICE
--------	------------	---------------	---------	-----------	------------

D x W x H

FWESTCT1446048	60-48 x 144 x 29	100	571	65	\$29332
FWESTCT1206048	60-48 x 120 x 29	100	511	60	\$23542

Four piece top. Two bases / power kit included. Includes technology trough with 4 doors

FWESTCT2406048	60 x 240 x 29	100	1037	114	\$42734
FWESTCT2166048	60 x 216 x 29	100	965	109	\$40478
FWESTCT1926048	60 x 192 x 29	100	893	104	\$37770
FWESTCT1686048	60 x 168 x 29	100	823	99	\$35520

Six piece top. Three bases. Add **C** or **E** to end of model number to specify base feed location. Includes technology trough with 8 doors.

- 168"W table - midsection is one piece

BOARDROOM TABLES - SQUARE

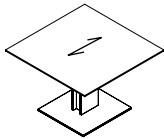

Square Table

MODEL#	DIMENSIONS	FREIGHT CLASS	WT/LBS.	CUBIC FT.	LIST PRICE
--------	------------	---------------	---------	-----------	------------

FRE6060	60 x 60 x 29	150	261	44	\$9072
FRE5454	54 x 54 x 29	150	233	42	\$8467
FRE4848	48 x 48 x 29	150	207	40	\$7833
FRE4242	42 x 42 x 29	150	185	39	\$7355

One base. No grommet option available.

BOARDROOM TABLES - ROUND

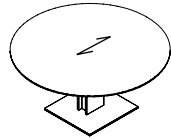

Round Table

MODEL#	DIMENSIONS	FREIGHT CLASS	WT/LBS.	CUBIC FT.	LIST PRICE
--------	------------	---------------	---------	-----------	------------

FRO60	60 x 60 x 29	150	261	44	\$9525
FRO54	54 x 54 x 29	150	233	42	\$8891
FRO48	48 x 48 x 29	150	207	40	\$8223
FRO42	42 x 42 x 29	150	185	39	\$7724

One base. No grommet option available.

Required Specifications

Top finish/base side finish
Base end finish
Metal finish

Optional Specifications

Grommet*

POWER/DATA



Single Sided Recessed Power Block

MODEL#	DIMENSIONS D x W x H	FREIGHT CLASS	WT/LBS.	CUBIC FT.	LIST PRICE
PRTMCS401B	4.22 x 10.78 x 4.86	100	4.3	0.51	\$486
PRTMCS401T	4.22 x 10.78 x 4.86	100	4.3	0.51	\$486
PRTMCS401W	4.22 x 10.78 x 4.86	100	4.3	0.51	\$486

Single-sided recessed power block with **one regular duplex and one telecom knockout on top; one power duplex on bottom**. 10' power cord with straight plug. Specify telecom options separately. Available in Black (**B**), Tungsten (**T**) or Designer White (**W**) as indicated by the last letter of model number. Duplexes always Grey. Corresponding cut-out options are **R1, R2** or **R3**. Units are not approved for daisy chaining. UL listed: UL 1363.



Single Sided Recessed Power Block - USB-A + USB-C

PRTMCS421B	4.22 x 10.78 x 4.86	100	4.3	0.51	\$638
PRTMCS421T	4.22 x 10.78 x 4.86	100	4.3	0.51	\$638
PRTMCS421W	4.22 x 10.78 x 4.86	100	4.3	0.51	\$638

Single-sided recessed power block with **one power/USB-A/USB-C duplex and one telecom knockout on top; one power duplex on bottom**. USB-A port charges max 2.4 amps at 5V and USB-C port charges max 3 amps at 5V. 10' power cord with straight plug. Specify telecom options separately. Available in Black (**B**), Tungsten (**T**) or Designer White (**W**) as indicated by the last letter of model number. Duplexes always Grey (duplex with USB ports is glossy finish). Corresponding cut-out options are **R1, R2** or **R3**. Units are not approved for daisy chaining. UL listed: UL 1363.



Double Sided Recessed Power Block

PRTMCD602B	6.22 x 10.78 x 4.86	92.5	5.9	0.51	\$555
PRTMCD602T	6.22 x 10.78 x 4.86	92.5	5.9	0.51	\$555
PRTMCD602W	6.22 x 10.78 x 4.86	92.5	5.9	0.51	\$555

Double-sided recessed power block with **two regular power duplexes and two telecom knockouts on top; one power duplex on bottom**. 10' power cord with straight plug. Specify telecom options separately. Available in Black (**B**), Tungsten (**T**) or Designer White (**W**) as indicated by last letter of model number. Duplexes always Grey. Corresponding cut-out options are **T1, T2** or **T3**. Units are not approved for daisy chaining. UL listed: UL 1363.



Double Sided Recessed Power Block - USB-A + USB-C

PRTMCD622B	6.22 x 10.78 x 4.86	92.5	6.1	0.51	\$699
PRTMCD622T	6.22 x 10.78 x 4.86	92.5	6.1	0.51	\$699
PRTMCD622W	6.22 x 10.78 x 4.86	92.5	6.1	0.51	\$699

Double-sided recessed power block with **one regular power duplex, one power/USB-A/USB-C duplex and two telecom knockouts on top; one power duplex on bottom**. USB-A port charges max 2.4 amps at 5V and USB-C port charges max 3 amps at 5V. 10' power cord with straight plug. Specify telecom options separately. Available in Black (**B**), Tungsten (**T**) or Designer White (**W**) as indicated by last letter of model number. Duplexes always Grey (duplex with USB ports is glossy finish). Corresponding cut-out options are **T1, T2** or **T3**. Units are not approved for daisy chaining. UL listed: UL 1363.



Double Sided Recessed Power Block - USB-A + USB-C

PRTMCD642B	6.22 x 10.78 x 4.86	85	6.3	0.51	\$842
PRTMCD642T	6.22 x 10.78 x 4.86	85	6.3	0.51	\$842
PRTMCD642W	6.22 x 10.78 x 4.86	85	6.3	0.51	\$842

Double-sided recessed power block with **two power/USB-A/USB-C duplexes and two telecom knockouts on top; one power duplex on bottom**. USB-A port charges max 2.4 amps at 5V and USB-C port charges max 3 amps at 5V. 10' power cord with straight plug. Specify telecom options separately. Available in Black (**B**), Tungsten (**T**) or Designer White (**W**) as indicated by last letter of model number. Duplexes always Grey (duplex with USB ports is glossy finish). Corresponding cut-out options are **T1, T2** or **T3**. Units are not approved for daisy chaining. UL listed: UL 1363.

Required Specifications

Finish

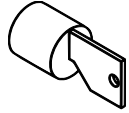
ACCESSORIES
MODEL# DIMENSIONS FREIGHT CLASS WT/LBS. CUBIC FT. LIST PRICE

Lock Assembly

D x W x H					
LO/C	--	70	--	--	\$113

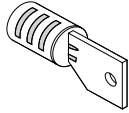
Tungsten.

Lock Drum with Key

LOB/C	--	70	--	--	\$47
-------	----	----	----	----	-------------

Tungsten.

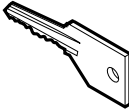
Extra Key

LOCK	--	70	--	--	\$46
------	----	----	----	----	-------------

Specify key #. Key range 401 - 420.

Grommet Cover Round

GM1	2 dia x --	70	--	--	\$70
GM1K	2 dia x --	70	--	--	\$70

2.75" diameter.

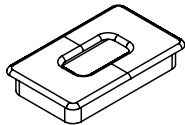
 • **Specify GM1 for Black or GM1K for Tungsten.**

Grommet

GM5C	2 x 3.5 x --	70	--	--	\$114
------	--------------	----	----	----	--------------

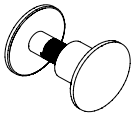
Rectangular grommet in metal, tungsten finish.

Quick Connector

QC50	--	70	.01	.01	\$11
QC30	--	70	.01	.01	\$11

Required Specifications

 Top finish
 Body finish

Optional Specifications

 Grommet
 Modesty Panel

F FOUNDATIONS

ACCESSORIES

MODEL#

DIMENSIONS

FREIGHT CLASS

WT/LBS.

CUBIC FT.

LIST PRICE

D x W x H

kingston





Kingston is a modern expression of old world craftsmanship. The classic proportion, attentive detailing, exquisite hand-matched veneers and solid wood edge details convey refined elegance with timeless beauty. Designed to highlight the warmth and majestic nature of real wood, Kingston offers an impressive array of storage components, fixed and freestanding worksurfaces that can be arranged to meet virtually any functional requirement.

Kingston detailing is contemporary with a 1" overhang on all edges. Solid walnut, cherry, maple, oak that bands worksurface perimeter is 1" wide by 1-3/8" thick for an overall thickness of 1-3/8". Kingston is a "top over pedestal" detailed series with a 1/4" reveal between the top and end panel. Tops have a 1" overhang. Floor storage unit bases are integrated in drawer faces. Products that are normally positioned against walls, such as credenzas, have a self-edge veneered back edge detail.

Features and Benefits

- Choice of 15 handle options for every door/drawer that features handles.
- Choice of six edge options
- Wide selection of storage components, fixed and freestanding worksurfaces.
- Sleek design



Interior veneer drawer edge

Edge options



K16



K18



K21



K22



K29



K30

GENERAL INFORMATION

- Distinguished by an elegant overhang detailed edge, Kingston pairs sleek European styling with functional design features that address the needs of today's dynamic and tech-savvy executive office.
- Kingston offers six distinctive edge shapes, as well as a multitude of drawer pull options.
- For environmental certification, please visit globalfurnituregroup.com

CONSTRUCTION

- Number One select, architectural grade "A" oak, American black walnut, American black cherry or maple. Wood worksurface molded edges are solid oak, walnut, cherry, or maple.
- Contemporary detailing with 1" overhang on all edges.
- Solid walnut, cherry, maple, oak that bands worksurface perimeter is 1" wide by 1-3/8" thick for an overall thickness of 1-3/8".

FINISHES

- Conversion varnish (similar to catalyzed lacquer, but tougher), 25 degree sheen. Finishes are not buffed or rubbed.
- All Global wood casegood products are veneered and finished on the back sides (360° finishing), except modular under-surface storage - tops and backs are unfinished.
- Touch up kits available, includes a touch up marker and fill crayon. Order **VTOUCHUPKIT, \$175** list. Specify finish when ordering.
- Global standard finish, on oak and walnut, is open pore and on cherry and maple is semi-closed pore. If a full finish is required for walnut, cherry, anigre and maple tops, Add the suffix "2" to the finish code and Add 5% to the base pricing for each product. **CUSTOM FINISH IS AVAILABLE.**

PEDESTALS

- Full-to-the-floor. Pedestals are fully assembled units that are either installed into desk and credenza shells, or available as modular units. Undersurface storage units include locks.
- Pedestal drawer suspensions are metal ball bearing type. Both box and file drawers are full extension.
- Hanging file rails are pre-installed on file drawer perimeters and accommodate both legal and letter size filing. Legal filing can be achieved either as side-to-side or front-to-back. Letter filing can be achieved as front-to-back filing only.
- Drawers are standard vinyl-wrapped construction with black drawer sides and bottom.
- The drawer front is an applied element to a four sided drawer. Drawer fronts are veneered on all surfaces except the vertical edges, which are solid oak, walnut, cherry and maple then routed with series detailing. Drawer fronts can be removed or replaced in the field.
- Levelers have 1" range of adjustment.

LOCKS

- Locks are standard on all below worksurface level drawer and door storage units, with the exception of pull-out tray units and single lateral file drawer combination tray/slot units.
- Combination storage unit comes with lock for file and lateral file drawer only; box drawers cannot lock.
- Lock color will match the handle option.
- Locks are optional on all above worksurface level closed storage.
- For optional lock, specify **LO. Add \$143** per lock.

HANDLES

- If no handle is specified, there will be a routed finger pull in drawer fronts and touch latch mechanism for doors.
- See next page for options.

1. SPECIFY MODEL NUMBER

2. SPECIFY FINISH

WORKSURFACE TOP & DRAWER/DOOR FRONTS, BODY FINISHES (INCLUDING PEDESTALS) - VENEER

Code	Finish	Veneer Type	Cut
AMW	Almond Cherry	Cherry	Flat Sliced
ACW	Amber Cherry	Cherry	Flat Sliced
BTW	Biscotti	White Oak	Rift
CAW	Cocoa Walnut	Walnut	Flat Sliced
CRW	Coral	White Oak	Rift
DCW	Dark Cherry	Cherry	Flat Sliced
DWW	Dark Walnut	Walnut	Flat Sliced
EWV	Espresso Walnut	Walnut	Flat Sliced
EVW	Evening Oak	White Oak	Rift
GRW	Grey on Oak	White Oak	Rift
HAW	Hazelnut	Maple	Flat Sliced
JAW	Java	White Oak	Rift
LTW	Latte Walnut	Walnut	Flat Sliced
MHW	Mahogany on Walnut	Walnut	Flat Sliced
MTW	Milestone	White Oak	Rift
MPW	Natural Maple	Maple	Flat Sliced
NLW	Natural Walnut	Walnut	Flat Sliced
RCW	Red Cherry	Cherry	Flat Sliced
VNW	Vintage Cherry	Cherry	Flat Sliced
ULW	Umber Walnut	Walnut	Flat Sliced
WLW	Walnut	Walnut	Flat Sliced
WCW	Warm Cherry	Cherry	Flat Sliced
WMW	White Maple	Maple	Flat Sliced

METAL FINISHES (see model # notes for available finish):

E	Black
K	Tungsten
DWT	Designer White
P	Brushed Chrome

GLASS FINISHES (for Glass Doors and Modesty Panels):

- Frosted Glass (standard)
- White back painted glass - contact customer care

3. SPECIFY OPTIONS

EDGES

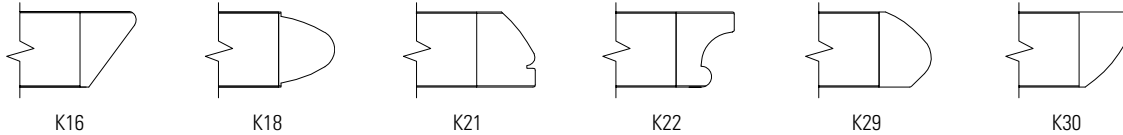

HANDLES

- If Handle is not specified Routed Pull, Black Lock & Grommet are standard
- If Handle is specified:
 - Black and Brass handle = Black Lock & Grommet
 - Silver, Nickel and Tungsten handle = Tungsten Lock & Grommet
- Handles are standard on most drawers/storage modules. Each handle is identified by letters: **PL33, PL34, PL64, PL66, PL92, PL93, PL94, PL95, PL96, PL97, PL98, PL99, PLS7, and PLS8**. To specify a handle, specify the code after the model number and finish selections.



PL33 Black Moon Pull, 4"



PL34 Nickel Moon Pull, 4"



PL64 Contemporary Nickel 5-3/8"



PL66 Transitional Nickel, 6-3/4"



PL92 Silver Bar, 5-3/8"



PL93 Black Bar, 5-3/8"



PL94 Silver Rectangular, 5-3/8"

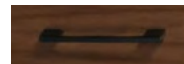

PL95 Black Rectangular, 5-3/8"



PL96 Silver Slimline Pull, 5-3/8"



PL97 Black Slimline Pull, 5-3/8"



PL98 Silver Princeton Bar, 5-3/8"



PL99 Black Princeton Bar, 5-3/8"



PLS7 Black Spaghetti, 7-3/8"



PLS8 Silver Spaghetti, 7-3/8"

GROMMETS

- Standard grommet on all components is **GM5**. Grommet is included with products where shown in line drawings in price book.
- Optional grommets may be ordered in standard worksurface locations (left, center or right). Order as **GM5TL, GM5TC or GM5TR**. Add \$103.
- Grommet hole dimensions are 3.5" x 2". Specify **GM5E** for Black or **GM5K** for Tungsten.
- To order a grommet cover only, Add \$61.
- Components that come standard with grommet may be ordered without a grommet. Order as RSG - Add \$57.

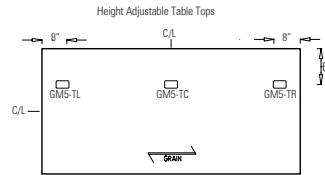
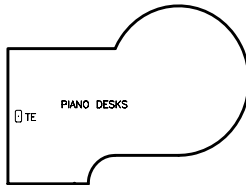
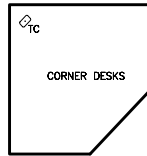
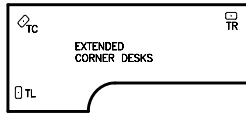
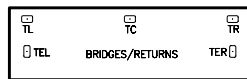
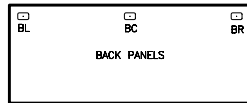
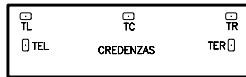
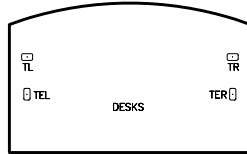
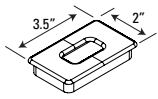

K KINGSTON - EDGE DETAILS

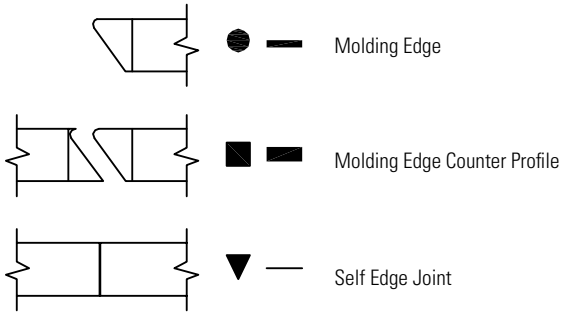

- D** - Desks and Credenzas
- B** - Executive Bridges
- E** - Executive Returns
- C** - Corner Components
- L** - Linking Bridges
- P** - Piano Desks

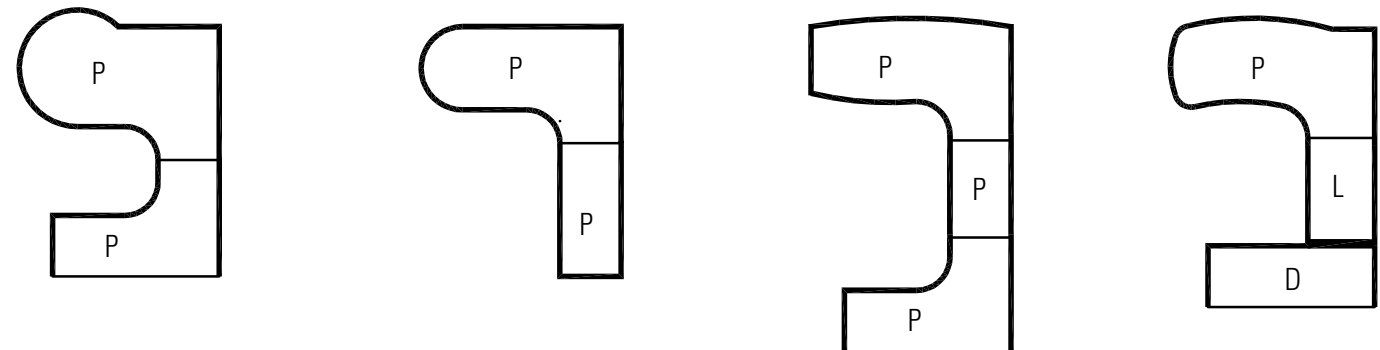
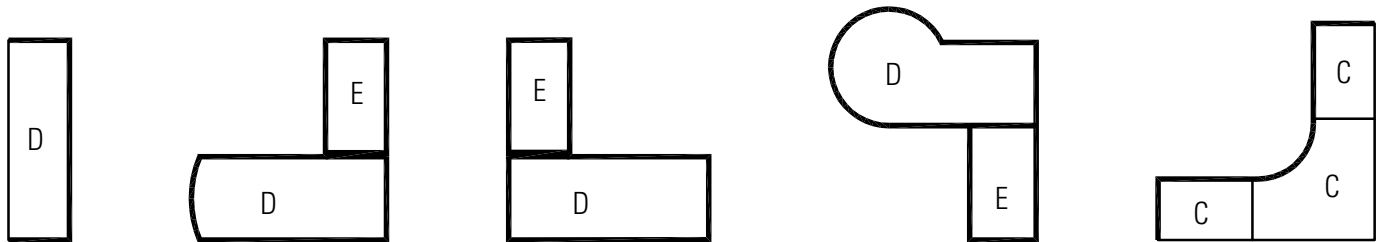
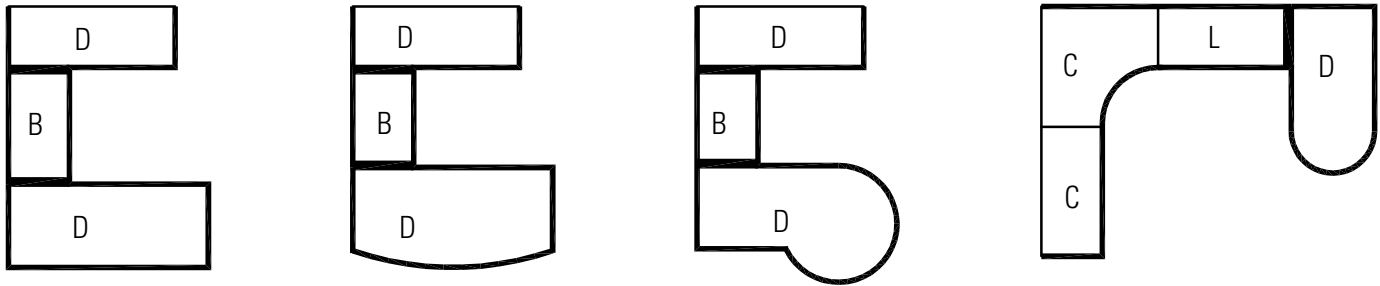
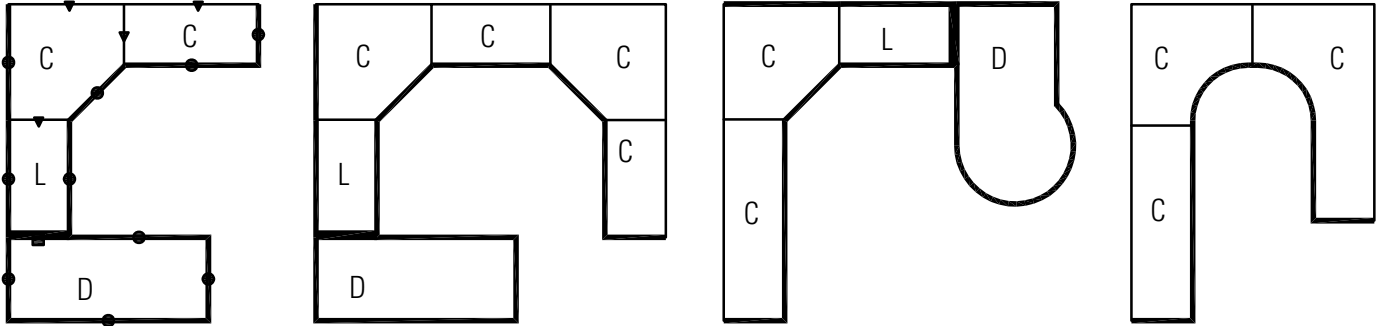

DESK AND CREDENZA NOTES

- Can be ordered as a shell or with pedestals
- Hand of Rectangular Desk is determined by location of pedestal from user side
- Hand of "D" Top is determined by outward orientation of curved end from user projection.
- Hand of "P" Top is determined by outward orientation of conference end from user projection.

Isometric View

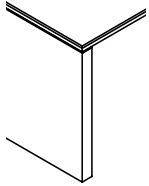

Side View
1-3/8" Top

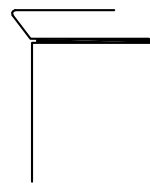

Front View
1-3/16" Slab

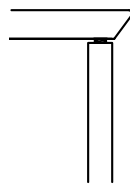

KT6030

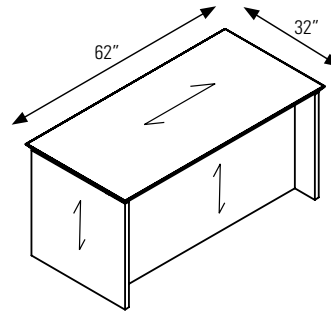

MODESTY PANEL CLEARANCE

KT7236

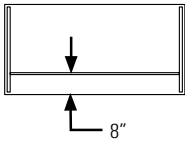

KMT7242

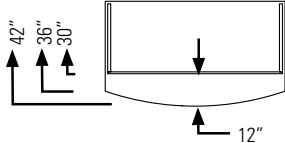

KiSR7230D

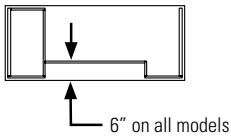

KDDCL7236

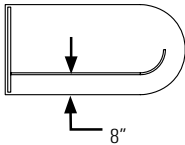

KT7236



Full Back Panel

KT7230

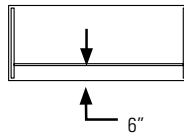

KMT7236

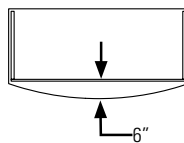

KDDF7230

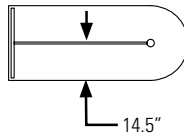

KDDCL7230

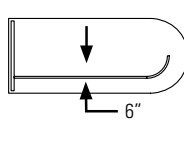

KTPL7242

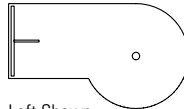

Left Shown

Field "punch out" to accommodate center drawer and keyboard

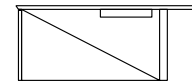

MODESTY PANEL OPTIONS

Standard Full Modesty

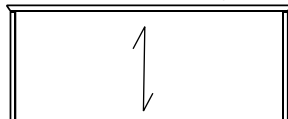

Glass Modesty

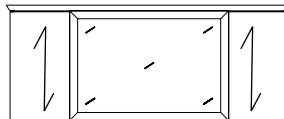

Breakfront

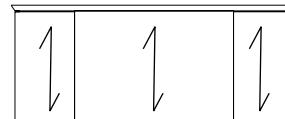

PIANO DESKS AND LINKING RETURNS

- All Desks are shipped assembled.
- Units include standard Grommets shown and installed horizontal wire management
- Unit is handed by Post Leg
- Not for use with regular Corner Units
- The standard grain direction is cross grain (**CG**). To remove cross grain veneer pattern on top, delete suffix "**CG**" from the model number (no upcharge)

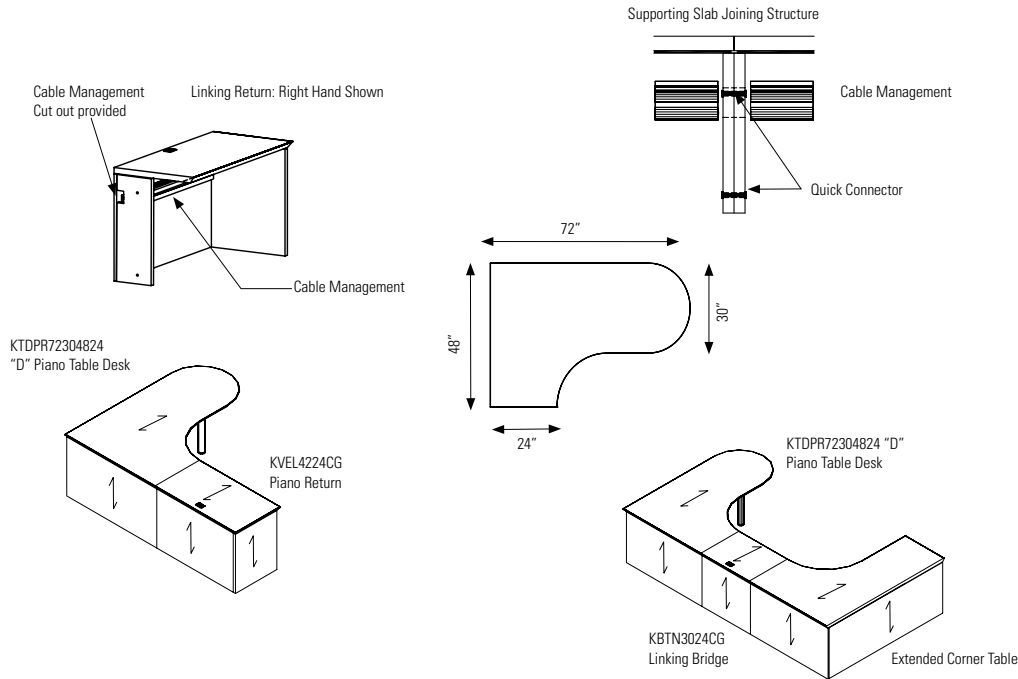

EXECUTIVE BRIDGES

- Executive Bridge is used to connect a Desk to a Credenza.
- Not to be used with Corner Components or Piano Desks.
- Three Back Panel options
- Back panel flush with end panels of Desk and Credenza
- Includes GM5 Grommet Top Center
- The standard grain direction is cross grain (**CG**). To remove cross grain veneer pattern on top, delete suffix "**CG**" from the model number (no upcharge)

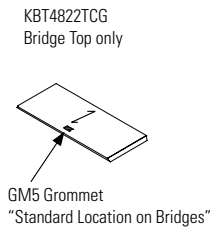
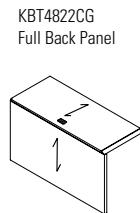
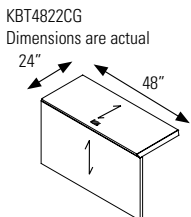
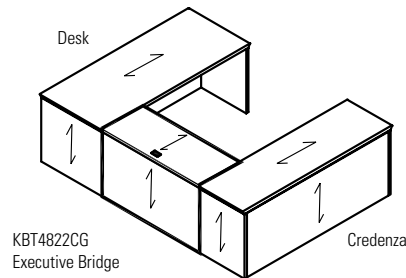

EXECUTIVE RETURNS

- Executive Return is used to attach to a Single Pedestal Desk, Single Pedestal Credenza, Desk Shell or Credenza Shell.
- Can be specified as a Shell or with a Pedestal.
- Back Panels are available as either full height or 8" from the underside of the worksurface.
- Hand of Executive Return is determined by location of full end panel from user side.
- Hand of Desk or Credenza is determined by location of pedestal from user side.
- The standard grain direction on return tops is cross grain (**CG**). To remove cross grain veneer pattern on top, delete suffix "**CG**" from the model number (no upcharge)

Executive Return attached to Desk or Credenza

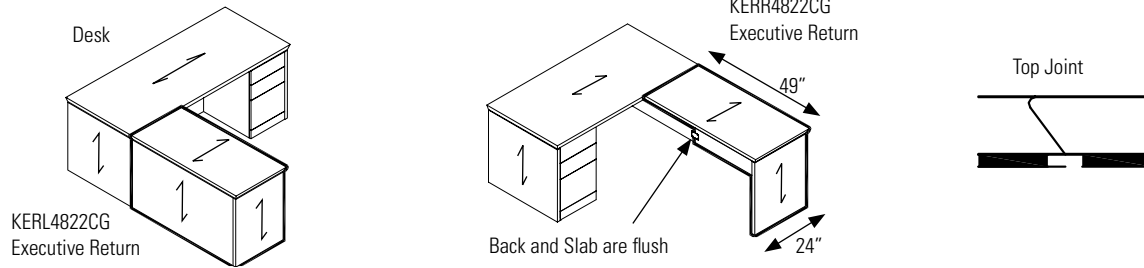

CORNER COMPONENTS

- Corner Table is used to connect to Linking Bridge and Linking Credenza.
- Cable management tray included.
- Back Panels are available as either full height or 8" from the underside of the worksurface.
- Hand of Linking Credenza is determined by location of full end panel from user side.
- Hand of Extended Corner is determined by location of long narrow end from user side
- The standard grain direction is cross grain (**CG**). To remove cross grain veneer pattern on top, delete suffix "**CG**" from the model number (no upcharge)

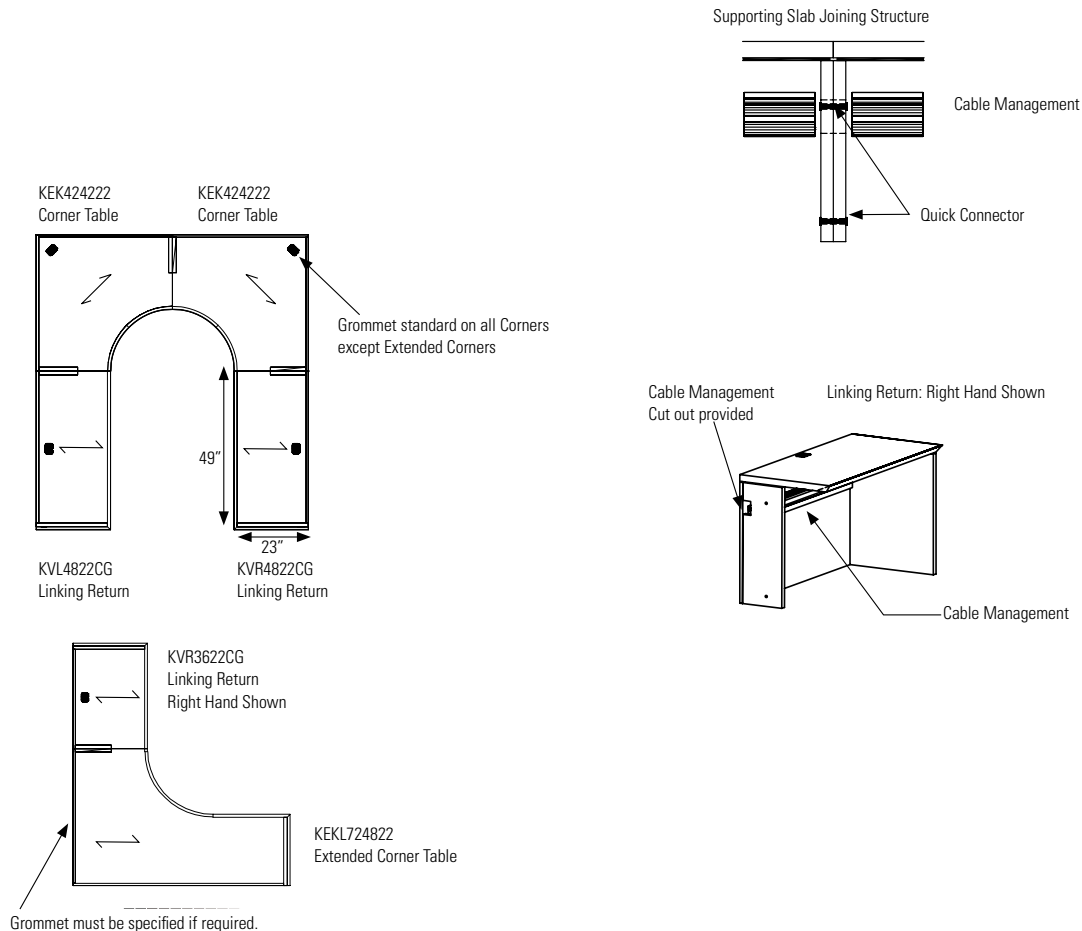

LINKING BRIDGES

- Linking Bridge is used to connect Corner Components to Single Pedestal Desk, Single Pedestal Credenza, Desk Shell or Credenza Shell.
- Back panels are available as either full height or 8" from the underside of the worksurface.
- Includes GM5 Grommet Top Center
- Hand of Linking Bridge is determined by location of half end panel from user side
- The standard grain direction is cross grain (**CG**). To remove cross grain veneer pattern on top, delete suffix "**CG**" from the model number (no upcharge)

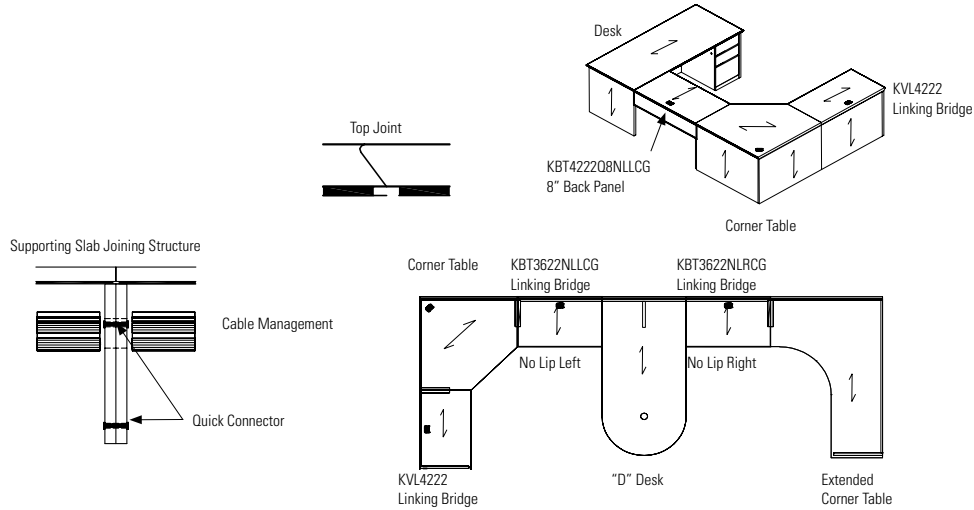

MODULAR PEDESTALS AND HANDLES

- Modular Pedestal for Kingston.
- Credenza Shells can only be completely filled with modular components that end in ".5" to create a full storage credenza.

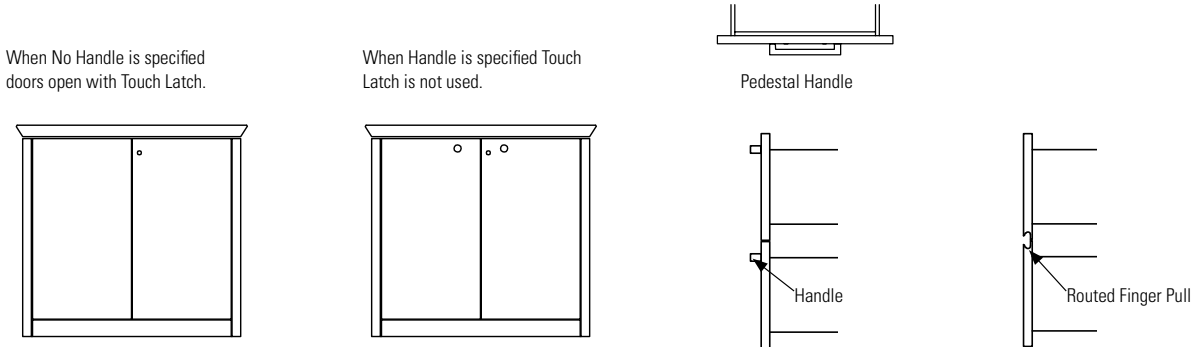

COPING AND SELF-EDGE OPTIONS

- Coping option provides an undercut on hutches only so that storage cabinets placed next to the hutch fit flush.
 - Specify **COP** for coping on both sides, **COPR** for coping on the right side and **COPL** for coping on the left side. No upcharge.
- Self edge options provide a flush fit when storage units are placed next to one another.
 - Specify **SE** for self-edge on both sides, **SER** for self-edge on the right side and **SEL** for self-edge on the left side. No upcharge.
 - Coping and self-edge handedness are from the users perspective. See diagram below.

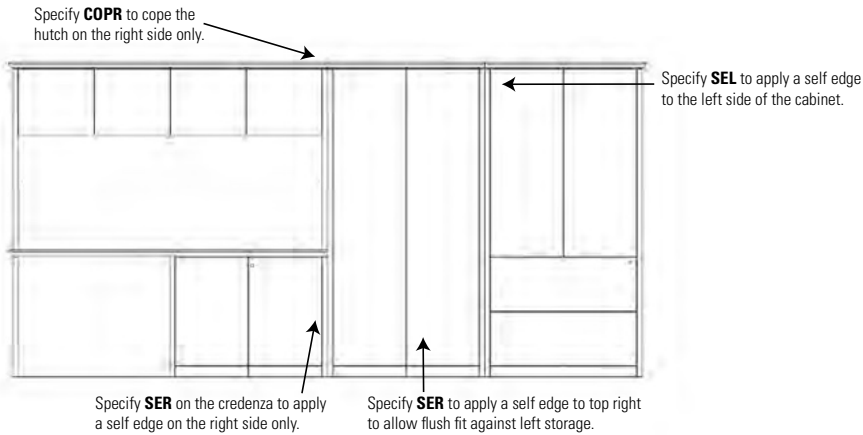

LOCKING

- Locks are standard on all below worksurface level drawer and door storage units with the exception of the pull-out tray units and single lateral file drawer combination tray/slot units.
- Locks are optional on all above worksurface level closed storage units. See Accessories Section (page 270) for lock specification details.

Standard Lock Positions

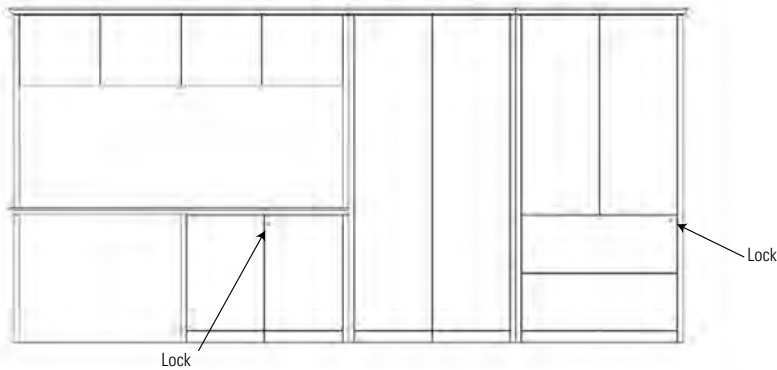

KZR
Combination Storage Unit:
Lock for File and Lateral File Drawer only,
Box Drawers do not lock.

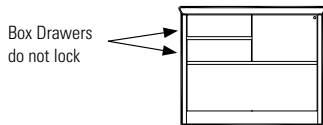

KD7236DE
Double Pedestal Desk/Credenza:
Lock for D and E Pedestals are on the inside Gable.

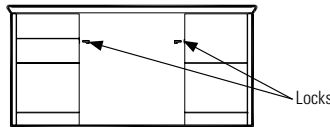

KCF7222
Full Storage Credenza: Locks are on the front.

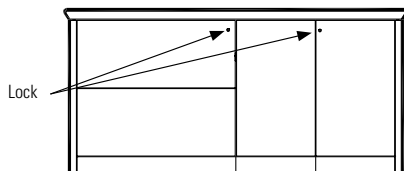

KWD
Modular Furniture:
Lock is on the front.

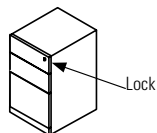

KWF
Modular Furniture:
Lock is on the front.

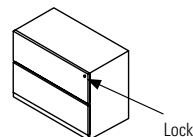

HUTCH POSITIONING

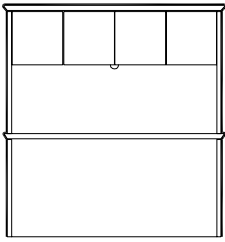

There must be an end panel under the hutch

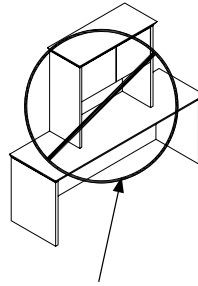
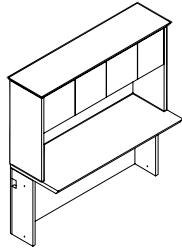

Missing Support
NOT Recommended

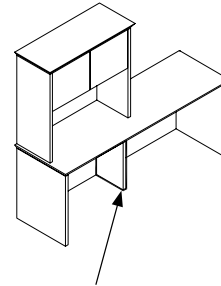

Add optional Support
SLAB12 (as Special)

TACKBOARDS

Tackboards for Storage Hutches

K72SH36

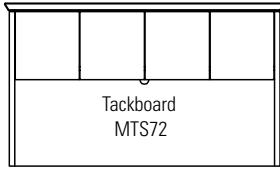

K72SHP42 and K72SHP42

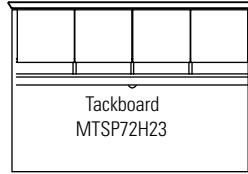

K72SH42 and K722SH54

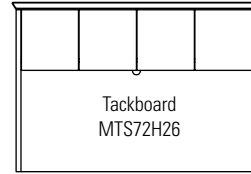

Tackboards with Accessory Rail

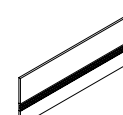
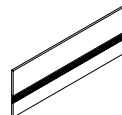
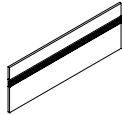

Tackboards for Wall Mount Overheads

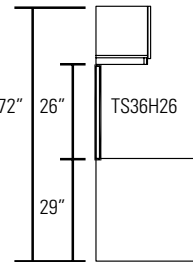
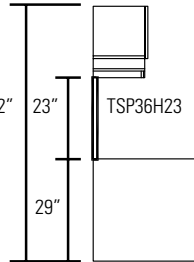
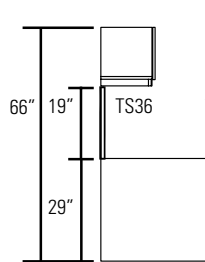
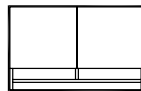

LIGHTING

For hutches and wall mount overheads

Wall Mount

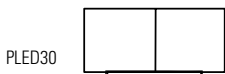

30" and 36" units



42" and 48" units



60" and longer units

Hutch

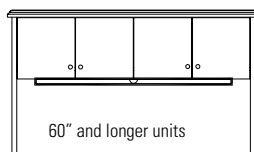
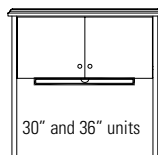

DESKS - NOTES

D x W x H

NOTE: Arrow indicates direction of grain

- All desks are shipped assembled
- Kneewell locking standard
- Desks available with a variety of modesty options: flush, breakfront, recessed and glass
- If Handle is not specified Routed Pull, Black Lock & Grommet are standard
- If Handle is specified:
 - Black and Brass handle = Black Lock & Grommet
 - Silver, Nickel and Tungsten handle = Tungsten Lock & Grommet
- Grommets are available as an option on Desks and most Credenzas.
- Edge options - must specify:

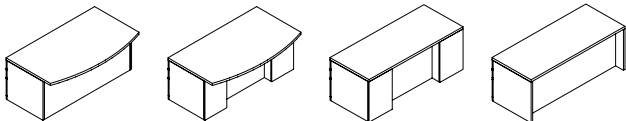
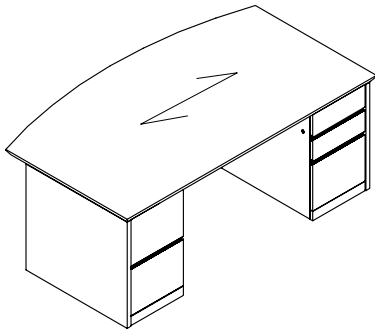
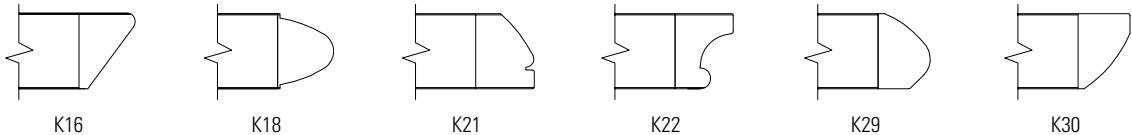

Flush Modesty Breakfront Recessed Modesty

DOUBLE PEDESTAL DESKS

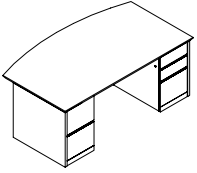

Double Pedestal Bow Top Desk

MODEL#	DIMENSIONS D x W x H	FREIGHT CLASS	WT/LBS.	CUBIC FT.	LIST PRICE
KMD8442ED	44 x 86 x 29	125	407	59	\$10778
KMD7842ED	44 x 80 x 29	125	392	55	\$10009
KMD7242ED	44 x 74 x 29	125	377	51	\$9236
KMD6636ED	38 x 68 x 29	100	340	40	\$8959

Standard with full to floor **file/file** pedestal on **left** and **box/box/file** pedestal on **right**. Pedestals lock.
Full Height Modesty Panel.

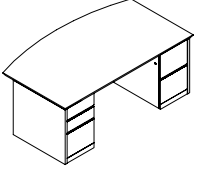

Double Pedestal Bow Top Desk

KMD8442DE	44 x 86 x 29	125	407	59	\$10778
KMD7842DE	44 x 80 x 29	125	392	55	\$10009
KMD7242DE	44 x 74 x 29	125	377	51	\$9236
KMD6636DE	38 x 68 x 29	100	340	40	\$8959

Standard with full to floor **file/file** pedestal on **right** and **box/box/file** pedestal on **left**. Pedestals lock.
Full Height Modesty Panel.

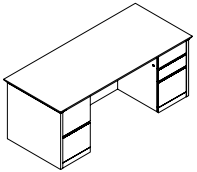

Double Pedestal Desk

KD8442ED	44 x 86 x 29	125	442	59	\$9164
KD7842ED	44 x 80 x 29	125	421	55	\$8512
KD7236ED	38 x 74 x 29	100	375	44	\$7858
KD7230ED	32 x 74 x 29	100	345	36	\$7739
KD6636ED	38 x 68 x 29	100	360	40	\$7739
KD6630ED	32 x 68 x 29	92.5	330	33	\$7614
KD6030ED	32 x 62 x 29	92.5	315	30	\$7376

Standard with full to floor **file/file** pedestal on **left** and **box/box/file** pedestal on **right**. Pedestals lock.
Full height modesty panel.

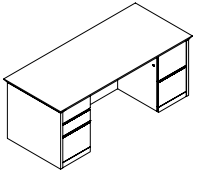

Double Pedestal Desk

KD8442DE	44 x 86 x 29	125	442	59	\$9164
KD7842DE	44 x 80 x 29	125	421	55	\$8512
KD7236DE	38 x 74 x 29	100	375	44	\$7858
KD7230DE	32 x 74 x 29	100	345	36	\$7739
KD6636DE	38 x 68 x 29	100	360	40	\$7739
KD6630DE	32 x 68 x 29	92.5	330	33	\$7614
KD6030DE	32 x 62 x 29	92.5	315	30	\$7376

Standard with full to floor **file/file** pedestal on **right** and **box/box/file** pedestal on **left**. Pedestals lock.
Full height modesty panel.

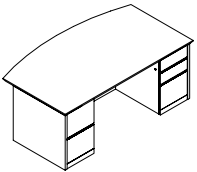

**Double Pedestal Bow Top Desk*
Breakfront Style**

KMID8442ED	44 x 86 x 29	125	407	59	\$11853
KMID7842ED	44 x 80 x 29	125	392	55	\$11008
KMID7242ED	44 x 74 x 29	125	377	51	\$10165
KMID6636ED	38 x 68 x 29	100	345	40	\$9852

Standard with full to floor **file/file** pedestal on **left** and **box/box/file** pedestal on **right**. Pedestals lock.
Inset Full Height Modesty Panel.

- For Aluminum Framed Glass Modesty option on Breakfront Style add "G" to the end of the product code. Add **\$1892**.

Required Specifications

Finish
Edge

Optional Specifications

Handles
Additional grommet
Glass modesty panel*

DESKS

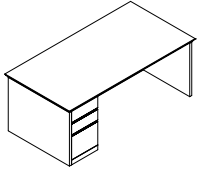

Single Pedestal Desk

MODEL#	DIMENSIONS D x W x H	FREIGHT CLASS	WT./LBS.	CUBIC FT.	LIST PRICE
KSL8442D	44 x 86 x 29	125	387	59	\$8031
KSL7842D	44 x 80 x 29	125	366	55	\$7565
KSL7236D	38 x 74 x 29	125	320	44	\$5993
KSL7230D	32 x 74 x 29	100	290	36	\$5724
KSL6636D	38 x 68 x 29	125	305	40	\$5724
KSL6630D	32 x 68 x 29	100	275	33	\$5463
KSL6030D	32 x 62 x 29	100	260	30	\$5222

Standard with full to floor **box/box/file** pedestal on **left**. Pedestals lock.
Full Height Modesty Panel.

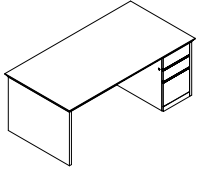

Single Pedestal Desk

KSR8442D	44 x 86 x 29	125	387	59	\$8031
KSR7842D	44 x 80 x 29	125	366	55	\$7565
KSR7236D	38 x 74 x 29	125	320	44	\$5993
KSR7230D	32 x 74 x 29	100	290	36	\$5724
KSR6636D	38 x 68 x 29	125	305	40	\$5724
KSR6630D	32 x 68 x 29	100	275	33	\$5463
KSR6030D	32 x 62 x 29	100	260	30	\$5222

Standard with full to floor **box/box/file** pedestal on **right**. Pedestals lock.
Full Height Modesty Panel.

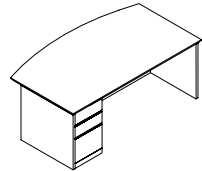

**Single Pedestal Desk - Left*
Breakfront Style**

KMISL8442D	44 x 86 x 29	125	452	59	\$9393
KMISL7842D	44 x 80 x 29	125	337	55	\$8723
KMISL7242D	44 x 74 x 29	125	322	51	\$8055
KMISL6636D	38 x 68 x 29	125	290	40	\$7746

Standard with full to floor **box/box/file** pedestal on **left**. Pedestals lock.
Inset Full Height Modesty Panel.

- For Aluminum Framed Glass Modesty option on Breakfront Style add "**G**" to the end of the product code. Add **\$1892**.

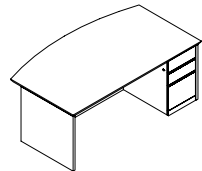

**Single Pedestal Desk - Right*
Breakfront Style**

KMISR8442D	44 x 86 x 29	125	452	59	\$9393
KMISR7842D	44 x 80 x 29	125	337	55	\$8723
KMISR7242D	44 x 74 x 29	125	322	51	\$8055
KMISR6636D	38 x 68 x 29	125	290	40	\$7746

Standard with full to floor **box/box/file** pedestal on **right**. Pedestals lock.
Inset Full Height Modesty Panel.

- For Aluminum Framed Glass Modesty option on Breakfront Style add "**G**" to the end of the product code. Add **\$1892**.

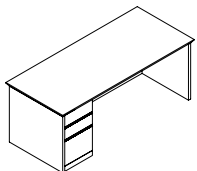

**Single Pedestal Desk - Left*
Breakfront Style**

KISL8442D	44 x 86 x 29	125	387	59	\$8969
KISL7842D	44 x 80 x 29	125	366	55	\$8329
KISL7236D	38 x 74 x 29	125	320	44	\$6590
KISL7230D	32 x 74 x 29	100	290	36	\$6296
KISL6636D	38 x 68 x 29	125	305	40	\$6296
KISL6630D	32 x 68 x 29	100	275	33	\$6009
KISL6030D	32 x 62 x 29	100	260	30	\$5743

Standard with full to floor **box/box/file** pedestal on **left**. Pedestals lock.
Inset Full Height Modesty Panel.

- For Aluminum Framed Glass Modesty option on Breakfront Style add "**G**" to the end of the product code. Add **\$1892**.

Required Specifications

Finish
Edge

Optional Specifications

Handles
Additional grommet
Glass modesty panel*

DESKS

MODEL# DIMENSIONS FREIGHT CLASS WT/LBS. CUBIC FT. LIST PRICE

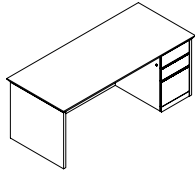

**Single Pedestal Desk - Right*
Breakfront Style**

	D x W x H				
KISR8442D	44 x 86 x 29	125	387	59	\$8969
KISR7842D	44 x 80 x 29	125	366	55	\$8329
KISR7236D	38 x 74 x 29	125	320	44	\$6590
KISR7230D	32 x 74 x 29	100	290	36	\$6296
KISR6636D	38 x 68 x 29	125	305	40	\$6296
KISR6630D	32 x 68 x 29	100	275	33	\$6009
KISR6030D	32 x 62 x 29	100	260	30	\$5743

Standard with full to floor **box/box/file** pedestal on **right**. Pedestals lock.
Inset Full Height Modesty Panel.

- For Aluminum Framed Glass Modesty option on Breakfront Style add "G" to the end of the product code. Add **\$1892**.

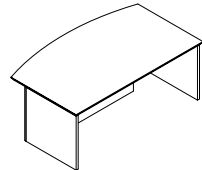

**Desk Shell, Bow Top
Breakfront Style**

KMIT8442	44 x 86 x 29	125	380	59	\$7247
KMIT7842	44 x 80 x 29	125	353	55	\$6775
KMIT7242	44 x 74 x 29	125	331	51	\$6308
KMIT6636	38 x 68 x 29	125	287	40	\$5985

Inset Full Height Modesty Panel.

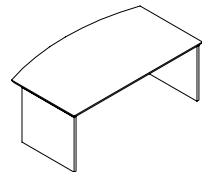

Desk Shell, Bow Top

KMT8442	44 x 86 x 29	150	297	59	\$6565
KMT7842	44 x 80 x 29	150	282	55	\$6092
KMT7242	44 x 74 x 29	150	267	51	\$5627
KMT6636	38 x 68 x 29	150	235	40	\$5304

Recessed Modesty Panel.

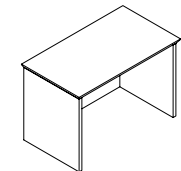

Desk Shell

KT8442	44 x 86 x 29	125	337	55	\$6103
KT7842	44 x 80 x 29	125	317	51	\$5667
KT8436	38 x 86 x 29	125	317	51	\$5233
KT7836	38 x 80 x 29	125	296	47	\$4861
KT7236	38 x 74 x 29	125	265	44	\$4491
KT7230	32 x 74 x 29	125	235	36	\$4225
KT6636	38 x 68 x 29	125	250	40	\$4225
KT6630	32 x 68 x 29	125	220	33	\$3970
KT6030	32 x 62 x 29	125	205	30	\$3629

Recessed Modesty Panel.

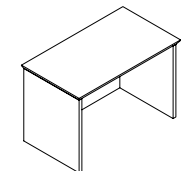

Desk Shell

KT4822	24 x 50 x 29	150	95	17	\$2599
KT4222	24 x 44 x 29	150	85	15	\$2177
KT3622	24 x 38 x 29	150	75	13	\$2101
KT3022	24 x 32 x 29	150	65	11	\$2059
KT4820	22 x 50 x 29	150	95	17	\$2367
KT4220	22 x 44 x 29	150	85	15	\$1979
KT3620	22 x 38 x 29	125	75	12	\$1912
KT3020	22 x 32 x 29	125	65	10	\$1875

Flush modesty panel.

Required Specifications

Finish
Edge

Optional Specifications

Handles
Additional grommet
Glass modesty panel*

DESKS

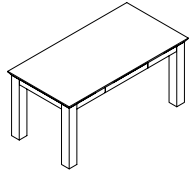
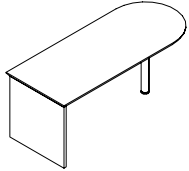

Table Desk*

MODEL#	DIMENSIONS D x W x H	FREIGHT CLASS	WT/LBS.	CUBIC FT.	LIST PRICE
KTB8442	44 x 86 x 29	150	272	59	\$11492
KTB7842	44 x 80 x 29	150	253	55	\$10673
KTB7236	38 x 74 x 29	150	205	44	\$8441
KTB7230	32 x 74 x 29	150	192	36	\$8288
KTB6636	38 x 68 x 29	150	192	40	\$8288
KTB6630	32 x 68 x 29	150	188	33	\$8126
KTB6030	32 x 62 x 29	150	171	30	\$7740

3" apron, center pencil drawer. 4" square legs.



"D" Shaped Connecting Table Desk*

KDD8436	36 x 84 x 29	125	343	51	\$5855
KDD7236	36 x 72 x 29	125	294	44	\$5015
KDD7230	30 x 72 x 29	125	264	36	\$4662
KDD6636	36 x 66 x 29	125	245	40	\$4662
KDD6030	30 x 60 x 29	125	225	30	\$4480

3" wood post and full end panel.

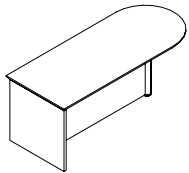

"D" Shaped Connecting Table Desk

KDDF8436	36 x 84 x 29	125	343	51	\$7190
KDDF7236	36 x 72 x 29	125	294	44	\$6171
KDDF7230	30 x 72 x 29	125	264	36	\$5811
KDDF6636	36 x 66 x 29	125	245	40	\$5811
KDDF6030	30 x 60 x 29	125	225	30	\$5629

3" wood post, full modesty panel, and full end panel.

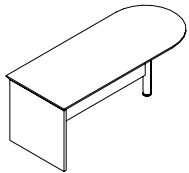

"D" Shaped Connecting Table Desk

KQDD8436	36 x 84 x 29	125	357	51	\$6753
KQDD7236	36 x 72 x 29	125	311	44	\$5785
KQDD7230	30 x 72 x 29	125	281	36	\$5431
KQDD6636	36 x 66 x 29	125	264	40	\$5431
KQDD6030	30 x 60 x 29	100	247	30	\$5251

3" wood post, 3/4 modesty panel, and full end panel.

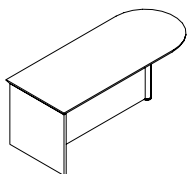

"D" Shaped Connecting Table Desk - Left

KDDCL8436	36 x 84 x 29	125	368	51	\$7645
KDDCL7236	36 x 72 x 29	125	320	44	\$6552
KDDCL7230	30 x 72 x 29	100	290	36	\$6193
KDDCL6636	36 x 66 x 29	125	270	40	\$6193
KDDCL6030	30 x 60 x 29	100	242	30	\$6016

Full height curved modesty panel, 3" wood post, and full end panel.

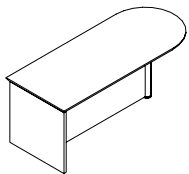

"D" Shaped Connecting Table Desk - Right

KDDCR8436	36 x 84 x 29	125	368	51	\$7645
KDDCR7236	36 x 72 x 29	125	320	44	\$6552
KDDCR7230	30 x 72 x 29	100	290	36	\$6193
KDDCR6636	36 x 66 x 29	125	270	40	\$6193
KDDCR6030	30 x 60 x 29	100	242	30	\$6016

Full height curved modesty panel, 3" wood post, and full end panel.

Required Specifications

Finish
Edge

Optional Specifications

Additional grommet
Base upgrade* (see accessories for options)

DESKS

MODEL# DIMENSIONS FREIGHT CLASS WT/LBS. CUBIC FT. LIST PRICE

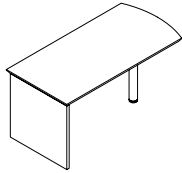

Connecting Bow End Table Desk*

D x W x H						
KDDBE8436	36 x 84 x 29	125	343	51		\$5855
KDDBE7236	36 x 72 x 29	125	294	44		\$5015
KDDBE7230	30 x 72 x 29	125	264	36		\$4662
KDDBE6636	36 x 66 x 29	125	245	40		\$4662
KDDBE6030	30 x 60 x 29	125	225	30		\$4480

3" wood post and full end panel.

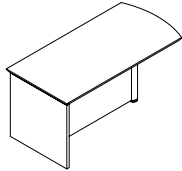

Connecting Bow End Table Desk

KDDBEF8436	36 x 84 x 29	125	368	51		\$7190
KDDBEF7236	36 x 72 x 29	125	320	44		\$6168
KDDBEF7230	30 x 72 x 29	100	290	36		\$5811
KDDBEF6636	36 x 66 x 29	125	271	40		\$5811
KDDBEF6030	30 x 60 x 29	100	247	30		\$5629

3" wood post, full modesty panel, and full end panel.

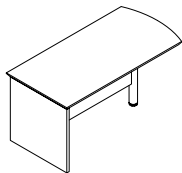

Connecting Bow End Table Desk

KQDDBE8436	36 x 84 x 29	125	357	51		\$6753
KQDDBE7236	36 x 72 x 29	125	311	44		\$5785
KQDDBE7230	30 x 72 x 29	125	281	36		\$5431
KQDDBE6636	36 x 66 x 29	125	264	40		\$5431
KQDDBE6030	30 x 60 x 29	100	247	30		\$5251

3" wood post, 3/4 modesty panel, and full end panel.

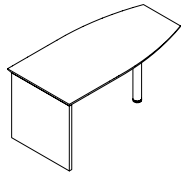

Connecting Boat Shaped Table Desk*

KDDBS8442	42 x 84 x 29	125	414	59		\$6930
KDDBS8436	36 x 84 x 29	125	343	51		\$5855
KDDBS7236	36 x 72 x 29	125	314	44		\$5015
KDDBS7230	30 x 72 x 29	125	284	36		\$4662
KDDBS6636	36 x 66 x 29	125	265	40		\$4662
KDDBS6030	30 x 60 x 29	100	245	30		\$4480

3" wood post and full end panel.

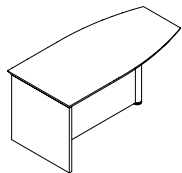

Connecting Boat Shaped Table Desk

KDDBSF8442	42 x 84 x 29	125	429	59		\$8392
KDDBSF8436	36 x 84 x 29	125	368	51		\$7190
KDDBSF7236	36 x 72 x 29	125	320	44		\$6168
KDDBSF7230	30 x 72 x 29	100	290	36		\$5811
KDDBSF6636	36 x 66 x 29	125	271	40		\$5811
KDDBSF6030	30 x 60 x 29	100	247	30		\$5629

3" wood post, full modesty panel, and full end panel.

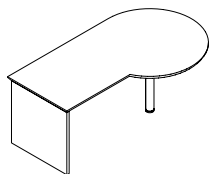

"P" Shaped Connecting Table - Left*

KTPL9642	42 x 96 x 29	125	440	68		\$7314
KTPL8442	42 x 84 x 29	125	385	59		\$6399
KTPL7242	42 x 72 x 29	125	319	51		\$5837

3" wood post and full end panel.

Required Specifications

Finish
Edge

Optional Specifications

Additional grommet
Base upgrade* (see accessories for options)

P-SHAPED CONNECTING TABLES

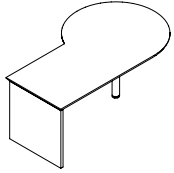

"P" Shaped Connecting Table - Right*

MODEL#	DIMENSIONS D x W x H	FREIGHT CLASS	WT/LBS.	CUBIC FT.	LIST PRICE
KTPR9642	42 x 96 x 29	125	440	68	\$7314
KTPR8442	42 x 84 x 29	125	385	59	\$6399
KTPR7242	42 x 72 x 29	125	319	51	\$5837

3" wood post and full end panel.

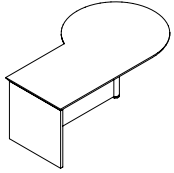

"P" Shaped Connecting Table - Left

KTPFL9642	42 x 96 x 29	150	317	68	\$8629
KTPFL8442	42 x 84 x 29	150	277	59	\$6657
KTPFL7242	42 x 72 x 29	150	211	51	\$6989

3" wood post, full height modesty panel, and full end panel.

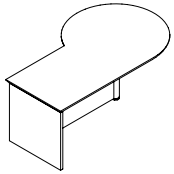

"P" Shaped Connecting Table - Right

KTPFR9642	42 x 96 x 29	150	317	68	\$8629
KTPFR8442	42 x 84 x 29	150	277	59	\$6657
KTPFR7242	42 x 72 x 29	150	211	51	\$6989

3" wood post, full height modesty panel, and full end panel.

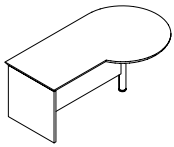

"P" Shaped Connecting Table - Left

KQTPL9642	42 x 96 x 29	150	291	68	\$8191
KQTPL8442	42 x 84 x 29	150	255	59	\$7168
KQTPL7242	42 x 72 x 29	250	189	51	\$6601

3" wood post, 3/4 height modesty panel, and full end panel.

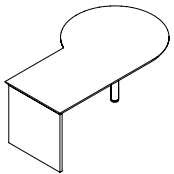

"P" Shaped Connecting Table - Right

KQTPR9642	42 x 96 x 29	150	291	68	\$8191
KQTPR8442	42 x 84 x 29	150	255	59	\$7168
KQTPR7242	42 x 72 x 29	250	189	51	\$6601

3" wood post, 3/4 height modesty panel, and full end panel.

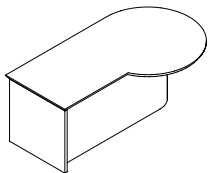

"P" Shaped Connecting Table - Left

KTPCL9642	42 x 96 x 29	150	317	68	\$9063
KTPCL8442	42 x 84 x 29	150	277	59	\$7936
KTPCL7242	42 x 72 x 29	150	211	51	\$7020

3" wood post, curved modesty panel, and full end panel.

Required Specifications

Finish
Edge

Optional Specifications

Additional grommet
Base upgrade* (see accessories for options)

P-SHAPED CONNECTING TABLES

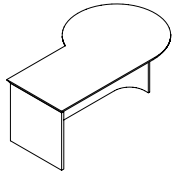

"P" Shaped Connecting Table - Right

MODEL# DIMENSIONS FREIGHT CLASS WT/LBS. CUBIC FT. LIST PRICE

D x W x H						
KTPCR9642	42 x 96 x 29	150	317	68		\$9063
KTPCR8442	42 x 84 x 29	150	277	59		\$7936
KTPCR7242	42 x 72 x 29	150	211	51		\$7020

3" wood post, curved modesty panel, and full end panel.

HEIGHT ADJUSTABLE TOPS

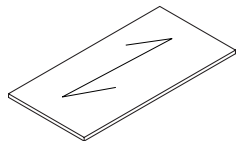

Height Adjustable Top

MODEL# DIMENSIONS FREIGHT CLASS WT/LBS. CUBIC FT. LIST PRICE

KRE8224T	24 x 82 x 1.18	92.5	85	7.7		\$2749
KRE8024T	24 x 80 x 1.18	92.5	84	7.5		\$2680
KRE7624T	24 x 76 x 1.18	92.5	80	7		\$2550
KRE6424T	24 x 64 x 1.18	92.5	69	6		\$2148
KRE5224T	24 x 52 x 1.18	92.5	58	5		\$1744
KRE4624T	24 x 46 x 1.18	92.5	53	4.5		\$1539
KRE4024T	24 x 40 x 1.18	100	37	4		\$1346
KRE8229T	29 x 82 x 1.18	92.5	101	9		\$3061
KRE7629T	29 x 76 x 1.18	92.5	99	8.5		\$2841
KRE7029T	29 x 70 x 1.18	92.5	94	8		\$2615
KRE6429T	29 x 64 x 1.18	92.5	81	7		\$2395
KRE5229T	29 x 52 x 1.18	92.5	68	6		\$1943
KRE4629T	29 x 46 x 1.18	85	61	5		\$1723
KRE4029T	29 x 40 x 1.18	85	55	4.5		\$1497
KRE8235T	35 x 82 x 1.18	92.5	120	10.5		\$3701
KRE7635T	35 x 76 x 1.18	92.5	117	10		\$3428
KRE7235T	35 x 72 x 1.18	300	12	9.5		\$3250
KRE6435T	35 x 64 x 1.18	92.5	96	9		\$2890
KRE5235T	35 x 52 x 1.18	85	80	6.5		\$2347
KRE4635T	35 x 46 x 1.18	85	72	6		\$2072
KRE4035T	35 x 40 x 1.18	85	64	5		\$1808

Kingston tops with Kingston edge on three sides, for use with FreeFit height adjustable table mechanisms, sold separately (FTxxxxx, see page 713 of the Desking price list for information).

- 26" deep tops accommodate FTxxxx24 mechanisms. Depth is exact to accommodate the Kingston edge + the Freefit mechanism. *Cannot be made smaller.*
- 29" and 35" deep tops accommodate FTxxxx30 mechanisms.



HA Return Tops

Left:

KRE6024CGCOPLT	24 x 60 x 1.18	92.5	65	5.5		\$2012
KRE5424CGCOPLT	24 x 54 x 1.18	85	60	5		\$1814
KRE4824CGCOPLT	24 x 48 x 1.18	85	54	4.5		\$1610
KRE4224CGCOPLT	24 x 42 x 1.18	85	49	4		\$1405

Right:

KRE6024CGCOPRT	24 x 60 x 1.18	92.5	65	5.5		\$2012
KRE5424CGCOPRT	24 x 54 x 1.18	85	60	5		\$1814
KRE4824CGCOPRT	24 x 48 x 1.18	85	54	4.5		\$1610
KRE4224CGCOPRT	24 x 42 x 1.18	85	49	4		\$1405

Kingston return tops with Kingston edge on three sides, for use with FreeFit height adjustable table mechanisms, sold separately (FTxxxxx, see page 713 of the Desking price list for information).

- 26" deep tops accommodate FTxxxx24 mechanisms. Depth is exact to accommodate the Kingston edge + the Freefit mechanism. *Cannot be made smaller.*

Required Specifications

Finish
Edge

Optional Specifications

Handles*
Additional grommet

RETURNS - NOTES

- All returns are shipped assembled
- Kneewell locking standard
- The standard grain direction on returns is cross grain (**CG**). To remove cross grain veneer pattern on top, delete suffix "**CG**" from the model number (no upcharge)
- If Handle is not specified Routed Pull, Black Lock & Grommet are standard
- If Handle is specified:
 - Black and Brass handle = Black Lock & Grommet
 - Silver, Nickel and Tungsten handle = Tungsten Lock & Grommet
- Grommets are available as an option on Desks and most Credenzas.
- Edge options - must specify:

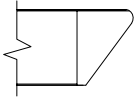

K16

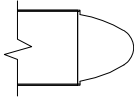

K18

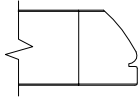

K21

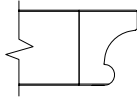

K22

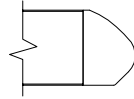

K29

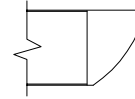

K30

• **NOTE:** Arrow indicates direction of grain

EXECUTIVE RETURNS

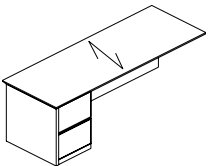

Executive Return - Left*

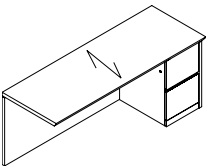

Executive Return - Right*

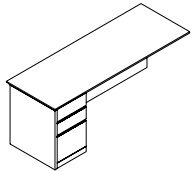

Executive Return - Left*

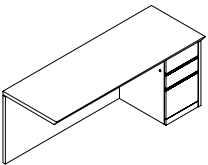

Executive Return - Right*

MODEL#	DIMENSIONS	FREIGHT CLASS	WT/LBS.	CUBIC FT.	LIST PRICE
--------	------------	---------------	---------	-----------	------------

KERL7222ECG	24 x 73 x 29	100	250	29	\$5926
KERL6622ECG	24 x 67 x 29	100	236	27	\$5709
KERL6022ECG	24 x 61 x 29	100	227	24	\$5189
KERL5422ECG	24 x 55 x 29	100	205	22	\$5005
KERL4822ECG	24 x 49 x 29	100	185	19	\$4448
KERL4222ECG	24 x 43 x 29	92.5	178	17	\$4282

Standard with full to floor **file/file** pedestal on **left**. Pedestal locks. Full height flush back panel.

KERR7222ECG	24 x 73 x 29	100	250	29	\$5926
KERR6622ECG	24 x 67 x 29	100	236	27	\$5709
KERR6022ECG	24 x 61 x 29	100	227	24	\$5189
KERR5422ECG	24 x 55 x 29	100	205	22	\$5005
KERR4822ECG	24 x 49 x 29	100	185	19	\$4448
KERR4222ECG	24 x 43 x 29	92.5	178	17	\$4282

Standard with full to floor **file/file** pedestal on **right**. Pedestal locks. Full height flush back panel.

KERL7222DCG	24 x 73 x 29	92.5	178	17	\$5926
KERL6622DCG	24 x 67 x 29	100	236	27	\$5709
KERL6022DCG	24 x 61 x 29	100	227	24	\$5189
KERL5422DCG	24 x 55 x 29	100	205	22	\$5005
KERL4822DCG	24 x 49 x 29	100	185	19	\$4448
KERL4222DCG	24 x 43 x 29	92.5	178	17	\$4282

Standard with full to floor **box/box/file** pedestal on **left**. Pedestal locks. Full height flush back panel.

KERR7222DCG	24 x 73 x 29	92.5	178	17	\$5926
KERR6622DCG	24 x 67 x 29	100	236	27	\$5709
KERR6022DCG	24 x 61 x 29	100	227	24	\$5189
KERR5422DCG	24 x 55 x 29	100	205	22	\$5005
KERR4822DCG	24 x 49 x 29	100	185	19	\$4448
KERR4222DCG	24 x 43 x 29	92.5	178	17	\$4282

Standard with full to floor **box/box/file** pedestal on **right**. Pedestal locks. Full height flush back panel.

Required Specifications

Finish
Edge

Optional Specifications

Additional grommet
Base upgrade* (see accessories for options)

EXECUTIVE RETURNS **MODEL#** **DIMENSIONS** **FREIGHT CLASS** **WT/LBS.** **CUBIC FT.** **LIST PRICE**

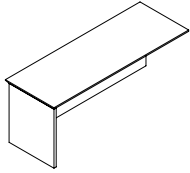

Executive Return - Left

	D x W x H					
KERL7222CG	24 x 73 x 29	150	135	29		\$3326
KERL6622CG	24 x 67 x 29	150	127	27		\$3051
KERL6022CG	24 x 61 x 29	150	120	24		\$2772
KERL5422CG	24 x 55 x 29	150	112	22		\$2493
KERL4822CG	24 x 49 x 29	150	105	19		\$2219
KERL4222CG	24 x 43 x 29	150	97	17		\$1938

Full height flush back panel.

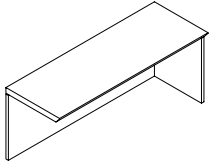

Executive Return - Right

KERR7222CG	24 x 73 x 29	150	135	29		\$3326
KERR6622CG	24 x 67 x 29	150	127	27		\$3051
KERR6022CG	24 x 61 x 29	150	120	24		\$2772
KERR5422CG	24 x 55 x 29	150	112	22		\$2493
KERR4822CG	24 x 49 x 29	150	105	19		\$2219
KERR4222CG	24 x 43 x 29	150	97	17		\$1938

Full height flush back panel.

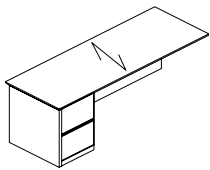

Executive Return - Left*

KERL7220ECG	22 x 73 x 29	100	240	27		\$5643
KERL6620ECG	22 x 67 x 29	100	231	24		\$5435
KERL6020ECG	22 x 61 x 29	92.5	222	22		\$4942
KERL5420ECG	22 x 55 x 29	92.5	200	20		\$4764
KERL4820ECG	22 x 49 x 29	92.5	180	18		\$4234
KERL4220ECG	22 x 43 x 29	92.5	173	16		\$4081

Standard with full to floor **file/file** pedestal on **left**. Pedestal locks. Full height flush back panel.

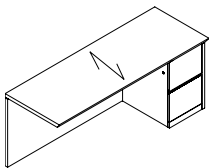

Executive Return - Right*

KERR7220ECG	22 x 73 x 29	100	240	27		\$5643
KERR6620ECG	22 x 67 x 29	100	231	24		\$5435
KERR6020ECG	22 x 61 x 29	92.5	222	22		\$4942
KERR5420ECG	22 x 55 x 29	92.5	200	20		\$4764
KERR4820ECG	22 x 49 x 29	92.5	180	18		\$4234
KERR4220ECG	22 x 43 x 29	92.5	173	16		\$4081

Standard with full to floor **file/file** pedestal on **right**. Pedestal locks. Full height flush back panel.

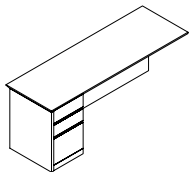

Executive Return - Left*

KERL7220DCG	22 x 73 x 29	100	240	27		\$5643
KERL6620DCG	22 x 67 x 29	100	231	24		\$5435
KERL6020DCG	22 x 61 x 29	92.5	222	22		\$4942
KERL5420DCG	22 x 55 x 29	92.5	200	20		\$4764
KERL4820DCG	22 x 49 x 29	92.5	180	18		\$4234
KERL4220DCG	22 x 43 x 29	92.5	173	16		\$4081

Standard with full to floor **box/box/file** pedestal on **left**. Pedestal locks. Full height flush back panel.

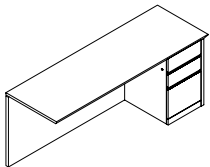

Executive Return - Right*

KERR7220DCG	22 x 73 x 29	100	240	27		\$5643
KERR6620DCG	22 x 67 x 29	100	231	24		\$5435
KERR6020DCG	22 x 61 x 29	92.5	222	22		\$4942
KERR5420DCG	22 x 55 x 29	92.5	200	20		\$4764
KERR4820DCG	22 x 49 x 29	92.5	180	18		\$4234
KERR4220DCG	22 x 43 x 29	92.5	173	16		\$4081

Standard with full to floor **box/box/file** pedestal on **right**. Pedestal locks. Full height flush back panel.

Required Specifications

Finish
Edge

Optional Specifications

Handles*
Additional grommet

EXECUTIVE RETURNS

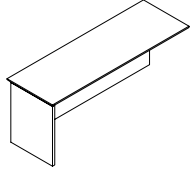

Executive Return - Left

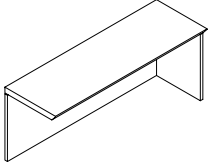

Executive Return - Right

MODEL#	DIMENSIONS	FREIGHT CLASS	WT/LBS.	CUBIC FT.	LIST PRICE
--------	------------	---------------	---------	-----------	------------

D x W x H

KERL7220CG	22 x 73 x 29	150	130	27	\$3168
KERL6620CG	22 x 67 x 29	150	122	24	\$2906
KERL6020CG	22 x 61 x 29	150	115	22	\$2641
KERL5420CG	22 x 55 x 29	150	105	20	\$2374
KERL4820CG	22 x 49 x 29	150	100	18	\$2115
KERL4220CG	22 x 43 x 29	150	90	16	\$1846

Full height flush back panel.

KERR7220CG	22 x 73 x 29	150	130	27	\$3168
KERR6620CG	22 x 67 x 29	150	122	24	\$2906
KERR6020CG	22 x 61 x 29	150	115	22	\$2641
KERR5420CG	22 x 55 x 29	150	105	20	\$2374
KERR4820CG	22 x 49 x 29	150	100	18	\$2115
KERR4220CG	22 x 43 x 29	150	90	16	\$1846

Full height flush back panel.

Required Specifications

Finish
Edge

Optional Specifications

Handles*
Additional grommet

PIANO DESKS - NOTES

- All desks are shipped assembled
- Units include installed horizontal wire management
- Unit is handed by Post leg.
- Not for use with regular corner units
- If grommet (optional) color is not specified, Black grommet is standard.
- Grommets are available as an option on Desks and most Credenzas.
- Edge options - must specify:

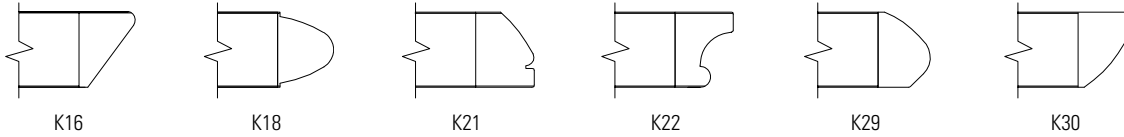

- **NOTE:** Arrow indicates direction of grain
- For cross grain veneer pattern on top, add **(CG)**.

PIANO DESKS	MODEL#	DIMENSIONS	FREIGHT CLASS	WT./LBS.	CUBIC FT.	LIST PRICE
-------------	--------	------------	---------------	----------	-----------	------------

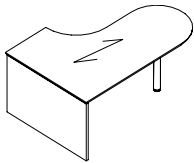

D-shaped Piano Desk - Left*

KTDP L96304822	48 x 96 x 29	125	464	77	\$7591
KTDP L84304822	48 x 84 x 29	150	406	68	\$6756
KTDP L72304822	48 x 72 x 29	125	348	58	\$5916

3" wood post and full end panel, 30"D worksurface and 24" return connection.

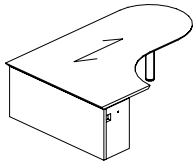

D-shaped Piano Desk - Right*

KTDP R96304822	48 x 96 x 29	125	464	77	\$7591
KTDP R84304822	48 x 84 x 29	150	406	68	\$6756
KTDP R72304822	48 x 72 x 29	125	348	58	\$5916

3" wood post and full end panel, 30"D worksurface and 24" return connection.

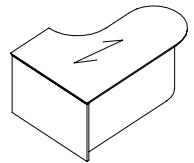

D-shaped Piano Desk - Left

KTDP CL96304822	48 x 96 x 29	125	479	77	\$9634
KTDP CL84304822	48 x 84 x 29	125	420	68	\$8544
KTDP CL72304822	48 x 72 x 29	125	360	58	\$7450

Full height curved modesty panel, 3" wood post, and full end panel, 30"D worksurface and 24" return connection.

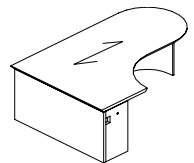

D-shaped Piano Desk - Right

KTDP CR96304822	48 x 96 x 29	125	479	77	\$9634
KTDP CR84304822	48 x 84 x 29	125	420	68	\$8544
KTDP CR72304822	48 x 72 x 29	125	360	58	\$7450

Full height curved modesty panel, 3" wood post, and full end panel, 30"D worksurface and 24" return connection.

Required Specifications

Finish
Edge

Optional Specifications

Handles*
Additional grommet

PIANO DESKS - NOTES

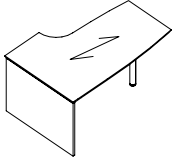

Boat-shaped Piano Desk - Left*

	D x W x H					
KTBPPL96364822	48 x 96 x 29	125	522	87		\$8544
KTBPPL84364822	48 x 84 x 29	125	457	76		\$7596
KTBPPL72364822	48 x 72 x 29	125	392	65		\$6652

3" wood post and full end panel, with 36"/30"D worksurface and 24" return connection.

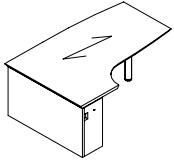

Boat-shaped Piano Desk - Right*

KTBPR96364822	48 x 96 x 29	125	522	87		\$8544
KTBPR84364822	48 x 84 x 29	125	457	76		\$7596
KTBPR72364822	48 x 72 x 29	125	392	65		\$6652

3" wood post and full end panel, with 36"/30"D worksurface and 24" return connection.

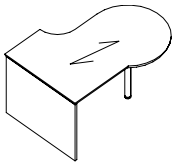

P-shaped Piano Desk - Left*

KTPLL96424822	48 x 96 x 29	150	580	97		\$8662
KTPLL84424822	48 x 84 x 29	150	508	85		\$7749
KTPLL72424822	48 x 72 x 29	150	435	73		\$7181

3" wood post and full end panel, with 42"/30"D worksurface and 24" return connection.

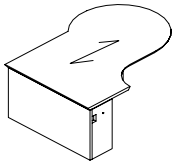

P-shaped Piano Desk - Right*

KTPPR96424822	48 x 96 x 29	150	580	97		\$8662
KTPPR84424822	48 x 84 x 29	150	508	85		\$7749
KTPPR72424822	48 x 72 x 29	150	435	73		\$7181

3" wood post and full end panel, with 42"/30"D worksurface and 24" return connection.

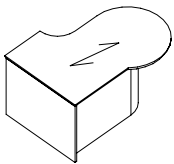

P-shaped Piano Desk - Left

KTPPCL96424822	48 x 96 x 29	125	590	97		\$10409
KTPPCL84424822	48 x 84 x 29	125	516	85		\$9277
KTPPCL72424822	48 x 72 x 29	125	442	73		\$8720

Full curved modesty panel, 3" wood post, and full end panel, with 42"/30"D worksurface and 24" return connection.

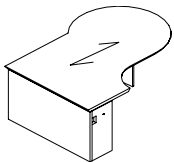

P-shaped Piano Desk - Right

KTPPCR96424822	48 x 96 x 29	125	590	97		\$10409
KTPPCR84424822	48 x 84 x 29	125	516	85		\$9277
KTPPCR72424822	48 x 72 x 29	125	442	73		\$8720

Full curved modesty panel, 3" wood post, and full end panel, with 42"/30"D worksurface and 24" return connection.

Required Specifications

Finish
Edge

Optional Specifications

Additional grommet
Base upgrade* (see accessories for options)

PIANO DESKS

MODEL# DIMENSIONS FREIGHT CLASS WT/LBS. CUBIC FT. LIST PRICE

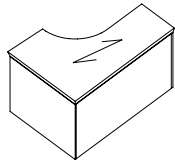

Extended Corner Table - Right

	D x W x H					
KEKL964822MR	98 x 48 x 29	150	387	77	\$8248	
KEKL904822MR	92 x 48 x 29	150	363	73	\$7790	
KEKL844822MR	86 x 48 x 29	150	338	68	\$7695	
KEKL784822MR	80 x 48 x 29	150	314	63	\$7656	
KEKL724822MR	74 x 48 x 29	150	290	58	\$6613	
KEKL664822MR	68 x 48 x 29	150	266	52	\$6786	
KEKL604822MR	62 x 48 x 29	150	242	48	\$6285	

Self edge on back edge, and 24" return connection.

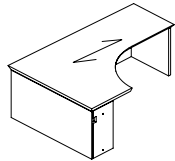

Extended Corner Table - Right

KEKR489622ML	98 x 48 x 29	150	387	77	\$8248	
KEKR489022ML	92 x 48 x 29	150	363	73	\$7790	
KEKR488422ML	86 x 48 x 29	150	338	68	\$7695	
KEKR487822ML	80 x 48 x 29	150	314	63	\$7656	
KEKR487222ML	74 x 48 x 29	150	290	58	\$7274	
KEKR486622ML	68 x 48 x 29	150	266	52	\$6786	
KEKR486022ML	62 x 48 x 29	150	242	48	\$6285	

Self edge on back edge, and 24" return connection.

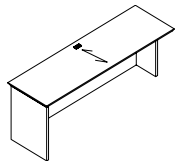

Linking Return - Left

KVEL9622CG	24 x 97 x 29	150	200	39	\$5012	
KVEL9022CG	24 x 91 x 29	150	187	36	\$4698	
KVEL8422CG	24 x 85 x 29	150	174	34	\$4386	
KVEL7822CG	24 x 79 x 29	150	162	31	\$4072	
KVEL7222CG	24 x 73 x 29	150	149	29	\$3763	
KVEL6622CG	24 x 67 x 29	150	141	27	\$3532	
KVEL6022CG	24 x 61 x 29	150	132	24	\$3140	
KVEL5422CG	24 x 55 x 29	150	121	22	\$3115	
KVEL4822CG	24 x 47 x 29	125	115	19	\$2927	
KVEL4222CG	24 x 43 x 29	150	99	17	\$2463	
KVEL3622CG	24 x 37 x 29	150	83	15	\$2377	
KVEL3022CG	24 x 31 x 29	125	77	12	\$2365	
KVEL2422CG	24 x 25 x 29	125	61	10	\$1959	

Used in conjunction with Extended Corner Units or Piano Table Desks

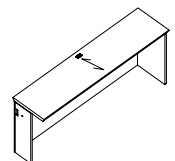

Linking Return - Right

KVER9622CG	24 x 97 x 29	150	200	39	\$5012	
KVER9022CG	24 x 91 x 29	150	187	36	\$4698	
KVER8422CG	24 x 85 x 29	150	174	34	\$4386	
KVER7822CG	24 x 79 x 29	150	162	31	\$4072	
KVER7222CG	24 x 73 x 29	150	149	29	\$3763	
KVER6622CG	24 x 67 x 29	150	141	27	\$3532	
KVER6022CG	24 x 61 x 29	150	132	24	\$3140	
KVER5422CG	24 x 55 x 29	150	121	22	\$3115	
KVER4822CG	24 x 47 x 29	125	115	19	\$2927	
KVER4222CG	24 x 43 x 29	150	99	17	\$2463	
KVER3622CG	24 x 37 x 29	150	83	15	\$2377	
KVER3022CG	24 x 31 x 29	125	77	12	\$2365	
KVER2422CG	24 x 25 x 29	125	61	10	\$1959	

Used in conjunction with Extended Corner Units or Piano Table Desks

Required Specifications

Finish
Edge

Optional Specifications

Additional grommet
Base upgrade* (see accessories for options)

EXTENDED CORNERS

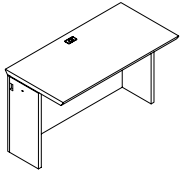

Bridge

MODEL#	DIMENSIONS	FREIGHT CLASS	WT./LBS.	CUBIC FT.	LIST PRICE
--------	------------	---------------	----------	-----------	------------

D x W x H

KBTN4822CG	24 x 48 x 29	125	116	19	\$2836
KBTN4222CG	24 x 42 x 29	125	102	17	\$2377
KBTN3622CG	24 x 36 x 29	150	87	15	\$2292
KBTN3022CG	24 x 30 x 29	125	73	12	\$2244
KBTN2422CG	24 x 24 x 29	150	58	10	\$1883
KBTN1822CG	24 x 18 x 29	150	43	8	\$1417
KBTN1222CG	24 x 12 x 29	150	29	5	\$943

For Extended Corner Units or Piano Table Desks, with full back panel and recessed end panels.

BRIDGES

- All bridges are shipped knockdown.
- Not for use with corner units.
- The standard grain direction is cross grain (**CG**). To remove cross grain veneer pattern on top, delete suffix "**CG**" from the model number (no upcharge).
- GM5 TC location is standard. If grommet color is not specified, Black grommet is standard.
- Edge options - must specify:

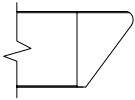

K16

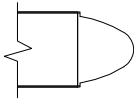

K18

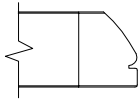

K21

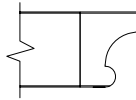

K22

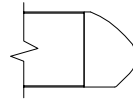

K29

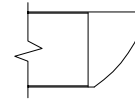

K30

- **NOTE:** Arrow indicates direction of grain

BRIDGES

MODEL#	DIMENSIONS	FREIGHT CLASS	WT./LBS.	CUBIC FT.	LIST PRICE
--------	------------	---------------	----------	-----------	------------

KBT6022CG	24 x 60 x 29	85	108	9	\$2641
KBT5422CG	24 x 54 x 29	85	99	8	\$2377
KBT4822CG	24 x 48 x 29	85	90	7	\$2115
KBT4222CG	24 x 42 x 29	85	81	6	\$1848
KBT6020CG	22 x 60 x 29	85	105	8	\$2405
KBT5420CG	22 x 54 x 29	85	96	8	\$2164
KBT4820CG	22 x 48 x 29	85	87	7	\$1922
KBT4220CG	22 x 42 x 29	85	78	6	\$1648

With full back panel.

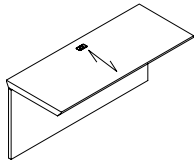

Executive Bridge Top

KBT6022Q8CG	24 x 60 x 9.5	100	83	9	\$2377
KBT5422Q8CG	24 x 54 x 9.5	100	74	8	\$2141
KBT4822Q8CG	24 x 48 x 9.5	100	65	7	\$1896
KBT4222Q8CG	24 x 42 x 9.5	100	56	6	\$1663

KBT6020Q8CG	22 x 60 x 9.5	92.5	80	8	\$2164
KBT5420Q8CG	22 x 54 x 9.5	100	71	8	\$1953
KBT4820Q8CG	22 x 48 x 9.5	100	62	7	\$1736
KBT4220Q8CG	22 x 42 x 9.5	100	53	6	\$1484

With 8" back panel.

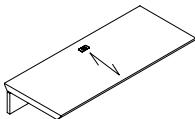

Executive Bridge Top

Required Specifications

Finish
Edge

Optional Specifications

Additional grommet

EXTENDED CORNERS

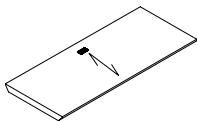

Executive Bridge Top

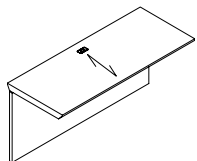

Executive Bridge Top

MODEL# DIMENSIONS FREIGHT CLASS WT./LBS. CUBIC FT. LIST PRICE

D x W x H						
KBT5422TCG	24 x 54 x 1.5	100	64	8		\$1422
KBT4822TCG	24 x 48 x 1.5	125	55	7		\$1270
KBT4222TCG	24 x 42 x 1.5	125	46	6		\$1113
KBT5420TCG	22 x 54 x 1.5	125	61	8		\$1303
KBT4820TCG	22 x 48 x 1.5	125	52	7		\$1157
KBT4220TCG	22 x 42 x 1.5	125	43	6		\$991

No back panel.

KHBT6022CG	24 x 60 x 29	85	108	9		\$3034
KHBT5422CG	24 x 54 x 29	85	99	8		\$2777
KHBT4822CG	24 x 48 x 29	85	90	7		\$2512
KHBT4222CG	24 x 42 x 29	85	81	6		\$2246

KHBT6020CG	22 x 60 x 29	85	105	8		\$2803
KHBT5420CG	22 x 54 x 29	85	96	8		\$2562
KHBT4820CG	22 x 48 x 29	85	87	7		\$2322
KHBT4220CG	22 x 42 x 29	85	78	6		\$2045

With hinged back panel, for U configurations.

CREDENZA NOTES

- All credenzas are shipped assembled.
- All Storage Cabinets include one adjustable shelf per set of doors.
- "F" and "G" depict 36", and "M" and "N" depict 30".
- "F" and "N" indicate lateral file drawers and "G" and "M" indicate storage cabinets with doors.
- Credenza shells accept modular storage. Use modular storage for top support, allowing no more than 72" unsupported.
- Credenza shells with a width of 96" and more will have a 12" center support gable.
- Credenza shells can only be completely filled with modular storage units with ".5" at the end of the model number.
- If Handle is not specified Routed Pull, Black Lock & Grommet are standard
- If Handle is specified:
 - Black and Brass handle = Black Lock & Grommet
 - Silver, Nickel and Tungsten handle = Tungsten Lock & Grommet
- **NOTE:** Arrow indicates direction of grain
- Edge options - must specify:

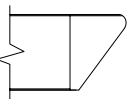
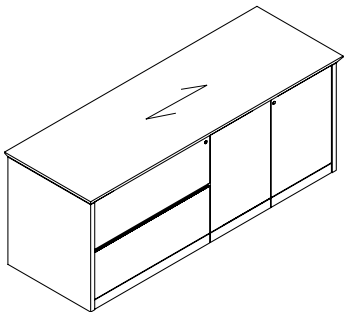

K16

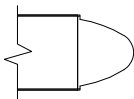

K18

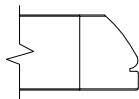

K21

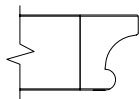

K22

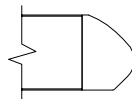

K29

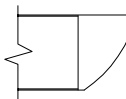

K30

CREDENZAS

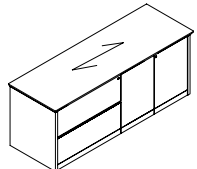

Full Storage Credenza*

MODEL# DIMENSIONS FREIGHT CLASS WT./LBS. CUBIC FT. LIST PRICE

KC7222FG	23 x 74 x 29	92.5	285	27		\$7110
KC6022NM	23 x 62 x 29	92.5	233	22		\$5925
KC7220FG	21 x 74 x 29	92.5	272	24		\$6769
KC6020NM	21 x 62 x 29	92.5	220	20		\$5639

Standard with lateral box/file on left and storage cabinet on right.

- For Aluminum Framed Glass Door option, contact Customer Care.

Required Specifications

Finish
Edge

Optional Specifications

Additional grommet

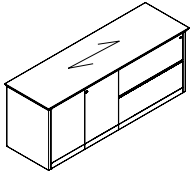
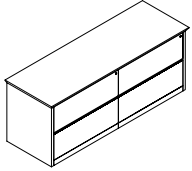
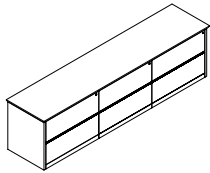
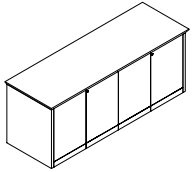
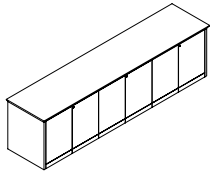
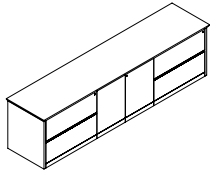
DESKS

Full Storage Credenza

Full Storage Credenza

Full Storage Credenza

Full Storage Credenza

Full Storage Credenza

Full Storage Credenza

MODEL#	DIMENSIONS	FREIGHT CLASS	WT/LBS.	CUBIC FT.	LIST PRICE
--------	------------	---------------	---------	-----------	------------

D x W x H

KC7222GF	23 x 74 x 29	92.5	285	27	\$7110
KC6022MN	23 x 62 x 29	92.5	233	22	\$5925
KC7220GF	21 x 74 x 29	92.5	272	24	\$6769
KC6020MN	21 x 62 x 29	92.5	220	20	\$5639

Standard with **lateral box/file** on **right** and **storage cabinet** on **left**.

- For Aluminum Framed Glass Door option, contact Customer Care.

KC7222FF	23 x 74 x 29	92.5	300	27	\$9090
KC6022NN	23 x 62 x 29	100	218	22	\$8337
KC7220FF	21 x 74 x 29	92.5	287	24	\$8657
KC6020NN	21 x 62 x 29	92.5	205	20	\$7582

Standard with **lateral box/file** on **left** and **right**.

KC10822FFF	23 x 110 x 29	92.5	435	40	\$15990
KC9022NNN	23 x 92 x 29	92.5	372	33	\$13326
KC10820FFF	21 x 110 x 29	92.5	412	36	\$14536
KC9020NNN	21 x 92 x 29	92.5	337	30	\$12116

Standard with **lateral box/file** on **left, center** and **right**.

KC7222GG	23 x 74 x 29	92.5	277	27	\$6747
KC6022MM	23 x 62 x 29	92.5	232	22	\$6186
KC7220GG	21 x 74 x 29	92.5	253	24	\$6427
KC6020MM	21 x 62 x 29	92.5	209	20	\$5624

Standard with **storage cabinets** on **left** and **right**.

KC10822GGG	23 x 110 x 29	100	348	40	\$12752
KC9022MMM	23 x 92 x 29	100	302	33	\$10626
KC10820GGG	21 x 110 x 29	125	278	36	\$11589
KC9020MMM	21 x 92 x 29	125	228	30	\$9597

Standard with **storage cabinets** on **left, center** and **right**.

KC10822FGF	23 x 110 x 29	100	348	40	\$14912
KC9022NMN	23 x 92 x 29	100	302	33	\$12428
KC10820FGF	21 x 110 x 29	125	278	36	\$13554
KC9020NMN	21 x 92 x 29	125	228	30	\$11296

Lateral files on **left** and **right**; **storage cabinet** in **center**

Required Specifications

Finish
Edge

Optional Specifications

Handles*
Additional grommet

CRENZAS

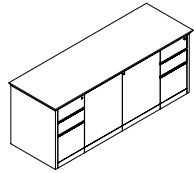

Full Storage Credenza

MODEL# DIMENSIONS FREIGHT CLASS WT/LBS. CUBIC FT. LIST PRICE

D x W x H

KC7222DGD	23 x 74 x 29	92.5	319	29	\$8337
KC6022DMD	23 x 62 x 29	92.5	266	24	\$7643
KC7220DGD	21 x 74 x 29	85	298	24	\$7937
KC6020DMD	21 x 62 x 29	85	246	20	\$6947

Standard with **box/box/file** on **left** and **right**; **storage cabinet** in **center**.

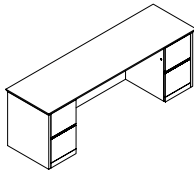

Double Pedestal Credenza

KCK8422EE	23 x 86 x 29	100	320	34	\$8711
KCK7822EE	23 x 80 x 29	100	298	31	\$8090
KCK7222EE	23 x 74 x 29	100	280	29	\$7470
KCK6622EE	23 x 68 x 29	100	257	27	\$7356
KCK6022EE	23 x 62 x 29	100	233	24	\$6844

KCK8420EE	21 x 86 x 29	92.5	307	28	\$8302
KCK7820EE	21 x 80 x 29	92.5	285	26	\$7709
KCK7220EE	21 x 74 x 29	92.5	267	24	\$7114
KCK6620EE	21 x 68 x 29	92.5	244	22	\$6520
KCK6020EE	21 x 62 x 29	92.5	220	20	\$5928

File/file pedestals on **left** and **right**. Full height back panel. Kneespace in center.

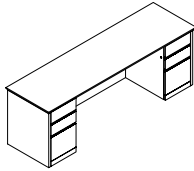

Double Pedestal Credenza

KCK8422DD	23 x 86 x 29	100	320	34	\$8711
KCK7822DD	23 x 80 x 29	100	298	31	\$8090
KCK7222DD	23 x 74 x 29	100	280	29	\$7470
KCK6622DD	23 x 68 x 29	100	257	27	\$7356
KCK6022DD	23 x 62 x 29	100	233	24	\$6844

KCK8420DD	21 x 86 x 29	92.5	307	28	\$8302
KCK7820DD	21 x 80 x 29	92.5	285	26	\$7709
KCK7220DD	21 x 74 x 29	92.5	267	24	\$7114
KCK6620DD	21 x 68 x 29	92.5	244	22	\$6520
KCK6020DD	21 x 62 x 29	92.5	220	20	\$5928

Box/box/file pedestals on **left** and **right**. Full height back panel. Kneespace in center.

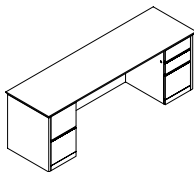

Double Pedestal Credenza

KCK8422ED	23 x 86 x 29	100	320	34	\$8711
KCK7822ED	23 x 80 x 29	100	298	31	\$8090
KCK7222ED	23 x 74 x 29	100	280	29	\$7470
KCK6622ED	23 x 68 x 29	100	257	27	\$7356
KCK6022ED	23 x 62 x 29	100	233	24	\$6844

KCK8420ED	21 x 86 x 29	92.5	307	28	\$8302
KCK7820ED	21 x 80 x 29	92.5	285	26	\$7709
KCK7220ED	21 x 74 x 29	92.5	267	24	\$7114
KCK6620ED	21 x 68 x 29	92.5	244	22	\$6520
KCK6020ED	21 x 62 x 29	92.5	220	20	\$5928

File/file pedestal on **left**, **box/box/file** pedestal on **right**. Full height back panel. Kneespace in center.

Required Specifications

Finish
Edge

Optional Specifications

Handles
Additional grommet

CREDENZAS

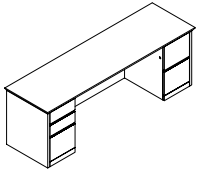

Double Pedestal Credenza

MODEL#	DIMENSIONS D x W x H	FREIGHT CLASS	WT./LBS.	CUBIC FT.	LIST PRICE
KCK8422DE	23 x 86 x 29	100	320	34	\$8711
KCK7822DE	23 x 80 x 29	100	298	31	\$8090
KCK7222DE	23 x 74 x 29	100	280	29	\$7470
KCK6622DE	23 x 68 x 29	100	257	27	\$7356
KCK6022DE	23 x 62 x 29	100	233	24	\$6844
KCK8420DE	21 x 86 x 29	92.5	307	28	\$8302
KCK7820DE	21 x 80 x 29	92.5	285	26	\$7709
KCK7220DE	21 x 74 x 29	92.5	267	24	\$7114
KCK6620DE	21 x 68 x 29	92.5	244	22	\$6520
KCK6020DE	21 x 62 x 29	92.5	220	20	\$5928

Box/box/file pedestal on **left** and **file/file** pedestal on **right**. Full height back panel. Kneespace in center.

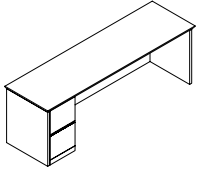

Single Pedestal Credenza - Left

KCL8422E	23 x 86 x 29	100	286	34	\$6586
KCL7822E	23 x 80 x 29	100	265	31	\$6119
KCL7222E	23 x 74 x 29	100	250	29	\$5643
KCL6622E	23 x 68 x 29	100	229	27	\$5435
KCL6022E	23 x 62 x 29	100	208	24	\$4942
KCL8420E	21 x 86 x 29	100	273	28	\$6275
KCL7820E	21 x 80 x 29	100	252	26	\$5829
KCL7220E	21 x 74 x 29	100	237	24	\$5378
KCL6620E	21 x 68 x 29	100	216	22	\$5176
KCL6020E	21 x 62 x 29	100	195	20	\$4710

File/file pedestal on **left**. Full height back panel.

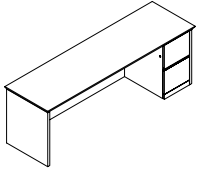

Single Pedestal Credenza - Right

KCR8422E	23 x 86 x 29	100	286	34	\$6586
KCR7822E	23 x 80 x 29	100	265	31	\$6119
KCR7222E	23 x 74 x 29	100	250	29	\$5643
KCR6622E	23 x 68 x 29	100	229	27	\$5435
KCR6022E	23 x 62 x 29	100	208	24	\$4942
KCR8420E	21 x 86 x 29	100	273	28	\$6275
KCR7820E	21 x 80 x 29	100	252	26	\$5829
KCR7220E	21 x 74 x 29	100	237	24	\$5378
KCR6620E	21 x 68 x 29	100	216	22	\$5176
KCR6020E	21 x 62 x 29	100	195	20	\$4710

File/file pedestal on **right**. Full height back panel.

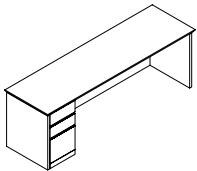

Single Pedestal Credenza - Left

KCL8422D	23 x 86 x 29	100	286	34	\$6586
KCL7822D	23 x 80 x 29	100	265	31	\$6119
KCL7222D	23 x 74 x 29	100	250	29	\$5643
KCL6622D	23 x 68 x 29	100	229	27	\$5435
KCL6022D	23 x 62 x 29	100	208	24	\$4942
KCL8420D	21 x 86 x 29	100	273	28	\$6275
KCL7820D	21 x 80 x 29	100	252	26	\$5829
KCL7220D	21 x 74 x 29	100	237	24	\$5378
KCL6620D	21 x 68 x 29	100	216	22	\$5176
KCL6020D	21 x 62 x 29	100	195	20	\$4710

Box/box/file pedestal on **left**. Full height back panel.

Required Specifications

Finish
Edge

Optional Specifications

Handles
Additional grommet

CREENZAS

MODEL# DIMENSIONS FREIGHT CLASS WT/LBS. CUBIC FT. LIST PRICE

D x W x H

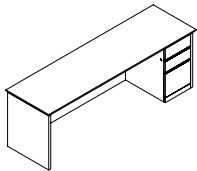

Single Pedestal Credenza - Right

KCR8422D	23 x 86 x 29	100	286	34	\$6586
KCR7822D	23 x 80 x 29	100	265	31	\$6119
KCR7222D	23 x 74 x 29	100	250	29	\$5643
KCR6622D	23 x 68 x 29	100	229	27	\$5435
KCR6022D	23 x 62 x 29	100	208	24	\$4942
KCR8420D	21 x 86 x 29	100	273	28	\$6275
KCR7820D	21 x 80 x 29	100	252	26	\$5829
KCR7220D	21 x 74 x 29	100	237	24	\$5378
KCR6620D	21 x 68 x 29	100	216	22	\$5176
KCR6020D	21 x 62 x 29	100	195	20	\$4710

Box/box/file pedestal on right. Full height back panel.

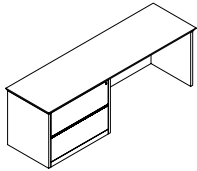

Single Pedestal Credenza - Left

KCL8422F	23 x 86 x 29	100	266	31	\$7656
KCL7822F	23 x 80 x 29	100	245	29	\$7108
KCL7222F	23 x 74 x 29	100	230	27	\$6565
KCL6622F	23 x 68 x 29	100	209	24	\$6319
KCL6022F	23 x 62 x 29	100	188	22	\$5736
KCL8420F	21 x 86 x 29	100	253	28	\$7289
KCL7820F	21 x 80 x 29	100	233	26	\$6766
KCL7220F	21 x 74 x 29	100	218	24	\$6247
KCL6620F	21 x 68 x 29	100	197	22	\$6017
KCL6020F	21 x 62 x 29	100	176	20	\$5463

36" lateral file pedestal on left. Full height back panel.

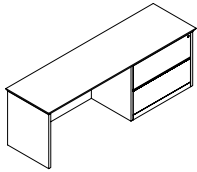

Single Pedestal Credenza - Right

KCR8422F	23 x 86 x 29	100	266	31	\$7656
KCR7822F	23 x 80 x 29	100	245	29	\$7108
KCR7222F	23 x 74 x 29	100	230	27	\$6565
KCR6622F	23 x 68 x 29	100	209	24	\$6319
KCR6022F	23 x 62 x 29	100	188	22	\$5736
KCR8420F	21 x 86 x 29	100	253	28	\$7289
KCR7820F	21 x 80 x 29	100	233	26	\$6766
KCR7220F	21 x 74 x 29	100	218	24	\$6247
KCR6620F	21 x 68 x 29	100	197	22	\$6017
KCR6020F	21 x 62 x 29	100	176	20	\$5463

36" lateral file pedestal on right. Full height back panel.

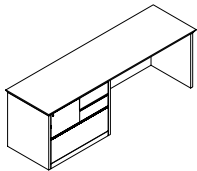

Single Pedestal Credenza - Left

KCL8422Z	23 x 86 x 29	100	309	31	\$8356
KCL7822Z	23 x 80 x 29	100	287	29	\$7762
KCL7222Z	23 x 74 x 29	92.5	270	27	\$7168
KCL6622Z	23 x 68 x 29	92.5	248	24	\$6893
KCL6022Z	23 x 62 x 29	92.5	225	22	\$6274
KCL8420Z	21 x 86 x 29	92.5	296	28	\$7964
KCL7820Z	21 x 80 x 29	92.5	274	26	\$7395
KCL7220Z	21 x 74 x 29	92.5	257	24	\$6501
KCL6620Z	21 x 68 x 29	92.5	235	22	\$6567
KCL6020Z	21 x 62 x 29	92.5	212	20	\$5971

Modular combination storage pedestal with 1 lateral file, 1 file drawer on top left, and two box drawers on top right.

Required Specifications

Finish
Edge

Optional Specifications

Handles
Additional grommet

CREENZAS

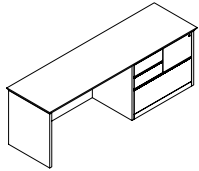

Single Pedestal Credenza - Right

96" and larger:

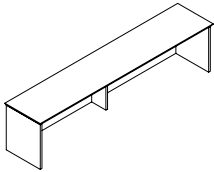

Less than 96":

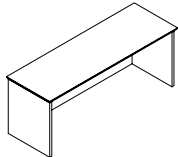

Credenza Shell

MODEL#	DIMENSIONS	FREIGHT CLASS	WT./LBS.	CUBIC FT.	LIST PRICE
--------	------------	---------------	----------	-----------	------------

D x W x H

KCR8422Z	23 x 86 x 29	100	309	31	\$8356
KCR7822Z	23 x 80 x 29	100	287	29	\$7762
KCR7222Z	23 x 74 x 29	92.5	270	27	\$7168
KCR6622Z	23 x 68 x 29	92.5	248	24	\$6893
KCR6022Z	23 x 62 x 29	92.5	225	22	\$6274
KCR8420Z	21 x 86 x 29	92.5	296	28	\$7964
KCR7820Z	21 x 80 x 29	92.5	274	26	\$7395
KCR7220Z	21 x 74 x 29	92.5	257	24	\$6501
KCR6620Z	21 x 68 x 29	92.5	235	22	\$6567
KCR6020Z	21 x 62 x 29	92.5	212	20	\$5971

Modular combination storage pedestal with 1 lateral file, 1 file drawer on top right, and two box drawers on top left.

KC10822	23 x 108 x 29	125	320	41	\$5290
KC10222	23 x 104 x 29	100	305	38	\$4997
KC9622	23 x 98 x 29	100	287	35	\$4705
KC9022	23 x 92 x 29	100	269	33	\$4199
KC8422	23 x 86 x 29	100	251	31	\$4118
KC7822	23 x 80 x 29	100	233	29	\$3822
KC7222	23 x 74 x 29	125	215	27	\$3532
KC6622	23 x 68 x 29	100	197	24	\$3397
KC6022	23 x 62 x 29	100	179	22	\$3091
KC5422	23 x 56 x 29	100	161	20	\$2927
KC4822	23 x 50 x 29	125	143	18	\$2767
KC4222	23 x 44 x 29	125	125	16	\$2341

KC10820	21 x 108 x 29	100	310	36	\$5042
KC10220	21 x 104 x 29	100	291	34	\$4763
KC9620	21 x 98 x 29	100	273	32	\$4482
KC9020	21 x 92 x 29	100	255	30	\$4205
KC8420	21 x 86 x 29	100	237	28	\$3924
KC7820	21 x 80 x 29	100	219	26	\$3641
KC7220	21 x 74 x 29	100	206	24	\$3358
KC6620	21 x 68 x 29	100	188	22	\$3234
KC6020	21 x 62 x 29	100	169	20	\$2944
KC5420	21 x 56 x 29	100	147	18	\$2784
KC4820	21 x 50 x 29	125	101	16	\$2633
KC4220	21 x 44 x 29	125	86	14	\$2231

With full back panel.

Required Specifications

Finish
Edge

Optional Specifications

Handles
Additional grommet

CRENZAS MODEL# DIMENSIONS FREIGHT CLASS WT./LBS. CUBIC FT. LIST PRICE

NOTE: Arrow indicates direction of grain

Corners

- All units are shipped assembled
- Unit includes grommets shown and installed horizontal wire management
- Corner units and extended corner units must be used exclusively with linking bridges and linking returns
- Edge options - must specify:

- **Linking bridges** are handed by recessed end panel
- **Extended corner tables** have no molding on back side.
- **Linking returns** include grommets shown and installed horizontal wire management. Handed by full end panel.
- **Tables** include grommets shown and installed horizontal wire management.

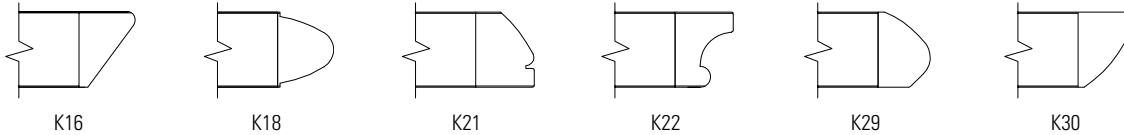

CORNERS AND COMPONENTS MODEL# DIMENSIONS FREIGHT CLASS WT./LBS. CUBIC FT. LIST PRICE

D x W x H

KBT6022NLLCG	24 x 60 x 29	125	145	24	\$2911
KBT5422NLLCG	24 x 54 x 29	150	131	22	\$2623
KBT4822NLLCG	24 x 48 x 29	125	116	19	\$2332
KBT4222NLLCG	24 x 42 x 29	125	102	17	\$1886
KBT3622NLLCG	24 x 36 x 29	150	87	15	\$1716
KBT3022NLLCG	24 x 30 x 29	125	73	12	\$1673
KBT6020NLLCG	22 x 60 x 29	150	131	22	\$2772
KBT5420NLLCG	22 x 54 x 29	150	118	20	\$2496
KBT4820NLLCG	22 x 48 x 29	125	110	18	\$2219
KBT4220NLLCG	22 x 42 x 29	150	95	16	\$1796
KBT3620NLLCG	22 x 36 x 29	125	80	13	\$1631
KBT3020NLLCG	22 x 30 x 29	150	65	11	\$1593

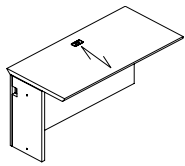

Linking Bridge - Left

To join corner worksurface to desk or credenza. Full back panel.

KBT6022NLRCG	24 x 60 x 29	125	145	24	\$2911
KBT5422NLRCG	24 x 54 x 29	150	131	22	\$2623
KBT4822NLRCG	24 x 48 x 29	125	116	19	\$2332
KBT4222NLRCG	24 x 42 x 29	125	102	17	\$1886
KBT3622NLRCG	24 x 36 x 29	150	87	15	\$1716
KBT3022NLRCG	24 x 30 x 29	125	73	12	\$1673
KBT6020NLRCG	22 x 60 x 29	150	131	22	\$2772
KBT5420NLRCG	22 x 54 x 29	150	118	20	\$2496
KBT4820NLRCG	22 x 48 x 29	125	110	18	\$2219
KBT4220NLRCG	22 x 42 x 29	150	95	16	\$1796
KBT3620NLRCG	22 x 36 x 29	125	80	13	\$1631
KBT3020NLRCG	22 x 30 x 29	150	65	11	\$1593

To join corner worksurface to desk or credenza. Full back panel.

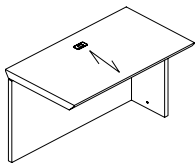

Linking Bridge - Right

Required Specifications

Finish
Edge

Optional Specifications

Handles
Additional grommet

CORNERS - NOTES

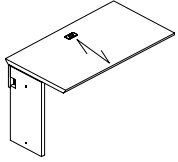

Linking Bridge - Left

	D x W x H				
KBT6022NLLQ8CG	24 x 60 x 9.5	125	145	24	\$2623
KBT5422NLLQ8CG	24 x 54 x 9.5	150	131	22	\$2365
KBT4822NLLQ8CG	24 x 48 x 9.5	125	116	19	\$2101
KBT4222NLLQ8CG	24 x 42 x 9.5	125	102	17	\$1695
KBT3622NLLQ8CG	24 x 36 x 9.5	150	87	15	\$1544
KBT3022NLLQ8CG	24 x 30 x 9.5	125	73	12	\$1510
KBT6020NLLQ8CG	22 x 60 x 9.5	150	131	22	\$2496
KBT5420NLLQ8CG	22 x 54 x 9.5	150	118	20	\$2249
KBT4820NLLQ8CG	22 x 48 x 9.5	125	110	18	\$2000
KBT4220NLLQ8CG	22 x 42 x 9.5	150	95	16	\$1619
KBT3620NLLQ8CG	22 x 36 x 9.5	125	80	13	\$1470
KBT3020NLLQ8CG	22 x 30 x 9.5	150	65	11	\$1438

To join corner worksurface to desk or credenza. 8" back panel.

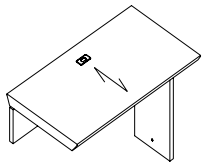

Linking Bridge - Right

KBT6022NLRQ8CG	24 x 60 x 9.5	125	145	24	\$2623
KBT5422NLRQ8CG	24 x 54 x 9.5	150	131	22	\$2365
KBT4822NLRQ8CG	24 x 48 x 9.5	125	116	19	\$2101
KBT4222NLRQ8CG	24 x 42 x 9.5	125	102	17	\$1695
KBT3622NLRQ8CG	24 x 36 x 9.5	150	87	15	\$1544
KBT3022NLRQ8CG	24 x 30 x 9.5	125	73	12	\$1510
KBT6020NLRQ8CG	22 x 60 x 9.5	150	131	22	\$2496
KBT5420NLRQ8CG	22 x 54 x 9.5	150	118	20	\$2249
KBT4820NLRQ8CG	22 x 48 x 9.5	125	110	18	\$2000
KBT4220NLRQ8CG	22 x 42 x 9.5	150	95	16	\$1619
KBT3620NLRQ8CG	22 x 36 x 9.5	125	80	13	\$1470
KBT3020NLRQ8CG	22 x 30 x 9.5	150	65	11	\$1438

To join corner worksurface to desk or credenza. 8" back panel.

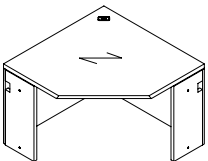

Corner Table

KE484822	48 x 48 x 29	150	201	39	\$4188
KE424222	42 x 42 x 29	150	155	30	\$3215
KE363622	36 x 36 x 29	125	135	22	\$3053
KE484820	48 x 48 x 29	150	196	39	\$4188
KE424220	42 x 42 x 29	150	150	30	\$3215
KE363620	36 x 36 x 29	150	130	22	\$3053

Connects to linking returns and linking bridges. 2 recessed end panels.

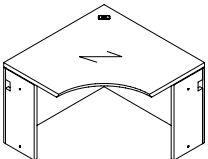

Corner Table

KEK484822	48 x 48 x 29	150	201	39	\$4822
KEK424222	42 x 42 x 29	150	155	30	\$3690
KEK363622	36 x 36 x 29	125	135	22	\$3506
KEK484820	48 x 48 x 29	150	196	39	\$4822
KEK424220	42 x 42 x 29	150	150	30	\$3690
KEK363620	36 x 36 x 29	150	130	22	\$3506

Connects to linking returns and linking bridges. 2 recessed end panels and inner curve.

Required Specifications

Finish
Edge

Optional Specifications

Additional grommet

CORNER COMPONENTS

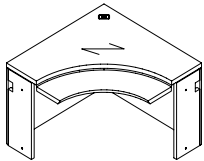

Corner Table

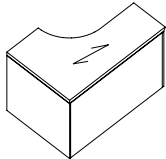

Extended Corner Table - Left

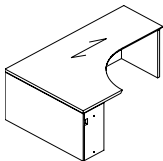

Extended Corner Table - Right

MODEL#	DIMENSIONS	FREIGHT CLASS	WT/LBS.	CUBIC FT.	LIST PRICE
D x W x H					
KEKS484822	48 x 48 x 29	150	201	39	\$8005
KEKS424222	42 x 42 x 29	150	155	30	\$6706
KEKS363622	36 x 36 x 29	125	135	22	\$6493
KEKS484820	48 x 48 x 29	150	196	39	\$8005
KEKS424220	42 x 42 x 29	150	150	30	\$6706
KEKS363620	36 x 36 x 29	150	130	22	\$6493

Connects to linking returns and linking bridges. 2 recessed end panels and inner curve. Adjustable keyboard tray and an articulating arm.

KEKL964822	48 x 97 x 29	150	387	77	\$7497
KEKL904822	48 x 91 x 29	150	363	73	\$7076
KEKL844822	48 x 85 x 29	150	338	68	\$6993
KEKL784822	48 x 79 x 29	150	314	63	\$6959
KEKL724822	48 x 73 x 29	150	290	58	\$6612
KEKL664822	48 x 67 x 29	150	266	52	\$6166
KEKL604822	48 x 61 x 29	150	242	48	\$5446

24" return connection.

KEKR489622	48 x 97 x 29	150	387	77	\$7497
KEKR489022	48 x 91 x 29	150	363	73	\$7076
KEKR488422	48 x 85 x 29	150	338	68	\$6993
KEKR487822	48 x 79 x 29	150	314	63	\$6959
KEKR487222	48 x 73 x 29	150	290	58	\$6612
KEKR486622	48 x 67 x 29	150	266	52	\$6166
KEKR486022	48 x 61 x 29	150	242	48	\$5446

24" return connection.

Required Specifications

Finish
Edge

Optional Specifications

Additional grommet

CORNER COMPONENTS

MODEL# DIMENSIONS FREIGHT CLASS WT./LBS. CUBIC FT. LIST PRICE

D x W x H

KVL9622CG	23 x 97 x 29	150	200	39	\$4827
KVL9022CG	23 x 91 x 29	150	187	36	\$4522
KVL8422CG	23 x 85 x 29	150	174	34	\$4222
KVL7822CG	23 x 79 x 29	150	162	31	\$3922
KVL7222CG	23 x 73 x 29	150	149	29	\$3619
KVL6622CG	23 x 67 x 29	150	141	27	\$3394
KVL6022CG	23 x 61 x 29	150	132	24	\$3174
KVL5422CG	23 x 55 x 29	150	121	22	\$2995
KVL4822CG	23 x 49 x 29	125	115	19	\$2814
KVL4222CG	23 x 43 x 29	150	99	17	\$2374
KVL3622CG	23 x 37 x 29	150	83	15	\$2290
KVL3022CG	23 x 31 x 29	125	77	12	\$2249
KVL2422CG	23 x 23 x 29	125	61	10	\$1883

KVL9620CG	21 x 97 x 29	150	187	39	\$4596
KVL9020CG	21 x 91 x 29	150	175	36	\$4307
KVL8420CG	21 x 85 x 29	150	163	34	\$4024
KVL7820CG	21 x 79 x 29	150	152	31	\$3734
KVL7220CG	21 x 73 x 29	150	140	29	\$3450
KVL6620CG	21 x 67 x 29	150	133	27	\$3234
KVL6020CG	21 x 61 x 29	150	125	24	\$3025
KVL5420CG	21 x 55 x 29	150	113	22	\$2853
KVL4820CG	21 x 49 x 29	150	110	19	\$2678
KVL4220CG	21 x 43 x 29	150	95	17	\$2261
KVL3620CG	21 x 37 x 29	150	80	15	\$2177
KVL3020CG	21 x 31 x 29	125	75	12	\$2141
KVL2420CG	21 x 23 x 29	125	60	10	\$1796

To be used with corner unit.

KVR9622CG	23 x 97 x 29	150	200	39	\$4827
KVR9022CG	23 x 91 x 29	150	187	36	\$4522
KVR8422CG	23 x 85 x 29	150	174	34	\$4222
KVR7822CG	23 x 79 x 29	150	162	31	\$3922
KVR7222CG	23 x 73 x 29	150	149	29	\$3619
KVR6622CG	23 x 67 x 29	150	141	27	\$3394
KVR6022CG	23 x 61 x 29	150	132	24	\$3174
KVR5422CG	23 x 55 x 29	150	121	22	\$2995
KVR4822CG	23 x 49 x 29	125	115	19	\$2814
KVR4222CG	23 x 43 x 29	150	99	17	\$2374
KVR3622CG	23 x 37 x 29	150	83	15	\$2290
KVR3022CG	23 x 31 x 29	125	77	12	\$2249
KVR2422CG	23 x 23 x 29	125	61	10	\$1883

KVR9620CG	21 x 97 x 29	150	187	39	\$4596
KVR9020CG	21 x 91 x 29	150	175	36	\$4307
KVR8420CG	21 x 85 x 29	150	163	34	\$4024
KVR7820CG	21 x 79 x 29	150	152	31	\$3734
KVR7220CG	21 x 73 x 29	150	140	29	\$3450
KVR6620CG	21 x 67 x 29	150	133	27	\$3234
KVR6020CG	21 x 61 x 29	150	125	24	\$3025
KVR5420CG	21 x 55 x 29	150	113	22	\$2853
KVR4820CG	21 x 49 x 29	150	110	19	\$2678
KVR4220CG	21 x 43 x 29	150	95	17	\$2261
KVR3620CG	21 x 37 x 29	150	80	15	\$2177
KVR3020CG	21 x 31 x 29	125	75	12	\$2141
KVR2420CG	21 x 23 x 29	125	60	10	\$1796

To be used with corner unit.

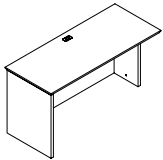

Linking Return - Left

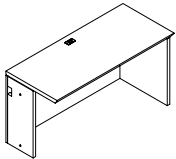

Linking Return - Right

Required Specifications

Finish
Edge

Optional Specifications

Additional grommet

LINKING RETURNS

MODEL# DIMENSIONS FREIGHT CLASS WT/LBS. CUBIC FT. LIST PRICE

D x W x H

KV9622CG	24 x 96 x 29	150	197	39	\$4714
KV9022CG	24 x 90 x 29	150	185	36	\$4422
KV8422CG	24 x 84 x 29	150	173	34	\$4123
KV7822CG	24 x 78 x 29	150	160	31	\$3826
KV7222CG	24 x 72 x 29	150	145	29	\$3534
KV6622CG	24 x 66 x 29	150	136	27	\$3314
KV6022CG	24 x 60 x 29	150	123	24	\$3093
KV5422CG	24 x 54 x 29	150	119	22	\$2911
KV4822CG	24 x 48 x 29	150	107	19	\$2732
KV4222CG	24 x 42 x 29	150	91	17	\$2517
KV3622CG	24 x 36 x 29	150	76	15	\$2290
KV3022CG	24 x 30 x 29	150	70	12	\$2160
KV2422CG	24 x 24 x 29	150	53	10	\$1815
KV9620CG	22 x 96 x 29	150	181	35	\$4494
KV9020CG	22 x 90 x 29	150	169	33	\$4214
KV8420CG	22 x 84 x 29	150	157	31	\$3929
KV7820CG	22 x 78 x 29	150	145	29	\$3648
KV7220CG	22 x 72 x 29	150	133	27	\$3367
KV6620CG	22 x 66 x 29	150	126	24	\$3157
KV6020CG	22 x 60 x 29	150	118	22	\$2947
KV5420CG	22 x 54 x 29	150	111	20	\$2772
KV4820CG	22 x 48 x 29	150	103	18	\$2599
KV4220CG	22 x 42 x 29	150	88	16	\$2177
KV3620CG	22 x 36 x 29	150	73	13	\$2101
KV3020CG	22 x 30 x 29	125	68	11	\$2059
KV2420CG	22 x 24 x 29	150	52	9	\$1728

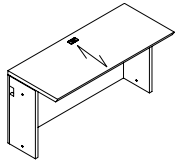

Center Surface*

With recessed end panels.

Required Specifications

Finish
Edge

Optional Specifications

Additional grommet

MODULAR STORAGE - NOTES

- All storage components are shipped assembled
- Components 28" high are intended for use with a desk, credenza or return shell
- Backs on 28" high pedestals and cabinets are unfinished. If finished back is required, see page 247.
- If a profiled top is required, see "Freestanding Storage" on page 256.
- If Handle is not specified Routed Pull, Black Lock & Grommet are standard
- If Handle is specified:
 - Black and Brass handle = Black Lock & Grommet
 - Silver, Nickel and Tungsten handle = Tungsten Lock & Grommet

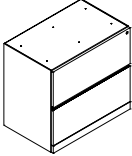
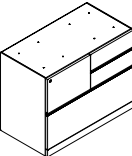
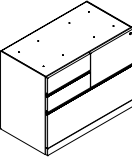
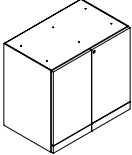
MODULAR STORAGE	MODEL#	DIMENSIONS	FREIGHT CLASS	WT/LBS.	CUBIC FT.	LIST PRICE
 <p>Modular Lateral File**</p>	D x W x H					
	KWF	19 x 35.1 x 28	92.5	115	11	\$3410
	KWN	19 x 30 x 28	92.5	96	9	\$2984
	KWF.5	19 x 34.5 x 28	92.5	115	11	\$3410
Units with ".5" at end of code are intended to be used if a Full Storage Credenza is to be created. For Single Pedestal installations either style can be used.						
 <p>Modular Combination Storage - Left**</p>	KWZL	19 x 35.1 x 28	92.5	115	11	\$3959
	KWZL.5	19 x 34.5 x 28	92.5	115	11	\$3959
1 lateral file, 2 box drawers top right, and 1 file top left.						
• Units with ".5" at end of code are intended to be used if a Full Storage Credenza is to be created. For Single Pedestal installations either style can be used.						
 <p>Modular Combination Storage - Right**</p>	KWZR	19 x 35.1 x 28	92.5	115	11	\$3959
	KWZR.5	19 x 34.5 x 28	92.5	115	11	\$3959
1 lateral file, 2 box drawers top left, and 1 file top right.						
• Units with ".5" at end of code are intended to be used if a Full Storage Credenza is to be created. For Single Pedestal installations either style can be used.						
 <p>Modular Storage Cabinet w/Doors*</p>	KWG	19 x 35.1 x 28	92.5	115	11	\$2377
	KWM	19 x 30 x 28	92.5	96	9	\$2004
	KWG.5	19 x 34.5 x 28	92.5	115	11	\$2377
Storage with 1 adjustable shelf.						
• Units with ".5" at end of code are intended to be used if a Full Storage Credenza is to be created. For Single Pedestal installations either style can be used.						

Required Specifications

Finish
Edge*

Optional Specifications

Handles**
Additional grommet

MODULAR STORAGE

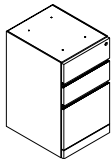

Modular Pedestal*

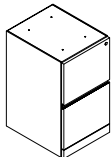

Modular Pedestal*

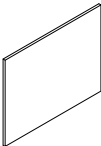

Finished Back

MODEL# DIMENSIONS FREIGHT CLASS WT/LBS. CUBIC FT. LIST PRICE

D x W x H

Letter width:

KWWD	23 x 15.6 x 28	85	72	6	\$2633
KWD	19 x 15.6 x 28	85	70	5	\$2293

Legal width:

KWWLD	23 x 18.5 x 28	85	85	7	\$3160
KWLD	19 x 18.5 x 28	85	83	6	\$2749

Box/box/file pedestal.

Letter width:

KWWE	23 x 15.6 x 28	85	72	6	\$2633
KWE	19 x 15.6 x 28	85	70	5	\$2293

Legal width:

KWWLE	23 x 18.5 x 28	85	85	7	\$3160
KWLE	19 x 18.5 x 28	85	83	6	\$2749

File/file pedestal.

KBA36	0.8 x 35 x 27.5	125	18	3	\$498
KBA30	0.8 x 30 x 27.5	150	15	3	\$414
KBA18	0.8 x 18.5 x 27.5	150	10	2	\$241
KBA15	0.8 x 15.5 x 27.5	150	8	2	\$209

For modular pedestals.

Required Specifications
Finish

Optional Specifications
Handles*

HUTCHES & WALL MOUNTED STORAGE NOTES

Hutches

- All hutches are shipped assembled
- Handles can be specified for hutches with wood doors.
- Handles cannot be specified on Aluminum framed glass doors.
- Frosted glass door is standard. White back painted clear glass is available, please contact customer care.

Closed pigeon hole storage hutch

- 42" unit has 21.5" of clearance

NOTE: Arrow indicates direction of grain

Edge options - must specify:

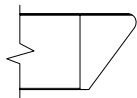

K16

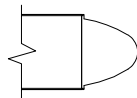

K18

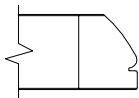

K21

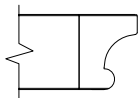

K22

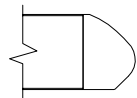

K29

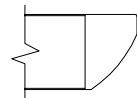

K30

Closed storage hutch

- 36" unit has 19.5" of clearance.
- 42" and 54" units have 25.5" of clearance
- For lock option, see page 270

Tasklight

- For proper size, see page 270.
- If Handle is specified:
 - Black and Brass handle = Black Lock & Grommet
 - Silver, Nickel and Tungsten handle = Tungsten Lock & Grommet

HUTCHES & WALL MOUNTED STORAGE

MODEL#

DIMENSIONS

FREIGHT CLASS

WT/LBS.

CUBIC FT.

LIST PRICE

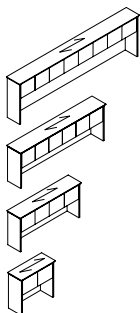

36" H Storage Hutch w/Wood Doors*

K108SH36	16 x 110 x 36	125	268	34	\$7771
K102SH36	16 x 104 x 36	125	254	32	\$7339
K96SH36	16 x 98 x 36	100	241	30	\$6793
K90SH36	16 x 92 x 36	100	227	28	\$6474
K84SH36	16 x 86 x 36	100	214	26	\$6042
K78SH36	16 x 80 x 36	100	200	24	\$5612
K72SH36	16 x 74 x 36	100	187	23	\$5177
K66SH36	16 x 68 x 36	100	173	21	\$4982
K60SH36	16 x 62 x 36	100	160	19	\$4749
K36SH36	16 x 38 x 36	100	94	11	\$3238
K30SH36	16 x 32 x 36	100	78	9	\$2834

Hutches longer than 102" have 8 doors, hutches between 102" and 86" have 6 doors, hutches between 80" and 62" have 4 doors, and 32" and 38" hutches have 2 doors. Locks are optional.

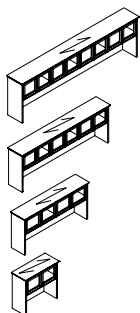

36" H Storage Hutch w/Glass Doors

K108SH36G	16 x 110 x 36	125	268	34	\$11297
K102SH36G	16 x 104 x 36	125	254	32	\$10140
K96SH36G	16 x 98 x 36	100	241	30	\$9670
K90SH36G	16 x 92 x 36	100	227	28	\$9195
K84SH36G	16 x 86 x 36	100	214	26	\$8727
K78SH36G	16 x 80 x 36	100	200	24	\$8264
K72SH36G	16 x 74 x 36	100	187	23	\$7075
K66SH36G	16 x 68 x 36	100	173	21	\$6883
K60SH36G	16 x 62 x 36	100	160	19	\$6533
K36SH36G	16 x 38 x 36	100	94	11	\$4178
K30SH36G	16 x 32 x 36	100	78	9	\$3724

Aluminum framed glass doors. Hutches longer than 102" have 8 doors, hutches between 102" and 86" have 6 doors, hutches between 80" and 62" have 4 doors, and 32" and 38" hutches have 2 doors. No lock option available.

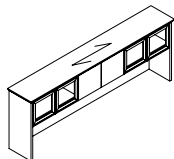

36" H Storage Hutch w/Doors*

K102SH36GDG	16 x 104 x 3	125	254	32	\$9120
K96SH36GDG	16 x 98 x 36	100	241	30	\$8688
K90SH36GDG	16 x 92 x 36	100	227	28	\$8255
K84SH36GDG	16 x 86 x 36	100	214	26	\$7455

Wood doors in the center and Aluminum framed glass doors on left and right. Locks are optional on wood doors.

Required Specifications

Finish
Edge

Optional Specifications

Handles* (wood doors only)
Locks* (wood doors only)

HUTCHES & WALL MOUNTED STORAGE

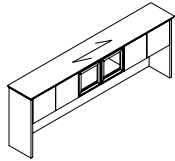

36" H Storage Hutch w/Doors*

MODEL#	DIMENSIONS D x W x H	FREIGHT CLASS	WT/LBS.	CUBIC FT.	LIST PRICE
K102SH36DGD	16 x 104 x 3	125	254	32	\$9120
K96SH36DGD	16 x 98 x 36	100	241	30	\$7567
K90SH36DGD	16 x 92 x 36	100	227	28	\$7360
K84SH36DGD	16 x 86 x 36	100	214	26	\$6930

Aluminum framed glass doors in the center and wood doors on left and right. Locks are optional on wood doors.

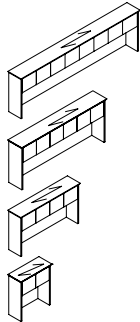

42" H Storage Hutch w/Wood Doors*

K108SH42	16 x 110 x 43	125	307	39	\$9060
K102SH42	16 x 104 x 43	125	290	37	\$8552
K96SH42	16 x 98 x 43	125	273	35	\$8055
K90SH42	16 x 92 x 43	125	256	33	\$7550
K84SH42	16 x 86 x 43	125	239	31	\$7044
K78SH42	16 x 80 x 43	150	222	38	\$6548
K72SH42	16 x 74 x 43	125	205	26	\$6042
K66SH42	16 x 68 x 43	125	188	24	\$5813
K60SH42	16 x 62 x 43	125	171	22	\$5538
K36SH42	16 x 38 x 43	125	102	13	\$3780
K30SH42	16 x 32 x 43	125	85	11	\$3307

Hutches longer than 102" have 8 doors, hutches between 102" and 86" have 6 doors, hutches between 80" and 62" have 4 doors, and 32" and 38" hutches have 2 doors. Locks are optional.

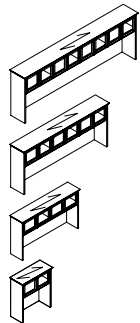

42" H Storage Hutch w/Glass Doors

K108SH42G	16 x 110 x 43	125	307	39	\$12590
K102SH42G	16 x 104 x 43	125	290	37	\$11359
K96SH42G	16 x 98 x 43	125	273	35	\$10817
K90SH42G	16 x 92 x 43	125	256	33	\$10277
K84SH42G	16 x 86 x 43	125	239	31	\$9735
K78SH42G	16 x 80 x 43	150	222	38	\$9194
K72SH42G	16 x 74 x 43	125	205	26	\$7938
K66SH42G	16 x 68 x 43	125	188	24	\$7658
K60SH42G	16 x 62 x 43	125	171	22	\$7385
K36SH42G	16 x 38 x 43	125	102	13	\$4720
K30SH42G	16 x 32 x 43	125	85	11	\$4198

Aluminum framed glass doors. Hutches longer than 102" have 8 doors, hutches between 102" and 86" have 6 doors, hutches between 80" and 62" have 4 doors, and 32" and 38" hutches have 2 doors. Lock option not available.

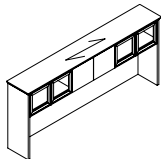

42" H Storage Hutch w/Doors*

K102SH42GDG	16 x 104 x 43	125	290	37	\$11850
K96SH42GDG	16 x 98 x 43	125	273	35	\$11153
K90SH42GDG	16 x 92 x 43	125	256	33	\$10458
K84SH42GDG	16 x 86 x 43	125	239	31	\$9759

Wood doors in the center and Aluminum framed glass doors on left and right. Locks are optional on wood doors.

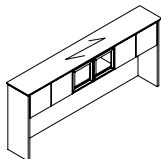

42" H Storage Hutch w/Doors*

K102SH42DGD	16 x 104 x 43	125	290	37	\$9919
K96SH42DGD	16 x 98 x 43	125	273	35	\$8942
K90SH42DGD	16 x 92 x 43	125	256	33	\$8438
K84SH42DGD	16 x 86 x 43	125	239	31	\$7938

Aluminum framed glass doors in the center and wood doors on left and right. Locks are optional on wood doors.

Required Specifications

Finish
Edge

Optional Specifications

Handles* (wood doors only)
Locks* (wood doors only)

HUTCHES & WALL MOUNTED STORAGE

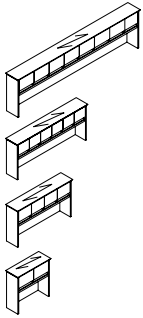

42" H Storage Hutch w/Wood Doors & Pigeon-Holes

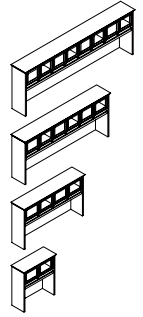

42" H Storage Hutch w/Glass Doors & Pigeon-Holes

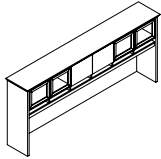

42" H Storage Hutch w/Doors & Pigeon-Holes

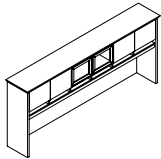

42" H Storage Hutch w/Doors & Pigeon-Holes

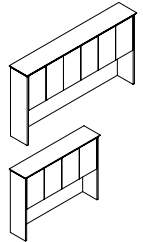

54" H Storage Hutch w/Wood Doors*

MODEL#	DIMENSIONS D x W x H	FREIGHT CLASS	WT./LBS.	CUBIC FT.	LIST PRICE
K108SHP42	16 x 110 x 43	125	307	39	\$10867
K102SHP42	16 x 104 x 43	125	290	37	\$10268
K96SHP42	16 x 98 x 43	125	273	35	\$9662
K90SHP42	16 x 92 x 43	125	256	33	\$9060
K84SHP42	16 x 86 x 43	125	239	31	\$8456
K78SHP42	16 x 80 x 43	150	222	38	\$7850
K72SHP42	16 x 74 x 43	125	205	26	\$7249
K66SHP42	16 x 68 x 43	125	188	24	\$6981
K60SHP42	16 x 62 x 43	125	171	22	\$6645
K36SHP42	16 x 38 x 43	125	102	13	\$4536
K30SHP42	16 x 32 x 43	125	85	11	\$3970

Hutches longer than 102" have 8 doors, hutches between 102" and 86" have 6 doors, hutches between 80" and 62" have 4 doors, and 32" and 38" hutches have 2 doors. Locks are optional.

K108SHP42G	16 x 110 x 43	125	307	39	\$14319
K102SHP42G	16 x 104 x 43	125	290	37	\$13002
K96SHP42G	16 x 98 x 43	125	273	35	\$12390
K90SHP42G	16 x 92 x 43	125	256	33	\$12352
K84SHP42G	16 x 86 x 43	125	239	31	\$11063
K78SHP42G	16 x 80 x 43	150	222	38	\$10429
K72SHP42G	16 x 74 x 43	125	205	26	\$9095
K66SHP42G	16 x 68 x 43	125	188	24	\$8807
K60SHP42G	16 x 62 x 43	125	171	22	\$8382
K36SHP42G	16 x 38 x 43	125	102	13	\$5446
K30SHP42G	16 x 32 x 43	125	85	11	\$4860

Aluminum framed glass doors. Hutches longer than 102" have 8 doors, hutches between 102" and 86" have 6 doors, hutches between 80" and 62" have 4 doors, and 32" and 38" hutches have 2 doors. No lock option available.

K102SHP42GDG	16 x 104 x 43	125	290	37	\$12002
K96SHP42GDG	16 x 98 x 43	125	273	35	\$11396
K90SHP42GDG	16 x 92 x 43	125	256	33	\$10799
K84SHP42GDG	16 x 86 x 43	125	239	31	\$9707

Wood doors in the center and Aluminum framed glass doors on left and right. Locks are optional on wood doors.

K102SHP42DGD	16 x 104 x 43	125	290	37	\$11159
K96SHP42DGD	16 x 98 x 43	125	273	35	\$10027
K90SHP42DGD	16 x 92 x 43	125	256	33	\$9562
K84SHP42DGD	16 x 86 x 43	125	239	31	\$9325

Aluminum framed glass doors in the center and wood doors on left and right. Locks are optional on wood doors.

K962SH54	16 x 98 x 55	125	351	45	\$10355
K902SH54	16 x 92 x 55	125	329	42	\$9707
K842SH54	16 x 86 x 55	125	307	39	\$9060
K782SH54	16 x 80 x 55	125	285	37	\$8412
K722SH54	16 x 74 x 55	125	263	34	\$7764
K662SH54	16 x 68 x 55	125	241	31	\$7474
K602SH54	16 x 62 x 55	125	219	28	\$7117

Hutches between 98" and 86" have 6 doors; hutches less than 86" have 4 doors. One adjustable shelf. Locks are optional.

Required Specifications

Finish
Edge

Optional Specifications

Handles* (wood doors only)
Locks* (wood doors only)

HUTCHES & WALL MOUNTED STORAGE

MODEL# DIMENSIONS FREIGHT CLASS WT/LBS. CUBIC FT. LIST PRICE

D x W x H

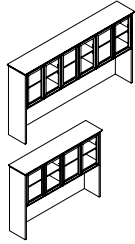

54" H Storage Hutch w/Glass Doors

K962SH54G	16 x 98 x 55	125	351	45	\$13816
K902SH54G	16 x 92 x 55	125	329	42	\$12868
K842SH54G	16 x 86 x 55	125	307	39	\$11915
K782SH54G	16 x 80 x 55	125	285	37	\$10960
K722SH54G	16 x 74 x 55	125	263	34	\$10014
K662SH54G	16 x 68 x 55	125	241	31	\$9653
K602SH54G	16 x 62 x 55	125	219	28	\$9227

Aluminum framed glass doors. Hutches between 98" and 86" have 6 doors; hutches less than 86" have 4 doors. One adjustable shelf. No lock option available.

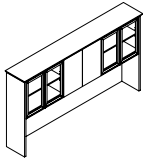

54" H Storage Hutch w/Doors*

K962SH54GDG	16 x 98 x 55	125	351	45	\$12463
K902SH54GDG	16 x 92 x 55	125	329	42	\$11812
K842SH54GDG	16 x 86 x 55	125	309	39	\$11167

Wood doors in the center and Aluminum framed glass doors on left and right. One adjustable shelf. Locks are optional on wood doors.

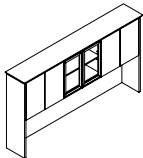

54" H Storage Hutch w/Doors*

K962SH54DGD	16 x 98 x 55	125	351	45	\$11405
K902SH54DGD	16 x 92 x 55	125	329	42	\$10760
K842SH54DGD	16 x 86 x 55	125	307	39	\$10115

Aluminum framed glass doors in the center and wood doors on left and right. One adjustable shelf. Locks are optional on wood doors.

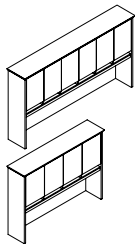

54" H Storage Hutch w/Wood Doors & Pigeon-Holes

K962SHP54	16 x 98 x 55	125	351	45	\$12428
K902SHP54	16 x 92 x 55	125	329	42	\$11644
K842SHP54	16 x 86 x 55	125	307	39	\$10865
K782SHP54	16 x 80 x 55	125	285	37	\$10865
K722SHP54	16 x 74 x 55	125	263	34	\$9313
K662SHP54	16 x 68 x 55	125	241	31	\$8970
K602SHP54	16 x 62 x 55	125	219	28	\$8545

Hutches between 98" and 86" have 6 doors; hutches less than 86" have 4 doors. One adjustable shelf. Locks are optional.

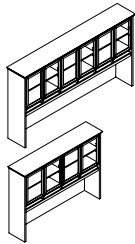

54" H Storage Hutch w/Glass Doors & Pigeon-Holes

K962SHP54G	16 x 98 x 55	125	351	45	\$15888
K902SHP54G	16 x 92 x 55	125	329	42	\$14807
K842SHP54G	16 x 86 x 55	125	307	39	\$13723
K782SHP54G	16 x 80 x 55	125	285	37	\$12645
K722SHP54G	16 x 74 x 55	125	263	34	\$11566
K662SHP54G	16 x 68 x 55	125	241	34	\$11150
K602SHP54G	16 x 62 x 55	125	219	28	\$10653

Aluminum framed glass doors. Hutches between 98" and 86" have 6 doors; hutches less than 86" have 4 doors. One adjustable shelf. No lock option available.

Required Specifications

Finish
Edge

Optional Specifications

Handles* (wood doors only)
Locks* (wood doors only)

HUTCHES & WALL MOUNTED STORAGE

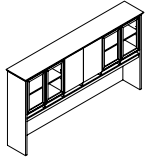

54" H Storage Hutch w/Doors & Pigeon-Holes

MODEL#	DIMENSIONS D x W x H	FREIGHT CLASS	WT/LBS.	CUBIC FT.	LIST PRICE
K962SHP54GDG	16 x 98 x 55	125	351	45	\$13479
K902SHP54GDG	16 x 92 x 55	125	329	42	\$12702
K842SHP54GDG	16 x 86 x 55	125	307	39	\$11921

Wood doors in the center and Aluminum framed glass doors on left and right. One adjustable shelf. Locks are optional on wood doors.

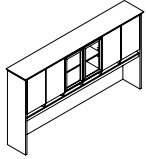

54" H Storage Hutch w/Doors &* Pigeon-Holes

K962SHP54DGD	16 x 98 x 55	125	351	45	\$14532
K902SHP54DGD	16 x 92 x 55	125	329	42	\$13756
K842SHP54DGD	16 x 86 x 55	125	307	39	\$12976

Aluminum framed glass doors in the center and wood doors on left and right. One adjustable shelf. Locks are optional on wood doors.

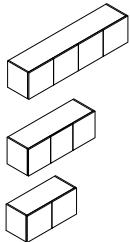

Wall Mount Storage w/Wood Doors*

CSF72	15.5 x 72 x 16.5	92.5	100	10	\$2418
CSF66	15.5 x 66 x 16.5	100	83	9	\$2218
CSF60	15.5 x 60 x 16.5	100	75	8	\$2010
CSF54	15.5 x 54 x 16.5	100	68	7	\$1812
CSF48	15.5 x 48 x 16.5	100	60	7	\$1611
CSF42	15.5 x 42 x 16.5	100	55	6	\$1481
CSF36	15.5 x 36 x 16.5	92.5	50	5	\$1453
CSF30	15.5 x 30 x 16.5	92.5	45	4	\$1429

Locks are optional.

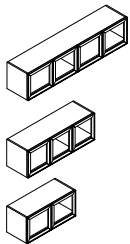

Wall Mount Storage w/Glass Doors

CSF72G	15.5 x 72 x 16.5	92.5	100	10	\$5087
CSF66G	15.5 x 66 x 16.5	100	83	9	\$4725
CSF60G	15.5 x 60 x 16.5	100	75	8	\$4429
CSF54G	15.5 x 54 x 16.5	100	68	7	\$3968
CSF48G	15.5 x 48 x 16.5	100	60	7	\$3505
CSF42G	15.5 x 42 x 16.5	100	55	6	\$3111
CSF36G	15.5 x 36 x 16.5	92.5	50	5	\$2876
CSF30G	15.5 x 30 x 16.5	92.5	45	4	\$2792

Aluminum framed glass doors. No lock option available.

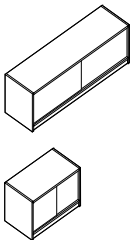

Wall Mount Storage w/Sliding Glass Doors

CSF72GSL	18 x 72 x 16.5	92.5	100	10	\$5087
CSF66GSL	18 x 66 x 16.5	100	83	9	\$4725
CSF60GSL	18 x 60 x 16.5	100	75	8	\$4429
CSF54GSL	18 x 54 x 16.5	100	68	7	\$3968
CSF48GSL	18 x 48 x 16.5	100	60	7	\$3505
CSF42GSL	18 x 42 x 16.5	100	55	6	\$3111
CSF36GSL	18 x 36 x 16.5	92.5	50	5	\$2876
CSF30GSL	18 x 30 x 16.5	92.5	45	4	\$2792

Frameless sliding glass doors. No lock option available.

Required Specifications

Finish
Edge

Optional Specifications

Handles* (wood doors only)
Locks* (wood doors only)

HUTCHES & WALL MOUNTED STORAGE

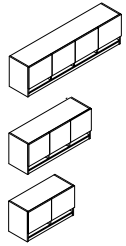

Wall Mount Storage w/Wood Doors &* Pigeon-Holes

MODEL#	D x W x H	FREIGHT CLASS	WT/LBS.	CUBIC FT.	LIST PRICE
CSFP72	15.5 x 72 x 20	92.5	100	10	\$2897
CSFP66	15.5 x 66 x 20	100	83	9	\$2658
CSFP60	15.5 x 60 x 20	100	75	8	\$2418
CSFP54	15.5 x 54 x 20	100	68	7	\$2176
CSFP48	15.5 x 48 x 20	100	60	7	\$1931
CSFP42	15.5 x 42 x 20	100	55	6	\$1832
CSFP36	15.5 x 36 x 20	92.5	50	5	\$1744
CSFP30	15.5 x 30 x 20	92.5	45	4	\$1715

Locks are optional.

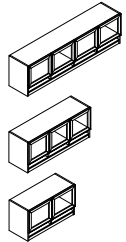

Wall Mount Storage w/Glass Doors & Pigeon-Holes

CSFP72G	15.5 x 72 x 20	100	100	12	\$5597
CSFP66G	15.5 x 66 x 20	125	83	11	\$5352
CSFP60G	15.5 x 60 x 20	125	75	10	\$4931
CSFP54G	15.5 x 54 x 20	125	68	9	\$4600
CSFP48G	15.5 x 48 x 20	125	60	8	\$3904
CSFP42G	15.5 x 42 x 20	125	55	7	\$3400
CSFP36G	15.5 x 36 x 20	100	50	6	\$3243
CSFP30G	15.5 x 30 x 20	100	45	5	\$3159

Aluminum framed glass doors. No lock option available.

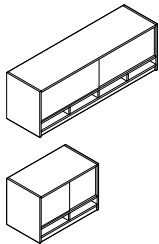

Wall Mount Storage w/Sliding Glass Doors & Pigeon-Holes

CSFP72GSL	18 x 72 x 20	100	100	12	\$5597
CSFP66GSL	18 x 66 x 20	125	83	11	\$5352
CSFP60GSL	18 x 60 x 20	125	75	10	\$4931
CSFP54GSL	18 x 54 x 20	125	68	9	\$4600
CSFP48GSL	18 x 48 x 20	125	60	8	\$3904
CSFP42GSL	18 x 42 x 20	125	55	7	\$3400
CSFP36GSL	18 x 36 x 20	100	50	6	\$3243
CSFP30GSL	18 x 30 x 20	100	45	5	\$3159

Frameless sliding glass doors. Locks are optional.

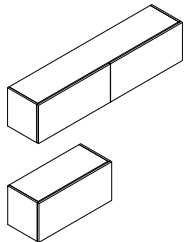

Wall Mount Storage w/Wood Flipper Doors

CSFF72	15.5 x 72 x 16.5	92.5	100	10	\$3564
CSFF66	15.5 x 66 x 16.5	100	83	9	\$3268
CSFF60	15.5 x 60 x 16.5	100	75	8	\$2969
CSFF54	15.5 x 54 x 16.5	100	68	7	\$2675
CSFF48	15.5 x 48 x 16.5	100	60	7	\$2378
CSFF42	15.5 x 42 x 16.5	100	55	6	\$2206
CSFF36	15.5 x 36 x 16.5	92.5	50	5	\$2166
CSFF30	15.5 x 30 x 16.5	92.5	45	4	\$2132

Locks are optional.

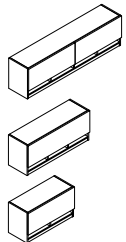

Wall Mount Storage w/Pigeon-Holes & Wood Flipper Doors

CSFFP72	15.5 x 72 x 20	100	100	12	\$4280
CSFFP66	15.5 x 66 x 20	125	83	11	\$3921
CSFFP60	15.5 x 60 x 20	125	75	10	\$3566
CSFFP54	15.5 x 54 x 20	125	68	9	\$3206
CSFFP48	15.5 x 48 x 20	125	60	8	\$2855
CSFFP42	15.5 x 42 x 20	125	55	7	\$2644
CSFFP36	15.5 x 36 x 20	100	50	6	\$2599
CSFFP30	15.5 x 30 x 20	100	45	5	\$2553

Locks are optional.

Required Specifications

Finish
Edge

Optional Specifications

Handles* (wood doors only)
Locks* (wood doors only)

HUTCHES & WALL MOUNTED STORAGE

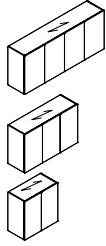

**Double High Wall Mount Storage*
w/Wood Doors**

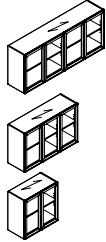

**Double High Wall Mount Storage
w/Glass Doors**

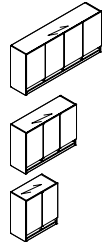

**Double High Wall Mount Storage*
w/Pigeon-Holes & Wood Doors**

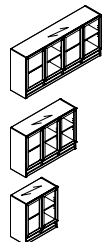

**Double High Wall Mount Storage
w/Pigeon-Holes & Glass Doors**

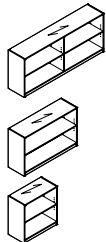

Double High Open Wall Mount Storage

MODEL#	DIMENSIONS D x W x H	FREIGHT CLASS	WT/LBS.	CUBIC FT.	LIST PRICE
CSF72H30	15.5 x 72 x 30	100	140	17	\$6352
CSF66H30	15.5 x 66 x 30	125	116	16	\$5829
CSF60H30	15.5 x 60 x 30	125	105	14	\$5290
CSF54H30	15.5 x 54 x 30	125	95	13	\$4761
CSF48H30	15.5 x 48 x 30	125	85	12	\$4234
CSF42H30	15.5 x 42 x 30	125	77	10	\$3888
CSF36H30	15.5 x 36 x 30	125	70	9	\$3816
CSF30H30	15.5 x 30 x 30	100	63	7	\$3749

Locks are optional.

CSF72H30G	15.5 x 72 x 30	100	140	17	\$9239
CSF66H30G	15.5 x 66 x 30	125	116	16	\$9119
CSF60H30G	15.5 x 60 x 30	60	1045	14	\$8551
CSF54H30G	15.5 x 54 x 30	125	95	13	\$7658
CSF48H30G	15.5 x 48 x 30	125	85	12	\$6765
CSF42H30G	15.5 x 42 x 30	125	77	10	\$6009
CSF36H30G	15.5 x 36 x 30	125	70	9	\$5552
CSF30H30G	15.5 x 30 x 30	100	63	7	\$5388

Aluminum framed glass doors. No lock option available.

CSFP72H34	15.5 x 72 x 34	100	140	17	\$6909
CSFP66H34	15.5 x 66 x 34	125	116	16	\$6336
CSFP60H34	15.5 x 60 x 34	125	105	14	\$5766
CSFP54H34	15.5 x 54 x 34	125	95	13	\$5185
CSFP48H34	15.5 x 48 x 34	125	85	12	\$4604
CSFP42H34	15.5 x 42 x 34	125	77	10	\$4376
CSFP36H34	15.5 x 36 x 34	125	70	9	\$4151
CSFP30H34	15.5 x 30 x 34	100	63	7	\$4083

Locks are optional.

CSFP72H34G	15.5 x 72 x 34	100	140	17	\$9801
CSFP66H34G	15.5 x 66 x 34	125	116	16	\$9369
CSFP60H34G	15.5 x 60 x 34	125	105	14	\$8629
CSFP54H34G	15.5 x 54 x 34	125	95	13	\$8049
CSFP48H34G	15.5 x 48 x 34	125	85	12	\$6835
CSFP42H34G	15.5 x 42 x 34	125	77	10	\$5952
CSFP36H34G	15.5 x 36 x 34	125	70	9	\$5952
CSFP30H34G	15.5 x 30 x 34	100	63	7	\$5526

Aluminum framed glass doors. No lock option available.

CSFO72H30	15.5 x 72 x 30	100	140	17	\$5160
CSFO66H30	15.5 x 66 x 30	125	116	16	\$4738
CSFO60H30	15.5 x 60 x 30	125	105	14	\$4303
CSFO54H30	15.5 x 54 x 30	125	95	13	\$3881
CSFO48H30	15.5 x 48 x 30	125	85	12	\$3452
CSFO42H30	15.5 x 42 x 30	125	77	10	\$3178
CSFO36H30	15.5 x 36 x 30	125	70	9	\$3140
CSFO30H30	15.5 x 30 x 30	100	63	7	\$3082

Required Specifications

Finish
Edge

Optional Specifications

Handles* (wood doors only)
Locks* (wood doors only)

HUTCHES **MODEL#** **DIMENSIONS** **FREIGHT CLASS** **WT./LBS.** **CUBIC FT.** **LIST PRICE**

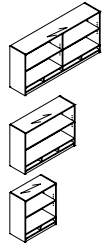

Double High Open Wall Mount Storage w/Pigeon-Holes

	D x W x H					
CSFOP72H34	15.5 x 72 x 34	100	140	17	\$5618	
CSFOP66H34	15.5 x 66 x 34	125	116	16	\$5151	
CSFOP60H34	15.5 x 60 x 34	125	105	14	\$4682	
CSFOP54H34	15.5 x 54 x 34	125	95	13	\$4220	
CSFOP48H34	15.5 x 48 x 34	125	85	12	\$3743	
CSFOP42H34	15.5 x 42 x 34	125	77	10	\$3512	
CSFOP36H34	15.5 x 36 x 34	125	70	9	\$3408	
CSFOP30H34	15.5 x 30 x 34	100	63	7	\$3358	

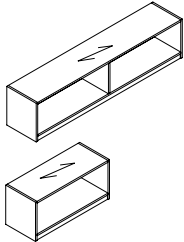

Open Wall Mount Storage

CSFO72	14.5 x 72 x 16.5	92.5	100	10	\$1960	
CSFO66	14.5 x 66 x 16.5	100	83	9	\$1799	
CSFO60	14.5 x 60 x 16.5	100	75	8	\$1641	
CSFO54	14.5 x 54 x 16.5	100	68	7	\$1481	
CSFO48	14.5 x 48 x 16.5	100	60	7	\$1316	
CSFO42	14.5 x 42 x 16.5	100	55	6	\$1212	
CSFO36	14.5 x 36 x 16.5	92.5	50	5	\$1194	
CSFO30	14.5 x 30 x 16.5	92.5	45	4	\$1171	

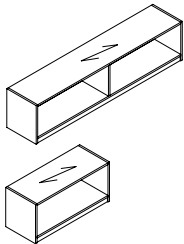

16" D Open Wall Mount Storage

CSFO72D16	16 x 72 x 16.5	92.5	100	10	\$2974	
CSFO66D16	16 x 66 x 16.5	100	83	9	\$2761	
CSFO60D16	16 x 60 x 16.5	100	75	8	\$2545	
CSFO54D16	16 x 54 x 16.5	100	68	7	\$2332	
CSFO48D16	16 x 48 x 16.5	100	60	7	\$2117	
CSFO42D16	16 x 42 x 16.5	100	55	6	\$1979	
CSFO36D16	16 x 36 x 16.5	92.5	50	5	\$1960	
CSFO30D16	16 x 30 x 16.5	92.5	45	4	\$1928	

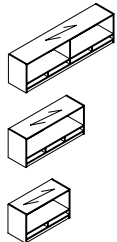

Open Wall Mount Storage w/Pigeon-Holes

CSFOP72	14.5 x 72 x 19.5	92.5	100	10	\$2354	
CSFOP66	14.5 x 66 x 19.5	100	83	9	\$2162	
CSFOP60	14.5 x 60 x 19.5	100	75	8	\$1964	
CSFOP54	14.5 x 54 x 19.5	100	68	7	\$1772	
CSFOP48	14.5 x 48 x 19.5	100	60	7	\$1569	
CSFOP42	14.5 x 42 x 19.5	100	55	6	\$1476	
CSFOP36	14.5 x 36 x 19.5	92.5	50	5	\$1434	
CSFOP30	14.5 x 30 x 19.5	92.5	45	4	\$1413	

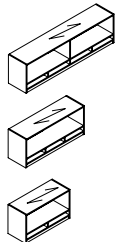

16" D Open Wall Mount Storage w/Pigeon-Holes

CSFOP72D16	16 x 72 x 19.5	100	100	12	\$3599	
CSFOP66D16	16 x 66 x 19.5	125	83	11	\$3332	
CSFOP60D16	16 x 60 x 19.5	125	75	10	\$3066	
CSFOP54D16	16 x 54 x 19.5	125	68	9	\$2800	
CSFOP48D16	16 x 48 x 19.5	125	60	8	\$2529	
CSFOP42D16	16 x 42 x 19.5	125	55	7	\$2400	
CSFOP36D16	16 x 36 x 19.5	100	50	6	\$2337	
CSFOP30D16	16 x 30 x 19.5	100	45	5	\$2307	

Required Specifications

Finish
Edge

FREESTANDING STORAGE NOTES

NOTE: Arrow indicates direction of grain

Pedestals

- All units are shipped assembled.
- Standard face locking.

Combination Storage

- All units are shipped assembled.
- No modifications accepted for this unit.
- Box drawers do not lock.
- Standard face locking.

Storage Cabinets

- Units include adjustable shelves.
- If Handle is specified:
 - Black and Brass handle = Black Lock & Grommet
 - Silver, Nickel and Tungsten handle = Tungsten Lock & Grommet

Edge options - must specify:

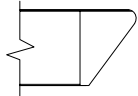

K16

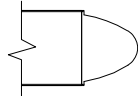

K18

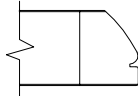

K21

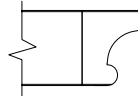

K22

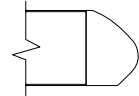

K29

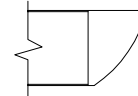

K30

FREESTANDING STORAGE	MODEL#	DIMENSIONS	FREIGHT CLASS	WT./LBS.	CUBIC FT.	LIST PRICE
		D x W x H				

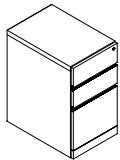

Freestanding Pedestal

KWDB	19.8 x 15.5 x 28	85	70	5	\$2501
KWWDB	23.8 x 15.5 x 28	85	75	6	\$2879

Box/box/file.

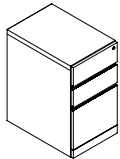

Freestanding Mobile Pedestal

KWDM	19.8 x 15.5 x 28	85	70	5	\$2690
KWWDM	23.8 x 15.5 x 28	85	75	6	\$3095

Box/box/file.

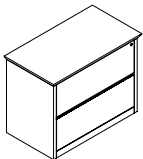

Lateral File - 2 high

KF3622	23 x 38 x 29	85	170	13	\$4662
KF3620	21 x 38 x 29	85	159	12	\$4239
KN3022	23 x 32.9 x 29	85	142	11	\$4081
KN3020	21 x 32.9 x 29	85	131	10	\$3708

Two lateral file drawers.

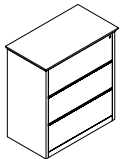

Lateral File - 3 high

KF36223	23 x 38 x 42	92.5	212	19	\$5692
KF36203	21 x 38 x 42	92.5	193	18	\$5317
KN30223	23 x 32.9 x 42	92.5	176	16	\$4979
KN30203	21 x 32.9 x 42	92.5	160	15	\$4649

Three lateral file drawers.

Required Specifications

Finish
Edge

Optional Specifications

Handles

FREESTANDING STORAGE

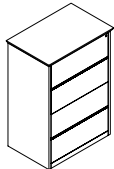

Lateral File - 4 high

MODEL#	DIMENSIONS D x W x H	FREIGHT CLASS	WT/LBS.	CUBIC FT.	LIST PRICE
KF36224	23 x 38 x 54	92.5	270	25	\$6933
KF36204	21 x 38 x 54	92.5	259	23	\$6586
KN30224	23 x 32.9 x 54	92.5	225	21	\$6069
KN30204	21 x 32.9 x 54	92.5	214	19	\$5766

Four lateral file drawers.

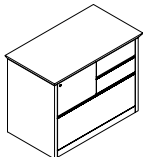

Combination Storage - Left

KZL3622	23 x 38 x 29	85	170	13	\$5053
KZL3620	21 x 38 x 29	85	160	12	\$4812

With 1 lateral file, 2 box drawers in the top right, and 1 file drawer in the top left.

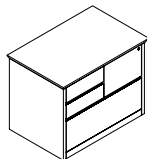

Combination Storage - Right

KZR3622	23 x 38 x 29	85	170	13	\$5053
KZR3620	21 x 38 x 29	85	160	12	\$4812

With 1 lateral file, 2 box drawers in the top left, and 1 file drawer in the top right.

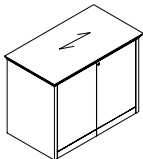

Storage Cabinet w/Doors

KBD3622	23 x 38 x 29	92.5	140	13	\$3173
KBD3620	21 x 38 x 29	92.5	129	12	\$3022
KBD3022	23 x 32.9 x 29	92.5	117	11	\$2779
KBD3020	21 x 32.9 x 29	92.5	106	10	\$2641

Storage with 1 adjustable shelf. For Aluminum framed glass door option, contact Customer Care.

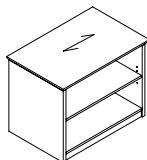

Open Storage Cabinet

KOB3622	23 x 38.75 x 29	100	115	13	\$2549
KOB3620	21 x 38.75 x 29	100	104	12	\$2426
KOB3022	23 x 33.63 x 29	100	96	11	\$2225
KOB3020	21 x 33.63 x 29	100	85	10	\$2117

Storage with 1 adjustable shelf.

Required Specifications

Finish
Edge

Optional Specifications

Handles

FREESTANDING STORAGE

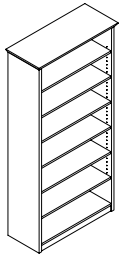

Open Bookcase

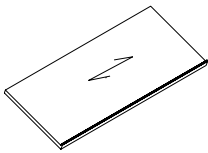

Additional Shelf

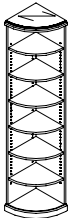

Quarter Round Open Bookcase

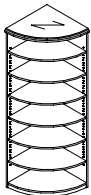

Quarter Round Open Bookcase

MODEL#	DIMENSIONS D x W x H	FREIGHT CLASS	WT/LBS.	CUBIC FT.	LIST PRICE
KB73615	16 x 38 x 78	100	228	24	\$3959
KB63615	16 x 38 x 72	100	210	23	\$3656
KB53615	16 x 38 x 65	100	188	21	\$3367
KB43615	16 x 38 x 48	100	140	15	\$2772
KB23615	16 x 38 x 29	92.5	90	9	\$2222
KB73015	16 x 32.9 x 78	92.5	228	20	\$3466
KB63015	16 x 32.9 x 72	92.5	210	19	\$3198
KB53015	16 x 32.9 x 65	92.5	188	17	\$2948
KB43015	16 x 32.9 x 48	92.5	140	13	\$2426
KB23015	16 x 32.9 x 29	92.5	90	8	\$1945

78" high models have 6 adjustable shelves, 72" has 5 adjustable shelves, 65" has 4 adjustable shelves, 48" has 3 adjustable shelves, 29" has 1 adjustable shelves.

KMAG3624	24 x 36 x 1	92.5	112	10	\$240
KMAG3622	22 x 36 x 1	92.5	104	10	\$218
KMAG3620	20 x 36 x 1	92.5	92	9	\$196
KMAG3615	15 x 36 x 1	92.5	81	8	\$173
KMAG3024	24 x 30 x 1	92.5	94	9	\$202
KMAG3022	22 x 30 x 1	100	87	9	\$184
KMAG3020	20 x 30 x 1	100	76	8	\$162
KMAG3015	15 x 30 x 1	100	67	8	\$143

For use with open bookcase. Can be specified for each shelf in an open bookcase.

KB7R1515	16 x 16 x 78	100	95	10	\$3119
KB6R1515	16 x 16 x 72	100	83	9	\$2876
KB5R1515	16 x 16 x 65	100	81	9	\$2648
KB4R1515	16 x 16 x 48	100	59	6	\$2179
KB2R1515	16 x 16 x 29	100	37	4	\$1753

84" and 78" high models have 6 adjustable shelves, 72" has 5 adjustable shelves, 65" has 4 adjustable shelves, 48" has 3 adjustable shelves, 29" has 1 adjustable shelf.

KB7R2222H84	23 x 23 x 84	100	191	23	\$5364
KB7R2222H72	23 x 23 x 72	100	171	20	\$4600
KB7R2222H65	23 x 23 x 65	100	157	18	\$5365
KB7R2020H84	21 x 21 x 84	100	163	19	\$5110
KB7R2020H72	21 x 21 x 72	100	142	17	\$4380
KB7R2020H65	21 x 21 x 65	100	130	15	\$5110

84" high models have 6 adjustable shelves, 72" has 5 adjustable shelves, and 65" has 4 adjustable shelves

Required Specifications

Finish
Edge

Optional Specifications

Handles

FREESTANDING STORAGE

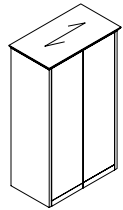

Storage Cabinet w/Wood Doors

MODEL# DIMENSIONS FREIGHT CLASS WT/LBS. CUBIC FT. LIST PRICE

	D x W x H				
K1D22W36H84	23 x 38 x 84	125	304	42	\$7448
K1D22W36H72	23 x 38 x 72	100	283	33	\$6385
K1D22W36H65	23 x 38 x 65	100	259	30	\$5851
K1D22W30H84	23 x 32.9 x 84	125	304	42	\$6516
K1D22W30H72	23 x 32.9 x 72	100	283	33	\$5586
K1D22W30H65	23 x 32.9 x 65	100	259	30	\$5123
K1D22W24H84	23 x 26 x 84	92.5	320	28	\$5583
K1D22W24H72	23 x 26 x 72	92.5	255	24	\$4787
K1D22W24H65	23 x 26 x 65	125	173	22	\$4397
K1D20W36H84	21 x 38 x 84	100	297	35	\$7098
K1D20W36H72	21 x 38 x 72	100	269	30	\$6084
K1D20W36H65	21 x 38 x 65	100	245	28	\$5577
K1D20W30H84	21 x 32.9 x 84	100	257	29	\$5911
K1D20W30H72	21 x 32.9 x 72	100	233	25	\$5068
K1D20W30H65	21 x 32.9 x 65	100	202	23	\$4645
K1D20W24H84	21 x 26 x 84	100	198	23	\$4731
K1D20W24H72	21 x 26 x 72	100	179	20	\$4054
K1D20W24H65	21 x 26 x 65	100	163	18	\$3712

84" high models have 6 adjustable shelves, 72" has 5 adjustable shelves, 65" has 4 adjustable shelves. For Aluminum framed glass door option, please contact customer care. Locks are optional.

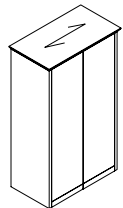

Wardrobe Cabinet

K2D22W36H84	23 x 38 x 84	125	304	42	\$6462
K2D22W36H72	23 x 38 x 72	100	283	33	\$5541
K2D22W36H65	23 x 38 x 65	100	259	30	\$5079
K2D22W30H84	23 x 32.9 x 84	125	304	42	\$5656
K2D22W30H72	23 x 32.9 x 72	100	283	33	\$4846
K2D22W30H65	23 x 32.9 x 65	100	259	30	\$4440
K2D22W24H84	23 x 26 x 84	92.5	320	28	\$4846
K2D22W24H72	23 x 26 x 72	92.5	255	24	\$4156
K2D22W24H65	23 x 26 x 65	125	173	22	\$3807
K2D20W36H84	21 x 38 x 84	100	297	35	\$6155
K2D20W36H72	21 x 38 x 72	100	269	30	\$5277
K2D20W36H65	21 x 38 x 65	100	245	28	\$4837
K2D20W30H84	21 x 32.9 x 84	100	257	29	\$5130
K2D20W30H72	21 x 32.9 x 72	100	233	25	\$4398
K2D20W30H65	21 x 32.9 x 65	100	202	23	\$4029
K2D20W24H84	21 x 26 x 84	100	198	23	\$4104
K2D20W24H72	21 x 26 x 72	100	179	20	\$3514
K2D20W24H65	21 x 26 x 65	100	163	18	\$3222

Doors, coat rack and hat shelf. 84" high models have 6 adjustable shelves, 72" has 5 adjustable shelves, 65" has 4 adjustable shelves. For Aluminum framed glass door option, please contact customer care. Locks are optional.

Required Specifications

Finish
Edge

Optional Specifications

Handles
Locks

FREESTANDING STORAGE

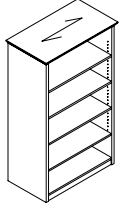

Open Bookcase

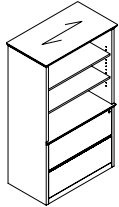

Open Cabinet

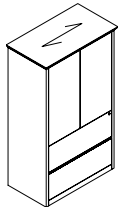

Storage Cabinet w/Doors*

MODEL#	DIMENSIONS	FREIGHT CLASS	WT/LBS.	CUBIC FT.	LIST PRICE
--------	------------	---------------	---------	-----------	------------

D x W x H

K7D22W36H84	23 x 38 x 84	125	331	43	\$5960
K7D22W36H72	23 x 38 x 72	100	306	36	\$5110
K7D22W36H65	23 x 38 x 65	100	281	33	\$4684
K7D22W30H84	23 x 32.9 x 84	125	280	36	\$5214
K7D22W30H72	23 x 32.9 x 72	100	255	30	\$4541
K7D22W30H65	23 x 32.9 x 65	100	234	28	\$4098
K7D20W36H84	21 x 38 x 84	125	282	36	\$5679
K7D20W36H72	21 x 38 x 72	100	257	30	\$4870
K7D20W36H65	21 x 38 x 65	100	234	28	\$4463
K7D20W30H84	21 x 32.9 x 84	100	248	29	\$4730
K7D20W30H72	21 x 32.9 x 72	100	223	25	\$4053
K7D20W30H65	21 x 32.9 x 65	100	193	23	\$3714

84" high models have 6 adjustable shelves, 72" has 5 adjustable shelves, 65" has 4 adjustable shelves.

K12D22W36H84	23 x 38 x 84	92.5	364	36	\$8087
K12D22W36H72	23 x 38 x 72	92.5	336	33	\$6932
K12D22W36H65	23 x 38 x 65	92.5	308	30	\$6359
K12D22W30H84	23 x 32.9 x 84	92.5	330	31	\$7075
K12D22W30H72	23 x 32.9 x 72	92.5	294	28	\$6069
K12D22W30H65	23 x 32.9 x 65	92.5	257	25	\$5561
K12D20W36H84	21 x 38 x 84	92.5	348	33	\$7705
K12D20W36H72	21 x 38 x 72	92.5	322	30	\$6602
K12D20W36H65	21 x 38 x 65	92.5	294	28	\$6052
K12D20W30H84	21 x 32.9 x 84	92.5	317	28	\$6741
K12D20W30H72	21 x 32.9 x 72	92.5	280	25	\$5775
K12D20W30H65	21 x 32.9 x 65	92.5	243	23	\$5046

Above two lateral file drawers. 84" high models have 6 adjustable shelves, 72" has 5 adjustable shelves, 65" has 4 adjustable shelves.

K13D22W36H84	23 x 38 x 84	92.5	364	36	\$9217
K13D22W36H72	23 x 38 x 72	92.5	341	33	\$7900
K13D22W36H65	23 x 38 x 65	92.5	313	30	\$7244
K13D22W30H84	23 x 32.9 x 84	92.5	330	31	\$8065
K13D22W30H72	23 x 32.9 x 72	92.5	299	28	\$6912
K13D22W30H65	23 x 32.9 x 65	92.5	261	25	\$6337
K13D20W36H84	21 x 38 x 84	92.5	365	35	\$8778
K13D20W36H72	21 x 38 x 72	92.5	327	30	\$7524
K13D20W36H65	21 x 38 x 65	92.5	299	28	\$6893
K13D20W30H84	21 x 32.9 x 84	92.5	305	29	\$7317
K13D20W30H72	21 x 32.9 x 72	92.5	285	25	\$6274
K13D20W30H65	21 x 32.9 x 65	92.5	247	23	\$5747

Above two lateral file drawers. 84" high models have 6 adjustable shelves, 72" has 5 adjustable shelves, 65" has 4 adjustable shelves. For Aluminum framed glass door option, please contact customer care. Lock for upper storage is optional.

Required Specifications

Finish
Edge

Optional Specifications

Handles
Lock*

FREESTANDING STORAGE

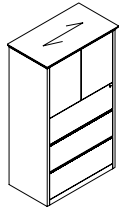

Storage Cabinet w/Doors*

MODEL# DIMENSIONS FREIGHT CLASS WT/LBS. CUBIC FT. LIST PRICE

D x W x H

K14D22W36H84	23 x 38 x 84	100	340	42	\$9908
K14D22W36H72	23 x 38 x 72	100	312	33	\$8493
K14D22W36H65	23 x 38 x 65	100	286	30	\$7788
K14D22W30H84	23 x 32.9 x 84	100	308	35	\$8667
K14D22W30H72	23 x 32.9 x 72	100	273	28	\$7431
K14D22W30H65	23 x 32.9 x 65	100	238	25	\$6812

K14D20W36H84	21 x 38 x 84	100	330	35	\$9436
K14D20W36H72	21 x 38 x 72	100	298	30	\$8090
K14D20W36H65	21 x 38 x 65	100	272	28	\$7416
K14D20W30H84	21 x 32.9 x 84	92.5	298	29	\$7864
K14D20W30H72	21 x 32.9 x 72	92.5	259	25	\$6742
K14D20W30H65	21 x 32.9 x 65	100	224	23	\$6180

Above three lateral file drawers. 84" high models have 2 adjustable shelves, 72" and 65" have 1 adjustable shelf. For Aluminum framed glass door option, please contact customer care. Lock for upper storage is optional

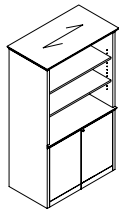

Open Storage*

K22D22W36H84	23 x 38 x 84	125	325	42	\$6788
K22D22W36H72	23 x 38 x 72	100	300	33	\$5815
K22D22W36H65	23 x 38 x 65	100	275	30	\$5334
K22D22W30H84	23 x 32.9 x 84	100	304	35	\$5940
K22D22W30H72	23 x 32.9 x 72	100	279	28	\$5092
K22D22W30H65	23 x 32.9 x 65	100	243	25	\$4668

K22D20W36H84	21 x 38 x 84	100	327	33	\$6462
K22D20W36H72	21 x 38 x 72	92.5	305	30	\$5541
K22D20W36H65	21 x 38 x 65	100	278	28	\$5079
K22D20W30H84	21 x 32.9 x 84	92.5	301	28	\$5393
K22D20W30H72	21 x 32.9 x 72	92.5	265	25	\$4622
K22D20W30H65	21 x 32.9 x 65	100	229	23	\$4232

Above storage cabinet. 84" high models have 4 adjustable shelves, 72" has 3 adjustable shelves, 65" has 3 adjustable shelves. For Aluminum framed glass door option, please contact customer care.

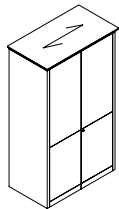

Closed Storage Cabinet*

K23D22W36H84	23 x 38 x 84	100	340	42	\$7955
K23D22W36H72	23 x 38 x 72	100	319	33	\$6818
K23D22W36H65	23 x 38 x 65	100	292	30	\$6244
K23D22W30H84	23 x 32.9 x 84	100	308	33	\$6626
K23D22W30H72	23 x 32.9 x 72	100	279	28	\$5679
K23D22W30H65	23 x 32.9 x 65	100	243	25	\$5209

K23D20W36H84	21 x 38 x 84	100	330	35	\$7574
K23D20W36H72	21 x 38 x 72	92.5	305	30	\$6493
K23D20W36H65	21 x 38 x 65	100	278	28	\$5950
K23D20W30H84	21 x 32.9 x 84	92.5	298	29	\$6311
K23D20W30H72	21 x 32.9 x 72	92.5	265	25	\$5411
K23D20W30H65	21 x 32.9 x 65	100	229	23	\$4960

With upper and lower split doors. 1 fixed shelf and 2 adjustable shelves. Lock for upper storage is optional For Aluminum framed glass door option, please contact customer care.

Required Specifications

Finish
Edge

Optional Specifications

Handles
Lock*

FREESTANDING STORAGE

MODEL# DIMENSIONS FREIGHT CLASS WT/LBS. CUBIC FT. LIST PRICE

D x W x H

K25D22W36H84	23 x 38 x 84	100	348	42	\$8353
K25D22W36H72	23 x 38 x 72	100	319	33	\$7164
K25D22W36H65	23 x 38 x 65	100	292	30	\$6565
K25D22W30H84	23 x 32.9 x 84	100	307	35	\$7309
K25D22W30H72	23 x 32.9 x 72	100	279	28	\$6267
K25D22W30H65	23 x 32.9 x 65	100	243	25	\$5743
K25D22W24H84	23 x 26 x 84	100	254	28	\$6265
K25D22W24H72	23 x 26 x 72	100	213	24	\$5369
K25D22W24H65	23 x 26 x 65	100	195	22	\$4918

K25D20W36H84	21 x 38 x 84	100	330	35	\$7954
K25D20W36H72	21 x 38 x 72	92.5	305	30	\$6814
K25D20W36H65	21 x 38 x 65	100	278	28	\$6247
K25D20W30H84	21 x 32.9 x 84	92.5	300	29	\$6627
K25D20W30H72	21 x 32.9 x 72	92.5	265	25	\$5680
K25D20W30H65	21 x 32.9 x 65	100	229	23	\$5209
K25D20W24H84	21 x 26 x 84	100	235	28	\$5304
K25D20W24H72	21 x 26 x 72	100	203	24	\$4546
K25D20W24H65	21 x 26 x 65	100	185	22	\$4171

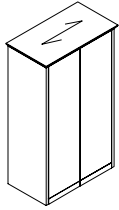

Cabinet w/Doors and Storage

Wardrobe with coat rack and hat shelf on left. Storage with adjustable shelves on right. 84" high models have 5 adjustable shelves, 72" and 65" have 4 adjustable shelves. For Aluminum framed glass door option, please contact customer care. Lock is optional.

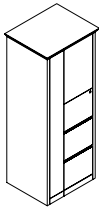

Tower Unit - Left

K27D22W24H84L	23 x 26 x 84	125	167	24	\$9891
K27D22W24H72L	23 x 26 x 72	125	154	22	\$8478
K27D22W24H65L	23 x 26 x 65	125	141	20	\$7778
K27D20W24H84L	21 x 26 x 84	125	152	22	\$9421
K27D20W24H72L	21 x 26 x 72	125	140	20	\$8079
K27D20W24H65L	21 x 26 x 65	125	128	18	\$7404

Wardrobe with coat rack and hat shelf on left. Three file drawers and storage with adjustable shelf on right. 84" high models have 2 adjustable shelves, 72" and 65" have 1 adjustable shelf. For Aluminum framed glass door option on right, please contact customer care. Lock for upper storage and wardrobe is optional.

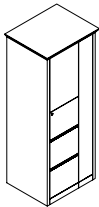

Tower Unit - Right

K27D22W24H84R	23 x 26 x 84	125	167	24	\$9891
K27D22W24H72R	23 x 26 x 72	125	154	22	\$8478
K27D22W24H65R	23 x 26 x 65	125	141	20	\$7778
K27D20W24H84R	21 x 26 x 84	125	152	22	\$9421
K27D20W24H72R	21 x 26 x 72	125	140	20	\$8079
K27D20W24H65R	21 x 26 x 65	125	128	18	\$7404

Wardrobe with coat rack and hat shelf on right. Three file drawers and storage with adjustable shelf on left. 84" high models have 2 adjustable shelves, 72" and 65" have 1 adjustable shelf. For Aluminum framed glass door option on left, please contact customer care. Lock for upper storage and wardrobe is optional.

Required Specifications

Finish
Edge

Optional Specifications

Handles
Locks

MODESTY PANELS

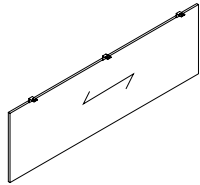

Veneer Modesty Panel*

MODEL#	DIMENSIONS D x W x H	FREIGHT CLASS	WT./LBS.	CUBIC FT.	LIST PRICE
CMP72W	0.75 x 67 x 18	--	20	1	\$1728
CMP66W	0.75 x 61 x 18	--	18	1	\$1728
CMP60W	0.75 x 55 x 18	--	16	1	\$1728
CMP54W	0.75 x 49 x 18	--	14	1	\$1673
CMP48W	0.75 x 43 x 18	--	13	1	\$1619

Straight modesty panel. Attaches to underside of worksurface. **Cannot be retrofitted in the field. Not sold individually - to be ordered as an upgrade option only.**

- CMP72W - Specify on 96" Piano desk: Boat, D or P
- CMP66W - Specify on 84" Piano desk: Boat or D
- CMP60W - For use on 84" Piano desk: P
- CMP54W - For use on 72" Piano desk: Boat or D/D table desk
- CMP48W - For use on 66" and 60" Piano desk: D or P/D table desk

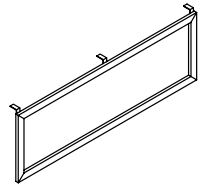

Glass Modesty Panel

CMP72G	0.75 x 67 x 18	--	20	1	\$2647
CMP66G	0.75 x 61 x 18	--	18	1	\$2647
CMP60G	0.75 x 55 x 18	--	16	1	\$2647
CMP54G	0.75 x 49 x 18	--	14	1	\$2504
CMP48G	0.75 x 43 x 18	--	13	1	\$2132

Straight modesty panel. Translucent, screened glass. Aluminum box frame construction in Tungsten Only. Attaches to underside of worksurface. **Cannot be retrofitted in the field. Not sold individually - to be ordered as an upgrade option only.**

- CMP72G - Specify on 96" Piano desk: Boat, D or P
- CMP66G - Specify on 84" Piano desk: Boat or D
- CMP60G - For use on 84" Piano desk: P
- CMP54G - For use on 72" Piano desk: Boat or D/D table desk
- CMP48G - For use on 66" and 60" Piano desk: D or P/D table desk
- Tungsten finish on the aluminum box frame closely resembles the existing Tungsten finish.

ACCESSORIES

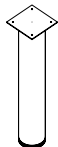

Metal Post Upgrade

MODEL#	DIMENSIONS	FREIGHT CLASS	WT./LBS.	CUBIC FT.	LIST PRICE
SM06	6 x 6 x 28	--	--	--	\$1105
SM04	4 x 4 x 28	--	--	--	\$610
SM03	3 x 3 x 28	--	--	--	\$434

Must specify at time of order. **Cannot be retrofitted in the field.**
Available in Black (E), Tungsten (K) and Brushed Chrome (P).

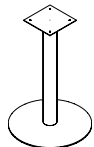

Metal Flat Plate Base Upgrade

F3P18	18 x 18 x 28	--	--	--	\$1638
-------	--------------	----	----	----	---------------

Must specify at time of order. **Can not be retrofitted in the field.**
Available in Black (E), Tungsten (K) and Brushed Chrome (P).

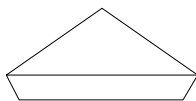

Corner Filler Top

KV1212CT	12 x 12 x 1.5	150	5	1	\$1045
----------	---------------	-----	---	---	---------------

Required Specifications

Finish*

TACKBOARDS FOR HUTCHES

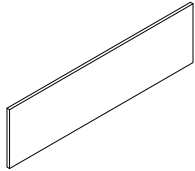

**Tackboard for 36" H
Non-Pigeon Hole Hutches**

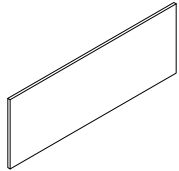

**Tackboard for 42" H & 54" H
Pigeon-Hole Hutches**

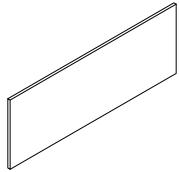

**Tackboard for 42" H & 54" H
Non-Pigeon Hole Hutches**

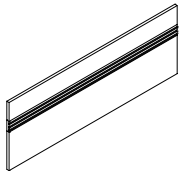

**Tackboard w/Rail for 36" H
Non-Pigeon Hole Hutches***

MODEL#	DIMENSIONS D x W x H	FREIGHT CLASS	WT/LBS.	CUBIC FT.	GR. 1-3	GR. 4-5
KTS108	1 x 105 x 20	92.5	23	2	\$1313	\$1578
KTS102	1 x 99 x 20	100	19	2	\$1242	\$1494
KTS96	1 x 93 x 20	70	15	1	\$1169	\$1406
KTS90	1 x 87 x 20	70	15	1	\$1097	\$1319
KTS84	1 x 81 x 20	85	14	1	\$1028	\$1237
KTS78	1 x 75 x 20	85	13	1	\$952	\$1144
KTS72	1 x 69 x 20	85	12	1	\$875	\$1051
KTS66	1 x 63 x 20	92.5	11	1	\$800	\$961
KTS60	1 x 57 x 20	92.5	10	1	\$733	\$882
KTS36	1 x 33 x 20	60	6	0.01	\$439	\$529
KTS30	1 x 27 x 20	60	4	0.01	\$366	\$442

Factory installed hutch tackboard.

KTSP108H23	1 x 105 x 23	70	30	2	\$1484	\$1783
KTSP102H23	1 x 99 x 23	85	24	2	\$1415	\$1700
KTSP96H23	1 x 93 x 23	92.5	20	2	\$1321	\$1588
KTSP90H23	1 x 87 x 23	70	20	1	\$1238	\$1488
KTSP84H23	1 x 81 x 23	70	18	1	\$1156	\$1389
KTSP78H23	1 x 75 x 23	70	17	1	\$1074	\$1291
KTSP72H23	1 x 69 x 23	70	16	1	\$998	\$1200
KTSP66H23	1 x 63 x 23	85	14	1	\$908	\$1092
KTSP60H23	1 x 57 x 23	85	13	1	\$830	\$1000
KTSP36H23	1 x 33 x 23	60	8	0.01	\$497	\$599
KTSP30H23	1 x 27 x 23	60	5	0.01	\$414	\$501

Factory installed hutch tackboard.

KTS108H26	1 x 105 x 26	70	30	2	\$1716	\$2062
KTS102H26	1 x 99 x 26	85	24	2	\$1617	\$1942
KTS96H26	1 x 93 x 26	92.5	20	2	\$1520	\$1827
KTS90H26	1 x 87 x 26	92.5	20	2	\$1432	\$1720
KTS84H26	1 x 81 x 26	100	18	2	\$1331	\$1599
KTS78H26	1 x 75 x 26	100	17	2	\$1236	\$1486
KTS72H26	1 x 69 x 26	70	16	1	\$1141	\$1372
KTS66H26	1 x 63 x 26	85	14	1	\$1046	\$1257
KTS60H26	1 x 57 x 26	85	13	1	\$952	\$1144
KTS36H26	1 x 33 x 26	60	8	0.01	\$573	\$690
KTS30H26	1 x 27 x 26	60	5	0.01	\$477	\$574

Factory installed hutch tackboard.

KTSAS108	1 x 105 x 20	92.5	23	2	\$2330	\$2798
KTSAS102	1 x 99 x 20	100	19	2	\$2102	\$2524
KTSAS96	1 x 93 x 20	70	15	1	\$2069	\$2486
KTSAS90	1 x 87 x 20	70	15	1	\$1945	\$2336
KTSAS84	1 x 81 x 20	85	14	1	\$1813	\$2179
KTSAS78	1 x 75 x 20	85	13	1	\$1685	\$2024
KTSAS72	1 x 69 x 20	85	12	1	\$1552	\$1863
KTSAS66	1 x 63 x 20	92.5	11	1	\$1422	\$1708
KTSAS60	1 x 57 x 20	92.5	10	1	\$1298	\$1584
KTSAS36	1 x 33 x 20	60	6	0.01	\$776	\$934
KTSAS30	1 x 27 x 20	60	4	0.01	\$647	\$780

Factory installed hutch tackboard.

- Specify Black (**E**), Tungsten (**K**), or Designer White (**DWT**) accessory rail finish.

Required Specifications

Fabric
Metal finish*

TACKBOARDS FOR HUTCHES

MODEL#	DIMENSIONS	FREIGHT CLASS	WT/LBS.	CUBIC FT.	GR.1-3	GR. 4-5
	D x W x H					
KTSPAS108H23	1 x 105 x 23	70	30	2	\$2529	\$3036
KTSPAS102H23	1 x 99 x 23	85	24	2	\$2405	\$2912
KTSPAS96H23	1 x 93 x 23	92.5	20	2	\$2258	\$2712
KTSPAS90H23	1 x 87 x 23	92.5	20	2	\$2115	\$2540
KTSPAS84H23	1 x 81 x 23	100	18	2	\$1972	\$2369
KTSPAS78H23	1 x 75 x 23	100	17	2	\$1831	\$2199
KTSPAS72H23	1 x 69 x 23	70	16	1	\$1690	\$2029
KTSPAS66H23	1 x 63 x 23	85	14	1	\$1549	\$1860
KTSPAS60H23	1 x 57 x 23	85	13	1	\$1408	\$1692
KTSPAS36H23	1 x 33 x 23	100	8	1	\$847	\$1019
KTSPAS30H23	1 x 27 x 23	150	5	1	\$711	\$855

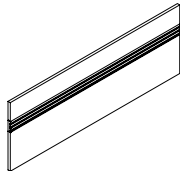

Tackboard w/Rail for 42”H & 54”H*
Pigeon-Hole Hutches

Factory installed hutch tackboard.
 • Specify Black (E), Tungsten (K), or Designer White (DWT) accessory rail finish.

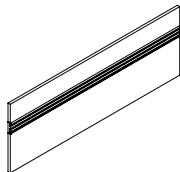

Tackboard w/Rail for 42”H & 54”H*
Non-Pigeon Hole Hutches

KTSAS108H26	1 x 105 x 26	92.5	23	2	\$2807	\$3372
KTSAS102H26	1 x 99 x 26	100	19	2	\$2642	\$3173
KTSAS96H26	1 x 93 x 26	70	15	1	\$2487	\$2987
KTSAS90H26	1 x 87 x 26	70	15	1	\$2341	\$2812
KTSAS84H26	1 x 81 x 26	85	14	1	\$2155	\$2588
KTSAS78H26	1 x 75 x 26	85	13	1	\$2022	\$2428
KTSAS72H26	1 x 69 x 26	85	12	1	\$1835	\$2204
KTSAS66H26	1 x 63 x 26	92.5	11	1	\$1716	\$2062
KTSAS60H26	1 x 57 x 26	92.5	10	1	\$1553	\$1867
KTSAS36H26	1 x 33 x 26	60	6	0.01	\$932	\$1122
KTSAS30H26	1 x 27 x 26	60	4	0.01	\$783	\$942

Factory installed hutch tackboard.
 • Specify Black (E), Tungsten (K), or Designer White (DWT) accessory rail finish.

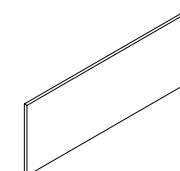

Tackboard for 65”H Non-Pigeon Hole
Wall Mount Cabinets

TS120	1 x 120 x 19.2	70	26	2	\$1621	\$2026
TS114	1 x 114 x 19.2	70	25	2	\$1544	\$1932
TS108	1 x 108 x 19.2	70	23	2	\$1460	\$1825
TS102	1 x 102 x 19.2	85	19	2	\$1383	\$1729
TS96	1 x 96 x 19.2	70	17	1	\$1293	\$1619
TS90	1 x 90 x 19.2	70	15	1	\$1216	\$1521
TS84	1 x 84 x 19.2	70	14	1	\$1139	\$1422
TS78	1 x 78 x 19.2	70	13	1	\$1055	\$1319
TS72	1 x 72 x 19.2	70	12	1	\$594	\$744
TS66	1 x 66 x 19.2	85	11	1	\$546	\$686
TS60	1 x 60 x 19.2	85	10	1	\$502	\$631
TS54	1 x 54 x 19.2	85	10	1	\$455	\$572
TS48	1 x 48 x 19.2	85	10	1	\$407	\$511
TS42	1 x 42 x 19.2	85	10	1	\$360	\$453
TS36	1 x 36 x 19.2	100	8	1	\$322	\$408
TS30	1 x 30 x 19.2	150	5	1	\$268	\$337

Factory installed tackboard for wall mount cabinets.

Required Specifications

Fabric
 Metal finish*

TACKBOARDS FOR WALL MOUNT CABINETS

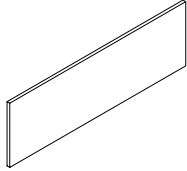

Tackboard for 72" H Pigeon-Hole Wall Mount Cabinets

MODEL#	DIMENSIONS D x W x H	FREIGHT CLASS	WT./LBS.	CUBIC FT.	GR. 1-3	GR. 4-5
TSP120H23	1 x 120 x 23	70	34	2	\$1830	\$2288
TSP114H23	1 x 114 x 23	70	32	2	\$1739	\$2172
TSP108H23	1 x 108 x 23	70	30	2	\$1704	\$2045
TSP102H23	1 x 102 x 23	85	24	2	\$1625	\$1951
TSP96H23	1 x 96 x 23	92.5	20	2	\$1467	\$1832
TSP90H23	1 x 90 x 23	92.5	20	1	\$1370	\$1714
TSP84H23	1 x 84 x 23	70	18	1	\$1280	\$1599
TSP78H23	1 x 78 x 23	70	17	1	\$1047	\$1273
TSP72H23	1 x 72 x 23	70	16	1	\$973	\$1222
TSP66H23	1 x 66 x 23	85	14	1	\$884	\$1109
TSP60H23	1 x 60 x 23	85	13	1	\$641	\$805
TSP54H23	1 x 54 x 23	85	13	1	\$812	\$1018
TSP48H23	1 x 48 x 23	85	13	1	\$642	\$653
TSP42H23	1 x 42 x 23	85	13	1	\$565	\$573
TSP36H23	1 x 36 x 23	100	8	1	\$488	\$505
TSP30H23	1 x 30 x 23	150	5	1	\$404	\$430

Factory installed tackboard for wall mount cabinets.

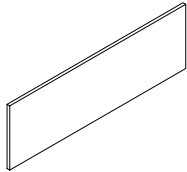

Tackboard for 72" H Non-Pigeon-Hole Wall Mount Cabinets

TS120H26	1 x 120 x 26	70	34	2	\$2108	\$2635
TS114H26	1 x 114 x 26	70	32	2	\$2003	\$2504
TS108H26	1 x 108 x 26	70	30	2	\$1898	\$2374
TS102H26	1 x 102 x 26	85	24	2	\$1788	\$2235
TS96H26	1 x 96 x 26	92.5	22	2	\$1691	\$2116
TS90H26	1 x 90 x 26	92.5	20	2	\$1585	\$1980
TS84H26	1 x 84 x 26	100	18	2	\$1473	\$1842
TS78H26	1 x 78 x 26	100	17	2	\$1370	\$1714
TS72H26	1 x 72 x 26	70	16	1	\$761	\$956
TS66H26	1 x 66 x 26	85	14	1	\$701	\$879
TS60H26	1 x 60 x 26	85	13	1	\$641	\$805
TS54H26	1 x 54 x 26	85	13	1	\$588	\$737
TS48H26	1 x 48 x 26	85	13	1	\$520	\$653
TS42H26	1 x 42 x 26	85	13	1	\$462	\$573
TS36H26	1 x 36 x 26	100	8	1	\$403	\$506
TS30H26	1 x 30 x 26	150	5	1	\$338	\$428

Factory installed tackboard for wall mount cabinets.

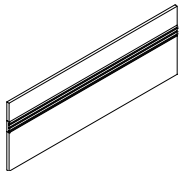

Tackboard w/Rail for 65" H* Non-Pigeon Hole Wall Mount Cabinets

TSAS120	1 x 120 x 19.2	85	26	1	\$2506	\$3134
TSAS114	1 x 114 x 19.2	85	25	2	\$2385	\$2981
TSAS108	1 x 108 x 19.2	92.5	23	2	\$2258	\$2826
TSAS102	1 x 102 x 19.2	100	19	2	\$2138	\$2668
TSAS96	1 x 96 x 19.2	70	17	1	\$2003	\$2509
TSAS90	1 x 90 x 19.2	70	15	1	\$1880	\$2353
TSAS84	1 x 84 x 19.2	85	14	1	\$1753	\$2194
TSAS78	1 x 78 x 19.2	85	13	1	\$1633	\$2043
TSAS72	1 x 72 x 19.2	85	12	1	\$1504	\$1884
TSAS66	1 x 66 x 19.2	92.5	11	1	\$1383	\$1733
TSAS60	1 x 60 x 19.2	92.5	10	1	\$1254	\$1569
TSAS54	1 x 54 x 19.2	92.5	10	1	\$1134	\$1416
TSAS48	1 x 48 x 19.2	92.5	10	1	\$1007	\$1257
TSAS42	1 x 42 x 19.2	92.5	10	1	\$879	\$1097
TSAS36	1 x 36 x 19.2	100	8	1	\$752	\$938
TSAS30	1 x 30 x 19.2	150	5	1	\$584	\$732

Factory installed tackboard for wall mount cabinets.

- Specify Black (E), Tungsten (K), or Designer White (DWT) accessory rail finish.

Required Specifications

Fabric
Metal finish*

TACKBOARDS FOR WALL MOUNT CABINETS

MODEL#	DIMENSIONS	FREIGHT CLASS	WT/LBS.	CUBIC FT.	GR. 1-3	GR. 4-5
	D x W x H					
TSPAS120H23	1 x 120 x 22.3	70	34	2	\$2721	\$3401
TSPAS114H23	1 x 114 x 22.3	70	32	2	\$2587	\$3236
TSPAS108H23	1 x 108 x 22.3	70	30	2	\$2447	\$3061
TSPAS102H23	1 x 102 x 22.3	85	24	2	\$2324	\$2909
TSPAS96H23	1 x 96 x 22.3	70	22	1	\$2185	\$2734
TSPAS90H23	1 x 90 x 22.3	70	20	1	\$2042	\$2555
TSPAS84H23	1 x 84 x 22.3	70	18	1	\$1908	\$2390
TSPAS78H23	1 x 78 x 22.3	70	17	1	\$1773	\$2217
TSPAS72H23	1 x 72 x 22.3	70	16	1	\$1640	\$2053
TSPAS66H23	1 x 66 x 22.3	85	14	1	\$1504	\$1884
TSPAS60H23	1 x 60 x 22.3	85	13	1	\$1363	\$1704
TSPAS54H23	1 x 54 x 22.3	85	13	1	\$1207	\$1510
TSPAS48H23	1 x 48 x 22.3	85	13	1	\$1094	\$1370
TSPAS42H23	1 x 42 x 22.3	85	13	1	\$960	\$1199
TSPAS36H23	1 x 36 x 22.3	100	8	1	\$682	\$856
TSPAS30H23	1 x 30 x 22.3	150	5	1	\$665	\$828

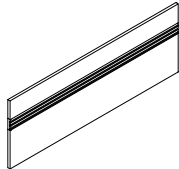

Tackboard w/Rail for 72"H*
Pigeon-Hole Wall Mount Cabinets

Factory installed tackboard for wall mount cabinets.

- Specify Black (E), Tungsten (K), or Designer White (DWT) accessory rail finish.

TSAS120H26	1 x 120 x 26	70	34	2	\$3010	\$3763
TSAS114H26	1 x 114 x 26	70	32	2	\$2854	\$3569
TSAS108H26	1 x 108 x 26	70	30	2	\$2715	\$3395
TSAS102H26	1 x 102 x 26	85	24	2	\$2560	\$3201
TSAS96H26	1 x 96 x 26	92.5	22	2	\$2405	\$3010
TSAS90H26	1 x 90 x 26	92.5	20	2	\$2265	\$2833
TSAS84H26	1 x 84 x 26	100	18	2	\$2089	\$2611
TSAS78H26	1 x 78 x 26	100	17	2	\$1955	\$2445
TSAS72H26	1 x 72 x 26	70	16	1	\$1779	\$2226
TSAS66H26	1 x 66 x 26	85	14	1	\$1661	\$2072
TSAS60H26	1 x 60 x 26	85	13	1	\$1504	\$1884
TSAS54H26	1 x 54 x 26	85	13	1	\$1356	\$1694
TSAS48H26	1 x 48 x 26	85	13	1	\$1207	\$1510
TSAS42H26	1 x 42 x 26	85	13	1	\$1061	\$1323
TSAS36H26	1 x 36 x 26	100	8	1	\$907	\$1137
TSAS30H26	1 x 30 x 26	150	5	1	\$758	\$950

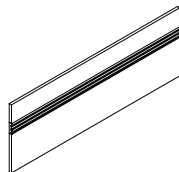

Tackboard w/Rail for 72"H*
Non-Pigeon-Hole Wall Mount Cabinets

Factory installed tackboard for wall mount cabinets.

- Specify Black (E), Tungsten (K), or Designer White (DWT) accessory rail finish.

TSP120H21	1 x 120 x 21	70	35	2	\$1764	\$2119
TSP114H21	1 x 114 x 21	70	32	2	\$1676	\$2013
TSP108H21	1 x 108 x 21	70	30	2	\$1586	\$1906
TSP102H21	1 x 102 x 21	85	24	2	\$1503	\$1805
TSP96H21	1 x 96 x 21	92.5	20	2	\$1408	\$1692
TSP90H21	1 x 90 x 21	70	1	1	\$1324	\$1591
TSP84H21	1 x 84 x 21	70	18	1	\$1238	\$1487
TSP78H21	1 x 78 x 21	70	17	1	\$1144	\$1375
TSP72H21	1 x 72 x 21	70	16	1	\$1057	\$1271
TSP66H21	1 x 66 x 21	85	14	1	\$966	\$1162
TSP60H21	1 x 60 x 21	85	13	1	\$883	\$1061
TSP54H21	1 x 54 x 21	85	13	1	\$796	\$957
TSP48H21	1 x 48 x 21	85	13	1	\$711	\$855
TSP42H21	1 x 42 x 21	125	6	1	\$620	\$747
TSP36H21	1 x 36 x 21	150	4	1	\$531	\$639
TSP30H21	1 x 30 x 21	250	3	1	\$445	\$535

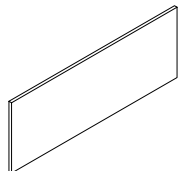

Tackboard for 84"H Double Height
Pigeon-Hole Wall Mount Cabinets

Factory installed tackboard for wall mount cabinets.

Required Specifications

- Fabric
- Metal finish*

TACKBOARDS

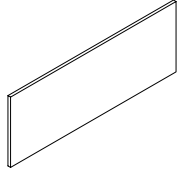

Tackboard for 84" H Double Height Non Pigeon-Hole Wall Mount Cabinets

MODEL#	DIMENSIONS D x W x H	FREIGHT CLASS	WT/LBS.	CUBIC FT.	GR. 3	GR. 4-5
TS120H25	1 x 120 x 25	85	27	2	\$2104	\$2526
TS114H25	1 x 114 x 25	85	25	2	\$2001	\$2403
TS108H25	1 x 108 x 25	92.5	23	2	\$1608	\$2007
TS102H25	1 x 102 x 25	100	19	2	\$1511	\$1892
TS96H25	1 x 96 x 25	70	17	1	\$1424	\$1777
TS90H25	1 x 90 x 25	70	15	1	\$1335	\$1671
TS84H25	1 x 84 x 25	85	14	1	\$1250	\$1564
TS78H25	1 x 78 x 25	85	13	1	\$1154	\$1444
TS72H25	1 x 72 x 25	85	12	1	\$1067	\$1338
TS66H25	1 x 66 x 25	92.5	11	1	\$980	\$1226
TS60H25	1 x 60 x 25	92.5	10	1	\$893	\$1120
TS54H25	1 x 54 x 25	92.5	10	1	\$947	\$1139
TS48H25	1 x 48 x 25	92.5	10	1	\$839	\$1009
TS42H25	1 x 42 x 25	92.5	10	1	\$735	\$884
TS36H25	1 x 36 x 25	125	6	1	\$630	\$758
TS30H25	1 x 30 x 25	150	4	1	\$528	\$635

Factory installed tackboard for wall mount cabinets.

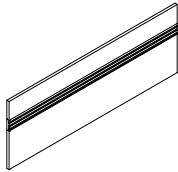

Tackboard w/Rail for 84" H Double Ht.* Pigeon-Hole Wall Mount Cabinets

TSPAS120H21	1 x 120 x 21	70	33	2	\$3102	\$3723
TSPAS114H21	1 x 114 x 21	70	32	2	\$2949	\$3542
TSPAS108H21	1 x 108 x 21	70	30	2	\$2793	\$3352
TSPAS102H21	1 x 102 x 21	85	24	2	\$2647	\$3178
TSPAS96H21	1 x 96 x 21	70	20	1	\$2481	\$2978
TSPAS90H21	1 x 90 x 21	70	20	1	\$2335	\$2804
TSPAS84H21	1 x 84 x 21	70	18	1	\$2176	\$2614
TSPAS78H21	1 x 78 x 21	70	17	1	\$2021	\$2427
TSPAS72H21	1 x 72 x 21	70	16	1	\$1862	\$2237
TSPAS66H21	1 x 66 x 21	85	14	1	\$1709	\$2052
TSPAS60H21	1 x 60 x 21	85	13	1	\$1552	\$1862
TSPAS54H21	1 x 54 x 21	85	13	1	\$1403	\$1686
TSPAS48H21	1 x 48 x 21	85	13	1	\$1249	\$1501
TSPAS42H21	1 x 42 x 21	85	13	1	\$1089	\$1308
TSPAS36H21	1 x 36 x 21	60	6	0.01	\$929	\$1116
TSPAS30H21	1 x 30 x 21	60	4	0.01	\$722	\$868

Factory installed tackboard for wall mount cabinets.

- Specify Black (E), Tungsten (K), or Designer White (DWT) accessory rail finish.

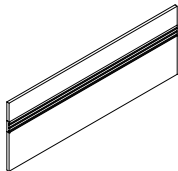

Tackboard w/Rail for 84" H Double Ht.* Non Pigeon-Hole Wall Mount Cabinets

TSAS120H25	1 x 120 x 25	85	27	2	\$3549	\$4260
TSAS114H25	1 x 114 x 25	85	25	2	\$3369	\$4044
TSAS108H25	1 x 108 x 25	92.5	23	2	\$2615	\$3270
TSAS102H25	1 x 102 x 25	100	19	2	\$2457	\$3075
TSAS96H25	1 x 96 x 25	70	17	1	\$2310	\$2893
TSAS90H25	1 x 90 x 25	70	15	1	\$2176	\$2724
TSAS84H25	1 x 84 x 25	85	14	1	\$2008	\$2511
TSAS78H25	1 x 78 x 25	85	13	1	\$1880	\$2353
TSAS72H25	1 x 72 x 25	85	12	1	\$1707	\$2137
TSAS66H25	1 x 66 x 25	92.5	11	1	\$1598	\$2003
TSAS60H25	1 x 60 x 25	92.5	10	1	\$1452	\$1817
TSAS54H25	1 x 54 x 25	92.5	10	1	\$1602	\$1925
TSAS48H25	1 x 48 x 25	92.5	10	1	\$1429	\$1715
TSAS42H25	1 x 42 x 25	92.5	10	1	\$1252	\$1504
TSAS36H25	1 x 36 x 25	60	6	0.01	\$1070	\$1286
TSAS30H25	1 x 30 x 25	60	4	0.01	\$893	\$1074

Factory installed tackboard for wall mount cabinets.

- Specify Black (E), Tungsten (K), or Designer White (DWT) accessory rail finish.

Required Specifications

Fabric
Metal finish*

ACCESSORIES

MODEL# DIMENSIONS FREIGHT CLASS WT/LBS. CUBIC FT. LIST PRICE

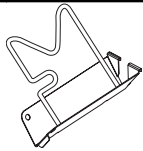

Flip Sorter

	D x W x H				
BAFS01	9.25 x 2.75 x 9.25	70	0.6	0.14	\$58

Load bar/accessory rail mounted metal flip sorter. Comes with chrome wire.
 • Specify Black (E), Tungsten (K), or Designer White (DWT) accessory finish.

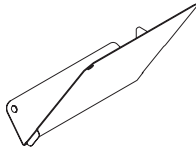

Slant Sorter

BASS01L (Left)	10.25 x 5 x 9.5	70	1	0.28	\$47
BASS01R (Right)	10.25 x 5 x 9.5	70	1	0.28	\$47

Load bar/accessory rail mounted metal slant sorter.
 • Specify Black (E), Tungsten (K), or Designer White (DWT) accessory finish.

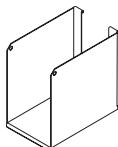

Binder Bin

BABB01	10.25 x 4 x 9	70	1.85	0.21	\$75
--------	---------------	----	------	------	------

Load bar/accessory rail mounted metal binder bin.
 • Specify Black (E), Tungsten (K), or Designer White (DWT) accessory finish.

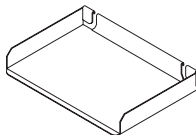

Letter Tray

BALTO1	9.25 x 13.5 x 2	70	0.5	0.15	\$62
--------	-----------------	----	-----	------	------

Load bar/accessory rail mounted metal letter tray.
 • Specify Black (E), Tungsten (K), or Designer White (DWT) accessory finish.

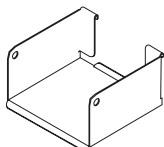

Media Bin

BAMB01	5.25 x 5.75 x 3	70	1.85	0.21	\$62
--------	-----------------	----	------	------	------

Load bar/accessory rail mounted metal media bin.
 • Specify Black (E), Tungsten (K), or Designer White (DWT) accessory finish.

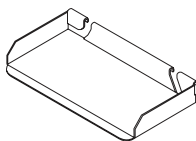

Utility Tray

BAUT01	3.75 x 5.75 x 3	70	0.5	0.02	\$41
--------	-----------------	----	-----	------	------

Load bar/accessory rail mounted metal utility tray.
 • Specify Black (E), Tungsten (K), or Designer White (DWT) accessory finish.

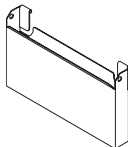

Mail Box

BAPP01	2.75 x 16 x 9	100	2	0.25	\$94
--------	---------------	-----	---	------	------

Load bar/accessory rail mounted metal mail box.
 • Specify Black (E), Tungsten (K), or Designer White (DWT) accessory finish.

Required Specifications

Fabric
 Metal finish*



ACCESSORIES

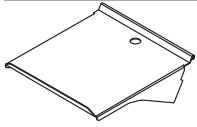

Telephone Holder

MODEL#	DIMENSIONS D x W x H	FREIGHT CLASS	WT./LBS.	CUBIC FT.	LIST PRICE
BATH01	10 x 9 x 2	125	2	0.26	\$91

Load bar/accessory rail mounted metal telephone holder.

- Specify Black (**E**), Tungsten (**K**), or Designer White (**DWT**) accessory finish.

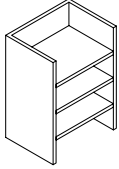

Paper Organizer, Letter & Legal Format

KCPH161226	12 x 16 x 27	125	20	3	\$1045
KCPH161223	12 x 16 x 23	125	18	3	\$883
KCPH161219	12 x 16 x 20	125	15	2	\$674
KCPH131226	12 x 13 x 27	100	16	2	\$847
KCPH131223	12 x 13 x 23	125	15	2	\$719
KCPH131219	12 x 13 x 20	125	12	2	\$546

- Specify Black (**E**), Tungsten (**K**), or Designer White (**DWT**) accessory finish.

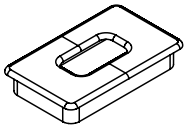

Grommet

GM5C	2 x 3.5 x --	70	--	--	\$114
------	--------------	----	----	----	--------------

Rectangular grommet in metal, tungsten finish.

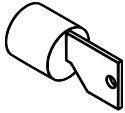

Lock Assembly

Black:					
LO	--	70	--	--	\$113

Tungsten:					
LO/C	--	70	--	--	\$113

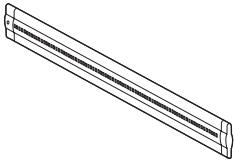

LED Task Light

PLED30	1.5 x 15.5 x .5	150	2	0.5	\$522
PLED50	1.5 x 23.5 x .5	150	2	0.5	\$601
PLED100	1.5 x 43.5 x .5	125	3	0.5	\$697

Energy efficient LED. Ultra slim design. Suitable for hanging under Hutch or Wallhung units. 6' power cord.

Required Specifications

Metal finish

lufton





GLOBAL is pleased to introduce the **LUFTON** wood veneer series. This contemporary collection features an all wood veneer construction with a variety of features that emphasize a modern approach to the private office.

1-3/16" worksurfaces include a choice of four 1/4" hardwood edges to choose from – Flat (L10), Radius (L20), Fluted (L30) and Soft Tail (L40). A black 5mm PVC inlay between the worksurface and gable provides a striking visual detail.

Drawers and storage items feature eight handle options to choose from (where applicable) – storage options are available in 29", 66" and 72" heights. Various models include different types of storage configurations.

New 23" height credenzas allow for different visual planes – combined with a spacer unit, worksurfaces can be supported over this credenza.

Above worksurface storage selections include overhead storage and hutches with or without pigeon-hole storage. Hutch doors are available in a choice of veneer or glass with an aluminum frame. Tackboards are offered in all fabric or with a built-in accessory rail for organizing folders, binders, CDs and more!



Features and Benefits

- Choice of eight handle options for every door/drawer that features handles.
- Modesty panel options include metal (in Black or Tungsten), veneer, and glass.
- Base upgrades to replace standard monopost on islands are available in four styles.
- Drawers are standard vinyl wrapped construction with black drawer slides and bottom.
- 75 lb. box – 150 lb. file drawer weight capacity with full height sides – pencil tray included in box drawer.
- Lateral file drawers can accommodate legal or letter documents.
- Box drawers mounted on 3/4 extension premium ball bearing slides.
- Power/Data accessories are available to be factory installed on any LUFTON unit, including Boardroom Tables to meet all today's technological requirements.
- A full array of complementary Boardroom and Reception area furnishings are available to coordinate the entire office.

GENERAL INFORMATION

- Lufton is a veneer desking system composed of hundreds of models, capable of furnishing executive suites, boardrooms and reception areas.
- 1-3/16" worksurfaces with 1/4" solid Wood Edge all around.
- 5MM Black PVC inlay between top and gables
- **Level 3 Certified**

FINISHES

- Conversion varnish (similar to catalyzed lacquer, but tougher), 35 to 40 degree sheen. Finishes are not buffed or rubbed.
- All Global wood casegood products are veneered and finished on the back sides (3600 finishing), except modular under-surface storage - tops and backs are unfinished.
- Touch up kits available, includes a touch up marker and fill crayon. Order **VTOUCHUPKIT**, **\$175** list. Specify finish when ordering.
- Global standard finish, on oak and walnut, is open pore and on cherry and maple is semi-closed pore. If a full finish is required for walnut, cherry, anigre and maple tops, add the suffix **"2"** to the finish code and add 5% to the base pricing for each product. Custom finish on standard veneer is available. Add 15% to the base pricing for each product.
- High Pressure laminate inlays are available at no upcharge. Contact Customer Care for specification information.
- Hanging file rails are pre-installed on file drawer perimeters and accommodate both legal and letter size filing. Legal filing can be achieved either as side-to-side or front-to-back. Letter filing can be achieved as front-to-back filing only.

WORKSURFACE TOP & DRAWER/DOOR FRONTS, BODY FINISHES

(INCLUDING PEDESTALS) - VENEER

Code	Finish	Veneer Type	Cut
AMW	Almond Cherry	Cherry	Flat Sliced
ACW	Amber Cherry	Cherry	Flat Sliced
BTW	Biscotti	White Oak	Rift
CAW	Cocoa Walnut	Walnut	Flat Sliced
CRW	Coral	White Oak	Rift
DCW	Dark Cherry	Cherry	Flat Sliced
DWW	Dark Walnut	Walnut	Flat Sliced
EWW	Espresso Walnut	Walnut	Flat Sliced
EVW	Evening Oak	White Oak	Rift
GRW	Grey on Oak	White Oak	Rift
HAW	Hazelnut	Maple	Flat Sliced
JAW	Java	White Oak	Rift
LTW	Latte Walnut	Walnut	Flat Sliced
MHW	Mahogany on Walnut	Walnut	Flat Sliced
MTW	Milestone	White Oak	Rift
MPW	Natural Maple	Maple	Flat Sliced
NLW	Natural Walnut	Walnut	Flat Sliced
RCW	Red Cherry	Cherry	Flat Sliced
VNW	Vintage Cherry	Cherry	Flat Sliced
ULW	Umber Walnut	Walnut	Flat Sliced
WLW	Walnut	Walnut	Flat Sliced
WCW	Warm Cherry	Cherry	Flat Sliced
WMW	White Maple	Maple	Flat Sliced

EDGES

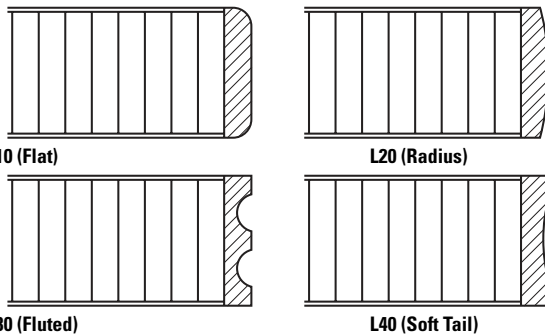

LOCKS

- Locks come standard on all storage beneath worksurface height. Above worksurface height locks are optional.
- For optional lock, specify **L0**. Add **\$143** per lock.

HANDLES

- Handles are standard on most drawers/storage modules. Each handle is identified by letters: **PL33, PL34, PL64, PL66, PL92, PL93, PL94, PL95, PL96, PL97, PL98, PL99, PLS7, and PLS8**. To specify a handle, specify the code after the model number and finish selections.



GROMMETS

- Standard grommet on all components is **GM5P**. Grommet is included with products where shown in line drawings in price book.
- Optional grommets may be ordered in standard worksurface locations (left, center or right). Order as **GM5PTL, GM5PTC or GM5PTR**. Add **\$103**.
- Grommet hole dimensions are 3.5" x 2".
- To order a grommet cover only, specify **GM5EP** for Black or **GM5KP** for Tungsten. Add **\$61**.
- Components that come standard with grommet may be ordered without a grommet. Order as RSG - Add **\$57**.

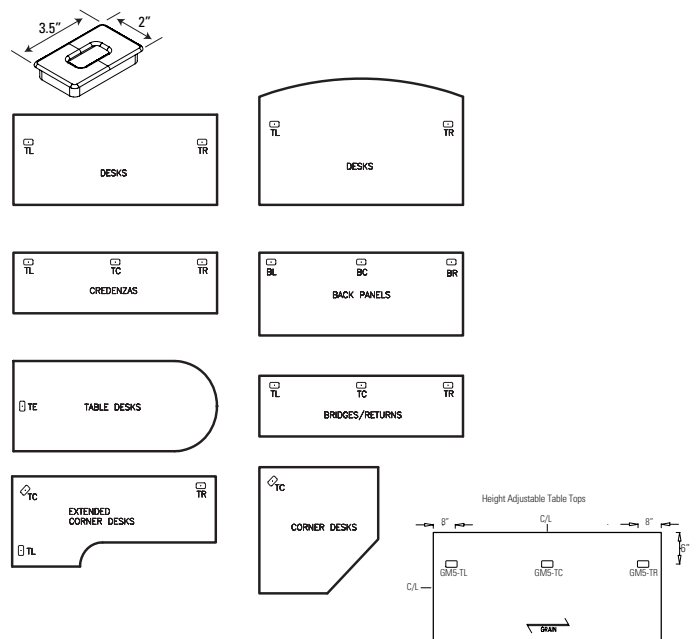

DOUBLE PEDESTAL DESK NOTES

- Can be ordered as a shell or with pedestals.
- Grommets are available as an option on Desks and most Credenzas.
- Hand of Rectangular Desk is determined by location of pedestal from user side.
- Hand of "D" Island is determined by outward orientation of conference end from user projection.

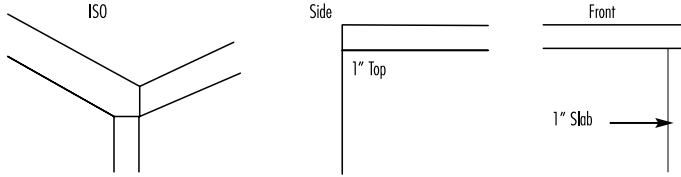

MODESTY PANEL CLEARANCE:

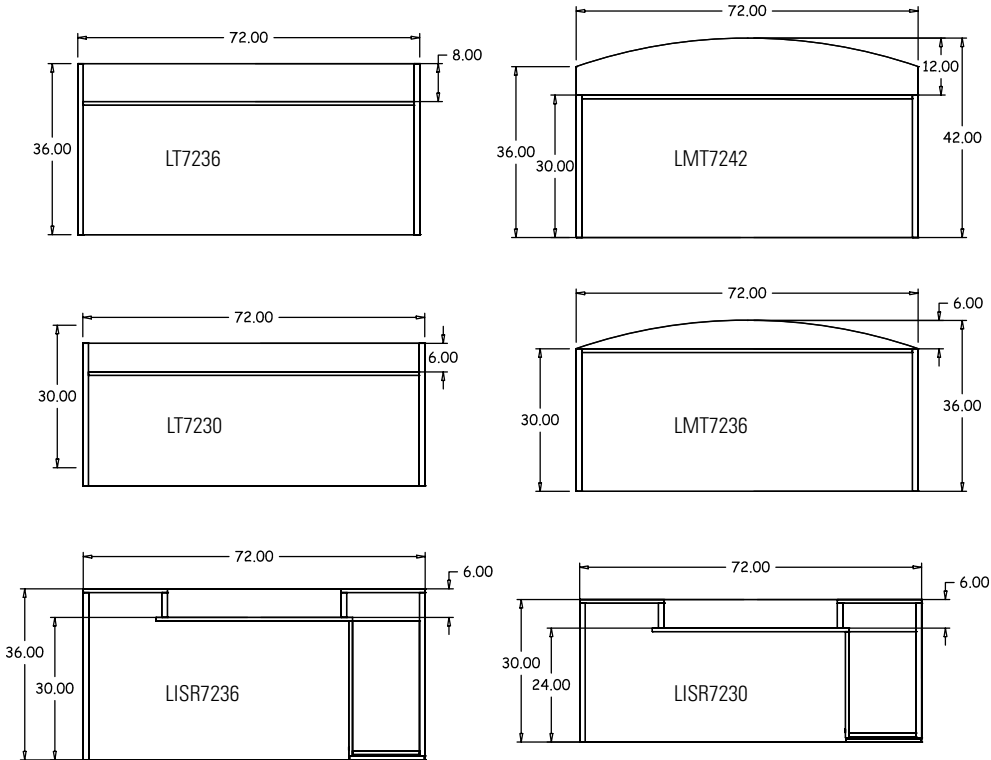

NOTE: Arrow indicates direction of grain.

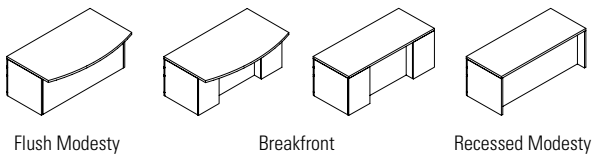
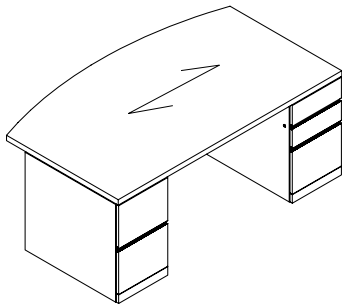

DESK MODESTY OPTIONS:

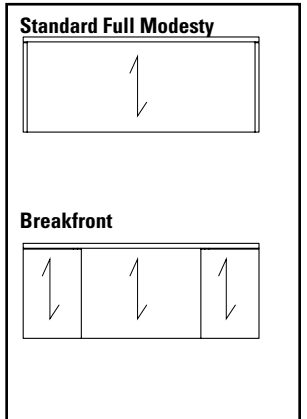

DOUBLE PEDESTAL DESKS - RECESSED FRONT MODESTY MODEL# **DIMENSIONS** **FREIGHT CLASS** **WT/LBS.** **CUBIC FT.** **LIST PRICE**

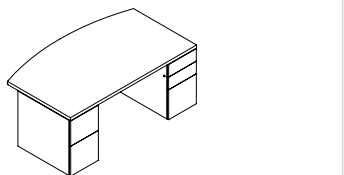

Double Pedestal Bow Top Desk

	D x W x H				
LMD8442ED	42 x 84 x 29	125	443	59	\$7401
LMD7842ED	42 x 78 x 29	125	412	55	\$6876
LMD7242ED	42 x 72 x 29	125	380	51	\$6344
LMD6636ED	36 x 66 x 29	125	240	40	\$6156

Standard with full to floor **file/file** pedestal on **left** and **box/box/file** pedestal on **right**. Bow top. Pedestals lock. One pencil tray. Refer to the Desks and Credenzas Notes Section above for overhang dimensions. Ships assembled in one carton.

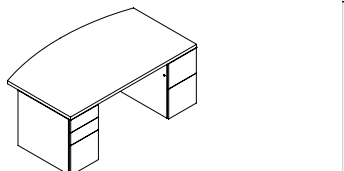

Double Pedestal Bow Top Desk

LMD8442DE	42 x 84 x 29	125	443	59	\$7401
LMD7842DE	42 x 78 x 29	125	412	55	\$6876
LMD7242DE	42 x 72 x 29	125	380	51	\$6344
LMD6636DE	36 x 66 x 29	125	240	40	\$6156

Standard with full to floor **box/box/file** pedestal on **left** and **file/file** pedestal on **right**. Bow top. Pedestals lock. One pencil tray. Refer to the Desks and Credenzas Notes Section on previous page for overhang dimensions. Ships assembled in one carton.

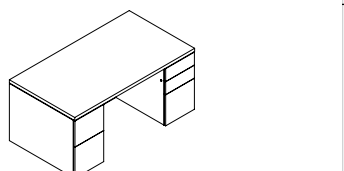

Double Pedestal Desk

LD8436ED	36 x 84 x 29	125	432	59	\$6291
LD7236ED	36 x 72 x 29	100	370	44	\$5394
LD7230ED	30 x 72 x 29	100	349	36	\$5315
LD6636ED	36 x 66 x 29	100	339	40	\$5315
LD6630ED	30 x 66 x 29	100	320	33	\$5230

Standard with full to floor **file/file** pedestal on **left** and **box/box/file** pedestal on **right**. Pedestals lock. Refer to the Desks and Credenzas Notes Section on previous page for overhang dimensions. Ships assembled in one carton.

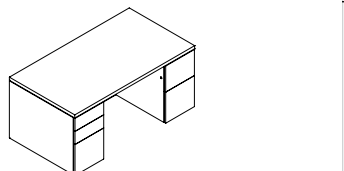

Double Pedestal Desk

LD8436DE	36 x 84 x 29	125	432	59	\$6291
LD7236DE	36 x 72 x 29	100	370	44	\$5394
LD7230DE	30 x 72 x 29	100	349	36	\$5315
LD6636DE	36 x 66 x 29	100	339	40	\$5315
LD6630DE	30 x 66 x 29	100	320	33	\$5230

Standard with full to floor **box/box/file** pedestal on **left** and **file/file** pedestal on **right**. Pedestals lock. Refer to the Desks and Credenzas Notes Section on previous page for overhang dimensions.

DOUBLE PEDESTAL DESKS - BREAKFRONT STYLE **MODEL#** **DIMENSIONS** **FREIGHT CLASS** **WT/LBS.** **CUBIC FT.** **LIST PRICE**

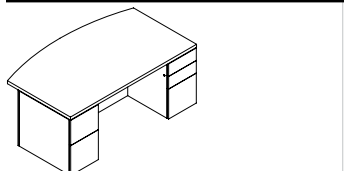

Double Pedestal Bow Top Desk Breakfront Style

LMID8442ED	42 x 84 x 29	125	443	59	\$8278
LMID7842ED	42 x 78 x 29	125	412	55	\$7703
LMID7242ED	42 x 72 x 29	125	380	51	\$7122
LMID6636ED	36 x 66 x 29	125	240	40	\$6856

Standard with full to floor **file/file** pedestal on **left** and **box/box/file** pedestal on **right**. Bow top. Pedestals lock. One pencil tray. Refer to the Desks and Credenzas Notes Section on previous page for overhang dimensions. Ships assembled in one carton.

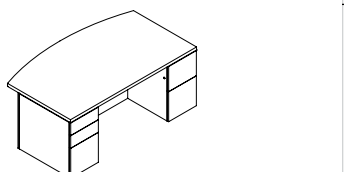

Double Pedestal Bow Top Desk Breakfront Style

LMID8442DE	42 x 84 x 29	125	443	59	\$8278
LMID7842DE	42 x 78 x 29	125	412	55	\$7703
LMID7242DE	42 x 72 x 29	125	380	51	\$7122
LMID6636DE	36 x 66 x 29	125	240	40	\$6856

Standard with full to floor **box/box/file** pedestal on **left** and **file/file** pedestal on **right**. Bow top. Pedestals lock. One pencil tray. Refer to the Desks and Credenzas Notes Section on previous page for overhang dimensions. Ships assembled in one carton.

Required Specifications

Veneer Finish
Edge

Optional Specifications

Grommet

DOUBLE PEDESTAL DESKS - BREAKFRONT STYLE

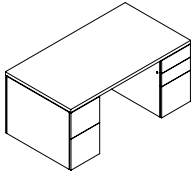

Double Pedestal Desk, Breakfront Style

MODEL#	DIMENSIONS D x W x H	FREIGHT CLASS	WT/LBS.	CUBIC FT.	LIST PRICE
LID8436ED	36 x 84 x 29	125	432	59	\$6496
LID7236ED	36 x 72 x 29	100	370	44	\$6031
LID7230ED	30 x 72 x 29	100	349	36	\$5937
LID6636ED	36 x 66 x 29	100	339	40	\$5937
LID6630ED	30 x 66 x 29	100	320	33	\$5846

Standard with full to floor **file/file** pedestal on **left** and **box/box/file** pedestal on **right**. Pedestals lock. Refer to the Desks and Credenzas Notes Section on previous page for overhang dimensions. Ships assembled in one carton.

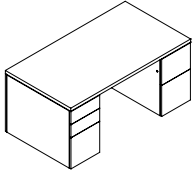

Double Pedestal Desk, Breakfront Style

LID8436DE	36 x 84 x 29	125	432	59	\$6496
LID7236DE	36 x 72 x 29	100	370	44	\$6031
LID7230DE	30 x 72 x 29	100	349	36	\$5937
LID6636DE	36 x 66 x 29	100	339	40	\$5937
LID6630DE	30 x 66 x 29	100	320	33	\$5846

Standard with full to floor **box/box/file** pedestal on **left** and **file/file** pedestal on **right**. Pedestals lock. Refer to the Desks and Credenzas Notes Section on page 274 for overhang dimensions. Ships assembled in one carton.

SINGLE PEDESTAL DESKS

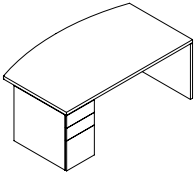

Single Pedestal Bow Top Desk - LEFT

MODEL#	DIMENSIONS	FREIGHT CLASS	WT/LBS.	CUBIC FT.	LIST PRICE
LMSL8442D	42 x 84 x 29	125	432	59	\$7087
LMSL7842D	42 x 78 x 29	125	401	55	\$6577
LMSL7242D	42 x 72 x 29	125	370	51	\$6078
LMSL6636D	36 x 66 x 29	150	230	40	\$5846

Standard with full to floor **box/box/file** pedestal on **left**. Bow top. Pedestal locks. Refer to the Desks and Credenzas Notes Section on page 274 for overhang dimensions. Ships assembled in one carton.

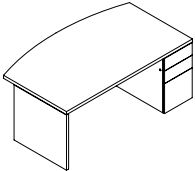

Single Pedestal Bow Top Desk - RIGHT

LMSR8442D	42 x 84 x 29	125	432	59	\$7087
LMSR7842D	42 x 78 x 29	125	401	55	\$6577
LMSR7242D	42 x 72 x 29	125	370	51	\$6078
LMSR6636D	36 x 66 x 29	150	230	40	\$5846

Standard with full to floor **box/box/file** pedestal on **right**. Bow top. Pedestal locks. Refer to the Desks and Credenzas Notes Section on page 274 for overhang dimensions. Ships assembled in one carton.

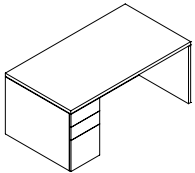

Single Pedestal Desk - LEFT

LSL8436D	42 x 84 x 29	125	463	59	\$4800
LSL7236D	36 x 72 x 29	125	340	44	\$4116
LSL7230D	30 x 72 x 29	125	283	36	\$3930
LSL6636D	36 x 66 x 29	125	312	40	\$3930
LSL6630D	30 x 66 x 29	100	295	33	\$3756

Standard with full to floor **box/box/file** pedestal on **left**. Pedestal locks. Refer to the Desks and Credenzas Notes Section on page 274 for overhang dimensions. Ships assembled in one carton.

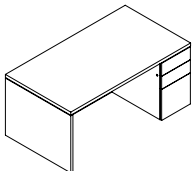

Single Pedestal Desk - RIGHT

LSR8436D	36 x 84 x 29	125	463	59	\$4800
LSR7236D	36 x 72 x 29	125	340	44	\$4116
LSR7230D	30 x 72 x 29	125	283	36	\$3930
LSR6636D	36 x 66 x 29	125	312	40	\$3930
LSR6630D	30 x 66 x 29	100	295	33	\$3756

Standard with full to floor **box/box/file** pedestal on **right**. Pedestal locks. Refer to the Desks and Credenzas Notes Section on page 274 for overhang dimensions. Ships assembled in one carton.

Required Specifications

Veneer Finish
Edge

Optional Specifications

Grommet

ELECTRIC HEIGHT ADJUSTABLE UNITS MODEL# DIMENSIONS FREIGHT CLASS WT/LBS. CUBIC FT. LIST PRICE

D x W x H

- All Height Adjustable (HA) units are shipped fully assembled.
- Simple Up / Down function enables the height adjustment of the worksurface.
- The height adjustment range for desks is 29" to 45", for table and bridge top 26" to 43" (including worksurface).
- Single stage HA mechanism with an electric motor in each column is used.
- The height adjustable mechanism operates at 1.5" per second.
- Max. weight / lift is 265 lbs.
- All columns are integrated into fully functional pedestals, or pedestal bases with the exception of the HA table and the HA bridge top.
- Height adjustable bases are available in three colors: **Black (BLK)**, **Tungsten (TUN)**, and **Designer White (DWT)**
- All desks include two (2) PVC wire management channels (L & R side) allowing for cabling through the pedestals.
- Hanging wood modesty panel on desk is standard.
- To avoid risk of pinching:
 - 4.9" / 124mm gap is kept between the pedestal and the lowest point of the worksurface.
 - Wood spacer HASP must be used to attach height adjustable unit in the "U" or "L" configuration. See assembly instructions.
 - 2" gap is required between the worksurfaces when using the HA Table or the HA Bridge Top.
 - Includes collision detector
- Optional grommet locations: **TL** - Top Left or **TR** - Top Right

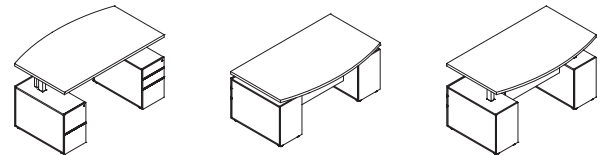
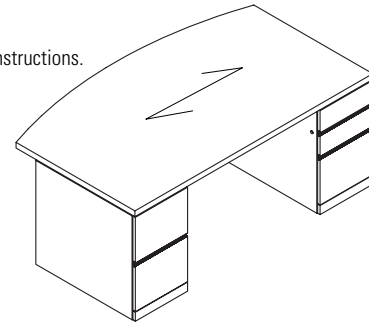

Note: Arrow indicates direction of grain.

HEIGHT ADJUSTABLE DOUBLE PEDESTAL DESKS MODEL# DIMENSIONS FREIGHT CLASS WT/LBS. CUBIC FT. LIST PRICE

D x W x H

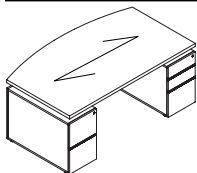

Height Adj. Double Ped. Bow Top Desk Breakfront Style

LHAMID8442ED	42 x 84 x 29	150	450	78	\$14581
LHAMID7842ED	42 x 78 x 29	150	430	72	\$13965
LHAMID7242ED	42 x 72 x 29	150	410	69	\$13349
LHAMID6636ED	36 x 66 x 29	125	390	54	\$12662

Built-in electric height adjustable double pedestal, standard with full to floor **box/box/file** pedestal on **right** and **file/file** pedestal on **left**. Bow top. Pedestals lock. One pencil tray. Refer to the Desks and Credenzas Notes Section on page 274 for overhang dimensions. Shipped RTA - ready to assemble.

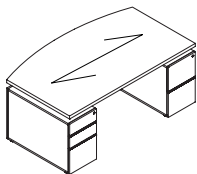

Height Adj. Double Ped. Bow Top Desk Breakfront Style

LHAMID8442DE	42 x 84 x 29	150	450	78	\$14581
LHAMID7842DE	42 x 78 x 29	150	430	72	\$13965
LHAMID7242DE	42 x 72 x 29	150	410	69	\$13349
LHAMID6636DE	36 x 66 x 29	125	390	54	\$12662

Built-in electric height adjustable double pedestal, standard with full to floor **box/box/file** pedestal on **left** and **file/file** pedestal on **right**. Bow top. Pedestals lock. One pencil tray. Refer to the Desks and Credenzas Notes Section on page 274 for overhang dimensions. Shipped RTA - ready to assemble.

Required Specifications

- Top finish
- Edge
- Base finish
- Handle style

Optional Specifications

- Grommet
- Glass modesty

HEIGHT ADJUSTABLE DOUBLE PEDESTAL DESKS **MODEL#** **DIMENSIONS** **FREIGHT CLASS** **WT/LBS.** **CUBIC FT.** **LIST PRICE**

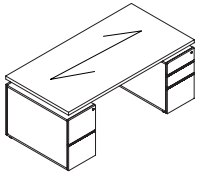

**Height Adj. Double Ped. Desk
Breakfront Style**

	D x W x H					
LHAID8436ED	36 x 84 x 29	125	440	68		\$12415
LHAID7836ED	36 x 78 x 29	125	420	63		\$12332
LHAID7236ED	36 x 72 x 29	125	400	58		\$12243
LHAID7230ED	30 x 72 x 29	125	390	49		\$12152
LHAID6630ED	30 x 66 x 29	100	380	46		\$11983

Built-in electric height adjustable double pedestal, standard with full to floor **box/box/file** pedestal on **right** and **file/file** pedestal on **left**. Pedestals lock. One pencil tray. Refer to the Desks and Credenzas Notes Section on page 274 for overhang dimensions. Shipped RTA - ready to assemble.

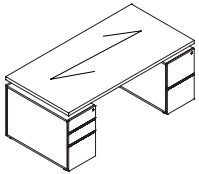

**Height Adj. Double Ped. Desk
Breakfront Style**

LHAID8436DE	36 x 84 x 29	125	440	68		\$12415
LHAID7836DE	36 x 78 x 29	125	420	63		\$12332
LHAID7236DE	36 x 72 x 29	125	400	58		\$12243
LHAID7230DE	30 x 72 x 29	125	390	49		\$12152
LHAID6630DE	30 x 66 x 29	100	380	46		\$11983

Built-in electric height adjustable double pedestal, standard with full to floor **box/box/file** pedestal on **left** and **file/file** pedestal on **right**. Pedestals lock. One pencil tray. Refer to the Desks and Credenzas Notes Section on page 274 for overhang dimensions. Shipped RTA - ready to assemble.

HEIGHT ADJUSTABLE SINGLE PEDESTAL DESKS **MODEL#** **DIMENSIONS** **FREIGHT CLASS** **WT/LBS.** **CUBIC FT.** **LIST PRICE**

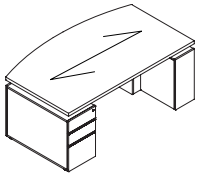

**Height Adj. Single Ped. Bow Top Desk
Breakfront Style - LEFT**

LHAMISL8442D	42 x 84 x 29	150	440	81		\$12787
LHAMISL7842D	42 x 78 x 29	150	420	72		\$12306
LHAMISL7242D	42 x 72 x 29	150	400	67		\$11823
LHAMISL6636D	36 x 66 x 29	125	390	54		\$11220

Built-in electric height adjustable single pedestal bow top desk. Standard with full to floor locking **box/box/file** pedestal on **left** and support pedestal on **right**. Refer to the Desks and Credenzas Notes Section on page 274 for overhang dimensions. Shipped RTA - ready to assemble.

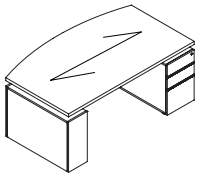

**Height Adj. Single Ped. Bow Top Desk
Breakfront Style - RIGHT**

LHAMISR8442D	42 x 84 x 29	150	440	81		\$12787
LHAMISR7842D	42 x 78 x 29	150	420	72		\$12306
LHAMISR7242D	42 x 72 x 29	150	400	67		\$11823
LHAMISR6636D	36 x 66 x 29	125	390	54		\$11220

Built-in electric height adjustable single pedestal bow top desk. Standard with full to floor locking **box/box/file** pedestal on **right** and support pedestal on **left**. Refer to the Desks and Credenzas Notes Section on page 274 for overhang dimensions. Shipped RTA - ready to assemble.

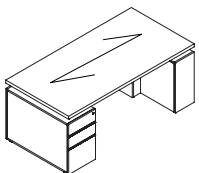

**Height Adjustable Single Ped. Desk
Breakfront Style - LEFT**

LHAISL8436D	36 x 84 x 29	125	430	68		\$10924
LHAISL7836D	36 x 78 x 29	125	410	63		\$10883
LHAISL7236D	36 x 72 x 29	125	390	58		\$10750
LHAISL7230D	30 x 72 x 29	125	380	49		\$10541
LHAISL6630D	30 x 66 x 29	125	360	46		\$10266
LHAISL6030D	30 x 60 x 29	100	340	42		\$10071

Built-in electric height adjustable single pedestal desk. Standard with full to floor locking **box/box/file** pedestal on **left** and support pedestal on **right**. Refer to the Desks and Credenzas Notes Section on page 274 for overhang dimensions. Shipped RTA - ready to assemble.

Required Specifications

- Top finish
- Edge
- Base finish
- Handle style

Optional Specifications

- Grommet
- Glass modesty

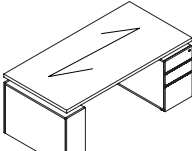
HEIGHT ADJUSTABLE SINGLE PEDESTAL DESKS	MODEL#	DIMENSIONS	FREIGHT CLASS	WT./LBS.	CUBIC FT.	LIST PRICE
D x W x H						
	LHAISR8436D	36 x 84 x 29	125	430	68	\$10924
	LHAISR7836D	36 x 78 x 29	125	410	63	\$10883
	LHAISR7236D	36 x 72 x 29	125	390	58	\$10750
	LHAISR7230D	30 x 72 x 29	125	380	49	\$10541
	LHAISR6630D	30 x 66 x 29	125	360	46	\$10266
	LHAISR6030D	30 x 60 x 29	100	340	42	\$10071

Height Adjustable Single Ped. Desk*
Breakfront Style - RIGHT

Built-in electric height adjustable single pedestal desk. Standard with full to floor locking **box/box/file** pedestal on **right** and support pedestal on **left**. Refer to the Desks and Credenzas Notes Section on page 274 for overhang dimensions. Shipped RTA - ready to assemble.

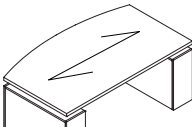
HEIGHT ADJUSTABLE DESK SHELLS	MODEL#	DIMENSIONS	FREIGHT CLASS	WT./LBS.	CUBIC FT.	LIST PRICE
	LHAMIT8442	42 x 84 x 29	150	350	81	\$12389
	LHAMIT7842	42 x 78 x 29	150	330	72	\$12122
	LHAMIT7242	42 x 72 x 29	150	310	67	\$11851
	LHAMIT6636	36 x 66 x 29	150	280	54	\$10694

Height Adjustable Bow Top Desk Shell
Breakfront Style

Built-in electric height adjustable bow top desk shell. Refer to the Desks and Credenzas Notes Section on page 274 for overhang dimensions. Shipped RTA - ready to assemble.

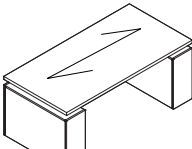
	LHAIT8436	36 x 84 x 29	150	330	68	\$11022
	LHAIT7836	36 x 78 x 29	150	310	63	\$10819
	LHAIT7236	36 x 72 x 29	150	290	58	\$10602
	LHAIT7230	30 x 72 x 29	150	280	49	\$9939
	LHAIT6636	36 x 66 x 29	150	260	54	\$10183
	LHAIT6630	30 x 66 x 29	150	250	46	\$9939
	LHAIT6030	30 x 60 x 29	150	240	42	\$9762

Height Adjustable Desk Shell
Breakfront Style

Built-in electric height adjustable desk shell. Refer to the Desks and Credenzas Notes Section on page 274 for overhang dimensions. Shipped RTA - ready to assemble.

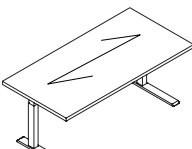
	LHA8436	36 x 84 x 29	250	160	68	\$8921
	LHA7836	36 x 78 x 29	250	150	63	\$8720
	LHA7236	36 x 72 x 29	250	140	58	\$8501
	LHA7230	30 x 72 x 29	250	130	49	\$7835
	LHA6636	36 x 66 x 29	250	140	54	\$8081
	LHA6630	30 x 66 x 29	250	120	46	\$7835
	LHA6030	30 x 60 x 29	250	115	42	\$7661

Height Adjustable Table

Electric height adjustable table. Shipped RTA - ready to assemble.

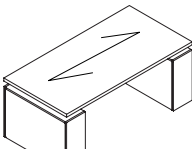
	LHA8436TP	36 x 84 x 29	150	320	68	\$10673
	LHA7836TP	36 x 78 x 29	150	300	63	\$10469
	LHA7236TP	36 x 72 x 29	150	280	58	\$10253
	LHA7230TP	30 x 72 x 29	150	270	49	\$9587
	LHA6636TP	36 x 66 x 29	150	250	54	\$9834
	LHA6630TP	30 x 66 x 29	150	240	46	\$9587
	LHA6030TP	30 x 60 x 29	150	230	42	\$9412

Height Adjustable Desk

Built-in electric height adjustable desk on TP bases. Shipped RTA - ready to assemble.

Required Specifications

- Top finish
- Edge
- Base finish
- Handle style*

Optional Specifications

- Grommet
- Glass modesty

HEIGHT ADJUSTABLE UNITS

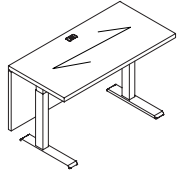

Height Adjustable Bridge Top

MODEL#	DIMENSIONS D x W x H	FREIGHT CLASS	WT/LBS.	CUBIC FT.	LIST PRICE
LHABT6024	24 x 60 x 29	150	150	35	\$8313
LHABT5424	24 x 54 x 29	150	140	31	\$8067
LHABT4824	24 x 48 x 29	150	130	28	\$7821
LHABT4224	24 x 42 x 29	150	120	26	\$7567

Electric height adjustable executive bridge top. Grommet in worksurface. Shipped RTA - ready to assemble.

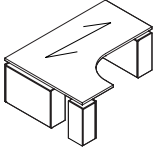

Height Adj. Right Extended Corner Desk*

LHAEKR60842436	24-36 x 60-84 x 29	150	450	108	\$16528
LHAEKR60782436	24-36 x 60-78 x 29	150	430	100	\$16488
LHAEKR60722436	24-36 x 60-72 x 29	150	410	93	\$16124
LHAEKR60662436	24-36 x 60-66 x 29	150	390	86	\$15654
LHAEKR60602436	24-36 x 60-60 x 29	150	370	79	\$15185

Built-in electric height adjustable right extended corner table desk with a 24" return connection. Extended worksurface on **right. Full end panel on right, narrow end panel on left.** Connects to Linking Bridges, Extended Corners and Connectable Tables. Shipped RTA - ready to assemble.

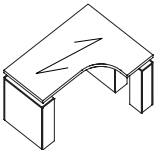

Height Adj. Left Extended Corner Desk*

LHAEKL84603624	24-36 x 60-84 x 29	150	450	108	\$16528
LHAEKL78603624	24-36 x 60-78 x 29	150	430	100	\$16488
LHAEKL72603624	24-36 x 60-72 x 29	150	410	93	\$16124
LHAEKL66603624	24-36 x 60-66 x 29	150	390	86	\$15654
LHAEKL60603624	24-36 x 60-60 x 29	150	370	79	\$15185

Built-in electric height adjustable right extended corner table desk with a 24" return connection. Extended worksurface on **left. Full end panel on left, narrow end panel on right.** Connects to Linking Bridges, Extended Corners and Connectable Tables. Shipped RTA - ready to assemble.



Spacer

LHASP	2 x 8 x 23	70	15	.75	\$598
-------	------------	----	----	-----	--------------

Connects height adjustable desks with linking bridges and returns.

Required Specifications

Top finish
Edge
Base finish

Optional Specifications

Grommet*
Glass modesty

HEIGHT ADJUSTABLE TOPS

MODEL#	DIMENSIONS	FREIGHT CLASS	WT/LBS.	CUBIC FT.	LIST PRICE
D x W x H					
LRE8223T	23 x 82 x 1.18	92.5	82	7	\$1760
LRE7623T	23 x 76 x 1.18	92.5	77	6.5	\$1631
LRE7023T	23 x 70 x 1.18	85	72	6	\$1507
LRE6423T	23 x 64 x 1.18	85	66	5.5	\$1372
LRE5223T	23 x 52 x 1.18	85	56	4.5	\$1114
LRE4623T	23 x 46 x 1.18	85	50	4	\$991
LRE4023T	23 x 40 x 1.18	85	45	3.5	\$862
LRE8229T	29 x 82 x 1.18	85	101	8	\$2222
LRE7629T	29 x 76 x 1.18	85	94	7.5	\$2061
LRE7029T	29 x 70 x 1.18	85	88	7	\$1894
LRE6429T	29 x 64 x 1.18	85	81	6.5	\$1733
LRE5229T	29 x 52 x 1.18	85	68	5.5	\$1411
LRE4629T	29 x 46 x 1.18	85	61	5	\$1249
LRE4029T	29 x 40 x 1.18	85	55	4.5	\$1083
LRE8235T	35 x 82 x 1.18	85	120	10	\$2680
LRE7635T	35 x 76 x 1.18	85	112	9	\$2486
LRE7235T	35 x 72 x 1.18	85	104	8.5	\$2357
LRE6435T	35 x 64 x 1.18	85	96	8	\$2093
LRE5235T	35 x 52 x 1.18	85	80	6.5	\$1700
LRE4635T	35 x 46 x 1.18	85	72	6	\$1507
LRE4035T	35 x 40 x 1.18	85	64	5	\$1308

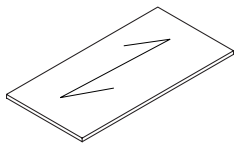

Height Adjustable Top

Lufton tops with Lufton edge on three sides, for use with FreeFit height adjustable table mechanisms, sold separately (FTxxxxx, see page 713 of the Desking price list for information).

- 23" deep tops accommodate FTxxxx24 mechanisms. Depth is exact to accommodate the Lufton edge + the Freefit mechanism. *Cannot be made smaller.*
- 29" and 35" deep tops accommodate FTxxxx30 mechanisms.

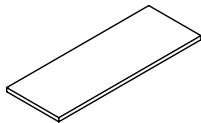

HA Return Top

LRE6024CGT	24 x 60 x 1.18	300	10	5.5	\$1346
LRE5424CGT	24 x 54 x 1.18	250	10	5	\$1211
LRE4824CGT	24 x 48 x 1.18	250	10	4.5	\$1077
LRE4224CGT	24 x 42 x 1.18	250	10	4	\$942

Lufton return tops with Lufton edge on three sides, for use with FreeFit height adjustable table mechanisms, sold separately (FTxxxxx, see page 713 of the Desking price list for information).

Required Specifications

Veneer finish
Edge

Optional Specifications

Grommet

MODESTY PANEL OPTIONS

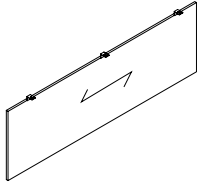

Veneer Modesty Panel Upgrade*

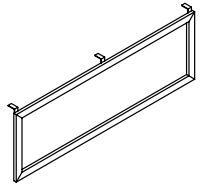

Glass Modesty Panel Upgrade

MODEL#	DIMENSIONS D x W x H	FREIGHT CLASS	WT./LBS.	CUBIC FT.	LIST PRICE
CMP72W	0.75 x 67 x 18	--	20	1	\$1728
CMP66W	0.75 x 61 x 18	--	18	1	\$1673
CMP60W	0.75 x 55 x 18	--	16	1	\$1647
CMP54W	0.75 x 49 x 18	--	14	1	\$1619
CMP48W	0.75 x 43 x 18	--	13	1	\$1594

Straight modesty panel. Attaches to underside of worksurface. **Can not be retrofitted in the field *Not sold individually - to be ordered as an upgrade option only.***

- CMP72W - Specify on "P" Top Islands or 96" x 48" Islands for Piano Desks.
- CMP66W - Specify on 84" x 36" "D" Top Islands.
- CMP60W - Specify on 84" x 42" "P" Top Islands or 84" x 48" Islands for Piano Desks.
- CMP54W - Specify on 72" x 30" "D" Top Islands.
- CMP48W - Specify on 66" x 36" , 60" x 30" "D" Top Islands, 72" x 42" "P" Top Islands or 72" x 48" Islands for Piano Desks.

CMP72G	0.75 x 67 x 18	--	20	1	\$2647
CMP66G	0.75 x 61 x 18	--	18	1	\$2504
CMP60G	0.75 x 55 x 18	--	16	1	\$2289
CMP54G	0.75 x 49 x 18	--	14	1	\$2132
CMP48G	0.75 x 43 x 18	--	13	1	\$2036

Straight modesty panel. Translucent, screened glass. Aluminum box frame construction in Tungsten Only. Attaches to underside of worksurface. **Can not be retrofitted in the field. *Not sold individually - to be ordered as an upgrade option only.***

- CMP72G - Specify on "P" Top Islands or 96" x 48" Islands for Piano Desks.
- CMP66G - Specify on 84" x 36" "D" Top Islands.
- CMP60G - Specify on 84" x 42" "P" Top Islands or 84" x 48" Islands for Piano Desks.
- CMP54G - Specify on 72" x 30" "D" Top Islands.
- CMP48G - Specify on 66" x 36" , 60" x 30" "D" Top Islands, 72" x 42" "P" Top Islands or 72" x 48" Islands for Piano Desks.
- Tungsten finish on the aluminum box frame closely resembles the existing Tungsten finish.

Required Specifications

Veneer finish
Edge
Handle style

Optional Specifications

Grommet

SINGLE PEDESTAL DESKS - BREAKFRONT STYLE **MODEL#** **DIMENSIONS** **FREIGHT CLASS** **WT/LBS.** **CUBIC FT.** **LIST PRICE**

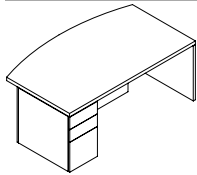

Single Pedestal Bow Top Desk - LEFT Breakfront Style*

	D x W x H					
LMISL8442D	42 x 84 x 29	125	432	59		\$7232
LMISL7842D	42 x 78 x 29	125	401	55		\$6724
LMISL7242D	42 x 72 x 29	125	370	51		\$6228
LMISL6636D	36 x 66 x 29	150	230	40		\$5937

Standard with full to floor **box/box/file** pedestal on **left**. Bow top. Pedestal locks. Refer to the Desks and Credenzas Notes Section on page 274 for overhang dimensions. Ships assembled in 1 carton.

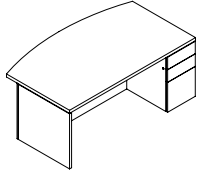

Single Pedestal Bow Top Desk - RIGHT Breakfront Style*

LMISR8442D	42 x 84 x 29	125	432	59		\$7232
LMISR7842D	42 x 78 x 29	125	401	55		\$6724
LMISR7242D	42 x 72 x 29	125	370	51		\$6228
LMISR6636D	36 x 66 x 29	150	230	40		\$5937

Standard with full to floor **box/box/file** pedestal on **right**. Bow top. Pedestal locks. Refer to the Desks and Credenzas Notes Section on page 274 for overhang dimensions. Ships assembled in 1 carton.

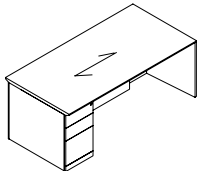

Single Pedestal Desk - LEFT Breakfront Style

LISL8436D	36 x 84 x 29	125	463	59		\$6308
LISL7236D	36 x 72 x 29	125	340	44		\$5373
LISL7230D	30 x 72 x 29	125	283	36		\$4423
LISL6636D	36 x 66 x 29	125	312	40		\$4423
LISL6630D	30 x 66 x 29	100	295	33		\$4225

Standard with full to floor **box/box/file** pedestal on **left**. Pedestal locks. Refer to the Desks and Credenzas Notes Section on page 274 for overhang dimensions. Ships assembled in 1 carton.

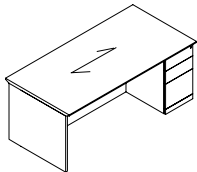

Single Pedestal Desk - RIGHT Breakfront Style

LISR8436D	42 x 84 x 29	125	463	59		\$6308
LISR7236D	36 x 72 x 29	125	340	44		\$5373
LISR7230D	30 x 72 x 29	125	283	36		\$4423
LISR6636D	36 x 66 x 29	125	312	40		\$4423
LISR6630D	30 x 66 x 29	100	295	33		\$4225

Standard with full to floor **box/box/file** pedestal on **right**. Pedestal locks. Refer to the Desks and Credenzas Notes Section on page 274 for overhang dimensions. Ships assembled in 1 carton.

Required Specifications

Veneer Finish
Laminate Finish
Handle Style

Optional Specifications

Grommet

DESK SHELLS

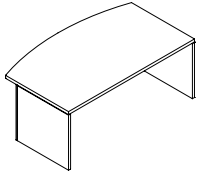

Bow Top Desk Shell

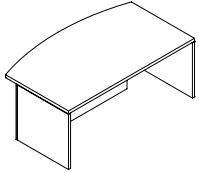

Bow Top Desk Shell, Breakfront Style

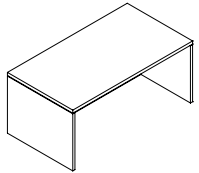

Desk Shell

MODEL#	DIMENSIONS	FREIGHT CLASS	WT/LBS.	CUBIC FT.	LIST PRICE
--------	------------	---------------	---------	-----------	------------

LMT8442	42 x 84 x 29	125	380	59	\$5447
LMT7842	42 x 78 x 29	125	353	55	\$5053
LMT7242	42 x 72 x 29	125	331	51	\$4677
LMT6636	36 x 66 x 29	125	287	40	\$4450

Bow top and recessed modesty panel. Refer to the Desks and Credenzas Notes Section on page 274 for overhang dimensions. Ships assembled in 1 carton.

LMIT8442	42 x 84 x 29	125	380	59	\$5596
LMIT7842	42 x 78 x 29	125	353	55	\$5274
LMIT7242	42 x 72 x 29	125	331	51	\$4954
LMIT6636	36 x 66 x 29	125	287	40	\$4774

Bow top and recessed modesty panel. Refer to the Desks and Credenzas Notes Section on page 274 for overhang dimensions. Ships assembled in 1 carton.

LT8436	36 x 84 x 29	150	362	51	\$3918
LT7236	36 x 72 x 29	125	315	44	\$3726
LT7230	30 x 72 x 29	125	271	36	\$3512
LT6636	36 x 66 x 29	100	271	40	\$3512
LT6630	30 x 66 x 29	100	265	33	\$3291

Recessed modesty panel. Refer to the Desks and Credenzas Notes Section on page 274 for overhang dimensions. Ships assembled in 1 carton.

Required Specifications

Veneer Finish
Edge

Optional Specifications

Grommet

RETURNS	MODEL#	DIMENSIONS	FREIGHT CLASS	WT/LBS.	CUBIC FT.	LIST PRICE
---------	--------	------------	---------------	---------	-----------	------------

D x W x H

- An Executive Return is used to attach to a Single Pedestal Desk, Single Pedestal Credenza, Desk Shell or Credenza Shell.
- Grommets are available as an option.
- Hand of Executive Return is determined by location of full end panel from user side.
- Hand of Desk or Credenza is determined by location of pedestal from user side.
- To remove cross grain veneer pattern on top, delete suffix "CG" from the model number. Available as a special - no upcharge.

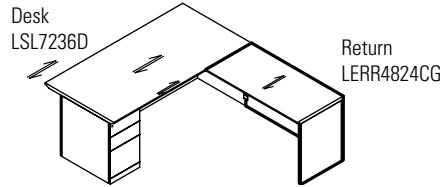
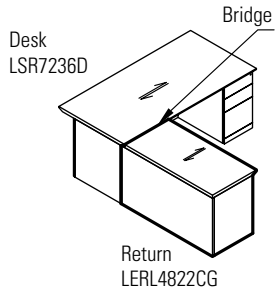

RETURNS	MODEL#	DIMENSIONS	FREIGHT CLASS	WT/LBS.	CUBIC FT.	LIST PRICE
---------	--------	------------	---------------	---------	-----------	------------

D x W x H

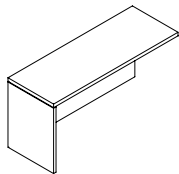

Flush Return - LEFT 24" Deep

LERL7224CG	24 x 72 x 29	150	135	29	\$2856
LERL6624CG	24 x 66 x 29	150	127	27	\$2668
LERL6024CG	24 x 60 x 29	150	120	24	\$2474
LERL5424CG	24 x 54 x 29	150	112	22	\$2289
LERL4824CG	24 x 48 x 29	150	105	19	\$2097
LERL4224CG	24 x 42 x 29	150	97	17	\$1904

Return has **no pedestal**. For use with right handed single pedestal desks, credenzas, desk shells, credenza shells, "D" islands or "P" islands.

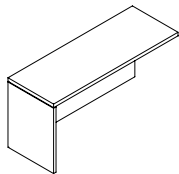

Flush Return - LEFT 20" Deep

LERL7220CG	20 x 72 x 29	150	130	27	\$2074
LERL6620CG	20 x 66 x 29	150	122	24	\$1904
LERL6020CG	20 x 60 x 29	150	115	22	\$1730
LERL5420CG	20 x 54 x 29	150	105	20	\$1562
LERL4820CG	20 x 48 x 29	150	100	18	\$1387
LERL4220CG	20 x 42 x 29	150	90	16	\$1217

Return has **no pedestal**. For use with right handed single pedestal desks, credenzas, desk shells, credenza shells, "D" islands or "P" islands.

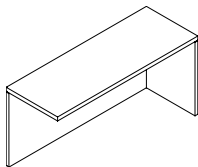

Flush Return - RIGHT 24" Deep

LERR7224CG	24 x 72 x 29	150	135	29	\$2856
LERR6624CG	24 x 66 x 29	150	127	27	\$2668
LERR6024CG	24 x 60 x 29	150	120	24	\$2474
LERR5424CG	24 x 54 x 29	150	112	22	\$2289
LERR4824CG	24 x 48 x 29	150	105	19	\$2097
LERR4224CG	24 x 42 x 29	150	97	17	\$1904

Return has **no pedestal**. For use with left handed single pedestal desks, credenzas, desk shells, credenza shells, "D" islands or "P" islands.

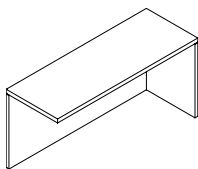

Flush Return - RIGHT 20" Deep

LERR7220CG	20 x 72 x 29	150	130	27	\$2074
LERR6620CG	20 x 66 x 29	150	122	24	\$1904
LERR6020CG	20 x 60 x 29	150	115	22	\$1730
LERR5420CG	20 x 54 x 29	150	105	20	\$1562
LERR4820CG	20 x 48 x 29	150	100	18	\$1387
LERR4220CG	20 x 42 x 29	150	90	16	\$1217

Return has **no pedestal**. For use with left handed single pedestal desks, credenzas, desk shells, credenza shells, "D" islands or "P" islands.

Required Specifications

Veneer Finish
Edge

Optional Specifications

Grommet

RETURNS

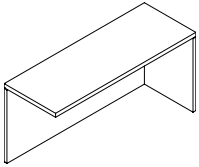

Non-Handed Return

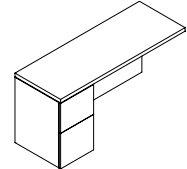

Flush Return - LEFT 24" Deep

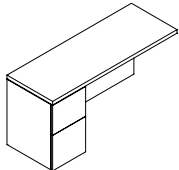

Flush Return - LEFT 20" Deep

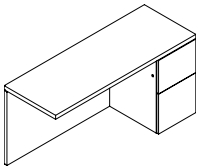

Flush Return - RIGHT 24" Deep

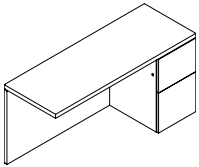

Flush Return - RIGHT 20" Deep

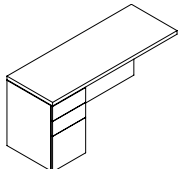

Flush Return - LEFT 24" Deep

MODEL#	DIMENSIONS	FREIGHT CLASS	WT/LBS.	CUBIC FT.	LIST PRICE
--------	------------	---------------	---------	-----------	------------

D x W x H

LERR-L4824CG	24 x 48 x 29	150	105	19	\$2723
LERR-L4224CG	24 x 42 x 29	150	97	17	\$2464
LERR-L4820CG	20 x 48 x 29	150	100	19	\$1804
LERR-L4220CG	20 x 42 x 29	150	90	17	\$1580

Return has **no pedestal**. For use with left or right handed single pedestal desks, credenzas, desk shells, credenza shells, "D" islands or "P" islands. Ships assembled in 1 carton.

LERL7224ECG	24 x 72 x 29	100	250	29	\$4765
LERL6624ECG	24 x 66 x 29	100	236	27	\$4608
LERL6024ECG	24 x 60 x 29	100	227	24	\$4232
LERL5424ECG	24 x 54 x 29	100	205	22	\$4092
LERL4824ECG	24 x 48 x 29	100	185	19	\$3688
LERL4224ECG	24 x 42 x 29	92.5	178	17	\$3565

Return has **file/file** pedestal on the **left**. Pedestal locks. For use with right handed single pedestal desks, credenzas, desk shells, credenza shells, "D" islands or "P" islands. Ships assembled in 1 carton.

LERL7220ECG	20 x 72 x 29	100	240	29	\$3696
LERL6620ECG	20 x 66 x 29	100	231	27	\$3560
LERL6020ECG	20 x 60 x 29	100	222	24	\$3236
LERL5420ECG	20 x 54 x 29	100	200	22	\$3120
LERL4820ECG	20 x 48 x 29	100	180	18	\$2779
LERL4220ECG	20 x 42 x 29	92.5	173	16	\$2668

Return has **file/file** pedestal on the **left**. Pedestal locks. For use with right handed single pedestal desks, credenzas, desk shells, credenza shells, "D" islands or "P" islands. Ships assembled in 1 carton.

LERR7224ECG	24 x 72 x 29	100	250	29	\$4765
LERR6624ECG	24 x 66 x 29	100	236	27	\$4608
LERR6024ECG	24 x 60 x 29	100	227	24	\$4232
LERR5424ECG	24 x 54 x 29	100	205	22	\$4092
LERR4824ECG	24 x 48 x 29	100	185	19	\$3688
LERR4224ECG	24 x 42 x 29	92.5	178	17	\$3565

Return has **file/file** pedestal on the **right**. Pedestal locks. For use with left handed single pedestal desks, credenzas, desk shells, credenza shells, "D" islands or "P" islands. Ships assembled in 1 carton.

LERR7220ECG	20 x 72 x 29	100	240	29	\$3696
LERR6620ECG	20 x 66 x 29	100	231	27	\$3560
LERR6020ECG	20 x 60 x 29	100	222	24	\$3236
LERR5420ECG	20 x 54 x 29	100	200	22	\$3120
LERR4820ECG	20 x 48 x 29	100	180	18	\$2779
LERR4220ECG	20 x 42 x 29	92.5	173	16	\$2668

Return has **file/file** pedestal on the **right**. Pedestal locks. For use with left handed single pedestal desks, credenzas, desk shells, credenza shells, "D" islands or "P" islands. Ships assembled in 1 carton.

LERL7224DCG	24 x 72 x 29	100	250	29	\$4765
LERL6624DCG	24 x 66 x 29	100	236	27	\$4608
LERL6024DCG	24 x 60 x 29	100	227	24	\$4232
LERL5424DCG	24 x 54 x 29	100	205	22	\$4092
LERL4824DCG	24 x 48 x 29	100	185	19	\$3688
LERL4224DCG	24 x 42 x 29	92.5	178	17	\$3565

Return has **box/box/file** pedestal on the **left**. Pedestal locks. For use with right handed single pedestal desks, credenzas, desk shells, credenza shells, "D" islands or "P" islands. Ships assembled in 1 carton.

Required Specifications

Veneer Finish
Edge

Optional Specifications

Grommet

RETURNS

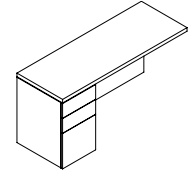

Flush Return - LEFT 20" Deep

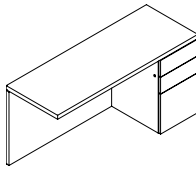

Flush Return - RIGHT 24" Deep

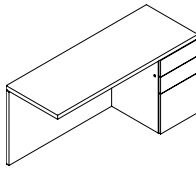

Flush Return - RIGHT 20" Deep

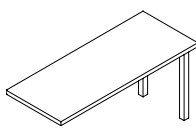

Return

MODEL#	DIMENSIONS D x W x H	FREIGHT CLASS	WT/LBS.	CUBIC FT.	LIST PRICE
LERL7220DCG	20 x 72 x 29	100	240	27	\$3696
LERL6620DCG	20 x 66 x 29	100	231	24	\$3560
LERL6020DCG	20 x 60 x 29	100	222	22	\$3236
LERL5420DCG	20 x 54 x 29	100	200	20	\$3120
LERL4820DCG	20 x 48 x 29	100	180	18	\$2779
LERL4220DCG	20 x 42 x 29	92.5	173	16	\$2668

Return has **box/box/file** pedestal on the **left**. Pedestal locks. For use with right handed single pedestal desks, credenzas, desk shells, credenza shells, "D" islands or "P" islands. Ships assembled in 1 carton.

LERR7224DCG	24 x 72 x 29	100	250	29	\$4765
LERR6624DCG	24 x 66 x 29	100	236	27	\$4608
LERR6024DCG	24 x 60 x 29	100	227	24	\$4232
LERR5424DCG	24 x 54 x 29	100	205	22	\$4092
LERR4824DCG	24 x 48 x 29	100	185	19	\$3688
LERR4224DCG	24 x 42 x 29	92.5	178	17	\$3565

Return has **box/box/file** pedestal on the **right**. Pedestal locks. For use with left handed single pedestal desks, credenzas, desk shells, credenza shells, "D" islands or "P" islands. Ships assembled in 1 carton.

LERR7220DCG	20 x 72 x 29	100	240	27	\$3696
LERR6620DCG	20 x 66 x 29	100	231	24	\$3560
LERR6020DCG	20 x 60 x 29	100	222	22	\$3236
LERR5420DCG	20 x 54 x 29	100	200	20	\$3120
LERR4820DCG	20 x 48 x 29	100	180	18	\$2779
LERR4220DCG	20 x 42 x 29	92.5	173	16	\$2668

Return has **box/box/file** pedestal on the **right**. Pedestal locks. For use with left handed single pedestal desks, credenzas, desk shells, credenza shells, "D" islands or "P" islands. Ships assembled in 1 carton.

LR8430CG	30 x 84 x 29	150	130	29	\$2074
LR7230CG	30 x 72 x 29	150	122	27	\$1832
LR6630CG	30 x 66 x 29	150	115	24	\$1726
LR6030CG	30 x 60 x 29	150	105	22	\$1608

Return has **no pedestal**. For use with single pedestal desks, credenzas, desk shells, credenza shells, "D" islands or "P" islands. Shipped RTA - ready to assemble.

BRIDGES - EXECUTIVE

- An Executive Bridge is used to connect a Desk to a Credenza.
- Not to be used with Corner Components or Piano Desks,
- Three Modesty Panel options - Full Modesty, 8" Modesty and No Modesty (Flush Bridge Top).
- Modesty panel flush with end panels of Desk and Credenza.
- Includes GM1 grommet in the top center position.
- Both connecting sides of executive bridges feature a reverse profile edge

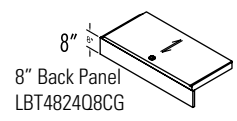
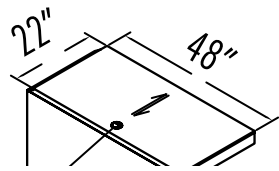
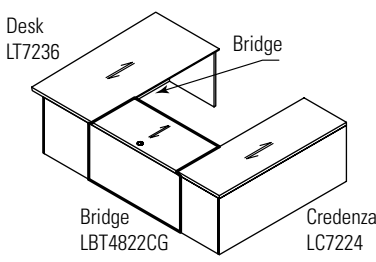

Required Specifications
Veneer Finish
Edge

Optional Specifications
Grommet

BRIDGES - LINKING

MODEL#

DIMENSIONS

FREIGHT CLASS

WT./LBS.

CUBIC FT.

LIST PRICE

D x W x H

- A linking bridge is used to connect corner components to a single pedestal desk, HA desk, single pedestal credenza, desk shell or credenza shell.
- When connecting HA desk, must specify LHASP spacer.
- Two modesty panel options - full modesty and 8" modesty.
- Includes GM1 grommet in the top center position.
- Hand of linking bridge is determined by location of half end panel from user side.
- Linking bridges are handed **left and right** (handedness is determined by connecting side with the self edge). The opposite connecting side features a reverse profile edge.

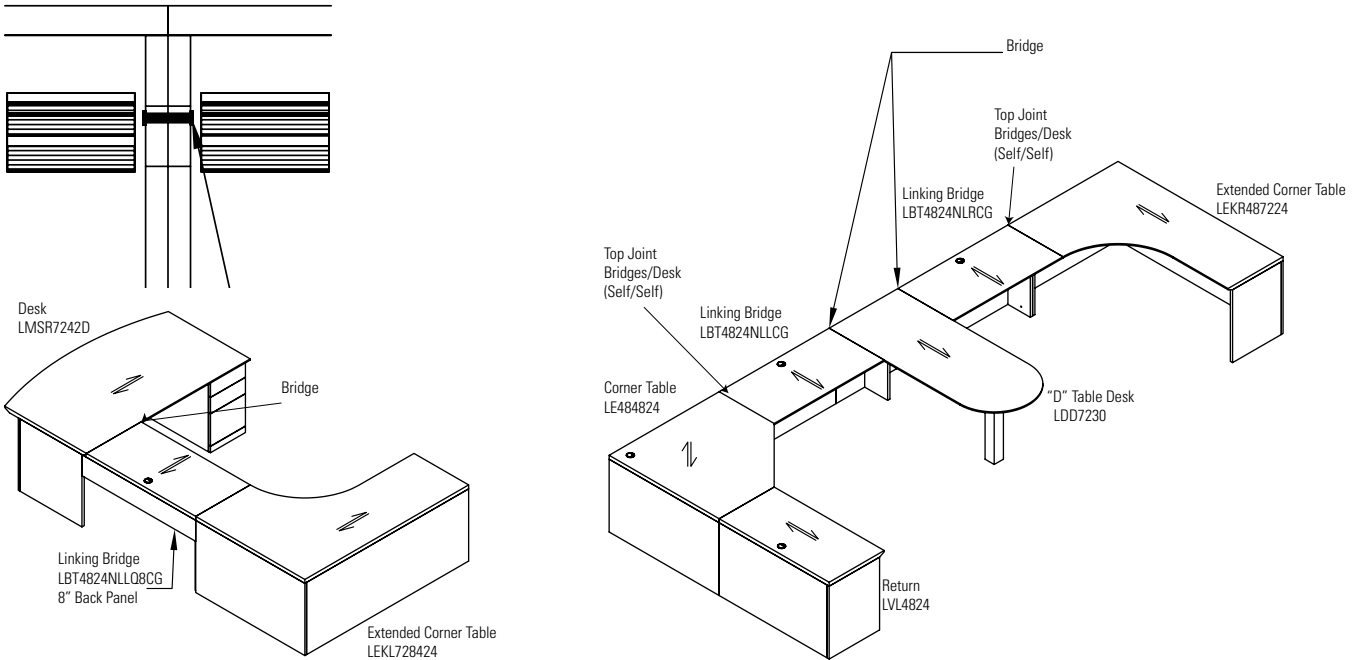

BRIDGES

MODEL#

DIMENSIONS

FREIGHT CLASS

WT./LBS.

CUBIC FT.

LIST PRICE

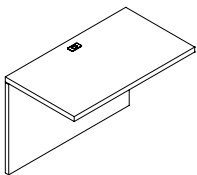

Flush Bridge

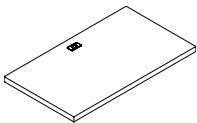

Flush Bridge Top

LBT6024CG	24 x 60 x 29	85	144	10	\$2018
LBT5424CG	24 x 54 x 29	85	129	9	\$1816
LBT4824CG	24 x 48 x 29	70	120	8	\$1619
LBT4224CG	24 x 42 x 29	70	105	7	\$1416
LBT6020CG	20 x 60 x 29	70	131	8	\$1660
LBT5420CG	20 x 54 x 29	85	118	8	\$1494
LBT4820CG	20 x 48 x 29	70	110	7	\$1324
LBT4220CG	20 x 42 x 29	70	96	6	\$1137

Top surface, back panel and hardware to create a "U" configuration with a single pedestal desk or credenza. **Cannot be used with corners.** Grommet in worksurface. Ships assembled in 1 carton.

- If linking to bookcase or open storage, add **/S** to end of model number

LBT5424TCG	24 x 54 x --	85	129	9	\$1422
LBT4824TCG	24 x 48 x --	70	120	8	\$1280
LBT4224TCG	24 x 42 x --	70	105	7	\$1125
LBT5420TCG	20 x 54 x --	85	118	8	\$1046
LBT4820TCG	20 x 48 x --	70	110	7	\$932
LBT4220TCG	20 x 42 x --	70	96	6	\$794

Top surface only to create a "U" configuration with a single pedestal desk or credenza. **Cannot be used with corners.** Grommet in worksurface. Ships assembled in 1 carton.

- If linking to bookcase or open storage, add **/S** to end of model number

Required Specifications

Veneer Finish
Edge

Optional Specifications

Grommet

BRIDGES **MODEL#** **DIMENSIONS** **FREIGHT CLASS** **WT/LBS.** **CUBIC FT.** **LIST PRICE**

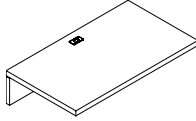

Flush Bridge Top, 8" Modesty Panel

D x W x H						
LBT6024Q8CG	24 x 60 x --	85	144	10		\$1812
LBT5424Q8CG	24 x 54 x --	85	129	9		\$1641
LBT4824Q8CG	24 x 48 x --	70	120	8		\$1458
LBT4224Q8CG	24 x 42 x --	70	105	7		\$1274
LBT6020Q8CG	20 x 60 x --	70	131	8		\$1494
LBT5420Q8CG	20 x 54 x --	85	118	8		\$1342
LBT4820Q8CG	20 x 48 x --	70	110	7		\$1194
LBT4220Q8CG	20 x 42 x --	70	96	6		\$1022

Top surface with 8" modesty panel for utility access. Create a "U" configuration with a single pedestal desk or credenza. **Cannot be used with corners.** Grommet in worksurface. Ships assembled in 1 carton.

- If linking to bookcase or open storage, add **/S** to end of model number

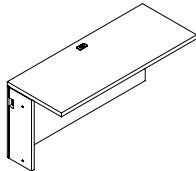

Linking Bridge - LEFT

LBT6024NLLCG	24 x 60 x 29	125	145	24	2002	
LBT5424NLLCG	24 x 54 x 29	150	131	22		\$1799
LBT4824NLLCG	24 x 48 x 29	125	116	19		\$1600
LBT4224NLLCG	24 x 42 x 29	125	102	17		\$1298
LBT3624NLLCG	24 x 36 x 29	150	87	15		\$1181
LBT3024NLLCG	24 x 30 x 29	125	73	12		\$1148
LBT6020NLLCG	22 x 60 x 29	150	131	22		\$1816
LBT5420NLLCG	22 x 54 x 29	150	118	20		\$1634
LBT4820NLLCG	22 x 48 x 29	125	110	18	1458	
LBT4220NLLCG	22 x 42 x 29	150	95	16	1181	
LBT3620NLLCG	22 x 36 x 29	125	80	13	1073	
LBT3020NLLCG	22 x 30 x 29	150	65	11	1046	

Top surface, back panel and hardware. **Left side** connects to a 5-Sided Corner, Extended Corner or Connectable Table. Right side connects to a single pedestal desk or credenza, "D" island, Boat shaped island, "P" island and Delta island with a "T" base. Grommet in worksurface. Ships assembled in 1 carton.

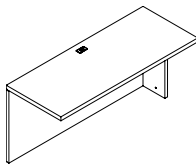

Linking Bridge - RIGHT

LBT6024NLR CG	24 x 60 x 29	125	145	24		\$2002
LBT5424NLR CG	24 x 54 x 29	150	131	22		\$1799
LBT4824NLR CG	24 x 48 x 29	125	116	19		\$1600
LBT4224NLR CG	24 x 42 x 29	125	102	17		\$1298
LBT3624NLR CG	24 x 36 x 29	150	87	15		\$1181
LBT3024NLR CG	24 x 30 x 29	125	73	12		\$1148
LBT6020NLR CG	22 x 60 x 29	150	131	22		\$1816
LBT5420NLR CG	22 x 54 x 29	150	118	20		\$1634
LBT4820NLR CG	22 x 48 x 29	125	110	18		\$1458
LBT4220NLR CG	22 x 42 x 29	150	95	16		\$1181
LBT3620NLR CG	22 x 36 x 29	125	80	13		\$1073
LBT3020NLR CG	22 x 30 x 29	150	65	11		\$1046

Top surface, back panel and hardware. **Right side** connects to a 5-Sided Corner, Extended Corner or Connectable Table. Right side connects to a single pedestal desk or credenza, "D" island, Boat shaped island, "P" island and Delta island with a "T" base. Grommet in worksurface. Ships assembled in 1 carton.

Required Specifications
Veneer Finish
Edge

Optional Specifications
Grommet

BRIDGES

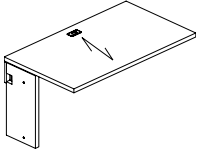

Linking Bridge, 8" Modesty Panel - LEFT

MODEL#	DIMENSIONS D x W x H	FREIGHT CLASS	WT/LBS.	CUBIC FT.	LIST PRICE
LBT6024NLLQ8CG	24 x 60 x 29	125	145	24	\$2207
LBT5424NLLQ8CG	24 x 54 x 29	150	131	22	\$1985
LBT4824NLLQ8CG	24 x 48 x 29	125	116	19	\$1744
LBT4224NLLQ8CG	24 x 42 x 29	125	102	17	\$1547
LBT3624NLLQ8CG	24 x 36 x 29	150	87	15	\$1280
LBT3024NLLQ8CG	24 x 30 x 29	125	73	12	\$1252
LBT6020NLLQ8CG	20 x 60 x 29	150	131	22	\$1634
LBT5420NLLQ8CG	20 x 54 x 29	150	118	20	\$1476
LBT4820NLLQ8CG	20 x 48 x 29	125	110	18	\$1316
LBT4220NLLQ8CG	20 x 42 x 29	150	95	16	\$1063
LBT3620NLLQ8CG	20 x 36 x 29	125	80	13	\$965
LBT3020NLLQ8CG	20 x 30 x 29	150	65	11	\$952

Top surface with 8" modesty panel for utility access and hardware. **Left side** connects to a 5-Sided Corner, Extended Corner or Connectable Table. Right side connects to a single pedestal desk or credenza, "D" island, Boat shaped island, "P" island and Delta island with a "T" base. Grommet in worksurface. Ships assembled in 1 carton.

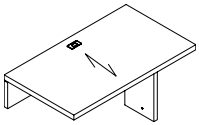

Linking Bridge, 8" Modesty Panel - RIGHT

LBT6024NLRQ8CG	24 x 60 x 29	125	145	24	\$2207
LBT5424NLRQ8CG	24 x 54 x 29	150	131	22	\$1985
LBT4824NLRQ8CG	24 x 48 x 29	125	116	19	\$1744
LBT4224NLRQ8CG	24 x 42 x 29	125	102	17	\$1547
LBT3624NLRQ8CG	24 x 36 x 29	150	87	15	\$1280
LBT3024NLRQ8CG	24 x 30 x 29	125	73	12	\$1252
LBT6020NLRQ8CG	20 x 60 x 29	150	131	22	\$1634
LBT5420NLRQ8CG	20 x 54 x 29	150	118	20	\$1476
LBT4820NLRQ8CG	20 x 48 x 29	125	110	18	\$1316
LBT4220NLRQ8CG	20 x 42 x 29	150	95	16	\$1063
LBT3620NLRQ8CG	20 x 36 x 29	125	80	13	\$965
LBT3020NLRQ8CG	20 x 30 x 29	150	65	11	\$952

Top surface with 8" modesty panel for utility access and hardware. **Right side** connects to a 5-Sided Corner, Extended Corner or Connectable Table. Right side connects to a single pedestal desk or credenza, "D" island, Boat shaped island, "P" island and Delta island with a "T" base. Grommet in worksurface. Ships assembled in 1 carton.

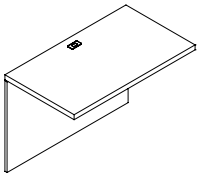

Bridge - Hinged Modesty

LHBT6024CG	24 x 60 x 29	85	144	10	\$2018
LHBT5424CG	24 x 54 x 29	85	129	9	\$1816
LHBT4824CG	24 x 48 x 29	70	120	8	\$1619
LHBT4224CG	24 x 42 x 29	70	105	7	\$1416
LHBT6020CG	20 x 60 x 29	70	131	8	\$1660
LHBT5420CG	20 x 54 x 29	85	118	8	\$1494
LHBT4820CG	20 x 48 x 29	70	110	7	\$1324
LHBT4220CG	20 x 42 x 29	70	96	6	\$1137

Executive Bridge Top and **Hinged Back Panel** to create a "U" configuration with a single pedestal desk or credenza. **Cannot be used with corners.** Grommet in worksurface. Ships assembled in 1 carton.

Required Specifications

Veneer Finish
Edge

Optional Specifications

Grommet

CREDENZAS **MODEL#** **DIMENSIONS** **FREIGHT CLASS** **WT/LBS.** **CUBIC FT.** **LIST PRICE**

D x W x H

LC10824	24 x 108 x 29	125	348	44	\$4521
LC10224	24 x 102 x 29	100	329	41	\$4311
LC9624	24 x 96 x 29	125	309	39	\$4082
LC9024	24 x 90 x 29	100	290	36	\$3870
LC8424	24 x 84 x 29	125	271	34	\$3652
LC7824	24 x 78 x 29	100	251	31	\$3424
LC7224	24 x 72 x 29	100	232	29	\$3213
LC6624	24 x 66 x 29	125	213	27	\$3109
LC6024	24 x 60 x 29	100	193	24	\$2880

LC10820	20 x 108 x 29	100	309	36	\$3607
LC10220	20 x 102 x 29	100	291	34	\$3420
LC9620	20 x 96 x 29	100	273	32	\$3222
LC9020	20 x 90 x 29	100	255	30	\$3029
LC8420	20 x 84 x 29	100	237	28	\$2841
LC7820	20 x 78 x 29	100	219	26	\$2645
LC7220	20 x 72 x 29	100	206	24	\$2453
LC6620	20 x 66 x 29	100	188	22	\$2367
LC6020	20 x 60 x 29	100	169	20	\$2166

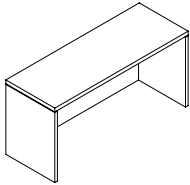

Credenza Shell

Standard with **no pedestals**. Flush full modesty panel. 96" w and larger includes a center support leg. If using storage component shells underneath to support the worksurface, **no more than 72" may be left unsupported**. Ships assembled in 1 carton.

LCK8424EE	24 x 84 x 29	92.5	348	34	\$6838
LCK7824EE	24 x 78 x 29	92.5	319	31	\$6618
LCK7224EE	24 x 72 x 29	100	280	29	\$6156
LCK6624EE	24 x 66 x 29	100	261	27	\$5659
LCK6024EE	24 x 60 x 29	100	238	24	\$5599

LCK8420EE	20 x 84 x 29	92.5	320	34	\$6777
LCK7820EE	20 x 78 x 29	92.5	298	31	\$6961
LCK7220EE	20 x 72 x 29	92.5	280	29	\$5692
LCK6620EE	20 x 66 x 29	92.5	257	27	\$5599
LCK6020EE	20 x 60 x 29	92.5	233	24	\$5533

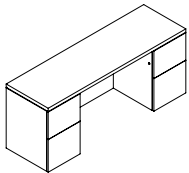

Kneespace Credenza

Standard with full to floor **file/file** pedestals on **left and right**. **Center is open**. Pedestals lock. Ships assembled in 1 carton.

LCK8424DD	24 x 84 x 29	92.5	348	34	\$6838
LCK7824DD	24 x 78 x 29	92.5	319	31	\$6618
LCK7224DD	24 x 72 x 29	100	280	29	\$5759
LCK6624DD	24 x 66 x 29	100	261	27	\$5659
LCK6024DD	24 x 60 x 29	100	238	24	\$5599

LCK8420DD	20 x 84 x 29	92.5	307	28	\$7093
LCK7820DD	20 x 78 x 29	92.5	285	26	\$6961
LCK7220DD	20 x 72 x 29	92.5	267	24	\$5692
LCK6620DD	20 x 66 x 29	92.5	244	22	\$5599
LCK6020DD	20 x 60 x 29	92.5	220	20	\$5533

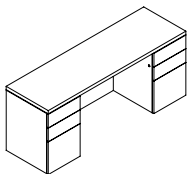

Kneespace Credenza

Standard with full to floor **box/box/file** pedestals on **left and right**. **Center is open**. Pedestals lock. Ships assembled in 1 carton.

Required Specifications

Veneer Finish
Edge

Optional Specifications

Grommet

CREDENZAS

MODEL#	DIMENSIONS	FREIGHT CLASS	WT/LBS.	CUBIC FT.	LIST PRICE
--------	------------	---------------	---------	-----------	------------

D x W x H

LCK8424ED	24 x 84 x 29	92.5	348	34	\$6838
LCK7824ED	24 x 78 x 29	92.5	319	31	\$6618
LCK7224ED	24 x 72 x 29	100	280	29	\$6156
LCK6624ED	24 x 66 x 29	100	261	27	\$5659
LCK6024ED	24 x 60 x 29	100	238	24	\$5599
LCK8420ED	20 x 84 x 29	92.5	307	28	\$6777
LCK7820ED	20 x 78 x 29	92.5	285	26	\$6961
LCK7220ED	20 x 72 x 29	92.5	267	24	\$5692
LCK6620ED	20 x 66 x 29	92.5	244	22	\$5599
LCK6020ED	20 x 60 x 29	92.5	220	20	\$5533

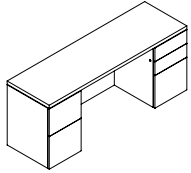

Kneespace Credenza

Standard with full to floor **file/file** pedestal on **left** and **box/box/file** pedestal on **right**. **Center is open** Pedestals lock. One pencil tray. Ships assembled in 1 carton.

LCK8424DE	24 x 84 x 29	92.5	348	34	\$6838
LCK7824DE	24 x 78 x 29	92.5	319	31	\$6618
LCK7224DE	24 x 72 x 29	100	280	29	\$5759
LCK6624DE	24 x 66 x 29	100	261	27	\$5659
LCK6024DE	24 x 60 x 29	100	238	24	\$5599
LCK8420DE	20 x 84 x 29	92.5	307	28	\$6777
LCK7820DE	20 x 78 x 29	92.5	285	26	\$6961
LCK7220DE	20 x 72 x 29	92.5	267	24	\$5692
LCK6620DE	20 x 66 x 29	92.5	244	22	\$5599
LCK6020DE	20 x 60 x 29	92.5	220	20	\$5533

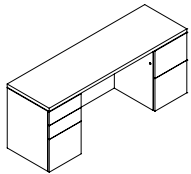

Kneespace Credenza

Standard with full to floor **box/box/file** pedestal on **left** and **file/file** pedestal on **right**. **Center is open** Pedestals lock. One pencil tray. Ships assembled in 1 carton.

LCL8424E	24 x 84 x 29	100	315	34	\$5492
LCL7824E	24 x 78 x 29	100	292	31	\$5137
LCL7224E	24 x 72 x 29	100	270	29	\$4789
LCL6624E	24 x 66 x 29	100	247	27	\$4634
LCL6024E	24 x 60 x 29	100	225	24	\$4270
LCL8420E	20 x 84 x 29	100	273	28	\$4888
LCL7820E	20 x 78 x 29	100	252	26	\$5232
LCL7220E	20 x 72 x 29	100	237	24	\$4246
LCL6620E	20 x 66 x 29	100	216	22	\$4092
LCL6020E	20 x 60 x 29	100	195	20	\$3778

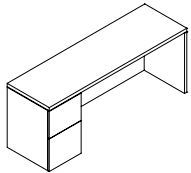

Single Pedestal Credenza - LEFT

Standard with full to floor **file/file** pedestal on **left**. Pedestal locks. Ships assembled in 1 carton.

LCR8424E	24 x 84 x 29	100	315	34	\$5492
LCR7824E	24 x 78 x 29	100	292	31	\$5137
LCR7224E	24 x 72 x 29	100	270	29	\$4789
LCR6624E	24 x 66 x 29	100	247	27	\$4634
LCR6024E	24 x 60 x 29	100	225	24	\$4270
LCR8420E	20 x 84 x 29	100	273	28	\$4888
LCR7820E	20 x 78 x 29	100	252	26	\$5232
LCR7220E	20 x 72 x 29	100	237	24	\$4246
LCR6620E	20 x 66 x 29	100	216	22	\$4092
LCR6020E	20 x 60 x 29	100	195	20	\$3778

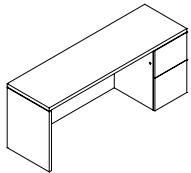

Single Pedestal Credenza - RIGHT

Standard with full to floor **file/file** pedestal on **right**. Pedestal locks. Ships assembled in 1 carton.

Required Specifications

Veneer Finish
Edge

Optional Specifications

Grommet

CRENZAS	MODEL#	DIMENSIONS	FREIGHT CLASS	WT/LBS.	CUBIC FT.	LIST PRICE
---------	--------	------------	---------------	---------	-----------	------------

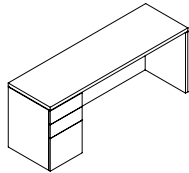

Single Pedestal Credenza - LEFT

	D x W x H					
LCL8424D	24 x 84 x 29	100	315	34	\$5492	
LCL7824D	24 x 78 x 29	100	292	31	\$5137	
LCL7224D	24 x 72 x 29	100	270	29	\$4789	
LCL6624D	24 x 66 x 29	100	247	27	\$4634	
LCL6024D	24 x 60 x 29	100	225	24	\$4270	
LCL8420D	20 x 84 x 29	100	273	28	\$4888	
LCL7820D	20 x 78 x 29	100	252	26	\$5232	
LCL7220D	20 x 72 x 29	100	237	24	\$4246	
LCL6620D	20 x 66 x 29	100	216	22	\$4092	
LCL6020D	20 x 60 x 29	100	195	20	\$3778	

Standard with full to floor **box/box/file** pedestal on **left**. Pedestal locks. Ships assembled in 1 carton.

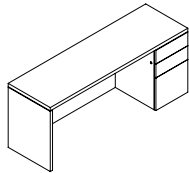

Single Pedestal Credenza - RIGHT

LCR8424D	24 x 84 x 29	100	315	34	\$5492
LCR7824D	24 x 78 x 29	100	292	31	\$5137
LCR7224D	24 x 72 x 29	100	270	29	\$4789
LCR6624D	24 x 66 x 29	100	247	27	\$4634
LCR6024D	24 x 60 x 29	100	225	24	\$4270
LCR8420D	20 x 84 x 29	100	273	28	\$4888
LCR7820D	20 x 78 x 29	100	252	26	\$5232
LCR7220D	20 x 72 x 29	100	237	24	\$4246
LCR6620D	20 x 66 x 29	100	216	22	\$4092
LCR6020D	20 x 60 x 29	100	195	20	\$3778

Standard with full to floor **box/box/file** pedestal on **right**. Pedestal locks. Ships assembled in 1 carton.

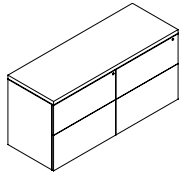

Lateral File Credenza

LC7224FF	24 x 72 x 29	92.5	328	29	\$7360
LC7220FF	20 x 72 x 29	92.5	287	24	\$6494
LC6024NN	24 x 60 x 29	92.5	273	24	\$6795
LC6020NN	20 x 60 x 29	92.5	205	20	\$5757

Two 2-drawer lateral files side-by-side. Locking drawers. Anti-lock tilt suspension. **Not for stacking materials on lateral file drawer bottom.** Ships assembled in 1 carton.

- "FF" models use two 36" wide lateral files, "NN" models use 30" wide.

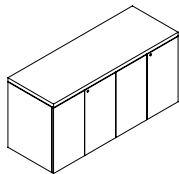

Storage Cabinet Credenza

LC7224GG	24 x 72 x 29	92.5	300	29	\$5629
LC7220GG	20 x 72 x 29	92.5	253	24	\$4977
LC6024MM	24 x 60 x 29	92.5	254	24	\$5195
LC6020MM	20 x 60 x 29	92.5	209	20	\$4435

Two 2-door storage cabinets side-by-side. Locking doors. Self-closing hinged doors cover one adjustable shelf. Ships assembled in 1 carton.

- "GG" models use two 36" wide storage cabinets, "MM" models use 30" wide.

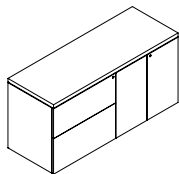

Lateral File/Storage Cabinet Credenza

LCF7224	24 x 72 x 29	92.5	305	29	\$5887
LCF7220	20 x 72 x 29	92.5	272	24	\$5212
LCF6024	24 x 60 x 29	92.5	254	24	\$5001
LCF6020	20 x 60 x 29	92.5	220	20	\$4435

One 2-drawer lateral file and one storage cabinet. Locking door/drawers. Storage cabinet includes one adjustable shelf. Anti-lock tilt suspension. **Not for stacking materials on lateral file drawer bottom.** Ships assembled in 1 carton.

Required Specifications

Veneer Finish
Edge

Optional Specifications

Grommet

CREDENZAS	MODEL#	DIMENSIONS	FREIGHT CLASS	WT/LBS.	CUBIC FT.	LIST PRICE
-----------	--------	------------	---------------	---------	-----------	------------

D x W x H

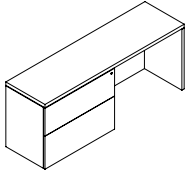

Kneespace Lateral File Credenza - LEFT

LCL8424F	24 x 84 x 29	100	305	34	\$5737
LCL7824F	24 x 78 x 29	100	285	31	\$5319
LCL7224F	24 x 72 x 29	100	261	29	\$4921
LCL6624F	24 x 66 x 29	100	239	27	\$4738
LCL6024F	24 x 60 x 29	100	218	24	\$4297
LCL8420F	20 x 84 x 29	100	273	28	\$5012
LCL7820F	20 x 78 x 29	100	252	26	\$4648
LCL7220F	20 x 72 x 29	100	237	24	\$4294
LCL6620F	20 x 66 x 29	100	216	22	\$4136
LCL6020F	20 x 60 x 29	100	195	20	\$3756

One 2-drawer lateral file on the **left**. Locking drawers. Anti-lock tilt suspension. **Not for stacking materials on lateral file drawer bottom.** Ships assembled in 1 carton.

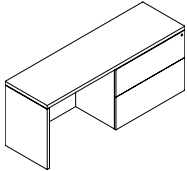

Kneespace Lateral File Credenza - RIGHT

LCR8424F	24 x 84 x 29	100	305	34	\$5737
LCR7824F	24 x 78 x 29	100	285	31	\$5319
LCR7224F	24 x 72 x 29	100	261	29	\$4921
LCR6624F	24 x 66 x 29	100	239	27	\$4738
LCR6024F	24 x 60 x 29	100	218	24	\$4297
LCR8420F	20 x 84 x 29	100	273	28	\$5012
LCR7820F	20 x 78 x 29	100	252	26	\$4648
LCR7220F	20 x 72 x 29	100	237	24	\$4294
LCR6620F	20 x 66 x 29	100	216	22	\$4136
LCR6020F	20 x 60 x 29	100	195	20	\$3756

One 2-drawer lateral file on the **right**. Locking drawers. Anti-lock tilt suspension. **Not for stacking materials on lateral file drawer bottom.** Ships assembled in 1 carton.

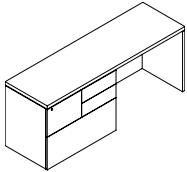

Mixed Storage Credenza - LEFT

LCL8424Z	24 x 84 x 29	100	338	34	\$6836
LCL7824Z	24 x 78 x 29	100	314	31	\$6384
LCL7224Z	24 x 72 x 29	100	290	29	\$5944
LCL6624Z	24 x 66 x 29	100	266	27	\$5737
LCL6024Z	24 x 60 x 29	100	242	24	\$4692
LCL8420Z	20 x 84 x 29	100	273	28	\$6052
LCL7820Z	20 x 78 x 29	100	252	26	\$5669
LCL7220Z	20 x 72 x 29	100	237	24	\$5274
LCL6620Z	20 x 66 x 29	100	216	22	\$5097
LCL6020Z	20 x 60 x 29	100	195	20	\$4692

Standard with two box drawers, one file drawer, and one 36"W lateral file drawer on the **left**. File drawer and lateral file drawer lock. **Not for stacking materials on lateral file drawer bottom.** Ships assembled in 1 carton.

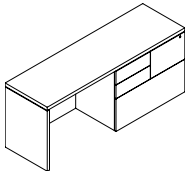

Mixed Storage Credenza - RIGHT

LCR8424Z	24 x 84 x 29	100	338	34	\$6836
LCR7824Z	24 x 78 x 29	100	314	31	\$6384
LCR7224Z	24 x 72 x 29	100	290	29	\$5944
LCR6624Z	24 x 66 x 29	100	266	27	\$5737
LCR6024Z	24 x 60 x 29	100	242	24	\$4692
LCR8420Z	20 x 84 x 29	100	273	28	\$6052
LCR7820Z	20 x 78 x 29	100	252	26	\$5669
LCR7220Z	20 x 72 x 29	100	237	24	\$5274
LCR6620Z	20 x 66 x 29	100	216	22	\$5097
LCR6020Z	20 x 60 x 29	100	195	20	\$4692

Standard with two box drawers, one file drawer, and one 36"W lateral file drawer on the **right**. File drawer and lateral file drawer lock. **Not for stacking materials on lateral file drawer bottom.** Ships assembled in 1 carton.

Required Specifications

Veneer Finish
Edge

Optional Specifications

Grommet

CREDENZAS **MODEL#** **DIMENSIONS** **FREIGHT CLASS** **WT/LBS.** **CUBIC FT.** **LIST PRICE**

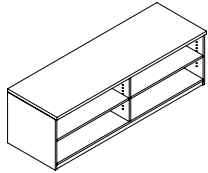

Credenza

	D x W x H					
LCO7224H23	24 x 72 x 23	92.5	305	29		\$3812
LCO7220H23	20 x 72 x 23	92.5	272	24		\$3332
LCO6024H23	24 x 60 x 23	92.5	254	24		\$3180
LCO6020H23	20 x 60 x 23	92.5	220	20		\$2779

Standard with open storage on **both sides**. Ships assembled in 1 carton.

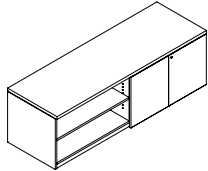

Credenza

LCOG7224H23	24 x 72 x 23	92.5	328	29		\$3840
LCOG7220H23	20 x 72 x 23	92.5	287	24		\$3360
LCOM6024H23	24 x 60 x 23	92.5	273	24		\$3529
LCOM6020H23	20 x 60 x 23	92.5	205	20		\$2938

Standard with open storage on the **left** and one storage cabinet on the **right**. Storage cabinet includes one adjustable shelf. Ships assembled in 1 carton.

- "G" model uses 36" wide storage cabinets, "M" model uses 30" wide.

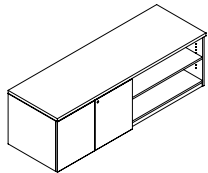

Credenza

LCG07224H23	24 x 72 x 23	92.5	328	29		\$3840
LCG07220H23	20 x 72 x 23	92.5	287	24		\$3360
LCM06024H23	24 x 60 x 23	92.5	273	24		\$3529
LCM06020H23	20 x 60 x 23	92.5	205	20		\$2938

Standard with open storage on the **right** and one storage cabinet on the **left**. Storage cabinet includes one adjustable shelf. Ships assembled in 1 carton.

- "G" model uses 36" wide storage cabinets, "M" model uses 30" wide.

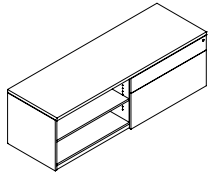

Credenza

LCOF7224H23	24 x 72 x 23	92.5	300	29		\$4677
LCOF7220H23	20 x 72 x 23	92.5	253	24		\$4082
LCON6024H23	24 x 60 x 23	92.5	254	24		\$4086
LCON6020H23	20 x 60 x 23	92.5	209	20		\$3565

Standard with one **box/file** drawer on **right** and open storage on the **left**. File drawer and lateral file drawer lock. Front-to-back and side-to-side filing. **Not for stacking materials on lateral file drawer bottom**. Ships assembled in 1 carton.

- "F" models use 36" wide lateral files, "N" models use 30" wide.

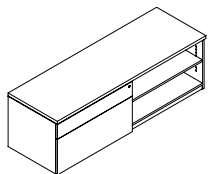

Credenza

LCF07224H23	24 x 72 x 23	92.5	300	29		\$4677
LCF07220H23	20 x 72 x 23	92.5	253	24		\$4082
LCN06024H23	24 x 60 x 23	92.5	254	24		\$4086
LCN06020H23	20 x 60 x 23	92.5	209	20		\$3565

Standard with one **box/file** drawer on **left** and open storage on the **right**. File drawer and lateral file drawer lock. Front-to-back and side-to-side filing. **Not for stacking materials on lateral file drawer bottom**. Ships assembled in 1 carton.

- "F" models use 36" wide lateral files, "N" models use 30" wide.

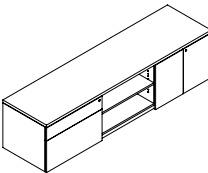

Credenza

LCNOM9024H23	24 x 90 x 23	92.5	300	29		\$8166
LCNOM9020H23	20 x 90 x 23	92.5	300	29		\$7754

Standard with one **box/file** drawer on **left**, open storage in the **center**, and one storage cabinet on the **right**. Storage cabinet includes one adjustable shelf. File drawer and lateral file drawer lock. Front-to-back and side-to-side filing. **Not for stacking materials on lateral file drawer bottom**. Ships assembled in 1 carton.

Required Specifications

Veneer Finish
Edge

Optional Specifications

Grommet

CREDENZAS

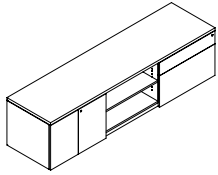

Credenza

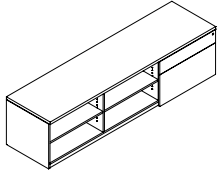

Credenza

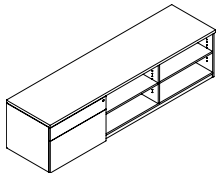

Credenza

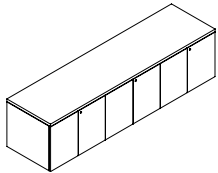

Credenza

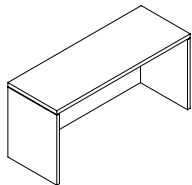

Credenza Shell

MODEL#	DIMENSIONS	FREIGHT CLASS	WT/LBS.	CUBIC FT.	LIST PRICE
LCMON9024H23	24 x 90 x 23	92.5	300	29	\$8166
LCMON9020H23	20 x 90 x 23	92.5	300	29	\$7754

Standard with one **box/file** drawer on **right**, open storage in the **center**, and one storage cabinet on the **left**. Storage cabinet includes one adjustable shelf. File drawer and lateral file drawer lock. Front-to-back and side-to-side filing. **Not for stacking materials on lateral file drawer bottom.** Ships assembled in 1 carton.

LCOON9024H23	24 x 90 x 23	92.5	300	29	\$7864
LCOON9020H23	20 x 90 x 23	92.5	300	29	\$7448

Standard with one **box/file** drawer on **right** and open storage in the **center** and **left**. File drawer and lateral file drawer lock. Front-to-back and side-to-side filing. **Not for stacking materials on lateral file drawer bottom.** Ships assembled in 1 carton.

LCN009024H23	24 x 90 x 23	92.5	300	29	\$7864
LCN009020H23	20 x 90 x 23	92.5	300	29	\$7448

Standard with one **box/file** drawer on **left** and open storage in the **center** and **right**. File drawer and lateral file drawer lock. Front-to-back and side-to-side filing. **Not for stacking materials on lateral file drawer bottom.** Ships assembled in 1 carton.

LCMMM9024H23	24 x 90 x 23	92.5	300	29	\$7562
LCMMM9020H23	20 x 90 x 23	92.5	300	29	\$6301

Standard with **three** storage cabinets. Storage cabinets include one adjustable shelf per cabinet. Ships assembled in 1 carton.

LC10824H23	24 x 108 x 23	125	348	44	\$4320
LC10224H23	24 x 102 x 23	100	329	41	\$4108
LC9624H23	24 x 96 x 23	125	309	39	\$3881
LC9024H23	24 x 90 x 23	100	290	36	\$3669
LC8424H23	24 x 84 x 23	125	271	34	\$3451
LC7824H23	24 x 78 x 23	100	251	31	\$3222
LC7224H23	24 x 72 x 23	100	232	29	\$3010
LC6624H23	24 x 66 x 23	125	213	27	\$2908
LC6024H23	24 x 60 x 23	100	193	24	\$2679
LC10820H23	20 x 108 x 23	100	309	36	\$3405
LC10220H23	20 x 102 x 23	100	291	34	\$3217
LC9620H23	20 x 96 x 23	100	273	32	\$3026
LC9020H23	20 x 90 x 23	100	255	30	\$2829
LC8420H23	20 x 84 x 23	100	237	28	\$2642
LC7820H23	20 x 78 x 23	100	219	26	\$2447
LC7220H23	20 x 72 x 23	100	206	24	\$2250
LC6620H23	20 x 66 x 23	100	188	22	\$2166
LC6020H23	20 x 60 x 23	100	169	20	\$1964

Standard with **no pedestals**. Flush full modesty panel. 96" w and larger includes a center support leg. If using storage component shells underneath to support the worksurface, **no more than 72" may be left unsupported.** Ships assembled in 1 carton.

Required Specifications

Veneer Finish
Edge

Optional Specifications

Grommet

CORNERS	MODEL#	DIMENSIONS D x W x H	FREIGHT CLASS	WT./LBS.	CUBIC FT.	LIST PRICE
---------	--------	-------------------------	---------------	----------	-----------	------------

- A Corner Desk is used to connect to a Linking Bridge and Linking Credenza, or Connectable Table
- Cable management tray is included.
- Full Modesty Panel option.
- 5-Sided Corners include a GM1 grommet in the top center position. Grommets are available as an option on Extended Corners.
- Hand of Linking Credenza is determined by location of full end panel from user side.
- Hand of Extended Corner is determined by location of long narrow end from user side.
- Connecting sides feature a self edge.

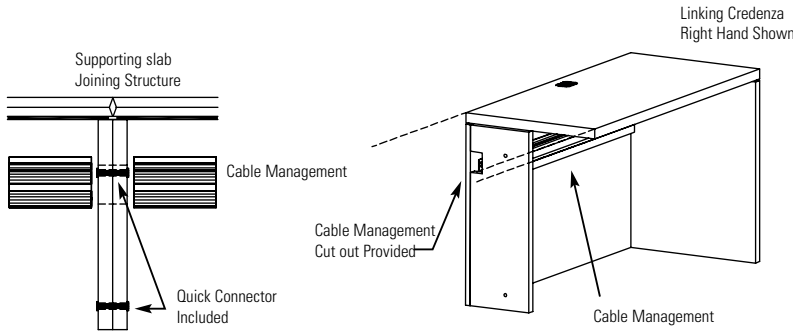

Code dimensions are actual

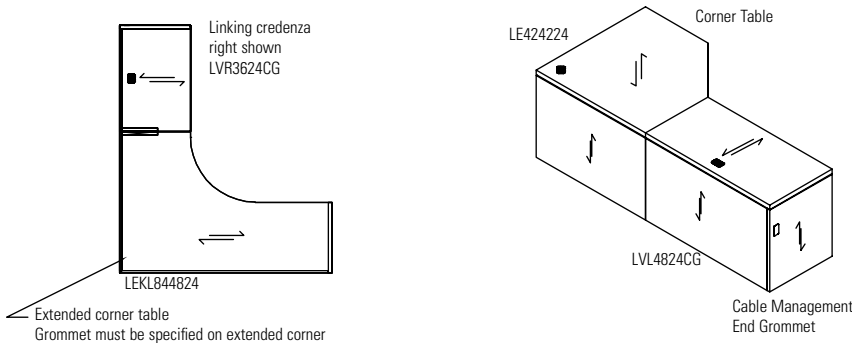

5-SIDED CORNERS	MODEL#	DIMENSIONS D x W x H	FREIGHT CLASS	WT./LBS.	CUBIC FT.	LIST PRICE
-----------------	--------	-------------------------	---------------	----------	-----------	------------

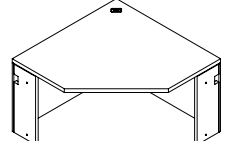

5-Sided Corner

LE484824	48 x 48 x 29	150	201	39	\$3412
LE424224	42 x 42 x 29	150	155	30	\$2718
LE363624	36 x 36 x 29	125	135	22	\$2600

Connects to **24" D** connectables, returns, extended corners, storage/lateral file credenzas, credenzas and bridges. Includes grommet and installed horizontal wire management. Narrow end panels on left and right. Ships assembled in 1 carton.

- *Not freestanding*

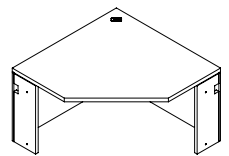

5-Sided Corner

LE484820	48 x 48 x 29	150	196	39	\$3412
LE424220	42 x 42 x 29	150	150	30	\$2718
LE363620	36 x 36 x 29	150	130	22	\$2600

Connects to **20" D** connectables, returns, extended corners, storage/lateral file credenzas, credenzas and bridges. Includes grommet and installed horizontal wire management. Narrow end panels on left and right. Ships assembled in 1 carton.

- *Not freestanding*

Required Specifications

Veneer Finish
Edge

Optional Specifications

Grommet

LEFT EXTENDED CORNERS

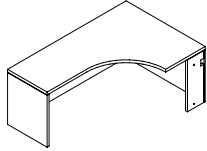

Left Extended Corner

MODEL#	DIMENSIONS	FREIGHT CLASS	WT/LBS.	CUBIC FT.	LIST PRICE
--------	------------	---------------	---------	-----------	------------

D x W x H

LEKL844824	24-48 x 84 x 29	150	338	68	\$5035
LEKL784824	24-48 x 78 x 29	150	314	63	\$4967
LEKL724824	24-48 x 72 x 29	150	290	58	\$4684
LEKL664824	24-48 x 66 x 29	150	266	52	\$4450
LEKL604824	24-48 x 60 x 29	150	242	48	\$4158
LEKL844820	20-48 x 84 x 29	150	338	68	\$4954
LEKL784820	20-48 x 78 x 29	150	314	63	\$4851
LEKL724820	20-48 x 72 x 29	150	290	58	\$4573
LEKL664820	20-48 x 66 x 29	150	266	52	\$4338
LEKL604820	20-48 x 60 x 29	150	242	48	\$4047

Extended worksurface on **left**. **Full end panel on left, narrow end panel on right**. Connects to Linking Bridges, Extended Corners and Connectable Tables. Ships assembled in 1 carton.

RIGHT EXTENDED CORNERS

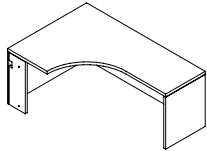

Right Extended Corner*

MODEL#	DIMENSIONS	FREIGHT CLASS	WT/LBS.	CUBIC FT.	LIST PRICE
--------	------------	---------------	---------	-----------	------------

LEKR488424	24-48 x 84 x 29	150	338	68	\$5035
LEKR487824	24-48 x 78 x 29	150	314	63	\$4967
LEKR487224	24-48 x 72 x 29	150	290	58	\$4684
LEKR486624	24-48 x 66 x 29	150	266	52	\$4450
LEKR486024	24-48 x 60 x 29	150	242	48	\$4158
LEKR488420	20-48 x 84 x 29	150	338	68	\$4954
LEKR487820	20-48 x 78 x 29	150	314	63	\$4851
LEKR487220	20-48 x 72 x 29	150	290	58	\$4573
LEKR486620	20-48 x 66 x 29	150	266	52	\$4338
LEKR486020	20-48 x 60 x 29	150	242	48	\$4047

Extended worksurface on **right**. **Full end panel on right, narrow end panel on left**. Connects to Linking Bridges, Extended Corners and Connectable Tables. Ships assembled in 1 carton.

CONNECTABLE TABLES - LEFT

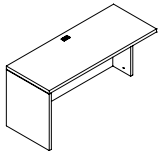

24" Deep Connectable Table - LEFT

MODEL#	DIMENSIONS	FREIGHT CLASS	WT/LBS.	CUBIC FT.	LIST PRICE
--------	------------	---------------	---------	-----------	------------

LVL9624CG	24 x 96 x 29	150	200	39	\$3702
LVL9024CG	24 x 90 x 29	150	187	36	\$3491
LVL8424CG	24 x 84 x 29	150	174	34	\$3291
LVL7824CG	24 x 78 x 29	150	162	31	\$3080
LVL7224CG	24 x 72 x 29	150	149	29	\$2880
LVL6624CG	24 x 66 x 29	150	141	27	\$2733
LVL6024CG	24 x 60 x 29	150	132	24	\$2583
LVL5424CG	24 x 54 x 29	150	121	22	\$2456
LVL4824CG	24 x 48 x 29	125	115	19	\$2343
LVL4224CG	24 x 42 x 29	150	99	17	\$2041
LVL3624CG	24 x 36 x 29	150	83	15	\$1985
LVL3024CG	24 x 30 x 29	125	77	12	\$1955
LVL2424CG	24 x 24 x 29	125	61	10	\$1708

Full end panel on left. Right narrow end panel connects to **24"D** center/right connectable table; **24"D** extended corners; **24"D** 5-sided corners; Grommet in worksurface. Ships assembled in 1 carton.

- To remove cross grain veneer pattern on top, **delete suffix "CG"** from the model number. Available as a special - no upcharge.

Required Specifications

Veneer Finish
Edge

Optional Specifications

Grommet*

CONNECTABLE TABLES - LEFT **MODEL#** **DIMENSIONS** **FREIGHT CLASS** **WT./LBS.** **CUBIC FT.** **LIST PRICE**

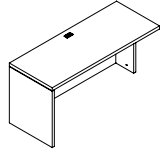

20" Deep Connectable Table - LEFT

	D x W x H					
LVL9620CG	20 x 96 x 29	150	187	39	\$3010	
LVL9020CG	20 x 90 x 29	150	175	36	\$2822	
LVL8420CG	20 x 84 x 29	150	163	34	\$2635	
LVL7820CG	20 x 78 x 29	150	152	31	\$2447	
LVL7220CG	20 x 72 x 29	150	140	29	\$2258	
LVL6620CG	20 x 66 x 29	150	133	27	\$2119	
LVL6020CG	20 x 60 x 29	150	125	24	\$1985	
LVL5420CG	20 x 54 x 29	150	113	22	\$1870	
LVL4820CG	20 x 48 x 29	150	110	19	\$1753	
LVL4220CG	20 x 42 x 29	150	95	17	\$1484	
LVL3620CG	20 x 36 x 29	150	80	15	\$1429	
LVL3020CG	20 x 30 x 29	125	75	12	\$1405	
LVL2420CG	20 x 24 x 29	125	60	10	\$1176	

Full end panel on left. Right narrow end panel connects to **20"D** center/right connectable table; **20"D** 5-sided corners; Grommet in worksurface. Ships assembled in 1 carton.

- To remove cross grain veneer pattern on top, **delete suffix "CG"** from the model number. Available as a special - no upcharge.

CONNECTABLE TABLES - RIGHT **MODEL#** **DIMENSIONS** **FREIGHT CLASS** **WT./LBS.** **CUBIC FT.** **LIST PRICE**

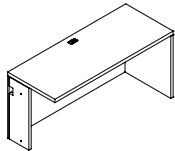

24" Deep Connectable Table - RIGHT

LVR9624CG	24 x 96 x 29	150	200	39	\$3702	
LVR9024CG	24 x 90 x 29	150	187	36	\$3491	
LVR8424CG	24 x 84 x 29	150	174	34	\$3291	
LVR7824CG	24 x 78 x 29	150	162	31	\$3080	
LVR7224CG	24 x 72 x 29	150	149	29	\$2880	
LVR6624CG	24 x 66 x 29	150	141	27	\$2733	
LVR6024CG	24 x 60 x 29	150	132	24	\$2583	
LVR5424CG	24 x 54 x 29	150	121	22	\$2456	
LVR4824CG	24 x 48 x 29	125	115	19	\$2343	
LVR4224CG	24 x 42 x 29	150	99	17	\$2041	
LVR3624CG	24 x 36 x 29	150	83	15	\$1985	
LVR3024CG	24 x 30 x 29	125	77	12	\$1955	
LVR2424CG	24 x 24 x 29	125	61	10	\$1708	

Full end panel on right. Left narrow end panel connects to **24"D** center/left connectable table; **24"D** extended corners, **24"D** 5-sided corners; Grommet in worksurface. Ships assembled in 1 carton.

- To remove cross grain veneer pattern on top, **delete suffix "CG"** from the model number. Available as a special - no upcharge.

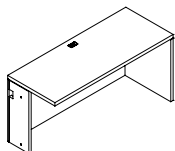

20" Deep Connectable Table - RIGHT

LVR9620CG	20 x 96 x 29	150	187	39	\$3010	
LVR9020CG	20 x 90 x 29	150	175	36	\$2822	
LVR8420CG	20 x 84 x 29	150	163	34	\$2635	
LVR7820CG	20 x 78 x 29	150	152	31	\$2447	
LVR7220CG	20 x 72 x 29	150	140	29	\$2258	
LVR6620CG	20 x 66 x 29	150	133	27	\$2119	
LVR6020CG	20 x 60 x 29	150	125	24	\$1985	
LVR5420CG	20 x 54 x 29	150	113	22	\$1870	
LVR4820CG	20 x 48 x 29	150	110	19	\$1753	
LVR4220CG	20 x 42 x 29	150	95	17	\$1484	
LVR3620CG	20 x 36 x 29	150	80	15	\$1429	
LVR3020CG	20 x 30 x 29	125	75	12	\$1405	
LVR2420CG	20 x 24 x 29	125	60	10	\$1176	

Full end panel on right. Left narrow end panel connects to **20"D** center/left connectable table; **20"D** 5-sided corners; Grommet in worksurface. Ships assembled in 1 carton.

- To remove cross grain veneer pattern on top, **delete suffix "CG"** from the model number. Available as a special - no upcharge.

Required Specifications

Veneer Finish
Edge
Monopost Finish - D Islands

Optional Specifications

Modesty Upgrade
Modesty Panel
Monopost (Base) Upgrade - D Islands

CONNECTABLE TABLES

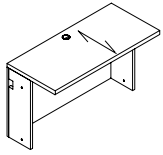

24" Deep Connectable Table

MODEL#	DIMENSIONS D x W x H	FREIGHT CLASS	WT/LBS.	CUBIC FT.	LIST PRICE
LV6024CG	24 x 60 x 29	150	132	24	\$2510
LV5424CG	24 x 54 x 29	150	121	22	\$2367
LV4824CG	24 x 48 x 29	125	115	19	\$2223
LV4224CG	24 x 42 x 29	150	99	17	\$1861
LV3624CG	24 x 36 x 29	150	83	15	\$1921
LV3024CG	24 x 30 x 29	125	77	12	\$1760
LV2424CG	24 x 24 x 29	125	61	10	\$1476

Narrow end panels on left and right connects to **24"D** connectable table; **24"D** extended corners, **24"D** 5-sided corners; Grommet in worksurface. Ships assembled in 1 carton.

- To remove cross grain veneer pattern on top, **delete suffix "CG"** from the model number. Available as a special - no upcharge.

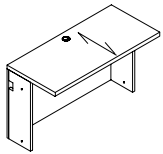

22" Deep Connectable Table

LV6020CG	20 x 60 x 29	150	125	24	\$1931
LV5420CG	20 x 54 x 29	150	113	22	\$1816
LV4820CG	20 x 48 x 29	150	110	19	\$1703
LV4220CG	20 x 42 x 29	150	95	17	\$1422
LV3620CG	20 x 36 x 29	150	80	15	\$1378
LV3020CG	20 x 30 x 29	125	75	12	\$1351
LV2420CG	20 x 24 x 29	125	60	10	\$1137

Narrow end panels on left and right connects to **22"D** connectable table; **22"D** extended corners, **22"D** 5-sided corners; Grommet in worksurface. Ships assembled in 1 carton.

- To remove cross grain veneer pattern on top, **delete suffix "CG"** from the model number. Available as a special - no upcharge.

"D" ISLANDS

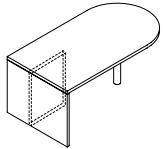

"D" Island - Full End Panel (T-Base) & Monopost

MODEL#	DIMENSIONS	FREIGHT CLASS	WT/LBS.	CUBIC FT.	LIST PRICE
LDD8430	30 x 84 x 29	125	343	51	\$5596
LDD7230	30 x 72 x 29	125	264	36	\$4446
LDD6630	30 x 66 x 29	125	245	40	\$4446
LDD6030	30 x 60 x 29	125	225	30	\$4282

Connects to Linking Bridges or Executive Returns. Attaching hardware included. **Not freestanding.** Shipped RTA - ready to assemble.

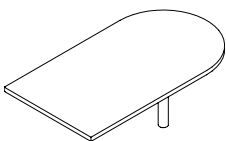

"D" Island with Monopost

LRD8430	30 x 84 x 29	125	135	51	\$3994
LRD7230	30 x 72 x 29	125	99	36	\$3180
LRD6630	30 x 66 x 29	125	99	40	\$3180
LRD6030	30 x 60 x 29	125	83	30	\$3057

Attaches to edge of worksurfaces with molding edge. Attaching hardware included. Shipped RTA - ready to assemble.

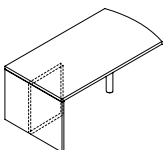

"D" Island - Full End Panel (T-Base) & Monopost, Bow End

LDDBE8430	30 x 84 x 29	125	343	51	\$5596
LDDBE7230	30 x 72 x 29	125	264	36	\$4446
LDDBE6630	30 x 66 x 29	125	245	40	\$4446
LDDBE6030	30 x 60 x 29	125	225	30	\$4275

Connects to Linking Bridges or Executive Returns. Attaching hardware included. **Not freestanding.** Shipped RTA - ready to assemble.

Required Specifications

Veneer Finish
Edge
Monopost Finish

Optional Specifications

Grommet
Monopost (Base) Upgrade

"D" ISLANDS **MODEL#** **DIMENSIONS** **FREIGHT CLASS** **WT/LBS.** **CUBIC FT.** **LIST PRICE**

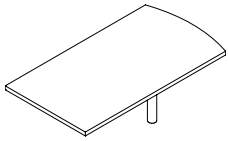

	D x W x H					
LRDBE8430	30 x 84 x 29	125	135	51	\$3994	
LRDBE7230	30 x 72 x 29	125	99	36	\$3180	
LRDBE6630	30 x 66 x 29	125	99	40	\$3180	
LRDBE6030	30 x 60 x 29	125	83	30	\$3057	

"D" Island with Monopost, Bow End

Attaches to edge of worksurfaces with molding edge. Attaching hardware included. Shipped RTA - ready to assemble.

PIANO DESKS

- Can be ordered as a shell or with pedestals.
- Components include a GM1 grommet in the top center position.
- Hand of Rectangular Desk is determined by location of pedestal from user side.
- Hand of "D" Top is determined by outward orientation of curved end from user projection.
- Hand of "P" Top is determined by outward orientation of conference end from user projection.
- Connectable Tables and Bridges - To remove cross grain veneer pattern on top, delete suffix "CG" from the model number. Available as a special - no upcharge.

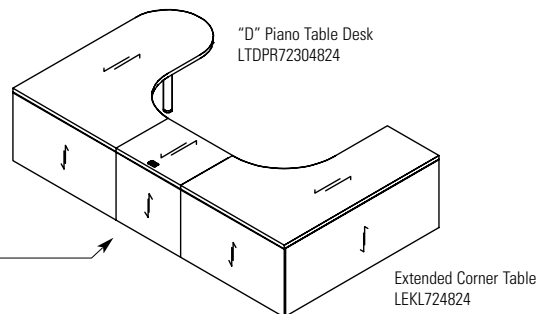
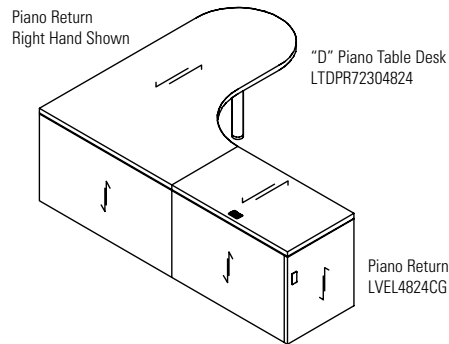
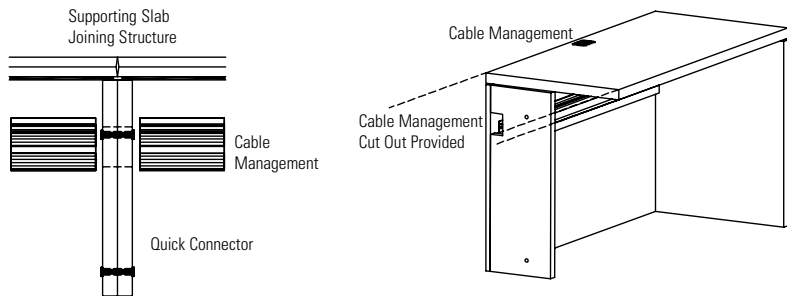

Required Specifications

- Veneer Finish
- Edge
- Monopost Finish

Optional Specifications

- Grommet
- Monopost (Base) Upgrade

PIANO DESKS

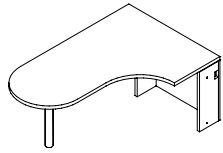

"D" Island LEFT - Full End Panel & Monopost, Piano Desk

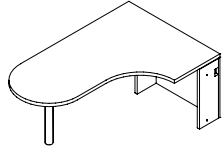

"D" Island LEFT - Full End Panel & Monopost, Piano Desk

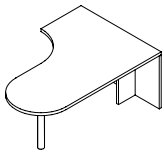

"D" Island RIGHT - Full End Panel & Monopost, Piano Desk

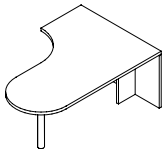

"D" Island RIGHT - Full End Panel & Monopost, Piano Desk

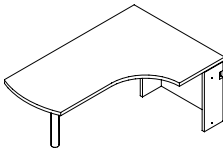

"D" Island LEFT - Full End Panel & Monopost, Piano Desk - Bow End

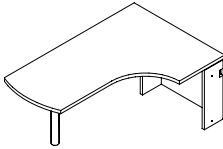

"D" Island LEFT - Full End Panel & Monopost, Piano Desk - Bow End

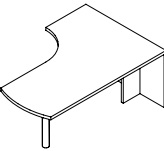

"D" Island RIGHT - Full End Panel & Monopost, Piano Desk - Bow End

MODEL#	DIMENSIONS D x W x H	FREIGHT CLASS	WT/LBS.	CUBIC FT.	LIST PRICE
LTDPL84304824	48 x 84 x 29	150	406	68	\$4634
LTDPL72304824	48 x 72 x 29	125	348	58	\$4063

Extended island worksurface on the **left**. Narrow end panel on right connects to **24"D** returns or bridges **for Piano Desks Only** (see page 303). **Not freestanding**. Includes installed horizontal wire management. Shipped RTA (ready to assemble).

LTDPL84304820	48 x 84 x 29	150	406	68	\$4521
LTDPL72304820	48 x 72 x 29	125	348	58	\$3947

Extended island worksurface on the **left**. Narrow end panel on right connects to **20"D** returns or bridges **for Piano Desks Only** (see page 303). **Not freestanding**. Includes installed horizontal wire management. Shipped RTA (ready to assemble).

LTDPR84304824	48 x 84 x 29	150	406	68	\$4634
LTDPR72304824	48 x 72 x 29	125	348	58	\$4063

Extended island worksurface on the **right**. Narrow end panel on left connects to **24"D** returns or bridges **for Piano Desks Only** (see page 303). **Not freestanding**. Includes installed horizontal wire management. Shipped RTA (ready to assemble).

LTDPR84304820	48 x 84 x 29	150	406	68	\$4521
LTDPR72304820	48 x 72 x 29	125	348	58	\$3947

Extended island worksurface on the **right**. Narrow end panel on left connects to **20"D** returns or bridges **for Piano Desks Only** (see page 303). **Not freestanding**. Includes installed horizontal wire management. Shipped RTA (ready to assemble).

LDBEPL84304824	48 x 84 x 29	150	406	68	\$4634
LDBEPL72304824	48 x 72 x 29	125	348	58	\$4063

Extended island worksurface on the **left**. Narrow end panel on right connects to **24"D** returns or bridges **for Piano Desks Only** (see page 303). **Not freestanding**. Includes installed horizontal wire management. Shipped RTA (ready to assemble).

LDBEPL84304820	48 x 84 x 29	150	406	68	\$4521
LDBEPL72304820	48 x 72 x 29	125	348	58	\$3947

Extended island worksurface on the **left**. Narrow end panel on right connects to **20"D** returns or bridges **for Piano Desks Only** (see page 303). **Not freestanding**. Includes installed horizontal wire management. Shipped RTA (ready to assemble).

LDBEPR84304824	48 x 84 x 29	150	406	68	\$4634
LDBEPR72304824	48 x 72 x 29	125	348	58	\$4063

Extended island worksurface on the **right**. Narrow end panel on left connects to **24"D** returns or bridges **for Piano Desks Only** (see page 303). **Not freestanding**. Includes installed horizontal wire management. Shipped RTA (ready to assemble).

Required Specifications

Veneer Finish
Edge
Monopost Finish - Piano Desk

Optional Specifications

Grommet
Monopost (Base) Upgrade - Piano Desk

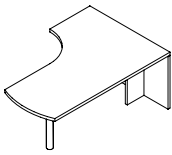
PIANO DESK	MODEL#	DIMENSIONS D x W x H	FREIGHT CLASS	WT/LBS.	CUBIC FT.	LIST PRICE
	LDBEPR84304820	48 x 84 x 29	150	406	68	\$4521
	LDBEPR72304820	48 x 72 x 29	125	348	58	\$3947

"D" Island RIGHT - Full End Panel & Monopost, Piano Desk - Bow End

Extended island worksurface on the **right**. Narrow end panel on left connects to **20"D** returns or bridges **for Piano Desks Only** (see page 303). **Not freestanding**. Includes installed horizontal wire management. Shipped RTA (ready to assemble).

CONNECTABLE TABLES - FOR PIANO DESKS	MODEL#	DIMENSIONS	FREIGHT CLASS	WT/LBS.	CUBIC FT.	LIST PRICE
	LVEL8424CG	24 x 84 x 29	150	174	34	\$3405
	LVEL7824CG	24 x 78 x 29	150	162	31	\$3190
	LVEL7224CG	24 x 72 x 29	150	149	29	\$2984
	LVEL6624CG	24 x 66 x 29	150	141	27	\$2822
	LVEL6024CG	24 x 60 x 29	150	132	24	\$2668
	LVEL5424CG	24 x 54 x 29	150	121	22	\$2537
	LVEL4824CG	24 x 48 x 29	125	115	19	\$2418
	LVEL4224CG	24 x 42 x 29	150	99	17	\$2104
	LVEL3624CG	24 x 36 x 29	150	83	15	\$2045

24" Deep Connectable Table - LEFT For Piano Desk

Full end panel on left. Right narrow end panel connects to **24"D** right connectable table, "D" islands, Boat shaped islands, "P" islands or Delta islands with "T" bases **for Piano Desks Only**. Grommet in worksurface. Ships assembled in 1 carton.

- To remove cross grain veneer pattern on top, **delete suffix "CG"** from the model number. Available as a special - no upcharge.

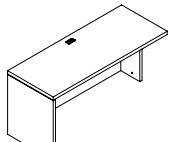
	LVEL8420CG	20 x 84 x 29	150	174	34	\$2635
	LVEL7820CG	20 x 78 x 29	150	162	31	\$2447
	LVEL7220CG	20 x 72 x 29	150	149	29	\$2258
	LVEL6620CG	20 x 66 x 29	150	141	27	\$2119
	LVEL6020CG	20 x 60 x 29	150	132	24	\$1985
	LVEL5420CG	20 x 54 x 29	150	121	22	\$1870
	LVEL4820CG	20 x 48 x 29	125	115	19	\$1753
	LVEL4220CG	20 x 42 x 29	150	99	17	\$1484
	LVEL3620CG	20 x 36 x 29	150	83	15	\$1429

20" Deep Connectable Table - LEFT For Piano Desk

Full end panel on left. Right narrow end panel connects to **20"D** right connectable table, "D" islands, Boat shaped islands, "P" islands or Delta islands with "T" bases **for Piano Desks Only**. Grommet in worksurface. Ships assembled in 1 carton.

- To remove cross grain veneer pattern on top, **delete suffix "CG"** from the model number. Available as a special - no upcharge.

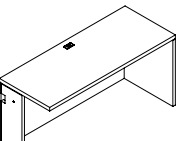
	LVER8424CG	24 x 84 x 29	150	174	34	\$3405
	LVER7824CG	24 x 78 x 29	150	162	31	\$3190
	LVER7224CG	24 x 72 x 29	150	149	29	\$2984
	LVER6624CG	24 x 66 x 29	150	141	27	\$2822
	LVER6024CG	24 x 60 x 29	150	132	24	\$2668
	LVER5424CG	24 x 54 x 29	150	121	22	\$2537
	LVER4824CG	24 x 48 x 29	125	115	19	\$2418
	LVER4224CG	24 x 42 x 29	150	99	17	\$2104
	LVER3624CG	24 x 36 x 29	150	83	15	\$2045

24" Deep Connectable Table - RIGHT For Piano Desk

Full end panel on right. Left narrow end panel connects to **24"D** left connectable table, "D" islands, Boat shaped islands, "P" islands or Delta islands with "T" bases **for Piano Desks Only**. Grommet in worksurface. Ships assembled in 1 carton.

- To remove cross grain veneer pattern on top, **delete suffix "CG"** from the model number. Available as a special - no upcharge.

Required Specifications

Veneer Finish
Edge
Monopost Finish - Piano Desk

Optional Specifications

Grommet
Monopost (Base) Upgrade - Piano Desk

CONNECTABLE TABLES - FOR PIANO DESKS

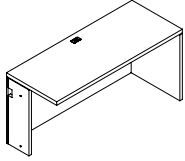

**20" Deep Connectable Table - RIGHT
For Piano Desk**

MODEL#	DIMENSIONS D x W x H	FREIGHT CLASS	WT/LBS.	CUBIC FT.	LIST PRICE
LVER8420CG	20 x 84 x 29	150	174	34	\$2635
LVER7820CG	20 x 78 x 29	150	162	31	\$2447
LVER7220CG	20 x 72 x 29	150	149	29	\$2258
LVER6620CG	20 x 66 x 29	150	141	27	\$2119
LVER6020CG	20 x 60 x 29	150	132	24	\$1985
LVER5420CG	20 x 54 x 29	150	121	22	\$1870
LVER4820CG	20 x 48 x 29	125	115	19	\$1753
LVER4220CG	20 x 42 x 29	150	99	17	\$1484
LVER3620CG	20 x 36 x 29	150	83	15	\$1429

Full end panel on right. Left narrow end panel connects to **20"D** left connectable table, "D" islands, Boat shaped islands, "P" islands or Delta islands with "T" bases **for Piano Desks Only**. Grommet in worksurface. Ships assembled in 1 carton.

- To remove cross grain veneer pattern on top, **delete suffix "CG"** from the model number. Available as a special - no upcharge.

BRIDGES - FOR PIANO DESKS

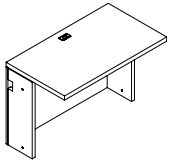

Flush Bridge

MODEL#	DIMENSIONS	FREIGHT CLASS	WT/LBS.	CUBIC FT.	LIST PRICE
LBTN4824CG	24 x 48 x 29	125	116	19	\$2139
LBTN4224CG	24 x 42 x 29	125	102	17	\$1861
LBTN3624CG	24 x 36 x 29	150	87	15	\$1805
LBTN3024CG	24 x 30 x 29	125	73	12	\$1772
LBTN2424CG	24 x 24 x 29	150	58	10	\$1562
LBTN1824CG	24 x 18 x 29	150	43	8	\$1280
LBTN1224CG	24 x 12 x 29	150	29	5	\$993

Full end panel on both sides connects to **24"D** worksurfaces, "D" islands, Boat shaped islands, "P" islands or Delta islands with "T" bases **for Piano Desks Only**. Grommet in worksurface. Ships assembled in 1 carton.

- To remove cross grain veneer pattern on top, **delete suffix "CG"** from the model number. Available as a special - no upcharge.

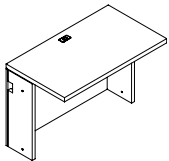

Flush Bridge

LBTN4820CG	20 x 48 x 29	125	116	19	\$1703
LBTN4220CG	20 x 42 x 29	125	102	17	\$1422
LBTN3620CG	20 x 36 x 29	150	87	15	\$1378
LBTN3020CG	20 x 30 x 29	125	73	12	\$1351
LBTN2420CG	20 x 24 x 29	150	58	10	\$1137
LBTN1820CG	20 x 18 x 29	150	43	8	\$1081
LBTN1220CG	20 x 12 x 29	150	29	5	\$1006

Full end panel on both sides connects to **20"D** worksurfaces, "D" islands, Boat shaped islands, "P" islands or Delta islands with "T" bases **for Piano Desks Only**. Grommet in worksurface. Ships assembled in 1 carton.

- To remove cross grain veneer pattern on top, **delete suffix "CG"** from the model number. Available as a special - no upcharge.

Required Specifications

Veneer Finish
Edge
Metal Finish - Modesty Panel

Optional Specifications

Grommet

MODESTY PANEL OPTIONS **MODEL#** **DIMENSIONS** **FREIGHT CLASS** **WT/LBS.** **CUBIC FT.** **LIST PRICE**

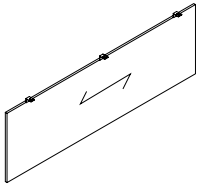

Veneer Modesty Panel Upgrade*

CMP72W	0.75 x 67 x 18	--	20	1	\$1728
CMP66W	0.75 x 61 x 18	--	18	1	\$1673
CMP60W	0.75 x 55 x 18	--	16	1	\$1647
CMP54W	0.75 x 49 x 18	--	14	1	\$1619
CMP48W	0.75 x 43 x 18	--	13	1	\$1594

Straight modesty panel. Attaches to underside of worksurface. **Can not be retrofitted in the field *Not sold individually - to be ordered as an upgrade option only.***

- CMP72W - Specify on "P" Top Islands or 96" x 48" Islands for Piano Desks.
- CMP66W - Specify on 84" x 36" "D" Top Islands.
- CMP60W - Specify on 84" x 42" "P" Top Islands or 84" x 48" Islands for Piano Desks.
- CMP54W - Specify on 72" x 30" "D" Top Islands.
- CMP48W - Specify on 66" x 36" , 60" x 30" "D" Top Islands, 72" x 42" "P" Top Islands or 72" x 48" Islands for Piano Desks.

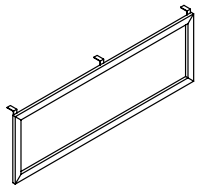

Glass Modesty Panel Upgrade

CMP72G	0.75 x 67 x 18	--	20	1	\$2647
CMP66G	0.75 x 61 x 18	--	18	1	\$2504
CMP60G	0.75 x 55 x 18	--	16	1	\$2289
CMP54G	0.75 x 49 x 18	--	14	1	\$2132
CMP48G	0.75 x 43 x 18	--	13	1	\$2036

Straight modesty panel. Translucent, screened glass. Aluminum box frame construction in Tungsten Only. Attaches to underside of worksurface. **Can not be retrofitted in the field. *Not sold individually - to be ordered as an upgrade option only.***

- CMP72G - Specify on "P" Top Islands or 96" x 48" Islands for Piano Desks.
- CMP66G - Specify on 84" x 36" "D" Top Islands.
- CMP60G - Specify on 84" x 42" "P" Top Islands or 84" x 48" Islands for Piano Desks.
- CMP54G - Specify on 72" x 30" "D" Top Islands.
- CMP48G - Specify on 66" x 36" , 60" x 30" "D" Top Islands, 72" x 42" "P" Top Islands or 72" x 48" Islands for Piano Desks.
- Tungsten finish on the aluminum box frame closely resembles the existing Tungsten finish.

Required Specifications

Metal finish

SIDE-BY-SIDE COMPONENTS MODEL# DIMENSIONS FREIGHT CLASS WT/LBS. CUBIC FT. LIST PRICE

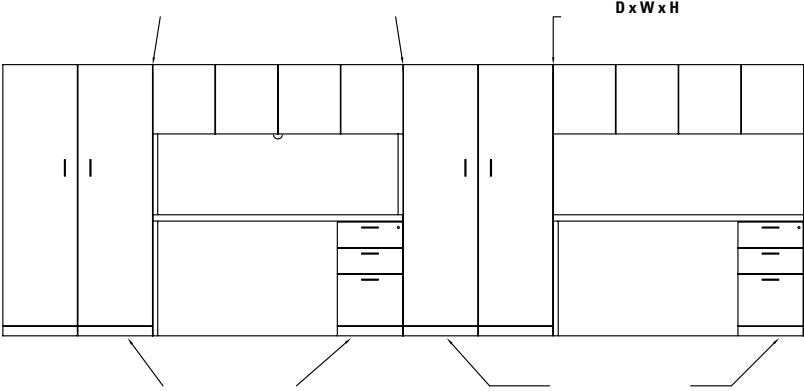

MODULAR PEDESTALS

- When using Storage Shells, laminate gables will show.
- Credenza shell cannot be completely filled up with storage shells to create a full storage credenza.
- Handle style must be specified.

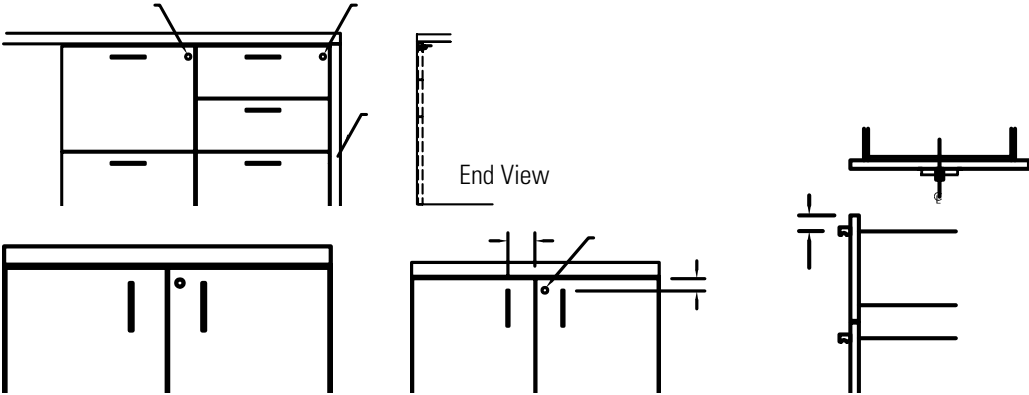

STORAGE SHELLS MODEL# DIMENSIONS FREIGHT CLASS WT/LBS. CUBIC FT. LIST PRICE

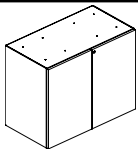

Storage Shell

MODEL#	DIMENSIONS D x W x H	FREIGHT CLASS	WT/LBS.	CUBIC FT.	LIST PRICE
LWG	18 x 35 x 28	92.5	115	11	\$1893
LWM	18 x 30 x 28	92.5	96	9	\$1703
LWG.5	18 x 34 x 28	92.5	115	11	\$1893

For use **under a freestanding worksurface (22", 24", 30" or 36"D)**. Top drilled to attach to worksurface. One adjustable shelf. Standard with lock. Ships assembled in 1 carton.

- **Specify LWG and LWM for kneespace applications**
- **Unfinished top and back**

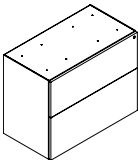

File/File Shell - Lateral

LWF	18 x 35 x 28	92.5	115	11	\$2668
LWN	18 x 30 x 28	92.5	96	9	\$2320
LWF.5	18 x 34 x 28	92.5	115	11	\$2668
LWN.5	18 x 29 x 28	92.5	96	9	\$2320

For use **under a freestanding worksurface (22", 24", 30" or 36"D)**. Top drilled to attach to worksurface. **Two lateral file drawers**. Lock secures all drawers. Side-to-side file bars included. Ships assembled in 1 carton.

- **Specify LWF and LWN for kneespace applications**
- **Unfinished top and back**

Required Specifications

Veneer Finish
Edge

STORAGE MODULES - FREESTANDING **MODEL#** **DIMENSIONS** **FREIGHT CLASS** **WT/LBS.** **CUBIC FT.** **LIST PRICE**

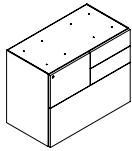

Mixed Storage Shell - LEFT

	D x W x H				
LWZL	18 x 35 x 28	92.5	115	11	\$3057
LWZL.5	18 x 34 x 28	92.5	115	11	\$3057

For use **under a freestanding worksurface (22", 24", 30" or 36"D)**. Top drilled to attach to worksurface. One file drawer on **left**, two box drawers on **right** and one lateral file drawer on bottom. File drawer and lateral file drawer lock. One pencil tray. **Not for stacking materials on lateral file drawer bottom.** Ships assembled in 1 carton.

- **Specify LWZL for kneespace applications**
- **Unfinished top and back**

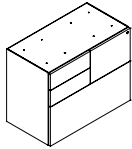

Mixed Storage Shell - RIGHT

LWZR	18 x 35 x 28	92.5	115	11	\$3057
LWZR.5	18 x 34 x 28	92.5	115	11	\$3057

For use **under a freestanding worksurface (22", 24", 30" or 36"D)**. Top drilled to attach to worksurface. One file drawer on **right**, two box drawers on **left** and one lateral file drawer on bottom. File drawer and lateral file drawer lock. One pencil tray. **Not for stacking materials on lateral file drawer bottom.** Ships assembled in 1 carton.

- **Specify LWZR for kneespace applications**
- **Unfinished top and back**

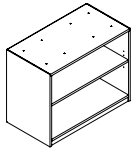

Open Shelving Shell

LWOB36	18 x 35 x 28	100	92	11	\$1462
LWOB30	18 x 30 x 28	100	77	9	\$1316

For use **under a freestanding worksurface (22", 24", 30" or 36"D)**. Top drilled to attach to worksurface. One adjustable veneer shelf. Ships assembled in 1 carton.

- **Unfinished top and back**

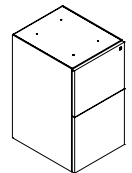

File/File Shell - Vertical

LETTER					
LWWE	23 x 16 x 28	92.5	72	6	\$2132
LWE	18 x 16 x 28	92.5	70	5	\$1893
LEGAL					
LWWLE	23 x 19 x 28	92.5	85	7	\$2492
LWLE	18 x 19 x 28	92.5	83	6	\$2207

For use **under a freestanding worksurface (22", 24", 30" or 36"D)**. Top drilled to attach to worksurface. **Two file drawers.** Lock secures all drawers. Ships assembled in 1 carton.

- *For 22" or 24"D worksurface, order **LWE or LWLE**. For 30" or 36"D worksurface, order **LWWE or LWWLE**.*
- **Unfinished top and back**

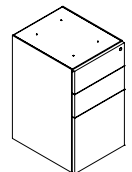

Box/Box/File Shell

LETTER					
LWWD	23 x 16 x 28	92.5	72	6	\$2132
LWD	19.1 x 16 x 28	92.5	70	5	\$1893
LEGAL					
LWWLD	23 x 19 x 28	92.5	85	7	\$2492
LWLD	19.1 x 19 x 28	92.5	83	6	\$2207

For use **under a freestanding worksurface (22", 24", 30" or 36"D)**. Top drilled to attach to worksurface. **Two box and one file drawers.** One pencil tray. Lock secures all drawers. Ships assembled in 1 carton.

- *For 22" or 24"D worksurface, order **LWD or LWLD**. For 30" or 36"D worksurface, order **LWWD or LWWLD**.*
- **Unfinished top and back**

Required Specifications

Veneer Finish
Edge

STORAGE MODULES - FREESTANDING

MODEL# DIMENSIONS FREIGHT CLASS WT/LBS. CUBIC FT. LIST PRICE

D x W x H

LWBM	18 x 16 x 21	85	70	5	\$1578
LWWBM	24 x 16 x 21	85	75	6	\$1851

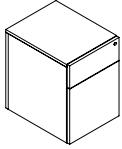

Box/File Freestanding Mobile Pedestal

One box and one file drawer. One pencil tray. Lock secures all drawers. Finished back. Ships assembled in 1 carton.

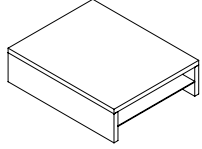

Spacer

LSPBOX1620	20 x 16 x 4.8	125	15	2	\$560
------------	---------------	-----	----	---	--------------

For use with 23" high credenzas to support an overlapping return. Includes shelf for paper management. Ships assembled in 1 carton.

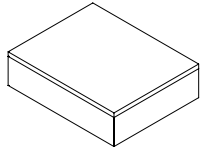

Spacer, Closed

LSPBOX1620C	20 x 16 x 4.8	125	15	2	\$618
-------------	---------------	-----	----	---	--------------

For use with 23" high credenzas to support an overlapping return. Ships assembled in 1 carton.

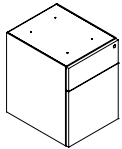

Box/File Pedestal

LWB15	19 x 16 x 19.5	70	50	3	\$1351
-------	----------------	----	----	---	---------------

One box and one file drawer. One pencil tray. Lock secures all drawers. Finished back. **For use with 23" high credenza shell.** Ships assembled in 1 carton.

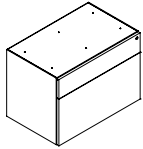

Box/Lateral File Pedestal

LWB36	19 x 36 x 19.5	92.5	115	11	\$2456
LWB30	19 x 30 x 19.5	92.5	96	9	\$2149

One box and one lateral file drawer. One pencil tray. Lock secures all drawers. Finished back. **For use with 23" high credenza shell.** Ships assembled in 1 carton.

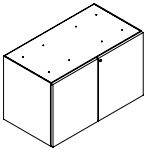

Storage Cabinet w/Doors

LWMH19.5	19 x 36 x 29	92.5	130	12	\$1520
LWGH19.5	19 x 30 x 29	92.5	107	10	\$1715

Includes one adjustable shelf. Standard with lock. **For use with 23" high credenza shell.** Ships assembled in 1 carton.

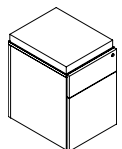

Box/File Freestanding Pedestal Mobile, with Cushion

					GRD 1/GRD 2	GRD 3	GRD 4
LWBMCU	20 x 16 x 24	85	70	5	\$2373	\$2889	\$2967
LWWBMCU	24 x 16 x 24	85	75	6	\$2709	\$3298	\$3387

One box and one file drawer. One pencil tray. Lock secures all drawers. Casters. Ships assembled in 1 carton. Pricing in grade 1 through 4. Pricing beyond grade 4 must be submitted as special.

Required Specifications

Veneer Finish
Edge

STORAGE MODULES - FREESTANDING **MODEL#** **DIMENSIONS** **FREIGHT CLASS** **WT/LBS.** **CUBIC FT.** **LIST PRICE**

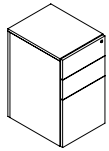

Box/Box/File Freestanding Pedestal

	D x W x H				
LWDB	19 x 16 x 28	85	70	5	\$1893
LWWDB	24 x 16 x 28	85	75	6	\$2176

Two box and one file drawer. One pencil tray. Lock secures all drawers. Finished back. Ships assembled in 1 carton.

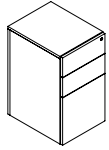

Box/Box/File Module, Mobile

LWDM	19 x 16 x 28	85	70	5	\$2036
LWWDM	24 x 16 x 28	85	75	6	\$2337

Two box and one file drawer. One pencil tray. Lock secures all drawers. Casters. Ships assembled in 1 carton.

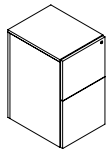

File/File Module, Mobile

LWEM	19 x 16 x 28	85	70	5	\$2207
LWWEM	24 x 16 x 28	85	75	6	\$2372

Two file drawer. Lock secures all drawers. Casters. Ships assembled in 1 carton. Ships assembled in 1 carton.

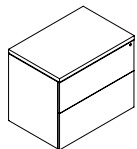

File/File Module, Lateral

LF3624	24 x 36 x 29	85	184	15	\$3491
LN3024	24 x 30 x 29	85	153	12	\$3057
LF3620	20 x 36 x 29	85	159	12	\$2621
LN3020	20 x 30 x 29	85	131	10	\$2292

Two lateral file drawers. Lock secures all drawers. Ships assembled in 1 carton.

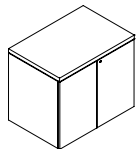

Storage Cabinet w/Doors

LBD3624	24 x 36 x 29	92.5	152	15	\$2375
LBD3024	24 x 30 x 29	92.5	127	12	\$2086
LBD3620	20 x 36 x 29	92.5	130	12	\$1875
LBD3020	20 x 30 x 29	92.5	107	10	\$1634

Includes one adjustable shelf. Standard with lock. Ships assembled in 1 carton.

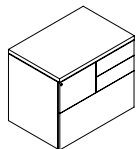

Mixed Storage Cabinet - LEFT

LZL3624	24 x 36 x 29	85	184	15	\$3791
LZL3620	20 x 36 x 29	85	170	13	\$2978

One file drawer on the **left**, two box drawers on the **right** and one lateral file drawer on the bottom. File drawer and lateral file drawer lock. One pencil tray. **Not for stacking materials on lateral file drawer bottom.** Ships assembled in 1 carton.

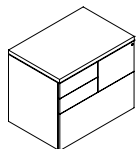

Mixed Storage Cabinet - RIGHT

LZR3624	24 x 36 x 29	85	184	15	\$3791
LZR3620	20 x 36 x 29	85	170	13	\$2978

One file drawer on the **right**, two box drawers on the **left** and one lateral file drawer on the bottom. File drawer and lateral file drawer lock. One pencil tray. **Not for stacking materials on lateral file drawer bottom.** Ships assembled in 1 carton.

Required Specifications

Veneer Finish
Edge

FREESTANDING STORAGE

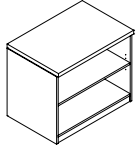

Open Storage Cabinet

MODEL#	DIMENSIONS D x W x H	FREIGHT CLASS	WT/LBS.	CUBIC FT.	LIST PRICE
LOB3624	24 x 36 x 29	100	123	15	\$1909
LOB3024	24 x 30 x 29	100	103	12	\$1668
LOB3620	20 x 36 x 29	100	115	13	\$1503
LOB3020	20 x 30 x 29	100	96	11	\$1308

One fixed and **one** adjustable veneer shelf. Shelves are 3/4" thick. Ships assembled in 1 carton.

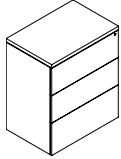

Three File Module

LF36243	24 x 36 x 42	92.5	231	21	\$4270
LN30243	24 x 30 x 42	92.5	193	18	\$3733
LF36203	20 x 36 x 42	92.5	212	19	\$3652
LN30203	20 x 30 x 42	92.5	176	16	\$3194

Three lateral file drawers. Lock secures all drawers. Ships assembled in 1 carton.

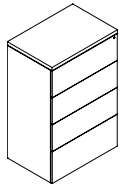

Four File Module

LF36244	24 x 36 x 54	92.5	297	27	\$5202
LN30244	24 x 30 x 54	92.5	248	23	\$4549
LF36204	20 x 36 x 54	92.5	270	25	\$4527
LN30204	20 x 30 x 54	92.5	225	21	\$3960

Four lateral file drawers. Lock secures all drawers. Ships assembled in 1 carton.

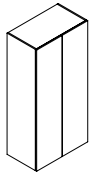

Storage Cabinet w/Doors*

L1D24H72	24 x 35 x 72	100	324	36	\$4544
L1D24W30H72	24 x 30 x 72	100	270	30	\$3968
L1D24W24H72	24 x 24 x 72	100	216	24	\$3389
L1H72	20 x 35 x 72	100	269	30	\$3968
L1W30H72	20 x 30 x 72	100	233	25	\$3311
L1W24H72	20 x 24 x 72	100	179	20	\$2645
L1D24	24 x 35 x 65	100	297	33	\$4167
L1D24W30	24 x 30 x 65	100	248	28	\$3647
L1D24W24	24 x 24 x 65	100	198	22	\$3127
L1W35	20 x 35 x 65	100	245	28	\$3640
L1W30	20 x 30 x 65	100	202	23	\$3034
L1W24	20 x 24 x 65	100	163	18	\$2430

Includes four adjustable shelves. Optional lock available. Ships assembled in 1 carton.

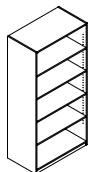

Open Storage Cabinet

L7D24H72	24 x 35 x 72	100	306	36	\$3640
L7D24W30H72	24 x 30 x 72	100	255	30	\$3184
L7H72	20 x 35 x 72	100	257	30	\$3180
L7W30H72	20 x 30 x 72	100	223	25	\$2645
L7D24	24 x 35 x 65	100	281	33	\$3339
L7D24W30	24 x 30 x 65	100	234	28	\$2920
L7	20 x 35 x 65	100	234	28	\$2914
L7W30	20 x 30 x 65	100	193	23	\$2430

Includes one fixed and **four** adjustable veneer shelves. Shelves are 3/4" thick. Ships assembled in 1 carton.

Required Specifications

Veneer finish
Edge (file modules)

Optional Specifications

Lock*

FREESTANDING STORAGE **MODEL#** **DIMENSIONS** **FREIGHT CLASS** **WT/LBS.** **CUBIC FT.** **LIST PRICE**

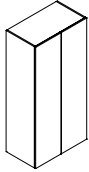

Wardrobe Cabinet

D x W x H						
L2D24H72	24 x 35 x 72	100	324	36	\$3873	
L2D24W30H72	24 x 30 x 72	100	270	30	\$3388	
L2D24W24H72	24 x 24 x 72	100	216	24	\$2902	
L2H72	20 x 35 x 72	100	269	30	\$3385	
L2W30H72	20 x 30 x 72	100	233	25	\$2876	
L2W24H72	20 x 24 x 72	100	179	20	\$2296	
L2D24	24 x 35 x 65	100	297	33	\$3550	
L2D24W30	24 x 30 x 65	100	246	28	\$3108	
L2D24W24	24 x 24 x 65	100	198	22	\$2666	
L2	20 x 35 x 65	100	245	28	\$3155	
L2W30	20 x 30 x 65	100	202	23	\$2635	
L2W24	20 x 24 x 65	100	163	18	\$2109	

Includes full length hanging rod and fixed hat shelf. Lock optional. Ships assembled in 1 carton.

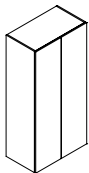

Wardrobe Cabinet/Shelving Combo

L25D24H72	24 x 35 x 72	100	324	36	\$5097	
L25D24W30H72	24 x 30 x 72	100	270	30	\$4460	
L25D24W24H72	24 x 24 x 72	100	216	24	\$3930	
L25H72	20 x 35 x 72	100	269	30	\$4446	
L25W30H72	20 x 30 x 72	100	233	25	\$3710	
L25W24H72	20 x 24 x 72	100	179	20	\$2972	
L25D24	24 x 35 x 65	100	297	33	\$4677	
L25D24W30	24 x 30 x 65	100	246	28	\$4086	
L25D24W24	24 x 24 x 65	100	198	22	\$3503	
L25	20 x 35 x 65	100	245	28	\$4075	
L25W30	20 x 30 x 65	100	202	23	\$3401	
L25W24	20 x 24 x 65	100	163	18	\$2726	

Wardrobe compartment on **left** includes hanging rod and fixed hat shelf. Storage compartment on **right** includes three adjustable shelves. Lock optional. Ships assembled in 1 carton.

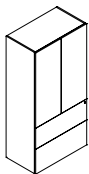

Two File Module w/Doors

L13D24H72	24 x 35 x 72	100	324	36	\$5623	
L13D24W30H72	24 x 30 x 72	100	270	30	\$4921	
L13H72	20 x 35 x 72	100	269	30	\$4911	
L13W30H72	20 x 30 x 72	100	233	25	\$4096	
L13D24	24 x 35 x 65	100	297	33	\$5157	
L13D24W30	24 x 30 x 65	100	248	28	\$4508	
L13	20 x 35 x 65	100	245	28	\$4503	
L13W30	20 x 30 x 65	100	202	23	\$3756	

Two lateral file drawers on bottom. Includes **two** adjustable shelves. Lower lock secures two file drawers. Optional lock available for upper storage compartment. **Not for stacking materials on lateral file drawer bottom.** Ships assembled in 1 carton.

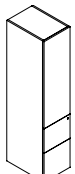

Two File Module w/Door - LEFT

L17D24H72L	24 x 16 x 72	125	99	15	\$3870
L17H72L	20 x 16 x 72	125	90	13	\$3291
L17D24L	24 x 16 x 65	125	91	13	\$3588
L17L	20 x 16 x 65	125	83	12	\$3018

Two file drawers on bottom. Includes two adjustable shelves. Lower lock secures two file drawers. Optional lock available for upper storage compartment. Handle is on the **right**, door opens to the **left**. Ships assembled in 1 carton.

Required Specifications
Veneer finish

Optional Specifications
Lock

FREESTANDING STORAGE

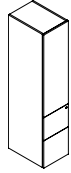

Two File Module w/Door - RIGHT

MODEL#	DIMENSIONS D x W x H	FREIGHT CLASS	WT/LBS.	CUBIC FT.	LIST PRICE
L17D24H72R	24 x 16 x 72	125	99	15	\$3870
L17H72R	20 x 16 x 72	125	90	13	\$3291
L17D24R	24 x 16 x 65	125	91	13	\$3588
L17R	20 x 16 x 65	125	83	12	\$3018

Two file drawers on bottom. Includes two adjustable shelves. Optional lock available on upper storage compartment. Lower lock secures two file drawers. Handle is on the **left**, door opens to the **right**. Ships assembled in 1 carton.

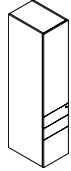

Box/Box/File Module w/Door - LEFT

L18D24H72L	24 x 16 x 72	125	99	15	\$3870
L18H72L	20 x 16 x 72	125	90	13	\$3291
L18D24L	24 x 16 x 65	125	91	13	\$3588
L18L	20 x 16 x 65	125	83	12	\$3018

Two box drawers and one file drawer on bottom. Includes two adjustable shelves. Optional lock available on upper storage compartment. Lower lock secures all drawers. Handle is on the **right**, door opens to the **left**. Ships assembled in 1 carton.

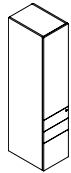

Box/Box/File Module w/Door - RIGHT

L18D24H72R	24 x 16 x 72	125	99	15	\$3870
L18H72R	20 x 16 x 72	125	90	13	\$3291
L18D24R	24 x 16 x 65	125	91	13	\$3588
L18R	20 x 16 x 65	125	83	12	\$3018

Two box drawers and one file drawer on bottom. Includes two adjustable shelves. Optional lock available on upper storage compartment. Lower lock secures all drawers. Handle is on the **left**, door opens to the **right**. Ships assembled in 1 carton.

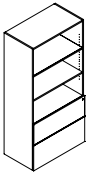

Two File Module w/Open Shelves

L12D24H72	24 x 35 x 72	100	324	36	\$4939
L12D24W30H72	24 x 30 x 72	100	270	30	\$4320
L12H72	20 x 35 x 72	100	269	30	\$4311
L12W30H72	20 x 30 x 72	100	233	25	\$3772
L12D24	24 x 35 x 65	100	297	33	\$4527
L12D24W30	24 x 30 x 65	100	248	28	\$3960
L12	20 x 35 x 65	100	245	28	\$3947
L12W30	20 x 30 x 65	100	239	23	\$3298

Three open veneer shelves and two lateral file drawers on bottom. Includes two adjustable shelves. Lock secures all drawers. Front-to-back and side-to-side filing. **Not for stacking materials on lateral file drawer bottom**. Ships assembled in 1 carton.

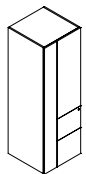

Personal Tower - LEFT

L29D24W24H72L	24 x 24 x 72	125	168	24	\$5757
L29W24H72L	20 x 24 x 72	125	140	20	\$4706
L29D24W24L	24 x 24 x 65	125	154	22	\$5167
L29W24L	20 x 24 x 65	125	128	18	\$4263

Two file drawers on bottom. Wardrobe compartment on **left** includes hanging rod. Storage compartment on **right** includes one adjustable shelf. Optional lock available on upper storage and wardrobe. Lower lock secures all drawers. Ships assembled in 1 carton.

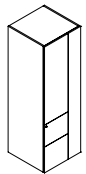

Personal Tower - RIGHT

L29D24W24H72R	24 x 24 x 72	125	168	24	\$5757
L29W24H72R	20 x 24 x 72	125	140	20	\$4706
L29D24W24R	24 x 24 x 65	125	154	22	\$5167
L29W24R	20 x 24 x 65	125	128	18	\$4263

Two file drawers on bottom. Wardrobe compartment on **right** includes hanging rod. Storage compartment on **left** includes one adjustable shelf. Optional lock available on upper storage and wardrobe. Lower lock secures all drawers. Ships assembled in 1 carton.

Required Specifications
Veneer Finish

Optional Specifications
Lock

FREESTANDING STORAGE **MODEL#** **DIMENSIONS** **FREIGHT CLASS** **WT/LBS.** **CUBIC FT.** **LIST PRICE**

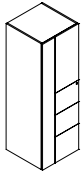

Personal Tower - LEFT

D x W x H						
L27D24W24H72L	24 x 24 x 72	125	168	24	\$6349	
L27W24H72L	20 x 24 x 72	125	140	20	\$5551	
L27D24W24L	24 x 24 x 65	125	154	22	\$5825	
L27W24L	20 x 24 x 65	125	128	18	\$5085	

Three file drawers on bottom. Wardrobe compartment on **left** includes hanging rod. Storage compartment on **right** includes one adjustable shelf. Optional lock available on upper storage and wardrobe. Lower lock secures all drawers. Ships assembled in 1 carton.

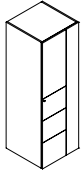

Personal Tower - RIGHT

L27D24W24H72R	24 x 24 x 72	125	168	24	\$6349
L27W24H72R	20 x 24 x 72	125	140	20	\$5551
L27D24W24R	24 x 24 x 65	125	154	22	\$5825
L27W24R	20 x 24 x 65	125	128	18	\$5085

Three file drawers on bottom. Wardrobe compartment on **right** includes hanging rod. Storage compartment on **left** includes one adjustable shelf. Optional lock available on upper storage and wardrobe. Lower lock secures all drawers. Ships assembled in 1 carton.

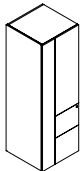

Personal Tower w/Open Bookcase - LEFT

L30D24W24H72L	24 x 24 x 72	125	168	24	\$5757
L30W24H72L	20 x 24 x 72	125	140	20	\$4706
L30D24W24L	24 x 24 x 65	125	154	22	\$5167
L30W24L	20 x 24 x 65	125	128	18	\$4263

Two file drawers on bottom. Wardrobe compartment on **left** includes hanging rod. Storage compartment on **right** includes one adjustable shelf. Open bookcase on **right** includes two adjustable shelves. Optional lock available on upper storage and wardrobe. Lower lock secures all drawers. Ships assembled in 1 carton.

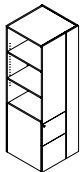

Personal Tower w/Open Bookcase - RIGHT

L30D24W24H72R	24 x 24 x 72	125	168	24	\$5757
L30W24H72R	20 x 24 x 72	125	140	20	\$4706
L30D24W24R	24 x 24 x 65	125	154	22	\$5167
L30W24R	20 x 24 x 65	125	128	18	\$4263

Two file drawers on bottom. Wardrobe compartment on **right** includes hanging rod. Storage compartment on **left** includes one adjustable shelf. Open bookcase on **left** includes two adjustable shelves. Upper lock secures storage and wardrobe compartments. Lower lock secures all drawers. Ships assembled in 1 carton.

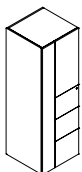

Personal Tower w/Open Bookcase - LEFT

L26D24W24H72L	24 x 24 x 72	125	168	24	\$6349
L26W24H72L	20 x 24 x 72	125	140	20	\$6285
L26D24W24L	24 x 24 x 65	125	154	22	\$5825
L26W24L	20 x 24 x 65	125	128	18	\$5807

Three file drawers on bottom. Wardrobe compartment on **left** includes hanging rod. Storage compartment on **right** includes one adjustable shelf. Open bookcase on **right** includes one adjustable shelf. Optional lock available on upper storage and wardrobe. Lower lock secures all drawers. Ships assembled in 1 carton.

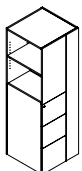

Personal Tower w/Open Bookcase - RIGHT

L26D24W24H72R	24 x 24 x 72	125	168	24	\$6349
L26W24H72R	20 x 24 x 72	125	140	20	\$6285
L26D24W24R	24 x 24 x 65	125	154	22	\$5825
L26W24R	20 x 24 x 65	125	128	18	\$5807

Three file drawers on bottom. Wardrobe compartment on **right** includes hanging rod. Storage compartment on **left** includes one adjustable shelf. Open bookcase on **left** includes one adjustable shelf. Optional lock available on upper storage and wardrobe. Lower lock secures all drawers. Ships assembled in 1 carton.

Required Specifications
Veneer Finish

Optional Specifications
Lock

FREESTANDING STORAGE

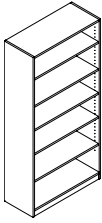

Bookcase



End Shelf - 72" High - Square

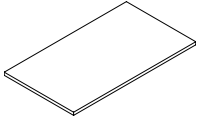

Shelf for Bookcase

MODEL#	DIMENSIONS D x W x H	FREIGHT CLASS	WT/LBS.	CUBIC FT.	LIST PRICE
LB73615	15 x 35 x 78	100	228	24	\$2590
LB63615	15 x 35 x 72	100	210	23	\$2389
LB53615	15 x 35 x 65	100	210	23	\$2200
LB73015	15 x 30 x 78	92.5	228	20	\$2265
LB63015	15 x 30 x 72	92.5	210	19	\$2086
LB53015	15 x 30 x 65	92.5	188	17	\$1925

Includes **adjustable** shelves. Shelf is ¾" thick. Ships assembled in 1 carton.

LB7S1515	15 x 15 x 78	100	95	10	\$2041
LB6S1515	15 x 15 x 72	100	83	9	\$1879
LB5S1515	15 x 15 x 65	100	81	9	\$1730
LB4S1515	15 x 15 x 48	100	59	6	\$1429

For use at end of **storage modules, wardrobe cabinets or personal towers**. Includes **adjustable** veneer shelves. Ships assembled in 1 carton.

MAG3624	24 x 35 x 1	92.5	112	10	\$183
MAG3620	20 x 35 x 1	92.5	92	9	\$156
MAG3615	15 x 35 x 1	92.5	81	8	\$131
MAG3024	24 x 30 x 1	92.5	94	9	\$156
MAG3020	20 x 30 x 1	100	76	8	\$124
MAG3015	15 x 30 x 1	100	67	8	\$109

Ships assembled in 1 carton.

Required Specifications

Veneer finish

FLOATING SHELVES

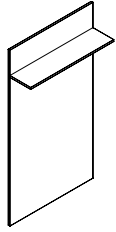

Wall Mounted Panel,
One Floating Shelf

MODEL# DIMENSIONS FREIGHT CLASS WT/LBS. CUBIC FT. LIST PRICE

D x W x H

TWF1S2466	11 x 24 x 66	250	42	13	\$1607
TWF1S3066	11 x 30 x 66	250	50	16	\$1874
TWF1S3666	11 x 36 x 66	250	58	19	\$2167
TWF1S4266	11 x 42 x 66	250	66	22	\$2489
TWF1S2472	11 x 24 x 72	250	45	14	\$1710
TWF1S3072	11 x 30 x 72	250	53	17	\$2012
TWF1S3672	11 x 36 x 72	250	62	20	\$2291
TWF1S4272	11 x 42 x 72	250	71	23	\$2624

Standard with pre-mounted "J" bracket for wall mount applications. End cap required at the end of a run of floating shelves. End cap sold separately. Shipped RTA - ready to assemble.

NOTE: Care should be taken to mount the units. Units should be mounted to wall studs using correct fasteners. Failure to do so may result in collapse of the unit and subsequent personal injury. **Fastening hardware not included.** Mounting hardware used should be based on wall material. Consult an installation professional for proper wall mounting.

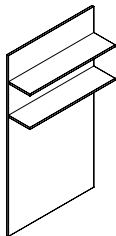

Wall Mounted Panel,
Two Floating Shelves

TWF2S2466	11 x 24 x 66	250	46	13	\$1645
TWF2S3066	11 x 30 x 66	250	56	16	\$1929
TWF2S3666	11 x 36 x 66	250	65	19	\$2219
TWF2S4266	11 x 42 x 66	250	74	21	\$2566
TWF2S2472	11 x 24 x 72	250	49	14	\$1756
TWF2S3072	11 x 30 x 72	250	59	17	\$2079
TWF2S3672	11 x 36 x 72	250	69	20	\$2343
TWF2S4272	11 x 42 x 72	250	79	23	\$2697

Standard with pre-mounted "J" bracket for wall mount applications. End cap required at the end of a run of floating shelves. End cap sold separately. Shipped RTA - ready to assemble.

NOTE: Care should be taken to mount the units. Units should be mounted to wall studs using correct fasteners. Failure to do so may result in collapse of the unit and subsequent personal injury. **Fastening hardware not included.** Mounting hardware used should be based on wall material. Consult an installation professional for proper wall mounting.



End Cap

ENDCAP66	.75 x 66 x 3	60	6	0.04	\$873
ENDCAP72	.75 x 72 x 3	60	8	0.05	\$942

For use with wall mounted panels.

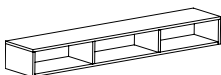

Wall Mounted Open Storage

CBYFO96D12H8	12 x 96 x 8	125	78	10	\$2863
CBYFO64D12H8	12 x 64 x 8	125	50	8	\$1873
CBYFO32D12H8	12 x 32 x 8	100	35	4	\$1697

To be used as a stand alone unit. Ships assembled in 1 carton.

Required Specifications

Veneer finish

WALLMOUNT STORAGE

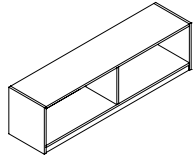

Open Front Overhead Storage

MODEL#	DIMENSIONS D x W x H	FREIGHT CLASS	WT/LBS.	CUBIC FT.	LIST PRICE
CSF072	15 x 72 x 17	92.5	100	10	\$1960
CSF066	15 x 66 x 17	100	83	9	\$1799
CSF060	15 x 60 x 17	100	75	8	\$1641
CSF054	15 x 54 x 17	100	68	7	\$1481
CSF048	15 x 48 x 17	100	60	7	\$1316
CSF042	15 x 42 x 17	100	55	6	\$1212
CSF036	15 x 36 x 17	92.5	50	5	\$1194
CSF030	15 x 30 x 17	92.5	45	4	\$1171

Includes pre-mounted "J" brackets for wall mount applications. Ships assembled in 1 carton.

- **NOTE:** Care should be taken to mount the units. Units should be mounted to wall studs using correct fasteners. Failure to do so may result in collapse of the unit and subsequent personal injury. **Mounting hardware not included.** Mounting hardware used should be based on wall material. Consult an installation professional for proper wall mounting.

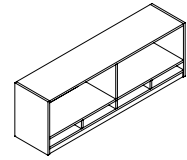

Open Front Overhead Storage - Pigeon-Hole Storage

CSFOP72	15 x 72 x 20	92.5	100	12	\$2354
CSFOP66	15 x 66 x 20	100	83	11	\$2162
CSFOP60	15 x 60 x 20	100	75	10	\$1964
CSFOP54	15 x 54 x 20	100	68	9	\$1772
CSFOP48	15 x 48 x 20	100	60	8	\$1569
CSFOP42	15 x 42 x 20	100	55	7	\$1476
CSFOP36	15 x 36 x 20	92.5	50	6	\$1434
CSFOP30	15 x 30 x 20	92.5	45	5	\$1413

Includes pre-mounted "J" brackets for wall mount applications. Horizontal pigeon-hole storage on bottom of overhead. Ships assembled in 1 carton.

- **NOTE:** Care should be taken to mount the units. Units should be mounted to wall studs using correct fasteners. Failure to do so may result in collapse of the unit and subsequent personal injury. **Mounting hardware not included.** Mounting hardware used should be based on wall material. Consult an installation professional for proper wall mounting.

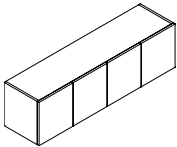

Closed Front Overhead Storage with Hinge Doors*

CSF72	15 x 72 x 17	92.5	100	10	\$2418
CSF66	15 x 66 x 17	100	83	9	\$2218
CSF60	15 x 60 x 17	100	75	8	\$2010
CSF54	15 x 54 x 17	100	68	7	\$1812
CSF48	15 x 48 x 17	100	60	7	\$1611
CSF42	15 x 42 x 17	100	55	6	\$1481
CSF36	15 x 36 x 17	92.5	50	5	\$1453
CSF30	15 x 30 x 17	92.5	45	4	\$1429

Includes pre-mounted "J" brackets for wall mount applications. Lock optional. Ships assembled in 1 carton.

- **NOTE:** Care should be taken to mount the units. Units should be mounted to wall studs using correct fasteners. Failure to do so may result in collapse of the unit and subsequent personal injury. **Mounting hardware not included.** Mounting hardware used should be based on wall material. Consult an installation professional for proper wall mounting.

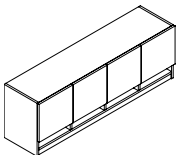

Closed Front Overhead Storage with Hinge Doors & Pigeon-Hole Storage*

CSFP72	15 x 72 x 20	92.5	100	12	\$2897
CSFP66	15 x 66 x 20	100	83	11	\$2658
CSFP60	15 x 60 x 20	100	75	10	\$2418
CSFP54	15 x 54 x 20	100	68	9	\$2176
CSFP48	15 x 48 x 20	100	60	8	\$1931
CSFP42	15 x 42 x 20	100	55	7	\$1832
CSFP36	15 x 36 x 20	92.5	50	6	\$1744
CSFP30	15 x 30 x 20	92.5	45	5	\$1715

Includes pre-mounted "J" brackets for wall mount applications. Horizontal pigeon-hole storage on bottom of overhead. Lock optional. Ships assembled in 1 carton.

- **NOTE:** Care should be taken to mount the units. Units should be mounted to wall studs using correct fasteners. Failure to do so may result in collapse of the unit and subsequent personal injury. **Mounting hardware not included.** Mounting hardware used should be based on wall material. Consult an installation professional for proper wall mounting.

Required Specifications
Veneer finish

Optional Specifications
Lock*

HUTCHES **MODEL#** **DIMENSIONS** **FREIGHT CLASS** **WT/LBS.** **CUBIC FT.** **LIST PRICE**

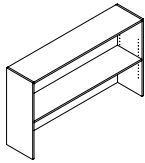

Open Hutch with Closed Back

	D x W x H					
L72CL36	14 x 72 x 36	125	155	23		\$2194
L66CL36	14 x 66 x 36	125	140	21		\$2036
L60CL36	14 x 60 x 36	125	130	19		\$1805
L48CL36	14 x 48 x 36	125	110	15		\$1720
L42CL36	14 x 42 x 36	125	95	13		\$1562
L36CL36	14 x 36 x 36	125	80	11		\$1458
L30CL36	14 x 30 x 36	125	67	9		\$1217

One adjustable shelf. Closed back. Ships assembled in 1 carton.
 • **A Tackboard cannot be used with this hutch.**

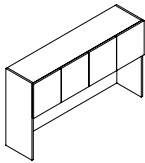

Closed Hutch w/Veneer Doors 36"H*

L108SH36	15 x 108 x 36	125	268	34		\$5337
L102SH36	15 x 102 x 36	125	254	32		\$5041
L96SH36	15 x 96 x 36	100	241	30		\$4742
L90SH36	15 x 90 x 36	100	227	28		\$4446
L84SH36	15 x 84 x 36	100	214	26		\$4154
L78SH36	15 x 78 x 36	100	200	24		\$3858
L72SH36	15 x 72 x 36	100	187	23		\$3560
L66SH36	15 x 66 x 36	100	173	21		\$3428
L60SH36	15 x 60 x 36	100	160	19		\$3263
L36SH36	15 x 36 x 36	100	94	11		\$2226
L30SH36	15 x 30 x 36	100	78	9		\$1951

One fixed shelf. Closed back features one grommet. Ships assembled in 1 carton. Lock optional.
 • Models 108" w have three fixed shelf dividers.
 • Models 84" w- 102" w have two fixed shelf dividers.
 • Models 60" w - 78" w have one fixed shelf divider.
 • Clearance from worksurface to valance is 19.5".

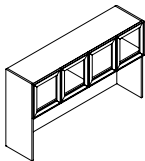

Closed Hutch w/Glass Doors 36"H

L108SH36G	15 x 108 x 36	125	268	34		\$7796
L102SH36G	15 x 102 x 36	125	254	32		\$7036
L96SH36G	15 x 96 x 36	100	241	30		\$6709
L90SH36G	15 x 90 x 36	100	227	28		\$6362
L84SH36G	15 x 84 x 36	100	214	26		\$6034
L78SH36G	15 x 78 x 36	100	200	24		\$5709
L72SH36G	15 x 72 x 36	100	187	23		\$4984
L66SH36G	15 x 66 x 36	100	173	21		\$4774
L60SH36G	15 x 60 x 36	100	160	19		\$4553
L36SH36G	15 x 36 x 36	100	94	11		\$2914
L30SH36G	15 x 30 x 36	100	78	9		\$2600

One fixed shelf. Closed back features one grommet. Aluminum frame available in Tungsten finish only. Ships assembled in 1 carton. Translucent, screened glass.
 • Models 108" w have three fixed shelf dividers.
 • Models 84" w- 102" w have two fixed shelf dividers.
 • Models 60" w - 78" w have one fixed shelf divider.
 • Clearance from worksurface to valance is 19.5".
 • **Locks are not available on hutches with Glass Doors.**

Required Specifications
 Veneer finish

Optional Specifications
 Lock*

HUTCHES

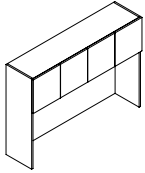

Closed Hutch w/Veneer Doors 42" H*

MODEL#	DIMENSIONS D x W x H	FREIGHT CLASS	WT/LBS.	CUBIC FT.	LIST PRICE
L108SH42	15 x 108 x 42	125	307	39	\$6224
L102SH42	15 x 102 x 42	125	290	37	\$5874
L96SH42	15 x 96 x 42	100	273	35	\$5533
L90SH42	15 x 90 x 42	100	256	33	\$5184
L84SH42	15 x 84 x 42	100	239	31	\$4841
L78SH42	15 x 78 x 42	100	222	38	\$4498
L72SH42	15 x 72 x 42	100	205	26	\$4151
L66SH42	15 x 66 x 42	100	188	24	\$4001
L60SH42	15 x 60 x 42	100	171	22	\$3805
L36SH42	15 x 36 x 42	100	102	13	\$2594
L30SH42	15 x 30 x 42	100	85	11	\$2273

One fixed shelf. Closed back features one grommet. Ships assembled in 1 carton. Lock optional.

- Models 108" w have three fixed shelf dividers.
- Models 84" w- 102" w have two fixed shelf dividers.
- Models 60" w - 78" w have one fixed shelf divider.
- *Clearance from worksurface to valance is 19.5".*

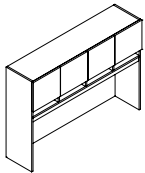

Closed Hutch w/Veneer Doors Pigeon-Hole Storage, 42" H*

L108SHP42	15 x 108 x 42	125	307	39	\$7468
L102SHP42	15 x 102 x 42	125	290	37	\$7053
L96SHP42	15 x 96 x 42	100	273	35	\$6637
L90SHP42	15 x 90 x 42	100	256	33	\$6224
L84SHP42	15 x 84 x 42	100	239	31	\$5807
L78SHP42	15 x 78 x 42	100	222	38	\$5394
L72SHP42	15 x 72 x 42	100	205	26	\$4977
L66SHP42	15 x 66 x 42	100	188	24	\$4794
L60SHP42	15 x 60 x 42	100	171	22	\$4567
L36SHP42	15 x 36 x 42	100	102	13	\$3113
L30SHP42	15 x 30 x 42	100	85	11	\$2726

One fixed shelf. Closed back features one grommet. Horizontal pigeon-hole storage top mounted to hutch. Ships assembled in 1 carton. Lock optional.

- Models 120" w- 108" w have three fixed shelf dividers.
- Models 84" w- 102" w have two fixed shelf dividers.
- Models 60" w - 78" w have one fixed shelf divider.
- *Clearance from worksurface to valance is 21.5".*

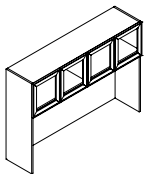

Closed Hutch w/Glass Doors 42" High

L108SH42G	15 x 108 x 42	125	307	39	\$8213
L102SH42G	15 x 102 x 42	125	290	37	\$7413
L96SH42G	15 x 96 x 42	100	273	35	\$7057
L90SH42G	15 x 90 x 42	100	256	33	\$6704
L84SH42G	15 x 84 x 42	100	239	31	\$6349
L78SH42G	15 x 78 x 42	100	222	38	\$6001
L72SH42G	15 x 72 x 42	100	205	26	\$5177
L66SH42G	15 x 66 x 42	100	188	24	\$5001
L60SH42G	15 x 60 x 42	100	171	22	\$4819
L36SH42G	15 x 36 x 42	100	102	13	\$3080
L30SH42G	15 x 30 x 42	100	85	11	\$2739

One fixed shelf. Closed back features one grommet. Aluminum frame available in Tungsten finish only. Ships assembled in 1 carton. Translucent, screened glass.

- Models 120" w- 108" w have three fixed shelf dividers.
- Models 84" w- 102" w have two fixed shelf dividers.
- Models 60" w - 78" w have one fixed shelf divider.
- *Clearance from worksurface to valance is 25.5".*
- **Locks are not available on hutches with Glass Doors.**

Required Specifications
Veneer Finish

Optional Specifications
Lock*

HUTCHES **MODEL#** **DIMENSIONS** **FREIGHT CLASS** **WT/LBS.** **CUBIC FT.** **LIST PRICE**

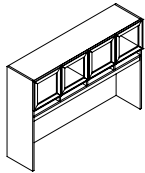

**Closed Hutch w/Glass Doors
Pigeon-Hole Storage, 42" High**

	D x W x H						
L108SHP42G	15 x 108 x 42	125	307	39	\$9344		
L102SHP42G	15 x 102 x 42	125	290	37	\$8481		
L96SHP42G	15 x 96 x 42	100	273	35	\$8083		
L90SHP42G	15 x 90 x 42	100	256	33	\$8207		
L84SHP42G	15 x 84 x 42	100	239	31	\$7219		
L78SHP42G	15 x 78 x 42	100	222	38	\$6807		
L72SHP42G	15 x 72 x 42	100	205	26	\$5934		
L66SHP42G	15 x 66 x 42	100	188	24	\$5737		
L60SHP42G	15 x 60 x 42	100	171	22	\$5470		
L36SHP42G	15 x 36 x 42	100	102	13	\$3553		
L30SHP42G	15 x 30 x 42	100	85	11	\$3171		

One fixed shelf. Closed back features one grommet. Aluminum frame available in Tungsten finish only. Horizontal pigeon-hole storage top mounted to hutch. Ships assembled in 1 carton. Translucent, screened glass.

- Models 120"w- 108"w have three fixed shelf dividers.
- Models 84"w- 102"w have two fixed shelf dividers.
- Models 60"w - 78"w have one fixed shelf divider.
- *Clearance from worksurface to valance is 21.5".*
- **Locks are not available on hutches with Glass Doors.**

Required Specifications
Veneer Finish

TACKBOARDS FOR OVERHEAD STORAGE

MODEL# DIMENSIONS FREIGHT CLASS WT/LBS. CUBIC FT. GR. 1-3 GR. 4-5

D x W x H

TACKBOARD Notes: Tackboards can be upholstered in all of the following fabrics:

Grade 1: Jenny, Quilt, Terrace, Urban, Waterfall

Grade 2: Imprint, Lola

Grade 3: Anchorage, Merge

LTS108	1 x 108 x 20	92.5	23	2	\$952	\$1193
LTS102	1 x 102 x 20	100	19	2	\$898	\$1125
LTS96	1 x 96 x 20	70	17	1	\$847	\$1063
LTS90	1 x 90 x 20	70	15	1	\$794	\$996
LTS84	1 x 84 x 20	85	14	1	\$744	\$935
LTS78	1 x 78 x 20	85	13	1	\$684	\$859
LTS72	1 x 72 x 20	85	12	1	\$636	\$799
LTS66	1 x 66 x 20	92.5	11	1	\$575	\$722
LTS60	1 x 60 x 20	92.5	10	1	\$532	\$668
LTS36	1 x 36 x 20	125	8	1	\$322	\$408
LTS30	1 x 30 x 20	150	5	1	\$269	\$338

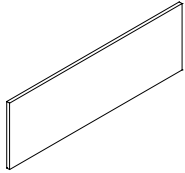

Tackboard for Hutch

For use on **36" H** hutches (**L_SH36, L_SH36G**). **Factory installed**, with velcro tape. Please specify hutch to be installed on. See "tackboard notes" exact fabric availability.

- **Not for use on non-Lufton hutches.**

LTS108H26	1 x 108 x 26	70	30	2	\$1234	\$1545
LTS102H26	1 x 102 x 26	85	24	2	\$1167	\$1463
LTS96H26	1 x 96 x 26	92.5	22	2	\$1097	\$1375
LTS90H26	1 x 90 x 26	92.5	20	2	\$1035	\$1296
LTS84H26	1 x 84 x 26	100	18	2	\$960	\$1203
LTS78H26	1 x 78 x 26	100	17	2	\$889	\$1114
LTS72H26	1 x 72 x 26	70	16	1	\$825	\$1035
LTS66H26	1 x 66 x 26	85	14	1	\$753	\$945
LTS60H26	1 x 60 x 26	85	13	1	\$684	\$859
LTS36H26	1 x 36 x 26	100	8	1	\$417	\$526
LTS30H26	1 x 30 x 26	150	5	1	\$349	\$439

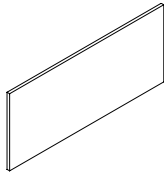

Tackboard for Hutch

For use on **42" H** hutches (**L_SH42, L_SH42**). **Factory installed**, with velcro tape. Please specify hutch to be installed on. See "tackboard notes" exact fabric availability.

- **Not for use on non-Lufton hutches.**

LTSP108H23	1 x 108 x 23	70	30	2	\$1067	\$1338
LTSP102H23	1 x 102 x 23	85	24	2	\$1022	\$1280
LTSP96H23	1 x 96 x 23	92.5	20	2	\$956	\$1198
LTSP90H23	1 x 90 x 23	92.5	20	1	\$898	\$1125
LTSP84H23	1 x 84 x 23	70	18	1	\$832	\$1043
LTSP78H23	1 x 78 x 23	70	17	1	\$777	\$974
LTSP72H23	1 x 72 x 23	70	16	1	\$720	\$903
LTSP66H23	1 x 66 x 23	85	14	1	\$655	\$825
LTSP60H23	1 x 60 x 23	85	13	1	\$616	\$757
LTSP36H23	1 x 36 x 23	100	8	1	\$360	\$453
LTSP30H23	1 x 30 x 23	150	5	1	\$304	\$382

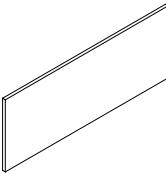

Tackboard for Hutch

For use on **42" H** hutches (**L_SHP42, L_SHP42G**) with Pigeon-Hole Storage. **Factory installed**, with velcro tape. Please specify hutch to be installed on. See "tackboard notes" exact fabric availability.

- **Not for use on non-Lufton hutches.**

Required Specifications

Fabric

TACKBOARDS FOR OVERHEAD STORAGE **MODEL#** **DIMENSIONS** **FREIGHT CLASS** **WT/LBS.** **CUBIC FT.** **GR. 1-3** **GR. 4-5**

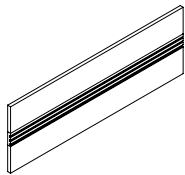

Tackboard for Hutch - Accessory Rail

	D x W x H						
LTSAS108	1 x 108 x 20	92.5	23	2		\$1681	\$2106
LTSAS102	1 x 102 x 20	100	19	2		\$1515	\$1896
LTSAS96	1 x 96 x 20	70	15	1		\$1494	\$1872
LTSAS90	1 x 90 x 20	70	15	1		\$1401	\$1756
LTSAS84	1 x 84 x 20	85	14	1		\$1308	\$1640
LTSAS78	1 x 78 x 20	85	13	1		\$1217	\$1525
LTSAS72	1 x 72 x 20	85	12	1		\$1119	\$1402
LTSAS66	1 x 66 x 20	92.5	11	1		\$1029	\$1289
LTSAS60	1 x 60 x 20	92.5	10	1		\$937	\$1174
LTSAS36	1 x 36 x 20	125	6	1		\$560	\$703
LTSAS30	1 x 30 x 20	150	4	1		\$468	\$588

For use on **36" H** hutches (**L_SH36, L_SH36G**). **Factory installed**, with velcro tape. Please specify hutch to be installed on. See "tackboard notes" exact fabric availability.

- **Must Specify Black (E) or Tungsten (K) Accessory Rail finish.**
- **Not for use on non-Lufton hutches.**

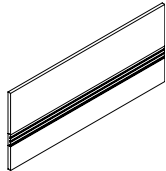

Tackboard for Hutch - Accessory Rail

LTSAS108H26	1 x 108 x 26	70	23	2		\$2022	\$2532
LTSAS102H26	1 x 102 x 26	85	19	2		\$1904	\$2383
LTSAS96H26	1 x 96 x 26	92.5	15	1		\$1796	\$2250
LTSAS90H26	1 x 90 x 26	92.5	15	1		\$1687	\$2115
LTSAS84H26	1 x 84 x 26	100	14	1		\$1556	\$1947
LTSAS78H26	1 x 78 x 26	100	13	1		\$1458	\$1825
LTSAS72H26	1 x 72 x 26	70	12	1		\$1324	\$1659
LTSAS66H26	1 x 66 x 26	85	11	1		\$1234	\$1545
LTSAS60H26	1 x 60 x 26	85	10	1		\$1119	\$1402
LTSAS36H26	1 x 36 x 26	100	6	1		\$674	\$846
LTSAS30H26	1 x 30 x 26	150	4	1		\$567	\$712

For use on **42" H** hutches (**L_SH42, L_SH42G**). **Factory installed**, with velcro tape. Please specify hutch to be installed on. See "tackboard notes" exact fabric availability.

- **Must Specify Black (E) or Tungsten (K) Accessory Rail finish.**
- **Not for use on non-Lufton hutches.**

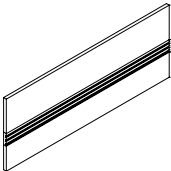

Tackboard for Hutch - Accessory Rail

LTSPAS108H23	1 x 108 x 23	92.5	30	2		\$1824	\$2284
LTSPAS102H23	1 x 102 x 23	100	24	2		\$2273	\$2844
LTSPAS96H23	1 x 96 x 23	70	20	2		\$1622	\$2031
LTSPAS90H23	1 x 90 x 23	70	20	2		\$1527	\$1910
LTSPAS84H23	1 x 84 x 23	85	18	2		\$1422	\$1782
LTSPAS78H23	1 x 78 x 23	85	17	2		\$1320	\$1653
LTSPAS72H23	1 x 72 x 23	85	16	1		\$1217	\$1525
LTSPAS66H23	1 x 66 x 23	92.5	14	1		\$1119	\$1402
LTSPAS60H23	1 x 60 x 23	92.5	13	1		\$1018	\$1274
LTSPAS36H23	1 x 36 x 23	125	6	1		\$613	\$769
LTSPAS30H23	1 x 30 x 23	150	4	1		\$514	\$645

For use on **42" H** hutches (**L_SHP42, L_SHP42G**) with Pigeon-Hole Storage. **Factory installed**, with velcro tape. Please specify hutch to be installed on. See "tackboard notes" exact fabric availability. List Price shown applies for all fabric grades.

- **Must Specify Black (E) or Tungsten (K) Accessory Rail finish.**
- **Not for use on non-Lufton hutches.**

Required Specifications

Fabric

WALLMOUNT TACKBOARDS

MODEL#	DIMENSIONS D x W x H	FREIGHT CLASS	WT/LBS.	CUBIC FT.	GR. 1-3	GR. 4-5
TS108	1 x 106 x 19	70	23	2	\$1460	\$1825
TS102	1 x 100 x 19	85	19	2	\$1383	\$1729
TS96	1 x 94 x 19	70	15	1	\$1293	\$1619
TS90	1 x 88 x 19	70	15	1	\$1216	\$1521
TS84	1 x 82 x 19	70	14	1	\$1139	\$1422
TS78	1 x 76 x 19	70	13	1	\$1055	\$1319
TS72	1 x 70 x 19	70	12	1	\$594	\$744
TS66	1 x 64 x 19	85	11	1	\$546	\$686
TS60	1 x 58 x 19	85	10	1	\$502	\$631
TS36	1 x 34 x 19	100	6	1	\$322	\$408
TS30	1 x 28 x 19	150	4	1	\$268	\$337

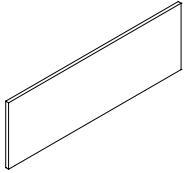

Tackboard - Wallmounted

For use on **16.5"H** overhead storage (CSFO_, CSF_, CSFF_) at a finished height of 66". See "tackboard notes" exact fabric availability. List Price shown applies for all fabric grades.

- **NOTE:** Care should be taken to mount the units. Units should be mounted to wall studs using correct fasteners. Failure to do so may result in collapse of the unit and subsequent personal injury. **Mounting hardware not included.** Mounting hardware used should be based on wall material. Consult an installation professional for proper wall mounting.

TS108H26	1 x 106 x 26	70	30	2	\$1898	\$2374
TS102H26	1 x 100 x 26	85	24	2	\$1788	\$2235
TS96H26	1 x 94 x 26	92.5	20	2	\$1691	\$2116
TS90H26	1 x 88 x 26	92.5	20	2	\$1585	\$1980
TS84H26	1 x 82 x 26	100	18	2	\$1473	\$1842
TS78H26	1 x 76 x 26	100	17	2	\$1370	\$1714
TS72H26	1 x 70 x 26	70	16	1	\$761	\$956
TS66H26	1 x 64 x 26	85	14	1	\$701	\$879
TS60H26	1 x 58 x 26	85	13	1	\$641	\$805
TS36H26	1 x 34 x 26	100	8	1	\$403	\$506
TS30H26	1 x 28 x 26	150	5	1	\$338	\$428

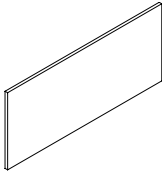

Tackboard - Wallmounted

For use on **16.5"H** overhead storage (CSFO_, CSF_) at a finished height of 72". See "tackboard notes" exact fabric availability. List Price shown applies for all fabric grades.

- **NOTE:** Care should be taken to mount the units. Units should be mounted to wall studs using correct fasteners. Failure to do so may result in collapse of the unit and subsequent personal injury. **Mounting hardware not included.** Mounting hardware used should be based on wall material. Consult an installation professional for proper wall mounting.

TSP108H23	1 x 106 x 23	70	30	2	\$1704	\$2045
TSP102H23	1 x 100 x 23	85	24	2	\$1625	\$1951
TSP96H23	1 x 94 x 23	92.5	20	2	\$1467	\$1832
TSP90H23	1 x 88 x 23	92.5	20	1	\$1370	\$1714
TSP84H23	1 x 82 x 23	70	18	1	\$1280	\$1599
TSP78H23	1 x 76 x 23	70	17	1	\$1047	\$1273
TSP72H23	1 x 70 x 23	70	16	1	\$973	\$1222
TSP66H23	1 x 64 x 23	85	14	1	\$884	\$1109
TSP60H23	1 x 58 x 23	85	13	1	\$641	\$805
TSP36H23	1 x 34 x 23	100	8	1	\$488	\$505
TSP30H23	1 x 28 x 23	150	5	1	\$404	\$430

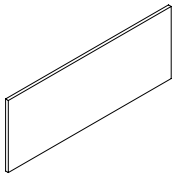

Tackboard - Wallmounted

For use on **19.5"H** overhead storage (CSFOP_, CSFP_) with Pigeon-Hole Storage at a finished height of 72". See "tackboard notes" exact fabric availability. List Price shown applies for all fabric grades.

- **NOTE:** Care should be taken to mount the units. Units should be mounted to wall studs using correct fasteners. Failure to do so may result in collapse of the unit and subsequent personal injury. **Mounting hardware not included.** Mounting hardware used should be based on wall material. Consult an installation professional for proper wall mounting.

Required Specifications

Fabric

WALLMOUNT TACKBOARDS **MODEL#** **DIMENSIONS** **FREIGHT CLASS** **WT/LBS.** **CUBIC FT.** **GR. 1-3** **GR. 4-5**

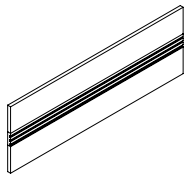

Tackboard - Accessory Rail, Wallmounted

	D x W x H						
TSAS108	1 x 106 x 20	92.5	23	2	\$2258	\$2826	
TSAS102	1 x 100 x 20	100	19	2	\$2138	\$2668	
TSAS96	1 x 94 x 20	70	15	1	\$2003	\$2509	
TSAS90	1 x 88 x 20	70	15	1	\$1880	\$2353	
TSAS84	1 x 82 x 20	85	14	1	\$1753	\$2194	
TSAS78	1 x 76 x 20	85	13	1	\$1633	\$2043	
TSAS72	1 x 70 x 20	85	12	1	\$1504	\$1884	
TSAS66	1 x 64 x 20	92.5	11	1	\$1383	\$1733	
TSAS60	1 x 58 x 20	92.5	10	1	\$1254	\$1569	
TSAS36	1 x 34 x 20	125	6	1	\$752	\$938	
TSAS30	1 x 28 x 20	150	4	1	\$584	\$732	

For use on **16.5"H** overhead storage (**CSFO_**, **CSF_**) at a finished height of **66"**. See "tackboard notes" exact fabric availability. List Price shown applies for all fabric grades.

- **Must Specify Black (E) or Tungsten (K) Accessory Rail finish.**
- **NOTE:** Care should be taken to mount the units. Units should be mounted to wall studs using correct fasteners. Failure to do so may result in collapse of the unit and subsequent personal injury. **Mounting hardware not included.** Mounting hardware used should be based on wall material. Consult an installation professional for proper wall mounting.

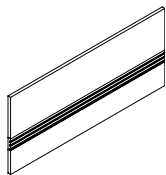

Tackboard - Accessory Rail, Wallmounted

TSAS108H26	1 x 106 x 26	70	23	2	\$2715	\$3395
TSAS102H26	1 x 100 x 26	85	19	2	\$2560	\$3201
TSAS96H26	1 x 94 x 26	92.5	15	1	\$2405	\$3010
TSAS90H26	1 x 88 x 26	92.5	15	1	\$2265	\$2833
TSAS78H26	1 x 76 x 26	100	13	1	\$1955	\$2445
TSAS72H26	1 x 70 x 26	70	12	1	\$1779	\$2226
TSAS66H26	1 x 64 x 26	85	11	1	\$1661	\$2072
TSAS60H26	1 x 58 x 26	85	10	1	\$1504	\$1884
TSAS36H26	1 x 34 x 26	100	6	1	\$907	\$1137
TSAS30H26	1 x 28 x 26	150	4	1	\$758	\$950

For use on **16.5"H** overhead storage (**CSFO_**, **CSF_**) at a finished height of **72"**. See "tackboard notes" exact fabric availability. List Price shown applies for all fabric grades.

- **Must Specify Black (E) or Tungsten (K) Accessory Rail finish.**
- **NOTE:** Care should be taken to mount the units. Units should be mounted to wall studs using correct fasteners. Failure to do so may result in collapse of the unit and subsequent personal injury. **Mounting hardware not included.** Mounting hardware used should be based on wall material. Consult an installation professional for proper wall mounting.

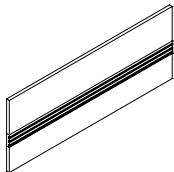

Tackboard - Accessory Rail, Wallmounted

TSPAS108H23	1 x 106 x 23	92.5	30	2	\$2447	\$3061
TSPAS102H23	1 x 100 x 23	100	24	2	\$2324	\$2909
TSPAS96H23	1 x 94 x 23	70	20	2	\$2185	\$2734
TSPAS90H23	1 x 88 x 23	70	20	2	\$2042	\$2555
TSPAS84H23	1 x 82 x 23	85	18	2	\$1908	\$2390
TSPAS78H23	1 x 76 x 23	85	17	2	\$1773	\$2217
TSPAS72H23	1 x 70 x 23	85	16	1	\$1640	\$2053
TSPAS66H23	1 x 64 x 23	92.5	14	1	\$1504	\$1884
TSPAS60H23	1 x 58 x 23	92.5	13	1	\$1363	\$1704
TSPAS36H23	1 x 34 x 23	125	8	1	\$682	\$856
TSPAS30H23	1 x 28 x 23	150	5	1	\$665	\$828

For use on **19.5"H** overhead storage (**CSFOP_**, **CSFP_**) with Pigeon-Hole Storage at a finished height of **72"**. See "tackboard notes" exact fabric availability. List Price shown applies for all fabric grades.

- **Must Specify Black (E) or Tungsten (K) Accessory Rail finish.**
- **NOTE:** Care should be taken to mount the units. Units should be mounted to wall studs using correct fasteners. Failure to do so may result in collapse of the unit and subsequent personal injury. **Mounting hardware not included.** Mounting hardware used should be based on wall material. Consult an installation professional for proper wall mounting.

Required Specifications
Fabric

WALLMOUNT TACKBOARDS

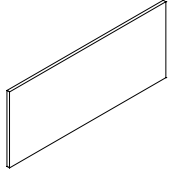

Tackboard - Wallmounted

MODEL#	DIMENSIONS D x W x H	FREIGHT CLASS	WT/LBS.	CUBIC FT.	GR. 1-3	GR. 4-5
TS108H25	1 x 106 x 25	92.5	23	2	\$1608	\$2007
TS102H25	1 x 100 x 25	100	19	2	\$1511	\$1892
TS96H25	1 x 94 x 25	70	17	1	\$1424	\$1777
TS90H25	1 x 88 x 25	70	15	1	\$1335	\$1671
TS84H25	1 x 82 x 25	85	14	1	\$1250	\$1564
TS78H25	1 x 76 x 25	85	13	1	\$1154	\$1444
TS72H25	1 x 70 x 25	85	12	1	\$1067	\$1338
TS66H25	1 x 64 x 25	92.5	11	1	\$980	\$1226
TS60H25	1 x 58 x 25	92.5	10	1	\$893	\$1120

For use on **16.5"H** overhead storage (CSFO_, CSF_) mounted above 23"H credenzas for a **finished height of 66"**. See "tackboard notes" exact fabric availability. List Price shown applies for all fabric grades

- **NOTE:** Care should be taken to mount the units. Units should be mounted to wall studs using correct fasteners. Failure to do so may result in collapse of the unit and subsequent personal injury. **Mounting hardware not included.** Mounting hardware used should be based on wall material. Consult an installation professional for proper wall mounting.

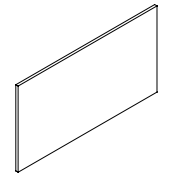

Tackboard - Wallmounted

TS108H32	1 x 106 x 32	70	30	2	\$2057	\$2566
TS102H32	1 x 100 x 32	85	24	2	\$1936	\$2422
TS96H32	1 x 94 x 32	92.5	20	2	\$1827	\$2288
TS90H32	1 x 88 x 32	92.5	20	2	\$1714	\$2145
TS84H32	1 x 82 x 32	100	18	2	\$1592	\$1995
TS78H32	1 x 76 x 32	100	17	2	\$1477	\$1849
TS72H32	1 x 70 x 32	70	16	1	\$1363	\$1704
TS66H32	1 x 64 x 32	85	14	1	\$1254	\$1569
TS60H32	1 x 58 x 32	85	13	1	\$1143	\$1430

For use on **16.5"H** overhead storage (CSFO_, CSF_) mounted above 23"H credenzas for a **finished height of 72"**. See "tackboard notes" exact fabric availability. List Price shown applies for all fabric grades

- **NOTE:** Care should be taken to mount the units. Units should be mounted to wall studs using correct fasteners. Failure to do so may result in collapse of the unit and subsequent personal injury. **Mounting hardware not included.** Mounting hardware used should be based on wall material. Consult an installation professional for proper wall mounting.

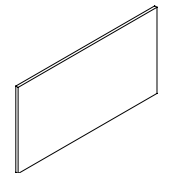

Tackboard - Wallmounted

TSP108H29	1 x 106 x 29	70	30	2	\$1859	\$2326
TSP102H29	1 x 100 x 29	85	24	2	\$1753	\$2194
TSP96H29	1 x 94 x 29	70	20	2	\$1651	\$2068
TSP90H29	1 x 88 x 29	70	20	2	\$1551	\$1940
TSP84H29	1 x 82 x 29	70	18	2	\$1444	\$1807
TSP78H29	1 x 76 x 29	70	17	2	\$1345	\$1676
TSP72H29	1 x 70 x 29	70	16	1	\$1236	\$1547
TSP66H29	1 x 64 x 29	85	14	1	\$1143	\$1430
TSP60H29	1 x 58 x 29	85	13	1	\$1034	\$1294

For use on **16.5"H** overhead storage (CSFO_, CSF_) mounted above 23"H credenzas for a **finished height of 72"**. See "tackboard notes" exact fabric availability. List Price shown applies for all fabric grades

- **NOTE:** Care should be taken to mount the units. Units should be mounted to wall studs using correct fasteners. Failure to do so may result in collapse of the unit and subsequent personal injury. **Mounting hardware not included.** Mounting hardware used should be based on wall material. Consult an installation professional for proper wall mounting.

Required Specifications

Fabric

WALLMOUNT TACKBOARDS **MODEL#** **DIMENSIONS** **FREIGHT CLASS** **WT/LBS.** **CUBIC FT.** **GR. 1-3** **GR. 4-5**

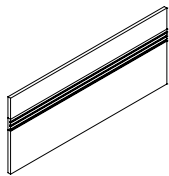

Tackboard - Accessory Rail, Wallmounted

	D x W x H						
TSAS108H25	1 x 106 x 25	92.5	23	2		\$2615	\$3270
TSAS102H25	1 x 100 x 25	100	19	2		\$2457	\$3075
TSAS96H25	1 x 94 x 25	70	15	1		\$2310	\$2893
TSAS90H25	1 x 88 x 25	70	15	1		\$2176	\$2724
TSAS78H25	1 x 76 x 25	85	13	1		\$1880	\$2353
TSAS72H25	1 x 70 x 25	85	12	1		\$1707	\$2137
TSAS66H25	1 x 64 x 25	92.5	11	1		\$1598	\$2003
TSAS60H25	1 x 58 x 25	92.5	10	1		\$1452	\$1817

For use on **16.5"H** overhead storage (**CSFO_**, **CSF_**) mounted above 23"H credenzas for a **finished height of 66"**. See "tackboard notes" exact fabric availability. List Price shown applies for all fabric grades

- **Must Specify Black (E) or Tungsten (K) Accessory Rail finish.**
- **NOTE:** Care should be taken to mount the units. Units should be mounted to wall studs using correct fasteners. Failure to do so may result in collapse of the unit and subsequent personal injury. **Mounting hardware not included.** Mounting hardware used should be based on wall material. Consult an installation professional for proper wall mounting.

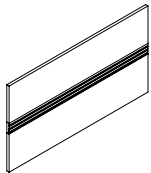

Tackboard - Accessory Rail, Wallmounted

TSAS108H32	1 x 106 x 32	70	23	2		\$3341	\$4178
TSAS102H32	1 x 100 x 32	85	19	2		\$3143	\$3930
TSAS96H32	1 x 94 x 32	92.5	15	1		\$2962	\$3707
TSAS90H32	1 x 88 x 32	92.5	15	1		\$2791	\$3485
TSAS78H32	1 x 76 x 32	100	13	1		\$2405	\$3010
TSAS72H32	1 x 70 x 32	70	12	1		\$2185	\$2734
TSAS66H32	1 x 64 x 32	85	11	1		\$2042	\$2555
TSAS60H32	1 x 58 x 32	85	10	1		\$1855	\$2320

For use on **16.5"H** overhead storage (**CSFO_**, **CSF_**) mounted above 23"H credenzas for a **finished height of 72"**. See "tackboard notes" exact fabric availability. List Price shown applies for all fabric grades

- **Must Specify Black (E) or Tungsten (K) Accessory Rail finish.**
- **NOTE:** Care should be taken to mount the units. Units should be mounted to wall studs using correct fasteners. Failure to do so may result in collapse of the unit and subsequent personal injury. **Mounting hardware not included.** Mounting hardware used should be based on wall material. Consult an installation professional for proper wall mounting.

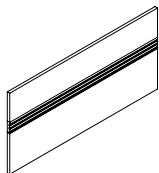

Tackboard - Accessory Rail, Wallmounted

TSPAS108H29	1 x 106 x 29	70	30	2		\$3031	\$3791
TSPAS102H29	1 x 100 x 29	85	24	2		\$2849	\$3559
TSPAS96H29	1 x 94 x 29	70	20	2		\$2682	\$3350
TSPAS90H29	1 x 88 x 29	70	20	2		\$2526	\$3161
TSPAS78H29	1 x 76 x 29	70	17	2		\$2185	\$2734
TSPAS72H29	1 x 70 x 29	70	16	1		\$1980	\$2480
TSPAS66H29	1 x 64 x 29	85	14	1		\$1855	\$2320
TSPAS60H29	1 x 58 x 29	85	13	1		\$1678	\$2103

For use on **16.5"H** overhead storage (**CSFO_**, **CSF_**) mounted above 23"H credenzas for a **finished height of 72"**. See "tackboard notes" exact fabric availability. List Price shown applies for all fabric grades

- **Must Specify Black (E) or Tungsten (K) Accessory Rail finish.**
- **NOTE:** Care should be taken to mount the units. Units should be mounted to wall studs using correct fasteners. Failure to do so may result in collapse of the unit and subsequent personal injury. **Mounting hardware not included.** Mounting hardware used should be based on wall material. Consult an installation professional for proper wall mounting.

Required Specifications

Fabric

PIGEON-HOLE STORAGE

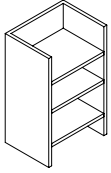

Vertical Pigeon-Hole Storage*

MODEL#	DIMENSIONS D x W x H	FREIGHT CLASS	WT/LBS.	CUBIC FT.	LIST PRICE
CPH161226	12 x 16 x 26	125	20	3	\$753
CPH161223	12 x 16 x 23	125	18	3	\$639
CPH161219	12 x 16 x 19	125	15	2	\$486
CPH131226	12 x 13 x 26	100	16	2	\$613
CPH131223	12 x 13 x 23	125	15	2	\$520
CPH131219	12 x 13 x 19	125	12	2	\$392

Used in conjunction with overhead storage units and hutches that incorporate horizontal pigeon-hole storage. Not freestanding. Shipped RTA (ready to assemble).

ACCESSORY RAIL/PANEL ORGANIZERS

Available Finishes:

BLK	Black	SIL	Silver
CHR	Charcoal	TPE	Taupe
DWT	Designer White	TUN	Tungsten
NEV	Nevada		

ACCESSORIES

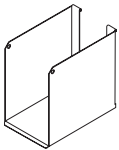

Binder Bin**

MODEL#	DIMENSIONS	FREIGHT CLASS	WT/LBS.	CUBIC FT.	LIST PRICE
BABB01	10.25 x 4 x 9	100	2	.21	\$75

Load bar/accessory rail mounted metal binder bin.

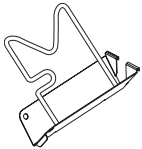

Flip Sorter**

BAFS01	9.25 x 2.75 x 9.25	70	.06	.14	\$58
--------	--------------------	----	-----	-----	-------------

Load bar/accessory rail mounted metal flip sorter. Comes with chrome wire.

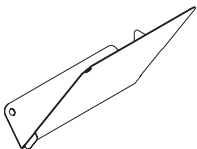

Slant Sorter

BASS01L (Left)	10.25 x 5 x 9.5	70	1	.28	\$47
BASS01R (Right)	10.25 x 5 x 9.5	70	1	.28	\$47

Load bar/accessory rail mounted metal slant sorter.

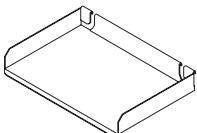

Letter Tray

BALTO1	9.25 x 13.5 x 2	70	.50	.15	\$62
--------	-----------------	----	-----	-----	-------------

Load bar/accessory rail mounted metal letter tray.

Required Specifications

- Fabric
- Veneer finish*
- Metal finish**

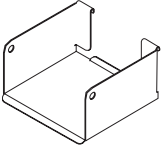
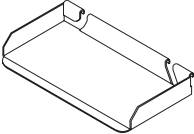
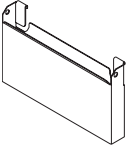
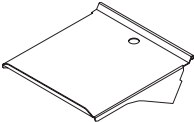
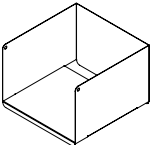
ACCESSORY RAIL/ PANEL ORGANIZERS	MODEL#	DIMENSIONS D x W x H	FREIGHT CLASS	WT/LBS.	CUBIC FT.	LIST PRICE
 <p>Media Bin</p>	BAMB01	5.25 x 5.75 x 3	70	.08	.05	\$62
Load bar/accessory rail mounted metal media bin.						
 <p>Utility Tray</p>	BAUT01	3.75 x 5.75 x 3	70	.05	.02	\$41
Load bar/accessory rail mounted metal utility tray.						
 <p>Mail Box</p>	BAPP01	2.75 x 16 x 9	100	2	.25	\$94
Load bar/accessory rail mounted metal mail box.						
 <p>Telephone Holder</p>	BATH01	10 x 9 x 2	125	2	.26	\$91
Load bar/accessory rail mounted metal telephone holder.						
 <p>Elevated Shelf Binder Bin</p>	BRTESBBIN	12 x 12 x 8	100	6	.66	\$193
Load bar/accessory rail mounted elevated shelf binder bin.						

Required Specifications
Metal finish

RECEPTION DESKS

MODEL#

DIMENSIONS

FREIGHT CLASS

WT./LBS.

CUBIC FT.

LIST PRICE

D x W x H

- To add storage use storage shells. See page 306 .
- Includes GM1 grommet.
- Transaction tops to be specified separately, handed by square edge from user side.
- Decorative Front Panels should be specified separately. Size chosen should be 12" less than desk dimensions. Available in Reverse Diamond, Vertical Rib, Vertical Grain and Horizontal Grain Patterns.

OPTION DETAILS

Decorative Front Panel (Reverse Diamond Pattern)
GFDP5430F

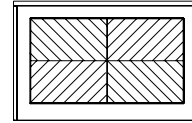

Decorative Front Panel (Vertical Rib Pattern)
GFDP5430RIB

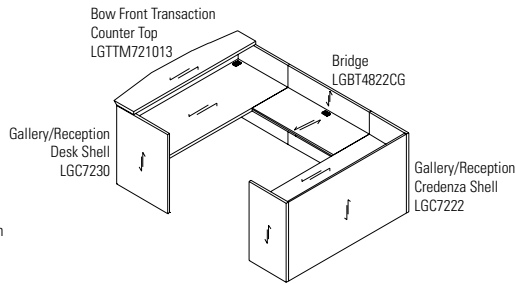
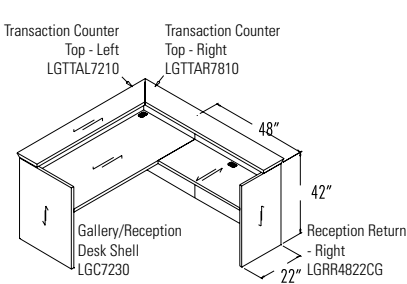
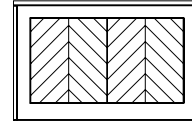

RECEPTION DESKS

MODEL#

DIMENSIONS

FREIGHT CLASS

WT./LBS.

CUBIC FT.

LIST PRICE

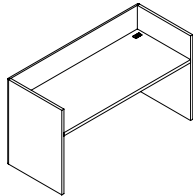

Gallery/Reception Desk Shell

LGC10836	36 x 108 x 42	150	533	95	\$7934
LGC10236	36 x 102 x 42	150	503	89	\$7493
LGC9636	36 x 96 x 42	150	473	84	\$7053
LGC9036	36 x 90 x 42	150	444	79	\$6612
LGC8436	36 x 84 x 42	150	414	74	\$6173
LGC7236	36 x 72 x 42	150	355	63	\$5291
LGC7230	30 x 72 x 42	150	315	53	\$5122
LGC6630	30 x 66 x 42	125	295	48	\$4612
LGC6030	30 x 60 x 42	125	275	44	\$4995

No pedestals. Two grommets in worksurface. For use with modular storage components. Ships assembled in 1 carton.

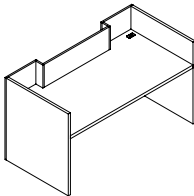

**Gallery/Reception Desk Shell
Breakfront Style**

LGIC10836	36 x 108 x 42	150	533	95	\$9757
LGIC10236	36 x 102 x 42	150	503	89	\$9205
LGIC9636	36 x 96 x 42	150	473	84	\$8675
LGIC9036	36 x 90 x 42	150	444	79	\$8128
LGIC8436	36 x 84 x 42	150	414	74	\$7595
LGIC7236	36 x 72 x 42	150	355	63	\$6497
LGIC7230	30 x 72 x 42	150	315	53	\$6291
LGIC6630	30 x 66 x 42	125	295	48	\$6132
LGIC6030	30 x 60 x 42	125	275	44	\$5779

No pedestals. Two grommets in worksurface. For use with modular storage components. Ships assembled in 1 carton.

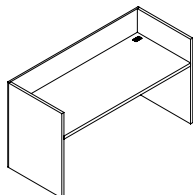

Gallery/Reception Credenza Shell

LGC10824	24 x 108 x 42	150	353	63	\$6219
LGC10224	24 x 102 x 42	150	333	60	\$5881
LGC9624	24 x 96 x 42	150	314	56	\$5526
LGC9024	24 x 90 x 42	150	294	53	\$5177
LGC8424	24 x 84 x 42	150	274	49	\$4841
LGC7224	24 x 72 x 42	150	235	42	\$4154
LGC6624	24 x 66 x 42	150	216	39	\$3898
LGC6024	24 x 60 x 42	150	196	35	\$3652

No pedestals. Two grommets in worksurface. For use with modular storage components. Ships assembled in 1 carton.

Required Specifications

Metal Finish (Accessories)
Veneer Finish
Edge

RECEPTION DESKS **MODEL#** **DIMENSIONS** **FREIGHT CLASS** **WT./LBS.** **CUBIC FT.** **LIST PRICE**

D x W x H

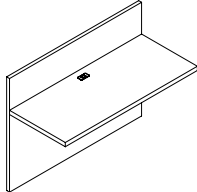

Bridge

LGBT5624CG	24 x 56 x 42	150	178	32	\$3485
LGBT5424CG	24 x 54 x 42	150	169	29	\$3485
LGBT5024CG	24 x 50 x 42	150	151	27	\$3091
LGBT4824CG	24 x 48 x 42	150	142	26	\$3091
LGBT4424CG	24 x 44 x 42	150	134	23	\$2715
LGBT4224CG	24 x 42 x 42	150	127	22	\$2715
LGBT3824CG	24 x 38 x 42	150	119	20	\$2440
LGBT3624CG	24 x 36 x 42	150	112	19	\$2440

Attaches between **Gallery Desk and Gallery Credenza Only**. One grommet in center of worksurface. Ships assembled in 1 carton.

- To remove cross-grain veneer pattern on top, **delete "CG"** from model number. Available as a special - no upcharge.

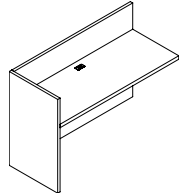

Reception Return - LEFT

LGRL7224	24 x 72 x 42	125	273	42	\$5219
LGRL6624	24 x 66 x 42	125	250	39	\$4794
LGRL6024	24 x 60 x 42	125	228	35	\$4363
LGRL5424	24 x 54 x 42	125	205	32	\$3921
LGRL4824	24 x 48 x 42	125	182	28	\$3485
LGRL4224	24 x 42 x 42	125	159	25	\$3053
LGRL3624	24 x 36 x 42	125	137	21	\$2739

No pedestal. One grommet in center of worksurface. For use with modular storage components. Ships assembled in 1 carton.

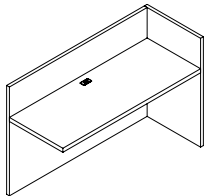

Reception Return - RIGHT

LGRR7224	24 x 72 x 42	125	273	42	\$5219
LGRR6624	24 x 66 x 42	125	250	39	\$4794
LGRR6024	24 x 60 x 42	125	228	35	\$4363
LGRR5424	24 x 54 x 42	125	205	32	\$3921
LGRR4824	24 x 48 x 42	125	182	28	\$3485
LGRR4224	24 x 42 x 42	125	159	25	\$3053
LGRR3624	24 x 36 x 42	125	137	21	\$2739

No pedestal. One grommet in center of worksurface. For use with modular storage components. Ships assembled in 1 carton.

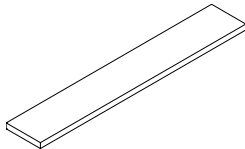

Transaction Counter Top

LGTT10810	10 x 108 x 1.50	100	78	8	\$1476
LGTT10210	10 x 102 x 1.50	92.5	72	7	\$1398
LGTT9610	10 x 96 x 1.50	100	66	7	\$1316
LGTT9010	10 x 90 x 1.50	92.5	60	6	\$1234
LGTT8410	10 x 84 x 1.50	100	54	6	\$1154
LGTT7210	10 x 72 x 1.50	100	48	5	\$978
LGTT6610	10 x 66 x 1.50	100	42	5	\$898
LGTT6010	10 x 60 x 1.50	100	36	4	\$816

Rectangular top for main reception desk. Counter sits on top of Gallery panels. Does not overhang. **Factory installed - specify Gallery to be used on.** Size must match dimension of desk front or combined desk side and return length. Hardware included.

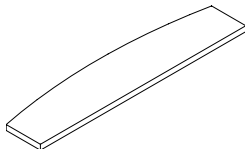

Bow Front Transaction Counter Top

LGTTM1081013	10-13 x 108 x 1.50	125	78	10	\$2315
LGTTM1021013	10-13 x 102 x 1.50	100	72	9	\$2190
LGTTM961013	10-13 x 96 x 1.50	125	66	9	\$2058
LGTTM901013	10-13 x 90 x 1.50	125	60	8	\$1925
LGTTM841013	10-13 x 84 x 1.50	125	54	8	\$1799
LGTTM721013	10-13 x 72 x 1.50	125	48	7	\$1547
LGTTM661013	10-13 x 66 x 1.50	125	42	6	\$1416
LGTTM601013	10-13 x 60 x 1.50	125	36	5	\$1284

Bow top for main reception desk. Counter sits on top of Gallery panels. Bow front overhangs 3". **Factory installed - specify Gallery to be used on.** Size must match dimension of desk front or combined desk side and return length. Hardware included.

Required Specifications

- Veneer Finish
- Edge

TRANSACTION COUNTERS

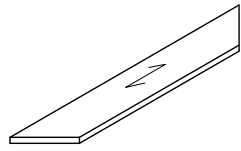

Trapezoid Transaction Counter Top

MODEL#	DIMENSIONS D x W x H	FREIGHT CLASS	WT/LBS.	CUBIC FT.	LIST PRICE
LGTTA10810	10 x 108 x 1.50	100	78	8	\$1859
LGTTA10210	10 x 102 x 1.50	92.5	72	7	\$1763
LGTTA9610	10 x 96 x 1.50	100	66	7	\$1672
LGTTA9010	10 x 90 x 1.50	92.5	60	6	\$1581
LGTTA8410	10 x 84 x 1.50	100	54	6	\$1490
LGTTA7210	10 x 72 x 1.50	100	48	5	\$1314
LGTTA6610	10 x 66 x 1.50	100	42	5	\$1218
LGTTA6010	10 x 60 x 1.50	100	36	4	\$1127

Trapezoid top for main reception desk. 45° mitered ends on left and right. For use with left and right 45° mitered return transaction counters. Counter sits on top of Gallery panels. Does not overhang. **Factory installed - specify Gallery to be used on.** Size must match dimension of desk front or combined desk side and return length. Hardware included.

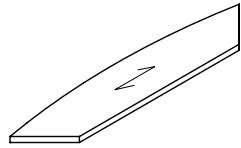

Bow Front Trapezoid Transaction Counter Top

LGTTMA1081013	10-13 x 108 x 1.50	125	78	10	\$2551
LGTTMA1021013	10-13 x 102 x 1.50	100	72	9	\$2455
LGTTMA961013	10-13 x 96 x 1.50	125	66	9	\$2364
LGTTMA901013	10-13 x 90 x 1.50	125	60	8	\$2273
LGTTMA841013	10-13 x 84 x 1.50	125	54	8	\$2182
LGTTMA721013	10-13 x 72 x 1.50	125	48	7	\$2000
LGTTMA661013	10-13 x 66 x 1.50	125	42	6	\$1910
LGTTMA601013	10-13 x 60 x 1.50	125	36	5	\$1819

Trapezoid bow top for main reception desk. 45° mitered ends on left and right. For use with left and right 45° mitered return transaction counters. Counter sits on top of Gallery panels. Bow front overhangs 3". **Factory installed - specify Gallery to be used on.** Size must match dimension of desk front or combined desk side and return length. Hardware included.

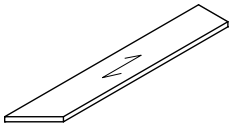

Transaction Counter Top - RIGHT

LGTTAR10810	10 x 108 x 1.50	100	78	8	\$1778
LGTTAR10210	10 x 102 x 1.50	92.5	72	7	\$1692
LGTTAR9610	10 x 96 x 1.50	100	66	7	\$1596
LGTTAR9010	10 x 90 x 1.50	92.5	60	6	\$1506
LGTTAR8410	10 x 84 x 1.50	100	54	6	\$1415
LGTTAR7210	10 x 72 x 1.50	100	48	5	\$1233
LGTTAR6610	10 x 66 x 1.50	100	42	5	\$1142
LGTTAR6010	10 x 60 x 1.50	100	36	4	\$1051

Rectangular top for main reception desk with 45° mitered end on **right**. For use with rectangular or bow front transaction counters with miters at both ends. **Factory installed - specify Gallery to be used on.** Size must match dimension of desk front or combined desk side and return length. Hardware included.

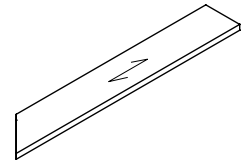

Transaction Counter Top - LEFT

LGTTAL10810	10 x 108 x 1.50	100	78	8	\$1778
LGTTAL10210	10 x 102 x 1.50	92.5	72	7	\$1692
LGTTAL9610	10 x 96 x 1.50	100	66	7	\$1596
LGTTAL9010	10 x 90 x 1.50	92.5	60	6	\$1506
LGTTAL8410	10 x 84 x 1.50	100	54	6	\$1415
LGTTAL7210	10 x 72 x 1.50	100	48	5	\$1233
LGTTAL6610	10 x 66 x 1.50	100	42	5	\$1142
LGTTAL6010	10 x 60 x 1.50	100	36	4	\$1051

Rectangular top for main reception desk with 45° mitered end on **left**. For use with rectangular or bow front transaction counters with miters at both ends. **Factory installed - specify Gallery to be used on.** Size must match dimension of desk front or combined desk side and return length. Hardware included.

Required Specifications

Veneer Finish
Edge

TRANSACTION COUNTERS **MODEL#** **DIMENSIONS** **FREIGHT CLASS** **WT/LBS.** **CUBIC FT.** **LIST PRICE**

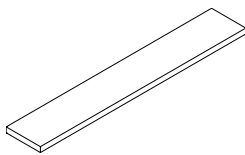

Transaction Counter Top - Glass

	D x W x H					
GTT10810G	10 x 108 x 1.50	100	78	8		\$3367
GTT10210G	10 x 102 x 1.50	92.5	72	7		\$3241
GTT9610G	10 x 96 x 1.50	100	66	7		\$3113
GTT9010G	10 x 90 x 1.50	92.5	60	6		\$2988
GTT8410G	10 x 84 x 1.50	100	54	6		\$2864
GTT7210G	10 x 72 x 1.50	100	48	5		\$2679
GTT6610G	10 x 66 x 1.50	100	42	5		\$2554
GTT6010G	10 x 60 x 1.50	100	36	4		\$2430

Rectangular top for main reception desk. Counter sits on top of Gallery panels. Does not overhang. **Factory installed - specify Gallery to be used on.** Size must match dimension of desk front or combined desk side and return length. Hardware included. 3/4" clear glass over wood subtop.

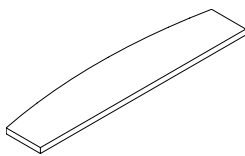

Bow Front Transaction Counter Top - Glass

GTTM1081013G	10-13 x 108 x 1.50	125	78	10		\$4154
GTTM1021013G	10-13 x 102 x 1.50	100	72	9		\$4075
GTTM961013G	10-13 x 96 x 1.50	125	66	9		\$4035
GTTM901013G	10-13 x 90 x 1.50	125	60	8		\$3858
GTTM841013G	10-13 x 84 x 1.50	125	54	8		\$3669
GTTM721013G	10-13 x 72 x 1.50	125	48	7		\$3372
GTTM661013G	10-13 x 66 x 1.50	125	42	6		\$3184
GTTM601013G	10-13 x 60 x 1.50	125	36	5		\$3006

Bow top for main reception desk. Counter sits on top of Gallery panels. Bow front overhangs 3". **Factory installed - specify Gallery to be used on.** Size must match dimension of desk front or combined desk side and return length. Hardware included. 3/4" clear glass over wood subtop.

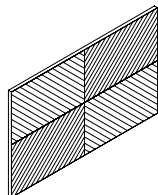

Decorative Front Panel Reverse Diamond Pattern

GFDP9630F	1 x 96 x 30	92.5	81	8		\$1904
GFDP9030F	1 x 90 x 30	100	78	8		\$1783
GFDP8430F	1 x 84 x 30	92.5	72	7		\$1663
GFDP7230F	1 x 72 x 30	100	66	7		\$1429
GFDP6030F	1 x 60 x 30	92.5	60	6		\$1194
GFDP5430F	1 x 54 x 30	100	54	6		\$1073
GFDP4830F	1 x 48 x 30	100	48	5		\$956

Raised decorative front panel for a reception desk. Size should be 12" less than desk dimensions. **Factory installed.** Hardware included.

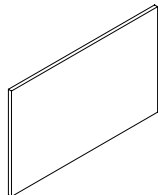

Decorative Front Panel Vertical Grain Pattern

GFDP9630V	1 x 96 x 30	92.5	81	8		\$1660
GFDP9030V	1 x 90 x 30	100	78	8		\$1556
GFDP8430V	1 x 84 x 30	92.5	72	7		\$1453
GFDP7230V	1 x 72 x 30	100	66	7		\$1241
GFDP6030V	1 x 60 x 30	92.5	60	6		\$1035
GFDP5430V	1 x 54 x 30	100	54	6		\$937
GFDP4830V	1 x 48 x 30	100	48	5		\$828

Raised decorative front panel for a reception desk. Size should be 12" less than desk dimensions. **Factory installed.** Hardware included.

Required Specifications

Veneer Finish*
Edge*

Optional Specifications

Grommet*

RECEPTION DESKS - CURVED

MODEL# DIMENSIONS FREIGHT CLASS WT/LBS. CUBIC FT. LIST PRICE

D x W x H

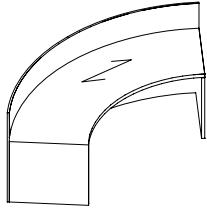

Gallery/Reception Curved Desk Shell**

LGCCUS10630H36	30 x 106 x 36	100	647	72	\$14621
LGCCUS10630H42	30 x 106 x 42	100	592	66	\$16815

No pedestals. For use with modular storage components. Ships assembled in 1 carton.

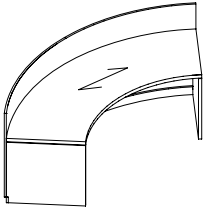

Gallery/Reception Curved Desk Shell**

LGCKCUS10630H36	30 x 106 x 36	100	647	72	\$15350
LGCKCUS10630H42	30 x 106 x 42	100	592	66	\$17655

Includes recessed kick plate. No pedestals. For use with modular storage components. Ships assembled in 1 carton.

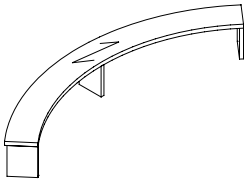

Wood Curved Transaction Counter*

LGTTMCUS10610	10 x 106 x 1.5	150	84	19	\$6633
---------------	----------------	-----	----	----	---------------

Curved wood transaction top. Ships assembled in 1 carton.

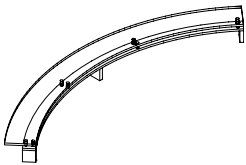

Glass Curved Transaction Counter

GCCCUS10610G	10 x 106 x 0.75	150	84	19	\$12166
--------------	-----------------	-----	----	----	----------------

3/4" clear glass bow front transaction counter over wood subtop. Ships assembled in 1 carton.

Required Specifications

Veneer Finish*

Edge*

philadelphia





Philadelphia detailing is traditional with a 1" overhang on all edges. Solid walnut, cherry, maple, oak that bands worksurface perimeter is 1" wide by 1-3/8" thick for an overall thickness of 1-3/8". Philadelphia is a "top over pedestal" detailed series. Philadelphia is standard with a base. Floor storage unit bases (i.e. kick-plates on pedestals, lateral files, bookcases, etc.) are extended out over drawer faces and horizontally grained. Products that are normally positioned against walls, such as credenzas, have a self-edge veneered back edge detail. All primary faces have pin molding decorations.

This elegantly designed traditional furniture series employs state-of-the-art manufacturing to create traditional pieces for executive offices, conference rooms and reception areas. Philadelphia is characterized by solid-wood edge detailing with solid-wood moldings on the cases and brass hardware throughout. The finest clear hardwoods are hand-selected to ensure that the best quality and consistency is achieved. Each piece is protected with a catalyzed conversion varnish to provide one of the most durable finishes in the industry. Philadelphia makes a truly impressive statement for the discerning customer.



Features and Benefits

- Philadelphia is a traditional collection characterized by craftsmanship and elegance
- Solid-wood edge detailing with solid-wood moldings on the cases and brass hardware throughout
- Drawers are standard vinyl-wrapped construction with black drawer sides and bottom.
- Pedestals feature antique brass handles, profiled drawer fronts and maple drawer interiors.
- The base is profiled, with pin moldings on desk fronts and sides.
- Bronze glass is standard with clear glass available as an option.
- Modesty panel upgrades are available on select models.

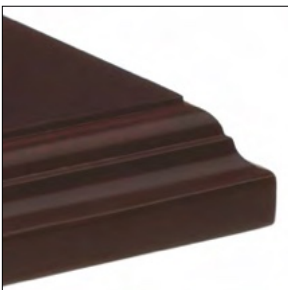

1-3/8" thick solid hardwood edge

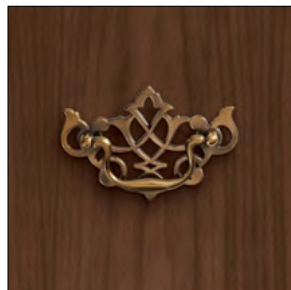

Antique brass pull (PL40)

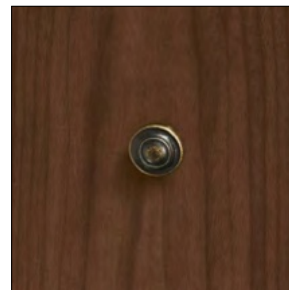

Knob on uppers (DK25)

GENERAL INFORMATION

- Philadelphia is comprised of hundreds of models for the traditional executive suite and coordinating meeting areas.
- Solid wood is used on all perimeter worksurface edges, as well as end panel bottoms for mounting leveling glides
- 1" overhang with a traditional detailing is featured on all user and approach sides.
- Brass bulls exclusive to Philadelphia detail the traditional style of the product.
- GM5 grommets are standard on all designated worksurfaces.
- **Level certified**

CONSTRUCTION

- Number One select, architectural grade "A" oak, American black walnut, American black cherry or maple. Wood worksurface molded edges are solid oak, walnut, cherry, or maple.
- Traditional detailing with 1" overhang on all edges.
- Solid walnut, cherry, maple, oak that bands worksurface perimeter is 1" wide by 1-3/8" thick for an overall thickness of 1-3/8".

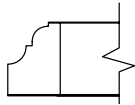

Edge detail

- Top over pedestal design
- Products that are normally positioned against walls, such as credenzas, have a self-edge veneered back edge detail. All primary faces have pin molding decorations.

FINISHES

- Conversion varnish (similar to catalyzed lacquer, but tougher), 25 degree sheen. Finishes are not buffed or rubbed.
- All Global wood casegood products are veneered and finished on the back sides (360° finishing), except modular under-surface storage - tops and backs are unfinished.
- Touch up kits available, includes a touch up marker and fill crayon. Order **VTUOUCHUPKIT, \$175** list. Specify finish when ordering.
- Global standard finish, on oak and walnut, is open pore and on cherry and maple is semi-closed pore. If a full finish is required for walnut, cherry, anigre and maple tops, Add the suffix "2" to the finish code and Add 5% to the base pricing for each product.

CUSTOM FINISH IS AVAILABLE.

PEDESTALS

- Full-to-the-floor. Pedestals are fully assembled units that are either installed into desk and credenza shells, or available as modular units. Undersurface storage units include locks.
- Pedestal drawer suspensions are metal ball bearing type. Both box and file drawers are full extension.
- Drawers are standard vinyl-wrapped construction with black drawer sides and bottom.
- The drawer front is an applied element to a four sided drawer. Drawer fronts are veneered on all surfaces except the vertical edges, which are solid oak, walnut, cherry and maple then routed with series detailing. Drawer fronts can be removed or replaced in the field.
- Levelers have 1" range of adjustment.

LOCKS

- Locks are standard on all below worksurface level drawer and door storage units, with the exception of pull-out tray units and single lateral file drawer combination tray/slot units.
- Combination storage unit comes with lock for file and lateral file drawer only; box drawers cannot lock.
- Lock color will match the handle option.
- Locks are optional on all above worksurface level closed storage.
- For optional lock, specify **LO**. Add **\$143** per lock.

HANDLES

- All drawer fronts come with traditional antique brass finished handles centered on drawer faces. All cabinet doors come with knobs in the same finish.

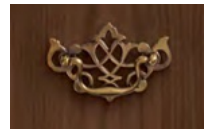

PL40 Brass Pull, 4.5"

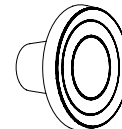

DK25 Knob on Uppers

HARDWARE

- All necessary hardware items for attaching furniture items are included in the shipment. Actual wall attachment fasteners for wall cabinets, tackboards and visual boards are not included due to variation between site conditions.

LEVELING GLIDES

- Shipped in a plastic bag attached to the bottom of the item or inside the pedestal. It is important to install leveling glides to ensure the unit is level. Levelers have a 1" range of adjustment.

HANGING FILE RAILS

- Pre-installed on file drawer perimeters and accommodate both legal and letter size filing. Legal filing can be achieved either as side-to-side or front-to-back. Letter filing can be achieved as front-to-back filing only.

FLAT PLATES

- Flat plates are used to attach bridges and returns to desks and are shipped pre-attached to the bottom of the bridge or return.
 - Mini flat plates for securing bridge back panels to desk or credenza end panels, and quick connectors for securing modular corner units to adjacent pieces, are shipped along with screws in a plastic bag attached to the bottom of the bridge or return.
- CAUTION:** Using screws other than those supplied by Global could result in damage to finished tops.

WALL-MOUNTED CABINETS, TACKBOARDS AND VISUAL BOARDS

- Pre-attached with horizontal wall rails to the back of each unit. The wall-side components must be detached from the unit and fastened to the wall accordingly.
- Wall fasteners are not included due to the variable site conditions. Securing the wall rail to a vertical structural member is the required manner of installation. The cabinet or visual board is then lowered on to the wall rail. It is important to level the wall rail before installation.
- Wall cabinets are equipped with levelers at the bottom of the back panels for proper cabinet alignment.
- Units with doors are equipped with adjustable European door hinges to assist in door alignment. It is required to use a #8 wood screw through the back of the cabinet and the wall-mounted rail, to further secure the wall attachment.
- Tackboards have vertical grooves in the back for tasklight wiring.
- Hutches and tackboards are installed with double faced tape applied to the bottom of the end panels. The tape is shipped in a plastic bag found in the hutch. Removal of the hutch requires moderate pressure to be applied on the top of the unit towards the wall for at least a minute for the pressure sensitive tape to release. Additional support may be added by installing flat plates along the outside back of the attached units. *These flat plates are not included in the shipment.*
- Hutch tackboards are factory-installed.
- Tackboards are standard in Grade 3 panel fabrics.

MODULAR STORAGE UNITS

- Pre-drilled holes through the unfinished tops for securing to the bottom of worksurfaces
- Screws and lock keys are included in a plastic bag fastened inside the pedestal. Installer should leave a 1/8" reveal between the Modular Storage Unit and the End panel. Disassemble the Modular Unit first before relocating the entire unit to avoid damage or bodily injuries.

PEDESTAL SPACERS

- Required if pedestals are placed side by side. A 1" gap is required between the modular pedestals to allow access to vertical fingerpulls. If required, order **SP700**.

5-SIDED CORNER TABLES

- Join bridge and credenza run-offs, using the supplied quick connectors.
- Recessed end-panels in these units are pre-drilled to accept quick-connectors for easy alignment
- Accurate leveling is critical for these units to align and connect properly.
- Flat-plates are pre-attached to the worksurface to secure to the desk unit.

1. SPECIFY MODEL NUMBER

2. SPECIFY FINISH

WORKSURFACE TOP & DRAWER/DOOR FRONTS, BODY FINISHES (INCLUDING PEDESTALS) - VENEER

Code	Finish	Veneer Type	Cut
AMW	Almond Cherry	Cherry	Flat Sliced
ACW	Amber Cherry	Cherry	Flat Sliced
BTW	Biscotti	White Oak	Rift
CAW	Cocoa Walnut	Walnut	Flat Sliced
CRW	Coral	White Oak	Rift
DCW	Dark Cherry	Cherry	Flat Sliced
DWW	Dark Walnut	Walnut	Flat Sliced
EWV	Espresso Walnut	Walnut	Flat Sliced
EVW	Evening Oak	White Oak	Rift
GRW	Grey on Oak	White Oak	Rift
HAW	Hazelnut	Maple	Flat Sliced
JAW	Java	White Oak	Rift
LTW	Latte Walnut	Walnut	Flat Sliced
MHW	Mahogany on Walnut	Walnut	Flat Sliced
MTW	Milestone	White Oak	Rift
MPW	Natural Maple	Maple	Flat Sliced
NLW	Natural Walnut	Walnut	Flat Sliced
RCW	Red Cherry	Cherry	Flat Sliced
VNW	Vintage Cherry	Cherry	Flat Sliced
ULW	Umber Walnut	Walnut	Flat Sliced
WLW	Walnut	Walnut	Flat Sliced
WCW	Warm Cherry	Cherry	Flat Sliced
WMW	White Maple	Maple	Flat Sliced

METAL FINISHES:

E	Black
K	Tungsten
DWT	Designer White
P	Brushed Chrome

GLASS FINISH (for Glass Doors and Modesty Panels)

- Bronze Glass (standard)
- Clear Glass - contact Customer Care

3. SPECIFY OPTIONS

GROMMETS

- Standard grommet on all components is **GM5**. Grommets are included with products where shown in product line drawings.
- Optional grommets may be ordered in standard worksurface locations (left, center or right). Order as **GM5L**, **GM5C** or **GM5R**. **Add \$103**.
- Grommet hole dimensions are 3.5" x 2". Specify **GM5E** for **Black** or **GM5K** for **Tungsten**.

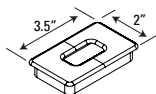

- Components that come standard with grommet may be ordered without a grommet. Order as RSG - **Add \$57**.
- View diagrams on the following pages for additional details.

GROMMET LOCATIONS

- Grommets and Grommet Locations must be specified.
- Includes standard and optional grommet locations.
- For TEL & TER location please contact Customer Care.

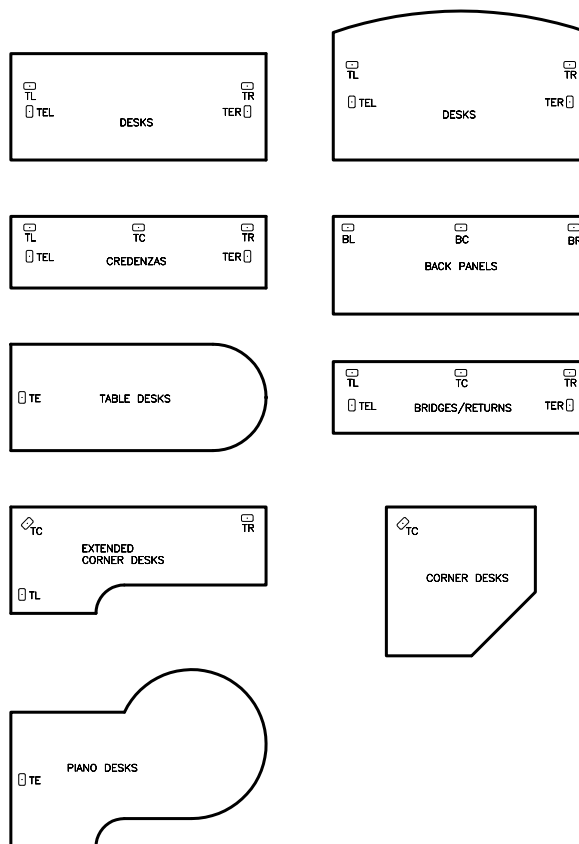

P PHILADELPHIA - EDGE DETAILS

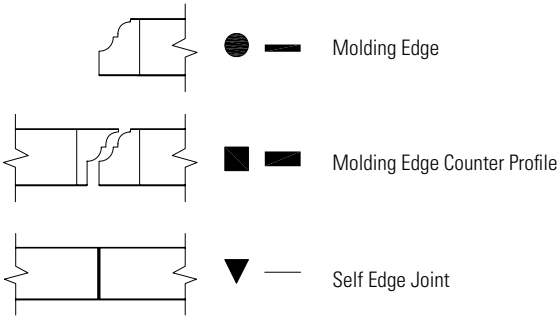

- D** - Desks and Credenzas
- B** - Executive Bridges
- E** - Executive Returns
- C** - Corner Components
- L** - Linking Bridges
- P** - Piano Desks

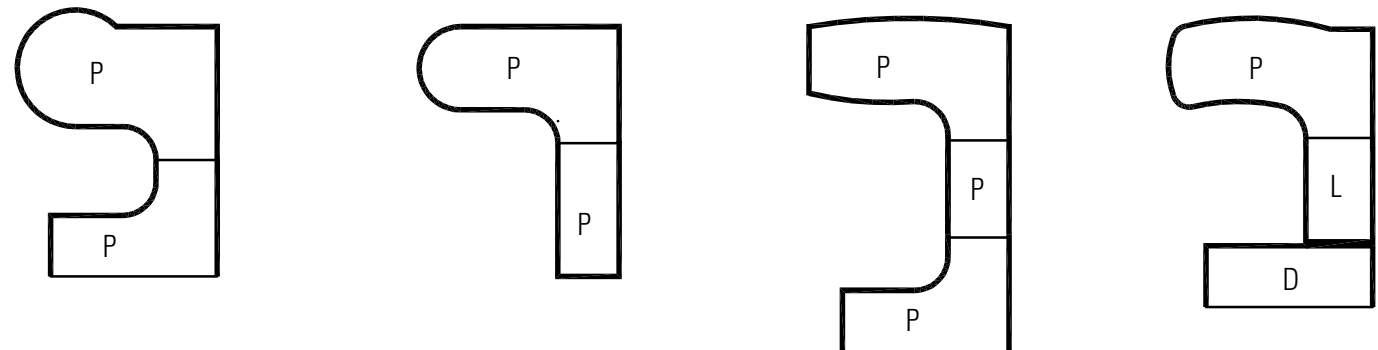
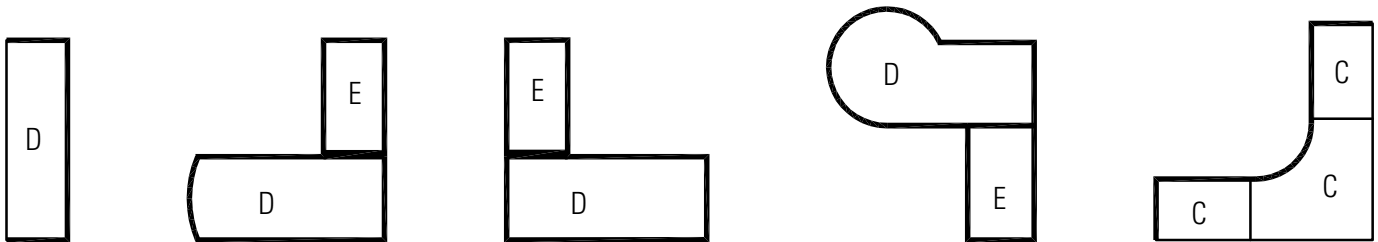
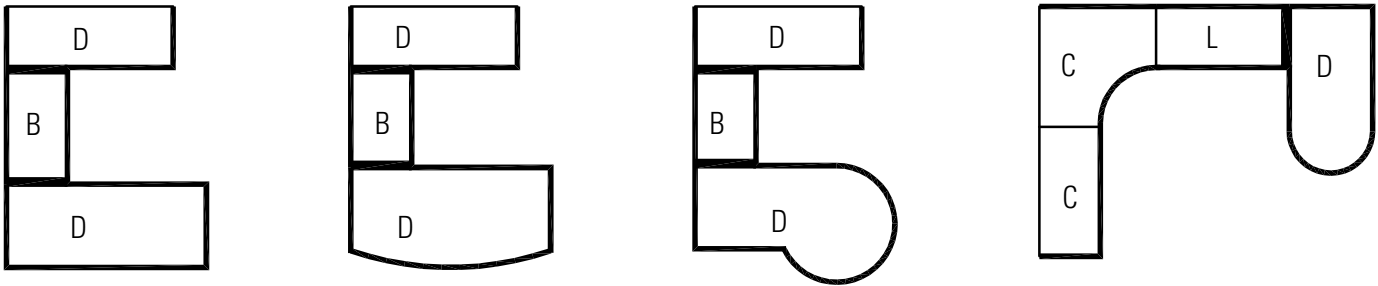
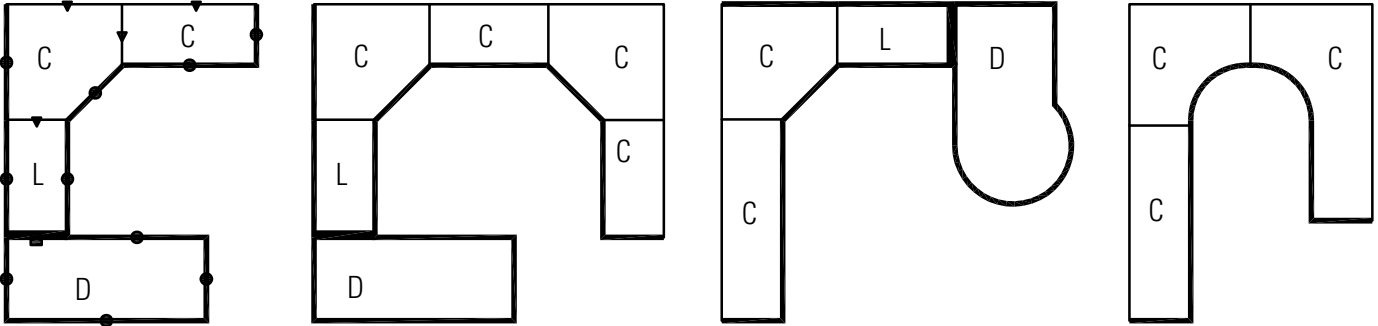

DESK AND CREDENZA NOTES

- Can be ordered as a shell or with pedestals
- Hand of Rectangular Desk is determined by location of pedestal from user side
- Hand of "D" Top is determined by outward orientation of curved end from user projection.
- Hand of "P" Top is determined by outward orientation of conference end from user projection.

Isometric View

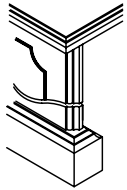

Side View
1-3/8" Top

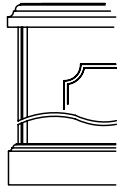

Front View
1-3/16" Slab

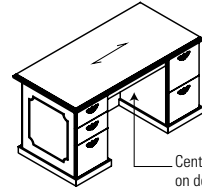
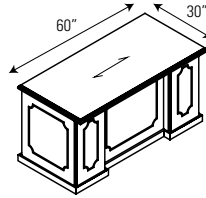
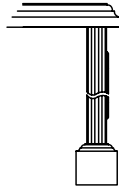

Center drawer standard on double pedestal desk

MODESTY PANEL CLEARANCE

PBID7236DE

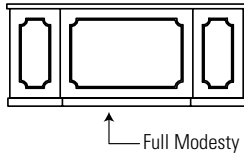

PBID7236 (7236 indicates top size)

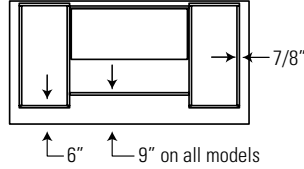

PBISR7230D

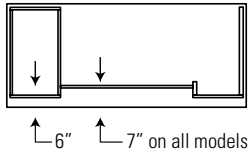

PBDDFL7230 (Left shown)

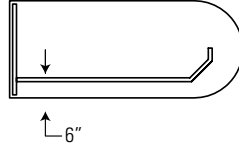

PBTPOL7242 (Left shown)

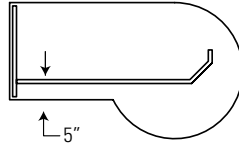

PBC7220

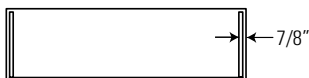

PIANO DESKS AND LINKING RETURNS

- All Desks are shipped assembled.
- Units include standard Grommets shown and installed horizontal wire management
- Unit is handed by Post Leg
- Not for use with regular Corner Units

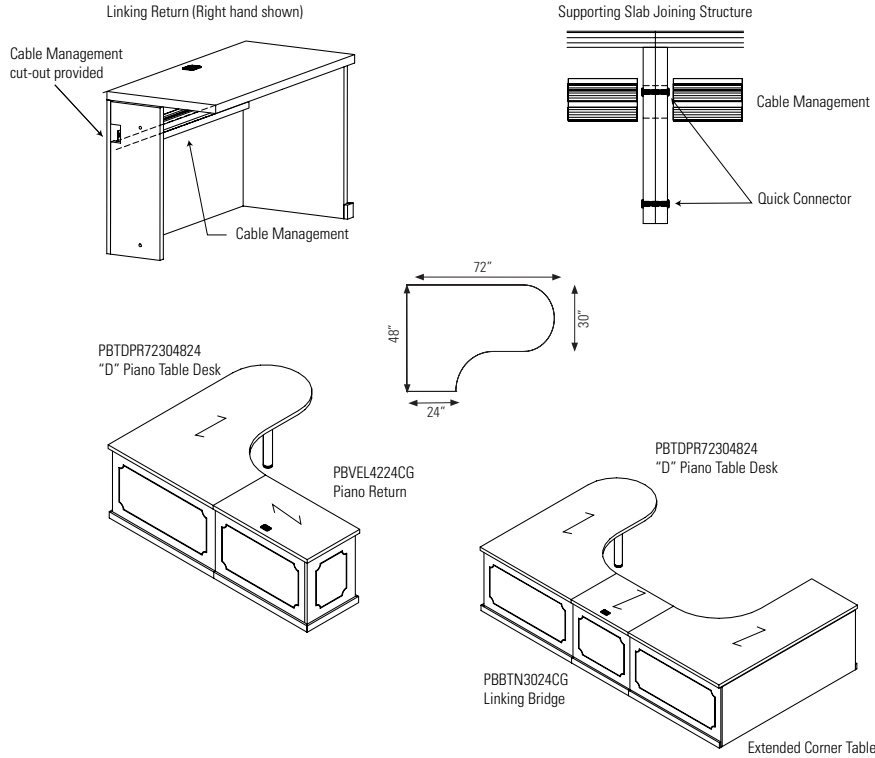

EXECUTIVE BRIDGES

- Executive Bridge is used to connect a Desk to a Credenza.
- Not to be used with Corner Components or Piano Desks.
- Three Back Panel options
- Back panel flush with end panels of Desk and Credenza
- Includes GM5 Grommet Top Center
- The standard grain direction is cross grain (**CG**). To remove cross grain veneer pattern on top, delete suffix "**CG**" from the model number (no upcharge)

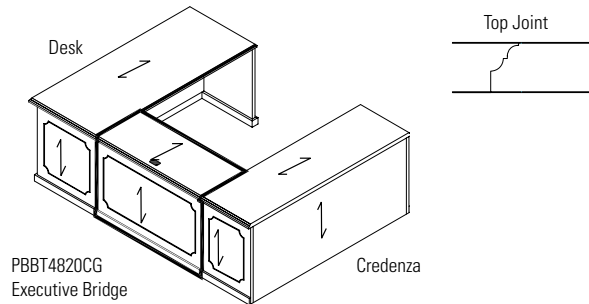

PBBT4820CG
Dimensions are actual

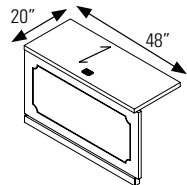

PBBT4820CG
Full Back Panel

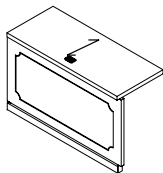

PBBT4820TCG
Bridge Top only



PBBT4820Q8CG
8" Back Panel

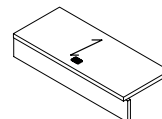

EXECUTIVE RETURNS

- Executive Return is used to attach to a Single Pedestal Desk, Single Pedestal Credenza, Desk Shell or Credenza Shell.
- Can be specified as a Shell or with a Pedestal.
- Back Panels are available as either full height or 8" from the underside of the worksurface.
- Hand of Executive Return is determined by location of full end panel from user side.
- Hand of Desk or Credenza is determined by location of pedestal from user side.
- The standard grain direction on return tops is cross grain (**CG**). To remove cross grain veneer pattern on top, delete suffix "**CG**" from the model number (no upcharge)

Executive Return attached to Desk or Credenza

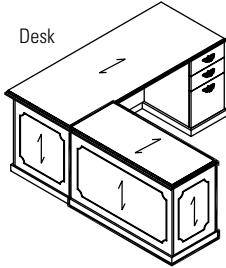

PBERL4822CG
Executive Return

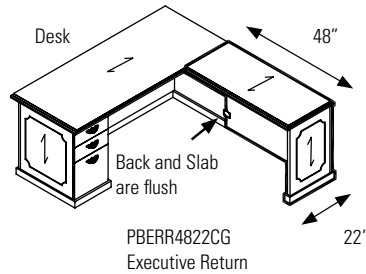

PBERR4822CG
Executive Return

CORNER COMPONENTS

- Corner Table is used to connect to Linking Bridge and Linking Credenza.
- Cable management tray included.
- Back Panels are available as either full height or 8" from the underside of the worksurface.
- Hand of Linking Credenza is determined by location of full end panel from user side.
- Hand of Extended Corner is determined by location of long narrow end from user side
- The standard grain direction is cross grain (**CG**). To remove cross grain veneer pattern on top, delete suffix "**CG**" from the model number (no upcharge)

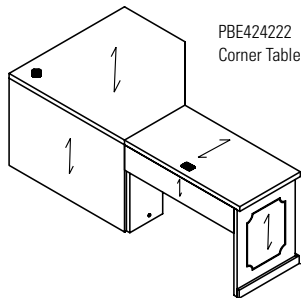

PBE424222
Corner Table

PBEK424222
Corner Table

PBEK424222
Corner Table

Supporting Slab Joining Structure

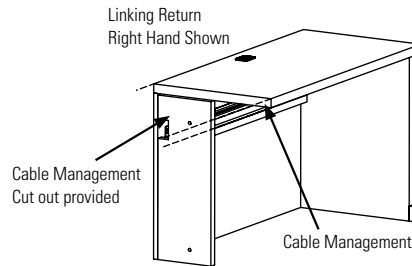
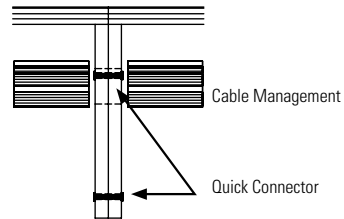

Linking Return
Right Hand Shown

Cable Management
Cut out provided

Cable Management

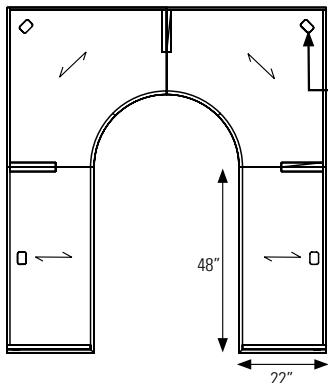

PBVL4822CG
Linking Return

PBVR4822CG
Linking Return

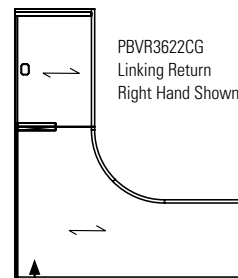

PBVR3622CG
Linking Return
Right Hand Shown

PBEKL724822
Extended Corner Table

Grommet must be specified if required.

LINKING BRIDGES

- Linking Bridge is used to connect Corner Components to Single Pedestal Desk, Single Pedestal Credenza, Desk Shell or Credenza Shell.
- Back panels are available as either full height or 8" from the underside of the worksurface.
- Includes GM5 Grommet Top Center
- Hand of Linking Bridge is determined by location of half end panel from user side
- The standard grain direction is cross grain (**CG**). To remove cross grain veneer pattern on top, delete suffix "**CG**" from the model number (no upcharge)

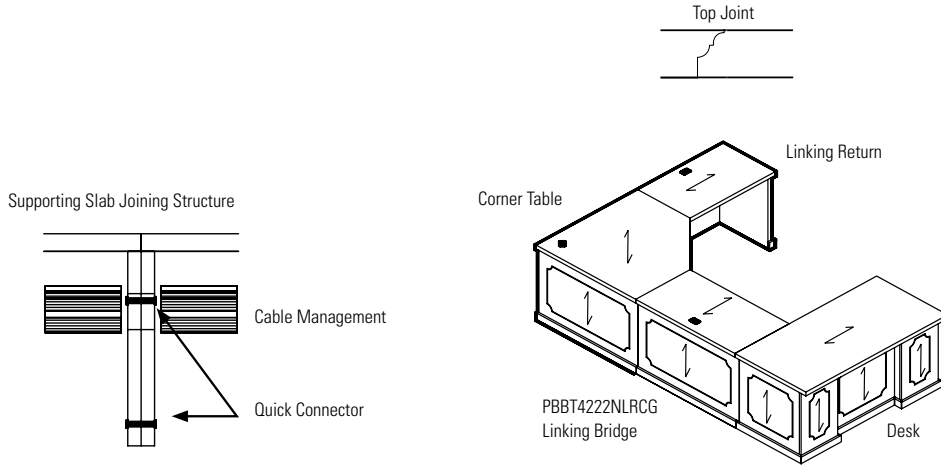

COPING AND SELF-EDGE OPTIONS

- Coping option provides an undercut on hutches only so that storage cabinets placed next to the hutch fit flush.
 - Specify **COP** for coping on both sides, **COPR** for coping on the right side and **COPL** for coping on the left side. No upcharge.
- Self edge options provide a flush fit when storage units are placed next to one another.
 - Specify **SE** for self-edge on both sides, **SER** for self-edge on the right side and **SEL** for self-edge on the left side. When **SE**, **SER**, **SEL** are specified, the corresponding bottom base molding will also be removed. No upcharge.
 - Coping and self-edge handedness are from the users perspective. See diagram below.

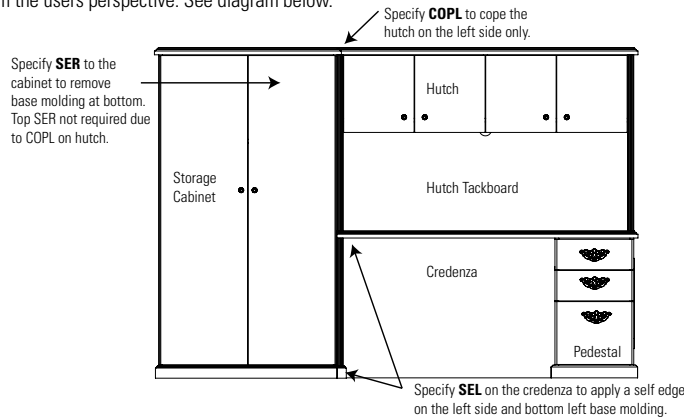

MODULAR PEDESTALS AND HANDLES

- Modular Pedestal for Philadelphia using "C" components.
- SP700 spacer is required if two Modular Pedestals are placed side by side when there is no handles. Order as special.
- Credenza shell cannot be completely filled up with modular components to create a full storage credenza.

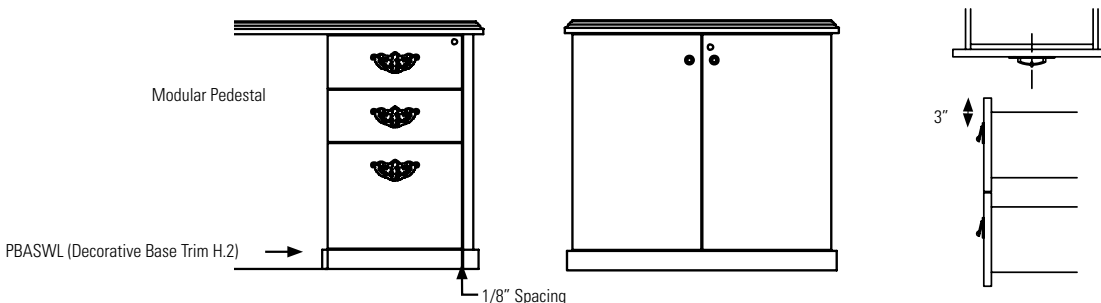

LOCKING

- Locks are standard on all below worksurface level drawer and door storage units with the exception of the pull-out tray units and single lateral file drawer combination tray/slot units.
- Locks are optional on all above worksurface level closed storage units.

Standard Lock Positions

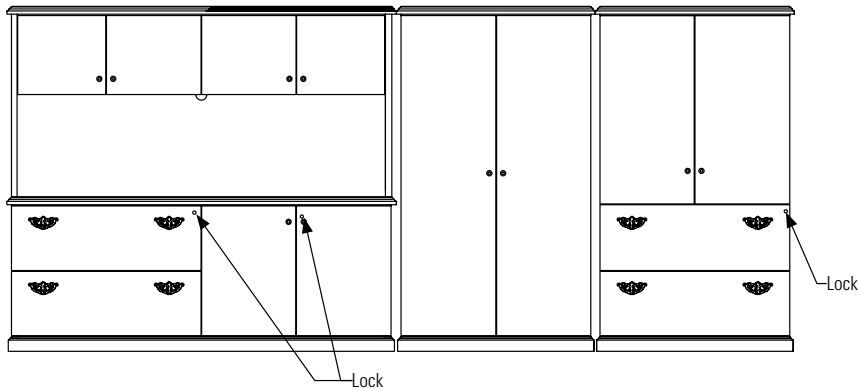

PBCF7222

Full Storage Credenza: Locks are on the front.

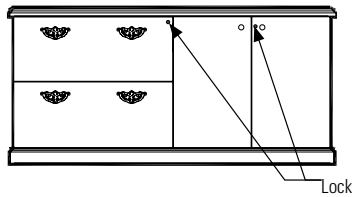

PB7236DE

Double Pedestal Desk/Credenza:

Lock for D and E Pedestals are on the inside Gable.

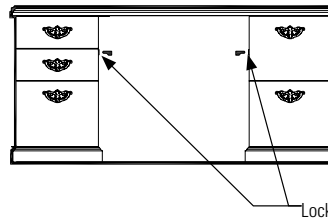

PBZR

Combination Storage Unit:

Lock for File and Lateral File Drawer only,
Box Drawers do not lock.

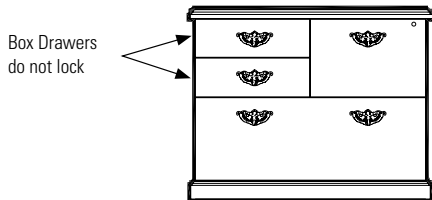

PBWF

Modular Furniture:
Lock is on the front.

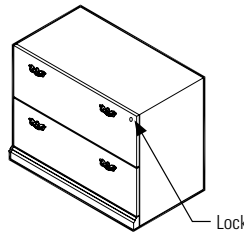

PBWD

Modular Furniture:
Lock is on the front.

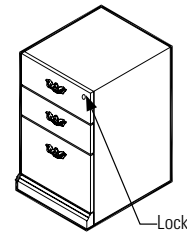

HUTCH POSITIONING

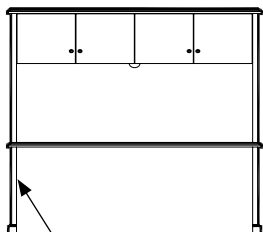

There must be an end panel
under the hutch

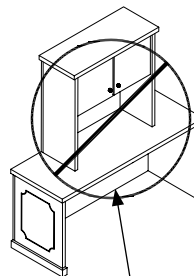
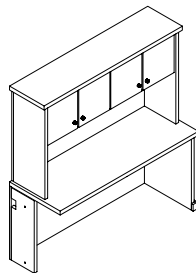

Missing Support
NOT Recommended

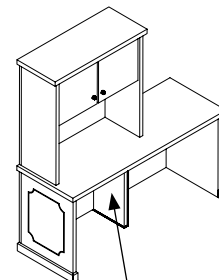

Add optional Support
SLAB12 (as Special)

TACKBOARDS

Tackboards for Storage Huches

PB72SH36

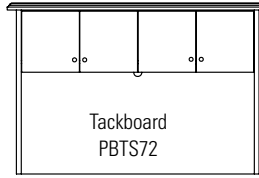

PB72SHP42 and PB722SHP54

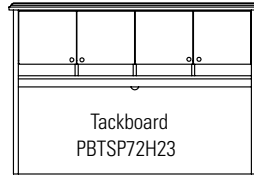

PB72SH42 and PB722SH54

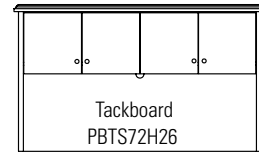

Tackboards with Accessory Rail

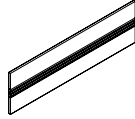

PBTSAS72

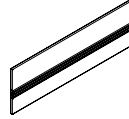

PBTSAS72H23

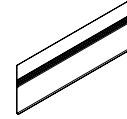

PBTSAS72H26

Tackboards for Wall Mount Overheads

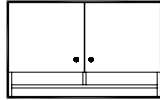

CSF36

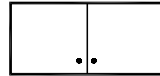

CSFP36

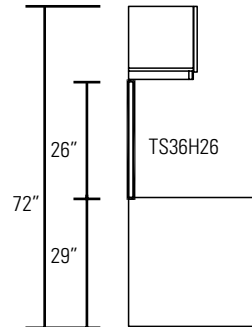
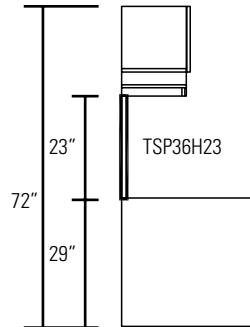
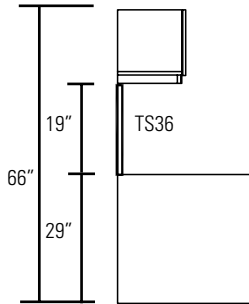

LIGHTING

Wall Mount

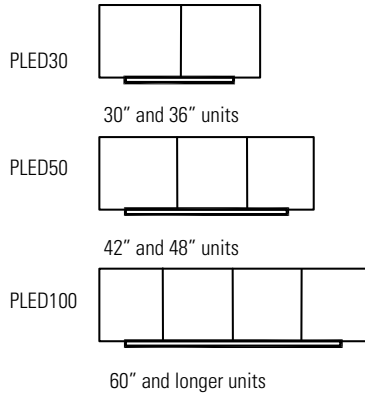

Hutch

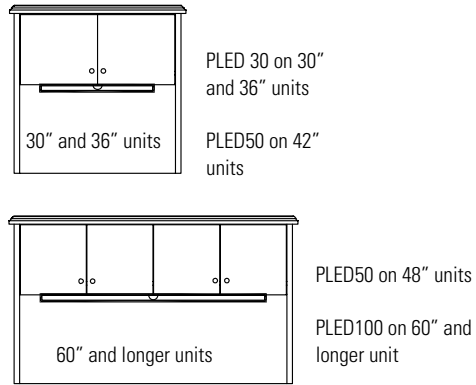

DESKS - NOTES

NOTE: Arrow indicates direction of grain

Double Pedestal Desks

- Shipped assembled
- Kneewell locking standard and keyed alike
- Standard with center drawer
- For optional pull-out writing tray, specify **WTD**. Add **\$679**.

Single Pedestal Desks

- Shipped assembled
- Kneewell locking standard and keyed alike
- For optional pull-out writing tray, specify **WTS**. Add **\$343**.

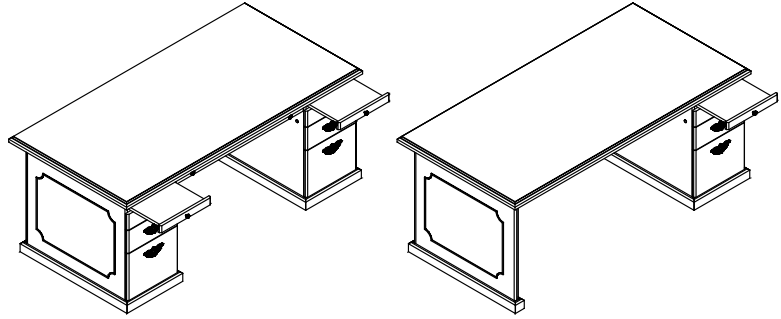

D and P shaped desks

- Shipped assembled.

D and P shaped connecting desks

- Shipped knocked down.
- The standard grain direction on D and P shaped connecting desks is cross grain (**CG**). To remove cross grain veneer pattern on top, delete suffix "**CG**" from the model number (no upcharge)
- Pedestals are handed:
 - Left pedestals have the handle offset from the center to the right, and the lock is placed on the right end panel
 - Right pedestals have the handle offset from the center to the left, and the lock is placed on the left end panel
- Modesty panels are available in wood or glass
- Grommets are available as an option on Desks and most Credenzas.

DOUBLE PEDESTAL DESKS **MODEL#** **DIMENSIONS** **FREIGHT CLASS** **WT/LBS.** **CUBIC FT.** **LIST PRICE**

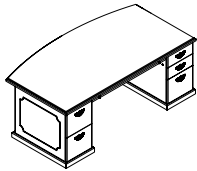

**Double Pedestal Bow Top Desk
Breakfront Style**

	D x W x H					
PBMID8442ED	42 x 84 x 29	125	443	59		\$13424
PBMID7842ED	42 x 78 x 29	125	412	55		\$12538
PBMID7242ED	42 x 72 x 29	125	380	51		\$11652
PBMID6636ED	36 x 66 x 29	100	340	40		\$11332

Standard with full to floor **file/file** pedestal on **left** and **box/box/file** pedestal on **right**. Pedestals lock.
Inset Full Height Modesty Panel.

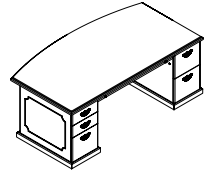

**Double Pedestal Bow Top Desk
Breakfront Style**

PBMID8442DE	42 x 84 x 29	125	443	59		\$13424
PBMID7842DE	42 x 78 x 29	125	412	55		\$12538
PBMID7242DE	42 x 72 x 29	125	380	51		\$11652
PBMID6636DE	36 x 66 x 29	100	340	40		\$11332

Standard with full to floor **box/box/file** pedestal on **left** and **file/file** pedestal on **right**. Pedestals lock.
Inset Full Height Modesty Panel.

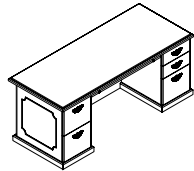

**Double Pedestal Desk
Breakfront Style**

PBID8442ED	42 x 84 x 29	125	442	59		\$11572
PBID7842ED	42 x 78 x 29	125	421	55		\$10817
PBID7236ED	36 x 72 x 29	100	375	44		\$10066
PBID7230ED	30 x 72 x 29	100	345	36		\$9928
PBID6636ED	36 x 66 x 29	100	360	40		\$9928
PBID6630ED	30 x 66 x 29	92.5	315	30		\$9790
PBID6030ED	30 x 60 x 29	92.5	315	30		\$9511

Standard with full to floor **file/file** pedestal on **left** and **box/box/file** pedestal on **right**. Pedestals lock.
Inset Full Height Modesty Panel.

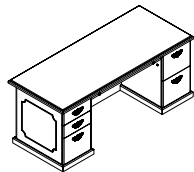

**Double Pedestal Desk
Breakfront Style**

PBID8442DE	42 x 84 x 29	125	442	59		\$11572
PBID7842DE	42 x 78 x 29	125	421	55		\$10817
PBID7236DE	36 x 72 x 29	100	375	44		\$10066
PBID7230DE	30 x 72 x 29	100	345	36		\$9928
PBID6636DE	36 x 66 x 29	100	360	40		\$9928
PBID6630DE	30 x 66 x 29	92.5	315	30		\$9790
PBID6030DE	30 x 60 x 29	92.5	315	30		\$9511

Standard with full to floor **box/box/file** pedestal on **left** and **file/file** pedestal on **right**. Pedestals lock.
Inset Full Height Modesty Panel.

Required Specifications

Finish

Optional Specifications

Grommet
Modesty panel
Pull-out writing tray

SINGLE PEDESTAL DESKS

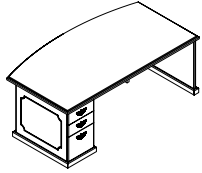

Single Pedestal Bow Top Desk - Left*
Breakfront Style

MODEL#	DIMENSIONS D x W x H	FREIGHT CLASS	WT./LBS.	CUBIC FT.	LIST PRICE
PBMISL8442D	42 x 84 x 29	125	452	59	\$9820
PBMISL7842D	42 x 78 x 29	125	337	55	\$9119
PBMISL7242D	42 x 72 x 29	125	322	51	\$8421
PBMISL6636D	36 x 66 x 29	125	290	40	\$8098

Standard with full to floor **box/box/file** pedestal on **left**. Pedestals lock.
Inset Full Height Modesty Panel.

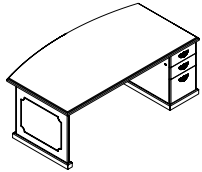

Single Pedestal Bow Top Desk - Right*
Breakfront Style

PBMISR8442D	42 x 84 x 29	125	452	59	\$9820
PBMISR7842D	42 x 78 x 29	125	337	55	\$9119
PBMISR7242D	42 x 72 x 29	125	322	51	\$8421
PBMISR6636D	36 x 66 x 29	125	290	40	\$8098

Standard with full to floor **box/box/file** pedestal on **right**. Pedestals lock.
Inset Full Height Modesty Panel.

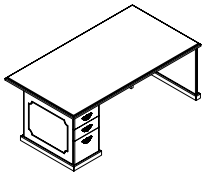

Single Pedestal Desk - Left*
Breakfront Style

PBISL8442D	42 x 84 x 29	125	387	59	\$9377
PBISL7842D	42 x 78 x 29	125	366	55	\$8705
PBISL7236D	36 x 72 x 29	125	320	44	\$6889
PBISL7230D	30 x 70 x 29	100	290	36	\$6582
PBISL6636D	36 x 66 x 29	125	305	40	\$6582
PBISL6630D	30 x 66 x 29	100	275	33	\$6282
PBISL6030D	30 x 60 x 29	100	260	30	\$6005

Standard with full to floor **box/box/file** pedestal on **left**. Pedestals lock.
Inset Full Height Modesty Panel.

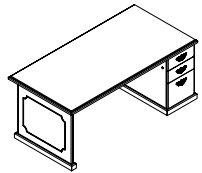

Single Pedestal Desk - Right*
Breakfront Style

PBISR8442D	42 x 84 x 29	125	387	59	\$9377
PBISR7842D	42 x 78 x 29	125	366	55	\$8705
PBISR7236D	36 x 72 x 29	125	320	44	\$6889
PBISR7230D	30 x 70 x 29	100	290	36	\$6582
PBISR6636D	36 x 66 x 29	125	305	40	\$6582
PBISR6630D	30 x 66 x 29	100	275	33	\$6282
PBISR6030D	30 x 60 x 29	100	260	30	\$6005

Standard with full to floor **box/box/file** pedestal on **right**. Pedestals lock.
Inset Full Height Modesty Panel.

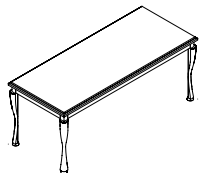

Table Desk
Queen Anne Style

PBQATB8442	42 x 84 x 29	150	272	59	\$10902
PBQATB7842	42 x 78 x 29	150	253	55	\$10222
PBQATB7236	36 x 72 x 29	150	205	44	\$8279
PBQATB7230	30 x 70 x 29	150	192	36	\$7458
PBQATB6636	36 x 66 x 29	150	192	40	\$7458
PBQATB6630	30 x 66 x 29	150	188	33	\$6561
PBQATB6030	30 x 60 x 29	150	171	30	\$5852

Inset Full Height Modesty Panel.

Required Specifications

Finish

Optional Specifications

Additional grommet
Modesty panel*
Pull-out writing tray*

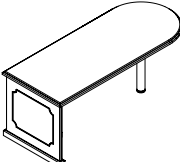
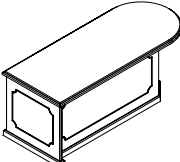
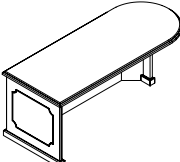
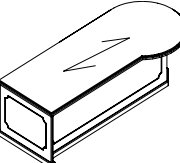
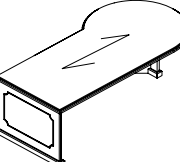
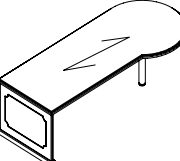
DESKS	MODEL#	DIMENSIONS	FREIGHT CLASS	WT/LBS.	CUBIC FT.	LIST PRICE
 <p>"D" Shaped Connecting Table Desk</p>	D x W x H					
	PBDD8436	36 x 84 x 29	125	343	51	\$6124
	PBDD7236	36 x 72 x 29	125	294	44	\$5247
	PBDD7230	30 x 72 x 29	125	264	36	\$4876
	PBDD6636	36 x 66 x 29	125	245	40	\$4876
	PBDD6030	30 x 60 x 29	125	225	30	\$4684
Wood column support and full end panel.						
 <p>"D" Shaped Table Desk - Left</p>	PBDDFL8436	36 x 84 x 29	125	367	51	\$7522
	PBDDFL7236	36 x 72 x 29	125	320	44	\$6449
	PBDDFL7230	30 x 72 x 29	100	290	36	\$6083
	PBDDFL6636	36 x 66 x 29	125	271	40	\$6083
	PBDDFL6030	30 x 60 x 29	100	247	30	\$5887
	With 45° angled modesty and end panel.					
 <p>"D" Shaped Table - Right</p>	PBDDFR8436	36 x 84 x 29	125	367	51	\$7522
	PBDDFR7236	36 x 72 x 29	125	320	44	\$6449
	PBDDFR7230	30 x 72 x 29	100	290	36	\$6083
	PBDDFR6636	36 x 66 x 29	125	271	40	\$6083
	PBDDFR6030	30 x 60 x 29	100	247	30	\$5887
	With 45° angled modesty and end panel.					
 <p>"P" Shaped Connecting Table - Left</p>	PBTPOL9642	42 x 96 x 29	150	317	68	\$9021
	PBTPOL8442	42 x 84 x 29	150	277	59	\$7892
	PBTPOL7242	42 x 72 x 29	150	211	51	\$7305
With 45° angled modesty and end panel.						
 <p>"P" Shaped Connecting Table - Right</p>	PBTPOR9642	42 x 96 x 29	150	317	68	\$9021
	PBTPOR8442	42 x 84 x 29	150	277	59	\$7892
	PBTPOR7242	42 x 72 x 29	150	211	51	\$7305
With 45° angled modesty and end panel.						
 <p>"P" Shaped Connecting Table - Left</p>	PBTPL9642	42 x 96 x 29	125	440	68	\$7646
	PBTPL8442	42 x 84 x 29	125	385	59	\$6692
	PBTPL7242	42 x 72 x 29	125	319	51	\$6100
Wood column support and full end panel.						

Required Specifications
Finish

Optional Specifications
Additional grommet

DESKS

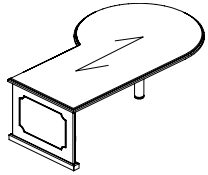

"P" Shaped Connecting Table - Right

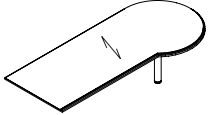

"P" Shaped Connecting Table - Left

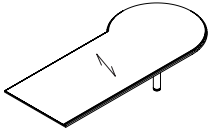

"P" Shaped Connecting Table - Right

MODEL#	DIMENSIONS D x W x H	FREIGHT CLASS	WT./LBS.	CUBIC FT.	LIST PRICE
PBTPR9642	42 x 96 x 29	125	440	68	\$7646
PBTPR8442	42 x 84 x 29	125	385	59	\$6692
PBTPR7242	42 x 72 x 29	125	319	51	\$6100

Wood column support and full end panel.

PBRPL9642CG	42 x 96 x 29	250	239	68	\$7250
PBRPL8442CG	42 x 84 x 29	250	209	59	\$6346
PBRPL7242CG	42 x 72 x 29	250	143	51	\$5436

Wood column support. No end panel.

PBRPR9642CG	42 x 96 x 29	250	239	68	\$7250
PBRPR8442CG	42 x 84 x 29	250	209	59	\$6346
PBRPR7242CG	42 x 72 x 29	250	143	51	\$5436

Wood column support. No end panel.

Required Specifications
Finish

Optional Specifications
Additional grommet

RETURNS - NOTES

D x W x H

- All returns are shipped assembled
- Kneewell locking standard
- The standard grain direction on returns is cross grain (**CG**). To remove cross grain veneer pattern on top, delete suffix "**CG**" from the model number (no upcharge)
- **NOTE:** Arrow indicates direction of grain

RETURNS MODEL# DIMENSIONS FREIGHT CLASS WT/LBS. CUBIC FT. LIST PRICE

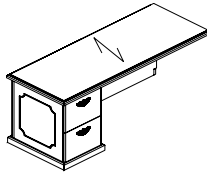

Executive Return - Left

PBERL7224ECG	24 x 72 x 29	100	250	29	\$6195
PBERL6624ECG	24 x 66 x 29	100	236	27	\$5969
PBERL6024ECG	24 x 60 x 29	100	227	24	\$5430
PBERL5424ECG	24 x 54 x 29	100	205	22	\$5230
PBERL4824ECG	24 x 48 x 29	100	185	19	\$4648
PBERL4224ECG	24 x 42 x 29	92.5	178	17	\$4473

Standard with full to floor **file/file** pedestal on **left**. Pedestal locks. Full height flush back panel.

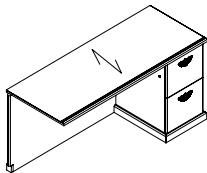

Executive Return - Right

PBERR7224ECG	24 x 72 x 29	100	250	29	\$6195
PBERR6624ECG	24 x 66 x 29	100	236	27	\$5969
PBERR6024ECG	24 x 60 x 29	100	227	24	\$5430
PBERR5424ECG	24 x 54 x 29	100	205	22	\$5230
PBERR4824ECG	24 x 48 x 29	100	185	19	\$4648
PBERR4224ECG	24 x 42 x 29	92.5	178	17	\$4473

Standard with full to floor **file/file** pedestal on **right**. Pedestal locks. Full height flush back panel.

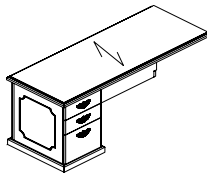

Executive Return - Left

PBERL7224DCG	24 x 72 x 29	100	250	29	\$6195
PBERL6624DCG	24 x 66 x 29	100	236	27	\$5969
PBERL6024DCG	24 x 60 x 29	100	227	24	\$5430
PBERL5424DCG	24 x 54 x 29	100	205	22	\$5230
PBERL4824DCG	24 x 48 x 29	100	185	19	\$4648
PBERL4224DCG	24 x 42 x 29	92.5	178	17	\$4473

Standard with full to floor **box/box/file** pedestal on **left**. Pedestal locks. Full height flush back panel.

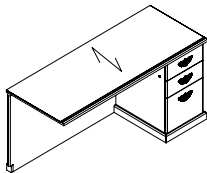

Executive Return - Right

PBERR7224DCG	24 x 72 x 29	100	250	29	\$4473
PBERR6624DCG	24 x 66 x 29	100	236	27	\$5969
PBERR6024DCG	24 x 60 x 29	100	227	24	\$5430
PBERR5424DCG	24 x 54 x 29	100	205	22	\$5230
PBERR4824DCG	24 x 48 x 29	100	185	19	\$4648
PBERR4224DCG	24 x 42 x 29	92.5	178	17	\$4473

Standard with full to floor **box/box/file** pedestal on **right**. Pedestal locks. Full height flush back panel.

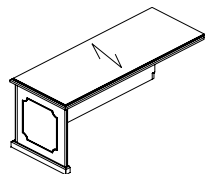

Executive Return - Left

PBERL7224CG	24 x 72 x 29	150	135	29	\$3475
PBERL6624CG	24 x 66 x 29	150	127	27	\$3184
PBERL6024CG	24 x 60 x 29	150	120	24	\$2897
PBERL5424CG	24 x 54 x 29	150	112	22	\$2600
PBERL4824CG	24 x 48 x 29	150	105	19	\$2320
PBERL4224CG	24 x 42 x 29	150	97	17	\$2025

Full height flush back panel.

Required Specifications
Finish

Optional Specifications
Grommet

RETURNS

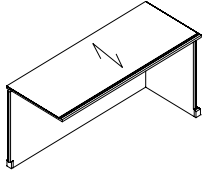

Executive Return - Right

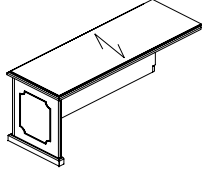

Executive Return - Left

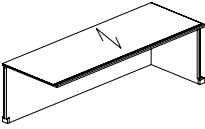

Executive Return - Right

MODEL#	DIMENSIONS	FREIGHT CLASS	WT./LBS.	CUBIC FT.	LIST PRICE
--------	------------	---------------	----------	-----------	------------

D x W x H

PBERR7224CG	24 x 72 x 29	150	135	29	\$3475
PBERR6624CG	24 x 66 x 29	150	127	27	\$3184
PBERR6024CG	24 x 60 x 29	150	120	24	\$2897
PBERR5424CG	24 x 54 x 29	150	112	22	\$2600
PBERR4824CG	24 x 48 x 29	150	105	19	\$2320
PBERR4224CG	24 x 42 x 29	150	97	17	\$2025

Full height flush back panel.

PBERL7222CG	22 x 72 x 29	150	130	27	\$3311
PBERL6622CG	22 x 66 x 29	150	122	24	\$3033
PBERL6022CG	22 x 60 x 29	150	115	22	\$2761
PBERL5422CG	22 x 54 x 29	150	105	20	\$2481
PBERL4822CG	22 x 48 x 29	150	100	18	\$2209
PBERL4222CG	22 x 42 x 29	150	90	16	\$1931

Full height flush back panel.

PBERR7222CG	22 x 72 x 29	150	130	27	\$3311
PBERR6622CG	22 x 66 x 29	150	122	24	\$3033
PBERR6022CG	22 x 60 x 29	150	115	22	\$2761
PBERR5422CG	22 x 54 x 29	150	105	20	\$2481
PBERR4822CG	22 x 48 x 29	150	100	18	\$2209
PBERR4222CG	22 x 42 x 29	150	90	16	\$1931

Full height flush back panel.

Required Specifications

Finish

Optional Specifications

Additional grommet

PIANO DESKS

D x W x H

- All desks are shipped assembled
- Units include installed horizontal wire management
- Unit is handed by Post Leg
- Not for use with Regular Corner Units
- The standard grain direction on piano desks is cross grain (**CG**). To remove cross grain veneer pattern on top, delete suffix "**CG**" from the model number (no upcharge)
- If grommet color is not specified, Black is standard
- **NOTE:** Arrow indicates direction of grain

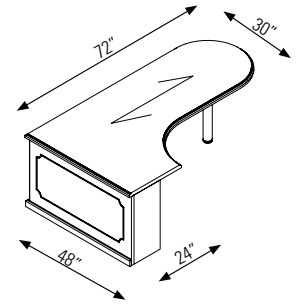

PIANO DESKS

MODEL# DIMENSIONS FREIGHT CLASS WT./LBS. CUBIC FT. LIST PRICE

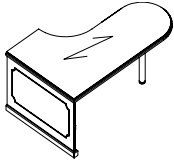

D-shaped Piano Desk - Left

PBTDPL96304824	48 x 96 x 29	125	464	77	\$7954
PBTDPL84304824	48 x 84 x 29	150	406	68	\$7074
PBTDPL72304824	48 x 72 x 29	125	348	58	\$6196

Wood column support and full end panel, 30"D worksurface extension and 24" return connection.

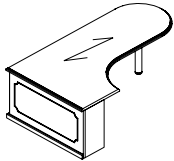

D-shaped Piano Desk - Right

PBTDPR96304824	48 x 96 x 29	125	464	77	\$7954
PBTDPR84304824	48 x 84 x 29	150	406	68	\$7074
PBTDPR72304824	48 x 72 x 29	125	348	58	\$6196

Wood column support and full end panel, 30"D worksurface extension and 24" return connection.

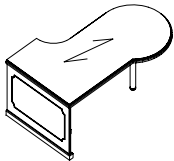

P-shaped Piano Desk - Left

PBTPPL96424824	54 x 96 x 29	150	580	97	\$9075
PBTPPL84424824	54 x 84 x 29	150	508	85	\$8114
PBTPPL72424824	54 x 72 x 29	150	435	73	\$7524

Wood column support and full end panel, 42"/30" worksurface and 24" return connection.

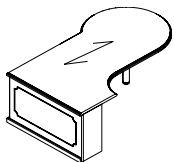

P-shaped Piano Desk - Right

PBTPPR96424824	54 x 96 x 29	150	580	97	\$9075
PBTPPR84424824	54 x 84 x 29	150	508	85	\$8114
PBTPPR72424824	54 x 72 x 29	150	435	73	\$7524

Wood column support and full end panel, 42"/30" worksurface and 24" return connection.

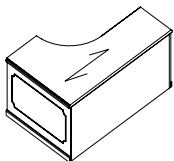

Extended Corner Table Desk - Left

PBEKL964824MR	48 x 96 x 29	150	387	77	\$8641
PBEKL904824MR	48 x 90 x 29	150	363	73	\$8159
PBEKL844824MR	48 x 84 x 29	150	338	68	\$8064
PBEKL784824MR	48 x 78 x 29	150	314	63	\$8020
PBEKL724824MR	48 x 72 x 29	150	290	58	\$7623
PBEKL664824MR	48 x 66 x 29	150	266	52	\$7107
PBEKL604824MR	48 x 60 x 29	150	242	48	\$6586

With 24" return connection.

Required Specifications
Finish

Optional Specifications
Additional grommet

PIANO DESKS

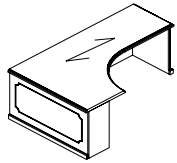

Extended Corner Table Desk - Right

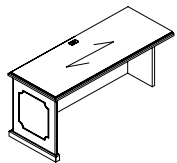

Linking Return - Left

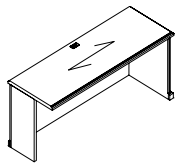

Linking Return - Right

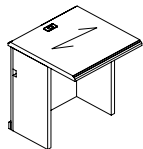

Bridge

MODEL#	DIMENSIONS	FREIGHT CLASS	WT/LBS.	CUBIC FT.	LIST PRICE
--------	------------	---------------	---------	-----------	------------

D x W x H

PBEKR489624ML	48 x 96 x 29	150	387	77	\$8641
PBEKR489024ML	48 x 90 x 29	150	363	73	\$8159
PBEKR488424ML	48 x 84 x 29	150	338	68	\$8064
PBEKR487824ML	48 x 78 x 29	150	314	63	\$8020
PBEKR487224ML	48 x 72 x 29	150	290	58	\$7623
PBEKR486624ML	48 x 66 x 29	150	266	52	\$7107
PBEKR486024ML	48 x 60 x 29	150	242	48	\$6586

With 24" return connection.

PBVEL9624CG	24 x 96 x 29	150	200	39	\$5252
PBVEL9024CG	24 x 90 x 29	150	187	36	\$4924
PBVEL8424CG	24 x 84 x 29	150	174	34	\$4596
PBVEL7824CG	24 x 78 x 29	150	162	31	\$4263
PBVEL7224CG	24 x 72 x 29	150	149	29	\$3940
PBVEL6624CG	24 x 66 x 29	150	141	27	\$3698
PBVEL6024CG	24 x 60 x 29	150	132	24	\$3456
PBVEL5424CG	24 x 54 x 29	150	121	22	\$3260
PBVEL4824CG	24 x 48 x 29	125	115	19	\$3066
PBVEL4224CG	24 x 42 x 29	150	99	17	\$2581
PBVEL3624CG	24 x 36 x 29	150	83	15	\$2493
PBVEL3024CG	24 x 30 x 29	125	77	12	\$2477
PBVEL2424CG	24 x 24 x 29	125	61	10	\$2054

Used in conjunction with extended piano corner units or piano shaped desks.

PBVER9624CG	24 x 96 x 29	150	200	39	\$5252
PBVER9024CG	24 x 90 x 29	150	187	36	\$4924
PBVER8424CG	24 x 84 x 29	150	174	34	\$4596
PBVER7824CG	24 x 78 x 29	150	162	31	\$4263
PBVER7224CG	24 x 72 x 29	150	149	29	\$3940
PBVER6624CG	24 x 66 x 29	150	141	27	\$3698
PBVER6024CG	24 x 60 x 29	150	132	24	\$3456
PBVER5424CG	24 x 54 x 29	150	121	22	\$3260
PBVER4824CG	24 x 48 x 29	125	115	19	\$3066
PBVER4224CG	24 x 42 x 29	150	99	17	\$2581
PBVER3624CG	24 x 36 x 29	150	83	15	\$2493
PBVER3024CG	24 x 30 x 29	125	77	12	\$2477
PBVER2424CG	24 x 24 x 29	125	61	10	\$2054

Used in conjunction with extended piano corner units or piano shaped desks.

PBBTN4824CG	24 x 48 x 29	150	110	19	\$2973
PBBTN4224CG	24 x 42 x 29	150	94	17	\$2493
PBBTN3624CG	24 x 36 x 29	150	79	15	\$2400
PBBTN3024CG	24 x 30 x 29	125	72	12	\$2349
PBBTN2424CG	24 x 24 x 29	150	56	10	\$1975
PBBTN1824CG	24 x 18 x 29	150	43	8	\$1482
PBBTN1224CG	24 x 12 x 29	150	29	5	\$988

For extended piano corner units or piano-shaped desks.

Required Specifications

Finish

Optional Specifications

Additional grommet

BRIDGES	MODEL#	DIMENSIONS	FREIGHT CLASS	WT/LBS.	CUBIC FT.	LIST PRICE
---------	--------	------------	---------------	---------	-----------	------------

D x W x H

- All bridges are shipped knockdown
- Not for use with Corner Units
- The standard grain direction is cross grain (**CG**). To remove cross grain veneer pattern on top, delete suffix "**CG**" from the model number (no upcharge)
- GM5 TC location is standard. If grommet color is not specified, Black is standard
- **NOTE:** Arrow indicates direction of grain

BRIDGES	MODEL#	DIMENSIONS	FREIGHT CLASS	WT/LBS.	CUBIC FT.	LIST PRICE
---------	--------	------------	---------------	---------	-----------	------------

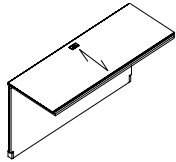

Executive Bridge Top

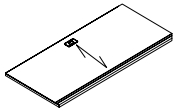

Executive Bridge Top

PBBT6022CG	22 x 60 x 29	92.5	108	10	\$3067
PBBT5422CG	22 x 54 x 29	92.5	99	9	\$2767
PBBT4822CG	22 x 48 x 29	92.5	90	8	\$2457
PBBT4222CG	22 x 42 x 29	92.5	81	7	\$2150
PBBT6020CG	20 x 60 x 29	85	105	8	\$2515
PBBT5420CG	20 x 54 x 29	85	96	8	\$2264
PBBT4820CG	20 x 48 x 29	85	87	7	\$2013
PBBT4220CG	20 x 42 x 29	85	78	6	\$1723

With full back panel.

PBBT5422TCG	22 x 54 x 1.3	125	64	9	\$1661
PBBT4822TCG	22 x 48 x 1.3	125	55	8	\$1473
PBBT4222TCG	22 x 42 x 1.3	125	46	7	\$1293
PBBT5420TCG	20 x 54 x 1.3	125	61	8	\$1356
PBBT4820TCG	20 x 48 x 1.3	125	52	7	\$1211
PBBT4220TCG	20 x 42 x 1.3	125	43	6	\$1038

Required Specifications
Finish

Optional Specifications
Additional grommet

CRENZAS	MODEL#	DIMENSIONS D x W x H	FREIGHT CLASS	WT./LBS.	CUBIC FT.	LIST PRICE
---------	--------	-------------------------	---------------	----------	-----------	------------

- All credenzas are shipped assembled
- All storage cabinets include one adjustable shelf per set of doors
- **F** and **G** depict 36". **M** and **N** depict 30".
- **F** and **N** indicate lateral file drawers. **G** and **M** indicate storage cabinets with doors.
- Credenza shells accept modular storage. Use modular storage for top support allowing no more than 72" unsupported.
- Credenza shells with a width of 96" and more will have a 12" middle support gable.
- For PBCF7220 and PBCF6020, standard face locking for cabinet and lateral file.
- Grommets are available as an option on Desks and most Credenzas.
- **NOTE:** Arrow indicates direction of grain

CRENZAS	MODEL#	DIMENSIONS	FREIGHT CLASS	WT./LBS.	CUBIC FT.	LIST PRICE
---------	--------	------------	---------------	----------	-----------	------------

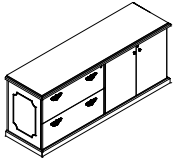

Full Storage Credenza

PBCF7224FG	24 x 72 x 29	92.5	272	24	\$8048
PBC6024NM	24 x 60 x 29	92.5	220	20	\$6704
PBCF7220FG	20 x 72 x 29	92.5	272	24	\$7076
PBCF6020NM	20 x 60 x 29	92.5	220	20	\$5896

Lateral file on **left** and storage cabinet on **right**.

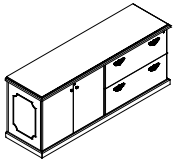

Full Storage Credenza

PBCF7224GF	24 x 72 x 29	92.5	272	24	\$8048
PBC6024MN	24 x 60 x 29	92.5	220	20	\$6704
PBCF7220GF	20 x 72 x 29	92.5	272	24	\$7076
PBCF6020MN	20 x 60 x 29	92.5	220	20	\$5896

Storage cabinet on **left** and lateral file on **right**.

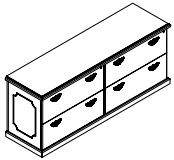

Full Storage Credenza

PBC7224FF	24 x 72 x 29	92.5	287	24	\$9806
PBC6024NN	24 x 60 x 29	92.5	205	20	\$8581
PBC7220FF	20 x 72 x 29	92.5	287	24	\$9053
PBC6020NN	20 x 60 x 29	92.5	205	20	\$7923

Lateral files on **left** and **right**.

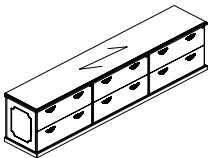

Full Storage Credenza

PBC10824FFF	24 x 108 x 29	92.5	412	36	\$16465
PBC9024NNN	24 x 90 x 29	92.5	337	30	\$13720
PBC10820FFF	20 x 108 x 29	92.5	412	36	\$15200
PBC9020NNN	20 x 90 x 29	92.5	337	30	\$12670

Lateral files on **left**, **center**, and **right**.

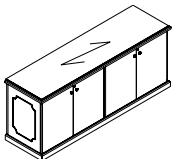

Full Storage Credenza

PBC7224GG	24 x 72 x 29	92.5	253	24	\$7277
PBC6024MM	24 x 60 x 29	92.5	209	20	\$6364
PBC7220GG	20 x 72 x 29	92.5	253	24	\$6719
PBC6020MM	20 x 60 x 29	92.5	209	20	\$5878

Storage cabinets on **left** and **right**.

Required Specifications
Finish

Optional Specifications
Additional grommet

CRENZAS MODEL# DIMENSIONS FREIGHT CLASS WT/LBS. CUBIC FT. LIST PRICE

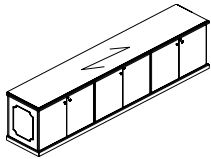

Full Storage Credenza

	D x W x H				
PBC10824GGG	24 x 108 x 29	125	278	36	\$13120
PBC9024MMM	24 x 90 x 29	125	228	30	\$10937
PBC10820GGG	20 x 108 x 29	125	278	36	\$12114
PBC9020MMM	20 x 90 x 29	125	228	30	\$10098

Storage cabinets on **left, center,** and **right.**

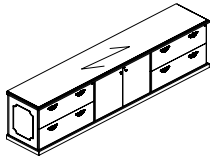

Full Storage Credenza

PBC10824FGF	24 x 108 x 29	92.5	479	44	\$17043
PBC9024NNM	24 x 90 x 29	92.5	399	36	\$14198
PBC10820FGF	20 x 108 x 29	92.5	388	36	\$14172
PBC9020NNM	20 x 90 x 29	92.5	321	30	\$11808

Lateral files on **left and right;** storage cabinet in **center.**

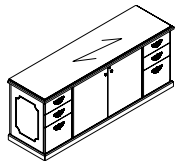

Full Storage Credenza

PBC7224DGD	24 x 72 x 29	92.5	319	29	\$10477
PBC6024DGD	24 x 60 x 29	92.5	266	24	\$9603
PBC7220DGD	20 x 72 x 29	85	298	24	\$9129
PBC6020DGD	20 x 60 x 29	85	246	20	\$7988

Box/box/file on **left and right;** storage cabinet in **center.**

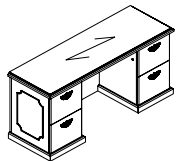

Double Pedestal Credenza

PBCK8424EE	24 x 84 x 29	92.5	348	34	\$9953
PBCK7824EE	24 x 78 x 29	92.5	319	31	\$9247
PBCK7224EE	24 x 72 x 29	100	280	29	\$8541
PBCK6624EE	24 x 66 x 29	100	261	27	\$8408
PBCK6024EE	24 x 60 x 29	100	238	24	\$7823

PBCK8420EE	20 x 84 x 29	92.5	307	28	\$8679
PBCK7820EE	20 x 78 x 29	92.5	285	26	\$8058
PBCK7220EE	20 x 72 x 29	92.5	267	24	\$7438
PBCK6620EE	20 x 66 x 29	92.5	244	22	\$6814
PBCK6020EE	20 x 60 x 29	92.5	220	20	\$6200

File/file pedestals on **left and right.** Full height back panel. Kneespace in center.

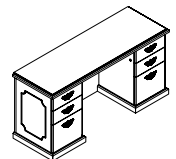

Double Pedestal Credenza

PBCK8424DD	24 x 84 x 29	92.5	348	34	\$9953
PBCK7824DD	24 x 78 x 29	92.5	319	31	\$9247
PBCK7224DD	24 x 72 x 29	100	280	29	\$8541
PBCK6624DD	24 x 66 x 29	100	261	27	\$8408
PBCK6024DD	24 x 60 x 29	100	238	24	\$7823

PBCK8420DD	20 x 84 x 29	92.5	307	28	\$8679
PBCK7820DD	20 x 78 x 29	92.5	285	26	\$8058
PBCK7220DD	20 x 72 x 29	92.5	267	24	\$7438
PBCK6620DD	20 x 66 x 29	92.5	244	22	\$6814
PBCK6020DD	20 x 60 x 29	92.5	220	20	\$6200

Box/box/file pedestals on **left and right.** Full height back panel. Kneespace in center.

Required Specifications
Finish

Optional Specifications
Additional grommet

CREDENZAS

MODEL# DIMENSIONS FREIGHT CLASS WT/LBS. CUBIC FT. LIST PRICE

D x W x H

PBCK8424ED	24 x 84 x 29	92.5	348	34	\$9953
PBCK7824ED	24 x 78 x 29	92.5	319	31	\$9247
PBCK7224ED	24 x 72 x 29	100	280	29	\$8541
PBCK6624ED	24 x 66 x 29	100	261	27	\$8408
PBCK6024ED	24 x 60 x 29	100	238	24	\$7823
PBCK8420ED	20 x 84 x 29	92.5	307	28	\$8679
PBCK7820ED	20 x 78 x 29	92.5	285	26	\$8058
PBCK7220ED	20 x 72 x 29	92.5	267	24	\$7438
PBCK6620ED	20 x 66 x 29	92.5	244	22	\$6814
PBCK6020ED	20 x 60 x 29	92.5	220	20	\$6200

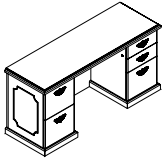

Double Pedestal Credenza

File/file pedestal on **left** and box/box/file pedestal on **right**. Full height back panel. Kneespace in center.

PBCK8424DE	24 x 84 x 29	92.5	348	34	\$9953
PBCK7824DE	24 x 78 x 29	92.5	319	31	\$9247
PBCK7224DE	24 x 72 x 29	100	280	29	\$8541
PBCK6624DE	24 x 66 x 29	100	261	27	\$8408
PBCK6024DE	24 x 60 x 29	100	238	24	\$7823
PBCK8420DE	20 x 84 x 29	92.5	307	28	\$8679
PBCK7820DE	20 x 78 x 29	92.5	285	26	\$8058
PBCK7220DE	20 x 72 x 29	92.5	267	24	\$7438
PBCK6620DE	20 x 66 x 29	92.5	244	22	\$6814
PBCK6020DE	20 x 60 x 29	92.5	220	20	\$6200

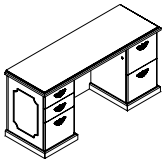

Double Pedestal Credenza

Box/box/file pedestal on **left** and file/file pedestal on **right**. Full height back panel. Kneespace in center.

PBCL8424E	24 x 84 x 29	100	315	34	\$7526
PBCL7824E	24 x 78 x 29	100	292	31	\$6991
PBCL7224E	24 x 72 x 29	100	270	29	\$6451
PBCL6624E	24 x 66 x 29	100	247	27	\$6209
PBCL6024E	24 x 60 x 29	100	225	24	\$5646
PBCL8420E	20 x 84 x 29	100	273	28	\$6560
PBCL7820E	20 x 78 x 29	100	252	26	\$6091
PBCL7220E	20 x 72 x 29	100	237	24	\$5624
PBCL6620E	20 x 66 x 29	100	216	22	\$5413
PBCL6020E	20 x 60 x 29	100	195	20	\$4924

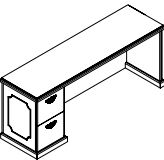

Single Pedestal Credenza - Left

File/file pedestal on **left**.

PBCR8424E	24 x 84 x 29	100	315	34	\$7526
PBCR7824E	24 x 78 x 29	100	292	31	\$6991
PBCR7224E	24 x 72 x 29	100	270	29	\$6451
PBCR6624E	24 x 66 x 29	100	247	27	\$6209
PBCR6024E	24 x 60 x 29	100	225	24	\$5646
PBCR8420E	20 x 84 x 29	100	273	28	\$6560
PBCR7820E	20 x 78 x 29	100	252	26	\$6091
PBCR7220E	20 x 72 x 29	100	237	24	\$5624
PBCR6620E	20 x 66 x 29	100	216	22	\$5413
PBCR6020E	20 x 60 x 29	100	195	20	\$4924

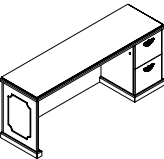

Single Pedestal Credenza - Right

File/file pedestal on **right**.

Required Specifications
Finish

Optional Specifications
Additional grommet

CREDENZAS	MODEL#	DIMENSIONS	FREIGHT CLASS	WT/LBS.	CUBIC FT.	LIST PRICE
		D x W x H				
	PBCL8424D	24 x 84 x 29	100	315	34	\$7526
	PBCL7824D	24 x 78 x 29	100	292	31	\$6991
	PBCL7224D	24 x 72 x 29	100	270	29	\$6451
	PBCL6624D	24 x 66 x 29	100	247	27	\$6209
	PBCL6024D	24 x 60 x 29	100	225	24	\$5646
	PBCL8420D	20 x 84 x 29	100	273	28	\$6560
	PBCL7820D	20 x 78 x 29	100	252	26	\$6091
	PBCL7220D	20 x 72 x 29	100	237	24	\$5624
	PBCL6620D	20 x 66 x 29	100	216	22	\$5413
	PBCL6020D	20 x 60 x 29	100	195	20	\$4924

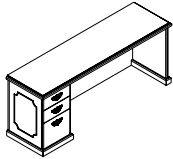

Single Pedestal Credenza - Left

Box/box/file pedestal on **left**.

PBCR8424D	24 x 84 x 29	100	315	34	\$7526
PBCR7824D	24 x 78 x 29	100	292	31	\$6991
PBCR7224D	24 x 72 x 29	100	270	29	\$6451
PBCR6624D	24 x 66 x 29	100	247	27	\$6209
PBCR6024D	24 x 60 x 29	100	225	24	\$5646
PBCR8420D	20 x 84 x 29	100	273	28	\$6560
PBCR7820D	20 x 78 x 29	100	252	26	\$6091
PBCR7220D	20 x 72 x 29	100	237	24	\$5624
PBCR6620D	20 x 66 x 29	100	216	22	\$5413
PBCR6020D	20 x 60 x 29	100	195	20	\$4924

Box/box/file pedestal on **right**.

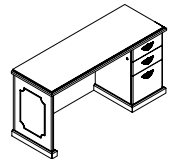

Single Pedestal Credenza - Right

PBCL8424F	24 x 84 x 29	100	305	34	\$8748
PBCL7824F	24 x 78 x 29	100	285	31	\$8119
PBCL7224F	24 x 72 x 29	100	261	29	\$7500
PBCL6624F	24 x 66 x 29	100	239	27	\$7281
PBCL6024F	24 x 60 x 29	100	218	24	\$6553
PBCL8420F	20 x 84 x 29	100	253	28	\$7626
PBCL7820F	20 x 78 x 29	100	233	26	\$7075
PBCL7220F	20 x 72 x 29	100	218	24	\$6531
PBCL6620F	20 x 66 x 29	100	197	22	\$6289
PBCL6020F	20 x 60 x 29	100	176	20	\$5711

36" lateral file on **left**.

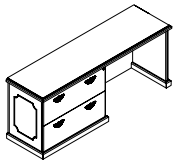

Single Pedestal Credenza - Left

PBCR8424F	24 x 84 x 29	100	305	34	\$8748
PBCR7824F	24 x 78 x 29	100	285	31	\$8119
PBCR7224F	24 x 72 x 29	100	261	29	\$7500
PBCR6624F	24 x 66 x 29	100	239	27	\$7281
PBCR6024F	24 x 60 x 29	100	218	24	\$6553
PBCR8420F	20 x 84 x 29	100	253	28	\$7626
PBCR7820F	20 x 78 x 29	100	233	26	\$7075
PBCR7220F	20 x 72 x 29	100	218	24	\$6531
PBCR6620F	20 x 66 x 29	100	197	22	\$6289
PBCR6020F	20 x 60 x 29	100	176	20	\$5711

36" lateral file on **right**.

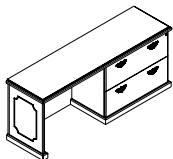

Single Pedestal Credenza - Right

Required Specifications
Finish

Optional Specifications
Additional grommet

CREDENZAS

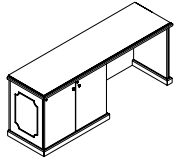

Single Pedestal Credenza - Left

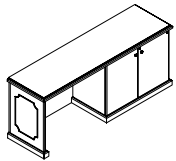

Single Pedestal Credenza - Right

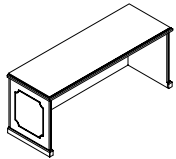

Credenza Shell

MODEL#	DIMENSIONS D x W x H	FREIGHT CLASS	WT/LBS.	CUBIC FT.	LIST PRICE
PBCL8424G	24 x 84 x 29	100	338	34	\$7858
PBCL7824G	24 x 78 x 29	92.5	314	31	\$7294
PBCL7224G	24 x 72 x 29	92.5	290	29	\$6754
PBCL6624G	24 x 66 x 29	100	266	27	\$6482
PBCL6024G	24 x 60 x 29	92.5	242	24	\$5893
PBCL8420G	20 x 84 x 29	92.5	290	28	\$6847
PBCL7820G	20 x 78 x 29	92.5	272	26	\$6357
PBCL7220G	20 x 72 x 29	92.5	252	24	\$5870
PBCL6620G	20 x 66 x 29	92.5	230	22	\$5641
PBCL6020G	20 x 60 x 29	92.5	208	20	\$5137

36" storage cabinet on **left**.

PBCR8424G	24 x 84 x 29	100	338	34	\$7858
PBCR7824G	24 x 78 x 29	92.5	314	31	\$7294
PBCR7224G	24 x 72 x 29	92.5	290	29	\$6754
PBCR6624G	24 x 66 x 29	100	266	27	\$6482
PBCR6024G	24 x 60 x 29	92.5	242	24	\$5893
PBCR8420G	20 x 84 x 29	92.5	290	28	\$6847
PBCR7820G	20 x 78 x 29	92.5	272	26	\$6357
PBCR7220G	20 x 72 x 29	92.5	252	24	\$5870
PBCR6620G	20 x 66 x 29	92.5	230	22	\$5641
PBCR6020G	20 x 60 x 29	92.5	208	20	\$5137

36" storage cabinet on **right**.

PBC12024	24 x 120 x 29	100	387	48	\$6704
PBC11424	24 x 114 x 29	125	367	46	\$6372
PBC10824	24 x 108 x 29	125	348	44	\$6036
PBC10224	24 x 102 x 29	100	329	41	\$5694
PBC9624	24 x 96 x 29	125	309	39	\$5363
PBC9024	24 x 90 x 29	100	290	36	\$5025
PBC8424	24 x 84 x 29	125	271	34	\$4694
PBC7824	24 x 78 x 29	100	251	31	\$4355
PBC7224	24 x 72 x 29	100	232	29	\$4024
PBC6624	24 x 66 x 29	125	213	27	\$3881
PBC6024	24 x 60 x 29	100	193	24	\$3522
PBC5424	24 x 54 x 29	125	174	22	\$3332
PBC4824	24 x 48 x 29	100	155	19	\$3150
PBC4224	24 x 42 x 29	125	135	17	\$2669

With full back panel.

Required Specifications
Finish

Optional Specifications
Additional grommet

CORNERS - NOTES

NOTE: Arrow indicates direction of grain

D x W x H

Corners

- All units are shipped assembled
- Unit includes grommets shown and installed horizontal wire management
- Corner units and extended corner units must be used exclusively with linking bridges and linking returns
- **Linking bridges** are handed by recessed end panel
- **Extended corner tables** have no molding on back side. Grommets are not included and must be specified.
- **Linking returns** include grommets shown and installed horizontal wire management. Handed by full end panel.
- **Tables** include grommets shown and installed horizontal wire management.

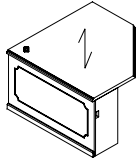
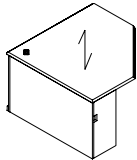
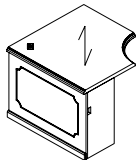
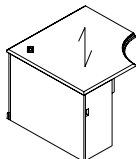
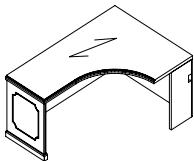
CORNERS AND COMPONENTS	MODEL#	DIMENSIONS	FREIGHT CLASS	WT./LBS.	CUBIC FT.	LIST PRICE
 <p>Corner Table - Left</p>	PBE484824ML	48 x 48 x 29	150	196	35	\$4685
	PBE424224ML	42 x 42 x 29	150	150	30	\$3604
	PBE363624ML	36 x 36 x 29	150	130	22	\$3426
With 2 recessed end panels.						
 <p>Corner Table - Right</p>	PBE484824MR	48 x 48 x 29	150	196	35	\$4685
	PBE424224MR	42 x 42 x 29	150	150	30	\$3604
	PBE363624MR	36 x 36 x 29	150	130	22	\$3426
With 2 recessed end panels.						
 <p>Corner Table - Left</p>	PBEK484824ML	48 x 48 x 29	150	196	39	\$5388
	PBEK424224ML	42 x 42 x 29	150	150	30	\$4147
	PBEK363624ML	36 x 36 x 29	150	130	22	\$3939
With 2 recessed end panels and inner curve.						
 <p>Corner Table - Right</p>	PBEK484824MR	48 x 48 x 29	150	196	39	\$5388
	PBEK424224MR	42 x 42 x 29	150	150	30	\$4147
	PBEK363624MR	36 x 36 x 29	150	130	22	\$3939
With 2 recessed end panels and inner curve.						
 <p>Extended Corner Table - Left</p>	PBEKL964824	96 x 48 x 29	150	387	77	\$7855
	PBEKL904824	90 x 48 x 29	150	363	73	\$7416
	PBEKL844824	84 x 48 x 29	150	338	68	\$7326
	PBEKL784824	78 x 48 x 29	150	314	63	\$7289
	PBEKL724824	72 x 48 x 29	150	290	58	\$6927
	PBEKL664824	66 x 48 x 29	150	266	52	\$6455
	PBEKL604824	60 x 48 x 29	150	242	48	\$5991
	With full back panel.					

Required Specifications
Finish

Optional Specifications
Additional grommet

CORNERS AND COMPONENTS

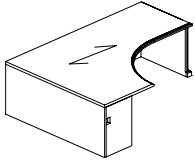

Extended Corner Table - Right

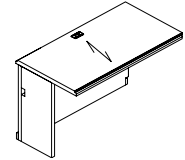

Linking Bridge - Left

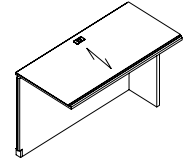

Linking Bridge - Right

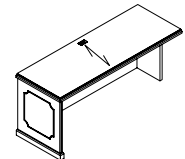

Linking Return - Left

MODEL#	DIMENSIONS	FREIGHT CLASS	WT/LBS.	CUBIC FT.	LIST PRICE
--------	------------	---------------	---------	-----------	------------

D x W x H

PBEKR489624	96 x 48 x 29	150	387	77	\$7855
PBEKR489024	90 x 48 x 29	150	363	73	\$7416
PBEKR488424	84 x 48 x 29	150	338	68	\$7326
PBEKR487824	78 x 48 x 29	150	314	63	\$7289
PBEKR487224	72 x 48 x 29	150	290	58	\$6927
PBEKR486624	66 x 48 x 29	150	266	52	\$6455
PBEKR486024	60 x 48 x 29	150	242	48	\$5991

With full back panel.

PBBT6024NLLCG	24 x 60 x 29	125	145	24	\$3052
PBBT5424NLLCG	24 x 54 x 29	150	131	22	\$2745
PBBT4824NLLCG	24 x 48 x 29	125	116	19	\$2440
PBBT4224NLLCG	24 x 42 x 29	125	102	17	\$1977
PBBT3624NLLCG	24 x 36 x 29	150	87	15	\$1796
PBBT3024NLLCG	24 x 30 x 29	125	73	12	\$1755

To join corner worksurface to desk or credenza. Full back panel.

PBBT6024NLR CG	24 x 60 x 29	125	145	24	\$3052
PBBT5424NLR CG	24 x 54 x 29	150	131	22	\$2745
PBBT4824NLR CG	24 x 48 x 29	125	116	19	\$2440
PBBT4224NLR CG	24 x 42 x 29	125	102	17	\$1977
PBBT3624NLR CG	24 x 36 x 29	150	87	15	\$1796
PBBT3024NLR CG	24 x 30 x 29	125	73	12	\$1755

To join corner worksurface to desk or credenza. Full back panel.

PBVL9624CG	24 x 96 x 29	150	200	39	\$5054
PBVL9024CG	24 x 90 x 29	150	187	36	\$4738
PBVL8424CG	24 x 84 x 29	150	174	34	\$4423
PBVL7824CG	24 x 78 x 29	150	162	31	\$4108
PBVL7224CG	24 x 72 x 29	150	149	29	\$3791
PBVL6624CG	24 x 66 x 29	150	141	27	\$3558
PBVL6024CG	24 x 60 x 29	150	132	24	\$3325
PBVL5424CG	24 x 54 x 29	150	121	22	\$3139
PBVL4824CG	24 x 48 x 29	125	115	19	\$2948
PBVL4224CG	24 x 42 x 29	150	99	17	\$2487
PBVL3624CG	24 x 36 x 29	150	83	15	\$2397
PBVL3024CG	24 x 30 x 29	125	77	12	\$2354
PBVL2424CG	24 x 24 x 29	125	61	10	\$1975

To be used with corner unit.

Required Specifications

Finish

Optional Specifications

Additional grommet

CORNERS AND COMPONENTS

MODEL# DIMENSIONS FREIGHT CLASS WT/LBS. CUBIC FT. LIST PRICE

D x W x H

PBVR9624CG	24 x 96 x 29	150	200	39	\$5054
PBVR9024CG	24 x 90 x 29	150	187	36	\$4738
PBVR8424CG	24 x 84 x 29	150	174	34	\$4423
PBVR7824CG	24 x 78 x 29	150	162	31	\$4108
PBVR7224CG	24 x 72 x 29	150	149	29	\$3791
PBVR6624CG	24 x 66 x 29	150	141	27	\$3558
PBVR6024CG	24 x 60 x 29	150	132	24	\$3325
PBVR5424CG	24 x 54 x 29	150	121	22	\$3139
PBVR4824CG	24 x 48 x 29	125	115	19	\$2948
PBVR4224CG	24 x 42 x 29	150	99	17	\$2487
PBVR3624CG	24 x 36 x 29	150	83	15	\$2397
PBVR3024CG	24 x 30 x 29	125	77	12	\$2354
PBVR2424CG	24 x 24 x 29	125	61	10	\$1975

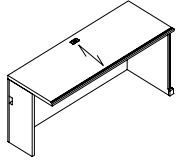

Linking Return - Right

To be used with corner unit.

PBVT9624	24 x 96 x 29	150	213	39	\$5164
PBVT9024	24 x 90 x 29	150	199	36	\$4841
PBVT8424	24 x 84 x 29	150	186	34	\$4519
PBVT7824	24 x 78 x 29	150	173	31	\$4190
PBVT7224	24 x 72 x 29	150	160	29	\$3874
PBVT6624	24 x 66 x 29	150	146	27	\$3641
PBVT6024	24 x 60 x 29	150	133	24	\$3413
PBVT5424	24 x 54 x 29	150	128	22	\$3221
PBVT4824	24 x 48 x 29	125	120	19	\$3033
PBVT4224	24 x 42 x 29	125	104	17	\$2566
PBVT3624	24 x 36 x 29	150	88	15	\$2481
PBVT3024	24 x 30 x 29	125	82	12	\$2433
PBVT2424	24 x 24 x 29	125	65	10	\$2046

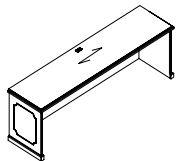

Freestanding Table

Full end panels.

PBV1212CT	12 x 12 x 1.3	150	5	1	\$1038
-----------	---------------	-----	---	---	---------------



Corner Filler Top

Required Specifications
Finish

Optional Specifications
Additional grommet

MODULAR STORAGE - NOTES

D x W x H

- All storage components are shipped assembled
- Components 28" high are intended for use with a desk, credenza or return shell
- Backs on 28" high pedestals and cabinets are unfinished. If finished back is required, see page 365.
- If a profiled top is required, please see "Freestanding Storage" section.

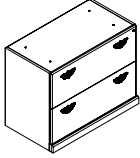
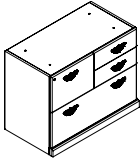
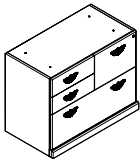
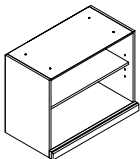
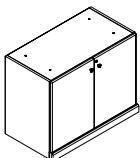
MODULAR STORAGE	MODEL#	DIMENSIONS	FREIGHT CLASS	WT/LBS.	CUBIC FT.	LIST PRICE
 <p>Modular Lateral File</p>	PBWF	19.1 x 35.1 x 28	92.5	115	11	\$4220
	PBWN	19.1 x 30 x 28	92.5	96	9	\$3694
 <p>Modular Combination Storage</p>	PBWZL	19.1 x 35.1 x 28	92.5	115	11	\$4148
	With 1 lateral file, 2 box drawers in the top right, and 1 file drawer in the top left.					
 <p>Modular Combination Storage</p>	PBWZR	19.1 x 35.1 x 28	92.5	115	11	\$4148
	With 1 lateral file, 2 box drawers in the top left, and 1 file drawer in the top right.					
 <p>Modular Open Storage</p>	PBWOB36	19.1 x 35.1 x 28	100	92	11	\$2083
	PBWOB30	19.1 x 30 x 28	100	77	9	\$1846
 <p>Modular Storage Cabinet w/Doors</p>	PBWG	19.1 x 35.1 x 28	92.5	115	11	\$2600
	PBWM	19.1 x 30 x 28	92.5	96	9	\$2305
Storage with 1 adjustable shelf.						

Required Specifications

Finish

MODULAR STORAGE **MODEL#** **DIMENSIONS** **FREIGHT CLASS** **WT./LBS.** **CUBIC FT.** **LIST PRICE**

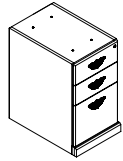

Box/Box/File Shell - Vertical

D x W x H

Letter width:

PBWWD	23 x 15.6 x 28	85	72	6	\$3257
PBWD	19 x 15.6 x 28	85	70	5	\$2834

Legal width:

PBWWLD	23 x 18.5 x 28	85	85	7	\$3908
PBWLD	19 x 18.5 x 28	85	83	6	\$3401

For use under a freestanding worksurface (22", 24", 30" or 36"D). Top drilled to attach to worksurface. **Two box and one file drawer.** One pencil tray. Lock secures all drawers.

- For 22" or 24"D worksurface, order or **PBWD or PBWLD**. For 30" or 36"D worksurface, order **PBWWD or PBWWLD**.
- **Unfinished top and back**

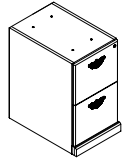

File/File Shell - Vertical

Letter width:

PBWWLE	23 x 15.6 x 28	85	72	6	\$3257
PBWE	19 x 15.6 x 28	85	70	5	\$2834

Legal width:

PBWWLE	23 x 18.5 x 28	85	85	7	\$3908
PBWLE	19 x 18.5 x 28	85	83	6	\$3401

For use under a freestanding worksurface (22", 24", 30" or 36"D). Top drilled to attach to worksurface. **Two file drawers.** Lock secures all drawers.

- For 22" or 24"D worksurface, order or **PBWE or PBWLE**. For 30" or 36"D worksurface, order **PBWWLE or PBWWLE**.
- **Unfinished top and back**

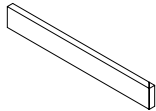

Decorative Base Trim - Left

PBAS-WL	1 x 19 x 2.5	70	1	0.01	\$319
PBAS-WWL	1 x 23 x 2.5	70	1	0.01	\$392

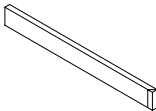

Decorative Base Trim - Right

PBAS-WR	1 x 19 x 2.5	70	1	0.01	\$319
PBAS-WWR	1 x 23 x 2.5	70	1	0.01	\$392

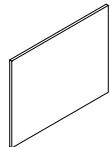

Finished Back

PBBA36	0.8 x 35 x 27.5	125	18	3	\$498
PBBA30	0.8 x 30 x 27.5	150	15	3	\$414
PBBA18	0.8 x 18.5 x 27.5	150	10	2	\$241
PBBA15	0.8 x 15.5 x 27.5	150	8	2	\$209

For modular pedestals.

Required Specifications

Finish

HUTCHES & WALL MOUNTED STORAGE NOTES

D x W x H

NOTE: Arrow indicates direction of grain

Hutches

- All hutches are shipped assembled
- Bronze glass door is standard. Clear glass is available, please contact customer care.

Closed pigeon hole storage hutch

- 42" unit has 21.5" of clearance
- Hutches longer than 102" have 8 doors, hutches between 102" and 84" have 6 doors, and hutches less than 84" have 4 doors.

Closed storage hutch

- 36" unit has 19.5" of clearance.
- 42" and 54" units have 25.5" of clearance
- Hutches longer than 102" have 8 doors, hutches between 102" and 84" have 6 doors, and hutches less than 84" have 4 doors.

Tasklight

- For proper size see page 345.

HUTCHES & WALL MOUNTED STORAGE	MODEL#	DIMENSIONS	FREIGHT CLASS	WT/LBS.	CUBIC FT.	LIST PRICE
<p>36" H Storage Hutch w/Wood Doors*</p>	PB108SH36	15 x 108 x 36	125	268	34	\$8123
	PB102SH36	15 x 102 x 36	125	254	32	\$7671
	PB96SH36	15 x 96 x 36	100	241	30	\$7216
	PB90SH36	15 x 90 x 36	100	227	28	\$6766
	PB84SH36	15 x 84 x 36	100	214	26	\$6317
	PB78SH36	15 x 78 x 36	100	200	24	\$5869
	PB72SH36	15 x 72 x 36	100	187	23	\$5415
	PB66SH36	15 x 66 x 36	100	173	21	\$5209
	PB60SH36	15 x 60 x 36	100	160	19	\$4967
	Hutches longer than 102" have 8 doors, hutches between 102" and 84" have 6 doors, and hutches less than 84" have 4 doors. Locks are optional.					
<p>36" H Storage Hutch w/Glass Doors</p>	PB108SH36G	15 x 108 x 36	125	268	34	\$11331
	PB102SH36G	15 x 102 x 36	125	254	32	\$10222
	PB96SH36G	15 x 96 x 36	100	241	30	\$9727
	PB90SH36G	15 x 90 x 36	100	227	28	\$9247
	PB84SH36G	15 x 84 x 36	100	214	26	\$8756
	PB78SH36G	15 x 78 x 36	100	200	24	\$8277
	PB72SH36G	15 x 72 x 36	100	187	23	\$7140
	PB66SH36G	15 x 66 x 36	100	173	21	\$6881
	PB60SH36G	15 x 60 x 36	100	160	19	\$6591
	Wood framed glass doors. Hutches longer than 102" have 8 doors, hutches between 102" and 84" have 6 doors, and hutches less than 84" have 4 doors. No lock option available.					
<p>36" H Storage Hutch w/Doors*</p>	PB102SH36GDG	15 x 102 x 36	125	254	32	\$9426
	PB96SH36GDG	15 x 96 x 36	100	241	30	\$8934
	PB90SH36GDG	15 x 90 x 36	100	227	28	\$8452
	PB84SH36GDG	15 x 84 x 36	100	214	26	\$7962
Wood doors in the center and wood framed glass doors on left and right. Locks are optional on wood doors.						

Required Specifications

Finish

Optional Specifications

Additional grommet
Locks* (wood doors only)

HUTCHES & WALL MOUNTED STORAGE

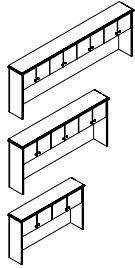

42" H Storage Hutch w/Wood Doors*

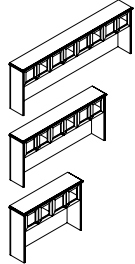

42" H Storage Hutch w/Glass Doors

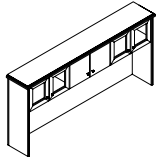

42" H Storage Hutch w/Doors*

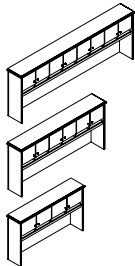

42" H Storage Hutch w/Wood Doors & Pigeon-Holes*

MODEL#	DIMENSIONS D x W x H	FREIGHT CLASS	WT/LBS.	CUBIC FT.	LIST PRICE
PB108SH42	15 x 108 x 42	125	307	39	\$9470
PB102SH42	15 x 102 x 42	125	290	37	\$8945
PB96SH42	15 x 96 x 42	125	273	35	\$8421
PB90SH42	15 x 90 x 42	125	256	33	\$7892
PB84SH42	15 x 84 x 42	125	239	31	\$7366
PB78SH42	15 x 78 x 42	150	222	38	\$6840
PB72SH42	15 x 72 x 42	125	205	26	\$6317
PB66SH42	15 x 66 x 42	125	188	24	\$6084
PB60SH42	15 x 60 x 42	125	171	22	\$5791

Hutches longer than 102" have 8 doors, hutches between 102" and 84" have 6 doors, and hutches less than 84" have 4 doors. Locks are optional.

PB108SH42G	15 x 108 x 42	125	307	39	\$12613
PB102SH42G	15 x 102 x 42	125	290	37	\$11496
PB96SH42G	15 x 96 x 42	125	273	35	\$10934
PB90SH42G	15 x 90 x 42	125	256	33	\$10367
PB84SH42G	15 x 84 x 42	125	239	31	\$9809
PB78SH42G	15 x 78 x 42	150	222	38	\$9251
PB72SH42G	15 x 72 x 42	125	205	26	\$8040
PB66SH42G	15 x 66 x 42	125	188	24	\$7754
PB60SH42G	15 x 60 x 42	125	171	22	\$7413

Wood framed glass doors. Hutches longer than 102" have 8 doors, hutches between 102" and 84" have 6 doors, and hutches less than 84" have 4 doors. No lock option available.

PB102SH42GDG	15 x 102 x 42	125	290	37	\$10701
PB96SH42GDG	15 x 96 x 42	125	273	35	\$10137
PB90SH42GDG	15 x 90 x 42	125	256	33	\$9575
PB84SH42GDG	15 x 84 x 42	125	239	31	\$9015

Wood doors in the center and wood framed glass doors on left and right. Locks are optional on wood doors.

PB108SHP42	15 x 108 x 42	125	307	39	\$11361
PB102SHP42	15 x 102 x 42	125	290	37	\$10734
PB96SHP42	15 x 96 x 42	125	273	35	\$10104
PB90SHP42	15 x 90 x 42	125	256	33	\$9470
PB84SHP42	15 x 84 x 42	125	239	31	\$8836
PB78SHP42	15 x 78 x 42	150	222	38	\$8210
PB72SHP42	15 x 72 x 42	125	205	26	\$7582
PB66SHP42	15 x 66 x 42	125	241	31	\$6704
PB60SHP42	15 x 60 x 42	125	171	22	\$6947

Hutches longer than 102" have 8 doors, hutches between 102" and 84" have 6 doors, and hutches less than 84" have 4 doors. Locks are optional.

Required Specifications
Finish

Optional Specifications
Additional grommet
Locks* (wood doors only)

HUTCHES & WALL MOUNTED STORAGE

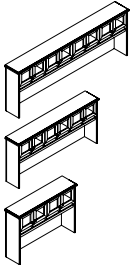

42" H Storage Hutch w/Glass Doors & Pigeon-Holes

MODEL#	DIMENSIONS D x W x H	FREIGHT CLASS	WT/LBS.	CUBIC FT.	LIST PRICE
PB108SHP42G	15 x 108 x 42	125	307	39	\$14497
PB102SHP42G	15 x 102 x 42	125	290	37	\$13217
PB96SHP42G	15 x 96 x 42	125	273	35	\$12587
PB90SHP42G	15 x 90 x 42	125	256	33	\$11911
PB84SHP42G	15 x 84 x 42	125		31	
PB78SHP42G	15 x 78 x 42	150	222	38	\$10553
PB72SHP42G	15 x 72 x 42	125	205	26	\$9261
PB66SHP42G	15 x 66 x 42	125	188	24	\$8956
PB60SHP42G	15 x 60 x 42	125	171	22	\$8522

Wood framed glass doors. Hutches longer than 102" have 8 doors, hutches between 102" and 84" have 6 doors, and hutches less than 84" have 4 doors. No lock option available.

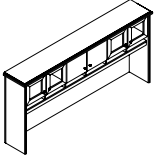

42" H Storage Hutch w/Doors & Pigeon-Holes

PB102SHP42GDG	15 x 102 x 42	125	290	37	\$12423
PB96SHP42GDG	15 x 96 x 42	125	273	35	\$11789
PB90SHP42GDG	15 x 90 x 42	125	256	33	\$11117
PB84SHP42GDG	15 x 84 x 42	125	239	31	\$10410

Wood doors in the center and wood framed glass doors on left and right. Locks are optional on wood doors.

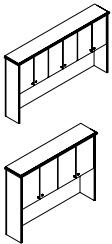

54" H Storage Hutch w/Wood Doors

PB962SH54	15 x 96 x 55	125	351	45	\$10819
PB902SH54	15 x 90 x 55	125	329	42	\$10146
PB842SH54	15 x 84 x 55	125	309	39	\$9470
PB782SH54	15 x 78 x 55	125	285	37	\$8794
PB722SH54	15 x 72 x 55	125	263	34	\$8122
PB662SH54	15 x 66 x 55	125	241	31	\$7818
PB602SH54	15 x 60 x 55	125	219	28	\$7440

Hutches between 96" and 84" have 6 doors; hutches less than 84" have 4 doors. One adjustable shelf. Locks are optional.

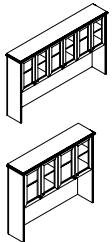

54" H Storage Hutch w/Glass Doors

PB962SH54G	15 x 96 x 55	125	351	45	\$13967
PB902SH54G	15 x 90 x 55	125	329	42	\$13019
PB842SH54G	15 x 84 x 55	125	307	39	\$12063
PB782SH54G	15 x 78 x 55	125	285	37	\$11113
PB722SH54G	15 x 72 x 55	125	263	34	\$10165
PB662SH54G	15 x 66 x 55	125	241	31	\$9794
PB602SH54G	15 x 60 x 55	125	219	28	\$9352

Wood framed glass doors. Hutches between 96" and 84" have 6 doors; hutches less than 84" have 4 doors. One adjustable shelf. No lock option available.

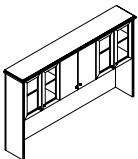

54" H Storage Hutch w/Doors

PB962SH54GDG	15 x 96 x 55	125	351	45	\$12974
PB902SH54GDG	15 x 90 x 55	125	329	42	\$12029
PB842SH54GDG	15 x 84 x 55	125	307	39	\$11070

Wood doors in the center and wood framed glass doors on left and right. One adjustable shelf. Locks are optional on wood doors.

Required Specifications

Finish

Optional Specifications

Locks* (wood doors only)

HUTCHES & WALL MOUNTED STORAGE

MODEL# DIMENSIONS FREIGHT CLASS WT/LBS. CUBIC FT. LIST PRICE

D x W x H

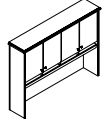
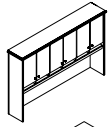

54" H Storage Hutch w/Wood Doors & Pigeon-Holes

PB962SHP54	15 x 96 x 55	125	351	45	\$12988
PB902SHP54	15 x 90 x 55	125	329	42	\$12178
PB842SHP54	15 x 84 x 55	125	307	39	\$11361
PB782SHP54	15 x 78 x 55	125	285	37	\$10553
PB722SHP54	15 x 72 x 55	125	263	34	\$9741
PB662SHP54	15 x 66 x 55	125	241	31	\$9379
PB602SHP54	15 x 60 x 55	125	219	28	\$8926

Hutches between 96" and 84" have 6 doors; hutches less than 84" have 4 doors. One adjustable shelf. Locks are optional.

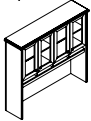
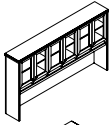

54" H Storage Hutch w/Glass Doors & Pigeon-Holes

PB962SHP54	15 x 96 x 55	125	351	45	\$12988
PB902SHP54	15 x 90 x 55	125	329	42	\$12178
PB842SHP54	15 x 84 x 55	125	307	39	\$11361
PB782SHP54	15 x 78 x 55	125	285	37	\$10553
PB722SHP54	15 x 72 x 55	125	263	34	\$9741
PB662SHP54	15 x 66 x 55	125	241	31	\$9379
PB602SHP54	15 x 60 x 55	125	219	28	\$8926

Wood framed glass doors. Hutches between 96" and 84" have 6 doors; hutches less than 84" have 4 doors. One adjustable shelf. No lock option available.

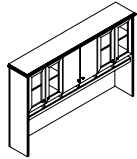

54" H Storage Hutch w/Doors & Pigeon-Holes

PB962SHP54GDG	15 x 96 x 55	125	351	45	\$15143
PB902SHP54GDG	15 x 90 x 55	125	329	42	\$14331
PB842SHP54GDG	15 x 84 x 55	125	307	39	\$13159

Wood doors in the center and wood framed glass doors on left and right. One adjustable shelf. Locks are optional on wood doors.

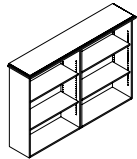

Open Hutch

PB720B54	15 x 72 x 55	125	260	35	\$7450
PB360B54	15 x 36.75 x 55	125	130	18	\$3735

Four adjustable shelves.

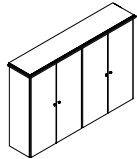

Hutch w/Wood Doors

PB72BD54	15 x 72 x 55	100	320	35	\$9594
PB36BD54	15 x 36.75 x 55	100	160	18	\$4806

Four adjustable shelves. Locks are optional.

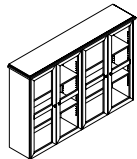

Hutch w/Glass Doors

PB72BG54	15 x 72 x 55	100	320	35	\$10877
PB36BG54	15 x 36.75 x 55	100	160	18	\$5442

Wood framed glass doors. Four adjustable shelves. No lock option available.

Required Specifications

Finish

Optional Specifications

Additional grommet
Locks* (wood doors only)

HUTCHES & WALL MOUNTED STORAGE

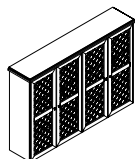

Hutch w/Wire Mesh Doors

MODEL#	DIMENSIONS D x W x H	FREIGHT CLASS	WT./LBS.	CUBIC FT.	LIST PRICE
PB72BW54	15 x 72 x 55	100	320	35	\$12164
PB36BW54	15 x 36.75 x 55	100	160	18	\$6241

Antique Brass wire mesh wood framed doors. Four adjustable shelves. No lock option available.

FREESTANDING STORAGE NOTES

NOTE: Arrow indicates direction of grain

Pedestals

- All units are shipped assembled.
- Standard face locking.

Combination Storage

- All units are shipped assembled.
- No modifications accepted for this unit.
- Box drawers do not lock.
- Standard face locking.

Storage Cabinets

- All units are shipped assembled.
- Units include adjustable shelves.
- Standard face locking.

TV Cabinets

- All units are shipped assembled.
- Units include 170° hinges, grommet on fixed shelf and adjustable shelf in lower cabinet.
- Standard face locking for lower cabinet.
- To add lock for upper cabinet, specify "LO".

FREESTANDING STORAGE

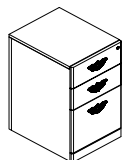

Freestanding Pedestal

MODEL#	DIMENSIONS D x W x H	FREIGHT CLASS	WT./LBS.	CUBIC FT.	LIST PRICE
PBWDB	19.8 x 15.5 x 28	85	70	5	\$2877
PBWWDB	23.8 x 15.5 x 28	85	75	6	\$3314

Box/box/file.

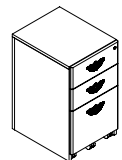

Freestanding Mobile Pedestal

PBWDM	19.8 x 15.5 x 28	85	70	5	\$3095
PBWWDM	23.8 x 15.5 x 28	85	75	6	\$3557

Box/box/file.

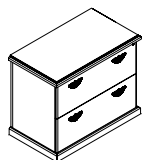

Lateral File - 2 high

PBF3624	24 x 36.75 x 29	85	184	15	\$5325
PBF3620	20 x 36.75 x 29	85	159	12	\$4429
PBN3024	24 x 31.63 x 29	85	153	12	\$4660
PBN3020	20 x 31.63 x 29	85	131	10	\$3875

Two lateral file drawers.

Required Specifications
Finish

Optional Specifications
Additional grommet

FREESTANDING STORAGE

MODEL# DIMENSIONS FREIGHT CLASS WT/LBS. CUBIC FT. LIST PRICE

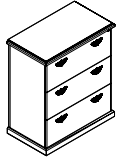

Lateral File - 3 high

	D x W x H				
PBF36243	24 x 36.75 x 42	92.5	231	21	\$6510
PBF36203	20 x 36.75 x 42	92.5	193	18	\$5557
PBN30243	24 x 31.63 x 42	92.5	193	18	\$5691
PBN30203	20 x 31.63 x 42	92.5	160	15	\$4861

Three lateral file drawers.

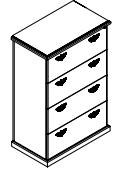

Lateral File - 4 high

PBF36244	24 x 36.75 x 54	92.5	297	27	\$7927
PBF36204	20 x 36.75 x 54	92.5	259	23	\$6885
PBN30244	24 x 31.63 x 54	92.5	248	23	\$6932
PBN30204	20 x 31.63 x 54	92.5	214	19	\$6024

Four lateral file drawers.

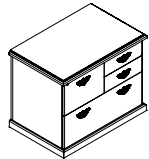

Combination Storage - Left

PBZL3624	24 x 36.75 x 29	85	184	15	\$5771
PBZL3620	20 x 36.75 x 29	85	160	12	\$4660

With 1 lateral file, 2 box drawers in the top right, and 1 file drawer in the top left.

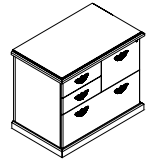

Combination Storage - Right

PBZR3624	24 x 36.75 x 29	85	184	15	\$5771
PBZR3620	20 x 36.75 x 29	85	160	12	\$4660

With 1 lateral file, 2 box drawers in the top left, and 1 file drawer in the top right.

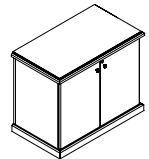

Storage Cabinet w/Doors

PBBD3624	24 x 36.75 x 29	92.5	152	15	\$3627
PBBD3620	20 x 36.75 x 29	92.5	129	12	\$3159
PBBD3024	24 x 31.63 x 29	92.5	127	12	\$3175
PBBD3020	20 x 31.63 x 29	92.5	106	10	\$2761

Storage with 1 adjustable shelf.

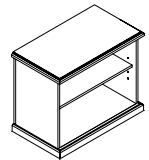

Open Storage Cabinet

PBOB3624	24 x 36.75 x 29	100	123	15	\$2910
PBOB3620	20 x 36.75 x 29	100	104	12	\$2535
PBOB3024	24 x 31.63 x 29	100	103	12	\$2541
PBOB3020	20 x 31.63 x 29	100	85	10	\$2210

Storage with 1 adjustable shelf.

Required Specifications

Finish

Optional Specifications

Additional grommet

FREESTANDING STORAGE

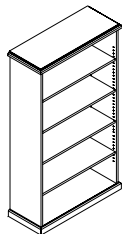

Open Bookcase

MODEL#	DIMENSIONS D x W x H	FREIGHT CLASS	WT/LBS.	CUBIC FT.	LIST PRICE
PBB83615	15 x 36.75 x 84	100	246	26	\$4459
PBB73615	15 x 36.75 x 78	100	228	24	\$4140
PBB63615	15 x 36.75 x 72	100	210	23	\$3822
PBB53615	15 x 36.75 x 65	100	188	21	\$3517
PBB43615	15 x 36.75 x 48	100	140	15	\$2897
PBB23615	15 x 36.75 x 29	92.5	90	8	\$2322
PBB83015	15 x 31.63 x 84	92.5	246	22	\$3897
PBB73015	15 x 31.63 x 78	92.5	228	20	\$3619
PBB63015	15 x 31.63 x 72	92.5	210	19	\$3344
PBB53015	15 x 31.63 x 65	92.5	188	17	\$3087
PBB43015	15 x 31.63 x 48	92.5	140	13	\$2535
PBB23015	15 x 31.63 x 29	92.5	90	8	\$2034

84" and 78" high models have 6 adjustable shelves, 72" has 5 adjustable shelves, 65" has 4 adjustable shelves, 48" has 3 adjustable shelves, 29" has 1 adjustable shelves.

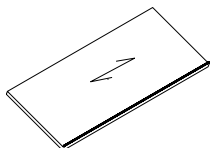

Additional Shelf

PBAG3624	24 x 36 x 1	92.5	112	10	\$240
PBAG3622	22 x 36 x 1	92.5	104	10	\$218
PBAG3620	20 x 36 x 1	92.5	92	9	\$196
PBAG3615	15 x 36 x 1	92.5	81	8	\$173
PBAG3024	24 x 30 x 1	92.5	94	9	\$202
PBAG3022	22 x 30 x 1	100	87	9	\$184
PBAG3020	20 x 30 x 1	100	76	8	\$162
PBAG3015	15 x 30 x 1	100	67	8	\$143

For use with open bookcase. Can be specified for each shelf in an open bookcase.

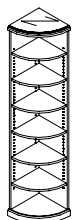

Quarter Round Open Bookcase

PB8R1515	15 x 15 x 84	125	142	22	\$3510
PB7R1515	15 x 15 x 78	100	95	10	\$3260
PB6R1515	15 x 15 x 72	100	83	9	\$3009
PB5R1515	15 x 15 x 65	100	81	9	\$2774
PB4R1515	15 x 15 x 48	100	59	6	\$2282
PB2R1515	15 x 15 x 29	100	37	4	\$1831

84" and 78" high models have 6 adjustable shelves, 72" has 5 adjustable shelves, 65" has 4 adjustable shelves, 48" has 3 adjustable shelves, 29" has 1 adjustable shelf.

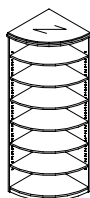

Quarter Round Open Bookcase

PBB7R2424H84	24 x 24 x 84	100	234	28	\$6126
PBB7R2424H72	24 x 24 x 72	125	204	28	\$5254
PBB7R2424H65	24 x 24 x 65	100	187	22	\$4819
PBB7R2020H84	20 x 20 x 84	100	163	19	\$5354
PBB7R2020H72	20 x 20 x 72	100	142	17	\$4587
PBB7R2020H65	20 x 20 x 65	100	130	15	\$4302

84" high models have 6 adjustable shelves, 72" has 5 adjustable shelves, and 65" has 4 adjustable shelves

Required Specifications

Finish

FREESTANDING STORAGE

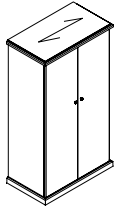

Storage Cabinet w/Wood Doors

MODEL# DIMENSIONS FREIGHT CLASS WT/LBS. CUBIC FT. LIST PRICE

D x W x H

PB1D24W36H84	24 x 36.75 x 84	125	304	42	\$8510
PB1D24W36H72	24 x 36.75 x 72	100	283	33	\$7294
PB1D24W36H65	24 x 36.75 x 65	100	259	30	\$6684
PB1D24W30H84	24 x 30.63 x 84	125	304	42	\$7435
PB1D24W30H72	24 x 30.63 x 72	100	283	33	\$6372
PB1D24W30H65	24 x 30.63 x 65	100	259	30	\$5853
PB1D24W24H84	24 x 24 x 84	92.5	320	28	\$6352
PB1D24W24H72	24 x 24 x 72	92.5	255	24	\$5446
PB1D24W24H65	24 x 24 x 65	125	173	22	\$5019
PB1D20W36H84	20 x 36.75 x 84	100	297	35	\$7435
PB1D20W36H72	20 x 36.75 x 72	100	269	30	\$6372
PB1D20W36H65	20 x 36.75 x 65	100	245	28	\$5842
PB1D20W30H84	20 x 30.63 x 84	100	257	29	\$6195
PB1D20W30H72	20 x 30.63 x 72	100	233	25	\$5312
PB1D20W30H65	20 x 30.63 x 65	100	202	23	\$4869
PB1D20W24H84	20 x 24 x 84	100	198	23	\$4959
PB1D20W24H72	20 x 24 x 72	100	179	20	\$4250
PB1D20W24H65	20 x 24 x 65	100	163	18	\$3889

84" high models have 6 adjustable shelves, 72" has 5 adjustable shelves, 65" has 4 adjustable shelves. For wood framed glass door option, please contact customer care. Lock is optional.

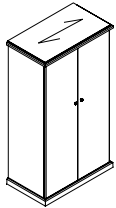

Wardrobe Cabinet

PB2D24W36H84	24 x 36.75 x 84	100	356	42	\$7384
PB2D24W36H72	24 x 36.75 x 72	100	324	36	\$6332
PB2D24W36H65	24 x 36.75 x 65	100	297	33	\$5804
PB2D24W30H84	24 x 30.63 x 84	100	296	35	\$6465
PB2D24W30H72	24 x 30.63 x 72	100	270	30	\$5541
PB2D24W30H65	24 x 30.63 x 65	100	248	28	\$5078
PB2D24W24H84	24 x 24 x 84	100	238	28	\$5541
PB2D24W24H72	24 x 24 x 72	100	216	24	\$4749
PB2D24W24H65	24 x 24 x 65	100	198	22	\$4353
PB2D20W36H84	20 x 36.75 x 84	100	297	35	\$6448
PB2D20W36H72	20 x 36.75 x 72	100	269	30	\$5517
PB2D20W36H65	20 x 36.75 x 65	100	245	28	\$5054
PB2D20W30H84	20 x 30.63 x 84	100	257	29	\$5376
PB2D20W30H72	20 x 30.63 x 72	100	233	25	\$4599
PB2D20W30H65	20 x 30.63 x 65	100	202	23	\$4216
PB2D20W24H84	20 x 24 x 84	100	198	23	\$4297
PB2D20W24H72	20 x 24 x 72	100	179	20	\$3675
PB2D20W24H65	20 x 24 x 65	100	163	18	\$3372

Doors, coat rack and hat shelf. 84" high models have 6 adjustable shelves, 72" has 5 adjustable shelves, 65" has 4 adjustable shelves. For wood framed glass door option, please contact customer care. Lock is optional.

Required Specifications

Finish

Optional Specifications

Lock

FREESTANDING STORAGE

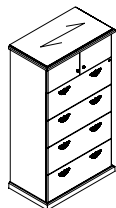

Storage Cupboard*

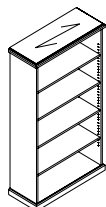

Open Bookcase

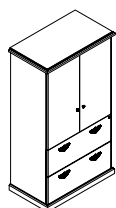

Storage Cabinet w/Doors*

MODEL#	DIMENSIONS D x W x H	FREIGHT CLASS	WT/LBS.	CUBIC FT.	LIST PRICE
PB6D24W36H84	24 x 36.75 x 84	92.5	449	42	\$12441
PB6D24W36H72	24 x 36.75 x 72	92.5	414	36	\$10666
PB6D24W36H65	24 x 36.75 x 65	92.5	380	33	\$9778
PB6D24W30H84	24 x 30.63 x 84	92.5	375	35	\$10891
PB6D24W30H72	24 x 30.63 x 72	92.5	345	30	\$9336
PB6D24W30H65	24 x 30.63 x 65	92.5	316	28	\$8557
PB6D20W36H84	20 x 36.75 x 84	92.5	382	35	\$10863
PB6D20W36H72	20 x 36.75 x 72	92.5	351	30	\$9294
PB6D20W36H65	20 x 36.75 x 65	92.5	321	28	\$8515
PB6D20W30H84	20 x 30.63 x 84	92.5	347	29	\$9053
PB6D20W30H72	20 x 30.63 x 72	85	306	25	\$7747
PB6D20W30H65	20 x 30.63 x 65	92.5	265	23	\$7102

Above lateral file cabinet with 4 drawers. 84" high model has 1 adjustable shelf. For wood framed glass door option, please contact customer care. Optional lock available for upper storage.

PB7D24W36H84	24 x 36.75 x 84	125	331	43	\$6812
PB7D24W36H72	24 x 36.75 x 72	100	306	36	\$5842
PB7D24W36H65	24 x 36.75 x 65	100	281	33	\$5354
PB7D24W30H84	24 x 30.63 x 84	125	280	36	\$5961
PB7D24W30H72	24 x 30.63 x 72	100	255	30	\$5097
PB7D24W30H65	24 x 30.63 x 65	100	234	28	\$4677
PB7D20W36H84	20 x 36.75 x 84	100	282	35	\$5947
PB7D20W36H72	20 x 36.75 x 72	100	257	30	\$5097
PB7D20W36H65	20 x 36.75 x 65	100	234	28	\$4677
PB7D20W30H84	20 x 30.63 x 84	100	248	29	\$4954
PB7D20W30H72	20 x 30.63 x 72	100	223	25	\$4248
PB7D20W30H65	20 x 30.63 x 65	100	193	23	\$3892

84" high models have 6 adjustable shelves, 72" has 5 adjustable shelves, and 65" has 4 adjustable shelves.

PB13D24W36H84	24 x 36.75 x 84	100	407	42	\$10532
PB13D24W36H72	24 x 36.75 x 72	92.5	387	36	\$9029
PB13D24W36H65	24 x 36.75 x 65	92.5	347	33	\$8278
PB13D24W30H84	24 x 30.63 x 84	92.5	350	35	\$9217
PB13D24W30H72	24 x 30.63 x 72	92.5	315	30	\$7900
PB13D24W30H65	24 x 30.63 x 65	92.5	289	28	\$7240
PB13D20W36H84	20 x 36.75 x 84	92.5	365	35	\$9194
PB13D20W36H72	20 x 36.75 x 72	92.5	327	30	\$7866
PB13D20W36H65	20 x 36.75 x 65	92.5	299	28	\$7211
PB13D20W30H84	20 x 30.63 x 84	92.5	305	29	\$7665
PB13D20W30H72	20 x 30.63 x 72	92.5	285	25	\$6558
PB13D20W30H65	20 x 30.63 x 65	92.5	247	23	\$6008

Above two lateral file drawers. 84" high models have 3 adjustable shelves, 72" has 2 adjustable shelves, and 65" has 1 adjustable shelf. For wood framed glass door option, please contact customer care. Optional lock available for upper storage.

Required Specifications

Finish

Optional Specifications

Additional grommet

Lock*

FREESTANDING STORAGE

MODEL# DIMENSIONS FREIGHT CLASS WT/LBS. CUBIC FT. LIST PRICE

D x W x H

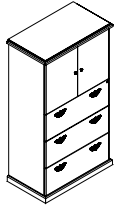

Storage Cabinet w/Doors

PB14D24W36H84	24 x 36.75 x 84	100	390	42	\$11324
PB14D24W36H72	24 x 36.75 x 72	92.5	360	36	\$9707
PB14D24W36H65	24 x 36.75 x 65	92.5	330	33	\$8896
PB14D24W30H84	24 x 30.63 x 84	100	325	35	\$9910
PB14D24W30H72	24 x 30.63 x 72	92.5	300	30	\$8382
PB14D24W30H65	24 x 30.63 x 65	100	275	28	\$7787

PB14D20W36H84	20 x 36.75 x 84	100	330	35	\$9885
PB14D20W36H72	20 x 36.75 x 72	92.5	305	30	\$8457
PB14D20W36H65	20 x 36.75 x 65	100	278	28	\$7754
PB14D20W30H84	20 x 30.63 x 84	92.5	298	29	\$8238
PB14D20W30H72	20 x 30.63 x 72	92.5	265	25	\$7047
PB14D20W30H65	20 x 30.63 x 65	100	229	23	\$6462

Above three lateral file drawers. 84" high models have 2 adjustable shelves, 72" and 65" have 1 adjustable shelf. For wood framed glass door option, please contact customer care. Optional lock available for upper storage.

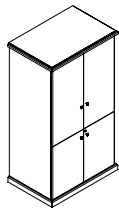

Closed Storage Cabinet

PB23D24W36H84	24 x 36.75 x 84	100	390	42	\$9089
PB23D24W36H72	24 x 36.75 x 72	92.5	360	36	\$7790
PB23D24W36H65	24 x 36.75 x 65	92.5	330	33	\$7140
PB23D24W30H84	24 x 30.63 x 84	100	325	35	\$7550
PB23D24W30H72	24 x 30.63 x 72	92.5	300	30	\$6475
PB23D24W30H65	24 x 30.63 x 65	100	275	28	\$5950

PB23D20W36H84	20 x 36.75 x 84	100	330	35	\$7934
PB23D20W36H72	20 x 36.75 x 72	92.5	305	30	\$6791
PB23D20W36H65	20 x 36.75 x 65	100	278	28	\$6220
PB23D20W30H84	20 x 30.63 x 84	92.5	298	29	\$6611
PB23D20W30H72	20 x 30.63 x 72	92.5	265	25	\$5655
PB23D20W30H65	20 x 30.63 x 65	100	229	23	\$5186

With upper and lower split doors. 1 fixed shelf and 2 adjustable shelves. For wood framed glass door option, please contact customer care. Optional lock available for upper storage.

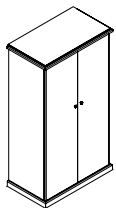

Cabinet w/Doors and Storage

PB25D24W36H84	24 x 36.75 x 84	100	390	42	\$9548
PB25D24W36H72	24 x 36.75 x 72	92.5	360	36	\$8182
PB25D24W36H65	24 x 36.75 x 65	92.5	330	33	\$7500
PB25D24W30H84	24 x 30.63 x 84	100	325	35	\$8352
PB25D24W30H72	24 x 30.63 x 72	92.5	300	30	\$7156
PB25D24W30H65	24 x 30.63 x 65	100	275	28	\$6565
PB25D24W24H84	24 x 24 x 84	100	260	28	\$7150
PB25D24W24H72	24 x 24 x 72	92.5	240	24	\$6126
PB25D24W24H65	24 x 24 x 65	92.5	220	22	\$5624

PB25D20W36H84	20 x 36.75 x 84	100	330	35	\$8330
PB25D20W36H72	20 x 36.75 x 72	92.5	305	30	\$7127
PB25D20W36H65	20 x 36.75 x 65	100	278	28	\$6528
PB25D20W30H84	20 x 30.63 x 84	92.5	300	29	\$6944
PB25D20W30H72	20 x 30.63 x 72	92.5	265	25	\$5938
PB25D20W30H65	20 x 30.63 x 65	100	229	23	\$5444
PB25D20W24H84	20 x 24 x 84	92.5	235	23	\$5559
PB25D20W24H72	20 x 24 x 72	92.5	203	20	\$4757
PB25D20W24H65	20 x 24 x 65	92.5	185	18	\$4362

Wardrobe with coat rack and hat shelf on left. Storage with adjustable shelves on right. 84" high models have 5 adjustable shelves, 72" and 65" have 4 adjustable shelves. For wood framed glass door option, please contact customer care. Lock is optional.

Required Specifications

Finish

Optional Specifications

Additional grommet
Lock

RECEPTION DESKS

MODEL#

DIMENSIONS

FREIGHT CLASS

WT./LBS.

CUBIC FT.

LIST PRICE

D x W x H

- To add storage use modular components. See page 364.
- Includes GM5 grommet.
- Transaction tops to be specified separately, handed by square edge from user side.

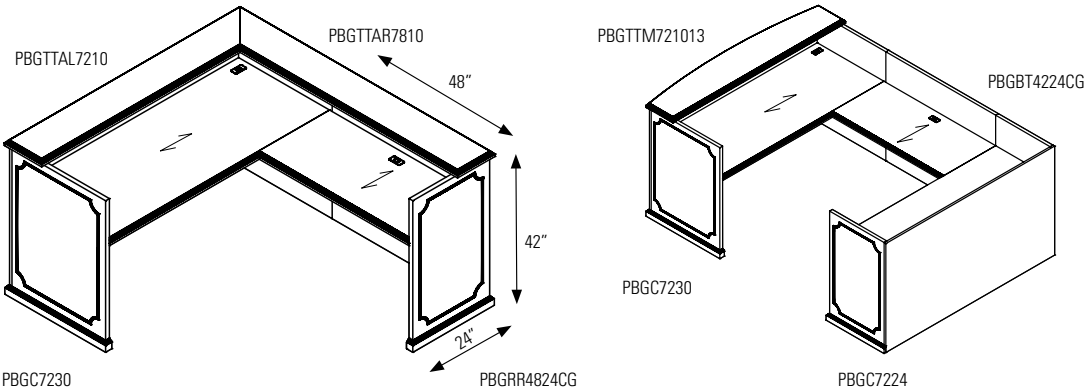

RECEPTION DESKS

MODEL#

DIMENSIONS

FREIGHT CLASS

WT./LBS.

CUBIC FT.

LIST PRICE

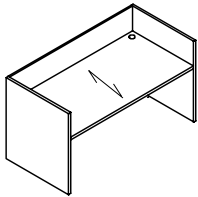

Gallery/Reception Desk Shell*

PBGC12036	36 x 120 x 42	150	592	105	\$13070
PBGC10836	36 x 108 x 42	150	533	95	\$11762
PBGC10236	36 x 102 x 42	150	503	89	\$11110
PBGC9636	36 x 96 x 42	150	473	84	\$10453
PBGC9036	36 x 90 x 42	150	444	79	\$9804
PBGC8436	36 x 84 x 42	150	414	74	\$9146
PBGC7236	36 x 72 x 42	150	355	63	\$7847
PBGC7230	30 x 72 x 42	150	315	53	\$7588
PBGC6630	30 x 66 x 42	125	295	48	\$7399
PBGC6030	30 x 60 x 42	125	275	44	\$6978

No pedestals. Two grommets in worksurface. For use with modular storage components. Pin molding included.

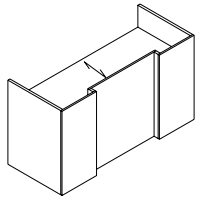

**Gallery/Reception Desk Shell
Breakfront Style**

PBGIC12036	36 x 120 x 42	150	592	105	\$14375
PBGIC10836	36 x 108 x 42	150	533	95	\$12935
PBGIC10236	36 x 102 x 42	150	503	89	\$12219
PBGIC9636	36 x 96 x 42	150	473	84	\$11498
PBGIC9036	36 x 90 x 42	150	444	79	\$10785
PBGIC8436	36 x 84 x 42	150	414	74	\$10060
PBGIC7236	36 x 72 x 42	150	355	63	\$8626
PBGIC7230	30 x 72 x 42	150	315	53	\$8348
PBGIC6630	30 x 66 x 42	125	295	48	\$8138
PBGIC6030	30 x 60 x 42	125	275	44	\$7676

No pedestals. Two grommets in worksurface. For use with modular storage components. Pin molding included.

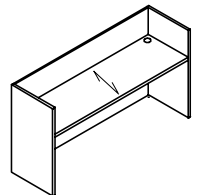

Gallery/Reception Credenza Shell*

PBGC12024	24 x 120 x 42	150	392	70	\$10253
PBGC10824	24 x 108 x 42	150	353	63	\$9217
PBGC10224	24 x 102 x 42	150	333	60	\$8709
PBGC9624	24 x 96 x 42	150	314	56	\$8194
PBGC9024	24 x 90 x 42	150	294	53	\$7682
PBGC8424	24 x 84 x 42	150	274	49	\$7173
PBGC7224	24 x 72 x 42	150	235	42	\$6150
PBGC6624	24 x 66 x 42	150	216	39	\$5778
PBGC6024	24 x 60 x 42	150	196	35	\$5414

No pedestals. Two grommets in worksurface. For use with modular storage components. Pin molding included.

Required Specifications

Finish

Optional Specifications

Additional grommet

RECEPTION DESKS

MODEL# DIMENSIONS FREIGHT CLASS WT/LBS. CUBIC FT. LIST PRICE

D x W x H

PBGBT5624CG	24 x 56 x 42	150	178	32	\$5520
PBGBT5424CG	24 x 54 x 42	150	169	29	\$5520
PBGBT5024CG	24 x 50 x 42	150	151	27	\$4906
PBGBT4824CG	24 x 48 x 42	150	142	26	\$4906
PBGBT4424CG	24 x 44 x 42	150	134	23	\$4291
PBGBT4224CG	24 x 42 x 42	150	127	22	\$4291
PBGBT3824CG	24 x 38 x 42	150	119	20	\$3865
PBGBT3624CG	24 x 36 x 42	150	112	19	\$3865

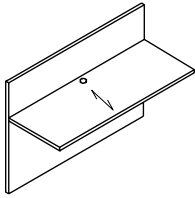

Bridge

Attaches between **Gallery Desk and Gallery Credenza Only**. One grommet in center of worksurface. Shipped RTA (ready to assemble). Pin molding included.

- To remove cross-grain veneer pattern on top, **delete "CG"** from model number. Available as a special - no upcharge.

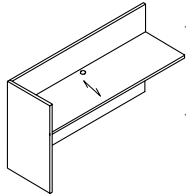

Reception Return - LEFT

PBGRL7224CG	24 x 72 x 42	125	273	42	\$7739
PBGRL6624CG	24 x 66 x 42	125	250	39	\$7098
PBGRL6024CG	24 x 60 x 42	125	228	35	\$6454
PBGRL5424CG	24 x 54 x 42	125	205	32	\$5813
PBGRL4824CG	24 x 48 x 42	125	182	28	\$5159
PBGRL4224CG	24 x 42 x 42	125	159	25	\$4519
PBGRL3624CG	24 x 36 x 42	125	137	21	\$4066

No pedestal. One grommet in center of worksurface. For use with modular storage components. Pin molding included.

- To remove cross-grain veneer pattern on top, **delete "CG"** from model number. Available as a special - no upcharge.

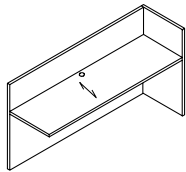

Reception Return - RIGHT

PBGRR7224CG	24 x 72 x 42	125	273	42	\$7739
PBGRR6624CG	24 x 66 x 42	125	250	39	\$7098
PBGRR6024CG	24 x 60 x 42	125	228	35	\$6454
PBGRR5424CG	24 x 54 x 42	125	205	32	\$5813
PBGRR4824CG	24 x 48 x 42	125	182	28	\$5159
PBGRR4224CG	24 x 42 x 42	125	159	25	\$4519
PBGRR3624CG	24 x 36 x 42	125	137	21	\$4066

No pedestal. One grommet in center of worksurface. For use with modular storage components. Pin molding included.

- To remove cross-grain veneer pattern on top, **delete "CG"** from model number. Available as a special - no upcharge.

Required Specifications

Finish

Optional Specifications

Additional grommet

TRANSACTION COUNTERS

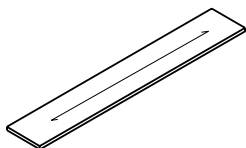

Transaction Counter Top

MODEL#	DIMENSIONS D x W x H	FREIGHT CLASS	WT/LBS.	CUBIC FT.	LIST PRICE
PBGTT12010	10 x 120 x 1.50	92.5	84	8	\$2189
PBGTT10810	10 x 108 x 1.50	100	78	8	\$1973
PBGTT10210	10 x 102 x 1.50	92.5	72	7	\$1865
PBGTT9610	10 x 96 x 1.50	100	66	7	\$1756
PBGTT9010	10 x 90 x 1.50	92.5	60	6	\$1644
PBGTT8410	10 x 84 x 1.50	100	54	6	\$1530
PBGTT7210	10 x 72 x 1.50	100	48	5	\$1313
PBGTT6610	10 x 66 x 1.50	100	42	5	\$1204
PBGTT6010	10 x 60 x 1.50	100	36	4	\$1097

Rectangular top for main reception desk. Counter sits on top of Gallery panels. Does not overhang. **Factory installed - specify Gallery to be used on.** Size must match dimension of desk front or combined desk side and return length. Hardware included.

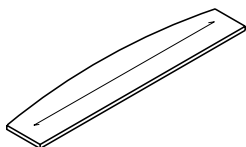

Bow Front Transaction Counter Top

PBGTTM1081013	10-13 x 108 x 1.50	125	78	10	\$2948
PBGTTM1021013	10-13 x 102 x 1.50	100	72	9	\$2840
PBGTTM961013	10-13 x 96 x 1.50	125	66	9	\$2733
PBGTTM901013	10-13 x 90 x 1.50	125	60	8	\$2621
PBGTTM841013	10-13 x 84 x 1.50	125	54	8	\$2505
PBGTTM721013	10-13 x 72 x 1.50	125	48	7	\$2290
PBGTTM661013	10-13 x 66 x 1.50	125	42	6	\$2182
PBGTTM601013	10-13 x 60 x 1.50	125	36	5	\$2073

Bow top for main reception desk. Counter sits on top of Gallery panels. Bow front overhangs 3". **Factory installed - specify Gallery to be used on.** Size must match dimension of desk front or combined desk side and return length. Hardware included.

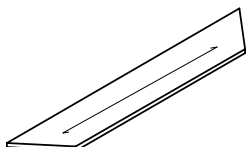

Trapezoid Transaction Counter Top

PBGTTA10810	10 x 108 x 1.50	100	78	8	\$2237
PBGTTA10210	10 x 102 x 1.50	92.5	72	7	\$2126
PBGTTA9610	10 x 96 x 1.50	100	66	7	\$2017
PBGTTA9010	10 x 90 x 1.50	92.5	60	6	\$1908
PBGTTA8410	10 x 84 x 1.50	100	54	6	\$1796
PBGTTA7210	10 x 72 x 1.50	100	48	5	\$1578
PBGTTA6610	10 x 66 x 1.50	100	42	5	\$1469
PBGTTA6010	10 x 60 x 1.50	100	36	4	\$1361

Trapezoid top for main reception desk. 45° mitered ends on left and right. For use with left and right 45° mitered return transaction counters. Counter sits on top of Gallery panels. Does not overhang. **Factory installed - specify Gallery to be used on.** Width must match dimension of desk front. Hardware included.

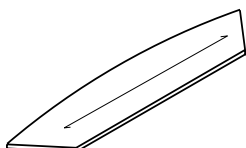

Bow Front Trapezoid Transaction Counter Top

PBGTTMA1081013	10-13 x 108 x 1.50	125	78	10	\$3072
PBGTTMA1021013	10-13 x 102 x 1.50	100	72	9	\$2960
PBGTTMA961013	10-13 x 96 x 1.50	125	66	9	\$2854
PBGTTMA901013	10-13 x 90 x 1.50	125	60	8	\$2741
PBGTTMA841013	10-13 x 84 x 1.50	125	54	8	\$2631
PBGTTMA721013	10-13 x 72 x 1.50	125	48	7	\$2413
PBGTTMA661013	10-13 x 66 x 1.50	125	42	6	\$2299
PBGTTMA601013	10-13 x 60 x 1.50	125	36	5	\$2193

Trapezoid bow top for main reception desk. 45° mitered ends on left and right. For use with left and right 45° mitered return transaction counters. Counter sits on top of Gallery panels. Bow front overhangs 3". **Factory installed - specify Gallery to be used on.** Width must match dimension of desk front. Hardware included.

Required Specifications
Finish

Optional Specifications
Additional grommet

TRANSACTION COUNTERS **MODEL#** **DIMENSIONS** **FREIGHT CLASS** **WT/LBS.** **CUBIC FT.** **LIST PRICE**

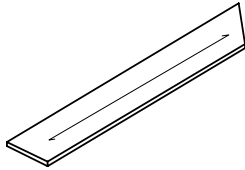

Transaction Counter Top - LEFT

	D x W x H					
PBGTTAL12010	10 x 120 x 1.50	92.5	84	8		\$2363
PBGTTAL11410	10 x 114 x 1.50	92.5	81	8		\$2247
PBGTTAL10810	10 x 108 x 1.50	100	78	8		\$2142
PBGTTAL10210	10 x 102 x 1.50	92.5	72	7		\$2036
PBGTTAL9610	10 x 96 x 1.50	100	66	7		\$1926
PBGTTAL9010	10 x 90 x 1.50	92.5	60	6		\$1817
PBGTTAL8410	10 x 84 x 1.50	100	54	6		\$1704
PBGTTAL7210	10 x 72 x 1.50	100	48	5		\$1487
PBGTTAL6610	10 x 66 x 1.50	100	42	5		\$1374
PBGTTAL6010	10 x 60 x 1.50	100	36	4		\$1269
PBGTTAL3610	10 x 36 x 1.50	100	24	3		\$762
PBGTTAL3010	10 x 30 x 1.50	92.5	20	2		\$633
PBGTTAL2410	10 x 24 x 1.50	100	16	2		\$510

Rectangular top for main reception desk with 45° mitered end on **left**. For use with rectangular or bow front transaction counters with miters at both ends. Width must match dimension of Gallery Desk end and Return width. Counter sits on top of Gallery panels. Does not overhang. **Factory installed - specify Gallery to be used on.** Hardware included.

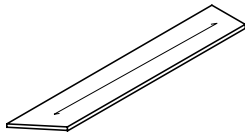

Transaction Counter Top - RIGHT

PBGTTAR12010	10 x 120 x 1.50	92.5	84	8		\$2363
PBGTTAR11410	10 x 114 x 1.50	92.5	81	8		\$2247
PBGTTAR10810	10 x 108 x 1.50	100	78	8		\$2142
PBGTTAR10210	10 x 102 x 1.50	92.5	72	7		\$2036
PBGTTAR9610	10 x 96 x 1.50	100	66	7		\$1926
PBGTTAR9010	10 x 90 x 1.50	92.5	60	6		\$1817
PBGTTAR8410	10 x 84 x 1.50	100	54	6		\$1704
PBGTTAR7210	10 x 72 x 1.50	100	48	5		\$1487
PBGTTAR6610	10 x 66 x 1.50	100	42	5		\$1374
PBGTTAR6010	10 x 60 x 1.50	100	36	4		\$1269
PBGTTAR3610	10 x 36 x 1.50	100	24	3		\$762
PBGTTAR3010	10 x 30 x 1.50	92.5	20	2		\$633
PBGTTAR2410	10 x 24 x 1.50	100	16	2		\$510

Rectangular top for main reception desk with 45° mitered end on **right**. For use with rectangular or bow front transaction counters with miters at both ends. Width must match dimension of Gallery Desk end and Return width. Counter sits on top of Gallery panels. Does not overhang. **Factory installed - specify Gallery to be used on.** Hardware included.

Required Specifications
Finish

Optional Specifications
Additional grommet

TACKBOARDS FOR HUTCHES & ACCESSORIES

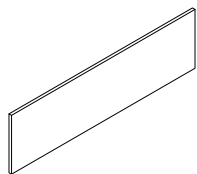

**Tackboard for 36"H*
Non-Pigeon Hole Hutches**

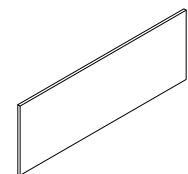

**Tackboard for 42"H & 54"H*
Pigeon Hole Hutches**

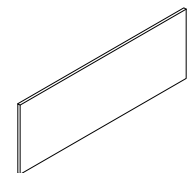

**Tackboard for 42"H & 54"H*
Non-Pigeon Hole Hutches**

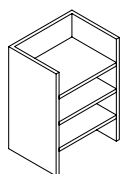

Paper Organizer, Letter & Legal Format

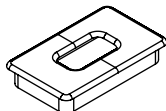

Grommet

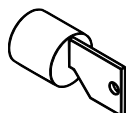

Lock Assembly

MODEL#	DIMENSIONS D x W x H	FREIGHT CLASS	WT/LBS.	CUBIC FT.	LIST PRICE
PBTS108	1 x 104.5 x 20	92.5	23	2	\$1313
PBTS102	1 x 98.5 x 20	100	19	2	\$1242
PBTS96	1 x 92.5 x 20	70	17	1	\$1169
PBTS90	1 x 86.5 x 20	70	15	1	\$1097
PBTS84	1 x 80.5 x 20	85	14	1	\$1030
PBTS78	1 x 74.5 x 20	85	13	1	\$953
PBTS72	1 x 68.5 x 20	85	12	1	\$879
PBTS66	1 x 62.5 x 20	92.5	11	1	\$802
PBTS60	1 x 56.5 x 20	92.5	10	1	\$733

Factory installed hutch tackboard.

PBTSP108H23	1 x 104.5 x 23	70	30	2	\$1485
PBTSP102H23	1 x 98.5 x 23	85	24	2	\$1415
PBTSP96H23	1 x 92.5 x 23	92.5	22	2	\$1321
PBTSP90H23	1 x 86.5 x 23	70	20	1	\$1238
PBTSP84H23	1 x 80.5 x 23	70	18	1	\$1156
PBTSP78H23	1 x 74.5 x 23	70	17	1	\$1074
PBTSP72H23	1 x 68.5 x 23	70	16	1	\$998
PBTSP66H23	1 x 62.5 x 23	85	14	1	\$908
PBTSP60H23	1 x 56.5 x 23	85	13	1	\$830

Factory installed hutch tackboard.

PBTS108H26	1 x 104.5 x 26	70	30	2	\$1716
PBTS102H26	1 x 98.5 x 26	85	24	2	\$1617
PBTS102H26	1 x 92.5 x 26	85	24	2	\$1617
PBTS90H26	1 x 86.5 x 26	92.5	20	2	\$1432
PBTS84H26	1 x 80.5 x 26	100	18	2	\$1236
PBTS78H26	1 x 74.5 x 26	100	17	2	\$1046
PBTS72H26	1 x 68.5 x 26	70	16	1	\$953
PBTS66H26	1 x 62.5 x 26	85	14	1	\$855
PBTS60H26	1 x 56.5 x 26	85	13	1	\$662

Factory installed hutch tackboard.

PBCPH161226	12 x 16 x 27	125	20	3	\$1045
PBCPH161223	12 x 16 x 23	125	18	3	\$1422
PBCPH161219	12 x 16 x 20	125	15	2	\$674
PBCPH131226	12 x 13 x 27	100	16	2	\$847
PBCPH131223	12 x 13 x 23	125	15	2	\$719
PBCPH131219	12 x 13 x 20	125	12	2	\$546

GM5C	2 x 3.5 x --	70	--	--	\$114
------	--------------	----	----	----	--------------

Rectangular grommet in metal, tungsten finish.

LO/C	--	70	--	--	\$113
------	----	----	----	----	--------------

Tungsten.

Required Specifications

Fabric*

boardroom tables



T BOARDROOM TABLES - NOTES

Boardroom Tops - all series

- Tops 120" and under ship in one piece
- Tops over 120" ship in two pieces
- Veneer wood grain will run with the **length** of the table and align at the seam

HOW TO SPECIFY

1. SPECIFY MODEL NUMBER

2. SPECIFY FINISH

TOP FINISH - WOOD VENEER

Code	Finish	Veneer Type	Cut
AMW	Almond Cherry	Cherry	Flat Sliced
ACW	Amber Cherry	Cherry	Flat Sliced
BTW	Biscotti	White Oak	Rift
CAW	Cocoa Walnut	Walnut	Flat Sliced
CRW	Coral	White Oak	Rift
DCW	Dark Cherry	Cherry	Flat Sliced
DWW	Dark Walnut	Walnut	Flat Sliced
EWV	Espresso Walnut	Walnut	Flat Sliced
EVW	Evening Oak	White Oak	Rift
GRW	Grey on Oak	White Oak	Rift
HAW	Hazelnut	Maple	Flat Sliced
JAW	Java	White Oak	Rift
LTW	Latte Walnut	Walnut	Flat Sliced
MHW	Mahogany on Walnut	Walnut	Flat Sliced
MTW	Milestone	White Oak	Rift
MPW	Natural Maple	Maple	Flat Sliced
NLW	Natural Walnut	Walnut	Flat Sliced
RCW	Red Cherry	Cherry	Flat Sliced
VNW	Vintage Cherry	Cherry	Flat Sliced
ULW	Umber Walnut	Walnut	Flat Sliced
WLW	Walnut	Walnut	Flat Sliced
WCW	Warm Cherry	Cherry	Flat Sliced
WMW	White Maple	Maple	Flat Sliced

BASE FINISH (refer to specific model for availability):

K	Black
E	Tungsten

3. SPECIFY OPTIONS

GROMMETS: DUFFERIN conference table tops

- Optional grommets may be ordered in standard table top locations (left, center or right). Order as **GM1TL, GM1TC or GM1TR. Add \$103.**
- Grommet hole dimensions are 2 3/4" in diameter. Specify **GM1** for **Black** or **GM1K** for **Tungsten.**

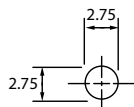

Standard Grommet Locations, Dufferin:

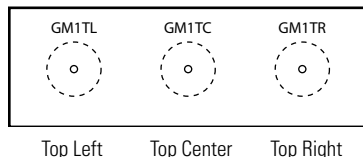

GROMMETS: KINGSTON + PHILADELPHIA conference table tops

- Optional grommets may be ordered in standard table top locations (left, center or right). Order as **GM5TL, GM5TC or GM5TR. Add \$103.**
- Grommet hole dimensions are 3.5" x 2".
- To order a grommet cover only, specify **GM5E** for Black or **GM5K** for Tungsten. Add **\$61.**

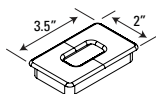

Standard Grommet Locations, Kingston and Philadelphia:

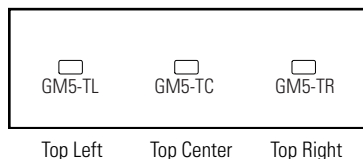

Order as **GM5L, GM5C or GM5R. Add \$103.**

- Grommet hole dimensions are 3.5" x 2". Specify **GM5E** for **Black** or **GM5K** for **Tungsten.**

GROMMETS: LUFTON conference table tops

- Optional grommets may be ordered in standard table top locations (left, center or right). Order as **G5PTL, G5PTC or G5PTR. Add \$103.**
- Grommet hole dimensions are 3.5" x 2". To order a grommet cover only, specify **G5PEC** for Black or **G5PKC** for Tungsten. Add **\$61.**

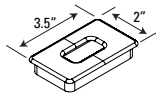

Standard Grommet Locations, Lufton:

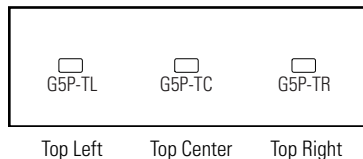

POWER/DATA ACCESSORIES: ALL SERIES

- Match power block desired with cut-out code and location from grid below.
- Please specify location in top as left, center or right (**TL/x, TC/x, or TR/x**) as per line drawing below. Location must be specified on product to be placed on at the time of the order. Please note orientation of power/data accessories on Boardroom Table tops is as shown in drawings below. **Add \$320** for each cut-out.
- When an **"M"** cut-out is ordered, certain bases will be notched to allow clearance for the Oasis Mini.

PRODUCT CODE DIAGRAM

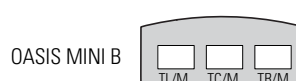
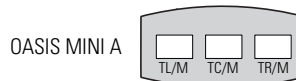
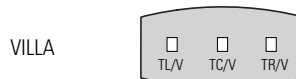
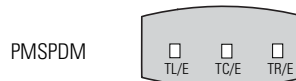

PRODUCT CODE DIAGRAM

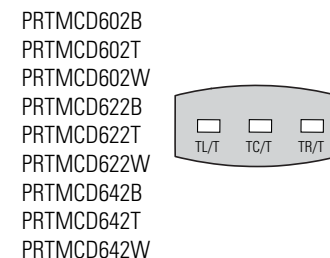
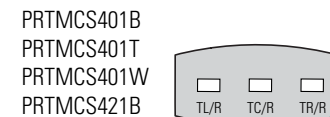

Custom Cut-out

- Optional custom sized cut-out available in standard locations - **CCUTL** (left), **CCUTC** (center) and **CCUTR** (right) for all boardroom table tops. Submit appropriate form (beginning on page 432) with order. **Add \$320** for each cut-out.

T BOARDROOM TABLES

BOARDROOM TABLE TOP AND BASE GUIDE

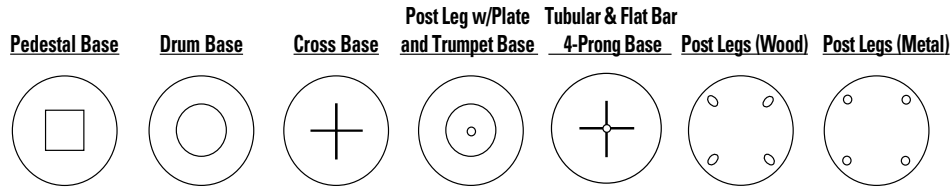

Requires 1 of the following: Pedestal, Drum, Cross, Post Leg w/Plate, Tubular and Flat Bar 4-Prong base, Trumpet Column Base

Requires 4 of the following: Wood Post Legs or Metal Post Legs.

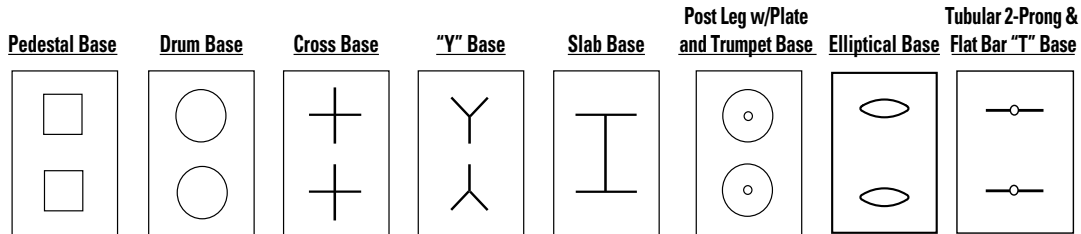

3-Prong Tubular or

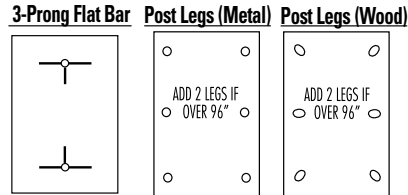
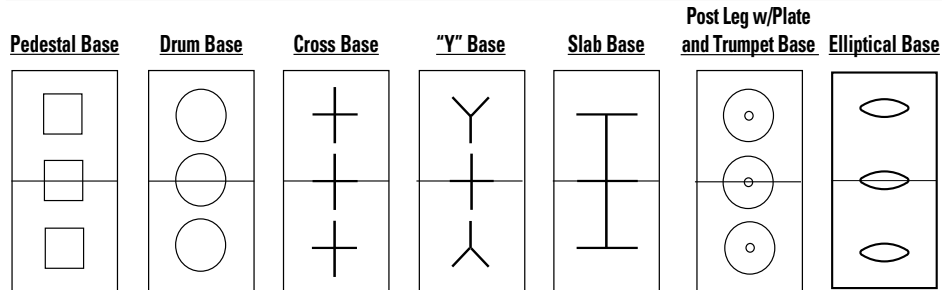

Table Tops up to 120" are in one section and require (2) bases.

Tubular, 2-Prong Base - Table Tops up to 84" require (2) bases.

Tubular and Flat Bar "T" Base - Table Tops up to 120" require (2) bases.

Post Legs - Table Tops up to 96" are in one section and require (4) legs. Tops 108" to 168" require (6) legs.



3-Prong Tubular or

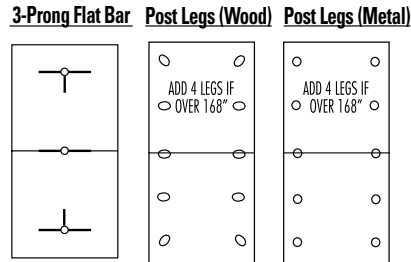

Table Tops 144" and over are in two sections and require (3) bases.

"Y" Base - Require (2) "Y" bases and (1) Cross base in the center.

Slab Base - Require (3) Slab bases.

Tubular and Flat Bar 3-Prong Base - Require (2) 3-Prong bases and (1) 2-Prong base in the center.

Post Legs - Table Tops 180" to 240" require (10) legs.

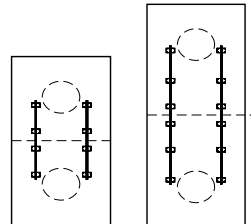

If design considerations or dimension requirements dictate an unsupported table joint, use metal table support rail.

Top section must not exceed 72" to use metal supports.

BOARDROOM TABLES - TOPS WITH DUFFERIN EDGE **MODEL#** **DIMENSIONS** **FREIGHT CLASS** **WT./LBS.** **CUBIC FT.** **LIST PRICE**

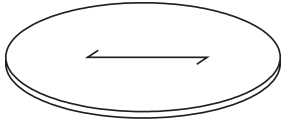

Round Top

	D x W x H					
RO60D	60 x 60 x 1.37	85	150	11		\$3134
RO48D	48 x 48 x 1.37	85	96	7		\$2506
RO42D	42 x 42 x 1.37	85	74	6		\$2267
RO36D	36 x 36 x 1.37	85	54	4		\$1925
RO30D	30 x 30 x 1.37	85	38	3		\$1348

For use with Drum Base, Pedestal Base, Cross Base, Wood Post Legs, Metal Post Legs, 4 Prong Base, Post leg w/Flat Plate, Flat Square Column Base, Trumpet Column base, Flat Bar "X" Base", Square Panel Base.

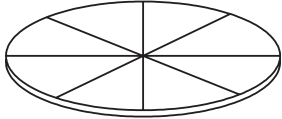

Round Top - Sunburst Veneer Pattern

RO60SD	60 x 60 x 1.37	85	150	11		\$3393
RO48SD	48 x 48 x 1.37	85	96	7		\$2870
RO42SD	42 x 42 x 1.37	85	74	6		\$2454
RO36SD	36 x 36 x 1.37	85	54	4		\$2112
RO30SD	30 x 30 x 1.37	85	38	3		\$1755

For use with Drum Base, Pedestal Base, "X" Shape Slab Base, Wood Post Legs, Metal Post Legs, 4 Prong Base, Post leg w/Flat Plate, Flat Square Column Base, Trumpet Column base, Flat Bar "X" Base", Square Panel Base.

RE24054D	54 x 240 x 1.37	85	540	39		\$10034
RE21654D	54 x 216 x 1.37	85	486	35		\$9031
RE19254D	54 x 192 x 1.37	85	432	31		\$7751
RE5454D	54 x 54 x 1.37	85	121	9		\$2206
RE16848D	48 x 168 x 1.37	85	336	25		\$5770
RE14448D	48 x 144 x 1.37	85	288	21		\$4347
RE12048D	48 x 120 x 1.37	85	240	18		\$3871
RE9648D	48 x 96 x 1.37	85	192	14		\$2856
RE4848D	48 x 48 x 1.37	85	96	7		\$1569
RE8442D	42 x 84 x 1.37	85	147	11		\$2632
RE7242D	42 x 72 x 1.37	85	126	9		\$2250
RE4242D	42 x 42 x 1.37	85	74	5		\$1468
RE8436D	36 x 84 x 1.37	85	126	9		\$2511
RE7236D	36 x 72 x 1.37	85	108	8		\$2153
RE6636D	36 x 66 x 1.37	85	99	7		\$1650
RE3636D	36 x 36 x 1.37	85	54	4		\$901
RE8430D	30 x 84 x 1.37	85	105	8		\$2095
RE7230D	30 x 72 x 1.37	85	90	7		\$1797
RE6630D	30 x 66 x 1.37	85	83	6		\$1650
RE6030D	30 x 60 x 1.37	85	75	6		\$1499
RE5430D	30 x 54 x 1.37	85	68	5		\$1353
RE3030D	30 x 30 x 1.37	85	38	3		\$756
RE8424D	24 x 84 x 1.37	85	84	6		\$1828
RE7224D	24 x 72 x 1.37	85	72	5		\$1567
RE6624D	24 x 66 x 1.37	85	66	5		\$1440
RE6024D	24 x 60 x 1.37	70	60	4		\$1308
RE5424D	24 x 54 x 1.37	85	55	4		\$1176
RE4824D	24 x 48 x 1.37	70	48	3		\$1134
RE2424D	24 x 24 x 1.37	125	21	3		\$521
RE8422D	22 x 84 x 1.37	85	77	6		\$1678
RE7222D	22 x 72 x 1.37	85	66	5		\$1440
RE6622D	22 x 66 x 1.37	85	61	5		\$1318
RE6022D	22 x 60 x 1.37	85	55	4		\$1200
RE5422D	22 x 54 x 1.37	85	50	4		\$1085
RE4822D	22 x 48 x 1.37	85	44	3		\$1039
RE2222D	22 x 22 x 1.37	92.5	20	2		\$479

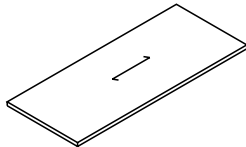

Rectangular Top

Grain runs the **length** of the worksurface. Tops 120" and under are shipped in one piece and require 2 bases. Tops 144" and over are shipped in two pieces and require 3 bases.

Required Specifications

Veneer Finish

Optional Specifications

Boardroom Table Base
Grommet (not available on Round Tops)
Custom cut-out

T BOARDROOM TABLES - DUFFERIN

BOARDROOM TABLES - TOPS

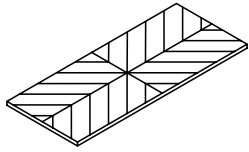

**Rectangular Top -
Reverse Diamond Pattern**

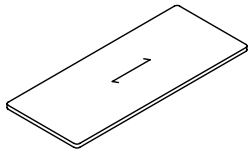

Rectangular Top Radius Corners

MODEL#	DIMENSIONS D x W x H	FREIGHT CLASS	WT/LBS.	CUBIC FT.	LIST PRICE
RE24054FD	54 x 240 x 1.37	85	540	39	\$11499
RE21654FD	54 x 216 x 1.37	85	486	35	\$10397
RE19254FD	54 x 192 x 1.37	85	432	31	\$8986
RE5454FD	54 x 54 x 1.37	85	119	9	\$2517
RE16848FD	48 x 168 x 1.37	85	336	25	\$6809
RE14448FD	48 x 144 x 1.37	85	288	21	\$5246
RE12048FD	48 x 120 x 1.37	85	240	18	\$4566
RE9648FD	48 x 96 x 1.37	85	192	14	\$3452
RE4848FD	48 x 48 x 1.37	85	98	7	\$1842
RE8442FD	42 x 84 x 1.37	85	147	11	\$3159
RE7242FD	42 x 72 x 1.37	85	126	9	\$2745
RE4242FD	42 x 42 x 1.37	85	74	5	\$1730
RE8436FD	36 x 84 x 1.37	85	126	9	\$2955
RE7236FD	36 x 72 x 1.37	85	108	8	\$2539
RE6636FD	36 x 66 x 1.37	85	99	7	\$1936
RE3636FD	36 x 36 x 1.37	85	54	4	\$1236
RE8430FD	30 x 84 x 1.37	85	105	8	\$2459
RE7230FD	30 x 72 x 1.37	85	90	7	\$2198
RE6630FD	30 x 66 x 1.37	85	83	6	\$2117
RE6030FD	30 x 60 x 1.37	85	75	6	\$1936
RE5430FD	30 x 54 x 1.37	85	68	5	\$1585
RE3030FD	30 x 30 x 1.37	85	38	3	\$879

Tops 120" and under are shipped in one piece and require 2 bases. Tops 144" and over are shipped in two pieces and require 3 bases.

RRE24054D	54 x 240 x 1.37	85	540	39	\$12233
RRE21654D	54 x 216 x 1.37	85	486	35	\$11076
RRE19254D	54 x 192 x 1.37	85	432	31	\$9607
RRE5454D	54 x 54 x 1.37	85	119	9	\$2679
RRE16848D	48 x 168 x 1.37	85	336	25	\$7330
RRE14448D	48 x 144 x 1.37	85	288	21	\$5692
RRE12048D	48 x 120 x 1.37	85	240	18	\$4913
RRE9648D	48 x 96 x 1.37	85	192	14	\$3748
RRE4848D	48 x 48 x 1.37	85	98	7	\$1972
RRE8442D	42 x 84 x 1.37	85	147	11	\$3426
RRE7242D	42 x 72 x 1.37	85	126	9	\$2988
RRE4242D	42 x 42 x 1.37	85	74	5	\$1855
RRE8436D	36 x 84 x 1.37	85	126	9	\$3182
RRE7236D	36 x 72 x 1.37	85	108	8	\$2729
RRE6636D	36 x 66 x 1.37	85	99	7	\$2082
RRE3636D	36 x 36 x 1.37	85	54	4	\$1143
RRE8430D	30 x 84 x 1.37	85	105	8	\$2647
RRE7230D	30 x 72 x 1.37	85	90	7	\$2269
RRE6630D	30 x 66 x 1.37	85	83	6	\$2082
RRE6030D	30 x 60 x 1.37	85	75	6	\$1898
RRE5430D	30 x 54 x 1.37	85	68	5	\$1702
RRE3030D	30 x 30 x 1.37	85	38	3	\$953

Grain runs the **length** of the worksurface. Tops 120" and under are shipped in one piece and require 2 bases. Tops 144" and over are shipped in two pieces and require 3 bases.

Required Specifications
Veneer Finish

Optional Specifications
Boardroom Table Base
Grommet
Custom cut-out

BOARDROOM TABLES - TOPS

MODEL# DIMENSIONS FREIGHT CLASS WT/LBS. CUBIC FT. LIST PRICE

D x W x H

REBE24054D	54 x 240 x 1.37	85	540	39	\$11352
REBE21654D	54 x 216 x 1.37	85	486	35	\$10313
REBE19254D	54 x 192 x 1.37	85	432	31	\$9001
REBE16848D	48 x 168 x 1.37	85	336	25	\$6909
REBE14448D	48 x 144 x 1.37	85	288	21	\$5469
REBE12048D	48 x 120 x 1.37	85	240	18	\$4645
REBE9648D	48 x 96 x 1.37	85	192	14	\$3604
REBE8442D	42 x 84 x 1.37	85	147	11	\$3285
REBE7242D	42 x 72 x 1.37	85	126	9	\$2891
REBE8436D	36 x 84 x 1.37	85	126	9	\$2891
REBE7236D	36 x 72 x 1.37	85	108	8	\$2474
REBE6636D	36 x 66 x 1.37	85	99	7	\$1893
REBE8430D	30 x 84 x 1.37	85	105	8	\$2408
REBE7230D	30 x 72 x 1.37	85	90	7	\$2067
REBE6630D	30 x 66 x 1.37	85	83	6	\$1893
REBE6030D	30 x 60 x 1.37	85	75	6	\$1716
REBE5430D	30 x 54 x 1.37	85	68	5	\$1550

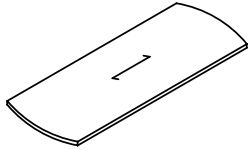

Rectangular Top - Bow Ends

Grain runs the **length** of the worksurface. Tops 120" and under are shipped in one piece and require 2 bases. Tops 144" and over are shipped in two pieces and require 3 bases.

RA24054D	54 x 240 x 1.37	85	540	39	\$13822
RA21654D	54 x 216 x 1.37	85	486	35	\$11676
RA19254D	54 x 192 x 1.37	85	432	31	\$11043
RA16848D	48 x 168 x 1.37	85	336	25	\$8268
RA14448D	48 x 144 x 1.37	85	288	21	\$6496
RA12048D	48 x 120 x 1.37	85	240	18	\$5763
RA9648D	48 x 96 x 1.37	85	192	14	\$4577
RA8442D	42 x 84 x 1.37	85	147	11	\$4145
RA7242D	42 x 72 x 1.37	85	126	9	\$3640
RA8436D	36 x 84 x 1.37	85	126	9	\$3763
RA7236D	36 x 72 x 1.37	85	108	8	\$3224
RA6636D	36 x 66 x 1.37	85	99	7	\$2466
RA8430D	30 x 84 x 1.37	85	105	8	\$3137
RA7230D	30 x 72 x 1.37	85	90	7	\$2693
RA6630D	30 x 66 x 1.37	85	83	6	\$2466
RA6030D	30 x 60 x 1.37	85	75	6	\$2242
RA5430D	30 x 54 x 1.37	85	68	5	\$2022
RA8422D	22 x 84 x 1.37	85	77	6	\$2511
RA7222D	22 x 72 x 1.37	85	66	5	\$2153
RA6622D	22 x 66 x 1.37	85	61	5	\$1972
RA6022D	22 x 60 x 1.37	85	55	4	\$1797
RA5422D	22 x 54 x 1.37	85	50	4	\$1615
RA4822D	22 x 48 x 1.37	85	44	3	\$1558

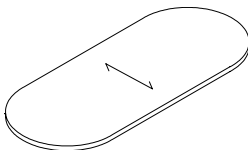

Racetrack Top - Cross Grain

Grain runs the **depth** of the worksurface. Tops 120" and under are shipped in one piece and require 2 bases. Tops 144" and over are shipped in two pieces and require 3 bases.

Required Specifications

Veneer Finish

Optional Specifications

Boardroom Table Base
Grommet
Custom cut-out

T BOARDROOM TABLES - DUFFERIN

BOARDROOM TABLES - TOPS

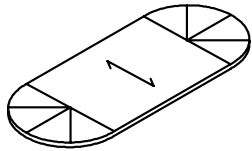

**Racetrack Top Cross Grain Center,
Sunburst Veneer Pattern on Left & Right**

MODEL#	DIMENSIONS D x W x H	FREIGHT CLASS	WT/LBS.	CUBIC FT.	LIST PRICE
RA24054SD	54 x 240 x 1.37	85	540	39	\$14893
RA21654SD	54 x 216 x 1.37	85	486	35	\$12729
RA19254SD	54 x 192 x 1.37	85	432	31	\$12089
RA16848SD	48 x 168 x 1.37	85	336	25	\$9285
RA14448SD	48 x 144 x 1.37	85	288	21	\$7493
RA12048SD	48 x 120 x 1.37	85	240	18	\$6444
RA9648SD	48 x 96 x 1.37	85	192	14	\$5252
RA8442SD	42 x 84 x 1.37	85	147	11	\$4675
RA7242SD	42 x 72 x 1.37	85	126	9	\$4222
RA8436SD	36 x 84 x 1.37	85	126	9	\$4222
RA7236SD	36 x 72 x 1.37	85	108	8	\$3617
RA6636SD	36 x 66 x 1.37	85	99	7	\$2765
RA8430SD	30 x 84 x 1.37	85	105	8	\$3515
RA7230SD	30 x 72 x 1.37	85	90	7	\$3020
RA6630SD	30 x 66 x 1.37	85	83	6	\$2765
RA6030SD	30 x 60 x 1.37	85	75	6	\$2517
RA5430SD	30 x 54 x 1.37	85	68	5	\$2265
RA8422SD	22 x 84 x 1.37	85	77	6	\$2818
RA7222SD	22 x 72 x 1.37	85	66	5	\$2416
RA6622SD	22 x 66 x 1.37	85	61	5	\$2220
RA6022SD	22 x 60 x 1.37	85	55	4	\$2014
RA5422SD	22 x 54 x 1.37	85	50	4	\$1812
RA4822SD	22 x 48 x 1.37	85	44	3	\$1746

Grain runs the **depth** of the worksurface. Tops 120" and under are shipped in one piece and require 2 bases. Tops 144" and over are shipped in two pieces and require 3 bases.

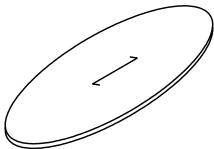

Oval Top

OV24054D	54 x 240 x 1.37	85	540	39	\$17278
OV21654D	54 x 216 x 1.37	85	486	35	\$14594
OV19254D	54 x 192 x 1.37	85	432	31	\$13803
OV16848D	48 x 168 x 1.37	85	336	25	\$10331
OV14448D	48 x 144 x 1.37	85	288	21	\$8121
OV12048D	48 x 120 x 1.37	85	240	18	\$7203
OV9648D	48 x 96 x 1.37	85	192	14	\$5720
OV8442D	42 x 84 x 1.37	85	147	11	\$5182
OV7242D	42 x 72 x 1.37	85	126	9	\$4548
OV8436D	36 x 84 x 1.37	85	126	9	\$4548
OV7236D	36 x 72 x 1.37	85	108	8	\$3899
OV6636D	36 x 66 x 1.37	85	99	7	\$2979
OV8430D	30 x 84 x 1.37	85	105	8	\$3924
OV7230D	30 x 72 x 1.37	85	90	7	\$3365
OV6630D	30 x 66 x 1.37	85	83	6	\$3087
OV6030D	30 x 60 x 1.37	85	75	6	\$2800
OV5430D	30 x 54 x 1.37	85	68	5	\$2525
OV8422D	22 x 84 x 1.37	85	77	6	\$3137
OV7222D	22 x 72 x 1.37	85	66	5	\$2693
OV6622D	22 x 66 x 1.37	85	61	5	\$2466
OV6022D	22 x 60 x 1.37	85	55	4	\$2242
OV5422D	22 x 54 x 1.37	85	50	4	\$2022
OV4822D	22 x 48 x 1.37	85	44	3	\$1943

Grain runs the **length** of the worksurface. Tops 120" and under are shipped in one piece and require 2 bases. Tops 144" and over are shipped in two pieces and require 3 bases.

Required Specifications

Veneer Finish

Optional Specifications

Boardroom Table Base

Grommet

Custom cut-out

BOARDROOM TABLES - TOPS

MODEL#	DIMENSIONS	FREIGHT CLASS	WT/LBS.	CUBIC FT.	LIST PRICE
--------	------------	---------------	---------	-----------	------------

D x W x H

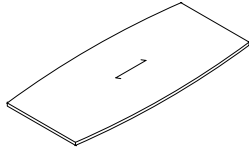

Boat Shape Top

B024054D	54 x 240 x 1.37	85	540	39	\$11246
B021654D	54 x 216 x 1.37	85	486	35	\$10108
B019254D	54 x 192 x 1.37	85	432	31	\$8967
B016848D	48 x 168 x 1.37	85	336	25	\$7145
B014448D	48 x 144 x 1.37	85	288	21	\$5782
B012048D	48 x 120 x 1.37	85	240	18	\$4842
B09648D	48 x 96 x 1.37	85	192	14	\$3930
B08442D	42 x 84 x 1.37	85	147	11	\$3627
B07242D	42 x 72 x 1.37	85	126	9	\$3194

Grain runs the **length** of the worksurface. Tops 120" and under are shipped in one piece and require 2 bases. Tops 144" and over are shipped in two pieces and require 3 bases.

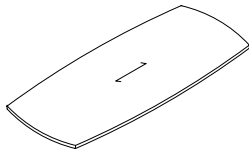

Boat Shape Top - Bow Ends

BOBE24054D	54 x 240 x 1.37	85	540	39	\$12927
BOBE21654D	54 x 216 x 1.37	85	486	35	\$11624
BOBE19254D	54 x 192 x 1.37	85	432	31	\$10313
BOBE5454D	54 x 54 x 1.37	85	121	9	\$2904
BOBE16848D	48 x 168 x 1.37	85	336	25	\$8215
BOBE14448D	48 x 144 x 1.37	85	288	21	\$6642
BOBE12048D	48 x 120 x 1.37	85	240	18	\$5572
BOBE9648D	48 x 96 x 1.37	85	192	14	\$4521
BOBE4848D	48 x 48 x 1.37	85	96	7	\$2453
BOBE8442D	42 x 84 x 1.37	85	147	11	\$4173
BOBE7242D	42 x 72 x 1.37	85	126	9	\$3678
BOBE4242D	42 x 42 x 1.37	85	74	5	\$2140

Grain runs the **length** of the worksurface. Tops 120" and under are shipped in one piece and require 2 bases. Tops 144" and over are shipped in two pieces and require 3 bases.

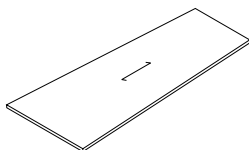

Wedge Shape Top

WE2405442D	54 - 42 x 240 x 1.37	85	540	39	\$9875
WE2165442D	54 - 42 x 216 x 1.37	85	486	35	\$8967
WE1925442D	54 - 42 x 192 x 1.37	85	432	31	\$7829
WE1684836D	48 - 36 x 168 x 1.37	85	336	25	\$6007
WE1444836D	48 - 36 x 144 x 1.37	85	288	21	\$4755
WE1204836D	48 - 36 x 120 x 1.37	85	240	18	\$4040
WE964836D	48 - 36 x 96 x 1.37	85	192	14	\$3133
WE844230D	42 - 30 x 84 x 1.37	85	147	11	\$2853
WE724230D	42 - 30 x 72 x 1.37	85	126	9	\$2511
WE843624D	36 - 24 x 84 x 1.37	85	126	9	\$2511
WE723624D	36 - 24 x 72 x 1.37	85	108	8	\$2153
WE663624D	36 - 24 x 66 x 1.37	85	99	7	\$1650

Grain runs the **length** of the worksurface. Tops 120" and under are shipped in one piece and require 2 bases. Tops 144" and over are shipped in two pieces and require 3 bases.

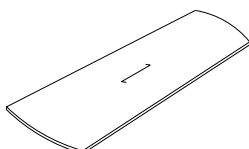

Wedge Shape Top - Bow Ends

WEBE2405442D	54 - 42 x 240 x 1.37	85	540	39	\$11352
WEBE2165442D	54 - 42 x 216 x 1.37	85	486	35	\$10313
WEBE1925442D	54 - 42 x 192 x 1.37	85	432	31	\$9001
WEBE1684836D	48 - 36 x 168 x 1.37	85	336	25	\$6909
WEBE1444836D	48 - 36 x 144 x 1.37	85	288	21	\$5469
WEBE1204836D	48 - 36 x 120 x 1.37	85	240	18	\$4645
WEBE964836D	48 - 36 x 96 x 1.37	85	192	14	\$3604
WEBE844230D	42 - 30 x 84 x 1.37	85	147	11	\$3285
WEBE724230D	42 - 30 x 72 x 1.37	85	126	9	\$2891
WEBE843624D	36 - 24 x 84 x 1.37	85	126	9	\$2891
WEBE723624D	36 - 24 x 72 x 1.37	85	108	8	\$2474
WEBE663624D	36 - 24 x 66 x 1.37	85	99	7	\$1893

Grain runs the **length** of the worksurface. Tops 120" and under are shipped in one piece and require 2 bases. Tops 144" and over are shipped in two pieces and require 3 bases.

Required Specifications

Veneer Finish

Optional Specifications

Boardroom Table Base
Grommet
Custom cut-out

T BOARDROOM TABLES - LUFTON

BOARDROOM TABLES - TOPS WITH LUFTON EDGE

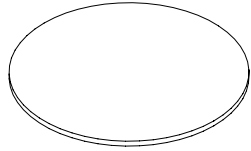

Round Top

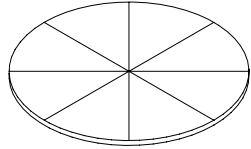

Round Top - Sunburst Veneer Pattern

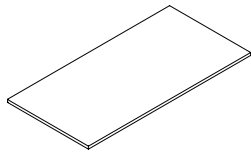

Rectangular Top

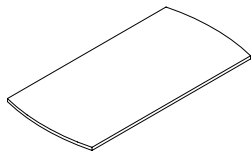

Rectangular Top - Bow Ends

MODEL#	DIMENSIONS D x W x H	FREIGHT CLASS	WT/LBS.	CUBIC FT.	LIST PRICE
RO60L	60 x 60 x 1.37	85	150	11	\$3057
RO48L	48 x 48 x 1.37	85	96	7	\$2440
RO42L	42 x 42 x 1.37	85	74	6	\$2200
RO36L	36 x 36 x 1.37	85	54	4	\$1960
RO30L	30 x 30 x 1.37	85	38	3	\$1308

For use with Drum Base, Pedestal Base, Cross Base, Wood Post Legs, Metal Post Legs, 4 Prong Base, Post leg w/Flat Plate, Flat Square Column Base, Trumpet Column base, Flat Bar "X" Base", Square Panel Base.

RO60SL	60 x 60 x 1.37	85	150	11	\$3354
RO48SL	48 x 48 x 1.37	85	96	7	\$2760
RO42SL	42 x 42 x 1.37	85	74	6	\$2389
RO36SL	36 x 36 x 1.37	85	54	4	\$2153
RO30SL	30 x 30 x 1.37	85	38	3	\$1904

For use with Drum Base, Pedestal Base, Cross Base, Wood Post Legs, Metal Post Legs, 4 Prong Base, Post leg w/Flat Plate, Flat Square Column Base, Trumpet Column base, Flat Bar "X" Base", Square Panel Base.

RE24054L	54 x 240 x 1.37	85	540	39	\$9517
RE21654L	54 x 216 x 1.37	85	486	35	\$8638
RE19254L	54 x 192 x 1.37	85	432	31	\$7540
RE16848L	48 x 168 x 1.37	85	336	25	\$5783
RE14448L	48 x 144 x 1.37	85	288	21	\$4578
RE12048L	48 x 120 x 1.37	300	240	18	\$3892
RE9648L	48 x 96 x 1.37	85	192	14	\$3018
RE8442L	42 x 84 x 1.37	85	147	11	\$2749
RE7242L	42 x 72 x 1.37	85	126	9	\$2418
RE8436L	36 x 84 x 1.37	85	126	9	\$2418
RE7236L	36 x 72 x 1.37	85	108	8	\$2074
RE6636L	36 x 66 x 1.37	92.5	99	7	\$1589
RE8430L	30 x 84 x 1.37	85	105	8	\$2018
RE7230L	30 x 72 x 1.37	85	90	7	\$1730
RE6630L	30 x 66 x 1.37	85	83	6	\$1589
RE6030L	30 x 60 x 1.37	85	75	6	\$1446
RE5430L	30 x 54 x 1.37	85	68	5	\$1298
RE4830L	30 x 48 x 1.37	85	44	3	\$1270

Grain runs the **length** of the worksurface. Tops 120" and under are shipped in one piece and require 2 bases. Tops 144" and over are shipped in two pieces and require 3 bases.

REBE24054L	54 x 240 x 1.37	85	540	39	\$10939
REBE21654L	54 x 216 x 1.37	85	486	35	\$9927
REBE19254L	54 x 192 x 1.37	85	432	31	\$8670
REBE16848L	48 x 168 x 1.37	85	336	25	\$6652
REBE14448L	48 x 144 x 1.37	85	288	21	\$5265
REBE12048L	48 x 120 x 1.37	300	240	18	\$4475
REBE9648L	48 x 96 x 1.37	85	192	14	\$3470
REBE8442L	42 x 84 x 1.37	85	147	11	\$3160
REBE7242L	42 x 72 x 1.37	85	126	9	\$2783
REBE8436L	36 x 84 x 1.37	85	126	9	\$2783
REBE7236L	36 x 72 x 1.37	85	108	8	\$2384

Grain runs the **length** of the worksurface. Tops 120" and under are shipped in one piece and require 2 bases. Tops 144" and over are shipped in two pieces and require 3 bases.

Required Specifications

Veneer Finish

Optional Specifications

Boardroom Table Base

Grommet

Custom cut-out

BOARDROOM TABLES - TOPS W/LUFTON EDGE

MODEL# DIMENSIONS FREIGHT CLASS WT/LBS. CUBIC FT. LIST PRICE

D x W x H

RA24054L	54 x 240 x 1.37	85	540	39	\$12803
RA21654L	54 x 216 x 1.37	85	486	35	\$10939
RA19254L	54 x 192 x 1.37	85	432	31	\$10390
RA16848L	48 x 168 x 1.37	85	336	25	\$7978
RA14448L	48 x 144 x 1.37	85	288	21	\$6442
RA12048L	48 x 120 x 1.37	300	240	18	\$5538
RA9648L	48 x 96 x 1.37	85	192	14	\$4508
RA8442L	42 x 84 x 1.37	85	147	11	\$4063
RA7242L	42 x 72 x 1.37	85	126	9	\$3630
RA8436L	36 x 84 x 1.37	85	126	9	\$3630
RA7236L	36 x 72 x 1.37	85	108	8	\$3109
RA6636L	36 x 66 x 1.37	92.5	99	7	\$2375

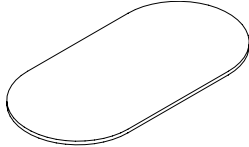

Racetrack Top - Cross Grain

Grain runs the **depth** of the worksurface. Tops 120" and under are shipped in one piece and require 2 bases. Tops 144" and over are shipped in two pieces and require 3 bases.

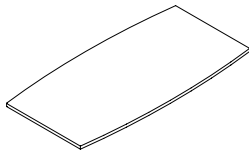

Boat Shape Top

B024054L	54 x 240 x 1.37	85	540	39	\$10823
B021654L	54 x 216 x 1.37	85	486	35	\$9732
B019254L	54 x 192 x 1.37	85	432	31	\$8638
B016848L	48 x 168 x 1.37	85	336	25	\$6883
B014448L	48 x 144 x 1.37	85	288	21	\$5560
B012048L	48 x 120 x 1.37	85	240	18	\$4663
B09648L	48 x 96 x 1.37	85	192	14	\$3791
B08442L	42 x 84 x 1.37	85	147	11	\$3491
B07242L	42 x 72 x 1.37	85	126	9	\$3080

Grain runs the **length** of the worksurface. Tops 120" and under are shipped in one piece and require 2 bases. Tops 144" and over are shipped in two pieces and require 3 bases.

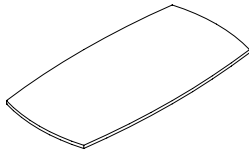

Boat Shape Top - Bow Ends

BOBE24054L	54 x 240 x 1.37	85	540	39	\$12452
BOBE21654L	54 x 216 x 1.37	85	486	35	\$11196
BOBE19254L	54 x 192 x 1.37	85	432	31	\$9927
BOBE5454L	54 x 54 x 1.37	85	121	9	\$2795
BOBE16848L	48 x 168 x 1.37	85	336	25	\$7910
BOBE14448L	48 x 144 x 1.37	85	288	21	\$6402
BOBE12048L	48 x 120 x 1.37	85	240	18	\$5363
BOBE9648L	48 x 96 x 1.37	85	192	14	\$3291
BOBE4848L	48 x 48 x 1.37	85	96	7	\$2367
BOBE8442L	42 x 84 x 1.37	85	147	11	\$3662
BOBE7242L	42 x 72 x 1.37	85	126	9	\$3536
BOBE4242L	42 x 42 x 1.37	85	74	5	\$2068

Grain runs the **length** of the worksurface. Tops 120" and under are shipped in one piece and require 2 bases. Tops 144" and over are shipped in two pieces and require 3 bases.

Required Specifications

Veneer Finish

Optional Specifications

Boardroom Table Base
Grommet
Custom cut-out

T BOARDROOM TABLES - LUFTON

BOARDROOM TABLES - TOPS W/LUFTON EDGE

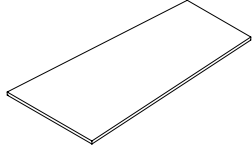

Wedge Shape Top

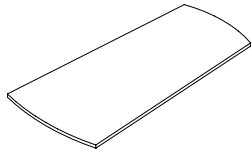

Wedge Shape Top - Bow Ends

MODEL#	DIMENSIONS D x W x H	FREIGHT CLASS	WT/LBS.	CUBIC FT.	LIST PRICE
WE2405442L	54 - 42 x 240 x 1.37	85	540	39	\$9517
WE2165442L	54 - 42 x 216 x 1.37	85	486	35	\$8638
WE1925442L	54 - 42 x 192 x 1.37	85	432	31	\$7540
WE1684836L	48 - 36 x 168 x 1.37	85	336	25	\$5783
WE1444836L	48 - 36 x 144 x 1.37	85	288	21	\$4578
WE1204836L	48 - 36 x 120 x 1.37	85	240	18	\$3892
WE964836L	48 - 36 x 96 x 1.37	85	192	14	\$3772
WE844230L	42 - 30 x 84 x 1.37	85	147	11	\$2749
WE724230L	42 - 30 x 72 x 1.37	85	126	9	\$2418

Grain runs the **length** of the worksurface. Tops 120" and under are shipped in one piece and require 2 bases. Tops 144" and over are shipped in two pieces and require 3 bases.

WEBE2405442L	54 - 42 x 240 x 1.37	85	540	39	\$10939
WEBE2165442L	54 - 42 x 216 x 1.37	85	486	35	\$9927
WEBE1925442L	54 - 42 x 192 x 1.37	85	432	31	\$8670
WEBE1684836L	48 - 36 x 168 x 1.37	85	336	25	\$6652
WEBE1444836L	48 - 36 x 144 x 1.37	85	288	21	\$5265
WEBE1204836L	48 - 36 x 120 x 1.37	85	240	18	\$4475
WEBE964836L	48 - 36 x 96 x 1.37	85	192	14	\$3470
WEBE844230L	42 - 30 x 84 x 1.37	85	147	11	\$3160
WEBE724230L	42 - 30 x 72 x 1.37	85	126	9	\$2783

Grain runs the **length** of the worksurface. Tops 120" and under are shipped in one piece and require 2 bases. Tops 144" and over are shipped in two pieces and require 3 bases.

Required Specifications

Veneer Finish

Optional Specifications

Boardroom Table Base

Grommet

Custom cut-out

BOARDROOM TABLES - TOPS W/PHILADELPHIA EDGE **MODEL#** **DIMENSIONS** **FREIGHT CLASS** **WT./LBS.** **CUBIC FT.** **LIST PRICE**

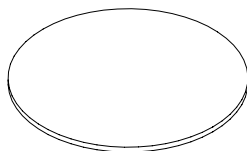

Round Top

	D x W x H					
RO60PB	60 x 60 x 1.5	85	150	11		\$5281
RO48PB	48 x 48 x 1.5	85	96	7		\$4225
RO42PB	42 x 42 x 1.5	85	74	6		\$3795
RO36PB	36 x 36 x 1.5	85	54	4		\$3384
RO30PB	30 x 30 x 1.5	85	38	3		\$2822

For use with Drum Base, Pedestal Base, Cross Base, Wood Post Legs, Metal Post Legs, 4 Prong Base, Post leg w/Flat Plate, Flat Square Column Base, Trumpet Column base, Flat Bar "X" Base", Square Panel Base.

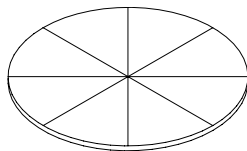

Round Top - Sunburst Veneer Pattern

RO60SPB	60 x 60 x 1.5	85	150	11		\$5806
RO48SPB	48 x 48 x 1.5	85	96	7		\$4771
RO42SPB	42 x 42 x 1.5	85	74	6		\$4127
RO36SPB	36 x 36 x 1.5	85	54	4		\$3713
RO30SPB	30 x 30 x 1.5	85	38	3		\$3291

For use with Drum Base, Pedestal Base, Cross Base, Wood Post Legs, Metal Post Legs, 4 Prong Base, Post leg w/Flat Plate, Flat Square Column Base, Trumpet Column base, Flat Bar "X" Base", Square Panel Base.

RE24054PB	54 x 240 x 1.5	85	540	39		\$16455
RE21654PB	54 x 216 x 1.5	85	486	35		\$14938
RE19254PB	54 x 192 x 1.5	85	432	31		\$13039
RE5454PB	54 x 54 x 1.5	85	121	9		\$3667
RE16848PB	48 x 168 x 1.5	85	336	25		\$10004
RE14448PB	48 x 144 x 1.5	85	288	21		\$7919
RE12048PB	48 x 120 x 1.5	85	240	18		\$6730
RE9648PB	48 x 96 x 1.5	85	192	14		\$5218
RE4848PB	48 x 48 x 1.5	85	96	7		\$2607
RE8442PB	42 x 84 x 1.5	85	147	11		\$4751
RE7242PB	42 x 72 x 1.5	85	126	9		\$4181
RE4242PB	42 x 42 x 1.5	85	74	5		\$2443
RE8436PB	36 x 84 x 1.5	85	126	9		\$4251
RE7236PB	36 x 72 x 1.5	85	108	8		\$3590
RE6636PB	36 x 66 x 1.5	85	99	7		\$2741
RE3636PB	36 x 36 x 1.5	85	54	4		\$1494
RE8430PB	30 x 84 x 1.5	85	105	8		\$3486
RE7230PB	30 x 72 x 1.5	85	90	7		\$2993
RE6630PB	30 x 66 x 1.5	85	83	6		\$2741
RE6030PB	30 x 60 x 1.5	85	75	6		\$2487
RE5430PB	30 x 54 x 1.5	85	68	5		\$2248
RE3030PB	30 x 30 x 1.5	85	38	3		\$1247
RE8424PB	24 x 84 x 1.5	85	84	6		\$3042
RE7224PB	24 x 72 x 1.5	85	72	5		\$2603
RE6624PB	24 x 66 x 1.5	85	66	5		\$2388
RE6024PB	24 x 60 x 1.5	70	60	4		\$2171
RE5424PB	24 x 54 x 1.5	85	55	4		\$1957
RE4824PB	24 x 48 x 1.5	70	48	3		\$1879
RE2424PB	24 x 24 x 1.5	125	21	3		\$867
RE8422PB	22 x 84 x 1.5	85	77	6		\$2793
RE7222PB	22 x 72 x 1.5	85	66	5		\$2388
RE6622PB	22 x 66 x 1.5	85	61	5		\$2192
RE6022PB	22 x 60 x 1.5	85	55	4		\$1995
RE5422PB	22 x 54 x 1.5	85	50	4		\$1790
RE4822PB	22 x 48 x 1.5	85	44	3		\$1726
RE2222PB	22 x 22 x 1.5	92.5	20	2		\$793

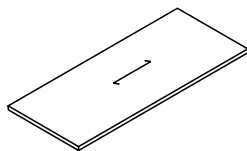

Rectangular Top

Grain runs the **length** of the worksurface. Tops 120" and under are shipped in one piece and require 2 bases. Tops 144" and over are shipped in two pieces and require 3 bases.

Required Specifications

Veneer Finish

Optional Specifications

Boardroom Table Base
Grommet
Custom cut-out

T BOARDROOM TABLES - PHILADELPHIA

BOARDROOM TABLES - TOPS W/PHILADELPHIA EDGE

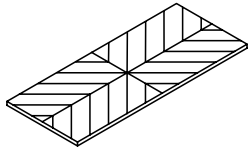

**Rectangular Top -
Reverse Diamond Pattern**

MODEL#	DIMENSIONS D x W x H	FREIGHT CLASS	WT./LBS.	CUBIC FT.	LIST PRICE
RE24054FPB	54 x 240 x 1.5	85	540	39	\$18652
RE21654FPB	54 x 216 x 1.5	85	486	35	\$16988
RE19254FPB	54 x 192 x 1.5	85	432	31	\$14895
RE5454FPB	54 x 54 x 1.5	85	121	9	\$4191
RE16848FPB	48 x 168 x 1.5	85	336	25	\$11563
RE14448FPB	48 x 144 x 1.5	85	288	21	\$9266
RE12048FPB	48 x 120 x 1.5	85	240	18	\$7774
RE9648FPB	48 x 96 x 1.5	85	192	14	\$6111
RE4848FPB	48 x 48 x 1.5	85	96	7	\$3054
RE8442FPB	42 x 84 x 1.5	85	147	11	\$4046
RE7242FPB	42 x 72 x 1.5	85	126	9	\$4921
RE4242FPB	42 x 42 x 1.5	85	74	5	\$2876
RE8436FPB	36 x 84 x 1.5	85	126	9	\$4921
RE7236FPB	36 x 72 x 1.5	85	108	8	\$4220
RE6636FPB	36 x 66 x 1.5	85	99	7	\$3225
RE3636FPB	36 x 36 x 1.5	85	54	4	\$2060
RE8430FPB	30 x 84 x 1.5	85	105	8	\$4098
RE7230FPB	30 x 72 x 1.5	85	90	7	\$3655
RE6630FPB	30 x 66 x 1.5	85	83	6	\$3518
RE6030FPB	30 x 60 x 1.5	85	75	6	\$3225
RE5430FPB	30 x 54 x 1.5	85	68	5	\$2639
RE3030FPB	30 x 30 x 1.5	85	38	3	\$1464

Tops 120" and under are shipped in one piece and require 2 bases. Tops 144" and over are shipped in two pieces and require 3 bases.

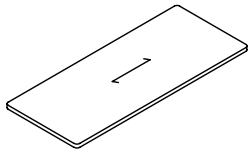

Rectangular Top - Radius Corners

RRE24054PB	54 x 240 x 1.5	85	540	39	\$19759
RRE21654PB	54 x 216 x 1.5	85	486	35	\$18012
RRE19254PB	54 x 192 x 1.5	85	432	31	\$15832
RRE5454PB	54 x 54 x 1.5	85	121	9	\$4458
RRE16848PB	48 x 168 x 1.5	85	336	25	\$12341
RRE14448PB	48 x 144 x 1.5	85	288	21	\$9939
RRE12048PB	48 x 120 x 1.5	85	240	18	\$8301
RRE9648PB	48 x 96 x 1.5	85	192	14	\$6557
RRE4848PB	48 x 48 x 1.5	85	96	7	\$3276
RRE8442PB	42 x 84 x 1.5	85	147	11	\$5945
RRE7242PB	42 x 72 x 1.5	85	126	9	\$5295
RRE4242PB	42 x 42 x 1.5	85	74	5	\$3091
RRE8436PB	36 x 84 x 1.5	85	126	9	\$5295
RRE7236PB	36 x 72 x 1.5	85	108	8	\$4535
RRE6636PB	36 x 66 x 1.5	85	99	7	\$3466
RRE3636PB	36 x 36 x 1.5	85	54	4	\$1893
RRE8430PB	30 x 84 x 1.5	85	105	8	\$4414
RRE7230PB	30 x 72 x 1.5	85	90	7	\$3780
RRE6630PB	30 x 66 x 1.5	85	83	6	\$3466
RRE6030PB	30 x 60 x 1.5	85	75	6	\$3149
RRE5430PB	30 x 54 x 1.5	85	68	5	\$2840
RRE3030PB	30 x 30 x 1.5	85	38	3	\$1580

Grain runs the **length** of the worksurface. Tops 120" and under are shipped in one piece and require 2 bases. Tops 144" and over are shipped in two pieces and require 3 bases.

Required Specifications

Veneer Finish

Optional Specifications

Boardroom Table Base
Grommet
Custom cut-out

BOARDROOM TABLES - TOPS W/PHILADELPHIA EDGE MODEL# DIMENSIONS FREIGHT CLASS WT/LBS. CUBIC FT. LIST PRICE

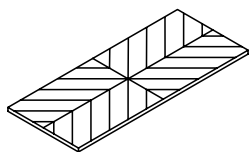

**Rectangular Top - Radius Corners
Reverse Diamond Pattern**

	D x W x H					
RRE24054FPB	54 x 240 x 1.5	85	540	39	\$22287	
RRE21654FPB	54 x 216 x 1.5	85	486	35	\$20366	
RRE19254FPB	54 x 192 x 1.5	85	432	31	\$17964	
RRE5454FPB	54 x 54 x 1.5	85	121	9	\$5055	
RRE16848FPB	48 x 168 x 1.5	85	336	25	\$14130	
RRE14448FPB	48 x 144 x 1.5	85	288	21	\$11484	
RRE12048FPB	48 x 120 x 1.5	85	240	18	\$9499	
RRE9648FPB	48 x 96 x 1.5	85	192	14	\$7572	
RRE4848FPB	48 x 48 x 1.5	85	96	7	\$3792	
RRE8442FPB	42 x 84 x 1.5	85	147	11	\$6864	
RRE7242FPB	42 x 72 x 1.5	85	126	9	\$6141	
RRE4242FPB	42 x 42 x 1.5	85	74	5	\$3582	
RRE8436FPB	36 x 84 x 1.5	85	126	9	\$6141	
RRE7236FPB	36 x 72 x 1.5	85	108	8	\$5269	
RRE6636FPB	36 x 66 x 1.5	85	99	7	\$4025	
RRE3636FPB	36 x 36 x 1.5	85	54	4	\$2200	
RRE8430FPB	30 x 84 x 1.5	85	105	8	\$5117	
RRE7230FPB	30 x 72 x 1.5	85	90	7	\$4389	
RRE6630FPB	30 x 66 x 1.5	85	83	6	\$4025	
RRE6030FPB	30 x 60 x 1.5	85	75	6	\$3655	
RRE5430FPB	30 x 54 x 1.5	85	68	5	\$3293	
RRE3030FPB	30 x 30 x 1.5	85	38	3	\$1832	

Tops 120" and under are shipped in one piece and require 2 bases. Tops 144" and over are shipped in two pieces and require 3 bases.

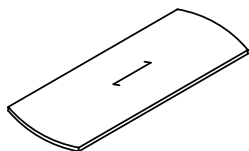

Rectangular Top - Bow Ends

REBE24054PB	54 x 240 x 1.5	85	540	39	\$18921	
REBE21654PB	54 x 216 x 1.5	85	486	35	\$17182	
REBE19254PB	54 x 192 x 1.5	85	432	31	\$14999	
REBE16848PB	48 x 168 x 1.5	85	336	25	\$11505	
REBE14448PB	48 x 144 x 1.5	85	288	21	\$9109	
REBE12048PB	48 x 120 x 1.5	85	240	18	\$7742	
REBE9648PB	48 x 96 x 1.5	85	192	14	\$5999	
REBE8442PB	42 x 84 x 1.5	85	147	11	\$5464	
REBE7242PB	42 x 72 x 1.5	85	126	9	\$4808	
REBE8436PB	36 x 84 x 1.5	85	126	9	\$4810	
REBE7236PB	36 x 72 x 1.5	85	108	8	\$4126	
REBE6636PB	36 x 66 x 1.5	85	99	7	\$3148	
REBE8430PB	30 x 84 x 1.5	85	105	8	\$4011	
REBE7230PB	30 x 72 x 1.5	85	90	7	\$3440	
REBE6630PB	30 x 66 x 1.5	85	83	6	\$3148	
REBE6030PB	30 x 60 x 1.5	85	75	6	\$2861	
REBE5430PB	30 x 54 x 1.5	85	68	5	\$2581	

Grain runs the **length** of the worksurface. Tops 120" and under are shipped in one piece and require 2 bases. Tops 144" and over are shipped in two pieces and require 3 bases.

Required Specifications

Veneer Finish

Optional Specifications

Boardroom Table Base
Grommet
Custom cut-out

T BOARDROOM TABLES - PHILADELPHIA

BOARDROOM TABLES - TOPS W/PHILADELPHIA EDGE MODEL# DIMENSIONS FREIGHT CLASS WT/LBS. CUBIC FT. LIST PRICE

D x W x H

RA24054PB	54 x 240 x 1.5	85	540	39	\$22147
RA21654PB	54 x 216 x 1.5	85	486	35	\$18921
RA19254PB	54 x 192 x 1.5	85	432	31	\$17976
RA16848PB	48 x 168 x 1.5	85	336	25	\$13800
RA14448PB	48 x 144 x 1.5	85	288	21	\$11145
RA12048PB	48 x 120 x 1.5	85	240	18	\$9579
RA9648PB	48 x 96 x 1.5	85	192	14	\$7798
RA8442PB	42 x 84 x 1.5	85	147	11	\$7025
RA7242PB	42 x 72 x 1.5	85	126	9	\$6269
RA8436PB	36 x 84 x 1.5	85	126	9	\$6269
RA7236PB	36 x 72 x 1.5	85	108	8	\$5370
RA6636PB	36 x 66 x 1.5	85	99	7	\$4104
RA8430PB	30 x 84 x 1.5	85	105	8	\$5224
RA7230PB	30 x 72 x 1.5	85	90	7	\$4479
RA6630PB	30 x 66 x 1.5	85	83	6	\$4104
RA6030PB	30 x 60 x 1.5	85	75	6	\$3731
RA5430PB	30 x 54 x 1.5	85	68	5	\$3363
RA8422PB	22 x 84 x 1.5	85	77	6	\$4181
RA7222PB	22 x 72 x 1.5	85	66	5	\$3590
RA6622PB	22 x 66 x 1.5	85	61	5	\$3287
RA6022PB	22 x 60 x 1.5	85	55	4	\$2988
RA5422PB	22 x 54 x 1.5	85	50	4	\$2694
RA4822PB	22 x 48 x 1.5	85	44	3	\$2592

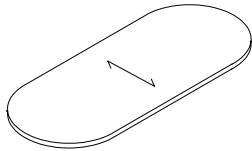

Racetrack Top - Cross Grain

Grain runs the **depth** of the worksurface. Tops 120" and under are shipped in one piece and require 2 bases. Tops 144" and over are shipped in two pieces and require 3 bases.

RA24054SPB	54 x 240 x 1.5	85	540	39	\$24819
RA21654SPB	54 x 216 x 1.5	85	486	35	\$21207
RA19254SPB	54 x 192 x 1.5	85	432	31	\$20143
RA16848SPB	48 x 168 x 1.5	85	336	25	\$15463
RA14448SPB	48 x 144 x 1.5	85	288	21	\$12487
RA12048SPB	48 x 120 x 1.5	85	240	18	\$10736
RA9648SPB	48 x 96 x 1.5	85	192	14	\$8737
RA8442SPB	42 x 84 x 1.5	85	147	11	\$7789
RA7242SPB	42 x 72 x 1.5	85	126	9	\$7025
RA8436SPB	36 x 84 x 1.5	85	126	9	\$7025
RA7236SPB	36 x 72 x 1.5	85	108	8	\$6026
RA6636SPB	36 x 66 x 1.5	85	99	7	\$4602
RA8430SPB	30 x 84 x 1.5	85	105	8	\$5852
RA7230SPB	30 x 72 x 1.5	85	90	7	\$5021
RA6630SPB	30 x 66 x 1.5	85	83	6	\$4852
RA6030SPB	30 x 60 x 1.5	85	75	6	\$4188
RA5430SPB	30 x 54 x 1.5	85	68	5	\$3767
RA8422SPB	22 x 84 x 1.5	85	77	5	\$4684
RA7222SPB	22 x 72 x 1.5	85	66	5	\$4017
RA6622SPB	22 x 66 x 1.5	85	61	5	\$3684
RA6022SPB	22 x 60 x 1.5	85	55	4	\$3349
RA5422SPB	22 x 54 x 1.5	85	50	4	\$3014
RA4822SPB	22 x 48 x 1.5	85	44	3	\$2902

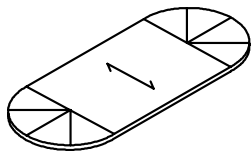

Racetrack Top Cross Grain Center, Sunburst Veneer Pattern on Left & Right

Grain runs the **depth** of the worksurface. Tops 120" and under are shipped in one piece and require 2 bases. Tops 144" and over are shipped in two pieces and require 3 bases.

Required Specifications

Veneer Finish

Optional Specifications

Boardroom Table Base

Grommet

Custom cut-out

BOARDROOM TABLES - TOPS W/PHILADELPHIA EDGE MODEL# DIMENSIONS FREIGHT CLASS WT/LBS. CUBIC FT. LIST PRICE

D x W x H

OV24054PB	54 x 240 x 1.5	85	540	39	\$27685
OV21654PB	54 x 216 x 1.5	85	486	35	\$23658
OV19254PB	54 x 192 x 1.5	85	432	31	\$22463
OV16848PB	48 x 168 x 1.5	85	336	25	\$17252
OV14448PB	48 x 144 x 1.5	85	288	21	\$13928
OV12048PB	48 x 120 x 1.5	85	240	18	\$11782
OV9648PB	48 x 96 x 1.5	85	192	14	\$9748
OV8442PB	42 x 84 x 1.5	85	147	11	\$8785
OV7242PB	42 x 72 x 1.5	85	126	9	\$7840
OV8436PB	36 x 84 x 1.5	85	126	9	\$7840
OV7236PB	36 x 72 x 1.5	85	108	8	\$6716
OV6636PB	36 x 66 x 1.5	85	99	7	\$5137
OV8430PB	30 x 84 x 1.5	85	105	8	\$6530
OV7230PB	30 x 72 x 1.5	85	90	7	\$5599
OV6630PB	30 x 66 x 1.5	85	83	6	\$5137
OV6030PB	30 x 60 x 1.5	85	75	6	\$4667
OV5430PB	30 x 54 x 1.5	85	68	5	\$4204
OV8422PB	22 x 84 x 1.5	85	77	6	\$5224
OV7222PB	22 x 72 x 1.5	85	66	5	\$4479
OV6622PB	22 x 66 x 1.5	85	61	5	\$4104
OV6022PB	22 x 60 x 1.5	85	55	4	\$3731
OV5422PB	22 x 54 x 1.5	85	50	4	\$3363
OV4822PB	22 x 48 x 1.5	85	44	3	\$3236

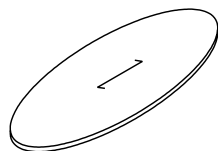

Oval Top

Grain runs the **length** of the worksurface. Tops 120" and under are shipped in one piece and require 2 bases. Tops 144" and over are shipped in two pieces and require 3 bases.

B024054PB	54 x 240 x 1.5	85	540	39	\$18732
B021654PB	54 x 216 x 1.5	85	486	35	\$16837
B019254PB	54 x 192 x 1.5	85	432	31	\$14938
B016848PB	48 x 168 x 1.5	85	336	25	\$11899
B014448PB	48 x 144 x 1.5	85	288	21	\$9629
B012048PB	48 x 120 x 1.5	85	240	18	\$8063
B09648PB	48 x 96 x 1.5	85	192	14	\$6549
B08442PB	42 x 84 x 1.5	85	147	11	\$6042
B07242PB	42 x 72 x 1.5	85	126	9	\$5317

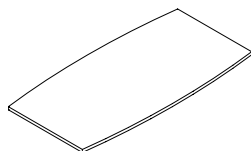

Boat Shape Top

Grain runs the **length** of the worksurface. Tops 120" and under are shipped in one piece and require 2 bases. Tops 144" and over are shipped in two pieces and require 3 bases.

BOBE24054PB	54 x 240 x 1.5	85	540	39	\$21539
BOBE21654PB	54 x 216 x 1.5	85	486	35	\$19363
BOBE19254PB	54 x 192 x 1.5	85	432	31	\$17182
BOBE5454PB	54 x 54 x 1.5	85	121	9	\$4832
BOBE16848PB	48 x 168 x 1.5	85	336	25	\$13687
BOBE14448PB	48 x 144 x 1.5	85	288	21	\$11070
BOBE12048PB	48 x 120 x 1.5	85	240	18	\$9272
BOBE9648PB	48 x 96 x 1.5	85	96	7	\$7531
BOBE4848PB	48 x 48 x 1.5	85	96	7	\$4076
BOBE8442PB	42 x 84 x 1.5	85	147	11	\$6737
BOBE7242PB	42 x 72 x 1.5	85	126	9	\$6116
BOBE4242PB	42 x 42 x 1.5	85	74	5	\$3569

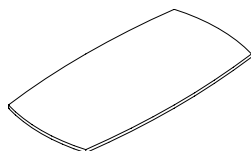

Boat Shape Top - Bow Ends

Grain runs the **length** of the worksurface. Tops 120" and under are shipped in one piece and require 2 bases. Tops 144" and over are shipped in two pieces and require 3 bases.

Required Specifications

Veneer Finish

Optional Specifications

Boardroom Table Base
Grommet
Custom cut-out

T BOARDROOM TABLES - PHILADELPHIA

BOARDROOM TABLES - TOPS W/PHILADELPHIA EDGE

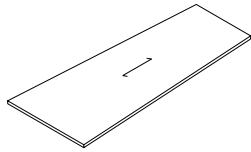

Wedge Shape Top

MODEL#	DIMENSIONS D x W x H	FREIGHT CLASS	WT/LBS.	CUBIC FT.	LIST PRICE
WE2405442PB	54 - 42 x 240 x 1.5	85	540	39	\$16455
WE2165442PB	54 - 42 x 216 x 1.5	85	486	35	\$14938
WE1925442PB	54 - 42 x 192 x 1.5	85	432	31	\$13039
WE1684836PB	48 - 36 x 168 x 1.5	85	336	25	\$10004
WE1444836PB	48 - 36 x 144 x 1.5	85	288	21	\$7919
WE1204836PB	48 - 36 x 120 x 1.5	85	240	18	\$6730
WE964836PB	48 - 36 x 96 x 1.5	85	192	14	\$5870
WE844230PB	42 - 30 x 84 x 1.5	85	147	11	\$4751
WE724230PB	42 - 30 x 72 x 1.5	85	126	9	\$4181
WE843624PB	36 - 24 x 84 x 1.5	85	126	9	\$4181
WE723624PB	36 - 24 x 72 x 1.5	85	108	8	\$3590
WE663624PB	36 - 24 x 66 x 1.5	85	99	7	\$2741

Grain runs the **length** of the worksurface. Tops 120" and under are shipped in one piece and require 2 bases. Tops 144" and over are shipped in two pieces and require 3 bases.

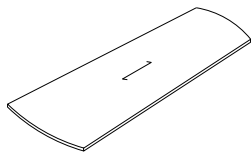

Wedge Shape Top - Bow Ends

WEBE2405442PB	54 - 42 x 240 x 1.5	85	540	39	\$18921
WEBE2165442PB	54 - 42 x 216 x 1.5	85	486	35	\$17182
WEBE1925442PB	54 - 42 x 192 x 1.5	85	432	31	\$14997
WEBE1684836PB	48 - 36 x 168 x 1.5	85	336	25	\$11505
WEBE1444836PB	48 - 36 x 144 x 1.5	85	288	21	\$9109
WEBE1204836PB	48 - 36 x 120 x 1.5	85	240	18	\$7742
WEBE964836PB	48 - 36 x 96 x 1.5	85	192	14	\$6000
WEBE844230PB	42 - 30 x 84 x 1.5	85	147	11	\$5464
WEBE724230PB	42 - 30 x 72 x 1.5	85	126	9	\$4808
WEBE843624PB	36 - 24 x 84 x 1.5	85	126	9	\$4808
WEBE723624PB	36 - 24 x 72 x 1.5	85	108	8	\$4126
WEBE663624PB	36 - 24 x 66 x 1.5	85	99	7	\$3148

Grain runs the **length** of the worksurface. Tops 120" and under are shipped in one piece and require 2 bases. Tops 144" and over are shipped in two pieces and require 3 bases.

Required Specifications

Veneer Finish

Optional Specifications

Boardroom Table Base
Grommet
Custom cut-out

BOARDROOM TABLES - TOPS W/KINGSTON EDGE

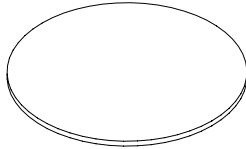

Round Top

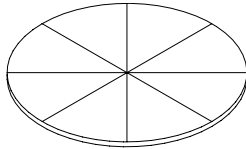

Round Top - Sunburst Veneer Pattern

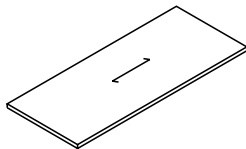

Rectangular Top

MODEL#	DIMENSIONS	FREIGHT CLASS	WT/LBS.	CUBIC FT.	LIST PRICE
D x W x H					
RO60K	60 x 60 x 1.5	85	150	11	\$5809
RO48K	48 x 48 x 1.5	85	96	7	\$4648
RO42K	42 x 42 x 1.5	85	74	6	\$4174
RO36K	36 x 36 x 1.5	85	54	4	\$3722
RO30K	30 x 30 x 1.5	85	38	3	\$3104

For use with Drum Base, Pedestal Base, Cross Base, Wood Post Legs, Metal Post Legs, 4 Prong Base, Post leg w/Flat Plate, Flat Square Column Base, Trumpet Column base, Flat Bar "X" Base", Square Panel Base.

RO60SK	60 x 60 x 1.5	85	150	11	\$6386
RO48SK	48 x 48 x 1.5	85	96	7	\$5248
RO42SK	42 x 42 x 1.5	85	74	6	\$4541
RO36SK	36 x 36 x 1.5	85	54	4	\$4085
RO30SK	30 x 30 x 1.5	85	38	3	\$3620

For use with Drum Base, Pedestal Base, Cross Base, Wood Post Legs, Metal Post Legs, 4 Prong Base, Post leg w/Flat Plate, Flat Square Column Base, Trumpet Column base, Flat Bar "X" Base", Square Panel Base.

RE24054K	54 x 240 x 1.5	85	540	39	\$18100
RE21654K	54 x 216 x 1.5	85	486	35	\$16431
RE19254K	54 x 192 x 1.5	85	432	31	\$14343
RE5454K	54 x 54 x 1.5	85	121	9	\$4034
RE16848K	48 x 168 x 1.5	85	336	25	\$11004
RE14448K	48 x 144 x 1.5	85	288	21	\$8710
RE12048K	48 x 120 x 1.5	85	240	18	\$7403
RE9648K	48 x 96 x 1.5	85	192	14	\$5740
RE4848K	48 x 48 x 1.5	85	96	7	\$2867
RE8442K	42 x 84 x 1.5	85	147	11	\$5226
RE7242K	42 x 72 x 1.5	85	126	9	\$4598
RE4242K	42 x 42 x 1.5	85	74	5	\$2686
RE8436K	36 x 84 x 1.5	85	126	9	\$4676
RE7236K	36 x 72 x 1.5	85	108	8	\$3948
RE6636K	36 x 66 x 1.5	85	99	7	\$3014
RE3636K	36 x 36 x 1.5	85	54	4	\$1643
RE8430K	30 x 84 x 1.5	85	105	8	\$3834
RE7230K	30 x 72 x 1.5	85	90	7	\$3292
RE6630K	30 x 66 x 1.5	85	83	6	\$3014
RE6030K	30 x 60 x 1.5	85	75	6	\$2736
RE5430K	30 x 54 x 1.5	85	68	5	\$2472
RE3030K	30 x 30 x 1.5	85	38	3	\$1371
RE8424K	24 x 84 x 1.5	85	84	6	\$3346
RE7224K	24 x 72 x 1.5	85	72	5	\$2863
RE6624K	24 x 66 x 1.5	85	66	5	\$2627
RE6024K	24 x 60 x 1.5	70	60	4	\$2388
RE5424K	24 x 54 x 1.5	85	55	4	\$2153
RE4824K	24 x 48 x 1.5	70	48	3	\$2067
RE2424K	24 x 24 x 1.5	125	21	3	\$954
RE8422K	22 x 84 x 1.5	85	77	6	\$3072
RE7222K	22 x 72 x 1.5	85	66	5	\$2627
RE6622K	22 x 66 x 1.5	85	61	5	\$2412
RE6022K	22 x 60 x 1.5	85	55	4	\$2194
RE5422K	22 x 54 x 1.5	85	50	4	\$1969
RE4822K	22 x 48 x 1.5	85	44	3	\$1898
RE2222K	22 x 22 x 1.5	92.5	20	2	\$873

Grain runs the **length** of the worksurface. Tops 120" and under are shipped in one piece and require 2 bases. Tops 144" and over are shipped in two pieces and require 3 bases.

Required Specifications

Veneer Finish

Optional Specifications

Boardroom Table Base
Grommet
Custom cut-out

T BOARDROOM TABLES - KINGSTON

BOARDROOM TABLES - TOPS W/KINGSTON EDGE

MODEL# DIMENSIONS FREIGHT CLASS WT/LBS. CUBIC FT. LIST PRICE

D x W x H

RE24054FK	54 x 240 x 1.5	85	540	39	\$20517
RE21654FK	54 x 216 x 1.5	85	486	35	\$18687
RE19254FK	54 x 192 x 1.5	85	432	31	\$16383
RE5454FK	54 x 54 x 1.5	85	121	9	\$4610
RE16848FK	48 x 168 x 1.5	85	336	25	\$12719
RE14448FK	48 x 144 x 1.5	85	288	21	\$10193
RE12048FK	48 x 120 x 1.5	85	240	18	\$8551
RE9648FK	48 x 96 x 1.5	85	192	14	\$6722
RE4848FK	48 x 48 x 1.5	85	96	7	\$3360
RE8442FK	42 x 84 x 1.5	85	147	11	\$4451
RE7242FK	42 x 72 x 1.5	85	126	9	\$5413
RE4242FK	42 x 42 x 1.5	85	74	5	\$3164
RE8436FK	36 x 84 x 1.5	85	126	9	\$5413
RE7236FK	36 x 72 x 1.5	85	108	8	\$4642
RE6636FK	36 x 66 x 1.5	85	99	7	\$3548
RE3636FK	36 x 36 x 1.5	85	54	4	\$2266
RE8430FK	30 x 84 x 1.5	85	105	8	\$4508
RE7230FK	30 x 72 x 1.5	85	90	7	\$4020
RE6630FK	30 x 66 x 1.5	85	83	6	\$3870
RE6030FK	30 x 60 x 1.5	85	75	6	\$3548
RE5430FK	30 x 54 x 1.5	85	68	5	\$2902
RE3030FK	30 x 30 x 1.5	85	38	3	\$1610

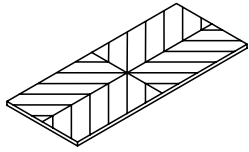

**Rectangular Top -
Reverse Diamond Pattern**

Tops 120" and under are shipped in one piece and require 2 bases. Tops 144" and over are shipped in two pieces and require 3 bases.

RRE24054K	54 x 240 x 1.5	85	540	39	\$21735
RRE21654K	54 x 216 x 1.5	85	486	35	\$19813
RRE19254K	54 x 192 x 1.5	85	432	31	\$17414
RRE5454K	54 x 54 x 1.5	85	121	9	\$4903
RRE16848K	48 x 168 x 1.5	85	336	25	\$13574
RRE14448K	48 x 144 x 1.5	85	288	21	\$10934
RRE12048K	48 x 120 x 1.5	85	240	18	\$9131
RRE9648K	48 x 96 x 1.5	85	192	14	\$7213
RRE4848K	48 x 48 x 1.5	85	96	7	\$3604
RRE8442K	42 x 84 x 1.5	85	147	11	\$6540
RRE7242K	42 x 72 x 1.5	85	126	9	\$5824
RRE4242K	42 x 42 x 1.5	85	74	5	\$3400
RRE8436K	36 x 84 x 1.5	85	126	9	\$5824
RRE7236K	36 x 72 x 1.5	85	108	8	\$4989
RRE6636K	36 x 66 x 1.5	85	99	7	\$3813
RRE3636K	36 x 36 x 1.5	85	54	4	\$2082
RRE8430K	30 x 84 x 1.5	85	105	8	\$4855
RRE7230K	30 x 72 x 1.5	85	90	7	\$4157
RRE6630K	30 x 66 x 1.5	85	83	6	\$3813
RRE6030K	30 x 60 x 1.5	85	75	6	\$3464
RRE5430K	30 x 54 x 1.5	85	68	5	\$3124
RRE3030K	30 x 30 x 1.5	85	38	3	\$1738

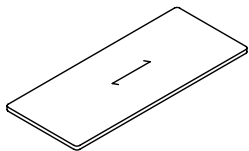

Rectangular Top - Radius Corners

Grain runs the **length** of the worksurface. Tops 120" and under are shipped in one piece and require 2 bases. Tops 144" and over are shipped in two pieces and require 3 bases.

Required Specifications

Veneer Finish

Optional Specifications

Boardroom Table Base

Grommet

Custom cut-out

BOARDROOM TABLES - TOPS W/KINGSTON EDGE **MODEL#** **DIMENSIONS** **FREIGHT CLASS** **WT/LBS.** **CUBIC FT.** **LIST PRICE**

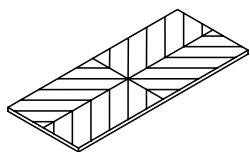

Rectangular Top - Radius Corners
Reverse Diamond Pattern

	D x W x H					
RRE24054FK	54 x 240 x 1.5	85	540	39		\$24515
RRE21654FK	54 x 216 x 1.5	85	486	35		\$22403
RRE19254FK	54 x 192 x 1.5	85	432	31		\$19761
RRE5454FK	54 x 54 x 1.5	85	121	9		\$5561
RRE16848FK	48 x 168 x 1.5	85	336	25		\$15542
RRE14448FK	48 x 144 x 1.5	85	288	21		\$12634
RRE12048FK	48 x 120 x 1.5	85	240	18		\$10449
RRE9648FK	48 x 96 x 1.5	85	192	14		\$8329
RRE4848FK	48 x 48 x 1.5	85	96	7		\$4171
RRE8442FK	42 x 84 x 1.5	85	147	11		\$7550
RRE7242FK	42 x 72 x 1.5	85	126	9		\$6755
RRE4242FK	42 x 42 x 1.5	85	74	5		\$3941
RRE8436FK	36 x 84 x 1.5	85	126	9		\$6755
RRE7236FK	36 x 72 x 1.5	85	108	8		\$5796
RRE6636FK	36 x 66 x 1.5	85	99	7		\$4428
RRE3636FK	36 x 36 x 1.5	85	54	4		\$2420
RRE8430FK	30 x 84 x 1.5	85	105	8		\$5629
RRE7230FK	30 x 72 x 1.5	85	90	7		\$4828
RRE6630FK	30 x 66 x 1.5	85	83	6		\$4428
RRE6030FK	30 x 60 x 1.5	85	75	6		\$4020
RRE5430FK	30 x 54 x 1.5	85	68	5		\$3623
RRE3030FK	30 x 30 x 1.5	85	38	3		\$2015

Tops 120" and under are shipped in one piece and require 2 bases. Tops 144" and over are shipped in two pieces and require 3 bases.

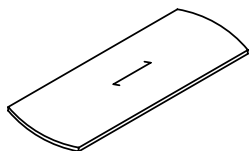

Rectangular Top - Bow Ends

REBE24054K	54 x 240 x 1.5	85	540	39		\$20814
REBE21654K	54 x 216 x 1.5	85	486	35		\$18900
REBE19254K	54 x 192 x 1.5	85	432	31		\$16498
REBE16848K	48 x 168 x 1.5	85	336	25		\$12655
REBE14448K	48 x 144 x 1.5	85	288	21		\$10020
REBE12048K	48 x 120 x 1.5	85	240	18		\$8516
REBE9648K	48 x 96 x 1.5	85	192	14		\$6598
REBE8442K	42 x 84 x 1.5	85	147	11		\$6009
REBE7242K	42 x 72 x 1.5	85	126	9		\$5289
REBE8436K	36 x 84 x 1.5	85	126	9		\$5290
REBE7236K	36 x 72 x 1.5	85	108	8		\$4538
REBE6636K	36 x 66 x 1.5	85	99	7		\$3462
REBE8430K	30 x 84 x 1.5	85	105	8		\$4413
REBE7230K	30 x 72 x 1.5	85	90	7		\$3784
REBE6630K	30 x 66 x 1.5	85	83	6		\$3462
REBE6030K	30 x 60 x 1.5	85	75	6		\$3147
REBE5430K	30 x 54 x 1.5	85	68	5		\$2839

Grain runs the **length** of the worksurface. Tops 120" and under are shipped in one piece and require 2 bases. Tops 144" and over are shipped in two pieces and require 3 bases.

Required Specifications

Veneer Finish

Optional Specifications

Boardroom Table Base
Grommet
Custom cut-out

T BOARDROOM TABLES - KINGSTON

BOARDROOM TABLES - TOPS W/KINGSTON EDGE

MODEL# DIMENSIONS FREIGHT CLASS WT/LBS. CUBIC FT. LIST PRICE

D x W x H

RA24054K	54 x 240 x 1.5	85	540	39	\$24362
RA21654K	54 x 216 x 1.5	85	486	35	\$20814
RA19254K	54 x 192 x 1.5	85	432	31	\$19773
RA16848K	48 x 168 x 1.5	85	336	25	\$15179
RA14448K	48 x 144 x 1.5	85	288	21	\$12259
RA12048K	48 x 120 x 1.5	85	240	18	\$10538
RA9648K	48 x 96 x 1.5	85	192	14	\$8578
RA8442K	42 x 84 x 1.5	85	147	11	\$7728
RA7242K	42 x 72 x 1.5	85	126	9	\$6896
RA8436K	36 x 84 x 1.5	85	126	9	\$6896
RA7236K	36 x 72 x 1.5	85	108	8	\$5907
RA6636K	36 x 66 x 1.5	85	99	7	\$4514
RA8430K	30 x 84 x 1.5	85	105	8	\$5746
RA7230K	30 x 72 x 1.5	85	90	7	\$4926
RA6630K	30 x 66 x 1.5	85	83	6	\$4514
RA6030K	30 x 60 x 1.5	85	75	6	\$4105
RA5430K	30 x 54 x 1.5	85	68	5	\$3698
RA8422K	22 x 84 x 1.5	85	77	6	\$4598
RA7222K	22 x 72 x 1.5	85	61	5	\$3948
RA6622K	22 x 66 x 1.5	85	61	5	\$3616
RA6022K	22 x 60 x 1.5	85	55	4	\$3286
RA5422K	22 x 54 x 1.5	85	50	4	\$2963
RA4822K	22 x 48 x 1.5	85	44	3	\$2850

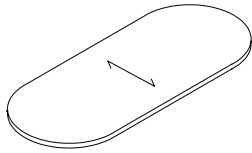

Racetrack Top - Cross Grain

Grain runs the **depth** of the worksurface. Tops 120" and under are shipped in one piece and require 2 bases. Tops 144" and over are shipped in two pieces and require 3 bases.

RA24054SK	54 x 240 x 1.5	85	540	39	\$27301
RA21654SK	54 x 216 x 1.5	85	486	35	\$23327
RA19254SK	54 x 192 x 1.5	85	432	31	\$22157
RA16848SK	48 x 168 x 1.5	85	336	25	\$17010
RA14448SK	48 x 144 x 1.5	85	288	21	\$13735
RA12048SK	48 x 120 x 1.5	85	240	18	\$11809
RA9648SK	48 x 96 x 1.5	85	192	14	\$9610
RA8442SK	42 x 84 x 1.5	85	147	11	\$8567
RA7242SK	42 x 72 x 1.5	85	126	9	\$7728
RA8436SK	36 x 84 x 1.5	85	126	9	\$7728
RA7236SK	36 x 72 x 1.5	85	108	8	\$6629
RA6636SK	36 x 66 x 1.5	85	99	7	\$5062
RA8430SK	30 x 84 x 1.5	85	105	8	\$6437
RA7230SK	30 x 72 x 1.5	85	90	7	\$5523
RA6630SK	30 x 66 x 1.5	85	83	6	\$5337
RA6030SK	30 x 60 x 1.5	85	75	6	\$4607
RA5430SK	30 x 54 x 1.5	85	68	5	\$4144
RA8422SK	22 x 84 x 1.5	85	77	6	\$5153
RA7222SK	22 x 72 x 1.5	85	66	5	\$4418
RA6622SK	22 x 66 x 1.5	85	61	5	\$4053
RA6022SK	22 x 60 x 1.5	85	55	4	\$3683
RA5422SK	22 x 54 x 1.5	85	50	4	\$3316
RA4822SK	22 x 48 x 1.5	85	44	3	\$3191

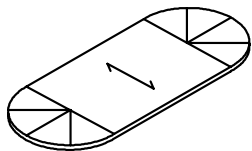

Racetrack Top Cross Grain Center, Sunburst Veneer Pattern on Left & Right

Grain runs the **depth** of the worksurface. Tops 120" and under are shipped in one piece and require 2 bases. Tops 144" and over are shipped in two pieces and require 3 bases.

Required Specifications

Veneer Finish

Optional Specifications

Boardroom Table Base

Grommet

Custom cut-out

BOARDROOM TABLES - TOPS W/KINGSTON EDGE

MODEL# DIMENSIONS FREIGHT CLASS WT/LBS. CUBIC FT. LIST PRICE

D x W x H

OV24054K	54 x 240 x 1.5	85	540	39	\$30454
OV21654K	54 x 216 x 1.5	85	486	35	\$26024
OV19254K	54 x 192 x 1.5	85	432	31	\$24711
OV16848K	48 x 168 x 1.5	85	336	25	\$18978
OV14448K	48 x 144 x 1.5	85	288	21	\$15321
OV12048K	48 x 120 x 1.5	85	240	18	\$12959
OV9648K	48 x 96 x 1.5	85	192	14	\$10723
OV8442K	42 x 84 x 1.5	85	147	11	\$9662
OV7242K	42 x 72 x 1.5	85	126	9	\$8624
OV8436K	36 x 84 x 1.5	85	126	9	\$8624
OV7236K	36 x 72 x 1.5	85	108	8	\$7388
OV6636K	36 x 66 x 1.5	85	99	7	\$5650
OV8430K	30 x 84 x 1.5	85	105	8	\$7183
OV7230K	30 x 72 x 1.5	85	90	7	\$6158
OV6630K	30 x 66 x 1.5	85	83	6	\$5650
OV6030K	30 x 60 x 1.5	85	75	6	\$5134
OV5430K	30 x 54 x 1.5	85	68	5	\$4625
OV8422K	22 x 84 x 1.5	85	77	6	\$5746
OV7222K	22 x 72 x 1.5	85	66	5	\$4926
OV6622K	22 x 66 x 1.5	85	61	5	\$4514
OV6022K	22 x 60 x 1.5	85	55	4	\$4105
OV5422K	22 x 54 x 1.5	85	50	4	\$3698
OV4822K	22 x 48 x 1.5	85	44	3	\$3560

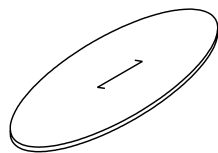

Oval Top

Grain runs the **length** of the worksurface. Tops 120" and under are shipped in one piece and require 2 bases. Tops 144" and over are shipped in two pieces and require 3 bases.

B024054K	54 x 240 x 1.5	85	540	39	\$20605
B021654K	54 x 216 x 1.5	85	486	35	\$18521
B019254K	54 x 192 x 1.5	85	432	31	\$16431
B016848K	48 x 168 x 1.5	85	336	25	\$13088
B014448K	48 x 144 x 1.5	85	288	21	\$10592
B012048K	48 x 120 x 1.5	85	240	18	\$8869
B09648K	48 x 96 x 1.5	85	192	14	\$7204
B08442K	42 x 84 x 1.5	85	147	11	\$6646
B07242K	42 x 72 x 1.5	85	126	9	\$5849

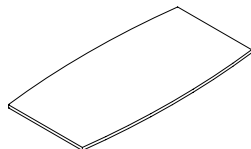

Boat Shape Top

Grain runs the **length** of the worksurface. Tops 120" and under are shipped in one piece and require 2 bases. Tops 144" and over are shipped in two pieces and require 3 bases.

BOBE24054K	54 x 240 x 1.5	85	540	39	\$23692
BOBE21654K	54 x 216 x 1.5	85	486	35	\$21299
BOBE19254K	54 x 192 x 1.5	85	432	31	\$18900
BOBE5454K	54 x 54 x 1.5	85	121	9	\$5316
BOBE16848K	48 x 168 x 1.5	85	336	25	\$15055
BOBE14448K	48 x 144 x 1.5	85	288	21	\$12178
BOBE12048K	48 x 120 x 1.5	85	240	18	\$10199
BOBE9648K	48 x 96 x 1.5	85	192	14	\$8284
BOBE4848K	48 x 48 x 1.5	85	96	7	\$4484
BOBE8442K	42 x 84 x 1.5	85	147	11	\$7410
BOBE7242K	42 x 72 x 1.5	85	126	9	\$6727
BOBE4242K	42 x 42 x 1.5	85	74	5	\$3926

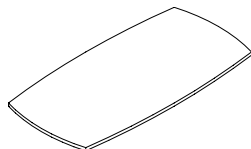

Boat Shape Top - Bow Ends

Grain runs the **length** of the worksurface. Tops 120" and under are shipped in one piece and require 2 bases. Tops 144" and over are shipped in two pieces and require 3 bases.

Required Specifications

Veneer Finish

Optional Specifications

Boardroom Table Base
Grommet
Custom cut-out

T BOARDROOM TABLES - KINGSTON

BOARDROOM TABLES - TOPS W/KINGSTON EDGE

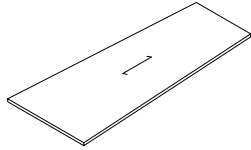

Wedge Shape Top

MODEL#	DIMENSIONS D x W x H	FREIGHT CLASS	WT/LBS.	CUBIC FT.	LIST PRICE
WE2405442K	54 - 42 x 240 x 1.5	85	540	39	\$18100
WE2165442K	54 - 42 x 216 x 1.5	85	486	35	\$16431
WE1925442K	54 - 42 x 192 x 1.5	85	432	31	\$14343
WE1684836K	48 - 36 x 168 x 1.5	85	336	25	\$11004
WE1444836K	48 - 36 x 144 x 1.5	85	288	21	\$8710
WE1204836K	48 - 36 x 120 x 1.5	85	240	18	\$7403
WE964836K	48 - 36 x 96 x 1.5	85	192	14	\$6457
WE844230K	42 - 30 x 84 x 1.5	85	147	11	\$5226
WE724230K	42 - 30 x 72 x 1.5	85	126	9	\$4598
WE843624K	36 - 24 x 84 x 1.5	85	126	9	\$4598
WE723624K	36 - 24 x 72 x 1.5	85	108	8	\$3948
WE663624K	36 - 24 x 66 x 1.5	85	99	7	\$3014

Grain runs the **length** of the worksurface. Tops 120" and under are shipped in one piece and require 2 bases. Tops 144" and over are shipped in two pieces and require 3 bases.

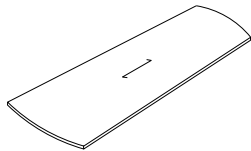

Wedge Shape Top - Bow Ends

WEBE2405442K	54 - 42 x 240 x 1.5	85	540	39	\$20814
WEBE2165442K	54 - 42 x 216 x 1.5	85	486	35	\$18900
WEBE1925442K	54 - 42 x 192 x 1.5	85	432	31	\$16496
WEBE1684836K	48 - 36 x 168 x 1.5	85	336	25	\$12655
WEBE1444836K	48 - 36 x 144 x 1.5	85	288	21	\$10020
WEBE1204836K	48 - 36 x 120 x 1.5	85	240	18	\$8516
WEBE964836K	48 - 36 x 96 x 1.5	85	192	14	\$6599
WEBE844230K	42 - 30 x 84 x 1.5	85	147	11	\$6009
WEBE724230K	42 - 30 x 72 x 1.5	85	126	9	\$5289
WEBE843624K	36 - 24 x 84 x 1.5	85	126	9	\$5289
WEBE723624K	36 - 24 x 72 x 1.5	85	108	8	\$4538
WEBE663624K	36 - 24 x 66 x 1.5	85	99	7	\$3462

Grain runs the **length** of the worksurface. Tops 120" and under are shipped in one piece and require 2 bases. Tops 144" and over are shipped in two pieces and require 3 bases.

Required Specifications

Veneer Finish

Optional Specifications

Boardroom Table Base
Grommet
Custom cut-out

BOARDROOM TABLE BASES - ALL SERIES

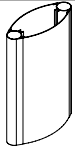

Elliptical Base*

MODEL#	DIMENSIONS	FREIGHT CLASS	WT/LBS.	CUBIC FT.	LIST PRICE
D x W x H					
TE42	8 x 42 x 28	100	70	8	\$1965
TE36	7 x 36 x 28	92.5	60	6	\$1965
TE30	6 x 30 x 28	85	50	4	\$1904
TE24	6 x 24 x 28	70	40	2	\$1827

Not to be used with round table tops. For tops up to 120", two Elliptical Bases must be ordered. For tops 144" and more, three Elliptical Bases must be ordered.

• **Plastic end gables are available in a Tungsten (K) or Black (E) finish. Please specify.**

- For 30" and 36" deep tops, order a 24" base (**TE24**).
- For 42" and 48" deep tops, order a 30" base (**TE30**).
- For 54" and 60" deep tops, order a 36" base (**TE36**) or 42" base (**TE42**).

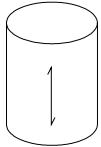

Drum Base - Veneer

TD30	30 x 30 x 28	125	93	15	\$3207
TD22	22 x 22 x 28	100	70	8	\$1545
TD18	18 x 18 x 28	85	62	5	\$1346

For tops up to 120", two Drum Bases must be ordered. For tops 144" and more, three Drum Bases must be ordered. Sand bag included to provide adequate stability.

- For 30", 36" and 42" deep tops, order a 18" base (**TD18**).
- For 48" and 54" deep tops, order a 22" base (**TD22**).
- For 60" deep tops, order a 30" base (**TD30**).

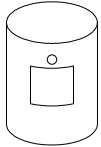

Drum Base with Power Access Door - Veneer

TD30J	30 x 30 x 28	125	93	15	\$4009
TD22J	22 x 22 x 28	100	70	8	\$2350
TD18J	18 x 18 x 28	85	62	5	\$2149

Access door and top and bottom cut-out to accommodate power/data grommet. For tops up to 120", two Drum Bases must be ordered. For tops 144" and more, three Drum Bases must be ordered. Sand bag included to provide adequate stability.

- Power access door is 12" x 12"
- For 30", 36" and 42" deep tops, order a 18" base (**TD18J**).
- For 48" and 54" deep tops, order a 22" base (**TD22J**).
- For 60" deep tops, order a 30" base (**TD30J**).

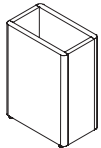

Rectangular Wood Pedestal Base

TP2412	12 x 24 x 28	85	86	7	\$1845
TP2012	12 x 20 x 28	70	71	4	\$1756
TP1612	12 x 16 x 28	70	58	3	\$1678

For tops up to 120", two Pedestal Bases must be ordered. For tops 144" and more, three Pedestal Bases must be ordered.

- For 30", 36" and 42" deep tops, order a 16" base (**TP1612**).
- For 48" and 54" deep tops, order a 20" base (**TP2012**).
- For 60" deep tops, order a 24" base (**TP2412**).

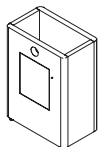

Rectangular Wood Pedestal Base w/Power Access Door

TP2412J	12 x 24 x 28	85	86	7	\$2423
TP2012J	12 x 20 x 28	70	71	4	\$2362
TP1612J	12 x 16 x 28	70	58	3	\$2289

Access door and top and bottom cut-out to accommodate power/data grommet. For tops up to 120", two Pedestal Bases must be ordered. For tops 144" and more, three Pedestal Bases must be ordered.

- Power access door is 12" x 12"
- For 30", 36" and 42" deep tops, order a 16" base (**TP1612J**).
- For 48" and 54" deep tops, order a 20" base (**TP2012J**).
- For 60" deep tops, order a 24" base (**TP2412J**).

Required Specifications

Veneer finish
Plastic finish*

T BOARDROOM TABLES

BOARDROOM TABLE BASES - ALL SERIES

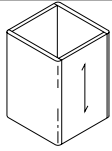

Pedestal Base

MODEL#	DIMENSIONS D x W x H	FREIGHT CLASS	WT/LBS.	CUBIC FT.	LIST PRICE	ALL VENEER
TP24	24 x 24 x 28	92.5	106	10	\$1678	
TP20	20 x 20 x 28	85	89	7	\$1612	
TP16	16 x 16 x 28	70	71	4	\$1545	

For tops up to 120", two pedestal bases must be ordered. For tops 144" and more, three pedestal bases must be ordered.

- For 30", 36" and 42" deep tops, order a 16" base (**TP16**).
- For 48" and 54" deep tops, order a 20" base (**TP20**).
- For 60" deep tops, order a 24" base (**TP24**).

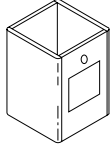

Pedestal Base with Power Access Door

TP24J	24 x 24 x 28	92.5	106	10	\$2483	
TP20J	20 x 20 x 28	85	89	7	\$2416	
TP16J	16 x 16 x 28	70	71	4	\$2350	

Access door and top and bottom cut-out to accommodate power/data grommet. For tops up to 120", two pedestal bases must be ordered. For tops 144" and more, three pedestal bases must be ordered.

- Power access door is 12" x 12"
- For 30", 36" and 42" deep tops, order a 16" base (**TP16J**).
- For 48" and 54" deep tops, order a 20" base (**TP20J**).
- For 60" deep tops, order a 24" base (**TP24J**).

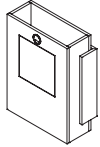

Lam. Pedestal Base w/Power Access Door + Decorative Outside Panel

TPML24J	10 x 24 x 28	92.5	53	5	\$2800	
TPML20J	10 x 20 x 28	85	43	3	\$2512	
TPML18J	10 x 18 x 28	70	36	2	\$2228	

Access door and top and bottom cut-out to accommodate power/data grommet. For tops up to 120", two pedestal bases must be ordered. For tops 144" and more, three pedestal bases must be ordered.

- Power access door is 12" x 12"
- For 30", 36" and 42" deep tops, order a 18" base (**TPML18J**).
- For 48" and 54" deep tops, order a 20" base (**TPML20J**).
- For 60" deep tops, order a 24" base (**TPML24J**).

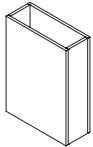

Laminate Rectangular Center Base

TPMLC24	10 x 24 x 28	92.5	53	5	\$1617	
TPMLC20	10 x 20 x 28	85	43	3	\$1528	
TPMLC18	10 x 18 x 28	70	36	2	\$1445	

For tops up to 120", two pedestal bases must be ordered. For tops 144" and more, three pedestal bases must be ordered.

- Power access door is 12" x 12"
- For 30", 36" and 42" deep tops, order a 18" base (**TPMLC18**).
- For 48" and 54" deep tops, order a 20" base (**TPMLC20**).
- For 60" deep tops, order a 24" base (**TPMLC24**).

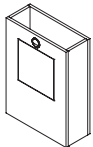

Laminate Rectangular Center Base w/Power Access Door

TPMLC24J	10 x 24 x 28	92.5	53	5	\$2073	
TPMLC20J	10 x 20 x 28	85	43	3	\$1984	
TPMLC18J	10 x 18 x 28	70	36	2	\$1906	

Access door and top and bottom cut-out to accommodate power/data grommet. For tops up to 120", two pedestal bases must be ordered. For tops 144" and more, three pedestal bases must be ordered.

- Power access door is 12" x 12"
- For 30", 36" and 42" deep tops, order a 18" base (**TPMLC18J**).
- For 48" and 54" deep tops, order a 20" base (**TPMLC20J**).
- For 60" deep tops, order a 24" base (**TPMLC24J**).

Required Specifications

Veneer finish
Laminate finish*

BOARDROOM TABLE BASES - ALL SERIES

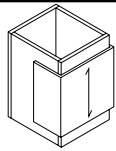

**Pedestal Base - Veneer
Decorative Outside Panel***

MODEL#	DIMENSIONS D x W x H	FREIGHT CLASS	WT/LBS.	CUBIC FT.	LIST PRICE	
TPM24	24 x 24 x 28	92.5	106	10	\$2599	\$3116
TPM20	20 x 20 x 28	85	86	7	\$2490	\$2987
TPM16	16 x 16 x 28	70	71	4	\$2392	\$2869

For tops up to 120", two pedestal bases must be ordered. For tops 144" and more, three pedestal bases must be ordered.

- For 30", 36" and 42" deep tops, order a 16" base (**TPM16**).
- For 48" and 54" deep tops, order a 20" base (**TPM20**).
- For 60" deep tops, order a 24" base (**TPM24**).

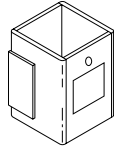

**Pedestal Base with Power Access Door
Veneer Decorative Outside Panel***

TPM24J	24 x 24 x 28	92.5	106	10	\$3020	\$3627
TPM20J	20 x 20 x 28	85	86	7	\$2910	\$3495
TPM16J	16 x 16 x 28	70	71	4	\$2932	\$3521

Access door and top and bottom cut-out to accommodate power/data grommet. For tops up to 120", two pedestal bases must be ordered. For tops 144" and more, three pedestal bases must be ordered.

- Power access door is 12" x 12"
- For 30", 36" and 42" deep tops, order a 16" base (**TPM16J**).
- For 48" and 54" deep tops, order a 20" base (**TPM20J**).
- For 60" deep tops, order a 24" base (**TPM24J**).

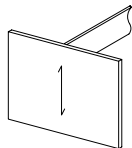

Slab Base

TH42	3 x 42 x 28	60	148	2	\$2353	
TH36	3 x 36 x 28	60	127	2	\$2123	
TH30	3 x 30 x 28	60	106	2	\$1545	
TH22	3 x 22 x 28	60	89	2	\$1338	

Not to be used with round table tops. For tops up to 120", two slab bases must be ordered. For tops 144" and more, three slab bases must be ordered.

- For 30" and 36" deep tops, order a 22" base (**TH22**).
- For 42" and 48" deep tops, order a 30" base (**TH30**).
- For 54" deep tops, order a 36" base (**TH36**).
- For 60" deep tops, order a 42" base (**TH42**).

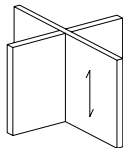

Cross Base

TX42	3 x 42 x 28	100	180	20	\$2269	
TX36	3 x 36 x 28	100	155	17	\$2123	
TX30	3 x 30 x 28	100	133	15	\$1545	
TX22	3 x 22 x 28	100	97	11	\$1338	

For tops up to 120", two cross bases must be ordered. For tops 144" and more, three cross bases must be ordered.

- For 30" and 36" deep tops, order a 22" base (**TX22**).
- For 42" and 48" deep tops, order a 30" base (**TX30**).
- For 54" deep tops, order a 36" base (**TX36**).
- For 60" deep tops, order a 42" base (**TX42**).

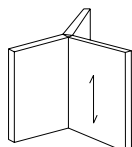

"Y" Base

TW42	4 x 42 x 28	125	140	20	\$1965	
TW36	4 x 36 x 28	125	120	17	\$1731	
TW30	4 x 30 x 28	125	100	15	\$1422	
TW22	4 x 22 x 28	125	73	11	\$1331	

Not to be used with round table tops. For tops up to 120", two "Y" bases must be ordered. For tops 144" and more, two "Y" bases and one cross base must be ordered.

- For 30" and 36" deep tops, order a 22" base (**TW22**).
- For 42" and 48" deep tops, order a 30" base (**TW30**).
- For 54" deep tops, order a 36" base (**TW36**).
- For 60" deep tops, order a 42" base (**TW42**).

Required Specifications

Veneer Finish (Veneer Post Legs)
Metal Finish (Metal Legs)

T BOARDROOM TABLES

BOARDROOM TABLE BASES - ALL SERIES

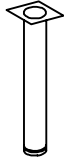

Post Leg Veneer

MODEL#	DIMENSIONS D x W x H	FREIGHT CLASS	WT/LBS.	CUBIC FT.	LIST PRICE
SN06	6 dia x 28	250	10	3	\$1617
SN04	4 dia x 28	125	7	1	\$1245
SN03	3 dia x 28	150	5	1	\$785

Available in 3", 4" and 6" diameters. Round tops and tops up to 96" require four legs. Tops 108" to 168" require six legs; tops 180" to 240" require ten legs.

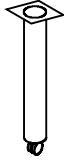

Post Leg Veneer w/Caster

SN06M	6 dia x 28	100	10	3	\$1708
SN04M	4 dia x 28	125	7	1	\$1335
SN03M	3 dia x 28	150	5	1	\$878

Available in 3", 4" and 6" diameters. Caster included. Round tops and tops up to 96" require four legs. Tops 108" to 168" require six legs; tops 180" to 240" require ten legs.

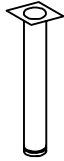

Post Leg Metal

SM06	6 dia x 28	100	10	3	\$1105
SM04	4 dia x 28	125	7	1	\$610
SM03	3 dia x 28	150	5	1	\$434

Available in 3", 4" and 6" diameters. Round tops and tops up to 96" require four legs. Tops 108" to 168" require six legs; tops 180" to 240" require ten legs.

• **Must Specify Black (E) or Tungsten (K) finish**

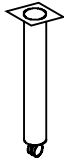

Post Leg Metal w/Casters

SM06M	6 dia x 28	100	10	3	\$1199
SM04M	4 dia x 28	125	7	1	\$702
SM03M	3 dia x 28	150	5	1	\$528

Available in 3", 4" and 6" diameters. Caster included. Round tops and tops up to 96" require four legs. Tops 108" to 168" require six legs; tops 180" to 240" require ten legs.

• **Must Specify Black (E) or Tungsten (K) finish**

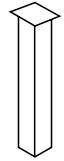

Post Leg Metal, Square

SMS4	4 x 4 x 28	125	7	1	\$479
------	------------	-----	---	---	--------------

Available in 4". Round tops and tops up to 96" require four legs. Tops 108" to 168" require six legs; tops 180" to 240" require ten legs.

• **Must Specify Black (E) or Tungsten (K) finish**

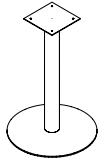

Post Leg w/Flat Plate

F6P36	36 x 36 x 28	150	100	22	\$3794
F4P30	30 x 30 x 28	150	80	15	\$2310
F4P24	24 x 24 x 28	125	60	10	\$1846
F3P18	18 x 18 x 28	100	45	5	\$1638

Round tops require a single base. For tops up to 120", two bases must be ordered. For tops 144" or more, three bases must be ordered.

• **Must Specify Black (E) or Tungsten (K) finish**

- For 30" deep tops, order a 18" base (**F3P18**).
- For 36" deep tops, order a 24" base (**F4P24**).
- For 42" and 48" deep tops, order a 30" base (**F4P30**).
- For 54" deep tops, order a 36" base (**F6P36**).

Required Specifications

Veneer Finish
* Laminate Finish

BOARDROOM TABLE BASES - ALL SERIES

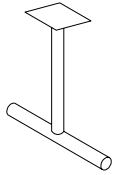

Tubular 2-Prong Base

MODEL#	DIMENSIONS D x W x H	FREIGHT CLASS	WT/LBS.	CUBIC FT.	LIST PRICE
TTM36	36 x 36 x 28	100	28	22	\$913
TTM26	26 x 26 x 28	85	24	11	\$876

Not to be used with round table tops. Two square edged prongs. For tops up to 84", two Tubular 2-Prong Bases must be ordered. Used as a 3rd base to provide center support in conjunction with two 3-Prong bases on tops 144" or more.

- **Must Specify Black (E) or Tungsten (K) finish**
- For 30", 36" and 42" deep tops, order a 26" base (**TTM26**).
- For 48", 54" and 60" deep tops, order a 36" base (**TTM36**).

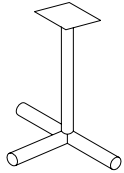

Tubular 3-Prong Base

TTE36	36 x 36 x 28	250	36	22	\$973
TTE26	26 x 26 x 28	85	32	11	\$866

Not to be used with round table tops. Three square edged prongs. For tops up to 120", two Tubular 3-Prong Bases must be ordered. For tops 144" and more, two Tubular 3-Prong Bases and one Tubular 2-Prong Base for the center must be ordered.

- **Must Specify Black (E) or Tungsten (K) finish**
- For 30", 36" and 42" deep tops, order a 26" base (**TTE26**).
- For 48", 54" and 60" deep tops, order a 36" base (**TTE36**).

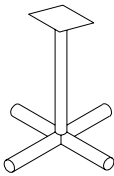

Tubular 4-Prong Base

TT36	36 x 36 x 28	300	40	22	\$1458
TT26	26 x 26 x 28	250	36	11	\$1005

Four square edged prongs. For tops up to 120", two Tubular 4-Prong Bases must be ordered. For tops 144" and more, three Tubular 4-Prong Bases must be ordered.

- **Must Specify Black (E) or Tungsten (K) finish**
 - For 30", 36" and 42" deep tops, order a 26" base (**TT26**).
 - For 48" and 54" deep tops, order a 36" base (**TT36**)*
- * Maximum diameter for Round Tops is 54".

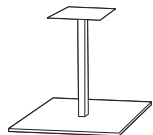

Flat Square Column Base

TTSQ23BH	23 x 23 x 41	150	75	14	\$3635
TTSQ18BH	18 x 18 x 41	125	65	10	\$3367
TTSQ30	30 x 30 x 28	150	80	14	\$3771
TTSQ23	23 x 23 x 28	150	55	12	\$3098
TTSQ18	18 x 18 x 28	150	45	8	\$2828

Round tops require a single base. For tops up to 120", two bases must be ordered. For tops 144" or more, three bases must be ordered.

- **Must Specify Black (E) or Tungsten (K) finish**
- For 30" deep tops, order a 18" base (**TTSQ18** or **TTSQ18BH**).
- For 36" deep tops, order a 24" base (**TTSQ23** or **TTSQ23BH**).
- For 42" and 48" deep tops, order a 30" base (**TTSQ30**).
 - Max diameter for round tops at standard height is 48".
 - Max diameter for round tops at bar height is 36".

Required Specifications

Veneer Finish (Veneer Post Legs)
Metal Finish (Metal Legs)

T BOARDROOM TABLES

BOARDROOM TABLE BASES

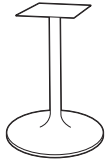

Trumpet Column Base

MODEL#	DIMENSIONS D x W x H	FREIGHT CLASS	WT/LBS.	CUBIC FT.	LIST PRICE
TRUM24BH	24 x 24 x 41	300	26	14	\$1753
TRUM18BH	18 x 18 x 41	300	24	16	\$1619
TRUM30	30 x 30 x 28	300	18	14	\$1687
TRUM24	24 x 24 x 28	300	16	12	\$1216
TRUM18	18 x 18 x 28	300	14	8	\$1081

Round tops require a single base. For tops up to 120", two bases must be ordered. For tops 144" or more, three bases must be ordered.

- **Must Specify Black (E) or Tungsten (K) finish**
- For 30" deep tops, order a 18" base (**TRUM18** or **TRUM18BH**).
- For 36" deep tops, order a 24" base (**TRUM24** or **TRUM24BH**).
- For 42" and 48" deep tops, order a 30" base (**TRUM30**).
 - Max diameter for round tops at standard height is 48".
 - Max diameter for round tops at bar height is 36".

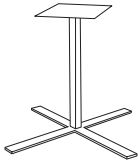

Flat Bar "X" Column Base

TTFLT36	36 x 36 x 28	300	18	14	\$3367
TTFLT30	30 x 30 x 28	300	16	12	\$3234
TTFLT22	22 x 22 x 28	300	15	10	\$2976

Round tops require a single base. For tops up to 120", two bases must be ordered. For tops 144" or more, three bases must be ordered.

- **Must Specify Black (E) or Tungsten (K) finish**
- For 30" and 36" deep tops, order a 22" base (**TTFLT22**)
- For 42" and 48" deep tops, order a 30" base (**TTFLT30**).
- For 54" deep tops, order a 36" base (**TTFLT36**).

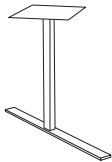

Flat Bar "T" Column Base

TTFLT36	36 x 36 x 28	150	14	3	\$2828
TTFLT24	24 x 24 x 28	150	10	2.50	\$2560

Not to be used with round table tops. For tops up to 84", two bases must be ordered. To be used as a 3rd base for center support in conjunction with two 3-prong bases on tops 144" or more.

- **Must Specify Black (E) or Tungsten (K) finish**
- For 30", 36" and 42" deep tops, order a 24" base (**TTFLT24**).
- For 48" and 54" deep tops, order a 36" base (**TTFLT36**).
- TTFLTxx bases are to be used as a middle base in combination with two TTFL3P bases



Flat Bar 3 Prong Column Base

TTFL3P36	36 x 36 x 28	400	16	22	\$3234
TTFL3P24	24 x 24 x 28	400	12	14	\$2962

Not to be used with round table tops. For tops up to 120", two bases must be ordered. For tops 144" or more, two 3-prong bases and one "T" column base must be ordered.

- **Must Specify Black (E) or Tungsten (K) finish**
- For 30", 36" and 42" deep tops, order a 24" base (**TTFL3P24**).
- For 48" and 54" deep tops, order a 36" base (**TTFL3P36**).
- When a third base is required, a TTFLTxx base may be used as the center base

Required Specifications

Finish

BOARDROOM TABLE BASES

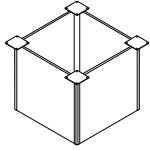

Square Panel Base - Anodized Aluminum Radius Corner Detail

MODEL#	DIMENSIONS	FREIGHT CLASS	WT/LBS.	CUBIC FT.	LIST PRICE
D x W x H					
TELRS24J	24 x 24 x 28	100	75	8	\$2721
TELRS20J	20 x 20 x 28	92.5	70	6	\$2347
TELRS16J	16 x 16 x 28	70	65	4	\$2129
TELRS24	24 x 24 x 28	100	75	8	\$2385
TELRS20	20 x 20 x 28	92.5	70	6	\$2008
TELRS16	16 x 16 x 28	70	65	4	\$1795

Round tops require a single base. For tops up to 120" two Square Panel bases must be ordered. For tops 144" or more, three bases must be ordered.

- **Model #'s with a "J" denote a power access door on one panel.**
- For 30", 36" and 42" deep tops, order a 16" base (**TELRS16** or **TELRS16J**).
- For 48" and 54" deep tops, order a 20" base (**TELRS20** or **TELRS20J**).
- For 60" deep tops, order a 24" base (**TELRS24** or **TELRS24J**).

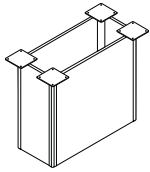

Rectangular Panel Base - Anodized Aluminum Radius Corner Detail

TELRR24J	12 x 24 x 28	100	65	8	\$2587
TELRR20J	12 x 20 x 28	92.5	60	6	\$2210
TELRR16J	12 x 16 x 28	85	50	4	\$1995
TELRR24	12 x 24 x 28	100	65	8	\$2250
TELRR20	12 x 20 x 28	92.5	60	6	\$1875
TELRR16	12 x 16 x 28	85	50	4	\$1661

Not to be used with round table tops. For tops up to 96" two Rectangular Panel bases must be ordered. To be used as a 3rd base for center support in conjunction with two Square Panel bases on tops 144" or more.

- **Model #'s with a "J" denote a power access door on one panel.**
- For 30", 36" and 42" deep tops, order a 16" base (**TELRR16** or **TELRR16J**).
- For 48" and 54" deep tops, order a 20" base (**TELRR20** or **TELRR20J**).
- For 60" deep tops, order a 24" base (**TELRR24** or **TELRR24J**).

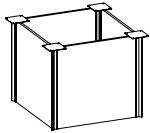

Square Panel Base - Anodized Aluminum Rectangular Corner Detail

TELBS24J	24 x 24 x 28	100	65	8	\$2721
TELBS20J	20 x 20 x 28	92.5	60	6	\$2347
TELBS16J	16 x 16 x 28	85	50	4	\$2129
TELBS24	24 x 24 x 28	100	65	8	\$2385
TELBS20	20 x 20 x 28	92.5	60	6	\$2008
TELBS16	16 x 16 x 28	85	50	4	\$1795

Round tops require a single base. For tops up to 120" two Square Panel bases must be ordered. For tops 144" or more, three bases must be ordered.

- **Model #'s with a "J" denote a power access door on one panel.**
- For 30", 36" and 42" deep tops, order a 16" base (**TELBS16** or **TELBS16J**).
- For 48" and 54" deep tops, order a 20" base (**TELBS20** or **TELBS20J**).
- For 60" deep tops, order a 24" base (**TELBS24** or **TELBS24J**).

Required Specifications

Finish

T BOARDROOM TABLES

BOARDROOM TABLE BASES

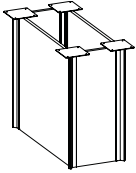

Rectangular Panel Base - Anodized Aluminum Rectangular Corner Detail

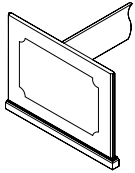

Philadelphia Wood Slab Base and Stretcher

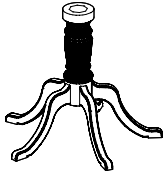

Wood Queen Anne Base

MODEL#	DIMENSIONS D x W x H	FREIGHT CLASS	WT/LBS.	CUBIC FT.	LIST PRICE
TELBR24J	12 x 24 x 28	100	65	8	\$2587
TELBR20J	12 x 20 x 28	92.5	60	6	\$2210
TELBR16J	12 x 16 x 28	85	50	4	\$1995
TELBR24	12 x 24 x 28	100	65	8	\$2250
TELBR20	12 x 20 x 28	92.5	60	6	\$1875
TELBR16	12 x 16 x 28	85	50	4	\$1661

Not to be used with round table tops. For tops up to 96" two Rectangular Panel bases must be ordered. To be used as a 3rd base for center support in conjunction with two Square Panel bases on tops 144" or more.

- **Model #'s with a "J" denote a power access door on one panel.**
- For 30", 36" and 42" deep tops, order a 16" base (**TELBR16** or **TELBR16J**).
- For 48" and 54" deep tops, order a 20" base (**TELBR20** or **TELBR20J**).
- For 60" deep tops, order a 24" base (**TELBR24** or **TELBR24J**).

PTH42PB	1 x 42 x 28	60	148	2	\$3706
PTH36PB	1 x 36 x 28	60	127	2	\$3348
PTH30PB	1 x 30 x 28	60	106	2	\$2439
PTH22PB	1 x 22 x 28	60	89	1	\$2111

- For 54" and 60" deep tops, order PTH36PB
- For 42" and 48" deep tops, order PTH30PB
- For 30" and 36" deep tops, order PTH22PB

PTQA30	30 x 30 x 28	150	73	15	\$3790
--------	--------------	-----	----	----	---------------

For use with 36", 42" and 48" deep tops.

Required Specifications

Finish

BOARDROOM - ACCESSORIES

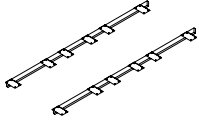

Metal Support Rails

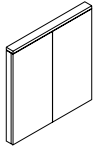

Visual Board

MODEL#	DIMENSIONS	FREIGHT CLASS	WT/LBS.	CUBIC FT.	LIST PRICE
	D x W x H				
TSUP102	1 x 102 x 2	70	0.10	0.10	\$1239
TSUP96	1 x 96 x 2	70	0.10	0.10	\$1162
TSUP90	1 x 90 x 2	70	0.10	0.10	\$1075
TSUP84	1 x 84 x 2	70	0.10	0.10	\$993
TSUP78	1 x 78 x 2	70	0.10	0.10	\$910
TSUP72	1 x 72 x 2	70	0.10	0.10	\$828
TSUP66	1 x 66 x 2	70	0.10	0.10	\$748
TSUP60	1 x 60 x 2	70	0.10	0.10	\$667
TSUP54	1 x 54 x 2	70	0.10	0.10	\$613

To be used when design considerations or dimension requirements dictate an unsupported table joint. Top section **MUST NOT** exceed 72" to use metal supports. **Sold in sets of two**

- **Available in Black only.**

VB4848E	5 x 48 x 48	70	115	7	\$4541
---------	-------------	----	-----	---	---------------

Includes porcelain on steel magnetic board and two side opening straight edge doors containing tackable fabric panels and 50-sheet paper writing pad that can be used on either door. Magnetic board can be used for projection. Set of 6 dry erase markers and eraser included. Interior fabric panels available in Anchorage. Specify color:

AN40 Birch	AN41 Green Apple	AN42 Lapis	AN43 Straw	AN44 Wolf
AN45 Goose	AN46 Angora	AN47 Cumin	AN48 Asteroid	AN49 Geranium
AN50 Thistle	AN51 Graphite	AN52 Slate	AN53 Quarry Blue	AN54 Onyx
AN55 Pumpkin	AN56 Red Delicious	AN57 Sunshine	AN59 Waterfall	AN61 Vanilla
AN62 Cobalt	AN64 Cloud			

- **NOTE:** Care should be taken to mount the units. Units should be mounted to wall studs using correct fasteners. Failure to do so may result in collapse of the unit and subsequent personal injury. **Mounting hardware not included.** Mounting hardware used should be based on wall material. Consult an installation professional for proper wall mounting.

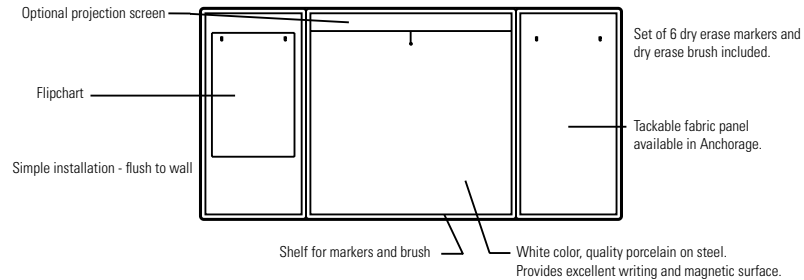

Required Specifications

Finish
Fabric

T BOARDROOM TABLES

BOARDROOM - ACCESSORIES

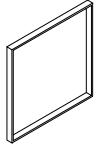

Visual Board, No Doors

MODEL#	DIMENSIONS D x W x H	FREIGHT CLASS	WT/LBS.	CUBIC FT.	LIST PRICE	
VB48480	5 x 48 x 48	70	115	7	\$3051	

Includes porcelain on steel magnetic board. Magnetic board can be used for projection. Set of 6 dry erase markers and eraser included.

• **NOTE:** Care should be taken to mount the units. Units should be mounted to wall studs using correct fasteners. Failure to do so may result in collapse of the unit and subsequent personal injury. **Mounting hardware not included.** Mounting hardware used should be based on wall material. Consult an installation professional for proper wall mounting.

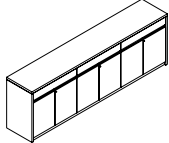

Credenza Buffet - Dufferin

DCB9022H36	22 x 90 x 36	92.5	440	44	\$9735	\$11680
DCB9020H36	20 x 90 x 36	92.5	400	40	\$8850	\$10621
DCB7222H36	22 x 72 x 36	92.5	330	33	\$6610	\$7932
DCB7220H36	20 x 72 x 36	92.5	300	30	\$5889	\$7069
DCB6022H36	22 x 60 x 36	100	275	28	\$5669	\$6804
DCB6020H36	20 x 60 x 36	92.5	250	25	\$5153	\$6182

90" w units have (3) two door storage cabinets with top drawer side-by-side. 72" w & 60" w units have (2) two door storage cabinets with top drawer side-by-side. Locking doors. Self-closing hinged doors cover one adjustable shelf.

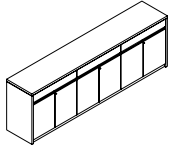

Credenza Buffet - Lufton

LCB9022H36	22 x 90 x 36	92.5	440	44	\$10567	
LCB9020H36	20 x 90 x 36	92.5	400	40	\$9615	
LCB7222H36	22 x 72 x 36	92.5	330	33	\$7180	
LCB7220H36	20 x 72 x 36	92.5	300	30	\$6390	
LCB6022H36	22 x 60 x 36	100	275	28	\$6165	
LCB6020H36	20 x 60 x 36	92.5	250	25	\$5602	

90" w units have (3) two door storage cabinets with top drawer side-by-side. 72" w & 60" w units have (2) two door storage cabinets with top drawer side-by-side. Locking doors. Self-closing hinged doors cover one adjustable shelf.

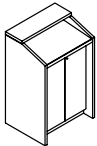

Lectern - Dufferin

DLEC3624	24 x 36 x 48	92.5	240	24	\$4611	\$5533
DLEC3024	24 x 30 x 48	92.5	200	20	\$3845	\$4613
DLEC2424	24 x 24 x 48	92.5	160	16	\$3075	\$3689

Features angled stand. Storage compartment with one adjustable and one fixed shelf. Locks optional.

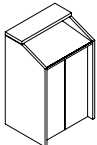

Lectern - Lufton

LEC3624L	24 x 36 x 48	92.5	240	24	\$5230	
LEC3024L	24 x 30 x 48	92.5	200	20	\$4363	
LEC2424L	24 x 24 x 48	92.5	160	16	\$3476	

Features angled stand. Storage compartment with one adjustable and one fixed shelf. Locks optional.

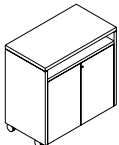



Utility Table - Dufferin

DTV3620M	20 x 36 x 34	85	121	10	\$2791	\$3346
----------	--------------	----	-----	----	---------------	---------------

Open shelf and storage compartment with one adjustable shelf. Locking doors. Casters.

Required Specifications

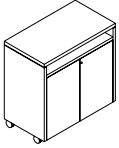
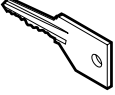
Finish

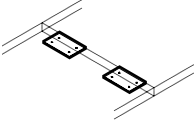
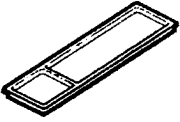
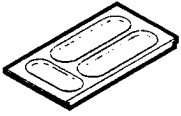
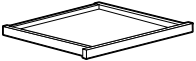
ACCESSORIES	MODEL#	DIMENSIONS	FREIGHT CLASS	WT/LBS.	CUBIC FT.	LIST PRICE
 Utility Table - Lufton	LTV3620M	D x W x H 20 x 36 x 34	85	121	10	\$3023
	Open shelf and storage compartment with one adjustable shelf. Locking doors. Casters.					
 Extra Key	LOCK	--	70	--	--	\$46
	Specify key #. Key range 400 - 500.					
 Grommet Cover, Round	GM1	2 dia x --	70	--	--	\$70
	GM1K	2 dia x --	70	--	--	\$70
	2.75" diameter. <ul style="list-style-type: none"> • Specify GM1 for Black or GM1K for Tungsten. 					
 Mending Plates	MP53	3 x 5 x 0.50	300	3	2	\$65
	Sold in sets of 2. <ul style="list-style-type: none"> • Available in Black Only. 					
 Pencil Tray - Black Plastic	PT	3 x 12.50 x 1	250	2	1	\$23
	Provides space for writing instruments and small items at the workspace. <ul style="list-style-type: none"> • Available in Black Only. 					
 Pencil Tray - Veneer	OPT	6 x 12.50 x 2	150	4	1	\$183
	Provides space for writing instruments and small items at the workspace. Solid oak finish.					
 Center Drawer - Veneer	CD	21 x 23 x 2	100	8	1	\$744
	Veneer drawer front is attached to a 4-sided frame. Must specify wood finish for drawer front.					

Required Specifications

Finish

T BOARDROOM TABLES

KEYBOARD DRAWERS

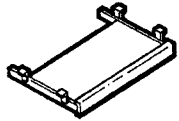

Keyboard Drawer

MODEL#	DIMENSIONS D x W x H	FREIGHT CLASS	WT/LBS.	CUBIC FT.	LIST PRICE
KD30	10 x 30 x 1	70	16	1	\$999
KD22	10 x 22 x 1	85	12	1	\$893
KD10	10 x 10 x 1	125	6	1	\$452

Pull-out veneer keyboard shelf. Clearance is 2 1/4". Must specify wood finish for drawer front.

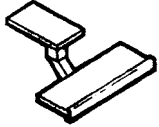

Articulating Keyboard Drawer

AKD30	10 x 30 x 1	65	24	1	\$1380
AKD22	10 x 22 x 1	70	18	1	\$1277

Adjustable pull-out keyboard shelf with articulating arm. Adjusts from flush with the worksurface to 5" below worksurface. Swivels 360° full arm rotation, angles -10° to +15°. Must specify wood finish for keyboard deck.

WIRE MANAGEMENT



Wire Management Cover

MODEL#	DIMENSIONS	FREIGHT CLASS	WT/LBS.	CUBIC FT.	LIST PRICE
WH24	1 x 1 x 24	70	1	1	\$79

To conceal wires and cords. Plastic.

- **Available in Black Plastic Only.**

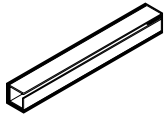

Wire Management Track - Single





C2M72	2 x 72 x 2	70	0.10	0.10	\$89
C2M60	2 x 60 x 2	70	0.10	0.10	\$74
C2M48	2 x 48 x 2	70	0.10	0.10	\$61
C2M36	2 x 36 x 2	70	0.10	0.10	\$45
C2M24	2 x 24 x 2	70	0.10	0.10	\$34
C2M12	2 x 12 x 2	70	0.10	0.10	\$19

To conceal and organize wires and cords. Attaches to Modesty Panel with double sided tape. Plastic.

- **Available in Black Plastic Only.**

Required Specifications

Finish

POWER / DATA	MODEL#	DIMENSIONS	FREIGHT CLASS	WT/LBS.	CUBIC FT.	LIST PRICE
 <p>Single Sided Recessed Power Block</p>	D x W x H					
	PRTMCS401B	4.22 x 10.78 x 4.86	100	4.3	0.51	\$486
	PRTMCS401T	4.22 x 10.78 x 4.86	100	4.3	0.51	\$486
	PRTMCS401W	4.22 x 10.78 x 4.86	100	4.3	0.51	\$486
<p>Single-sided recessed power block with one regular duplex and one telecom knockout on top; one power duplex on bottom. 10' power cord with straight plug. Specify telecom options separately, see page 418. Available in Black (B), Tungsten (T) or Designer White (W) as indicated by the last letter of model number. Duplexes always Grey. Corresponding cut-out options are R1, R2 or R3. Units are not approved for daisy chaining. UL listed: UL 1363.</p>						
 <p>Single Sided Recessed Power Block - USB-A + USB-C</p>	D x W x H					
	PRTMCS421B	4.22 x 10.78 x 4.86	100	4.3	0.51	\$638
	PRTMCS421T	4.22 x 10.78 x 4.86	100	4.3	0.51	\$638
	PRTMCS421W	4.22 x 10.78 x 4.86	100	4.3	0.51	\$638
<p>Single-sided recessed power block with one power/USB-A/USB-C duplex and one telecom knockout on top; one power duplex on bottom. USB-A port charges max 2.4 amps at 5V and USB-C port charges max 3 amps at 5V. 10' power cord with straight plug. Specify telecom options separately, see page 418. Available in Black (B), Tungsten (T) or Designer White (W) as indicated by the last letter of model number. Duplexes always Grey (duplex with USB ports is glossy finish). Corresponding cut-out options are R1, R2 or R3. Units are not approved for daisy chaining. UL listed: UL 1363.</p>						
 <p>Double Sided Recessed Power Block</p>	D x W x H					
	PRTMCD602B	6.22 x 10.78 x 4.86	92.5	5.9	0.51	\$555
	PRTMCD602T	6.22 x 10.78 x 4.86	92.5	5.9	0.51	\$555
	PRTMCD602W	6.22 x 10.78 x 4.86	92.5	5.9	0.51	\$555
<p>Double-sided recessed power block with two regular power duplexes and two telecom knockouts on top; one power duplex on bottom. 10' power cord with straight plug. Specify telecom options separately, see page 418. Available in Black (B), Tungsten (T) or Designer White (W) as indicated by last letter of model number. Duplexes always Grey. Corresponding cut-out options are T1, T2 or T3. Units are not approved for daisy chaining. UL listed: UL 1363.</p>						
 <p>Double Sided Recessed Power Block - USB-A + USB-C</p>	D x W x H					
	PRTMCD622B	6.22 x 10.78 x 4.86	92.5	6.1	0.51	\$699
	PRTMCD622T	6.22 x 10.78 x 4.86	92.5	6.1	0.51	\$699
	PRTMCD622W	6.22 x 10.78 x 4.86	92.5	6.1	0.51	\$699
<p>Double-sided recessed power block with one regular power duplex, one power/USB-A/USB-C duplex and two telecom knockouts on top; one power duplex on bottom. USB-A port charges max 2.4 amps at 5V and USB-C port charges max 3 amps at 5V. 10' power cord with straight plug. Specify telecom options separately, see page 418. Available in Black (B), Tungsten (T) or Designer White (W) as indicated by last letter of model number. Duplexes always Grey (duplex with USB ports is glossy finish). Corresponding cut-out options are T1, T2 or T3. Units are not approved for daisy chaining. UL listed: UL 1363.</p>						
 <p>Double Sided Recessed Power Block - USB-A + USB-C</p>	D x W x H					
	PRTMCD642B	6.22 x 10.78 x 4.86	85	6.3	0.51	\$842
	PRTMCD642T	6.22 x 10.78 x 4.86	85	6.3	0.51	\$842
	PRTMCD642W	6.22 x 10.78 x 4.86	85	6.3	0.51	\$842
<p>Double-sided recessed power block with two power/USB-A/USB-C duplexes and two telecom knockouts on top; one power duplex on bottom. USB-A port charges max 2.4 amps at 5V and USB-C port charges max 3 amps at 5V. 10' power cord with straight plug. Specify telecom options separately, see page 418. Available in Black (B), Tungsten (T) or Designer White (W) as indicated by last letter of model number. Duplexes always Grey (duplex with USB ports is glossy finish). Corresponding cut-out options are T1, T2 or T3. Units are not approved for daisy chaining. UL listed: UL 1363.</p>						

Required Specifications
Finish

T BOARDROOM TABLES

TELECOM PLATES

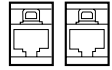

Telecom Plate - 2 x 6

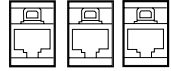

Telecom Plate - 3 x 6

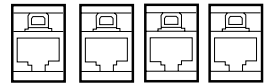

Telecom Plate - 4 x 6



Telecom Plate - 3TSV

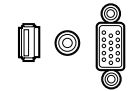

Telecom Plate - 3SVH

MODEL#	DIMENSIONS	FREIGHT CLASS	WT/LBS.	CUBIC FT.	LIST PRICE
--------	------------	---------------	---------	-----------	------------

D x W x H

PTELO1	- x - x -	70	0.01	0.05	\$175
--------	-----------	----	------	------	--------------

Includes 2 x RJ45 cat 6 data. Black telecom plate. To be hardwired by data contractor.

PTELO2	- x - x -	70	0.01	0.05	\$237
--------	-----------	----	------	------	--------------

Includes 2 x RJ45 cat 6 data and 1 RJ11 cat phone. Black telecom plate. To be hardwired by data contractor.

PTELO3	- x - x -	70	0.01	0.05	\$363
--------	-----------	----	------	------	--------------

Includes 4 x RJ45 cat 6 data. Black telecom plate. To be hardwired by data contractor.

PTELO4	- x - x -	70	0.01	0.05	\$309
--------	-----------	----	------	------	--------------

Includes 1 x RJ45 cat 6 data, mini stereo and 15 pin HD VGA. Black telecom plate. To be hardwired by data contractor.

PTELO5	- x - x -	70	0.01	0.05	\$428
--------	-----------	----	------	------	--------------

Includes mini stereo, 15 pin HD VGA and HDMI. Black telecom plate.

Required Specifications

Finish

VILLA I SERIES CORDED UNITS

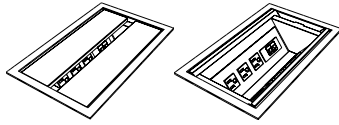

Oasis Mini A, Corded

MODEL#	DIMENSIONS	FREIGHT CLASS	WT/LBS.	CUBIC FT.	LIST PRICE
OAM-A-PC- <u> </u>	15 x 9 x 5.25	92.5	16	1.53	\$1945

D x W x H



Mini Oasis A unit. 15" Trough with six power receptacles, two telecom plate cut-outs (**telecom plates sold separate**, see page page 424) and two 108" 3-prong plugs. **M1, M2 or M3 cut-out(s) must be specified on conference table** (see product notes section for more details and cut-out upcharge). UL Listed.

- **Cannot be daisy-chained.**
- Replace with **B** for **Black**
- Replace with **S** for **Silver Pearl**

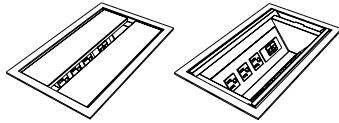

Oasis Mini A, DaisyLink Version

OAM-A-PC-4-1- <u> </u>	15 x 9 x 5.25	92.5	16	1.53	\$2227
-------------------------	---------------	------	----	------	---------------

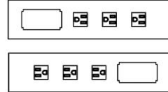

For hardwire and daisy chain applications. Mini Oasis A unit. 15" Trough with six power receptacles, two telecom plate cut-outs (**telecom plates sold separate**, see page page 424). **Power infeed sold separate** (see page page 425). **M1, M2 or M3 cut-out(s) must be specified on conference table** (see product notes section for more details and cut-out upcharge). For multiple circuit configurations, please contact customer service. *Please see our **Daisy-Chain guide** on page page 422 for appropriate cable lengths and important notes.* UL Listed.

- Replace with **B** for **Black**
- Replace with **S** for **Silver Pearl**

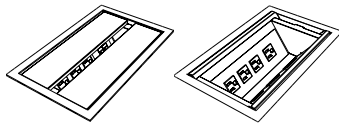

Oasis Mini B, Corded

OAM-B-PC- <u> </u>	15 x 9 x 5.25	92.5	16	1.53	\$1945
---------------------	---------------	------	----	------	---------------

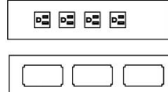

Mini Oasis B unit. 15" Trough with four power receptacles, three telecom plate cut-outs (**telecom plates sold separate**, see page page 424) and one 108" 3-prong plug. **M1, M2 or M3 cut-out(s) must be specified on conference table** (see product notes section for more details and cut-out upcharge). UL Listed.

- **Cannot be daisy-chained.**
- Replace with **B** for **Black**
- Replace with **S** for **Silver Pearl**

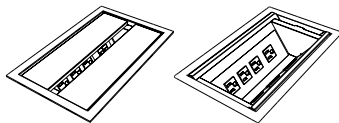

Oasis Mini B, DaisyLink Version

OAM-B-PC-4-1- <u> </u>	15 x 9 x 5.25	92.5	16	1.53	\$2227
-------------------------	---------------	------	----	------	---------------

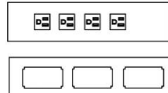

For hardwire and daisy chain applications. Mini Oasis B unit. 15" Trough with four power receptacles, three telecom plate cut-outs (**telecom plates sold separate**, see page page 424). **Power infeed sold separate** (see page page 425). **M1, M2 or M3 cut-out(s) must be specified on conference table** (see product notes section for more details and cut-out upcharge). For multiple circuit configurations, please contact customer service. *Please see our **Daisy-Chain guide** on page page 422 for appropriate cable lengths and important notes.* UL Listed.

- Replace with **B** for **Black**
- Replace with **S** for **Silver Pearl**

Required Specifications

Finish
Power infeed
Cut-out location

T BOARDROOM TABLES

OASIS MINI

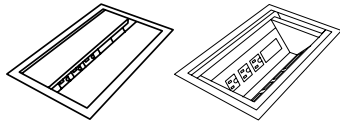

Oasis Mini USB, Corded

MODEL#	DIMENSIONS D x W x H	FREIGHT CLASS	WT/LBS.	CUBIC FT.	LIST PRICE
OAM-U-PC-__	15 x 9 x 5.25	92.5	16	1.53	\$2177

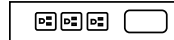
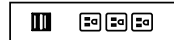

Mini Oasis USB unit. 15" trough with six power receptacles, two 2.1 AMP USB charging ports and one telecom plate cut-out (**telecom plates sold separate**, see page page 424) and two 108" 3-prong plugs. **M1, M2 or M3 cut-out(s) must be specified on conference table** (see product notes section for more details and cut-out upcharge). UL Listed.

- **Cannot be daisy-chained.**
- Replace _ with **B** for **Black**
- Replace _ with **S** for **Silver Pearl**

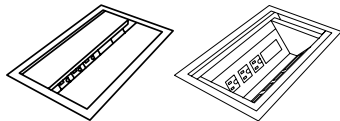

Oasis Mini USB, DaisyLink Version

OAM-U-PC-4-1-__	15 x 9 x 5.25	92.5	16	1.53	\$2457
-----------------	---------------	------	----	------	---------------

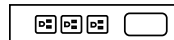
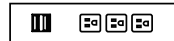

For hardwire and daisy chain applications. Mini Oasis USB unit. 15" trough with six power receptacles, two 2.1 AMP USB charging ports and one telecom plate cut-out (**telecom plates sold separate**, see page page 424). **Power infeed sold separate** (see page page 425). **M1, M2 or M3 cut-out(s) must be specified on conference table** (see product notes section for more details and cut-out upcharge). For multiple circuit configurations, please contact customer service. *Please see our **Daisy-Chain guide** on page page 422 for appropriate cable lengths and important notes.* UL Listed.

- Replace _ with **B** for **Black**
- Replace _ with **S** for **Silver Pearl**

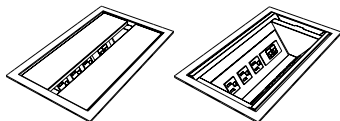

Oasis Mini, Chicago Code

GL-OAMPD_P72HW	15 x 9 x 5.25	92.5	16	1.53	\$2652
----------------	---------------	------	----	------	---------------

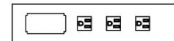

Mini Oasis for Chicago code includes electrical trough with (2) separate hardwire inserts. Each insert includes (3) simplex outlets and (1) telecom plate cut-out (**telecom plates sold separate**, see page page 424). **M1, M2 or M3 cut-out(s) must be specified on conference table** (see product notes section for more details and cut-out upcharge). Each component is UL listed.

- **Cannot be daisy-chained.**
- Replace _ with **B** for **Black**
- Replace _ with **S** for **Silver Pearl**

Required Specifications

Finish
Power infeed
Cut-out location

OASIS MINI CUT OUT POSITIONS

D x W x H
OASIS MINI A & B CABLE LENGTHS NEEDED FOR DAISY-CHAINING

Model #	Oasis Mini A & Oasis Mini B	Oasis Mini A & Oasis Mini B	Oasis Mini A	Oasis Mini A	Oasis Mini B	Oasis Mini B
Cut-out Positions	TL/M & TR/M	TL/M & TR/M	TL/M, TC/M & TR/M	TL/M, TC/M & TR/M	TL/M, TC/M & TR/M	TL/M, TC/M & TR/M
Infeed Position	Left or Right	Center	Left or Right	Center	Left or Right	Center
Reference	Drawing 1A/1B	Drawing 2A/2B	Drawing 3	Drawing 4	Drawing 5	Drawing 6
8' Dufferin & Lufton Tables	(1) 42FF-55 SPECIFY INFEED	(1) 42FF-29 (1) 42FM-29 (1) DAISY-T SPECIFY INFEED	N/A	N/A	N/A	N/A
10' Dufferin & Lufton Tables	(1) 42FF-79 SPECIFY INFEED	(1) 42FF-41 (1) 42FM-41 (1) DAISY-T SPECIFY INFEED	(3) 42FF-37 SPECIFY INFEED	(3) 42FF-37 SPECIFY INFEED	(2) 42FF-37 SPECIFY INFEED	(2) 42FF-37 (1) 42FM-12 (1) DAISY-T SPECIFY INFEED
12' Dufferin & Lufton Tables	(1) 42FF-103 SPECIFY INFEED	(1) 42FF-55 (1) 42FM-55 (1) DAISY-T SPECIFY INFEED	(3) 42FF-52 SPECIFY INFEED	(3) 42FF-52 SPECIFY INFEED	(2) 42FF-52 SPECIFY INFEED	(2) 42FF-52 (1) 42FM-12 (1) DAISY-T SPECIFY INFEED
14' Dufferin & Lufton Tables	(1) 42FF-64 (1) 42FM-64 SPECIFY INFEED	1) 42FF-67 (1) 42FM-67 (1) DAISY-T SPECIFY INFEED	(3) 42FF-61 SPECIFY INFEED	(3) 42FF-61 SPECIFY INFEED	(2) 42FF-61 SPECIFY INFEED	(2) 42FF-61 (1) 42FM-12 (1) DAISY-T SPECIFY INFEED
16' Dufferin & Lufton Tables	(1) 42FF-79 (1) 42FM-79 SPECIFY INFEED	1) 42FF-82 (1) 42FM-82 (1) DAISY-T SPECIFY INFEED	(3) 42FF-76 SPECIFY INFEED	(3) 42FF-76 SPECIFY INFEED	(2) 42FF-76 SPECIFY INFEED	(2) 42FF-76 (1) 42FM-12 (1) DAISY-T SPECIFY INFEED
18' Dufferin & Lufton Tables	(1) 42FF-88 (1) 42FM-88 SPECIFY INFEED	1) 42FF-91 (1) 42FM-91 (1) DAISY-T SPECIFY INFEED	(3) 42FF-85 SPECIFY INFEED	(3) 42FF-85 SPECIFY INFEED	(2) 42FF-85 SPECIFY INFEED	(2) 42FF-85 (1) 42FM-12 (1) DAISY-T SPECIFY INFEED
20' Dufferin & Lufton Tables	(1) 42FF-100 (1) 42FM-100 SPECIFY INFEED	1) 42FF-103 (1) 42FM-103 (1) DAISY-T SPECIFY INFEED	(3) 42FF-100 SPECIFY INFEED	(3) 42FF-100 SPECIFY INFEED	(2) 42FF-100 SPECIFY INFEED	(2) 42FF-100 (1) 42FM-12 (1) DAISY-T SPECIFY INFEED

Interconnecting Cables - Common Cable Lengths (in inches)

Female/Female

42FF-21	\$116	42FF-94	\$212	42FM-91	\$215
42FF-29	\$127	42FF-100	\$219	42FM-94	\$217
42FF-32	\$129	42FF-103	\$222	42FM-103	\$231
42FF-37	\$137	42FF-106	\$225	42FM-106	\$233
42FF-41	\$142	42FF-112	\$234	42FM-115	\$245
42FF-46	\$149	42FF-115	\$240	42FM-118	\$251
42FF-52	\$157	42FF-118	\$243		
42FF-55	\$161				
42FF-58	\$165	Female/Male			
42FF-61	\$168	42FM-12	\$111		
42FF-64	\$172	42FM-21	\$123		
42FF-67	\$176	42FM-32	\$137		
42FF-70	\$179	42FM-46	\$156		
42FF-76	\$188	42FM-55	\$167		
42FF-79	\$192	42FM-58	\$170		
42FF-82	\$196	42FM-67	\$182		
42FF-85	\$200	42FM-70	\$187		
42FF-88	\$204	42FM-79	\$199		
42FF-91	\$208	42FM-82	\$203		

T BOARDROOM TABLES

OASIS MINI NOTES

D x W x H

DRAWING 1A - MINI OASIS A

Female/ Female Interconnecting Cable Included with Oasis A Unit

Female/ Female Interconnecting Cable Included with Oasis A Unit

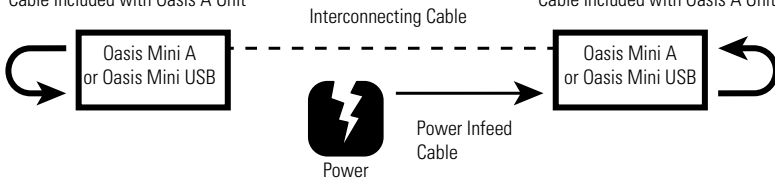

DRAWING 1B - MINI OASIS B

Interconnecting Cable

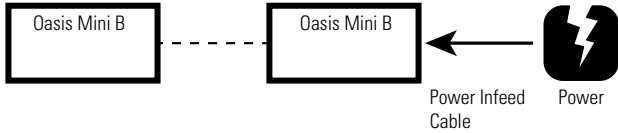

DRAWING 2A - MINI OASIS A

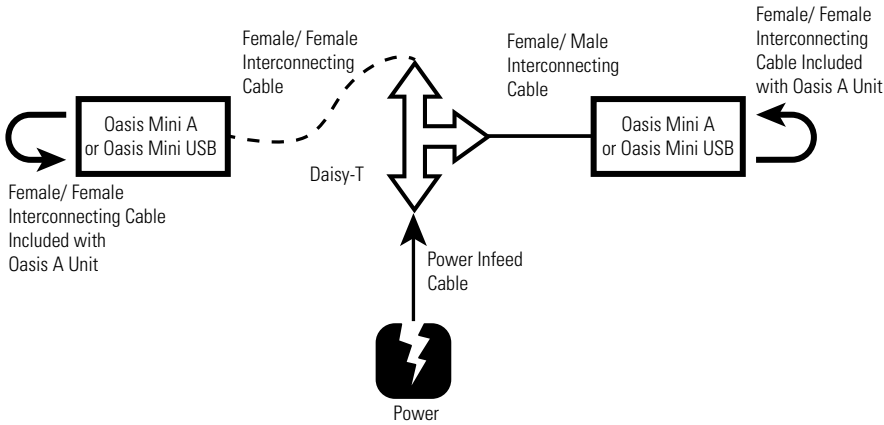

DRAWING 2B - MINI OASIS B

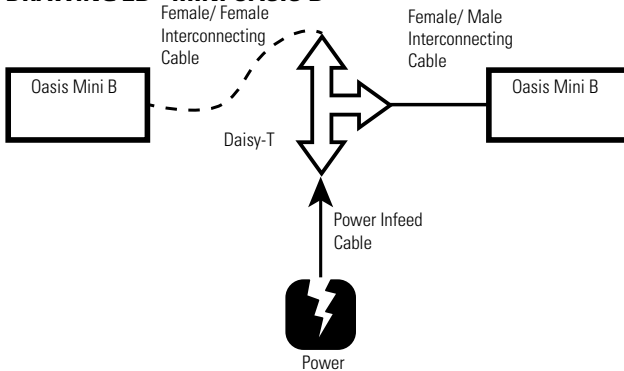

DRAWING 3 - MINI OASIS A

Female/ Female Interconnecting Cable Included with Oasis A Unit

Female/ Female Interconnecting Cable

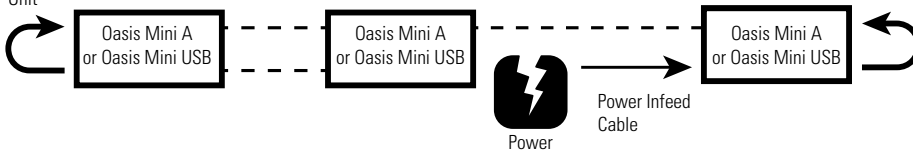

OASIS MINI NOTES

D x W x H

DRAWING 4 - MINI OASIS A

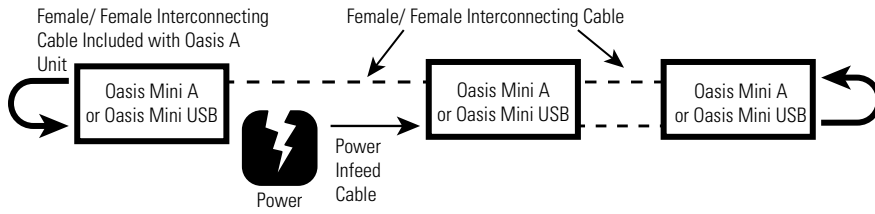

DRAWING 5 - MINI OASIS B

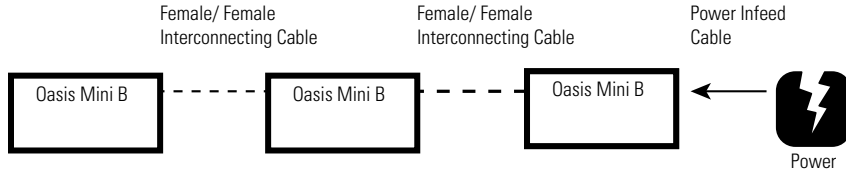

DRAWING 6 - MINI OASIS B

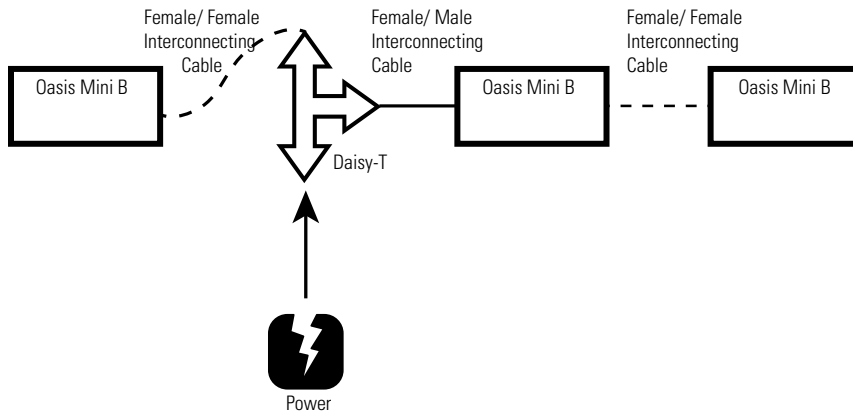







T BOARDROOM TABLES

TOP TELECOM PLATES

TOP TELECOM PLATE	MODEL	CONFIGURATION	D x W x H	LIST PRICE
	A-__-A-B	Telecom plate with RJ11 Cat 3 Phone and RJ45 Cat 6 Data		\$116
	A-__-B-B	(2) RJ45 Cat 6 Connectors		\$151
	A-__-B-B-B	(3) RJ45 Cat 6 Connectors		\$220
	A-__-B-B-B-B	(4) RJ45 Cat 6 Connectors		\$292
	A-__-B-C51-L	RJ45 Cat 6 Data, Mini-Stereo Inline and 15 pin HD VGA Female/Female with 72" patch cord attached.		\$260
	A-__-B-B-C51	(2) RJ45 Cat 6 Data and (1) 15 pin HD VGA Female/Female with 72" patch cord attached.		\$271
	A-__-A-B-102	RJ11 Cat 3 phone, RJ45 Cat 6 Data and USB with 72" patch cord attached.		\$260
	A-__-B	RJ45 Cat 6 Data		\$81
	A-__-C51-L	Mini Stereo Inline and 15 pin HD VGA Female/Female with 72" patch cord attached.		\$204
	A-__-CRDMINDER	Cordminder Plate - 2 5/8" holes and 1 7/8" holes		\$46
	A-__-C45-C51-L	HDMI Female/Female with 36" patch cord attached. Mini Stereo Inline and 15 Pin HD VGA Female/Female with 72" patch cord attached.		\$355

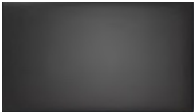
Required Specifications

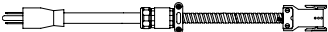
Finish
Power infeed
Cut-out location

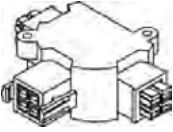
TOP TELECOM PLATES		MODEL#	DIMENSIONS	FREIGHT CLASS	WT/LBS.	CUBIC FT.	LIST PRICE
TOP TELECOM PLATE	MODEL	CONFIGURATION	D x W x H				LIST PRICE
	A-__-C45	HDMI Female/Female with 36" patch cord attached.					\$175
	A-__-A-B-B	(1) RJ11 Cat 3 Phone and (2) RJ45 Cat 6 data.					\$190
	A-__	Blank telecom plate					\$29
	A-__-102	USB with 72" patch cord attached.					\$81
	A-__-C51	15 pin HD VGA Female/Female with 72" patch cord attached.					\$131
		<ul style="list-style-type: none"> • Replace __ with BL for Black • Replace __ with GR for Grey 					
		42AP1-72	--	--	--	--	\$261
	Plug and Play Infeed	Single Circuit 20 AMP Power Infeed with 72" 3-prong plug. Provides single power entry from floor or wall mounted standard power supply. Connects to Oasis Mini or Villa units that require a separate infeed. UL Listed.					
		42SB2-108	--	--	--	--	\$217
		42SB2-72	--	--	--	--	\$169
		42SB2-36	--	--	--	--	\$123
	Multi-Circuit Hardwire Power Infeed	Multi-Circuit Hardwire Infeed (up to 20 AMPS per circuit), two circuits. Provides single power entry from floor or wall located building power supply. Connects to Oasis Mini or Villa units that require a power infeed. TO BE HARDWIRED BY A LICENSED ELECTRICIAN. UL Listed.					
		DAISY-T	--	70	1	1	\$200
	3 Way Power Splitter	Daisy-T power manager includes two male and one female connection. For use in splitting a power source two ways.					

Required Specifications

Veneer Finish
Laminate Finish
Handle Style

Optional Specifications

Grommet

T BOARDROOM TABLES

POWER INFEEDES	MODEL#	DIMENSIONS	FREIGHT CLASS	WT./LBS.	CUBIC FT.	LIST PRICE
		D x W x H				

Required Specifications

- Veneer Finish
- Laminate Finish
- Handle Style

Optional Specifications

- Grommet

textiles and finishes

Care and Cleaning

Textiles

Fabrics: To extend the life of your seating upholstered in fabric, regularly dust the chair to prevent airborne particles from penetrating the fabric surface.

For light soiling, use a damp cloth and blot the spot with very slight pressure, taking care never to soak the fabric. Dry with a clean cloth by blotting - never rub fabric. More intense stains can be treated the same way, but with a mild detergent. Always test fabric first in an unseen area before using any cleaning method.

Leather: For regular cleaning, simply use a soft damp cloth, taking care not to soak the leather. For more thorough treatment, soak a soft cloth in mild soap solution and wipe surface in a light circular motion. Repeat with clean water. Allow to dry and polish with a soft dry cloth. Do not use detergents, aerosol sprays or other polishes.

Hard Surfaces

Wood Veneer Finishes: Waxing or polishing catalyzed finishes is not recommended because this will give a greasy, cloudy or uneven appearance to the product and could void your warranty. Global's conversion varnish is best cleaned by wiping the surface with a damp cloth, followed by a soft dry cloth in the direction of the grain. If the surfaces are heavily soiled, a gentle product like "Windex" can be used, following the same instructions as above.

Laminate, painted & plated metal finishes, and solid surfaces: Wipe the surface with a clean soft damp cloth; if needed, a mild soap solution can be used. To prevent streaks, dry the surface with a clean dry cloth moving in a circular motion.

-
- **Water-Based Cleaner:** Spot clean, using the foam only from a water-based cleaning agent, such as a mild detergent or non-solvent upholstery shampoo product. Apply foam with a soft brush in a circular motion. Vacuum when dry. Pretest small area before proceeding.
 - **Solvent Cleaner:** Spot clean, using a mild water-free solvent or dry cleaning product. Clean only in a well-ventilated room and avoid any product containing carbon tetrachloride or other toxic materials. Pretest a small area before proceeding.
 - **Water/Solvent Cleaner:** Spot clean with a mild solvent, an upholstery shampoo, or the foam from a mild detergent. When using a solvent or dry cleaning product, follow instructions carefully and clean only in a well-ventilated room. Avoid any product that contains carbon tetrachloride or other toxic materials. With either method, pretest a small area before proceeding.
 - **Vacuum Only:** Clean this fabric only by vacuuming or light brushing to prevent accumulation of dust and grime. Water-based foam cleaning agents of any kind may cause excessive shrinking, staining, or distortion of the surface pile and therefore, should not be used.
 - **Crypton Cleaning:** Generally stains are removed with plain water and powdered enzyme detergent. Upholstery foam shampoo, water-based cleaning products and germicidal detergents can be used. Be sure to remove all residue from cleaning products with clean water. Do not use solvent-based cleaners or dry cleaning products.
 - These recommendations and codes were developed by fabric specialists. However, because of the various ways fabric can be stained or damaged, there is no guarantee that the results will be completely successful. Use suggested methods on your own responsibility. To help prevent overall soil, frequent vacuuming or light brushing to remove dust and grime is recommended. Use professional furniture cleaning service when overall soiled condition has been reached.

Textile Price Grades - Global Textiles

Grade 1	Carrera, Dobby, Fusion, Illusion, Jenny, Quilt, Terrace, Trak, Urban, Waterfall, Wavelength
Grade 2	Allante FRee, Elevate, Etch, GC Linen, Imprint, Luxhide, Release
Grade 3	Non standard GLOBAL textiles
Grade 4	Non standard GLOBAL textiles
Grade 5	Non standard GLOBAL textiles
Grade 6	Novaro Genuine Leather, non standard GLOBAL textiles
Grade 7	Non standard GLOBAL textiles
Grade 8	Non standard GLOBAL textiles
Grade 9	Non standard GLOBAL textiles
Grade 11	Non standard GLOBAL textiles
Grade 10	Non standard GLOBAL textiles
Grade 12	Non standard GLOBAL textiles

Please refer to individual seating series for availability of a particular textile.

The charts above do not include Textiles offered by Alliance Partners: Arc-Com Fabrics, Architex, CF Stinson, Designtex, Knoll Textiles, Green Hides, LDI Interiors, Luum Textiles, Maharam, Mayer Fabrics, Momentum, and Ultrafabrics.

Blend Seating Textiles

The grid below outlines the grade structure for using multiple textiles on select seating series. Blended textiles occur when one textile is chosen for one part of the chair and a different textile is selected for another part of the chair, resulting in a revised blended grade. For opportunities regarding more than two different textiles, please contact Global CustomerCare for approval process and grading.

		FIRST TEXTILE SELECTED																	
		1	2	3	4	5	6	7	8	9	10	11	12	13	14	15	16	17	18
SECOND TEXTILE SELECTED	1	1																	
	2	2	2																
	3	3	3	3															
	4	3	4	4	4														
	5	4	4	5	5	5													
	6	5	5	5	6	6	6												
	7	5	6	6	6	7	7	7											
	8	6	6	7	7	7	8	8	8										
	9	7	7	7	8	8	8	9	9	9									
	10	8	8	8	8	9	9	9	10	10	10								
	11	9	9	9	9	9	10	10	10	11	11	11							
	12	10	10	10	10	10	10	11	11	11	12	12	12						
	13	11	11	11	11	11	11	12	12	12	12	13	13	13					
	14	11	12	12	12	12	12	12	13	13	13	13	14	14	14				
	15	12	12	13	13	13	13	13	13	14	14	14	14	15	15	15			
	16	13	13	13	14	14	14	14	14	14	15	15	15	15	16	16	16		
	17	14	14	14	14	15	15	15	15	15	15	16	16	16	16	17	17	17	
	18	15	15	15	15	15	16	16	16	16	16	16	17	17	17	17	18	18	18

TEXTILE AND COLOR LISTINGS

Grade 1

Carrera 100% Polyester

CE84 Zest	CE85 Savannah	CE86 Slate	CE87 Rainforest	CE88 Aspen	CE89 Dune	CE90 Flannel
CE91 Azure	CE92 Chili	CE93 Jute	CE95 Ink	CE96 Sangria	CE97 Java	CE98 Charcoal

Dobby 96% Recycled Polyester / 4% Virgin Polyester

DB30 Snowcap	DB31 Bonsai	DB32 Cloud	DB33 Sand	DB34 Pewter	DB35 Santa Fe	DB36 Corfu
DB37 Medium Taupe	DB38 Charcoal	DB39 Berry	DB40 Royal	DB41 Titanium	DB42 Black	

Fusion 90% Virgin Polyester / 10% Post-Consumer Recycled Polyester

FU71 Tangerine	FU72 Fresh	FU73 Moss	FU74 Tomato	FU75 Aqua	FU76 Sandstone	FU77 Granite
FU78 Poppy	FU79 Cadet	FU80 Oasis	FU81 Graphite	FU82 Viola	FU83 Cobalt	FU84 Flax
FU85 Carbon						

Illusion 100% Virgin Polyester

II01 Cappuccino	II02 Paprika	II03 Tropic	II04 Wicker	II05 Hemp	II06 Cayenne	II07 Maui
II08 Dusk	II09 Smoke	II10 Currant	II11 Fiji	II12 Ozone	II13 Ebony	

Jenny 100% Polyester

JN01 Midnite	JN02 Ebony	JN03 Slate	JN07 Vermilion	JN08 Admiral	JN11 Charcoal	JN25 Silver Lining
JN26 Oatmeal	JN27 Sunflower	JN28 Cascade	JN29 Harvest	JN30 Melon	JN31 Berry	JN32 Green Grass
JN33 Roast						

Quilt 100% Polyester

QL10 Black	QL11 Charcoal Grey	QL14 Navy	QL16 Wine	QL19 Silver	QL20 Feather	QL21 Dune
QL22 Meadow	QL23 Cadet	QL24 Geranium	QL25 Daisy	QL26 Quest	QL27 Punch	QL28 Tangerine
QL29 Cocoa						

Terrace 70% Virgin Polyester / 30% Post-Consumer Recycled Polyester

TC61 Tigerlily	TC62 Shadow	TC63 Cobble	TC64 Cherry Blossom	TC65 Bluebell	TC66 Apple	TC67 Haze
TC68 Cerise	TC69 Twilight	TC70 Wintergreen	TC71 Ironwork	TC72 Pine Cone	TC73 Flirt	TC74 Echo
TC75 Glacier						

Trak 100% Recycled Polyester

TK40 Taupe	TK41 Mustard	TK42 Latte	TK43 Cement	TK44 Silver	TK45 Copper	TK46 Teal
TK47 Apple	TK48 Steel	TK49 Merlot	TK50 Midnight Sky	TK51 Mocha	TK52 Carbon	

Urban 62% Recycled Polyester / 32% Polyester

UR10 Red Rose	UR11 Ocean Blue	UR12 Blue Bayou	UR13 Green Grass	UR14 Sandcastle	UR15 Beach Day	UR16 Boardwalk
UR17 Earth	UR18 Brown Ridge	UR19 White Sand	UR20 Granite Rock	UR21 Gravel Road	UR22 Black Coal	

Waterfall 60% Virgin Polyester / 40% Post-Consumer Recycled Polyester

WA40 Trance	WA41 Tryst	WA42 Splash	WA43 Victoria	WA44 Imagine	WA45 Sky	WA46 Rainforest
WA47 Rumble	WA48 Prism	WA49 Tranquility	WA50 Grand	WA51 Rushing	WA52 Magestic	WA53 Pacific
WA54 Dance						

Wavelength 100% Virgin Polyester

WV01 Lime	WV02 Mint	WV03 Stone	WV04 Flame	WV05 Mykonos	WV06 Savannah	WV07 Mesa
WV08 Plasma	WV09 Cancun	WV10 Quartz	WV11 Moonrock	WV12 Rubine	WV13 Corfu	WV14 Bluejay
WV14 Panther						

Grade 2

Elevate 80% Post-Consumer Recycled Polyester / 20% Rayon

EL51 Halo	EL52 Dove	EL53 Safari	EL54 Sunglow	EL55 Margarita	EL56 Fiji	EL57 Mist
EL58 Blaze	EL59 Wasabi	EL60 Mystic	EL61 Mica	EL62 Cherry	EL63 Scuba	EL64 Lapis
EL65 Onyx						

Etch 80% Post-Consumer Recycled Polyester / 20% Rayon

ET81 Drift	ET82 Citron	ET83 Calypso	ET84 Mandarin	ET85 Crisp	ET86 Iris	ET87 Nickel
ET88 Paprika	ET89 Nutmeg	ET90 Marine	ET91 Magnet	ET92 Infrared	ET93 Espresso	ET94 Indigo
ET95 Anthracite						

Imprint 100% Post-Consumer Polyester

IM70 Almond	IM71 Cork	IM72 Sand	IM73 Currie	IM74 Candy Apple	IM75 Ocean	IM76 Navy
IM77 Green Tea	IM78 Celery	IM79 Oregon	IM80 Walnut	IM81 Paprika	IM82 Graphite	IM83 Slate
IM84 Licorice						

T TEXTILES + FINISHES

Grade 2 (Vinyl) For availability of chair series in Vinyl, please contact a Global Sales Representative.

Allante Free 100% Vinyl Face / 100% Polyester Backing

A01F Illusion	A02F Bright White	A03F White Crush	A04F Ivory	A05F Ice	A06F Bleached Sand	A07F Taupe Fawn
A08F Warm Smoke	A09F Autumn Rain	A10F Cookie	A11F Sierra Brick	A12F Gibraltar	A13F Chateau Grey	A14F Garden Green
A15F Oasis Green	A16F Ink Black	A17F Purple Impulse	A18F Italian Rose	A19F Mountain Sky	A20F Old Navy	A21F Galaxy
A22F Red Truffle	A23F Chocolate Sundae	A24F Province Blue	A25F Eclipse			

GC Linen 100% Vinyl Face

LE50 Potters Clay	LE51 Pearl	LE52 Tan	LE53 Storm	LE54 Butter	LE55 Haystack	LE56 Ganache
LE57 Sunset	LE58 Burnt Orange	LE59 Cayenne	LE60 Navy	LE61 Bamboo	LE62 Gray	LE63 Charcoal
LE64 Moss						

Luxhide 100% Vinyl Face / Bonded Leather Backing

BL20 Black	BL22 Parchment	BL23 Saddle	BL24 Dark Brown	BL26 Burgundy	BL27 Charcoal	BL28 White
BL34 Light Grey						

Release 100% Vinyl Face

RL11 White	RL12 Chalk	RL13 Stone	RL14 Taupe	RL15 Orange	RL16 Country	RL17 Tuscan
RL18 Cottage	RL19 Yellow	RL21 Red Barn	RL22 Brave Red	RL23 Gypsy Red	RL24 Cajun	RL25 Vineyard
RL26 Olive	RL27 Bonsai	RL28 Summer's Dream	RL29 Calico	RL31 Green	RL32 Blue	RL33 Black
RL34 Cool Grey	RL35 Thunder Grey	RL36 Navy	RL37 Dark Chocolate	RL38 Espresso		

Grade 6

Novaro Genuine Leather 100% Leather

N050 Ash	N051 Asphalt	N052 Bison	N053 Blueberry	N054 Cloud	N055 Clove	N056 Cordovan
N057 Doe	N058 Linen	N059 Marina	N060 Phantom	N061 Pigeon	N062 Scarlet	N063 Turtle
N064 Wheat						

PANEL/TACKBOARD FABRICS

GRADE 2

Lola 100% Polyester.

LL11 Medium Taupe	LL12 Caramel Cream	LL14 Blue Mist	LL35 Spray	LL36 Granite	LL37 Cinder	LL38 Sandstone
-------------------	--------------------	----------------	------------	--------------	-------------	----------------

GRADE 3

Anchorage 65% Pre-consumer Polyester / 35% Post-consumer Polyester

AN40 Birch	AN41 Green Apple	AN42 Lapis	AN43 Straw	AN44 Wolf	AN45 Goose	AN46 Angora
AN47 Cumin	AN48 Asteroid	AN49 Geranium	AN50 Thistle	AN51 Graphite	AN52 Slate	AN53 Quarry Blue
AN54 Onyx	AN55 Pumpkin	AN56 Red Delicious	AN57 Sunshine	AN59 Waterfall	AN61 Vanilla	AN62 Cobalt
AN64 Cloud						

Merge 100% Polyester / 75% Post-consumer Recycled Polyester

MG20 Fawn	MG21 Marshmallow	MG22 Driftwood	MG23 Dove	MG24 Graphite	MG25 Slate	MG26 Eucalyptus
MG27 Fire Engine	MG28 Mediterranean	MG29 Midnight				

FINISHES

Seating Finishes - Metal & Polymer: *Please consult each Seating Series for finish availability.*

Black (BK)	Charcoal Grey (CHR)	Chrome (CHM)	Fog (FG)	Polished Aluminum (ALU)	Tungsten (TUN)
------------	---------------------	--------------	----------	-------------------------	----------------

Seating Finishes - Plastic (Duet, Popcorn, Sonic and Stream)

Buzz Blue (BZB)	Cactus (CCT)	Carrot (CRO)	Cloud (IVC)	Dijon (DJN)	Eggplant (EGP)	Fog (FOG)
Frost (FRO)	Ink (INK)	Latte (LAB)	Night (BLK)	Sand (SND)	Scarlet (SAR)	Shadow (SHW)

Seating Finishes - Wood Seating finishes will not necessarily match Casegoods finishes. This is due to the fact that Seating and Casegoods finishes use different wood species and are manufactured at multiple locations.

Absolute (AAM)	Black (BKM)	Cherry (ACM)	Espresso Cafe (ECM)	English Oak (EOM)	Fruitwood (TFM)	Gray (HGM)
Honey (AHM)	Mahogany (TMM)	Maple (AVM)	Medium Walnut (MWM)	Natural Walnut (NLW)	Night (ASM)	Noce Biondo (NBM)
Noce Grigio (NGM)	Noce Leggero (NEM)	Noce Medio (NMM)	Shaker Cherry (SKM)	Walnut (TWM)	WC Cream (WTM)	White (WHM)
Winter Cherry (WCM)						

Desks, Workstations, Tables and Accessories - Laminate

Absolute Acajou (ACJ)	Asian Night (ASN)	Avant Cherry (AWC)	Avant Honey (AWH)	Black (BLK)	Blizzard (BZD)	Brushed Cobalt (BRC)
Clear Maple (CMB)	Custom Grey (CGY)	Dark Espresso (DES)	Designer White (DWT)	Fashionista (FAS)	First Class (FCL)	Noce Biondo (NBL)
Noce Grigio (NGL)	Noce Leggero (NEL)	Noce Medio (NML)	Quartered Mahogany (QTM)	Sheer Beauty (SBY)	Stonedust (SDT)	Storm Grey (SOG)
Walnut Heights (WHE)	White Chocolate (WHC)	Winter Cherry (WCR)				

Desks, Workstations, Tables and Accessories - Wood Veneer

Almond Cherry (AMW)	Amber Cherry (ACW)	Biscotti (BTW)	Cocoa Walnut (CAW)	Coral (CRW)	Dark Cherry (DCW)	Dark Walnut (DWW)
Espresso Walnut (EWW)	Evening Oak (EVW)	Grey on Oak (GRW)	Hazelnut (HAW)	Java (JAW)	Latte Walnut (LTW)	Mahogany on Walnut (MHW)
Milestone (MTW)	Natural Maple (MPW)	Natural Walnut (NLW)	Red Cherry (RCW)	Umber Walnut (ULW)	Vintage Cherry (VNW)	Walnut (WLW)
Warm Cherry (WCW)	White Maple (WMM)					

Metal Leg Finishes *(check series for applicable finishes)*

Antique Copper (ACO)	Black (TBL)	Brushed Chrome (BCH)	Buzz Blue (TBZ)	Cactus (TCC)	Carrot (TCR)	Cloud (TIV)
Chrome (CHM)	Designer White (TDW)	Dijon (TDJ)	Eggplant (TEG)	Fog (TFO)	Frost (TFR)	Ink (TIN)
Kalua (TKA)	Latte (TLA)	Mocha (TMO)	Nevada (TNE)	Sand (TSN)	Satin Brass (SBR)	Scarlet (TSR)
Shadow (TSH)	Toast (TOA)	Tungsten (TTU)				

Metal File + Storage Finishes

Business Grey (BGR)	Black Coffee Textured (BKC)	Black (BLK)	Bone (BNE)	Blizzard Textured (BZD)	Charcoal (CHR)
Claret (CLT)	Dark Chocolate Textured (DCH)	Desert Putty (DPT)	Designer White (DWT)	Fog (FOG)	Grey (GRY)
Light Grey (LGR)	Ice (ICE)	Ivory (IVR)	Mocha Textured (MCH)	Metro (MET)	Moss (MOS)
Nevada (NEV)	Navy (NVY)	Oyster (OYS)	Stonedust Textured (SDT)	Storm Grey (SGR)	Silver (SIL)
Sky (SKY)	Stone (STN)	Taupe (TPE)	Tahiti Sand (TSA)	Tungsten (TUN)*	Willow (WIL)

* 10% upcharge applies

THIS FORM IS TO BE USED FOR NON-STANDARD CUT-OUT SIZES

Dufferin and Lufton tables up to 120" (Corby up to 84").

Model # _____ (please use one page for each model #)

Please check all that apply. Note: Base positions will vary based on style chosen. Outer cut-outs are approximately 18"-20" in from each end.

CUT-OUT POSITION(S)

- Position 1 - near left base - use option code **CCUTL**
- Position 2 - center of table - use option code **CCUTC**
- Position 3 - near right base - use option code **CCUTR**
- Custom position(s) - indicate on diagram below w/dimensions to **center point** of cut-outs - use option code **CCUS**

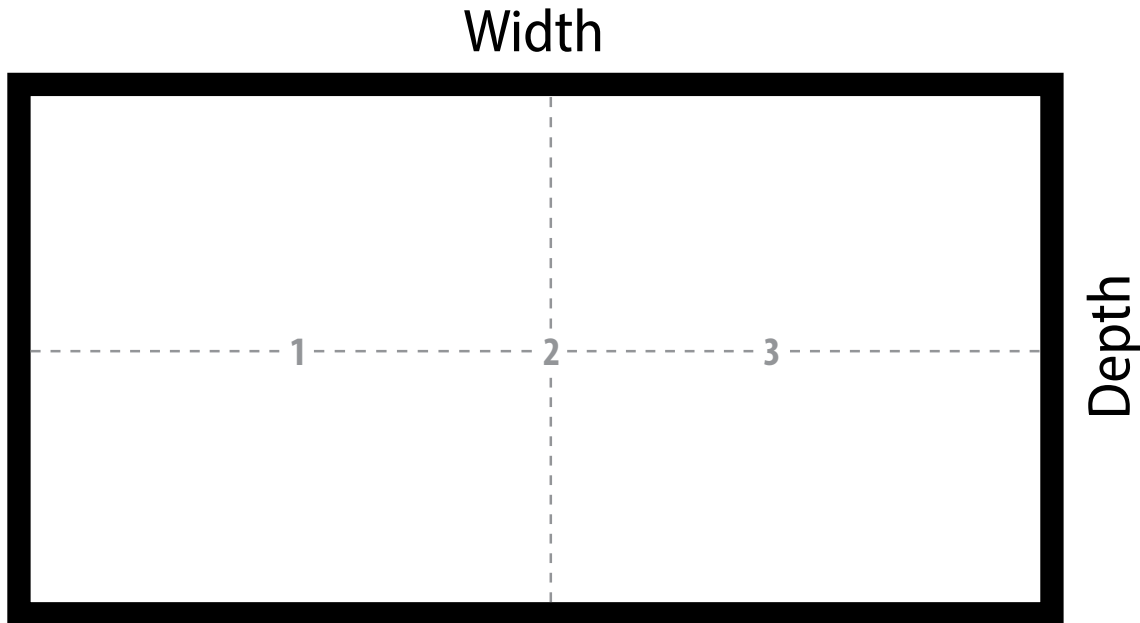

CUT-OUT CRITERIA

All cut-outs require a minimum 8mm radius at each corner.

Cut-outs **must be centered** on the depth of each table due to wire management runners below the worksurface.

Indicate cut-out size:

_____ " X dimension of cut-out runs the width of the table.

_____ " Y dimension of cut-out runs the depth of the table.

Y dimension not to exceed 14"

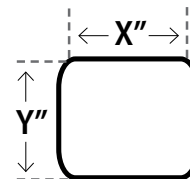

Dealer PO# _____

Internal use only

Global order# _____

Global trailer/load #: L _____ ID #: _____

THIS FORM IS TO BE USED FOR NON-STANDARD CUT-OUT SIZES

Dufferin and Lufton tables 144" - 240".

Model # _____ (please use one page for each model #)

Please check all that apply. Note: Base positions will vary based on style chosen. Outer cutouts are approximately 18"-20" in from each end

CUT-OUT POSITION(S)

- Position 1 - near left base - use option code **CCUTL**
- Position 2 - center of table - use option code **CCUTC**
- Position 3 - near right base - use option code **CCUTR**
- Custom position(s) - indicate on diagram below w/dimensions to **center point** of cut-outs - use option code **CCUS**

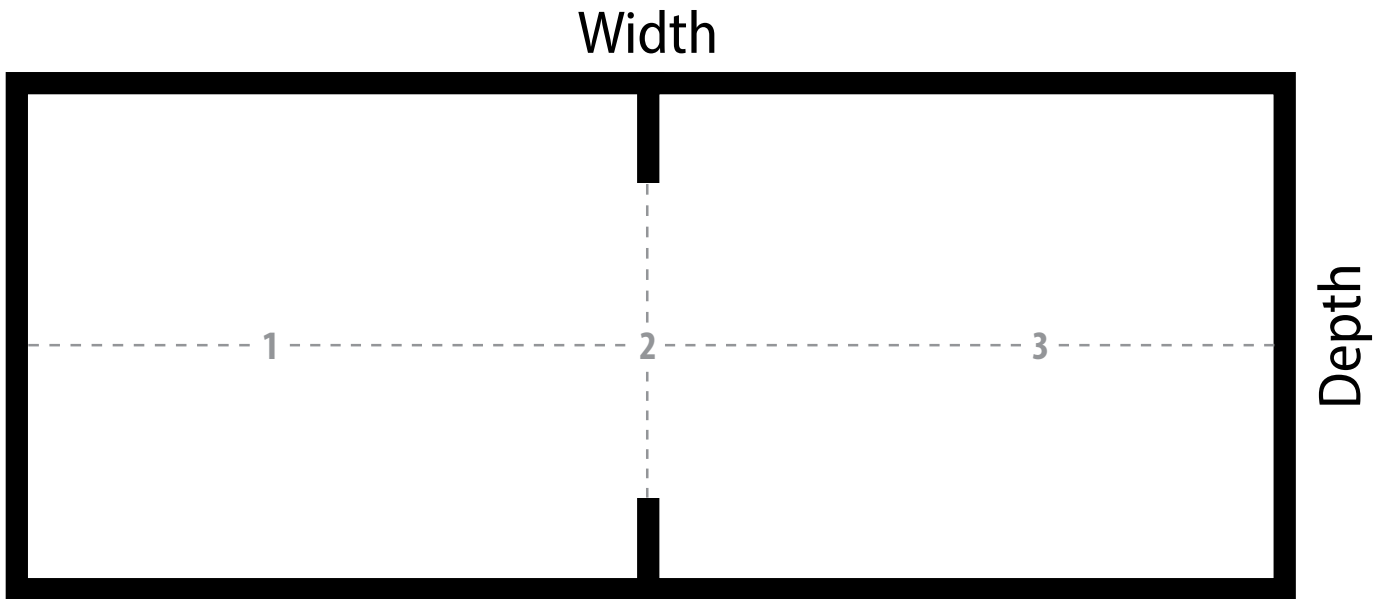

CUT-OUT CRITERIA

All cut-outs require a minimum 8mm radius at each corner.

Cut-outs **must be centered** on the depth of each table due to wire management runners below the worksurface.

Indicate cut-out size:

_____ " X dimension of cut-out runs the width of the table.

_____ " Y dimension of cut-out runs the depth of the table.
Y dimension not to exceed 14"

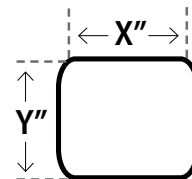

Dealer PO# _____

Internal use only

Global order# _____

Global trailer/load #: L _____ ID #: _____

CUSTOM COLOR APPROVAL FORM - GLOBAL WOOD VENEER DESKS AND TABLES

Corby, Dufferin, Kadin and Lufton series only

Dealer will be billed a matching fee of \$375 upon receipt of the match sample.
All standard and special products with a custom stain receive a 15% upcharge.
Please complete the form below and mail it, along with TWO samples (no smaller than 3" x 3") to:

Global Furniture Group
ATTN: Casegoods - Custom Stain Match
17 West Stow Road, PO Box 562
Marlton, NJ 08053

CONTACT INFORMATION

Date:	Project Name:		
A+D/Dealer/Company Name:	Contact Name:		
Billing Address:	Phone:		
City:	State:	Zip:	E-mail:

CUSTOM STAIN INFORMATION

Manufacturer's Name:
Color Name:
Color Code:
Comments / Sample to be matched on (species):

PLEASE FILL OUT THE SECTION BELOW ONCE SAMPLE HAS BEEN RECEIVED AND APPROVED. SUBMIT THIS PAPERWORK WITH THE ORDER.

APPROVED:	YES	NO	DATE:
SIGNATURE			
PRINT NAME			
PO #			

INTERNAL USE ONLY

Sample Received on:	VMID:
Special Finish Upcharge:	Color #:
Wood Species:	

CARE AND MAINTENANCE GUIDE

Wood Casegoods Care: Global furniture is constructed to strict specifications to ensure years of satisfied use. As with all wood products, certain care requirements and periodic maintenance are necessary in order to maintain the original new appearance and function.

Finishes: Global veneers and solid woods are carefully selected for color, tone and grain. Since the distinctive characteristics and nature of wood cause variations, exact matches are not always possible. Wood veneer, being a natural material, will have shade differences between veneer leaves. This will be more apparent between flitches. Fading on wood veneers can be caused by exposure to UV rays / sunlight.

Finish Protection: All clear wood finishes are susceptible to scratches from rough and abrasive objects, such as staples, paper clips, ceramic coffee mugs, flower pots, picture frames, etc. Computer equipment with rubber feet can also cause discoloration and softening of the finish due to petroleum distillates in the rubber.

The most practical protection is the use of desk pads, paper management bins and coasters. Common sense, caution with rough items, and adding pressure sensitive felt to the feet or bottoms of any potentially destructive item will help to ensure a mar free surface.

Finish Care: Wax or polish should never be used on the finish; they will give a greasy, cloudy or uneven appearance to the product. Global's conversion varnish finish is best cleaned by wiping the surfaces with a damp cloth, followed by a soft dry cloth in the direction of the grain. If the surfaces are very dirty, use of a glass cleaning type of product is recommended. Touch-up of wood furniture should only be attempted by a qualified refinisher/touch-up technician. Contact your furniture dealer if this need should arise.

GENERAL INSTALLATION AND HARDWARE

Leveling wood office furniture properly is the most important procedure to ensure proper functioning and alignment of drawers, locks and doors.

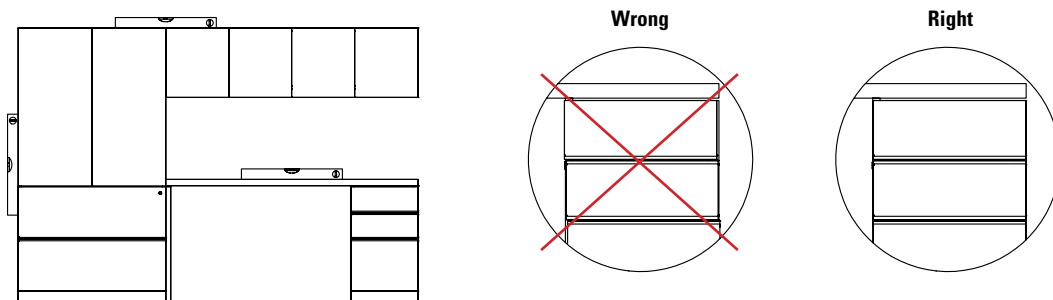

Hutch and wall cabinet doors may require field adjustment from time to time, due to shifting weight load factors inside the cabinet.

Modular furniture items, such as Desk Shells and Modular Pedestals **must be disassembled** prior to moving or relocating to avoid damage to the furniture.

Drawer suspensions are lubricated prior to shipment. Periodic lubrication may be applied to the ball bearing housing with a high quality lubricant found in most hardware stores.

Hanging file rails: Pre-installed on file drawer perimeters and accommodates both letter (front to back) and legal (side to side) size filing.

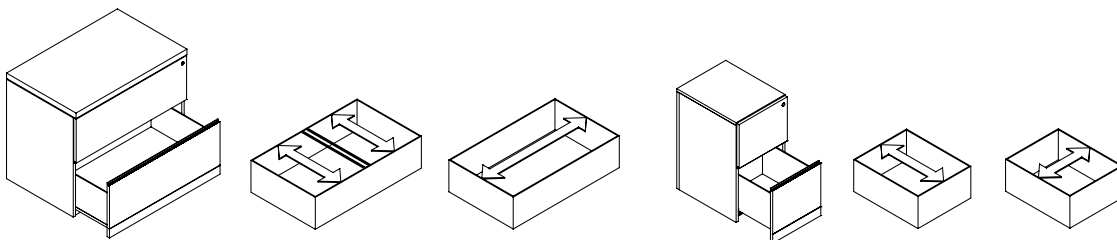

ATTENTION: Always load the bottom drawer of Lateral Files and Freestanding Pedestals first!

This illustrated price list has been designed to facilitate fast reference and easy use. Products are categorized into "seating", "desks", "files", "panels", or "tables", and are listed numerically within their categories. The line drawings match actual photographs (where possible) to aid in instant recognition of the total range within a series.

Sales of Global Furniture Group ("Global") products are made only on Global's standard Terms and Conditions of sale which are contained in this price book. These standard terms and conditions may be modified or supplemented only by a separately written document signed by Global's authorized personnel at its head office in Marlton, NJ. Any term or condition contained in any purchase order or other form used by dealer/purchaser to order goods (including standard, printed language) which is different from, in addition to, or in any way inconsistent with Global's standard terms and conditions shall be of no force or effect whatsoever.

All illustrations, specifications and prices in this list price book are based on the latest product information available at time of publication. Global reserves the right to make changes at any time and without prior notice to prices, colors, materials, specifications and models offered.

Description

Each product shown or described in this price list is standard Global product. Available options are noted at the beginning of each series. Available options may require additional delivery time and cost, and may affect the warranty given. Sizes and weights shown are approximate and are subject to slight changes from time to time.

Prices and Payment

The prices shown in this book, as well as those quoted by Global, are in United States dollars for orders shipped to destinations in the U.S. and Mexico.

If shipping date requested is more than 90 days from date of order, Global shall reserve right to use published list prices effective at the time of shipment.

Orders are invoiced at the time of shipment. Terms of payment are net 30 days from date of invoice unless otherwise stated. The customer agrees that Global shall have the right to enforce a charge amounting to 1.5% per month (18% per year) on invoices outstanding more than 30 days.

If dealer/purchaser's most recent annual net volume is less than \$5,000.00, payment must be made in advance.

Any products sold by Global shall remain the personal property of Global until fully paid.

Prices are suggested list prices only and are subject to change without notice. Global will, however, attempt to keep dealer/purchasers up-to-date on all developments including price changes.

Taxes

All prices shown in this book are exclusive of sales, use, excise and other applicable taxes and are the dealer/purchaser's responsibility as per the invoice issued by Global. If dealer/purchaser claims an exemption from such taxes, it shall be the dealer/purchaser's responsibility to furnish Global with an appropriate exemption certificate at time of order.

Ordering Information

To avoid errors and/or duplication, Global requires that all orders be submitted in writing. All orders submitted to Global in writing and will be acknowledged on Global's acknowledgment forms governing the transaction. The details

appearing on this acknowledgment will describe the items to be shipped and the approximate shipping date. It is the dealer/purchaser's responsibility to determine that the information in the acknowledgment is correct. In the event of an error, the dealer/purchaser must notify Global immediately by telephone followed by written confirmation. Shipping dates are assigned to orders based on the item having the longest manufacturing lead time (unless instructed to partial ship).

When ordering, please provide the following information:

- 1) Account number (if possible)
- 2) P.O. number
- 3) "Bill to" and "ship to" name and address
- 4) Complete model number
- 5) Description
- 6) Options:
 - a. Upholstery fabric type and color (specify by name and number)
 - b. Color of paint finish, laminate or wood (if applicable)
 - c. Trim options (frame)
 - d. Arms
 - e. Base, Casters
 - f. Mechanism
 - g. Accessories

Dealer/purchaser is responsible for providing correct information when placing an order. Orders with incorrect information (finish, etc.) will be scheduled for manufacturing upon receipt of complete information.

All phone orders must be confirmed in writing by the customer within 7 days.

To prevent a delay in processing orders, please specify delivery routing.

Changes and Cancellations

After the date of Global's acknowledgment of a dealer/purchaser's order, the order may not be changed or canceled by dealer/purchaser without the written consent of Global. Special order items, C.O.M. and fabric-covered items already in production are not subject to change or cancellation under any circumstances. Textile-covered items are considered to be in production once the textile is scheduled for cutting. Other standard items already in production are subject to a minimum 35% cancellation charge.

Errors and Omissions

All quotations, acknowledgements and invoices are subject to corrections for any errors and omissions.

FINISHES

Wood Finishes

For custom stain requests, submit a special request for quotation. Non-standard wood finish orders will incur a one time charge of \$250 net to dealer per matching custom wood stain. This one time fee will be valid for 5 years from the time of matching. After 5 years, a new \$250 net to dealer charge will apply. All custom wood stain products will receive a 10% list per unit upcharge, included on the special quote. Requests with unit quantities of 30 or more, may be considered for reduced or eliminated upcharge. At time of order, a 3" x 3" color sample is required to be submitted with order. Extended order lead time is required for custom matching and approval process..

File Finishes

All non-standard file finishes must be approved by Global prior to acceptance of order and may be subject to an upcharge.

Laminate Tops - pricing for all non-standard finishes and sizes must be provided by Global Customer Service and may be subject to an upcharge.

Desk Finishes

Because the distinctive characteristics and the nature of wood products cause variations, exact matches are not always possible.

Global has launched a finishes program between marketing companies within the Global Group to match products as best as possible when same finishes are specified.

Customers Own Material (COM)

Use of COM must be approved by Global prior to acceptance of order. Please refer to the back of the Seating List Price Book and fill out the Authorization Request Form. Photocopy and use this form as often as necessary. The customer must provide a 12" x 12" fabric sample and advise how the fabric is to be applied. **Textile yardage requirement will be advised by the factory, and additional yardage may be required if pattern requires matching.** Yardage shown in the List Price Book does not allow for pattern repeat/matching. Send to the address provided on shipping document upon approval from Global. If C.O.M. is difficult to apply or if product shall be modified, extra charges shall be made. Global reserves the right to cancel an order at any time if C.O.M. is inadequate for any reason. Customer's Own Material must be shipped freight and duties paid to our factory. Such shipment must be fully identified with purchaser's order number, RGA # provided by Global, and the item for which material is intended. Performance of C.O.M. when applied to product is the sole responsibility of the purchaser. Global's standard product warranty shall not apply to C.O.M. Use of C.O.M. will not reduce the published list price.

Textile Grading

All products are priced according to their standard textile grade. Lower grade textiles are available (unless otherwise specified) at same price as standard textile grade.

The listing of prices for each model indicates the prices for higher upholstery grades. Prices are based on yardage in imperial measurements.

TEXTILE PRICE GRADES - GLOBAL TEXTILES

Grade Upholstery (Seating Fabrics)

- | | |
|---|---|
| 1 | Carrera, Dobby, Fusion, Illusion, Jenny, Quilt, Terrace, Trak, Urban, Waterfall, Wavelength |
| 2 | Allante FRee, Elevate, Etch, GC Linen, Imprint, Luxhide, Release |
| 6 | Novaro Genuine Leather |

Grade Upholstery (Panel Fabrics)

- | | |
|---|------------------|
| 2 | Lola |
| 3 | Anchorage, Merge |

The charts above do not include textiles offered by Alliance Partners: Arc-Com Fabrics, CF Stinson, Designtex, Knoll Textiles, Green Hides, LDI Interiors, Luum Textiles, Maharam, Mayer Fabrics, Momentum, and Ultrafabrics.

Upholstery Coverings

Slight variations in color may occur between dye lots. Although Global attempts to minimize these variances, they do occur and must be accepted as normal and will not be considered defects.

Yardage

Required yardage (ydg) is based on unmatched materials with widths of 54" for seating, 63" for panels. Yardage calculations are based on imperial measurements.

Arms

A wide selection of arms are available for some series. See Arm Charts in the Seating price list for details.

Delays

Global's order acknowledgement will state a shipping date which is Global's best estimate at the time the order is acknowledged. However, Global shall not incur any obligation or liability to Purchaser for failure to ship by specified date unless Global has agreed to an unequivocal shipping date in a separately signed written document executed by its authorized personnel at its head office. In addition, Global shall not be liable for any loss or damage resulting from any delay or failure in shipment or other failure to perform all or any part of the agreement between the parties with respect to the goods shown on the face of the order acknowledgement where such delay, failure, loss or damage is the proximate result of any act of any governmental authority or political subdivision thereof, revolution, riot, civil disorder or disturbance, delay or default in transportation, strike disputes among or between labor unions or other labor disputes, delay or inability in obtaining materials and facilities, fire, flood, act of God or any cause not within the reasonable control of the company, whether of the class of causes enumerated or otherwise.

F.O.B.

F.O.B. point is Global's Factory, Downsview, Ontario, Canada, or any Global Regional Distribution Center.

FedEx and UPS Shipments

Seating products marked with a FedEx or UPS symbol are packaged for shipment via FedEx or UPS.

Handling

Non-UPS/FedEx orders under \$10,000 list incur \$100 net handling fee. Small packages (FedEx, UPS) incur \$25 net handling fee per carton (up to four cartons).

Special Delivery Requirements

Global's delivered pricing provides for dock delivery during normal business hours (considered to be 8 am to 4 pm Monday through Friday) to customer/end user only. Additional delivery requirements such as inside delivery, lift gate, limited access sites, installations and weekend deliveries will incur an additional expense and will be the responsibility of the dealer.

Service

Service requests are normally the responsibility of Global's authorized dealers. Where this cannot be accomplished on a local level, service problems should be referred to Global's Customer Service Department in the nearest distribution center.

Returns

No returns of goods will be accepted without written consent and shipping instruction of Global. A minimum re-stocking charge of 35% is made on all authorized returns for credit or refund, provided goods are received by Global in the condition in which they left the factory. This may increase depending on the type of product. Global's Return Goods Authorization (R.G.A.) numbers must appear prominently on all authorized

returns. Global will not be responsible for freight costs. No credit will be given if goods cannot be reused as new. Special order items, non-stock items and C.O.M. products are in no event subject to return. All returns must be approved and authorized in writing by Global Customer Service. Global reserves the right to refuse delivery of any unauthorized returns.

Claims

All goods are sold FOB plant or Global Distribution Center. Global is not responsible for damage which occurs in transit (or in storage). The carrier signs for all goods received in apparently good order. It is the dealer/purchaser's responsibility to examine goods upon receipt and to file any claims with the carrier for losses or damage to the product occurring during transit, including concealed damage.

Any claims made against Global for apparent defects, errors or shortages must be made by the dealer/purchaser, in writing, within 15 working days after any delivery. Failure by the dealer/purchaser to make any claim against Global within 15 days shall constitute acceptance of the goods and a waiver of any apparent defects, errors or shortages.

Suspension

In the event that the dealer/purchaser defaults in the payment of any sum due to Global, or in the event the dealer/purchaser's financial condition becomes unsatisfactory to Global, Global shall have the right to defer or discontinue shipment of any goods until such time as the default is cured or the dealer/purchaser provides assurance of payment to Global.

Copyright

All catalogs, photographs, drawings, price lists and other printed material are protected by copyright. All rights reserved.

Trademarks

All trademarks are owned by Global Furniture Group other than OBUSFORME™ which is owned by OBUSFORME LTD. and are used under license. OBUSFORME® and the distinctive backrest design are registered trademarks of OBUSFORME LTD.

Designs and Patents

Many of the products produced by Global are protected by design registrations, design patents and/or patents. Design and specifications are subject to change, discontinuance or additions without notice.

For a full listing of issued trademarks, please visit globalfurnituregroup.com.

Cubic Measure

The stated volume is an approximate cubic foot measure to calculate freight costs. The figure shown is the total shipping volume of a unit (e.g. if a part is sent in 2 cartons the volume indicated reflects both cartons together) and is subject to change without notice. It is most economical to purchase the specified number per carton.

Combined Shipments

Global will make every effort to combine shipments and orders on written request. However, Global cannot be held responsible where such request is not complied with.

Offer of Sale

Possession of this price list or any other literature shall not imply the company's willingness to sell to the holder and shall not be construed as a direct offer of sale.

If a conflict arises between: (i) prices found in software support packages furnished to the customer by Global or by any other source on behalf of Global; and (ii) Global's current pricing found on Global's website, then the most current shall prevail.

Disclaimer

All dimensions are in inches. Prices shown are current manufacturer's suggested list prices at the time of printing. Updated pricing is available on Global's website. All applicable taxes are extra. Descriptions, specifications and prices are subject to change without notice. Errors and omissions are subject to correction.

Testing Qualifications

Many Global products pass or exceed the most stringent industry testing standards.

Flammability

The foam used in Global chairs meets the requirements of California TB117:2013. In addition to the foam, upholstery materials must also meet the California TB117 smolder resistant requirements. Please contact Customer Care to determine if a selected textile meets the California TB117 requirement.

This list price book is effective as of July 14, 2025.

For periodic updates, please check the PDF at globalfurnituregroup.com. Select Resources then Price Lists. From here you will have the option to select either the Seating, Desking + Tables or Metal Filing + Storage price list books. Global warrants that all commercial products are free from defects in material and workmanship, for the life of the product, to the original Purchaser.

LIMITED LIFETIME WARRANTY

Global will repair or replace, at Global's option, as the sole remedy for any defect covered by the warranty. The warranty applies to products manufactured after March 22, 2016.

Global makes no warranty that any of its products are suitable for any particular purpose and makes no other warranties, express or implied, other than those set out here. As codes and standards vary from one jurisdiction to another, references to compliance are solely for convenience and without any representation as to accuracy or suitability. Users must verify the suitability of such information or product for their specific application. In no event shall Global be liable in either tort or contract for any loss or direct, special, incidental, consequential, or exemplary damages. The warranty applies to single shift, standard commercial usage, defined as a standard eight (8) hour day, forty (40) hour week for users weighing up to 300 pounds.

General Commercial Seating

Global's warranty for general commercial seating covers all chair components including pneumatic cylinders, bases, casters, glides, frames, arms, plastic seats, backs and other structural components.

Exceptions to the warranty for general commercial seating are as follows:

- Foam, textiles (as sampled on Global branded and textile program cards), mesh material and electrical devices, are warranted for five (5) Years. Novaro Leather is warranted for one (1) year.
- Control mechanisms are warranted for twelve (12) Years
- Heavy duty seating and Indoor/Outdoor Furniture are not defined as General commercial seating (see below for warranty exceptions)

Heavy Duty Seating

Global offers products designed for multiple shift applications (24 hours a day / 7 days a week) and larger individuals weighing up to 400, 500 and/or 600 pounds (depending on series and/or model). Global warrants these products for twelve (12) years to the original purchaser. All components (including control mechanisms, pneumatic cylinders, bases, casters, glides, frames, arms, plastic seats/backs, etc.) are covered for 24/7 applications under the warranty. The exceptions are foam, upholstery and textiles, which are covered for five (5) years. Fabric or upholstery material on these products must exceed 100,000 double rubs for the textile portion of the warranty to apply. Heavy Duty product series that apply under this warranty can be found in the Heavy Duty section of this list price book.

Outdoor Furniture

Global offers products designed for use indoors or outdoors. Global warrants these products for three (3) years to the original purchaser. This warranty applies to single shift (eight (8) hour day, forty (40) hour week) for users weighing up to 275 pounds, unless noted otherwise. Outdoor furniture must be stored indoors during inclement or extreme weather such as extreme cold, extreme heat, or excessive wind.

Exceptions to the warranty for indoor/outdoor furniture is as follows:

- Only Global branded textiles and Alliance Partner carded textile program materials expressly identified for outdoor application are covered for three (3) years when used outdoors.

Global's Warranty does not apply (for any product category) to the following:

- Products not purchased directly from authorized Global resellers
- Nominal or normal amount of wear and tear that can occur over time
- Failures which result from negligence, abuse, accident or misuse
- Failure to apply, install or maintain products according to Global's written instructions and warnings
- Modifications, attachments or repair methods not approved by Global
- Damage caused by a carrier in transit, or delivery/installation contractors
- The matching of colors, grains or textures (wood, leather, etc.) of natural materials
- Products exposed to extreme hot or cold temperatures or excessively dry or humid environments
- Colorfastness or the matching of color of textiles, dye lots of textile can vary
- Damage by markings or staining; damage by sharp objects or imprinting from instruments
- Damage to textiles or laminate and wood surfaces/edges from exposure to sunlight (including UV rays)
- Products used for rental purposes
- Purchased parts are warranted for one (1) year
- Failure to follow specific cleaning and disinfecting instructions posted on globalfurnituregroup.com

Seating Warranty Summary

Seating Type	Components Warranty For Original Purchaser	Use Time For Warranty Coverage	Exceptions
General Commercial Seating	Lifetime	8 Hours/5 Days Per Week	Foam/Upholstery/Textiles/Mesh/Electrical Devices - 5 Years Control Mechanisms - 12 Years
Heavy Duty Seating	12 Years	24 Hours/7 Days Per Week	Foam/Upholstery/Textiles - 5 Years
Indoor/Outdoor Furniture	3 Years	8 Hours/5 Days Per Week	Outdoor Use Textiles – 3 Years

Textiles

Global warrants Global branded textiles and Alliance Partner carded textile programs inclusive of fabrics, vinyls and leather products for five (5) years, with the exception of Novaro Leather, which has a one (1) year warranty. Global does not warrant COM (Customer Own Materials) or graded-in materials (non-carded) and purchased by Global for a customer. For graded-in or COM products, please contact the textile supplier for performance information and warranty details. Please refer to our website at globalfurnituregroup.com for detailed information on cleaning and disinfecting procedures. Improper usage of disinfecting/cleaning products may void the warranty.

Global textiles and finishes are updated periodically to meet the demand and trends of the market. As a result, some textiles and finishes may be discontinued by Global or the manufacturer. In the event that a textile or finish is discontinued, Global will make every reasonable effort to provide an alternative product(s) of comparable function.

LIMITED LIFETIME WARRANTY

Global warrants that all commercial products are free from defects in material and workmanship, for the life of the product, to the original Purchaser.

Global will repair or replace, at Global's option, as the sole remedy for any defect covered by the warranty. The warranty applies to products manufactured after March 22, 2016.

Global makes no warranty that any of its products are suitable for any particular purpose and makes no other warranties, express or implied, other than those set out here. As codes and standards vary from one jurisdiction to another, references to compliance are solely for convenience and without any representation as to accuracy or suitability. Users must verify the suitability of such information or product for their specific application. In no event shall Global be liable in either tort or contract for any loss or direct, special, incidental, consequential, or exemplary damages.

Files, Desks, Modular Furniture, Tables, Panels & Accessories

Global warrants all components of metal storage and filing, laminate and wood veneer desks, laminate and wood veneer tables, metal leg components and panels for the lifetime of the product to the original purchaser.

The warranty applies to single shift, standard commercial usage, defined as a standard eight (8) hour day, forty (40) hour week. Load restrictions apply, refer to individual product descriptions.

Exceptions to the warranty for files/desks/tables and panels are as follows:

- Electrical devices, panel and tackboard textiles, adjustable keyboard mechanisms, non-electrical table mechanisms, monitor arms, lecterns, coat trees and task lights - five (5) years
- Writeable surfaces and whiteboards - three (3) years
- Laminate folding tables - one (1) year
- Motorized electrical components - two (2) years
- Keyless lock options - two (2) years

Files, Desks, Modular Furniture, Tables, Panels & Accessories Warranty Summary

Product Type	Components Warranty For Original Purchaser	Exceptions
Metal storage and filing	lifetime	keyless lock options - 2 years
Laminate/wood veneer desks and modular furniture	lifetime	tackboard textiles, electrical devices, task lights - 5 years
Boardroom, conference, training and general tables	lifetime	electrical devices - 5 years moving parts - 5 years
Electric height adjustable bases	7 years	battery pack - 1 year
Non-electric height adjustable bases	5 years	
Productivity Solutions and Accessories (adjustable keyboard mechanisms, monitor arms, coat trees, writeable surfaces/whiteboards)	5 years	writeable surfaces/whiteboards - 3 years
Overbed tables	2 years	
Panels	lifetime	panel and tackboard textiles, electrical devices, task lights - 5 years

Global's Warranty does not apply (for any product category) to the following:

- Nominal or normal amount of wear and tear that can occur over time
- Failures which result from negligence, abuse, accident or misuse
- Failure to apply, install or maintain products according to Global's written instructions and warnings
- Modifications, attachments or repair methods not approved by Global
- Damage caused by a carrier in transit, or delivery/installation contractors
- The matching of colors, grains or textures (wood, leather, etc.) of natural materials
- Products exposed to extreme hot or cold temperatures or excessively dry or humid environments
- Colorfastness or the matching of color of textiles, dye lots of textile can vary
- Damage by markings or staining; damage by sharp objects or imprinting from instruments
- Damage to textiles or laminate and wood surfaces/edges from exposure to sunlight (including UV rays)
- Products used for rental purposes
- Purchased parts are warranted for one (1) year
- Failure to follow specific cleaning and disinfecting instructions posted on globalfurnituregroup.com

Global's warranty does not cover the costs of transportation or labor. Repair or replacement will be at Global's option.

Global's warranty applies to products sold within the United States of America, Mexico, the Commonwealth of Puerto Rico and Canada.

Textiles and Finishes

Global textiles and finishes are updated periodically to meet the demand and trends of the market. As a result, some textiles and finishes may be discontinued by Global or the manufacturer. In the event that a textile or finish is discontinued, Global will make every reasonable effort to provide an alternative product(s) of comparable function.

Global US Headquarters/Distribution Center

17 West Stow Road, P.O. Box 562
Marlton, New Jersey U.S.A. 08053
T (856) 596-3390
T (800) 220-1900

Showrooms

Atlanta

10 10th Street
Suite 150
Atlanta, GA 30309
T (404) 879-0998

Boston

One Harbor Street
Suite 104
Boston, MA 02210
T (617) 406-5435

Chicago

222 Merchandise
Mart Plaza
10th Floor, Suite 1035
Chicago, IL 60654
T (312) 755-0843

Irvine

18400 Von Karman Ave.
Suite 100
Irvine, CA 92618

Miami

112 NE 41st Street
6th floor
Miami, FL 33137

New York City

386 Park Avenue South
7th floor
New York, NY 10016
T (212) 545-9900

Philadelphia

1735 Market Street
38th Floor
Philadelphia PA, 19103
T (215) 861-0963

New Jersey (Southern)

119 West Greentree Road
Marlton, NJ 08053
T (856) 596-3390

Phoenix

4675 E Cotton Center Blvd.
Suite 165
Phoenix, AZ 85040
T (602) 426-0666
T (602) 426-0777

Washington, DC

1130 Connecticut Avenue
10th Floor, Suite 1000
Washington, DC 20036
T (202) 659-0230
T (202) 659-0236

Distribution Centers

Atlanta Area

6715 Maple Ave.
Suite 100
Buford, GA 30518
T (678) 602-4130

Baltimore Area

Troy Hill
Corporate Center
7030 Troy Hill Drive
Elkridge, MD 21075
T (410) 379-8021

Chicago Area

27W501 North Ave.
Suite 300
West Chicago, IL 60185
T (630) 681-2818

Cincinnati Area

8712 LeSaint Drive
Fairfield, OH 45014
T (513) 777-0009

Dallas Area

2025 West Beltline Road
#100
Carrollton, TX 75006
T (972) 236-1366

Denver Area

19080 E. 38th Ave.
Unit # 30
Aurora, CO 80011
T (303) 340-1617

Ft. Lauderdale Area

560 Sawgrass
Corporate Pkwy
Sunrise, FL 33325
T (954) 846-8888

Houston Area

7865 Northcourt Road
Suite 200
Houston, TX 77040
T (713) 695-5777

Los Angeles Area

3629 Workman Mill Road
Whittier, CA 90601
T (562) 484-9686

Seattle Area

Oakesdale Commerce Ctr.
820 Southwest 34th Street
Building W7, Suite A
Renton, WA 98057
T (425) 291-9282

Kansas City Area

11617 West 81st Street
Lenexa, KS 66214
T (913) 310-9963

Tampa Area

10351 Windhorst Road
Tampa, FL 33619
T (813) 621-6272



globalfurnituregroup.com

