



# evolve systems



**ISO 14001:2004 Registered**  
CGSB #006b



**level**™  
the BIFMA sustainability standard  
SCS-SCF0245-4  
SCS-SCF0245-4

## PROTECTING THE ENVIRONMENT FOR FUTURE GENERATIONS

Our environmental success story began with the challenge to create an office system that would meet today's business requirements while maintaining a firm commitment to save and protect the environment.

Sustainability became a part of the creative focus and development of Evolve that incorporates the latest technology and design features to provide excellent performance at a competitive price.

As government and industry environment ratings such as LEEDS & Greenguard become more prevalent, Evolve offers designers and architects functional, attractive, and economical office designs that meet these standards.

Evolve is a leader in reducing waste in the manufacturing of its products as well as utilizing recycled materials wherever possible. We make extensive use of recycled plastic and wood waste from other Global factories.

Evolve is committed to the continuous improvement of our environmental systems, the prevention of pollution, and to comply with both the spirit and the letter of all relevant environmental legislation.

Evolve Panels are 100% recyclable at the end of their lifespan. Nothing from an Evolve Panel needs to end up in a landfill.

## PRODUCT INFORMATION

Evolve offers fabrics that are made from 100% recycled polyester, which means less waste going to landfills. These fabrics also reduced the demand for petroleum products, and decrease the environmental impacts of processing those petroleum products into polyester.

Evolve has developed a Panel interior made from 100% recycled wood and polypropylene. Through innovative design and technology, Evolve utilizes waste that would have normally been sent to landfill.

Evolve Panels are insulated with Roxul, a mineral wood insulation made from slag, an inert steel by-product, and basalt rock. Roxul is a high density product that provides maximum sound absorption to reduce noise in the work environment. Roxul insulation is fire resistant, water repellent and will not support the growth of fungi or mildew.

Evolve's epoxy powder coating process involves no liquids and is solvent free. It contains no harmful VOC's or lead. Up to 99% of over sprayed powdered is reclaimed, mixed with virgin powder and reused.



**REFERENCES**

Features, Benefits & General Information ..... 4-5  
 Coding an Order ..... 6-8  
 Textiles & Finishes ..... 320-324  
 Panel COM Form ..... 325  
 Panel Fabric Specification Sheet ..... 326  
 Panel Fabric Sample..... 328  
 Appendix ..... 329  
 Terms & Conditions ..... 330-331

**PANELS**

Panels – Technical Information..... 10  
 Panel – Types ..... 11-19  
 Panel – Configurations..... 20-21  
 Graphic Panels ..... 22-26  
 Monolithic ..... 27-31  
 Segmented ..... 33-38  
 Partly Glazed ..... 39-48  
 Fully Glazed ..... 49-52  
 Reception ..... 53-54  
 Pass-thru Sliding door ..... 55-56  
 Slatwall ..... 57-63  
 Write Board ..... 64-65  
 Laminate..... 66-69  
 Airflow..... 70-73  
 Metal Skin..... 74-77  
 Open ..... 78-83  
 No Raceway ..... 84-96  
 Gallery ..... 97-110  
 1” Laminate..... 111-112  
 Double Inline Connector..... 113-114  
 Door..... 115-117  
 Acoustic Grid ..... 118-120

**EXTENSION MODULES**

Extension Modules – Technical Information ..... 121  
 Extension Modules – Types ..... 121  
 Fabric..... 122  
 Tempered Glass..... 123  
 Reception Panel ..... 124  
 Write Board..... 125  
 Laminate..... 127-128  
 Airflow..... 129  
 Open ..... 130  
 Bridge Panel ..... 131-133  
 Bridge Module..... 134-139  
 Privacy Glass ..... 140-150

Felt Divider ..... 150-153  
 Ceiling Filler ..... 154-156  
 Privacy Panels ..... 157-173

**PANELS - CONNECTORS**

Panels – Technical Information..... 176  
 Inline Connector ..... 177-179  
 End-of-Run..... 180  
 Two-Way Post ..... 181-184  
 Three-Way Post..... 185-189  
 Four-Way Post..... 190-193  
 One Way Post..... 194-195  
 Inline Two-Way Post ..... 196-197  
 60 Degree..... 198-200  
 45 Degree..... 200-201  
 Upmount End of Run ..... 201-202  
 Extension ..... 203-206  
 Trims ..... 207-210

**ELECTRICAL**

Electrical – Technical Information ..... 212  
 Electrical – Wire Schematic ..... 213  
 Electrical – Configurations..... 214-215  
 Power Distribution Housing..... 216  
 Cables..... 217  
 Power Entry ..... 217-219  
 Post Extension..... 219-221  
 Task Lights..... 221  
 LED Lights ..... 221-223  
 Accessories ..... 223-226

**WORKSURFACES**

Worksurfaces – Technical Information..... 228  
 Worksurfaces – Configuration ..... 229  
 Worksurfaces – Grain Direction ..... 230  
 Straight Worksurface..... 231-233  
 Curvilinear Worksurface ..... 234  
 Corner Worksurface ..... 235-238  
 “L” Worksurface..... 240  
 Transition Worksurface..... 240  
 Hatchet Worksurfaces ..... 241  
 “D” Worksurface..... 241  
 “P” Top ..... 241  
 Straight Wedge Worksurfaces ..... 242  
 Piano Top..... 243  
 Quarter Round Panel Worksurface ..... 244  
 Radius Worksurface..... 245

Arc Front Worksurface ..... 245  
 Transaction Worksurfaces ..... 246-249  
 Height Adjustable ..... 250-253  
 Accessories ..... 253-260

**FREESTANDING DESKING**

Freestanding Worksurface with Corner Legs .. 264-265

**STORAGE**

Storage – Technical Information ..... 268-271  
 Overhead Storage ..... 272-283  
 1200 Series Pedestal ..... 284-283  
 Cube Storage..... 287-291  
 Lateral Files..... 291-292, 300-303, 311-312  
 Conversion Kits ..... 294  
 Double Wall Cabinets ..... 295-298  
 1200 Series Storage Towers..... 298-300  
 Storage Cabinets..... 303-204  
 Accessories ..... 305-308  
 Laminate Pedestals..... 309-310  
 Storage Towers ..... 313-314  
 Credenza..... 305-316  
 Key Alike Form ..... 317

**ACCESSORIES**

Tack Board..... 320  
 White Marker Board ..... 321  
 Load Bars..... 321  
 Rail Accessories..... 324-326  
 Keyboard Supports ..... 327  
 Mouse Supports ..... 328  
 Keyboard Combination Chart ..... 329  
 Monitor Arms ..... 330-332  
 Laptop Support..... 332  
 Desktop Document Holder ..... 333  
 Foot Rest ..... 333  
 Touch-up Paint Kit ..... 333



## PANELS

- NOTE: Panels consist of module frames, module interiors and a variety of skins.

### Panel Information

- All metal components are painted with environmentally friendly epoxy powder.
- Raceway Interiors are coated with recycled epoxy powder.
- The entire Evolve Panel and the processes used to manufacture it are designed to save and protect the environment. Evolve panels are made from recycled materials and are 100% recyclable.
- Panels conform to CGSB and ANSI/BIFMA Standards
- The quality and performance level of these panels have been tested to equal or exceed the requirements of the U.S. Government.
- Classified as Acoustic, these panels meet the acoustical requirements of the U.S. Government with the following ratings:
  - .65 NRC
  - 23 STC
- Panel has a steel frame and is 2 7/8" thick. Corner posts create a panel creep of 3 1/4".
- Leveling Glides extend 2 1/2" high. (Carpet grippers are available, contact Evolve Customer Support).

### Panel Options

- Standard, Beltline and Light\* Segmented Panels are available in the following heights: 30", 42", 54" and 66".
- Standard, Beltline and Light\* Monolithic Panels are available in the following heights: 42", 48", 54" and 66"
  - \* Light panels do not contain a base raceway, therefore the listed heights consider the 6" open space that would have contained a raceway.
- Standard and Light Panel widths come in (8) sizes: 18", 24", 30", 36", 42", 48" 54" and 60"
- Beltline Panel widths come in (7) sizes: 24", 30", 36", 42", 48", 54" and 60". The 6" Power Belt Module is metal with knockouts on both sides.
- Beltline Panel with Chimney widths come in (2) sizes: 36" and 42".

### Panel Skin Options

- Acoustic Fabric (Tackable), Glazed, Open, Laminate, Whiteboard, Metal, Air Flow, Slat

### Panel Extension Modules

- Attaches to the top of Standard, Beltline or Light panels.
- Offered in 6", 12", 18" and 24" heights
- Can be stacked in an excess of 14'-0". (Contact the Evolve Specification Department regarding additional support required.)

## Extension Module Options

- Fabric, Glazed, Open, Laminate, Whiteboard and Airflow. Laminate and Whiteboard available in single and double sided.

## Panel Reconfiguration

- Panels can be modified on site by replacing fabric modules with Glazed, Open, Laminate, Whiteboard or Air Flow at any time after the initial installation\*.
  - All panel types existing on site can have their height altered by replacing the vertical liners (on each side of the panel) and adding or subtracting modules\* as required.
  - Fabric can be replaced easily; using pre-cut segments of fabric, a drawstring (C-Jex) is sewn in around the edges. Then a rubber spline is used to 'screen' the fabric in place.
  - Panels can be removed from the workstation, without having to remove an overhead or worksurface.
  - Corner connectors can be converted from 2-way to 3-way, etc., by attaching an in-line connector with one screw.
  - The Power Belt Module for the Beltline Panels cannot be relocated.
- \*Contact Evolve Customer Support for information on field installed modules (they are available in heights of 6", 12" and 24")

## VOICE/DATA AND ELECTRICAL POWER

- NOTE: Panels and Electric components are CSA/UL approved. Tools are not required to install electrical in the Evolve Panel System.

### Voice and Data can be run at the following levels:

- Standard Panels—Base of the panel.
- Beltline Panels—Base, Beltline of the panel.
- Beltline Light Panels—Beltline of the panel.

### Electric can be run at the following levels:

- Standard Panels—Base raceway
- Beltline Panels—Base and/or Beltline raceway
- Light Panels—Do not contain a raceway for electric.
- Beltline Light Panels—Beltline raceway

### Additional Data and Electric Options

- A panel mounted power bar can be mounted on-module at any level and contains a 14' cord.
- Desktop modules are available to install in the worksurface scoop for electric and data.
- 6" Vertical Panel provides electric and data above the worksurface and electric just below the worksurface.

## Electric Information

- Electric can be run in any raceway whether it is at the base or Beltline.
  - 8-Wire, 4-Circuit Capability
  - 2 Utility + 2 Dedicated Circuits
  - 10 Gauge (oversized) Neutrals.
- All circuits can support up to 20 amps (15 CSA).

## Raceway Information

- Raceway knockouts sizes conform to the ANSI/TIA/EIA Furniture Opening Standard of 1.38" x 2.71" at the base and Beltline.
- Panels 24" wide include raceway covers with one knockout.
- Panels 30" wide include raceway covers with two knockouts.
- Panels 36"-60" wide include raceway covers with three knockouts.
- Standard data face mount plates can be used without the need of adapter plates (supplied by others).
- **Cabling Capacities**  
(calculations below are based on CAT5 cables)
- **Base Raceway— for Standard and Beltline Panels**
  - Without Electric— 140 Cables
  - With Electric— 48 Cables
- **Beltline Raceway— for Beltline and Light Beltline Panels**
  - Without Electric— 65 Cables
  - With Electric— 54 Cables
- **Panel Connectors - 45 Degree Connectors Posts**
  - Without Electric— 20 Cables
  - With Electric— 6 Cables
- **Panel Connectors - 60 Degree Connector Posts**
  - Without Electric— 20 cables
  - With Electric— 6 Cables
- **Post Extension - 90 Degree Post**
  - Without Electric - 45 Cables
  - With Electric - 25 Cables
- **Post Extension - 45 Degree Post**
  - Without Electric - 20 Cables
  - With Electric - 6 Cables
- **Post Extension - 60 Degree Post**
  - Without Electric - 20 Cables
  - With Electric - 6 Cables

## WORKSURFACES

- NOTE: Worksurfaces come in a variety of shapes and sizes.

### Worksurface Options

- Standard worksurface depths are 18"d, 24"d and 30"d.
- Standard worksurface widths range from 24"w – 84"w standard depending on the shape.



## Worksurface Laminate Options

- Thermally Fused – 1" thick
- High Pressure – 1-1/16" thick
- High Pressure – 1-7/16" thick
- Wood Veneer – Contact Customer Support for Quotes

## Worksurface Information

- Cable scoops are located in the back of each worksurface to route power and data cables
- Depth from center of scoop to panel is 1-1/8".
- Once installed there is a 3/8" gap between the worksurface and the panels for additional cabling needs.
- Custom sizes are available, contact Customer Support for Quotes.
- Metal inserts are standard for a metal to metal connection between the worksurface and the supporting hardware. This will allow product to be reconfigured many times and still perform.
- All worksurfaces utilize balanced construction.

## STORAGE

### Pedestals

- Available as Worksurface Supporting, Freestanding and Mobile.
- Mobile pedestals are available with or without a cushion. Mobile pedestals with a cushion can have an upholstery fabric applied to them.
- Standard Pedestal Depths are 18"d, 19"d, 23"d, 24"d, 29"d and 30"d
- Pedestal widths are 15"w. Please note maximum extension of pedestal glide is 1".

### File Drawers

- 150 lb Full Extension Slides
- Full height drawer sides are standard on all File drawers which enables the hanging of files from the drawer side so no extra hardware is necessary. File drawers accept legal, letter and metric sized files.

### Box Drawers

- 75 lb Single Action Slides

## Drawer Information

- Steel construction guarantees the performance of the product over the long term.
- Welded joints with a full top, back and base ensure that the pedestal will sit square and adequately support the worksurface where necessary.
- Double wall drawer face
- 20 gauge steel
- Metal roller ball bearing slides
- Adjustable glides are accessible from the inside of the pedestal.
- Standard positive and secure locking system.
- Epoxy powder coated.
- Locks can be keyed alike or master keyed\*. Please note Key list(s) required to key alike.
- \*Master Key must be ordered separate.
- Standard recessed handle offers uncluttered aesthetic.

## Lateral Files

- All lateral files are 18" deep
- Standard widths are 30"w, 36"w and 42"w.
- Standard EV12 Heights are 27.75"h, 40.5"h, 54"h and 65.88"h.
- Available with fixed front drawers, receding doors with roll-out shelf, and half height drawers (See page 184 for more information Lateral File)

## Lateral File Information

- Drawer anti-locking system
- Three Stage, anti-bounceback suspension
- Receding door features 16 gauge, spring loaded hinges
- Premium drawer slides with black zinc coating for smoother, quieter motion.
- Pre-Installed file bars
- 18-20 gauge steel
- Adjustable glides are accessible from the inside of the lateral file. Please note maximum extension for lateral glide is 5/8"

## Storage Towers

- Features all metal construction and a choice of 20 different configurations.
- Heights include 50"h, 54"h and 65.875"h. 42"h and 48"h available upon request.
- 24" w x 24" d
- Side shelving available.

## Bookcases and Storage Cabinets

- Features all metal construction.
- Available in widths of 30"w, 36"w and 42"w.
- Heights include 27.75"h, 40.5"h, 54"h and 65.88"h.

## Overhead Storage

- Standard widths include 24"w (not available on all units), 30"w, 36"w, 42"w, 48"w, 54"w and 60"w. Please note ADA and Double Wall Overheads are not available in 24"
- Standard heights range from 12"h to 17.5"h.
- Overhead Options
- Flat Front 12" Flipper Door
- Full Pull 13" Flipper Door
- Full Pull Double Wall Flipper Door (also available with shelf option)
- Full Pull 16" Flipper Door (door retracts inside cabinet)
- Sliding glass doors
- ADA Compliant Overhead with soft close mechanism
- High and Low Profile Shelf
- A magnetic whiteboard is available for metal front overheads.

## WARRANTIES AND PERFORMANCE

- A Lifetime Warranty
- Non Obsolescence Warranty
- Reduced cost of assembly and reconfiguration
- ISO9001:2000 Registered
- ISO14001:2004 Registered
- GreenGuard Certified
- ANSI/BIFMA CGSB testing on all products
- For piece of mind over the long term, we cover you with a comprehensive warranty that is supported by our dealer network.
- Some installation companies claim that the Evolve Panels System can be installed in half the time it takes to install most of our competitor's segmented panels. This cost saving can amount to thousands of dollars over the lifetime of our furniture.
- Your assurance of consistent quality to an international standard. Evolve Systems is committed to design, manufacture and distribute superior quality office furniture, which meets or exceeds the requirements of our customers.
- Confirmation that Evolve is committed (1) to providing product that, through their entire life cycle, minimize negative environmental impacts on the environment, (2) to continuous improvement to our environmental systems and programs and (3) to comply to all relevant environmental legislation and regulations.
- Evolve Systems can help a company meet LEED requirements for office furniture.
- Evolve components are tested to the highest standard in the industry. This is your assurance of quality and longevity.

Evolve products have been coded using alphas that correspond with the product name. This creates an easy-to-remember code. The following breaks down the coding logic and highlights the required code components needed to order within each product category.

## PANELS

### Example:

### Product: Segmented Panel

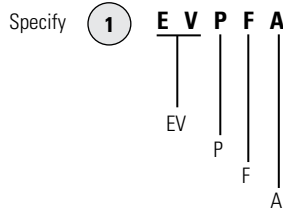

Base Code found on the product page to the left of the product name and a simple product illustration.

**EV**olve product line

**P**anel category

**F**abric-covered or partly fabric-covered Panel

**A**coustic Panel  
(EVPF P – represents Premium Acoustic)

**2** EVPFA**6648**

Panel size offering. Listed on every product page with price listing.

Note: Additional dimensions are provided for most products on the far right hand side of each page. These dimensions are not required in the ordering code.

**3** EVPFA6648 –**BLK**

Finish code for frame. See Textiles & Finishes pages 251-252.

To specify fabric for an Evolve Panel, please note:

**4** EVPFA6648–BLK–**B84A**

Fabric code for all modules on both sides of the Panel\*.  
See Textiles & Finishes pages 251-252.

**\* NOTE:** If different fabrics are to be included on an Evolve Panel, please use the following ordering format. **Start at the bottom** of one side of a Panel and work to the top module of that Panel. Then start the process over on the other side of the Panel. As an example:

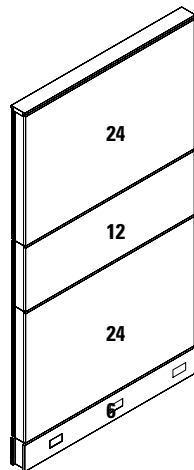

= 66

Position 3

Position 2

Position 1

11	B86A	I = Inside
12	B84A	O = Outside
13	B86A	
01	B86A	
02	B86A	
03	B86A	



**ELECTRICAL**

**Example: Product: Pass-Through Cables**

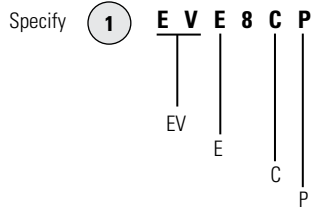

Base Code found on the product page to the left of the product name and a simple product illustration.

**EV**olve product line

**E**lectrical category

**C**able Panel.

**P**ass-Through.

**2** EVE8CP40

Product size offering – length. Listed on every product page with price listing. Note: Additional dimensions are provided for most products on the far right hand side of each page. These dimensions are not required in the ordering code.

**WORKSURFACES**

**Example: Product: Curvilinear Worksurface - Left**

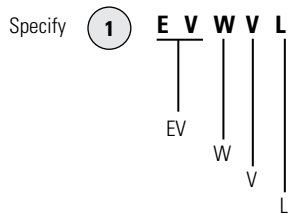

Base Code found on the product page to the left of the product name and a simple product illustration.

**EV**olve product line

**W**orksurface category

Cur**V**ilinear shape

**L**eft hand configuration

**2** EWWL3042

Worksurface size offering. Listed on every product page with price listing. Note: Additional dimensions are provided for most products on the far right hand side of each page. These dimensions are not required in the ordering code.

**3** EWWL3042-T431

Laminate code for surface. See Textiles & Finishes pages 251-252.

**4** EWWL3042-T431-CHR

PVC code for trim. See Textiles & Finishes pages 240-241.

**WORKSURFACES - HARDWARE**

**Example:**

**Product:**

**End Panel**

Specify

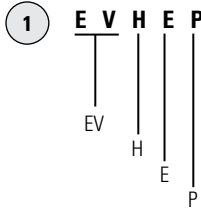

Base Code found on the product page to the left of the product name and a simple product illustration.

**EV**olve product line

**H**ardware category

**E**nd Panel.

End **P**anel.

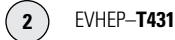

Laminate code for End Panel. See Textiles & Finishes pages 251-252.

**STORAGE**

**Example:**

**Product:**

**Box, Box, File Pedestal**

Specify

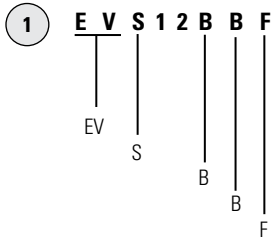

Base Code found on the product page to the left of the product name and a simple product illustration.

**EV**olve product line

**S**torage category

**B**ox drawer

**B**ox drawer

**F**ile drawer

**ACCESSORIES**

**Example:**

**Product:**

**White Board**

Specify

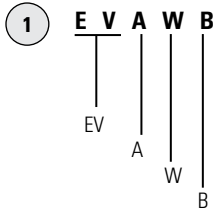

Base Code found on the product page to the left of the product name and a simple product illustration.

**EV**olve product line

**A**ccessories category

**W**hite Board

**W**hite Board





panels

## TECHNICAL FEATURES OF EVOLVE PANELS:

- Evolve Panels are 2 7/8" thick.
- An aluminum low profile top cap is included with the panel.
- Base Raceway will allow for 140 data cables without electrical, or 48 data cables with electrical.
- Beltline Raceway will allow for 65 data cables without electrical or 54 data cables with electrical.
- 90 degree post extension will allow for 45 data cables without electric and 25 data cables with electric.
- Raceway knockout openings are 1.38" x 2.71".
- Acoustic Rating: .65 = NRC - Noise Reduction Coefficient
- STC: 23 = Sound Transmission Coefficient

## BASIC FEATURES OF EVOLVE PANELS:

- Evolve Segmented Panels are available in four (4) basic heights: 30", 42", 54" and 66"; and eight (8) widths: 18", 24", 30" 36", 42", 48", 54" High and 60".
- Evolve Monolithic Panels are available in four (4) basic heights: 42", 48", 54" and 66"; and eight (8) widths: 18", 24", 30" 36", 42", 48", 54" and 60".
- Evolve Panels must include the same segmentation on both sides of the panel. Cannot be Monolithic on one side and Segmented on the other.
- Opposite sides of each Fabric Module may have a different fabric within the same grade at no upcharge.
- If different grades of fabric are used on one panel, the entire panel must be priced at the highest grade.
- There is no panel creep in a straight Panel-to-Panel configuration; however, a corner post (2, 3, 4 way) will add 3.25" inches to a panel run.
- All Fabric Acoustic Panels (EVPFA) are composed of a 6" raceway module and a 24" base-height module which create the EVPFA30. Subsequent heights are created by adding either a 12" high module to create an EVPFA42 or a 24" high module to create an EVPFA54. The addition of both 12" and 24" modules creates a EVPFA66.
- In contrast, a Premium Panel (EVFPF) is composed of a 6" raceway module, a 24" base-height module and either two (2) or three (3) 12" modules which make up the two premium heights: EVFPF54 and EVFPF66.
- All Panels available with Aluminum trim as a standard option.
- Individual fabric covered acoustic modules incorporated into a rigid steel frame.
- Raceway covers included with panels
- Beltline Panels contain a 6" Power Belt Module that is metal with knockouts on both sides.

## BASIC FEATURES OF EXTENSION MODULES:

- Stackability: Evolve Panels can be increased in height in 6", 12", 18" or 24" increments. See Extension Module (pages 82-90) for part numbers.
- Panel Extension Modules stack on the top of a Panel.
- Modules can be stacked to add privacy or divide space.
- Opposite sides of a fabric module may have a different fabric within the same grade at no upcharge.
- If different grades of fabric are used on one Panel, the entire Module must be priced at highest grade.

## GENERAL WARRANTY INFORMATION:

- Panel and tackboard textiles, adjustable keyboard mechanisms, tasklights and electrical devices = ten (10) Years
- Other parts = Lifetime Warranty



MONOLITHIC PANELS - PAGES 22-27

Monolithic Panel

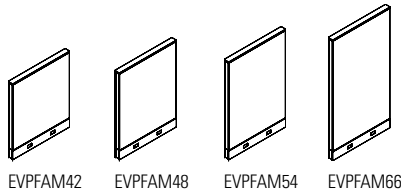

Monolithic Light Panel

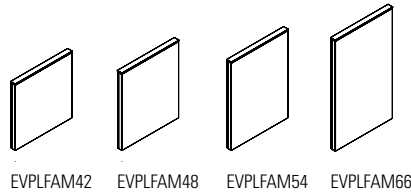

Monolithic Beltline Powered Panel

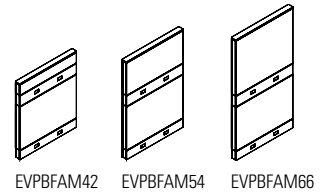

Monolithic Beltline Powered Light Panel

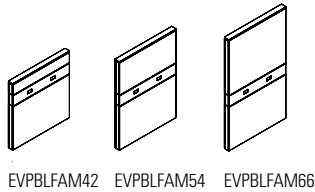

Monolithic Beltline Powered Chimney Panel

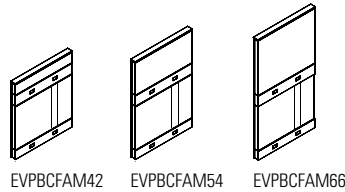

Chimney Jumper Cable Kit

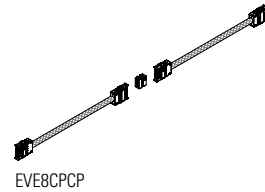

Monolithic Beltline Non-Powered Panel

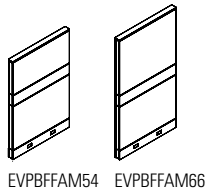

Monolithic Beltline Non-Powered Light Panel

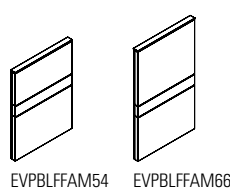

SEGMENTED PANELS - PAGES 28-33

Segmented Panel

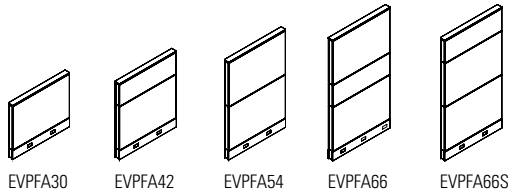

Segmented Light Panel

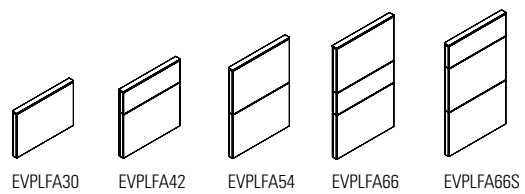

Segmented Premium Panel

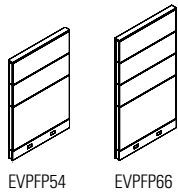

Segmented Premium Light Panel

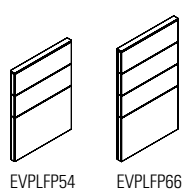

Segmented Beltline Powered Panel

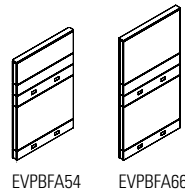

Segmented Beltline Powered Light Panel

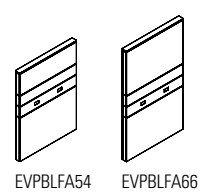

Segmented Beltline Powered Chimney Panel

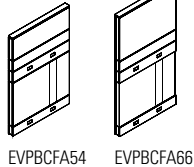

Chimney Jumper Cable Kit

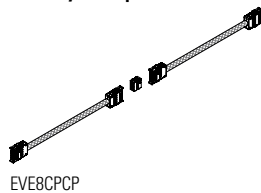

Segmented Beltline Non-Powered Panel

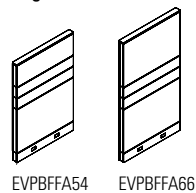

Segmented Beltline Non-Powered Light Panel

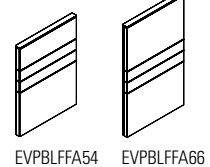

PARTLY GLAZED - TEMPERED GLASS PANELS - PAGES 34-43

Monolithic 12"H Glazed Panel

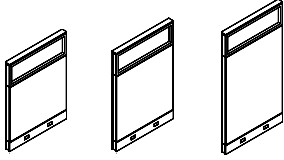

EVPMGTU48 EVPMGTU54 EVPMGTU66

Monolithic 12"H Glazed Light Panel

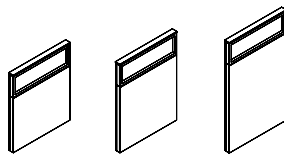

EVPLMGTU48 EVPLMGTU54 EVPLMGTU66

Segmented 12"H Glazed Panel

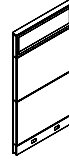

EVPPGTU66

Segmented 12"H Glazed Light Panel

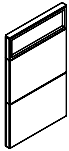

EVPLFGTU66

Segmented 12"H Glazed Premium Panel

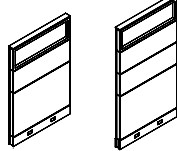

EVPPFGTU54 EVPPFGTU66

Segmented 12"H Glazed Premium Light Panel

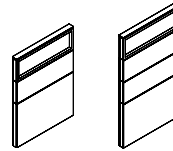

EVPLFGTU54 EVPLFGTU66

Partly Glazed Panel

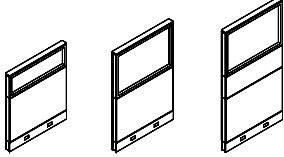

EVPGT42 EVPGT54 EVPGT66

Partly Glazed Light Panel

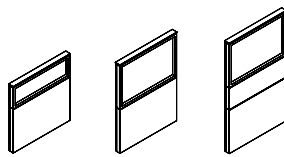

EVPLFGT42 EVPLFGT54 EVPLFGT66

Partly Glazed Panel - 36"H



EVPGTX66

Partly Glazed Light Panel - 36"H

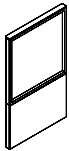

EVPLFGTX66

Partly Glazed Beltline Powered Panel

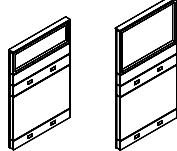

EVPPBFGT54 EVPPBFGT66

Partly Glazed Beltline Powered Light Panel

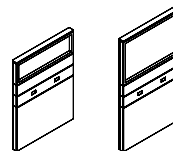

EVPPBFGT54 EVPPBFGT66

Partly Glazed Beltline Powered Chimney Panel

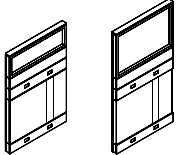

EVPPBCFGT54 EVPPBCFGT66

Chimney Jumper Cable Kit

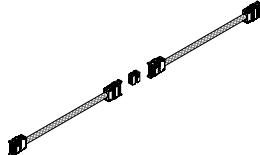

EVE8CPCP

Partly Glazed Premium Panel

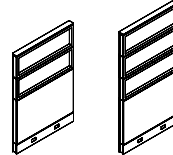

EVPPFGT54 EVPPFGT66

Partly Glazed Premium Light Panel

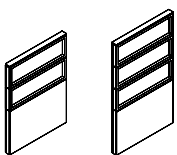

EVPLFGT54 EVPLFGT66



FULLY GLAZED - TEMPERED GLASS PANELS - PAGES 44-47

Fully Monolithic Panel

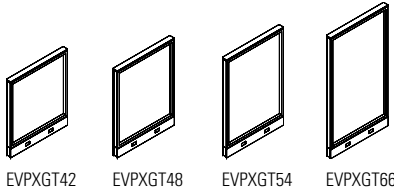

Fully Monolithic Light Panel

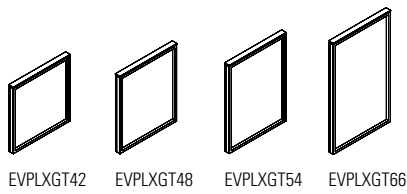

Fully Glazed Segmented Panel



Fully Glazed Segmented Light Panel

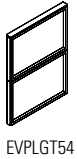

Fully Glazed Premium Panel

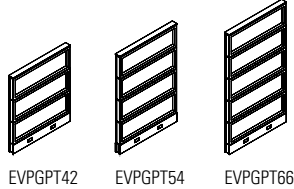

Fully Glazed Premium Light Panel

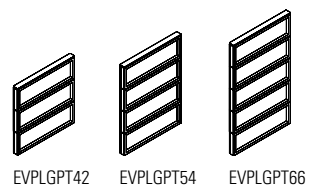

PASS-THRU SLIDING DOOR - PAGES 50-51

Pass-Thru Sliding Door Glazed Panel

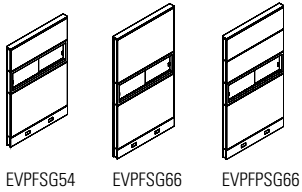

Fabric Glazed Pass-Thru Sliding Door Panel

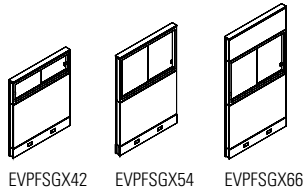



SLATWALL PANELS - PAGES 52-58

Slatwall Panel - Single Sided

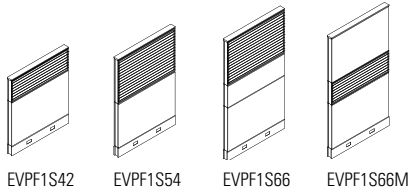

Slatwall Light Panel - Single Sided

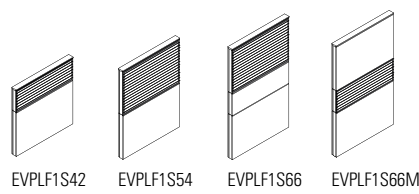

Slatwall Panel - Double Sided

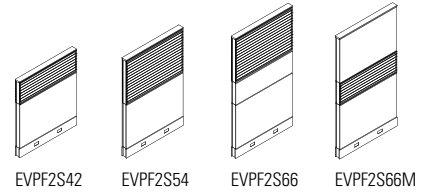

Slatwall Light Panel - Double Sided

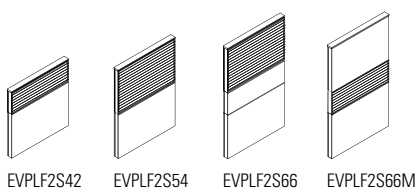

Frameless Slatwall Panel - Double Sided

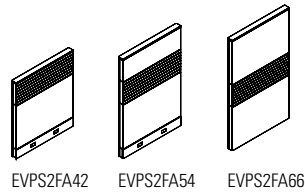

Frameless Slatwall Beltline Powered Panel - DS

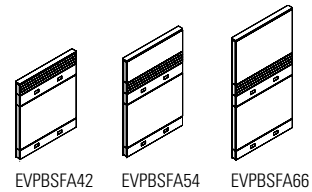

Frameless Slatwall Beltline Powered Light Panel - DS

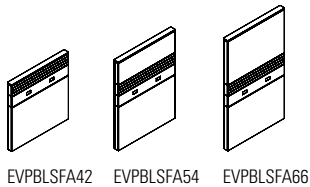

Frameless Slatwall Beltline Powered Chimney Panel - Double Sided

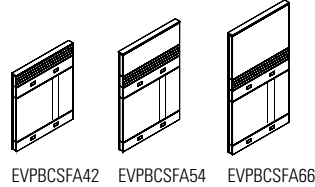

Chimney Jumper Cable Kit

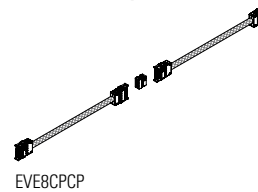

WRITE BOARD PANELS - PAGES 59-60

Write Board Panel - Single Sided

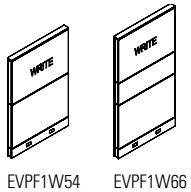

Write Board Light Panel - Single Sided

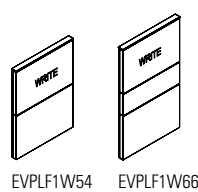

Write Board Panel - Double Sided

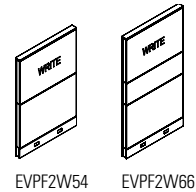

Write Board Light Panel - Double Sided

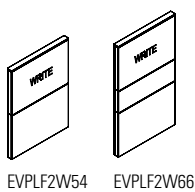

LAMINATE PANELS - PAGES 61-64

Laminate Panel - Single Sided

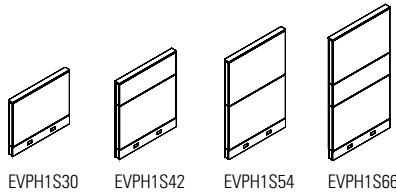

Laminate Light Panel - Single Sided

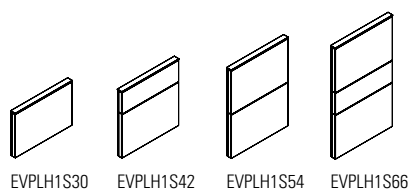

Laminate Panel - Double Sided

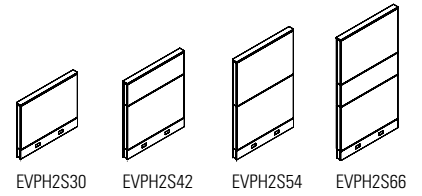

Laminate Light Panel - Double Sided

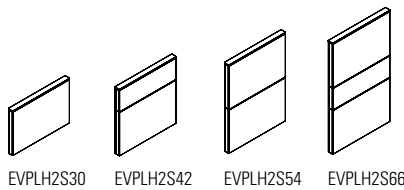

AIRFLOW PANELS - PAGES 65-68

Airflow Panel

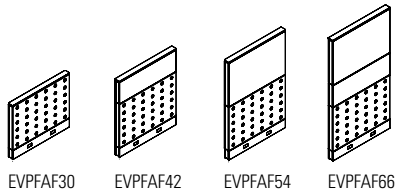

Airflow Light Panel

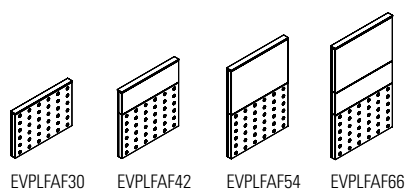

Airflow Premium Panel

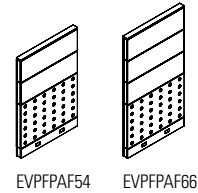

Airflow Premium Light Panel

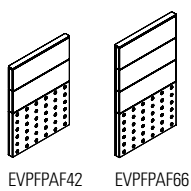

Airflow Middle Premium Panel

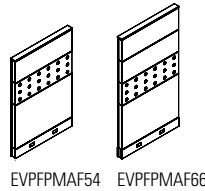

Airflow Middle Premium Light Panel

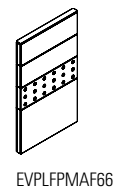

METAL SKIN PANELS - PAGES 69-72

Metal Skin Panel - Single Sided

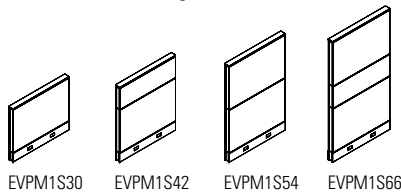

Metal Skin Light Panel - Single Sided

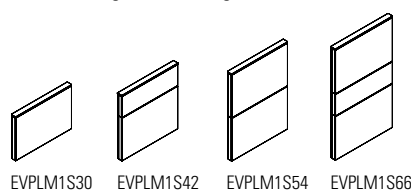

Metal Skin Panel - Double Sided

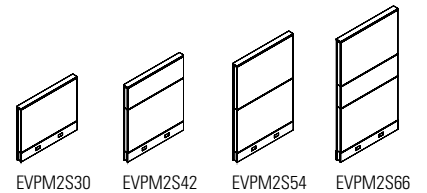

Metal Skin Light Panel - Double Sided

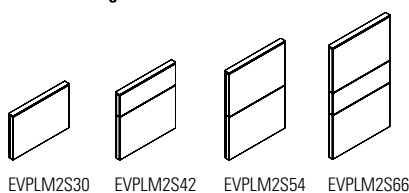

OPEN PANELS - PAGES 73-78

Open Bottom Panel

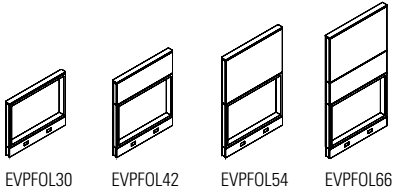

Open Bottom Light Panel

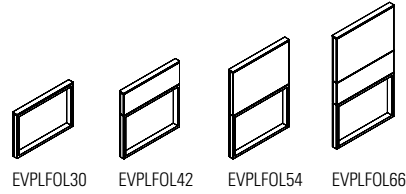

Open Bottom Premium Panel

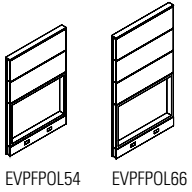

Open Bottom Premium Light Panel

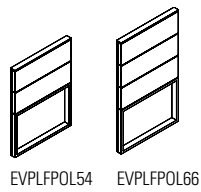

Open Middle Panel - 12"H Opening

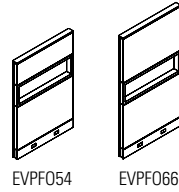

Open Middle Light Panel - 12"H Opening

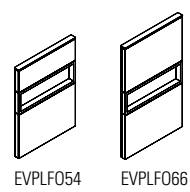

Open Middle Premium Panel - 12"H Opening

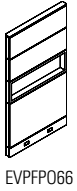

Open Middle Premium Light Panel - 12"H Opening

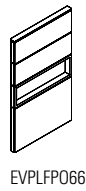

Open Middle Panel - 24"H Opening

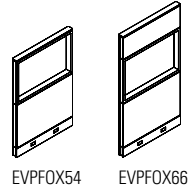

Open Middle Light Panel - 24"H Opening

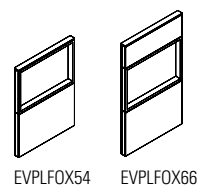

NO RACEWAY PANELS - PAGES 79-91

Segmented

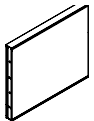

EVPFA3018NR

Monolithic

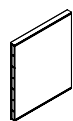

EVPFAM4218NR

Laminate - Single Sided

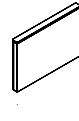

EVPH1S3018NR

Laminate - Double Sided

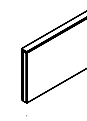

EVPH2S3018NR

Fully Glazed Monolithic

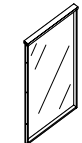

EVPXGT9018NR

Inline Connector

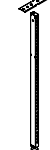

EVPIC30NR

End of Run

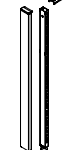

EVPERA30NR

Corner Post - One Way

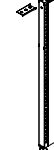

EVPCPA130NR

Inline Corner Post - Two Way

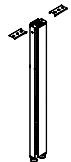

EVPIPA230NR

Corner Post - Two Way

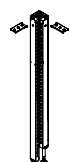

EVPCPA230PNR

Corner Post - Three Way

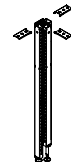

EVPCPA330PNR

Corner Post - Four Way

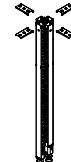

EVPCPA430PNR



GALLERY PANELS - PAGES 92-105

**Laminate Double Sided Finished Ends**



EVLEPDS4251NC

**Laminate Double Sided Connector Ends**



EVLEPDS4251

**Laminate Single Sided Finished Ends**



EVLEPSSL4227NC

**Laminate Double Sided Connector Ends**



EVLEPSSL4227

**Laminate Double Sided Middle Base Power, Finished Ends**



EVLEPDC4251NC

**Laminate Double Sided Middle Beltline Power, Finished Ends**



EVICLXP4251NC

**Laminate Double Sided Base Power, Connector Ends**



EVLEPDC4251

**Laminate Double Sided Middle Beltline Power, Connector Ends**



EVICLXP4251

**Laminate Single Sided Middle Base Power, Finished Ends**



EVLEPSC4227NC

**Laminate Single Sided Middle Base Power, Connector End**



EVLEPSC4227

**Laminate Single Sided Middle Beltline Power, Finished Ends**



EVLEPSCB4227NC

**Laminate Single Sided Middle Beltline Power, Connector End**



EVLEPSCB4227

**Laminate Gallery Extension Finished End**



EVLXPML4224NC

**Laminate Gallery Straight Extension, Connector Ends**



EVLXPML4224

**Laminate Gallery Two-Way Extension, Finished Ends**



EV2LXPL4225

**Laminate Gallery Three-Way Extension, Finished Ends**



EV3LXPL4249

**Laminate Double Gallery for Four-Way, Finished Ends**



EV4LXP4249

**Laminate Extension Panel for Four-Way, Finished Ends**



EV4LXPM4224

**Panel Connector with U Channel**



EVPERCH42

**Panel Connector w/U Channel For Beltline Panels**



EVPPERCH42

**Laminate Gallery Panel Bottom Bracket**



EVHLPBB01

**Laminate Gallery Panel Corner Bracket**



EVHLPBB01

**Connector w/U Channel Top Trim Aluminum**



EVPTTAU24

1" LAMINATE PANELS - PAGES 106-108

1" Laminate End Panel

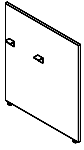

EVLEPR42

1" Laminate Middle Panel

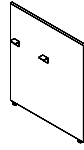

EVLMP42

1" Laminate End Panel w/ Accessory Rail

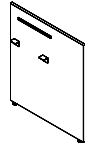

EVLEPR42A

1" Laminate Middle Panel w/ Accessory Rail



EVLMP42A

Double Inline Panel Connector

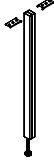

EVPDIC42

Beltline DoubleInline Panel Connector

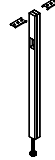

EVBDIC42

Double Inline Connector Trim

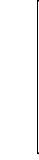

EVPDVTF42

Double Inline Panel Connector Top Trim - Aluminum

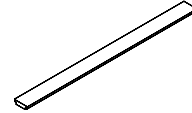

EVPTTA25

DOOR PANELS - PAGES 110-112

Door Panel - Solid

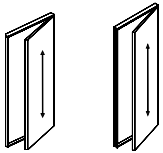

EVPS84

EVPS90

Knob Lock Set

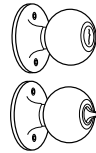

EVPSL01

Lever Lock Set



EVPSL02

Sliding Door Lock

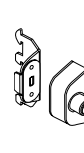

EVPSLLOCK

Sliding Privacy Door

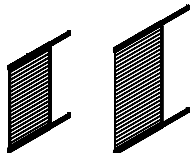

EVPSL66

EVPSL81

Mini Panel Kit

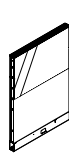

EVMPK02

High Profile Foot

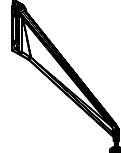

EVHFF01





PRIVACY PANELS - PAGES 149-164

**Glazed Monolithic Privacy Panel**



EVPPXGT4218 EVPPXGT4218M EVPPXGTF4218

**Ribbed Monolithic Privacy Panel**



EVPPXGR4218 EVPPXGR4218M EVPPXGRF4218

**78" Glazed Monolithic Privacy Panel**



EVPPXGT7824 EVPPXGT7824M EVPPXGTF7824

**Glazed Privacy Panel**



EVPPGT5424 EVPPGT5424M

**Glazed Privacy Panel**

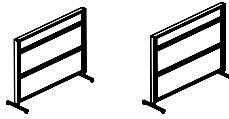

EVPPGT6624 EVPPGT6624M

**Laminate Glazed Privacy Panel**



EVPPHGTU5424 EVPPHGTU5424M

**Laminate Glazed Privacy Panel**



EVPPHGT5424 EVPPHGT6624M

**Laminate Privacy Panel**

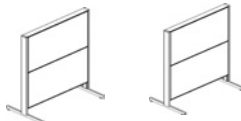

EVPPH2S5424 EVPPH2S5424M

**Write Board Glazed Privacy Panel**

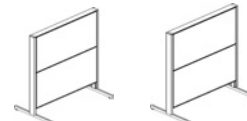

EVPPF2W5424 EVPPF2W5424M

**Write Board Laminate Privacy Panel**

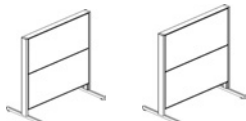

EVPPH2W5424 EVPPH2W5424M

This page provides an exploded view of a sample configuration highlighting each **Panel** component required when specifying this configuration.

**Components**

- |  |   |
|--|---|
| <p><b>A.</b> EVPERA66      End-of-Run Kit (Wall mount)<br/>Note: adds 1" to the width of a Panel Run.</p> <p><b>B.</b> EVPFA6636      Segmented Panel</p> <p><b>C.</b> EVPIC66          Inline Panel Connector</p> <p><b>D.</b> EVPCPA266      Two-Way Corner Post<br/>Note: Trim kit included.<br/>Post Connectors can be custom manufactured with or without slots. Contact your Evolve Customer Support Representative for a special quote.</p> | <p><b>E.</b> EVPVC66          Variable-Height Connector<br/>Note: Connector height must reference taller Panel.</p> <p><b>F.</b> EVPTVA24        Panel Trim Variable-Height</p> <p><b>G.</b> EVPFA4236      Segmented Panel</p> |
|--|---|

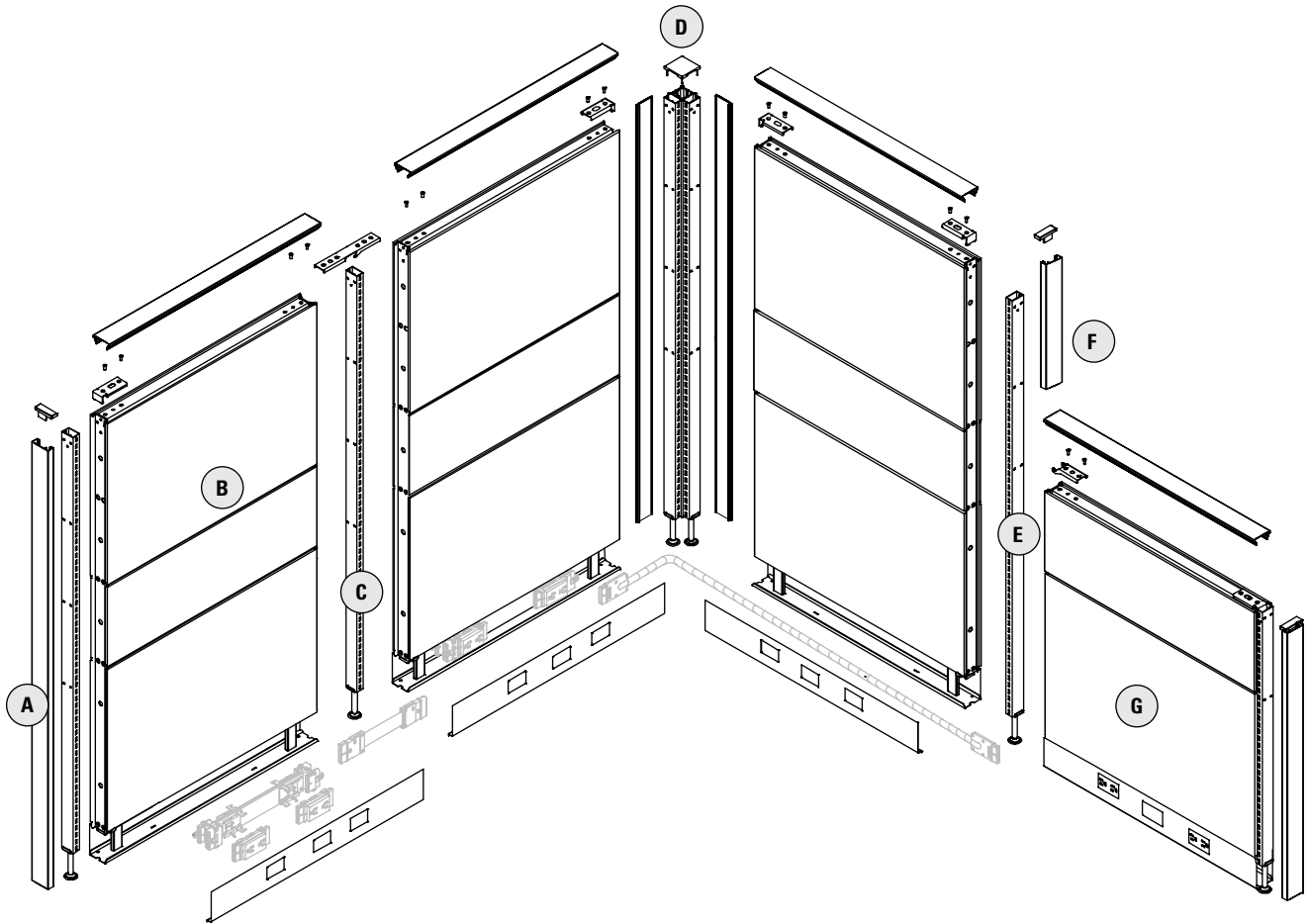

This page provides an exploded view of a sample configuration highlighting each **Beltline Power Panel** component required when specifying this configuration.

**Components**

- |   |   |
|---|---|
| <p><b>A.</b> EVPERA66 End-of-Run Kit (Wall mount)<br/>Note: adds 1" to the width of a Panel Run.</p> <p><b>B.</b> EVPBCFAM6636 Monolithic Beltline Powered Chimney Panel</p> <p><b>C.</b> EVPBIC66 Inline Panel Connector for Beltline Electric Panels</p> <p><b>D.</b> EVPBIPA266 Two-Way Corner Post for Beltline Electric Panels<br/>Note: Trim kit included.<br/>Post Connectors can be custom manufactured with or without slots. Contact your Evolve Customer Support Representative for a special quote.<br/>Note: All beltline post connectors come with PVC covers to install at beltline height on all sides.</p> | <p><b>E.</b> EVPVC66 Variable-Height Connector for Beltline Electric Panels<br/>Note: Connector height must reference taller Panel.</p> <p><b>F.</b> EVPTEA24 Panel Extension Trim</p> <p><b>G.</b> EVPBFAM4236 Monolithic Beltline Powered Panel</p> |
|---|---|

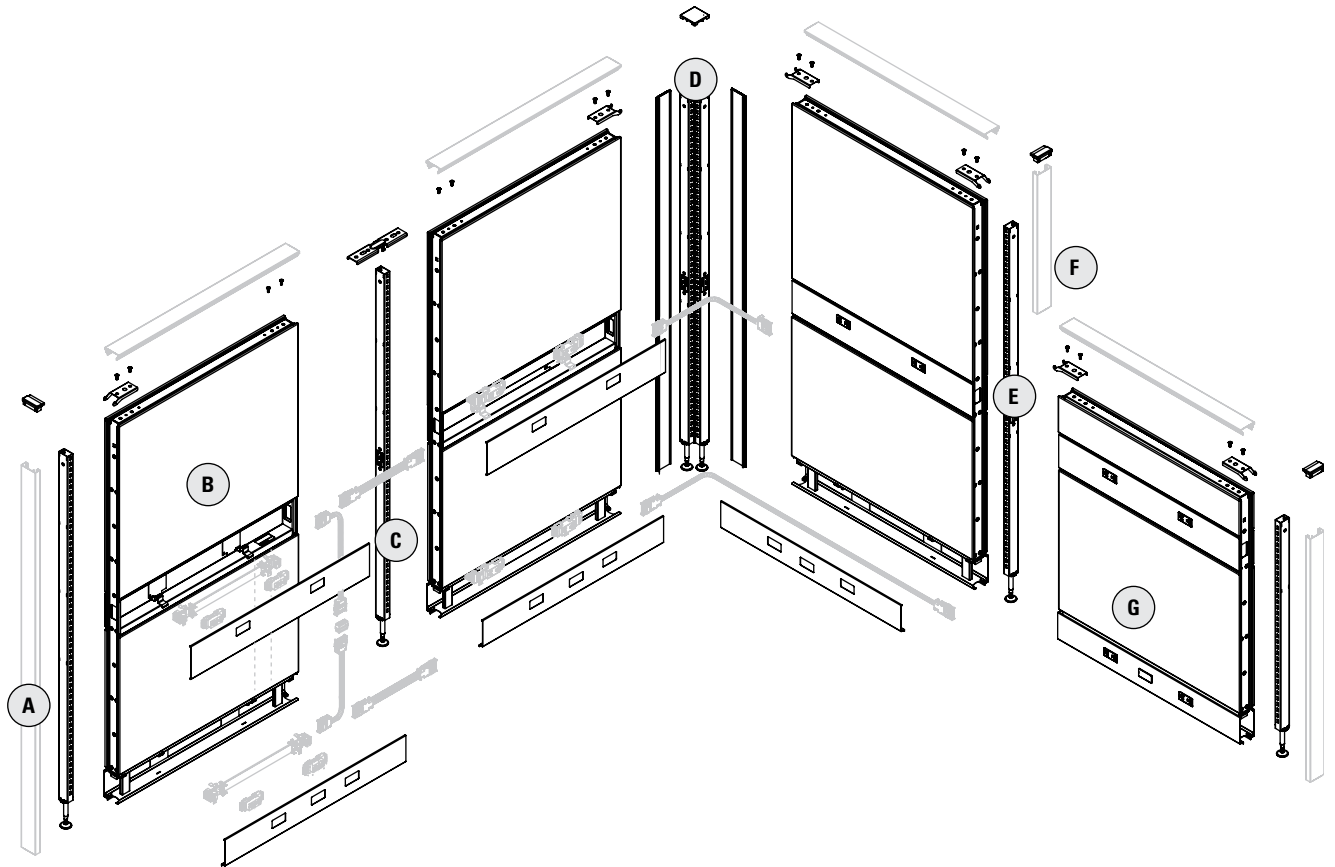

## EACH ORDER MUST INCLUDE:

- Purchase Order
- Layout showing where the image(s) appear in the run of panels.
- A completed Price Chart, showing the location of the image(s) on each appropriate panel.
- Artwork must be submitted in accordance with the following artwork specifications.
- NOTE: Final artwork specification approval must be given before order can be processed.

## TRANSFER DEVICES

- E-mail up to 10MB to your Evolve/Global Contract Customer Service Representative.
- Courier CD/DVD/USB stick to your Evolve/Global Contract Customer Service Representative.

## ARTWORK SPECIFICATIONS

- Non-Photographic artwork should be vector art. Saved in Adobe Illustrator (.ai) or as an EPS (.eps)
- All bitmap or photographic artwork has to be at a minimum of 100 dpi at the full size of the panel to be printed.
- We accept Adobe CS5 files.
- Any linked files must be included or imbedded.
- Leave any PSD files un-flattened
- All fonts must be converted to outlines.
- Do not convert to CMYK, leave all images as RGB if possible
- No Word, Powerpoint, Publisher or other Microsoft files can be used.
- Include a PDF or .jpg for reference when sending native Photoshop or Illustrator format files.

## COLOR MATCHING

- A Pantone color reference must be supplied or we cannot accept responsibility for correct color or color correction.
- When it is not possible to refer to Pantone colors, we will do our best to meet your requirements.

## IMAGE CLARITY

- We will advise should the selected image not lend itself to the element size requested.

## NOTE:

- We reserve the right to put an order on hold when the files are found to be incomplete or when documents have been either incorrectly saved, fonts have not been converted to curves or the job appears not to be commercially acceptable.

## IMAGE BLEED:

- To facilitate placement on the panel. Extension of the image past the finished visible area of the panel (bleed) is required.
- Evolve Panels need a 3" bleed on all sides



**EXAMPLE OF IMAGE RESOLUTION:**

- The resolution required for a 36 wide x 24 high Evolve panel at 100dpi (minimum resolution)

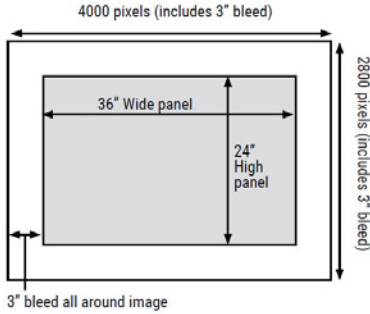

- The resolution required for a 36 wide x 24 high Evolve panel at 300dpi (higher quality)

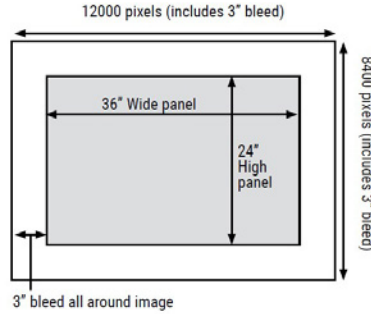

**EVOLVE SYSTEMS - GRAPHIC PANEL EXAMPLE PROCEDURE**

**STEP 1:** Customer orders the following EVPFA6636 panel with;

- Bottom module inside face (24/36 size fabric) with image 01.
- Middle module inside face (12/36 size fabric) with image 02.
- All other fabric material is regular fabric - top module inside face and all outside module faces.

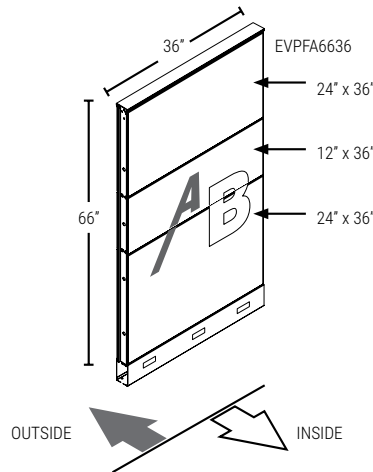

**Note: To order, please use graphic codes below**

- (A)  
EVPGRP1236
- (B)  
EVPGRP2436

**STEP 2:** On the regular panel - replace fabric pieces with corresponding graphic pieces.

**STEP 3:** On the regular panel - replace fabric pieces with corresponding graphic pieces.

- EVPGRP1236 for the middle module inside face
- EVPGRP2436 for the bottom module inside face



**EVGGRP - 6”H GRAPHIC FABRIC FACTORY INSTALLED**

- Graphic fabric for one side of 6” module.
- Graphic fabric to be installed at factory at specified 6” H module of fabric panel
- Fabric panel not included. Prices shown are an upcharge to the applicable panel price. Please add the upcharge to the list price of the panel on which you are specifying a graphic.
- Applies to the following panels: EVPFA, EVFPF, EVPF1W, EVPF2W, EVPF1S, EVPF2S, EVPFGT, EVFPFGTU, EVPFOL, EVFPOL, EVPFO, EVFPFO, EVPFE, EVPFPE
- Note: initial set up charge is \$250 net per image

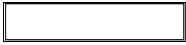
DESCRIPTION	PRODUCT CODE	LIST PRICE	DIMENSIONS/INCHES		
			H	W	D
 Graphic fabric for 6” Module	EVGGRP0624	159	6	24	
	EVGGRP0630	200	6	30	
	EVGGRP0636	240	6	36	
	EVGGRP0642	279	6	42	
	EVGGRP0648	319	6	48	
	EVGGRP0654	362	6	54	
	EVGGRP0660	403	6	60	

**EVGGRP - 12”H GRAPHIC FABRIC FACTORY INSTALLED**

- Graphic fabric for one side of 12” module.
- Graphic fabric to be installed at factory at specified 12” H module of fabric panel
- Fabric panel not included. Prices shown are an upcharge to the applicable panel price. Please add the upcharge to the list price of the panel on which you are specifying a graphic.
- Applies to the following panels: EVPFA, EVFPF, EVPF1W, EVPF2W, EVPF1S, EVPF2S, EVPFGT, EVFPFGTU, EVPFOL, EVFPOL, EVPFO, EVFPFO, EVPFE, EVPFPE
- Note: initial set up charge is \$250 net per image

DESCRIPTION	PRODUCT CODE	LIST PRICE	DIMENSIONS/INCHES		
			H	W	D
 Graphic fabric for 12” Module	EVGGRP1224	159	12	24	
	EVGGRP1230	200	12	30	
	EVGGRP1236	240	12	36	
	EVGGRP1242	279	12	42	
	EVGGRP1248	319	12	48	
	EVGGRP1254	362	12	54	
	EVGGRP1260	403	12	60	

**EVGGRP - 18”H GRAPHIC FABRIC FACTORY INSTALLED**

- Graphic fabric for one side of 18” module.
- Graphic fabric to be installed at factory at specified 18” H module of fabric panel
- Fabric panel not included. Prices shown are an upcharge to the applicable panel price. Please add the upcharge to the list price of the panel on which you are specifying a graphic.
- Applies to the following panels: EVPFA, EVFPF, EVPF1W, EVPF2W, EVPF1S, EVPF2S, EVPFGT, EVFPFGTU, EVPFOL, EVFPOL, EVPFO, EVFPFO, EVPFE, EVPFPE
- Note: initial set up charge is \$250 net per image

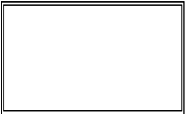
DESCRIPTION	PRODUCT CODE	LIST PRICE	DIMENSIONS/INCHES		
			H	W	D
 Graphic fabric for 18” Module	EVGGRP1824	314	18	24	
	EVGGRP1830	394	18	30	
	EVGGRP1836	476	18	36	
	EVGGRP1842	558	18	42	
	EVGGRP1848	638	18	48	
	EVGGRP1854	718	18	54	
	EVGGRP1860	801	18	60	



**EVPGRP - 24”H GRAPHIC FABRIC FACTORY INSTALLED**

- Graphic fabric for one side of 24” module.
- Graphic fabric to be installed at factory at specified 24” H module of fabric panel
- Fabric panel not included. Prices shown are an upcharge to the applicable panel price. Please add the upcharge to the list price of the panel on which you are specifying a graphic.
- Applies to the following panels: EVPFA, EVFPF, EVPF1W, EVPF2W, EVPF1S, EVPF2S, EVPFGT, EVFPFGTU, EVPFOL, EVFPFOL, EVPFO, EVFPFO, EVPFE, EVFPFE
- Note: initial set up charge is \$250 net per image

DESCRIPTION	PRODUCT CODE	LIST PRICE	DIMENSIONS/INCHES		
			H	W	D
 <p>Graphic fabric for 24” Module</p>	EVPGRP2424	314	24	24	
	EVPGRP2430	394	24	30	
	EVPGRP2436	476	24	36	
	EVPGRP2442	558	24	42	
	EVPGRP2448	638	24	48	
	EVPGRP2454	718	24	54	
	EVPGRP2460	801	24	60	

**EVPGRP - 36”H GRAPHIC FABRIC FACTORY INSTALLED**

- Graphic fabric for one side of 36” module (42” panel)
- Graphic fabric to be installed at factory on monolithic module
- Fabric panel not included. Prices shown are an upcharge to the applicable panel price. Please add the upcharge to the list price of the panel on which you are specifying a graphic.
- Applies to the following panels: EVPFAM
- Note: initial set up charge is \$250 net per image

DESCRIPTION	PRODUCT CODE	LIST PRICE	DIMENSIONS/INCHES		
			H	W	D
 <p>Graphic fabric for 36” Monolithic Module</p>	EVPGRP3624	476	36	24	
	EVPGRP3630	613	36	30	
	EVPGRP3636	733	36	36	
	EVPGRP3642	854	36	42	
	EVPGRP3648	975	36	48	
	EVPGRP3654	1099	36	54	
	EVPGRP3660	1220	36	60	

**EVPGRP - 42”H GRAPHIC FABRIC FACTORY INSTALLED**

- Graphic fabric for one side of 42” module (48” panel)
- Graphic fabric to be installed at factory on monolithic module
- Fabric panel not included. Prices shown are an upcharge to the applicable panel price. Please add the upcharge to the list price of the panel on which you are specifying a graphic.
- Applies to the following panels: EVPFAM
- Note: initial set up charge is \$250 net per image

DESCRIPTION	PRODUCT CODE	LIST PRICE	DIMENSIONS/INCHES		
			H	W	D
 <p>Graphic fabric for 42” Monolithic Module</p>	EVPGRP4224	559	42	24	
	EVPGRP4230	712	42	30	
	EVPGRP4236	854	42	36	
	EVPGRP4242	997	42	42	
	EVPGRP4248	1141	42	48	
	EVPGRP4254	1281	42	54	
	EVPGRP4260	1424	42	60	

**EVPGRP - 48”H GRAPHIC FABRIC FACTORY INSTALLED**

- Graphic fabric for one side of 48” module (54” panel).
- Graphic fabric to be installed at factory on monolithic module
- Fabric panel not included. Prices shown are an upcharge to the applicable panel price. Please add the upcharge to the list price of the panel on which you are specifying a graphic.
- Applies to the following panels: EVPFAM
- Note: initial set up charge is \$250 net per image

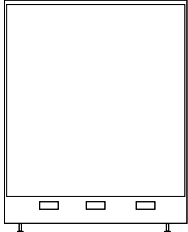
	DESCRIPTION	PRODUCT CODE	LIST PRICE	DIMENSIONS/INCHES		
				H	W	D
	Graphic fabric for 48” Monolithic Module	EVPGRP4824	636	48	24	
		EVPGRP4830	813	48	30	
		EVPGRP4836	975	48	36	
		EVPGRP4842	1141	48	42	
		EVPGRP4848	1302	48	48	
		EVPGRP4854	1466	48	54	
		EVPGRP4860	1627	48	60	

**EVPGRP - 60”H GRAPHIC FABRIC FACTORY INSTALLED**

- Graphic fabric for one side of 60” module (66” panel).
- Graphic fabric to be installed at factory on monolithic module
- Fabric panel not included. Prices shown are an upcharge to the applicable panel price. Please add the upcharge to the list price of the panel on which you are specifying a graphic.
- Applies to the following panels: EVPFAM
- Note: initial set up charge is \$250 net per image

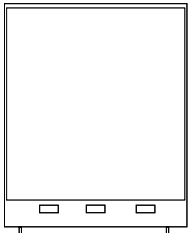
	DESCRIPTION	PRODUCT CODE	LIST PRICE	DIMENSIONS/INCHES		
				H	W	D
	Graphic fabric for 60” Monolithic Module	EVPGRP6024	801	60	24	
		EVPGRP6030	1018	60	30	
		EVPGRP6036	1220	60	36	
		EVPGRP6042	1424	60	42	
		EVPGRP6048	1627	60	48	
		EVPGRP6054	1829	60	54	
		EVPGRP6060	2033	60	60	

**EVPGRP - 90”H GRAPHIC FABRIC FACTORY INSTALLED**

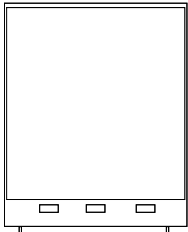

- Graphic fabric for one side of 90” module NR Panel.
- Graphic fabric to be installed at factory at specified 90” H module of fabric panel
- Fabric panel not included. Prices shown are an upcharge to the applicable panel price. Please add the upcharge to the list price of the panel on which you are specifying a graphic.
- Applies to the following panels: EVPFAM
- Note: initial set up charge is \$250 net per image

	DESCRIPTION	PRODUCT CODE	LIST PRICE	DIMENSIONS/INCHES		
				H	W	D
	Graphic fabric for 90” Monolithic Module	EVPGRP8812	853	88	18	
		EVPGRP8824	1113	88	24	
		EVPGRP8830	1356	88	30	
		EVPGRP8836	1605	88	36	





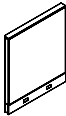

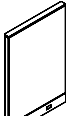
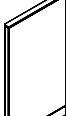
**EVPFAM - MONOLITHIC PANEL**

- Monolithic Panel incorporates fabric modules within a solid steel frame.
- Fabric covered modules are tackable and acoustical.
- Opposite sides of each panel may have a different fabric within the same grade at no upcharge.
- If different grades of fabric are used on one panel, the entire panel must be priced at highest grade.
- An aluminum low profile top cap is included.
- Stackability: Evolve panels can be increased in height in 6”H, 12”H, 18”H or 24”H increments. See Extension Module (pages 82-90) for part numbers.

	DESCRIPTION	PRODUCT CODE	LIST PRICE		DIMENSIONS/INCHES		
			Gr1	Gr2	H	W	D
	Monolithic Panel - 42" High	EVPFAM4218	363	398	42	18	2 7/8
		EVPFAM4224	389	428	42	24	2 7/8
		EVPFAM4230	445	495	42	30	2 7/8
		EVPFAM4236	475	532	42	36	2 7/8
		EVPFAM4242	525	593	42	42	2 7/8
		EVPFAM4248	572	648	42	48	2 7/8
		EVPFAM4254	629	711	42	54	2 7/8
	Monolithic Panel - 48" High	EVPFAM4818	368	403	48	18	2 7/8
		EVPFAM4824	405	449	48	24	2 7/8
		EVPFAM4830	469	519	48	30	2 7/8
		EVPFAM4836	511	568	48	36	2 7/8
		EVPFAM4842	570	636	48	42	2 7/8
		EVPFAM4848	618	692	48	48	2 7/8
		EVPFAM4854	684	769	48	54	2 7/8
	Monolithic Panel - 54" High	EVPFAM5418	373	408	54	18	2 7/8
		EVPFAM5424	411	454	54	24	2 7/8
		EVPFAM5430	477	527	54	30	2 7/8
		EVPFAM5436	531	590	54	36	2 7/8
		EVPFAM5442	592	658	54	42	2 7/8
		EVPFAM5448	644	719	54	48	2 7/8
		EVPFAM5454	706	792	54	54	2 7/8
	Monolithic Panel - 66" High	EVPFAM6618	460	496	66	18	2 7/8
		EVPFAM6624	504	548	66	24	2 7/8
		EVPFAM6630	570	623	66	30	2 7/8
		EVPFAM6636	664	722	66	36	2 7/8
		EVPFAM6642	743	811	66	42	2 7/8
		EVPFAM6648	806	879	66	48	2 7/8
		EVPFAM6654	896	978	66	54	2 7/8
EVPFAM6660	983	1073	66	60	2 7/8		

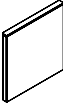
**EVPLFAM - MONOLITHIC LIGHT PANEL**

- Monolithic Light Panel incorporates fabric modules within a solid steel frame.
- There is no base raceway in Light Panels to accommodate electrical.
- Light Panel Connectors must be used in conjunction with Light Panels.
- Fabric covered modules are tackable and acoustical.
- Opposite sides of each panel may have a different fabric within the same grade at no upcharge.
- If different grades of fabric are used on one panel, the entire panel must be priced at highest grade.
- An aluminum low profile top cap is included.
- Stackability: Evolve Light panels can be increased in height in 6”H, 12”H, 18”H or 24”H increments. See Extension Module (pages 82-90) for part numbers.

	DESCRIPTION	PRODUCT CODE	LIST PRICE		DIMENSIONS/INCHES		
			Gr1	Gr2	H	W	D
	Monolithic Light Panel - 42” High	EVPLFAM4218	349	378	42	18	2 7/8
		EVPLFAM4224	367	407	42	24	2 7/8
		EVPLFAM4230	422	470	42	30	2 7/8
		EVPLFAM4236	451	504	42	36	2 7/8
		EVPLFAM4242	501	561	42	42	2 7/8
		EVPLFAM4248	543	613	42	48	2 7/8
		EVPLFAM4254	598	674	42	54	2 7/8
	Monolithic Light Panel - 48” High	EVPLFAM4818	354	383	48	18	2 7/8
		EVPLFAM4824	385	423	48	24	2 7/8
		EVPLFAM4830	445	493	48	30	2 7/8
		EVPLFAM4836	484	537	48	36	2 7/8
		EVPLFAM4842	541	602	48	42	2 7/8
		EVPLFAM4848	588	656	48	48	2 7/8
		EVPLFAM4854	649	726	48	54	2 7/8
	Monolithic Light Panel - 54” High	EVPLFAM5418	355	385	54	18	2 7/8
		EVPLFAM5424	391	425	54	24	2 7/8
		EVPLFAM5430	454	501	54	30	2 7/8
		EVPLFAM5436	504	558	54	36	2 7/8
		EVPLFAM5442	561	625	54	42	2 7/8
		EVPLFAM5448	611	679	54	48	2 7/8
		EVPLFAM5454	671	748	54	54	2 7/8
	Monolithic Light Panel - 66” High	EVPLFAM6618	440	470	66	18	2 7/8
		EVPLFAM6624	479	517	66	24	2 7/8
		EVPLFAM6630	541	591	66	30	2 7/8
		EVPLFAM6636	629	684	66	36	2 7/8
		EVPLFAM6642	706	768	66	42	2 7/8
		EVPLFAM6648	766	833	66	48	2 7/8
		EVPLFAM6654	849	926	66	54	2 7/8
EVPLFAM6660	932	1019	66	60	2 7/8		



**EVPBFAM - MONOLITHIC BELTLINE POWERED PANEL**

- Monolithic Beltline Powered Panel incorporates fabric modules with a power beltline raceway, within a solid steel frame.
- 6”H power beltline raceway, to accommodate electrical, is metal with knockouts on both side.
- A Chimney Panel is required to run electric and data from the base to belt.
- Beltline Connectors must be used in conjunction with beltline panels.
- Fabric covered modules are tackable and acoustical.
- Opposite sides of each panel may have a different fabric within the same grade at no upcharge.
- If different grades of fabric are used on one panel, the entire panel must be priced at highest grade.
- An aluminum low profile top cap is included.
- Stackability: Evolve panels can be increased in height in 6”H, 12”H, 18”H or 24”H increments. See Extension Module (pages 82-90) for part numbers.

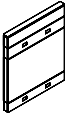
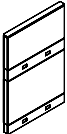
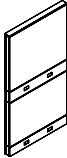
	DESCRIPTION	PRODUCT CODE	LIST PRICE		DIMENSIONS/INCHES		
			Gr1	Gr2	H	W	D
	Monolithic Beltline Powered Panel - 42” High 24” Fabric /6” Power Belt /6” Fabric	EVPBFAM4224	480	504	42	24	2 7/8
		EVPBFAM4230	567	597	42	30	2 7/8
		EVPBFAM4236	646	679	42	36	2 7/8
		EVPBFAM4242	728	768	42	42	2 7/8
		EVPBFAM4248	806	849	42	48	2 7/8
		EVPBFAM4254	882	931	42	54	2 7/8
	Monolithic Beltline Powered Panel - 54” High 24” Fabric /6” Power Belt /18” Fabric	EVPBFAM5424	576	611	54	24	2 7/8
		EVPBFAM5430	676	715	54	30	2 7/8
		EVPBFAM5436	764	809	54	36	2 7/8
		EVPBFAM5442	857	910	54	42	2 7/8
		EVPBFAM5448	941	1006	54	48	2 7/8
		EVPBFAM5454	1033	1103	54	54	2 7/8
	Monolithic Beltline Powered Panel - 66” High 24” Fabric /6” Power Belt /30” Fabric	EVPBFAM6624	682	744	66	24	2 7/8
		EVPBFAM6630	796	867	66	30	2 7/8
		EVPBFAM6636	900	982	66	36	2 7/8
		EVPBFAM6642	1014	1110	66	42	2 7/8
		EVPBFAM6648	1119	1227	66	48	2 7/8
		EVPBFAM6654	1227	1347	66	54	2 7/8
		EVPBFAM6660	1335	1468	66	60	2 7/8

**EVPBLFAM - MONOLITHIC BELTLINE POWERED LIGHT PANEL**

- Monolithic Beltline Powered Light Panel incorporates fabric modules with a power beltline raceway within a solid steel frame
- 6”H power beltline raceway, to accommodate electrical, is metal with knockouts on both sides.
- There is no base raceway in Light Panels to accommodate electrical
- Light Beltline Panel Connectors must be used in conjunction with Light Beltline Panels.
- Fabric covered modules are tackable and acoustical.
- Opposite sides of each panel may have a different fabric within the same grade at no upcharge.
- If different grades of fabric are used on one panel, the entire panel must be priced at highest grade.
- An aluminum low profile top cap is included.
- Stackability: Evolve Light panels can be increased in height in 6”H, 12”H, 18”H or 24”H increments. See Extension Module (pages 82-90) for part numbers.

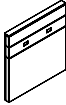
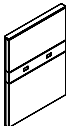
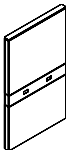
	DESCRIPTION	PRODUCT CODE	LIST PRICE		DIMENSIONS/INCHES		
			Gr1	Gr2	H	W	D
	Monolithic Beltline Powered Light Panel - 42” High	EVPBLFAM4224	456	480	42	24	2 7/8
		EVPBLFAM4230	539	567	42	30	2 7/8
	24” Fabric /6” Power Belt /6” Fabric	EVPBLFAM4236	613	648	42	36	2 7/8
		EVPBLFAM4242	690	730	42	42	2 7/8
		EVPBLFAM4248	766	808	42	48	2 7/8
		EVPBLFAM4254	839	888	42	54	2 7/8
		EVPBLFAM4260	912	968	42	60	2 7/8
	Monolithic Beltline Powered Light Panel - 54” High	EVPBLFAM5424	531	564	54	24	2 7/8
		EVPBLFAM5430	622	664	54	30	2 7/8
	24” Fabric /6” Power Belt /18” Fabric	EVPBLFAM5436	702	747	54	36	2 7/8
		EVPBLFAM5442	785	840	54	42	2 7/8
		EVPBLFAM5448	867	929	54	48	2 7/8
		EVPBLFAM5454	952	1020	54	54	2 7/8
		EVPBLFAM5460	1029	1105	54	60	2 7/8
	Monolithic Beltline Powered Light Panel - 66” High	EVPBLFAM6624	634	696	66	24	2 7/8
		EVPBLFAM6630	737	810	66	30	2 7/8
	24” Fabric /6” Power Belt /30” Fabric	EVPBLFAM6636	835	920	66	36	2 7/8
		EVPBLFAM6642	941	1038	66	42	2 7/8
		EVPBLFAM6648	1040	1151	66	48	2 7/8
		EVPBLFAM6654	1141	1260	66	54	2 7/8
		EVPBLFAM6660	1241	1374	66	60	2 7/8



**EVPBCFAM - MONOLITHIC BELTLINE POWERED CHIMNEY PANEL**

- Monolithic Chimney Beltline Powered Panel incorporates fabric modules with a power beltline raceway within a solid steel frame.
- A Chimney Panel is required to run electric and data from the base to belt.
- Separate electric harness required to go from base to belt (see EVE8CPCP).
- 6”H power beltline raceway, to accommodate electrical, is metal with knockouts on both sides.
- Beltline Connectors must be used in conjunction with beltline panels.
- Fabric covered modules are tackable and acoustical.
- Opposite sides of each panel may have a different fabric within the same grade at no upcharge.
- If different grades of fabric are used on one panel, the entire panel must be priced at highest grade.
- An aluminum low profile top cap is included.
- Stackability: Evolve panels can be increased in height in 6”H, 12”H, 18”H or 24”H increments. See Extension Module listings for part numbers

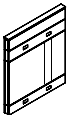
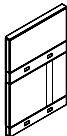
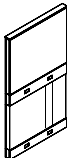
	DESCRIPTION	PRODUCT CODE	LIST PRICE		DIMENSIONS/INCHES		
			Gr1	Gr2	H	W	D
	Monolithic Beltline Powered Chimney Panel - 42” High 24” Fabric Chimney /6” Power Belt /6” Fabric	EVPBCFAM4236	726	764	42	36	2 7/8
		EVPBCFAM4242	808	847	42	42	2 7/8
	Monolithic Beltline Powered Chimney Panel - 54” High 24” Fabric Chimney /6” Power Belt /18” Fabric	EVPBCFAM5436	840	888	54	36	2 7/8
		EVPBCFAM5442	935	988	54	42	2 7/8
	Monolithic Beltline Powered Chimney Panel - 66” High 24” Fabric Chimney /6” Power Belt /30” Fabric	EVPBCFAM6636	978	1062	66	36	2 7/8
		EVPBCFAM6642	1093	1190	66	42	2 7/8

**EVE8CPCP - CHIMNEY PANEL JUMPER CABLE KIT**

- Contains two (2) 17” flexible harnesses and one (1) “I” connector.
- Used to connect electric from the base to the beltline raceway in Beltline Powered Chimney panel.
- Must use in conjunction with base power distribution harness and beltline power distribution harness (sold separately)

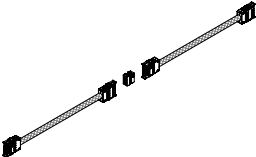
	DESCRIPTION	PRODUCT CODE	LIST PRICE	DIMENSIONS/INCHES		
				H	W	D
	Chimney Panel Jumper Cable Kit	EVE8CPCP	341			



**EVPBFFAM - MONOLITHIC BELTLINE NON-POWERED PANEL**

- Monolithic Beltline Non-Powered Panel incorporates fabric modules within a solid steel frame.
- Electrical cannot pass through panel at the beltline level.
- Fabric covered modules are tackable and acoustical.
- Opposite sides of each panel may have a different fabric within the same grade at no upcharge.
- If different grades of fabric are used on one panel, the entire panel must be priced at highest grade.
- An aluminum low profile top cap is included.
- Stackability: Evolve panels can be increased in height in 6”H, 12”H, 18”H or 24”H increments. See Extension Module (pages 82-90) for part numbers.

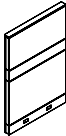
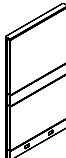
	DESCRIPTION	PRODUCT CODE	LIST PRICE		DIMENSIONS/INCHES		
			Gr1	Gr2	H	W	D
	Monolithic Beltline Non-Powered Panel - 54” High	EVPBFFAM5424	576	615	54	24	2 7/8
	24” Fabric /6” Fabric /18” Fabric	EVPBFFAM5430	676	721	54	30	2 7/8
		EVPBFFAM5436	764	814	54	36	2 7/8
		EVPBFFAM5442	857	919	54	42	2 7/8
		EVPBFFAM5448	941	1014	54	48	2 7/8
		EVPBFFAM5454	1033	1113	54	54	2 7/8
		EVPBFFAM5460	1120	1209	54	60	2 7/8
	Monolithic Beltline Non-Powered Panel - 66” High	EVPBFFAM6624	682	746	66	24	2 7/8
	24” Fabric /6” Fabric /30” Fabric	EVPBFFAM6630	796	871	66	30	2 7/8
		EVPBFFAM6636	900	987	66	36	2 7/8
		EVPBFFAM6642	1014	1118	66	42	2 7/8
		EVPBFFAM6648	1119	1235	66	48	2 7/8
		EVPBFFAM6654	1227	1356	66	54	2 7/8
		EVPBFFAM6660	1335	1479	66	60	2 7/8

**EVPBLFFAM - MONOLITHIC BELTLINE NON-POWERED LIGHT PANEL**

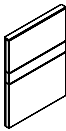
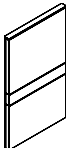

- Monolithic Beltline Non-Powered Light Panel incorporates all fabric modules within a solid steel frame.
- There is no base raceway in Light Panels to accommodate electrical.
- Electrical cannot pass through panel at the beltline level.
- Fabric covered modules are tackable and acoustical.
- Opposite sides of each panel may have a different fabric within the same grade at no upcharge.
- If different grades of fabric are used on one panel, the entire panel must be priced at highest grade.
- An aluminum low profile top cap is included.
- Stackability: Evolve panels can be increased in height in 6”H, 12”H, 18”H or 24”H increments. See Extension Module (pages 82-90) for part numbers.

	DESCRIPTION	PRODUCT CODE	LIST PRICE		DIMENSIONS/INCHES		
			Gr1	Gr2	H	W	D
	Monolithic Beltline Non-Powered Light Panel - 54” High	EVPBLFFAM5424	531	570	54	24	2 7/8
	24” Fabric /6” Fabric /18” Fabric	EVPBLFFAM5430	625	673	54	30	2 7/8
		EVPBLFFAM5436	702	753	54	36	2 7/8
		EVPBLFFAM5442	785	849	54	42	2 7/8
		EVPBLFFAM5448	867	938	54	48	2 7/8
		EVPBLFFAM5454	952	1029	54	54	2 7/8
		EVPBLFFAM5460	1029	1118	54	60	2 7/8
	Monolithic Beltline Non-Powered Light Panel - 66” High	EVPBLFFAM6624	634	699	66	24	2 7/8
	24” Fabric /6” Fabric /30” Fabric	EVPBLFFAM6630	737	814	66	30	2 7/8
		EVPBLFFAM6636	835	926	66	36	2 7/8
		EVPBLFFAM6642	941	1048	66	42	2 7/8
		EVPBLFFAM6648	1040	1158	66	48	2 7/8
		EVPBLFFAM6654	1141	1270	66	54	2 7/8
		EVPBLFFAM6660	1241	1384	66	60	2 7/8

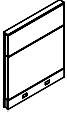
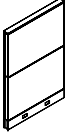
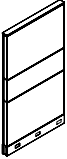

**EVPFA - SEGMENTED PANEL**

- Segmented Panel incorporates fabric modules within a solid steel frame.
- Fabric covered modules are tackable and acoustical.
- Opposite sides of each panel may have a different fabric within the same grade at no upcharge.
- If different grades of fabric are used on one panel, the entire panel must be priced at highest grade.
- An aluminum low profile top cap is included.
- Stackability: Evolve panels can be increased in height in 6”H, 12”H, 18”H or 24”H increments. See Extension Module (pages 82-90) for part numbers.

	DESCRIPTION	PRODUCT CODE	LIST PRICE		DIMENSIONS/INCHES		
			Gr1	Gr2	H	W	D
	Segmented Panel - 30" High	EVPPFA3018	355	370	30	18	2 7/8
		EVPPFA3024	367	392	30	24	2 7/8
		EVPPFA3030	411	435	30	30	2 7/8
		EVPPFA3036	444	471	30	36	2 7/8
		EVPPFA3042	475	508	30	42	2 7/8
		EVPPFA3048	524	560	30	48	2 7/8
		EVPPFA3054	566	607	30	54	2 7/8
		EVPPFA3060	607	654	30	60	2 7/8
	Segmented Panel - 42" High	EVPPFA4218	392	417	42	18	2 7/8
		EVPPFA4224	415	446	42	24	2 7/8
		EVPPFA4230	481	517	42	30	2 7/8
		EVPPFA4236	515	559	42	36	2 7/8
		EVPPFA4242	591	638	42	42	2 7/8
		EVPPFA4248	634	689	42	48	2 7/8
		EVPPFA4254	703	765	42	54	2 7/8
		EVPPFA4260	770	836	42	60	2 7/8
	Segmented Panel - 54" High	EVPPFA5418	421	454	54	18	2 7/8
		EVPPFA5424	459	500	54	24	2 7/8
		EVPPFA5430	525	574	54	30	2 7/8
		EVPPFA5436	587	644	54	36	2 7/8
		EVPPFA5442	664	728	54	42	2 7/8
		EVPPFA5448	736	810	54	48	2 7/8
		EVPPFA5454	799	876	54	54	2 7/8
		EVPPFA5460	858	943	54	60	2 7/8
	Segmented Panel - 66" High	EVPPFA6618	531	570	66	18	2 7/8
		EVPPFA6624	570	621	66	24	2 7/8
		EVPPFA6630	632	690	66	30	2 7/8
		EVPPFA6636	739	812	66	36	2 7/8
		EVPPFA6642	833	914	66	42	2 7/8
		EVPPFA6648	896	986	66	48	2 7/8
		EVPPFA6654	971	1070	66	54	2 7/8
		EVPPFA6660	1052	1161	66	60	2 7/8
	Segmented Panel - 66" High	EVPPFA6618S	531	570	66	18	2 7/8
		EVPPFA6624S	570	621	66	24	2 7/8
		EVPPFA6630S	632	690	66	30	2 7/8
		EVPPFA6636S	739	812	66	36	2 7/8
		EVPPFA6642S	833	914	66	42	2 7/8
		EVPPFA6648S	896	986	66	48	2 7/8
		EVPPFA6654S	971	1070	66	54	2 7/8
		EVPPFA6660S	1052	1161	66	60	2 7/8

**EVPLFA - SEGMENTED LIGHT PANEL**

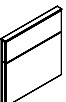
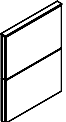
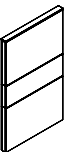
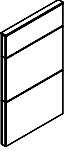

- Segmented Light Panel incorporates fabric modules within a solid steel frame.
- There is no base raceway in Light Panels to accommodate electrical.
- Light Panel Connectors must be used in conjunction with Light Panels.
- Fabric covered modules are tackable and acoustical.
- Opposite sides of each panel may have a different fabric within the same grade at no upcharge.
- If different grades of fabric are used on one panel, the entire panel must be priced at highest grade.
- An aluminum low profile top cap is included.
- Stackability: Evolve Light panels can be increased in height in 6”H, 12”H, 18”H or 24”H increments. See Extension Module (pages 82-90) for part numbers.

	DESCRIPTION	PRODUCT CODE	LIST PRICE		DIMENSIONS/INCHES		
			Gr1	Gr2	H	W	D
	Segmented Light Panel - 30" High	EVPLFA3018	337	352	30	18	2 7/8
		EVPLFA3024	352	367	30	24	2 7/8
		EVPLFA3030	391	412	30	30	2 7/8
		EVPLFA3036	421	445	30	36	2 7/8
		EVPLFA3042	451	480	30	42	2 7/8
		EVPLFA3048	499	533	30	48	2 7/8
		EVPLFA3054	537	574	30	54	2 7/8
	Segmented Light Panel - 42" High	EVPLFA4218	371	393	42	18	2 7/8
		EVPLFA4224	394	421	42	24	2 7/8
		EVPLFA4230	457	493	42	30	2 7/8
		EVPLFA4236	493	531	42	36	2 7/8
		EVPLFA4242	560	602	42	42	2 7/8
		EVPLFA4248	602	655	42	48	2 7/8
		EVPLFA4254	667	721	42	54	2 7/8
	Segmented Light Panel - 54" High	EVPLFA5418	400	429	54	18	2 7/8
		EVPLFA5424	439	472	54	24	2 7/8
		EVPLFA5430	501	543	54	30	2 7/8
		EVPLFA5436	557	607	54	36	2 7/8
		EVPLFA5442	629	687	54	42	2 7/8
		EVPLFA5448	702	768	54	48	2 7/8
		EVPLFA5454	761	831	54	54	2 7/8
	Segmented Light Panel - 66" High	EVPLFA6618	504	539	66	18	2 7/8
		EVPLFA6624	539	588	66	24	2 7/8
		EVPLFA6630	600	655	66	30	2 7/8
		EVPLFA6636	704	769	66	36	2 7/8
		EVPLFA6642	794	866	66	42	2 7/8
		EVPLFA6648	849	931	66	48	2 7/8
		EVPLFA6654	922	1017	66	54	2 7/8
	Segmented Light Panel - 66" High	EVPLFA6618S	504	539	66	18	2 7/8
		EVPLFA6624S	539	588	66	24	2 7/8
		EVPLFA6630S	600	655	66	30	2 7/8
		EVPLFA6636S	704	769	66	36	2 7/8
		EVPLFA6642S	794	866	66	42	2 7/8
		EVPLFA6648S	849	931	66	48	2 7/8
		EVPLFA6654S	922	1017	66	54	2 7/8
EVPLFA6660S	1000	1102	66	60	2 7/8		

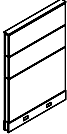

**EVFPF - SEGMENTED PREMIUM PANEL**

- Segmented Premium Panel incorporates fabric modules within a solid steel frame.
- Segmented Premium panels incorporate 12" H acoustic modules above 24" base module , plus 6" H base raceway.
- Fabric covered modules are tackable and acoustical.
- Opposite sides of each panel may have a different fabric within the same grade at no upcharge.
- If different grades of fabric are used on one panel, the entire panel must be priced at highest grade.
- An aluminum low profile top cap is included.
- Stackability: Evolve panels can be increased in height in 6"H, 12"H, 18"H or 24"H increments. See Extension Module (pages 82-90) for part numbers.

	DESCRIPTION	PRODUCT CODE	LIST PRICE		DIMENSIONS/INCHES		
			Gr1	Gr2	H	W	D
	Segmented Premium Panel - 54" High	EVFPF5418	494	525	54	18	2 7/8
		EVFPF5424	524	563	54	24	2 7/8
		EVFPF5430	577	625	54	30	2 7/8
		EVFPF5436	679	734	54	36	2 7/8
		EVFPF5442	768	832	54	42	2 7/8
		EVFPF5448	821	891	54	48	2 7/8
		EVFPF5454	871	955	54	54	2 7/8
		EVFPF5460	921	1009	54	60	2 7/8
	Segmented Premium Panel - 66" High	EVFPF6618	621	659	66	18	2 7/8
		EVFPF6624	646	695	66	24	2 7/8
		EVFPF6630	703	765	66	30	2 7/8
		EVFPF6636	744	817	66	36	2 7/8
		EVFPF6642	886	967	66	42	2 7/8
		EVFPF6648	970	1061	66	48	2 7/8
		EVFPF6654	1033	1130	66	54	2 7/8
		EVFPF6660	1098	1208	66	60	2 7/8

**EVPLFP - SEGMENTED LIGHT PANEL - PREMIUM**

- Segmented Premium Light Panel incorporates fabric modules within a solid steel frame.
- Segmented Premium panels incorporate 12" H acoustic modules above 24" base module , plus 6" H open base.
- There is no base raceway in Light Panels to accommodate electrical.
- Light Panel Connectors must be used in conjunction with Light Panels.
- Fabric covered modules are tackable and acoustical.
- Opposite sides of each panel may have a different fabric within the same grade at no upcharge.
- If different grades of fabric are used on one panel, the entire panel must be priced at highest grade.
- An aluminum low profile top cap is included.
- Stackability: Evolve Light panels can be increased in height in 6"H, 12"H, 18"H or 24"H increments. See Extension Module (pages 82-90) for part numbers.

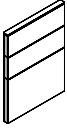
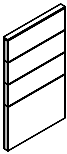
	DESCRIPTION	PRODUCT CODE	LIST PRICE		DIMENSIONS/INCHES		
			Gr1	Gr2	H	W	D
	Segmented Premium Light Panel - Premium - 54" High	EVPLFP5418	470	499	54	18	2 7/8
		EVPLFP5424	499	535	54	24	2 7/8
		EVPLFP5430	548	593	54	30	2 7/8
		EVPLFP5436	647	697	54	36	2 7/8
		EVPLFP5442	730	788	54	42	2 7/8
		EVPLFP5448	779	845	54	48	2 7/8
		EVPLFP5454	829	902	54	54	2 7/8
		EVPLFP5460	874	959	54	60	2 7/8
	Segmented Premium Light Panel - Premium - 66" High	EVPLFP6618	591	625	66	18	2 7/8
		EVPLFP6624	613	657	66	24	2 7/8
		EVPLFP6630	667	721	66	30	2 7/8
		EVPLFP6636	707	774	66	36	2 7/8
		EVPLFP6642	840	918	66	42	2 7/8
		EVPLFP6648	921	1006	66	48	2 7/8
		EVPLFP6654	982	1073	66	54	2 7/8
		EVPLFP6660	1042	1146	66	60	2 1/4

**EVPBFA - SEGMENTED BELTLINE POWERED PANEL**

- Segmented Beltline Powered Panel incorporates fabric modules with a power beltline raceway, within a solid steel frame.
- A Chimney Panel is required to run electric and data from the base to belt.
- 6”H power beltline raceway, to accommodate electrical, is metal with knockouts on both sides.
- Beltline connectors must be used in conjunction with beltline panels.
- Fabric covered modules are tackable and acoustical.
- Opposite sides of each panel may have a different fabric within the same grade at no upcharge.
- If different grades of fabric are used on one panel, the entire panel must be priced at highest grade.
- An aluminum low profile top cap is included.
- Stackability: Evolve panels can be increased in height in 6”H, 12”H, 18”H or 24”H increments. See Extension Module (pages 82-90) for part numbers.

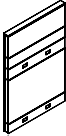
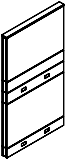
	DESCRIPTION	PRODUCT CODE	LIST PRICE		DIMENSIONS/INCHES		
			Gr1	Gr2	H	W	D
	Segmented Beltline Powered Panel - 54” High 24” Fabric /6” Power /6” Fabric /12” Fabric	EVPBFA5424	575	608	54	24	2 7/8
		EVPBFA5430	674	713	54	30	2 7/8
		EVPBFA5436	775	824	54	36	2 7/8
		EVPBFA5442	869	923	54	42	2 7/8
		EVPBFA5448	951	1014	54	48	2 7/8
		EVPBFA5454	1042	1113	54	54	2 7/8
		EVPBFA5460	1136	1213	54	60	2 7/8
	Segmented Beltline Powered Panel - 66” High 24” Fabric /6” Power /6” Fabric /24” Fabric	EVPBFA6624	687	733	66	24	2 7/8
		EVPBFA6630	806	857	66	30	2 7/8
		EVPBFA6636	912	976	66	36	2 7/8
		EVPBFA6642	1027	1098	66	42	2 7/8
		EVPBFA6648	1135	1214	66	48	2 7/8
		EVPBFA6654	1246	1334	66	54	2 7/8
		EVPBFA6660	1355	1450	66	60	2 7/8

**EVPBLFA - SEGMENTED BELTLINE POWERED LIGHT PANEL**

- Segmented Beltline Powered Light Panel incorporates fabric modules with a power beltline raceway, within a solid steel frame.
- There is no base raceway in Light Panels to accommodate electrical.
- 6”H power beltline raceway, to accommodate electrical, is metal with knockouts on both sides.
- Beltline Light Panel Connectors must be used in conjunction with Beltline Light Panels.
- Fabric covered modules are tackable and acoustical.
- Opposite sides of each panel may have a different fabric within the same grade at no upcharge.
- If different grades of fabric are used on one panel, the entire panel must be priced at highest grade.
- An aluminum low profile top cap is included.
- Stackability: Evolve Light panels can be increased in height in 6”H, 12”H, 18”H or 24”H increments. See Extension Module (pages 82-90) for part numbers.

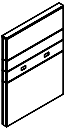
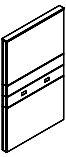
	DESCRIPTION	PRODUCT CODE	LIST PRICE		DIMENSIONS/INCHES		
			Gr1	Gr2	H	W	D
	Segmented Beltline Powered Light Panel - 54” High 24” Fabric /6” Power /6” Fabric /12” Fabric	EVPBLFA5424	528	561	54	24	2 7/8
		EVPBLFA5430	618	657	54	30	2 7/8
		EVPBLFA5436	714	765	54	36	2 7/8
		EVPBLFA5442	801	857	54	42	2 7/8
		EVPBLFA5448	874	938	54	48	2 7/8
		EVPBLFA5454	960	1028	54	54	2 7/8
		EVPBLFA5460	1048	1121	54	60	2 7/8
	Segmented Beltline Powered Light Panel - 66” High 24” Fabric /6” Power /6” Fabric /24 Fabric	EVPBLFA6624	634	677	66	24	2 7/8
		EVPBLFA6630	739	794	66	30	2 7/8
		EVPBLFA6636	840	905	66	36	2 7/8
		EVPBLFA6642	946	1017	66	42	2 7/8
		EVPBLFA6648	1042	1121	66	48	2 7/8
		EVPBLFA6654	1146	1234	66	54	2 7/8
		EVPBLFA6660	1247	1345	66	60	2 7/8



**EVPBCFA - SEGMENTED BELTLINE POWERED CHIMNEY PANEL**

- Segmented Chimney Beltline Powered Panel incorporates fabric modules with a power beltline raceway, within a solid steel frame.
- A Chimney Panel is required to run electric and data from the base to belt.
- Separate electric harness required to go from base to belt (see EVE8CPCP).
- 6”H power beltline raceway, to accommodate electrical, is metal with knockouts on both sides.
- Beltline Connectors must be used in conjunction with beltline panels.
- Fabric covered modules are tackable and acoustical.
- Opposite sides of each panel may have a different fabric within the same grade at no upcharge.
- If different grades of fabric are used on one panel, the entire panel must be priced at highest grade.
- An aluminum low profile top cap is included.
- Stackability: Evolve panels can be increased in height in 6”H, 12”H, 18”H or 24”H increments. See Extension Module (pages 82-90) for part numbers.

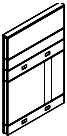
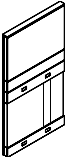
	DESCRIPTION	PRODUCT CODE	LIST PRICE		DIMENSIONS/INCHES		
			Gr1	Gr2	H	W	D
	Segmented Beltline Powered Chimney Panel - 54” High 24” Fabric Chimney /6” Power / 6” Fabric /12” Fabric	EVPBCFA5436	857	905	54	36	2 7/8
		EVPBCFA5442	951	1006	54	42	2 7/8
	Segmented Beltline Powered Chimney Panel - 66” High 24” Fabric Chimney /6” Power / 6” Fabric /24” Fabric	EVPBCFA6636	992	1058	66	36	2 7/8
		EVPBCFA6642	1107	1179	66	42	2 7/8

**EVE8CPCP - CHIMNEY PANEL JUMPER CABLE KIT**

- Contains two (2) 17” flexible harnesses and one (1) “I” connector.
- Used to connect electric from the base to the beltline raceway in Beltline Powered Chimney panel.
- Must use in conjunction with base power distribution harness and beltline power distribution harness (sold separately)

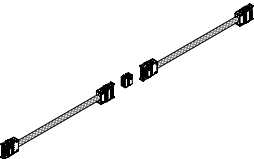
	DESCRIPTION	PRODUCT CODE	LIST PRICE	DIMENSIONS/INCHES		
				H	W	D
	Chimney Panel Jumper Cable Kit	EVE8CPCP	341			

**EVPBFFA - SEGMENTED BELTLINE NON-POWERED PANEL**

- Double Beltline Non-Powered Panel incorporates all fabric modules within a solid steel frame.
- Electrical cannot pass through panel at the beltline level.
- Fabric covered modules are tackable and acoustical.
- Opposite sides of each panel may have a different fabric within the same grade at no upcharge.
- If different grades of fabric are used on one panel, the entire panel must be priced at highest grade.
- An aluminum low profile top cap is included.
- Stackability: Evolve panels can be increased in height in 6”H, 12”H, 18”H or 24”H increments. See Extension Module (pages 82-90) for part numbers.

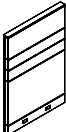
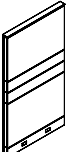
	DESCRIPTION	PRODUCT CODE	LIST PRICE		DIMENSIONS/INCHES		
			Gr1	Gr2	H	W	D
	Segmented Beltline Non-Powered Panel - 54” High	EVPBFFA5424	555	587	54	24	2 7/8
		EVPBFFA5430	607	653	54	30	2 7/8
	24” Fabric /6” Fabric /6” Fabric /12” Fabric	EVPBFFA5436	714	769	54	36	2 7/8
		EVPBFFA5442	806	867	54	42	2 7/8
		EVPBFFA5448	864	931	54	48	2 7/8
		EVPBFFA5454	911	988	54	54	2 7/8
		EVPBFFA5460	956	1041	54	60	2 7/8
	Segmented Beltline Non-Powered Panel - 66” High	EVPBFFA6624	601	648	66	24	2 7/8
		EVPBFFA6630	706	765	66	30	2 7/8
	24” Fabric /6” Fabric /6” Fabric /24” Fabric	EVPBFFA6636	814	882	66	36	2 7/8
		EVPBFFA6642	916	992	66	42	2 7/8
		EVPBFFA6648	1001	1088	66	48	2 7/8
		EVPBFFA6654	1100	1195	66	54	2 7/8
		EVPBFFA6660	1196	1307	66	60	2 7/8

**EVPBLFFA - SEGMENTED BELTLINE NON-POWERED LIGHT PANEL**

- Double Beltline Non-Powered Panel incorporates all fabric modules within a solid steel frame.
- Electrical cannot pass through panel at the beltline level.
- There is no base raceway in Light Panels to accommodate electrical
- Fabric covered modules are tackable and acoustical.
- Opposite sides of each panel may have a different fabric within the same grade at no upcharge.
- If different grades of fabric are used on one panel, the entire panel must be priced at highest grade.
- An aluminum low profile top cap is included.
- Stackability: Evolve panels can be increased in height in 6”H, 12”H, 18”H or 24”H increments.
- See Extension Module (pages 82-90) for part numbers.

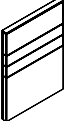
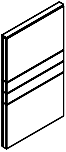
	DESCRIPTION	PRODUCT CODE	LIST PRICE		DIMENSIONS/INCHES		
			Gr1	Gr2	H	W	D
	Segmented Beltline Non-Powered Light Panel - 54” High	EVPBLFFA5424	457	497	54	24	2 7/8
		EVPBLFFA5430	539	583	54	30	2 7/8
	24” Fabric /6” Fabric /6” Fabric /12” Fabric	EVPBLFFA5436	612	667	54	36	2 7/8
		EVPBLFFA5442	685	747	54	42	2 7/8
		EVPBLFFA5448	761	829	54	48	2 7/8
		EVPBLFFA5454	866	942	54	54	2 7/8
		EVPBLFFA5460	908	992	54	60	2 7/8
	Segmented Beltline Non-Powered Light Panel - 66” High	EVPBLFFA6624	570	616	66	24	2 7/8
		EVPBLFFA6630	632	687	66	30	2 7/8
	24” Fabric /6” Fabric /6” Fabric /24” Fabric	EVPBLFFA6636	739	808	66	36	2 7/8
		EVPBLFFA6642	833	911	66	42	2 7/8
		EVPBLFFA6648	896	982	66	48	2 7/8
		EVPBLFFA6654	971	1069	66	54	2 7/8
		EVPBLFFA6660	1052	1159	66	60	2 7/8



**EVPMTU - MONOLITHIC 12”H GLAZED PANEL - TEMPERED GLASS**

- Monolithic 12”H Glazed Panel incorporates a lower fabric module with a 12”H top position glazed module, into a solid steel frame.
- Fabric covered modules are tackable and acoustical.
- Opposite sides of each panel may have a different fabric within the same grade at no upcharge.
- If different grades of fabric are used on one panel, the entire panel must be priced at highest grade.
- An aluminum low profile top cap is included.
- Stackability: Evolve panels can be increased in height in 6”H, 12”H, 18”H or 24”H increments. See Extension Module (pages 82-90) for part numbers.
- Standard in clear (CLR) or smoked glass (SMK) as an option. Please note the smoked glass (SMK) has 51% light transmittance.
- Frosted glass (FRST) 20% upcharge.

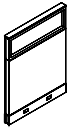
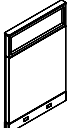
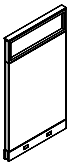
	DESCRIPTION	PRODUCT CODE	LIST PRICE		DIMENSIONS/INCHES		
			Gr1	Gr2	H	W	D
	Monolithic 12”H Glazed Panel - Tempered Glass - 48” High	EVPMTU4818	539	570	48	18	2 7/8
		EVPMTU4824	631	675	48	24	2 7/8
		EVPMTU4830	732	782	48	30	2 7/8
		EVPMTU4836	835	896	48	36	2 7/8
		EVPMTU4842	927	992	48	42	2 7/8
		EVPMTU4848	1008	1084	48	48	2 7/8
		EVPMTU4854	1119	1196	48	54	2 7/8
EVPMTU4860	1227	1319	48	60	2 7/8		
	Monolithic 12”H Glazed Panel - Tempered Glass - 54” High	EVPMTU5418	556	592	54	18	2 7/8
		EVPMTU5424	646	687	54	24	2 7/8
		EVPMTU5430	736	790	54	30	2 7/8
		EVPMTU5436	821	875	54	36	2 7/8
		EVPMTU5442	911	977	54	42	2 7/8
		EVPMTU5448	1008	1084	54	48	2 7/8
		EVPMTU5454	1103	1188	54	54	2 7/8
EVPMTU5460	1195	1289	54	60	2 7/8		
	Monolithic 12”H Glazed Panel - Tempered Glass - 66” High	EVPMTU6618	593	626	66	18	2 7/8
		EVPMTU6624	710	754	66	24	2 7/8
		EVPMTU6630	809	863	66	30	2 7/8
		EVPMTU6636	906	965	66	36	2 7/8
		EVPMTU6642	1007	1073	66	42	2 7/8
		EVPMTU6648	1111	1188	66	48	2 7/8
		EVPMTU6654	1215	1299	66	54	2 7/8
EVPMTU6660	1324	1414	66	60	2 7/8		



**EVPLMGU - MONOLITHIC 12”H GLAZED LIGHT PANEL - TEMPERED GLASS**

- Monolithic 12”H Glazed Light Panel incorporates a lower fabric module with a 12”H top position glazed module, into a solid steel frame.
- There is no base raceway in Light Panels to accommodate electrical.
- Light Panel Connectors must be used in conjunction with Light Panels.
- Fabric covered modules are tackable and acoustical.
- Opposite sides of each panel may have a different fabric within the same grade at no upcharge.
- If different grades of fabric are used on one panel, the entire panel must be priced at highest grade.
- An aluminum low profile top cap is included.
- Stackability: Evolve panels can be increased in height in 6”H, 12”H, 18”H or 24”H increments. See Extension Module (pages 82-90) for part numbers.
- Standard in clear (CLR) or smoked glass (SMK) as an option. Please note the smoked glass (SMK) has 51% light transmittance.
- Frosted glass (FRST) 20% upcharge.

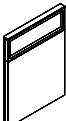
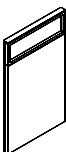
	DESCRIPTION	PRODUCT CODE	LIST PRICE		DIMENSIONS/INCHES		
			Gr1	Gr2	H	W	D
	Monolithic 12”H Glazed Light Panel - Tempered Glass - 48” High	EVPLMGU4818	527	557	48	18	2 7/8
		EVPLMGU4824	616	656	48	24	2 7/8
		EVPLMGU4830	715	766	48	30	2 7/8
		EVPLMGU4836	821	875	48	36	2 7/8
		EVPLMGU4842	909	972	48	42	2 7/8
		EVPLMGU4848	986	1062	48	48	2 7/8
		EVPLMGU4854	1095	1171	48	54	2 7/8
		EVPLMGU4860	1204	1293	48	60	2 7/8
	Monolithic 12”H Glazed Light Panel - Tempered Glass - 54” High	EVPLMGU5418	544	577	54	18	2 7/8
		EVPLMGU5424	633	673	54	24	2 7/8
		EVPLMGU5430	721	773	54	30	2 7/8
		EVPLMGU5436	806	858	54	36	2 7/8
		EVPLMGU5442	896	959	54	42	2 7/8
		EVPLMGU5448	986	1062	54	48	2 7/8
		EVPLMGU5454	1080	1160	54	54	2 7/8
		EVPLMGU5460	1174	1262	54	60	2 7/8
	Monolithic 12”H Glazed Light Panel - Tempered Glass - 66” High	EVPLMGU6618	581	612	66	18	2 7/8
		EVPLMGU6624	696	737	66	24	2 7/8
		EVPLMGU6630	795	842	66	30	2 7/8
		EVPLMGU6636	887	942	66	36	2 7/8
		EVPLMGU6642	984	1052	66	42	2 7/8
		EVPLMGU6648	1088	1161	66	48	2 7/8
		EVPLMGU6654	1191	1272	66	54	2 7/8
		EVPLMGU6660	1295	1383	66	60	2 7/8



**EVPFGTU - FABRIC 12”H GLAZED PANEL - TEMPERED GLASS**

- Segmented 12”H Glazed Panel incorporates a lower fabric module with a 12”H top position glazed module, into a solid steel frame.
- Panels incorporate 12”H acoustic modules above 30”H base section with a 12”H glazed module at the top.
- Fabric covered modules are tackable and acoustical.
- Opposite sides of each panel may have a different fabric within the same grade at no upcharge.
- If different grades of fabric are used on one panel, the entire panel must be priced at highest grade.
- An aluminum low profile top cap is included.
- Stackability: Evolve panels can be increased in height in 6”H, 12”H, 18”H or 24”H increments. See Extension Module (pages 82-90) for part numbers.
- Standard in clear (CLR) or smoked glass (SMK) as an option. Please note the smoked glass (SMK) has 51% light transmittance.
- Frosted glass (FRST) 20% upcharge.

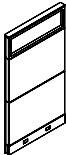
	DESCRIPTION	PRODUCT CODE	LIST PRICE		DIMENSIONS/INCHES		
			Gr1	Gr2	H	W	D
	Fabric 12” Glazed Panel - Tempered Glass 66” High	EVPFGTU6618	665	696	66	18	2 7/8
		EVPFGTU6624	775	818	66	24	2 7/8
		EVPFGTU6630	885	933	66	30	2 7/8
		EVPFGTU6636	989	1048	66	36	2 7/8
		EVPFGTU6642	1118	1180	66	42	2 7/8
		EVPFGTU6648	1213	1286	66	48	2 7/8
		EVPFGTU6654	1355	1435	66	54	2 7/8
		EVPFGTU6660	1493	1580	66	60	2 7/8

**EVPLFGTU - FABRIC 12”H GLAZED LIGHT PANEL**

- Segmented 12”H Glazed Light Panel incorporates a lower fabric module with a 12”H top position glazed module, into a solid steel frame.
- Panels incorporate 12”H acoustic modules above 30”H base section with a 12”H glazed module at the top.
- There is no base raceway in Light Panels to accommodate electrical.
- Light Panel Connectors must be used in conjunction with Light Panels.
- Opposite sides of each panel may have a different fabric within the same grade at no upcharge.
- If different grades of fabric are used on one panel, the entire panel must be priced at highest grade.
- An aluminum low profile top cap is included.
- Stackability: Evolve panels can be increased in height in 6”H, 12”H, 18”H or 24”H increments.
- See Extension Module (pages 82-90) for part numbers.
- Standard in clear (CLR) or smoked glass (SMK) as an option. Please note the smoked glass (SMK) has 51% light transmittance.
- Frosted glass (FRST) 20% upcharge.

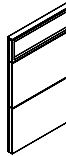
	DESCRIPTION	PRODUCT CODE	LIST PRICE		DIMENSIONS/INCHES		
			Gr1	Gr2	H	W	D
	Fabric 12”H Glazed Light Panel - 66” High	EVPLFGTU6618	649	678	66	18	2 7/8
		EVPLFGTU6624	763	800	66	24	2 7/8
		EVPLFGTU6630	867	911	66	30	2 7/8
		EVPLFGTU6636	972	1026	66	36	2 7/8
		EVPLFGTU6642	1094	1154	66	42	2 7/8
		EVPLFGTU6648	1187	1256	66	48	2 7/8
		EVPLFGTU6654	1327	1403	66	54	2 7/8
		EVPLFGTU6660	1465	1546	66	60	2 7/8

**EVFPFGTU - SEGMENTED 12”H GLAZED PANEL - PREMIUM - TEMPERED GLASS**

- Segmented 12”H Glazed Premium Panel incorporates a lower fabric module with a 12”H top position glazed module, into a solid steel frame.
- Premium panels incorporate 12”H acoustic modules above 30”H base section with a 12”H glazed module at the top.
- Fabric covered modules are tackable and acoustical.
- Opposite sides of each panel may have a different fabric within the same grade at no upcharge.
- If different grades of fabric are used on one panel, the entire panel must be priced at highest grade.
- An aluminum low profile top cap is included.
- Stackability: Evolve panels can be increased in height in 6”H, 12”H, 18”H or 24”H increments. See Extension Module (pages 82-90) for part numbers.
- Standard in clear (CLR) or smoked glass (SMK) as an option. Please note the smoked glass (SMK) has 51% light transmittance.
- Frosted glass (FRST) 20% upcharge.

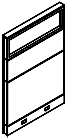
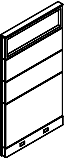
	DESCRIPTION	PRODUCT CODE	LIST PRICE		DIMENSIONS/INCHES		
			Gr1	Gr2	H	W	D
	Segmented 12”H Glazed Premium Panel - Tempered Glass - 54” High	EVFPFGTU5418	612	636	54	18	2 7/8
		EVFPFGTU5424	717	747	54	24	2 7/8
		EVFPFGTU5430	810	849	54	30	2 7/8
		EVFPFGTU5436	911	957	54	36	2 7/8
		EVFPFGTU5442	1022	1072	54	42	2 7/8
		EVFPFGTU5448	1111	1165	54	48	2 7/8
		EVFPFGTU5454	1246	1307	54	54	2 7/8
		EVFPFGTU5460	1377	1445	54	60	2 7/8
	Segmented 12”H Glazed Premium Panel - Tempered Glass - 66” High	EVFPFGTU6618	748	777	66	18	2 7/8
		EVFPFGTU6624	878	922	66	24	2 7/8
		EVFPFGTU6630	1000	1046	66	30	2 7/8
		EVFPFGTU6636	1122	1179	66	36	2 7/8
		EVFPFGTU6642	1267	1332	66	42	2 7/8
		EVFPFGTU6648	1371	1444	66	48	2 7/8
		EVFPFGTU6654	1533	1614	66	54	2 7/8
		EVFPFGTU6660	1702	1790	66	60	2 7/8

**EVPLFPGTU - SEGMENTED 12”H GLAZED PREMIUM LIGHT PANEL – TEMPERED GLASS**

- Segmented 12”H Glazed Premium Light Panel incorporates a lower fabric module with a 12”H top position glazed module, into a solid steel frame.
- Premium panels incorporate 12”H acoustic modules above 30”H base section with a 12”H glazed module at the top.
- There is no base raceway in Light Panels to accommodate electrical.
- Light Panel Connectors must be used in conjunction with Light Panels.
- Opposite sides of each panel may have a different fabric within the same grade at no upcharge.
- If different grades of fabric are used on one panel, the entire panel must be priced at highest grade.
- An aluminum low profile top cap is included.
- Stackability: Evolve panels can be increased in height in 6”H, 12”H, 18”H or 24”H increments.
- See Extension Module (pages 82-90) for part numbers.
- Standard in clear (CLR) or smoked glass (SMK) as an option. Please note the smoked glass (SMK) has 51% light transmittance.
- Frosted glass (FRST) 20% upcharge.

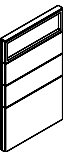
	DESCRIPTION	PRODUCT CODE	LIST PRICE		DIMENSIONS/INCHES		
			Gr1	Gr2	H	W	D
	Segmented 12”H Glazed Premium Panel - Premium - Tempered Glass - 54” High	EVPLFPGTU5418	600	621	54	18	2 7/8
		EVPLFPGTU5424	704	733	54	24	2 7/8
		EVPLFPGTU5430	796	830	54	30	2 7/8
		EVPLFPGTU5436	896	932	54	36	2 7/8
		EVPLFPGTU5442	1004	1052	54	42	2 7/8
		EVPLFPGTU5448	1088	1141	54	48	2 7/8
		EVPLFPGTU5454	1220	1278	54	54	2 7/8
		EVPLFPGTU5460	1348	1414	54	60	2 7/8
	Segmented 12”H Glazed Premium Panel - Premium - Tempered Glass - 66” High	EVPLFPGTU6618	735	764	66	18	2 7/8
		EVPLFPGTU6624	862	901	66	24	2 7/8
		EVPLFPGTU6630	978	1021	66	30	2 7/8
		EVPLFPGTU6636	1102	1154	66	36	2 7/8
		EVPLFPGTU6642	1242	1304	66	42	2 7/8
		EVPLFPGTU6648	1344	1413	66	48	2 7/8
		EVPLFPGTU6654	1501	1578	66	54	2 7/8
		EVPLFPGTU6660	1669	1756	66	60	2 7/8



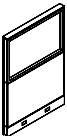
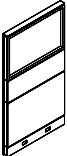

**EVPPFGT - PARTLY GLAZED PANEL - TEMPERED GLASS**

- Partly Glazed Panel incorporates a lower fabric module with a 12”H or 24”H top position glazed module, into a solid steel frame.
- Opposite sides of each panel may have a different fabric within the same grade at no upcharge.
- If different grades of fabric are used on one panel, the entire panel must be priced at highest grade.
- An aluminum low profile top cap is included.
- Stackability: Evolve panels can be increased in height in 6”H, 12”H, 18”H or 24”H increments. See Extension Module (pages 82-90) for part numbers.
- Standard in clear (CLR) or smoked glass (SMK) as an option. Please note the smoked glass (SMK) has 51% light transmittance.
- Frosted glass (FRST) 20% upcharge.

	DESCRIPTION	PRODUCT CODE	LIST PRICE		DIMENSIONS/INCHES		
			Gr1	Gr2	H	W	D
	Partly Glazed Panel - Tempered Glass - 42" High	EVPPFGT4218	471	489	42	18	2 7/8
		EVPPFGT4224	556	577	42	24	2 7/8
		EVPPFGT4230	629	655	42	30	2 7/8
		EVPPFGT4236	702	732	42	36	2 7/8
		EVPPFGT4242	780	815	42	42	2 7/8
		EVPPFGT4248	854	889	42	48	2 7/8
		EVPPFGT4254	954	992	42	54	2 7/8
		EVPPFGT4260	1053	1099	42	60	2 7/8
	Partly Glazed Panel - Tempered Glass - 54" High	EVPPFGT5418	520	541	54	18	2 7/8
		EVPPFGT5424	604	628	54	24	2 7/8
		EVPPFGT5430	702	728	54	30	2 7/8
		EVPPFGT5436	796	826	54	36	2 7/8
		EVPPFGT5442	889	922	54	42	2 7/8
		EVPPFGT5448	970	1008	54	48	2 7/8
		EVPPFGT5454	1124	1165	54	54	2 7/8
		EVPPFGT5460	1276	1325	54	60	2 7/8
	Partly Glazed Panel - Tempered Glass - 66" High	EVPPFGT6618	659	685	66	18	2 7/8
		EVPPFGT6624	767	798	66	24	2 7/8
		EVPPFGT6630	885	923	66	30	2 7/8
		EVPPFGT6636	1007	1051	66	36	2 7/8
		EVPPFGT6642	1131	1184	66	42	2 7/8
		EVPPFGT6648	1229	1284	66	48	2 7/8
		EVPPFGT6654	1414	1476	66	54	2 7/8
		EVPPFGT6660	1600	1668	66	60	2 7/8

**EVPLFGT - PARTLY GLAZED LIGHT PANEL - TEMPERED GLASS**

- Partly Glazed Light Panel incorporates a lower fabric module with a 12”H or 24”H top position glazed module, into a solid steel frame.
- There is no base raceway in Light Panels to accommodate electrical.
- Light Panel Connectors must be used in conjunction with Light Panels.
- Opposite sides of each panel may have a different fabric within the same grade at no upcharge.
- If different grades of fabric are used on one panel, the entire panel must be priced at highest grade.
- An aluminum low profile top cap is included.
- Stackability: Evolve panels can be increased in height in 6”H, 12”H, 18”H or 24”H increments. See Extension Module (pages 82-90) for part numbers.
- Standard in clear (CLR) or smoked glass (SMK) as an option. Please note the smoked glass (SMK) has 51% light transmittance.
- Frosted glass (FRST) 20% upcharge.

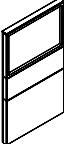
	DESCRIPTION	PRODUCT CODE	LIST PRICE		DIMENSIONS/INCHES		
			Gr1	Gr2	H	W	D
	Partly Glazed Light Panel - Tempered Glass - 42” High	EVPLFGT4218	460	477	42	18	2 7/8
		EVPLFGT4224	544	564	42	24	2 7/8
		EVPLFGT4230	615	641	42	30	2 7/8
		EVPLFGT4236	685	714	42	36	2 7/8
		EVPLFGT4242	767	799	42	42	2 7/8
		EVPLFGT4248	834	869	42	48	2 7/8
		EVPLFGT4254	932	972	42	54	2 7/8
		EVPLFGT4260	1032	1073	42	60	2 7/8
	Partly Glazed Light Panel - Tempered Glass - 54” High	EVPLFGT5418	511	525	54	18	2 7/8
		EVPLFGT5424	593	612	54	24	2 7/8
		EVPLFGT5430	685	710	54	30	2 7/8
		EVPLFGT5436	777	808	54	36	2 7/8
		EVPLFGT5442	872	905	54	42	2 7/8
		EVPLFGT5448	951	984	54	48	2 7/8
		EVPLFGT5454	1103	1141	54	54	2 7/8
		EVPLFGT5460	1251	1295	54	60	2 7/8
	Partly Glazed Light Panel - Tempered Glass - 66” High	EVPLFGT6618	647	673	66	18	2 7/8
		EVPLFGT6624	748	779	66	24	2 7/8
		EVPLFGT6630	867	902	66	30	2 7/8
		EVPLFGT6636	984	1026	66	36	2 7/8
		EVPLFGT6642	1111	1158	66	42	2 7/8
		EVPLFGT6648	1207	1256	66	48	2 7/8
		EVPLFGT6654	1385	1445	66	54	2 7/8
		EVPLFGT6660	1569	1631	66	60	2 7/8



**EVPPFGTX - PARTLY GLAZED PANEL - 36”H TEMPERED GLASS**

- Partly Glazed Panel incorporates a lower fabric module with 36”H top position glazed module, into a solid steel frame.
- Opposite sides of each panel may have a different fabric within the same grade at no upcharge.
- If different grades of fabric are used on one panel, the entire panel must be priced at highest grade.
- An aluminum low profile top cap is included.
- Stackability: Evolve panels can be increased in height in 6”H, 12”H, 18”H or 24”H increments. See Extension Module (pages 82-90) for part numbers.
- Standard in clear (CLR) or smoked glass (SMK) as an option. Please note the smoked glass (SMK) has 51% light transmittance.
- Frosted glass (FRST) 40% upcharge.

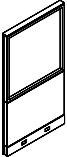
	DESCRIPTION	PRODUCT CODE	LIST PRICE		DIMENSIONS/INCHES		
			Gr1	Gr2	H	W	D
	Fabric 36” Glazed Panel -	EVPPFGTX6618	764	779	66	18	2 7/8
	Tempered Glass - 66” High	EVPPFGTX6624	842	867	66	24	2 7/8
		EVPPFGTX6630	976	1004	66	30	2 7/8
		EVPPFGTX6636	1110	1139	66	36	2 7/8
		EVPPFGTX6642	1241	1274	66	42	2 7/8
		EVPPFGTX6648	1358	1394	66	48	2 7/8
		EVPPFGTX6654	1493	1536	66	54	2 7/8
		EVPPFGTX6660	1628	1675	66	60	2 7/8

**EVPLFGTX - PARTLY GLAZED LIGHT PANEL - 36”H TEMPERED GLASS**

- Partly Glazed Light Panel incorporates a lower fabric module with 36”H top position glazed module, into a solid steel frame.
- There is no base raceway in Light Panels to accommodate electrical.
- Light Panel Connectors must be used in conjunction with Light Panels.
- Opposite sides of each panel may have a different fabric within the same grade at no upcharge.
- If different grades of fabric are used on one panel, the entire panel must be priced at highest grade.
- An aluminum low profile top cap is included.
- Stackability: Evolve panels can be increased in height in 6”H, 12”H, 18”H or 24”H increments. See Extension Module (pages 82-90) for part numbers.
- Standard in clear (CLR) or smoked glass (SMK) as an option. Please note the smoked glass (SMK) has 51% light transmittance.
- Frosted glass (FRST) 40% upcharge.

	DESCRIPTION	PRODUCT CODE	LIST PRICE		DIMENSIONS/INCHES		
			Gr1	Gr2	H	W	D
	Partly Glazed Light Panel -	EVPLFGTX6618	737	751	66	18	2 7/8
	36”H Tempered Glass - 66” High	EVPLFGTX6624	816	838	66	24	2 7/8
		EVPLFGTX6630	948	970	66	30	2 7/8
		EVPLFGTX6636	1074	1104	66	36	2 7/8
		EVPLFGTX6642	1204	1234	66	42	2 7/8
		EVPLFGTX6648	1317	1353	66	48	2 7/8
		EVPLFGTX6654	1448	1485	66	54	2 7/8
		EVPLFGTX6660	1580	1625	66	60	2 7/8

**EVPBFGT - PARTLY GLAZED BELTLINE POWERED PANEL**

- Partly Glazed Beltline Powered Panel incorporates fabric modules with a power beltline raceway and a 12”H or 24”H glazed module, within a solid steel frame.
- A Chimney Panel is required to run electric and data from the base to belt.
- 6”H power beltline raceway, to accommodate electrical, is metal with knockouts on both sides.
- Beltline Connectors must be used in conjunction with beltline panels.
- Opposite sides of each panel may have a different fabric within the same grade at no upcharge.
- If different grades of fabric are used on one panel, the entire panel must be priced at highest grade.
- An aluminum low profile top cap is included.
- Stackability: Evolve panels can be increased in height in 6”H, 12”H, 18”H or 24”H increments. See Extension Module (pages 82-90) for part numbers.
- Standard in clear (CLR) or smoked glass (SMK) as an option. Please note the smoked glass (SMK) has 51% light transmittance.
- Frosted glass (FRST) 20% upcharge.

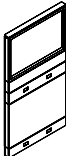
	DESCRIPTION	PRODUCT CODE	LIST PRICE		DIMENSIONS/INCHES		
			Gr1	Gr2	H	W	D
	Partly Glazed Beltline Powered Panel - 54” High	EVPBFGT5424	770	796	54	24	2 7/8
	24” Fabric /6” Power Belt/ 6” Fabric /12” Glass	EVPBFGT5430	902	930	54	30	2 7/8
		EVPBFGT5436	1026	1061	54	36	2 7/8
		EVPBFGT5442	1155	1194	54	42	2 7/8
		EVPBFGT5448	1280	1325	54	48	2 7/8
		EVPBFGT5454	1404	1454	54	54	2 7/8
		EVPBFGT5460	1531	1584	54	60	2 7/8
	Partly Glazed Beltline Powered Panel - 66” High	EVPBFGT6624	874	900	66	24	2 7/8
	24” Fabric /6” Power Belt/ 6” Fabric /24” Glass	EVPBFGT6630	1019	1049	66	30	2 7/8
		EVPBFGT6636	1159	1193	66	36	2 7/8
		EVPBFGT6642	1302	1341	66	42	2 7/8
		EVPBFGT6648	1436	1483	66	48	2 7/8
		EVPBFGT6654	1580	1615	66	54	2 7/8
		EVPBFGT6660	1720	1773	66	60	2 7/8

**EVPBLFGT - PARTLY GLAZED BELTLINE POWER LIGHT PANEL**

- Partly Glazed Beltline Powered Light Panel incorporates fabric modules with a power beltline raceway and a 12”H or 24”H glazed module, within a solid steel frame.
- 6”H power beltline raceway, to accommodate electrical, is metal with knockouts on both sides.
- There is no base raceway in Light Panels to accommodate electrical.
- Light Beltline Panel Connectors must be used in conjunction with Light Beltline Panels.
- Opposite sides of each panel may have a different fabric within the same grade at no upcharge.
- If different grades of fabric are used on one panel, the entire panel must be priced at highest grade.
- An aluminum low profile top cap is included.
- Stackability: Evolve Light panels can be increased in height in 6”H, 12”H, 18”H or 24”H increments. See Extension Module (pages 82-90) for part numbers.
- Standard in clear (CLR) or smoked glass (SMK) as an option. Please note the smoked glass (SMK) has 51% light transmittance.
- Frosted glass (FRST) 20% upcharge.

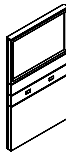
	DESCRIPTION	PRODUCT CODE	LIST PRICE		DIMENSIONS/INCHES		
			Gr1	Gr2	H	W	D
	Partly Glazed Beltline Powered Light Panel - 54” High	EVPBLFGT5424	733	757	54	24	2 7/8
	24” Fabric /6” Power Belt/ 6” Fabric /12” Glass	EVPBLFGT5430	858	886	54	30	2 7/8
		EVPBLFGT5436	974	1009	54	36	2 7/8
		EVPBLFGT5442	1098	1138	54	42	2 7/8
		EVPBLFGT5448	1215	1259	54	48	2 7/8
		EVPBLFGT5454	1335	1385	54	54	2 7/8
		EVPBLFGT5460	1454	1509	54	60	2 7/8
	Partly Glazed Beltline Powered Light Panel - 66” High	EVPBLFGT6624	830	855	66	24	2 7/8
	24” Fabric /6” Power Belt/ 6” Fabric /24” Glass	EVPBLFGT6630	968	999	66	30	2 7/8
		EVPBLFGT6636	1102	1136	66	36	2 7/8
		EVPBLFGT6642	1235	1276	66	42	2 7/8
		EVPBLFGT6648	1368	1413	66	48	2 7/8
		EVPBLFGT6654	1501	1549	66	54	2 7/8
		EVPBLFGT6660	1632	1688	66	60	2 7/8



**EVPBCFGT - PARTLY GLAZED BELTLINE POWERED CHIMNEY PANEL - TEMPERED GLASS**

- Partly Glazed Beltline Powered Chimney Panel incorporates fabric modules with a power beltline raceway and a 12”H or 24”H glazed module, within a solid steel frame.
- A Chimney Panel is required to run electric and data from the base to belt.
- Separate electric harness required to go from base to belt (see EVE8CPCP).
- 6”H power beltline raceway, to accommodate electrical, is metal with knockouts on both sides.
- Beltline Connectors must be used in conjunction with beltline panels.
- Opposite sides of each panel may have a different fabric within the same grade at no upcharge.
- If different grades of fabric are used on one panel, the entire panel must be priced at highest grade.
- An aluminum low profile top cap is included.
- Stackability: Evolve panels can be increased in height in 6”H, 12”H, 18”H or 24”H increments. See Extension Module (pages 82-90) for part numbers.
- Standard in clear (CLR) or smoked glass (SMK) as an option. Please note the smoked glass (SMK) has 51% light transmittance.
- Frosted glass (FRST) 20% upcharge.

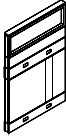
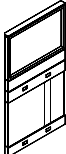
	DESCRIPTION	PRODUCT CODE	LIST PRICE		DIMENSIONS/INCHES		
			Gr1	Gr2	H	W	D
	Partly Glazed Beltline Powered Chimney Panel - Tempered Glass - 54” High	EVPBCFGT5436	1105	1141	54	36	2 7/8
	24” Fabric Chimney /6” Power Belt / 6” Fabric /12” Glass	EVPBCFGT5442	1235	1276	54	42	2 7/8
	Partly Glazed Beltline Powered Chimney Panel - Tempered Glass - 66” High	EVPBCFGT6636	1254	1290	66	36	2 7/8
	24” Fabric Chimney /6” Power Belt / 6” Fabric /24” Glass	EVPBCFGT6642	1383	1423	66	42	2 7/8

**EVE8CPCP - CHIMNEY PANEL JUMPER CABLE KIT**

- Contains two (2) 17” flexible harnesses and one (1) “I” connector.
- Used to connect electric from the base to the beltline raceway in Beltline Powered Chimney panel.
- Must use in conjunction with base power distribution harness and beltline power distribution harness (sold separately)

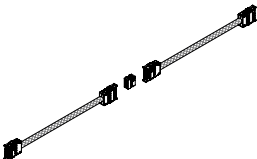
	DESCRIPTION	PRODUCT CODE	LIST PRICE	DIMENSIONS/INCHES		
				H	W	D
	Chimney Panel Jumper Cable Kit	EVE8CPCP	341			



**EVFPFGT - PARTLY GLAZED PREMIUM PANEL - TEMPERED GLASS**

- Partly Glazed Premium Panel incorporates 12”H glazed modules above 30”H fabric base section.
- Opposite sides of each panel may have a different fabric within the same grade at no upcharge.
- If different grades of fabric are used on one panel, the entire panel must be priced at highest grade.
- An aluminum low profile top cap is included.
- Stackability: Evolve panels can be increased in height in 6”H, 12”H, 18”H or 24”H increments. See Extension Module (pages 82-90) for part numbers.
- Standard in clear (CLR) or smoked glass (SMK) as an option. Please note the smoked glass (SMK) has 51% light transmittance.
- Frosted glass (FRST) 20% upcharge.

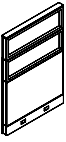
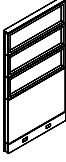
	DESCRIPTION	PRODUCT CODE	LIST PRICE		DIMENSIONS/INCHES		
			Gr1	Gr2	H	W	D
	Partly Glazed Premium Panel - Tempered Glass - 54” High	EVFPFGT5418	629	648	54	18	2 7/8
		EVFPFGT5424	748	769	54	24	2 7/8
		EVFPFGT5430	839	867	54	30	2 7/8
		EVFPFGT5436	932	963	54	36	2 7/8
		EVFPFGT5442	1040	1073	54	42	2 7/8
		EVFPFGT5448	1144	1182	54	48	2 7/8
		EVFPFGT5454	1280	1323	54	54	2 7/8
		EVFPFGT5460	1412	1460	54	60	2 7/8
	Partly Glazed Premium Panel - Tempered Glass - 66” High	EVFPFGT6618	784	802	66	18	2 7/8
		EVFPFGT6624	942	969	66	24	2 7/8
		EVFPFGT6630	1058	1083	66	30	2 7/8
		EVFPFGT6636	1163	1193	66	36	2 7/8
		EVFPFGT6642	1297	1332	66	42	2 7/8
		EVFPFGT6648	1433	1474	66	48	2 7/8
		EVFPFGT6654	1620	1666	66	54	2 7/8
		EVFPFGT6660	1803	1851	66	60	2 7/8

**EVPLFPGT - PARTLY GLAZED PREMIUM LIGHT PANEL – TEMPERED GLASS**

- Partly Glazed Premium Panel incorporates 12”H glazed modules above 30”H fabric base section.
- There is no base raceway in Light Panels to accommodate electrical.
- Light Panel Connectors must be used in conjunction with Light Panels.
- Opposite sides of each panel may have a different fabric within the same grade at no upcharge.
- If different grades of fabric are used on one panel, the entire panel must be priced at highest grade.
- An aluminum low profile top cap is included.
- Stackability: Evolve panels can be increased in height in 6”H, 12”H, 18”H or 24”H increments.
- See Extension Module (pages 82-90) for part numbers.
- Standard in clear (CLR) or smoked glass (SMK) as an option. Please note the smoked glass (SMK) has 51% light transmittance. .
- Frosted glass (FRST) 20% upcharge.

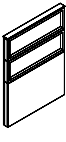
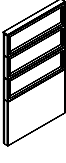
	DESCRIPTION	PRODUCT CODE	LIST PRICE		DIMENSIONS/INCHES		
			Gr1	Gr2	H	W	D
	Partly Glazed Premium Light Panel - Tempered Glass - 54” High	EVPLFPGT5418	608	626	54	18	2 7/8
		EVPLFPGT5424	728	745	54	24	2 7/8
		EVPLFPGT5430	813	838	54	30	2 7/8
		EVPLFPGT5436	908	932	54	36	2 7/8
		EVPLFPGT5442	1009	1040	54	42	2 7/8
		EVPLFPGT5448	1111	1144	54	48	2 7/8
		EVPLFPGT5454	1241	1281	54	54	2 7/8
		EVPLFPGT5460	1369	1414	54	60	2 7/8
	Partly Glazed Premium Light Panel - Tempered Glass - 66” High	EVPLFPGT6618	764	775	66	18	2 7/8
		EVPLFPGT6624	916	938	66	24	2 7/8
		EVPLFPGT6630	1022	1049	66	30	2 7/8
		EVPLFPGT6636	1129	1159	66	36	2 7/8
		EVPLFPGT6642	1260	1291	66	42	2 7/8
		EVPLFPGT6648	1389	1426	66	48	2 7/8
		EVPLFPGT6654	1570	1610	66	54	2 7/8
		EVPLFPGT6660	1752	1793	66	60	2 7/8



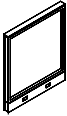
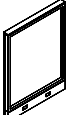
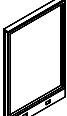
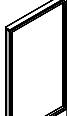

**EVPXGT - FULLY GLAZED MONOLITHIC PANEL - TEMPERED GLASS**

- Fully Glazed Monolithic Panels are incorporated into a solid steel frame.
- An aluminum low profile top cap is included.
- Stackability: Evolve panels can be increased in height in 6”H, 12”H, 18”H or 24”H increments. See Extension Module (pages 82-90) for part numbers.
- Standard in clear (CLR) or smoked glass (SMK) as an option. Please note the smoked glass (SMK) has 51% light transmittance.
- Frosted glass (FRST) 40% upcharge.

	DESCRIPTION	PRODUCT CODE	LIST PRICE	DIMENSIONS/INCHES		
				H	W	D
	Fully Glazed Monolithic Panel - Tempered Glass - 42” High	EVPXGT4218	504	42	18	2 7/8
		EVPXGT4224	556	42	24	2 7/8
		EVPXGT4230	646	42	30	2 7/8
		EVPXGT4236	726	42	36	2 7/8
		EVPXGT4242	808	42	42	2 7/8
	Fully Glazed Monolithic Panel - Tempered Glass - 48” High	EVPXGT4818	450	48	18	2 7/8
		EVPXGT4824	575	48	24	2 7/8
		EVPXGT4830	635	48	30	2 7/8
		EVPXGT4836	784	48	36	2 7/8
		EVPXGT4842	827	48	42	2 7/8
	Fully Glazed Monolithic Panel - Tempered Glass - 54” High	EVPXGT5418	558	54	18	2 7/8
		EVPXGT5424	656	54	24	2 7/8
		EVPXGT5430	763	54	30	2 7/8
		EVPXGT5436	858	54	36	2 7/8
		EVPXGT5442	951	54	42	2 7/8
	Fully Glazed Monolithic Panel - Tempered Glass - 66” High	EVPXGT6618	655	66	18	2 7/8
		EVPXGT6624	757	66	24	2 7/8
		EVPXGT6630	874	66	30	2 7/8
		EVPXGT6636	983	66	36	2 7/8
		EVPXGT6642	1094	66	42	2 7/8

**EVPLXGT - FULLY GLAZED MONOLITHIC LIGHT PANEL - TEMPERED GLASS**

- Fully Glazed Monolithic Light Panels are incorporated into a solid steel frame.
- There is no base raceway in Light Panels to accommodate electrical.
- Light Panel Connectors must be used in conjunction with Light Panels.
- An aluminum low profile top cap is included.
- Stackability: Evolve panels can be increased in height in 6”H, 12”H, 18”H or 24”H increments. See Extension Module (pages 82-90) for part numbers.
- Standard in clear (CLR) or smoked glass (SMK) as an option. Please note the smoked glass (SMK) has 51% light transmittance.
- Frosted glass (FRST) 40% upcharge.

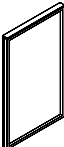
	DESCRIPTION	PRODUCT CODE	LIST PRICE	DIMENSIONS/INCHES		
				H	W	D
	Fully Glazed Monolithic Light Panel - Tempered Glass - 42” High	EVPLXGT4218	479	42	18	2 7/8
		EVPLXGT4224	528	42	24	2 7/8
		EVPLXGT4230	613	42	30	2 7/8
		EVPLXGT4236	687	42	36	2 7/8
		EVPLXGT4242	768	42	42	2 7/8
	Fully Glazed Monolithic Light Panel - Tempered Glass - 48” High	EVPLXGT4818	424	48	18	2 7/8
		EVPLXGT4824	546	48	24	2 7/8
		EVPLXGT4830	604	48	30	2 7/8
		EVPLXGT4836	746	48	36	2 7/8
		EVPLXGT4842	781	48	42	2 7/8
	Fully Glazed Monolithic Light Panel - Tempered Glass - 54”	EVPLXGT5418	533	54	18	2 7/8
		EVPLXGT5424	625	54	24	2 7/8
		EVPLXGT5430	719	54	30	2 7/8
		EVPLXGT5436	813	54	36	2 7/8
		EVPLXGT5442	902	54	42	2 7/8
	Fully Glazed Monolithic Light Panel - Tempered Glass - 66” High	EVPLXGT6618	624	66	18	2 7/8
		EVPLXGT6624	718	66	24	2 7/8
		EVPLXGT6630	831	66	30	2 7/8
		EVPLXGT6636	932	66	36	2 7/8
		EVPLXGT6642	1040	66	42	2 7/8

**EVPGT - FULLY GLAZED SEGMENTED PANEL - TEMPERED GLASS**

- Fully Glazed Segmented Panel incorporates (2) 24”H Glazed modules into a solid steel frame.
- An aluminum low profile top cap is included.
- Stackability: Evolve panels can be increased in height in 6”H, 12”H, 18”H or 24”H increments. See Extension Module (pages 82-90) for part numbers.
- Standard in clear (CLR) or smoked glass (SMK) as an option. Please note the smoked glass (SMK) has 51% light transmittance.
- Frosted glass (FRST) 40% upcharge.

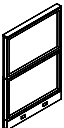
	DESCRIPTION	PRODUCT CODE	LIST PRICE	DIMENSIONS/INCHES		
				H	W	D
	Fully Glazed Segmented Panel - Tempered Glass - 54” High	EVPGT5418	714	54	18	2 7/8
		EVPGT5424	875	54	24	2 7/8
		EVPGT5430	968	54	30	2 7/8
		EVPGT5436	1058	54	36	2 7/8
		EVPGT5442	1171	54	42	2 7/8
		EVPGT5448	1306	54	48	2 7/8
		EVPGT5454	1436	54	54	2 7/8
		EVPGT5460	1569	54	60	2 7/8



**EVPLGT - FULLY GLAZED SEGMENTED LIGHT PANEL - TEMPERED GLASS**

- Fully Glazed Segmented Light Panel incorporates (2) 24”H Glazed modules into a solid steel frame.
- There is no base raceway in Light Panels to accommodate electrical.
- Light Panel Connectors must be used in conjunction with Light Panels.
- An aluminum low profile top cap is included.
- Stackability: Evolve panels can be increased in height in 6”H, 12”H, 18”H or 24”H increments. See Extension Module (pages 82-90) for part numbers.
- Standard in clear (CLR) or smoked glass (SMK) as an option. Please note the smoked glass (SMK) has 51% light transmittance.
- Frosted glass (FRST) 40% upcharge.

	DESCRIPTION	PRODUCT CODE	LIST PRICE	DIMENSIONS/INCHES		
				H	W	D
	Fully Glazed Segmented Light Panel Tempered Glass - 54” High	EVPLGT5418	678	54	18	2 7/8
		EVPLGT5424	833	54	24	2 7/8
		EVPLGT5430	920	54	30	2 7/8
		EVPLGT5436	1004	54	36	2 7/8
		EVPLGT5442	1115	54	42	2 7/8
		EVPLGT5448	1240	54	48	2 7/8
		EVPLGT5454	1366	54	54	2 7/8
		EVPLGT5460	1489	54	60	2 7/8

**EVPGPT - FULLY GLAZED PREMIUM PANEL - TEMPERED GLASS**

- Fully Glazed Premium Panel incorporates 12”H Glazed Modules into a solid steel frame.
- An aluminum low profile top cap is included.
- Stackability: Evolve panels can be increased in height in 6”H, 12”H, 18”H or 24”H increments. See Extension Module (pages 82-90) for part numbers.
- Standard in clear (CLR) or smoked glass (SMK) as an option. Please note the smoked glass (SMK) has 51% light transmittance.
- Frosted glass (FRST) 40% upcharge.

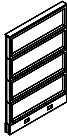
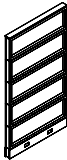
	DESCRIPTION	PRODUCT CODE	LIST PRICE	DIMENSIONS/INCHES		
				H	W	D
	Fully Glazed Premium Panel - Tempered Glass - 42” High	EVPGPT4218	704	42	18	2 7/8
		EVPGPT4224	862	42	24	2 7/8
		EVPGPT4230	954	42	30	2 7/8
		EVPGPT4236	1040	42	36	2 7/8
		EVPGPT4242	1154	42	42	2 7/8
		EVPGPT4248	1282	42	48	2 7/8
		EVPGPT4254	1413	42	54	2 7/8
		EVPGPT4260	1539	42	60	2 7/8
	Fully Glazed Premium Panel - Tempered Glass - 54” High	EVPGPT5418	890	54	18	2 7/8
		EVPGPT5424	1094	54	24	2 7/8
		EVPGPT5430	1210	54	30	2 7/8
		EVPGPT5436	1317	54	36	2 7/8
		EVPGPT5442	1465	54	42	2 7/8
		EVPGPT5448	1630	54	48	2 7/8
		EVPGPT5454	1798	54	54	2 7/8
		EVPGPT5460	1960	54	60	2 7/8
	Fully Glazed Premium Panel - Tempered Glass - 66” High	EVPGPT6618	1078	66	18	2 7/8
		EVPGPT6624	1326	66	24	2 7/8
		EVPGPT6630	1467	66	30	2 7/8
		EVPGPT6636	1595	66	36	2 7/8
		EVPGPT6642	1771	66	42	2 7/8
		EVPGPT6648	1972	66	48	2 7/8
		EVPGPT6654	2176	66	54	2 7/8
		EVPGPT6660	2379	66	60	2 7/8

**EVPLGPT - FULLY GLAZED PREMIUM LIGHT PANEL - TEMPERED GLASS**

- Fully Glazed Premium Light Panel incorporates 12”H Glazed Modules into a solid steel frame.
- There is no base raceway in Light Panels to accommodate electrical.
- Light Panel Connectors must be used in conjunction with Light Panels.
- An aluminum low profile top cap is included.
- Stackability: Evolve panels can be increased in height in 6”H, 12”H, 18”H or 24”H increments. See Extension Module (pages 82-90) for part numbers.
- Standard in clear (CLR) or smoked glass (SMK) as an option. Please note the smoked glass (SMK) has 51% light transmittance.
- Frosted glass (FRST) 40% upcharge.

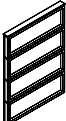
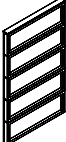
	DESCRIPTION	PRODUCT CODE	LIST PRICE	DIMENSIONS/INCHES		
				H	W	D
	Fully Glazed Premium Light Panel - Tempered Glass - 42” High	EVPLGPT4218	682	42	18	2 7/8
		EVPLGPT4224	834	42	24	2 7/8
		EVPLGPT4230	923	42	30	2 7/8
		EVPLGPT4236	1009	42	36	2 7/8
		EVPLGPT4242	1119	42	42	2 7/8
		EVPLGPT4248	1243	42	48	2 7/8
		EVPLGPT4254	1371	42	54	2 7/8
		EVPLGPT4260	1493	42	60	2 7/8
	Fully Glazed Premium Light Panel - Tempered Glass - 54” High	EVPLGPT5418	866	54	18	2 7/8
		EVPLGPT5424	1062	54	24	2 7/8
		EVPLGPT5430	1171	54	30	2 7/8
		EVPLGPT5436	1280	54	36	2 7/8
		EVPLGPT5442	1422	54	42	2 7/8
		EVPLGPT5448	1581	54	48	2 7/8
		EVPLGPT5454	1741	54	54	2 7/8
		EVPLGPT5460	1900	54	60	2 7/8
	Fully Glazed Premium Light Panel - Tempered Glass - 66” High	EVPLGPT6618	1048	66	18	2 7/8
		EVPLGPT6624	1285	66	24	2 7/8
		EVPLGPT6630	1424	66	30	2 7/8
		EVPLGPT6636	1546	66	36	2 7/8
		EVPLGPT6642	1720	66	42	2 7/8
		EVPLGPT6648	1914	66	48	2 7/8
		EVPLGPT6654	2109	66	54	2 7/8
		EVPLGPT6660	2307	66	60	2 7/8



**EVPHSG - RECEPTION PANEL LAMINATE**

- Reception panel incorporates glazed module and pass thru module within steel frame.
- 6" H or 12" H pass thru with sliding glass door module.
- 24" H Laminate bottom module.
- Aluminum low profile top is included.
- Stackability: Evolve panels can be increased in height in 6", 12", 24" increments. See module listing for part numbers.

	DESCRIPTION	PRODUCT CODE	LIST PRICE	DIMENSIONS/INCHES		
				H	W	D
	Reception Panel with 12" H Pass Thru	EVPHSG2M6636	1444	66	36	2 7/8
		EVPHSG2M6642	1561	66	42	2 7/8
		EVPHSG2M6648	1688	66	48	2 7/8

**EVPHSG - RECEPTION PANEL LAMINATE**

- Reception panel incorporates glazed module and pass thru module within steel frame.
- 6" H pass thru with sliding glass door module.
- 30" H Laminate bottom module.
- Aluminum low profile top is included.
- Stackability: Evolve panels can be increased in height in 6", 12", 24" increments. See module listing for part numbers.

	DESCRIPTION	PRODUCT CODE	LIST PRICE	DIMENSIONS/INCHES		
				H	W	D
	Reception Panel with 6" H Pass Thru	EVPHSG3M6636	1499	66	36	2 7/8
		EVPHSG3M6642	1611	66	42	2 7/8
		EVPHSG3M6648	1764	66	48	2 7/8

**EVPHSG - RECEPTION PANEL LAMINATE**

- Reception panel incorporates glazed module and pass thru module within steel frame.
- 6" H or 12" H pass thru with sliding glass door module.
- 24" H Laminate bottom module.
- Aluminum low profile top is included.
- Stackability: Evolve panels can be increased in height in 6", 12", 24" increments. See module listing for part numbers.

	DESCRIPTION	PRODUCT CODE	LIST PRICE	DIMENSIONS/INCHES		
				H	W	D
	Reception Panel with 6" H Pass Thru	EVPHSG5M6636	1477	66	36	2 7/8
		EVPHSG5M6642	1595	66	42	2 7/8
		EVPHSG5M6648	1722	66	48	2 7/8

**EVPHSG - RECEPTION PANEL FABRIC**

- Reception panel incorporates glazed module and pass thru module within steel frame.
- 6" H or 12" H pass thru with sliding glass door module.
- 24" H Fabric bottom module.
- Aluminum low profile top is included.
- Stackability: Evolve panels can be increased in height in 6", 12", 24" increments. See module listing for part numbers.

	DESCRIPTION	PRODUCT CODE	LIST PRICE		DIMENSIONS/INCHES		
			Gr1	Gr2	H	W	D
	Reception Panel with 12" H Pass Thru	EVPHSG2M6636	1291	1319	66	36	2 7/8
		EVPHSG2M6642	1422	1457	66	42	2 7/8
		EVPHSG2M6648	1566	1601	66	48	2 7/8

**EVPHSG - RECEPTION PANEL FABRIC**

- Reception panel incorporates glazed module and pass thru module within steel frame.
- 6" H pass thru with sliding glass door module.
- 30" H Fabric bottom module.
- Aluminum low profile top is included.
- Stackability: Evolve panels can be increased in height in 6", 12", 24" increments. See module listing for part numbers.

	DESCRIPTION	PRODUCT CODE	LIST PRICE		DIMENSIONS/INCHES		
			Gr1	Gr2	H	W	D
	Reception Panel with 6" H Pass Thru	EVPHSG3M6636	1362	1391	66	36	2 7/8
		EVPHSG3M6642	1485	1520	66	42	2 7/8
		EVPHSG3M6648	1611	1646	66	48	2 7/8

**EVPHSG - RECEPTION PANEL FABRIC**

- Reception panel incorporates glazed module and pass thru module within steel frame.
- 6" H or 12" H pass thru with sliding glass door module.
- 24" H Fabric bottom module.
- Aluminum low profile top is included.
- Stackability: Evolve panels can be increased in height in 6", 12", 24" increments. See module listing for part numbers.

	DESCRIPTION	PRODUCT CODE	LIST PRICE		DIMENSIONS/INCHES		
			Gr1	Gr2	H	W	D
	Reception Panel with 6" H Pass Thru	EVPHSG5M6636	1313	1342	66	36	2 7/8
		EVPHSG5M6642	1462	1495	66	42	2 7/8
		EVPHSG5M6648	1609	1644	66	48	2 7/8

**EVSLs - LAMINATED SHELF FOR RECEPTION PANEL**

- Laminated Wood Shelf Panel Mounted.
- Shelf thickness 1".
- Available in LP.
- Includes attachment hardware.

	DESCRIPTION	PRODUCT CODE	LIST PRICE	DIMENSIONS/INCHES		
				H	W	D
	Reception Panel Shelf	EVSLs1218	258	1.125	18	12
		EVSLs1224	277	1.125	24	12
		EVSLs1230	294	1.125	30	12
		EVSLs1236	313	1.125	36	12
		EVSLs1242	330	1.125	42	12
		EVSLs1248	349	1.125	48	12



**EVPFSG - PASS-THRU SLIDING DOOR GLAZED PANEL - TEMPERED GLASS**

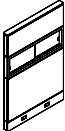
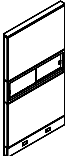
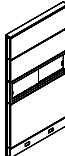

- Pass-Thru Sliding Door Glazed Panel incorporates fabric modules on upper and lower positions, with Middle 12”H Pass-Thru Sliding Door module, into a solid steel frame.
- Tracks for Sliding glass door available in Tungsten only.
- Opposite sides of each panel may have a different fabric within the same grade at no upcharge.
- If different grades of fabric are used on one panel, the entire panel must be priced at highest grade.
- An aluminum low profile top cap is included.
- Stackability: Evolve panels can be increased in height in 6”H, 12”H, 18”H or 24”H increments. See Extension Module (pages 82-90) for part numbers.
- Standard in clear (CLR) or smoked glass (SMK) as an option. Please note the smoked glass (SMK) has 51% light transmittance.
- Frosted glass (FRST) 20% upcharge.

	DESCRIPTION	PRODUCT CODE	LIST PRICE		DIMENSIONS/INCHES		
			Gr1	Gr2	H	W	D
	Pass-Thru Sliding Door Glazed Panel - Tempered Glass - 54” High	EVPFSG5424	717	746	54	24	2 7/8
		EVPFSG5430	810	847	54	30	2 7/8
		EVPFSG5436	911	954	54	36	2 7/8
		EVPFSG5442	1022	1072	54	42	2 7/8
		EVPFSG5448	1111	1162	54	48	2 7/8
		EVPFSG5454	1246	1304	54	54	2 7/8
		EVPFSG5460	1377	1444	54	60	2 7/8
	Pass-Thru Sliding Door Glazed Panel - Tempered Glass - 66” High	EVPFSG6624	775	814	66	24	2 7/8
		EVPFSG6630	885	930	66	30	2 7/8
		EVPFSG6636	989	1048	66	36	2 7/8
		EVPFSG6642	1118	1179	66	42	2 7/8
		EVPFSG6648	1213	1282	66	48	2 7/8
		EVPFSG6654	1355	1432	66	54	2 7/8
		EVPFSG6660	1525	1578	66	60	2 7/8
	Pass-Thru Sliding Door Glazed Panel - Tempered Glass - 66” High	EVPFPSG6624	775	814	66	24	2 7/8
		EVPFPSG6630	885	930	66	30	2 7/8
		EVPFPSG6636	989	1048	66	36	2 7/8
		EVPFPSG6642	1118	1179	66	42	2 7/8
		EVPFPSG6648	1213	1282	66	48	2 7/8
		EVPFPSG6654	1355	1432	66	54	2 7/8
		EVPFPSG6660	1525	1578	66	60	2 7/8



**EVPFSGX - FABRIC GLAZED PASS-THRU SLIDING DOOR PANEL - TEMPERED GLASS**

- Pass-Thru Sliding Door Glazed Panel incorporates fabric modules with 12”H or 24”H Pass-Thru Sliding Door module, into a solid steel frame.
- Tracks for Sliding glass door available in Tungsten only.
- Opposite sides of each panel may have a different fabric within the same grade at no upcharge.
- If different grades of fabric are used on one panel, the entire panel must be priced at highest grade.
- An aluminum low profile top cap is included.
- Stackability: Evolve panels can be increased in height in 6”H, 12”H, 18”H or 24”H increments. See Extension Module (pages 82-90) for part numbers.
- Standard in clear (CLR) or smoked glass (SMK) as an option. Please note the smoked glass (SMK) has 51% light transmittance.
- Frosted glass (FRST) 20% upcharge.

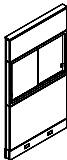
	DESCRIPTION	PRODUCT CODE	LIST PRICE		DIMENSIONS/INCHES		
			Gr1	Gr2	H	W	D
	Fabric Glazed Pass-Thru Sliding Door Panel - Tempered Glass - 42” High	EVPFSGX4224	556	575	42	24	2 7/8
		EVPFSGX4230	629	652	42	30	2 7/8
		EVPFSGX4236	702	730	42	36	2 7/8
		EVPFSGX4242	780	813	42	42	2 7/8
		EVPFSGX4248	854	887	42	48	2 7/8
		EVPFSGX4254	954	989	42	54	2 7/8
		EVPFSGX4260	1053	1095	42	60	2 7/8
	Fabric Glazed Pass-Thru Sliding Door Panel - Tempered Glass - 54” High	EVPFSGX5424	604	625	54	24	2 7/8
		EVPFSGX5430	702	725	54	30	2 7/8
		EVPFSGX5436	796	824	54	36	2 7/8
		EVPFSGX5442	889	921	54	42	2 7/8
		EVPFSGX5448	970	1006	54	48	2 7/8
		EVPFSGX5454	1124	1162	54	54	2 7/8
		EVPFSGX5460	1276	1324	54	60	2 7/8
	Fabric Glazed Pass-Thru Sliding Door Panel - Tempered Glass - 66” High	EVPFSGX6624	767	797	66	24	2 7/8
		EVPFSGX6630	885	920	66	30	2 7/8
		EVPFSGX6636	1007	1048	66	36	2 7/8
		EVPFSGX6642	1131	1182	66	42	2 7/8
		EVPFSGX6648	1229	1282	66	48	2 7/8
		EVPFSGX6654	1414	1473	66	54	2 7/8
		EVPFSGX6660	1600	1666	66	60	2 7/8



**EVPF1S - SLATWALL PANEL - SINGLE SIDED**

- Slatwall Panel incorporates fabric modules with a single 12”H or 24”H top position slatwall module, into a solid steel frame.
- 66”H panel can be configured with either a 24”H slatwall module at the top or a 12”H slatwall at the middle Position (EVPF1S66xxM)
- Opposite side is fabric covered.
- Slatwall is made of aluminum.
- Accessories can be used on slatwall modules. Please see accessory section for additional details.
- Opposite sides of each panel may have a different fabric within the same grade at no upcharge.
- If different grades of fabric are used on one panel, the entire panel must be priced at highest grade.
- An aluminum low profile top cap is included.
- Stackability: Evolve panels can be increased in height in 6”H, 12”H, 18”H or 24”H increments. See Extension Module (pages 82-90) for part numbers.

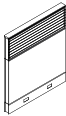
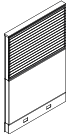
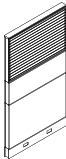
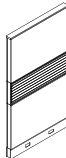
	DESCRIPTION	PRODUCT CODE	LIST PRICE		DIMENSIONS/INCHES		
			Gr1	Gr2	H	W	D
	Slatwall Panel - Single Sided - 42” High	EVPF1S4218	525	546	42	18	2 7/8
		EVPF1S4224	626	654	42	24	2 7/8
		EVPF1S4230	734	765	42	30	2 7/8
		EVPF1S4236	839	875	42	36	2 7/8
		EVPF1S4242	954	992	42	42	2 7/8
		EVPF1S4248	1037	1084	42	48	2 7/8
		EVPF1S4254	1152	1200	42	54	2 7/8
		EVPF1S4260	1260	1317	42	60	2 7/8
	Slatwall Panel - Single Sided - 54” High	EVPF1S5418	618	643	54	18	2 7/8
		EVPF1S5424	744	774	54	24	2 7/8
		EVPF1S5430	869	907	54	30	2 7/8
		EVPF1S5436	1000	1039	54	36	2 7/8
		EVPF1S5442	1129	1180	54	42	2 7/8
		EVPF1S5448	1231	1288	54	48	2 7/8
		EVPF1S5454	1372	1433	54	54	2 7/8
		EVPF1S5460	1509	1570	54	60	2 7/8
	Slatwall Panel - Single Sided - 66” High	EVPF1S6618	785	813	66	18	2 7/8
		EVPF1S6624	942	986	66	24	2 7/8
		EVPF1S6630	1104	1154	66	30	2 7/8
		EVPF1S6636	1272	1322	66	36	2 7/8
		EVPF1S6642	1446	1512	66	42	2 7/8
		EVPF1S6648	1573	1637	66	48	2 7/8
		EVPF1S6654	1752	1822	66	54	2 7/8
		EVPF1S6660	1930	2007	66	60	2 7/8
	Slat Wall Panel - Single Sided - Middle Module - 66” High	EVPF1S6618M	765	800	66	18	2 7/8
		EVPF1S6624M	920	966	66	24	2 7/8
		EVPF1S6630M	1073	1127	66	30	2 7/8
		EVPF1S6636M	1235	1299	66	36	2 7/8
		EVPF1S6642M	1406	1480	66	42	2 7/8
		EVPF1S6648M	1531	1612	66	48	2 7/8
		EVPF1S6654M	1702	1793	66	54	2 7/8
		EVPF1S6660M	1873	1972	66	60	2 7/8

**EVPLF1S - SLATWALL LIGHT PANEL - SINGLE SIDED**

- Slatwall Light Panel incorporates fabric modules with a single 12”H or 24”H top position slatwall module, into a solid steel frame.
- 66”H panel can be configured with either a 24”H slatwall module at the top or a 12”H slatwall at the middle Position (EVPLF1S66xxM)
- Opposite side is fabric covered
- Slatwall is made of aluminum.
- Accessories can be used on slatwall modules. Please see accessory section for additional details.
- There is no base raceway in Light Panels to accommodate electrical.
- Light Panel Connectors must be used in conjunction with Light Panels.
- Opposite sides of each panel may have a different fabric within the same grade at no upcharge.
- If different grades of fabric are used on one panel, the entire panel must be priced at highest grade.
- An aluminum low profile top cap is included.
- Stackability: Evolve panels can be increased in height in 6”H, 12”H, 18”H or 24”H increments. See Extension Module (pages 82-90) for part numbers.

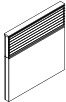
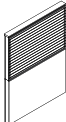
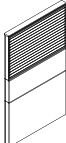
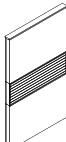
	DESCRIPTION	PRODUCT CODE	LIST PRICE		DIMENSIONS/INCHES		
			Gr1	Gr2	H	W	D
	Slatwall Light Panel - Single Sided- 42” High	EVPLF1S4218	513	534	42	18	2 7/8
		EVPLF1S4224	613	641	42	24	2 7/8
		EVPLF1S4230	718	747	42	30	2 7/8
		EVPLF1S4236	824	857	42	36	2 7/8
		EVPLF1S4242	932	972	42	42	2 7/8
		EVPLF1S4248	1017	1060	42	48	2 7/8
		EVPLF1S4254	1127	1175	42	54	2 7/8
		EVPLF1S4260	1235	1290	42	60	2 7/8
	Slatwall Light Panel - Single Sided - 54” High	EVPLF1S5418	605	626	54	18	2 7/8
		EVPLF1S5424	730	757	54	24	2 7/8
		EVPLF1S5430	854	887	54	30	2 7/8
		EVPLF1S5436	978	1018	54	36	2 7/8
		EVPLF1S5442	1107	1154	54	42	2 7/8
		EVPLF1S5448	1210	1262	54	48	2 7/8
		EVPLF1S5454	1345	1403	54	54	2 7/8
		EVPLF1S5460	1479	1535	54	60	2 7/8
	Slatwall Light Panel - Single Sided - 66” High	EVPLF1S6618	770	796	66	18	2 7/8
		EVPLF1S6624	923	965	66	24	2 7/8
		EVPLF1S6630	1081	1127	66	30	2 7/8
		EVPLF1S6636	1246	1294	66	36	2 7/8
		EVPLF1S6642	1417	1479	66	42	2 7/8
		EVPLF1S6648	1540	1604	66	48	2 7/8
		EVPLF1S6654	1714	1781	66	54	2 7/8
		EVPLF1S6660	1892	1965	66	60	2 7/8
	Slatwall Light Panel - Single Sided - Middle Module - 66” High	EVPLF1S6618M	747	779	66	18	2 7/8
		EVPLF1S6624M	902	942	66	24	2 7/8
		EVPLF1S6630M	1053	1103	66	30	2 7/8
		EVPLF1S6636M	1213	1273	66	36	2 7/8
		EVPLF1S6642M	1378	1448	66	42	2 7/8
		EVPLF1S6648M	1500	1577	66	48	2 7/8
		EVPLF1S6654M	1669	1757	66	54	2 7/8
		EVPLF1S6660M	1835	1931	66	60	2 7/8



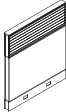
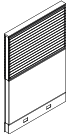
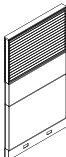
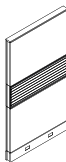

**EVPF2S - SLATWALL PANEL - DOUBLE SIDED**

- Slatwall Panel incorporates fabric modules with a single 12”H or 24”H top position slatwall module, into a solid steel frame.
- 66”H panel can be configured with either a 24”H slatwall module at the top or a 12”H slatwall at the middle Position (EVPF2S66xxM)
- Slatwall module has slatwall on both sides.
- Slatwall is made of aluminum.
- Accessories can be used on slatwall modules. Please see accessory section for additional details.
- Opposite sides of each panel may have a different fabric within the same grade at no upcharge.
- If different grades of fabric are used on one panel, the entire panel must be priced at highest grade.
- An aluminum low profile top cap is included.
- Stackability: Evolve panels can be increased in height in 6”H, 12”H, 18”H or 24”H increments. See Extension Module (pages 82-90) for part numbers.

	DESCRIPTION	PRODUCT CODE	LIST PRICE		DIMENSIONS/INCHES		
			Gr1	Gr2	H	W	D
	Slatwall Panel - Double Sided - 42” High	EVPF2S4218	588	605	42	18	2 7/8
		EVPF2S4224	710	734	42	24	2 7/8
		EVPF2S4230	835	863	42	30	2 7/8
		EVPF2S4236	974	1005	42	36	2 7/8
		EVPF2S4242	1111	1144	42	42	2 7/8
		EVPF2S4248	1243	1281	42	48	2 7/8
		EVPF2S4254	1369	1408	42	54	2 7/8
		EVPF2S4260	1488	1537	42	60	2 7/8
	Slatwall Panel - Double Sided - 54” High	EVPF2S5418	686	704	54	18	2 7/8
		EVPF2S5424	840	866	54	24	2 7/8
		EVPF2S5430	992	1019	54	30	2 7/8
		EVPF2S5436	1158	1188	54	36	2 7/8
		EVPF2S5442	1325	1358	54	42	2 7/8
		EVPF2S5448	1487	1525	54	48	2 7/8
		EVPF2S5454	1636	1677	54	54	2 7/8
		EVPF2S5460	1781	1829	54	60	2 7/8
	Slatwall Panel - Double Sided - 66” High	EVPF2S6618	889	914	66	18	2 7/8
		EVPF2S6624	1094	1125	66	24	2 7/8
		EVPF2S6630	1295	1333	66	30	2 7/8
		EVPF2S6636	1503	1546	66	36	2 7/8
		EVPF2S6642	1721	1771	66	42	2 7/8
		EVPF2S6648	1930	1985	66	48	2 7/8
		EVPF2S6654	2131	2189	66	54	2 7/8
		EVPF2S6660	2325	2394	66	60	2 7/8
	Slatwall Panel - Double Sided - Middle Module - 66” High	EVPF2S6618M	866	897	66	18	2 7/8
		EVPF2S6624M	1063	1106	66	24	2 7/8
		EVPF2S6630M	1260	1309	66	30	2 7/8
		EVPF2S6636M	1463	1517	66	36	2 7/8
		EVPF2S6642M	1671	1733	66	42	2 7/8
		EVPF2S6648M	1873	1948	66	48	2 7/8
		EVPF2S6654M	2072	2149	66	54	2 7/8
		EVPF2S6660M	2263	2350	66	60	2 7/8

**EVPLF2S - SLATWALL LIGHT PANEL - DOUBLE SIDED**

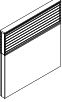
- Slatwall Light Panel incorporates fabric modules with a single 12”H or 24”H top position slatwall module, into a solid steel frame.
- 66”H panel can be configured with either a 24”H slatwall module at the top or a 12”H slatwall at the middle Position (EVPLF2S66xxM)
- Slatwall module has slatwall on both sides.
- Slatwall is made of aluminum.
- Accessories can be used on slatwall modules. Please see accessory section for additional details.
- There is no base raceway in Light Panels to accommodate electrical.
- Light Panel Connectors must be used in conjunction with Light Panels.
- Opposite sides of each panel may have a different fabric within the same grade at no upcharge.
- If different grades of fabric are used on one panel, the entire panel must be priced at highest grade.
- An aluminum low profile top cap is included.
- Stackability: Evolve panels can be increased in height in 6”H, 12”H, 18”H or 24”H increments.
- See Extension Module (pages 82-90) for part numbers.

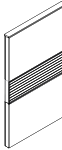
	DESCRIPTION	PRODUCT CODE	LIST PRICE		DIMENSIONS/INCHES		
			Gr1	Gr2	H	W	D
	Slatwall Light Panel - Double Sided - 42" High	EVPLF2S4218	576	592	42	18	2 7/8
		EVPLF2S4224	696	715	42	24	2 7/8
		EVPLF2S4230	821	842	42	30	2 7/8
		EVPLF2S4236	956	983	42	36	2 7/8
		EVPLF2S4242	1088	1120	42	42	2 7/8
		EVPLF2S4248	1219	1253	42	48	2 7/8
		EVPLF2S4254	1341	1378	42	54	2 7/8
	EVPLF2S4260	1457	1503	42	60	2 7/8	
	Slatwall Light Panel - Double Sided - 54" High	EVPLF2S5418	674	686	54	18	2 7/8
		EVPLF2S5424	827	844	54	24	2 7/8
		EVPLF2S5430	974	999	54	30	2 7/8
		EVPLF2S5436	1135	1161	54	36	2 7/8
		EVPLF2S5442	1296	1328	54	42	2 7/8
		EVPLF2S5448	1456	1490	54	48	2 7/8
		EVPLF2S5454	1604	1639	54	54	2 7/8
	EVPLF2S5460	1746	1790	54	60	2 7/8	
	Slatwall Light Panel - Double Sided - 66" High	EVPLF2S6618	872	896	66	18	2 7/8
		EVPLF2S6624	1072	1103	66	24	2 7/8
		EVPLF2S6630	1272	1306	66	30	2 7/8
		EVPLF2S6636	1473	1514	66	36	2 7/8
		EVPLF2S6642	1687	1732	66	42	2 7/8
		EVPLF2S6648	1892	1940	66	48	2 7/8
		EVPLF2S6654	2086	2143	66	54	2 7/8
	EVPLF2S6660	2280	2343	66	60	2 7/8	
	Slatwall Light Panel - Double Sided - 66" High	EVPLF2S6618M	840	878	66	18	2 7/8
		EVPLF2S6624M	1042	1081	66	24	2 7/8
		EVPLF2S6630M	1235	1281	66	30	2 7/8
		EVPLF2S6636M	1433	1484	66	36	2 7/8
		EVPLF2S6642M	1638	1699	66	42	2 7/8
		EVPLF2S6648M	1835	1903	66	48	2 7/8
		EVPLF2S6654M	2030	2105	66	54	2 7/8
	EVPLF2S6660M	2219	2304	66	60	2 7/8	



**EVPBSFA - FRAMELESS SLATWALL BELTLINE POWERED PANEL - DOUBLE SIDED ONLY**

- Frameless Slatwall Beltline Powered Panel incorporates fabric modules with a single 6”H slatwall module above a power beltline raceway, into a solid steel frame.
- Slatwall module has slatwall on both sides only, and is not available Single Sided.
- Slatwall is made of aluminum.
- Slatwall is not encompassed within a frame.
- A Chimney Panel is required to run electric and data from the base to belt
- 6”H power beltline raceway, to accommodate electrical, is metal with knockouts on both sides.
- Beltline Connectors must be used in conjunction with beltline panels.
- Accessories can be used on slatwall modules. Please see accessory section for additional details.
- Opposite sides of each panel may have a different fabric within the same grade at no upcharge.
- If different grades of fabric are used on one panel, the entire panel must be priced at highest grade.
- An aluminum low profile top cap is included.
- Stackability: Evolve panels can be increased in height in 6”H, 12”H, 18”H or 24”H increments. See Extension Module (pages 82-90) for part numbers.

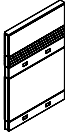
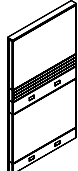
	DESCRIPTION	PRODUCT CODE	LIST PRICE		DIMENSIONS/INCHES		
			Gr1	Gr2	H	W	D
	Frameless Slatwall Beltline Powered Panel - Double Sided Only - 42” High	EVPBSFA4224	520	541	42	24	2 7/8
		EVPBSFA4230	605	627	42	30	2 7/8
		EVPBSFA4236	706	732	42	36	2 7/8
		EVPBSFA4242	794	824	42	42	2 7/8
		EVPBSFA4248	874	938	42	48	2 7/8
		EVPBSFA4254	961	1001	42	54	2 7/8
	Frameless Slatwall Beltline Powered Panel - Double Sided Only - 54” High	EVPBSFA4260	1044	1088	42	60	2 7/8
		EVPBSFA5424	657	686	54	24	2 7/8
		EVPBSFA5430	765	799	54	30	2 7/8
		EVPBSFA5436	902	941	54	36	2 7/8
		EVPBSFA5442	1009	1055	54	42	2 7/8
		EVPBSFA5448	1111	1163	54	48	2 7/8
	Frameless Slatwall Beltline Powered Panel - Double Sided Only - 66” High	EVPBSFA5454	1207	1265	54	54	2 7/8
		EVPBSFA5460	1314	1379	54	60	2 7/8
		EVPBSFA6624	733	769	66	24	2 7/8
		EVPBSFA6630	849	897	66	30	2 7/8
		EVPBSFA6636	981	1034	66	36	2 7/8
		EVPBSFA6642	1102	1162	66	42	2 7/8
		EVPBSFA6648	1216	1286	66	48	2 7/8
		EVPBSFA6654	1333	1408	66	54	2 7/8
		EVPBSFA6660	1448	1533	66	60	2 7/8

**EVPBLSFA - FRAMELESS SLATWALL BELTLINE POWERED LIGHT PANEL - DOUBLE SIDED ONLY**

- Frameless Slatwall Beltline Powered Light Panel incorporates fabric modules with a single 6”H slatwall module above a power beltline raceway, into a solid steel frame.
- Slatwall module has slatwall on both sides only, and is not available Single Sided.
- Slatwall is made of aluminum.
- Slatwall is not encompassed within a frame.
- 6”H power beltline raceway, to accommodate electrical, is metal with knockouts on both sides.
- There is no base raceway in Light Panels to accommodate electrical.
- Light Beltline Panel Connectors must be used in conjunction with Light Beltline Panels.
- Accessories can be used on slatwall modules. Please see accessory section for additional details.
- Opposite sides of each panel may have a different fabric within the same grade at no upcharge.
- If different grades of fabric are used on one panel, the entire panel must be priced at highest grade.
- An aluminum low profile top cap is included.
- Stackability: Evolve panels can be increased in height in 6”H, 12”H, 18”H or 24”H increments. See Extension Module (pages 82-90) for part numbers.

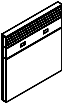
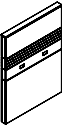
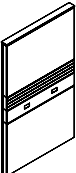
	DESCRIPTION	PRODUCT CODE	LIST PRICE		DIMENSIONS/INCHES		
			Gr1	Gr2	H	W	D
	Frameless Slatwall Beltline Powered Light Panel - Double Sided Only- 42” High	EVPBLSFA4224	497	514	42	24	2 7/8
		EVPBLSFA4230	576	598	42	30	2 7/8
		EVPBLSFA4236	674	699	42	36	2 7/8
		EVPBLSFA4242	753	785	42	42	2 7/8
		EVPBLSFA4248	834	869	42	48	2 7/8
		EVPBLSFA4254	919	957	42	54	2 7/8
	Frameless Slatwall Beltline Powered Light Panel - Double Sided Only- 54” High	EVPBLSFA5424	611	641	54	24	2 7/8
		EVPBLSFA5430	667	744	54	30	2 7/8
		EVPBLSFA5436	796	880	54	36	2 7/8
		EVPBLSFA5442	940	984	54	42	2 7/8
		EVPBLSFA5448	1034	1088	54	48	2 7/8
		EVPBLSFA5454	1122	1182	54	54	2 7/8
	Frameless Slatwall Beltline Powered Light Panel - Double Sided Only - 66” High	EVPBLSFA6624	678	714	66	24	2 7/8
		EVPBLSFA6630	784	831	66	30	2 7/8
		EVPBLSFA6636	910	963	66	36	2 7/8
		EVPBLSFA6642	1018	1081	66	42	2 7/8
		EVPBLSFA6648	1124	1194	66	48	2 7/8
		EVPBLSFA6654	1234	1308	66	54	2 7/8
		EVPBLSFA6660	1341	1426	66	60	2 7/8



**EVPBCSFA - FRAMELESS SLATWALL BELTLINE POWERED CHIMNEY PANEL - DOUBLE SIDED ONLY**

- Frameless Slatwall Beltline Powered Chimney Panel incorporates fabric modules with a single 6”H slatwall module above a power beltline raceway, into a solid steel frame.
- Slatwall module has slatwall on both sides only, and is not available Single Sided.
- Slatwall is made of aluminum.
- Slatwall is not encompassed within a frame.
- A Chimney Panel is required to run electric and data from the base to belt.
- Separate electric harness required to go from base to belt (see EVE8CPCP).
- 6”H power beltline raceway, to accommodate electrical, is metal with knockouts on both sides.
- Beltline Connectors must be used in conjunction with beltline panels.
- Accessories can be used on slatwall modules. Please see accessory section for additional details.
- Opposite sides of each panel may have a different fabric within the same grade at no upcharge.
- If different grades of fabric are used on one panel, the entire panel must be priced at highest grade.
- An aluminum low profile top cap is included.
- Stackability: Evolve panels can be increased in height in 6”H, 12”H, 18”H or 24”H increments. See Extension Module (pages 82-90) for part numbers.

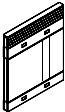
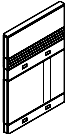
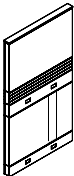
	DESCRIPTION	PRODUCT CODE	LIST PRICE		DIMENSIONS/INCHES		
			Gr1	Gr2	H	W	D
	Frameless Slatwall Beltline Powered -	EVPBCSFA4236	780	808	42	36	2 7/8
	Chimney Panel - Double Sided Only - 42” High	EVPBCSFA4242	868	901	42	42	2 7/8
	Frameless Slatwall Beltline Powered -	EVPBCSFA5436	978	1018	54	36	2 7/8
	Chimney Panel - Double Sided Only - 54” High	EVPBCSFA5442	1085	1130	54	42	2 7/8
	Frameless Slatwall Beltline Powered -	EVPBCSFA6636	1059	1111	66	36	2 7/8
	Chimney Panel - Double Sided Only - 66” High	EVPBCSFA6642	1176	1240	66	42	2 7/8

**EVE8CPCP - CHIMNEY PANEL JUMPER CABLE KIT**

- Contains two (2) 17” flexible harnesses and one (1) “I” connector.
- Used to connect electric from the base to the beltline raceway in Beltline Powered Chimney panel.
- Must use in conjunction with base power distribution harness and beltline power distribution harness (sold separately)

	DESCRIPTION	PRODUCT CODE	LIST PRICE	DIMENSIONS/INCHES		
				H	W	D

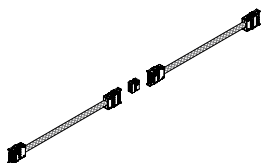



Chimney Panel Jumper Cable Kit	EVE8CPCP	341			
--------------------------------	----------	-----	--	--	--





**EVPF1W - WRITE BOARD PANEL - SINGLE SIDED**

- Write Board Panel incorporates fabric modules with a single 24”H top position write board module, into a solid steel frame.
- Use erasable writeboard markers only.
- Fabric covered modules are tackable and acoustical.
- Opposite sides of each panel may have a different fabric within the same grade at no upcharge.
- If different grades of fabric are used on one panel, the entire panel must be priced at highest grade.
- An aluminum low profile top cap is included.
- Stackability: Evolve panels can be increased in height in 6”H, 12”H, 18”H or 24”H increments. See Extension Module (pages 82-90) for part numbers.

	DESCRIPTION	PRODUCT CODE	LIST PRICE		DIMENSIONS/INCHES		
			Gr1	Gr2	H	W	D
	Write Board Panel - Single Sided - 54” High	EVPF1W5418	512	530	54	18	2 7/8
		EVPF1W5424	634	665	54	24	2 7/8
		EVPF1W5430	766	802	54	30	2 7/8
		EVPF1W5436	847	890	54	36	2 7/8
		EVPF1W5442	954	1004	54	42	2 7/8
		EVPF1W5448	1074	1129	54	48	2 7/8
		EVPF1W5454	1194	1237	54	54	2 7/8
		EVPF1W5460	1315	1381	54	60	2 7/8
	Write Board Panel - Single Sided - 66” High	EVPF1W6618	649	676	66	18	2 7/8
		EVPF1W6624	800	839	66	24	2 7/8
		EVPF1W6630	950	996	66	30	2 7/8
		EVPF1W6636	1058	1113	66	36	2 7/8
		EVPF1W6642	1195	1260	66	42	2 7/8
		EVPF1W6648	1335	1408	66	48	2 7/8
		EVPF1W6654	1484	1569	66	54	2 7/8
		EVPF1W6660	1637	1727	66	60	2 7/8

**EVPLF1W - WRITE BOARD LIGHT PANEL - SINGLE SIDED**



- Write Board Panel incorporates fabric modules with a single 24”H top position write board module, into a solid steel frame.
- Use erasable writeboard markers only.
- Fabric covered modules are tackable and acoustical.
- Opposite sides of each panel may have a different fabric within the same grade at no upcharge.
- If different grades of fabric are used on one panel, the entire panel must be priced at highest grade.
- Light panel connectors must be used for Light Panels.
- There is no base raceway in Light Panels to accommodate electrical.
- An aluminum low profile top cap is included.
- Stackability: Evolve panels can be increased in height in 6”H, 12”H, 18”H or 24”H increments. See Extension Module (pages 82-90) for part numbers.

	DESCRIPTION	PRODUCT CODE	LIST PRICE		DIMENSIONS/INCHES		
			Gr1	Gr2	H	W	D
	Write Board Light Panel - Single Sided - 54” High	EVPLF1W5418	497	512	54	18	2 7/8
		EVPLF1W5424	615	645	54	18	2 7/8
		EVPLF1W5430	743	775	54	18	2 7/8
		EVPLF1W5436	822	862	54	18	2 7/8
		EVPLF1W5442	923	971	54	18	2 7/8
		EVPLF1W5448	1042	1094	54	18	2 7/8
		EVPLF1W5454	1160	1195	54	18	2 7/8
		EVPLF1W5460	1276	1337	54	18	2 7/8
	Write Board Light Panel - Single Sided - 66” High	EVPLF1W6618	632	653	66	18	2 7/8
		EVPLF1W6624	775	811	66	24	2 7/8
		EVPLF1W6630	920	963	66	30	2 7/8
		EVPLF1W6636	1022	1077	66	36	2 7/8
		EVPLF1W6642	1161	1220	66	42	2 7/8
		EVPLF1W6648	1294	1363	66	48	2 7/8
		EVPLF1W6654	1437	1518	66	54	2 7/8
		EVPLF1W6660	1587	1671	66	60	2 7/8





**EVPF2W - WRITE BOARD PANEL - DOUBLE SIDED**

- Write Board Panel incorporates fabric modules with a single 24”H top position write board module, into a solid steel frame.
- Use erasable writeboard markers only.
- Opposite sides of each panel may have a different fabric within the same grade at no upcharge.
- If different grades of fabric are used on one panel, the entire panel must be priced at highest grade.
- An aluminum low profile top cap is included.
- Stackability: Evolve panels can be increased in height in 6”H, 12”H, 18”H or 24”H increments. See Extension Module (pages 82-90) for part numbers.

	DESCRIPTION	PRODUCT CODE	LIST PRICE		DIMENSIONS/INCHES		
			Gr1	Gr2	H	W	D
	Write Board Panel - Double Sided - 54” High	EVPF2W5418	554	570	54	18	2 7/8
		EVPF2W5424	693	712	54	24	2 7/8
		EVPF2W5430	864	889	54	30	2 7/8
		EVPF2W5436	932	963	54	36	2 7/8
		EVPF2W5442	1059	1092	54	42	2 7/8
		EVPF2W5448	1239	1275	54	48	2 7/8
		EVPF2W5454	1375	1416	54	54	2 7/8
	Write Board Panel - Double Sided - 66” High	EVPF2W6618	687	713	66	18	2 7/8
		EVPF2W6624	857	886	66	24	2 7/8
		EVPF2W6630	1048	1084	66	30	2 7/8
		EVPF2W6636	1146	1190	66	36	2 7/8
		EVPF2W6642	1297	1346	66	42	2 7/8
		EVPF2W6648	1493	1546	66	48	2 7/8
		EVPF2W6654	1666	1727	66	54	2 7/8
		EVPF2W6660	1835	1903	66	60	2 7/8

**EVPLF2W - WRITE BOARD LIGHT PANEL - DOUBLE SIDED**

- Write Board Light Panel incorporates fabric modules with a single 24”H top position write board module, into a solid steel frame.
- Use erasable writeboard markers only.
- There is no base raceway in Light Panels to accommodate electrical.
- Light Panel Connectors must be used in conjunction with Light Panels.
- Opposite sides of each panel may have a different fabric within the same grade at no upcharge.
- If different grades of fabric are used on one panel, the entire panel must be priced at highest grade.
- An aluminum low profile top cap is included.
- Stackability: Evolve panels can be increased in height in 6”H, 12”H, 18”H or 24”H increments. See Extension Module (pages 82-90) for part numbers.

	DESCRIPTION	PRODUCT CODE	LIST PRICE		DIMENSIONS/INCHES		
			Gr1	Gr2	H	W	D
	Write Board Light Panel - Double Sided - 54” High	EVPLF2W5418	537	548	54	18	2 7/8
		EVPLF2W5424	673	687	54	18	2 7/8
		EVPLF2W5430	835	861	54	18	2 7/8
		EVPLF2W5436	908	932	54	18	2 7/8
		EVPLF2W5442	1026	1059	54	18	2 7/8
		EVPLF2W5448	1199	1234	54	18	2 7/8
		EVPLF2W5454	1334	1372	54	18	2 7/8
	Write Board Light Panel - Double Sided - 66” High	EVPLF2W6618	668	687	66	18	2 7/8
		EVPLF2W6624	830	861	66	24	2 7/8
		EVPLF2W6630	1015	1052	66	30	2 7/8
		EVPLF2W6636	1113	1153	66	36	2 7/8
		EVPLF2W6642	1260	1307	66	42	2 7/8
		EVPLF2W6648	1448	1496	66	48	2 7/8
		EVPLF2W6654	1616	1671	66	54	2 7/8
		EVPLF2W6660	1843	1843	66	60	2 7/8

**EVPH1S - LAMINATE PANEL - SINGLE SIDED**

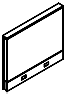
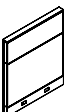
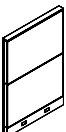
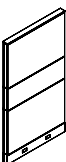

- Laminate Panel incorporates single sided laminate modules, into a solid steel frame.
- Opposite side is fabric covered.
- Laminate faces on all modules provide durable, washable surfaces on Single Sided of the panel.
- Available in high pressure laminate only.
- If wood grain is selected, grain runs horizontally.
- If different grades of fabric are used on one panel, the entire panel must be priced at highest grade.
- An aluminum low profile top cap is included.
- Stackability: Evolve panels can be increased in height in 6”H, 12”H, 18”H or 24”H increments. See Extension Module (pages 82-90) for part numbers.

	DESCRIPTION	PRODUCT CODE	LIST PRICE		DIMENSIONS/INCHES		
			Gr1	Gr2	H	W	D
	Laminate Panel - Single Sided - 30” High	EVPH1S3018	422	432	30	18	2 7/8
		EVPH1S3024	504	517	30	24	2 7/8
		EVPH1S3030	587	602	30	30	2 7/8
		EVPH1S3036	668	685	30	36	2 7/8
		EVPH1S3042	761	776	30	42	2 7/8
		EVPH1S3048	827	843	30	48	2 7/8
		EVPH1S3054	910	931	30	54	2 7/8
		EVPH1S3060	1000	1021	30	60	2 7/8
	Laminate Panel - Single Sided - 42” High	EVPH1S4218	502	515	42	18	2 7/8
		EVPH1S4224	597	614	42	24	2 7/8
		EVPH1S4230	699	718	42	30	2 7/8
		EVPH1S4236	800	826	42	36	2 7/8
		EVPH1S4242	908	933	42	42	2 7/8
		EVPH1S4248	986	1015	42	48	2 7/8
		EVPH1S4254	1094	1125	42	54	2 7/8
		EVPH1S4260	1199	1235	42	60	2 7/8
	Laminate Panel - Single Sided - 54” High	EVPH1S5418	588	602	54	18	2 7/8
		EVPH1S5424	708	733	54	24	2 7/8
		EVPH1S5430	830	857	54	30	2 7/8
		EVPH1S5436	951	978	54	36	2 7/8
		EVPH1S5442	1077	1112	54	42	2 7/8
		EVPH1S5448	1175	1213	54	48	2 7/8
		EVPH1S5454	1307	1346	54	54	2 7/8
		EVPH1S5460	1435	1482	54	60	2 7/8
	Laminate Panel - Single Sided - 66” High	EVPH1S6618	728	749	66	18	2 7/8
		EVPH1S6624	874	903	66	24	2 7/8
		EVPH1S6630	1021	1054	66	30	2 7/8
		EVPH1S6636	1179	1217	66	36	2 7/8
		EVPH1S6642	1340	1381	66	42	2 7/8
		EVPH1S6648	1457	1504	66	48	2 7/8
		EVPH1S6654	1624	1674	66	54	2 7/8
		EVPH1S6660	1786	1843	66	60	2 7/8





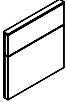
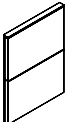

**EVPLH1S - LAMINATE LIGHT PANEL - SINGLE SIDED**

- Laminate Panel incorporates single sided laminate modules, into a solid steel frame.
- Opposite side is fabric covered.
- Laminate faces on all modules provide durable, washable surfaces on Single Sided of the panel.
- Available in high pressure laminate only.
- If wood grain is selected, grain runs horizontally.
- There is no base raceway in Light Panels to accommodate electrical.
- Light Panel Connectors must be used in conjunction with Light Panels.
- If different grades of fabric are used on one panel, the entire panel must be priced at highest grade.
- An aluminum low profile top cap is included.
- Stackability: Evolve panels can be increased in height in 6”H, 12”H, 18”H or 24”H increments. See Extension Module (pages 82-90) for part numbers.

	DESCRIPTION	PRODUCT CODE	LIST PRICE		DIMENSIONS/INCHES		
			Gr1	Gr2	H	W	D
	Laminate Light Panel - Single Sided - 30" High	EVPLH1S3018	411	418	30	18	2 7/8
		EVPLH1S3024	491	501	30	24	2 7/8
		EVPLH1S3030	570	578	30	30	2 7/8
		EVPLH1S3036	648	665	30	36	2 7/8
		EVPLH1S3042	735	748	30	42	2 7/8
		EVPLH1S3048	801	814	30	48	2 7/8
		EVPLH1S3054	882	905	30	54	2 7/8
		EVPLH1S3060	968	987	30	60	2 7/8
	Laminate Light Panel - Single Sided - 42" High	EVPLH1S4218	488	497	42	18	2 7/8
		EVPLH1S4224	577	594	42	24	2 7/8
		EVPLH1S4230	677	697	42	30	2 7/8
		EVPLH1S4236	775	799	42	36	2 7/8
		EVPLH1S4242	879	905	42	42	2 7/8
		EVPLH1S4248	959	982	42	48	2 7/8
		EVPLH1S4254	1062	1092	42	54	2 7/8
		EVPLH1S4260	1163	1195	42	60	2 7/8
	Laminate Light Panel - Single Sided - 54" High	EVPLH1S5418	571	578	54	18	2 7/8
		EVPLH1S5424	686	707	54	24	2 7/8
		EVPLH1S5430	807	828	54	30	2 7/8
		EVPLH1S5436	921	950	54	36	2 7/8
		EVPLH1S5442	1044	1074	54	42	2 7/8
		EVPLH1S5448	1139	1174	54	48	2 7/8
		EVPLH1S5454	1267	1306	54	54	2 7/8
		EVPLH1S5460	1392	1434	54	60	2 7/8
	Laminate Light Panel - Single Sided - 66" High	EVPLH1S6618	706	725	66	18	2 7/8
		EVPLH1S6624	849	872	66	24	2 7/8
		EVPLH1S6630	989	1020	66	30	2 7/8
		EVPLH1S6636	1142	1176	66	36	2 7/8
		EVPLH1S6642	1297	1336	66	42	2 7/8
		EVPLH1S6648	1416	1456	66	48	2 7/8
		EVPLH1S6654	1573	1624	66	54	2 7/8
		EVPLH1S6660	1732	1786	66	60	2 7/8

**EVPH2S - LAMINATE PANEL - DOUBLE SIDED**





- Laminate Panel incorporates double sided laminate modules, into a solid steel frame.
- Laminate faces on all modules provide durable, washable surfaces on Single Sided of the panel.
- Available in high pressure laminate only.
- If wood grain is selected, grain runs horizontally.
- If different grades of fabric are used on one panel, the entire panel must be priced at highest grade.
- An aluminum low profile top cap is included.
- Stackability: Evolve panels can be increased in height in 6”H, 12”H, 18”H or 24”H increments. See Extension Module (pages 82-90) for part numbers.

	DESCRIPTION	PRODUCT CODE	LIST PRICE	DIMENSIONS/INCHES		
				H	W	D
	Laminate Panel - Double Sided - 30" High	EVPH2S3018	575	30	18	2 7/8
		EVPH2S3024	575	30	24	2 7/8
		EVPH2S3030	678	30	30	2 7/8
		EVPH2S3036	775	30	36	2 7/8
		EVPH2S3042	882	30	42	2 7/8
		EVPH2S3048	984	30	48	2 7/8
		EVPH2S3054	1092	30	54	2 7/8
	EVPH2S3060	1179	30	60	2 7/8	
	Laminate Panel - Double Sided - 42" High	EVPH2S4218	558	42	18	2 7/8
		EVPH2S4224	678	42	24	2 7/8
		EVPH2S4230	799	42	30	2 7/8
		EVPH2S4236	929	42	36	2 7/8
		EVPH2S4242	1059	42	42	2 7/8
		EVPH2S4248	1185	42	48	2 7/8
		EVPH2S4254	1304	42	54	2 7/8
	EVPH2S4260	1417	42	60	2 7/8	
	Laminate Panel - Double Sided - 54" High	EVPH2S5418	655	54	18	2 7/8
		EVPH2S5424	801	54	24	2 7/8
		EVPH2S5430	950	54	30	2 7/8
		EVPH2S5436	1103	54	36	2 7/8
		EVPH2S5442	1259	54	42	2 7/8
		EVPH2S5448	1416	54	48	2 7/8
		EVPH2S5454	1560	54	54	2 7/8
	EVPH2S5460	1697	54	60	2 7/8	
	Laminate Panel - Double Sided - 66" High	EVPH2S6618	827	66	18	2 7/8
		EVPH2S6624	1014	66	24	2 7/8
		EVPH2S6630	1199	66	30	2 7/8
		EVPH2S6636	1392	66	36	2 7/8
		EVPH2S6642	1593	66	42	2 7/8
		EVPH2S6648	1786	66	48	2 7/8
		EVPH2S6654	1971	66	54	2 7/8
	EVPH2S6660	2153	66	60	2 7/8	





**EVPLH2S - LAMINATE LIGHT PANEL - DOUBLE SIDED**

- Laminate Panel incorporates double sided laminate modules, into a solid steel frame.
- Laminate faces on all modules provide durable, washable surfaces on Single Sided of the panel.
- Available in high pressure laminate only
- If wood grain is selected, grain runs horizontally.
- There is no base raceway in Light Panels to accommodate electrical.
- Light Panel Connectors must be used in conjunction with Light Panels.
- If different grades of fabric are used on one panel, the entire panel must be priced at highest grade.
- An aluminum low profile top cap is included.
- Stackability: Evolve panels can be increased in height in 6”H, 12”H, 18”H or 24”H increments. See Extension Module (pages 82-90) for part numbers.

	DESCRIPTION	PRODUCT CODE	LIST PRICE	DIMENSIONS/INCHES		
				H	W	D
	Laminate Light Panel - Double Sided - 30" High	EVPLH2S3018	557	30	18	2 7/8
		EVPLH2S3024	557	30	24	2 7/8
		EVPLH2S3030	657	30	30	2 7/8
		EVPLH2S3036	751	30	36	2 7/8
		EVPLH2S3042	858	30	42	2 7/8
		EVPLH2S3048	957	30	48	2 7/8
		EVPLH2S3054	1060	30	54	2 7/8
		EVPLH2S3060	1142	30	60	2 7/8
	Laminate Light Panel - Double Sided - 42" High	EVPLH2S4218	543	42	18	2 7/8
		EVPLH2S4224	657	42	24	2 7/8
		EVPLH2S4230	774	42	30	2 7/8
		EVPLH2S4236	902	42	36	2 7/8
		EVPLH2S4242	1026	42	42	2 7/8
		EVPLH2S4248	1152	42	48	2 7/8
		EVPLH2S4254	1263	42	54	2 7/8
		EVPLH2S4260	1375	42	60	2 7/8
	Laminate Light Panel - Double Sided - 54" High	EVPLH2S5418	635	54	18	2 7/8
		EVPLH2S5424	776	54	24	2 7/8
		EVPLH2S5430	920	54	30	2 7/8
		EVPLH2S5436	1069	54	36	2 7/8
		EVPLH2S5442	1220	54	42	2 7/8
		EVPLH2S5448	1374	54	48	2 7/8
		EVPLH2S5454	1513	54	54	2 7/8
		EVPLH2S5460	1643	54	60	2 7/8
	Laminate Light Panel - Double Sided - 66" High	EVPLH2S6618	706	66	18	2 7/8
		EVPLH2S6624	982	66	24	2 7/8
		EVPLH2S6630	1163	66	30	2 7/8
		EVPLH2S6636	1349	66	36	2 7/8
		EVPLH2S6642	1544	66	42	2 7/8
		EVPLH2S6648	1732	66	48	2 7/8
		EVPLH2S6654	1912	66	54	2 7/8
		EVPLH2S6660	2088	66	60	2 7/8

**EVPPAF - AIRFLOW PANEL**

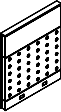
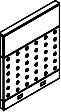



- Airflow Panel incorporates bottom 24”H airflow module with individual fabric modules, within a steel frame.
- The 24”H Metal airflow module is positioned in the base section to provide air circulation.
- Opposite sides of each panel may have a different fabric within the same grade at no upcharge.
- If different grades of fabric are used on one panel, the entire panel must be priced at highest grade.
- An aluminum low profile top cap is included.
- Stackability: Evolve panels can be increased in height in 6”H, 12”H, 18”H or 24”H increments. See Extension Module (pages 82-90) for part numbers.

	DESCRIPTION	PRODUCT CODE	LIST PRICE		DIMENSIONS/INCHES		
			Gr1	Gr2	H	W	D
	Airflow Panel - 30” High	EVPPAF3024	483		30	24	2 7/8
		EVPPAF3030	574		30	30	2 7/8
		EVPPAF3036	635		30	36	2 7/8
		EVPPAF3042	706		30	42	2 7/8
		EVPPAF3048	796		30	48	2 7/8
		EVPPAF3054	912		30	54	2 7/8
		EVPPAF3060	1029		30	60	2 7/8
	Airflow Panel - 42” High	EVPPAF4224	615	625	42	24	2 7/8
		EVPPAF4230	728	743	42	30	2 7/8
		EVPPAF4236	810	827	42	36	2 7/8
		EVPPAF4242	900	917	42	42	2 7/8
		EVPPAF4248	1017	1035	42	48	2 7/8
		EVPPAF4254	1158	1179	42	54	2 7/8
		EVPPAF4260	1175	1199	42	60	2 7/8
	Airflow Panel - 54” High	EVPPAF5424	690	714	54	24	2 7/8
		EVPPAF5430	795	820	54	30	2 7/8
		EVPPAF5436	888	918	54	36	2 7/8
		EVPPAF5442	989	1024	54	42	2 7/8
		EVPPAF5448	1113	1152	54	48	2 7/8
		EVPPAF5454	1295	1339	54	54	2 7/8
		EVPPAF5460	1413	1459	54	60	2 7/8
	Airflow Panel - 66” High	EVPPAF6624	806	835	66	24	2 7/8
		EVPPAF6630	950	985	66	30	2 7/8
		EVPPAF6636	1063	1107	66	36	2 7/8
		EVPPAF6642	1185	1233	66	42	2 7/8
		EVPPAF6648	1335	1389	66	48	2 7/8
		EVPPAF6654	1509	1570	66	54	2 7/8
		EVPPAF6660	1679	1747	66	60	2 7/8



**EVPLFAF - AIRFLOW LIGHT PANEL**

- Airflow Light Panel incorporates bottom 24”H airflow module with individual fabric modules, within a steel frame.
- The 24”H Metal airflow module is positioned in the base section to provide air circulation.
- There is no base raceway in Light Panels to accommodate electrical.
- Light Panel Connectors must be used in conjunction with Light Panels.
- Opposite sides of each panel may have a different fabric within the same grade at no upcharge.
- If different grades of fabric are used on one panel, the entire panel must be priced at highest grade.
- An aluminum low profile top cap is included.
- Stackability: Evolve panels can be increased in height in 6”H, 12”H, 18”H or 24”H increments. See Extension Module listings for part numbers

	DESCRIPTION	PRODUCT CODE	LIST PRICE		DIMENSIONS/INCHES		
			Gr1	Gr2	H	W	D
	Airflow Light Panel - 30” High	EVPLFAF3024	470		30	18	2 7/8
		EVPLFAF3030	556		30	30	2 7/8
		EVPLFAF3036	616		30	36	2 7/8
		EVPLFAF3042	684		30	42	2 7/8
		EVPLFAF3048	770		30	48	2 7/8
		EVPLFAF3054	886		30	54	2 7/8
		EVPLFAF3060	1001		30	60	2 7/8
	Airflow Light Panel - 42” High	EVPLFAF4224	598	605	42	18	2 7/8
		EVPLFAF4230	706	718	42	30	2 7/8
		EVPLFAF4236	785	801	42	36	2 7/8
		EVPLFAF4242	871	887	42	42	2 7/8
		EVPLFAF4248	984	1004	42	48	2 7/8
		EVPLFAF4254	1121	1141	42	54	2 7/8
		EVPLFAF4260	1139	1161	42	60	2 7/8
	Airflow Light Panel - 54” High	EVPLFAF5424	671	687	54	18	2 7/8
		EVPLFAF5430	769	795	54	30	2 7/8
		EVPLFAF5436	864	888	54	36	2 7/8
		EVPLFAF5442	961	992	54	42	2 7/8
		EVPLFAF5448	1078	1115	54	48	2 7/8
		EVPLFAF5454	1257	1293	54	54	2 7/8
		EVPLFAF5460	1371	1413	54	60	2 7/8
	Airflow Light Panel - 66” High	EVPLFAF6624	779	808	66	18	2 7/8
		EVPLFAF6630	920	956	66	30	2 7/8
		EVPLFAF6636	1032	1072	66	36	2 7/8
		EVPLFAF6642	1152	1194	66	42	2 7/8
		EVPLFAF6648	1294	1346	66	48	2 7/8
		EVPLFAF6654	1465	1518	66	54	2 7/8
		EVPLFAF6660	1630	1691	30	60	2 7/8



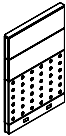
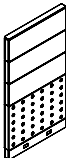

**EVPPPAF - AIRFLOW PREMIUM PANEL**

- Airflow Premium Panel incorporates bottom 24”H airflow module with individual fabric modules, within a steel frame.
- The 24”H Metal airflow module is positioned in the base section to provide air circulation.
- Premium panels incorporate 12”H acoustic modules above 30”H base section.
- Opposite sides of each panel may have a different fabric within the same grade at no upcharge.
- If different grades of fabric are used on one panel, the entire panel must be priced at highest grade.
- An aluminum low profile top cap is included.
- Stackability: Evolve panels can be increased in height in 6”H, 12”H, 18”H or 24”H increments. See Extension Module (pages 82-90) for part numbers.

	DESCRIPTION	PRODUCT CODE	LIST PRICE		DIMENSIONS/INCHES		
			Gr1	Gr2	H	W	D
	Airflow Premium Panel - 54” High	EVPPPAF5424	767	785	54	24	2 7/8
		EVPPPAF5430	878	905	54	30	2 7/8
		EVPPPAF5436	982	1011	54	36	2 7/8
		EVPPPAF5442	1091	1124	54	42	2 7/8
		EVPPPAF5448	1235	1273	54	48	2 7/8
		EVPPPAF5454	1396	1439	54	54	2 7/8
	Airflow Premium Panel - 66” High	EVPPPAF6624	879	910	66	24	2 7/8
		EVPPPAF6630	1032	1070	66	30	2 7/8
		EVPPPAF6636	1155	1198	66	36	2 7/8
		EVPPPAF6642	1282	1331	66	42	2 7/8
		EVPPPAF6648	1456	1513	66	48	2 7/8
		EVPPPAF6654	1639	1701	66	54	2 7/8
EVPPPAF6660	1829	1895	66	60	2 7/8		

**EVPLPPAF - AIRFLOW PREMIUM LIGHT PANEL**

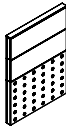
- Airflow Premium Light Panel incorporates bottom 24”H airflow module with individual 12”H fabric modules, within a steel frame.
- The 24”H Metal airflow module is positioned in the base section to provide air circulation.
- Premium panels incorporate 12”H acoustic modules above 30”H base section.
- There is no base raceway in Light Panels to accommodate electrical.
- Light Panel Connectors must be used in conjunction with Light Panels.
- Opposite sides of each panel may have a different fabric within the same grade at no upcharge.
- If different grades of fabric are used on one panel, the entire panel must be priced at highest grade.
- An aluminum low profile top cap is included.
- Stackability: Evolve panels can be increased in height in 6”H, 12”H, 18”H or 24”H increments. See Extension Module (pages 82-90) for part numbers.

	DESCRIPTION	PRODUCT CODE	LIST PRICE		DIMENSIONS/INCHES		
			Gr1	Gr2	H	W	D
	Airflow Premium Light Panel - 54” High	EVPLPPAF5424	744	764	54	18	2 7/8
		EVPLPPAF5430	854	874	54	30	2 7/8
		EVPLPPAF5436	954	978	54	36	2 7/8
		EVPLPPAF5442	1059	1088	54	42	2 7/8
		EVPLPPAF5448	1196	1231	54	48	2 7/8
		EVPLPPAF5454	1356	1391	54	54	2 7/8
	Airflow Premium Light Panel - 66” High	EVPLPPAF6624	855	880	66	18	2 7/8
		EVPLPPAF6630	1003	1034	66	30	2 7/8
		EVPLPPAF6636	1120	1161	66	36	2 7/8
		EVPLPPAF6642	1243	1287	66	42	2 7/8
		EVPLPPAF6648	1414	1466	66	48	2 7/8
		EVPLPPAF6654	1591	1643	66	54	2 7/8
EVPLPPAF6660	1773	1834	66	60	2 7/8		



**EVFPMAF - AIRFLOW MIDDLE PREMIUM PANEL**

- Airflow Panel Middle Premium Panel incorporates a 12”H middle position airflow module with fabric modules, within a steel frame.
- Premium panels incorporate 12”H modules above 30”H base section.
- 12”H airflow panel is located at the beltline.
- Opposite sides of each panel may have a different fabric within the same grade at no upcharge.
- If different grades of fabric are used on one panel, the entire panel must be priced at highest grade.
- An aluminum low profile top cap is included.
- Stackability: Evolve panels can be increased in height in 6”H, 12”H, 18”H or 24”H increments. See Extension Module (pages 82-90) for part numbers.

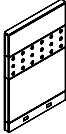
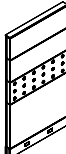
	DESCRIPTION	PRODUCT CODE	LIST PRICE		DIMENSIONS/INCHES		
			Gr1	Gr2	H	W	D
	Airflow Middle Premium Panel - 54” High	EVFPMAF5424	842	877	54	24	2 7/8
		EVFPMAF5430	999	1040	54	30	2 7/8
		EVFPMAF5436	1131	1184	54	36	2 7/8
		EVFPMAF5442	1273	1330	54	42	2 7/8
		EVFPMAF5448	1423	1485	54	48	2 7/8
		EVFPMAF5454	1608	1677	54	54	2 7/8
	Airflow Middle Premium Panel - 66” High	EVFPMAF6624	957	995	66	24	2 7/8
		EVFPMAF6630	1129	1158	66	30	2 7/8
		EVFPMAF6636	1283	1337	66	36	2 7/8
		EVFPMAF6642	1436	1497	66	42	2 7/8
		EVFPMAF6648	1608	1676	66	48	2 7/8
		EVFPMAF6654	1812	1889	66	54	2 7/8
EVFPMAF6660	2015	2100	66	60	2 7/8		



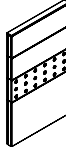

**EVPLPMAF - AIRFLOW MIDDLE PREMIUM LIGHT PANEL**

- Airflow Panel Middle Premium Light Panel incorporates a 12”H middle position airflow module with fabric modules, within a steel frame.
- Premium panels incorporate 12”H modules above 30”H base section.
- 12”H airflow panel is located at the beltline.
- There is no base raceway in Light Panels to accommodate electrical.
- Light Panel Connectors must be used in conjunction with Light Panels.
- Opposite sides of each panel may have a different fabric within the same grade at no upcharge.
- If different grades of fabric are used on one panel, the entire panel must be priced at highest grade.
- An aluminum low profile top cap is included.
- Stackability: Evolve panels can be increased in height in 6”H, 12”H, 18”H or 24”H increments. See Extension Module (pages 82-90) for part numbers.

	DESCRIPTION	PRODUCT CODE	LIST PRICE		DIMENSIONS/INCHES		
			Gr1	Gr2	H	W	D
	Airflow Middle Premium Light Panel - 66” High	EVPLPMAF6624	773	808	66	18	2 7/8
		EVPLPMAF6630	911	946	66	30	2 7/8
		EVPLPMAF6636	1038	1091	66	36	2 7/8
		EVPLPMAF6642	1165	1223	66	42	2 7/8
		EVPLPMAF6648	1418	1485	66	48	2 7/8
		EVPLPMAF6654	1466	1535	66	54	2 7/8
		EVPLPMAF6660	1631	1712	66	60	2 7/8

**EVPM1S - METAL SKIN PANEL - SINGLE SIDED**



- Metal Skin Panel incorporates single sided metal skin modules, into a solid steel frame.
- Opposite side is fabric covered.
- Metal faces on all modules provide durable, washable and magnetic surfaces on Single Sided of the panel.
- If different grades of fabric are used on one panel, the entire panel must be priced at highest grade.
- An aluminum low profile top cap is included.
- Stackability: Evolve panels can be increased in height in 6”H, 12”H, 18”H or 24”H increments. See Extension Module (pages 82-90) for part numbers.

	DESCRIPTION	PRODUCT CODE	LIST PRICE		DIMENSIONS/INCHES		
			Gr1	Gr2	H	W	D
	Metal Skin Panel - Single Sided 30" High	EVPM1S3018	547	557	30	18	2 7/8
		EVPM1S3024	655	669	30	24	2 7/8
		EVPM1S3030	763	776	30	30	2 7/8
		EVPM1S3036	867	883	30	36	2 7/8
		EVPM1S3042	983	1002	30	42	2 7/8
		EVPM1S3048	1071	1090	30	48	2 7/8
		EVPM1S3054	1183	1202	30	54	2 7/8
		EVPM1S3060	1295	1319	30	60	2 7/8
	Metal Skin Panel - Single Sided 42" High	EVPM1S4218	649	662	42	18	2 7/8
		EVPM1S4224	773	788	42	24	2 7/8
		EVPM1S4230	908	926	42	30	2 7/8
		EVPM1S4236	1038	1065	42	36	2 7/8
		EVPM1S4242	1179	1205	42	42	2 7/8
		EVPM1S4248	1281	1310	42	48	2 7/8
		EVPM1S4254	1423	1452	42	54	2 7/8
		EVPM1S4260	1561	1594	42	60	2 7/8
	Metal Skin Panel - Single Sided 54" High	EVPM1S5418	765	780	54	18	2 7/8
		EVPM1S5424	920	939	54	24	2 7/8
		EVPM1S5430	1077	1103	54	30	2 7/8
		EVPM1S5436	1231	1261	54	36	2 7/8
		EVPM1S5442	1397	1432	54	42	2 7/8
		EVPM1S5448	1526	1565	54	48	2 7/8
		EVPM1S5454	1697	1741	54	54	2 7/8
		EVPM1S5460	1865	1909	54	60	2 7/8
	Metal Skin Panel - Single Sided 66" High	EVPM1S6618	942	966	66	18	2 7/8
		EVPM1S6624	1136	1163	66	24	2 7/8
		EVPM1S6630	1327	1358	66	30	2 7/8
		EVPM1S6636	1531	1569	66	36	2 7/8
		EVPM1S6642	1740	1781	66	42	2 7/8
		EVPM1S6648	1894	1941	66	48	2 7/8
		EVPM1S6654	2106	2157	66	54	2 7/8
		EVPM1S6660	2320	2377	66	60	2 7/8





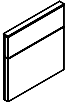
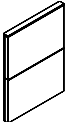

**EVPLM1S - METAL SKIN LIGHT PANEL - SINGLE SIDED**

- Metal Skin Light Panel incorporates single sided metal skin modules, into a solid steel frame.
- Opposite side is fabric covered.
- Metal faces on all modules provide durable, washable and magnetic surfaces on Single Sided of the panel.
- There is no base raceway in Light Panels to accommodate electrical.
- Light Panel Connectors must be used in conjunction with Light Panels.
- If different grades of fabric are used on one panel, the entire panel must be priced at highest grade.
- An aluminum low profile top cap is included.
- Stackability: Evolve panels can be increased in height in 6”H, 12”H, 18”H or 24”H increments. See Extension Module (pages 82-90) for part numbers.

	DESCRIPTION	PRODUCT CODE	LIST PRICE		DIMENSIONS/INCHES		
			Gr1	Gr2	H	W	D
	Metal Skin Light Panel - Single Sided - 30” High	EVPLM1S3018	533	541	30	18	2 7/8
		EVPLM1S3024	635	646	30	24	2 7/8
		EVPLM1S3030	736	747	30	30	2 7/8
		EVPLM1S3036	840	857	30	36	2 7/8
		EVPLM1S3042	956	970	30	42	2 7/8
		EVPLM1S3048	1038	1055	30	48	2 7/8
		EVPLM1S3054	1150	1164	30	54	2 7/8
		EVPLM1S3060	1257	1278	30	60	2 7/8
	Metal Skin Light Panel - Single Sided - 42” High	EVPLM1S4218	632	642	42	18	2 7/8
		EVPLM1S4224	748	765	42	24	2 7/8
		EVPLM1S4230	879	899	42	30	2 7/8
		EVPLM1S4236	1008	1028	42	36	2 7/8
		EVPLM1S4242	1142	1164	42	42	2 7/8
		EVPLM1S4248	1242	1270	42	48	2 7/8
		EVPLM1S4254	1378	1406	42	54	2 7/8
		EVPLM1S4260	1514	1544	42	60	2 7/8
	Metal Skin Light Panel - Single Sided - 54” High	EVPLM1S5418	739	753	54	18	2 7/8
		EVPLM1S5424	890	910	54	24	2 7/8
		EVPLM1S5430	1044	1066	54	30	2 7/8
		EVPLM1S5436	1194	1221	54	36	2 7/8
		EVPLM1S5442	1357	1388	54	42	2 7/8
		EVPLM1S5448	1481	1515	54	48	2 7/8
		EVPLM1S5454	1643	1687	54	54	2 7/8
		EVPLM1S5460	1808	1851	54	60	2 7/8
	Metal Skin Light Panel - Single Sided - 66” High	EVPLM1S6618	916	932	66	18	2 7/8
		EVPLM1S6624	1103	1124	66	24	2 7/8
		EVPLM1S6630	1286	1316	66	30	2 7/8
		EVPLM1S6636	1484	1520	66	36	2 7/8
		EVPLM1S6642	1688	1726	66	42	2 7/8
		EVPLM1S6648	1835	1879	66	48	2 7/8
		EVPLM1S6654	2044	2090	66	54	2 7/8
		EVPLM1S6660	2250	2305	66	60	2 7/8

**EVPM2S - METAL SKIN PANEL - DOUBLE SIDED**



- Metal Skin Panel incorporates double sided metal skin modules, into a solid steel frame.
- Metal faces on all modules provide durable, washable and magnetic surfaces on Single Sided of the panel.
- If different grades of fabric are used on one panel, the entire panel must be priced at highest grade.
- An aluminum low profile top cap is included.
- Stackability: Evolve panels can be increased in height in 6”H, 12”H, 18”H or 24”H increments. See Extension Module (pages 82-90) for part numbers.

	DESCRIPTION	PRODUCT CODE	LIST PRICE	DIMENSIONS/INCHES		
				H	W	D
	Metal Skin Panel - Double Sided - 30” High	EVPM2S3018	806	30	18	2 7/8
		EVPM2S3024	806	30	24	2 7/8
		EVPM2S3030	948	30	30	2 7/8
		EVPM2S3036	1085	30	36	2 7/8
		EVPM2S3042	1085	30	42	2 7/8
		EVPM2S3048	1231	30	48	2 7/8
		EVPM2S3054	1377	30	54	2 7/8
	EVPM2S3060	1645	30	60	2 7/8	
	Metal Skin Panel - Double Sided - 42” High	EVPM2S4218	779	42	18	2 7/8
		EVPM2S4224	948	42	24	2 7/8
		EVPM2S4230	1116	42	30	2 7/8
		EVPM2S4236	1297	42	36	2 7/8
		EVPM2S4242	1479	42	42	2 7/8
		EVPM2S4248	1659	42	48	2 7/8
		EVPM2S4254	1822	42	54	2 7/8
	EVPM2S4260	1983	42	60	2 7/8	
	Metal Skin Panel - Double Sided - 54” High	EVPM2S5418	916	54	18	2 7/8
		EVPM2S5424	1120	54	24	2 7/8
		EVPM2S5430	1326	54	30	2 7/8
		EVPM2S5436	1540	54	36	2 7/8
		EVPM2S5442	1762	54	42	2 7/8
		EVPM2S5448	1980	54	48	2 7/8
		EVPM2S5454	2178	54	54	2 7/8
	EVPM2S5460	2375	54	60	2 7/8	
	Metal Skin Panel - Double Sided - 66” High	EVPM2S6618	1153	66	18	2 7/8
		EVPM2S6624	1417	66	24	2 7/8
		EVPM2S6630	1678	66	30	2 7/8
		EVPM2S6636	1949	66	36	2 7/8
		EVPM2S6642	2227	66	42	2 7/8
		EVPM2S6648	2499	66	48	2 7/8
		EVPM2S6654	2756	66	54	2 7/8
	EVPM2S6660	3016	66	60	2 7/8	

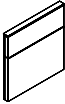
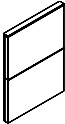

**EVPLM2S - METAL SKIN LIGHT PANEL - DOUBLE SIDED**

- Metal Skin Light Panel incorporates double sided metal skin modules, into a solid steel frame.
- Metal faces on all modules provide durable, washable and magnetic surfaces on Single Sided of the panel.
- There is no base raceway in Light Panels to accommodate electrical.
- Light Panel Connectors must be used in conjunction with Light Panels.
- If different grades of fabric are used on one panel, the entire panel must be priced at highest grade.
- An aluminum low profile top cap is included.
- Stackability: Evolve panels can be increased in height in 6”H, 12”H, 18”H or 24”H increments. See Extension Module (pages 82-90) for part numbers.

	DESCRIPTION	PRODUCT CODE	LIST PRICE	DIMENSIONS/INCHES		
				H	W	D
	Metal Skin Light Panel - Double Sided - 30" High	EVPLM2S3018	779	30	18	2 7/8
		EVPLM2S3024	779	30	24	2 7/8
		EVPLM2S3030	919	30	30	2 7/8
		EVPLM2S3036	1053	30	36	2 7/8
		EVPLM2S3042	1053	30	42	2 7/8
		EVPLM2S3048	1194	30	48	2 7/8
		EVPLM2S3054	1335	30	54	2 7/8
		EVPLM2S3060	1598	30	60	2 7/8
	Metal Skin Light Panel - Double Sided - 42" High	EVPLM2S4218	757	42	18	2 7/8
		EVPLM2S4224	919	42	24	2 7/8
		EVPLM2S4230	1081	42	30	2 7/8
		EVPLM2S4236	1260	42	36	2 7/8
		EVPLM2S4242	1433	42	42	2 7/8
		EVPLM2S4248	1608	42	48	2 7/8
		EVPLM2S4254	1768	42	54	2 7/8
		EVPLM2S4260	1923	42	60	2 7/8
	Metal Skin Light Panel - Double Sided - 54" High	EVPLM2S5418	887	54	18	2 7/8
		EVPLM2S5424	1087	54	24	2 7/8
		EVPLM2S5430	1285	54	30	2 7/8
		EVPLM2S5436	1494	54	36	2 7/8
		EVPLM2S5442	1709	54	42	2 7/8
		EVPLM2S5448	1920	54	48	2 7/8
		EVPLM2S5454	2111	54	54	2 7/8
		EVPLM2S5460	2304	54	60	2 7/8
	Metal Skin Light Panel - Double Sided - 66" High	EVPLM2S6618	1118	66	18	2 7/8
		EVPLM2S6624	1375	66	24	2 7/8
		EVPLM2S6630	1628	66	30	2 7/8
		EVPLM2S6636	1891	66	36	2 7/8
		EVPLM2S6642	2158	66	42	2 7/8
		EVPLM2S6648	2425	66	48	2 7/8
		EVPLM2S6654	2671	66	54	2 7/8
		EVPLM2S6660	2953	66	60	2 7/8

**EVPFOL - OPEN BOTTOM PANEL**

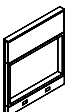
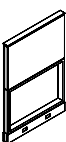
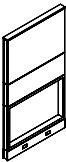

- Open Bottom Panel incorporates bottom 24”H open module with individual fabric modules, within a steel frame.
- The 24”H open bottom module in the base section is to provide air circulation and access to electrical or data.
- Opposite sides of each panel may have a different fabric within the same grade at no upcharge.
- If different grades of fabric are used on one panel, the entire panel must be priced at highest grade.
- An aluminum low profile top cap is included.
- Stackability: Evolve panels can be increased in height in 6”H, 12”H, 18”H or 24”H increments. See Extension Module (pages 82-90) for part numbers.

	DESCRIPTION	PRODUCT CODE	LIST PRICE		DIMENSIONS/INCHES		
			Gr1	Gr2	H	W	D
	Open Bottom Panel - 30" High	EVPFOL3018	279		30	18	2 7/8
		EVPFOL3024	317		30	24	2 7/8
		EVPFOL3030	358		30	30	2 7/8
		EVPFOL3036	393		30	36	2 7/8
		EVPFOL3042	431		30	42	2 7/8
		EVPFOL3048	465		30	48	2 7/8
		EVPFOL3054	503		30	54	2 7/8
EVPFOL3060	539		30	60	2 7/8		
	Open Bottom Panel - 42" High	EVPFOL4218	415	423	42	18	2 7/8
		EVPFOL4224	477	490	42	24	2 7/8
		EVPFOL4230	539	554	42	30	2 7/8
		EVPFOL4236	604	622	42	36	2 7/8
		EVPFOL4242	671	688	42	42	2 7/8
		EVPFOL4248	721	739	42	48	2 7/8
		EVPFOL4254	795	813	42	54	2 7/8
EVPFOL4260	862	883	42	60	2 7/8		
	Open Bottom Panel - 54" High	EVPFOL5418	469	486	54	18	2 7/8
		EVPFOL5424	534	558	54	24	2 7/8
		EVPFOL5430	612	636	54	30	2 7/8
		EVPFOL5436	685	716	54	36	2 7/8
		EVPFOL5442	764	797	54	42	2 7/8
		EVPFOL5448	827	865	54	48	2 7/8
		EVPFOL5454	905	941	54	54	2 7/8
EVPFOL5460	978	1026	54	60	2 7/8		
	Open Bottom Panel - 66" High	EVPFOL6618	608	634	66	18	2 7/8
		EVPFOL6624	699	730	66	24	2 7/8
		EVPFOL6630	799	835	66	30	2 7/8
		EVPFOL6636	897	938	66	36	2 7/8
		EVPFOL6642	1007	1058	66	42	2 7/8
		EVPFOL6648	1078	1132	66	48	2 7/8
		EVPFOL6654	1191	1250	66	54	2 7/8
EVPFOL6660	1297	1366	66	60	2 7/8		



**EVPLFOL - OPEN BOTTOM LIGHT PANEL**

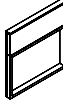
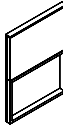

- Open Bottom Light Panel incorporates bottom 24”H open module with individual fabric modules, within a steel frame.
- The 24”H open bottom module in the base section is to provide air circulation and access to electrical or data.
- There is no base raceway in Light Panels to accommodate electrical.
- Light Panel Connectors must be used in conjunction with Light Panels.
- Opposite sides of each panel may have a different fabric within the same grade at no upcharge.
- If different grades of fabric are used on one panel, the entire panel must be priced at highest grade.
- An aluminum low profile top cap is included.
- Stackability: Evolve panels can be increased in height in 6”H, 12”H, 18”H or 24”H increments. See Extension Module (pages 82-90) for part numbers.

	DESCRIPTION	PRODUCT CODE	LIST PRICE		DIMENSIONS/INCHES		
			Gr1	Gr2	H	W	D
	Open Bottom Light Panel - 30” High	EVPLFOL3018	269		30	18	2 7/8
		EVPLFOL3024	304		30	24	2 7/8
		EVPLFOL3030	348		30	30	2 7/8
		EVPLFOL3036	382		30	36	2 7/8
		EVPLFOL3042	418		30	42	2 7/8
		EVPLFOL3048	445		30	48	2 7/8
		EVPLFOL3054	490		30	54	2 7/8
		EVPLFOL3060	523		30	60	2 7/8
	Open Bottom Light Panel - 42” High	EVPLFOL4218	401	409	42	18	2 7/8
		EVPLFOL4224	462	472	42	24	2 7/8
		EVPLFOL4230	523	535	42	30	2 7/8
		EVPLFOL4236	587	601	42	36	2 7/8
		EVPLFOL4242	649	667	42	42	2 7/8
		EVPLFOL4248	703	715	42	48	2 7/8
		EVPLFOL4254	769	785	42	54	2 7/8
		EVPLFOL4260	834	857	42	60	2 7/8
	Open Bottom Light Panel - 54” High	EVPLFOL5418	450	464	54	18	2 7/8
		EVPLFOL5424	512	533	54	24	2 7/8
		EVPLFOL5430	588	607	54	30	2 7/8
		EVPLFOL5436	657	685	54	36	2 7/8
		EVPLFOL5442	732	764	54	42	2 7/8
		EVPLFOL5448	794	828	54	48	2 7/8
		EVPLFOL5454	868	906	54	54	2 7/8
		EVPLFOL5460	940	983	54	60	2 7/8
	Open Bottom Premium Panel - 66” High	EVPLFOL6618	583	605	60	18	2 7/8
		EVPLFOL6624	673	702	60	24	2 7/8
		EVPLFOL6630	767	800	60	30	2 7/8
		EVPLFOL6636	862	900	60	36	2 7/8
		EVPLFOL6642	967	1014	60	42	2 7/8
		EVPLFOL6648	1034	1087	60	48	2 7/8
		EVPLFOL6654	1142	1196	60	54	2 7/8
		EVPLFOL6660	1248	1312	60	60	2 7/8



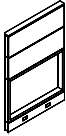

**EVFPOL - OPEN BOTTOM PREMIUM PANEL**

- Open Bottom Premium Panel incorporates bottom 24”H open module with individual fabric modules, within a steel frame.
- The 24”H open bottom module in the base section is to provide air circulation and access to electrical or data.
- Premium panels incorporate 12”H fabric modules above 30”H base section.
- Opposite sides of each panel may have a different fabric within the same grade at no upcharge.
- If different grades of fabric are used on one panel, the entire panel must be priced at highest grade.
- An aluminum low profile top cap is included.
- Stackability: Evolve panels can be increased in height in 6”H, 12”H, 18”H or 24”H increments. See Extension Module (pages 82-90) for part numbers.

	DESCRIPTION	PRODUCT CODE	LIST PRICE		DIMENSIONS/INCHES		
			Gr1	Gr2	H	W	D
	Open Bottom Premium Panel - 54” High	EVFPOL5418	554	570	54	18	2 7/8
		EVFPOL5424	634	658	54	24	2 7/8
		EVFPOL5430	725	750	54	30	2 7/8
		EVFPOL5436	813	841	54	36	2 7/8
		EVFPOL5442	916	949	54	42	2 7/8
		EVFPOL5448	982	1020	54	48	2 7/8
		EVFPOL5454	1080	1120	54	54	2 7/8
	Open Bottom Premium Panel - 66” High	EVFPOL6618	693	719	66	18	2 7/8
		EVFPOL6624	800	831	66	24	2 7/8
		EVFPOL6630	909	944	66	30	2 7/8
		EVFPOL6636	1026	1070	66	36	2 7/8
		EVFPOL6642	1158	1207	66	42	2 7/8
		EVFPOL6648	1240	1295	66	48	2 7/8
		EVFPOL6654	1374	1435	66	54	2 7/8
		EVFPOL6660	1506	1574	66	60	2 7/8

**EVPLPOL - OPEN BOTTOM PREMIUM LIGHT PANEL**

- Open Bottom Premium Light Panel incorporates bottom 24”H open module with individual fabric modules, within a steel frame.
- The 24”H open bottom module in the base section is to provide air circulation and access to electrical or data.
- Premium panels incorporate 12”H fabric modules above 30”H base section.
- There is no base raceway in Light Panels to accommodate electrical.
- Light Panel Connectors must be used in conjunction with Light Panels.
- Opposite sides of each panel may have a different fabric within the same grade at no upcharge.
- If different grades of fabric are used on one panel, the entire panel must be priced at highest grade.
- An aluminum low profile top cap is included.
- Stackability: Evolve panels can be increased in height in 6”H, 12”H, 18”H or 24”H increments. See Extension Module (pages 82-90) for part numbers.

	DESCRIPTION	PRODUCT CODE	LIST PRICE		DIMENSIONS/INCHES		
			Gr1	Gr2	H	W	D
	Open Bottom Premium Light Panel - 54” High	EVPLPOL5418	531	544	54	18	2 7/8
		EVPLPOL5424	608	631	54	24	2 7/8
		EVPLPOL5430	696	715	54	30	2 7/8
		EVPLPOL5436	780	808	54	36	2 7/8
		EVPLPOL5442	878	908	54	42	2 7/8
		EVPLPOL5448	942	977	54	48	2 7/8
		EVPLPOL5454	1037	1074	54	54	2 7/8
	Open Bottom Premium Light Panel - 66” High	EVPLPOL6618	666	686	60	18	2 7/8
		EVPLPOL6624	768	797	60	24	2 7/8
		EVPLPOL6630	871	908	60	30	2 7/8
		EVPLPOL6636	983	1022	60	36	2 7/8
		EVPLPOL6642	1111	1155	60	42	2 7/8
		EVPLPOL6648	1190	1242	60	48	2 7/8
		EVPLPOL6654	1317	1375	60	54	2 7/8
		EVPLPOL6660	1446	1511	60	60	2 7/8



**EVVFO - OPEN MIDDLE PANEL - 12”H OPENING**

- Open Middle Panel incorporates a 12”H middle position open module with fabric modules, within a steel frame.
- Open Middle Panel Incorporates a 12”H opening above 30”H base module to provide pass-through convenience.
- Opposite sides of each panel may have a different fabric within the same grade at no upcharge.
- If different grades of fabric are used on one panel, the entire panel must be priced at highest grade.
- An aluminum low profile top cap is included.
- Stackability: Evolve panels can be increased in height in 6”H, 12”H, 18”H or 24”H increments. See Extension Module (pages 82-90) for part numbers.

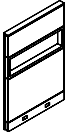
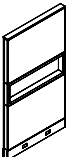
	DESCRIPTION	PRODUCT CODE	LIST PRICE		DIMENSIONS/INCHES		
			Gr1	Gr2	H	W	D
	Open Middle Panel - 12”H Opening - 54” High	EVVFO5418	560	587	54	18	2 7/8
		EVVFO5424	652	683	54	24	2 7/8
		EVVFO5430	750	786	54	30	2 7/8
		EVVFO5436	854	897	54	36	2 7/8
		EVVFO5442	961	1010	54	42	2 7/8
		EVVFO5448	1037	1094	54	48	2 7/8
		EVVFO5454	1150	1207	54	54	2 7/8
	Open Middle Panel - 12”H Opening - 66” High	EVVFO6618	618	649	66	18	2 7/8
		EVVFO6624	714	753	66	24	2 7/8
		EVVFO6630	822	869	66	30	2 7/8
		EVVFO6636	932	989	66	36	2 7/8
		EVVFO6642	1052	1114	66	42	2 7/8
		EVVFO6648	1135	1210	66	48	2 7/8
		EVVFO6654	1259	1336	66	54	2 7/8
	EVVFO6660	1375	1466	66	60	2 7/8	

**EVPLFO - OPEN MIDDLE LIGHT PANEL - 12”H OPENING**

- Open Middle Light Panel incorporates a 12”H middle position open module with fabric modules, within a steel frame.
- Open Middle Light Panel Incorporates a 12”H opening above 30”H base module to provide pass-through convenience.
- There is no base raceway in Light Panels to accommodate electrical.
- Light Panel Connectors must be used in conjunction with Light Panels.
- Opposite sides of each panel may have a different fabric within the same grade at no upcharge.
- If different grades of fabric are used on one panel, the entire panel must be priced at highest grade.
- An aluminum low profile top cap is included.
- Stackability: Evolve panels can be increased in height in 6”H, 12”H, 18”H or 24”H increments. See Extension Module (pages 82-90) for part numbers.

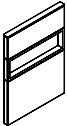
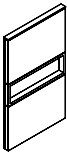
	DESCRIPTION	PRODUCT CODE	LIST PRICE		DIMENSIONS/INCHES		
			Gr1	Gr2	H	W	D
	Open Middle Light Panel - 12”H Opening - 54” High	EVPLFO5418	534	556	54	18	2 7/8
		EVPLFO5424	621	648	54	24	2 7/8
		EVPLFO5430	714	747	54	30	2 7/8
		EVPLFO5436	810	849	54	36	2 7/8
		EVPLFO5442	912	959	54	42	2 7/8
		EVPLFO5448	984	1034	54	48	2 7/8
		EVPLFO5454	1091	1146	54	54	2 7/8
	Open Middle Light Panel - 12”H Opening - 66” High	EVPLFO6618	588	616	60	18	2 7/8
		EVPLFO6624	678	715	60	24	2 7/8
		EVPLFO6630	779	824	60	30	2 7/8
		EVPLFO6636	887	939	60	36	2 7/8
		EVPLFO6642	1000	1058	60	42	2 7/8
		EVPLFO6648	1078	1146	60	48	2 7/8
		EVPLFO6654	1195	1270	60	54	2 7/8
	EVPLFO6660	1307	1389	60	60	2 7/8	

**EVFPFO - OPEN MIDDLE PREMIUM PANEL - 12”H OPENING**

- Open Middle Premium Panel incorporates a 12”H middle position open module with fabric modules, within a steel frame.
- Open Middle Premium Panel Incorporates a 12”H opening above 30”H base module to provide pass-through convenience.
- Premium panels incorporate 12”H modules above 30”H base section.
- Opposite sides of each panel may have a different fabric within the same grade at no upcharge.
- If different grades of fabric are used on one panel, the entire panel must be priced at highest grade.
- An aluminum low profile top cap is included.
- Stackability: Evolve panels can be increased in height in 6”H, 12”H, 18”H or 24”H increments. See Extension Module (pages 82-90) for part numbers.

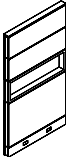
	DESCRIPTION	PRODUCT CODE	LIST PRICE		DIMENSIONS/INCHES		
			Gr1	Gr2	H	W	D
	Open Middle Premium Panel - 12”H Opening - 66” High	EVFPFO6618	703	734	66	18	2 7/8
		EVFPFO6624	813	857	66	24	2 7/8
		EVFPFO6630	935	985	66	30	2 7/8
		EVFPFO6636	1059	1113	66	36	2 7/8
		EVFPFO6642	1204	1268	66	42	2 7/8
		EVFPFO6648	1294	1368	66	48	2 7/8
		EVFPFO6654	1435	1514	66	54	2 7/8
		EVFPFO6660	1580	1671	66	60	2 7/8

**EVPLFPO - OPEN MIDDLE PREMIUM LIGHT PANEL - 12” OPENING**

- Open Middle Premium Light Panel incorporates a 12”H middle position open module with fabric modules, within a steel frame.
- Open Middle Premium Light Panel Incorporates a 12”H opening above 30”H base module to provide pass-through convenience.
- Premium panels incorporate 12”H modules above 30”H base section.
- There is no base raceway in Light Panels to accommodate electrical.
- Light Panel Connectors must be used in conjunction with Light Panels.
- Opposite sides of each panel may have a different fabric within the same grade at no upcharge.
- If different grades of fabric are used on one panel, the entire panel must be priced at highest grade.
- An aluminum low profile top cap is included.
- Stackability: Evolve panels can be increased in height in 6”H, 12”H, 18”H or 24”H increments. See Extension Module (pages 82-90) for part numbers.

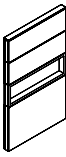
	DESCRIPTION	PRODUCT CODE	LIST PRICE		DIMENSIONS/INCHES		
			Gr1	Gr2	H	W	D
	Open Middle Premium Light Panel - 12”H Opening - 66” High	EVPLFPO6618	667	696	66	18	2 7/8
		EVPLFPO6624	774	810	66	24	2 7/8
		EVPLFPO6630	888	931	66	30	2 7/8
		EVPLFPO6636	1006	1055	66	36	2 7/8
		EVPLFPO6642	1144	1204	66	42	2 7/8
		EVPLFPO6648	1230	1296	66	48	2 7/8
		EVPLFPO6654	1363	1436	66	54	2 7/8
		EVPLFPO6660	1501	1584	66	60	2 7/8



**EVFOX - OPEN MIDDLE PANEL - 24”H OPENING**

- Open Middle Panel incorporates a 24”H middle position open module with fabric modules, within a steel frame.
- Open Middle Panel Incorporates a 24”H opening above 30”H base module to provide pass-through convenience.
- Opposite sides of each panel may have a different fabric within the same grade at no upcharge.
- If different grades of fabric are used on one panel, the entire panel must be priced at highest grade.
- An aluminum low profile top cap is included.
- Stackability: Evolve panels can be increased in height in 6”H, 12”H, 18”H or 24”H increments. See Extension Module (pages 82-90) for part numbers.

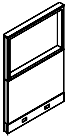
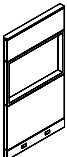
	DESCRIPTION	PRODUCT CODE	LIST PRICE		DIMENSIONS/INCHES		
			Gr1	Gr2	H	W	D
	Open Middle Panel - 24”H Opening - 54” High	EVFOX5418	469	486	54	18	2 7/8
		EVFOX5424	534	558	54	24	2 7/8
		EVFOX5430	612	636	54	30	2 7/8
		EVFOX5436	685	716	54	36	2 7/8
		EVFOX5442	763	796	54	42	2 7/8
		EVFOX5448	822	860	54	48	2 7/8
		EVFOX5454	902	940	54	54	2 7/8
	Open Middle Panel - 24”H Opening - 66” High	EVFOX6618	608	634	66	18	2 7/8
		EVFOX6624	699	730	66	24	2 7/8
		EVFOX6630	822	860	66	30	2 7/8
		EVFOX6636	897	938	66	36	2 7/8
		EVFOX6642	1007	1058	66	42	2 7/8
		EVFOX6648	1078	1132	66	48	2 7/8
		EVFOX6654	1191	1250	66	54	2 7/8
		EVFOX6660	1297	1366	66	60	2 7/8



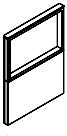
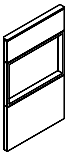

**EVPLFOX - OPEN MIDDLE LIGHT PANEL - 24”H OPENING**

- Open Middle Panel incorporates a 24”H middle position open module with fabric modules, within a steel frame.
- Open Middle Panel Incorporates a 24”H opening above 30”H base module to provide pass-through convenience.
- There is no base raceway in Light Panels to accommodate electrical.
- Light Panel Connectors must be used in conjunction with Light Panels.
- Opposite sides of each panel may have a different fabric within the same grade at no upcharge.
- If different grades of fabric are used on one panel, the entire panel must be priced at highest grade.
- An aluminum low profile top cap is included.
- Stackability: Evolve panels can be increased in height in 6”H, 12”H, 18”H or 24”H increments. See Extension Module (pages 82-90) for part numbers.

	DESCRIPTION	PRODUCT CODE	LIST PRICE		DIMENSIONS/INCHES		
			Gr1	Gr2	H	W	D
	Open Middle Light Panel - 24”H Opening - 54” High	EVPLFOX5418	445	459	54	18	2 7/8
		EVPLFOX5424	505	527	54	24	2 7/8
		EVPLFOX5430	581	601	54	30	2 7/8
		EVPLFOX5436	652	678	54	36	2 7/8
		EVPLFOX5442	719	750	54	42	2 7/8
		EVPLFOX5448	779	813	54	48	2 7/8
		EVPLFOX5454	858	896	54	54	2 7/8
	Open Middle Light Panel - 24”H Opening - 66” High	EVPLFOX6618	577	600	66	18	2 7/8
		EVPLFOX6624	665	693	66	24	2 7/8
		EVPLFOX6630	779	813	66	30	2 7/8
		EVPLFOX6636	851	888	66	36	2 7/8
		EVPLFOX6642	957	1003	66	42	2 7/8
		EVPLFOX6648	1022	1074	66	48	2 7/8
		EVPLFOX6654	1130	1185	66	54	2 7/8
		EVPLFOX6660	1235	1296	66	60	2 7/8

**EVPFANR - SEGMENTED NO RACEWAY PANEL**

- Segmented No Raceway panel incorporates fabric modules within steel frame.
- There is no base raceway in No Raceway Panels to accommodate electric.
- No Raceway connectors to be used.
- Fabric covered modules are tackable and acoustical.
- Each side of fabric module may have different fabric within the same grade at no charge.
- If different grades of fabric are used, the entire module must be price at highest grade.
- Aluminum low profile top and bottom cap is included.
- Stackability: Evolve panels can be increased in height in 6”H, 12”H, 18”H, 24”H increments. See module listing for part numbers See Extension Module (pages 82-90) for part numbers.

	DESCRIPTION	PRODUCT CODE	LIST PRICE		DIMENSIONS/INCHES		
			Gr1	Gr2	H	W	D
	Segmented NR Panel - 30" High	EVPPFA3018NR	371	385	30	18	2 7/8
		EVPPFA3024NR	385	407	30	24	2 7/8
		EVPPFA3030NR	432	453	30	30	2 7/8
		EVPPFA3036NR	466	494	30	36	2 7/8
		EVPPFA3042NR	499	533	30	42	2 7/8
		EVPPFA3048NR	548	588	30	48	2 7/8
		EVPPFA3054NR	594	634	30	54	2 7/8
	Segmented NR Panel - 42" High	EVPPFA4218NR	411	435	42	18	2 7/8
		EVPPFA4224NR	436	466	42	24	2 7/8
		EVPPFA4230NR	504	542	42	30	2 7/8
		EVPPFA4236NR	542	587	42	36	2 7/8
		EVPPFA4242NR	621	666	42	42	2 7/8
		EVPPFA4248NR	666	721	42	48	2 7/8
		EVPPFA4254NR	737	800	42	54	2 7/8
	Segmented NR Panel - 48" High	EVPPFA4818NR	442	475	48	18	2 7/8
		EVPPFA4824NR	481	523	48	24	2 7/8
		EVPPFA4830NR	553	600	48	30	2 7/8
		EVPPFA4836NR	615	674	48	36	2 7/8
		EVPPFA4842NR	695	763	48	42	2 7/8
		EVPPFA4848NR	774	847	48	48	2 7/8
		EVPPFA4854NR	839	918	48	54	2 7/8
	Segmented NR Panel - 54" High	EVPPFA5418NR	442	475	54	18	2 7/8
		EVPPFA5424NR	481	523	54	24	2 7/8
		EVPPFA5430NR	553	600	54	30	2 7/8
		EVPPFA5436NR	615	674	54	36	2 7/8
		EVPPFA5442NR	695	763	54	42	2 7/8
		EVPPFA5448NR	774	847	54	48	2 7/8
		EVPPFA5454NR	839	918	54	54	2 7/8
	Segmented NR Panel - 66" High	EVPPFA6618NR	556	596	66	18	2 7/8
		EVPPFA6624NR	597	648	66	24	2 7/8
		EVPPFA6630NR	664	721	66	30	2 7/8
		EVPPFA6636NR	776	849	66	36	2 7/8
		EVPPFA6642NR	874	956	66	42	2 7/8
		EVPPFA6648NR	940	1032	66	48	2 7/8
		EVPPFA6654NR	1019	1121	66	54	2 7/8
EVPPFA6660NR	1104	1216	66	60	2 7/8		





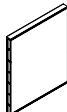
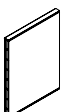
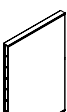
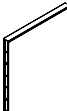
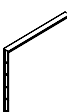

**EVPFAMNR - MONOLITHIC NO RACEWAY PANEL**

- Monolithic No Raceway panel incorporates fabric modules within steel frame.
- There is no base raceway in No Raceway Panels to accommodate electric.
- No Raceway connectors to be used.
- Fabric covered modules are tackable and acoustical.
- Each side of fabric module may have different fabric within the same grade at no charge.
- If different grades of fabric are used, the entire module must be price at highest grade.
- Aluminum low profile top and bottom cap is included.
- Stackability: Evolve panels can be increased in height in 6”H, 12”H, 18”H, 24”H increments. See module listing for part numbers See Extension Module (pages 82-90) for part numbers.

	DESCRIPTION	PRODUCT CODE	LIST PRICE		DIMENSIONS/INCHES		
			Gr1	Gr2	H	W	D
	Monolithic NR Panel 42" High	EVPFAM4218NR	383	416	42	18	2 7/8
		EVPFAM4224NR	407	446	42	24	2 7/8
		EVPFAM4230NR	469	517	42	30	2 7/8
		EVPFAM4236NR	499	556	42	36	2 7/8
		EVPFAM4242NR	553	622	42	42	2 7/8
		EVPFAM4248NR	600	678	42	48	2 7/8
		EVPFAM4254NR	658	744	42	54	2 7/8
		EVPFAM4260NR	714	807	42	60	2 7/8
	Monolithic NR Panel - 48" High	EVPFAM4818NR	388	421	48	18	2 7/8
		EVPFAM4824NR	425	470	48	24	2 7/8
		EVPFAM4830NR	493	542	48	30	2 7/8
		EVPFAM4836NR	536	594	48	36	2 7/8
		EVPFAM4842NR	597	666	48	42	2 7/8
		EVPFAM4848NR	648	725	48	48	2 7/8
		EVPFAM4854NR	717	805	48	54	2 7/8
		EVPFAM4860NR	779	872	48	60	2 7/8
	Monolithic NR Panel - 54" High	EVPFAM5418NR	393	425	54	18	2 7/8
		EVPFAM5424NR	432	472	54	24	2 7/8
		EVPFAM5430NR	501	553	54	30	2 7/8
		EVPFAM5436NR	556	616	54	36	2 7/8
		EVPFAM5442NR	622	689	54	42	2 7/8
		EVPFAM5448NR	676	750	54	48	2 7/8
		EVPFAM5454NR	737	829	54	54	2 7/8
		EVPFAM5460NR	810	906	54	60	2 7/8
	Monolithic NR Panel - 66" High	EVPFAM6618NR	483	517	66	18	2 7/8
		EVPFAM6624NR	532	574	66	24	2 7/8
		EVPFAM6630NR	597	649	66	30	2 7/8
		EVPFAM6636NR	695	753	66	36	2 7/8
		EVPFAM6642NR	779	847	66	42	2 7/8
		EVPFAM6648NR	844	919	66	48	2 7/8
		EVPFAM6654NR	940	1021	66	54	2 7/8
		EVPFAM6660NR	1033	1124	66	60	2 7/8
	Monolithic NR Panel - 90" High	EVPFAM9018NR	849	911	90	18	2 7/8
		EVPFAM9024NR	919	994	90	24	2 7/8
		EVPFAM9030NR	1022	1118	90	30	2 7/8
		EVPFAM9036NR	1190	1295	90	36	2 7/8

**EVPH1SNR - LAMINATE NO RACEWAY - PANEL SINGLE SIDED**



- Laminate No Raceway panel incorporates single sided laminate modules within steel frame.
- Opposite side is fabric covered.
- Laminate faces on all modules provide durable, washable surfaces on One Side of the panel.
- Available in high pressure laminate only.
- If wood grain is selected, grain runs horizontally.
- There is no base raceway in No Raceway Panels to accommodate electric.
- No Raceway connectors to be used.
- If different grades of fabric are used, the entire module must be priced at highest grade.
- An aluminum low profile top and bottom cap is included.
- Stackability: Evolve panels can be increased in height in 6”H, 12”H, 18”H, 24”H increments. See module listing for part numbers.

	DESCRIPTION	PRODUCT CODE	LIST PRICE		DIMENSIONS/INCHES		
			Gr1	Gr2	H	W	D
	Laminate NR Panel - Single Sided - 30" High	EVPH1S3018NR	456	464	30	18	2 7/8
		EVPH1S3024NR	546	557	30	24	2 7/8
		EVPH1S3030NR	634	646	30	30	2 7/8
		EVPH1S3036NR	721	737	30	36	2 7/8
		EVPH1S3042NR	821	834	30	42	2 7/8
		EVPH1S3048NR	891	908	30	48	2 7/8
		EVPH1S3054NR	983	1007	30	54	2 7/8
		EVPH1S3060NR	1081	1103	30	60	2 7/8
	Laminate NR Panel - Single Sided - 42" High	EVPH1S4218NR	543	554	42	18	2 7/8
		EVPH1S4224NR	645	664	42	24	2 7/8
		EVPH1S4230NR	757	775	42	30	2 7/8
		EVPH1S4236NR	866	888	42	36	2 7/8
		EVPH1S4242NR	981	1007	42	42	2 7/8
		EVPH1S4248NR	1067	1095	42	48	2 7/8
		EVPH1S4254NR	1183	1216	42	54	2 7/8
		EVPH1S4260NR	1296	1334	42	60	2 7/8
	Laminate NR Panel - Single Sided - 54" High	EVPH1S5418NR	635	646	54	18	2 7/8
		EVPH1S5424NR	767	788	54	24	2 7/8
		EVPH1S5430NR	899	922	54	30	2 7/8
		EVPH1S5436NR	1028	1055	54	36	2 7/8
		EVPH1S5442NR	1163	1199	54	42	2 7/8
		EVPH1S5448NR	1272	1311	54	48	2 7/8
		EVPH1S5454NR	1413	1452	54	54	2 7/8
		EVPH1S5460NR	1553	1599	54	60	2 7/8
	Laminate NR Panel - Single Sided - 66" High	EVPH1S6618NR	786	808	66	18	2 7/8
		EVPH1S6624NR	945	974	66	24	2 7/8
		EVPH1S6630NR	1105	1140	66	30	2 7/8
		EVPH1S6636NR	1275	1313	66	36	2 7/8
		EVPH1S6642NR	1448	1489	66	42	2 7/8
		EVPH1S6648NR	1448	1489	66	48	2 7/8
		EVPH1S6654NR	1757	1807	66	54	2 7/8
		EVPH1S6660NR	1931	1989	66	60	2 7/8

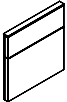
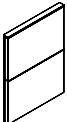

**EVPH2SNR - LAMINATE NO RACEWAY - PANEL DOUBLE SIDED**

- Laminate No Raceway panel incorporates double sided laminate modules, within steel frame.
- Laminate faces on all modules provide durable, washable surfaces on both sides of the panel.
- Available in high pressure laminate only.
- If wood grain is selected, grain runs horizontally.
- There is no base raceway in No Raceway Panels to accommodate electric.
- No Raceway connectors to be used.
- If different grades of fabric are used, the entire module must be priced at highest grade.
- An aluminum low profile top and bottom cap is included.
- Stackability: Evolve panels can be increased in height in 6”H, 12”H, 18”H, 24”H increments. See module listing for part numbers.

	DESCRIPTION	PRODUCT CODE	LIST PRICE	DIMENSIONS/INCHES		
				H	W	D
	Laminate NR Panel - Double Sided - 30" High	EVPH2S3018NR	622	30	18	2 7/8
		EVPH2S3024NR	622	30	24	2 7/8
		EVPH2S3030NR	734	30	30	2 7/8
		EVPH2S3036NR	839	30	36	2 7/8
		EVPH2S3042NR	954	30	42	2 7/8
		EVPH2S3048NR	1066	30	48	2 7/8
		EVPH2S3054NR	1181	30	54	2 7/8
EVPH2S3060NR	1275	30	60	2 7/8		
	Laminate NR Panel - Double Sided - 42" High	EVPH2S4218NR	604	42	18	2 7/8
		EVPH2S4224NR	734	42	24	2 7/8
		EVPH2S4230NR	865	42	30	2 7/8
		EVPH2S4236NR	1004	42	36	2 7/8
		EVPH2S4242NR	1144	42	42	2 7/8
		EVPH2S4248NR	1282	42	48	2 7/8
		EVPH2S4254NR	1410	42	54	2 7/8
EVPH2S4260NR	1533	42	60	2 7/8		
	Laminate NR Panel - Double Sided - 54" High	EVPH2S5418NR	708	54	18	2 7/8
		EVPH2S5424NR	867	54	24	2 7/8
		EVPH2S5430NR	1027	54	30	2 7/8
		EVPH2S5436NR	1192	54	36	2 7/8
		EVPH2S5442NR	1362	54	42	2 7/8
		EVPH2S5448NR	1531	54	48	2 7/8
		EVPH2S5454NR	1687	54	54	2 7/8
EVPH2S5460NR	1834	54	60	2 7/8		
	Laminate NR Panel - Double Sided - 66" High	EVPH2S6618NR	891	66	18	2 7/8
		EVPH2S6624NR	1095	66	24	2 7/8
		EVPH2S6630NR	1296	66	30	2 7/8
		EVPH2S6636NR	1504	66	36	2 7/8
		EVPH2S6642NR	1723	66	42	2 7/8
		EVPH2S6648NR	1931	66	48	2 7/8
		EVPH2S6654NR	2132	66	54	2 7/8
EVPH2S6660NR	2328	66	60	2 7/8		

**EVPGTNR - FULLY GLAZED SEGMENTED NO RACEWAY PANEL**



# PANELS

# FULLY GLAZED MONOLITHIC - NO RACEWAY

- Fully Glazed Segmented No Raceway Panels are incorporated in solid steel frame
- There is no base raceway in No Raceway Panels to accommodate electric
- No Raceway connectors to be used
- Standard in clear (CLR) or smoked glass (SMK) as option
- Frosted glass (FRST) 40% upcharge
- Aluminum low profile top and bottom cap is included
- Stackability: Evolve panels can be increased in height in 6"H, 12"H, 18"H, 24"H increments. See module listing for part numbers.

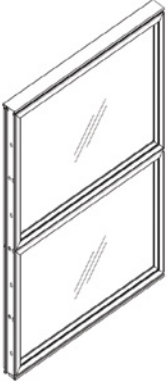
DESCRIPTION	PRODUCT CODE	LIST PRICE	DIMENSIONS/INCHES		
			H	W	D
 Glazed Segmented NR Panel 48" H	EVPGT4818NR	748	48	18	2 7/8
	EVPGT4824NR	919	48	24	2 7/8
	EVPGT4830NR	1017	48	30	2 7/8
	EVPGT4836NR	1110	48	36	2 7/8
	EVPGT4842NR	1229	48	42	2 7/8
	EVPGT4848NR	1371	48	48	2 7/8
	EVPGT4854NR	1509	48	54	2 7/8
	EVPGT4860NR	1646	48	60	2 7/8

## EVPXGTNR - FULLY GLAZED MONOLITHIC NO RACEWAY PANEL

- Fully Glazed Monolithic No Raceway Panels are incorporated in solid steel frame.
- There is no base raceway in No Raceway Panels to accommodate electric.
- No Raceway connectors to be used.
- Standard in clear (CLR) or smoked glass (SMK) as option.
- Frosted glass (FRST) 40% upcharge.
- Size 90"x36"W is maximum size allowed.
- Panel height to align with standard door height.
- Aluminum low profile top and bottom cap is included.
- Stackability: Evolve panels can be increased in height in 6"H, 12"H, 18"H, 24"H increments. See module listing for part numbers.

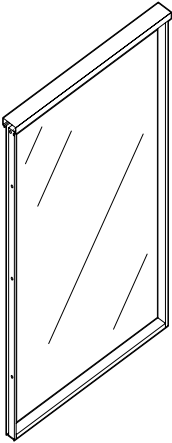
DESCRIPTION	PRODUCT CODE	LIST PRICE	DIMENSIONS/INCHES		
			H	W	D
 Glazed Monolithic NR Panel 90" High	EVPXGT9018NR	951	90	18	2 7/8
	EVPXGT9024NR	1085	90	24	2 7/8
	EVPXGT9030NR	1230	90	30	2 7/8
	EVPXGT9036NR	1330	90	36	2 7/8



**EVPICNR - INLINE CONNECTOR NO RACEWAY PANEL**

- Connects two No Raceway Panels in a straight run.
- Provides slotted support for worksurfaces and hang on components.
- Includes one slotted connector with leveling glide and connecting hardware.
- Connectors are available without slots, as a special at no extra charge. Contact Customer Support.

	DESCRIPTION	PRODUCT CODE	LIST PRICE	DIMENSIONS/INCHES		
				H	W	D
	Inline Connector No Raceway Panel	EVPIC30NR	77	30	2	
	To be used only with 90" H NR Glazed Panels	EVPIC42NR	90	42	2	
		EVPIC48NR	94	48	2	
		EVPIC54NR	97	54	2	
		EVPIC66NR	108	66	2	

**EVPICPNR - INLINE CONNECTOR PANEL - NO RACEWAY PANEL**

- Connects Panel to No Raceway panel in straight run.
- Provides slotted support for worksurfaces and hang on components.
- Includes one slotted connector with leveling glide and connecting hardware.
- Connectors are available without slots, as a special at no extra charge. Contact Customer Support.
- Note: Allows to connect panel to NR panel in straight run.

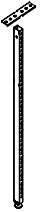
	DESCRIPTION	PRODUCT CODE	LIST PRICE	DIMENSIONS/INCHES		
				H	W	D
	Inline Connector Panel - No Raceway Panel	EVPIC30PNR	74	30	2	
		EVPIC42PNR	86	42	2	
		EVPIC48PNR	90	48	2	
		EVPIC54PNR	92	54	2	
		EVPIC66PNR	102	66	2	

**EVPIC90NR - INLINE CONNECTOR NO RACEWAY PANEL**

- Connects two 90" H No Raceway panel in straight run.
- Includes one slotted connector with leveling glide and connecting hardware.
- Connectors are without slots
- To be used only with 90" H NR Glazed Panels.

	DESCRIPTION	PRODUCT CODE	LIST PRICE	DIMENSIONS/INCHES		
				H	W	D
	Inline Connector No Raceway Panel	EVPIC90NR	162	90	2	

**EVVIC90PNR - INLINE CONNECTOR PANEL - NO RACEWAY PANEL**

- Connects 90" H No Raceway panel to 90" H door in straight run.
- Includes one non slotted connector with leveling glide and connecting hardware
- Connectors are without slots.
- Note: To be used only with 90" H NR Glazed Panels and 90" H door

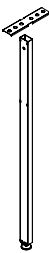
	DESCRIPTION	PRODUCT CODE	LIST PRICE	DIMENSIONS/INCHES		
				H	W	D
	Inline Connector Panel - No Raceway Panel	EVVIC90PNR	162	90	2	

**EVVVCNR - INLINE VARIABLE HEIGHT CONNECTOR NO RACEWAY PANEL**

- Connects two No Raceway panels of differing height in straight run.
- Connector must reference taller panel.
- Can be used for any variation of panel height.
- Variable height trim must be ordered separately (see EVPTVA).
- Provides slotted support for worksurfaces and hang on components.
- Includes one slotted connector with leveling glide and connecting hardware.
- Connectors are available without slots, as a special at no extra charge. Contact customer support..

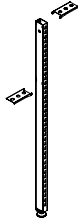
	DESCRIPTION	PRODUCT CODE	LIST PRICE	DIMENSIONS/INCHES		
				H	W	D
	Inline Variable Height Connector No Raceway Panel	EVVVC42NR	97	42	2	
		EVVVC48NR	99	48	2	
		EVVVC54NR	101	54	2	
		EVVVC66NR	109	66	2	

**EVVVC66PNR - INLINE VARIABLE HEIGHT CONNECTOR PANEL - NO RACEWAY PANEL**

- Connects Panel to No Raceway panels of differing height in straight run.
- Connector must reference taller panel.
- Can be used for any variation of panel height.
- Variable height trim must be ordered separately (see EVPTVA).
- Provides slotted support for worksurfaces and hang on components.
- Includes one slotted connector with leveling glide and connecting hardware.
- Connectors are available without slots, as a special at no extra charge. Contact customer support.
- Note: Allows to connect panel to NR panel in straight run

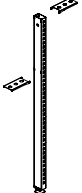
	DESCRIPTION	PRODUCT CODE	LIST PRICE	DIMENSIONS/INCHES		
				H	W	D
	Inline Variable Height Connector Panel - No Raceway Panel	EVVVC42PNR	102	42	2	
		EVVVC48PNR	109	48	2	
		EVVVC54PNR	123	54	2	
		EVVVC66PNR	136	66	2	



**EVPERANR - END OF RUN POST KIT FOR NO RACEWAY PANEL**

- Connects at end of No Raceway panel and can attach to a panel to fixed wall.
- Adds 1" to width of panel run.
- Provides slotted support for worksurfaces and hang on components.
- Includes one slotted connector with leveling glide and connecting hardware and glide and connecting hardware and trim kit.
- Can be attached to face of another panel to provide off modular connection.
- Connectors are available without slots, as a special at no extra charge. Contact customer support.

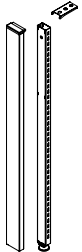
DESCRIPTION	PRODUCT CODE	LIST PRICE	DIMENSIONS/INCHES		
			H	W	D
 End End of Run Post Kit No Raceway Panel	EVPERA30NR	94	30	2	
	EVPERA42NR	108	42	2	
	EVPERA48NR	114	48	2	
	EVPERA54NR	128	54	2	
	EVPERA66NR	142	66	2	

**EVPERA90NR - END OF RUN POST KIT FOR NO RACEWAY PANEL**

- Connects two 90" H No Raceway panel and can attach to a panel to fixed wall.
- Adds 1" to width of panel run.
- Includes Non-Slotted connector with leveling glide and connecting hardware and trim kit.
- Can be attached to face of another panel to provide off modular connection.
- Connectors are without slots.
- To be used only with 90" H NR Glazed Panels.

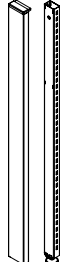
DESCRIPTION	PRODUCT CODE	LIST PRICE	DIMENSIONS/INCHES		
			H	W	D
 End End of Run Post Kit To be used only with 90" H NR Glazed Panels	EVPERA90NR	203	66	2	

**EVPCPA1NR - ONE WAY CORNER POST NO RACEWAY PANEL**

- Connects at end of No Raceway panel run in place of EVPERA- End of run post kit.
- Should not be used to attach panel to fixed wall.
- Post and connecting hardware add 3.25" to power beam run.
- Provides slotted support for worksurfaces and hang on components.
- Includes post, panel connectors and power beam connectors, post with trim all around, levelling glide, hardware and trim kit.
- Connectors are available without slots, as a special at no extra charge. Contact customer support.

	DESCRIPTION	PRODUCT CODE	LIST PRICE	DIMENSIONS/INCHES		
				H	W	D
	One Way Corner Post	EVPCPA130NR	125	30	2 7/8	
	No Raceway Panel	EVPCPA142NR	142	42	2 7/8	
		EVPCPA148NR	167	48	2 7/8	
		EVPCPA154NR	190	54	2 7/8	
		EVPCPA166NR	233	66	2 7/8	

**EVPCPA190NR - ONE WAY CORNER POST NO RACEWAY PANEL**

- Connects at end of 90" H No Raceway panel run in place of EVPERA - End of run post kit.
- Should not be used to attach panel to fixed wall.
- Post and connecting hardware add 3.25" to power beam run.
- Includes post, panel connectors and power beam connectors, post with trim all around, levelling glide, hardware and trim kit.
- Connectors are without slots.
- To be used only with 90" H NR Glazed Panels.

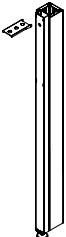
	DESCRIPTION	PRODUCT CODE	LIST PRICE	DIMENSIONS/INCHES		
				H	W	D
	One Way Corner Post No Raceway Panel To be used only with 90" H NR Glazed Panels	EVPCPA190NR	344	90	2 7/8	



**EVPIPA2NR - INLINE TWO WAY CORNER POST NO RACEWAY PANEL**

- Connects two No Raceway panel of equal height in straight run.
- Post and connecting hardware add 3.25" to power beam run.
- Provides slotted support for worksurfaces and hang on components.
- Includes post, panel connectors and power beam connectors, post with trim all around, levelling glide, hardware and trim kit.
- Connectors are available without slots, as a special at no extra charge. Contact customer support.

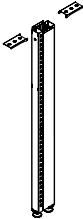
	DESCRIPTION	PRODUCT CODE	LIST PRICE	DIMENSIONS/INCHES		
				H	W	D
	Inline Two Way Corner Post	EVPIPA230NR	171	30	2 7/8	
	No Raceway Panel	EVPIPA242NR	216	42	2 7/8	
		EVPIPA248NR	236	48	2 7/8	
		EVPIPA254NR	258	54	2 7/8	
		EVPIPA266NR	306	66	2 7/8	

**EVPIPA290NR - INLINE TWO WAY CORNER POST NO RACEWAY PANEL**

- Connects two No Raceway panel of equal height in a straight run.
- Post and connecting hardware add 3.25" to power beam run.
- Includes post, panel connectors and power beam connectors, post with trim all around, levelling glide, hardware and trim kit.
- Connectors are without slots.
- To be used only with 90" H NR Glazed Panels.

	DESCRIPTION	PRODUCT CODE	LIST PRICE	DIMENSIONS/INCHES		
				H	W	D
	Inline Two Way Corner Post	EVPIPA290NR	460	90	2 7/8	
	No Raceway Panel					
	To be used only with 90" H NR Glazed Panels					

**EVPCPA2PNR - TWO WAY CORNER POST NO RACEWAY PANEL-PANEL**

- Connects No Raceway panel and Raceway Panel of equal height in 90 degree configuration.
- Post and connecting hardware add 3.25" to power beam run.
- Provides slotted support for worksurfaces and hang on components.
- Includes post, panel connectors and power beam connectors, post with trim all around, levelling glide, hardware and trim kit.
- Connectors are available without slots, as a special at no extra charge. Contact customer support.

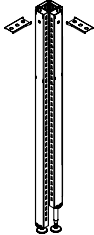
	DESCRIPTION	PRODUCT CODE	LIST PRICE	DIMENSIONS/INCHES		
				H	W	D
	Two Way Corner Post	EVPCPA230PNR	175	30	2 7/8	
	No Raceway Panel	EVPCPA242PNR	219	42	2 7/8	
		EVPCPA248PNR	233	48	2 7/8	
		EVPCPA254PNR	270	54	2 7/8	
		EVPCPA266PNR	321	66	2 7/8	

**EVPCPA290NR - TWO WAY CORNER POST NO RACEWAY PANEL**

- Connects two 90" H No Raceway panels of equal height in "T" configuration.
- Post and connecting hardware add 3.25" to power beam run.
- Includes post, panel connectors and power beam connectors, post with trim all around, levelling glide, hardware and trim kit.
- Connectors are without slots.
- To be used only with 90" H NR Glazed Panels.

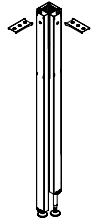
	DESCRIPTION	PRODUCT CODE	LIST PRICE	DIMENSIONS/INCHES		
				H	W	D
	Two Way Corner Post No Raceway Panel To be used only with 90" H NR Glazed Panels	EVPCPA290NR	461	90	2 7/8	



**EVPCPA3PNR - THREE WAY CORNER POST NO RACEWAY PANEL-PANEL-NO RACEWAY PANEL**

- Connects two No Raceway panels and Raceway Panels of equal height in "T" configuration.
- Post and connecting hardware add 3.25" to power beam run.
- Provides slotted support for worksurfaces and hang on components.
- Includes post, panel connectors and power beam connectors, post with trim all around, levelling glide, hardware and trim kit.
- Connectors are available without slots, as a special at no extra charge. Contact customer support.

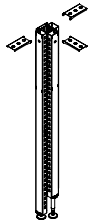

DESCRIPTION	PRODUCT CODE	LIST PRICE	DIMENSIONS/INCHES		
			H	W	D
Three Way Corner Post	EVPCPA330PNR	218	30	2 7/8	
No Raceway Panel	EVPCPA342PNR	291	42	2 7/8	
	EVPCPA348PNR	321	48	2 7/8	
	EVPCPA354PNR	352	54	2 7/8	
	EVPCPA366PNR	415	66	2 7/8	

**EVPCPA3PNRP - THREE WAY CORNER POST PANEL-NO RACEWAY PANEL-PANEL**

- Connects two panels and No raceway Panel of equal height in "T" configuration.
- Post and connecting hardware add 3.25" to power beam run.
- Provides slotted support for worksurfaces and hang on components.
- Includes post, panel connectors and power beam connectors, post with trim all around, levelling glide, hardware and trim kit.
- Connectors available without slots, as a special at no extra charge. Contact CustomerCare

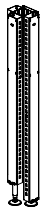

DESCRIPTION	PRODUCT CODE	LIST PRICE	DIMENSIONS/INCHES		
			H	W	D
Three Way Corner Post	EVPCPA330PNRP	218	30	2 7/8	
No Raceway Panel	EVPCPA342PNRP	291	42	2 7/8	
	EVPCPA348PNRP	321	48	2 7/8	
	EVPCPA354PNRP	352	54	2 7/8	
	EVPCPA366PNRP	415	66	2 7/8	

**EVPCPA390NR - THREE WAY CORNER POST NO RACEWAY PANEL**

- Connects two 90" H No Raceway panels of equal height in "T" configuration.
- Post and connecting hardware add 3.25" to power beam run.
- Includes post, panel connectors and power beam connectors, post with trim all around, levelling glide, hardware and trim kit.
- Connectors are without slots.
- To be used only with 90" H NR Glazed Panels.

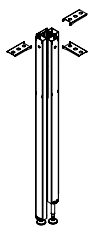

DESCRIPTION	PRODUCT CODE	LIST PRICE	DIMENSIONS/INCHES		
			H	W	D
Three Way Corner Post	EVPCPA390NR	582	90	2 7/8	
No Raceway Panel					
To be used only with 90" H NR Glazed Panels					



**EVPCPA4PNR - FOUR WAY CORNER POST NO RACEWAY PANEL-PANEL-NO RACEWAY PANEL-PANEL**

- Connects two No Raceway panels and two Raceway panels of equal height in "+" configuration.
- Post and connecting hardware add 3.25" to power beam run.
- Provides slotted support for worksurfaces and hang on components.
- Includes post, panel connectors and power beam connectors, post with trim all around, levelling glide, hardware and trim kit.
- Connectors are available without slots, as a special at no extra charge. Contact customer support.

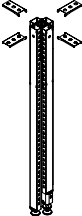
	DESCRIPTION	PRODUCT CODE	LIST PRICE	DIMENSIONS/INCHES		
				H	W	D
	Four Way Corner Post	EVPCPA430PNR	267	30	2 7/8	
	No Raceway Panel	EVPCPA442PNR	341	42	2 7/8	
		EVPCPA448PNR	378	48	2 7/8	
		EVPCPA454PNR	412	54	2 7/8	
		EVPCPA466PNR	483	66	2 7/8	

**EVPCPA490NR - FOUR WAY CORNER POST NO RACEWAY PANEL**

- Connects four 90" H No Raceway panels of equal height in "+" configuration.
- Post and connecting hardware add 3.25" to power beam run.
- Includes post, panel connectors and power beam connectors, post with trim all around, levelling glide, hardware and trim kit.
- Connectors are without slots.
- To be used only with 90" H NR Glazed Panels.

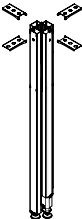
	DESCRIPTION	PRODUCT CODE	LIST PRICE	DIMENSIONS/INCHES		
				H	W	D
	Four Way Corner Post No Raceway Panel To be used only with 90" H NR Glazed Panels	EVPCPA490NR	668	90	2 7/8	



**EVLEPDSNC - LAMINATE DOUBLE SIDED GALLERY PANEL, FINISHED ENDS**

- Attaches to end of run connector with "U" channel.
- To be installed at end of panel run.
- Finished in thermally fused laminate.
- No connection on both sides.
- Laminate Gallery Panel height is inclusive of panel glides extended to their full height.
- If wood grain is selected, grain runs horizontally.
- End of run connector with "U" channel and bottom connecting brackets to be ordered separately.

	DESCRIPTION	PRODUCT CODE	LIST PRICE	DIMENSIONS/INCHES		
			LP	H	W	D
	Laminate Double Sided Gallery Panel	EVLEPDS4251NC	692	42	51	1
	Finished Ends - 42" High	EVLEPDS4263NC	901	42	63	1
		EVLEPDS4275NC	1110	42	75	1
	Laminate Double Sided Gallery Panel	EVLEPDS4851NC	754	48	51	1
	Finished Ends - 48" High	EVLEPDS4863NC	999	48	63	1
		EVLEPDS4875NC	1214	48	75	1
	Laminate Double Sided Gallery Panel	EVLEPDS5451NC	875	54	51	1
	Finished Ends - 54" High	EVLEPDS5463NC	1143	54	63	1
		EVLEPDS5475NC	1322	54	75	1





**EVLEPDS - LAMINATE DOUBLE SIDED GALLERY PANEL, CONNECTOR ENDS**

- Attaches to end of run connector with "U" channel.
- To be installed at end of panel run.
- Finished in thermally fused laminate.
- Locking connection both sides.
- Laminate Gallery Extension Panel height is inclusive of panel glides extended to their full height.
- If wood grain is selected, grain runs horizontally.
- End of run connector with "U" channel and bottom connecting brackets to be ordered separately.

	DESCRIPTION	PRODUCT CODE	LIST PRICE	DIMENSIONS/INCHES		
			LP	H	W	D
	Laminate Double Sided Gallery	EVLEPDS4251	692	42	51	1
	Panel - Connector Ends - 42" High	EVLEPDS4263	901	42	63	1
		EVLEPDS4275	1110	42	75	1
	Laminate Double Sided Gallery	EVLEPDS4851	754	48	51	1
	Panel - Connector Ends - 48" High	EVLEPDS4863	999	48	63	1
		EVLEPDS4875	1214	48	75	1
	Laminate Double Sided Gallery	EVLEPDS5451	875	54	51	1
	Panel - Connector Ends - 54" High	EVLEPDS5463	1143	54	63	1
		EVLEPDS5475	1322	54	75	1

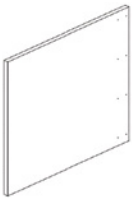
**EVLEPSSNC - LAMINATE SINGLE SIDED GALLERY PANEL, FINISHED ENDS**

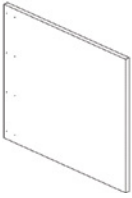



- Attaches to end of run connector with "U" channel.
- To be installed at end of panel run on one side.
- Finished in thermally fused laminate.
- No connection both sides.
- Laminate Gallery Extension Panel height is inclusive of panel glides extended to their full height.
- If wood grain is selected, grain runs horizontally.
- End of run connector with "U" channel and bottom connecting brackets to be ordered separately.

	DESCRIPTION	PRODUCT CODE	LIST PRICE LP	DIMENSIONS/INCHES		
				H	W	D
	Laminate Single Sided Gallery Panel - Finished Ends - 42" High	EVLEPSSL4227NC	450	42	27	1
		EVLEPSSL4233NC	502	42	33	1
		EVLEPSSL4239NC	564	42	39	1
		EVLEPSSL4245NC	646	42	45	1
		EVLEPSSL4251NC	692	42	51	1
	Laminate Single Sided Gallery Panel - Finished Ends - 48" High	EVLEPSSL4827NC	492	48	27	1
		EVLEPSSL4833NC	558	48	33	1
		EVLEPSSL4839NC	625	48	39	1
		EVLEPSSL4845NC	692	48	45	1
		EVLEPSSL4851NC	784	48	51	1
	Laminate Single Sided Gallery Panel - Finished Ends - 54" High	EVLEPSSL5427NC	541	54	27	1
		EVLEPSSL5433NC	618	54	33	1
		EVLEPSSL5439NC	704	54	39	1
		EVLEPSSL5445NC	824	54	45	1
		EVLEPSSL5451NC	875	54	51	1
	Laminate Single Sided Gallery Panel - Finished Ends - 42" High	EVLEPSSR4227NC	450	42	27	1
		EVLEPSSR4233NC	502	42	33	1
		EVLEPSSR4239NC	564	42	39	1
		EVLEPSSR4245NC	646	42	45	1
		EVLEPSSR4251NC	692	42	51	1
	Laminate Single Sided Gallery Panel - Finished Ends - 48" High	EVLEPSSR4827NC	492	48	27	1
		EVLEPSSR4833NC	558	48	33	1
		EVLEPSSR4839NC	625	48	39	1
		EVLEPSSR4845NC	692	48	45	1
		EVLEPSSR4851NC	784	48	51	1
	Laminate Single Sided Gallery Panel - Finished Ends - 54" High	EVLEPSSR5427NC	754	54	27	1
		EVLEPSSR5433NC	618	54	33	1
		EVLEPSSR5439NC	704	54	39	1
		EVLEPSSR5445NC	824	54	45	1
		EVLEPSSR5451NC	875	54	51	1



**EVLEPSS - LAMINATE SINGLE SIDED GALLERY PANEL, CONNECTOR END**

- Attaches to end of run connector with "U" channel.
- To be installed at end of panel run on one side.
- Finished in thermally fused laminate.
- Locking connection on one side.
- Laminate Gallery Extension Panel height is inclusive of panel glides extended to their full height.
- If wood grain is selected, grain runs horizontally.
- End of run connector with "U" channel and bottom connecting brackets to be ordered separately

	DESCRIPTION	PRODUCT CODE	LIST PRICE	DIMENSIONS/INCHES		
			LP	H	W	D
	Laminate Single Sided Gallery Panel - Connector Ends - 42" High	EVLEPSSL4227	450	42	27	1
		EVLEPSSL4233	502	42	33	1
		EVLEPSSL4239	564	42	39	1
		EVLEPSSL4245	646	42	45	1
		EVLEPSSL4251	692	42	51	1
	Laminate Single Sided Gallery Pannel - Connector Ends - 48" High	EVLEPSSL4827	492	48	27	1
		EVLEPSSL4833	558	48	33	1
		EVLEPSSL4839	625	48	39	1
		EVLEPSSL4845	692	42	45	1
		EVLEPSSL4851	784	42	51	1
	Laminate Single Sided Gallery Pannel - Connector Ends - 54" High	EVLEPSSL5427	541	54	27	1
		EVLEPSSL5433	618	54	33	1
		EVLEPSSL5439	704	42	39	1
		EVLEPSSL5445	824	54	45	1
		EVLEPSSL5451	875	42	51	1
	Laminate Single Sided Gallery Pannel - Connector Ends - 42" High	EVLEPSSR4227	450	42	27	1
		EVLEPSSR4233	502	42	33	1
		EVLEPSSR4239	564	42	39	1
		EVLEPSSR4245	646	42	45	1
		EVLEPSSR4251	692	42	51	1
	Laminate Single Sided Gallery Pannel - Connector Ends - 48" High	EVLEPSSR4827	492	48	27	1
		EVLEPSSR4833	558	48	33	1
		EVLEPSSR4839	625	48	39	1
		EVLEPSSR4845	692	42	45	1
		EVLEPSSR4851	784	42	51	1
	Laminate Single Sided Gallery Pannel - Connector Ends - 54" High	EVLEPSSR5427	541	54	27	1
		EVLEPSSR5433	618	54	33	1
		EVLEPSSR5439	704	54	39	1
		EVLEPSSR5445	824	42	45	1
		EVLEPSSR5451	875	42	51	1

**EVLEPDCNC - LAMINATE DOUBLE SIDED MIDDLE GALLERY PANEL, BASE POWER, FINISHED ENDS**

- Attaches in middle of panel run with connector with "U" channel.
- To be installed in middle between two panels in straight run.
- Finished in thermally fused laminate.
- Locking connection on both side.
- Laminate Gallery Panel height is inclusive of panel glides extended to their full height.
- If wood grain is selected, grain runs horizontally.
- End of run connector with "U" channel and bottom connecting brackets to be ordered separately.

	DESCRIPTION	PRODUCT CODE	LIST PRICE LP	DIMENSIONS/INCHES		
				H	W	D
	Laminate Double Sided Gallery Panel Finished Ends - 42" High	EVLEPDC4251NC	875	42	51	1
		EVLEPDC4263NC	901	42	63	1
		EVLEPDC4275NC	1110	42	75	1
	Laminate Double Sided Gallery Panel Finished Ends - 48" High	EVLEPDC4851NC	754	48	51	1
		EVLEPDC4863NC	999	48	63	1
		EVLEPDC4875NC	1214	48	75	1
	Laminate Double Sided Gallery Panel Finished Ends - 54" High	EVLEPDC4851NC	754	54	51	1
		EVLEPDC4863NC	999	54	63	1
		EVLEPDC4875NC	1214	54	75	1

**EVICLXPNC - LAMINATE DOUBLE SIDED MIDDLE GALLERY PANEL, BELTLINE POWER, FINISHED ENDS**

- Attaches in middle of panel run with connector with "U" channel
- To be installed in middle between two beltline panels in straight run .
- Finished in thermally fused laminate.
- No connection both sides.
- Laminate Gallery Panel height is inclusive of panel glides extended to their full height.
- If wood grain is selected, grain runs horizontally.
- End of run connector with "U" channel and bottom connecting brackets to be ordered separately.

	DESCRIPTION	PRODUCT CODE	LIST PRICE LP	DIMENSIONS/INCHES		
				H	W	D
	Laminate Double Sided Middle Gallery Panel - Finished Ends - 42" High	EVICLXP4251NC	692	42	51	1
		EVICLXP4263NC	901	42	63	1
		EVICLXP4275NC	1110	42	75	1
	Laminate Double Sided Middle Gallery Panel - Finished Ends - 48" High	EVICLXP4851NC	754	48	51	1
		EVICLXP4863NC	999	48	63	1
		EVICLXP4875NC	1214	48	75	1
	Laminate Double Sided Middle Gallery Panel - Finished Ends - 54" High	EVICLXP5451NC	875	54	51	1
		EVICLXP5463NC	1143	54	63	1
		EVICLXP5475NC	1322	54	75	1



**EVLEPDC - LAMINATE DOUBLE SIDED MIDDLE GALLERY PANEL, BASE POWER, CONNECTOR ENDS**

- Attaches to end of run connector with "U" channel.
- To be installed in middle between two panels in straight run.
- Finished in thermally fused laminate.
- Locking connection both sides.
- Laminate Gallery Extension Panel height is inclusive of panel glides extended to their full height.
- If wood grain is selected, grain runs horizontally.
- End of run connector with "U" channel and bottom connecting brackets to be ordered separately.

	DESCRIPTION	PRODUCT CODE	LIST PRICE	DIMENSIONS/INCHES		
			LP	H	W	D
	Laminate Double Sided Middle Gallery Panel - Connector End - 42" High	EVLEPDC4251	692	42	51	1
		EVLEPDC4263	901	42	63	1
		EVLEPDC4275	1110	42	75	1
	Laminate Single Sided Middle Gallery Panel - Connector End - 48" High	EVLEPDC4851	754	48	51	1
		EVLEPDC4863	999	48	63	1
		EVLEPDC4875	1214	48	75	1
	Laminate Single Sided Middle Gallery Panel - Connector End - 54" High	EVLEPDC5451	875	54	51	1
		EVLEPDC5463	1143	54	63	1
		EVLEPDC5475	1322	54	75	1

**EVICLXP - LAMINATE DOUBLE SIDED MIDDLE GALLERY PANEL, BELTLINE POWER, CONNECTOR ENDS**

- Attaches in middle of panel run with connector with "U" channel.
- To be installed in middle between two panels in straight run on one side.
- Finished in thermally fused laminate.
- Locking connection on both sides.
- Laminate Gallery Panel height is inclusive of panel glides extended to their full height.
- If wood grain is selected, grain runs horizontally.
- End of run connector with "U" channel and bottom connecting brackets to be ordered separately.

	DESCRIPTION	PRODUCT CODE	LIST PRICE	DIMENSIONS/INCHES		
			LP	H	W	D
	Laminate Double Sided Gallery Panel Connector Ends - 42" High	EVICLXP4251	692	42	51	1
		EVICLXP4263	901	42	63	1
		EVICLXP4275	1110	42	75	1
	Laminate Double Sided Gallery Panel Connector Ends - 48" High	EVICLXP4851	754	48	51	1
		EVICLXP4863	999	48	63	1
		EVICLXP4875	1214	48	75	1
	Laminate Double Sided Gallery Panel Connector Ends - 54" High	EVICLXP5451	875	54	51	1
		EVICLXP5463	1143	54	63	1
		EVICLXP5475	1322	42	75	1

**EVLEPSCNC - LAMINATE SINGLE SIDED MIDDLE GALLERY PANEL, BASE POWER, FINISHED ENDS**

- Attaches in middle of panel run with connector with "U" channel.
- To be installed in middle between two panels in straight run on one side.
- Cut out for electrics at base height.
- Finished in thermally fused laminate.
- No connection both sides.
- Laminate Gallery Panel height is inclusive of panel glides extended to their full height.
- If wood grain is selected, grain runs horizontally.
- End of run connector with "U" channel and bottom connecting brackets to be ordered separately.

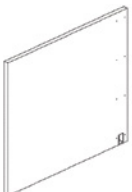
	DESCRIPTION	PRODUCT CODE	LIST PRICE LP	DIMENSIONS/INCHES		
				H	W	D
	Laminate Single Sided Gallery Panel - Finished End - 42" High	EVLEPSC4227NC	450	42	27	1
		EVLEPSC4233NC	502	42	33	1
		EVLEPSC4239NC	564	42	39	1
		EVLEPSC4245NC	646	42	45	1
		EVLEPSC4251NC	692	42	51	1
	Laminate Single Sided Gallery Panel - Finished End - 48" High	EVLEPSC4827NC	492	48	27	1
		EVLEPSC4833NC	558	48	33	1
		EVLEPSC4839NC	625	48	39	1
		EVLEPSC4845NC	692	48	45	1
		EVLEPSC4851NC	784	48	51	1
	Laminate Single Sided Gallery Panel - Finished End - 54" High	EVLEPSC5427NC	541	54	27	1
		EVLEPSC5433NC	618	54	33	1
		EVLEPSC5439NC	704	54	39	1
		EVLEPSC5445NC	824	54	45	1
		EVLEPSC5451NC	875	54	51	1

**EVLEPSC - LAMINATE SINGLE SIDED MIDDLE GALLERY PANEL, BASE POWER, CONNECTOR END**

- Attaches in middle of panel run with connector with "U" channel.
- To be installed in middle between two panels in straight run on one side.
- Finished in thermally fused laminate.
- Locking connection on one side.
- Laminate Gallery Panel height is inclusive of panel glides extended to their full height.
- If wood grain is selected, grain runs horizontally.
- End of run connector with "U" channel and bottom connecting brackets to be ordered separately.

	DESCRIPTION	PRODUCT CODE	LIST PRICE LP	DIMENSIONS/INCHES		
				H	W	D
	Laminate Single Sided Middle Gallery Panel - Connector Ends - 42" High	EVLEPSC4227	450	42	27	1
		EVLEPSC4233	502	42	33	1
		EVLEPSC4239	564	42	39	1
		EVLEPSC4245	646	42	45	1
		EVLEPSC4251	692	42	51	1
	Laminate Single Sided Middle Gallery Panel - Connector Ends - 48" High	EVLEPSC4827	492	48	27	1
		EVLEPSC4833	558	48	33	1
		EVLEPSC4839	625	48	39	1
		EVLEPSC4845	692	42	45	1
		EVLEPSC4851	784	42	51	1
	Laminate Single Sided Middle Gallery Panel - Connector Ends - 54" High	EVLEPSC5427	541	54	27	1
		EVLEPSC5433	618	54	33	1
		EVLEPSC5439	704	42	39	1
		EVLEPSC5445	824	54	45	1
		EVLEPSC5451	875	42	51	1



**EVLEPSCNC - LAMINATE SINGLE SIDED MIDDLE GALLERY PANEL, BELTLINE POWER, FINISHED ENDS**

- Attaches in middle of panel run with connector with “U” channel.
- To be installed in middle between two beltline panels in straight run.
- Cut out for electrics at beltline height.
- Finished in thermally fused laminate.
- No connection both sides.
- Laminate Gallery Panel height is inclusive of panel glides extended to their full height.
- If wood grain is selected, grain runs horizontally.
- End of run connector with “U” channel and bottom connecting brackets to be ordered separately.

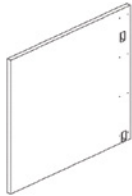
	DESCRIPTION	PRODUCT CODE	LIST PRICE	DIMENSIONS/INCHES		
			LP	H	W	D
	Laminate Single Sided Gallery Panel Finished Ends - 42” High	EVLEPSCB4227NC	450	42	27	1
		EVLEPSCB4233NC	502	42	33	1
		EVLEPSCB4239NC	564	42	39	1
		EVLEPSCB4245NC	692	42	45	1
		EVLEPSCB4251NC	692	42	51	1
	Laminate Single Sided Gallery Panel Finished Ends - 48” High	EVLEPSCB4827NC	492	48	27	1
		EVLEPSCB4833NC	558	48	33	1
		EVLEPSCB4839NC	625	48	39	1
		EVLEPSCB4845NC	692	48	45	1
		EVLEPSCB4851NC	784	48	51	1
	Laminate Single Sided Gallery Panel Finished Ends - 54” High	EVLEPSCB5427NC	541	54	27	1
		EVLEPSCB5433NC	618	54	33	1
		EVLEPSCB5439NC	704	54	39	1
		EVLEPSCB5445NC	824	54	45	1
		EVLEPSCB5451NC	875	54	51	1

**EVLEPSC - LAMINATE SINGLE SIDED MIDDLE GALLERY PANEL, BELTLINE POWER, CONNECTOR END**



- Attaches in middle of panel run with connector with “U” channel.
- To be installed in middle between two panels in straight run on one side.
- Finished in thermally fused laminate.
- Locking connection on one side.
- Laminate Gallery Panel height is inclusive of panel glides extended to their full height.
- If wood grain is selected, grain runs horizontally.
- End of run connector with “U” channel and bottom connecting brackets to be ordered separately.

	DESCRIPTION	PRODUCT CODE	LIST PRICE	DIMENSIONS/INCHES		
			LP	H	W	D
	Laminate Single Sided Middle Gallery Panel - Connector Ends - 42” High	EVLEPSCB4227	450	42	27	1
		EVLEPSCB4233	502	42	33	1
		EVLEPSCB4239	564	42	39	1
		EVLEPSCB4245	646	42	45	1
		EVLEPSCB4251	692	42	51	1
	Laminate Single Sided Middle Gallery Panel - Connector Ends - 48” High	EVLEPSCB4827	492	48	27	1
		EVLEPSCB4833	558	48	33	1
		EVLEPSCB4839	625	48	39	1
		EVLEPSCB4845	692	48	45	1
		EVLEPSCB4851	784	48	51	1
	Laminate Single Sided Middle Gallery Panel - Connector Ends - 54” High	EVLEPSCB5427	541	54	27	1
		EVLEPSCB5433	618	54	33	1
		EVLEPSCB5439	704	54	39	1
		EVLEPSCB5445	824	54	45	1
		EVLEPSCB5451	875	42	51	1



**EVLXPMNC - LAMINATE GALLERY EXTENSION PANEL, FINISHED END**



- Locking connection on one side, no connection at end.
- Finished in thermally fused laminate.
- Laminate Gallery Extension Panel height is inclusive of panel glides extended to their full height.
- If wood grain is selected, grain runs horizontally.
- Bottom connecting brackets to be ordered separately.

	DESCRIPTION	PRODUCT CODE	LIST PRICE LP	DIMENSIONS/INCHES		
				H	W	D
	Laminate Gallery Extension Panel	EVLXPML4224NC	369	42	24	1
	Finished End - 42" High	EVLXPML4230NC	450	42	30	1
		EVLXPML4236NC	502	42	36	1
		EVLXPML4242NC	563	42	42	1
		EVLXPML4248NC	645	42	48	1
	Laminate Gallery Extension Panel	EVLXPML4824NC	424	48	24	1
	Finished End - 48" High	EVLXPML4830NC	492	48	30	1
		EVLXPML4836NC	558	48	36	1
		EVLXPML4842NC	625	48	42	1
		EVLXPML4848NC	692	48	48	1
	Laminate Gallery Extension Panel	EVLXPML5424NC	754	54	24	1
	Finished End - 54" High	EVLXPML5430NC	541	54	30	1
		EVLXPML5436NC	618	54	36	1
		EVLXPML5442NC	704	54	42	1
		EVLXPML5448NC	824	54	48	1
	Laminate Gallery Extension Panel	EVLXPMR4224NC	369	42	24	1
	Finished End - 42" High	EVLXPMR4230NC	450	42	30	1
		EVLXPMR4236NC	502	42	36	1
		EVLXPMR4242NC	563	42	42	1
		EVLXPMR4248NC	645	42	48	1
	Laminate Gallery Extension Panel	EVLXPMR4824NC	424	48	24	1
	Finished End - 48" High	EVLXPMR4830NC	492	48	30	1
		EVLXPMR4836NC	558	48	36	1
		EVLXPMR4842NC	625	48	42	1
		EVLXPMR4848NC	692	48	48	1
	Laminate Gallery Extension Panel	EVLXPMR5424NC	462	54	24	1
	Finished End - 54" High	EVLXPMR5430NC	541	54	30	1
		EVLXPMR5436NC	618	54	36	1
		EVLXPMR5442NC	704	54	42	1
		EVLXPMR5448NC	824	54	48	1





**EVLXPM - LAMINATE GALLERY STRAIGHT EXTENSION PANEL, CONNECTOR ENDS**

- Locking connection both sides.
- Finished in thermally fused laminate.
- Laminate Gallery Panel height is inclusive of panel glides extended to their full height.
- If wood grain is selected, grain runs horizontally.
- Bottom connecting brackets to be ordered separately.

	DESCRIPTION	PRODUCT CODE	LIST PRICE LP	DIMENSIONS/INCHES		
				H	W	D
	Laminate Gallery Straight Extension	EVLXPML4224	692	42	24	1
	Panel - Connector Ends - Left - 42" High	EVLXPML4230	450	42	30	1
		EVLXPML4236	502	42	36	1
		EVLXPML4242	563	42	42	1
		EVLXPML4248	645	42	48	1
	Laminate Gallery Straight Extension	EVLXPML4824	424	48	24	1
	Panel - Connector Ends - Left - 48" High	EVLXPML4830	492	48	30	1
		EVLXPML4836	558	48	36	1
		EVLXPML4842	625	48	42	1
		EVLXPML4848	692	48	48	1
	Laminate Gallery Straight Extension	EVLXPML5424	462	54	24	1
	Panel - Connector Ends - Left - 54" High	EVLXPML5430	541	54	30	1
		EVLXPML5436	618	54	36	1
		EVLXPML5442	704	54	42	1
		EVLXPML5448	824	54	48	1
	Laminate Gallery Straight Extension	EVLXPMR4224	369	42	24	1
	Panel - Connector Ends - Right - 42" High	EVLXPMR4230	450	42	30	1
		EVLXPMR4236	502	42	36	1
		EVLXPMR4242	563	42	42	1
		EVLXPMR4248	645	42	48	1
	Laminate Gallery Straight Extension	EVLXPMR4824	424	48	24	1
	Panel - Connector Ends - Right - 48" High	EVLXPMR4830	492	48	30	1
		EVLXPMR4836	558	48	36	1
		EVLXPMR4842	625	48	42	1
		EVLXPMR4848	692	48	48	1
	Laminate Gallery Straight Extension	EVLXPMR5424	462	54	24	1
	Panel - Connector Ends - Right - 54" High	EVLXPMR5430	541	54	30	1
		EVLXPMR5436	618	54	36	1
		EVLXPMR5442	704	54	42	1
		EVLXPMR5448	824	54	48	1

**EV2LXP - LAMINATE GALLERY TWO-WAY EXTENSION PANEL, FINISHED ENDS**

- Panel connects at 90 degree with extension panel.
- Finished in thermally fused laminate.
- Laminate Gallery Extension Panel height is inclusive of panel glides extended to their full height.
- If wood grain is selected, grain runs horizontally.
- Corner connecting brackets to be ordered separately.

	DESCRIPTION	PRODUCT CODE	LIST PRICE LP	DIMENSIONS/INCHES		
				H	W	D
	Laminate Gallery Two-Way Extension Panel - Finished Ends - Left - 42" High	EV2LXPL4225	371	42	25	1
		EV2LXPL4231	450	42	31	1
		EV2LXPL4237	502	42	37	1
		EV2LXPL4243	564	42	43	1
		EV2LXPL4249	646	42	49	1
	Laminate Gallery Two-Way Extension Panel - Finished Ends - Left - 48" High	EV2LXPL4825	424	48	25	1
		EV2LXPL4831	492	48	31	1
		EV2LXPL4837	558	48	37	1
		EV2LXPL4843	625	48	43	1
		EV2LXPL4849	692	48	49	1
	Laminate Gallery Two-Way Extension Panel - Finished Ends - Left - 54" High	EV2LXPL5425	497	54	25	1
		EV2LXPL5431	568	54	31	1
		EV2LXPL5437	638	54	37	1
		EV2LXPL5443	776	54	43	1
		EV2LXPL5449	875	54	49	1
	Laminate Gallery Two-Way Extension Panel - Finished Ends - Right - 42" High	EV2LXPR4225	371	42	25	1
		EV2LXPR4231	450	42	33	1
		EV2LXPR4237	502	42	37	1
		EV2LXPR4243	564	42	43	1
		EV2LXPR4249	646	42	49	1
	Laminate Gallery Two-Way Extension Panel - Finished Ends - Right - 48" High	EV2LXPR4825	424	48	25	1
		EV2LXPR4831	492	48	33	1
		EV2LXPR4837	558	48	37	1
		EV2LXPR4843	625	48	43	1
		EV2LXPR4849	692	48	49	1
	Laminate Gallery Two-Way Extension Panel - Finished Ends - Right - 54" High	EV2LXPR5425	497	54	25	1
		EV2LXPR5431	568	54	31	1
		EV2LXPR5437	638	54	37	1
		EV2LXPR5443	776	54	43	1
		EV2LXPR5449	875	54	49	1



**EV3LXP - LAMINATE GALLERY THREE-WAY EXTENSION PANEL, FINISHED ENDS**

- Panel connects "T" configuration with extension panel.
- Finished in thermally fused laminate.
- Laminate Gallery Extension Panel height is inclusive of panel glides extended to their full height.
- If wood grain is selected, grain runs horizontally.
- Corner connecting brackets to be ordered separately.

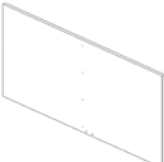
	DESCRIPTION	PRODUCT CODE	LIST PRICE LP	DIMENSIONS/INCHES		
				H	W	D
	Laminate Gallery Three-Way Extension Panel - Finished Ends - Left - 42" High	EV3LXPL4249	692	42	49	1
		EV3LXPL4261	824	42	61	1
		EV3LXPL4273	959	42	73	1
	Laminate Gallery Three-Way Extension Panel - Finished Ends - Left - 48" High	EV3LXPL4849	784	48	49	1
		EV3LXPL4861	963	48	61	1
		EV3LXPL4873	1143	48	73	1
	Laminate Gallery Three-Way Extension Panel - Finished Ends - Left - 54" High	EV3LXPL5449	875	54	49	1
		EV3LXPL5461	1143	54	61	1
		EV3LXPL5473	1322	54	73	1
	Laminate Gallery Three-Way Extension Panel - Finished Ends - Left - 42" High	EV3LXPR4249	692	42	49	1
		EV3LXPR4261	824	42	61	1
		EV3LXPR4273	959	42	73	1
	Laminate Gallery Three-Way Extension Panel - Finished Ends - Left - 48" High	EV3LXPR4849	784	48	49	1
		EV3LXPR4861	963	48	61	1
		EV3LXPR4873	1143	48	73	1
	Laminate Gallery Three-Way Extension Panel - Finished Ends - Left - 54" High	EV3LXPR5449	875	54	49	1
		EV3LXPR5461	1143	54	61	1
		EV3LXPR5473	1322	54	73	1

**EV4LXP - LAMINATE DOUBLE GALLERY PANEL FOR FOUR-WAY, FINISHED ENDS**

- Panel connects "+" configuration with extension panel.
- Finished in thermally fused laminate.
- Laminate Gallery Extension Panel height is inclusive of panel glides extended to their full height.
- If wood grain is selected, grain runs horizontally.
- Corner connecting brackets to be ordered separately

	DESCRIPTION	PRODUCT CODE	LIST PRICE LP	DIMENSIONS/INCHES		
				H	W	D
	Laminate Double Gallery Panel	EV4LXP4249	692	42	49	1
	Four-Way - Finished Ends - 42" High	EV4LXP4261	901	42	61	1
		EV4LXP4273	1110	42	73	1
	Laminate Double Gallery Panel	EV4LXP4849	754	48	49	1
	Four-Way - Finished Ends - 48" High	EV4LXP4861	999	48	61	1
		EV4LXP4873	1214	48	73	1
	Laminate Double Gallery Panel	EV4LXP5449	875	54	49	1
	Four-Way - Finished Ends - 48" High	EV4LXP5461	1143	54	61	1
		EV4LXP5473	1322	54	73	1

**EV4LXPM - LAMINATE GALLERY EXTENSION PANEL FOR FOUR-WAY CONFIGURATION, FINISHED ENDS**

- Locking connection on one side only for four way panel.
- Finished in thermally fused laminate.
- Universal to be used on both sides of four way laminate panel.
- Laminate Gallery Extension Panel height is inclusive of panel glides extended to their full height.
- If wood grain is selected, grain runs horizontally.
- Bottom connecting brackets to be ordered separately.

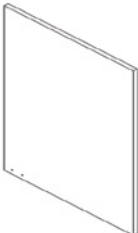
	DESCRIPTION	PRODUCT CODE	LIST PRICE LP	DIMENSIONS/INCHES		
				H	W	D
	Laminate Gallery Extension Panel	EV4LXPM4224	369	42	24	1
	Four-Way - Finished Ends - 42" High	EV4LXPM4230	450	42	30	1
		EV4LXPM4236	502	42	36	1
		EV4LXPM4242	563	42	42	1
		EV4LXPM4248	645	42	58	1
	Laminate Gallery Extension Panel	EV4LXPM4824	424	48	24	1
	Four-Way - Finished Ends - 42" High	EV4LXPM4830	492	48	30	1
		EV4LXPM4836	558	48	36	1
		EV4LXPM4842	625	48	42	1
		EV4LXPM4848	692	48	48	1
	Laminate Gallery Extension Panel	EV4LXPM5424	462	54	24	1
	Four-Way - Finished Ends - 42" High	EV4LXPM5430	541	54	30	1
		EV4LXPM5436	618	54	36	1
		EV4LXPM5442	704	54	42	1
		EV4LXPM5448	824	54	48	1



**EVERCH - EVOLVE PANEL CONNECTOR WITH U CHANNEL**

- U channel attaches with screws to laminate end panel or laminate middle panel.
- Evolve panels attaches to connector.
- Pass thru at bottom and beltline location for power/data.
- U channel is welded to connector.
- Includes connector with U channel and hardware.

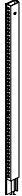
	DESCRIPTION	PRODUCT CODE	LIST PRICE	DIMENSIONS/INCHES		
			LP	H	W	D
	Panel Connector	EVERCH42	172	42	2.875	1
	U Channel	EVERCH48	185	48	2.875	1
		EVERCH54	200	54	2.875	1

**EVPBERCH - EVOLVE PANEL CONNECTOR WITH U CHANNEL FOR BELTLINE PANELS**

- U channel attaches with screws to laminate middle panel.
- Evolve panels attaches to connector.
- Pass thru at bottom and beltline location for power/data.
- U channel is welded to connector.
- Includes connector with U channel and hardware.

	DESCRIPTION	PRODUCT CODE	LIST PRICE	DIMENSIONS/INCHES		
			LP	H	W	D
	Panel Connector	EVPBERCH42	172	42	2.875	1
	U Channel	EVPBERCH48	185	48	2.875	1
		EVPBERCH54	200	54	2.875	1

**EVERCHNR - NO RACEWAY PANEL CONNECTOR WITH U CHANNEL**

- U channel attaches with screws to laminate end panel or laminate middle panel.
- Evolve NR panels attaches to connector.
- U channel is welded to NR connector.
- Includes NR connector with U channel and hardware.

	DESCRIPTION	PRODUCT CODE	LIST PRICE	DIMENSIONS/INCHES		
			LP	H	W	D
	No Raceway Connector with U Channel	EVERCH42NR	172	42	2.875	1
		EVERCH48NR	185	48	2.875	1
		EVERCH54NR	200	54	2.875	1

**EVPGDCP - GALLERY PANEL DATA POST / COMM LAY-IN**

- One way post attaches to Gallery Panel at the end to bring power and/or data cables from ceiling to Evolve panels.
- Accommodates up to 25 CAT 5 cables with electric. Accommodates up to 45 CAT 5 cables without electric.
- Middle Gallery panel with bottom cut out for electric must be ordered.
- Standard data post extension used above.
- Standard data post extension to be ordered separately.

	DESCRIPTION	PRODUCT CODE	LIST PRICE	DIMENSIONS/INCHES		
			LP	H	W	D
	Data Post	EVPGDCP42	230	42	3	
		EVPGDCP48	270	48	3	
		EVPGDCP54	295	54	3	

**EVHLPBB01 - LAMINATE GALLERY PANEL BOTTOM BRACKET**

- Laminate panel bottom bracket connects two laminate end panels at bottom with screws. • Bracket and screws included
- Available in standard paint colors.

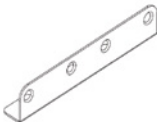
DESCRIPTION	PRODUCT CODE	LIST PRICE LP	DIMENSIONS/INCHES		
			H	W	D
 Bottom Bracket	EVHLPBB01	47	1.5	8	1

**EVHLPB01 - LAMINATE GALLERY PANEL CORNER BRACKET**

- Laminate panel corner bottom bracket connects two laminate panels at 90 degree. • Bracket and screws included.
- Available in standard paint colors.

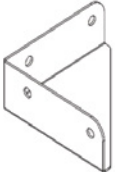
DESCRIPTION	PRODUCT CODE	LIST PRICE LP	DIMENSIONS/INCHES		
			H	W	D
 Corner Bracket	EVHLPB01	46	1.5	4	4

**EVPTTAU - EVOLVE CONNECTOR WITH U CHANNEL TOP TRIM ALUMINUM**

- Aluminum top trim longer by 0.625" to cover width of connector with U channel. • Available in standard paint colors.
- Trim can not span a post.

DESCRIPTION	PRODUCT CODE	LIST PRICE LP	DIMENSIONS/INCHES		
			H	W	D
 Top Trim Aluminum	EVPTTAU24	25	1	24.625	1
	EVPTTAU30	27	1	30.625	1
	EVPTTAU36	30	1	36.625	1
	EVPTTAU42	35	1	42.625	1
	EVPTTAU48	48	1	48.625	1
	EVPTTAU54	54	1	54.625	1
	EVPTTAU60	59	1	60.625	1
	EVPTTAU66	65	1	66.625	1
	EVPTTAU72	73	1	72.625	1
	EVPTTAU78	81	1	78.625	1
EVPTTAU84	86	1	84.625	1	



**EVLEP - 1" LAMINATE END PANEL**

- 1" Laminate End Panel attaches to an end of run connector.
- Left Hand or Right Hand available.
- Finished in thermally Fused Laminate.
- Includes threaded metal inserts and support brackets to attach a worksurface on one side.
- 1" Laminate end panel have panel leveling glides.
- If wood grain is selected, grain runs vertically.

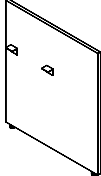
	DESCRIPTION	PRODUCT CODE	LIST PRICE LP	DIMENSIONS/INCHES		
				H	W	D
	1" Laminate End Panel - Right - 42" High	EVLEPR4224	376	42	24	1
		EVLEPR4230	470	42	30	1
		EVLEPR4236	563	42	36	1
		EVLEPR4242	656	42	42	1
		EVLEPR4248	750	42	48	1
	1" Laminate End Panel - Left - 42" High	EVLEPL4224	376	42	24	1
		EVLEPL4230	470	42	30	1
		EVLEPL4236	563	42	36	1
		EVLEPL4242	656	42	42	1
		EVLEPL4248	750	42	48	1
	1" Laminate End Panel - Right - 48" High	EVLEPR4824	424	48	24	1
		EVLEPR4830	537	48	30	1
		EVLEPR4836	644	48	36	1
		EVLEPR4842	747	48	42	1
		EVLEPR4848	857	48	48	1
	1" Laminate End Panel - Left - 48" High	EVLEPL4824	424	48	24	1
		EVLEPL4830	537	48	30	1
		EVLEPL4836	644	48	36	1
		EVLEPL4842	747	48	42	1
		EVLEPL4848	857	48	48	1

**EVLMP - 1" LAMINATE MIDDLE PANEL**

- 1" Laminate Middle Panel attaches to a double inline connector.
- Finished in thermally Fused Laminate.
- Includes threaded metal inserts and support brackets to attach worksurfaces on both sides.
- 1" Laminate middle panel has panel leveling glides.
- If wood grain is selected, grain runs vertically.

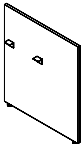
	DESCRIPTION	PRODUCT CODE	LIST PRICE LP	DIMENSIONS/INCHES		
				H	W	D
	1" Laminate Middle Panel - 42" High	EVLMP4224	420	42	24	1
		EVLMP4230	511	42	30	1
		EVLMP4236	605	42	36	1
		EVLMP4242	703	42	42	1
		EVLMP4248	845	42	48	1
	1" Laminate Middle Panel - 48" High	EVLMP4824	469	48	24	1
		EVLMP4830	578	48	30	1
		EVLMP4836	685	48	36	1
		EVLMP4842	794	48	42	1
		EVLMP4848	901	48	48	1



**EVLEPXXYYA - 1" LAMINATE END PANEL WITH ACCESSORY RAIL**

- 1" Laminate End Panel attaches to an end of run connector.
- Includes accessory rail.
- Accessories can be used on accessory rail. Please see accessory section for additional details.
- Finished in thermally Fused Laminate.
- Includes threaded metal inserts and support brackets to attach a worksurface on one side.
- 1" Laminate end panel have panel leveling glides.
- If wood grain is selected, grain runs vertically.

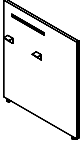
	DESCRIPTION	PRODUCT CODE	LIST PRICE LP	DIMENSIONS/INCHES		
				H	W	D
	1" Laminate End Panel with Accessory Rail - Right - 42" High	EVLEPR4224A	425	42	24	1
		EVLEPR4230A	517	42	30	1
		EVLEPR4236A	613	42	36	1
		EVLEPR4242A	710	42	42	1
		EVLEPR4248A	808	42	48	1
	1" Laminate End Panel with Accessory Rail - Left - 42" High	EVLEPL4224A	425	42	24	1
		EVLEPL4230A	517	42	30	1
		EVLEPL4236A	613	42	36	1
		EVLEPL4242A	710	42	42	1
		EVLEPL4248A	808	42	48	1
1" Laminate End Panel with Accessory Rail - Right - 48" High	EVLEPR4824A	476	48	24	1	
	EVLEPR4830A	576	48	30	1	
	EVLEPR4836A	649	48	36	1	
	EVLEPR4842A	744	48	42	1	
	EVLEPR4848A	910	48	48	1	
1" Laminate End Panel with Accessory Rail - Left - 48" High	EVLEPL4824A	476	48	24	1	
	EVLEPL4830A	576	48	30	1	
	EVLEPL4836A	649	48	36	1	
	EVLEPL4842A	744	48	42	1	
	EVLEPL4848A	910	48	48	1	

**EVLMPXXYYA - 1" LAMINATE MIDDLE PANEL WITH ACCESSORY RAIL**

- 1" Laminate Middle Panel attaches to a double inline connector.
- Includes accessory rail.
- Accessories can be used on accessory rail. Please see accessory section for additional details.
- Finished in thermally Fused Laminate.
- Includes threaded metal inserts and support brackets to attach a worksurface on one side.
- 1" Laminate middle panel has panel leveling glides.
- If wood grain is selected, grain runs vertically.

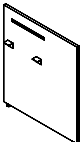
	DESCRIPTION	PRODUCT CODE	LIST PRICE LP	DIMENSIONS/INCHES		
				H	W	D
	1" Laminate Middle Panel with Accessory Rail - 42" High	EVLMP4224A	479	42	24	1
		EVLMP4230A	574	42	30	1
		EVLMP4236A	674	42	36	1
		EVLMP4242A	766	42	42	1
		EVLMP4248A	865	42	48	1
	1" Laminate Middle Panel with Accessory Rail - 48" High	EVLMP4824A	528	48	24	1
		EVLMP4830A	644	48	30	1
		EVLMP4836A	747	48	36	1
		EVLMP4842A	857	48	42	1
		EVLMP4848A	965	48	48	1



**EVPDIC - DOUBLE INLINE PANEL CONNECTOR**

- Used to connect 1" laminate middle panel to panels of equal height in a straight run.
- Aluminum top trim for double inline connector must be used.
- Provides slotted support for worksurfaces and hardware support.
- Includes two slotted posts with leveling glides and connection hardware.
- Use 17" flexible mesh jumper cable to pass-through panels.

DESCRIPTION	PRODUCT CODE	LIST PRICE	DIMENSIONS/INCHES		
			H	W	D
Double Inline Panel Connector	EVPDIC42	168	42	2	
	EVPDIC48	178	48	2	

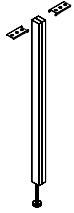

**EVPBIC - BELTLINE DOUBLE INLINE PANEL CONNECTOR**

- Used to connect 1" laminate middle panel to panels of equal height in a straight run.
- Use in-between beltline panels.
- Aluminum top trim for double inline connector must be used.
- Provides slotted support for worksurfaces and hardware support.
- Includes two slotted posts with leveling glides and connection hardware.
- Use 17" flexible mesh jumper cable to pass-through panels.

DESCRIPTION	PRODUCT CODE	LIST PRICE	DIMENSIONS/INCHES		
			H	W	D
Beltline Double Inline Panel Connector	EVPBIC42	168	42	2	
	EVPBIC48	178	48	2	

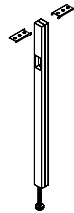

**EVPDVTF - DOUBLE INLINE CONNECTOR TRIM**

- Attaches to exposed side of double inline connector.

	DESCRIPTION	PRODUCT CODE	LIST PRICE	DIMENSIONS/INCHES		
				H	W	D
	Double Inline Connector Trim	EVPDVTF42	21	42		
		EVPDVTF48	27	48		

**EVPTTA - DOUBLE INLINE PANEL CONNECTOR TOP TRIM - ALUMINUM**

- Aluminum top trim is longer by 1.125" to cover width of panel and double inline connector.
- Trim cannot span a post connector.
- Available in standard and premium paint colors.

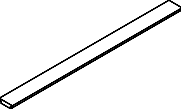
	DESCRIPTION	PRODUCT CODE	LIST PRICE	DIMENSIONS/INCHES		
				H	W	D
	Double Inline Connector Trim - Aluminum	EVPTTA25	25	25		
		EVPTTA31	27	31		
		EVPTTA37	21	37		
		EVPTTA43	35	43		
		EVPTTA49	48	49		
		EVPTTA55	54	55		
		EVPTTA61	59	61		
		EVPTTA67	65	67		
		EVPTTA73	73	73		
		EVPTTA79	81	79		
	EVPTTA85	86	83			



**EVPS - DOOR PANEL - SOLID**

- All door surfaces are high pressure laminate.
- HP Laminate finish available in all standard Evolve colors.
- Two panel widths: 36" or 42" High.
- 84" Door Panel height = 66"H panel plus one 18"H Panel Extension Module.
- 90" Door Panel height = 66" H panel plus one 24"H or two 12"H Panel Extension Modules.
- Door and door trim can be specified left- or right-handed (see diagram).
- Handedness of Door Panel can be changed in the field.
- Select door frame color from standard trim colors.
- Door Sizes:
  - 36"W Door is 33.63"W without frame (This door is not ADA compliant)
  - 42"W Door is 39.63"W without frame
  - 84"H Door is 81.5"H without frame
  - 90"H Door is 87.5"H without frame
- If laminate is selected in a wood grain, the grain runs vertical.
- Customer is responsible to confirm and meet all city, county or any other municipality codes in relation to door clearances.
- Knob or lever to be ordered separately

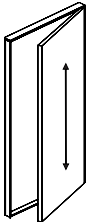
	DESCRIPTION	PRODUCT CODE	LIST PRICE		DIMENSIONS/INCHES		
			CLR	FRST	H	W	D
	Door Panel - Solid - 84" High x 36" Wide	EVPDS8436L	2859		84	36	2 7/8
		EVPDS8436R	2859		84	36	2 7/8
	Door Panel - Solid - 84" High x 42" Wide	EVPDS8442L	3309		84	42	2 7/8
		EVPDS8442R	3309		84	42	2 7/8
	Door Panel - Solid - 90" High x 36" Wide	EVPDS9036L	2859		90	36	2 7/8
		EVPDS9036R	2859		90	36	2 7/8
	Door Panel - Solid - 90" High x 42" Wide	EVPDS9042L	3309		90	42	2 7/8
		EVPDS9042R	3309		90	42	2 7/8

**EVDPG- FULL GLAZED DOOR PANEL**

- All door surfaces are high pressure laminate with window.
- HP laminate finish available in all standard Evolve colors.
- Two panels width 36" or 42"
- 84" Door panel height = 66"H panel and 18" H Panel Extension Modules.
- 90" Door panel height = 66"H panel and 24" H or two 12" H Panel extension modules.
- Door and door trim can be specified left or right handed (see diagram).
- Handedness of Door can be changed in field.
- Select frame color from standard trim colors.
- Door Sizes:
  - 36"W Door is 33.63"W without frame (This door is not ADA compliant)
  - 42"W Door is 39.63"W without frame
  - 84"H Door is 81.5"H without frame
  - 90"H Door is 87.5"H without frame
- If laminate is selected in wood grain, the grain runs vertical.
- Customer is responsible to confirm and meet, city, county or any other municipality codes in relation to door clearances
- Knob or lever to be ordered separately

	DESCRIPTION	PRODUCT CODE	LIST PRICE		DIMENSIONS/INCHES		
			CLR	FRST	H	W	D
	Door Panel - Glazed - 84" High x 36" Wide	EVPDG8436L	3212	3339	84	36	2 7/8
		EVPDG8436R	3212	3339	84	36	2 7/8
	Door Panel - Glazed - 84" High x 42" Wide	EVPDG8442L	3661	3788	84	42	2 7/8
		EVPDG8442R	3661	3788	84	42	2 7/8
	Door Panel - Glazed - 90" High x 36" Wide	EVPDG9036L	3212	3339	90	36	2 7/8
		EVPDG9036R	3212	3339	90	36	2 7/8
	Door Panel - Glazed - 90" High x 42" Wide	EVPDG9042L	3661	3788	90	42	2 7/8
		EVPDG9042R	3661	3788	90	42	2 7/8

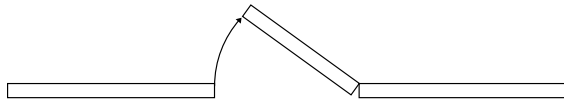

Right Hand Hung Door

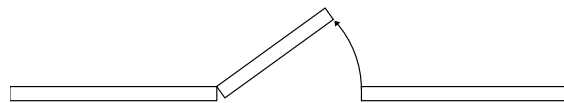

Left Hand Hung Door

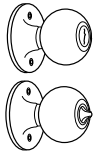

Knob Lock Set  
(Knob Lock Set is not ADA compliant)  
Lock set sold separately from doors.  
Specific core #'s and Master Key not available

EVPSL01 119



Lever Lock Set  
Lock set sold separately from doors.  
Specific core #'s and Master Key not available

EVPSL02 163

**EVHLPF01 - LOW PROFILE FOOT**

- Used to provide additional support to panel run without adding panels
- Connects to inline connector or end of run at base of panels

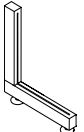
DESCRIPTION	PRODUCT CODE	LIST PRICE	DIMENSIONS/INCHES		
			H	W	D
 <p>Low Profile Foot</p>	EVHLPF01	129	11	1	11

**EVPSL/R - SLIDING PRIVACY DOOR**

- Sliding Privacy Door attaches to Evolve Panels using standard connectors to add privacy. Brackets that attach to Connectors are included.
- This door must mount on panels of equal width. It is also intended to be used for openings of equal width.
- Left (L) or right-handedness (R) is determined by the direction of door movement (from compressed to expanded position), while facing the door on the panel mounted side.
- Painted frame may match any Evolve Standard Paint Finish. The door interior is standard with a louvered acrylic finish.
- Telescoping arms eliminate the need for thresholds, wheels or casters.
- 81" H door must connect to panels 84" or higher.
- Thickness of louvered acrylic is 6 mm.

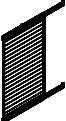
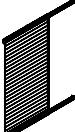
DESCRIPTION	PRODUCT CODE	LIST PRICE	DIMENSIONS/INCHES		
			H	W	D
 <p>Sliding Privacy Door - 66" High</p>	EVPSL6636R	3217	66	36	3
	EVPSL6636L	3217	66	36	3
	EVPSL6642R	3300	66	42	3
	EVPSL6642L	3300	66	42	3
 <p>Sliding Privacy Door - 81" High</p>	EVPSL8136R	3397	81	36	3
	EVPSL8136L	3397	81	36	3
	EVPSL8142R	3647	81	42	3
	EVPSL8142L	3647	81	42	3



**EVPSLLOCK - SLIDING DOOR LOCK**

- Lock bracket attaches to sliding door with screws.
- Includes strike plate bracket which attaches to slots in connector.
- Lock included.
- Lock sets sold separately from sliding doors.
- Available in Tungsten only.

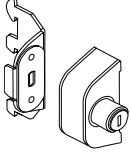
	DESCRIPTION	PRODUCT CODE	LIST PRICE	DIMENSIONS/INCHES		
				H	W	D
	Sliding Door Lock - Right	EVPSLLOCKR	295	2.65	1.2	0.9
	Sliding Door Lock - Left	EVPSLLOCKL	295	2.65	1.2	0.9

**EVMPK02 - MINI PANEL KIT**

- Evolve's Mini Panel Kits are available to our dealers and their sales staff.
- All Mini Panel Kit orders receive standard freight terms (5% of list)
- The Evolve mini panel is an excellent sales tool featuring a cut away of a module and samples of various hardware and electrical components and consists of the following:
  - 1 EVPP3024 30 x 24 Premium with cut-away
  - 1 EVPCP232 Two-way corner post
  - 1 EVPER30 End of run trim kit
  - 1 EVDHPT24 High Profile Top Cap
  - 1 EVDCPHP2 Two-way High Profile Top Cap
  - 1 EVDPE4 Post Extension Lay in
  - 1 EVE8PD24 Power distribution housing
  - 1 EVE8CP16 Jumper Cable
  - 1 EVE8RDA/B Duplex Receptacle
  - 1 Pizza cutter spline tool
  - 1 Replacement fabric
  - 1 Panel Bag with Evolve Logo
  - 1 Parts Bag with Evolve Logo

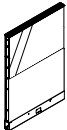
	DESCRIPTION	PRODUCT CODE	LIST PRICE	DIMENSIONS/INCHES		
				H	W	D
	Mini Panel Kit	EVMPK02	2752	30	24	2 7/8

**EVPRGLAXYY - Acoustic Grid 5FT WIDE**

- PET Acoustic Grid installed on top of panels
- Acoustic Grid kit includes PET pieces, aluminum channel, hardware
- Panels configuration in back 30-30 , aluminum channel runs depth wise
- PET slats run from side to side
- PET pieces available in standard PET colors
- Separate PET colors available for outer skirt and inner structure
- Top trim with channel to be ordered separately
- Shipped KD , to be assembled on job site
- Additional sizes available up to 10' x 12'

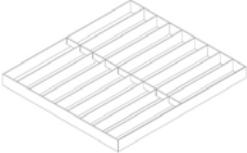
DESCRIPTION	PRODUCT CODE	LIST PRICE	DIMENSIONS/INCHES		
			H	W	D
	EVPRGLA4860D	2552	5.5	60	48
	EVPRGLA6060D	3024	5.5	60	60
	EVPRGLA7260D	3496	5.5	60	72
	EVPRGLA8460D	3968	5.5	60	84
	EVPRGLA9060D	4204	5.5	60	90
	EVPRGLA9660D	4475	5.5	60	96

**EVPRGLAXYY - Acoustic Grid 6FT WIDE**

- PET Acoustic Grid installed on top of panels
- Acoustic Grid kit includes PET pieces, aluminum channel, hardware
- Panels configuration in back 24-24-24 , aluminum channel runs depth wise
- PET slats run from side to side
- PET pieces available in standard PET colors
- Separate PET colors available for outer skirt and inner structure
- Top trim with channel to be ordered separately
- Shipped KD , to be assembled on job site
- Additional sizes available up to 10' x 12'

DESCRIPTION	PRODUCT CODE	LIST PRICE	DIMENSIONS/INCHES		
			H	W	D
	EVPRGLA4872D	3068	5.5	72	48
	EVPRGLA6072D	3641	5.5	72	60
	EVPRGLA7272D	4212	5.5	72	72
	EVPRGLA8472D	4783	5.5	72	84
	EVPRGLA9072D	5067	5.5	72	90
	EVPRGLA9672D	5388	5.5	72	96

**EVPRGLAXYY - Acoustic Grid 7FT WIDE**

- PET Acoustic Grid installed on top of panels
- Acoustic Grid kit includes PET pieces, aluminum channel, hardware
- Panels configuration in back 24-36-24 , aluminum channel runs depth wise
- PET slats run from side to side
- PET pieces available in standard PET colors
- Separate PET colors available for outer skirt and inner structure
- Top trim with channel to be ordered separately
- Shipped KD , to be assembled on job site
- Additional sizes available up to 10' x 12'

DESCRIPTION	PRODUCT CODE	LIST PRICE	DIMENSIONS/INCHES		
			H	W	D
	EVPRGLA4884D	3430	5.5	84	48
	EVPRGLA6084D	4061	5.5	84	60
	EVPRGLA7284D	4692	5.5	84	72
	EVPRGLA8484D	5323	5.5	84	84
	EVPRGLA9084D	5639	5.5	84	90
	EVPRGLA9684D	5989	5.5	84	96



**EVPRGLAXXY - Acoustic Grid 7-1/2 FT WIDE**

- PET Acoustic Grid installed on top of panels
- Acoustic Grid kit includes PET pieces, aluminum channel, hardware
- Panels configuration in back 30-30-30 , aluminum channel runs depth wise
- PET slats run from side to side
- PET pieces available in standard PET colors
- Separate PET colors available for outer skirt and inner structure
- Top trim with channel to be ordered separately
- Shipped KD, to be assembled on job site
- Additional sizes available up to 10' x 12'

DESCRIPTION	PRODUCT CODE	LIST PRICE	DIMENSIONS/INCHES		
			H	W	D
	EVPRGLA4890D	3562	5.5	90	48
	EVPRGLA6090D	4222	5.5	90	60
	EVPRGLA7290D	4883	5.5	90	72
	EVPRGLA8490D	5544	5.5	90	84
	EVPRGLA9090D	5876	5.5	90	90
	EVPRGLA9690D	6241	5.5	90	96

**EVPRGLAXXY - Acoustic Grid 8FT WIDE**

- PET Acoustic Grid installed on top of panels
- Acoustic Grid kit includes PET pieces, aluminum channel, hardware
- Panels configuration in back 30-36-30 , aluminum channel runs depth wise
- PET slats run from side to side
- PET pieces available in standard PET colors
- Separate PET colors available for outer skirt and inner structure
- Top trim with channel to be ordered separately
- Shipped KD, to be assembled on job site
- Additional sizes available up to 10' x 12'

DESCRIPTION	PRODUCT CODE	LIST PRICE	DIMENSIONS/INCHES		
			H	W	D
	EVPRGLA4896D	3826	5.5	96	48
	EVPRGLA6096D	4517	5.5	96	60
	EVPRGLA7296D	5207	5.5	96	72
	EVPRGLA8496D	5899	5.5	96	84
	EVPRGLA9096D	6246	5.5	96	90
	EVPRGLA9696D	6625	5.5	96	96

**EVPRGLAXXY - Acoustic Grid 12FT WIDE**

- PET Acoustic Grid installed on top of panels
- Acoustic Grid kit includes PET pieces, aluminum channel, hardware
- Panels configuration in back 24-30--36-30-24 , aluminum channel runs depth wise
- PET slats run from side to side
- PET pieces available in standard PET colors
- Top trim with channel to be ordered separately
- Beam kit above opening for Acoustic Grid to be ordered separately
- Shipped KD, to be assembled on job site

DESCRIPTION	PRODUCT CODE	LIST PRICE	DIMENSIONS/INCHES		
			H	W	D
	EVPRGLA120144D	8805	5.5	144	120



**EVPTTCA - ALUMINUM TOP TRIM WITH CHANNEL**

- Top trim with channel
- Available in standard paint colors
- Note: Trim can span inline connector, but not a Post

DESCRIPTION	PRODUCT CODE	LIST PRICE	DIMENSIONS/INCHES		
			H	W	D
	EVPTTCA18	18	18	2.875	
	EVPTTCA24	26	24	2.875	
	EVPTTCA30	33	30	2.875	
	EVPTTCA36	36	36	2.875	
	EVPTTCA42	43	42	2.875	
	EVPTTCA48	53	48	2.875	
	EVPTTCA54	62	54	2.875	
	EVPTTCA60	69	60	2.875	
	EVPTTCA66	75	66	2.875	
	EVPTTCA72	84	72	2.875	
	EVPTTCA78	91	78	2.875	
	EVPTTCA84	101	84	2.875	
	EVPTTCA90	107	90	2.875	
	EVPTTCA96	116	96	2.875	



When ordering Panel Extension Modules, Inline Panel Extension Connectors (EVPIEC) must be ordered separately. Please see EVPIEC for details.

Inline Panel Extension Connectors connect two panel extension modules of equal height in a straight run.

Extension connectors do **not** provide support for hang-on storage components above 66" H.

When specifying stacking panels up to 66" H and using a single full height connector additional single clamps (EVCLVAR) are recommended. Order 2 clamps per extension module.

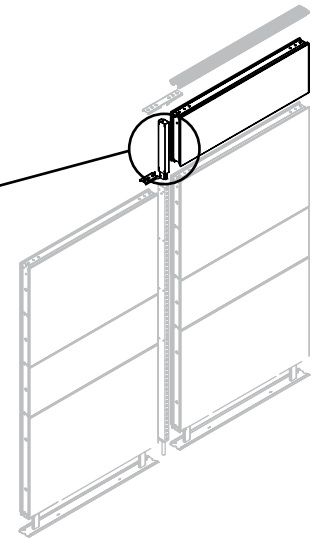
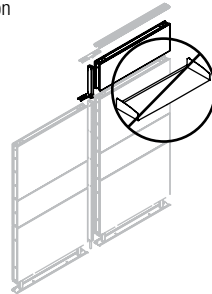

## EXTENSION MODULES BY TYPE

### Fabric Panel Extension Module

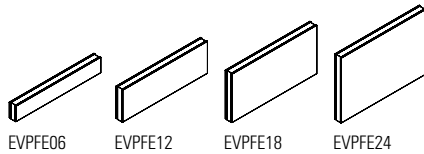

### Fabric Panel Extension Module - Premium

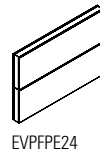

### Tempered Glass Panel Extension Module

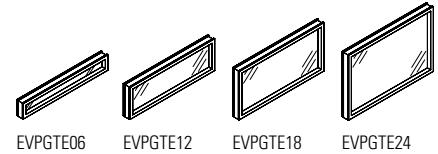

### Tempered Glass Panel Extension Module - Premium

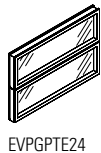

### Write Board Extension Module - Single Sided

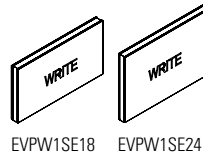

### Write Board Extension Module - Double Sided

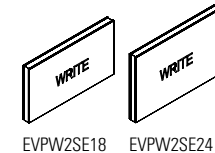

### Laminate Extension Module - Single Sided

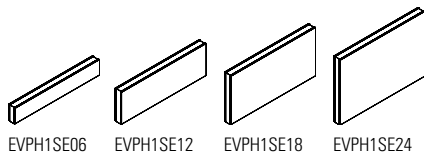

### Laminate Extension Module - Double Sided

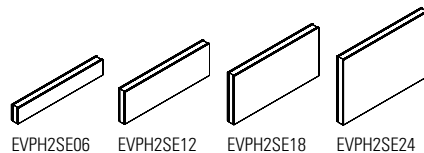

### Air Flow Extension Module

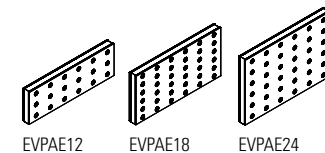

### Open Panel Extension Module

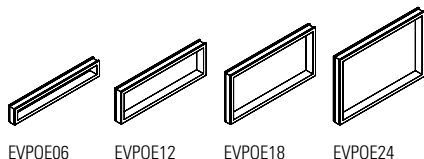

### Panel Mount Privacy Glass

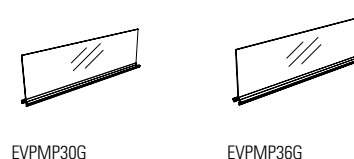

### Panel Mount PET Felt Divider

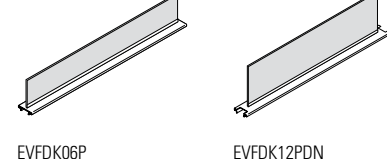

**EVPFE - FABRIC PANEL EXTENSION MODULE**

- Attaches on top of a panel.
- Modules can be stacked to add privacy or divide space.
- Panel Extension Modules are not load bearing if installed higher than 66" High.
- Each side of the fabric module may have a different fabric within the same grade at no charge.
- If different grades of fabric are used on one module, the entire module must be priced at highest grade.
- When ordering Panel Extension Modules, additional connectors are required.
- \*Top Trims are not included with Extension Modules.

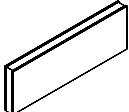
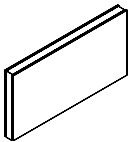
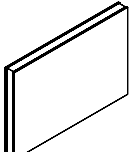
	DESCRIPTION	PRODUCT CODE	LIST PRICE		DIMENSIONS/INCHES		
			Gr1	Gr2	H	W	D
	Fabric Panel Extension Module - 6" High	EVPFE0618	185	193	6	18	2 7/8
		EVPFE0624	187	201	6	24	2 7/8
		EVPFE0630	205	221	6	30	2 7/8
		EVPFE0636	228	246	6	36	2 7/8
		EVPFE0642	258	273	6	42	2 7/8
		EVPFE0648	277	298	6	48	2 7/8
		EVPFE0654	299	320	6	54	2 7/8
		EVPFE0660	321	348	6	60	2 7/8
	Fabric Panel Extension Module - 12" High	EVPFE1218	185	193	12	18	2 7/8
		EVPFE1224	187	201	12	24	2 7/8
		EVPFE1230	205	221	12	30	2 7/8
		EVPFE1236	228	246	12	36	2 7/8
		EVPFE1242	258	273	12	42	2 7/8
		EVPFE1248	277	298	12	48	2 7/8
		EVPFE1254	299	320	12	54	2 7/8
		EVPFE1260	321	348	12	60	2 7/8
	Fabric Panel Extension Module - 18" High	EVPFE1818	223	239	18	18	2 7/8
		EVPFE1824	231	252	18	24	2 7/8
		EVPFE1830	251	277	18	30	2 7/8
		EVPFE1836	291	318	18	36	2 7/8
		EVPFE1842	319	354	18	42	2 7/8
		EVPFE1848	349	385	18	48	2 7/8
		EVPFE1854	378	419	18	54	2 7/8
		EVPFE1860	411	455	18	60	2 7/8
	Fabric Panel Extension Module - 24" High	EVPFE2418	223	239	24	18	2 7/8
		EVPFE2424	231	252	24	24	2 7/8
		EVPFE2430	251	277	24	30	2 7/8
		EVPFE2436	291	318	24	36	2 7/8
		EVPFE2442	319	354	24	42	2 7/8
		EVPFE2448	349	385	24	48	2 7/8
		EVPFE2454	378	419	24	54	2 7/8
		EVPFE2460	411	455	24	60	2 7/8

**EVPFPE - FABRIC PANEL EXTENSION MODULE - PREMIUM**

- Attaches on top of a panel.
- Modules can be stacked to add privacy or to divide space.
- Panel Extension Modules are not load bearing above 66" High.
- Each side of each module may have a different fabric within the same grade at no charge.
- If different grades of fabric are used on the Panel Extension Module, the module must be priced at highest grade.
- When ordering Panel Extension Modules, additional connectors are required.
- \*Top Trims are not included with Extension Modules.

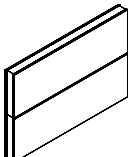
	DESCRIPTION	PRODUCT CODE	LIST PRICE		DIMENSIONS/INCHES		
			Gr1	Gr2	H	W	D
	Fabric Panel Extension Module - Premium - 24" High	EVPFPE2418	301	318	24	18	2 7/8
		EVPFPE2424	321	345	24	24	2 7/8
		EVPFPE2430	360	386	24	30	2 7/8
		EVPFPE2436	405	432	24	36	2 7/8
		EVPFPE2442	455	490	24	42	2 7/8
		EVPFPE2448	488	526	24	48	2 7/8
		EVPFPE2454	539	580	24	54	2 7/8
		EVPFPE2460	588	634	24	60	2 7/8



**EVPGTE - TEMPERED GLASS PANEL EXTENSION MODULE**

- Attaches on top of panel.
- Modules can be stacked to add privacy or to divide space.
- Panel Extension Modules are not load bearing above 66" H.
- Standard in clear (CLR) or smoked glass (SMK) as an option. Please note the smoked glass (SMK) has 51% light transmittance.
- Frosted Glass (FRST) 40% upcharge. Contact EVOLVE Customer Support for details.
- When ordering Panel Extension Modules, additional connectors are required.
- \*Top Trims are not included with Extension Modules.

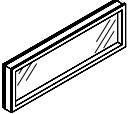
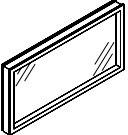
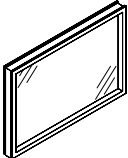
	DESCRIPTION	PRODUCT CODE	LIST PRICE	DIMENSIONS/INCHES		
				H	W	D
	Tempered Glass Panel Extension Module - 6" High	EVPGTE0618	355	6	18	2 7/8
		EVPGTE0624	383	6	24	2 7/8
		EVPGTE0630	459	6	30	2 7/8
		EVPGTE0636	481	6	36	2 7/8
		EVPGTE0642	588	6	42	2 7/8
		EVPGTE0648	656	6	48	2 7/8
		EVPGTE0654	717	6	54	2 7/8
	EVPGTE0660	773	6	60	2 7/8	
	Tempered Glass Panel Extension Module - 12" High	EVPGTE1218	355	12	18	2 7/8
		EVPGTE1224	383	12	24	2 7/8
		EVPGTE1230	459	12	30	2 7/8
		EVPGTE1236	481	12	36	2 7/8
		EVPGTE1242	588	12	42	2 7/8
		EVPGTE1248	656	12	48	2 7/8
		EVPGTE1254	717	12	54	2 7/8
	EVPGTE1260	773	12	60	2 7/8	
	Tempered Glass Panel Extension Module - 18" High	EVPGTE1818	533	18	18	2 7/8
		EVPGTE1824	548	18	24	2 7/8
		EVPGTE1830	587	18	30	2 7/8
		EVPGTE1836	641	18	36	2 7/8
		EVPGTE1842	726	18	42	2 7/8
		EVPGTE1848	813	18	48	2 7/8
		EVPGTE1854	882	18	54	2 7/8
	EVPGTE1860	946	18	60	2 7/8	
	Tempered Glass Panel Extension Module - 24" High	EVPGTE2418	533	24	18	2 7/8
		EVPGTE2424	548	24	24	2 7/8
		EVPGTE2430	587	24	30	2 7/8
		EVPGTE2436	641	24	36	2 7/8
		EVPGTE2442	726	24	42	2 7/8
		EVPGTE2448	813	24	48	2 7/8
		EVPGTE2454	882	24	54	2 7/8
	EVPGTE2460	946	24	60	2 7/8	

**EVPGPTE - TEMPERED GLASS PREMIUM PANEL EXTENSION MODULE**

- Attaches to top of a panel.
- Modules can be stacked to add privacy or to divide space.
- Panel Extension Modules are not load bearing above 66" H.
- Standard in clear (CLR) or smoked glass (SMK) as an option. Please note the smoked glass (SMK) has 51% light transmittance.
- Frosted Glass (FRST) 40% upcharge. Contact EVOLVE Customer Support for details.
- When ordering Panel Extension Modules, additional connectors are required.
- \*Top Trims are not included with Extension Modules.

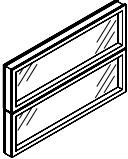
	DESCRIPTION	PRODUCT CODE	LIST PRICE	DIMENSIONS/INCHES		
				H	W	D
	Tempered Glass Premium Panel Extension Module - 24" High	EVPGPTE2418	525	24	18	2 7/8
		EVPGPTE2424	582	24	24	2 7/8
		EVPGPTE2430	665	24	30	2 7/8
		EVPGPTE2436	757	24	36	2 7/8
		EVPGPTE2442	839	24	42	2 7/8
		EVPGPTE2448	941	24	48	2 7/8
		EVPGPTE2454	1026	24	54	2 7/8
	EVPGPTE2460	1111	224	60	2 7/8	

**EVPSG - PASS THRU SLIDING GLASS EXTENSION MODULE**

- Pass thru with sliding glass door module.
- Attaches on top of a panel.
- Module can be stacked to add privacy or divide space.
- Panel extension module is not load bearing if installed higher than 66" High.
- When ordering panel extension modules , additional connectors are required.
- \*Top Trims are not included with Extension Modules.

	DESCRIPTION	PRODUCT CODE	LIST PRICE		DIMENSIONS/INCHES		
			CLR	FRS	H	W	D
	Reception Panel Extension Module - 6" High	EVPSGE0636	384	461	6	36	2 7/8
		EVPSGE0642	411	494	6	42	2 7/8
		EVPSGE0648	500	598	6	48	2 7/8

**EVPSG - PASS THRU SLIDING GLASS EXTENSION MODULE**

- Pass thru with sliding glass door module.
- Attaches on top of a panel.
- Module can be stacked to add privacy or divide space.
- Panel extension module is not load bearing if installed higher than 66" High.
- When ordering panel extension modules , additional connectors are required.
- \*Top Trims are not included with Extension Modules.

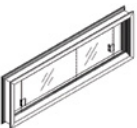
	DESCRIPTION	PRODUCT CODE	LIST PRICE		DIMENSIONS/INCHES		
			CLR	FRS	H	W	D
	Reception Panel Extension Module - 12" High	EVPSGE1236	465	558	12	36	2 7/8
		EVPSGE1242	492	591	12	42	2 7/8
		EVPSGE1248	515	621	12	48	2 7/8

**EVPSGX - TALK THRU GLASS EXTENSION MODULE**

- Talk thru glass module.
- Attaches on top of a panel.
- Module can be stacked to add privacy or divide space.
- Panel extension module is not load bearing if installed higher than 66" High.
- When ordering panel extension modules , additional connectors are required.
- \*Top Trims are not included with Extension Modules.

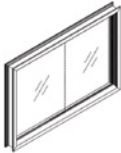
	DESCRIPTION	PRODUCT CODE	LIST PRICE		DIMENSIONS/INCHES		
			CLR	FRS	H	W	D
	Reception Panel Extension Module - 24" High	EVPSGXE2436	598	717	24	36	2 7/8
		EVPSGXE2442	658	789	24	42	2 7/8
		EVPSGXE2448	717	862	24	48	2 7/8

**EVPSGX - TALK THRU GLASS EXTENSION MODULE**

- Talk thru glass module.
- Attaches on top of a panel.
- Module can be stacked to add privacy or divide space.
- Panel extension module is not load bearing if installed higher than 66" High.
- When ordering panel extension modules , additional connectors are required.
- \*Top Trims are not included with Extension Modules.

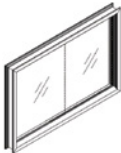
	DESCRIPTION	PRODUCT CODE	LIST PRICE		DIMENSIONS/INCHES		
			CLR	FRS	H	W	D
	Reception Panel Extension Module - 30" High	EVPSGXE3036	652	781	30	36	2 7/8
		EVPSGXE3042	733	879	30	42	2 7/8
		EVPSGXE3048	794	951	30	48	2 7/8



**EVPW1SE - WRITE BOARD EXTENSION MODULE - SINGLE SIDED**

- Attaches on top of a panel.
- Provides writing surface on a Single Side.
- Modules can be stacked to add privacy or to divide space.
- Panel Extension Modules are not load bearing above 66" H.
- When ordering Panel Extension Modules, additional connectors are required.
- High pressure only
- Use erasable Write Board markers only.
- \*Top Trims are not included with Extension Modules.

DESCRIPTION	PRODUCT CODE	LIST PRICE		DIMENSIONS/INCHES		
		Gr1	Gr2	H	W	D
 Write Board Extension Module - Single Sided 6"High	EVPW1SE0618	251	259	6	36	7/8
	EVPW1SE0624	292	301	6	36	2 7/8
	EVPW1SE0636	371	381	6	36	2 7/8
	EVPW1SE0642	420	425	6	42	2 7/8
	EVPW1SE0648	457	469	6	48	2 7/8
	EVPW1SE0654	515	527	6	54	2 7/8
	EVPW1SE0660	542	554	6	60	2 7/8
Write Board Extension Module - Single Sided 12"High	EVPW1SE1218	251	259	12	36	2 7/8
	EVPW1SE1224	292	301	12	36	2 7/8
	EVPW1SE1236	371	381	12	36	2 7/8
	EVPW1SE1242	420	425	12	42	2 7/8
	EVPW1SE1248	457	469	12	48	2 7/8
	EVPW1SE1254	515	527	12	54	2 7/8
	EVPW1SE1260	542	554	12	60	2 7/8
Write Board Extension Module - Single Sided 18"High	EVPW1SE1818	269	279	18	18	2 7/8
	EVPW1SE1824	308	319	18	24	2 7/8
	EVPW1SE1830	347	356	18	30	2 7/8
	EVPW1SE1836	404	418	18	36	2 7/8
	EVPW1SE1842	453	469	18	42	2 7/8
	EVPW1SE1848	497	514	18	48	2 7/8
	EVPW1SE1854	541	558	18	54	2 7/8
EVPW1SE1860	582	602	18	60	2 7/8	
Write Board Extension Module - Single Sided 24"High	EVPW1SE2418	269	279	24	18	2 7/8
	EVPW1SE2424	308	321	24	24	2 7/8
	EVPW1SE2430	347	360	24	30	2 7/8
	EVPW1SE2436	404	419	24	36	2 7/8
	EVPW1SE2442	453	471	24	42	2 7/8
	EVPW1SE2448	497	516	24	48	2 7/8
	EVPW1SE2454	541	558	24	54	2 7/8
EVPW1SE2460	582	603	24	60	2 7/8	

**EVPW2SE - WRITE BOARD EXTENSION MODULE - DOUBLE SIDED**

- Attaches on top of a panel.
- Provides writing surface on two sides.
- Modules can be stacked to add privacy or to divide space.
- Panel Extension Modules are not load bearing above 66" H.
- When ordering Panel Extension Modules, additional connectors are required.
- High pressure only
- Use erasable Write Board markers only.
- \*Top Trims are not included with Extension Modules.

	DESCRIPTION	PRODUCT CODE	LIST PRICE	DIMENSIONS/INCHES			
				H	W	D	
	Write Board Extension Module - Double Sided - 6" High	EVPW2SE0618	270	6	18	2 7/8	
		EVPW2SE0624	319	6	24	2 7/8	
		EVPW2SE0630	368	6	30	2 7/8	
		EVPW2SE0636	422	6	36	2 7/8	
		EVPW2SE0642	479	6	42	2 7/8	
		EVPW2SE0648	534	6	48	2 7/8	
		EVPW2SE0654	616	6	54	2 7/8	
		EVPW2SE0660	632	6	60	2 7/8	
		Write Board Extension Module - Double Sided - 12" High	EVPW2SE1218	270	12	18	2 7/8
			EVPW2SE1224	319	12	24	2 7/8
EVPW2SE1230	368		12	30	2 7/8		
EVPW2SE1236	422		12	36	2 7/8		
EVPW2SE1242	479		12	42	2 7/8		
EVPW2SE1248	534		12	48	2 7/8		
EVPW2SE1254	616		12	54	2 7/8		
EVPW2SE1260	632		12	60	2 7/8		
Write Board Extension Module - Double Sided - 18" High	EVPW2SE1818	325	18	18	2 7/8		
	EVPW2SE1824	383	18	24	2 7/8		
	EVPW2SE1830	440	18	30	2 7/8		
	EVPW2SE1836	515	18	36	2 7/8		
	EVPW2SE1842	582	18	42	2 7/8		
	EVPW2SE1848	649	18	48	2 7/8		
	EVPW2SE1854	718	18	54	2 7/8		
	EVPW2SE1860	784	18	60	2 7/8		
Write Board Extension Module - Double Sided - 24" High	EVPW2SE2418	325	24	18	2 7/8		
	EVPW2SE2424	383	24	24	2 7/8		
	EVPW2SE2430	440	24	30	2 7/8		
	EVPW2SE2436	515	24	36	2 7/8		
	EVPW2SE2442	582	24	42	2 7/8		
	EVPW2SE2448	649	24	48	2 7/8		
	EVPW2SE2454	718	24	54	2 7/8		
	EVPW2SE2460	784	24	60	2 7/8		



**EVPH1SE - LAMINATE EXTENSION MODULE - SINGLE SIDED**

- Attaches on top of a panel.
- Laminate face on the module provides a durable, washable surface on Single Side of the panel.
- Modules can be stacked to add privacy or to divide space.
- Panel Extension Modules are not load bearing above 66" H.
- When ordering Panel Extension Modules, additional connectors are required.
- Available in high pressure only.
- \*Top Trims are not included with Extension Modules.

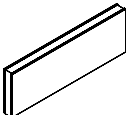
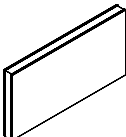
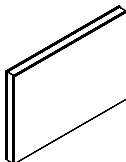
	DESCRIPTION	PRODUCT CODE	LIST PRICE		DIMENSIONS/INCHES		
			Gr1	Gr2	H	W	D
	Laminate Extension Module - Single Sided 6" High	EVPH1SE0618	251	259	6	18	2 7/8
		EVPH1SE0624	292	295	6	24	2 7/8
		EVPH1SE0630	327	329	6	30	2 7/8
		EVPH1SE0636	371	376	6	36	2 7/8
		EVPH1SE0642	420	422	6	42	2 7/8
		EVPH1SE0648	457	470	6	48	2 7/8
		EVPH1SE0654	515	527	6	54	2 7/8
		EVPH1SE0660	542	547	6	60	2 7/8
	Laminate Extension Module - Single Sided 12" High	EVPH1SE1218	251	259	12	18	2 7/8
		EVPH1SE1224	292	302	12	24	2 7/8
		EVPH1SE1230	327	334	12	30	2 7/8
		EVPH1SE1236	371	384	12	36	2 7/8
		EVPH1SE1242	420	429	12	42	2 7/8
		EVPH1SE1248	457	471	12	48	2 7/8
		EVPH1SE1254	515	529	12	54	2 7/8
		EVPH1SE1260	542	556	12	60	2 7/8
	Laminate Extension Module - Single Sided 18" High	EVPH1SE1818	335	344	18	18	2 7/8
		EVPH1SE1824	395	405	18	24	2 7/8
		EVPH1SE1830	455	469	18	30	2 7/8
		EVPH1SE1836	520	534	18	36	2 7/8
		EVPH1SE1842	587	601	18	42	2 7/8
		EVPH1SE1848	644	659	18	48	2 7/8
		EVPH1SE1854	697	717	18	54	2 7/8
		EVPH1SE1860	767	788	18	60	2 7/8
	Laminate Extension Module - Single Sided 24" High	EVPH1SE2418	335	348	24	18	2 7/8
		EVPH1SE2424	395	409	24	24	2 7/8
		EVPH1SE2430	455	471	24	30	2 7/8
		EVPH1SE2436	520	537	24	36	2 7/8
		EVPH1SE2442	587	604	24	42	2 7/8
		EVPH1SE2448	644	662	24	48	2 7/8
		EVPH1SE2454	697	721	24	54	2 7/8
		EVPH1SE2460	767	792	24	60	2 7/8



**EVPH2SE - LAMINATE EXTENSION MODULE - DOUBLE SIDED**

- Attaches on top of a panel.
- Laminate faces on both sides of the module provide durable, washable surfaces
- Modules can be stacked to add privacy or to divide space.
- Panel Extension Modules are not load bearing above 66" H
- When ordering Panel Extension Modules, additional connectors are required.
- Available in high pressure only.
- \*Top Trims are not included with Extension Modules.

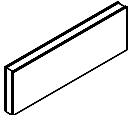
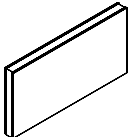
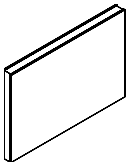
	DESCRIPTION	PRODUCT CODE	LIST PRICE	DIMENSIONS/INCHES		
				H	W	D
	Laminate Extension Module - Double Sided 6" High	EVPH2SE0618	270	6	18	2 7/8
		EVPH2SE0624	319	6	24	2 7/8
		EVPH2SE0630	368	6	30	2 7/8
		EVPH2SE0636	422	6	36	2 7/8
		EVPH2SE0642	479	6	42	2 7/8
		EVPH2SE0648	534	6	48	2 7/8
		EVPH2SE0654	616	6	54	2 7/8
		EVPH2SE0660	646	6	60	2 7/8
	Laminate Extension Module - Double Sided 12" High	EVPH2SE1218	270	12	18	2 7/8
		EVPH2SE1224	319	12	24	2 7/8
		EVPH2SE1230	368	12	30	2 7/8
		EVPH2SE1236	422	12	36	2 7/8
		EVPH2SE1242	479	12	42	2 7/8
		EVPH2SE1248	534	12	48	2 7/8
		EVPH2SE1254	616	12	54	2 7/8
		EVPH2SE1260	632	12	60	2 7/8
	Laminate Extension Module - Double Sided 18" High	EVPH2SE1818	388	18	18	2 7/8
		EVPH2SE1824	469	18	24	2 7/8
		EVPH2SE1830	542	18	30	2 7/8
		EVPH2SE1836	629	18	36	2 7/8
		EVPH2SE1842	710	18	42	2 7/8
		EVPH2SE1848	805	18	48	2 7/8
		EVPH2SE1854	882	18	54	2 7/8
		EVPH2SE1860	950	18	60	2 7/8
	Laminate Extension Module - Double Sided 24" High	EVPH2SE2418	388	24	18	2 7/8
		EVPH2SE2424	469	24	24	2 7/8
		EVPH2SE2430	542	24	30	2 7/8
		EVPH2SE2436	629	24	36	2 7/8
		EVPH2SE2442	710	24	42	2 7/8
		EVPH2SE2448	805	24	48	2 7/8
		EVPH2SE2454	882	24	54	2 7/8
		EVPH2SE2460	950	24	60	2 7/8



**EVPAE - AIR FLOW EXTENSION MODULE**

- Metal air flow panel extension
- Attaches to top of panel
- Modules can be stacked to add privacy or to divide space.
- Panel Extension Modules are not load bearing above 66" H.
- When ordering Panel Extension Modules, additional connectors are required.
- \*Top Trims are not included with Extension Modules.

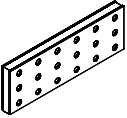
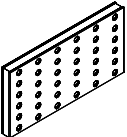
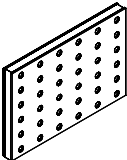
	DESCRIPTION	PRODUCT CODE	LIST PRICE	DIMENSIONS/INCHES		
				H	W	D
	Air Flow Extension Module - 12" High	EVPAE1224	325	12	24	2 7/8
		EVPAE1230	388	12	30	2 7/8
		EVPAE1236	439	12	36	2 7/8
		EVPAE1242	484	12	42	2 7/8
		EVPAE1248	548	12	48	2 7/8
		EVPAE1254	633	18	54	2 7/8
		EVPAE1260	721	12	60	2 7/8
	Air Flow Extension Module - 18" High	EVPAE1824	409	18	24	2 7/8
		EVPAE1830	477	18	30	2 7/8
		EVPAE1836	528	18	36	2 7/8
		EVPAE1842	578	18	42	2 7/8
		EVPAE1848	665	18	48	2 7/8
		EVPAE1854	764	18	54	2 7/8
		EVPAE1860	858	18	60	2 7/8
	Air Flow Extension Module - 24" High	EVPAE2424	409	24	24	2 7/8
		EVPAE2430	477	24	30	2 7/8
		EVPAE2436	528	24	36	2 7/8
		EVPAE2442	578	24	42	2 7/8
		EVPAE2448	665	24	48	2 7/8
		EVPAE2454	757	18	54	2 7/8
		EVPAE2460	858	24	60	2 7/8

**EVPOE - OPEN PANEL EXTENSION MODULE**

- Attaches to top portion of a panel.
- Modules can be stacked to add privacy or to divide space
- Panel Extension Modules are not load bearing above 66" H.
- When ordering Panel Extension Modules, additional connectors are required.
- \*Top Trims are not included with Extension Modules.

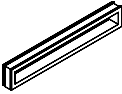
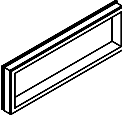
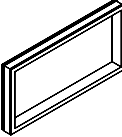
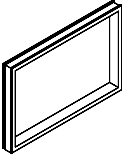
	DESCRIPTION	PRODUCT CODE	LIST PRICE	DIMENSIONS/INCHES		
				H	W	D
	Open Panel Extension Module - 6" High	EVPOE0618	289	6	18	2 7/8
		EVPOE0624	295	6	24	2 7/8
		EVPOE0630	360	6	30	2 7/8
		EVPOE0636	376	6	36	2 7/8
		EVPOE0642	456	6	42	2 7/8
		EVPOE0648	512	6	48	2 7/8
		EVPOE0654	558	6	54	2 7/8
		EVPOE0660	602	6	60	2 7/8
	Open Panel Extension Module - 12" High	EVPOE1218	291	12	18	2 7/8
		EVPOE1224	297	12	24	2 7/8
		EVPOE1230	360	12	30	2 7/8
		EVPOE1236	376	12	36	2 7/8
		EVPOE1242	456	12	42	2 7/8
		EVPOE1248	513	12	48	2 7/8
		EVPOE1254	558	12	54	2 7/8
		EVPOE1260	604	12	60	2 7/8
	Open Panel Extension Module - 18" High	EVPOE1818	424	18	18	2 7/8
		EVPOE1824	431	18	24	2 7/8
		EVPOE1830	456	18	30	2 7/8
		EVPOE1836	499	18	36	2 7/8
		EVPOE1842	561	18	42	2 7/8
		EVPOE1848	633	18	48	2 7/8
		EVPOE1854	686	18	54	2 7/8
		EVPOE1860	739	18	60	2 7/8
	Open Panel Extension Module - 24" High	EVPOE2418	431	24	18	2 7/8
		EVPOE2424	424	24	24	2 7/8
		EVPOE2430	456	24	30	2 7/8
		EVPOE2436	499	24	36	2 7/8
		EVPOE2442	561	24	42	2 7/8
		EVPOE2448	633	24	48	2 7/8
		EVPOE2454	686	24	54	2 7/8
		EVPOE2460	739	24	60	2 7/8



**EVPIECBS - BRIDGE PANEL INLINE EXTENSION CONNECTOR**

- Connects bridge panel to inline extension connector.
- Includes one bridge extension connector and connecting hardware.

	DESCRIPTION	PRODUCT CODE	LIST PRICE	DIMENSIONS/INCHES		
				H	W	D
	Bridge Panel Inline Extension Connector	EVPIECBS06	49	6	3	3
		EVPIECBS12	49	12	3	3
		EVPIECBS18	58	18	3	3
		EVPIECBS24	58	24	3	3

**EVPEERBSA - BRIDGE PANEL END OF RUN EXTENSION CONNECTOR - ALUMINUM TRIM**

- Connects at end of run of bridge panel and can attach panel to fixed wall.
- Adds 1" to width of panel run.
- Provides slotted support for worksurfaces and hang on components up to 66"H.
- Includes one slotted bridge extension connector and connecting hardware and trim kit.

	DESCRIPTION	PRODUCT CODE	LIST PRICE	DIMENSIONS/INCHES		
				H	W	D
	Bridge Panel End of Run Extension Connector	EVPEERBSA06	53	6	3	3
	Aluminum Trim	EVPEERBSA12	53	12	3	3
		EVPEERBSA18	64	18	3	3
		EVPEERBSA24	64	24	3	3

**EVPICBS - BRIDGE PANEL INLINE CONNECTOR WITHOUT ALUMINUM INSERT**

- Connects two bridge panels to inline connector.
- Inline connector in middle between two bridge panels, above opening, using double clamp at bottom.
- Includes one bridge extension connector without aluminum insert, includes connecting hardware.

	DESCRIPTION	PRODUCT CODE	LIST PRICE	DIMENSIONS/INCHES		
				H	W	D
	Bridge Panel Inline Connector	EVPICBS06	49	6	3	3
	without Aluminum Insert	EVPICBS12	49	12	3	3
		EVPICBS18	58	18	3	3
		EVPICBS24	58	24	3	3

**EVPCEPB1 - BRIDGE PANEL CORNER EXTENSION POST 1 WAY**

- Connects at end of a run of extension modules.
- Post and connecting hardware add 3.25" to power beam run.
- Includes one extension post, one slotted extension connectors for bridge panel, connecting hardware and trim kit.

	DESCRIPTION	PRODUCT CODE	LIST PRICE	DIMENSIONS/INCHES		
				H	W	D
	Bridge Panel Inline Extension Connector	EVPCEPBSA106	90	6	3	3
		EVPCEPBSA112	90	12	3	3
		EVPCEPBSA118	114	18	3	3
		EVPCEPBSA124	114	24	3	3

**EVPCEPB2 - BRIDGE PANEL CORNER EXTENSION POST 2 WAY**

- Connects two bridge panels in 90 degree configuration.
- Post and connecting hardware add 3.25" to power beam run.
- Includes one extension post, two one slotted extension connectors for bridge panel, connecting hardware and trim kit.

	DESCRIPTION	PRODUCT CODE	LIST PRICE	DIMENSIONS/INCHES		
				H	W	D
	Bridge Panel Corner Extension Post 2 way	EVPCEPBSA206	92	6	3	3
		EVPCEPBSA212	92	12	3	3
		EVPCEPBSA218	145	18	3	3
		EVPCEPBSA224	145	24	3	3

**EVPCEPB3 - BRIDGE PANEL CORNER EXTENSION POST 3 WAY**

- Connects three bridge panels in T degree configuration.
- Post and connecting hardware add 3.25" to power beam run.
- Includes one extension post, three one slotted extension connectors for bridge panel, connecting hardware and trim kit.

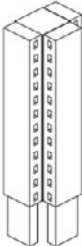
	DESCRIPTION	PRODUCT CODE	LIST PRICE	DIMENSIONS/INCHES		
				H	W	D
	Bridge Panel Corner Extension Post 3 way	EVPCEPBSA306	110	6	3	3
		EVPCEPBSA312	110	12	3	3
		EVPCEPBSA318	170	18	3	3
		EVPCEPBSA324	170	24	3	3



**EVPCEPB4 - BRIDGE PANEL CORNER EXTENSION POST 4 WAY**

- Connects four bridge panels in X degree configuration.
- Post and connecting hardware add 3.25" to power beam run.
- Includes one extension post, four one slotted extension connectors for bridge panel, connecting hardware and trim kit.

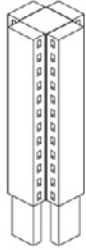

DESCRIPTION	PRODUCT CODE	LIST PRICE	DIMENSIONS/INCHES		
			H	W	D
Bridge Panel Corner Extension Post 4 way	EVPCEPBS406	127	6	3	3
	EVPCEPBS412	127	12	3	3
	EVPCEPBS418	187	18	3	3
	EVPCEPBS424	187	24	3	3

**EVPCEIPBSA2 - BRIDGE PANEL INLINE TWO WAY POST EXTENSION**

- Connects two bridge panels in straight run.
- Post and connecting hardware add 3.25" to power beam run.
- Includes one extension post, two slotted extension connectors for bridge panel, connecting hardware and trim kit.



DESCRIPTION	PRODUCT CODE	LIST PRICE	DIMENSIONS/INCHES		
			H	W	D
Bridge Panel Inline Extension Post 2 way	EVPCEIPBSA206	97	6	3	3
	EVPCEIPBSA212	97	12	3	3
	EVPCEIPBSA218	158	18	3	3
	EVPCEIPBSA224	158	24	3	3

**EVPFEB - FABRIC PANEL BRIDGE MODULE**

- Bridge modules connects two panels above opening.
- Requires bridge extension connectors, connects with clamps on top and at bottom.
- Each side of fabric module may have different fabric within the same grade at no charge.
- If different grades of fabric are used, the entire module must be price at highest grade.
- When ordering bridge modules , additional bridge connectors are required.
- Aluminum trim for bottom to be ordered separately.

	DESCRIPTION	PRODUCT CODE	LIST PRICE		DIMENSIONS/INCHES				
			Gr1	Gr2	H	W	D		
	Fabric Panel Bridge Module - 6" High	EVPFEB0618	185	193	6	18	3		
		EVPFEB0624	187	201	6	24	3		
		EVPFEB0630	205	221	6	30	3		
		EVPFEB0636	228	246	6	36	3		
		EVPFEB0642	258	273	6	42	3		
		EVPFEB0648	277	298	6	48	3		
		EVPFEB0654	299	320	6	54	3		
		EVPFEB0660	321	348	6	60	3		
		Fabric Panel Bridge Module - 12" High	Fabric Panel Bridge Module - 12" High	EVPFEB1218	185	193	12	18	3
				EVPFEB1224	187	201	12	24	3
EVPFEB1230	205			221	12	30	3		
EVPFEB1236	228			246	12	36	3		
EVPFEB1242	258			273	12	42	3		
EVPFEB1248	277			298	12	48	3		
EVPFEB1254	299			320	12	54	3		
EVPFEB1260	321			348	12	60	3		
Fabric Panel Bridge Module - 18" High	Fabric Panel Bridge Module - 18" High	EVPFEB1818	223	239	18	18	3		
		EVPFEB1824	231	252	18	24	3		
		EVPFEB1830	251	277	18	30	3		
		EVPFEB1836	291	318	18	36	3		
		EVPFEB1842	319	354	18	42	3		
		EVPFEB1848	349	385	18	48	3		
		EVPFEB1854	378	419	18	54	3		
		EVPFEB1860	411	455	18	60	3		
Fabric Panel Bridge Module - 24" High	Fabric Panel Bridge Module - 24" High	EVPFEB2418	223	239	24	18	3		
		EVPFEB2424	231	252	24	24	3		
		EVPFEB2430	251	277	24	30	3		
		EVPFEB2436	291	318	24	36	3		
		EVPFEB2442	319	354	24	42	3		
		EVPFEB2448	349	385	24	48	3		
		EVPFEB2454	378	419	24	54	3		
		EVPFEB2460	411	455	24	60	3		

**EVPFPEB - FABRIC PANEL BRIDGE MODULE - PREMIUM**

- Bridge modules connects two panels above opening.
- Requires bridge extension connectors, connects with clamps on top and at bottom.
- Each side of fabric module may have different fabric within the same grade at no charge.
- If different grades of fabric are used, the entire module must be price at highest grade.
- When ordering bridge modules , additional bridge connectors are required.
- Aluminum trim for bottom to be ordered separately.

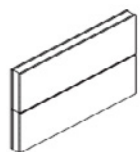
	DESCRIPTION	PRODUCT CODE	LIST PRICE		DIMENSIONS/INCHES		
			Gr1	Gr2	H	W	D
	Fabric Panel Bridge Module - Premium	EVPFPEB2418	301	318	24	18	3
		EVPFPEB2424	321	345	24	24	3
		EVPFPEB2430	360	386	24	30	3
		EVPFPEB2436	405	432	24	36	3
		EVPFPEB2442	455	490	24	42	3
		EVPFPEB2448	488	526	24	48	3
		EVPFPEB2454	539	580	24	54	3
		EVPFPEB2460	588	634	24	60	3



**EVPGTB - TEMPERED GLASS BRIDGE MODULE**

- Bridge modules connects two panels above opening.
- Requires bridge extension connectors, connects with clamps on top and at bottom.
- Standard in Clear (CLR) or smoked (SMK) as a option.
- Please note that smoked glass (SMK) has 51% light transmittance.
- Frosted glass (FRST) 40% upcharge. Contact Evolve Customer support for details.
- When ordering bridge modules, additional bridge connectors are required.
- Aluminum trim for bottom to be ordered separately.

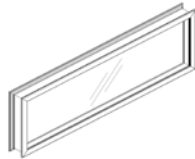

DESCRIPTION	PRODUCT CODE	LIST PRICE	DIMENSIONS/INCHES		
			H	W	D
Tempered Glass Bridge Module - 6" High	EVPGTB0618	355	6	18	3
	EVPGTB0624	383	6	24	3
	EVPGTB0630	459	6	30	3
	EVPGTB0636	481	6	36	3
	EVPGTB0642	588	6	42	3
	EVPGTB0648	656	6	48	3
	EVPGTB0654	717	6	54	3
	EVPGTB0660	773	6	60	3
Tempered Glass Bridge Module - 12" High	EVPGTB1218	355	12	18	3
	EVPGTB1224	383	12	24	3
	EVPGTB1230	459	12	30	3
	EVPGTB1236	481	12	36	3
	EVPGTB1242	588	12	42	3
	EVPGTB1248	656	12	48	3
	EVPGTB1254	717	12	54	3
	EVPGTB1260	773	12	60	3
Tempered Glass Bridge Module - 18" High	EVPGTB1818	533	18	18	3
	EVPGTB1824	548	18	24	3
	EVPGTB1830	587	18	30	3
	EVPGTB1836	641	18	36	3
	EVPGTB1842	726	18	42	3
	EVPGTB1848	813	18	48	3
	EVPGTB1854	882	18	54	3
	EVPGTB1860	946	18	60	3
Tempered Glass Bridge Module - 24" High	EVPGTB2418	533	24	18	3
	EVPGTB2424	548	24	24	3
	EVPGTB2430	587	24	30	3
	EVPGTB2436	641	24	36	3
	EVPGTB2442	726	24	42	3
	EVPGTB2448	813	24	48	3
	EVPGTB2454	882	24	54	3
	EVPGTB2460	946	24	60	3

**EVPGTEB - TEMPERED GLASS BRIDGE MODULE - PREMIUM**

- Bridge modules connects two panels above opening.
- Requires bridge extension connectors, connects with clamps at bottom.
- Standard in Clear (CLR) or smoked (SMK) as a option.
- Please note that smoked glass (SMK) has 51% light transmittance.
- Frosted glass (FRST) 40% upcharge. Contact Evolve Customer support for details.
- When ordering bridge modules, additional bridge connectors are required.
- Aluminum trim for bottom to be ordered separately.

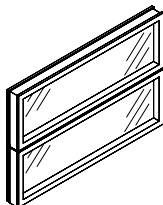

DESCRIPTION	PRODUCT CODE	LIST PRICE	DIMENSIONS/INCHES		
			H	W	D
Tempered Glass Bridge Module - Premium	EVPGTEB2418	525	24	18	3
	EVPGTEB2424	582	24	24	3
	EVPGTEB2430	665	24	30	3
	EVPGTEB2436	757	24	36	3
	EVPGTEB2442	839	24	42	3
	EVPGTEB2448	941	24	48	3
	EVPGTEB2454	1026	24	54	3
	EVPGTEB2460	1111	24	60	3



**EVPW1SEB - WRITE BOARD BRIDGE MODULE - SINGLE SIDED**

- Bridge modules connects two panels above opening.
- Requires bridge extension connectors, connects with clamps at bottom.
- Provides writing surface on Single side.
- Panel extension module is not load bearing if installed higher than 66" High.
- Use erasable Write Board markers only.
- When ordering bridge modules, additional bridge connectors are required.
- Aluminum trim for bottom to be ordered separately.

DESCRIPTION	PRODUCT CODE	LIST PRICE		DIMENSIONS/INCHES		
		Gr1	Gr2	H	W	D
 Write Board Bridge Module - 6" High Single Sided	EVPW1SEB0618	251	259	6	18	3
	EVPW1SEB0624	292	302	6	24	3
	EVPW1SEB0630	327	334	6	30	3
	EVPW1SEB0636	371	384	6	36	3
	EVPW1SEB0642	420	429	6	42	3
	EVPW1SEB0648	457	529	6	48	3
	EVPW1SEB0654	515	529	6	54	3
	EVPW1SEB0660	542	556	6	60	3
Write Board Bridge Module - 12" High Single Sided	EVPW1SEB1218	251	259	12	18	3
	EVPW1SEB1224	292	302	12	24	3
	EVPW1SEB1230	327	334	12	30	3
	EVPW1SEB1236	371	384	12	36	3
	EVPW1SEB1242	420	429	12	42	3
	EVPW1SEB1248	457	471	12	48	3
	EVPW1SEB1254	515	529	12	54	3
	EVPW1SEB1260	542	556	12	60	3
Write Board Bridge Module - 18" High Single Sided	EVPW1SEB1818	335	348	18	18	3
	EVPW1SEB1824	395	409	18	24	3
	EVPW1SEB1830	455	471	18	30	3
	EVPW1SEB1836	520	537	18	36	3
	EVPW1SEB1842	587	604	18	42	3
	EVPW1SEB1848	644	662	18	48	3
	EVPW1SEB1854	697	721	18	54	3
	EVPW1SEB1860	767	792	18	60	3
Write Board Bridge Module - 24" High Single Sided	EVPW1SEB2418	335	348	24	18	3
	EVPW1SEB2424	395	409	24	24	3
	EVPW1SEB2430	455	471	24	30	3
	EVPW1SEB2436	520	537	24	36	3
	EVPW1SEB2442	587	604	24	42	3
	EVPW1SEB2448	644	662	24	48	3
	EVPW1SEB2454	697	721	24	54	3
	EVPW1SEB2460	767	792	24	60	3



**EVPW2SEB - WRITE BOARD BRIDGE MODULE - DOUBLE SIDED**

- Bridge modules connects two panels above opening.
- Requires bridge extension connectors, connects with clamps at bottom.
- Provides writing surface on Single side.
- Panel extension module is not load bearing if installed higher than 66" High.
- Available in high pressure only.
- Use erasable Write Board markers only.
- When ordering bridge modules, additional bridge connectors are required.
- Aluminum trim for bottom to be ordered separately.

DESCRIPTION	PRODUCT CODE	LIST PRICE	DIMENSIONS/INCHES		
			H	W	D
 Write Board Bridge Module - 6" High Double Sided	EVPW2SEB0618	270	6	18	3
	EVPW2SEB0624	319	6	24	3
	EVPW2SEB0630	368	6	30	3
	EVPW2SEB0636	422	6	36	3
	EVPW2SEB0642	479	6	42	3
	EVPW2SEB0648	534	6	48	3
	EVPW2SEB0654	616	6	54	3
	EVPW2SEB0660	632	6	60	3
Tempered Glass Bridge Module - 12" High Double Sided	EVPW2SEB1218	270	12	18	3
	EVPW2SEB1224	319	12	24	3
	EVPW2SEB1230	368	12	30	3
	EVPW2SEB1236	422	12	36	3
	EVPW2SEB1242	479	12	42	3
	EVPW2SEB1248	534	12	48	3
	EVPW2SEB1254	616	12	54	3
	EVPW2SEB1260	632	12	60	3
Tempered Glass Bridge Module - 18" High Double Sided	EVPW2SEB1818	388	18	18	3
	EVPW2SEB1824	469	18	24	3
	EVPW2SEB1830	542	18	30	3
	EVPW2SEB1836	629	18	36	3
	EVPW2SEB1842	710	18	42	3
	EVPW2SEB1848	805	18	48	3
	EVPW2SEB1854	882	18	54	3
	EVPW2SEB1860	950	18	60	3
Tempered Glass Bridge Module - 24" High Double Sided	EVPW2SEB2418	388	24	18	3
	EVPW2SEB2424	469	24	24	3
	EVPW2SEB2430	542	24	30	3
	EVPW2SEB2436	629	24	36	3
	EVPW2SEB2442	710	24	42	3
	EVPW2SEB2448	805	24	48	3
	EVPW2SEB2454	882	24	54	3
	EVPW2SEB2460	950	24	60	3

**EVPH1SEB - LAMINATE BRIDGE MODULE - SINGLE SIDED**

- Bridge modules connects two panels above opening.
- Requires bridge extension connectors, connects with clamps at bottom.
- Laminate face on module provides durable, washable surface on Single side of panel.
- Panel extension module is not load bearing if installed higher than 66" High.
- Available in high pressure only.
- When ordering bridge modules , additional bridge connectors are required.
- Aluminum trim for bottom to be ordered separately.

DESCRIPTION	PRODUCT CODE	LIST PRICE		DIMENSIONS/INCHES		
		Gr1	Gr2	H	W	D
 Laminate Bridge Module - 6" High Single Sided	EVPH1SEB0618	251	259	6	18	3
	EVPH1SEB0624	292	302	6	24	3
	EVPH1SEB0630	327	334	6	30	3
	EVPH1SEB0636	371	384	6	36	3
	EVPH1SEB0642	420	429	6	42	3
	EVPH1SEB0648	457	471	6	48	3
	EVPH1SEB0654	515	529	6	54	3
	EVPH1SEB0660	542	556	6	60	3
Laminate Bridge Module - 12" High Single Sided	EVPH1SEB1218	251	259	12	18	3
	EVPH1SEB1224	292	302	12	24	3
	EVPH1SEB1230	327	334	12	30	3
	EVPH1SEB1236	371	384	12	36	3
	EVPH1SEB1242	420	429	12	42	3
	EVPH1SEB1248	457	471	12	48	3
	EVPH1SEB1254	515	529	12	54	3
	EVPH1SEB1260	542	556	12	60	3
Laminate Bridge Module - 18" High Single Sided	EVPH1SEB1818	335	348	18	18	3
	EVPH1SEB1824	395	409	18	24	3
	EVPH1SEB1830	455	471	18	30	3
	EVPH1SEB1836	520	537	18	36	3
	EVPH1SEB1842	587	604	18	42	3
	EVPH1SEB1848	644	662	18	48	3
	EVPH1SEB1854	697	721	18	54	3
	EVPH1SEB1860	767	792	18	60	3
Laminate Bridge Module - 24" High Single Sided	EVPH1SEB2418	335	348	24	18	3
	EVPH1SEB2424	395	409	24	24	3
	EVPH1SEB2430	455	471	24	30	3
	EVPH1SEB2436	520	537	24	36	3
	EVPH1SEB2442	587	604	24	42	3
	EVPH1SEB2448	644	662	24	48	3
	EVPH1SEB2454	697	721	24	54	3
	EVPH1SEB2460	767	792	24	60	3



**EVPH2SEB - LAMINATE BRIDGE MODULE - DOUBLE SIDED**

- Bridge modules connects two panels above opening.
- Requires bridge extension connectors, connects with clamps at bottom.
- Laminate face on both sides of the module provides durable, washable surface.
- Panel extension module is not load bearing if installed higher than 66" High.
- When ordering panel extension modules, additional connectors are required.
- Available in high pressure only.
- When ordering bridge modules , additional bridge connectors are required.
- Aluminum trim for bottom to be ordered separately.

DESCRIPTION	PRODUCT CODE	LIST PRICE	DIMENSIONS/INCHES		
			H	W	D
 Laminate Bridge Module - 6" High Double Sided	EVPH2SEB0618	270	6	18	3
	EVPH2SEB0624	319	6	24	3
	EVPH2SEB0630	368	6	30	3
	EVPH2SEB0636	422	6	36	3
	EVPH2SEB0642	479	6	42	3
	EVPH2SEB0648	534	6	48	3
	EVPH2SEB0654	616	6	54	3
	EVPH2SEB0660	632	6	60	3
	Laminate Bridge Module - 12" High Double Sided	EVPH2SEB1218	270	12	18
EVPH2SEB1224		319	12	24	3
EVPH2SEB1230		368	12	30	3
EVPH2SEB1236		422	12	36	3
EVPH2SEB1242		479	12	42	3
EVPH2SEB1248		534	12	48	3
EVPH2SEB1254		616	12	54	3
EVPH2SEB1260		632	12	60	3
Laminate Bridge Module - 18" High Double Sided	EVPH2SEB1818	388	18	18	3
	EVPH2SEB1824	469	18	24	3
	EVPH2SEB1830	542	18	30	3
	EVPH2SEB1836	629	18	36	3
	EVPH2SEB1842	710	18	42	3
	EVPH2SEB1848	805	18	48	3
	EVPH2SEB1854	882	18	54	3
	EVPH2SEB1860	950	18	60	3
Laminate Bridge Module - 24" High Double Sided	EVPH2SEB2418	388	24	18	3
	EVPH2SEB2424	469	24	24	3
	EVPH2SEB2430	542	24	30	3
	EVPH2SEB2436	629	24	36	3
	EVPH2SEB2442	710	24	42	3
	EVPH2SEB2448	805	24	48	3
	EVPH2SEB2454	882	24	54	3
	EVPH2SEB2460	950	24	60	3

**EVPMPXXGI6P - 6" H PANEL MOUNT PRIVACY GLASS W/ ALUMINUM TRIM**

- Attaches on top of Evolve Panels to add privacy or divide space.
- Privacy Glass is integrated into the aluminum top trim.
- Aluminum trim must be specified for entire station when ordering panel mount privacy glass.
- Includes aluminum trim with channel and glass tile
- Glass and attachment hardware ship separately.
- Standard in clear (CLR) or frosted (FRST) glass.

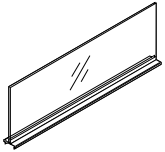
	DESCRIPTION	PRODUCT CODE	LIST PRICE		DIMENSIONS/INCHES		
			Clear	Frosted	H	W	D
	6" H Panel Mount Privacy Glass w/ Aluminum Trim - 24" Wide	EVPMP24GI6P	281	347	6	24	2 7/8
	6" H Panel Mount Privacy Glass w/ Aluminum Trim - 30" Wide	EVPMP30GI6P	304	352	6	30	2 7/8
	6" H Panel Mount Privacy Glass w/ Aluminum Trim - 36" Wide	EVPMP36GI6P	335	367	6	36	2 7/8
	6" H Panel Mount Privacy Glass w/ Aluminum Trim - 42" Wide	EVPMP42GI6P	350	404	6	42	2 7/8
	6" H Panel Mount Privacy Glass w/ Aluminum Trim - 48" Wide	EVPMP48GI6P	359	442	6	48	2 7/8
	6" H Panel Mount Privacy Glass w/ Aluminum Trim - 54" Wide	EVPMP54GI6P	372	476	6	54	2 7/8
	6" H Panel Mount Privacy Glass w/ Aluminum Trim - 60" Wide	EVPMP60GI6P	383	514	6	60	2 7/8
	6" H Panel Mount Privacy Glass w/ Aluminum Trim - 66" Wide	EVPMP66GI6P	443	587	6	66	2 7/8
6" H Panel Mount Privacy Glass w/ Aluminum Trim - 72" Wide	EVPMP72GI6P	456	588	6	72	2 7/8	



**EVMPXXGI9P - 9"H PANEL MOUNT PRIVACY GLASS W/ ALUMINUM TRIM**

- Attaches on top of Evolve Panels to add privacy or divide space.
- Privacy Glass is integrated into the aluminum top trim.
- Aluminum trim must be specified for entire station when ordering panel mount privacy glass.
- Includes aluminum trim with channel and glass tile
- Glass and attachment hardware ship separately.
- Standard in clear (CLR) or frosted (FRST) glass.

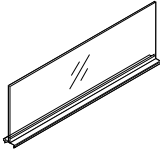
	DESCRIPTION	PRODUCT CODE	LIST PRICE		DIMENSIONS/INCHES		
			Clear	Frosted	H	W	D
	9" H Panel Mount Privacy Glass w/ Aluminum Trim - 24" Wide	EVMPMP24GI9P	281	347	9	24	2 7/8
	9" H Panel Mount Privacy Glass w/ Aluminum Trim - 30" Wide	EVMPMP30GI9P	304	352	9	30	2 7/8
	9" H Panel Mount Privacy Glass w/ Aluminum Trim - 36" Wide	EVMPMP36GI9P	335	367	9	36	2 7/8
	9" H Panel Mount Privacy Glass w/ Aluminum Trim - 42" Wide	EVMPMP42GI9P	350	407	9	42	2 7/8
	9" H Panel Mount Privacy Glass w/ Aluminum Trim - 48" Wide	EVMPMP48GI9P	359	421	9	48	2 7/8
	9" H Panel Mount Privacy Glass w/ Aluminum Trim - 54" Wide	EVMPMP54GI9P	372	455	9	54	2 7/8
	9" H Panel Mount Privacy Glass w/ Aluminum Trim - 60" Wide	EVMPMP60GI9P	383	492	9	60	2 7/8
	9" H Panel Mount Privacy Glass w/ Aluminum Trim - 66" Wide	EVMPMP66GI9P	443	588	9	66	2 7/8
9" H Panel Mount Privacy Glass w/ Aluminum Trim - 72" Wide	EVMPMP72GI9P	456	612	9	72	2 7/8	

**EVPMPXXGIP - 12" PANEL MOUNT PRIVACY GLASS W/ ALUMINUM TRIM**

- Attaches on top of Evolve Panels to add privacy or divide space.
- Privacy Glass is integrated into the aluminum top trim.
- Includes aluminum trim with channel and glass tile.
- Standard in clear (CLR), frosted (FRST) or writeable (WRW) glass.

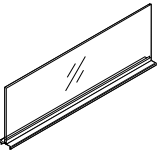
	DESCRIPTION	PRODUCT CODE	LIST PRICE			DIMENSIONS/INCHES		
			CLR	FRST	WRW	H	W	D
	Panel Mount Privacy Glass w/ Aluminum Trim - 24" Wide	EVPMP24GIP	290	354	472	12	24	2 7/8
	Panel Mount Privacy Glass w/ Aluminum Trim - 30" Wide	EVPMP30GIP	315	360	481	12	30	2 7/8
	Panel Mount Privacy Glass w/ Aluminum Trim - 36" Wide	EVPMP36GIP	335	367	492	12	36	2 7/8
	Panel Mount Privacy Glass w/ Aluminum Trim - 42" Wide	EVPMP42GIP	350	404	542	12	42	2 7/8
	Panel Mount Privacy Glass w/ Aluminum Trim - 48" Wide	EVPMP48GIP	369	442	592	12	48	2 7/8
	Panel Mount Privacy Glass w/ Aluminum Trim - 54" Wide	EVPMP54GIP	384	477	638	12	54	2 7/8
	Panel Mount Privacy Glass w/ Aluminum Trim - 60" Wide	EVPMP60GIP	395	514	689	12	60	2 7/8
	Panel Mount Privacy Glass w/ Aluminum Trim - 66" Wide	EVPMP66GIP	443	587	785	12	66	2 7/8
Panel Mount Privacy Glass w/ Aluminum Trim - 72" Wide	EVPMP72GIP	470	612	820	12	72	2 7/8	

**EVPMPNXXGIP - 12" H PANEL MOUNT PRIVACY GLASS W/ NOTCHED TOP TRIM FOR INLINE VARIABLE HEIGHT CONNECTOR**

- Privacy Glass integrated with aluminum top trim.
- Attaches on top of panels to add privacy or divide space.
- Includes aluminum top trim with channel with notched end and glass tile.
- Standard in clear (CLR) or frosted (FRST) glass.
- Aluminium trim must be specified for entire station when ordering panel mount privacy glass.
- Glass and attachment hardware to ship separately

	DESCRIPTION	PRODUCT CODE	LIST PRICE		DIMENSIONS/INCHES		
			Clear	Frosted	H	W	D
	Panel Mount Privacy Glass w/ Notched Top Trim for Variable Height Connector - 12" High	EVPMPN24GIP	290	354	12	24	2 7/8
		EVPMPN30GIP	315	360	12	30	2 7/8
		EVPMPN36GIP	335	367	12	36	2 7/8
		EVPMPN42GIP	350	404	12	42	2 7/8
		EVPMPN48GIP	369	442	12	48	2 7/8
		EVPMPN54GIP	384	477	12	54	2 7/8
		EVPMPN60GIP	395	514	12	60	2 7/8



**EVPMPDNXXGIP - 12" H PANEL MOUNT PRIVACY GLASS W/ DOUBLE NOTCHED TOP TRIM FOR INLINE VARIABLE HEIGHT CONNECTOR**

- Privacy Glass integrated with aluminum top trim.
- Attaches on top of panels to add privacy or divide space.
- Includes aluminum top trim with channel with notched ends and glass tile.
- Standard in clear (CLR) or frosted (FRST) glass.
- Aluminium trim must be specified for entire station when ordering panel mount privacy glass.
- Glass and attachment hardware to ship separately.

	DESCRIPTION	PRODUCT CODE	LIST PRICE		DIMENSIONS/INCHES		
			Clear	Frosted	H	W	D
	Panel Mount Privacy Glass w/ double notched top trim for variable height connector - 12" High	EVPMPDN24GIP	290	354	12	24	2 7/8
		EVPMPDN30GIP	315	360	12	30	2 7/8
		EVPMPDN36GIP	335	367	12	36	2 7/8
		EVPMPDN42GIP	350	404	12	42	2 7/8
		EVPMPDN48GIP	369	442	12	48	2 7/8
		EVPMPDN54GIP	384	477	12	54	2 7/8
		EVPMPDN60GIP	395	514	12	60	2 7/8

**EVPMPXXGI18P - 18" H PANEL MOUNT PRIVACY GLASS**

- Privacy Glass integrated with aluminum top trim.
- Attaches on top of panels to add privacy or divide space.
- Includes aluminum trim with channel and glass tile.
- Aluminium trim must be specified for entire station when ordering panel mount privacy glass.
- Glass and attachment hardware to ship separately.

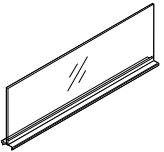
	DESCRIPTION	PRODUCT CODE	LIST PRICE		DIMENSIONS/INCHES		
			Clear	Frosted	H	W	D
	18" H Panel Mount Privacy Glass w/ Aluminum Trim - 24" Wide	EVPMP24G118P	433	528	18	24	2 7/8
	18" H Panel Mount Privacy Glass w/ Aluminum Trim - 30" Wide	EVPMP30G118P	470	539	18	30	2 7/8
	18" H Panel Mount Privacy Glass w/ Aluminum Trim - 36" Wide	EVPMP36G118P	501	548	18	36	2 7/8
	18" H Panel Mount Privacy Glass w/ Aluminum Trim - 42" Wide	EVPMP42G118P	523	604	18	42	2 7/8
	18" H Panel Mount Privacy Glass w/ Aluminum Trim - 48" Wide	EVPMP48G118P	554	659	18	48	2 7/8
	18" H Panel Mount Privacy Glass w/ Aluminum Trim - 54" Wide	EVPMP54G118P	574	714	18	54	2 7/8
	18" H Panel Mount Privacy Glass w/ Aluminum Trim - 60" Wide	EVPMP60G118P	593	773	18	60	2 7/8
	18" H Panel Mount Privacy Glass w/ Aluminum Trim - 66" Wide	EVPMP66G118P	665	877	18	66	2 7/8
	18" H Panel Mount Privacy Glass w/ Aluminum Trim - 72" Wide	EVPMP72G118P	703	917	18	72	2 7/8



**EVPMPNXXG118P - 18" H PANEL MOUNT PRIVACY GLASS WITH NOTCHED TOP TRIM FOR VARIABLE HEIGHT CONNECTOR**

- Privacy Glass integrated with aluminum top trim.
- Attaches on top of panels to add privacy or divide space.
- Includes aluminum trim with channel and glass tile.
- Standard in clear (CLR) or frosted (FRST) glass.
- Aluminium trim must be specified for entire station when ordering panel mount privacy glass.
- Glass and attachment hardware to ship separately.

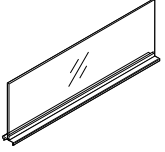
	DESCRIPTION	PRODUCT CODE	LIST PRICE		DIMENSIONS/INCHES		
			Clear	Frosted	H	W	D
	18" H Panel Mount Privacy Glass w/ Aluminum Trim - 24" Wide	EVPMPN24G118P	433	528	18	24	2 7/8
	18" H Panel Mount Privacy Glass w/ Aluminum Trim - 30" Wide	EVPMPN30G118P	470	539	18	30	2 7/8
	18" H Panel Mount Privacy Glass w/ Aluminum Trim - 36" Wide	EVPMPN36G118P	501	548	18	36	2 7/8
	18" H Panel Mount Privacy Glass w/ Aluminum Trim - 42" Wide	EVPMPN42G118P	523	604	18	42	2 7/8
	18" H Panel Mount Privacy Glass w/ Aluminum Trim - 48" Wide	EVPMPN48G118P	554	659	18	48	2 7/8
	18" H Panel Mount Privacy Glass w/ Aluminum Trim - 54" Wide	EVPMPN54G118P	574	714	18	54	2 7/8
	18" H Panel Mount Privacy Glass w/ Aluminum Trim - 60" Wide	EVPMPN60G118P	593	773	18	60	2 7/8
	18" H Panel Mount Privacy Glass w/ Aluminum Trim - 66" Wide	EVPMPN66G118P	665	877	18	66	2 7/8
18" H Panel Mount Privacy Glass w/ Aluminum Trim - 72" Wide	EVPMPN72G118P	703	917	18	72	2 7/8	



**EVPMPDNXXGI18P-18"H PANEL MOUNT PRIVACY GLASS WITH DOUBLE NOTCHED TOP TRIM FOR VARIABLE HEIGHT CONNECTOR**

- Privacy Glass integrated with aluminum top trim.
- Attaches on top of panels to add privacy or divide space.
- Includes aluminum trim with channel and glass tile.
- Standard in clear (CLR) or frosted (FRST) glass.
- Aluminium trim must be specified for entire station when ordering panel mount privacy glass.
- Glass and attachment hardware to ship separately.

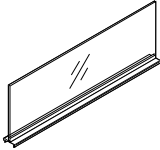
	DESCRIPTION	PRODUCT CODE	LIST PRICE		DIMENSIONS/INCHES		
			Clear	Frosted	H	W	D
	18" H Panel Mount Privacy Glass w/ Aluminum Trim - 24" Wide	EVPMPDN24GI18P	433	528	18	24	2 7/8
	18" H Panel Mount Privacy Glass w/ Aluminum Trim - 30" Wide	EVPMPDN30GI18P	470	539	18	30	2 7/8
	18" H Panel Mount Privacy Glass w/ Aluminum Trim - 36" Wide	EVPMPDN36GI18P	501	548	18	36	2 7/8
	18" H Panel Mount Privacy Glass w/ Aluminum Trim - 42" Wide	EVPMPDN42GI18P	523	604	18	42	2 7/8
	18" H Panel Mount Privacy Glass w/ Aluminum Trim - 48" Wide	EVPMPDN48GI18P	554	659	18	48	2 7/8
	18" H Panel Mount Privacy Glass w/ Aluminum Trim - 54" Wide	EVPMPDN54GI18P	574	714	18	54	2 7/8
	18" H Panel Mount Privacy Glass w/ Aluminum Trim - 60" Wide	EVPMPDN60GI18P	593	773	18	60	2 7/8
	18" H Panel Mount Privacy Glass w/ Aluminum Trim - 66" Wide	EVPMPDN66GI18P	665	877	18	66	2 7/8
18" H Panel Mount Privacy Glass w/ Aluminum Trim - 72" Wide	EVPMPDN72GI18P	703	917	18	72	2 7/8	

**EVPMPXXGI6PU - 6" H PANEL MOUNT PRIVACY GLASS FOR U CHANNEL FOR GALLERY PANEL ON ONE END**

- Privacy Glass integrated with aluminum top trim to be used with U channel with connector for Gallery Panels.
- Attaches on top of panels to add privacy or divide space.
- Includes aluminum trim with channel and glass tile.
- Standard in clear (CLR) or frosted (FRST) glass.
- Aluminium trim must be specified for entire station when ordering panel mount privacy glass.
- Glass and attachment hardware to ship separately.
- Trim and glass extended for U channel from one end.

DESCRIPTION	PRODUCT CODE	LIST PRICE		DIMENSIONS/INCHES		
		Clear	Frosted	H	W	D
 6" H Panel Mount Privacy Glass U Channel for Gallery Panel	EVPMP24GI6PU	324	371	6	24	5/8
	EVPMP30GI6PU	347	378	6	30	5/8
	EVPMP36GI6PU	360	416	6	36	5/8
	EVPMP42GI6PU	382	455	6	42	5/8
	EVPMP48GI6PU	395	492	6	48	5/8
	EVPMP54GI6PU	407	532	6	54	5/8
	EVPMP60GI6PU	443	587	6	60	5/8
	EVPMP66GI6PU	470	612	6	66	5/8
	EVPMP72GI6PU	497	637	6	72	5/8

**EVPMPXXGI9PU - 9" H PANEL MOUNT PRIVACY GLASS FOR U CHANNEL FOR GALLERY PANEL ON ONE END**

- Privacy Glass integrated with aluminum top trim to be used with U channel with connector for Gallery Panels.
- Attaches on top of panels to add privacy or divide space.
- Includes aluminum trim with channel and glass tile.
- Standard in clear (CLR) or frosted (FRST) glass.
- Aluminium trim must be specified for entire station when ordering panel mount privacy glass.
- Glass and attachment hardware to ship separately.
- Trim and glass extended for U channel from one end.

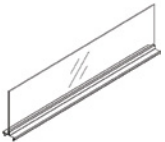
DESCRIPTION	PRODUCT CODE	LIST PRICE		DIMENSIONS/INCHES		
		Clear	Frosted	H	W	D
 9" H Panel Mount Privacy Glass U Channel for Gallery Panel	EVPMP24GI9PU	324	371	9	24	5/8
	EVPMP30GI9PU	378	378	9	30	5/8
	EVPMP36GI9PU	416	378	9	36	5/8
	EVPMP42GI9PU	455	455	9	42	5/8
	EVPMP48GI9PU	492	492	9	48	5/8
	EVPMP54GI9PU	532	532	9	54	5/8
	EVPMP60GI9PU	443	587	9	60	5/8
	EVPMP66GI9PU	470	612	9	66	5/8
	EVPMP72GI9PU	497	637	9	72	5/8

**EVPMPXXGI12PU - 12" H PANEL MOUNT PRIVACY GLASS FOR U CHANNEL FOR GALLERY PANEL ON ONE END**

- Privacy Glass integrated with aluminum top trim to be used with U channel with connector for Gallery Panels.
- Attaches on top of panels to add privacy or divide space.
- Includes aluminum trim with channel and glass tile.
- Standard in clear (CLR) or frosted (FRST) glass.
- Aluminium trim must be specified for entire station when ordering panel mount privacy glass.
- Glass and attachment hardware to ship separately.
- Trim and glass extended for U channel from one end.

DESCRIPTION	PRODUCT CODE	LIST PRICE		DIMENSIONS/INCHES		
		Clear	Frosted	H	W	D
 12" H Panel Mount Privacy Glass U Channel for Gallery Panel	EVPMP24GI12PU	324	371	12	24	5/8
	EVPMP30GI12PU	347	378	12	30	5/8
	EVPMP36GI12PU	360	416	12	36	5/8
	EVPMP42GI12PU	382	455	12	42	5/8
	EVPMP48GI12PU	395	492	12	48	5/8
	EVPMP54GI12PU	407	532	12	54	5/8
	EVPMP60GI12PU	443	587	12	60	5/8
	EVPMP66GI12PU	470	612	12	66	5/8
	EVPMP72GI12PU	497	637	12	72	5/8



**EVPMPXXGI18PU - 18" H PANEL MOUNT PRIVACY GLASS FOR U CHANNEL FOR GALLERY PANEL ON ONE END**

- Privacy Glass integrated with aluminum top trim to be used with U channel with connector for Gallery Panels.
- Attaches on top of panels to add privacy or divide space.
- Includes aluminum trim with channel and glass tile.
- Standard in clear (CLR) or frosted (FRST) glass.
- Aluminium trim must be specified for entire station when ordering panel mount privacy glass.
- Glass and attachment hardware to ship separately.
- Trim and glass extended for U channel from one end.

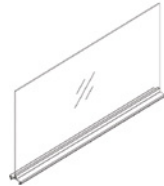

DESCRIPTION	PRODUCT CODE	LIST PRICE		DIMENSIONS/INCHES		
		Clear	Frosted	H	W	D
18" H Panel Mount Privacy Glass U Channel for Gallery Panel	EVPMP24GI18PU	470	539	18	24	5/8
	EVPMP30GI18PU	501	548	18	30	5/8
	EVPMP36GI18PU	523	604	18	36	5/8
	EVPMP42GI18PU	554	659	18	42	5/8
	EVPMP48GI18PU	574	714	18	48	5/8
	EVPMP54GI18PU	593	773	18	54	5/8
	EVPMP60GI18PU	665	877	18	60	5/8
	EVPMP66GI18PU	703	917	18	66	5/8
	EVPMP72GI18PU	743	957	18	72	5/8

**EVPMPXXGI6PDU - 6" H PANEL MOUNT PRIVACY GLASS FOR U CHANNEL FOR GALLERY PANELS ON BOTH ENDS**

- Privacy Glass integrated with aluminum top trim to be used with U channel with connector for Gallery Panels.
- Attaches on top of panels to add privacy or divide space.
- Includes aluminum trim with channel and glass tile.
- Standard in clear (CLR) or frosted (FRST) glass.
- Aluminium trim must be specified for entire station when ordering panel mount privacy glass.
- Glass and attachment hardware to ship separately.
- Trim and glass extended for U channel from both ends.



DESCRIPTION	PRODUCT CODE	LIST PRICE		DIMENSIONS/INCHES		
		Clear	Frosted	H	W	D
6" H Panel Mount Privacy Glass U Channel for Gallery Panel	EVPMP24GI6PDU	324	371	6	25	1/4
	EVPMP30GI6PDU	344	378	6	31	1/4
	EVPMP36GI6PDU	360	416	6	37	1/4
	EVPMP42GI6PDU	381	455	6	43	1/4
	EVPMP48GI6PDU	395	492	6	49	1/4
	EVPMP54GI6PDU	407	532	6	55	1/4
	EVPMP60GI6PDU	443	587	6	61	1/4
	EVPMP66GI6PDU	470	612	6	67	1/4
	EVPMP72GI6PDU	497	637	6	73	1/4

**EVPMPXXGI9PDU - 9" H PANEL MOUNT PRIVACY GLASS FOR U CHANNEL FOR GALLERY PANELS ON BOTH ENDS**

- Privacy Glass integrated with aluminum top trim to be used with U channel with connector for Gallery Panels.
- Attaches on top of panels to add privacy or divide space.
- Includes aluminum trim with channel and glass tile.
- Standard in clear (CLR) or frosted (FRST) glass.
- Aluminium trim must be specified for entire station when ordering panel mount privacy glass.
- Glass and attachment hardware to ship separately.
- Trim and glass extended for U channel from both ends.



DESCRIPTION	PRODUCT CODE	LIST PRICE		DIMENSIONS/INCHES		
		Clear	Frosted	H	W	D
9" H Panel Mount Privacy Glass U Channel for Gallery Panel	EVPMP24GI9PDU	324	371	9	25	1/4
	EVPMP30GI9PDU	344	378	9	31	1/4
	EVPMP36GI9PDU	360	416	9	37	1/4
	EVPMP42GI9PDU	381	455	9	43	1/4
	EVPMP48GI9PDU	395	492	9	49	1/4
	EVPMP54GI9PDU	407	532	9	55	1/4
	EVPMP60GI9PDU	443	587	9	61	1/4
	EVPMP66GI9PDU	470	612	9	67	1/4
	EVPMP72GI9PDU	497	637	9	73	1/4

**EVPMPXXGIPDU - 12" H PANEL MOUNT PRIVACY GLASS FOR U CHANNEL FOR GALLERY PANELS ON BOTH ENDS**

- Privacy Glass integrated with aluminum top trim to be used with U channel with connector for Gallery Panels.
- Attaches on top of panels to add privacy or divide space.
- Includes aluminum trim with channel and glass tile.
- Standard in clear (CLR) or frosted (FRST) glass.
- Aluminium trim must be specified for entire station when ordering panel mount privacy glass.
- Glass and attachment hardware to ship separately.
- Trim and glass extended for U channel from both ends.

	DESCRIPTION	PRODUCT CODE	LIST PRICE		DIMENSIONS/INCHES		
			Clear	Frosted	H	W	D
	12" H Panel Mount Privacy Glass	EVPMP24GIPDU	324	371	12	25 1/4	
	U Channel for Gallery Panel	EVPMP30GIPDU	344	378	12	31 1/4	
		EVPMP36GIPDU	360	416	12	37 1/4	
		EVPMP42GIPDU	381	455	12	43 1/4	
		EVPMP48GIPDU	395	492	12	49 1/4	
		EVPMP54GIPDU	407	532	12	55 1/4	
		EVPMP60GIPDU	443	587	12	61 1/4	
		EVPMP66GIPDU	470	612	12	67 1/4	
		EVPMP72GIPDU	497	637	12	73 1/4	

**EVPMPXXGI18PDU - 18" H PANEL MOUNT PRIVACY GLASS FOR U CHANNEL FOR GALLERY PANELS ON BOTH ENDS**

- Privacy Glass integrated with aluminum top trim to be used with U channel with connector for Gallery Panels.
- Attaches on top of panels to add privacy or divide space.
- Includes aluminum trim with channel and glass tile.
- Standard in clear (CLR) or frosted (FRST) glass.
- Aluminium trim must be specified for entire station when ordering panel mount privacy glass.
- Glass and attachment hardware to ship separately.
- Trim and glass extended for U channel from both ends.

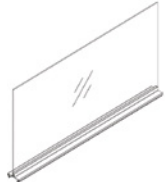
	DESCRIPTION	PRODUCT CODE	LIST PRICE		DIMENSIONS/INCHES		
			Clear	Frosted	H	W	D
	18" H Panel Mount Privacy Glass	EVPMP24GI18PDU	471	537	18	25 1/4	
	U Channel for Gallery Panel	EVPMP30GI18PDU	501	548	18	31 1/4	
		EVPMP36GI18PDU	522	605	18	37 1/4	
		EVPMP42GI18PDU	554	659	18	43 1/4	
		EVPMP48GI18PDU	574	713	18	49 1/4	
		EVPMP54GI18PDU	593	770	18	55 1/4	
		EVPMP60GI18PDU	664	877	18	61 1/4	
		EVPMP66GI18PDU	704	917	18	67 1/4	
		EVPMP72GI18PDU	743	957	18	73 1/4	

**EVMPMPXXGI6W - 6" H PRIVACY GLASS W/ ALUMINUM TRIM FOR 1" LAMINATE PANEL**

- Attaches on top of Evolve 1" Laminate Panels to add privacy or divide space.
- Privacy Glass is integrated into the aluminum top trim.
- Aluminum trim has rail for accessories.
- Includes aluminum trim with end caps and glass tile
- Glass and attachment hardware ship separately.
- Standard in clear (CLR) or frosted (FRST) glass.

	DESCRIPTION	PRODUCT CODE	LIST PRICE		DIMENSIONS/INCHES		
			Clear	Frosted	H	W	D
	6" H Privacy Glass w/ Aluminum Trim for 1" Laminate Panel - 24" Wide	EVMPMP24GI6W	290	356	6	24	1
	6" H Privacy Glass w/ Aluminum Trim for 1" Laminate Panel- 30" Wide	EVMPMP30GI6W	315	361	6	30	1
	6" H Privacy Glass w/ Aluminum Trim for 1" Laminate Panel - 36" Wide	EVMPMP36GI6W	335	368	6	36	1
	6" H Privacy Glass w/ Aluminum Trim for 1" Laminate Panel- 42" Wide	EVMPMP42GI6W	350	405	6	42	1
	6" H Privacy Glass w/ Aluminum Trim for 1" Laminate Panel- 48" Wide	EVMPMP48GI6W	369	440	6	48	1

**EVMPMPXXGI9W - 9" H PRIVACY GLASS W/ ALUMINUM TRIM FOR 1" LAMINATE PANEL**

- Attaches on top of Evolve 1" Laminate Panels to add privacy or divide space.
- Privacy Glass is integrated into the aluminum top trim.
- Aluminum trim has rail for accessories.
- Includes aluminum trim with end caps and glass tile
- Glass and attachment hardware ship separately.
- Standard in clear (CLR) or frosted (FRST) glass.

	DESCRIPTION	PRODUCT CODE	LIST PRICE		DIMENSIONS/INCHES		
			Clear	Frosted	H	W	D
	9" H Privacy Glass w/ Aluminum Trim for 1" Laminate Panel - 24" Wide	EVMPMP24GI9W	290	356	9	24	1
	9" H Privacy Glass w/ Aluminum Trim for 1" Laminate Panel- 30" Wide	EVMPMP30GI9W	315	361	9	30	1
	9" H Privacy Glass w/ Aluminum Trim for 1" Laminate Panel - 36" Wide	EVMPMP36GI9W	335	368	9	36	1
	9" H Privacy Glass w/ Aluminum Trim for 1" Laminate Panel- 42" Wide	EVMPMP42GI9W	350	405	9	42	1
	9" H Privacy Glass w/ Aluminum Trim for 1" Laminate Panel- 48" Wide	EVMPMP48GI9W	369	440	9	48	1

**EVPMPXXGIW - 12" H PRIVACY GLASS W/ ALUMINUM TRIM FOR 1" LAMINATE PANEL**

- Attaches on top of Evolve 1" Laminate Panels to add privacy or divide space.
- Privacy Glass is integrated into the aluminum top trim.
- Aluminum trim has rail for accessories.
- Includes aluminum trim with end caps and glass tile
- Glass and attachment hardware ship separately.
- Standard in clear (CLR), frosted (FRST) or writeable (WRW) glass.

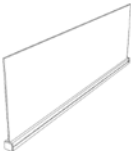
	DESCRIPTION	PRODUCT CODE	LIST PRICE			DIMENSIONS/INCHES		
			CLR	FRST	WRW	H	W	D
	12" H Privacy Glass w/ Aluminum Trim for 1" Laminate Panel - 24" Wide	EVPMP24GIW	290	356	472	12	24	1
	12" H Privacy Glass w/ Aluminum Trim for 1" Laminate Panel - 30" Wide	EVPMP30GIW	315	361	481	12	30	1
	12" H Privacy Glass w/ Aluminum Trim for 1" Laminate Panel - 36" Wide	EVPMP36GIW	335	368	491	12	36	1
	12" H Privacy Glass w/ Aluminum Trim for 1" Laminate Panel - 42" Wide	EVPMP42GIW	350	405	542	12	42	1
	12" H Privacy Glass w/ Aluminum Trim for 1" Laminate Panel - 48" Wide	EVPMP48GIW	369	440	591	12	48	1

**EVFPFDW - 6" H FELT DIVIDER W/ ALUMINUM TRIM FOR 1" LAMINATE PANEL**

- Privacy Felt Divider integrated with aluminum top trim.
- Attaches on top of laminate panels to add privacy or divide space.
- Includes aluminum trim with channel and felt tile.
- Felt and attachment hardware to ship separately.
- 9 mm felt material is tackable and comes in 9 different colors. Please specify color.
- Aluminum top trim available in standard paint finishes.

	DESCRIPTION	PRODUCT CODE	LIST PRICE	DIMENSIONS/INCHES		
				H	W	D
	6" H Felt Divider w/ Aluminum Trim for 1" Laminate Panel	EVFPD0624W	116	6	24	1
		EVFPD0630W	135	6	30	1
		EVFPD0636W	160	6	36	1
		EVFPD0642W	180	6	42	1
		EVFPD0648W	264	6	48	1
		EVFPD0654W	289	6	54	1
		EVFPD0660W	310	6	60	1
		EVFPD0666W	327	6	66	1
		EVFPD0672W	369	6	72	1

**EVFPFDW - 9" H FELT DIVIDER W/ ALUMINUM TRIM FOR 1" LAMINATE PANEL**

- Privacy Felt Divider integrated with aluminum top trim.
- Attaches on top of laminate panels to add privacy or divide space.
- Includes aluminum trim with channel and felt tile.
- Felt and attachment hardware to ship separately.
- 9 mm felt material is tackable and comes in 9 different colors. Please specify color.
- Aluminum top trim available in standard paint finishes.

	DESCRIPTION	PRODUCT CODE	LIST PRICE	DIMENSIONS/INCHES		
				H	W	D
	9" H Felt Divider w/ Aluminum Trim for 1" Laminate Panel	EVFPD0924W	116	9	24	1
		EVFPD0930W	135	9	30	1
		EVFPD0936W	160	9	36	1
		EVFPD0942W	180	9	42	1
		EVFPD0948W	264	9	48	1
		EVFPD0954W	289	9	54	1
		EVFPD0960W	310	9	60	1
		EVFPD0966W	327	9	66	1
		EVFPD0972W	369	9	72	1



**EVFPDW - 12" H FELT DIVIDER W/ ALUMINUM TRIM FOR 1" LAMINATE PANEL**

- Privacy Felt Divider integrated with aluminum top trim.
- Attaches on top of laminate panels to add privacy or divide space.
- Includes aluminum trim with channel and felt tile.
- Felt and attachment hardware to ship separately.
- 9 mm felt material is tackable and comes in 9 different colors. Please specify color.
- Aluminum top trim available in standard paint finishes.

DESCRIPTION	PRODUCT CODE	LIST PRICE	DIMENSIONS/INCHES		
			H	W	D
 <p>12" H Felt Divider w/ Aluminum Trim for 1" Laminate Panel</p>	EVFPD1224W	116	12	24	1
	EVFPD1230W	135	12	30	1
	EVFPD1236W	160	12	36	1
	EVFPD1242W	180	12	42	1
	EVFPD1248W	264	12	48	1
	EVFPD1254W	289	12	54	1
	EVFPD1260W	310	12	60	1
	EVFPD1266W	327	12	66	1
	EVFPD1272W	369	12	72	1

**EVFPDW - 18" H FELT DIVIDER W/ ALUMINUM TRIM FOR 1" LAMINATE PANEL**

- Privacy Felt Divider integrated with aluminum top trim.
- Attaches on top of laminate panels to add privacy or divide space.
- Includes aluminum trim with channel and felt tile.
- Felt and attachment hardware to ship separately.
- 9 mm felt material is tackable and comes in 9 different colors. Please specify color.
- Aluminum top trim available in standard paint finishes.

DESCRIPTION	PRODUCT CODE	LIST PRICE	DIMENSIONS/INCHES		
			H	W	D
 <p>18" H Felt Divider w/ Aluminum Trim for 1" Laminate Panel</p>	EVFPD1824W	145	18	24	1
	EVFPD1830W	169	18	30	1
	EVFPD1836W	200	18	36	1
	EVFPD1842W	223	18	42	1
	EVFPD1848W	329	18	48	1
	EVFPD1854W	359	18	54	1
	EVFPD1860W	388	18	60	1
	EVFPD1866W	407	18	66	1
	EVFPD1872W	462	18	72	1



**EVFDK06P - 6" PANEL MOUNTED FELT DIVIDER**

- Privacy felt panel integrated with aluminum top trim.
- Attaches on top of panels to add privacy or divide space. Includes aluminum trim with channel and felt tile.
- Aluminum trim must be specified for entire station when ordering panel mount privacy felt.
- Felt and attachment hardware to ship separately.
- 9mm thick Felt material is tackable and comes in 9 different colors. Please specify color. Graphite (GPH), Mist (MTS), Pewter (PWT), Harvest (HVT), Shamrock (SHR), Brick (BRI), Denim (DEN), Black (BLK) or White (WHT).

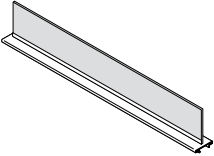
DESCRIPTION	PRODUCT CODE	LIST PRICE Gr1	DIMENSIONS/INCHES		
			H	W	D
 <p>6" Privacy felt panel integrated with aluminum top trim</p>	EVFDK0624P	116	6	24	2 7/8
	EVFDK0630P	135	6	30	2 7/8
	EVFDK0636P	160	6	36	2 7/8
	EVFDK0642P	180	6	42	2 7/8
	EVFDK0648P	264	6	48	2 7/8
	EVFDK0654P	289	6	54	2 7/8
	EVFDK0660P	310	6	60	2 7/8
	EVFDK0666P	327	6	66	2 7/8
	EVFDK0672P	369	6	72	2 7/8

**EVFDK09P - 9" PANEL MOUNTED FELT DIVIDER**

- Privacy felt panel integrated with aluminum top trim.
- Attaches on top of panels to add privacy or divide space. Includes aluminum trim with channel and felt tile.
- Aluminum trim must be specified for entire station when ordering panel mount privacy felt.
- Felt and attachment hardware to ship separately.
- 9mm thick Felt material is tackable and comes in 9 different colors. Please specify color. Graphite (GPH), Mist (MTS), Pewter (PWT), Harvest (HVT), Shamrock (SHR), Brick (BRI), Denim (DEN), Black (BLK) or White (WHT).

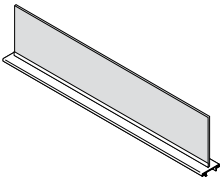
DESCRIPTION	PRODUCT CODE	LIST PRICE Gr1	DIMENSIONS/INCHES		
			H	W	D
 <p>9" Privacy felt panel integrated with aluminum top trim</p>	EVFDK0924P	116	9	24	2 7/8
	EVFDK0930P	135	9	30	2 7/8
	EVFDK0936P	160	9	36	2 7/8
	EVFDK0942P	180	9	42	2 7/8
	EVFDK0948P	264	9	48	2 7/8
	EVFDK0954P	289	9	54	2 7/8
	EVFDK0960P	310	9	60	2 7/8
	EVFDK0966P	327	9	66	2 7/8
	EVFDK0972P	369	9	72	2 7/8

**EVFDK12P - 12" PANEL MOUNTED FELT DIVIDER**

- Privacy felt panel integrated with aluminum top trim.
- Attaches on top of panels to add privacy or divide space. Includes aluminum trim with channel and felt tile.
- Aluminum trim must be specified for entire station when ordering panel mount privacy felt.
- Felt and attachment hardware to ship separately.
- 9mm thick Felt material is tackable and comes in 9 different colors. Please specify color. Graphite (GPH), Mist (MTS), Pewter (PWT), Harvest (HVT), Shamrock (SHR), Brick (BRI), Denim (DEN), Black (BLK) or White (WHT).

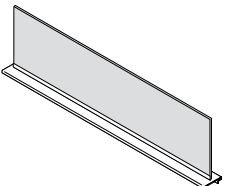
DESCRIPTION	PRODUCT CODE	LIST PRICE Gr1	DIMENSIONS/INCHES		
			H	W	D
 <p>12" Privacy felt panel integrated with aluminum top trim</p>	EVFDK01224P	116	12	24	2 7/8
	EVFDK01230P	135	12	30	2 7/8
	EVFDK01236P	160	12	36	2 7/8
	EVFDK01242P	180	12	42	2 7/8
	EVFDK01248P	264	12	48	2 7/8
	EVFDK01254P	289	12	54	2 7/8
	EVFDK01260P	310	12	60	2 7/8



**EVFDK12PN - 12" PANEL MOUNTED FELT DIVIDER, 1 NOTCH**

- Privacy felt panel integrated with aluminum top trim.
- Attaches on top of panels to add privacy or divide space. Includes aluminum trim with channel and felt tile.
- Aluminum trim must be specified for entire station when ordering panel mount privacy felt.
- Felt and attachment hardware to ship separately.
- 9mm thick Felt material is tackable and comes in 9 different colors. Please specify color. Graphite (GPH), Mist (MTS), Pewter (PWT), Harvest (HVT), Shamrock (SHR), Brick (BRI), Denim (DEN), Black (BLK) or White (WHT).

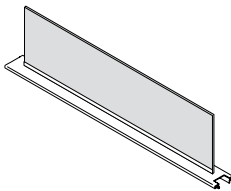
DESCRIPTION	PRODUCT CODE	LIST PRICE Gr1	DIMENSIONS/INCHES		
			H	W	D
 <p>12" Privacy felt panel integrated with aluminum top trim with 1 Notch</p>	EVFDK1224PN	116	12	22.68	2 7/8
	EVFDK1230PN	135	12	28.68	2 7/8
	EVFDK1236PN	160	12	34.68	2 7/8
	EVFDK1242PN	180	12	40.68	2 7/8
	EVFDK1248PN	264	12	46.68	2 7/8
	EVFDK1254PN	289	12	52.68	2 7/8
	EVFDK1260PN	310	12	58.68	2 7/8

**EVFDK12PDN - 12" PANEL MOUNTED FELT DIVIDER, 2 NOTCHES**

- Privacy felt panel integrated with aluminum top trim.
- Attaches on top of panels to add privacy or divide space. Includes aluminum trim with channel and felt tile.
- Aluminum trim must be specified for entire station when ordering panel mount privacy felt.
- Felt and attachment hardware to ship separately.
- 9mm thick Felt material is tackable and comes in 9 different colors. Please specify color. Graphite (GPH), Mist (MTS), Pewter (PWT), Harvest (HVT), Shamrock (SHR), Brick (BRI), Denim (DEN), Black (BLK) or White (WHT).

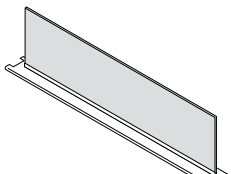
DESCRIPTION	PRODUCT CODE	LIST PRICE Gr1	DIMENSIONS/INCHES		
			H	W	D
 <p>12" Privacy felt panel integrated with aluminum top trim with 2 Notches</p>	EVFDK1224PDN	116	12	21.44	2 7/8
	EVFDK1230PDN	135	12	27.44	2 7/8
	EVFDK1236PDN	160	12	33.44	2 7/8
	EVFDK1242PDN	180	12	39.44	2 7/8
	EVFDK1248PDN	264	12	45.44	2 7/8
	EVFDK1254PDN	289	12	51.44	2 7/8
	EVFDK1260PDN	310	12	57.44	2 7/8

**EVFDK18P - 18" PANEL MOUNTED FELT DIVIDER**

- Privacy felt panel integrated with aluminum top trim.
- Attaches on top of panels to add privacy or divide space. Includes aluminum trim with channel and felt tile.
- Aluminum trim must be specified for entire station when ordering panel mount privacy felt.
- Felt and attachment hardware to ship separately.
- 9mm thick Felt material is tackable and comes in 9 different colors. Please specify color. Graphite (GPH), Mist (MTS), Pewter (PWT), Harvest (HVT), Shamrock (SHR), Brick (BRI), Denim (DEN), Black (BLK) or White (WHT).

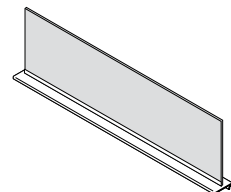
DESCRIPTION	PRODUCT CODE	LIST PRICE Gr1	DIMENSIONS/INCHES		
			H	W	D
 <p>18" Privacy felt panel integrated with aluminum top trim</p>	EVFDK01824P	145	18	24	2 7/8
	EVFDK01830P	169	18	30	2 7/8
	EVFDK01836P	200	18	36	2 7/8
	EVFDK01842P	223	18	42	2 7/8
	EVFDK01848P	325	18	48	2 7/8
	EVFDK01854P	359	18	54	2 7/8
	EVFDK01860P	388	18	60	2 7/8
	EVFDK01866P	407	18	66	2 7/8
	EVFDK01872P	462	18	72	2 7/8

**EVFPDK06XXPCF - 6" H PANEL MOUNT PRIVACY DIVIDER CEILING FILLER KIT**

- Privacy Felt Divider integrated with aluminum top trim.
- Aluminum top trim available in standard paint finishes.
- Attaches on top of panels to add privacy or divide space.
- Includes aluminum trim with channel and Felt tile.
- Felt tile and attachment hardware to ship separately.
- Felt material available in Graphite (GPH), Mist (MTS), Pewter (PWT), Harvest (HVT), Shamrock (SHR), Brick (BRI), Denim (DEN), Black (BLK) or White (WHT).
- PVC cap for closing gap at ceiling included.
- PVC cap available in white only.

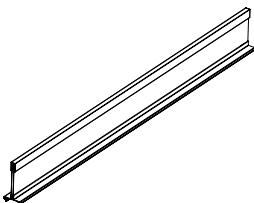
DESCRIPTION	PRODUCT CODE	LIST PRICE	DIMENSIONS/INCHES		
			H	W	D
 Panel Mount Felt Divider Ceiling Filler Kit	EVFPDK0618PCF	110	6	18	
	EVFPDK0624PCF	131	6	24	
	EVFPDK0630PCF	156	6	30	
	EVFPDK0636PCF	183	6	36	
	EVFPDK0642PCF	206	6	42	
	EVFPDK0648PCF	304	6	48	
	EVFPDK0654PCF	329	6	54	
	EVFPDK0660PCF	358	6	60	
	EVFPDK0666PCF	376	6	66	
	EVFPDK0672PCF	424	6	72	

**EVFPDK06XXPCFP - 6" H PANEL MOUNT PRIVACY DIVIDER CEILING FILLER KIT**

- Privacy Felt Divider integrated with aluminum top trim.
- Aluminum top trim available in standard paint finishes.
- Aluminum trim is width of panel.
- Attaches on top of panels to add privacy or divide space.
- Includes aluminum trim with channel and Felt tile.
- Felt tile and attachment hardware to ship separately.
- Felt material available in Graphite (GPH), Mist (MTS), Pewter (PWT), Harvest (HVT), Shamrock (SHR), Brick (BRI), Denim (DEN), Black (BLK) or White (WHT).
- Felt tile is longer and overhangs half of width of post.
- PVC cap for closing gap at ceiling included.
- PVC cap available in white only.

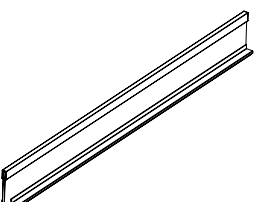
DESCRIPTION	PRODUCT CODE	LIST PRICE	DIMENSIONS/INCHES		
			H	W	D
 Panel Mount Felt Divider Ceiling Filler at Post Kit	EVFPDK0619PCF	131	6	19 3/4	
	EVFPDK0625PCF	156	6	25 3/4	
	EVFPDK0631PCF	183	6	31 3/4	
	EVFPDK0637PCF	206	6	37 3/4	
	EVFPDK0643PCF	304	6	43 3/4	
	EVFPDK0649PCF	329	6	49 3/4	
	EVFPDK0655PCF	358	6	55 3/4	
	EVFPDK0661PCF	376	6	61 3/4	
	EVFPDK0667PCF	424	6	67 3/4	
	EVFPDK0673PCF	475	6	73 3/4	

**EVFPDK09XXPCF - 9" H PANEL MOUNT PRIVACY DIVIDER CEILING FILLER KIT**

- Privacy Felt Divider integrated with aluminum top trim.
- Aluminum top trim available in standard paint finishes.
- Attaches on top of panels to add privacy or divide space.
- Includes aluminum trim with channel and Felt tile.
- Felt tile and attachment hardware to ship separately.
- Felt material available in Graphite (GPH), Mist (MTS), Pewter (PWT), Harvest (HVT), Shamrock (SHR), Brick (BRI), Denim (DEN), Black (BLK) or White (WHT).
- PVC cap for closing gap at ceiling included.
- PVC cap available in white only.

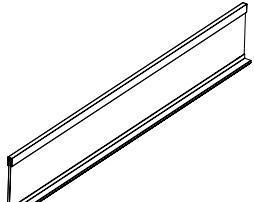
DESCRIPTION	PRODUCT CODE	LIST PRICE	DIMENSIONS/INCHES		
			H	W	D
 Panel Mount Felt Divider Ceiling Filler Kit	EVFPDK0918PCF	110	9	18	
	EVFPDK0924PCF	131	9	24	
	EVFPDK0930PCF	156	9	30	
	EVFPDK0936PCF	183	9	36	
	EVFPDK0942PCF	206	9	42	
	EVFPDK0948PCF	304	9	48	
	EVFPDK0954PCF	329	9	54	
	EVFPDK0960PCF	358	9	60	
	EVFPDK0966PCF	376	9	66	
	EVFPDK0972PCF	424	9	72	



**EVFPDK09XXPCFP - 9" H PANEL MOUNT PRIVACY DIVIDER CEILING FILLER KIT**

- Privacy Felt Divider integrated with aluminum top trim.
- Aluminum trim is width of panel.
- Aluminum top trim available in standard paint finishes.
- Attaches on top of panels to add privacy or divide space.
- Includes aluminum trim with channel and Felt tile.
- Felt tile and attachment hardware to ship separately.
- Felt material available in Graphite (GPH), Mist (MTS), Pewter (PWT), Harvest (HVT), Shamrock (SHR), Brick (BRI), Denim (DEN), Black (BLK) or White (WHT).
- Felt tile is longer and overhangs half of width of post.
- PVC cap for closing gap at ceiling included.
- PVC cap available in white only.

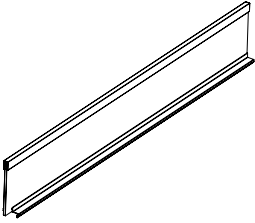
DESCRIPTION	PRODUCT CODE	LIST PRICE	DIMENSIONS/INCHES		
			H	W	D
 Panel Mount Felt Divider Ceiling Filler at Post Kit	EVFDK0919PCF	131	9	19 3/4	
	EVFDK0925PCF	156	9	25 3/4	
	EVFDK0931PCF	183	9	31 3/4	
	EVFDK0937PCF	206	9	37 3/4	
	EVFDK0943PCF	304	9	43 3/4	
	EVFDK0949PCF	329	9	49 3/4	
	EVFDK0955PCF	358	9	55 3/4	
	EVFDK0961PCF	376	9	61 3/4	
	EVFDK0967PCF	424	9	67 3/4	
	EVFDK0973PCF	475	9	73 3/4	

**EVPTFC - CEILING FILLER PVC CAP FOR FELT DIVIDER**

- To be installed on top on felt divider when used as ceiling filler.
- Field installed on top of felt divider to close gap at ceiling.
- Available in 18"-96" lengths.
- Available in white only.
- Felt divider with top trim kit to be ordered separately.

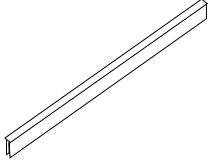
DESCRIPTION	PRODUCT CODE	LIST PRICE	DIMENSIONS/INCHES		
			H	W	D
 PVC Cap for Felt Divider	EVPTFC18	17	1 3/8	18	3/4
	EVPTFC24	19	1 3/8	24	3/4
	EVPTFC30	24	1 3/8	30	3/4
	EVPTFC36	27	1 3/8	36	3/4
	EVPTFC42	29	1 3/8	42	3/4
	EVPTFC48	43	1 3/8	48	3/4
	EVPTFC54	47	1 3/8	54	3/4
	EVPTFC60	49	1 3/8	60	3/4
	EVPTFC66	53	1 3/8	66	3/4
	EVPTFC72	58	1 3/8	72	3/4
	EVPTFC78	64	1 3/8	78	3/4
	EVPTFC84	69	1 3/8	84	3/4
	EVPTFC90	75	1 3/8	90	3/4
	EVPTFC96	81	1 3/8	96	3/4

**EVFELTPXXHWR - ALUMINUM TOP TRIM WITH CHANNEL**

- Top trim with channel.
- Available in standard paint colors.
- Note: Trim can span inline connector, but not a Post

DESCRIPTION	PRODUCT CODE	LIST PRICE	DIMENSIONS/INCHES		
			H	W	D
 Aluminum Top Trip	EVFELTP18HWR	43		18	2.875
	EVFELTP24HWR	44		24	2.875
	EVFELTP30HWR	51		30	2.875
	EVFELTP36HWR	57		36	2.875
	EVFELTP42HWR	64		42	2.875
	EVFELTP48HWR	70		48	2.875
	EVFELTP54HWR	76		54	2.875
	EVFELTP60HWR	84		60	2.875
	EVFELTP66HWR	92		66	2.875
	EVFELTP72HWR	104		72	2.875

**EVFELTXXYP - FELT TILE**

- Felt tile.
- Available in standard felt colors.
- Top trim with channel and PVC cap to be ordered separately.

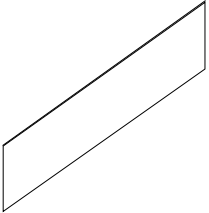
DESCRIPTION	PRODUCT CODE	LIST PRICE	DIMENSIONS/INCHES		
			H	W	D
 <p>Felt Tile - 6" High</p>	EVFELT0618P	31	6	18	
	EVFELT0624P	39	6	24	
	EVFELT0630P	54	6	30	
	EVFELT0636P	69	6	36	
	EVFELT0642P	85	6	42	
	EVFELT0648P	105	6	48	
	EVFELT0654P	119	6	54	
	EVFELT0660P	132	6	60	
	EVFELT0666P	149	6	66	
	EVFELT0672P	163	6	72	
<p>Felt Tile - 9" High</p>	EVFELT0918P	53	9	18	
	EVFELT0924P	64	9	24	
	EVFELT0930P	75	9	30	
	EVFELT0936P	91	9	36	
	EVFELT0942P	102	9	42	
	EVFELT0948P	169	9	48	
	EVFELT0954P	185	9	54	
	EVFELT0960P	202	9	60	
	EVFELT0966P	218	9	66	
	EVFELT0972P	231	9	72	



**EVPP - GLAZED FREESTANDING PRIVACY PANEL**

- Includes panel with two connectors with T legs.
- 3" thick freestanding panels with leveling glides.
- 22" deep T-legs for stability (9.5" on each side)
- All Modules are Tempered Glass.
- Includes end of run trim.

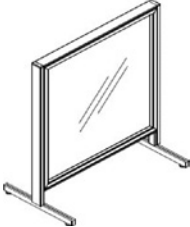
DESCRIPTION	PRODUCT CODE	LIST PRICE		DIMENSIONS/INCHES		
		CLR	FRST	H	W	D
 Glazed Monolithic Freestanding Privacy Panel	EVPPXGT4218	715	862	42	18	27/8
	EVPPXGT4224	787	963	42	24	27/8
	EVPPXGT4230	855	1058	42	30	27/8
	EVPPXGT4236	920	1149	42	36	27/8
	EVPPXGT4242	994	1252	42	42	27/8

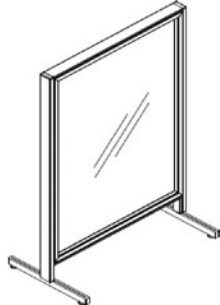
DESCRIPTION	PRODUCT CODE	LIST PRICE		DIMENSIONS/INCHES		
		CLR	FRST	H	W	D
 Glazed Monolithic Freestanding Privacy Panel	EVPPXGT5418	833	1010	54	18	27/8
	EVPPXGT5424	919	1130	54	24	27/8
	EVPPXGT5430	999	1242	54	30	27/8
	EVPPXGT5436	1075	1351	54	36	27/8
	EVPPXGT5442	1161	1472	54	42	27/8

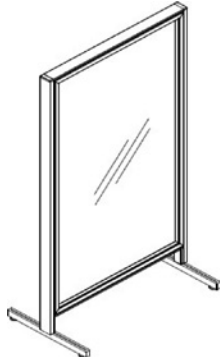
DESCRIPTION	PRODUCT CODE	LIST PRICE		DIMENSIONS/INCHES		
		CLR	FRST	H	W	D
 Glazed Monolithic Freestanding Privacy Panel	EVPPXGT6618	960	1175	66	18	27/8
	EVPPXGT6624	1054	1307	66	24	27/8
	EVPPXGT6630	1150	1437	66	30	27/8
	EVPPXGT6636	1237	1561	66	36	27/8
	EVPPXGT6642	1340	1707	66	42	27/8

**EVPP - GLAZED MOBILE PRIVACY PANEL**

- Includes panel with two connectors with T legs.
- 3" thick freestanding panels with 1" locking casters.
- 22" deep T-legs for stability (9.5" on each side)
- All Modules are Tempered Glass.
- Includes end of run trim.

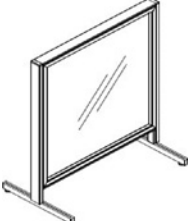
DESCRIPTION	PRODUCT CODE	LIST PRICE		DIMENSIONS/INCHES		
		CLR	FRST	H	W	D
 Mobile Glazed Monolithic Privacy Panel	EVPPXGT4218M	786	931	42	18	2 7/8
	EVPPXGT4224M	858	1033	42	24	2 7/8
	EVPPXGT4230M	926	1127	42	30	2 7/8
	EVPPXGT4236M	989	1217	42	36	2 7/8
	EVPPXGT4242M	1063	1324	42	42	2 7/8

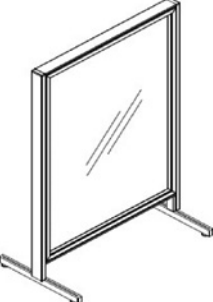
DESCRIPTION	PRODUCT CODE	LIST PRICE			DIMENSIONS/INCHES		
		CLR	FRST	WRW	H	W	D
 Mobile Glazed Monolithic Privacy Panel	EVPPXGT5418M	905	1081	1374	54	18	2 7/8
	EVPPXGT5424M	988	1201	1582	54	24	2 7/8
	EVPPXGT5430M	1069	1313	1783	54	30	2 7/8
	EVPPXGT5436M	1146	1423	1984	54	36	2 7/8
	EVPPXGT5442M	1232	1542	2195	54	42	2 7/8

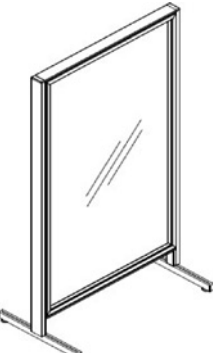
DESCRIPTION	PRODUCT CODE	LIST PRICE			DIMENSIONS/INCHES		
		CLR	FRST	WRW	H	W	D
 Mobile Glazed Monolithic Privacy Panel	EVPPXGT6618M	1029	1247	1615	66	18	2 7/8
	EVPPXGT6624M	1124	1378	1860	66	24	2 7/8
	EVPPXGT6630M	1219	1509	2105	66	30	2 7/8
	EVPPXGT6636M	1307	1631	2341	66	36	2 7/8
	EVPPXGT6642M	1410	1777	2598	66	42	2 7/8



**EVPP - MONOLITHIC PRIVACY PANEL - RIBBED POLYCARBONATE**

- Includes panel with two connectors with T legs.
- 3" thick freestanding panels with leveling glides
- 22" deep T-legs for stability (9.5" on each side)
- Ribbed Panels are semi-private translucent polycarbonate.
- Includes end of run trim.

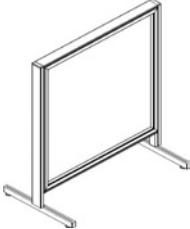
DESCRIPTION	PRODUCT CODE	LIST PRICE	DIMENSIONS/INCHES		
			H	W	D
 Freestanding Ribbed Monolithic Privacy Panel	EVPPXGR4218	761	42	18	2 7/8
	EVPPXGR4224	797	42	24	2 7/8
	EVPPXGR4230	868	42	30	2 7/8
	EVPPXGR4236	939	42	36	2 7/8
	EVPPXGR4242	1012	42	42	2 7/8

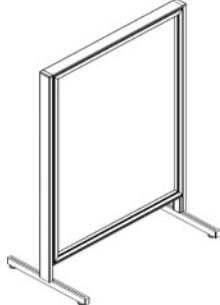
DESCRIPTION	PRODUCT CODE	LIST PRICE	DIMENSIONS/INCHES		
			H	W	D
 Freestanding Ribbed Monolithic Privacy Panel	EVPPXGR5418	891	54	18	2 7/8
	EVPPXGR5424	946	54	24	2 7/8
	EVPPXGR5430	1028	54	30	2 7/8
	EVPPXGR5436	1111	54	36	2 7/8
	EVPPXGR5442	1201	54	42	2 7/8

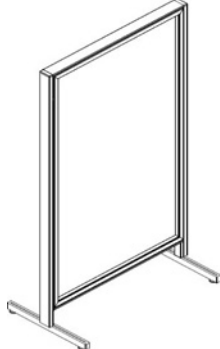
DESCRIPTION	PRODUCT CODE	LIST PRICE	DIMENSIONS/INCHES		
			H	W	D
 Freestanding Ribbed Monolithic Privacy Panel	EVPPXGR6618	976	66	18	2 7/8
	EVPPXGR6624	1078	66	24	2 7/8
	EVPPXGR6630	1173	66	30	2 7/8
	EVPPXGR6636	1267	66	36	2 7/8
	EVPPXGR6642	1369	66	42	2 7/8



**EVPP - MONOLITHIC PRIVACY PANEL - RIBBED POLYCARBONATE**

- Includes panel with two connectors with T legs.
- 3" thick freestanding panels with 1" locking casters.
- 22" deep T-legs for stability (9.5" on each side)
- Ribbed Panels are semi-private translucent polycarbonate.
- Includes end of run trim.

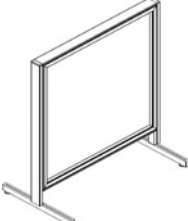
	DESCRIPTION	PRODUCT CODE	LIST PRICE	DIMENSIONS/INCHES		
				H	W	D
	Mobile Ribbed Monolithic Privacy Panel	EVPPXGR4218M	830	42	18	2 7/8
		EVPPXGR4224M	868	42	24	2 7/8
		EVPPXGR4230M	939	42	30	2 7/8
		EVPPXGR4236M	1009	42	36	2 7/8
		EVPPXGR4242M	1082	42	42	2 7/8

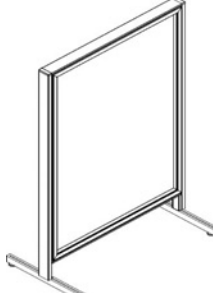
	DESCRIPTION	PRODUCT CODE	LIST PRICE	DIMENSIONS/INCHES		
				H	W	D
	Mobile Ribbed Monolithic Privacy Panel	EVPPXGR5418M	965	54	18	2 7/8
		EVPPXGR5424M	1017	54	24	2 7/8
		EVPPXGR5430M	1100	54	30	2 7/8
		EVPPXGR5436M	1182	54	36	2 7/8
		EVPPXGR5442M	1272	54	42	2 7/8

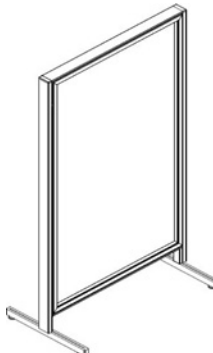
	DESCRIPTION	PRODUCT CODE	LIST PRICE	DIMENSIONS/INCHES		
				H	W	D
	Mobile Ribbed Monolithic Privacy Panel	EVPPXGR6618M	1047	66	18	2 7/8
		EVPPXGR6624M	1150	66	24	2 7/8
		EVPPXGR6630M	1173	66	30	2 7/8
		EVPPXGR6636M	1337	66	36	2 7/8
		EVPPXGR6642M	1438	66	42	2 7/8



**EVPP - MONOLITHIC PRIVACY PANEL - GLAZED**

- Includes panel with two connectors with T legs
- 3" thick freestanding panels with flat foot
- 22" deep T-legs for stability (9.5" on each side)
- Glazed Panels are available in tempered Clear glass (CLR) and Frosted glass (FRST)
- Includes end of run trim

DESCRIPTION	PRODUCT CODE	LIST PRICE		DIMENSIONS/INCHES		
		CLR	FRST	H	W	D
 Freestanding Glazed Monolithic Privacy Panel	EVPPXGTF4218	715	862	42	18	27/8
	EVPPXGTF4224	787	963	42	24	27/8
	EVPPXGTF4230	855	1058	42	30	27/8
	EVPPXGTF4236	920	1149	42	36	27/8
	EVPPXGTF4242	994	1252	42	42	27/8

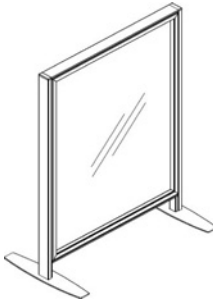
DESCRIPTION	PRODUCT CODE	LIST PRICE		DIMENSIONS/INCHES		
		CLR	FRST	H	W	D
 Freestanding Glazed Monolithic Privacy Panel	EVPPXGTF5418	833	1010	54	18	27/8
	EVPPXGTF5424	919	1130	54	24	27/8
	EVPPXGTF5430	999	1242	54	30	27/8
	EVPPXGTF5436	1075	1351	54	36	27/8
	EVPPXGTF5442	1161	1472	54	42	27/8

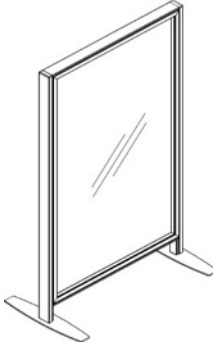
DESCRIPTION	PRODUCT CODE	LIST PRICE		DIMENSIONS/INCHES		
		CLR	FRST	H	W	D
 Freestanding Glazed Monolithic Privacy Panel	EVPPXGTF6618	960	1175	66	18	27/8
	EVPPXGTF6624	1054	1307	66	24	27/8
	EVPPXGTF6630	1150	1437	66	30	27/8
	EVPPXGTF6636	1237	1561	66	36	27/8
	EVPPXGTF6642	1340	1707	66	42	27/8

**EVPP - MONOLITHIC PRIVACY PANEL - RIBBED POLYCARBONATE**

- Includes panel with two connectors with T legs
- 3" thick freestanding panels with flat foot
- 22" deep T-legs for stability (9.5" on each side)
- Ribbed Panels are semi-private translucent polycarbonate.
- Includes end of run trim.

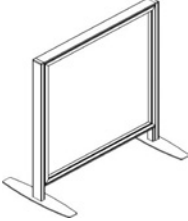
	DESCRIPTION	PRODUCT CODE	LIST PRICE	DIMENSIONS/INCHES		
				H	W	D
	Freestanding Ribbed Monolithic Privacy Panel	EVPPXGRF4218	761	42	18	2 7/8
		EVPPXGRF4224	797	42	24	2 7/8
		EVPPXGRF4230	868	42	30	2 7/8
		EVPPXGRF4236	939	42	36	2 7/8
		EVPPXGRF4242	1012	42	42	2 7/8

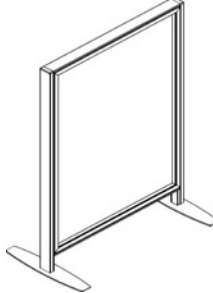
	DESCRIPTION	PRODUCT CODE	LIST PRICE	DIMENSIONS/INCHES		
				H	W	D
	Freestanding Ribbed Monolithic Privacy Panel	EVPPXGRF5418	891	54	18	2 7/8
		EVPPXGRF5424	946	54	24	2 7/8
		EVPPXGRF5430	1028	54	30	2 7/8
		EVPPXGRF5436	1111	54	36	2 7/8
		EVPPXGRF5442	1201	54	42	2 7/8

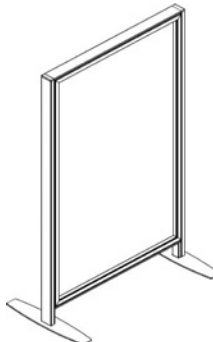
	DESCRIPTION	PRODUCT CODE	LIST PRICE	DIMENSIONS/INCHES		
				H	W	D
	Freestanding Ribbed Monolithic Privacy Panel	EVPPXGRF6618	976	66	18	2 7/8
		EVPPXGRF6624	1078	66	24	2 7/8
		EVPPXGRF6630	1173	66	30	2 7/8
		EVPPXGRF6636	1267	66	36	2 7/8
		EVPPXGRF6642	1369	66	42	2 7/8



**EVPP - MONOLITHIC PRIVACY PANEL - 78" HIGH**

- Includes panel with two connectors with T legs.
- 3" thick freestanding panels with leveling glides
- 22" deep T-legs for stability (9.5" on each side)
- Glazed Panels are available in tempered Clear glass (CLR) and Frosted glass (FRST)
- Ribbed Panels are semi-private translucent polycarbonate.
- Includes end of run trim.
- Includes 48"H Glazed module and 29"H legs

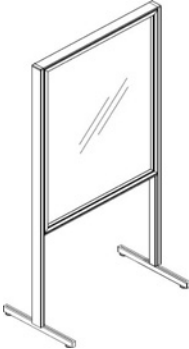
	DESCRIPTION	PRODUCT CODE	LIST PRICE		DIMENSIONS/INCHES		
			CLR	FRST	H	W	D
	Freestanding Glazed Monolithic Privacy Panel	EVPPXGT7824	984	1196	78	24	2 7/8
		EVPPXGT7830	1063	1308	78	30	2 7/8
		EVPPXGT7836	1142	1417	78	36	2 7/8
		EVPPXGT7842	1229	1538	78	42	2 7/8

**EVPP - MONOLITHIC PRIVACY PANEL - 78" HIGH**

- Includes panel with two connectors with T legs.
- 3" thick freestanding panels with leveling glides
- 22" deep T-legs for stability (9.5" on each side)
- Glazed Panels are available in tempered Clear glass (CLR) and Frosted glass (FRST)
- Ribbed Panels are semi-private translucent polycarbonate.
- Includes end of run trim.
- Includes 48"H Ribbled module and 29"H legs

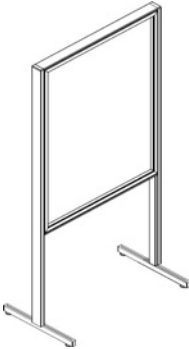
	DESCRIPTION	PRODUCT CODE	LIST PRICE	DIMENSIONS/INCHES		
				H	W	D
	Freestanding Ribbed Monolithic Privacy Panel	EVPPXGR7824	1020	78	24	2 7/8
		EVPPXGR7830	1104	78	30	2 7/8
		EVPPXGR7836	1020	78	36	2 7/8
		EVPPXGR7842	1276	78	42	2 7/8

**EVPP - MONOLITHIC PRIVACY PANEL - 78" HIGH**

- Includes panel with two connectors with T legs.
- 3" thick freestanding panels with 1" locking casters
- 22" deep T-legs for stability (9.5" on each side)
- Glazed Panels are available in tempered Clear glass (CLR) and Frosted glass (FRST)
- Ribbed Panels are semi-private translucent polycarbonate.
- Includes end of run trim.
- Includes 48"H Glazed module and 29"H legs

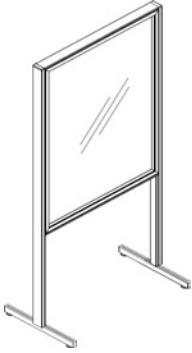
DESCRIPTION	PRODUCT CODE	LIST PRICE		DIMENSIONS/INCHES		
		CLR	FRST	H	W	D
 Mobile Glazed Monolithic Privacy Panel	EVPPXGT7824M	1055	1267	78	24	2 7/8
	EVPPXGT7830M	1136	1379	78	30	2 7/8
	EVPPXGT7836M	1213	1488	78	36	2 7/8
	EVPPXGT7842M	1297	1609	78	42	2 7/8

**EVPP - MONOLITHIC PRIVACY PANEL - 78" HIGH**

- Includes panel with two connectors with T legs.
- 3" thick freestanding panels with 1" locking casters
- 22" deep T-legs for stability (9.5" on each side)
- Glazed Panels are available in tempered Clear glass (CLR) and Frosted glass (FRST)
- Ribbed Panels are semi-private translucent polycarbonate.
- Includes end of run trim.
- Includes 48"H Ribbed module and 29"H legs

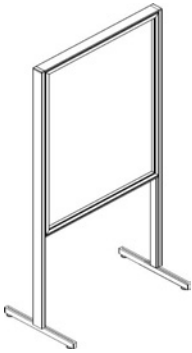
DESCRIPTION	PRODUCT CODE	LIST PRICE	DIMENSIONS/INCHES		
			H	W	D
 Mobile Ribbed Monolithic Privacy Panel	EVPPXGR7824M	1092	78	24	2 7/8
	EVPPXGR7830M	1174	78	30	2 7/8
	EVPPXGR7836M	1092	78	36	2 7/8
	EVPPXGR7842M	1347	78	42	2 7/8



**EVPP - MONOLITHIC PRIVACY PANEL - 78" HIGH**

- Includes panel with two connectors with T legs
- 3" thick freestanding panels with flat foot
- 22" deep T-legs for stability (9.5" on each side)
- Glazed Panels are available in tempered Clear glass (CLR) and Frosted glass (FRST)
- Ribbed Panels are semi-private translucent polycarbonate.
- Includes end of run trim.
- Includes 48"H Glazed module and 29"H legs

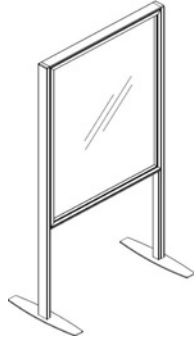

DESCRIPTION	PRODUCT CODE	LIST PRICE		DIMENSIONS/INCHES		
		CLR	FRST	H	W	D
Freestanding Glazed Monolithic Privacy Panel	EVPPXGTF7824	984	1196	78	24	2 7/8
	EVPPXGTF7830	1063	1308	78	30	2 7/8
	EVPPXGTF7836	1142	1417	78	36	2 7/8
	EVPPXGTF7842	1229	1538	78	42	2 7/8

**EVPP - MONOLITHIC PRIVACY PANEL - 78" HIGH**

- Includes panel with two connectors with T legs
- 3" thick freestanding panels with flat foot
- 22" deep T-legs for stability (9.5" on each side)
- Glazed Panels are available in tempered Clear glass (CLR) and Frosted glass (FRST)
- Ribbed Panels are semi-private translucent polycarbonate.
- Includes end of run trim.
- Includes 48"H Ribbed module and 29"H legs

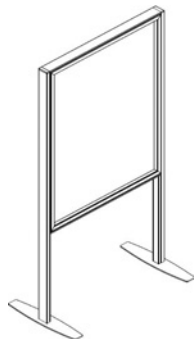

DESCRIPTION	PRODUCT CODE	LIST PRICE	DIMENSIONS/INCHES		
			H	W	D
Freestanding Ribbed Monolithic Privacy Panel	EVPPXGRF7824	1020	78	24	2 7/8
	EVPPXGRF7830	1104	78	30	2 7/8
	EVPPXGRF7836	1020	78	36	2 7/8
	EVPPXGRF7842	1276	78	42	2 7/8

**EVPP - GLAZED PRIVACY PANEL**

- Includes panel with two connectors with T legs.
- 3" thick freestanding panels with leveling glides
- 22" deep T-legs for stability (9.5" on each side)
- All Modules are Tempered Glass.
- Available in clear glass (CLR) and frosted glass (FRST)
- Includes end of run trim.

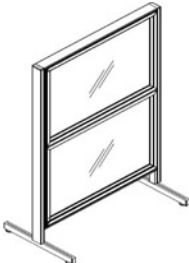
DESCRIPTION	PRODUCT CODE	LIST PRICE		DIMENSIONS/INCHES		
		CLR	FRST	H	W	D
 Freestanding Glazed Privacy Panel	EVPPGT5424	949	1175	54	24	2 7/8
	EVPPGT5430	1042	1307	54	30	2 7/8
	EVPPGT5436	1135	1435	54	36	2 7/8
	EVPPGT5442	1234	1575	54	42	2 7/8
	EVPPGT5448	1331	1712	54	48	2 7/8
	EVPPGT5454	1435	1859	54	54	2 7/8
	EVPPGT5460	1525	1982	54	60	2 7/8

**EVPP - GLAZED PRIVACY PANEL**

- Includes panel with two connectors with T legs.
- 3" thick freestanding panels with leveling glides
- 22" deep T-legs for stability (9.5" on each side)
- All Modules are Tempered Glass.
- Available in clear glass (CLR) and frosted glass (FRST)
- Includes end of run trim.

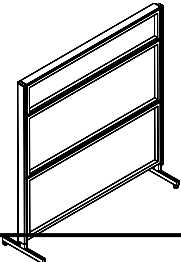
DESCRIPTION	PRODUCT CODE	LIST PRICE		DIMENSIONS/INCHES		
		CLR	FRST	H	W	D
 Freestanding Glazed Privacy Panel	EVPPGT6624	1185	1493	66	24	2 7/8
	EVPPGT6630	1300	1656	66	30	2 7/8
	EVPPGT6636	1481	1905	66	36	2 7/8
	EVPPGT6642	1606	2083	66	42	2 7/8
	EVPPGT6648	1733	2260	66	48	2 7/8
	EVPPGT6654	1875	2459	66	54	2 7/8
	EVPPGT6660	2030	2671	66	60	2 7/8

**EVPP - MOBILE GLAZED PRIVACY PANEL**

- Includes panel with two connectors with T legs.
- 3" thick freestanding panels with 1" locking casters.
- 22" deep T-legs for stability (9.5" on each side)
- All Modules are Tempered Glass.
- Available in clear glass (CLR) and frosted glass (FRST)
- Includes end of run trim.

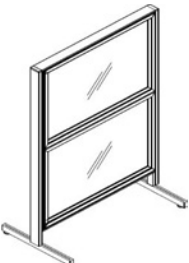
DESCRIPTION	PRODUCT CODE	LIST PRICE		DIMENSIONS/INCHES		
		CLR	FRST	H	W	D
 Mobile Glazed Privacy Panel	EVPPGT5424M	1019	1247	54	24	2 7/8
	EVPPGT5430M	1113	1378	54	30	2 7/8
	EVPPGT5436M	1204	1505	54	36	2 7/8
	EVPPGT5442M	1304	1645	54	42	2 7/8
	EVPPGT5448M	1402	1781	54	48	2 7/8
	EVPPGT5454M	1505	1930	54	54	2 7/8
	EVPPGT5460M	1595	2052	54	60	2 7/8



**EVPP - MOBILE GLAZED PRIVACY PANEL**

- Includes panel with two connectors with T legs.
- 3" thick freestanding panels with 1" locking casters.
- 22" deep T-legs for stability (9.5" on each side)
- All Modules are Tempered Glass.
- Available in clear glass (CLR) and frosted glass (FRST)
- Includes end of run trim.

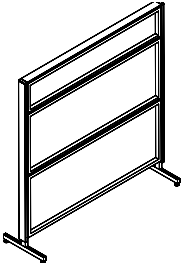
DESCRIPTION	PRODUCT CODE	LIST PRICE		DIMENSIONS/INCHES		
		CLR	FRST	H	W	D
 <p>Mobile Glazed Privacy Panel</p>	EVPPGT6624M	1256	1565	66	24	2 7/8
	EVPPGT6630M	1371	1725	66	30	2 7/8
	EVPPGT6636M	1550	1975	66	36	2 7/8
	EVPPGT6642M	1677	2152	66	42	2 7/8
	EVPPGT6648M	1803	2330	66	48	2 7/8
	EVPPGT6654M	1946	2529	66	54	2 7/8
	EVPPGT6660M	2098	2743	66	60	2 7/8

**EVPP - LAMINATE GLAZED PRIVACY PANEL**

- Includes panel with two connectors with T legs.
- 3" thick freestanding panels with leveling glides
- 22" deep T-legs for stability (9.5" on each side)
- All Modules are Tempered Glass.
- Bottom Two Modules are Laminate w/12" Tempered Glass on top.
- Includes end of run trim.

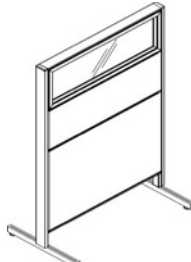
DESCRIPTION	PRODUCT CODE	LIST PRICE		DIMENSIONS/INCHES		
		CLR	FRST	H	W	D
 <p>Freestanding Laminate Glazed Privacy Panel</p>	EVPPHGTU5424	1158	1313	54	24	2 7/8
	EVPPHGTU5430	1285	1466	54	30	2 7/8
	EVPPHGTU5436	1414	1622	54	36	2 7/8
	EVPPHGTU5442	1542	1775	54	42	2 7/8
	EVPPHGTU5448	1670	1930	54	48	2 7/8
	EVPPHGTU5454	1811	2097	54	54	2 7/8
	EVPPHGTU5460	1941	2252	54	60	2 7/8

**EVPP - LAMINATE GLAZED PRIVACY PANEL**

- Includes panel with two connectors with T legs.
- 3" thick freestanding panels with leveling glides
- 22" deep T-legs for stability (9.5" on each side)
- Bottom Two Modules are Laminate w/12" Tempered Glass on top.
- Includes end of run trim.

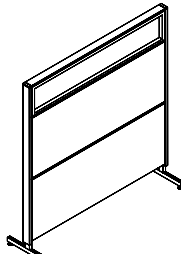
DESCRIPTION	PRODUCT CODE	LIST PRICE		DIMENSIONS/INCHES		
		CLR	FRST	H	W	D
 <p>Freestanding Laminate Glazed Privacy Panel</p>	EVPPHGTU6624	1295	1472	66	24	2 7/8
	EVPPHGTU6630	1446	1652	66	30	2 7/8
	EVPPHGTU6636	1626	1869	66	36	2 7/8
	EVPPHGTU6642	1774	2045	66	42	2 7/8
	EVPPHGTU6648	1920	2224	66	48	2 7/8
	EVPPHGTU6654	2088	2423	66	54	2 7/8
	EVPPHGTU6660	2271	2642	66	60	2 7/8



**EVPP - MOBILE LAMINATE GLAZED PRIVACY PANEL**

- Includes panel with two connectors with T legs.
- 3" thick freestanding panels with 1" locking casters.
- 22" deep T-legs for stability (9.5" on each side)
- Bottom Two Modules are Laminate w/12" Tempered Glass on top.
- Includes end of run trim.

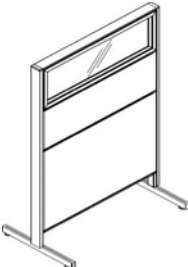
DESCRIPTION	PRODUCT CODE	LIST PRICE		DIMENSIONS/INCHES		
		CLR	FRST	H	W	D
 <p>Mobile Laminate Glazed Privacy Panel</p>	EVPPHGTU5424M	1229	1384	54	24	2 7/8
	EVPPHGTU5430M	1355	1535	54	30	2 7/8
	EVPPHGTU5436M	1485	1691	54	36	2 7/8
	EVPPHGTU5442M	1615	1845	54	42	2 7/8
	EVPPHGTU5448M	1741	2000	54	48	2 7/8
	EVPPHGTU5454M	1880	2169	54	54	2 7/8
	EVPPHGTU5460M	2011	2324	54	60	2 7/8

**EVPP - MOBILE LAMINATE GLAZED PRIVACY PANEL**

- Includes panel with two connectors with T legs.
- 3" thick freestanding panels with 1" locking casters.
- 22" deep T-legs for stability (9.5" on each side)
- Bottom Two Modules are Laminate w/12" Tempered Glass on top.
- Includes end of run trim.

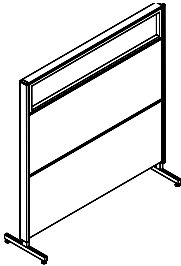
DESCRIPTION	PRODUCT CODE	LIST PRICE		DIMENSIONS/INCHES		
		CLR	FRST	H	W	D
 <p>Mobile Laminate Glazed Privacy Panel</p>	EVPPHGTU6624M	1366	1542	66	24	2 7/8
	EVPPHGTU6630M	1516	1722	66	30	2 7/8
	EVPPHGTU6636M	1697	1940	66	36	2 7/8
	EVPPHGTU6642M	1844	2115	66	42	2 7/8
	EVPPHGTU6648M	1993	2293	66	48	2 7/8
	EVPPHGTU6654M	2158	2493	66	54	2 7/8
	EVPPHGTU6660M	2341	2712	66	60	2 7/8

**EVPP - LAMINATE GLAZED PRIVACY PANEL**

- Includes panel with two connectors with T legs.
- 3" thick freestanding panels with leveling glides
- 22" deep T-legs for stability (9.5" on each side)
- All Modules are Tempered Glass.
- Laminate Base Module w/24" Tempered Glass above.
- Includes end of run trim.

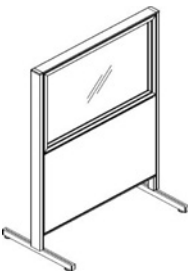
DESCRIPTION	PRODUCT CODE	LIST PRICE		DIMENSIONS/INCHES		
		CLR	FRST	H	W	D
 <p>Freestanding Laminate Glazed Privacy Panel</p>	EVPPHGT5424	1003	1127	54	24	2 7/8
	EVPPHGT5430	1114	1261	54	30	2 7/8
	EVPPHGT5436	1229	1396	54	36	2 7/8
	EVPPHGT5442	1341	1533	54	42	2 7/8
	EVPPHGT5448	1450	1666	54	48	2 7/8
	EVPPHGT5454	1570	1810	54	54	2 7/8
	EVPPHGT5460	1676	1935	54	60	2 7/8



**EVPP - LAMINATE GLAZED PRIVACY PANEL**

- Includes panel with two connectors with T legs.
- 3" thick freestanding panels with leveling glides
- 22" deep T-legs for stability (9.5" on each side)
- Laminate Base Module w/36" Tempered Glass above.
- Includes end of run trim.

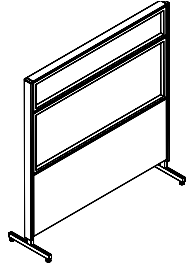

DESCRIPTION	PRODUCT CODE	LIST PRICE		DIMENSIONS/INCHES		
		CLR	FRST	H	W	D
Freestanding Laminate Glazed Privacy Panel	EVPPHGT6624	1241	1405	66	24	2 7/8
	EVPPHGT6630	1374	1565	66	30	2 7/8
	EVPPHGT6636	1547	1774	66	36	2 7/8
	EVPPHGT6642	1678	1931	66	42	2 7/8
	EVPPHGT6648	1814	2095	66	48	2 7/8
	EVPPHGT6654	1969	2280	66	54	2 7/8
	EVPPHGT6660	2149	2494	66	60	2 7/8

**EVPP - MOBILE LAMINATE GLAZED PRIVACY PANEL**

- Includes panel with two connectors with T legs.
- 3" thick freestanding panels with 1" locking casters.
- 22" deep T-legs for stability (9.5" on each side)
- Laminate Base Module w/36" Tempered Glass above.
- Includes end of run trim.

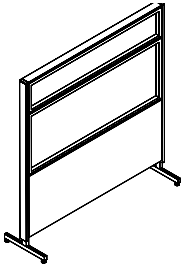

DESCRIPTION	PRODUCT CODE	LIST PRICE		DIMENSIONS/INCHES		
		CLR	FRST	H	W	D
Mobile Laminate Glazed Privacy Panel	EVPPHGT6624M	1312	1477	66	24	2 7/8
	EVPPHGT6630M	1445	1635	66	30	2 7/8
	EVPPHGT6636M	1619	1844	66	36	2 7/8
	EVPPHGT6642M	1748	2001	66	42	2 7/8
	EVPPHGT6648M	1885	2165	66	48	2 7/8
	EVPPHGT6654M	2040	2349	66	54	2 7/8
	EVPPHGT6660M	2220	2565	66	60	2 7/8

**EVPP - MOBILE LAMINATE GLAZED PRIVACY PANEL**

- Includes panel with two connectors with T legs.
- 3" thick freestanding panels with 1" locking casters.
- 22" deep T-legs for stability (9.5" on each side)
- Laminate Base Module w/24" Tempered Glass above.
- Includes end of run trim.

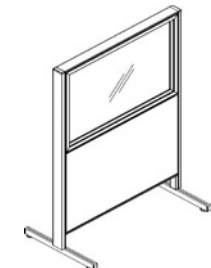

DESCRIPTION	PRODUCT CODE	LIST PRICE		DIMENSIONS/INCHES		
		CLR	FRST	H	W	D
Mobile Laminate Glazed Privacy Panel	EVPPHGT5424M	1073	1198	54	24	2 7/8
	EVPPHGT5430M	1184	1333	54	30	2 7/8
	EVPPHGT5436M	1297	1468	54	36	2 7/8
	EVPPHGT5442M	1412	1604	54	42	2 7/8
	EVPPHGT5448M	1523	1736	54	48	2 7/8
	EVPPHGT5454M	1641	1879	54	54	2 7/8
	EVPPHGT5460M	1746	2006	54	60	2 7/8

**EVPP - LAMINATE PRIVACY PANEL**

- Includes panel with two connectors with T legs.
- 3" thick freestanding panels with leveling glides
- 22" deep T-legs for stability (9.5" on each side)
- All Modules are Laminate.
- Includes end of run trim.

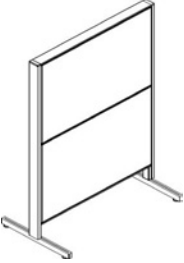
DESCRIPTION	PRODUCT CODE	LIST PRICE	DIMENSIONS/INCHES		
			H	W	D
 Freestanding Laminate Privacy Panel	EVPPH2S5424	1058	54	24	2 7/8
	EVPPH2S5430	1187	54	30	2 7/8
	EVPPH2S5436	1324	54	36	2 7/8
	EVPPH2S5442	1448	54	42	2 7/8
	EVPPH2S5448	1570	54	48	2 7/8
	EVPPH2S5454	1705	54	54	2 7/8
	EVPPH2S5460	1826	54	60	2 7/8

**EVPP - LAMINATE PRIVACY PANEL**

- Includes panel with two connectors with T legs.
- 3" thick freestanding panels with leveling glides
- 22" deep T-legs for stability (9.5" on each side)
- All Modules are Laminate.
- Includes end of run trim.

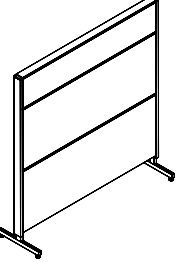
DESCRIPTION	PRODUCT CODE	LIST PRICE	DIMENSIONS/INCHES		
			H	W	D
 Freestanding Laminate Privacy Panel	EVPPH2S6624	1281	66	24	2 7/8
	EVPPH2S6630	1447	66	30	2 7/8
	EVPPH2S6636	1637	66	36	2 7/8
	EVPPH2S6642	1801	66	42	2 7/8
	EVPPH2S6648	1960	66	48	2 7/8
	EVPPH2S6654	2126	66	54	2 7/8
	EVPPH2S6660	2301	66	60	2 7/8

**EVPP - MOBILE LAMINATE PRIVACY PANEL**

- Includes panel with two connectors with T legs.
- 3" thick freestanding panels with 1" locking casters.
- 22" deep T-legs for stability (9.5" on each side)
- All Modules are Laminate.
- Available in clear glass (CLR) and frosted glass (FRST)
- Includes end of run trim.

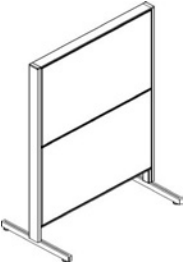
DESCRIPTION	PRODUCT CODE	LIST PRICE	DIMENSIONS/INCHES		
			H	W	D
 Mobile Laminate Privacy Panel	EVPPH2S5424M	1127	54	24	2 7/8
	EVPPH2S5430M	1257	54	30	2 7/8
	EVPPH2S5436M	1393	54	36	2 7/8
	EVPPH2S5442M	1520	54	42	2 7/8
	EVPPH2S5448M	1641	54	48	2 7/8
	EVPPH2S5454M	1775	54	54	2 7/8
	EVPPH2S5460M	1898	54	60	2 7/8



**EVPP - MOBILE LAMINATE PRIVACY PANEL**

- Includes panel with two connectors with T legs.
- 3" thick freestanding panels with 1" locking casters.
- 22" deep T-legs for stability (9.5" on each side)
- All Modules are Laminate.
- Includes end of run trim.

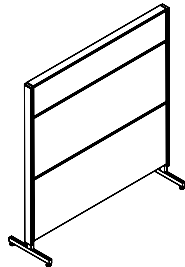

DESCRIPTION	PRODUCT CODE	LIST PRICE	DIMENSIONS/INCHES		
			H	W	D
Mobile Laminate Privacy Panel	EVPPH2S6624M	1351	66	24	2 7/8
	EVPPH2S6630M	1518	66	30	2 7/8
	EVPPH2S6636M	1708	66	36	2 7/8
	EVPPH2S6642M	1872	66	42	2 7/8
	EVPPH2S6648M	2031	66	48	2 7/8
	EVPPH2S6654M	2196	66	54	2 7/8
	EVPPH2S6660M	2371	66	60	2 7/8

**EVPP - FABRIC WRITE BOARD PRIVACY PANEL**

- Includes panel with two connectors with T legs.
- 3" thick freestanding panels with leveling glides
- 22" deep T-legs for stability (9.5" on each side)
- Fabric Base Module with Write Board above.
- Includes end of run trim.

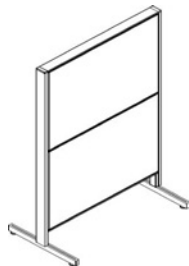

DESCRIPTION	PRODUCT CODE	LIST PRICE		DIMENSIONS/INCHES		
		GR 1	GR 2	H	W	D
Freestanding Write Board Privacy Panel	EVPPF2W5424	1021	1040	54	24	2 7/8
	EVPPF2W5430	1143	1164	54	30	2 7/8
	EVPPF2W5436	1265	1295	54	36	2 7/8
	EVPPF2W5442	1388	1418	54	42	2 7/8
	EVPPF2W5448	1527	1564	54	48	2 7/8
	EVPPF2W5454	1659	1699	54	54	2 7/8
	EVPPF2W5460	1777	1823	54	60	2 7/8

**EVPP - MOBILE FABRIC WRITE BOARD PRIVACY PANEL**

- Includes panel with two connectors with T legs.
- 3" thick freestanding panels with 1" locking casters.
- 22" deep T-legs for stability (9.5" on each side)
- Fabric Base Module with Write Board above.
- Includes end of run trim.

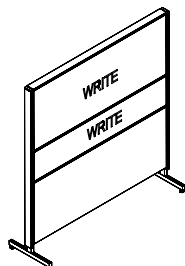

DESCRIPTION	PRODUCT CODE	LIST PRICE		DIMENSIONS/INCHES		
		GR 1	GR 2	H	W	D
Mobile Write Board Glazed Privacy Panel	EVPPF2W6624M	1304	1324	66	24	2 7/8
	EVPPF2W6630M	1516	1539	66	30	2 7/8
	EVPPF2W6636M	1701	1726	66	36	2 7/8
	EVPPF2W6642M	1869	1901	66	42	2 7/8
	EVPPF2W6648M	2054	2088	66	48	2 7/8
	EVPPF2W6654M	2226	2273	66	54	2 7/8
	EVPPF2W6660M	2440	2481	66	60	2 7/8

**EVPP - MOBILE FABRIC WRITE BOARD PRIVACY PANEL**

- Includes panel with two connectors with T legs.
- 3" thick freestanding panels with 1" locking casters.
- 22" deep T-legs for stability (9.5" on each side)
- Fabric Base Module with Write Board above.
- Includes end of run trim.

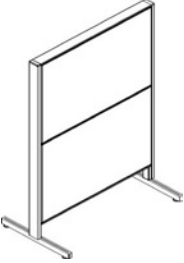
DESCRIPTION	PRODUCT CODE	LIST PRICE		DIMENSIONS/INCHES		
		GR 1	GR 2	H	W	D
 <p>Mobile Write Board Privacy Panel</p>	EVPPF2W5424M	1093	1110	54	24	2 7/8
	EVPPF2W5430M	1214	1237	54	30	2 7/8
	EVPPF2W5436M	1336	1366	54	36	2 7/8
	EVPPF2W5442M	1457	1489	54	42	2 7/8
	EVPPF2W5448M	1598	1632	54	48	2 7/8
	EVPPF2W5454M	1729	1768	54	54	2 7/8
	EVPPF2W5460M	1848	1895	54	60	2 7/8

**EVPP - MOBILE LAMINATE WRITE BOARD PRIVACY PANEL**

- Includes panel with two connectors with T legs.
- 3" thick freestanding panels with 1" locking casters.
- 22" deep T-legs for stability (9.5" on each side)
- Laminate Base Module with Write Board above.
- Includes end of run trim.

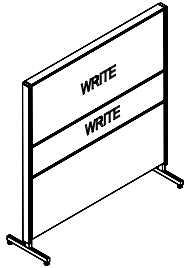
DESCRIPTION	PRODUCT CODE	LIST PRICE	DIMENSIONS/INCHES		
			H	W	D
 <p>Mobile Write Board Laminate Privacy Panel</p>	EVPPH2W6624M	1395	66	24	2 7/8
	EVPPH2W6630M	1639	66	30	2 7/8
	EVPPH2W6636M	1862	66	36	2 7/8
	EVPPH2W6642M	2044	66	42	2 7/8
	EVPPH2W6648M	2228	66	48	2 7/8
	EVPPH2W6654M	2420	66	54	2 7/8
	EVPPH2W6660M	2615	66	60	2 7/8

**EVPP - LAMINATE WRITE BOARD PRIVACY PANEL**

- Includes panel with two connectors with T legs.
- 3" thick freestanding panels with leveling glides
- 22" deep T-legs for stability (9.5" on each side)
- Laminate Base Module with Write Board above.
- Includes end of run trim.

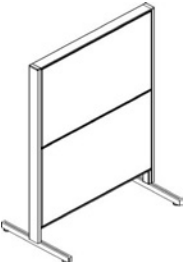
DESCRIPTION	PRODUCT CODE	LIST PRICE	DIMENSIONS/INCHES		
			H	W	D
 <p>Freestanding Write Board Privacy Panel</p>	EVPPH2W5424	1121	54	24	2 7/8
	EVPPH2W5430	1268	54	30	2 7/8
	EVPPH2W5436	1422	54	36	2 7/8
	EVPPH2W5442	1564	54	42	2 7/8
	EVPPH2W5448	1701	54	48	2 7/8
	EVPPH2W5454	1852	54	54	2 7/8
	EVPPH2W5460	1989	54	60	2 7/8



**EVPP - LAMINATE WRITE BOARD PRIVACY PANEL**

- Includes panel with two connectors with T legs.
- 3" thick freestanding panels with leveling glides
- 22" deep T-legs for stability (9.5" on each side)
- Laminate Base Module with Write Board above
- Includes end of run trim.

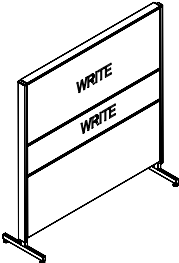
DESCRIPTION	PRODUCT CODE	LIST PRICE	DIMENSIONS/INCHES		
			H	W	D
 Freestanding Write Board Laminate Privacy Panel	EVPPH2W6624	1326	66	24	27/8
	EVPPH2W6630	1569	66	30	27/8
	EVPPH2W6636	1792	66	36	27/8
	EVPPH2W6642	1973	66	42	27/8
	EVPPH2W6648	2156	66	48	27/8
	EVPPH2W6654	2349	66	54	27/8
	EVPPH2W6660	2546	66	60	27/8

**EVPP - MOBILE LAMINATE WRITE BOARD PRIVACY PANEL**

- Includes panel with two connectors with T legs.
- 3" thick freestanding panels with 1" locking casters.
- 22" deep T-legs for stability (9.5" on each side)
- Laminate Base Module with Write Board above.
- Includes end of run trim.

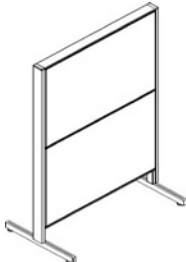
DESCRIPTION	PRODUCT CODE	LIST PRICE	DIMENSIONS/INCHES		
			H	W	D
 Mobile Write Board Privacy Panel	EVPPH2W5424M	1193	54	24	27/8
	EVPPH2W5430M	1340	54	30	27/8
	EVPPH2W5436M	1490	54	36	27/8
	EVPPH2W5442M	1632	54	42	27/8
	EVPPH2W5448M	1771	54	48	27/8
	EVPPH2W5454M	1922	54	54	27/8
	EVPPH2W5460M	2060	54	60	27/8

**EVPP - FABRIC WRITE BOARD PRIVACY PANEL**

- Includes panel with two connectors with T legs.
- 3" thick freestanding panels with leveling glides
- 22" deep T-legs for stability (9.5" on each side)
- Fabric Base Module with Write Board above
- Includes end of run trim.

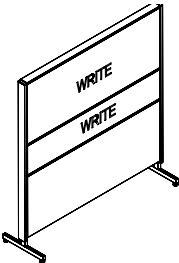
DESCRIPTION	PRODUCT CODE	LIST PRICE		DIMENSIONS/INCHES		
		GR 1	GR 2	H	W	D
 Freestanding Write Board Glazed Privacy Panel	EVPPF2W6624	1234	1252	66	24	27/8
	EVPPF2W6630	1446	1469	66	30	27/8
	EVPPF2W6636	1630	1657	66	36	27/8
	EVPPF2W6642	1799	1831	66	42	27/8
	EVPPF2W6648	1985	2017	66	48	27/8
	EVPPF2W6654	2154	2203	66	54	27/8
	EVPPF2W6660	2370	2412	66	60	27/8



# panel connectors





Slotted posts are included with each Variable-Height Corner Post. The height of each slotted post must be specified when ordering a Variable-Height Corner Post. Slotted post height is determined by the height of the connecting panel run.

**Example**

Step 1 Specify base code listed on pricing page.

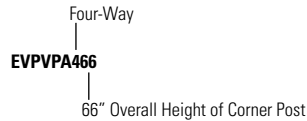

**Segmented Panel**

Step 2 Specify slotted post heights.

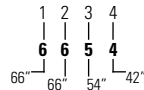

**Note:** To specify height, use the first number of the connecting panel run height dimension.

**Slotted Post Positions**

As illustrated in the example below, start with position 1 and continue clockwise specifying the height of each slotted post.

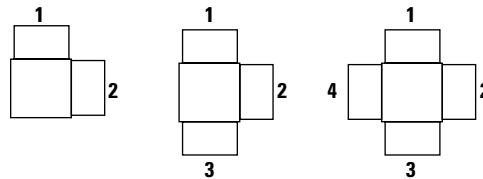

**Sample Configuration - EVPVPA466-6654**

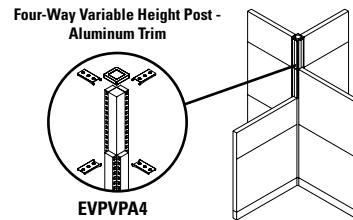

**PANEL CONNECTORS BY TYPE**

**Inline Connector ..... 121-123**

- Inline Connector
- Inline Connector for Light Panels
- Inline Connector for Beltline Powered Panels
- Inline Connector for Beltline Powered Light Panels
- Inline Variable - Height Connector
- Inline Variable - Height Connector for Light Panels
- Inline Variable - Height Connector for Beltline Powered Panels
- Inline Variable - Height Connector for Beltline Powered Light Panels

**End-of-Run ..... 124**

- End-of-Run Post Kit (Wall Mountable) - Aluminum Trim
- End-of-Run Post Kit for Light Panels (Wall Mountable) - Aluminum Trim

**Two-Way Post ..... 125-128**

- Two-Way Post - Aluminum Trim
- Two-Way Post for Light Panels - Aluminum Trim
- Two-Way Post for Beltline Powered Panels - Aluminum Trim
- Two-Way Post for Beltline Powered Light Panels - Aluminum Trim
- Two-Way Variable - Height Post - Aluminum Trim
- Two-Way Variable - Height Post for Light Panels - Aluminum Trim
- Two-Way Variable - Height Post for Beltline Powered Panels - Aluminum Trim
- Two-Way Variable - Height Post for Beltline Powered Light Panels - Aluminum Trim

**Three-Way Post ..... 129-132**

- Three-Way Post - Aluminum Trim
- Three-Way Post for Light Panels - Aluminum Trim
- Three-Way Post for Beltline Powered Panels - Aluminum Trim
- Three-Way Post for Beltline Powered Light Panels - Aluminum Trim
- Three-Way Variable - Height Post - Aluminum Trim
- Three-Way Variable - Height Post for Light Panels - Aluminum Trim
- Three-Way Variable - Height Post for Beltline Powered Panels - Aluminum Trim
- Three-Way Variable - Height Post for Beltline Powered Light Panels - Aluminum Trim

**Four-Way Post ..... 133-136**

- Four-Way Post
- Four-Way Post for Light Panels
- Four-Way Post for Beltline Powered Panels
- Four-Way Post for Beltline Powered Light Panels
- Four-Way Variable - Height Post - Aluminum Trim
- Four-Way Variable - Height Post for Light Panels - Aluminum Trim
- Four-Way Variable - Height Post for Beltline Powered Panels - Aluminum Trim
- Four-Way Variable - Height Post for Beltline Powered Light Panels - Aluminum Trim

**One-Way Post ..... 137-138**

- One-Way Post - Aluminum Trim
- One-Way Post for Light Panels - Aluminum Trim
- One-Way Post for Beltline Powered Panels - Aluminum Trim
- One-Way Post for Beltline Powered Light Panels - Aluminum Trim

**Inline Two-Way Post ..... 139-140**

- Inline Two-Way Post - Aluminum Trim
- Inline Two-Way Post for Light Panels - Aluminum Trim
- Inline Two-Way Post for Beltline Powered Panels - Aluminum Trim
- Inline Two-Way Post for Beltline Powered Light Panels - Aluminum Trim

**60 Degree ..... 141-143**

- Two-Way 60 Degree Post - Aluminum Trim
- Two-Way 60 Degree Post for Beltline Powered Panels - Aluminum Trim
- Two-Way 60 Degree Variable - Height Post - Aluminum Trim
- Two-Way 60 Degree Variable - Height Post for Beltline Powered Panels - Aluminum Trim
- Three-Way 60 Degree Post
- Three-Way 60 Degree Post for Beltline Powered Panels
- Three-Way 60 Degree Variable - Height Post - Aluminum Trim
- Three-Way 60 Degree Variable - Height Post for Beltline Powered Panels - Aluminum Trim

**45 Degree ..... 143-144**

- Two-Way 45 Degree Post
- Two-Way 45 Degree Variable - Height Post

**Upmount End of Run ..... 144-145**

- Upmount End-of-Run Post Kit (Wall Mountable) - Aluminum
- Upmount End-of-Run Post Kit for Light Panels (Wall Mountable) - Aluminum
- Upmount End-of-Run Trim - Aluminum
- Upmount End-of-Run Trim for Light Panels - Aluminum

**Extension ..... 146-149**

- Inline Extension Connector - Slotted
- End-of-Run Extension Connector - Slotted - Aluminum
- Two-Way Post Extension - Slotted - Aluminum
- Three-Way Post Extension - Slotted - Aluminum
- Four-Way Post Extension - Slotted - Aluminum
- One-Way Post Extension - Slotted - Aluminum
- Inline Two-Way Post Extension - Slotted - Aluminum
- Two-Way 60 Degree Post Extension - Slotted - Aluminum
- Three Way 60 Degree Post Extension - Slotted - Aluminum
- One-Way 60 Degree Post Extension - Slotted - Aluminum
- Two-Way 45 Degree Post Extension - Slotted - Aluminum
- One-Way 45 Degree Post Extension - Slotted - Aluminum

**Trims ..... 150-153**

- Upmount Extension Trim - Aluminum
- End-of-Run Trim - Aluminum
- End-of-Run Trim for Light Panels - Aluminum
- Panel Trim Variable Height - Aluminum
- Panel Extension Trim - Aluminum
- Flat Trim - Aluminum
- Flat Trim for Light Panels - Aluminum
- Flat Extension Trim - Aluminum
- Panel Top Trim - Aluminum
- Panel Top Single Notched Trim - Aluminum
- Panel Top Double Notched Trim - Aluminum
- Slot Cover



**EVPIC - INLINE CONNECTOR**

- Connects two panels of equal height in a straight run.
- Provides slotted support for worksurfaces and hang-on storage components.
- Includes one slotted connector with leveling glide and connecting hardware.
- Connectors available without slots, as a special at no upcharge. Contact Customer Support.

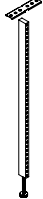
DESCRIPTION	PRODUCT CODE	LIST PRICE	DIMENSIONS/INCHES		
			H	W	D
 <p>Inline Connector</p>	EVPLIC30	74	30	2	
	EVPLIC42	86	42	2	
	EVPLIC48	90	48	2	
	EVPLIC54	92	54	2	
	EVPLIC66	102	60	2	

**EVPLTIC - LIGHT PANEL INLINE CONNECTOR LEG WITH TRIMS**

- Connects two Light panel in straight run.
- Provides slotted support for worksurfaces and hang on components.
- Includes one slotted connector with leveling glide with leg and trims and connecting hardware.
- Connectors available without slots, as a special at no extra charge. Contact customer support.

DESCRIPTION	PRODUCT CODE	LIST PRICE	DIMENSIONS/INCHES		
			H	W	D
 <p>Light Panel Inline Connector Leg with Trims</p>	EVPLTIC30	74	30	2	
	EVPLTIC42	86	42	2	
	EVPLTIC48	90	48	2	
	EVPLTIC54	92	54	2	
	EVPLTIC66	102	66	2	

**EVPBIC - INLINE CONNECTOR FOR BELTLINE POWERED PANELS**

- Connects two Beltline Powered panels of equal height in a straight run.
- Provides slotted support for worksurfaces and hang-on storage components.
- Includes one slotted connector with leveling glide and connecting hardware.
- Connectors available without slots, as a special at no upcharge. Contact Customer Support.

DESCRIPTION	PRODUCT CODE	LIST PRICE	DIMENSIONS/INCHES		
			H	W	D
 <p>Inline Connector for Beltline Powered Panels</p>	EVPBIC42	86	42	2	
	EVPBIC54	92	54	2	
	EVPBIC66	102	66	2	

**EVPBLTIC - BELTLINE LIGHT PANEL INLINE CONNECTOR LEG WITH TRIMS**

- Connects two Light panel in straight run.
- Provides slotted support for worksurfaces and hang on components.
- Includes one slotted connector with leveling glide with leg and trims and connecting hardware.
- Connectors available without slots, as a special at no extra charge. Contact customer support.

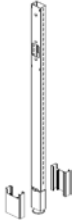
DESCRIPTION	PRODUCT CODE	LIST PRICE	DIMENSIONS/INCHES		
			H	W	D
 Beltline Light Panel Inline Connector Leg with trims	EVPBLTIC42	86	42	2	
	EVPBLTIC54	92	54	2	
	EVPBLTIC66	102	66	2	

**EVPVC - INLINE VARIABLE - HEIGHT CONNECTOR**

- Connects two panels of differing height in a straight run.
- Connector must reference taller panel.
- Can be used for any variation of panel heights.
- Variable-height trim must be ordered separately (see EVPTVAXX)
- Provides slotted support for worksurfaces and hang-on storage components.
- Includes one slotted connector with leveling glide and connecting hardware.
- Connectors available without slots, as a special at no upcharge. Contact Customer Support.
- Please see page 92 on how to specify.

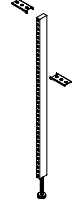
DESCRIPTION	PRODUCT CODE	LIST PRICE	DIMENSIONS/INCHES		
			H	W	D
 Inline Variable - Height Connector	EVPVC42	92	42	2	
	EVPVC48	94	48	2	
	EVPVC54	95	54	2	
	EVPVC66	104	66	2	

**EVPLTVC - INLINE VARIABLE HEIGHT CONNECTOR WITH LEG WITH TRIMS**

- Connects two Light panels of differing height in straight run.
- Connector must reference taller panel.
- Can be used for any variation of panel height.
- Variable height trim must be ordered separately (see EVPTVAXX).
- Provides slotted support for worksurfaces and hang on components.
- Includes one slotted connector with leveling glide with leg and trims and connecting hardware.
- Connectors available without slots, as a special at no extra charge. Contact customer support.

DESCRIPTION	PRODUCT CODE	LIST PRICE	DIMENSIONS/INCHES		
			H	W	D
 Inline Variable Height Connector with Leg with Trims	EVPLTVC42	92	42	2	
	EVPLTVC48	94	48	2	
	EVPLTVC54	95	54	2	
	EVPLTVC66	104	66	2	



**EVPBVC - INLINE VARIABLE - HEIGHT CONNECTOR FOR BELTLINE POWERED PANELS**

- Connects two Beltline Powered panels of differing height in a straight run.
- Connector must reference taller panel.
- Can be used for any variation of panel heights.
- Variable-height trim must be ordered separately (see EVPTVAXX)
- Provides slotted support for worksurfaces and hang-on storage components.
- Includes one slotted connector with leveling glide and connecting hardware.
- Connectors available without slots, as a special at no upcharge. Contact Customer Support.
- Please see page 92 on how to specify.

	DESCRIPTION	PRODUCT CODE	LIST PRICE	DIMENSIONS/INCHES		
				H	W	D
	Inline Variable - Height Connector for Beltline Powered Panels	EVPBVC54	95	54	2	
		EVPBVC66	104	66	2	

**EVPBTVVC - INLINE VARIABLE HEIGHT CONNECTOR FOR BELTLINE LIGHT PANEL**

- Connects two Light panels of differing height in straight run.
- Connector must reference taller panel.
- Can be used for any variation of panel height.
- Variable height trim must be ordered separately (see EVPTVAXX)
- Provides slotted support for worksurfaces and hang on components.
- Includes one slotted connector with leveling glide with leg and trims and connecting hardware.
- Includes one slotted connector with leveling glide with leg and trims and connecting hardware.

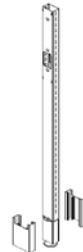
	DESCRIPTION	PRODUCT CODE	LIST PRICE	DIMENSIONS/INCHES		
				H	W	D
	Inline Variable Height Connector	EVPBTVVC54	95	54	2	
		EVPBTVVC66	104	60	2	

**EVPERA - END-OF-RUN POST KIT (WALL MOUNTABLE) - ALUMINUM TRIM**

- Connects at the end of a panel run and can be used to attach a panel to a fixed wall.
- Adds 1" to the width of the panel run.
- Provides slotted support for worksurfaces and hang-on storage components.
- Includes one slotted connector with leveling glide, connecting hardware and trim kit.
- Can be attached to face of another panel to provide off-modular panel connection.
- Connectors available without slots, as a special at no upcharge. Contact Customer Support.

	DESCRIPTION	PRODUCT CODE	LIST PRICE	DIMENSIONS/INCHES		
				H	W	D
	End-of-Run Post Kit (Wall Mountable) -	EVPERA30	90	30	2 7/8	
	Aluminum Trim	EVPERA42	102	42	2 7/8	
		EVPERA48	109	48	2 7/8	
		EVPERA54	123	54	2 7/8	
		EVPERA66	136	66	2 7/8	

**EVPLTERA - END OF RUN POST KIT FOR LIGHT PANEL**

- Connects at end of Light panel and can attach to a panel to fixed wall.
- Adds 1" to width of panel run.
- Provides slotted support for worksurfaces and hang on components.
- Includes one slotted connector with leveling glide with leg and trims and connecting hardware.
- Can be attached to face of another panel to provide off modular connection.
- Connectors available without slots, as a special at no extra charge. Contact customer support.

	DESCRIPTION	PRODUCT CODE	LIST PRICE	DIMENSIONS/INCHES		
				H	W	D
	End of run post kit for Light Panel	EVPLTERA30	90	30	2	
		EVPLTERA42	102	42	2	
		EVPLTERA48	109	48	2	
		EVPLTERA54	123	54	2	
		EVPLTERA66	136	66	2	



**EVPCPA2 - TWO-WAY POST - ALUMINUM TRIM**

- Connects two panels of equal height in a 90 degree configuration.
- Post and connecting hardware adds 3.25" to the panel run.
- Provides slotted support for worksurfaces and hang-on storage components.
- Includes one post, two slotted connectors with leveling glides, connecting hardware and trim kit.
- Connectors available without slots, as a special at no upcharge. Contact Customer Support.

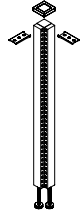

DESCRIPTION	PRODUCT CODE	LIST PRICE	DIMENSIONS/INCHES		
			H	W	D
Two-Way Post - Aluminum Trim	EVPCPA230	168	30	2 7/8	
	EVPCPA242	209	42	2 7/8	
	EVPCPA248	223	48	2 7/8	
	EVPCPA254	259	54	2 7/8	
	EVPCPA266	304	66	2 7/8	

**EVPLTCPA2 - TWO WAY CORNER POST FOR LIGHT PANEL**

- Connects two Light panel of equal height in 90 degree configuration.
- Post and connecting hardware add 3.25" to power beam run.
- Provides slotted support for worksurfaces and hang on components.
- Includes post, panel connectors and power beam connectors, post with trim all around, levelling glide, hardware and trim kit.
- Leg trim matches selected trim color.
- Connectors available without slots, as a special at no extra charge. Contact customer support.

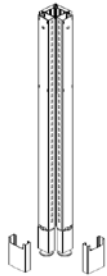

DESCRIPTION	PRODUCT CODE	LIST PRICE	DIMENSIONS/INCHES		
			H	W	D
Two Way Corner Post for Light Panel	EVPLTCPA230	168	30	2 7/8	
	EVPLTCPA242	209	42	2 7/8	
	EVPLTCPA248	223	48	2 7/8	
	EVPLTCPA254	259	54	2 7/8	
	EVPLTCPA266	304	66	2 7/8	

**EVPLTCPA2P- TWO WAY CORNER POST FOR LIGHT PANEL**

- Connects Light panel and Panel of equal height in 90 degree configuration.
- Post and connecting hardware add 3.25" to power beam run.
- Provides slotted support for worksurfaces and hang on components.
- Includes post, panel connectors and power beam connectors, post with trim all around, levelling glide, hardware and trim kit.
- Leg trim matches selected trim color.
- Connectors are available without slots, as a special at no extra charge. Contact customer support.

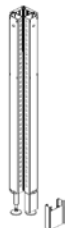

DESCRIPTION	PRODUCT CODE	LIST PRICE	DIMENSIONS/INCHES		
			H	W	D
Two Way Corner Post for Light Panel	EVPLTCPA230P	168	30	2 7/8	
	EVPLTCPA242P	209	42	2 7/8	
	EVPLTCPA248P	223	48	2 7/8	
	EVPLTCPA254P	259	54	2 7/8	
	EVPLTCPA266P	304	66	2 7/8	

**EVPBCPA2 - TWO-WAY POST FOR BELTLINE POWERED PANELS - ALUMINUM TRIM**

- Connects two Beltline Powered panels of equal height in a 90 degree configuration.
- Post and connecting hardware adds 3.25" to the panel run.
- Provides slotted support for worksurfaces and hang-on storage components.
- Includes one post, two slotted connectors with leveling glides, connecting hardware and trim kit.
- Connectors available without slots, as a special at no upcharge. Contact Customer Support.

DESCRIPTION	PRODUCT CODE	LIST PRICE	DIMENSIONS/INCHES		
			H	W	D
Two-Way Post for Beltline Powered Panels - Aluminum Trim	EVPBCPA242	209	42	2 7/8	
	EVPBCPA254	259	54	2 7/8	
	EVPBCPA266	304	66	2 7/8	

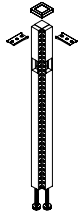

**EVPBLTCPA2 - TWO WAY CORNER POST FOR BELTLINE LIGHT PANEL**

- Connects two Light panel of equal height in 90 degree configuration.
- Post and connecting hardware add 3.25" to power beam run.
- Provides slotted support for worksurfaces and hang on components.
- Includes post, panel connectors and power beam connectors, post with trim all around, levelling glide, hardware and trim kit.
- Leg trim matches selected trim color.
- Connectors available without slots, as a special at no extra charge. Contact customer support.

DESCRIPTION	PRODUCT CODE	LIST PRICE	DIMENSIONS/INCHES		
			H	W	D
Two Way Corner Post for Beltline Light Panel	EVPBLTCPA242	209	42	2	
	EVPBLTCPA248	223	48	2	
	EVPBLTCPA254	259	54	2	
	EVPBLTCPA266	304	66	2	



**EVPBLTCPA2P - TWO WAY CORNER POST FOR BELTLINE LIGHT PANEL**

- Connects Beltline Light panel and Beltline Panel of equal height in 90 degree configuration.
- Post and connecting hardware add 3.25" to power beam run.
- Provides slotted support for worksurfaces and hang on components.
- Includes post, panel connectors and power beam connectors, post with trim all around, levelling glide, hardware and trim kit.
- Leg trim matches selected trim color.
- Connectors are available without slots, as a special at no extra charge. Contact customer support.

DESCRIPTION	PRODUCT CODE	LIST PRICE	DIMENSIONS/INCHES		
			H	W	D
Two Way Corner Post for Beltline Light Panel	EVPBLTCPA242P	209	42	2 7/8	
	EVPBLTCPA248P	223	48	2 7/8	
	EVPBLTCPA254P	259	54	2 7/8	
	EVPBLTCPA266P	304	66	2 7/8	

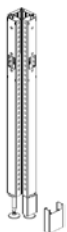

**EVVPVA2 - TWO-WAY VARIABLE - HEIGHT POST - ALUMINIM TRIM**

- Connects two panels of differing height in a 90 degree configuration.
- Connector must reference taller panel.
- Post and connecting hardware adds 3.25" to the panel run.
- Provides slotted support for worksurfaces and hang-on storage components.
- Includes one post, two slotted connectors with leveling glides, connecting hardware and trim kit.
- Connectors available without slots as a special at no upcharge. Contact Customer Support
- Please see page 92 on how to specify.

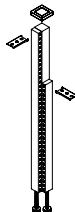
	DESCRIPTION	PRODUCT CODE	LIST PRICE	DIMENSIONS/INCHES		
				H	W	D
	Two-Way Variable - Height Post - Aluminum Trim	EVVPVA242	209	42	2 7/8	
		EVVPVA248	233	48	2 7/8	
		EVVPVA254	259	54	2 7/8	
		EVVPVA266	304	66	2 7/8	

**EVPLTVPA2 - TWO WAY VARIABLE HEIGHT CORNER POST FOR LIGHT PANEL**

- Connects two Light panel of differing height in 90 degree configuration.
- Connector must reference taller panel.
- Post and connecting hardware add 3.25" to power beam run.
- Provides slotted support for worksurfaces and hang on components.
- Includes post, panel connectors and power beam connectors, post with trim all around, levelling glide, hardware and trim kit.
- Leg trim matches selected trim color.
- Connectors available without slots, as a special at no extra charge. Contact customer support.

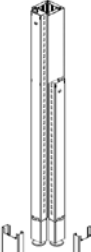
	DESCRIPTION	PRODUCT CODE	LIST PRICE	DIMENSIONS/INCHES		
				H	W	D
	Two Way Variable Height Corner Post for Beltline Light Panel	EVPLTVPA242	209	42	2 7/8	
		EVPLTVPA248	223	48	2 7/8	
		EVPLTVPA254	259	54	2 7/8	
		EVPLTVPA266	304	66	2 7/8	

**EVPLTVPA2P- TWO WAY VARIABLE HEIGHT CORNER POST FOR LIGHT PANEL - PANEL**

- Connects Light panel and Panel of differing height in 90 degree configuration.
- Connector must reference taller panel.
- Post and connecting hardware add 3.25" to power beam run.
- Provides slotted support for worksurfaces and hang on components.
- Includes post, panel connectors and power beam connectors, post with trim all around, levelling glide, hardware and trim kit.
- Leg trim matches selected trim color.
- Connectors are available without slots, as a special at no extra charge. Contact customer support.

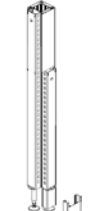
	DESCRIPTION	PRODUCT CODE	LIST PRICE	DIMENSIONS/INCHES		
				H	W	D
	Two Way Variable Height Corner Post for Light Panel-Panel	EVPLTVPA242P	209	42	2 7/8	
		EVPLTVPA248P	223	48	2 7/8	
		EVPLTVPA254P	259	54	2 7/8	
		EVPLTVPA266P	304	66	2 7/8	



**EVPBVPA2 - TWO-WAY VARIABLE - HEIGHT POST FOR BELTLINE POWERED PANELS - ALUMINIM TRIM**

- Connects two Beltline Powered panels of differing height in a 90 degree configuration.
- Connector must reference taller panel.
- Post and connecting hardware adds 3.25" to the panel run.
- Provides slotted support for worksurfaces and hang-on storage components.
- Includes one post, two slotted connectors with leveling glides, connecting hardware and trim kit.
- Connectors available without slots, as a special at no upcharge. Contact Customer Support.

DESCRIPTION	PRODUCT CODE	LIST PRICE	DIMENSIONS/INCHES		
			H	W	D

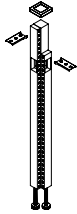

Two-Way Variable - Height Post for Beltline Powered Panels - Aluminum Trim

EVPBVPA254  
EVPBVPA266

259  
304

54 2 7/8  
66 2 7/8

**EVPBLTVA2 - TWO WAY VARIABLE HEIGHT CORNER POST FOR BELTLINE LIGHT PANEL**

- Connects two Light panel of differing height in 90 degree configuration.
- Connector must reference taller panel.
- Post and connecting hardware add 3.25" to power beam run.
- Provides slotted support for worksurfaces and hang on components.
- Leg trim matches selected trim color.
- Includes post, panel connectors and power beam connectors, post with trim all around, levelling glide, hardware and trim kit.
- Connectors available without slots, as a special at no extra charge. Contact customer support.

DESCRIPTION	PRODUCT CODE	LIST PRICE	DIMENSIONS/INCHES		
			H	W	D



Two Way Variable Height Corner Post for Beltline Light Panel

EVPBLTVA254  
EVPBLTVA266

259  
304

54 2 7/8  
66 2 7/8

**EVPBLTVA2P - TWO WAY VARIABLE HEIGHT CORNER POST FOR BELTLINE LIGHT PANEL**

- Connects Beltline Light panel and Beltline Panel of differing height in 90 degree configuration.
- Connector must reference taller panel.
- Post and connecting hardware add 3.25" to power beam run.
- Provides slotted support for worksurfaces and hang on components.
- Includes post, panel connectors and power beam connectors, post with trim all around, levelling glide, hardware and trim kit.
- Leg trim matches selected trim color.
- Connectors are available without slots, as a special at no extra charge. Contact customer support.

DESCRIPTION	PRODUCT CODE	LIST PRICE	DIMENSIONS/INCHES		
			H	W	D



Two Way Variable Height Corner Post for Beltline Light Panel

EVPBLTVA254P  
EVPBLTVA266P

335  
304

54 2 7/8  
66 2 7/8



**EVPCPA3 - THREE-WAY POST - ALUMINUM TRIM**

- Connects three panels of equal height in a "T" configuration.
- Post and connecting hardware adds 3.25" to the panel run.
- Provides slotted support for worksurfaces and hang-on storage components.
- Includes one post, three slotted connectors with leveling glides, connecting hardware and trim kit.
- Connectors available without slots, as a special at no upcharge. Contact Customer Support.

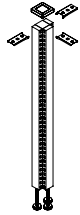

DESCRIPTION	PRODUCT CODE	LIST PRICE	DIMENSIONS/INCHES		
			H	W	D
Three-Way Post - Aluminum Trim	EVPCPA330	207	30	2 7/8	
	EVPCPA342	277	42	2 7/8	
	EVPCPA348	304	48	2 7/8	
	EVPCPA354	335	54	2 7/8	
	EVPCPA366	395	66	2 7/8	

**EVPLTCPA3 - THREE WAY CORNER POST FOR LIGHT PANEL**

- Connects three Light panel of equal height in "T" configuration.
- Post and connecting hardware add 3.25" to power beam run.
- Provides slotted support for worksurfaces and hang on components.
- Includes post, panel connectors and power beam connectors, post with trim all around, levelling glide, hardware and trim kit.
- Leg trim matches selected trim color.
- Connectors available without slots, as a special at no extra charge. Contact customer support.



DESCRIPTION	PRODUCT CODE	LIST PRICE	DIMENSIONS/INCHES		
			H	W	D
Three Way Corner Post for Light Panel	EVPLTCPA330	207	30	2 7/8	
	EVPLTCPA342	277	42	2 7/8	
	EVPLTCPA348	304	48	2 7/8	
	EVPLTCPA354	335	54	2 7/8	
	EVPLTCPA366	395	66	2 7/8	

**EVPLTCPA3P - THREE WAY CORNER POST FOR PANEL - LIGHT PANEL**

- Connects one Light panel and two Panels of equal height in "T" configuration, Panel-Light Panel-Panel.
- Post and connecting hardware add 3.25" to power beam run.
- Provides slotted support for worksurfaces and hang on components.
- Includes post, panel connectors and power beam connectors, post with trim all around, levelling glide, hardware and trim kit.
- Leg trim matches selected trim color.
- Connectors are available without slots, as a special at no extra charge. Contact customer support.

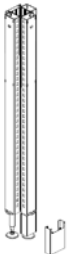

DESCRIPTION	PRODUCT CODE	LIST PRICE	DIMENSIONS/INCHES		
			H	W	D
Three Way Corner Post for Panel-Light Panel	EVPLTCPA330P	207	30	2 7/8	
	EVPLTCPA342P	277	42	2 7/8	
	EVPLTCPA348P	304	48	2 7/8	
	EVPLTCPA354P	335	54	2 7/8	
	EVPLTCPA366P	395	66	2 7/8	

**EVPLTCPA3PT - THREE WAY CORNER POST FOR LIGHT PANEL -PANEL-LIGHT PANEL**

- Connects one Light panel and two Panels of equal height in “T” configuration , Light Panel-Panel-Light Panel.
- Post and connecting hardware add 3.25” to Power Beam run.
- Provides slotted support for worksurfaces and hang on components.
- Includes post, panel connectors and power beam connectors, post with trim all around, leveling glide, hardware and trim kit.
- Leg trim matches selected trim color.
- Connectors available without slots, as a special at no upcharge. Contact Customer Support.

DESCRIPTION	PRODUCT CODE	LIST PRICE	DIMENSIONS/INCHES		
			H	W	D
 Three-Way Corner Post Light Panel-Panel-Light Panel	EVPLTCPA330PT	207	30	2 7/8	
	EVPLTCPA342PT	277	42	2 7/8	
	EVPLTCPA348PT	304	48	2 7/8	
	EVPLTCPA354PT	335	54	2 7/8	
	EVPLTCPA366PT	395	66	2 7/8	

**EVPBCPA3 - THREE-WAY POST FOR BELTLINE POWERED PANELS - ALUMINUM TRIM**

- Connects three Beltline Powered panels of equal height in a “T” configuration.
- Post and connecting hardware adds 3.25” to the panel run.
- Provides slotted support for worksurfaces and hang-on storage components.
- Includes one post, three slotted connectors with leveling glides, connecting hardware and trim kit.
- Connectors available without slots, as a special at no upcharge. Contact Customer Support.

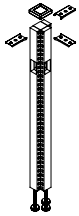
DESCRIPTION	PRODUCT CODE	LIST PRICE	DIMENSIONS/INCHES		
			H	W	D
 Three-Way Post for Beltline Powered Panels - Aluminum Trim	EVPBCPA342	277	42	2 7/8	
	EVPBCPA354	335	54	2 7/8	
	EVPBCPA366	395	66	2 7/8	

**EVPLTCPA3 - THREE WAY CORNER POST FOR BELTLINE LIGHT PANEL**

- Connects three Light panel of equal height in “T” configuration.
- Post and connecting hardware add 3.25” to power beam run.
- Provides slotted support for worksurfaces and hang on components.
- Includes post, panel connectors and power beam connectors, post with trim all around, levelling glide, hardware and trim kit.
- Leg trim matches selected trim color.
- Connectors available without slots, as a special at no extra charge. Contact customer support.

DESCRIPTION	PRODUCT CODE	LIST PRICE	DIMENSIONS/INCHES		
			H	W	D
 Three Way Corner Post for Beltline Light Panel	EVPLTCPA342	277	42	2	
	EVPLTCPA348	304	48	2	
	EVPLTCPA354	335	54	2	
	EVPLTCPA366	395	66	2	



**EVPBLTCPA3P - THREE WAY CORNER POST FOR BELTLINE LIGHT PANEL**

- Connects one Beltline Light panel and two Beltline panels of equal height in "T" configuration.
- Post and connecting hardware add 3.25" to power beam run.
- Provides slotted support for worksurfaces and hang on components.
- Includes post, panel connectors and power beam connectors, post with trim all around, levelling glide, hardware and trim kit.
- Leg trim matches selected trim color.
- Connectors are available without slots, as a special at no extra charge. Contact customer support.

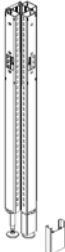
DESCRIPTION	PRODUCT CODE	LIST PRICE	DIMENSIONS/INCHES		
			H	W	D
 <p>Three way Corner Post Light Panel</p>	EVPBLTCPA342P	277	42	2 7/8	
	EVPBLTCPA348P	304	48	2 7/8	
	EVPBLTCPA354P	335	54	2 7/8	
	EVPBLTCPA366P	395	66	2 7/8	

**EVVPA3 - THREE-WAY VARIABLE - HEIGHT POST - ALUMINUM TRIM**

- Connects three panels of differing height in a "T" configuration.
- Connector must reference taller panel.
- Post and connecting hardware adds 3.25" to the panel run.
- Provides slotted support for worksurfaces and hang-on storage components.
- Includes one post, three slotted connectors with leveling glides, connecting hardware and trim kit.
- Connectors available without slots, as a special at no upcharge. Contact Customer Support.
- Please see page 92 on how to specify.

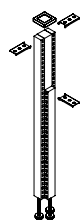
DESCRIPTION	PRODUCT CODE	LIST PRICE	DIMENSIONS/INCHES		
			H	W	D
 <p>Three-Way Variable - Height Post - Aluminum Trim</p>	EVVPA342	277	42	2 7/8	
	EVVPA348	304	48	2 7/8	
	EVVPA354	335	54	2 7/8	
	EVVPA366	395	66	2 7/8	

**EVPLTVPA3 - THREE WAY VARIABLE HEIGHT CORNER POST FOR LIGHT PANEL**

- Connects three Light panel of differing height in "T" configuration.
- Connector must reference taller panel.
- Post and connecting hardware add 3.25" to power beam run.
- Provides slotted support for worksurfaces and hang on components.
- Includes post, panel connectors and power beam connectors, post with trim all around, levelling glide, hardware and trim kit.
- Leg trim matches selected trim color.
- Connectors available without slots, as a special at no extra charge. Contact customer support.

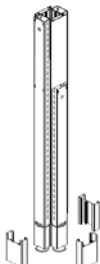
DESCRIPTION	PRODUCT CODE	LIST PRICE	DIMENSIONS/INCHES		
			H	W	D
 <p>Three Way Variable Height Corner Post for Light Panel</p>	EVPLTVPA342	277	42	2 7/8	
	EVPLTVPA348	304	48	2 7/8	
	EVPLTVPA354	335	54	2 7/8	
	EVPLTVPA366	395	66	2 7/8	

**EVPLTVPA3P- THREE WAY VARIABLE HEIGHT CORNER POST FOR LIGHT PANEL - PANEL**

- Connects one Light panel and two Panels of differing height in "T" configuration, Panel-Light Panel-Panel.
- Connector must reference taller panel.
- Post and connecting hardware add 3.25" to power beam run.
- Provides slotted support for worksurfaces and hang on components.
- Includes post, panel connectors and power beam connectors, post with trim all around, levelling glide, hardware and trim kit.
- Leg trim matches selected trim color.
- Connectors are available without slots, as a special at no extra charge. Contact customer support.

DESCRIPTION	PRODUCT CODE	LIST PRICE	DIMENSIONS/INCHES		
			H	W	D

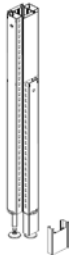

Three Way Variable Height Corner Post for Panel-Light Panel-Panel

EVPLTVPA342P	277	42	2 7/8
EVPLTVPA348P	304	48	2 7/8
EVPLTVPA354P	335	54	2 7/8
EVPLTVPA366P	395	66	2 7/8

**EVPBVPA3 - THREE-WAY VARIABLE - HEIGHT POST FOR BELTLINE POWERED PANELS - ALUMINUM TRIM**

- Connects three Beltline Powered panels of differing height in a "T" configuration.
- Connector must reference taller panel.
- Post and connecting hardware adds 3.25" to the panel run.
- Provides slotted support for worksurfaces and hang-on storage components.
- Includes one post, three slotted connectors with leveling glides, connecting hardware and trim kit.
- Connectors available without slots, as a special at no upcharge. Contact Customer Support.
- Please see page 92 on how to specify.

DESCRIPTION	PRODUCT CODE	LIST PRICE	DIMENSIONS/INCHES		
			H	W	D

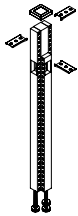

Three-Way Variable - Height Post for Beltline Powered Panels - Aluminum Trim

EVPBVPA354	335	54	2 7/8
EVPBVPA366	395	66	2 7/8



**EVPBLTVPA3 - THREE WAY VARIABLE HEIGHT CORNER POST FOR BELTLINE LIGHT PANEL**

- Connects one Beltline Light panel and two beltline Panels of differing height in "T" configuration.
- Connector must reference taller panel.
- Post and connecting hardware add 3.25" to power beam run.
- Provides slotted support for worksurfaces and hang on components.
- Includes post, panel connectors and power beam connectors, post with trim all around, levelling glide, hardware and trim kit.
- Leg trim matches selected trim color.
- Connectors available without slots, as a special at no extra charge. Contact customer support.

	DESCRIPTION	PRODUCT CODE	LIST PRICE	DIMENSIONS/INCHES		
				H	W	D
	Three Way Variable Height Corner Post for Beltline Light Panel	EVPBLTVPA354	335	54	2 7/8	
		EVPBLTVPA366	395	66	2 7/8	

**EVPBLTVPA3P - THREE WAY VARIABLE HEIGHT CORNER POST FOR BELTLINE LIGHT PANEL**

- Connects one Beltline Light panel and two Beltline panels of equal height in "T" configuration.
- Connector must reference taller panel.
- Post and connecting hardware add 3.25" to power beam run.
- Provides slotted support for worksurfaces and hang on components.
- Includes post, panel connectors and power beam connectors, post with trim all around, levelling glide, hardware and trim kit.
- Leg trim matches selected trim color.
- Connectors are available without slots, as a special at no extra charge. Contact customer support.

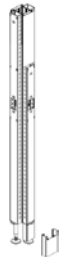
	DESCRIPTION	PRODUCT CODE	LIST PRICE	DIMENSIONS/INCHES		
				H	W	D
	Three Way Variable Height Corner Post for Beltline	EVPBLTVPA354P	335	54	2 7/8	
	Light Panel	EVPBLTVPA366P	395	66	2 7/8	

## EVPCP4 - FOUR-WAY POST

- Connects four panels of equal height in a "+" configuration.
- Post and connecting hardware adds 3.25" to the panel run.
- Provides slotted support for worksurfaces and hang-on storage components.
- Includes one post, four slotted connectors with leveling glides and connecting hardware.
- Connectors available without slots, as a special at no upcharge. Contact Customer Support.

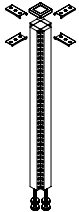
DESCRIPTION	PRODUCT CODE	LIST PRICE	DIMENSIONS/INCHES		
			H	W	D
 Four-Way Post	EVPCP430	257	30	2 7/8	
	EVPCP442	325	42	2 7/8	
	EVPCP448	360	48	2 7/8	
	EVPCP454	393	54	2 7/8	
	EVPCP466	459	66	2 7/8	

## EVPLTCPA4 - FOUR WAY CORNER POST FOR LIGHT PANEL

- Connects three Light panel of equal height in "+" configuration.
- Post and connecting hardware add 3.25" to power beam run.
- Provides slotted support for worksurfaces and hang on components.
- Includes post, panel connectors and power beam connectors, post with trim all around, levelling glide, hardware and trim kit.
- Leg trim matches selected trim color.
- Connectors available without slots, as a special at no extra charge. Contact customer support.

DESCRIPTION	PRODUCT CODE	LIST PRICE	DIMENSIONS/INCHES		
			H	W	D
 Four Way Corner Post for Light Panel	EVPLTCPA430	257	30	2 7/8	
	EVPLTCPA442	325	42	2 7/8	
	EVPLTCPA448	360	48	2 7/8	
	EVPLTCPA454	393	54	2 7/8	
	EVPLTCPA466	459	66	2 7/8	

## EVPLTCPA4P- FOUR WAY CORNER POST FOR LIGHT PANEL - PANEL

- Connects two Beltline Light panel and two Beltline Panels of equal height in "+" configuration.
- Post and connecting hardware add 3.25" to power beam run.
- Provides slotted support for worksurfaces and hang on components.
- Includes post, panel connectors and power beam connectors, post with trim all around, levelling glide, hardware and trim kit.
- Leg trim matches selected trim color.
- Connectors are available without slots, as a special at no extra charge. Contact customer support.

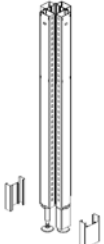
DESCRIPTION	PRODUCT CODE	LIST PRICE	DIMENSIONS/INCHES		
			H	W	D
 Four Way Corner Post for Light Panel-Panel	EVPLTCPA430P	257	30	2 7/8	
	EVPLTCPA442P	325	42	2 7/8	
	EVPLTCPA448P	360	48	2 7/8	
	EVPLTCPA454P	393	54	2 7/8	
	EVPLTCPA466P	459	66	2 7/8	



## EVPBCP4 - FOUR-WAY POST FOR BELTLINE POWERED PANELS

- Connects four Beltline Powered panels of equal height in a "+" configuration.
- Post and connecting hardware adds 3.25" to the panel run.
- Provides slotted support for worksurfaces and hang-on storage components.
- Includes one post, four slotted connectors with leveling glides and connecting hardware.
- Connectors available without slots, as a special at no upcharge. Contact Customer Support.

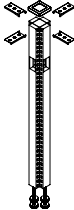
DESCRIPTION	PRODUCT CODE	LIST PRICE	DIMENSIONS/INCHES		
			H	W	D
 <p>Four-Way Post for Beltline Powered Panels</p>	EVPBCP442	325	42	2 7/8	
	EVPBCP454	393	54	2 7/8	
	EVPBCP466	459	66	2 7/8	

## EVPLTCA4 - FOUR WAY CORNER POST FOR BELTLINE LIGHT PANEL

- Connects four Light panel of equal height in "+" configuration.
- Post and connecting hardware add 3.25" to power beam run.
- Provides slotted support for worksurfaces and hang on components.
- Includes post, panel connectors and power beam connectors, post with trim all around, levelling glide, hardware and trim kit.
- Leg trim matches selected trim color.
- Connectors available without slots, as a special at no extra charge. Contact customer support.

DESCRIPTION	PRODUCT CODE	LIST PRICE	DIMENSIONS/INCHES		
			H	W	D
 <p>Four Way Corner Post for Beltline Light Panel</p>	EVPLTCA442	325	42	2	
	EVPLTCA448	360	48	2	
	EVPLTCA454	393	54	2	
	EVPLTCA466	459	66	2	

## EVPLTVA4P- FOUR WAY VARIABLE HEIGHT CORNER POST FOR LIGHT PANEL - PANEL

- Connects two Light panels and two Panels of differing height in "+" configuration, Panel-Light Panel-Panel-Light Panel.
- Connector must reference taller panel.
- Post and connecting hardware add 3.25" to power beam run.
- Provides slotted support for worksurfaces and hang on components.
- Includes post, panel connectors and power beam connectors, post with trim all around, levelling glide, hardware and trim kit.
- Leg trim matches selected trim color.
- Connectors are available without slots, as a special at no extra charge. Contact customer support.

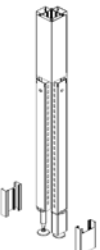
DESCRIPTION	PRODUCT CODE	LIST PRICE	DIMENSIONS/INCHES		
			H	W	D
 <p>Three Way Variable Height Corner Post for Panel-Light Panel-Panel-Light Panel</p>	EVPLTVA442P	325	42	2 7/8	
	EVPLTVA448P	360	48	2 7/8	
	EVPLTVA454P	393	54	2 7/8	
	EVPLTVA466P	459	66	2 7/8	



## EVPVPA4 - FOUR-WAY VARIABLE - HEIGHT POST - ALUMINUM TRIM

- Connects four panels of differing heights in a "+" configuration.
- Connector must reference taller panel.
- Post and connecting hardware adds 3.25" to the panel run.
- Provides slotted support for worksurfaces and hang-on storage components.
- Includes one post, four slotted connectors with leveling glides, connecting hardware and trim kit.
- Connectors available without slots, as a special at no upcharge. Contact Customer Support.
- Please see page 92 on how to specify.

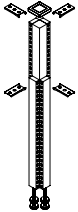
	DESCRIPTION	PRODUCT CODE	LIST PRICE	DIMENSIONS/INCHES		
				H	W	D
	Four-Way Variable - Height Corner Post - Aluminum Trim	EVPVPA442	325	42	2 7/8	
		EVPVPA448	360	48	2 7/8	
		EVPVPA454	393	54	2 7/8	
		EVPVPA466	459	66	2 7/8	

## EVPLTVPA4 - FOUR WAY VARIABLE HEIGHT CORNER POST FOR LIGHT PANEL

- Connects four Light panel of differing height in "+" configuration.
- Connector must reference taller panel.
- Post and connecting hardware add 3.25" to power beam run.
- Provides slotted support for worksurfaces and hang on components.
- Includes post, panel connectors and power beam connectors, post with trim all around, levelling glide, hardware and trim kit.
- Leg trim matches selected trim color.
- Connectors available without slots, as a special at no extra charge. Contact customer support.

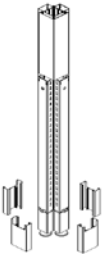
	DESCRIPTION	PRODUCT CODE	LIST PRICE	DIMENSIONS/INCHES		
				H	W	D
	Four Way Variable Height Corner Post for Light Panel	EVPLTVPA442	325	42	2 7/8	
		EVPLTVPA448	360	48	2 7/8	
		EVPLTVPA454	393	54	2 7/8	
		EVPLTVPA466	459	66	2 7/8	

## EVPLTCA4P - FOUR WAY CORNER POST FOR BELTLINE LIGHT PANEL

- Connects two Beltline Light panel and two Beltline Panels of equal height in "+" configuration.
- Post and connecting hardware add 3.25" to power beam run.
- Provides slotted support for worksurfaces and hang on components.
- Leg trim matches selected trim color.
- Includes post, panel connectors and power beam connectors, post with trim all around, levelling glide, hardware and trim kit.
- Connectors are available without slots, as a special at no extra charge. Contact customer support.

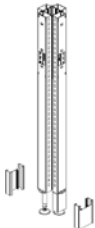
	DESCRIPTION	PRODUCT CODE	LIST PRICE	DIMENSIONS/INCHES		
				H	W	D
	Four Way Corner Post Beltline Light Panel	EVPLTCA442P	257	42	2 7/8	
		EVPLTCA448P	325	48	2 7/8	
		EVPLTCA454P	360	54	2 7/8	
		EVPLTCA466P	459	66	2 7/8	



**EVPBVPA4 - FOUR-WAY VARIABLE - HEIGHT POST FOR BELTLINE POWERED PANELS - ALUMINUM TRIM**

- Connects four Beltline Powered panels of differing heights in an a "+" configuration.
- Connector must reference taller panel.
- Post and connecting hardware adds 3.25" to the panel run.
- Provides slotted support for worksurfaces and hang-on storage components.
- Includes one post, four slotted connectors with leveling glides, connecting hardware and trim kit.
- Connectors available without slots, as a special at no upcharge. Contact Customer Support.
- Please see page 92 on how to specify.

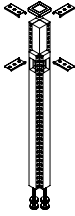
	DESCRIPTION	PRODUCT CODE	LIST PRICE	DIMENSIONS/INCHES		
				H	W	D
	Four-Way Variable - Height Post for Beltline Powered Panels - Aluminum Trim	EVPBVPA454	393	54	2 7/8	
		EVPBVPA466	459	66	2 7/8	

**EVPBLTVA4 - FOUR WAY VARIABLE HEIGHT CORNER POST FOR BELTLINE LIGHT PANEL**

- Connects four Light panel of differing height in "+" configuration.
- Connector must reference taller panel.
- Post and connecting hardware add 3.25" to power beam run.
- Provides slotted support for worksurfaces and hang on components.
- Includes post, panel connectors and power beam connectors, post with trim all around, levelling glide, hardware and trim kit.
- Leg trim matches selected trim color.
- Connectors available without slots, as a special at no extra charge. Contact customer support.

	DESCRIPTION	PRODUCT CODE	LIST PRICE	DIMENSIONS/INCHES		
				H	W	D
	Four Way Variable Height Corner Post for Beltline Light Panel Aluminum Trim	EVPBLTVA454	393	54	2 7/8	
		EVPBLTVA466	459	66	2 7/8	

**EVPBLTVA4P- FOUR WAY VARIABLE HEIGHT CORNER POST FOR BELTLINE LIGHT PANEL**

- Connects two Beltline Light panel and two Beltline Panels of differing height in "+" configuration.
- Connector must reference taller panel.
- Post and connecting hardware add 3.25" to power beam run.
- Provides slotted support for worksurfaces and hang on components.
- Includes post, panel connectors and power beam connectors, post with trim all around, levelling glide, hardware and trim kit.
- Leg trim matches selected trim color.
- Connectors are available without slots, as a special at no extra charge. Contact customer support.

	DESCRIPTION	PRODUCT CODE	LIST PRICE	DIMENSIONS/INCHES		
				H	W	D
	Four Way Variable Height Corner Post for Beltline Light Panel	EVPBLTVA454P	393	54	2 7/8	
		EVPBLTVA466P	459	66	2 7/8	

**EVPCPA1 - ONE-WAY POST - ALUMINUM TRIM**

- Connects at the end of a panel run in place of an EVPERA – End-of-Run Post Kit.
- Should not be used to attach a panel to a fixed wall.
- Post and connecting hardware adds 3.25" to the panel run.
- Provides slotted support for worksurfaces and hang-on storage components.
- Includes one post and one slotted connector with a leveling glide, connecting hardware and trim kit.
- Connectors available without slots, as a special at no upcharge. Contact Customer Support.

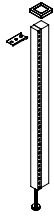
DESCRIPTION	PRODUCT CODE	LIST PRICE	DIMENSIONS/INCHES		
			H	W	D
 <p>One-Way Post - Aluminum Trim</p>	EVPCPA130	119	30	2 7/8	
	EVPCPA142	136	42	2 7/8	
	EVPCPA148	159	48	2 7/8	
	EVPCPA154	182	54	2 7/8	
	EVPCPA166	223	66	2 7/8	

**EVPLTCPA1 - ONE WAY CORNER POST FOR LIGHT PANEL**

- Connects at end of Light panel run in place of EVPERA- End of run post kit..
- Should not be used to attach panel to fixed wall.
- Post and connecting hardware add 3.25" to power beam run.
- Provides slotted support to worksurfaces and hang on components.
- Includes post, panel connectors and power beam connectors, post with trim all around, levelling glide, hardware and trim kit.
- Connectors are available without slots, as a special at no extra charge. Contact customer support

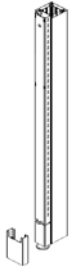
DESCRIPTION	PRODUCT CODE	LIST PRICE	DIMENSIONS/INCHES		
			H	W	D
 <p>One Way Corner Post for Light Panel</p>	EVPLTCPA130	119	30	2 7/8	
	EVPLTCPA142	136	30	2 7/8	
	EVPLTCPA148	159	30	2 7/8	
	EVPLTCPA154	182	30	2 7/8	
	EVPLTCPA166	223	30	2 7/8	



**EVPBCPA1 - ONE-WAY POST FOR BELTLINE POWERED PANELS - ALUMINUM TRIM**

- Connects at the end of a Beltline Powered panel run in place of an EVPERA – End-of-Run Post Kit.
- Should not be used to attach a panel to a fixed wall.
- Post and connecting hardware adds 3.25" to the panel run.
- Provides slotted support for worksurfaces and hang-on storage components.
- Includes one post and one slotted connector with a leveling glide, connecting hardware and trim kit.
- Connectors available without slots, as a special at no upcharge. Contact Customer Support.

	DESCRIPTION	PRODUCT CODE	LIST PRICE	DIMENSIONS/INCHES		
				H	W	D
	One-Way Post for Beltline Powered Panels - Aluminum Trim	EVPBCPA142	136	42	2 7/8	
		EVPBCPA154	182	54	2 7/8	
		EVPBCPA166	223	66	2 7/8	

**EVPBLTCPA1 - ONE WAY CORNER POST FOR BELTLINE LIGHT PANEL**

- Connects at end of Light panel run in place of EVPERA- End of run post kit.
- Should not be used to attach pane to fixed wall.
- Post and connecting hardware add 3.25" to power beam run.
- Provides slotted support for worksurfaces and hang on components.
- Includes post, panel connectors and power beam connectors, post with trim all around, levelling glide, hardware and trim kit.
- Connectors are available without slots, as a special at no extra charge. Contact customer support.

	DESCRIPTION	PRODUCT CODE	LIST PRICE	DIMENSIONS/INCHES		
				H	W	D
	One Way Corner Post for Beltline Light Panel	EVPBLTCPA142	136	42	2	
		EVPBLTCPA148	159	48	2	
		EVPBLTCPA154	182	54	2	
		EVPBLTCPA166	223	66	2	

**EVPIPA2 - INLINE TWO-WAY POST - ALUMINUM TRIM**

- Connects two panels of equal height in a straight line in place of EVPIC – In-Line Connector.
- Post and connecting hardware adds 3.25" to the panel run.
- Provides slotted support for worksurfaces and hang-on storage components.
- Includes one post, two slotted connectors with leveling glides, connecting hardware and trim kit.
- Connectors available without slots, as a special at no upcharge. Contact Customer Support.

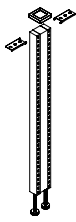
	DESCRIPTION	PRODUCT CODE	LIST PRICE	DIMENSIONS/INCHES		
				H	W	D
	Inline Two-Way Post - Aluminum Trim	EVPIPA230	163	30	2 7/8	
		EVPIPA242	205	42	2 7/8	
		EVPIPA248	226	48	2 7/8	
		EVPIPA254	246	54	2 7/8	
		EVPIPA266	292	66	2 7/8	

**EVLPTIPA2 - INLINE TWO WAY CORNER POST LIGHT PANEL**

- Connects two Light panel of equal height in straight run.
- Post and connecting hardware add 3.25" to power beam run.
- Provides slotted support for worksurfaces and hang on components.
- Includes post, panel connectors and power beam connectors, post with trim all around, levelling glide, hardware and trim kit.
- Leg trim matches selected trim color.
- Connectors are available without slots, as a special at no extra charge. Contact customer support.

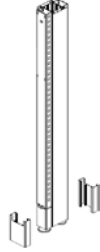
	DESCRIPTION	PRODUCT CODE	LIST PRICE	DIMENSIONS/INCHES		
				H	W	D
	Inline Two way Corner Post Light Panel	EVPLTIPA230	163	30	2 7/8	
		EVPLTIPA242	205	42	2 7/8	
		EVPLTIPA248	226	48	2 7/8	
		EVPLTIPA254	246	54	2 7/8	
		EVPLTIPA266	292	66	2 7/8	



**EVPBIPA2 - INLINE TWO-WAY POST FOR BELTLINE POWERED PANELS - ALUMINUM TRIM**

- Connects two Beltline Powered panels of equal height in between a post in a straight line in place of EVPIC – In-Line Connector.
- Post and connecting hardware adds 3.25" to the panel run.
- Provides slotted support for worksurfaces and hang-on storage components.
- Includes one post, two slotted connectors with leveling glides, connecting hardware and trim kit.
- Connectors available without slots, as a special at no upcharge. Contact Customer Support.

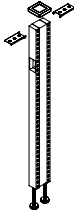
DESCRIPTION	PRODUCT CODE	LIST PRICE	DIMENSIONS/INCHES		
			H	W	D
 Inline Two-Way Post for Beltline Powered Panels - Aluminum Trim	EVPBIPA242	205	42	2 7/8	
	EVPBIPA254	246	54	2 7/8	
	EVPBIPA266	292	66	2 7/8	

**EVPBLTPIPA2 - INLINE TWO WAY CORNER POST BELTLINE LIGHT PANEL**

- Connects two Light panel of equal height in straight run.
- Post and connecting hardware add 3.25" to power beam run.
- Provides slotted support for worksurfaces and hang on components.
- Leg trim matches selected trim color.
- Includes post, panel connectors and power beam connectors, post with trim all around, levelling glide, hardware and trim kit.
- Connectors are available without slots, as a special at no extra charge. Contact customer support.

DESCRIPTION	PRODUCT CODE	LIST PRICE	DIMENSIONS/INCHES		
			H	W	D
 Inline Two Way Corner Post Beltline Light Panel	EVPBLTPIPA242	205	42	2 7/8	
	EVPBLTPIPA248	226	48	2 7/8	
	EVPBLTPIPA254	246	54	2 7/8	
	EVPBLTPIPA266	292	66	2 7/8	

**EVP6PA2 - TWO-WAY 60 DEGREE POST - ALUMINUM TRIM**

- Connects two panels of equal height in a 120 degree configuration.
- Provides slotted support for worksurfaces and hang-on storage components.
- Includes one 60 degree post, two slotted connectors with leveling glides, connecting hardware and trim kit.
- Connectors available without slots as a special at no upcharge. Contact Customer Service.

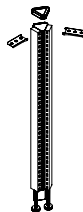
	DESCRIPTION	PRODUCT CODE	LIST PRICE	DIMENSIONS/INCHES		
				H	W	D
	Two-Way 60 Degree Post - Aluminum	EVP6PA230	168	30	3.65	
		EVP6PA242	207	42	3.65	
		EVP6PA248	223	48	3.65	
		EVP6PA254	259	54	3.65	
		EVP6PA266	304	66	3.65	

**EVPB6PA2 - TWO-WAY 60 DEGREE POST FOR BELTLINE POWERED PANELS - ALUMINUM TRIM**

- Connects two Beltline Powered panels of equal height in a 120 degree configuration.
- Provides slotted support for worksurfaces and hang-on storage components.
- Includes one 60 degree post, two slotted connectors with leveling glides, connecting hardware and trim kit.
- Connectors available without slots, as a special at no upcharge. Contact Customer Support.

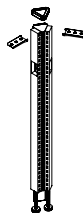
	DESCRIPTION	PRODUCT CODE	LIST PRICE	DIMENSIONS/INCHES		
				H	W	D
	Two-Way 60 Degree Post for Beltline Powered Panels - Aluminum Trim	EVPB6PA242	239	42	3.65	
		EVPB6PA254	259	54	3.65	
		EVPB6PA266	304	66	3.65	

**EVP6VPA2 - TWO-WAY 60 DEGREE VARIABLE - HEIGHT POST - ALUMINUM TRIM**

- Connects two panels of differing height in a 120 degree configuration.
- Connector must reference taller panel.
- Provides slotted support for worksurfaces and hang-on storage components.
- Includes one 60 degree post, two slotted connectors with leveling glides, connecting hardware and trim kit.
- Connectors available without slots, as a special at no upcharge. Contact Customer Support.
- Please see page 92 on how to specify.

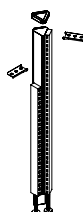
	DESCRIPTION	PRODUCT CODE	LIST PRICE	DIMENSIONS/INCHES		
				H	W	D
	Two-Way 60 Degree Variable - Height Post - Aluminum Trim	EVP6VPA242	207	42	3.65	
		EVP6VPA248	233	48	3.65	
		EVP6VPA254	259	54	3.65	
		EVP6VPA266	306	66	3.65	

**EVPB6VPA2 - TWO-WAY 60 DEGREE VARIABLE - HEIGHT POST FOR BELTLINE POWERED PANELS - ALUMINUM TRIM**

- Connects two Beltline Powered panels of differing height in a 120 degree configuration.
- Connector must reference taller panel.
- Provides slotted support for worksurfaces and hang-on storage components.
- Includes one 60 degree post, two slotted connectors with leveling glides, connecting hardware and trim kit.
- Connectors available without slots, as a special at no upcharge. Contact Customer Support.
- Please see page 92 on how to specify.

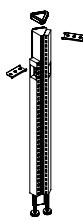
DESCRIPTION	PRODUCT CODE	LIST PRICE	DIMENSIONS/INCHES		
			H	W	D
 Two-Way 60 Degree Variable - Height Post for Beltline Powered Panels - Aluminum Trim	EVPB6VPA242	207	42	3.65	
	EVPB6VPA254	259	54	3.65	
	EVPB6VPA266	306	66	3.65	

**EVP6P3 - THREE-WAY 60 DEGREE POST**

- Connects three panels of equal height in a 120 degree configuration.
- Provides slotted support for worksurfaces and hang-on storage components.
- Includes one 60 degree post, three slotted connectors with leveling glides and connecting hardware.
- Connectors available without slots, as a special at no upcharge. Contact Customer Support.

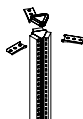
DESCRIPTION	PRODUCT CODE	LIST PRICE	DIMENSIONS/INCHES		
			H	W	D
 Three-Way 60 Degree Post	EVP6P330	206	30	3.65	
	EVP6P342	274	42	3.65	
	EVP6P348	304	48	3.65	
	EVP6P354	335	54	3.65	
	EVP6P366	395	66	3.65	

**EVPB6P3 - THREE-WAY 60 DEGREE POST FOR BELTLINE POWERED PANELS**

- Connects three Beltline Powered panels of equal height in a 120 degree configuration.
- Provides slotted support for worksurfaces and hang-on storage components.
- Includes one 60 degree post, three slotted connectors with leveling glides and connecting hardware.
- Connectors available without slots, as a special at no upcharge. Contact Customer Support.

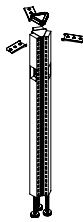
DESCRIPTION	PRODUCT CODE	LIST PRICE	DIMENSIONS/INCHES		
			H	W	D
 Three-Way 60 Degree Post for Beltline Powered Panels	EVPB6P342	262	42	3.65	
	EVPB6P354	319	54	3.65	
	EVPB6P366	376	66	3.65	



**EVP6VPA3 - THREE-WAY 60 DEGREE VARIABLE - HEIGHT POST - ALUMINUM TRIM**

- Connects three panels of differing height in a 120 degree configuration.
- Connector must reference taller panel.
- Provides slotted support for worksurfaces and hang-on storage components.
- Includes one 60 degree post, three slotted connectors with leveling glides, connecting hardware and trim kit.
- Connectors available without slots, as a special at no upcharge. Contact Customer Support.
- Please see page 92 on how to specify.

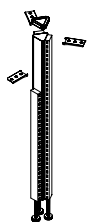
DESCRIPTION	PRODUCT CODE	LIST PRICE	DIMENSIONS/INCHES		
			H	W	D
 Three-Way 60 Degree Variable - Height Post - Aluminum Trim	EVP6VPA342	274	42	3.65	
	EVP6VPA348	304	48	3.65	
	EVP6VPA354	335	54	3.65	
	EVP6VPA366	395	66	3.65	

**EVPB6VPA3 - THREE-WAY 60 DEGREE VARIABLE - HEIGHT POST FOR BELTLINE POWERED PANELS - ALUMINUM TRIM**

- Connects three Beltline Powered panels of differing height in a 120 degree configuration.
- Connector must reference taller panel.
- Provides slotted support for worksurfaces and hang-on storage components.
- Includes one 60 degree post, three slotted connectors with leveling glides, connecting hardware and trim kit.
- Connectors available without slots, as a special at no upcharge. Contact Customer Support.
- Please see page 92 on how to specify.

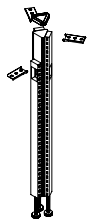
DESCRIPTION	PRODUCT CODE	LIST PRICE	DIMENSIONS/INCHES		
			H	W	D
 Three-Way for 60 Degree Variable - Height Post for Beltline Powered Panels - Aluminum Trim	EVPB6VPA342	301	42	3.65	
	EVPB6VPA354	335	54	3.65	
	EVPB6VPA366	395	66	3.65	

**EVP4P2 - TWO-WAY 45 DEGREE POST - ALUMINUM TRIM**

- Connects two panels of equal height in a 135 degree configuration.
- Provides slotted support for worksurfaces and hang-on storage components.
- Includes one 45 degree post, two slotted connectors with leveling glides, connecting hardware and trim kit.
- Connectors available without slots, as a special at no upcharge. Contact Customer Support.

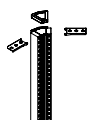
DESCRIPTION	PRODUCT CODE	LIST PRICE	DIMENSIONS/INCHES		
			H	W	D
 Two-Way 45 Degree Post Aluminum Trim	EVP4P230	168	30	3.65	
	EVP4P242	207	42	3.65	
	EVP4P248	223	48	3.65	
	EVP4P254	259	54	3.65	
	EVP4P266	304	66	3.65	



**EVP4VPA2 - TWO-WAY 45 DEGREE VARIABLE - HEIGHT POST - ALUMINUM TRIM**

- Connects two panels of differing height in a 135 degree configuration.
- Connector must reference taller panel.
- Provides slotted support for worksurfaces and hang-on storage components.
- Includes one 45 degree post, two slotted connectors with leveling glides, connecting hardware and trim kit.
- Connectors available without slots, as a special at no upcharge. Contact Customer Support.
- Please see page 92 on how to specify.

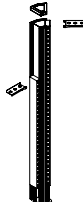
	DESCRIPTION	PRODUCT CODE	LIST PRICE	DIMENSIONS/INCHES		
				H	W	D
	Two-Way 45 Degree Variable - Height Post	EVP4VPA242	274	42	3.65	
	Aluminum Trim	EVP4VPA248	304	48	3.65	
		EVP4VPA254	335	54	3.65	
		EVP4VPA266	395	66	3.65	

**EVPUERA - UPMOUNT END-OF-RUN POST KIT - ALUMINUM TRIM**

- Used at the end of Panel run to support Worksurfaces and Upmount Overhead Storage.
- Can attach to a Panel run to fixed wall.
- Adds 1" to the width of Light Panel run.
- 10% upcharge for Tungsten trim/paint.
- Aluminum trim must be specified when using premium color paints. Premium color paints are not available on PVC trim.

	DESCRIPTION	PRODUCT CODE	LIST PRICE	DIMENSIONS/INCHES		
				H	W	D
	Upmount End-of-Run Post Kit - Aluminum Trim.	EVPUERA66	152	66	2 7/8	

**EVPLUERA - UPMOUNT END-OF-RUN POST KIT FOR LIGHT PANELS (WALL MOUNTABLE) - ALUMINUM**

- Used at the end of Panel run to support Worksurfaces and Upmount Overhead Storage.
- Can attach to a Panel run to fixed wall.
- Adds 1" to the width of Light Panel run.
- Includes slotted Connector with leveling glide, connecting hardware, decorative sleeve and trim kit.

	DESCRIPTION	PRODUCT CODE	LIST PRICE	DIMENSIONS/INCHES		
				H	W	D
	Upmount End-of Run Post Kit - for Light Panels - Wall Mountable - Aluminum	EVPLUERA66	152	66	2 7/8	

**EVPUETA - UPMOUNT END-OF-RUN TRIM - ALUMINUM**

- Replaces existing 66”h End-of-Run Trim Only
- Comes with one Upmount Extension Trim EVPUET12 and one Upmount End-of-Run Trim.
- Must be used in conjunction with slotted connectors.

	DESCRIPTION	PRODUCT CODE	LIST PRICE	DIMENSIONS/INCHES		
				H	W	D
	Upmount End-of-Run Trim - Aluminum	EVPUETA66	108		2 7/8	

**EVPLUETA - UPMOUNT END-OF-RUN TRIM FOR LIGHT PANELS - ALUMINUM**

- Includes one Upmount Extension Trim EVPUETA12 and one Upmount End-of-Run Trim.
- Must be used in conjunction with Slotted Connector.

	DESCRIPTION	PRODUCT CODE	LIST PRICE	DIMENSIONS/INCHES		
				H	W	D
	Upmount End-of-Run Trim for Light Panels - Aluminum	EVPLUETA66	108	63	2 7/8	

**EVAFMB01 - FLOOR MOUNT PLATE**

- Attaches to floor.
- Secures panel to floor.
- Attachment screws are not included.
- Care should be taken to use correct fasteners for type of floor.
- Available in chrome finish only.

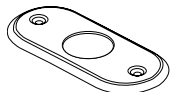
	DESCRIPTION	PRODUCT CODE	LIST PRICE	DIMENSIONS/INCHES		
				H	W	D
	Floor Mount Plate	EVAFMB01	91	0.25	5	2.5



**EVPIECS - INLINE EXTENSION CONNECTOR - SLOTTED**

- Connects two extension modules in a straight run.
- Includes one slotted inline extension connector and connecting hardware.
- Provides slotted support for worksurfaces and hang-on storage, up to 66”H.

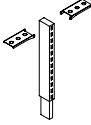
DESCRIPTION	PRODUCT CODE	LIST PRICE	DIMENSIONS/INCHES		
			H	W	D
 Inline Extension Connector - Slotted	EVPIECS06	49	6	2 7/8	
	EVPIECS12	49	12	2 7/8	
	EVPIECS18	58	18	2 7/8	
	EVPIECS24	58	24	2 7/8	

**EVPEERSA - END-OF-RUN EXTENSION CONNECTOR - SLOTTED - ALUMINUM TRIM**

- Connects at the end of a run of extension modules, and can be used to attach a panel to a fixed wall.
- Adds 1” to the width of panel run.
- Includes one slotted inline extension connector, connecting hardware and trim kit.
- Provides slotted support for worksurfaces and hang-on storage, up to 66”H.

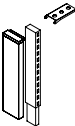
DESCRIPTION	PRODUCT CODE	LIST PRICE	DIMENSIONS/INCHES		
			H	W	D
 End-of-Run Extension Connector - Slotted - Aluminum Trim	EVPEERSA06	53	6	2 7/8	
	EVPEERSA12	53	12	2 7/8	
	EVPEERSA18	64	18	2 7/8	
	EVPEERSA24	64	24	2 7/8	

**EVPCPSA2 - TWO-WAY POST EXTENSION - SLOTTED - ALUMINUM TRIM**

- Connects two extension modules in a 90 degree configuration.
- Post and connecting hardware adds 3.25” to the panel run.
- Includes one post, two slotted inline extension connectors, connecting hardware and trim kit.
- Provides slotted support for worksurfaces and hang-on storage, up to 66”H.

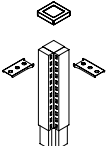
DESCRIPTION	PRODUCT CODE	LIST PRICE	DIMENSIONS/INCHES		
			H	W	D
 Two-Way Post Extension - Slotted Aluminum Trim	EVPCPSA206	92	6	2 7/8	
	EVPCPSA212	92	12	2 7/8	
	EVPCPSA218	145	18	2 7/8	
	EVPCPSA224	145	24	2 7/8	

**EVPCPSA3 - THREE-WAY POST EXTENSION - SLOTTED - ALUMINUM TRIM**

- Connects three extension modules in a “T” configuration.
- Post and connecting hardware adds 3.25” to the panel run.
- Includes one post, three slotted inline extension connectors, connecting hardware and trim kit.
- Provides slotted support for worksurfaces and hang-on storage, up to 66”H.

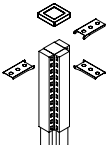
DESCRIPTION	PRODUCT CODE	LIST PRICE	DIMENSIONS/INCHES		
			H	W	D
 Three-Way Post Extension - Slotted Aluminum Trim	EVPCPSA306	110	6	2 7/8	
	EVPCPSA312	110	12	2 7/8	
	EVPCPSA318	170	18	2 7/8	
	EVPCPSA324	170	24	2 7/8	

**EVPCEPS4 - FOUR-WAY POST EXTENSION - SLOTTED**

- Connects four extension modules in a “+” configuration.
- Post and connecting hardware adds 3.25” to the panel run.
- Includes one post, four slotted inline extension connectors, connecting hardware and trim kit.
- Provides slotted support for worksurfaces and hang-on storage, up to 66”H.

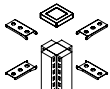
DESCRIPTION	PRODUCT CODE	LIST PRICE	DIMENSIONS/INCHES		
			H	W	D
 Four-Way Post Extension - Slotted	EVPCEPS406	127	6	2 7/8	
	EVPCEPS412	127	12	2 7/8	
	EVPCEPS418	187	18	2 7/8	
	EVPCEPS424	187	24	2 7/8	

**EVPCEPSA1 - ONE-WAY POST EXTENSION - SLOTTED - ALUMINUM TRIM**

- Connects at the end of a run of extension modules in place of an EVPEERSA – End-of-Run Extension Connector.
- Should not be used to attach a panel to a fixed wall.
- Post and connecting hardware adds 3.25” to the panel run.
- Includes one post, one slotted inline extension connector, connecting hardware and trim kit.
- Provides slotted support for worksurfaces and hang-on storage, up to 66”H.

DESCRIPTION	PRODUCT CODE	LIST PRICE	DIMENSIONS/INCHES		
			H	W	D
 One-Way Post Extension - Slotted Aluminum Trim	EVPCEPSA106	90	6	2 7/8	
	EVPCEPSA112	90	12	2 7/8	
	EVPCEPSA118	114	18	2 7/8	
	EVPCEPSA124	114	24	2 7/8	

**EVPCEPSA2 – INLINE TWO-WAY POST EXTENSION - SLOTTED - ALUMINUM TRIM**

- Connects two extension modules in a straight line in place of EVPIECS – In-Line Extension Connector.
- Post and connecting hardware adds 3.25” to the panel run.
- Includes one post, two slotted inline extension connectors, connecting hardware and trim kit.
- Provides slotted support for worksurfaces and hang-on storage, up to 66”H.

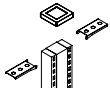
DESCRIPTION	PRODUCT CODE	LIST PRICE	DIMENSIONS/INCHES		
			H	W	D
 Inline Two-Way Post Extension - Slotted Aluminum Trim	EVPCEPSA206	97	6	2 7/8	
	EVPCEPSA212	97	12	2 7/8	
	EVPCEPSA218	158	18	2 7/8	
	EVPCEPSA224	158	24	2 7/8	



**EVP6CEPSA2 - TWO-WAY 60 DEGREE POST EXTENSION - SLOTTED - ALUMINUM TRIM**

- Connects two extension modules in a 120 degree configuration.
- Includes one post, two slotted inline extension connectors, connecting hardware and trim kit.
- Provides slotted support for worksurfaces and hang-on storage, up to 66"H.

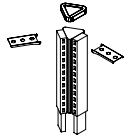

DESCRIPTION	PRODUCT CODE	LIST PRICE	DIMENSIONS/INCHES		
			H	W	D
Two-Way 60 Degree Post Extension - Slotted - Aluminum Trim	EVP6CEPSA206	92	6	3.65	
	EVP6CEPSA212	92	12	3.65	
	EVP6CEPSA218	142	18	3.65	
	EVP6CEPSA224	142	24	3.65	

**EVP6CEPS3 - THREE-WAY 60 DEGREE POST EXTENSION - SLOTTED**

- Connects three extension modules in a 120 degree configuration.
- Includes one post, three slotted inline extension connectors and connecting hardware.
- Provides slotted support for worksurfaces and hang-on storage, up to 66"H.

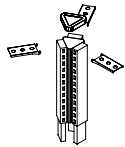

DESCRIPTION	PRODUCT CODE	LIST PRICE	DIMENSIONS/INCHES		
			H	W	D
Three-Way 60 Degree Post Extension - Slotted	EVP6CEPS306	109	6	3.65	
	EVP6CEPS312	109	12	3.65	
	EVP6CEPS318	170	18	3.65	
	EVP6CEPS324	170	24	3.65	

**EVP6CEPSA1 - ONE-WAY 60 DEGREE POST EXTENSION - SLOTTED - ALUMINUM TRIM**

- Connects at the end of a run of extension modules in a 120 degree configuration.
- Should not be used to attach a panel to a fixed wall.
- Includes one post, one slotted inline extension connector, connecting hardware and trim kit.
- Provides slotted support for worksurfaces and hang-on storage, up to 66"H.

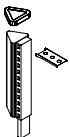

DESCRIPTION	PRODUCT CODE	LIST PRICE	DIMENSIONS/INCHES		
			H	W	D
One-Way 60 Degree Post Extension - Slotted - Aluminum Trim	EVP6CEPSA106	90	6	3.65	
	EVP6CEPSA112	90	12	3.65	
	EVP6CEPSA118	112	18	3.65	
	EVP6CEPSA124	112	24	3.65	

**EVP4CEPS2 - TWO-WAY 45 DEGREE POST EXTENSION - SLOTTED - ALUMINUM TRIM**

- Connects two extension modules in a 135 degree configuration.
- Provides slotted support for worksurfaces and hang-on storage, up to 66"H.
- Includes one post, two slotted inline extension connectors, connecting hardware and trim kit.

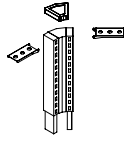
	DESCRIPTION	PRODUCT CODE	LIST PRICE	DIMENSIONS/INCHES		
				H	W	D
	Two-Way 45 Degree Post Extension - Slotted - Aluminum Trim	EVP4CEPS206	92	6	3.65	
		EVP4CEPS212	92	12	3.65	
		EVP4CEPS218	142	18	3.65	
		EVP4CEPS224	142	24	3.65	

**EVP4CEPSA1 - ONE-WAY 45 DEGREE POST EXTENSION - SLOTTED - ALUMINUM TRIM**

- Connects at the end of a run of extension modules in a 135 degree configuration.
- Provides slotted support for worksurfaces and hang-on storage, up to 66"H.
- Should not be used to attach a panel to a fixed wall.
- Includes one post, one slotted inline extension connector, connecting hardware and trim kit.

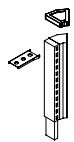
	DESCRIPTION	PRODUCT CODE	LIST PRICE	DIMENSIONS/INCHES		
				H	W	D
	One-Way 45 Degree Post Extension - Slotted - Aluminum Trim	EVP4CEPSA106	90	6	3.65	
		EVP4CEPSA112	90	12	3.65	
		EVP4CEPSA118	112	18	3.65	
		EVP4CEPSA124	112	24	3.65	

**EVHCBP01 - CEILING BRACKET FOR POST**

- Used to secure corner post to ceiling deck (not ceiling grid).
- Note: Care should be taken to attach ceiling brackets to secure ceiling using correct fasteners. Failure to do so may result in collapse of unit and subsequent possible injury
- 4.8" x 4.8" top plate with 1.5 x 1.5 square tube 12" H , square tube fits inside aluminum Corner Post.
- Square tube can slide in post , bracket pushed to ceiling to be secured.

	DESCRIPTION	PRODUCT CODE	LIST PRICE	DIMENSIONS/INCHES		
				H	W	D
	Ceiling Bracket for Post	EVHCBP01	73	12	4.8	4.8

**EVHCBIC01 - CEILING BRACKET FOR INLINE CONNECTOR**

- Used to secure corner post to ceiling deck (not ceiling grid).
- Note: Care should be taken to attach ceiling brackets to secure ceiling using correct fasteners. Failure to do so may result in collapse of unit and subsequent possible injury
- 4.8" x 4.8" top plate with 7.5"H insert in middle of plate, insert fits inside Inline Connector.
- 7.5" H insert can slide in connector , bracket pushed to ceiling to be secure.

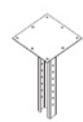
	DESCRIPTION	PRODUCT CODE	LIST PRICE	DIMENSIONS/INCHES		
				H	W	D
	Ceiling Bracket for Inline Connector	EVHCBP01	73	7.5	4.8	4.8



**EVHCBER01 - CEILING BRACKET FOR END OF RUN CONNECTOR**

- Used to secure corner post to ceiling deck (not ceiling grid).
- 4.8" x 4.8" top plate with 7.5"H insert offset from center of plate, insert fits inside End-of-Run or Inline Connector.
- 7.5" H insert can slide in connector , bracket pushed to ceiling to secure.
- Note: Care should be taken to attach ceiling brackets to secure ceiling using correct fasteners. Failure to do so may result in collapse of unit and subsequent possible injury

DESCRIPTION	PRODUCT CODE	LIST PRICE	DIMENSIONS/INCHES		
			H	W	D
Ceiling Bracket for Inline Connector	EVHCBER01	73	7.5	4.8	4.8

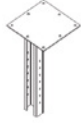

**EVPUETA - UPMOUNT EXTENSION TRIM - ALUMINUM**

- Finishes the exposed connector above a shorter panel.
- Slotted connector not included.

DESCRIPTION	PRODUCT CODE	LIST PRICE	DIMENSIONS/INCHES		
			H	W	D
Upmount Extension Trim - Aluminum	EVPUETA12	49	12	2 7/8	

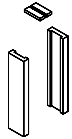

**EVPERTA - END-OF-RUN TRIM - ALUMINUM**

- Finishes the exposed Connector at the end of a run.
- Slotted Connector not included.
- Please note that actual cut sizes are nominally smaller than quoted

DESCRIPTION	PRODUCT CODE	LIST PRICE	DIMENSIONS/INCHES		
			H	W	D
End-of-Run Trim - Aluminum	EVPERTA30	54	30	2 7/8	
	EVPERTA42	73	42	2 7/8	
	EVPERTA48	77	48	2 7/8	
	EVPERTA54	82	54	2 7/8	
	EVPERTA66	91	66	2 7/8	
	EVPERTA78	101	78	2 7/8	
	EVPERTA84	104	84	2 7/8	
	EVPERTA90	104	90	2 7/8	

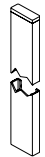

**EVPLERTA - END-OF-RUN TRIM FOR LIGHT PANELS - ALUMINUM**

- Finishes the exposed Connector at the end of a run of the Light Panels.
- Slotted Connector not included.
- Please note that actual cut sizes are nominally smaller than quoted

DESCRIPTION	PRODUCT CODE	LIST PRICE	DIMENSIONS/INCHES		
			H	W	D
End-of-Run Trim for Light Panels - Aluminum	EVPLERTA30	55	26 1/4	2 7/8	
	EVPLERTA42	64	38 1/4	2 7/8	
	EVPLERTA48	73	44 1/4	2 7/8	
	EVPLERTA54	85	50 1/4	2 7/8	
	EVPLERTA66	91	62 1/4	2 7/8	
	EVPLERTA72	94	68 1/4	2 7/8	
	EVPLERTA78	97	74 1/4	2 7/8	
	EVPLERTA84	102	80 1/4	2 7/8	
	EVPLERTA90	108	86 1/4	2 7/8	

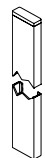



**EVPTVA - PANEL TRIM - VARIABLE HEIGHT -ALUMINUM**

- Attaches to the exposed end of the taller panel when 2 panels of different height meet in straight run.
- Slotted Connector not included.
- Please note that actual cut sizes are nominally smaller than quoted

DESCRIPTION	PRODUCT CODE	LIST PRICE	DIMENSIONS/INCHES		
			H	W	D
 Panel Trim - Variable Height - Aluminum	EVPTVA06	21	6	2 7/8	
	EVPTVA12	29	12	2 7/8	
	EVPTVA18	36	18	2 7/8	
	EVPTVA24	48	24	2 7/8	
	EVPTVA30	55	30	2 7/8	
	EVPTVA36	64	36	2 7/8	

**EVPTVA - PANEL TRIM - VARIABLE HEIGHT -ALUMINUM**

- Attaches to bottom of exposed end of panel to provide extension for End-of-Run post trim kit when using panel extensions.
- Does not include slotted connector nor connecting hardware.
- Please note that actual cut sizes are nominally smaller than quoted

DESCRIPTION	PRODUCT CODE	LIST PRICE	DIMENSIONS/INCHES		
			H	W	D
 Panel Extension Trim - Aluminum	EVPTVA12	27	12	2 7/8	
	EVPTVA18	36	18	2 7/8	
	EVPTVA24	46	24	2 7/8	

**EVPTVA - PANEL TRIM - VARIABLE HEIGHT -ALUMINUM**

- To be used with 30"H posts as a replacement trim.
- For "U" trim configuration use three flat trim according to height specifications.
- For "L" trim configuration use two flat trim according to height configurations.
- Please note that actual cut sizes are nominally smaller than quoted

DESCRIPTION	PRODUCT CODE	LIST PRICE	DIMENSIONS/INCHES		
			H	W	D
 Flat Trim - Aluminum	EVPTVA30	17	29 1/8	2 7/8	
	EVPTVA36	18	34 1/8	2 7/8	
	EVPTVA42	21	41 1/8	2 7/8	
	EVPTVA48	27	47 1/8	2 7/8	
	EVPTVA54	27	53 1/8	2 7/8	
	EVPTVA66	29	65 1/8	2 7/8	
	EVPTVA78	30	77 1/8	2 7/8	
	EVPTVA84	33	83 1/8	2 7/8	
	EVPTVA90	31	89 1/8	2 7/8	
	EVPTVA96	35	95 1/8	2 7/8	



**EVPVTFEA - FLAT EXTENSION TRIM - ALUMINUM**

- Finishes exposed faces of One-Way, Two-Way, Three-Way and Inline Panels.
- For reconfiguration and replacement use only.
- For "U" trim configuration use three flat trim according to height specification.
- For "L" trim configuration use two flat trim according to height specification.
- Aluminum Trim must be specified when using premium color paints.
- Please note that actual cut sizes are nominally smaller than quoted

DESCRIPTION	PRODUCT CODE	LIST PRICE	DIMENSIONS/INCHES		
			H	W	D
 Flat Extension Trim - Aluminum	EVPVTFEA12	16	12 3/8	2 7/8	
	EVPVTFEA18	18	18 3/8	2 7/8	
	EVPVTFEA24	18	24 3/8	2 7/8	
	EVPVTFEA30	21	30 3/8	2 7/8	
	EVPVTFEA36	27	36 3/8	2 7/8	
	EVPVTFEA42	28	42 3/8	2 7/8	
	EVPVTFEA48	29	48 3/8	2 7/8	
	EVPVTFEA54	30	54 3/8	2 7/8	
	EVPVTFEA66	33	66 3/8	2 7/8	
	EVPVTFEA78	35	78 3/8	2 7/8	
	EVPVTFEA84	44	84 3/8	2 7/8	
	EVPVTFEA90	46	90 3/8	2 7/8	
	EVPVTFEA96	48	96 3/8	2 7/8	

**EVPLVTFA - FLAT TRIM FOR LIGHT PANELS - ALUMINUM**

- Finishes exposed faces of One-Way, Two-Way, Three-Way and Inline Panels.
- For reconfiguration and replacement use only.
- For "U" trim configuration use three flat trim according to height specification.
- For "L" trim configuration use two flat trim according to height specification.
- Aluminum Trim must be specified when using premium color paints.
- Please note that actual cut sizes are nominally smaller than quoted

DESCRIPTION	PRODUCT CODE	LIST PRICE	DIMENSIONS/INCHES		
			H	W	D
 Flat Trim for Light Panels - Aluminum	EVPLVTFA30	17	26 1/4	2 7/8	
	EVPLVTFA42	21	38 1/4	2 7/8	
	EVPLVTFA48	27	44 1/4	2 7/8	
	EVPLVTFA54	27	50 1/4	2 7/8	
	EVPLVTFA66	29	62 1/4	2 7/8	
	EVPLVTFA72	29	68 1/4	2 7/8	
	EVPLVTFA78	30	74 1/4	2 7/8	
	EVPLVTFA84	30	80 1/4	2 7/8	
	EVPLVTFA90	31	86 1/4	2 7/8	

**EVPTTA - PANEL TOP TRIM - ALUMINUM - FIELD INSTALLED**

- This trim can span an Inline Connector, but not a Post Connector.
- Please note that actual cut sizes are nominally smaller than quoted

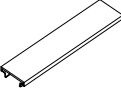
DESCRIPTION	PRODUCT CODE	LIST PRICE	DIMENSIONS/INCHES		
			H	W	D
 Panel Top Trim - Aluminum	EVPTTA18F	16	18	2 7/8	
	EVPTTA24F	21	24	2 7/8	
	EVPTTA30F	28	30	2 7/8	
	EVPTTA36F	30	36	2 7/8	
	EVPTTA42F	36	42	2 7/8	
	EVPTTA48F	46	48	2 7/8	
	EVPTTA54F	53	54	2 7/8	
	EVPTTA60F	58	60	2 7/8	
	EVPTTA66F	64	66	2 7/8	
	EVPTTA72F	70	72	2 7/8	
	EVPTTA78F	77	78	2 7/8	
	EVPTTA84F	85	84	2 7/8	
	EVPTTA90F	90	90	2 7/8	
EVPTTA96F	97	96	2 7/8		

**EVPTNTA - PANEL TOP SINGLE NOTCHED TRIM - ALUMINUM - FIELD INSTALLED**

- Used when connecting a lower Panel to a higher Panel
- This trim can span an Inline Connector, but not a Post Connector.
- Please note that actual cut sizes are nominally smaller than quoted

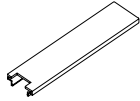
DESCRIPTION	PRODUCT CODE	LIST PRICE	DIMENSIONS/INCHES		
			H	W	D
 Panel Top Singled Notched Trim - Aluminum	EVPTNTA18F	18	18	2 7/8	
	EVPTNTA24F	25	24	2 7/8	
	EVPTNTA30F	28	30	2 7/8	
	EVPTNTA36F	30	36	2 7/8	
	EVPTNTA42F	35	42	2 7/8	
	EVPTNTA48F	48	48	2 7/8	
	EVPTNTA54F	54	54	2 7/8	
	EVPTNTA60F	61	60	2 7/8	
	EVPTNTA66F	65	66	2 7/8	
	EVPTNTA72F	70	72	2 7/8	
	EVPTNTA78F	75	78	2 7/8	
	EVPTNTA84F	82	84	2 7/8	
	EVPTNTA90F	86	90	2 7/8	
	EVPTNTA96F	90	96	2 7/8	

**EVPTDNTA - PANEL TOP DOUBLE NOTCHED TRIM - ALUMINUM - FIELD INSTALLED**

- Used when connecting a lower Panel to a higher Panel
- This trim can span an Inline Connector, but not a Post Connector.
- Please note that actual cut sizes are nominally smaller than quoted

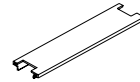
DESCRIPTION	PRODUCT CODE	LIST PRICE	DIMENSIONS/INCHES		
			H	W	D
 Panel Top Double Notched Trim - Aluminum	EVPTDNTA18F	21	18	2 7/8	
	EVPTDNTA24F	28	24	2 7/8	
	EVPTDNTA30F	30	30	2 7/8	
	EVPTDNTA36F	33	36	2 7/8	
	EVPTDNTA42F	36	42	2 7/8	
	EVPTDNTA48F	49	48	2 7/8	
	EVPTDNTA54F	55	54	2 7/8	
	EVPTDNTA60F	64	60	2 7/8	
	EVPTDNTA66F	69	66	2 7/8	
	EVPTDNTA72F	74	72	2 7/8	
	EVPTDNTA78F	81	78	2 7/8	
	EVPTDNTA84F	60	87	2 7/8	
	EVPTDNTA90F	88	90	2 7/8	
	EVPTDNTA96F	92	96	2 7/8	

**EVSC12 - SLOT COVER**

- Covers the slots of a slotted connector between modules as well as corner post situation.
- Available in all standard colors (Black, Charcoal Silver, Taupe, Tungsten, White and Nevada)
- Sold per foot. The desired quantity of the slot covers is the required length in feet.
- An easy way to calculate the required length is to sum the length of all inline connectors used in a project (including the posts) and multiply by 2.
- Should be field cut to required length.

DESCRIPTION	PRODUCT CODE	LIST PRICE	DIMENSIONS/INCHES		
			H	W	D
 Slot Cover	EVSC12	9			



electrical

**STEP-BY-STEP SPECIFICATION – 8-WIRE ELECTRICAL SYSTEM**

**Step 1 Determine the location of the source power entering the Panel Run.**

1. At the base of the Panel.
  - (a) Use EVE8FR1 Reversible Floor Power Entry (default to EVE8FR1).
  - (b) Select the Panel to which the Floor Power Entry will be attached. This Panel requires an EVEPD Power Distribution Housing.
  - (c) Select the side of the Panel and the receptacle outlet to which the Floor Power Entry is to be attached.
2. From the ceiling.
  - (a) Use EVE8EC1 Ceiling Power Entry.
  - (b) Select the post through which to feed the Ceiling Power Entry.
  - (c) One Panel adjacent to the selected post requires an EVEPD Power Distribution Housing.
  - (d) Attach Ceiling Power entry to the nearest end of the Power Distribution Housing.

**Step 2 Determine which Panels are to be powered.**

1. Use EVE8PD Power Distribution Housing that corresponds with the width of the Panel.

**Step 3 Connect power to the powered Panels.**

1. Use EVE8CP16 Jumper Cable between two adjacent powered Panels, separated by an Inline Connector.
2. Use EVE8CP18 Jumper Cable between two adjacent powered Panels separated by a post.
3. Use EVE8CP Pass-Through Cables to connect powered Panels that are separated by one or more non-powered Panels (maximum distance between the powered Panels is 16 feet).
  - (a) The length of the Pass-Through Cable is calculated by adding together the widths of the non-powered Panels (that separate the two powered Panels) and applying an additional 16" to the total. (EVE8PD Power Distribution Housing is positioned 8" in from the ends of the powered Panel.)
  - (b) An additional 3" must be added to the Pass-Through Cable for each post that the cable passes through.
4. From the price list, select the EVE8CP Pass-Through Cable that matches the calculated length. If the length is between listed sizes, use the next size up.

**Step 4 Determine the location and circuitry of the receptacles.**

1. Each powered Panel has four (4) potential locations for EVE8RD Duplex Receptacles – 2 per side. (Exception: 24" wide Panel has only two potential locations – 1 per side, 18" wide Panel has no locations for receptacles.)
2. At each receptacle location there is a choice of four circuit options. Select a circuit option for each location. Circuits one & two are utility circuits; circuits A & B are dedicated circuits.

**BELTLINE TIPS:**

**DO** - use a 17" long Mesh Beltline Jumper when making 90 degree turns in the Beltline raceways only.

**DO NOT** - use a 20" long Metal Flex Jumper when attempting to make 90 degree turns in the Beltline Raceways. The end connector is too long to make the turn.

**DO** - use a 20" long Metal Flex Jumper when traveling through a Beltline Post, in a straight line only.

**DO NOT** - use a 17" long Mesh Beltline Jumper Traveling through a Beltline Post, in a straight line only. The Jumper is too short to make the connection.

**EVOLVE'S MODIFIED 8-WIRE ELECTRICAL SYSTEM**

Evolve has modified its 8-Wire Electrical System to stay abreast of changing industry standards.

Evolve's electrical system allows for the integration of the commonly required "2+2" configuration (2 utility circuits, 2 dedicated circuits) found in the source power of most of today's North American buildings.

**This system is rated for connection to:**

1. A grounded 120/240V, single phase, 20 A, 60Hz
2. A 120/208V, 3 phase, 20 A, 60Hz branch circuit

**EQUIPMENT AMPERAGE**

Calculator .....	0.25
Electric Eraser .....	0.50
Pencil Sharpener .....	1.00
Radio .....	0.05
Paper Shredder.....	4.40 - 13.00
Electric Typewriter .....	1.20
Personal Computer.....	2.00 - 4.00
Video Display Terminal .....	0.08
Draft / Letter Quality Printer.....	1.20 - 3.00

**Data/Comm**

Evolve's duplex receptacle openings will now conform to the ANSI/TIA/EIA Furniture Opening Standard of 1.38 +/- .035 x 2.71 +/- .04. There will no longer be the need to use adapter plates to reduce the size of Evolve's raceway opening, or to use Evolve dedicated data plates for data/comm terminations.

**Transition**

A transition cable is available to connect the previous electrical system prior to April 1, 2005 to the current system when adding Panels to an existing installation. Also, new raceway covers with the smaller openings can be provided and applied to existing Panels when retrofitted with new electrics.

Fan.....	1.00
Heater.....	8.50 - 12.50
Coffee Pot.....	15.00
Task Light .....	1.00
Slide Projector.....	2.00 - 6.00
Laser Printer .....	5.00 - 8.00
Processor / Disk Unit .....	1.00 - 10.00
Desk Top Plotter .....	1.50

Some equipment, such as large copiers, printers, plotters, heaters and coffee makers may occupy most of the circuit capacity. It is recommended that such devices be supplied with the power directly from the wall or building receptacle.



WIRING SCHEMATIC

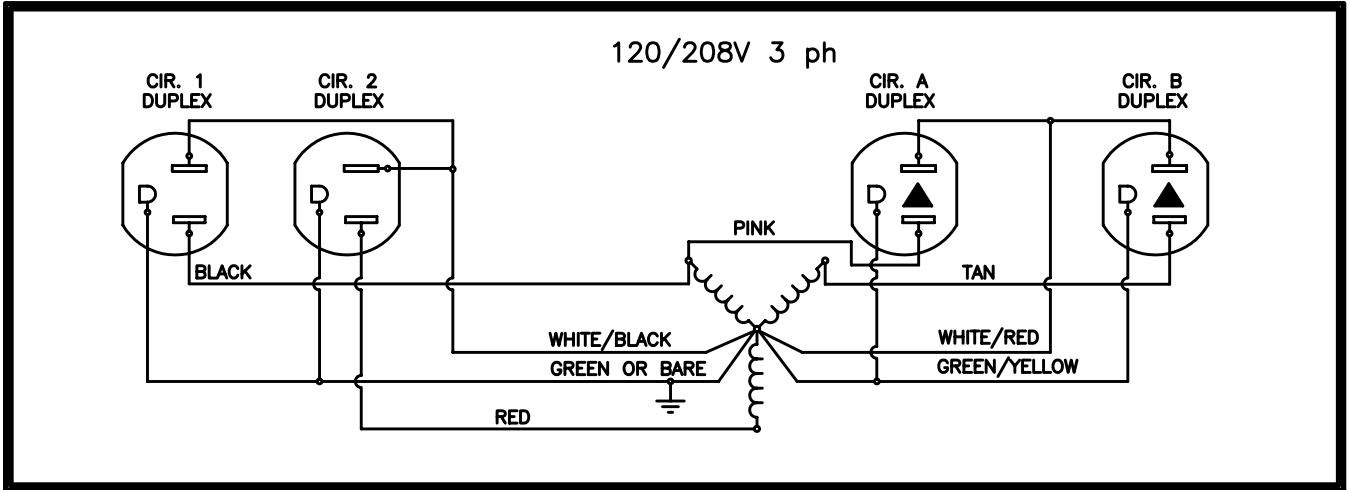
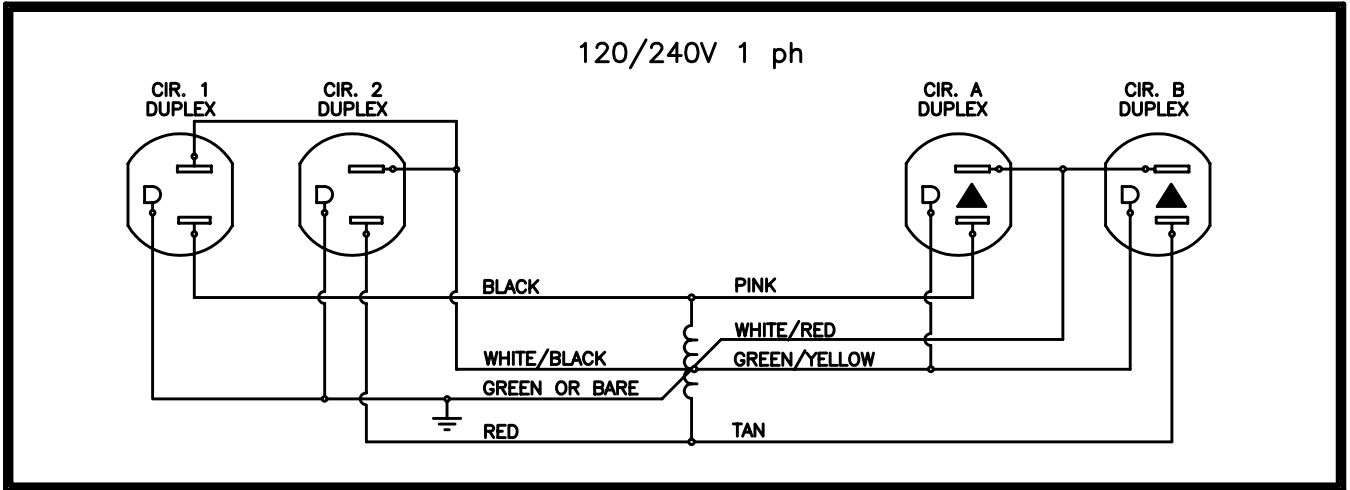

**DEFINING “2 + 2” WIRING CONFIGURATIONS**

**2 + 2 Configuration (8 wire, 4 circuit)**

Two Utility Circuits [Evolve’s #1 & #2 circuits] share one neutral wire and one ground wire.  
 (2 hot [circuit] wires + 1 neutral wire\*\*\* + 1 green ground wire\* = 4 wires)

Two Dedicated Circuits [Evolve’s “A” & “B” circuits] share one neutral wire and one ground wire.  
 (2 hot [circuit] wires + 1 neutral wire \*\*\* + 1 green/yellow ground wire\*\* = 4 wires)

**NOTE:**

It is the ground wire that makes the difference between “Utility” and “Dedicated” circuits. Refer to Wiring Schematics found in the Price List.

\* A Green ground wire is a “system” ground. This means it could be grounded to any piece of metal, including the Panel.

\*\* A Green/Yellow ground wire is isolated, within the wiring conduit, all the way back to the box at the source (building ground).

\*\*\* All Neutral Wires are 10 gauge rather than 12 gauge meaning they are larger than normal, allowing greater protection against “noise” or interference on the circuit.

This page provides an exploded view of a sample configuration highlighting each **Electrical** component required when specifying this configuration.

## Components

- A.** EVE8PD42 Power Distribution Housing  
Note: 8 wire, 4 circuits (3rd/4th circuits dedicated) labeled A or B.
- B.** EVE8CP16 Jumper Cable  
Note: EVE8CP16 connects two powered panels positioned side by side, separated by an Inline Connector  
EVE8CP18 connects two powered panels separated by a post.
- C.** EVE8RD Duplex Receptacle
- D.** EVE8CP Pass-Through Cable  
Note: Pass-Through Extension Cable (EVE8CPF154) available – extends power capability beyond 208".

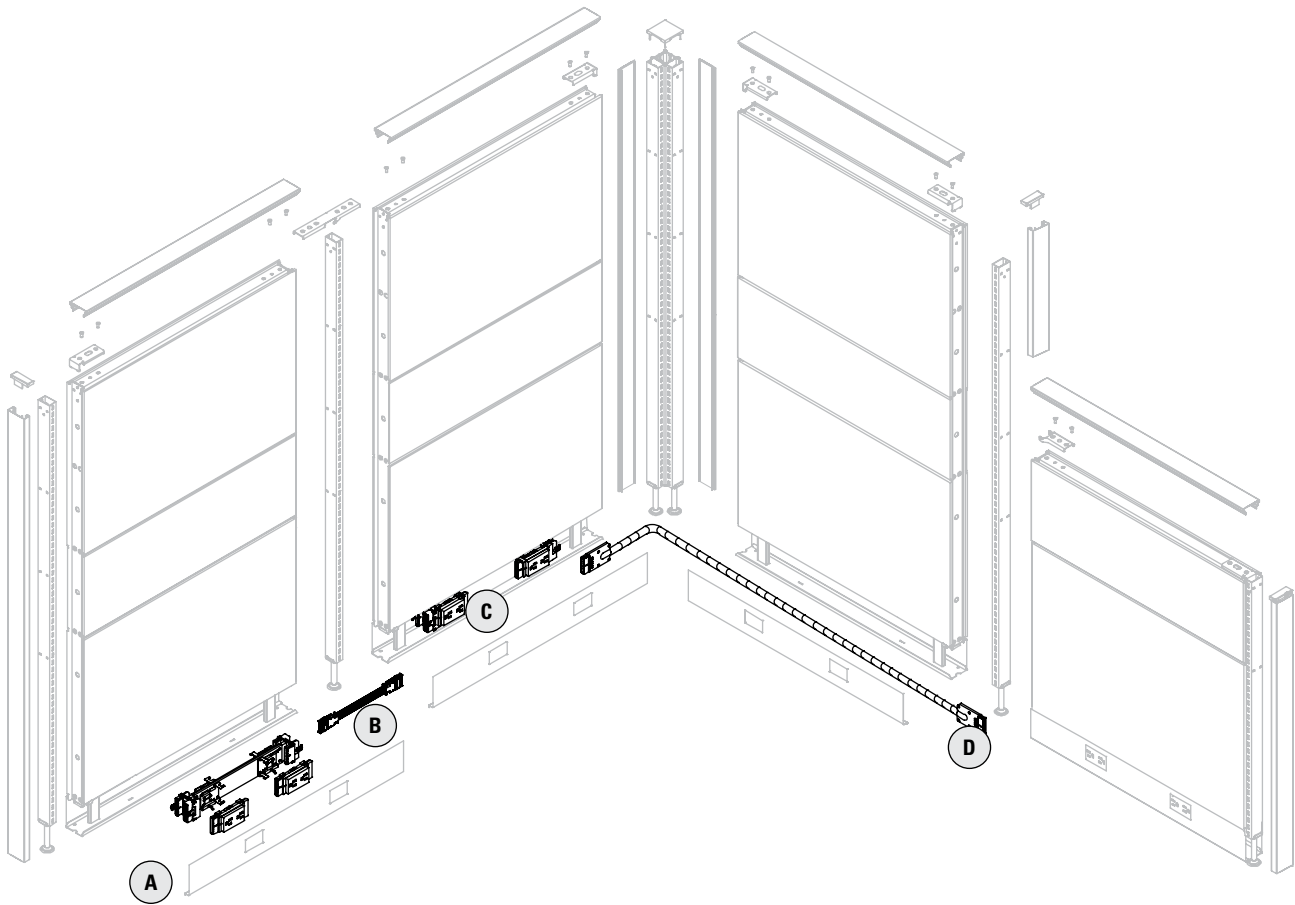

This page provides an exploded view of a sample configuration highlighting each **Beltline Power Panel** component required when specifying this configuration.

- |   |   |
|---|---|
| <p><b>A.</b> EVE8PD36 Power Distribution Housing<br/>Note: 8 wire, 4 circuits (3rd/4th circuits dedicated) labeled A or B.</p> <p><b>B.</b> EVE8CP17 Jumper Cable<br/>Note: EVE8CP17 connects two powered panels positioned side by side, separated by an Inline Connector</p> <p><b>C.</b> EVE8RD Duplex Receptacle</p> <p><b>D.</b> EVE8CP Pass-Through Cable<br/>Note: Pass-Through Extension Cable (EVE8CPF154) available – extends power capability beyond 208".</p> | <p><b>E.</b> EVE8CP18 Jumper Cable<br/>Note: EVE8CP18 connects two powered panels separated by a post, in a straight line.</p> <p><b>F.</b> EVE8CP17 Jumper Cable<br/>Note: EVE8CP17 connects two powered panels separated by a post, for turns through post.</p> <p><b>G.</b> EVE8CPCP Base to Belt Pass Through Kit<br/>Note: For use in Chimney Panels only.</p> |
|---|---|

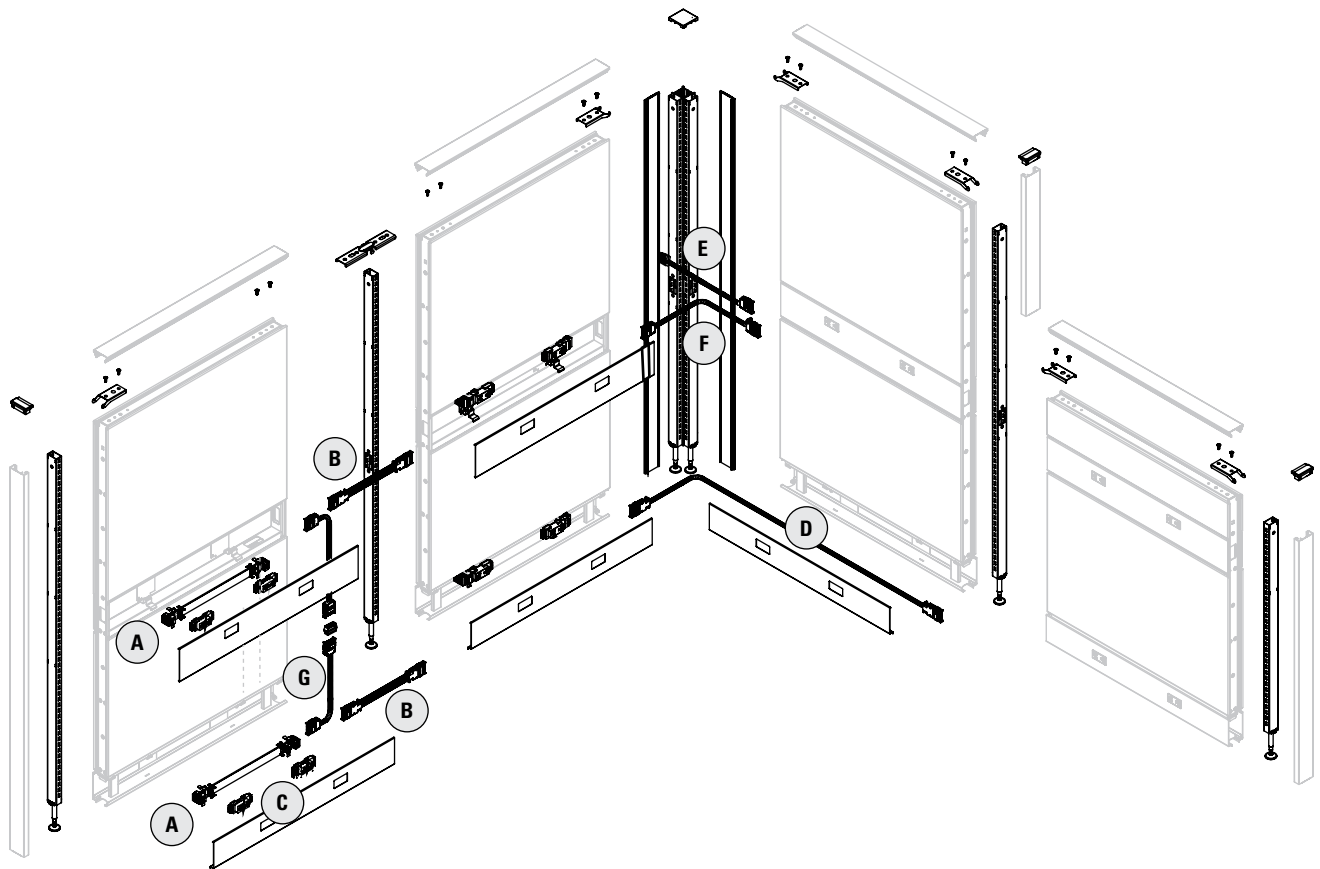



# ELECTRICAL

## EVE8PD - POWER DISTRIBUTION HOUSING

- Power housing is specified per panel size (e.g. EVE8PD36 is for use in a 36" panel).
- 8 wire, 4 circuits (2+2 configuration).
- Provides two duplex receptacles per panel side on all panel widths except the 24" wide panel.
- 24" wide panel allows for only one (1) duplex receptacle per panel side.
- Each power distribution housing supports 15-20 amps.

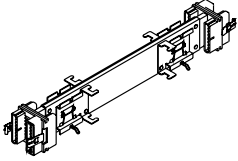
DESCRIPTION	PRODUCT CODE	LIST PRICE	DIMENSIONS/INCHES		
			H	L	D
 Power Distribution Housing	EVE8PD24	163		6 1/4	
	EVE8PD30	220		11 1/2	
	EVE8PD36	231		17 1/2	
	EVE8PD42	237		23 1/2	
	EVE8PD48	257		29 1/2	
	EVE8PD54	258		39 1/4	
	EVE8PD60	259		41 1/2	

## EVE8CP16 - JUMPER CABLE

- The EVE8CP16 electrically connects two powered panels positioned side by side, separated by an Inline connector.

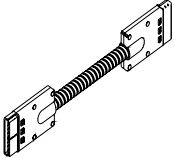
DESCRIPTION	PRODUCT CODE	LIST PRICE	DIMENSIONS/INCHES		
			H	L	D
 Jumper Cable	EVE8CP16	136		16	

## EVE8CP - FLEXIBLE MESH JUMPER CABLE

- Used to connect two power distribution housings at the beltline level at 90 degrees.
- 18.5" flexible mesh jumper replaces EVE8CP18 jumper for corner post applications.

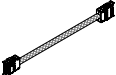
DESCRIPTION	PRODUCT CODE	LIST PRICE	DIMENSIONS/INCHES		
			H	L	D
 Flexible Mesh Jumper Cable	EVE8CP17	126		17 1/2	
	EVE8CP18	156		18 1/2	

## EVE8CPCP - CHIMNEY PANEL JUMPER CABLE KIT

- Contains two (2) 17" flexible harnesses and one (1) "I" connector.
- Used to connect electric from the base to the beltline raceway in Beltline Powered Chimney panel.
- Must use in conjunction with base power distribution harness and beltline power distribution harness (sold separately).

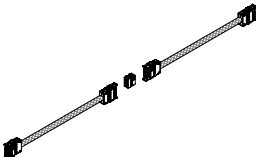
DESCRIPTION	PRODUCT CODE	LIST PRICE	DIMENSIONS/INCHES		
			H	L	D
 Chimney Panel Jumper Cable Kit	EVE8CPCP	341			



# ELECTRICAL

## EVE8CPXX-H - PASS-THROUGH CABLE

- Flexible metal conduit with wire mesh distributes electrical power through non-powered beams.
- To calculate the length of a Pass-Through Cable, add the widths of the non-powered panels separating the powered panels (panels with distribution housing attached). To this, add 16" (distance from the edge of the panel to the distribution housing x 2).
- Add additional 3" when passing through a post. See the Tips at the beginning of the section for more details.
- Hybrid pass-through cables with wire mesh allows connection at 90 degree post at one end for Evolve panels including Beltline and Power Beam

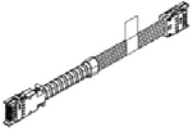
	DESCRIPTION	PRODUCT CODE	LIST PRICE	DIMENSIONS/INCHES		
				H	L	D
	Pass-Through Cable	EVE8CP40-H	211		40	
		EVE8CP46-H	218		46	
		EVE8CP52-H	224		52	
		EVE8CP58-H	238		58	
		EVE8CP64-H	248		64	
		EVE8CP70-H	256		70	
		EVE8CP76-H	258		76	
		EVE8CP82-H	269		82	
		EVE8CP88-H	278		88	
		EVE8CP94-H	285		88	
		EVE8CP100-H	294		100	
		EVE8CP106-H	308		106	
		EVE8CP118-H	323		118	
		EVE8CP130-H	355		130	
		EVE8CP142-H	371		142	
		EVE8CP154-H	388		154	
		EVE8CP172-H	417		172	
		EVE8CP190-H	437		190	
		EVE8CP208-H	454		208	

## EVE8CI-1 - "I" CONNECTOR

- Female - Female connector used to connect two Pass-Through Cables

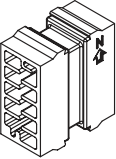
	DESCRIPTION	PRODUCT CODE	LIST PRICE	DIMENSIONS/INCHES		
				H	W	D
	"I" Connector	EVE8CI-1	94			

## EVE8RD - DUPLEX RECEPTACLE

- Duplex receptacles are rated for 15 Amps.
- EVE8RD1 = Circuit #1 (utility circuit)
- EVE8RD2 = Circuit #2 (utility circuit)
- EVE8RDA = Circuit A (dedicated)
- EVE8RDB = Circuit B (dedicated)

### NOTE:

- EVE8RD1 and EVE8RD2 (#1 and #2 share common ground)
- EVE8RDA and EVE8RDB (A and B share common ground)
- Up to 6 receptacles per circuit (24 per infeed), not to exceed total of 15 Amps per circuit.
- Standard in black. Available in White or Nevada with upcharge, add \$3.00.

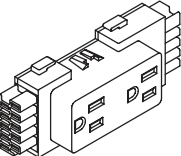
	DESCRIPTION	PRODUCT CODE	LIST PRICE	DIMENSIONS/INCHES		
				H	W	D
	Duplex Receptacle	EVE8RD1	36	2	4 5/8	1 1/4
		EVE8RD2	36	2	4 5/8	1 1/4
		EVE8RDA	36	2	4 5/8	1 1/4
		EVE8RDB	36	2	4 5/8	1 1/4

# ELECTRICAL

## EVE8RD - DUPLEX RECEPTACLE

- Duplex receptacles are rated for 15 Amps.
- EVE8RD1 = Circuit #1 (utility circuit)
- EVE8RD2 = Circuit #2 (utility circuit)
- EVE8RDA = Circuit A (dedicated)
- EVE8RDB = Circuit B (dedicated)

### NOTE:

- EVE8RD1 and EVE8RD2 (#1 and #2 share common ground)
- EVE8RDA and EVE8RDB (A and B share common ground)
- Up to 6 receptacles per circuit (24 per infeed), not to exceed total of 15 Amps per circuit.
- Standard in black. Available in White or Nevada with upcharge, add \$3.00.

DESCRIPTION	PRODUCT CODE	LIST PRICE	DIMENSIONS/INCHES		
			H	W	D
Duplex Receptacle	EVE8RD1	36	2	4 5/8	1 1/4
	EVE8RD2	36	2	4 5/8	1 1/4
	EVE8RDA	36	2	4 5/8	1 1/4
	EVE8RDB	36	2	4 5/8	1 1/4

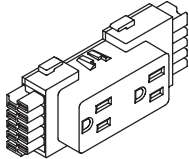

## EVE8RDxca - CALIFORNIA CONTROLLED DUPLEX RECEPTACLE

- California Title 24 meets federal and LEED certification guidelines
- Allows circuit to be controlled or switched off when utility is not in use.
- Duplex receptacles are rated for 15 Amps.
- EVE8RD1CA = Circuit #1 (utility circuit)
- EVE8RD2CA = Circuit #2 (utility circuit)
- EVE8RDACA = Circuit A (dedicated)
- EVE8RDBCA = Circuit B (dedicated)

### NOTE:

- EVE8RD1CA and EVE8RD2CA (#1 and #2 share common ground)
- EVE8RDACA and EVE8RDBCA (A and B share common ground)
- Up to 6 receptacles per circuit (24 per infeed), not to exceed total of 15 Amps per circuit.
- Available in BLK finish only.

DESCRIPTION	PRODUCT CODE	LIST PRICE	DIMENSIONS/INCHES		
			H	W	D
Duplex Receptacle	EVE8RD1CA	39	2	4 5/8	1 1/4
	EVE8RD2CA	39	2	4 5/8	1 1/4
	EVE8RDACA	39	2	4 5/8	1 1/4
	EVE8RDBCA	39	2	4 5/8	1 1/4

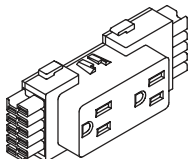

## EVE8RD - DUPLEX RECEPTACLE TO CONVERT STANDARD 2 + 2 SYSTEM TO 3 + 1

- Duplex receptacle are rated for 15 Amps
- EVE8RDA-4 = Duplex receptacle A without triangle to be utility circuit
- EVE8RDB-4 = Duplex receptacle B without triangle to be utility circuit

- Up to 6 receptacles per circuit (24 per infeed) not to exude total 15 Amps per circuit
- Standard in black. Available in White or Nevada with upcharge. Add \$3

DESCRIPTION	PRODUCT CODE	LIST PRICE	DIMENSIONS/INCHES		
			H	L	D
Duplex Receptacle	EVE8RDA-4	36	2	4 5/8	1 1/4
	EVE8RDB-4	36	2	4 5/8	1 1/4

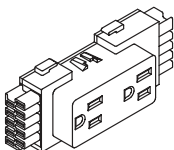

# ELECTRICAL

## EVEUSB01 - USB MODULE

- Includes two USB ports.
- Available in White and Black.

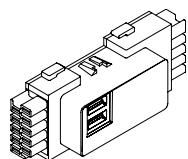

DESCRIPTION	PRODUCT CODE	LIST PRICE	DIMENSIONS/INCHES		
			H	L	D
USB Module - White	EVEUSB01WHT	226	2	4 5/8	1 1/4
USB Module - Black	EVEUSB01BLK	226	2	4 5/8	1 1/4

## EVE8FR1 - REVERSIBLE FLOOR POWER ENTRY

- Takes the place of a duplex receptacle by snapping into the base power way or Beltline power way.
- Includes 72" long flexible vinyl conduit.
- Must be hard wired to source power by a licensed electrician.
- Diameter is 0.85"

## EVE8FR2 - REVERSIBLE FLOOR POWER ENTRY

- Takes the place of a duplex receptacle by snapping into the base power way or Beltline power way.
- Includes 144" long flexible vinyl conduit.
- Must be hard wired to source power by a licensed electrician.
- Diameter is 0.85"

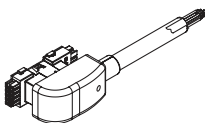

DESCRIPTION	PRODUCT CODE	LIST PRICE	DIMENSIONS/INCHES		
			H	L	D
Reversible Floor Power Entry	EVE8FR1	367		72	
	EVE8FR2	475		144	

## EVE8F - FLOOR POWER ENTRY

- Snaps in end of power distribution housing.
- Includes flexible vinyl conduit.
- Must be hard wired to source power by a licensed electrician.
- Diameter is 0.85"

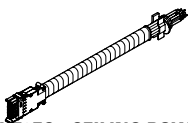

DESCRIPTION	PRODUCT CODE	LIST PRICE	DIMENSIONS/INCHES		
			H	L	D
Floor Power Entry	EVE8F1P	356		72	
	EVE8F2P	460		144	

## VE8EC - CEILING POWER ENTRY

- Snaps into the end of a Power Distribution Housing.
- Flexible metal conduit extends into the ceiling through a corner post and post extension.
- Must be hard wired to source power by a licensed electrician.
- 4" junction box included.
- Post extension ordered separately
- Can feed directly into beltline power when Beltline Post Connectors are specified.
- Cannot feed through Inline or End-of-run Connectors.

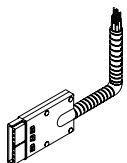

DESCRIPTION	PRODUCT CODE	LIST PRICE	DIMENSIONS/INCHES		
			H	L	D
Ceiling Power Entry	EVE8EC1	284		132	
	EVE8EC2	497		144	
	EVE8EC3	560		180	

# ELECTRICAL

## EVEENY-2 - HARDWARE POWER ENTRY BOX - NEW YORK

- A licensed electrician must provide hard wire connection within the junction box.
- Not for use in panels less than 36"W.

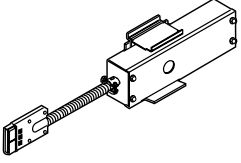
	DESCRIPTION	PRODUCT CODE	LIST PRICE	DIMENSIONS/INCHES		
				H	W	D
	Hardware Power Entry Box - New York	EVEENY2	470	3	28	2 1/5

## EVEJBC-1 - HARDWARE JUNCTION BOX - CHICAGO

- Can be retrofitted in any size of panel at the receptacle location.
- Gives access from one side only at each location.
- Customer to supply conduit, wiring, receptacle, and face plate.
- 2 per panel, except 24" panels only one is needed.
- A licensed electrician must provide hardware connection with the junction box.

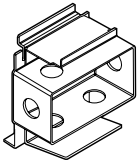
	DESCRIPTION	PRODUCT CODE	LIST PRICE	DIMENSIONS/INCHES		
				H	W	D
	Hardware Junction Box - Chicago	EVEJBC-1	108			

## EVDPE - POST EXTENSION DATA/COMM LAY-IN

- Attaches to the top of a post to bring power and/or data cables from the ceiling to the panel power way
- Three-sided power pole with snap-on fourth side.
- Post extension can be opened on one side for lay-in or power and/or data cables.
- Made of aluminum and can be field cut.
- Accommodates up to 25CAT 5 Cables with electric. Accommodates up to 45 CAT 5 Cables without electric.
- Actual size interior dimension of post, 1.80"x 1.80"

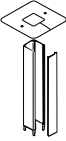
	DESCRIPTION	PRODUCT CODE	LIST PRICE	DIMENSIONS/INCHES		
				H	W	D
	Post Extension Data/Comm Lay-in	EVDPE64	182	64	2	
		EVDPE82	220	82	2	

## EVDPE6E - 60° POST EXTENSION DATA/COMM LAY-IN

- Attaches to the top of at 60° corner post to bring power and/or data cables from the ceiling to the panel power way.
- Two-sided power pole with snap-on third side.
- Post extension can be opened on one side for lay-in or power and/or data cables.
- Made of aluminum and can be field cut.
- Accommodates up to 6 CAT 5 Cables with electric. Accommodates up to 20 CAT 5 Cables without electric.

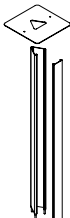
	DESCRIPTION	PRODUCT CODE	LIST PRICE	DIMENSIONS/INCHES		
				H	W	D
	60° Post Extension Data/Comm Lay-in	EVDPE6E64	182	64	2	
		EVDPE6E82	220	82	2	



# ELECTRICAL

## EVDP4E - 45° POST EXTENSION DATA/COMM LAY-IN

- Attaches to the top of at 45° corner post to bring power and/or data cables from the ceiling to the panel power way.
- Two-sided power pole with snap-on third side.
- Post extension can be opened on one side for lay-in or power and/or data cables.
- Made of aluminum and can be field cut.
- Accommodates up to 6 CAT 5 Cables with electric. Accommodates up to 20 CAT 5 Cables without electric.

	DESCRIPTION	PRODUCT CODE	LIST PRICE	DIMENSIONS/INCHES		
				H	W	D
	45° Post Extension Data/Comm Lay-in	EVDP4E64	190	64	3.65	
		EVDP4E84	166	84	3.65	

## EVLEDES - STARTER LED TASK LIGHT

- Undercabinet slim profile LED linear light fixture with lens and On/Off switch.
- May be used as stand-alone or extended with add-on section below (EVLEDES\_DSC).
- Plug-in power supply with 72" cord length plus 78" DC cable.
- Includes magnet mounting bracket with optional adhesive metal plate.
- Light enclosure in clear anodizing finish. Color temperature cool white 4000K.
- Lifespan rated 30,000 hours.

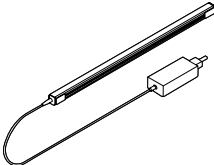
	DESCRIPTION	PRODUCT CODE	LIST PRICE	DIMENSIONS/INCHES		
				H	W	D
	Led Task Light	EVLEDES24	277	1	22.9	1
		EVLEDES36	318	1	33.5	1
		EVLEDES48	354	1	45.5	1

## EVLEDES - ADD-ON LED TASK LIGHT

- Undercabinet slim profile LED linear add-on light fixture with lens.
- Daisy chain unit with 39" linking cable, no power supply.
- Add-on units can only be linked up to a total of 48 watts per power supply; this is equivalent to 10 feet of nominal length of light per power supply.
- Includes magnet mounting bracket with optional adhesive metal plate. Light enclosure in clear anodizing finish. Color temperature cool white 4000K. Lifespan rated 30,000 hours.

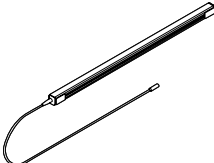
	DESCRIPTION	PRODUCT CODE	LIST PRICE	DIMENSIONS/INCHES		
				H	W	D
	Led Task Light	EVLEDES24DSC	227	1	24	39
		EVLEDES36DSC	267	1	36	39
		EVLEDES48DSC	303	1	48	39

# ELECTRICAL

## EVEDESOS - OCCUPANCY SENSOR

- Inline add-on controller for dimming and occupancy sensor.
- Sensor bypass switch.

DESCRIPTION	PRODUCT CODE	LIST PRICE	DIMENSIONS/INCHES		
			H	W	D

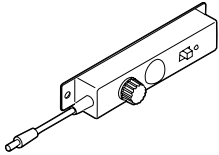

Occupancy Sensor	EVEDESOS	114	6	2.4	2
------------------	----------	-----	---	-----	---

## EVELEDVS - VOYAGE LED SINGLE LIGHT FIXTURE

- Single arm option with 6 ft. cord.
- Touch & hold dimming capability.
- Brightness adjustment from 100% to 15%.
- Available in Designer White (WHT), Black (BLK) or Silver (SIL).
- Mercury free LEDs and 94% post consumer recyclability by weight.
- Mounting accessories sold separately.

DESCRIPTION	PRODUCT CODE	LIST PRICE	DIMENSIONS/INCHES		
			H	W	D



Voyage LED Single Light Fixture	EVELEDVS	763			
Voyage LED Single Light Fixture w/Occupancy Sensor	EVELEDVSO	1130			

## EVELEDVD - VOYAGE LED DOUBLE LIGHT FIXTURE

- Double arm option with 6 ft. cord.
- Touch & hold dimming capability.
- Brightness adjustment from 100% to 15%.
- Available in Designer White (WHT), Black (BLK) or Silver (SIL).
- Mercury free LEDs and 94% post consumer recyclability by weight.
- Mounting accessories sold separately.

DESCRIPTION	PRODUCT CODE	LIST PRICE	DIMENSIONS/INCHES		
			H	W	D



Voyage LED Double Light Fixture	EVELEDVD	775			
Voyage LED Double Light Fixture w/Occupancy Sensor	EVELEDVDO	1146			



# ELECTRICAL

## EVELEDRS - REVO LED SINGLE LIGHT FIXTURE

- Single arm option with 9 ft. cord.
- Touch & hold dimming capability.
- Brightness adjustment from 100% to 15%.
- Available in Designer White (WHT), Black (BLK) or Silver (SIL).
- Mercury free LEDs and 94% post consumer recyclability by weight.
- Mounting accessories sold separately.

	DESCRIPTION	PRODUCT CODE	LIST PRICE	DIMENSIONS/INCHES		
				H	W	D
	Revo LED Single Light Fixture	EVELEDRS	763			
	Revo LED Single Light Fixture w/Occupancy Sensor	EVELEDRSO	1130			

## EVELEDRD - REVO LED DOUBLE LIGHT FIXTURE

- Double arm option with 9 ft. cord.
- Touch & hold dimming capability.
- Brightness adjustment from 100% to 15%.
- Available in Designer White (WHT), Black (BLK) or Silver (SIL).
- Mercury free LEDs and 94% post consumer recyclability by weight.
- Mounting accessories sold separately.

	DESCRIPTION	PRODUCT CODE	LIST PRICE	DIMENSIONS/INCHES		
				H	W	D
	Revo LED Double Light Fixture	EVELEDRD	775			
	Revo LED Double Light Fixture w/Occupancy Sensor	EVELEDRDO	1146			

## EVELEDAFS - FREESTANDING BASE

	DESCRIPTION	PRODUCT CODE	LIST PRICE	DIMENSIONS/INCHES		
				H	W	D
	Freestanding Base	EVELEDAFS	216			

## EVELEDACM - CLAMP MOUNT

	DESCRIPTION	PRODUCT CODE	LIST PRICE	DIMENSIONS/INCHES		
				H	W	D
	Clamp Mount	EVELEDACM	193			



# ELECTRICAL

## EVELEDASW - SLATWALL MOUNT

DESCRIPTION	PRODUCT CODE	LIST PRICE	DIMENSIONS/INCHES		
			H	W	D



Slatwall Mount	EVELEDASW	193			
----------------	-----------	-----	--	--	--

## EVELEDAPM - PANEL MOUNT

DESCRIPTION	PRODUCT CODE	LIST PRICE	DIMENSIONS/INCHES		
			H	W	D



Panel Mount	EVELEDAPM	193			
-------------	-----------	-----	--	--	--

## EVELEDASM - SURFACE MOUNT

DESCRIPTION	PRODUCT CODE	LIST PRICE	DIMENSIONS/INCHES		
			H	W	D



Surface Mount	EVELEDASM	193			
---------------	-----------	-----	--	--	--

## EVECC - CORD COVER

- Attaches to panels vertically between modules to provide enclosures for power or data cords.
- Available in 21" and 36" lengths, 6 per pack.
- Can be field cut to required length.

DESCRIPTION	PRODUCT CODE	LIST PRICE	DIMENSIONS/INCHES		
			H	W	D



Inline Cord Cover For use at panel Inline connections	EVECC121	35	21		
	EVECC136	53	36		
Corner Cord Cover For use at panel Inline connections	EVECC221	35	21		
	EVECC236	53	36		



# ELECTRICAL

## EVH8RC - RACEWAY COVERS

- Raceway Cover with 1.38" x 2.71" duplex receptacle openings.
- Includes up to three receptacle opening shields depending on width of raceway cover.
- Raceway Covers are sold individually.

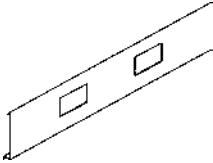
DESCRIPTION	PRODUCT CODE	LIST PRICE	DIMENSIONS/INCHES		
			H	W	D
 Raceway Covers	EVH8RC18	25	6	18	
	EVH8RC24	36	6	24	
	EVH8RC30	49	6	30	
	EVH8RC36	55	6	36	
	EVH8RC42	61	6	42	
	EVH8RC48	66	6	48	
	EVH8RC54	77	6	54	
	EVH8RC60	85	6	60	

## EVEMAE - MINI-ADAPT POWER MODULE

- Attaches to scoop at the back of the worksurface.
- Includes two Simplex outlets.
- 6' black cord
- Available in black only.
- Note: Height (H) is measured above the worksurface.

DESCRIPTION	PRODUCT CODE	LIST PRICE	DIMENSIONS/INCHES		
			H	W	D
 Mini-Adapt Power Module	EVEMAE1	233	2	3 5/8	3

## EVEMAD - MINI-ADAPT POWER MODULE

- Attaches to scoop at the back of the worksurface.
- Includes two Voice/Data Port, Voice/Data Adapter Kit.
- Accepts Cat3, Cat 5, Cat 5e, Cat 6 jacks.
- Available in black only.
- Note: Height (H) is measured above the worksurface.

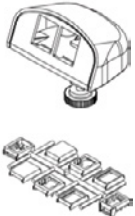
DESCRIPTION	PRODUCT CODE	LIST PRICE	DIMENSIONS/INCHES		
			H	W	D
 Mini-Adapt Power Module	EVEMAD1	189	2	3 5/8	3

# ELECTRICAL

## EVED - DUO POWER ADAPTER

- Includes two outlets and two USB ports.
- Clamp mounts above worksurface.
- Available in White only, with Tungsten support bracket.

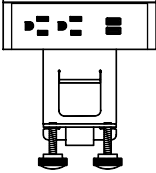
	DESCRIPTION	PRODUCT CODE	LIST PRICE	DIMENSIONS/INCHES		
				H	L	D
	Duo Power Adapter	EVED50	419	1.8	5.5	3.2

## EVEDU - DUO UNDER POWER ADAPTER

- Includes two outlets and two USB ports.
- Mounts underneath worksurface or table top with 4 screws.
- Available in White only.

	DESCRIPTION	PRODUCT CODE	LIST PRICE	DIMENSIONS/INCHES		
				H	L	D
	Duo Under Power Adapter	EVEDU51	362	1.8	6.5	2.8

## EVETP - TRIO POWER ADAPTER

- Includes three outlets, USB ports and data port.
- Clamp mounts above worksurface.
- Available in White only, with Tungsten support bracket.

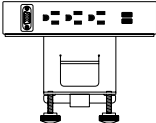
	DESCRIPTION	PRODUCT CODE	LIST PRICE	DIMENSIONS/INCHES		
				H	L	D
	Trio Power Adapter	EVETP53	472	1.8	8	3.2

## EVETPU - TRIO UNDER POWER ADAPTER

- Includes three outlets, USB ports and data port.
- Mounts underneath worksurface or table top with 4 screws.
- Available in White only.

	DESCRIPTION	PRODUCT CODE	LIST PRICE	DIMENSIONS/INCHES		
				H	L	D
	Trio Under Power Adapter	EVETPU54	437	1.8	8	3.9



worksurfaces

**THE INFORMATION LISTED BELOW PROVIDES YOU WITH BASIC FEATURES OF EVOLVE WORKSURFACES.**

- Evolve thermally fused worksurfaces are 1" thick, high pressure is 1 1/16" and 1 7/16" thick. These are finished with 3 mm PVC edging on all sides.
- Standard laminate offerings are available in thermally-fused (TF) and most high pressure laminates (HP). See laminate listings for details.
- Wood grain laminates on corner worksurfaces up to 42" available in laminate run diagonally for an upcharge. Otherwise, standard horizontal application of laminate will be used.
- To avoid unsatisfactory results in laminate application when attaching two corner surfaces side by side, select "WG" surfaces for matching grain.
- Some wood grain laminate worksurfaces will have matching wood grain PVC trim unless specified otherwise.
- The depth of the worksurface scoops are 1 1/8" when measured from the panel the worksurface is attached to.

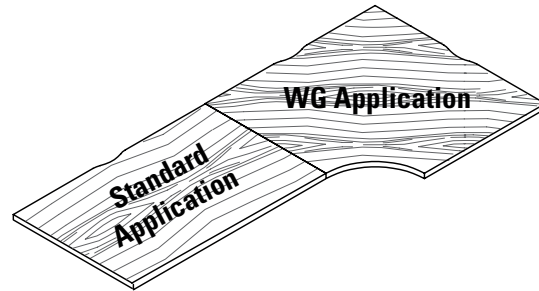

- All worksurfaces have threaded inserts for metal-to-metal connection for support hardware.
- All worksurfaces require support hardware. These are priced separately within this section.
- Communication and electrical wires are routed through a cable scoop located at the back of the worksurface. Depending on the specific surface, note that the number of cable scoops depends upon the width of the worksurface. All worksurface shapes have at least one scoop on the Panel edge.
- A 3/8" separation between the back of the worksurfaces and panels allows for cables to be moved to the panel seams and concealed by wire managers.
- Note: Wood veneer options for worksurfaces are available at an upcharge and with an extended lead time. Contact Evolve Customer Support for details.
- Tungsten (TUN) and Designer White (DWT) trim available at no charge.
- Note the following abbreviations:  
**TF = Thermally-Fused Laminate; (1") HP = High-Pressure Laminate (1 1/16"); HPW = High-Pressure Laminate (1 7/16"); WG = Wood Grain**

**One Scoop EVWS 24" - 48"**

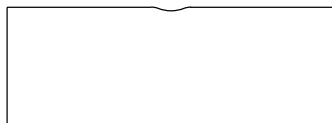

**Two Scoops EVWS 54" - 72"**

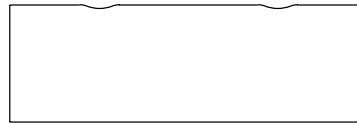

**One Scoop EVWL 24" - 48"**

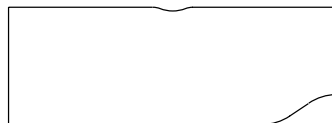

**Two Scoops EVWL 54" - 72"**



This page provides a three dimensional view of a sample configuration highlighting each **Worksurface** component required when specifying this configuration.

## Components

- A. EVWVL2436 Curvilinear Worksurface – Left  
Note: When deepest end equals 24", opposite depth is 18"  
When deepest end equals 30", opposite depth is 24"
- B. EVWCC3618 Corner Curved Worksurface
- C. EVWVR2436 Curvilinear Worksurface – Right
- D. EVWTEV1536 End Transaction Surface with Cut-out

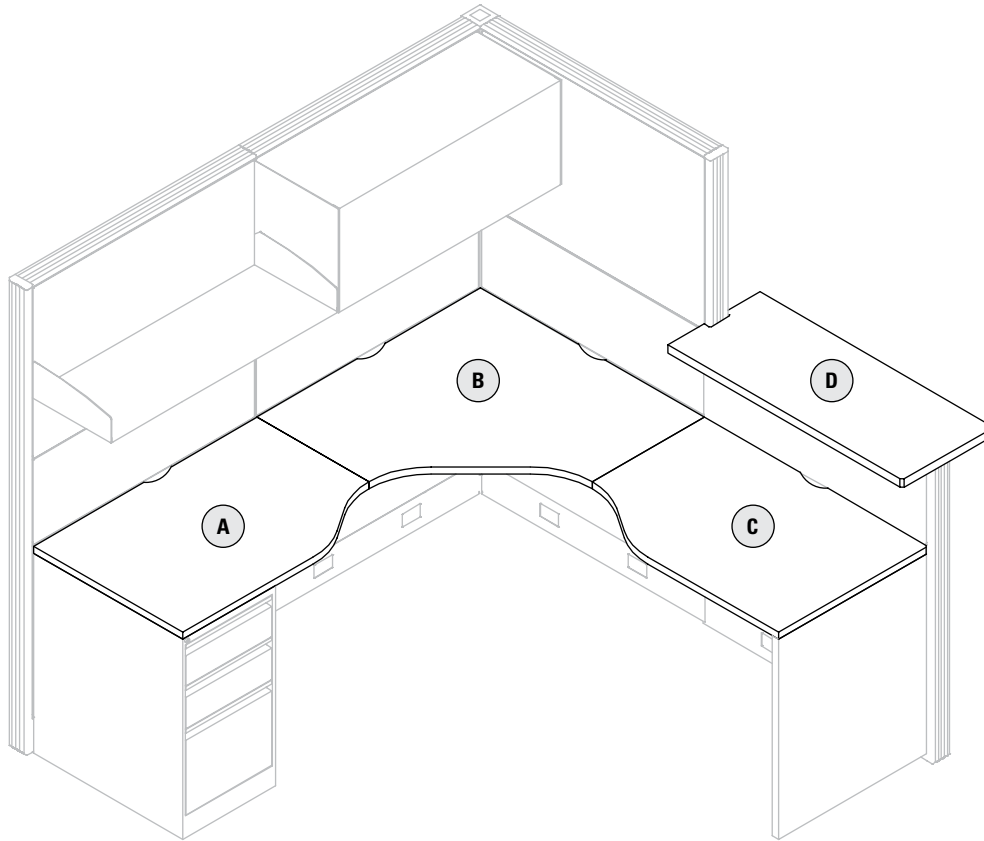

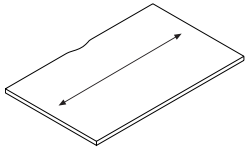

**EVWS Worksurfaces**

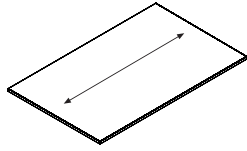

**EVWSNS Worksurfaces**

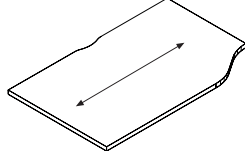

**EVWVR Worksurfaces**

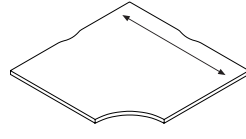

**EVWCC Worksurfaces**

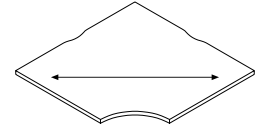

**EVWCCxxxWG Worksurfaces**

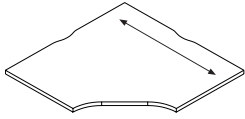

**EVWCK Worksurfaces**

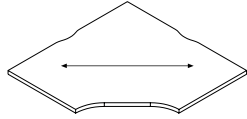

**EVWCKxxxxWG Worksurfaces**

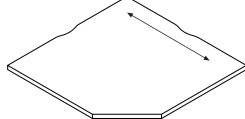

**EVWCF Worksurfaces**

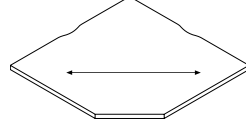

**EVWCFxxxxWG Worksurfaces**

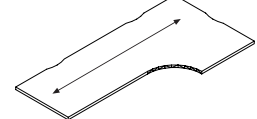

**EVWCE Worksurfaces**

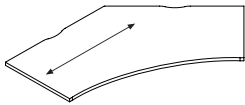

**EVWC4C Worksurfaces**

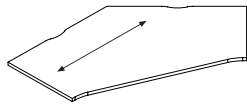

**EVWC4K Worksurfaces**

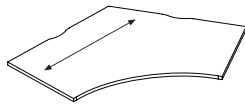

**EVWC6C Worksurfaces**

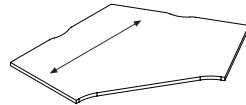

**EVWC6K Worksurfaces**

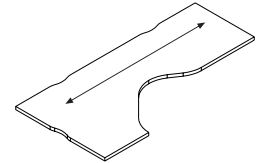

**EVWL Worksurfaces**

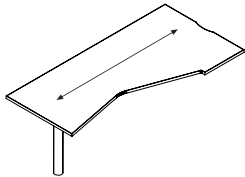

**EVWHL Worksurfaces**

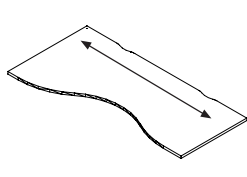

**EVWBTL/R Worksurfaces**

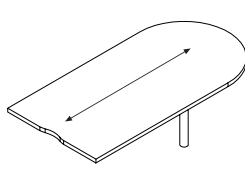

**EVWD Worksurfaces**

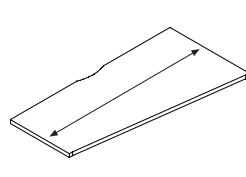

**EVWSWL/R Worksurfaces**

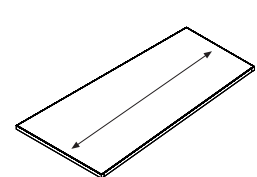

**EVWSWNSL/R Worksurfaces**

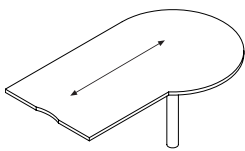

**EVWP Worksurfaces**

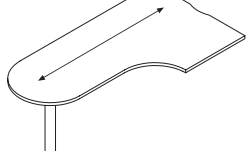

**EVWPL/R Worksurfaces**

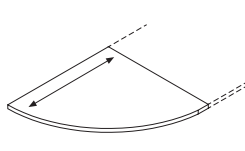

**EVWQR and EVWQRC Worksurfaces**

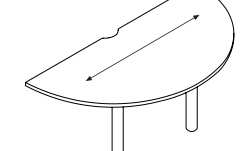

**EVWR Worksurfaces**

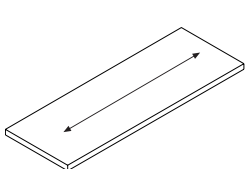

**EVWT, EVWTV, EVWTW, EWTEV, EVWTD, EVWTDV, EVWTD D Worksurfaces**

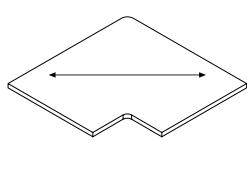

**EVWTCLxxxxWG Worksurfaces**

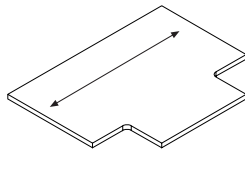

**EVWTC Worksurfaces**

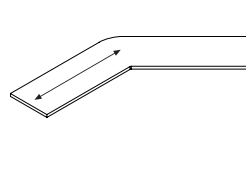

**EVW4T Worksurface**

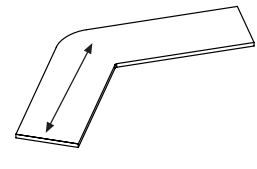

**EVW6T Worksurfaces**



## EVWS - STRAIGHT WORKSURFACE

- Support hardware must be ordered separately. See listing in this section of the price book.
- Worksurfaces greater than 48" wide require additional structural support.
- Please choose from Designer White (DWT), Silver (SIL) or Black (BLK) for scoop covers.

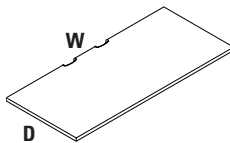
	DESCRIPTION	PRODUCT CODE	LIST PRICE			DIMENSIONS/INCHES	
			TF	HP	HPW	D	W
	Straight Worksurface - 18" Deep	EVWS1824P	147	200	297	18	24
		EVWS1830P	154	213	319	18	30
		EVWS1836P	175	239	358	18	36
		EVWS1842P	227	317	472	18	42
		EVWS1848P	271	376	564	18	48
		EVWS1854P	319	444	666	18	54
		EVWS1860P	358	495	743	18	60
		EVWS1866P	374	515	775	18	66
		EVWS1872P	391	539	807	18	72
		EVWS1878P	554	835	1253	18	78
		EVWS1884P	594	901	1351	18	84
		EVWS1890P	636	965	1406	18	90
		EVWS1896P	678	1028	1540	18	96
	Straight Worksurface - 24" Deep	EVWS2424P	149	202	301	24	24
		EVWS2430P	159	217	323	24	30
		EVWS2436P	180	246	362	24	36
		EVWS2442P	229	319	477	24	42
		EVWS2448P	274	383	574	24	48
		EVWS2454P	323	446	671	24	54
		EVWS2460P	361	499	746	24	60
		EVWS2466p	378	523	780	24	66
		EVWS2472P	394	542	810	24	72
		EVWS2478P	633	810	1215	24	78
		EVWS2484P	637	822	1231	24	84
		EVWS2490P	636	965	1447	24	90
		EVWS2496P	678	1028	1540	24	96
	Straight Worksurface - 30" Deep	EVWS3024P	175	237	355	30	24
		EVWS3030P	185	259	388	30	30
		EVWS3036P	219	300	450	30	36
		EVWS3042P	306	421	632	30	42
		EVWS3048P	323	446	671	30	48
		EVWS3054P	355	488	730	30	54
		EVWS3060P	378	523	780	30	60
		EVWS3066P	393	542	810	30	66
		EVWS3072P	415	575	864	30	72
		EVWS3078P	786	1017	1523	30	78
		EVWS3084P	799	1022	1535	30	84
		EVWS3090P	795	1207	1808	30	90
		EVWS3096P	847	1285	1927	30	96



**EVWSNSC - STRAIGHT WORKSURFACE NO SCOOP**

- There is no scoop on this work surface.
- Support hardware must be ordered separately. See listing in this section of the price book.
- Surfaces not available in HPW.
- Worksurfaces greater than 48" wide require additional structural support.

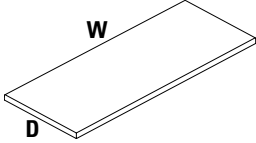
	DESCRIPTION	PRODUCT CODE	LIST PRICE		DIMENSIONS/INCHES	
			TF	HP	D	W
	Straight Worksurface No Scoops - 24" Deep	EVWSNSC2424	149	202	24	24
		EVWSNSC2430	159	217	24	30
		EVWSNSC2436	180	246	24	36
		EVWSNSC2442	229	319	24	42
		EVWSNSC2448	274	383	24	48
		EVWSNSC2454	323	446	24	54
		EVWSNSC2460	361	499	24	60
		EVWSNSC2466	378	523	24	66
		EVWSNSC2472	394	542	24	72
		EVWSNSC2478	633	810	24	78
		EVWSNSC2484	637	822	24	84
		EVWSNSC2490	636	965	24	90
		EVWSNSC2496	678	1028	24	96
			Straight Worksurface No Scoops - 30" Deep	EVWSNSC3024	175	237
EVWSNSC3030	185			259	30	30
EVWSNSC3036	219			300	30	30
EVWSNSC3042	306			421	30	42
EVWSNSC3048	323			446	30	48
EVWSNSC3054	355			488	30	54
EVWSNSC3060	378			523	30	60
EVWSNSC3066	393			542	30	66
EVWSNSC3072	415			575	30	72
EVWSNSC3078	786			1017	30	78
EVWSNSC3084	799			1022	30	84
EVWSNSC3090	795			1207	30	90
EVWSNSC3096	847			1285	30	96

**EVWSWNSC - WEDGE WORKSURFACE NO SCOOP**

- There is no scoop on this work surface.

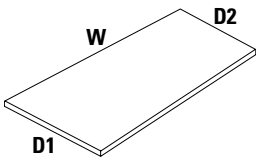
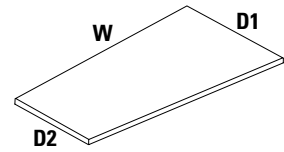
	DIMENSIONS/INCHES	PRODUCT CODE	LIST PRICE		DIMENSIONS/INCHES		
			TF	HP	D1	D2	W
	Straight Wedge Worksurface No Scoops - Left	EVWSWNSC241848	385	494	24	18	48
		EVWSWNSC241854	434	556	24	18	54
		EVWSWNSC241860	479	618	24	18	60
		EVWSWNSC241866	531	678	24	18	66
		EVWSWNSC241872	575	743	24	18	72
		EVWSWNSC302448	479	618	30	24	48
		EVWSWNSC302454	539	695	30	24	54
		EVWSWNSC302460	600	770	30	24	60
		EVWSWNSC302466	658	847	30	24	66
		EVWSWNSC302472	719	923	30	24	72
	Straight Wedge Worksurface No Scoops - Right	EVWSWNSC182448	385	494	24	18	48
		EVWSWNSC182454	434	556	24	18	54
		EVWSWNSC182460	479	618	24	18	60
		EVWSWNSC182466	531	678	24	18	66
		EVWSWNSC182472	575	743	24	18	72
		EVWSWNSC243048	479	618	30	24	48
		EVWSWNSC243054	539	695	30	24	54
		EVWSWNSC243060	600	770	30	24	60
		EVWSWNSC243066	658	847	30	24	66
		EVWSWNSC243072	719	923	30	24	72



**EWSP - STRAIGHT WORKSURFACE TO SPAN-A-POST**

- Support hardware must be ordered separately. See listing in this section of the price book.
- Worksurfaces greater than 48" wide require additional structural support.
- Please choose from Designer White (DWT), Silver (SIL) or Black (BLK) for scoop covers.

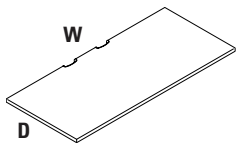
	DESCRIPTION	PRODUCT CODE	LIST PRICE			DIMENSIONS/INCHES	
			TF	HP	HPW	D	W
	Straight Worksurface to Span-a-Post - 18" Deep	EWWS1827P	171	260	389	18	27
		EWWS1833P	154	213	319	18	33
		EWWS1839P	226	340	510	18	39
		EWWS1845P	271	389	581	18	45
		EWWS1851P	321	444	666	18	51
		EWWS1857P	358	495	741	18	57
		EWWS1863P	374	515	775	18	63
		EWWS1869P	391	539	808	18	69
		EWWS1875P	415	629	941	18	75
		EWWS1881P	544	699	1048	18	81
	EWWS1887P	556	712	1066	18	87	
	Straight Worksurface to Span-a-Post - 24" Deep	EWWS2427P	216	323	483	24	27
		EWWS2433P	258	389	581	24	33
		EWWS2439P	300	453	677	24	39
		EWWS2445P	340	514	773	24	42
		EWWS2451P	384	578	868	24	48
		EWWS2457P	424	645	967	24	57
		EWWS2463P	469	708	1061	24	63
		EWWS2469P	510	773	1158	24	69
		EWWS2475P	633	835	1252	24	75
		EWWS2481P	637	901	1349	24	81
	EWWS2487P	648	965	1448	24	87	
	Straight Worksurface to Span-a-Post - 30" Deep	EWWS3027P	267	404	605	30	27
		EWWS3033P	321	483	724	30	33
		EWWS3039P	371	564	845	30	39
		EWWS3045P	424	645	967	30	45
		EWWS3051P	479	725	1087	30	48
		EWWS3057P	532	806	1207	30	57
		EWWS3063P	583	885	1327	30	63
		EWWS3069P	636	965	1447	30	69
		EWWS3075P	786	1044	1567	30	75
		EWWS3081P	799	1067	1599	30	81
	EWWS3087P	839	1207	1808	30	87	

**EVWVL - CURVILINEAR WORKSURFACE - LEFT**

- When deepest end equals 24", the opposite depth is 18". When deepest end equals 30", the opposite depth is 24".
- Support hardware must be ordered separately. See listing in this section of the price book.
- Worksurfaces greater than 48" wide require additional structural support.
- Please choose from Designer White (DWT), Silver (SIL) or Black (BLK) for scoop covers.

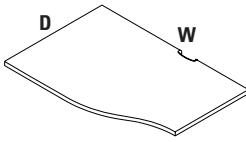
DESCRIPTION	PRODUCT CODE	LIST PRICE			DIMENSIONS/INCHES	
		TF	HP	HPW	D	W
 Curvilinear Worksurface - 24" Deep	EVWVL2424P	190	262	393	24	24
	EVWVL2430P	200	270	407	24	30
	EVWVL2436P	237	327	493	24	36
	EVWVL2442P	274	383	574	24	42
	EVWVL2448P	317	438	652	24	48
	EVWVL2454P	355	488	730	24	54
	EVWVL2460P	384	542	810	24	60
	EVWVL2466P	423	594	889	24	66
	EVWVL2472P	455	649	974	24	72
	EVWVL2478P	633	810	1215	24	78
EVWVL2484P	637	822	1231	24	84	
Curvilinear Worksurface - 30" Deep	EVWVL3024P	200	270	407	30	24
	EVWVL3030P	209	284	423	30	30
	EVWVL3036P	249	350	523	30	36
	EVWVL3042P	339	469	702	30	42
	EVWVL3048P	355	488	730	30	48
	EVWVL3054P	393	542	810	30	54
	EVWVL3060P	423	594	889	30	60
	EVWVL3066P	455	649	974	30	66
	EVWVL3072P	483	703	1052	30	72
	EVWVL3078P	786	1017	1523	30	78
EVWVL3084P	799	1022	1535	30	84	

**EVWVR - CURVILINEAR WORKSURFACE - RIGHT**

- When deepest end equals 24", the opposite depth is 18". When deepest end equals 30", the opposite depth is 24".
- Support hardware must be ordered separately. See listing in this section of the price book.
- Please choose from Designer White (DWT), Silver (SIL) or Black (BLK) for scoop covers.

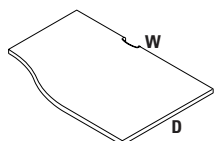
DESCRIPTION	PRODUCT CODE	LIST PRICE			DIMENSIONS/INCHES	
		TF	HP	HPW	D	W
 Curvilinear Worksurface - 24" Deep	EVWVR2424P	190	262	393	24	24
	EVWVR2430P	200	270	407	24	30
	EVWVR2436P	237	327	493	24	36
	EVWVR2442P	274	383	574	24	42
	EVWVR2448P	317	438	652	24	48
	EVWVR2454P	355	488	730	24	54
	EVWVR2460P	384	542	810	24	60
	EVWVR2466P	423	594	889	24	66
	EVWVR2472P	455	649	974	24	72
	EVWVR2478P	633	810	1215	24	78
EVWVR2484P	637	822	1231	24	84	
Curvilinear Worksurface - 30" Deep	EVWVR3024P	200	270	407	30	24
	EVWVR3030P	209	284	423	30	30
	EVWVR3036P	249	350	523	30	36
	EVWVR3042P	339	469	702	30	42
	EVWVR3048P	355	488	730	30	48
	EVWVR3054P	393	542	810	30	54
	EVWVR3060P	423	594	889	30	60
	EVWVR3066P	455	649	974	30	66
	EVWVR3072P	483	703	1052	30	72
	EVWVR3078P	786	1017	1523	30	78
EVWVR3084P	799	1022	1535	30	84	



**EVWCC - CORNER CURVED WORKSURFACE**

- When specifying woodgrain laminate (WG) for corner worksurfaces 42" wide or less, choose from a diagonally run grain for an upcharge or standard application at no upcharge.
- Support hardware must be ordered separately. See listings in this section.
- Worksurfaces greater than 48" wide require additional structural support.
- Please choose from Designer White (DWT), Silver (SIL) or Black (BLK) for scoop covers.

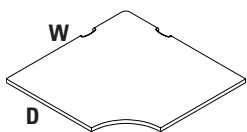
	DESCRIPTION	PRODUCT CODE	LIST PRICE			DIMENSIONS/INCHES	
			TF	HP	HPW	D	W
	Corner Curved Worksurface - 36"	EVWCC3618P	499	656	983	18	36
		EVWCC3624P	544	721	1082	24	36
		EVWCC3618WGP	556	734	1100	18	36
		EVWCC3624WGP	612	808	1212	24	36
	Corner Curved Worksurface - 42"	EVWCC4224P	737	976	1465	24	42
		EVWCC4230P	801	1058	1582	30	42
		EVWCC4224WGP	827	1139	1709	24	42
		EVWCC4230WGP	899	1183	1773	30	42
	Corner Curved Worksurface - 48"	EVWCC4824P	862	1118	1674	24	48
		EVWCC4830P	902	1287	1931	30	48

**EVWCC - CORNER ASYMMETRICAL WORKSURFACE**

- When specifying woodgrain laminate (WG) for corner worksurfaces 42" wide or less, choose from a diagonally run grain for an upcharge or standard application at no upcharge.
- Support hardware must be ordered separately. See listings in this section.
- Please choose from Designer White (DWT), Silver (SIL) or Black (BLK) for scoop covers.

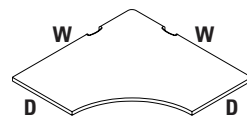
	DESCRIPTION	PRODUCT CODE	LIST PRICE			DIMENSIONS/INCHES		
			TF	HP	HPW	D1	D2	W
	Corner Worksurface - 36" x 36" x 18" x 24"	EVWCC36361824P	554	679	1020	18	24	36
		EVWCC36362418P	554	679	1020	24	18	36
		EVWCC36361824WGP	618	764	1141	18	24	36
		EVWCC36362418WGP	618	764	1141	24	18	36
	Corner Worksurface - 36" x 36" x 24" x 30"	EVWCC36362430P	597	718	1078	24	30	36
		EVWCC36363024P	597	718	1078	30	24	36
		EVWCC36362430WGP	668	806	1207	24	30	36
		EVWCC36363024WGP	668	806	1207	30	24	36
	Corner Worksurface - 42" x 42" x 18" x 24"	EVWCC42421824P	753	1009	1514	18	24	42
		EVWCC42422418P	753	1009	1514	24	18	42
		EVWCC42421824WGP	844	1130	1696	18	24	42
		EVWCC42422418WGP	844	1130	1696	24	18	42
	Corner Worksurface - 42" x 42" x 24" x 30"	EVWCC42422430P	814	1257	1889	24	30	42
		EVWCC42423024P	814	1257	1889	30	24	42
		EVWCC42422430WGP	912	1406	2108	24	30	42
		EVWCC42423024WGP	912	1406	2108	30	24	42
	Corner Worksurface - 48" x 48" x 24" x 30"	EVWCC48482430P	1042	1429	2143	24	30	42
		EVWCC48483024P	1042	1429	2143	30	24	42

**EVWCK - CORNER KEYBOARD WORKSURFACE**

- When specifying woodgrain laminate (WG) for corner worksurfaces 42" wide or less, choose from a diagonally run grain for an upcharge or standard application at no upcharge.
- Support hardware must be ordered separately. See listings in this section.
- Worksurfaces greater than 48" wide require additional structural support.
- Please choose from Designer White (DWT), Silver (SIL) or Black (BLK) for scoop covers.

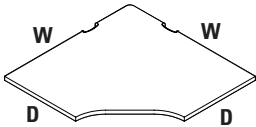
	DESCRIPTION	PRODUCT CODE	LIST PRICE			DIMENSIONS/INCHES	
			TF	HP	HPW	D	W
	Corner Keyboard Worksurface - 36"	EWCK3618P	505	667	1000	18	36
		EWCK3624P	649	830	1243	24	36
		EWCK3618WGP	567	746	1119	18	36
		EWCK3624WGP	730	929	1392	24	36
	Corner Keyboard Worksurface - 42"	EWCK4224P	745	987	1483	24	42
		EWCK4230P	849	1165	1753	30	42
		EWCK4224WGP	834	1105	1659	24	42
		EWCK4230WGP	950	1308	1960	30	42
	Corner Keyboard Worksurface - 48"	EWCK4824P	909	1297	1950	24	48
		EWCK4830P	1010	1425	2137	30	48

**EVWCF - FIVE-SIDED WORKSURFACE**

- When specifying woodgrain laminate (WG) for corner worksurfaces 42" wide or less, choose from a diagonally run grain for an upcharge or standard application at no upcharge.
- Support hardware must be ordered separately. See listings in this section.
- Please choose from Designer White (DWT), Silver (SIL) or Black (BLK) for scoop covers.

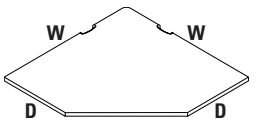
	DESCRIPTION	PRODUCT CODE	LIST PRICE			DIMENSIONS/INCHES	
			TF	HP	HPW	D	W
	Five-Sided Keyboard Worksurface - 36"	EWCF3012P	347	459	667	12	30
	Five-Sided Keyboard Worksurface - 36"	EWCF3612P	459	607	882	12	30
		EWCF3618P	499	656	983	18	36
		EWCF3624P	544	721	1082	24	36
		EWCF3618WGP	556	735	1103	18	36
	Five-Sided Keyboard Worksurface - 42"	EWCF4224P	737	976	1465	24	42
		EWCF4230P	801	1058	1582	30	42
		EWCF4224WGP	824	1092	1636	24	42
		EWCF4230WGP	899	1182	1771	30	42
	Five-Sided Keyboard Worksurface - 48"	EWCF4824P	862	1118	1674	24	48
		EWCF4830P	902	1287	1931	30	48



**EVWCCEL - EXTENDED CURVED CORNER - LEFT**

- There are three cable scoops on this worksurface.
- Support hardware must be ordered separately. See listing in this section of the price book.
- Wood Grain Laminates do not run diagonally on Extended Curved Corners.
- Worksurfaces greater than 48" wide require additional structural support.
- Please choose from Designer White (DWT), Silver (SIL) or Black (BLK) for scoop covers.

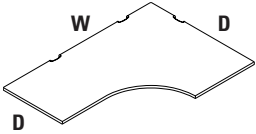
	DESCRIPTION	PRODUCT CODE	LIST PRICE			DIMENSIONS/INCHES		
			TF	HP	HPW	D1	D2	W
	Extended Curved Corner - 36" x 24"	EVWCCEL362448P	675	862	1290	36	24	48
		EVWCCEL362460P	735	941	1413	36	24	60
		EVWCCEL362466P	808	1037	1553	36	24	66
		EVWCCEL362472P	891	1150	1721	36	24	72
		EVWCCEL362478P	954	1224	1837	36	24	78
		EVWCCEL362484P	1027	1318	1980	36	24	84
	Extended Curved Corner - 42" x 24"	EVWCCEL422460P	774	988	1484	42	24	60
		EVWCCEL422466P	849	1093	1637	42	24	66
		EVWCCEL422472P	940	1207	1804	42	24	72
		EVWCCEL422478P	1004	1287	1931	42	24	78
		EVWCCEL422484P	1081	1389	2084	42	24	84
	Extended Curved Corner - 42" x 30"	EVWCCEL423060P	869	1120	1679	42	30	60
		EVWCCEL423066P	954	1224	1837	42	30	66
		EVWCCEL423072P	1042	1337	2007	42	30	72
		EVWCCEL423078P	1118	1434	2149	42	30	78
		EVWCCEL423084P	1191	1529	2290	42	30	84
	Extended Curved Corner - 48" x 24"	EVWCCEL482460P	917	1131	1699	48	24	60
		EVWCCEL482466P	988	1260	1892	48	24	66
		EVWCCEL482472P	1062	1377	2065	48	24	72
		EVWCCEL482478P	1165	1470	2204	48	24	78
		EVWCCEL482484P	1215	1560	2337	48	24	84
	Extended Curved Corner - 48" x 30"	EVWCCEL483060P	968	1246	1868	48	30	60
		EVWCCEL483066P	1053	1358	2037	48	30	66
		EVWCCEL483072P	1144	1472	2205	48	30	72
		EVWCCEL483078P	1229	1581	2373	48	30	78
		EVWCCEL483084P	1296	1669	2502	48	30	84

**EVWCER - EXTENDED CURVED CORNER - RIGHT**

- There are three cable scoops on this worksurface.
- Support hardware must be ordered separately. See listing in this section of the price list.
- Wood Grain Laminates do not run diagonally on Extended Curved Corners.
- Worksurfaces greater than 48" wide require additional structural support.
- Please choose from Designer White (DWT), Silver (SIL) or Black (BLK) for scoop covers.

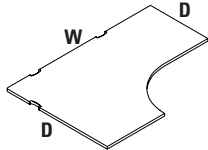
DESCRIPTION	PRODUCT CODE	LIST PRICE			DIMENSIONS/INCHES		
		TF	HP	HPW	D1	D2	W
 Extended Curved Corner - 36" x 24"	EVWCER362448P	675	862	1290	36	24	48
	EVWCER362460P	735	941	1413	36	24	60
	EVWCER362466P	808	1037	1553	36	24	66
	EVWCER362472P	891	1150	1721	36	24	72
	EVWCER362478P	954	1224	1837	36	24	78
	EVWCER362484P	1027	1318	1980	36	24	84
Extended Curved Corner - 42" x 24"	EVWCER422460P	774	988	1484	42	24	60
	EVWCER422466P	849	1093	1637	42	24	66
	EVWCER422472P	940	1207	1804	42	24	72
	EVWCER422478P	1004	1287	1931	42	24	78
	EVWCER422484P	1081	1389	2084	42	24	84
	Extended Curved Corner - 42" x 30"	EVWCER423060P	869	1120	1679	42	30
EVWCER423066P		954	1224	1837	42	30	66
EVWCER423072P		1042	1337	2007	42	30	72
EVWCER423078P		1118	1434	2149	42	30	78
EVWCER423084P		1191	1529	2290	42	30	84
Extended Curved Corner - 48" x 24"		EVWCER482460P	917	1131	1699	48	24
	EVWCER482466P	988	1260	1892	48	24	66
	EVWCER482472P	1062	1377	2065	48	24	72
	EVWCER482478P	1165	1470	2204	48	24	78
	EVWCER482484P	1215	1560	2337	48	24	84
	Extended Curved Corner - 48" x 30"	EVWCER483060P	968	1246	1868	48	30
EVWCER483066P		1053	1358	2037	48	30	66
EVWCER483072P		1144	1472	2205	48	30	72
EVWCER483078P		1229	1581	2373	48	30	78
EVWCER483084P		1296	1669	2502	48	30	84

**EVWC4C - CURVED CORNER SURFACE FOR 45° POST**

- Support hardware must be ordered separately. See the listing in this section.
- Please choose from Designer White (DWT), Silver (SIL) or Black (BLK) for scoop covers.

DESCRIPTION	PRODUCT CODE	LIST PRICE			DIMENSIONS/INCHES	
		TF	HP	HPW	D	W
 Corner Curved Surface for 45° Post - 18"	EVWC4C1824P	476	612	918	18	24
	EVWC4C1830P	733	941	1413	18	30
	EVWC4C1836P	1042	1341	2011	18	36
	EVWC4C1842P	1300	1671	2510	18	42
	EVWC4C1848P	1516	1951	2925	18	48
Corner Curved Surface for 45° Post - 24"	EVWC4C2424P	571	734	1100	24	24
	EVWC4C2430P	854	1100	1645	24	30
	EVWC4C2436P	1192	1534	2301	24	36
	EVWC4C2442P	1300	1671	2510	24	42
	EVWC4C2448P	1705	2193	3291	24	48
Corner Curved Surface for 45° Post - 30"	EVWC4C3024P	665	857	1282	30	24
	EVWC4C3030P	1053	1254	1880	30	30
	EVWC4C3036P	1192	1534	2301	30	36
	EVWC4C3042P	1460	1880	2821	30	42
	EVWC4C3048P	1895	2438	3656	30	48



**EVWC4K - KEYBOARD CORNER SURFACE FOR 45° POST**

- Support hardware must be ordered separately. See the listing in this section.
- Worksurfaces greater than 48" wide require additional structural support.
- Please choose from Designer White (DWT), Silver (SIL) or Black (BLK) for scoop covers.

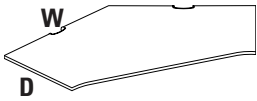
	DESCRIPTION	PRODUCT CODE	LIST PRICE			DIMENSIONS/INCHES	
			TF	HP	HPW	D	W
	Keyboard Curved Surface for 45° Post - 18"	EVWC4K1824P	476	612	918	18	24
		EVWC4K1830P	733	780	1171	18	30
		EVWC4K1836P	1042	1358	2037	18	36
	Keyboard Curved Surface for 45° Post - 24"	EVWC4K1842P	1300	1671	2510	18	42
		EVWC4K1848P	1516	1951	2925	18	48
		EVWC4K2424P	571	734	1100	24	24
		EVWC4K2430P	854	1100	1645	24	30
		EVWC4K2436P	1192	1534	2301	24	36
		EVWC4K2442P	1300	1671	2510	24	42
	Keyboard Curved Surface for 45° Post - 30"	EVWC4K2448P	1705	2193	3291	24	48
		EVWC4K3024P	665	857	1282	30	24
		EVWC4K3030P	976	1254	1880	30	30
EVWC4K3036P		1192	1534	2301	30	36	
EVWC4K3042P		1460	1880	2821	30	42	
EVWC4K3048P		1895	2438	3656	30	48	

**EVWC6C - CURVED CORNER SURFACE FOR 60° POST**

- Support hardware must be ordered separately. See the listing in this section.
- Please choose from Designer White (DWT), Silver (SIL) or Black (BLK) for scoop covers.

	DESCRIPTION	PRODUCT CODE	LIST PRICE			DIMENSIONS/INCHES	
			TF	HP	HPW	D	W
	Curved Curved Surface for 60° Post - 18"	EVWC6C1824P	382	505	761	18	24
		EVWC6C1830P	596	675	1010	18	30
		EVWC6C1836P	891	1010	1516	18	36
	Curved Curved Surface for 60° Post - 24"	EVWC6C1842P	1092	1235	1852	18	42
		EVWC6C1848P	1487	1685	2526	18	48
		EVWC6C2424P	446	508	764	24	24
		EVWC6C2430P	794	900	1347	24	30
		EVWC6C2436P	891	1010	1516	24	36
		EVWC6C2442P	1363	1542	2315	24	42
	Curved Curved Surface for 60° Post - 30"	EVWC6C2448P	1487	1685	2526	24	48
		EVWC6C3024P	446	508	764	30	24
		EVWC6C3030P	794	900	1347	30	30
EVWC6C3036P		891	1010	1516	30	36	
EVWC6C3042P		1363	1542	2315	30	42	
EVWC6C3048P		1487	1685	2526	30	48	

**EVWC6K - CURVED CORNER SURFACE FOR 60° POST**

- Support hardware must be ordered separately. See the listing in this section.
- Please choose from Designer White (DWT), Silver (SIL) or Black (BLK) for scoop covers.

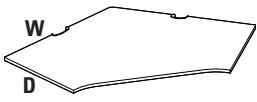
	DESCRIPTION	PRODUCT CODE	LIST PRICE			DIMENSIONS/INCHES	
			TF	HP	HPW	D	W
	Keyboard Curved Surface for 60° Post - 18"	EVWC6K1824P	373	422	633	18	24
		EVWC6K1830P	596	675	1010	18	30
		EVWC6K1836P	891	1010	1516	18	36
	Keyboard Curved Surface for 60° Post - 24"	EVWC6K1842P	1092	1235	1852	18	42
		EVWC6K1848P	1487	1685	2526	18	48
		EVWC6K2430P	794	900	1347	24	30
		EVWC6K2436P	891	1010	1516	24	36
		EVWC6K2442P	1363	1542	2315	24	42
		EVWC6K2448P	1487	1685	2526	24	48
	Keyboard Curved Surface for 60° Post - 30"	EVWC6K3030P	794	900	1347	30	30
		EVWC6K3036P	889	1184	1775	30	36
		EVWC6K3042P	1216	1624	2431	30	42
EVWC6K3048P		1473	1975	2959	30	48	



# WORKSURFACES

## EVWL - "L" WORKSURFACE

- There are three cable scoops on this worksurface.
- Support hardware must be ordered separately. See listing in this section of the price list.
- Must be specified either left or right handed.
- Wood Grain Laminates do not run diagonally on Extended Curved Corners.
- Worksurfaces greater than 48" wide require additional structural support.
- Please choose from Designer White (DWT), Silver (SIL) or Black (BLK) for scoop covers.

DESCRIPTION	PRODUCT CODE	LIST PRICE			DIMENSIONS/INCHES	
		TF	HP	HPW	D	W
"L" Worksurface	EVWLL2472P	765	1048	1569	24	72
	EVWLR2472P	765	1048	1569	24	72

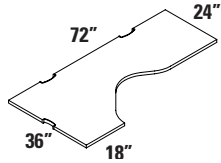

Right shown

## EVWBT - 30" TRANSITION WORKSURFACE

- Support hardware must be ordered separately. See the listing in this section of the price list.
- Opposing side of 30" deep (D1) Transition Worksurface has depth of 24" (D2).
- Scoops located on back edge only.
- Must be specified as right or left handed.
- Please choose from Designer White (DWT), Silver (SIL) or Black (BLK) for scoop covers.

DESCRIPTION	PRODUCT CODE	LIST PRICE			DIMENSIONS/INCHES		
		TF	HP	HPW	D1	D2	W
Transition Worksurface - Left - 30"	EVWBTL3060P	601	774	1160	30	24	60
	EVWBTL3066P	664	851	1275	30	24	66
	EVWBTL3072P	721	929	1393	30	24	72
Transition Worksurface - Right - 30"	EVWBTR3060P	601	774	1160	30	24	60
	EVWBTR3066P	664	851	1275	30	24	66
	EVWBTR3072P	721	929	1393	30	24	72

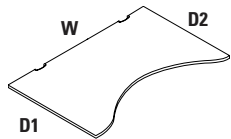

Left shown

## EVWBT - 36" TRANSITION WORKSURFACE

- Support hardware must be ordered separately. See the listing in this section of the price list.
- Opposing side of 36" deep (D1) Transition Worksurface has depth of 30" (D2).
- Scoops located on back edge only.
- Must be specified as right or left handed.
- Please choose from Designer White (DWT), Silver (SIL) or Black (BLK) for scoop covers.

DESCRIPTION	PRODUCT CODE	LIST PRICE			DIMENSIONS/INCHES		
		TF	HP	HPW	D1	D2	W
Transition Worksurface - Left - 36"	EVWBTL3660P	721	929	1393	36	30	60
	EVWBTL3666P	794	1020	1531	36	30	66
	EVWBTL3672P	866	1115	1669	36	30	72
Transition Worksurface - Right - 36"	EVWBTR3660P	721	929	1393	36	30	60
	EVWBTR3666P	794	1020	1531	36	30	66
	EVWBTR3672P	866	1115	1669	36	30	72

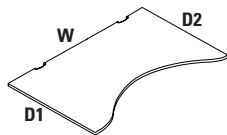

Left shown



# WORKSURFACES

## EVWSH - STRAIGHT EDGE HATCHET WORKSURFACE (LEFT SHOWN)

- Cable scoop is in the center of the 36" wide edge.
- Support hardware must be ordered separately. See listing in this section of the price list
- Monoleg is included
- Must be specified either left or right handed.
- Wood Grain Laminates do not run diagonally on Hatchet Corners
- Please choose from Designer White (DWT), Silver (SIL) or Black (BLK) for scoop covers.

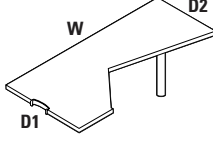
	DESCRIPTION	PRODUCT CODE	LIST PRICE	DIMENSIONS/INCHES		
				D1	D2	W
	Straight Edge Hatchet Worksurface - Left	EVWSHL3672P	1163	36	30	72
	Straight Edge Hatchet Worksurface - Right	EVWSHR3672P	1163	36	30	72

Left Shown

## EVWD - "D" WORKSURFACE

- Support hardware must be ordered separately. See listing in this section of the price list.
- Monoleg is included
- Worksurfaces greater than 48" wide require additional structural support.
- Please choose from Designer White (DWT), Silver (SIL) or Black (BLK) for scoop covers.

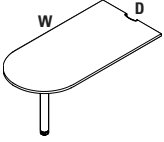
	DESCRIPTION	PRODUCT CODE	LIST PRICE			DIMENSIONS/INCHES	
			TF	HP	HPW	D	W
	"D" Worksurface - 24"	EVWD2442P	544	761	1136	24	42
		EVWD2448P	563	775	1161	24	48
		EVWD2460P	591	813	1219	24	60
		EVWD2472P	633	875	1314	24	72
	"D" Worksurface - 30"	EVWD3048P	600	838	1256	30	48
		EVWD3060P	633	875	1314	30	60
		EVWD3072P	699	970	1454	30	72

## EVWPTR - "P" TOP

- There is one scoop on this worksurface.
- Support hardware must be ordered separately. See listing in this section of the price book.
- Must be specified either left or right handed.
- Monoleg is included.
- Please choose from Designer White (DWT), Silver (SIL) or Black (BLK) for scoop covers.

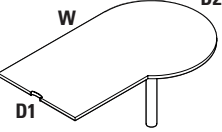
	DESCRIPTION	PRODUCT CODE	LIST PRICE			DIMENSIONS/INCHES		
			TF	HP	HPW	D1	D2	W
	"P" Top Worksurface - 24" Right	EVWPTR245430P	834	1074	1611	24	30	54
		EVWPTR246030P	896	1131	1699	24	30	60
		EVWPTR246630P	938	1192	1787	24	30	66
		EVWPTR247230P	987	1252	1875	24	30	72
	"P" Top Worksurface - 30" Right	EVWPTR306036P	987	1243	1864	30	36	60
		EVWPTR306636P	1067	1314	1969	30	36	66
		EVWPTR307236P	1141	1378	2066	30	36	72
	"P" Top Worksurface - 24" Left	EVWPTL245430P	834	1074	1611	24	30	54
		EVWPTL246030P	896	1131	1699	24	30	60
		EVWPTL246630P	938	1192	1787	24	30	66
		EVWPTL247230P	987	1252	1875	24	30	72
	"P" Top Worksurface - 30" Left	EVWPTL306036P	987	1243	1864	30	36	60
		EVWPTL306636P	1067	1314	1969	30	36	66
		EVWPTL307236P	1141	1378	2066	30	36	72

Left Hand Shown

**EVWSW - STRAIGHT WEDGE WORKSURFACES**

- There is one scoop on this worksurface.
- Must be specified either left or right handed.
- Support hardware must be ordered separately. See listing in this section of the price book.
- Worksurfaces greater than 48" wide require additional structural support.
- Please choose from Designer White (DWT), Silver (SIL) or Black (BLK) for scoop covers.

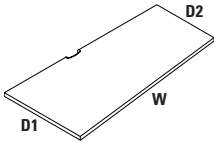
	DESCRIPTION	PRODUCT CODE	LIST PRICE			DIMENSIONS/INCHES			
			TF	HP	HPW	D1	D2	W	
	Straight Wedge Worksurface - Left	EVWSW241848P	385	494	737	24	18	48	
		EVWSW241854P	434	556	833	24	18	54	
		EVWSW241860P	479	618	926	24	18	60	
		EVWSW241866P	531	678	1018	24	18	66	
		EVWSW241872P	575	743	1113	24	18	72	
			EVWSW302448P	479	618	926	30	24	48
			EVWSW302454P	539	695	1040	30	24	54
			EVWSW302460P	600	770	1155	30	24	60
			EVWSW302466P	658	847	1272	30	24	66
			EVWSW302472P	719	923	1386	30	24	72
		Straight Wedge Worksurface - Right	EVWSW182448P	385	494	737	18	24	48
			EVWSW182454P	434	556	833	18	24	54
			EVWSW182460P	479	618	926	18	24	60
			EVWSW182466P	531	678	1018	18	24	66
			EVWSW182472P	575	743	1113	18	24	72
				EVWSW243048P	479	618	926	24	30
EVWSW243054P				539	695	1040	24	30	54
EVWSW243060P				600	770	1155	24	30	60
EVWSW243066P				658	847	1272	24	30	66
EVWSW243072P				719	923	1386	24	30	72

**EVWSWNSC - STRAIGHT WEDGE WORKSURFACES NO SCOOPS**

- There is no scoop on this worksurface.
- Support hardware must be ordered separately. See listing in this section of the price book.
- Must be specified either left or right handed.
- Surfaces not available in HPW.

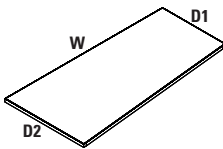
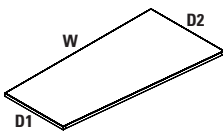
	DESCRIPTION	PRODUCT CODE	LIST PRICE		DIMENSIONS/INCHES			
			TF	HP	D1	D2	W	
	Straight Wedge Worksurface No Scoops - Left	EVWSWNSC241848	385	494	24	18	48	
		EVWSWNSC241854	434	556	24	18	54	
		EVWSWNSC241860	479	618	24	18	60	
		EVWSWNSC241866	531	678	24	18	66	
		EVWSWNSC241872	575	743	24	18	72	
			EVWSWNSC302448	479	618	30	24	48
			EVWSWNSC302454	539	695	30	24	54
			EVWSWNSC302460	600	770	30	24	60
			EVWSWNSC302466	658	847	30	24	66
			EVWSWNSC302472	719	923	30	24	72
	Straight Wedge Worksurface No Scoops - Right	EVWSWNSC182448	385	494	18	24	48	
		EVWSWNSC182454	434	556	18	24	54	
		EVWSWNSC182460	479	618	18	24	60	
		EVWSWNSC182466	531	678	18	24	66	
		EVWSWNSC182472	575	743	18	24	72	
			EVWSWNSC243048	479	618	24	30	48
			EVWSWNSC243054	539	695	24	30	54
			EVWSWNSC243060	600	770	24	30	60
			EVWSWNSC243066	658	847	24	30	66
			EVWSWNSC243072	719	923	24	30	72



**EVWPL - PIANO TOP - LEFT**

- There is one scoop on this worksurface.
- Monoleg is included.
- Wood Grain Laminates do not run diagonally on Extended Curved Corners.
- Support hardware must be ordered separately. See listing in this section of the price book.
- Worksurfaces greater than 48" wide require additional structural support. Please choose from Designer White (DWT), Silver (SIL) or Black (BLK) for scoop covers.

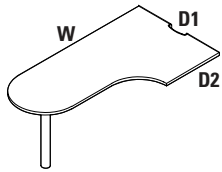

DESCRIPTION	PRODUCT CODE	LIST PRICE			DIMENSIONS/INCHES		
		TF	HP	HPW	D1	D2	W
Piano Top - Left - 36" x 18"	EVWPL361848P	757	999	1493	36	18	48
	EVWPL361854P	829	1058	1582	36	18	54
	EVWPL361860P	891	1119	1676	36	18	60
	EVWPL361866P	961	1179	1767	36	18	66
	EVWPL361872P	1026	1239	1854	36	18	72
Piano Top - Left - 36" x 24"	EVWPL362448P	765	1004	1503	36	24	48
	EVWPL362454P	834	1062	1593	36	24	54
	EVWPL362460P	901	1122	1685	36	24	60
	EVWPL362466P	970	1185	1777	36	24	66
	EVWPL362472P	1032	1243	1864	36	24	72
Piano Top - Left - 42" x 24"	EVWPL422454P	1026	1146	1720	42	24	54
	EVWPL422460P	1088	1213	1817	42	24	60
	EVWPL422466P	1204	1285	1927	42	24	66
Piano Top - Left - 42" x 30"	EVWPL422472P	1278	1348	2021	42	24	72
	EVWPL423060P	1113	1240	1858	42	30	60
	EVWPL423066P	1230	1311	1963	42	30	66
Piano Top - Left - 42" x 30"	EVWPL423072P	1302	1379	2068	42	30	72
	EVWPL482460P	1152	1389	2084	48	24	60
	EVWPL482466P	1276	1472	2205	48	24	66
Piano Top - Left - 48" x 24"	EVWPL482472P	1352	1555	2336	48	24	72
	EVWPL483066P	1282	1477	2213	48	30	66
	EVWPL483072P	1358	1565	2343	48	30	72

**EVWPR - PIANO TOP - RIGHT**

- There is one scoop on this worksurface.
- Monoleg is included.
- Support hardware must be ordered separately. See listing in this section of the price book.
- Please choose from Designer White (DWT), Silver (SIL) or Black (BLK) for scoop covers.

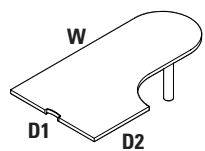

DESCRIPTION	PRODUCT CODE	LIST PRICE			DIMENSIONS/INCHES		
		TF	HP	HPW	D1	D2	W
Piano Top - Right - 36" x 18"	EVWPR361848P	757	999	1493	36	18	48
	EVWPR361854P	829	1058	1582	36	18	54
	EVWPR361860P	891	1119	1676	36	18	60
	EVWPR361866P	961	1179	1767	36	18	66
	EVWPR361872P	1026	1239	1854	36	18	72
Piano Top - Right - 36" x 24"	EVWPR362448P	765	1004	1503	36	24	48
	EVWPR362454P	834	1062	1593	36	24	54
	EVWPR362460P	901	1122	1685	36	24	60
	EVWPR362466P	970	1185	1777	36	24	66
	EVWPR362472P	1032	1243	1864	36	24	72
Piano Top - Right - 42" x 24"	EVWPR422454P	1026	1146	1720	42	24	54
	EVWPR422460P	1088	1213	1817	42	24	60
	EVWPR422466P	1204	1285	1927	42	24	66
Piano Top - Right - 42" x 30"	EVWPR422472P	1278	1348	2021	42	24	72
	EVWPR423060P	1113	1240	1858	42	30	60
	EVWPR423066P	1230	1311	1963	42	30	66
Piano Top - Right - 42" x 30"	EVWPR423072P	1302	1379	2068	42	30	72
	EVWPR482460P	1152	1389	2084	48	24	60
	EVWPR482466P	1276	1472	2205	48	24	66
Piano Top - Right - 48" x 24"	EVWPR482472P	1352	1555	2336	48	24	72
	EVWPR483066P	1282	1477	2213	48	30	66
	EVWPR483072P	1358	1565	2343	48	30	72

**EVWQR - QUARTER ROUND PANEL WORKSURFACE**

- The worksurface edge running along the panel is a slightly different length than that of the worksurface end, causing the surface to be handed.
- Left hand surface shown.
- The user edge abutting the adjacent worksurface runs straight for 3" before starting to curve.
- Support hardware must be ordered separately. See listing in this section of the price book.
- Worksurfaces greater than 48" wide require additional structural support.

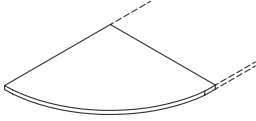
	DESCRIPTION	PRODUCT CODE	LIST PRICE			DIMENSIONS/INCHES	
			TF	HP	HPW	D	W
	Quarter Round Panel Worksurface - Left	EWQRL1818	163	217	323	18	18
		EWQRL2424	229	304	457	24	24
		EWQRL3030	302	393	588	30	30
	Quarter Round Panel Worksurface - Right	EWQRR1818	163	217	323	18	18
		EWQRR2424	229	304	457	24	24
		EWQRR3030	302	393	588	30	30

**EVWQRC - QUARTER ROUND PANEL CORNER WORKSURFACE**

- Wraps around a 90° corner post.
- The user edge abutting the adjacent worksurface runs straight for 3" before starting to curve.
- Support hardware must be ordered separately. See the listing in this section.

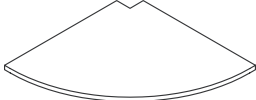
	DESCRIPTION	PRODUCT CODE	LIST PRICE			DIMENSIONS/INCHES	
			TF	HP	HPW	D	W
	Quarter Round Panel Corner Worksurface	EWQRC1818	190	251	376	18	18
		EWQRC2424	272	360	541	24	24
		EWQRC3030	338	445	667	30	30



## EVWR - RADIUS WORKSURFACE

- Support hardware must be ordered separately. See listing in this section of the price book.
- Monoleg is included.
- Notched end is not finished.
- 18" and 24" come with one monoleg.
- 30" comes with two monolegs.
- Worksurfaces greater than 48" wide require additional structural support.
- Please choose from Designer White (DWT), Silver (SIL) or Black (BLK) for scoop covers.

DESCRIPTION	PRODUCT CODE	LIST PRICE			DIMENSIONS/INCHES	
		TF	HP	HPW	D	W
Radius Worksurface	EVWR18P	470	649	974	18	39
	EVWR24P	543	753	1130	24	51
	EVWR30P	977	1353	2028	30	63

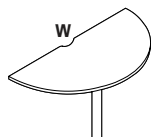

## EVWSAC - ARC FRONT WORKSURFACE

- Use 12" cantilever supports on shorter 13" depth
- Support hardware must be order separately. See the listing in the section.

DESCRIPTION	PRODUCT CODE	LIST PRICE		DIMENSIONS/INCHES		
		LP	HP	D1	D2	W
Arc Front Worksurface - Left	EVWSAC122430	248	348	12	24	30
	EVWSAC122436	292	413	12	24	36
	EVWSAC122442	340	490	12	24	42
	EVWSAC122448	391	548	12	24	48
	EVWSAC122454	439	616	12	24	54
	EVWSAC122460	479	686	12	24	60
Arc Front Worksurface - Right	EVWSAC241230	248	348	12	24	30
	EVWSAC241236	292	413	12	24	36
	EVWSAC241242	340	490	12	24	42
	EVWSAC241248	391	548	12	24	48
	EVWSAC241254	439	616	12	24	54
	EVWSAC241260	479	686	12	24	60

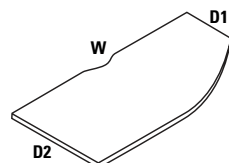

Left shown

**EVWKKR - ANGLE FRONT EDGE WORKSURFACE**

- To be used with EVWCF3012 and EVWCF3612 Corner Worksurface.
- Creates an efficient, compact keyboard corner worksurface.
- Use 12" cantilever supports on shorter 12" depth
- For use with flat screen monitor.
- Support hardware must be order separately. See the listing in the section.
- Worksurfaces greater than 48" wide require additional structural support.

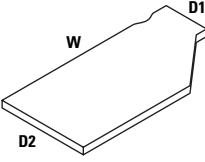
	DESCRIPTION	PRODUCT CODE	LIST PRICE		DIMENSIONS/INCHES		
			LP	HP	D1	D2	W
	Angle Front Edge Worksurface - Right	EVWKKR2436	257	338	12	24	36
		EVWKKR2442	297	393	12	24	42
		EVWKKR2448	339	451	12	24	48
	Angle Front Edge Worksurface - Left	EVWKKL2436	257	338	12	24	36
		EVWKKL2442	297	393	12	24	42
		EVWKKL2448	339	451	12	24	48

Left shown

**EVWT - STRAIGHT TRANSACTION WORKSURFACE**

- Support hardware must be ordered separately. See listing in this section of the price book.

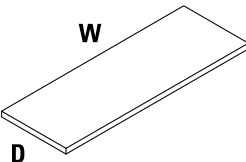
	DESCRIPTION	PRODUCT CODE	TF	LIST PRICE		DIMENSIONS/INCHES	
				HP	HPW	D	W
	Straight Transaction Worksurface	EVWT1512	66	92	138	15	12
		EVWT1518	87	119	175	15	18
		EVWT1524	104	145	216	15	24
		EVWT1530	125	169	252	15	30
		EVWT1536	141	193	291	15	36
		EVWT1542	160	220	328	15	42
		EVWT1548	181	247	365	15	48
		EVWT1554	197	269	405	15	54
		EVWT1560	218	299	445	15	60
		EVWT1566	233	324	488	15	66
		EVWT1572	252	350	523	15	72
		EVWT1578	271	373	558	15	78
		EVWT1584	290	400	600	15	84

**EVWTV - STRAIGHT TRANSACTION WORKSURFACE WITH CUT-OUT**

- Used when mounted to a panel that has a taller panel against it in a straight run at an inline.
- Support hardware must be ordered separately. See listing in this section of the price book.

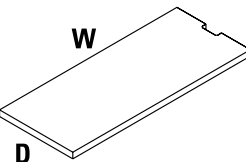
	DESCRIPTION	PRODUCT CODE	TF	LIST PRICE		DIMENSIONS/INCHES	
				HP	HPW	W	D
	Straight Transaction Worksurface with Cut-Out	EVWTV1524	119	154	228	15	24
		EVWTV1530	131	182	269	15	30
		EVWTV1536	152	205	304	15	36
		EVWTV1542	171	231	349	15	42
		EVWTV1548	190	260	389	15	48
		EVWTV1554	209	281	421	15	54
		EVWTV1560	227	301	451	15	60
		EVWTV1566	249	354	527	15	66
		EVWTV1572	262	360	541	15	72



**EVWTCL - "L" CORNER TRANSACTION SURFACE**

- When specifying this item along with a straight surface, deduct 12" from each return side.
- Support hardware must be ordered separately. See listing in this section of the price book.
- Worksurfaces greater than 48" wide require additional structural support.

DESCRIPTION	PRODUCT CODE	LIST PRICE			DIMENSIONS/INCHES	
		TF	HP	HPW	D	W
"L" Corner Transaction Surface	EVWTCL90	192	257	382	15	21

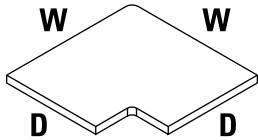

**EVWTCT - "T" CORNER TRANSACTION SURFACE**

- When specifying this item along with a straight surface, deduct 12" from each return side.
- Support hardware must be ordered separately. See listing in this section of the price book.

DESCRIPTION	PRODUCT CODE	LIST PRICE			DIMENSIONS/INCHES	
		TF	HP	HPW	D	W
"T" Corner Transaction Surface	EVWTCT90	170	231	349	15	27

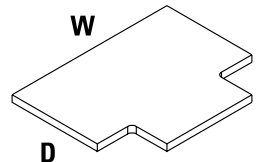

**EVWTE - END TRANSACTION SURFACE**

- Extends 1" past end of run.
- Support hardware must be ordered separately. See listing in this section of the price book.

DESCRIPTION	PRODUCT CODE	LIST PRICE			DIMENSIONS/INCHES	
		TF	HP	HPW	D	W
End Transaction Surface	EVWTE1512	87	119	175	15	14
	EVWTE1518	104	145	216	15	20
	EVWTE1524	125	169	252	15	26
	EVWTE1530	141	193	291	15	32
	EVWTE1536	160	220	328	15	38
	EVWTE1542	181	247	365	15	44
	EVWTE1548	197	269	405	15	50
	EVWTE1554	218	299	445	15	56
	EVWTE1560	233	324	488	15	62
	EVWTE1566	252	350	523	15	68
EVWTE1572	271	373	558	15	74	

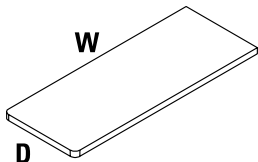

**EVWTEV - END TRANSACTION SURFACE WITH CUT-OUT**

- Used when mounted to a panel that has a taller panel against it in a straight run at an inline.
- Support hardware must be ordered separately. See listing in this section of the price book.
- Notched end is not finished.
- Extends 1" past end of run

DESCRIPTION	PRODUCT CODE	LIST PRICE			DIMENSIONS/INCHES	
		TF	HP	HPW	D	W
End Transaction Surface with Cut-Out	EVWTEV1524	131	182	269	15	26
	EVWTEV1530	152	205	304	15	32
	EVWTEV1536	171	231	349	15	38
	EVWTEV1542	190	260	389	15	44
	EVWTEV1548	209	281	421	15	50
	EVWTEV1554	227	310	464	15	56
	EVWTEV1560	249	335	502	15	62
	EVWTEV1566	262	361	542	15	68
	EVWTEV1572	282	389	578	15	74

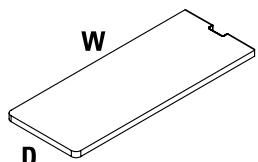



**EVWTD - "D" TRANSACTION SURFACE**

- Support hardware must be ordered separately. See listing in this section of the price book.
- Worksurfaces greater than 48" wide require additional structural support.

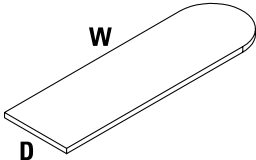
	DESCRIPTION	PRODUCT CODE	LIST PRICE			DIMENSIONS/INCHES	
			TF	HP	HPW	D	W
	"D" Transaction Surface	EVWTD1530	159	217	323	15	37
		EVWTD1536	170	233	350	15	43
		EVWTD1542	187	260	389	15	49
		EVWTD1548	209	284	423	15	55
		EVWTD1554	226	313	469	15	61
		EVWTD1560	249	340	508	15	67
		EVWTD1566	263	365	548	15	73
		EVWTD1572	289	399	598	15	79

**EVWTDV - END "D" TRANSACTION SURFACE WITH CUT-OUT**

- Notched end is not finished.
- Used when mounted to a panel that has a taller panel against it in a straight run at an inline.
- Support hardware must be ordered separately. See listing in this section of the price book.

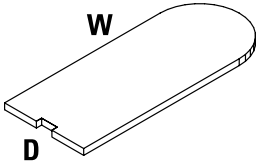
	DESCRIPTION	PRODUCT CODE	LIST PRICE			DIMENSIONS/INCHES	
			TF	HP	HPW	D	W
	End "D" Transaction Surface with Cut-Out	EVWTDV1530	170	227	340	15	37
		EVWTDV1536	181	246	362	15	43
		EVWTDV1542	200	268	401	15	49
		EVWTDV1548	219	297	444	15	55
		EVWTDV1554	233	321	479	15	61
		EVWTDV1560	258	352	525	15	67

**EVWTD - DOUBLE "D" TRANSACTION SURFACE**

- Support hardware must be ordered separately. See listing in this section of the price book.

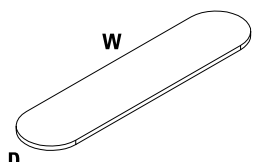
	DESCRIPTION	PRODUCT CODE	LIST PRICE			DIMENSIONS/INCHES	
			TF	HP	HPW	D	W
	Double "D" Transaction Surface	EVWTD1548	233	324	488	15	48
		EVWTD1560	271	373	558	15	60
		EVWTD1572	317	438	652	15	72

**EVW4T - CORNER TRANSACTION SURFACE FOR 45° POST**

- Support hardware must be ordered separately. See listing in this section of the price book.

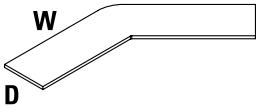
	DESCRIPTION	PRODUCT CODE	LIST PRICE			DIMENSIONS/INCHES	
			TF	HP	HPW	W	D
	Corner Transaction Surface for 45° Post	EVW4T1524	652	838	1256	15	24
		EVW4T1530	813	1048	1569	15	30
		EVW4T1536	1138	1465	2193	15	36
		EVW4T1542	1516	1951	2925	15	42
		EVW4T1548	1625	2088	3135	15	48



**EVW6T - CORNER TRANSACTION SURFACE FOR 60° POST**

- Support hardware must be ordered separately. See listing in this section of the price book.
- Worksurfaces greater than 48" wide require additional structural support.

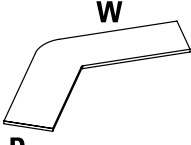
DESCRIPTION	PRODUCT CODE	TF	LIST PRICE			DIMENSIONS/INCHES	
			HP	HPW	D	W	
 Corner Transaction Surface for 60° Post	EVW6T1518	382	503	751	15	18	
	EVW6T1524	597	796	1191	15	24	
	EVW6T1530	777	1037	1553	15	30	
	EVW6T1536	1080	1440	2158	15	36	
	EVW6T1542	1176	1569	2350	15	42	
	EVW6T1548	1538	2052	3078	15	48	

**EVW9T - CORNER TRANSACTION SURFACE FOR 90° POST**

- Support hardware must be ordered separately. See listing in this section of the price book.

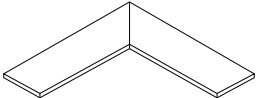
DESCRIPTION	PRODUCT CODE	TF	LIST PRICE			DIMENSIONS/INCHES	
			HP	HPW	D	W	
 Corner Transaction Surface for 90° Post - Left	EVW9TL1524	371	564	845	15	24	
	EVW9TL1530	445	682	1020	15	30	
	EVW9TL1536	520	788	1182	15	36	
	EVW9TL1542	594	901	1349	15	42	
	EVW9TL1548	668	1014	1520	15	48	
Corner Transaction Surface for 90° Post - Right	EVW9TR1524	371	564	845	15	24	
	EVW9TR1530	445	682	1020	15	30	
	EVW9TR1536	520	788	1182	15	36	
	EVW9TR1542	594	901	1349	15	42	
	EVW9TR1548	668	1014	1520	15	48	

**EVWMP - WORKSURFACE MODESTY PANEL**

- Modesty panel fastens to the worksurface and monoleg to provide additional privacy and support
- Made of cold rolled steel
- Metal finish is durable epoxy powder coated.

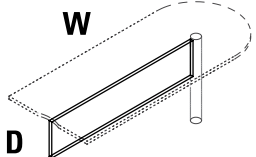
DESCRIPTION	PRODUCT CODE	LIST PRICE	DIMENSIONS/INCHES	
			D	W
 Worksurface Modesty Panel	EVWMP1242	127	12	26
	EVWMP1248	127	12	32
	EVWMP1260	151	12	44
	EVWMP1272	170	12	56

**EVHEP - END PANEL**

- Supports the worksurface and enhances the stability of connected panels.
- Provides solid support at the end of a run of worksurfaces.
- Finished in thermally-fused laminate.
- Includes flat brackets and hardware.
- End panel height is inclusive of panel glides extended to their fullest height.
- If wood grains is selected, grain runs vertically.

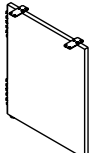
DESCRIPTION	PRODUCT CODE	LIST PRICE	DIMENSIONS/INCHES	
			D	H
 End Panel - 29" High	EVHEP2918	190	18	28
	EVHEP2924	280	24	28
	EVHEP2930	327	30	28

## EVWS - STRAIGHT WORKSURFACE - HEIGHT ADJUSTABLE

- Support hardware must be ordered separately. See listing in this section of the price book.
- There is no scoop in this worksurface.

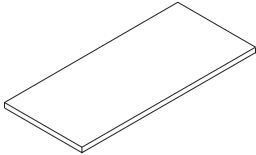
DESCRIPTION	PRODUCT CODE	LIST PRICE			DIMENSIONS/INCHES	
		LP	HP	HPW	D	W
 Straight Worksurface	EWWS2346	274	383	574	23	46
	EWWS2352	323	446	671	23	52
	EWWS2358	361	499	746	23	58
	EWWS2364	378	523	780	23	64
	EWWS2370	394	542	810	23	70
	EWWS2376	633	810	1215	23	76
	EWWS2382	637	822	1231	23	82
	EWWS2946	323	446	671	29	46
	EWWS2952	355	488	730	29	52
	EWWS2958	378	523	780	29	58
	EWWS2964	393	542	810	29	64
	EWWS2970	415	575	864	29	70
	EWWS2976	786	1017	1523	29	76
	EWWS2982	799	1022	1535	29	82

## EVWS - STRAIGHT WORKSURFACE - HEIGHT ADJUSTABLE RETURNS

- Support hardware must be ordered separately. See listing in this section of the price book.
- There is no scoop in this worksurface.

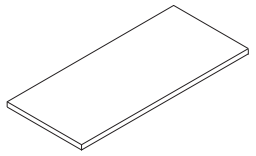
DESCRIPTION	PRODUCT CODE	LIST PRICE			DIMENSIONS/INCHES	
		LP	HP	HPW	D	W
 Straight Worksurface	EWWS2329	159	217	323	23	29
	EWWS2335	180	246	362	23	35
	EWWS2341	229	319	477	23	41
	EWWS2347	274	383	574	23	47
	EWWS2353	323	446	671	23	53
	EWWS2359	361	499	746	23	59
	EWWS2929	185	259	388	29	29
	EWWS2935	219	300	450	29	35
	EWWS2941	306	421	632	29	41
	EWWS2947	323	446	671	29	47
	EWWS2953	355	488	730	29	53
	EWWS2959	378	523	780	29	59

## EVWCC - CORNER SURVED WORKSURFACE - HEIGHT ADJUSTABLE

- Support hardware must be ordered separately. See listing in this section of the price book.
- There is no scoop in this worksurface.

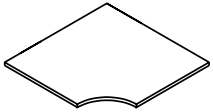
DESCRIPTION	PRODUCT CODE	LIST PRICE			DIMENSIONS/INCHES	
		LP	HP	HPW	D	W
 Corner Curved Worksurface	EWWCC5223	978	1404	1958	23	52
	EWWCC5823	1302	1830	2339	23	58
	EWWCC4629	902	1287	1931	29	46
	EWWCC5229	978	1404	1958	29	52
	EWWCC5829	1302	1830	2339	29	58



## EVWCCEL - EXTENDED CORNER WORKSURFACE - HEIGHT ADJUSTABLE

- Support hardware must be ordered separately. See listing in this section of the price book.
- There is no scoop in this worksurface.

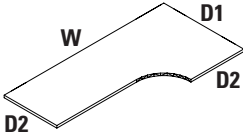
	DESCRIPTION	PRODUCT CODE	LIST PRICE			DIMENSIONS/INCHES		
			LP	HP	HPW	D1	D2	W
	Extended Corner Worksurface	EWWCCEL462358	917	1131	1699	46	23	58
		EWWCCEL462364	988	1260	1892	46	23	64
		EWWCCEL462370	1062	1377	2065	46	23	70
		EWWCCEL462376	1165	1470	2204	46	23	76
		EWWCCEL462382	1215	1560	2337	46	23	82
		EWWCCEL522358	1072	1557	2028	52	23	58
		EWWCCEL522364	1153	1688	2206	52	23	64
		EWWCCEL522370	1235	1818	2384	52	23	70
		EWWCCEL522376	1399	2079	2739	52	23	76
		EWWCCEL522382	1566	2343	3097	52	23	82
		EWWCCEL582364	1179	1710	2230	58	23	64
		EWWCCEL582370	1268	1855	2426	58	23	70
		EWWCCEL582376	1470	2166	2841	58	23	76
		EWWCCEL582382	1668	2479	3265	58	23	82
		EWWCCEL462958	968	1246	1868	46	29	58
		EWWCCEL462964	1053	1358	2037	46	29	64
		EWWCCEL462970	1144	1472	2205	46	29	70
		EWWCCEL462976	1229	1581	2373	46	29	76
		EWWCCEL462982	1296	1669	2502	46	29	82
		EWWCCEL522958	1114	1619	2108	52	29	58
		EWWCCEL522964	1198	1756	2293	52	29	64
		EWWCCEL522970	1285	1891	2479	52	29	70
		EWWCCEL522976	1456	2164	2851	52	29	76
		EWWCCEL522982	1627	2437	3219	52	29	82
		EWWCCEL582964	1260	1839	2400	58	29	64
		EWWCCEL582970	1349	1980	2593	58	29	70
		EWWCCEL582976	1528	2266	2979	58	29	76
		EWWCCEL582982	1709	2551	3369	58	29	82

## EVWCER - EXTENDED CORNER WORKSURFACE - HEIGHT ADJUSTABLE

- Support hardware must be ordered separately. See listing in this section of the price book.
- There is no scoop in this worksurface.

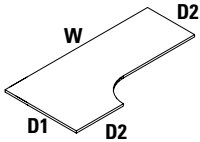
DESCRIPTION	PRODUCT CODE	LIST PRICE			DIMENSIONS/INCHES		
		LP	HP	HPW	D1	D2	W
 Extended Corner Worksurface	EWWCER462358	917	1131	1699	46	23	58
	EWWCER462364	988	1260	1892	46	23	64
	EWWCER462370	1062	1377	2065	46	23	70
	EWWCER462376	1165	1470	2204	46	23	76
	EWWCER462382	1215	1560	2337	46	23	82
	EWWCER522358	1072	1557	2028	52	23	58
	EWWCER522364	1153	1688	2206	52	23	64
	EWWCER522370	1235	1818	2384	52	23	70
	EWWCER522376	1399	2079	2739	52	23	76
	EWWCER522382	1566	2343	3097	52	23	82
	EWWCER582364	1179	1710	2230	58	23	64
	EWWCER582370	1268	1855	2426	58	23	70
	EWWCER582376	1470	2166	2841	58	23	76
	EWWCER582382	1668	2479	3265	58	23	82
	EWWCER462958	968	1246	1868	46	29	58
	EWWCER462964	1053	1358	2037	46	29	64
	EWWCER462970	1144	1472	2205	46	29	70
	EWWCER462976	1229	1581	2373	46	29	76
EWWCER462982	1296	1669	2502	46	29	82	
EWWCER522958	1114	1619	2108	52	29	58	
EWWCER522964	1198	1756	2293	52	29	64	
EWWCER522970	1285	1891	2479	52	29	70	
EWWCER522976	1456	2164	2851	52	29	76	
EWWCER522982	1627	2437	3219	52	29	82	
EWWCER582964	1260	1839	2400	58	29	64	
EWWCER582970	1349	1980	2593	58	29	70	
EWWCER582976	1528	2266	2979	58	29	76	
EWWCER582982	1709	2551	3369	58	29	82	



## EVWS - EXTENDED CURVED CORNER RETURN - HEIGHT ADJUSTABLE

- Support hardware must be ordered separately. See listing in this section of the price book.
- There is no scoop in this worksurface.

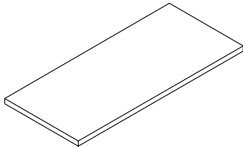
	DESCRIPTION	PRODUCT CODE	LIST PRICE			DIMENSIONS/INCHES	
			LP	HP	HPW	D	W
	Extended Corner Worksurface	EVWS2324	149	202	301	23	24
		EVWS2336	159	217	323	23	36
		EVWS2348	180	246	362	23	38
		EVWS2924	175	237	355	23	24
		EVWS2936	185	259	388	23	36
		EVWS2948	219	300	450	23	48

## EVWC6C - 60 DEGREE CURVED CORNER WORKSURFACE - HEIGHT ADJUSTABLE

- Support hardware must be ordered separately. See listing in this section of the price book.
- There is no scoop in this worksurface.

	DESCRIPTION	PRODUCT CODE	LIST PRICE			DIMENSIONS/INCHES	
			LP	HP	HPW	D	W
	Curved Corner Worksurface	EVWC6C2346	1487	1685	2526	23	46
		EVWC6C2352	1588	2362	3118	23	52
		EVWC6C2946	1487	1685	2526	29	46
		EVWC6C2952	1588	2362	3118	29	52

**EVTHLEG - EVOLVE BRIDGES LEG**

- Leg assembly attaches to panel for application which requires functionality of panels with environment of bridges tables.
- One leg with horizontal member connection to 1" increment slots in connector. Provides support to panel and panel connected worksurface at end of run- design coordinated with Bridges freestanding tables.
- Supports 24" and 30" deep worksurface
- One leg can support 2 adjoining worksurfaces by specifying 2 flat brackets.
- Leveling glides is standard
- No worksurface supporting beams, use panel cantilever and storage for worksurface support.
- One aluminum leg with steel structure - specify left or right and 24" or 30" deep for corresponding worksurface depth.
- Panel bracket, dislodgment clip and worksurface hardware included.
- Anodized aluminum upcharge \$32.00.
- Please specify paint finish.

	DESCRIPTION	PRODUCT CODE	LIST PRICE	DIMENSIONS/INCHES		
				H	D	W
	Evolve Bridges Leg	EVTRHLEG24LL	439	29	2.5	24
		EVTRHLEG24RL	439	29	2.5	24
		EVTRHLEG30LL	460	29	2.5	30
		EVTRHLEG30RL	460	29	2.5	30

**EVHPL - EVOLVE PRINCETON LEG**

- Princeton leg supports Evolve worksurfaces
- Includes leveling glides
- Legs must used with exact depth worksurfaces only
- Available in standard paint finishes

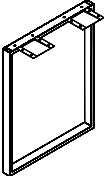
	DESCRIPTION	PRODUCT CODE	LIST PRICE	DIMENSIONS/INCHES		
				H	D	W
	Evolve Princeton Leg	EVHPL24	418	27.5	6.75	24
		EVHPL30	434	27.5	6.75	30

**EVHPL - EVOLVE PRINCETON LEG WITH BRACKET**

- Bracket attaches to back of Princeton leg and connects Princeton leg to panel connector
- Supports the worksurface and enhance stability of connected panels
- Includes levelling glides
- Available in standard paint finishes

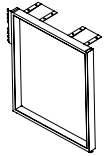
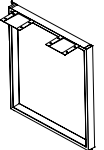
	DESCRIPTION	PRODUCT CODE	LIST PRICE	DIMENSIONS/INCHES		
				H	D	W
	Evolve Princeton Leg with Left Bracket	EVHPL24L	460	27.5	6.75	24
		EVHPL30L	475	27.5	6.75	30
	Evolve Princeton Leg with Right Bracket	EVHPL24R	460	27.5	6.75	24
		EVHPL30R	475	27.5	6.75	30



**EVHMEGR - METAL END GABLE - RIGHT**

- Supports the worksurface and enhances the stability of connected panels.
- Includes a levelling glide and decorative PVC sleeve to cover the glide.
- Leveling glide may be extended up to 1 1/2" maximum.
- Available in standard paint colors.

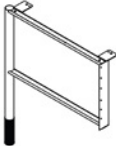
	DESCRIPTION	PRODUCT CODE	LIST PRICE	DIMENSIONS/INCHES		
				H	D	W
	Metal End Gable - Right	EVHMEG18R	274	28	17	4
		EVHMEG24R	292	28	23	4
		EVHMEG30R	307	28	29	4

**EVHMEGL - METAL END GABLE - LEFT**

- Supports the worksurface and enhances the stability of connected panels.
- Includes a levelling glide and decorative PVC sleeve to cover the glide.
- Leveling glide may be extended up to 1 1/2" maximum.
- Available in standard paint colors.

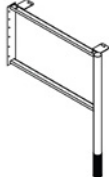
	DESCRIPTION	PRODUCT CODE	LIST PRICE	DIMENSIONS/INCHES		
				H	W	D
	Metal End Gable - Left	EVHMEG18L	274	28	17	4
		EVHMEG24L	292	28	23	4
		EVHMEG30L	307	28	29	4

**EVHMSEL - METAL SUPPORT LEG**

- Supports two adjoining worksurfaces and enhances the stability of connected panels.
- Includes a levelling glide and decorative PVC sleeve to cover the glide.
- Leveling glide may be extended up to 1 1/2" maximum.
- Flat brackets recommended to ensure alignment of neighboring surface.
- Available in standard paint colors.
- Not designed for use at the end of a worksurface.
- Handedness of support leg cannot be changed.
- Not designed to be used with radius worksurfaces.

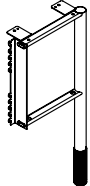
	DESCRIPTION	PRODUCT CODE	LIST PRICE	DIMENSIONS/INCHES		
				H	W	D
	Metal Support Leg	EVHMSEL12	246	28	11	4

**EVHC - CANTILEVER FOR KEYBOARD WORKSURFACES**

- Attaches a worksurface to a panel connector.
- Used to support two convergent worksurfaces.
- 2 flat brackets are included.
- Priced individually
- Specify handedness of each cantilever
- Available in standard paint colors.

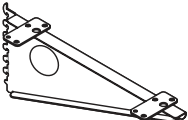
	DESCRIPTION	PRODUCT CODE	LIST PRICE	DIMENSIONS/INCHES	
				D	W
	Cantilever for Keyboard Worksurfaces	EVHC12L/R	110	12	6
		EVHC18L/R	110	18	6
		EVHC24L/R	126	24	6



**EVHS - SUPPORT LEG**

- Used in conjunction with a EVHC cantilever.
- Provides extra support where needed.
- Used to help support two convergent worksurfaces.
- Available in standard paint colors.

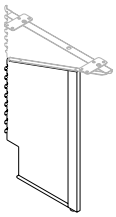
	DESCRIPTION	PRODUCT CODE	LIST PRICE	DIMENSIONS/INCHES		
				H	W	D
	Support Leg - Left	EVHSL2918	102	23.38	0.75	12.5
		EVHSL2924	102	23.38	0.75	12.5
	Support Leg - Right	EVHSR2918	102	23.38	0.75	12.5
		EVHSR2924	102	23.38	0.75	12.5

**EVHCL - CORNER LEG WITH LEVELER**

- Provides support for a worksurface.
- Includes leveling glide, PVC Sleeve and attachment plate.
- Leveling glide may be extended up to 1 1/2" maximum.
- 1.5" diameter
- Available in standard paint colors.
- Legs can be used in the corner of a single worksurface or be rotated 45 degrees to support the corners of two worksurfaces.

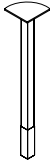
	DESCRIPTION	PRODUCT CODE	LIST PRICE	DIMENSIONS/INCHES	
				H	
 	Corner Leg Round	EVHCL1	130	28	
	Corner Leg Square	EVHCL2	130	28	

Round      Square

**EVHMSL - MID SUPPORT LEG**

- Provides support for a worksurface.
- Includes leveling glide, PVC Sleeve and 4.8" x 4.8" attachment plate.
- Leveling glide may be extended up to 1 1/2" maximum.
- 1.5" diameter.
- Available in standard paint colors.

	DESCRIPTION	PRODUCT CODE	LIST PRICE	DIMENSIONS/INCHES	
				H	
	Mid Support Leg - Round	EVHMSL1	94	28	
	Mid Support Leg - Square	EVHMSL2	94	28	

**EVHMSL - MID SUPPORT LEG**

- Provides additional support for worksurface.
- Includes leveling glide, PVC Sleeve and 4.8" x 4.8" attachment plate.
- 1.5" square tube.
- Available in standard paint colors.

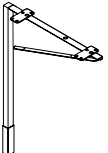
	DESCRIPTION	PRODUCT CODE	LIST PRICE	DIMENSIONS/INCHES		
				H	W	D
	Mid Support Leg - Cantilever Bracket	EVHMSCL18	151	28	18	1.5



**EVWS - 5" SURFACE TO STORAGE SUPPORT LEG**

- Provides support for a worksurface.
- Includes leveling glide, PVC Sleeve and 4.8" x 4.8" attachment plate.
- 1.5" diameter.
- Available in standard paint colors.

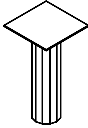
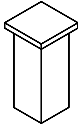
		DESCRIPTION	PRODUCT CODE	LIST PRICE	DIMENSIONS/INCHES H
		5" Surface to Storage Support Leg - Round	EVWSRL01	58	4.5
		5" Surface to Storage Support Leg - Square	EVWSSL01	58	4.5
Round	Square				

**EVHCB - CORNER BRACKETS**

- Attaches the corner of any worksurface to a panel connector.
- Priced and shipped in pairs.
- Available in black only.

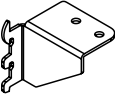
		DESCRIPTION	PRODUCT CODE	LIST PRICE	DIMENSIONS/INCHES D W
		Corner Brackets	EVHCB2	31	2.5 3.5

**EVHTB - TRANSACTION BRACKETS**

- Securely attaches a transaction surface to the top of a panel.
- One pair must be on each side of transaction surface.
- Priced and shipped in pairs.
- Available in standard paint colors.

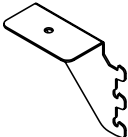
		DESCRIPTION	PRODUCT CODE	LIST PRICE	DIMENSIONS/INCHES D W
		Transaction Brackets	EVHTB2	31	2.5 3.5

**EVHFB - FLAT BRACKET**

- Must be used in conjunction with cantilevers or transaction brackets to ensure alignment of neighboring surfaces.
- Priced individually
- Available in Black only.

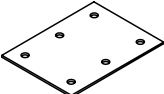
		DESCRIPTION	PRODUCT CODE	LIST PRICE	DIMENSIONS/INCHES D W
		Flat Bracket	EVHFB1	21	3 4

**EVHPB - PEDESTAL BRACKET**

- Attaches to back edge of a pedestal and connects a pedestal to panel connector.
- Available in standard paint colors.

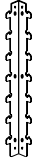
	DESCRIPTION	PRODUCT CODE	LIST PRICE	DIMENSIONS/INCHES H
	Pedestal Bracket	EVHPB1	36	11

**EVHWSC - WORKSURFACE SUPPORT CHANNEL**

- Support channel attaches to underside of worksurface with screws.
- Support channel should be 14" shorter than top length.
- Screws are included.
- Only available in Black.
- Tops with post legs should be specified with support channel for structural reinforcement.

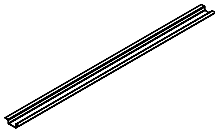
	DESCRIPTION	PRODUCT CODE	LIST PRICE	DIMENSIONS/INCHES L D	
	Worksurface Support Channel	EVHWSC40 - for 54" wide table	80	40	5
		EVHWSC46 - for 60" wide table	86	46	5
		EVHWSC52 - for 66" wide table	92	52	5
		EVHWSC58 - for 72" wide table	104	58	5
		EVHWSC64 - for 78" wide table	116	64	5
		EVHWSC70 - for 84" wide table	127	70	5

**EVHWCB1 - WORKSURFACE TO STORAGE BRACKETS**

- Bracket connects Worksurface to Storage Towers as additional support.
- Bracket EVHWCB1 cannot fully support a Worksurface. It is to be used in conjunction with a Cantilever.
- Available in standard paint colors.

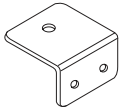
	DESCRIPTION	PRODUCT CODE	LIST PRICE	DIMENSIONS/INCHES H D W		
	Worksurface to Storage Brackets	EVHWCB1	13	1.25	2	2

**EVHV - SINGLE SLOTTED WALL ADAPTER**

- To attach system components to a fixed wall. The vertical wall adapter is a "U" shaped channel with a vertical row of 1" slots on center.
  - Mounting hardware not included. Mounting hardware selection to be based on wall material.
  - Use of wall rack requires lower tooth of top hook on cantilever or shelf to be notched in the field.
  - Available in standard paint colors.
  - Shipped & priced per pair.
- NOTE:**
- Care should be taken to mount adapters only to wall studs using correct fasteners. Failure to do this may result in collapse of the unit and subsequent possible personal injury.

	DESCRIPTION	PRODUCT CODE	LIST PRICE	DIMENSIONS/INCHES H D	
	Single Slotted Wall Track	EVHV01	92	60	.5



**EVSPD2015 - PENCIL DRAWER**

- Accommodates writing instruments and small items at the workspace.
- Attaches to underside of a worksurface with drawer slides.
- Available in Black ABS plastic only.

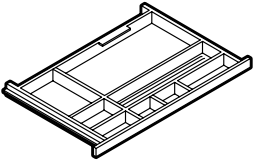
	DESCRIPTION	PRODUCT CODE	LIST PRICE	DIMENSIONS/INCHES		
				H	D	W
	Pencil Drawer	EVSPD2015	190	1.5	22.5	17.75

**EVDCP - CENTRAL SUPPORT PANEL**

- Supports and connects 2 worksurfaces
- Includes two end panel brackets, two levelling glides and modesty inter connect bracket (EVDECCR)
- Attaches to modesty panel
- End panel height is inclusive of panel glides extended to their fullest height
- All Freestanding products are available in thermally fused thickness only.

	DESCRIPTION	PRODUCT CODE	LIST PRICE	DIMENSIONS/INCHES	
				H	W
	Central Support Panel	EVDCP2910	180	10	28
		EVDCP2914	227	14	28
		EVDCP2610	160	10	28
		EVDCP2614	213	14	28

**EVDHMSB - MID SUPPORT BRACKET**

- Provides mid support for worksurfaces
- Recommended for any lengths over 42"
- Available in black only.

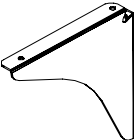
	DESCRIPTION	PRODUCT CODE	LIST PRICE	DIMENSIONS/INCHES		
				D	W	H
	Mid Support Bracket	EVDHMSB	55	7 1/2	7 1/2	1/2

**EVDECCR - MODESTY INTER-CONNECT BRACKET**

- Attaches two modesty panels to a mid support panel

	DESCRIPTION	PRODUCT CODE	LIST PRICE	DIMENSIONS/INCHES	
				W	H
	Modesty Inter-Connect Bracket	EVDECCR	30	12 1/2	4

**EVDHLB - END PANEL "L" BRACKET**

- Attaches a modesty panel to an end panel
- Available in black only.

	DESCRIPTION	PRODUCT CODE	LIST PRICE	DIMENSIONS/INCHES		
				D	W	H
	End Panel "L" Bracket	EVDHLB	31	1 1/2	12	1 1/2







freestanding



**EVWFR - RECTANGULAR FREESTANDING WORKSURFACE WITH CORNER LEGS**

- Worksurface include 6 threaded-metal inserts in corners, to allow for metal-to-metal connections.
- Worksurface is available in 1-1/16" thick High Pressure laminate only.
- Legs are 1.5" diameter and include leveling glide, PVC sleeve and attachment plate. PVC sleeve available in Evolve standard colors only.
- Legs can be used in the corner of a single worksurface, or rotated 45 degrees to support the corners of two worksurfaces.
- Ships Knocked Down.
- All Freestanding products are available in thermally fused thickness only.

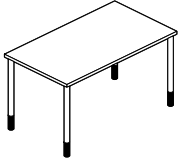
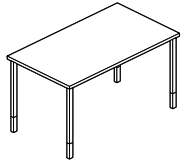
	DESCRIPTION	PRODUCT CODE	LIST PRICE	DIMENSIONS/INCHES		
				D	W	H
	Rectangular Freestanding Worksurface with Round Corner Legs	EWWFR2448HP	888	24	48	29
		EWWFR2460HP	1029	24	60	29
		EWWFR3048HP	967	30	48	29
		EWWFR3060HP	1058	30	60	29
	Rectangular Freestanding Worksurface with Square Corner Legs	EWFRS2448HP	888	24	48	29
		EWFRS2460HP	1029	24	60	29
		EWFRS3048HP	967	30	48	29
		EWFRS3060HP	1058	30	60	29

**EVWFS - SQUARE FREESTANDING WORKSURFACE WITH CORNER LEGS**

- Worksurface include 6 threaded-metal inserts in corners, to allow for metal-to-metal connections.
- Worksurface is available in 1-1/16" thick High Pressure laminate only.
- Legs are 1.5" diameter and include leveling glide, PVC sleeve and attachment plate. PVC sleeve available in Evolve standard colors only.
- Legs can be used in the corner of a single worksurface, or rotated 45 degrees to support the corners of two worksurfaces.
- Ships Knocked Down.
- All Freestanding products are available in thermally fused thickness only.

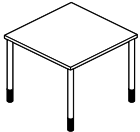
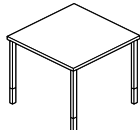
	DESCRIPTION	PRODUCT CODE	LIST PRICE	DIMENSIONS/INCHES		
				D	W	H
	Square Freestanding Worksurface with Round Corner Legs	EWWFS36HP	939	36	36	29
		EWWFS42HP	1077	42	42	29
		EWWFS48HP	1272	48	48	29
	Square Freestanding Worksurface with Square Corner Legs	EWWFSS36HP	939	36	36	29
		EWWFSS42HP	1077	42	42	29
		EWWFSS48HP	1272	48	48	29



**EVWFC - ROUND FREESTANDING WORKSURFACE WITH CORNER LEGS**

- Worksurface include 6 threaded-metal inserts in corners, to allow for metal-to-metal connections.
- Worksurface is available in 1-1/16" thick High Pressure laminate only.
- Legs are 1.5" diameter and include leveling glide, PVC sleeve and attachment plate.
- Legs can be used in the corner of a single worksurface, or rotated 45 degrees to support the corners of two worksurfaces.
- Ships Knocked Down.
- All Freestanding products are available in thermally fused thickness only.

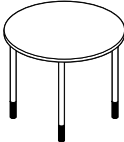
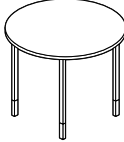
	DESCRIPTION	PRODUCT CODE	LIST PRICE	DIMENSIONS/INCHES	
				W	H
	Round Freestanding Worksurface with Corner Legs	EWWFC36HP	1001	36	29
		EWWFC42HP	1204	42	29
		EWWFC48HP	1436	48	29
	Round Freestanding Worksurface with Square Corner Legs	EWWFCS36HP	1001	36	29
		EWWFCS42HP	1204	42	29
		EWWFCS48HP	1436	48	29

**EWWFD - PANEL MOUNTED WORKSURFACE WITH CORNER LEGS**

- "D" top table with 2 legs, panel mounted.
- Support hardware must be ordered separately. See the listings in this section.
- Worksurface include 6 threaded-metal inserts in corners, to allow for metal-to-metal connections.
- Worksurface is available in 1-1/16" thick High Pressure laminate only.
- Legs are 1.5" diameter and include leveling glide, PVC sleeve and attachment plate.
- Legs can be used in the corner of a single worksurface, or rotated 45 degrees to support the corners of two worksurfaces.
- Ships Knocked Down.
- All Freestanding products are available in thermally fused thickness only.

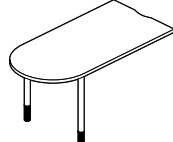
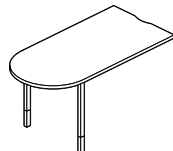
	DESCRIPTION	PRODUCT CODE	LIST PRICE	DIMENSIONS/INCHES		
				D	W	H
	Panel Mounted Worksurface with Corner Legs	EWWFD2448HP	726	24	48	29
		EWWFD2460HP	849	24	60	29
		EWWFD3048HP	868	30	48	29
		EWWFD3060HP	918	30	60	29
	Panel Mounted Worksurface with Square Corner Legs	EWWFDS2448HP	726	24	48	29
		EWWFDS2460HP	849	24	60	29
		EWWFDS3048HP	868	30	48	29
		EWWFDS3060HP	918	30	60	29



storage

**LATERAL FILE FEATURES**

## LATERAL FILES

- Binder storage
- EDP storage (with optional EDP sides)
- Lifetime Warranty (see Terms & Conditions)
- Counterweights must be specified on lateral files with pull out drawers, unless worksurface supporting, ganged together or anchored to the floor or wall.

## DRAWERS/SHELVES

- Drawer interlocking system
- Three-stage, anti-bounceback suspension
- Pre-installed file bars
- Side-to-side file bars for letter, legal and A4
- Looped full pull
- Front-to-back file bars – optional
- Label holder
- Fixed front drawers – available
- Receding door, roll-out shelves – available
- Slotted, pull-out shelves with rolled edge
- Full-height dividers – optional

## LATERAL FILES 1200 SERIES

- Receding door series features 16 gauge, spring loaded hinges
- Mig welded top corners
- Thicker receding door with redesigned pivot motion to prevent door rub
- Half height drawers - optional
- Premium drawer slides with black zinc coating for smoother, quieter

## MOTION

- Salt spray resistance treatment
- Durable epoxy powder coating
- Superior locking system with anti-lift mechanism
- Large standard color palette
- ANSI / BIFMA approved
- CSGB approved

## CONSTRUCTION

- Top stiffener bar
- Corner gussets
- 18 – 20 gauge cold-rolled steel
- Four (4) ganging drill points are marked to ensure correct positioning
- Cam lock included
- Leveling glides
- Counterweights are recommended in all heights/widths – optional

**STANDARD PAINT COLORS**

Evolve Colors		Evolve Colors (10% upcharge)
BLK	Black	TUN Tungsten
CHR	Charcoal	
SIL	Silver	TEXTURED COLORS
TPE	Taupe	BZD Blizzard
NEV	Nevada	SDT Stone Dust
DWT	Designer White	
FOG	Fog	

**ADDITIONAL STANDARD COLORS (FOR STORAGE ITEMS ONLY)**

PREMIUM GLOBAL COLORS		TEXTURED COLORS
BNE	Bone	BKC Black Coffee
BGR	Business Grey	DCH Dark Chocolate
CLT	Claret	MCH Mocha
DPT	Desert Putty	
GRY	Grey	
LGR	Light Grey	
ICE	Ice	
IVR	Ivory	
MOS	Moss	
MET	Metro	
NVY	Navy	
OYS	Oyster	
SKY	Sky	
SGR	Storm Grey	
STN	Stone	
TSA	Tahiti Sand	
WIL	Willow	

\*Extended lead times for premium paints apply. Contact Evolve Customer Support for details.

Global matte paint finishes are available on most Evolve Storage pieces without an up charge regardless of quantities.

All Mica and Metallic paint finishes will incur a minimum up charge of 10%.

All non-standard paint finishes must be approved by Evolve prior to placing an order.

**GENERAL WARRANTY INFORMATION**

- Evolve warrants all components of metal storage and filing for the lifetime of the product to the original purchaser.



This page provides a three dimensional view of a sample configuration highlighting each storage component required when specifying this configuration.

## Components

- A. EVS12BBF      Box, Box, File Pedestal
- B. EVSSL          Low-Profile Shelf
- C. EVSOF          Overhead Flipper Door Storage Unit

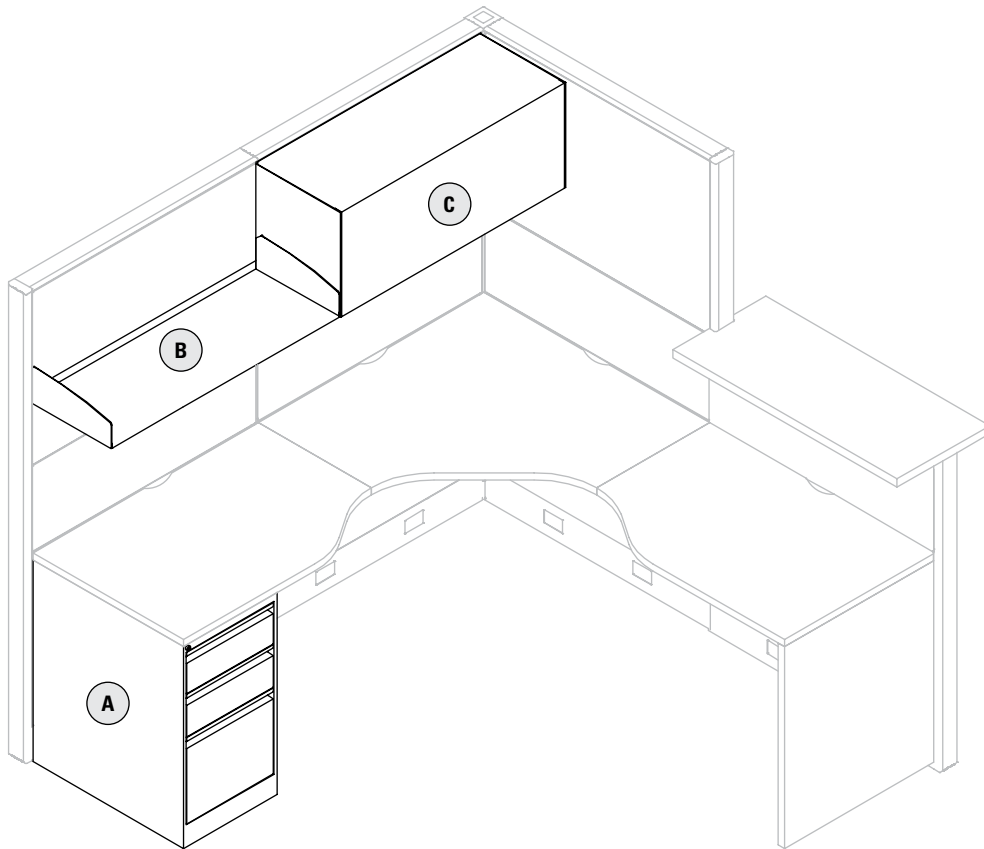

## INTERIOR CLEAR OPENING HEIGHT DIMENSIONS

### "B" Opening

Fixed Front Drawer	13"
Receding Door and Roll-Out Shelf	12 1/8"
Receding Door and Fixed Shelf	12"
Fixed Shelf and no Receding Door	12 3/4"

### "B" and "L" Opening

Drawer – Depth	15 3/4"
Roll-Out Shelf – Depth	15 3/4"
Fixed Shelf – Depth	15 3/4"

### "L" Opening

Fixed Front Drawer	10 7/8"
Receding Door and Roll-Out Shelf	10"
Receding Door and Fixed Shelf	9 7/8"
Fixed Shelf and no Receding Door	10 5/8"

## INTERIOR CLEAR OPENING WIDTH DIMENSIONS AND FILING CAPACITY

### 30" Wide Cabinet

Fixed Front Drawer	26 9/16"
Receding Door and Roll-Out Shelf	26 9/16"
Receding Door and Fixed Shelf	26 9/16"

### 42" Wide Cabinet

Fixed Front Drawer	38 9/16"
Receding Door and Roll-Out Shelf	38 9/16"
Receding Door and Fixed Shelf	38 9/16"

### 36" Wide Cabinet

Fixed Front Drawer	32 9/16"
Receding Door and Roll-Out Shelf	32 9/16"
Receding Door and Fixed Shelf	32 3/16"

## OPENING CAPACITIES 30" WIDE UNITS

### Letter

"B" and "L" Openings  
Fixed Front Drawers and  
Roll-Out Shelves

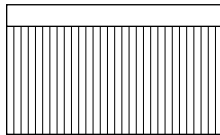

Capacity — 26 9/16"  
Accessories required EVSHFB30

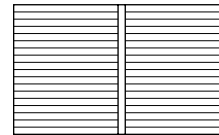

Capacity — 26 1/2"  
Accessories required EVSHFB30 and one pair of FBB  
Not recommended for "L" openings with Roll-Out Shelves

### Legal

"B" and "L" Openings  
Fixed Front Drawers and  
Roll-Out Shelves

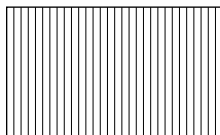

Capacity — 26 9/16"  
Accessories required EVSHFB30

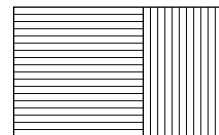

Capacity — 26 5/16"  
Accessories required EVSHFB30 and one pair FBB  
Not recommended for "L" openings with Roll-Out Shelves

### EDP

"B" Opening  
Fixed Front Drawer ONLY

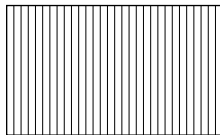

Capacity — 26 9/16"  
Accessories required EVSHFB30 and one pair EDPS



**OPENING CAPACITIES 36" WIDE UNITS**

**Letter**

"B" and "L" Openings  
Fixed Front Drawers and  
Roll-Out Shelves

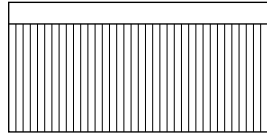

Capacity — 32 9/16"  
Accessories required EVSHFB36

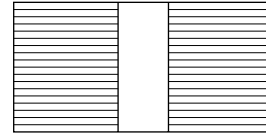

Capacity — 31 1/2"  
Accessories required EVSHFB36 and one pair of FBB  
Not recommended for "L" openings with Roll-Out Shelves

**Legal**

"B" and "L" Openings  
Fixed Front Drawers and  
Roll-Out Shelves

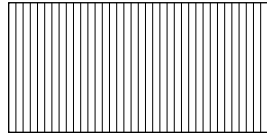

Capacity — 32 9/16"  
Accessories required EVSHFB36

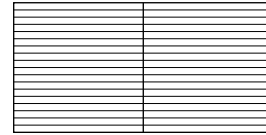

Capacity — 31 1/2"  
Accessories required EVSHFB36 and one pair FBB  
Not recommended for "L" openings with Roll-Out Shelves

**EDP**

"B" Opening  
Fixed Front Drawer ONLY

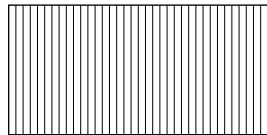

Capacity — 32 9/16"  
Accessories required EVSHFB36 and one pair EDPS

**OPENING CAPACITIES 42" WIDE UNITS**

**Letter**

"B" and "L" Openings  
Fixed Front Drawers and  
Roll-Out Shelves

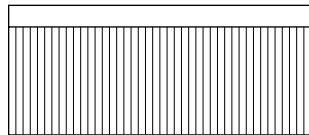

Capacity — 38 9/16"  
Accessories required EVSHFB42

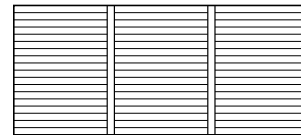

Capacity — 47 1/4"  
Accessories required EVSHFB42 and one pair of FBB  
Not recommended for "L" openings with Roll-Out Shelves

**Legal**

"B" and "L" Openings  
Fixed Front Drawers and  
Roll-Out Shelves

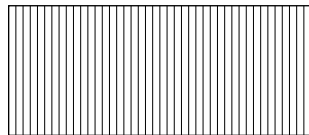

Capacity — 38 9/16"  
Accessories required EVSHFB42

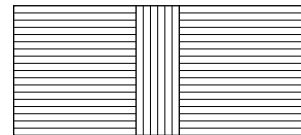

Capacity — 31 1/2"  
Accessories required EVSHFB42 and one pair FBB  
Not recommended for "L" openings with Roll-Out Shelves

**EDP**

"B" Opening  
Fixed Front Drawer ONLY

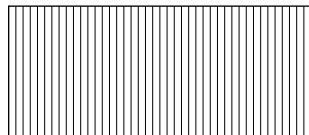

Capacity — 38 9/16"  
Accessories required EVSHFB42 and one pair EDPS



**EVSOFF - OVERHEAD FLIPPER DOOR STORAGE UNIT**

- Door retracts up and over the cabinet.
- Ready for quick assembly on site.
- Quality steel construction.
- 60" unit is reinforced for proper weight distribution.
- Inside dimensions: 12" H x 11.75" D.
- Lock not included (specify EVSLK12).

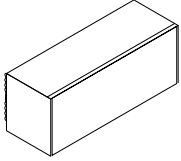
	DESCRIPTION	PRODUCT CODE	LIST PRICE	DIMENSIONS/INCHES		
				H	D	W
	Overhead Flipper Door Storage Unit	EVSOFF1224	517	14.5	12	24
		EVSOFF1230	535	14.5	12	30
		EVSOFF1236	593	14.5	12	36
		EVSOFF1242	653	14.5	12	42
		EVSOFF1248	709	14.5	12	48
		EVSOFF1254	772	14.5	12	54
		EVSOFF1260	828	14.5	12	60

**EVSOFF - FULL PULL OVERHEAD FLIPPER DOOR STORAGE UNIT**

- Door retracts up and over the cabinet.
- Ready for quick assembly on site.
- Quality steel construction.
- 60" unit is reinforced for proper weight distribution.
- Inside dimensions: 13.25" H x 12.75" D
- Includes lock
- When ordering EVSOFF13 lock only, specify part code EVSLK13 (\$69 list).

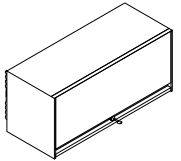
	DESCRIPTION	PRODUCT CODE	LIST PRICE	DIMENSIONS/INCHES		
				H	D	W
	Full Pull Overhead Flipper Door Storage Unit	EVSOFF1324	693	16	14.5	24
		EVSOFF1330	703	16	14.5	30
		EVSOFF1336	725	16	14.5	36
		EVSOFF1342	763	16	14.5	42
		EVSOFF1348	813	16	14.5	48
		EVSOFF1354	860	16	14.5	54
		EVSOFF1360	907	16	14.5	60



**EVSOFF - OVERHEAD FLIPPER DOOR STORAGE UNIT - FULLY ASSEMBLED**

- Quality steel construction.
- 60" unit is reinforced for proper weight distribution.
- Inside dimensions: 14" H x 14.75" D.
- Door retracts inside storage unit.
- Lock is included
- Task lights must be screwed into support channel underneath shelf, standard spring mounts will not work.

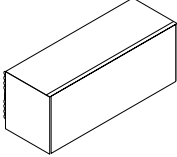
DESCRIPTION	PRODUCT CODE	LIST PRICE	DIMENSIONS/INCHES		
			H	D	W
 Overhead Flipper Door Storage Unit - Fully Assembled	EVSOFF1624	918	17.5	16	24
	EVSOFF1630	941	17.5	16	30
	EVSOFF1636	988	17.5	16	36
	EVSOFF1642	1051	17.5	16	42
	EVSOFF1648	1119	17.5	16	48
	EVSOFF1654	1183	17.5	16	54
	EVSOFF1660	1232	17.5	16	60

**EVSOGD - OVERHEAD WITH SLIDING GLASS DOORS**

- Sliding overheads are specially designed EVSOFF12 cabinets with sliding/glass doors.
- Glass overheads available in standard widths of 24" - 60".
- Inside depth - 12"; Inside height - 12".
- Available in Tempered Frosted Glass option only.
- Overhead unit does not come with a lock option.
- Body of unit made of quality steel construction.
- Tracks for sliding glass door available in Tungsten only.

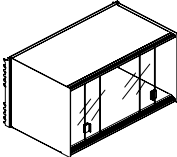
DESCRIPTION	PRODUCT CODE	LIST PRICE	DIMENSIONS/INCHES		
			H	D	W
 Overhead with Sliding Glass Doors	EVSOGD1224	1076	14.5	12	24
	EVSOGD1230	1087	14.5	12	30
	EVSOGD1236	1129	14.5	12	36
	EVSOGD1242	1193	14.5	12	42
	EVSOGD1248	1274	14.5	12	48
	EVSOGD1254	1316	14.5	12	54
	EVSOGD1260	1363	14.5	12	60

**EVSOGDL - OVERHEAD WITH SLIDING GLASS DOORS WITH LOCK UNIT**

- Sliding overheads are specially designed EVSOFF12 cabinets with sliding/glass doors.
- Glass Overheads available in standard widths of 24" - 60".
- Inside depth - 12"; Inside height - 12".
- Available in Tempered Frosted Glass option only
- Body of unit made of quality steel construction.
- Tracks for sliding glass door available in Tungsten only
- Push in lock. No keys alike.

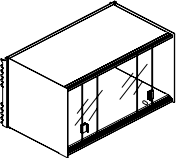
DESCRIPTION	PRODUCT CODE	LIST PRICE	DIMENSIONS/INCHES		
			H	D	W
 Overhead with Sliding Glass Doors (Lockable)	EVSOGDL1224	1125	14.5	12	24
	EVSOGDL1230	1137	14.5	12	30
	EVSOGDL1236	1176	14.5	12	36
	EVSOGDL1242	1240	14.5	12	42
	EVSOGDL1248	1325	14.5	12	48
	EVSOGDL1254	1366	14.5	12	54
	EVSOGDL1260	1412	14.5	12	60

**EVSOD - DOUBLE WALL OVERHEAD FLIPPER DOOR STORAGE UNIT**

- Easy and quick assembly on site.
- Quality steel construction.
- Inside height - 13"; Inside depth - 13"
- Includes lock.
- This model is subject to minimum quantity requirements, when ordering in a premium paint finish. See page 242 for more details.

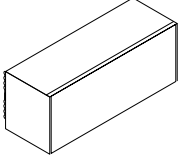
	DESCRIPTION	PRODUCT CODE	LIST PRICE	DIMENSIONS/INCHES		
				H	D	W
	Double Wall Overhead Flipper Door Storage Unit	EVSOD1330	872	15.4	14.7	30
		EVSOD1336	897	15.4	14.7	36
		EVSOD1342	924	15.4	14.7	42
		EVSOD1348	998	15.4	14.7	48
		EVSOD1354	1028	15.4	14.7	54
		EVSOD1360	1061	15.4	14.7	60

**EVSODS - DOUBLE WALL OVERHEAD WITH SHELF FLIPPER DOOR STORAGE UNIT**

- Easy and quick assembly on site.
- Quality steel construction.
- Inside height - 13".
- Inside depth - 13".
- Includes lock.
- This model is subject to minimum quantity requirements, when ordering in a premium paint finish. See page 242 for more details.

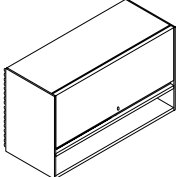
	DESCRIPTION	PRODUCT CODE	LIST PRICE	DIMENSIONS/INCHES		
				H	D	W
	Double Wall Overhead with Shelf Flipper Door Storage Unit	EVSODS1330	988	22.4	14.7	30
		EVSODS1336	1026	22.4	14.7	36
		EVSODS1342	1067	22.4	14.7	42
		EVSODS1348	1157	22.4	14.7	48
		EVSODS1354	1195	22.4	14.7	54
		EVSODS1360	1238	22.4	14.7	60

**EVSODGD - DOUBLE WALL OVERHEAD GLASS SLIDING DOOR UNIT**

- Sliding overheads are specially designed EVSOD cabinets with sliding/glass doors.
- Available in Tempered Frosted Glass option only.
- Glass Overheads available in standard widths of 30"- 60".
- Quality steel construction.
- Panel mount (mounting brackets are included).
- Inside height - 13".
- Inside depth - 13".
- Tracks for sliding glass door available in Tungsten only.
- This model is subject to minimum quantity requirements, when ordering in a premium paint finish. See page 242 for more details.

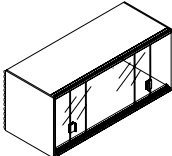
	DESCRIPTION	PRODUCT CODE	LIST PRICE	DIMENSIONS/INCHES		
				H	D	W
	Double Wall Overhead Glass Sliding Door Unit	EVSODGD1330	863	15.4	14.7	30
		EVSODGD1336	897	15.4	14.7	36
		EVSODGD1342	981	15.4	14.7	42
		EVSODGD1348	1053	15.4	14.7	48
		EVSODGD1354	1107	15.4	14.7	54
		EVSODGD1360	1157	15.4	14.7	60



**EVSODGDL - DOUBLE WALL OVERHEAD GLASS SLIDING DOOR WITH LOCK UNIT**

- Sliding overheads are specially designed EVSOD cabinets with sliding/glass doors.
- Available in Tempered Frosted Glass option only.
- Glass Overheads available in standard widths of 30" - 60".
- Quality steel construction.
- Panel mount (mounting brackets are included).
- Inside height - 13".
- Inside depth - 13".
- Tracks for sliding glass door available in Tungsten only.
- Push in lock; No keys alike. Cannot be keyed alike.
- This model is subject to minimum quantity requirements, when ordering in a premium paint finish. See page 242 for more details.

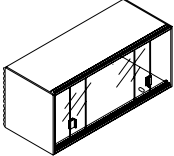
	DESCRIPTION	PRODUCT CODE	LIST PRICE	DIMENSIONS/INCHES		
				H	D	W
	Double Wall Overhead	EVSODGDL1330	953	15.4	14.7	30
	Glass Sliding Door with Lock Unit	EVSODGDL1336	984	15.4	14.7	36
		EVSODGDL1342	1069	15.4	14.7	42
		EVSODGDL1348	1140	15.4	14.7	48
		EVSODGDL1354	1195	15.4	14.7	54
		EVSODGDL1360	1240	15.4	14.7	60

**EVSODSGD - DOUBLE WALL OVERHEAD WITH SHELF GLASS SLIDING DOOR UNIT**

- Sliding overheads are specially designed EVSOD cabinets with sliding/glass doors.
- Available in Tempered Frosted Glass option only.
- Glass Overheads available in standard widths of 30" - 60".
- Quality steel construction.
- Inside height - 13".
- Inside depth - 13".
- Tracks for sliding Glass door available in Tungsten only.
- This model is subject to minimum quantity requirements, when ordering in a premium paint finish. See page 242 for more details.

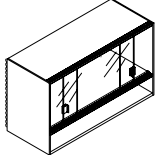
	DESCRIPTION	PRODUCT CODE	LIST PRICE	DIMENSIONS/INCHES		
				H	D	W
	Double Wall Overhead with Shelf	EVSODSGD1330	968	22.4	14.7	30
	Glass Sliding Door Unit	EVSODSGD1336	1006	22.4	14.7	36
		EVSODSGD1342	1097	22.4	14.7	42
		EVSODSGD1348	1181	22.4	14.7	48
		EVSODSGD1354	1239	22.4	14.7	54
		EVSODSGD1360	1292	22.4	14.7	60

**EVSODSGDL - DOUBLE WALL OVERHEAD WITH SHELF GLASS SLIDING DOOR UNIT WITH LOCK UNIT**

- Sliding overheads are specially designed EVSOD cabinets with sliding/glass doors.
- Available in Tempered Frosted Glass option only.
- Glass Overheads available in standard widths of 30" - 60".
- Quality steel construction.
- Inside height - 13".
- Inside depth - 13".
- Tracks for sliding glass door available in Tungsten only.
- Push in lock; No keys alike. Cannot be keyed alike.
- This model is subject to minimum quantity requirements, when ordering in a premium paint finish. See page 242 for more details.

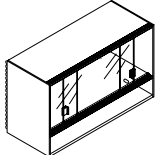
	DESCRIPTION	PRODUCT CODE	LIST PRICE	DIMENSIONS/INCHES		
				H	D	W
	Double Wall Overhead with Shelf	EVSODSGDL1330	1060	22.4	14.7	30
	Glass Sliding Door with Lock Unit	EVSODSGDL1336	1093	22.4	14.7	36
		EVSODSGDL1342	1187	22.4	14.7	42
		EVSODSGDL1348	1268	22.4	14.7	48
		EVSODSGDL1354	1329	22.4	14.7	54
		EVSODSGDL1360	1380	22.4	14.7	60

**EVSDAOH - DUAL ACCESS OVERHEAD**

- Inside dimensions 13"high x 13"deep.
- Laminate Overhead. Available in standard Evolve laminate finishes
- Top mount on panels.
- Dual Access Overhead Support Brackets to be ordered separately.

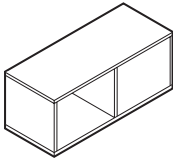
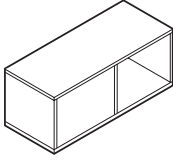
	DESCRIPTION	PRODUCT CODE	LIST PRICE	DIMENSIONS/INCHES		
				H	D	W
	Dual Access Overhead - Left	EVSDAOHL36	1053	15	14.125	36
		EVSDAOHL42	1143	15	14.125	42
		EVSDAOHL48	1195	15	14.125	48
		EVSDAOHL54	1286	15	14.125	54
		EVSDAOHL60	1336	15	14.125	60
	Dual Access Overhead - Right	EVSDAOHR36	1053	15	14.125	36
		EVSDAOHR42	1143	15	14.125	42
		EVSDAOHR48	1195	15	14.125	48
		EVSDAOHR54	1286	15	14.125	54
		EVSDAOHR60	1336	15	14.125	60

**EVSDAOHOS - DUAL ACCESS OVERHEAD WITH OPENING TO ONE SIDE**

- Inside dimensions 13"high x 13"deep
- Laminate Overhead
- Available in standard Evolve laminate finishes
- Top mount on panels
- Dual Access Overhead with both opening to one side
- Dual Access Overhead Support Brackets to be ordered separately

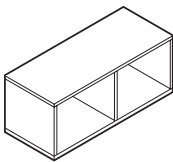
	DESCRIPTION	PRODUCT CODE	LIST PRICE	DIMENSIONS/INCHES		
				H	D	W
	Dual Access Overhead	EVSDAOHOS36	1104	15	14.125	36
		EVSDAOHOS42	1199	15	14.125	42
		EVSDAOHOS48	1253	15	14.125	48
		EVSDAOHOS54	1348	15	14.125	54
		EVSDAOHOS60	1403	15	14.125	60

**EVSDAOHBKTE - END OF RUN BRACKET**

- Bracket supports dual access overhead on one side only
- Includes one bracket, aluminum insert and end of run plastic cap
- End of run plastic cap attaches to end of run trim
- Bracket available in standard Evolve paint finishes

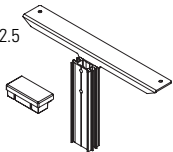
	DESCRIPTION	PRODUCT CODE	LIST PRICE	DIMENSIONS/INCHES		
				H	D	W
	End of Run Single Bracket	EVSDAOHBKTE	94	6.5	12	

**EVSDAOHCBKTER/L - END OF RUN CANTILEVER BRACKET**

- Bracket supports dual access overhead on one side only
- Includes one bracket, aluminum insert and end of run plastic cap
- End of run plastic cap attaches to end of run trim
- Bracket available in standard Evolve paint finishes
- Bracket overhang to one side

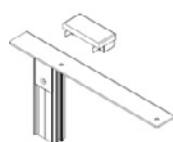
	DESCRIPTION	PRODUCT CODE	LIST PRICE	DIMENSIONS/INCHES		
				H	D	W
	End of Run Single Bracket Right	EVSDAOHCBKTER	94	6.5	12	2.5
	End of Run Single Bracket Left	EVSDAOHCBKTEL	94	6.5	12	2.5



**EVSDAOHBKTS - INLINE SINGLE BRACKET**

- Bracket supports dual access overhead on one side only
- Includes one bracket , aluminum insert and inline plastic cap
- Inline plastic cap and top trim align
- Bracket available in standard Evolve paint finishes
- Single clamps must be used when inline single bracket is used

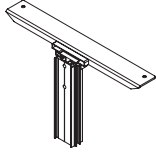
DESCRIPTION	PRODUCT CODE	LIST PRICE	DIMENSIONS/INCHES		
			H	D	W
 Inline Single Bracket	EVSDAOHBKTS	94	6.5	12	2.5

**EVSDAOHCBKTSR/L - INLINE SINGLE CANTILEVER BRACKET**

- Bracket supports dual access overhead on one side only
- Includes one bracket , aluminum insert and inline plastic cap
- Inline plastic cap and top trim align
- Bracket available in standard Evolve paint finishes
- Bracket overhang to one side
- Note: Single clamps must be used when inline single bracket is used

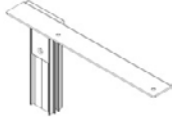
DESCRIPTION	PRODUCT CODE	LIST PRICE	DIMENSIONS/INCHES		
			H	D	W
 Inline Single Bracket Right Inline Single Bracket Left	EVSDAOHCBKTSR EVSDAOHCBKTSL	94 94	6.5 6.5	12 12	2.5 2.5

**EVSDAOHBKTD - DOUBLE BRACKET**

- Double Bracket supports sides of dual access overheads when overhead are side by side.
- Includes two brackets, aluminum insert and plastic caps.
- Plastic caps installed between brackets
- Brackets available in standard Evolve paint finishes.
- Single clamps must be used when double bracket is used.

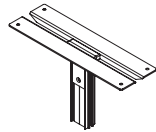
DESCRIPTION	PRODUCT CODE	LIST PRICE	DIMENSIONS/INCHES		
			H	D	W
 Double Bracket	EVSDAOHBKTD	186	6.5	12	4

**EVSDAOHCBKTD - DOUBLE CANTILEVER BRACKET**

- Double Bracket supports sides of dual access overheads when overhead are side by side
- Includes two brackets, aluminum insert and plastic caps
- Plastic caps installed between brackets
- Brackets available in standard Evolve paint finishes
- Bracket overhang to one side
- Note: Single clamps must be used when double bracket is used

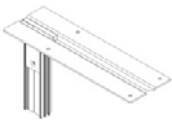
DESCRIPTION	PRODUCT CODE	LIST PRICE	DIMENSIONS/INCHES		
			H	D	W
 Double Bracket	EVSDAOHCBKTD	186	6.5	12	4

**EVSSOH - TOP MOUNT KD OVERHEAD WITH SLIDING GLASS DOOR LEFT**

- Inside dimensions 13"high x 13"deep.
- Laminate Side Walls and Divider, available in standard laminate finishes
- Metal Shelves and Back Wall, available in standard paint finishes
- Available in Temperate Frosted Glass only
- Tracks for sliding glass available in Tungsten only
- Top mount on panels
- Ready for quick assembly on site
- Top Mount Overhead Support Brackets to be ordered separately

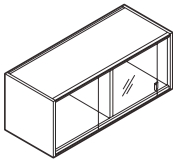
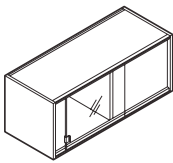
	DESCRIPTION	PRODUCT CODE	LIST PRICE	DIMENSIONS/INCHES		
				H	D	W
	Top Mount KD Overhead - Left	EVSSOHL30	1153	15	15	30
		EVSSOHL36	1275	15	15	36
		EVSSOHL42	1403	15	15	42
		EVSSOHL48	1492	15	15	48
		EVSSOHL54	1582	15	15	54
		EVSSOHL60	1726	15	15	60
	Top Mount KD Overhead - Right	EVSSOHR30	1153	15	15	30
		EVSSOHR36	1275	15	15	36
		EVSSOHR42	1403	15	15	42
		EVSSOHR48	1492	15	15	48
		EVSSOHR54	1582	15	15	54
		EVSSOHR60	1726	15	15	60

**EVSSOHBKTEE - END OF RUN BRACKET**

- Bracket supports Top mount KD overhead on one side only
- Includes one bracket , aluminum insert and end of run plastic cap
- End of run plastic cap attaches to end of run trim
- Bracket available in standard Evolve paint finishes

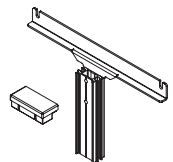
	DESCRIPTION	PRODUCT CODE	LIST PRICE	DIMENSIONS/INCHES		
				H	D	W
	End of Run Single Bracket	EVSSOHBKTE	94	7.5	12	1.5

**EVSSOHBKTS - INLINE SINGLE BRACKET**

- Bracket supports Top mount KD overhead on one side only
- Includes one bracket , aluminum insert and inline plastic cap
- Inline plastic cap and top trim align
- Bracket available in standard Evolve paint finishes
- Single clamps must be used when inline single bracket is used

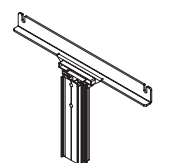
	DESCRIPTION	PRODUCT CODE	LIST PRICE	DIMENSIONS/INCHES		
				H	D	W
	Inline Single Bracket	EVSSOHBKTS	94	7.5	12	1.5



**EVSSOHBKTD - DOUBLE BRACKET**

- Double Bracket supports sides of Top Mount KD overheads when overhead are side by side
- Includes two brackets, aluminum insert and plastic caps
- Plastic caps installed between brackets
- Brackets available in standard Evolve paint finishes
- Single clamps must be used when double bracket is used

	DESCRIPTION	PRODUCT CODE	LIST PRICE	DIMENSIONS/INCHES		
				H	D	W
	Double Bracket	EVSSOHBKTD	186	7.5	12	2

**EVPIECH - 12 "H CHANNEL**

- 12" channel to attach panel to side of center mount overhead
- Attaches with wood screws to side of installed center mount overhead with laminate sides
- Includes 12 "H channel and connecting hardware

	DESCRIPTION	PRODUCT CODE	LIST PRICE	DIMENSIONS/INCHES		
				H	D	W
	12" Channel	EVPIECH12	49	12	3	

**EVADA-PM - EASY-UP OVERHEAD STORAGE UNIT**

- Panel Mounted Overhead Storage with metal sides and opaque door that retracts on top of the unit
- Meets CSA B651 Barrier Free Design & ADA (American Disabilities Act).
- 16" high units accept standard and A4 binders.
- All shelves are reinforced for proper weight distribution.
- Inside dimensions: 14.25" high x 12" deep.
- Unit includes attachment hardware, lock and mounting brackets. Back not included.
- Not recommended for use with wall adapter.
- Unit can be converted into an upmount unit in the field by using EVADAxxKIT.
- Shipped partially assembled.
- Available in standard Evolve paint colors only. Door made of opaque plastic. \*\*add 10% upcharge for Tungsten

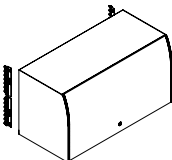
	DESCRIPTION	PRODUCT CODE	LIST PRICE	DIMENSIONS/INCHES		
				H	D	W
	Easy-Up Overhead Storage Unit	EVADA30PM	1230	16	14.2	30
		EVADA36PM	1327	16	14.2	36
		EVADA42PM	1416	16	14.2	42
		EVADA48PM	1512	16	14.2	48
		EVADA54PM	1608	16	14.2	54
		EVADA60PM	1700	16	14.2	60



## EVADA-UM - EASY-UP UPMOUNT OVERHEAD STORAGE UNIT

- Meets CSA B651 Barrier Free Design & ADA (American Disabilities Act).
- 16" high units accept standard and A4 binders.
- All shelves are reinforced for proper weight distribution.
- Inside dimensions: 14.25" high x 12" deep.
- Unit includes attachment hardware, lock, mounting cantilevers and has a complete back.
- Shipped partially assembled.
- Available in standard Evolve paint colors only. Door made of opaque plastic.

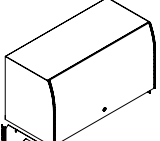
DESCRIPTION	PRODUCT CODE	LIST PRICE	DIMENSIONS/INCHES		
			H	D	W
 Easy-Up Upmount Overhead Storage Unit	EVADA30UM	1458	16	14.2	30
	EVADA36UM	1527	16	14.2	36
	EVADA42UM	1612	16	14.2	42
	EVADA48UM	1696	16	14.2	48
	EVADA54UM	1785	16	14.2	54
	EVADA60UM	1884	16	14.2	60

## EVSHJB - J BARS FOR DOUBLE WALL OVERHEAD

- Converts existing panel mounted Double Wall Overhead EVSOD13, EVSODGD13 OR EVSODGDL13 into a wall mounted overhead.
- Available in Evolve standard paint finishes.
- Note: Care should be taken to fasten "J" bars only to wall studs with correct fasteners. Failure to do so may result in collapse of unit and subsequent possible personal injury.

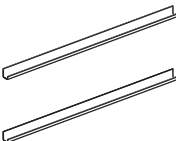
DESCRIPTION	PRODUCT CODE	LIST PRICE	DIMENSIONS/INCHES		
			H	D	W
 J Bars for Double Wall Overhead	EVSHJB30	29	1.4	30	1
	EVSHJB36	31	1.4	36	1
	EVSHJB42	35	1.4	42	1
	EVSHJB48	39	1.4	48	1
	EVSHJB54	44	1.4	54	1
	EVSHJB60	49	1.4	60	1

## EVSSL - LOW-PROFILE SHELF

- 12" deep panel-mounted storage shelf with back lip.
- Includes attachment hardware.

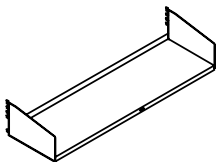
DESCRIPTION	PRODUCT CODE	LIST PRICE	DIMENSIONS/INCHES		
			H	D	W
 Low Profile Shelf	EVSSL1224	141	5	12	24
	EVSSL1230	151	5	12	30
	EVSSL1236	167	5	12	36
	EVSSL1242	172	5	12	42
	EVSSL1248	180	5	12	48
	EVSSL1254	187	5	12	54
	EVSSL1260	196	5	12	60

## EVSOH - HIGH-PROFILE SHELF

- 12" deep panel-mounted storage shelf with back lip.
- Includes attachment hardware.

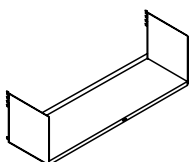
DESCRIPTION	PRODUCT CODE	LIST PRICE	DIMENSIONS/INCHES		
			H	D	W
 High Profile Shelf	EVSOH1224	277	14.5	12	24
	EVSOH1230	307	14.5	12	30
	EVSOH1236	324	14.5	12	36
	EVSOH1242	335	14.5	12	42
	EVSOH1248	341	14.5	12	48
	EVSOH1254	355	14.5	12	54
	EVSOH1260	358	14.5	12	60



**EVSSC - CORNER SHELF KIT**

- Used in conjunction with a Low or High Profile Shelf.
- Includes handed corner side panel, flat bracket and hardware.
- Corner shelf must be specified 12" smaller than panel width.

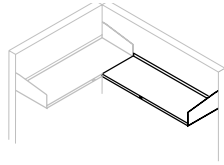

DESCRIPTION	PRODUCT CODE	LIST PRICE	DIMENSIONS/INCHES		
			H	D	W
Corner Shelf Kit	EVSSC1224L	131	5	12	24
	EVSSC1230L	136	5	12	30
	EVSSC1236L	141	5	12	36
	EVSSC1224R	131	5	12	24
	EVSSC1230R	136	5	12	30
	EVSSC1236R	141	5	12	36

**EVSLs - LAMINATED SHELF**

- Laminated panel mounted wood shelf
- Shelf thickness is 1".
- Available in LP only.
- Includes attachment hardware.

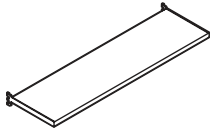

DESCRIPTION	PRODUCT CODE	LIST PRICE	DIMENSIONS/INCHES		
			H	W	D
Laminated Shelf	EVSLs0818	216	1.125	18	8.5
	EVSLs0824	233	1.125	24	8.5
	EVSLs0830	251	1.125	30	8.5
	EVSLs0836	269	1.125	36	8.5
	EVSLs0842	290	1.125	42	8.5
	EVSLs0848	306	1.125	48	8.5

**EVHV - SINGLE SLOTTED WALL ADAPTER**

- To attach system components to a fixed wall. The vertical wall adapter is a "U" shaped channel with a vertical row of 1" slots on center.
  - Mounting hardware not included. Mounting hardware selection to be based on wall material.
  - Use of wall rack requires lower tooth of top hook on cantilever or shelf to be notched in the field.
  - Available in standard paint colors.
  - Shipped & priced per pair.
- NOTE:**
- Care should be taken to mount adapters only to wall studs using correct fasteners. Failure to do this may result in collapse of the unit and subsequent possible personal injury.



DESCRIPTION	PRODUCT CODE	LIST PRICE	DIMENSIONS/INCHES	
			D	H
Single Slotted Wall Track	EVHV01	92	60	.5

**EVADA-KIT - UPMOUNT CONVERSION KIT**

- Converts an existing panel overhead storage unit EVADA-PM to an upmounted unit (EVADA-UM).
- Kit includes a back panel for the overhead and cantilevers.
- When used on a 54" high panel, the top of the overhead will match the height of 66" high panels.

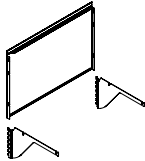
DESCRIPTION	PRODUCT CODE	LIST PRICE	DIMENSIONS/INCHES			
			H	D	W	
	Upmount Conversion Kit	EVADA30KIT	260	16	30	2
		EVADA36KIT	274	16	36	2
		EVADA42KIT	289	16	42	2
		EVADA48KIT	303	16	48	2
		EVADA54KIT	316	16	54	2
		EVADA60KIT	332	16	60	2

**EVADAPMKIT - PANEL MOUNT CONVERSION KIT**

- Converts an existing up mount overhead storage unit EVADA-UM to a panel mounted overhead storage unit EVADA-PM.
- Kit includes panel mounted brackets.

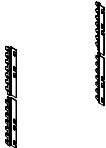
DESCRIPTION	PRODUCT CODE	LIST PRICE	DIMENSIONS/INCHES			
			H	D	W	
	Panel Mount Conversion Kit	EVADAPMKIT	61	16	2	.5

**EVSQB - OVERHEAD BACK WALL**

- Metal back wall attaches to EVSOF12 overhead to provide interior security.
- Can be field installed or retrofitted.

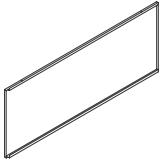
DESCRIPTION	PRODUCT CODE	LIST PRICE	DIMENSIONS/INCHES			
			H	D	W	
	Overhead Back Wall	EVSQB24	72	14	.5	24
		EVSQB30	85	14	.5	30
		EVSQB36	96	14	.5	36
		EVSQB42	109	14	.5	42
		EVSQB48	119	14	.5	48
		EVSQB54	132	14	.5	54
		EVSQB60	141	14	.5	60



**EVSOFPB - FULL PULL OVERHEAD BACK WALL**

- Metal back wall attaches to EVSOF13 overhead to provide interior security.
- Can be field installed or retrofitted.

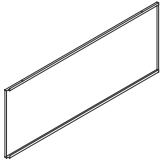
DESCRIPTION	PRODUCT CODE	LIST PRICE	DIMENSIONS/INCHES		
			H	D	W
 Full Pull Overhead Back Wall	EVSOFPB24	72	14	.5	24
	EVSOFPB30	85	14	.5	30
	EVSOFPB36	96	14	.5	36
	EVSOFPB42	109	14	.5	42
	EVSOFPB48	119	14	.5	48
	EVSOFPB54	132	14	.5	54
	EVSOFPB60	141	14	.5	60

**EVSOIB - INTERNATIONAL OVERHEAD BACK WALL**

- Metal back wall attaches to EVSOF17 overhead to provide interior security.
- Can be field installed or retrofitted.

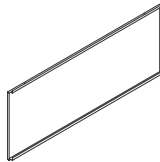
DESCRIPTION	PRODUCT CODE	LIST PRICE	DIMENSIONS/INCHES		
			H	D	W
 International Overhead Back Wall	EVSOIB24	76	17	.5	24
	EVSOIB30	92	17	.5	30
	EVSOIB36	99	17	.5	36
	EVSOIB42	115	17	.5	42
	EVSOIB48	126	17	.5	48

**EVAOMFD - DRY ERASE MARKER BOARD**

- Adheres magnetically to the front of Flipper Door (EVSOF) Overhead.
- Use erasable writeboard markers only.

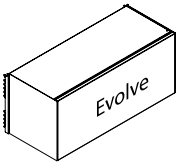
DESCRIPTION	PRODUCT CODE	LIST PRICE	DIMENSIONS/INCHES		
			H	D	W
 Dry Erase Marker Board	EVAOMFD24	323	14.4	.5	22.8
	EVAOMFD30	371	14.4	.5	28.8
	EVAOMFD36	420	14.4	.5	34.8
	EVAOMFD42	476	14.4	.5	40.8
	EVAOMFD48	524	14.4	.5	46.8
	EVAOMFD54	564	14.4	.5	52.8
	EVAOMFD60	597	14.4	.5	58.8

**EVSOFD - OVERHEAD DIVIDER**

- Attaches to overhead top shelf inside the overhead.
- Provides rigid division for books and binders.
- Not for use with 1600 series overhead storage units.
- Can be used with a hutch.

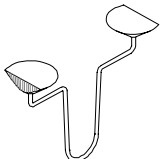
DESCRIPTION	PRODUCT CODE	LIST PRICE	DIMENSIONS/INCHES		
			H	D	W
 Overhead Divider	EVSOFD01	76	21	30	

**EVS12BBF - TWELVE SERIES BOX/BOX/FILE PEDESTAL - WORKSURFACE SUPPORTING**

- Freestanding/Worksurface Supporting Pedestal.
- Includes one pencil tray and one divider.
- Lock is standard. Lock positioned on the front face, right side.
- Can be retrofit to a panel using a pedestal bracket, please specify EVHBP1. Pedestal bracket is specified separately, see Worksurfaces for listing.

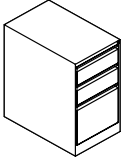
	DESCRIPTION	PRODUCT CODE	LIST PRICE	DIMENSIONS/INCHES		
				H	D	W
	Twelve Series Box/Box/File Pedestal - Worksurface Supporting	EVS1218BBF	720	27.75	18	15
		EVS1223BBF	728	27.75	23	15
		EVS1224BBF	728	27.75	24	15
		EVS1229BBF	805	27.75	29	15
		EVS1230BBF	805	27.75	30	15

**EVS12FF - TWELVE SERIES FILE/FILE PEDESTAL - WORKSURFACE SUPPORTING**

- Freestanding/Worksurface Supporting Pedestal with long pull and double wall drawer front construction.
- Lock is standard. Lock positioned on the front face, right side.
- Can be retrofit to a panel using a pedestal bracket, please specify EVHBP1. Pedestal bracket is specified separately, see Worksurfaces for listing.

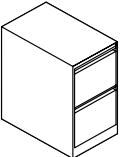
	DESCRIPTION	PRODUCT CODE	LIST PRICE	DIMENSIONS/INCHES		
				H	D	W
	Twelve Series File/File Pedestal - Worksurface Supporting	EVS1218FF	720	27.75	18	15
		EVS1223FF	728	27.75	23	15
		EVS1224FF	728	27.75	24	15
		EVS1229FF	805	27.75	29	15
		EVS1230FF	805	27.75	30	15

**EVS12BF - TWELVE SERIES BOX/FILE PEDESTAL**

- Freestanding Pedestal.
- Includes one pencil tray and one divider.
- Lock is standard. Lock positioned on the front face, right side.
- Not worksurface supporting.

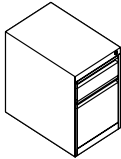
	DESCRIPTION	PRODUCT CODE	LIST PRICE	DIMENSIONS/INCHES		
				H	D	W
	Twelve Series Box/File Pedestal	EVS1218BF	720	21.75	18	15
		EVS1223BF	728	21.75	23	15
		EVS1229BF	805	21.75	29	15

**EVS12BFM - TWELVE SERIES MOBILE BOX/FILE PEDESTAL**

- Mobile Pedestal that includes one pencil tray and one divider.
- Includes factory installed counterweight balance.
- Lock is standard. Lock positioned on the front face, right side.
- Not for use with pedestal seat cushion.
- Casters do not lock.

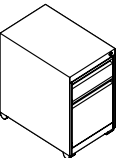
	DESCRIPTION	PRODUCT CODE	LIST PRICE	DIMENSIONS/INCHES		
				H	D	W
	Twelve Series Mobile Box/File Pedestal	EVS1218BFM	871	21.6	18	15
		EVS1223BFM	877	21.6	23	15
		EVS1229BFM	1039	21.6	29	15



**EVS12DBBBFM - TWELVE SERIES MOBILE BOX/BOX/FILE PEDESTAL WITH SMALL BASE**

- Mobile pedestal with flat front, double wall drawer construction.
- Includes 4 casters and 1 counterweight balance.
- Lock is positioned on front face, on right side.
- Pedestal will fit under 29" high worksurface.
- All casters are non locking.

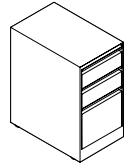

DESCRIPTION	PRODUCT CODE	LIST PRICE	DIMENSIONS/INCHES		
			H	D	W
Twelve Series Mobile Box/Box/File Pedestal	EVS12SB19BBFM	845	28	19	15
	EVS12SB23BBFM	860	28	23	15
	EVS12SB29BBFM	868	28	29	15

**EVS12SBFFM - TWELVE SERIES MOBILE FILE/FILE PEDESTAL WITH SMALL BASE**

- Mobile pedestal with flat front, double wall drawer construction.
- Includes 4 casters and 1 counterweight balance.
- Lock is positioned on front face, on right side.
- Pedestal will fit under 29" high worksurface.
- All casters are non locking.

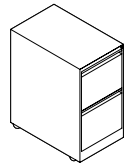

DESCRIPTION	PRODUCT CODE	LIST PRICE	DIMENSIONS/INCHES		
			H	D	W
Twelve Series Mobile File/File Pedestal	EVS12SB19FFM	845	28	19	15
	EVS12SB23FFM	860	28	23	15
	EVS12SB29FFM	868	28	29	15

**EVS12BFLCM - MOBILE BOX/FILE PEDESTAL WITH 60MM CASTERS**

- Mobile pedestal that includes one pencil tray and one divider.
- Includes factory installed counterweight.
- Lock is standard.
- 60mm high casters.
- For use with pedestal seat cushion. See model below.
- Casters do not lock.

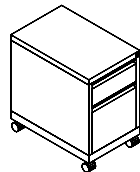

DESCRIPTION	PRODUCT CODE	LIST PRICE	DIMENSIONS/INCHES		
			H	D	W
Mobile Box/File Pedestal with 60mm Casters	EVS1219BFLCM	871	24.125	19	15
	EVS1223BFLCM	877	24.125	23	15
	EVS1229BFLCM	1039	24.125	29	15

**EVCUSHION15 - PEDESTAL SEAT CUSHIONS**

- Cushions will have single stitching at the seams.
- Velcro included for quick attachment to pedestal file.
- 1" Cushion will have a rectilinear design on all sides.
- 2" Cushion will have waterfall edges Front and Back,
- Cushions are for use on EVS12BFLCM Mobile Pedestals.
- Please choose a fabric from the standard cushion textiles on pages 244-246.

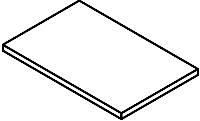
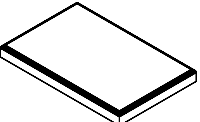
	DESCRIPTION	PRODUCT CODE	LIST PRICE/GRADES														DIM./INCH			YRDS			
			1	2	3	4	5	6	7	8	9	10	11	12	13	14	15	16	17		H	D	W
	Pedestal Seat	EVCUSHION15X18X1	205	241	267	306	361	387	436	516	578	645	785	935	864	981	1220	1457	1692	1	18	15	1
	Cushions - 1" Thick	EVCUSHION15X19X1	205	241	267	306	361	387	436	516	578	645	785	935	864	981	1220	1457	1692	1	19	15	1
		EVCUSHION15X23X1	229	266	293	330	387	411	460	542	602	671	809	961	884	1002	1241	1476	1712	1	23	15	1
		EVCUSHION15X24X1	229	266	293	330	387	411	460	542	602	671	809	961	884	1002	1241	1476	1712	1	24	15	1
		EVCUSHION15X29X1	303	350	380	435	508	543	607	716	797	890	1076	1277	1175	1332	1649	1963	2279	1	29	15	1
		EVCUSHION15X30X1	303	350	380	435	508	543	607	716	797	890	1076	1277	1175	1332	1649	1963	2279	1	30	15	1
	Pedestal Seat	EVCUSHION15X18X2	227	263	288	326	381	408	457	538	599	666	804	959	882	1000	1236	1474	1236	2	18	15	2
	Cushions - 2" Thick	EVCUSHION15X19X2	227	263	288	326	381	408	457	538	599	666	821	959	882	1000	1236	1474	1236	2	19	15	2
		EVCUSHION15X23X2	255	291	317	356	411	437	488	566	628	695	835	985	904	1023	1261	1497	1734	2	23	15	2
		EVCUSHION15X24X2	255	291	317	356	411	437	488	566	628	695	835	985	904	1023	1261	1497	1734	2	24	15	2
		EVCUSHION15X29X2	338	382	415	468	543	578	642	750	831	924	1108	1308	1204	1359	1676	1990	2309	2	29	15	2
		EVCUSHION15X30X2	338	382	415	468	543	578	642	750	831	924	1108	1308	1204	1359	1676	1990	2309	2	30	15	2

**EVS1230DP - TWELVE SERIES LINEAR COMBINATION DOUBLE PEDESTAL**

- Measures 30" wide.
- Right (R) or Left (L) is determined by the side of cabinet with file drawer.
- Include one pencil tray and one divider.
- Freestanding/Worksurface Supporting Pedestal.
- Includes one lock.

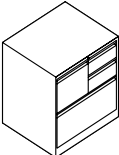
	DESCRIPTION	PRODUCT CODE	LIST PRICE	DIMENSIONS/INCHES		
				H	D	W
	Twelve Series Linear Combination	EVS1230DPL	1900	27.875	18	30
	Double Pedestal	EVS1230DPR	1900	27.875	18	30

**EVHPB - PEDESTAL BRACKET**

- Attaches to back edge of a pedestal and connects a pedestal to panel connector.
- Available in standard paint colors.

	DESCRIPTION	PRODUCT CODE	LIST PRICE	DIMENSIONS/INCHES
	Pedestal Bracket	EVHPB1	36	H 11



**EVSSP12BFM - CUBE STORAGE BF MOBILE PEDESTAL**

- Mobile pedestal with door and shelf
- Includes four locking casters
- File interior dimensions: 11 7/8"H x 11 13/16"W x 10 7/16"D
- Metal wire divider file is 3-7/16" from side, can be installed either on the left or right side
- Includes lock
- Shipped KD



DESCRIPTION	PRODUCT CODE	LIST PRICE	DIMENSIONS/INCHES		
			H	D	W
	EVSSP12BFMKL	819	22	12	12
	EVSSP12BFMKR	819	22	12	12

**EVSSP12BBFM - CUBE STORAGE BBF MOBILE PEDESTAL**

- Mobile pedestal with door and shelf
- Includes four locking casters
- File interior dimensions: 11 7/8"H x 11 13/16"W x 10 7/16"D
- Metal wire divider in file is 3-7/16" from side, can be installed either on the left or right side
- Includes lock
- Shipped KD

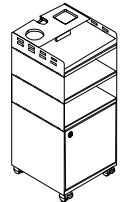

DESCRIPTION	PRODUCT CODE	LIST PRICE	DIMENSIONS/INCHES		
			H	D	W
	EVSSP12BBFMKL	1021	28	12	12
	EVSSP12BBFMKR	1021	28	12	12

**EVSSP12SFM - CUBE STORAGE SF MOBILE PEDESTAL**

- Mobile pedestal with doors
- Includes four locking casters
- File interior dimensions: 11 7/8"H x 11 13/16"W x 10 7/16"D
- Metal wire divider in storage and file is 3-7/16" from side, can be installed either on the left or right side
- Storage interior dimension: 10 1/2"H x 11 13/16"W x 10 7/16"D
- Includes lock
- Shipped KD

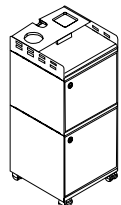

DESCRIPTION	PRODUCT CODE	LIST PRICE	DIMENSIONS/INCHES		
			H	D	W
	EVSSP12SFMKL	1070	28	12	12
	EVSSP12SFMKR	1070	28	12	12



**EVSSP12BFM - CUBE STORAGE BF MOBILE PEDESTAL**

- Mobile pedestal with door and shelf
  - Includes four locking casters
  - File interior dimensions: 11 7/8"H x 11 13/16"W x 10 7/16"D
  - Metal wire divider in file is 3-7/16" from side, can be installed either on the left or right side
- Shipped KD

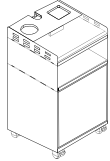

DESCRIPTION	PRODUCT CODE	LIST PRICE	DIMENSIONS/INCHES		
			H	D	W
	EVSSP12BFML	735	22	12	12
	EVSSP12BFMR	735	22	12	12

**EVSSP12BBFM - CUBE STORAGE BBF MOBILE PEDESTAL**

- Mobile pedestal with door and shelf
  - Includes four locking casters
  - File interior dimensions: 11 7/8"H x 11 13/16"W x 10 7/16"D
  - Metal wire divider in file is 3-7/16" from side, can be installed either on the left or right side
- Shipped KD

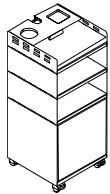

DESCRIPTION	PRODUCT CODE	LIST PRICE	DIMENSIONS/INCHES		
			H	D	W
	EVSSP12BBFML	938	28	12	12
	EVSSP12BBFMR	938	28	12	12

**EVSSP12SFM - CUBE STORAGE SF MOBILE PEDESTAL**

- Mobile pedestal with doors
  - Includes four locking casters
  - File interior dimensions: 11 7/8"H x 11 13/16"W x 10 7/16"D
  - Metal wire divider in storage and file is 3-7/16" from side, can be installed either on the left or right side
- Storage interior dimension: 10 1/2"H x 11 13/16"W x 10 7/16"D
  - Shipped KD

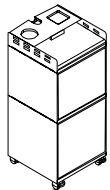

DESCRIPTION	PRODUCT CODE	LIST PRICE	DIMENSIONS/INCHES		
			H	D	W
	EVSSP12SFML	854	28	12	12
	EVSSP12SFMR	854	28	12	12



**EVFELT03BC-PET PIECE FOR SHELF FOR PEDESTAL WITH CLOSED BACK**

- PET piece for shelf for pedestal with closed back
- Front edge at 45 degree

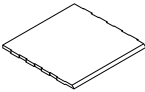
DESCRIPTION	PRODUCT CODE	LIST PRICE	DIMENSIONS/INCHES		
			H	D	W
	EVFELT03BC	42	12	12	.038

**EVSSPH12BF - CUBE STORAGE BF**

- Hanging storage
- Attaches to underside of worksurface
- File interior dimensions: 11 7/8"H x 11 13/16"W x 10 7/16"D
- Metal wire divider in file is 3-7/16" from side, can be installed either on the left or right side
- Configuration box/file with door
- Includes lock
- Shipped KD

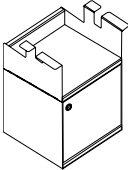
DESCRIPTION	PRODUCT CODE	LIST PRICE	DIMENSIONS/INCHES		
			H	D	W
	EVSSPH12BFKL	610	18.5	12	12
	EVSSPH12BFKR	610	18.5	12	12

**EVSSPH12BFB - CUBE STORAGE BFB**

- Hanging storage
- Attaches to underside of worksurface
- File interior dimensions: 11 7/8"H x 11 13/16"W x 10 7/16"D
- Metal wire divider in file is 3-7/16" from side, can be installed either on the left or right side
- Configuration box/file with door/box
- Includes lock
- Shipped KD

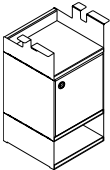
DESCRIPTION	PRODUCT CODE	LIST PRICE	DIMENSIONS/INCHES		
			H	D	W
	EVSSPH12BFBKL	812	24	12	12
	EVSSPH12BFBKR	812	24	12	12

**EVSSPH12BF - CUBE STORAGE BF**

- Hanging storage
- Attaches to underside of worksurface
- File interior dimensions: 11 7/8"H x 11 13/16"W x 10 7/16"D
- Metal wire divider in file is 3-7/16" from side, can be installed either on the left or right side
- Configuration box/file with door
- Shipped KD

DESCRIPTION	PRODUCT CODE	LIST PRICE	DIMENSIONS/INCHES		
			H	D	W
	EVSSPH12BFL	526	18.5	12	12
	EVSSPH12BFR	526	18.5	12	12

**EVSSPH12BFB - CUBE STORAGE BFB**

- Hanging storage
- Attaches to underside of worksurface
- File interior dimensions: 11 7/8"H x 11 13/16"W x 10 7/16"D
- Metal wire divider in file is 3-7/16" from side, can be installed either on the left or right side
- Configuration box/file with door/box
- Shipped KD

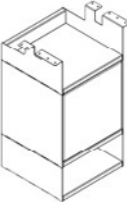
DESCRIPTION	PRODUCT CODE	LIST PRICE	DIMENSIONS/INCHES		
			H	D	W
	EVSSPH12BFBFL	729	24	12	12
	EVSSPH12BFBFR	729	24	12	12

**EVSSPH12B - CUBE STORAGE B**

- Hanging storage
- Attaches to underside of worksurface
- Configuration box
- Shipped KD

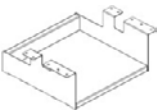
DESCRIPTION	PRODUCT CODE	LIST PRICE	DIMENSIONS/INCHES		
			H	D	W
	EVSSPH12B	204	11.5	12	12



**EVSSPH12BB - CUBE STORAGE BB**

- Hanging storage
- Attaches to underside of worksurface
- Configuration box/box
- Shipped KD

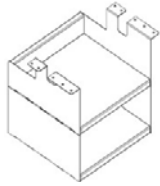

DESCRIPTION	PRODUCT CODE	LIST PRICE	DIMENSIONS/INCHES		
			H	D	W
	EVSSPH12BB	406	17	12	12

**EVS12X1H1F - ONE 1/2 HEIGHT FIXED FRONT & ONE 12" FIXED FRONT LATERAL FILE**

- 1/2 Height Box Drawer.
- 1 Fixed Drawer Front.
- Includes Lock.
- Counterweights must be specified on lateral files with pull out drawers, unless worksurface supporting, ganged together or anchored to the floor or wall.

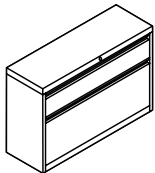

DESCRIPTION	PRODUCT CODE	LIST PRICE	DIMENSIONS/INCHES		
			H	D	W
One 1/2 Height Fixed Front & One 12" Fixed Front Lateral File	EVS1230X1H1F	1679	21.75	18	30
	EVS1236X1H1F	1748	21.75	18	36
	EVS1242X1H1F	1808	21.75	18	42

**EVS12X1S1F - ONE 1/2 HEIGHT OPEN SHELF & ONE 12" FIXED FRONT LATERAL FILE**

- 1/2 Height Open Shelf.
- 1 Fixed Drawer Front.
- Includes Lock.
- Counterweights must be specified on lateral files with pull out drawers, unless worksurface supporting, ganged together or anchored to the floor or wall.

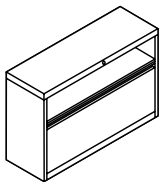

DESCRIPTION	PRODUCT CODE	LIST PRICE	DIMENSIONS/INCHES		
			H	D	W
One 1/2 Height Open Shelf & One 12" Fixed Front Lateral File	EVS1230X1S1F	1625	21.75	18	30
	EVS1236X1S1F	1660	21.75	18	36
	EVS1242X1S1F	1697	21.75	18	42

**EVS12X1SND - ONE 1/2 HEIGHT OPEN SHELF & ONE 12" OPEN SHELF LATERAL CABINET**

- 1/2 Height Open Shelf.
- Bottom Open Shelf.

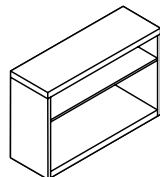

DESCRIPTION	PRODUCT CODE	LIST PRICE	DIMENSIONS/INCHES		
			H	D	W
One 1/2 Height Open Shelf & One 12" Open Shelf Lateral Cabinet	EVS1230X1SND	1313	21.75	18	30
	EVS1236X1SND	1430	21.75	18	36
	EVS1242X1SND	1528	21.75	18	42

**EVS12X1S - ONE 1/2 HEIGHT SHELF & ONE 12" SHELF LATERAL CABINET WITH DOORS**

- One 1/2 height storage module with long pull handles. • Includes Lock.
- Storage cabinet with doors.

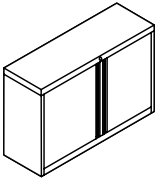
	DESCRIPTION	PRODUCT CODE	LIST PRICE		DIMENSIONS/INCHES		
					H	D	W
	One and 1/2 Height Shelf &	EVS1230X1S	1380		21.75	18	30
	One 12" Shelf Lateral Cabinet with Doors	EVS1236X1S	1537		21.75	18	36
		EVS1242X1S	1685		21.75	18	42

**EVCUSHION18 - LATERAL SEAT CUSHIONS**

- Cushions will have single stitching at the seams, • 2" Cushion will have waterfall edges Front and Back.
- Velcro included for quick attachment to lateral file. • Please choose a fabric from the standard cushion textiles on pages 244-246.
- 1" Cushion will have a rectilinear design on all sides.

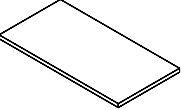
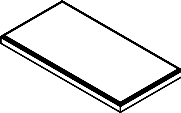
	DESCRIPTION	PRODUCT CODE	LIST PRICE/GRADES															DIM./INCH			YRDS		
			1	2	3	4	5	6	7	8	9	10	11	12	13	14	15	16	17	H		D	W
	Lateral Seat	EVCUSHION18X30X1	318	365	398	449	523	557	624	731	813	752	1091	1290	1186	1346	1659	1976	2292	1	18	30	1
	Cushions - 1" Thick	EVCUSHION18X36X1	354	401	436	486	561	595	662	768	848	941	1127	1328	1528	1727	2127	2528	2925	1	18	36	1
		EVCUSHION18X42X1	378	425	459	510	585	618	686	792	873	966	1152	1354	1236	1396	1711	2026	2341	1	18	42	1
	Lateral Seat	EVCUSHION18X30X2	1322	396	427	480	555	590	654	762	844	936	1123	1322	1214	1370	1686	2002	2316	2	18	30	2
	Cushions - 2" Thick	EVCUSHION18X36X2	392	439	472	522	598	632	698	804	885	979	1166	1364	1564	1765	2163	2564	2964	2	18	36	2
		EVCUSHION18X42X2	392	439	472	522	598	632	698	804	885	979	1166	1364	1267	1424	1740	2057	2371	2	18	42	2

**EVT - LATERAL FILE TOPS**

- Note the following abbreviations: • Available in standard Evolve finishes see page 240.  
T = Thermally-Fused Laminate and H = High Pressure Laminate.

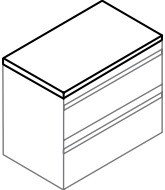
	DESCRIPTION	PRODUCT CODE	LIST PRICE		DIMENSIONS/INCHES		
			Gr1	Gr2	H	D	W
	Lateral File Tops	EVT1830	163	228	1	18	30
		EVT1836	185	260	1	18	36
		EVT1842	223	340	1	18	42
		EVT1860	301	515	1	18	60
		EVT1872	355	582	1	18	72
		EVT1884	495	666	1	18	84
		EVT1890	534	725	1	18	90
		EVT18108	645	894	1	18	108



**EVS12FKIT - 1212 DRAWER CONVERSION KIT**

- Converts an existing box/box/file pedestal into a file/file pedestal.
- Kit includes 1 - 12" high drawer front, 1 - 12" high drawer body, 2 sets of slides and lock bar.
- Specify type of conversion kit, color of front and color of handle. Existing pedestal depth to be retrofitted.

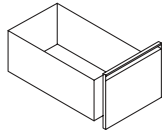

DESCRIPTION	PRODUCT CODE	LIST PRICE	DIMENSIONS/INCHES		
			H	D	W
1212 Drawer Conversion Kit	EVS1218FKIT	251	15	18	15
	EVS1223FKIT	251	15	23	15
	EVS1224FKIT	251	15	24	15
	EVS1229FKIT	251	15	29	15
	EVS1230FKIT	251	15	30	15

**EVS12BKIT - 6612 DRAWER CONVERSION KIT**

- Converts an existing file/file pedestal into a box/box/file pedestal.
- Kit includes 2 - 6" high drawer front, 2 - 6" high drawer body, set of slides and lock bar.
- Specify type of conversion kit, color of front and color of handle. Existing pedestal depth to be retrofitted.

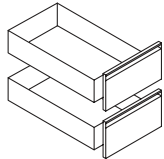

DESCRIPTION	PRODUCT CODE	LIST PRICE	DIMENSIONS/INCHES		
			H	D	W
6612 Drawer Conversion Kit	EVS1218BKIT	251	15	18	15
	EVS1223BKIT	251	15	23	15
	EVS1224BKIT	251	15	24	15
	EVS1229BKIT	251	15	29	15
	EVS1230BKIT	251	15	30	15

**EVS12FFKIT - FIXED FRONT DOOR CONVERSION KIT**

- Fixed front drawer conversion with receding door roll out drawer.
- Must indicate position (1,2,3,4,5) of conversion from top to bottom.
- Drawer interiors are finished Black.

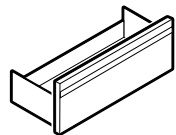

DESCRIPTION	PRODUCT CODE	LIST PRICE	DIMENSIONS/INCHES		
			H	D	W
Fixed Front Door Conversion Kit	EVS1230FFKIT	278	13.5	17	30
	EVS1236FFKIT	278	13.5	17	36
	EVS1242FFKIT	278	13.5	17	42

**EVS12RDKIT - RECEDING DOOR WITH FIXED SLOTTED SHELF**

- Receding door and fixed slotted shelf conversion from fixed front drawer.
- Fixed front drawer can be substituted for a roll out drawer in a receding opening at no extra charge at the time of order.
- Add list price to each opening being converted.
- Indicate position (1,2,3,4,5) of conversion from top to bottom.
- Drawer interiors are finished Black.

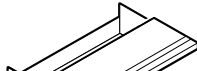
DESCRIPTION	PRODUCT CODE	LIST PRICE	DIMENSIONS/INCHES		
			H	D	W
 Receding Door with Fixed Slotted Shelf	EVS1230RDKIT	278	9.1	16.5	30
	EVS1236RDKIT	278	9.1	16.5	36
	EVS1242RDKIT	278	9.1	16.5	42

**EVS12BHHKIT - HALF HEIGHT DOOR CONVERSION KIT**

- Receding door and fixed slotted shelf conversion from fixed front drawer.
- Fixed front drawer can be substituted for a roll out drawer in a receding opening at no extra charge at the time of order.
- Add list price to each opening being converted.
- Indicate position (1,2,3,4,5) of conversion from top to bottom.
- Drawer interiors are finished Black.

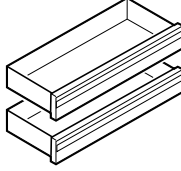
DESCRIPTION	PRODUCT CODE	LIST PRICE	DIMENSIONS/INCHES		
			H	D	W
 Half Height Door Conversion Kit	EVS1230BHHKIT	311	6.75	17	30
	EVS1236BHHKIT	311	6.75	17	36
	EVS1242BHHKIT	311	6.75	17	42



**EVSCR/SGD-P - 21" HIGH PANEL MOUNTED DOUBLE WALL CABINET**

- Inside dimensions 13"high x 13"deep
- Quality steel construction
- Available in standard Evolve paint finishes
- Tracks for sliding Glass door available in Tungsten only
- Available in Tempered Frosted Glass option only
- Push in Lock, No Keys alike. Cannot be keyed alike.
- **R**-Round legs
- **S**-Square legs
- Panel supported( brackets included)
- Double wall cabinet top not included.

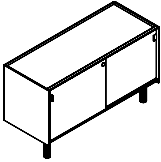
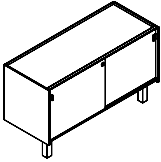
	DESCRIPTION	PRODUCT CODE	LIST PRICE	DIMENSIONS/INCHES		
				H	D	W
	21" High Panel Mounted Double Wall Cabinet - Round Legs	EVSCRGD1330P	928	21	14.7	30
		EVSCRGD1336P	979	21	14.7	36
		EVSCRGD1342P	1049	21	14.7	42
		EVSCRGD1348P	1117	21	14.7	48
		EVSCRGD1354P	1187	21	14.7	54
		EVSCRGD1360P	1238	21	14.7	60
	21" High Panel Mounted Double Wall Cabinet - Square Legs	EVSCSGD1330P	928	21	14.7	30
		EVSCSGD1336P	979	21	14.7	36
		EVSCSGD1342P	1049	21	14.7	42
		EVSCSGD1348P	1117	21	14.7	48
		EVSCSGD1354P	1187	21	14.7	54
		EVSCSGD1360P	1238	21	14.7	60

**EVSCR/SGD-F - 21" HIGH FREESTANDING DOUBLE WALL CABINET**

- Inside dimensions 13"high x 13"deep
- Quality steel construction
- Available in standard Evolve paint finishes
- Tracks for sliding Glass door available in Tungsten only
- Available in Tempered Frosted Glass option only
- Push in Lock, No Keys alike. Cannot be keyed alike.
- **R**-Round legs
- **S**-Square legs
- Free Standing with Back Wall
- Double wall cabinet top not included.

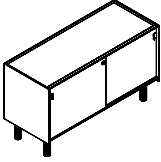
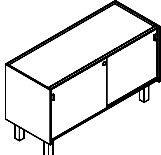
	DESCRIPTION	PRODUCT CODE	LIST PRICE	DIMENSIONS/INCHES		
				H	D	W
	21" High Freestanding Double Wall Cabinet - Round Legs	EVSCRGD1330F	1076	21	14.7	30
		EVSCRGD1336F	1132	21	14.7	36
		EVSCRGD1342F	1213	21	14.7	42
		EVSCRGD1348F	1286	21	14.7	48
		EVSCRGD1354F	1364	21	14.7	54
		EVSCRGD1360F	1423	21	14.7	60
	21" High Freestanding Double Wall Cabinet - Square Legs	EVSCSGD1330F	1076	21	14.7	30
		EVSCSGD1336F	1132	21	14.7	36
		EVSCSGD1342F	1213	21	14.7	42
		EVSCSGD1348F	1286	21	14.7	48
		EVSCSGD1354F	1364	21	14.7	54
		EVSCSGD1360F	1423	21	14.7	60



**EVSDCR/SGD - 21" HIGH BACK TO BACK DOUBLE WALL CABINET**

- Inside dimensions 13"high x 13"deep
- Quality steel construction
- Available in standard Evolve paint finishes
- Tracks for sliding Glass door available in Tungsten only
- Available in Tempered Frosted Glass option only
- Push in Lock, No Keys alike
- **R**-Round legs
- **S**-Square legs
- Back to Back Free Standing (back wall included)
- Back to Back top not included.

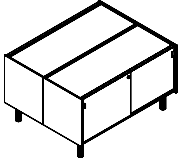
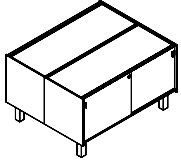
	DESCRIPTION	PRODUCT CODE	LIST PRICE	DIMENSIONS/INCHES		
				H	D	W
	21" High Back to Back Double Wall Cabinet - Round Legs	EVSDCRGD1330	1885	21	29.4	30
		EVSDCRGD1336	1993	21	29.4	36
		EVSDCRGD1342	2142	21	29.4	42
		EVSDCRGD1348	2240	21	29.4	48
		EVSDCRGD1354	2434	21	29.4	54
		EVSDCRGD1360	2540	21	29.4	60
	21" High Back to Back Double Wall Cabinet - Square Legs	EVSDCSGD1330	1885	21	29.4	30
		EVSDCSGD1336	1993	21	29.4	30
		EVSDCSGD1342	2142	21	29.4	30
		EVSDCSGD1348	2240	21	29.4	30
		EVSDCSGD1354	2434	21	29.4	30
		EVSDCSGD1360	2540	21	29.4	30

**EVSCR/SGD-P - 28" HIGH PANEL MOUNTED DOUBLE WALL CABINET**

- Inside dimensions 13"high x 13"deep
- Quality steel construction
- Available in standard Evolve paint finishes
- Tracks for sliding Glass door available in Tungsten only
- Available in Tempered Frosted Glass option only
- Push in Lock, No Keys alike
- **R**-Round legs
- **S**-Square legs
- Panel supported (brackets included)
- Double wall cabinet top not included.

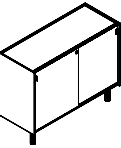
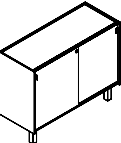
	DESCRIPTION	PRODUCT CODE	LIST PRICE	DIMENSIONS/INCHES		
				H	D	W
	28" High Panel Mounted Double Wall Cabinet - Round Legs	EVSCRGD2230P	1226	28	14.7	30
		EVSCRGD2236P	1284	28	14.7	36
		EVSCRGD2242P	1361	28	14.7	42
		EVSCRGD2248P	1437	28	14.7	48
		EVSCRGD2254P	1518	28	14.7	54
		EVSCRGD2260P	1583	28	14.7	60
	28" High Panel Mounted Double Wall Cabinet - Square Legs	EVSCSGD2230P	1226	28	14.7	30
		EVSCSGD2236P	1284	28	14.7	36
		EVSCSGD2242P	1361	28	14.7	42
		EVSCSGD2248P	1437	28	14.7	48
		EVSCSGD2254P	1518	28	14.7	54
		EVSCSGD2260P	1583	28	14.7	60



**EVSCR/SGD-F - 28" HIGH FREESTANDING DOUBLE WALL CABINET**

- Inside dimensions 13"high x 13"deep
- Quality steel construction
- Available in standard Evolve paint finishes
- Tracks for sliding Glass door available in Tungsten only
- Available in Tempered Frosted Glass option only
- Push in Lock, No Keys alike
- **R**-Round legs
- **S**-Square legs
- Free Standing with Back Wall
- Double wall cabinet top not included.

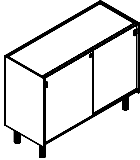
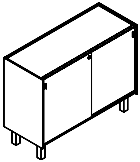
	DESCRIPTION	PRODUCT CODE	LIST PRICE	DIMENSIONS/INCHES		
				H	D	W
	28" High Freestanding Double Wall Cabinet - Round Legs	EVSCRGD2230F	1372	28	14.7	30
		EVSCRGD2236F	1437	28	14.7	36
		EVSCRGD2242F	1532	28	14.7	42
		EVSCRGD2248F	1615	28	14.7	48
		EVSCRGD2254F	1709	28	14.7	54
		EVSCRGD2260F	1773	28	14.7	60
	28" High Freestanding Double Wall Cabinet - Square Legs	EVSCSGD2230F	1372	28	14.7	30
		EVSCSGD2236F	1437	28	14.7	36
		EVSCSGD2242F	1532	28	14.7	42
		EVSCSGD2248F	1615	28	14.7	48
		EVSCSGD2254F	1709	28	14.7	54
		EVSCSGD2260F	1773	28	14.7	60

**EVSDCR/SGD - 28" HIGH BACK TO BACK DOUBLE WALL CABINET**

- Inside dimensions 13"high x 13"deep
- Quality steel construction
- Available in standard Evolve paint finishes
- Tracks for sliding Glass door available in Tungsten only
- Available in Tempered Frosted Glass option only
- Push in Lock, No Keys alike
- **R**-Round legs
- **S**-Square legs
- Back to Back Free Standing (back wall included)
- Back to Back top not included.

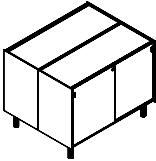
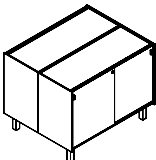
	DESCRIPTION	PRODUCT CODE	LIST PRICE	DIMENSIONS/INCHES		
				H	D	W
	28" High Back to Back Double Wall Cabinet - Round Legs	EVSDCRGD2230	2480	28	29.4	30
		EVSDCRGD2236	2593	28	29.4	36
		EVSDCRGD2242	2772	28	29.4	42
		EVSDCRGD2248	2930	28	29.4	48
		EVSDCRGD2254	3112	28	29.4	54
		EVSDCRGD2260	3226	28	29.4	60
	28" High Back to Back Double Wall Cabinet - Square Legs	EVSDCSGD2230	2480	28	29.4	30
		EVSDCSGD2236	2593	28	29.4	36
		EVSDCSGD2242	2772	28	29.4	42
		EVSDCSGD2248	2930	28	29.4	48
		EVSDCSGD2254	3112	28	29.4	54
		EVSDCSGD2260	3226	28	29.4	60

**DOUBLE WALL CABINET TOP**

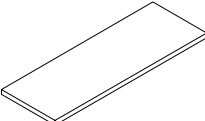
	DESCRIPTION	PRODUCT CODE	LIST PRICE	DIMENSIONS/INCHES		
				H	D	W
	Double Wall Cabinet Top	EVT1430	125	1	14.5	30
		EVT1436	141	1	14.5	36
		EVT1442	160	1	14.5	42
		EVT1448	181	1	14.5	48
		EVT1454	197	1	14.5	54
		EVT1460	218	1	14.5	60

**BACK TO BACK DOUBLE WALL CABINET TOP**

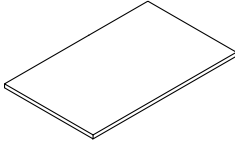
	DESCRIPTION	PRODUCT CODE	LIST PRICE	DIMENSIONS/INCHES		
				H	D	W
	Back to Double Wall Cabinet Top	EVT2930	185	1	29.4	30
		EVT2936	219	1	29.4	36
		EVT2942	306	1	29.4	42
		EVT2948	323	1	29.4	48
		EVT2954	355	1	29.4	54
		EVT2960	378	1	29.4	60

**EVS12TXX2B1F - TWELVE SERIES BOX/BOX/FILE STORAGE TOWER**

- This versatile tower can be used freestanding or integrated into a workstation to provide efficient vertical storage and filing, and provides storage for hats and coats.
- Storage tower has 1 adjustable shelf and 1 fixed shelf.
- Coat storage may be specified right or left.
- Tower comes with 3 locks - 1 for the drawers, 1 for the storage door and 1 for the coat locker.
- Full height coat storage is 7" wide with ventilation.
- Locks are keyed alike.

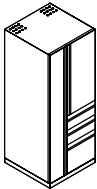
	DESCRIPTION	PRODUCT CODE	LIST PRICE	DIMENSIONS/INCHES		
				H	D	W
	Twelve Series Box/Box File Storage Tower - 42" High	EVS12T422B1FR	3196	42	24	24
		EVS12T422B1FL	3196	42	24	24
	Twelve Series Box/Box File Storage Tower - 50" High	EVS12T502B1FR	3196	50	24	24
		EVS12T502B1FL	3196	50	24	24
	Twelve Series Box/Box File Storage Tower - 54" High	EVS12T542B1FR	3196	54	24	24
		EVS12T542B1FL	3196	54	24	24
Left shown	Twelve Series Box/Box/File Storage Tower - 65 7/8" High	EVS12T662B1FR	3341	65.875	24	24
		EVS12T662B1FL	3341	65.875	24	24

**EVS12TXX2F - TWELVE SERIES FILE/FILE STORAGE TOWER**

- This versatile tower can be used freestanding or integrated into a workstation to provide efficient vertical storage and filing, and provides storage for hats and coats.
- Storage tower has 1 adjustable shelf and 1 fixed shelf.
- Coat storage may be specified right or left.
- Tower comes with 3 locks - 1 for the drawers, 1 for the storage door and 1 for the coat locker.
- Full height coat storage is 7" wide with ventilation.
- Locks are keyed alike.

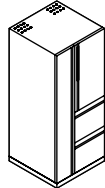
	DESCRIPTION	PRODUCT CODE	LIST PRICE	DIMENSIONS/INCHES		
				H	D	W
	Twelve Series File/File Storage Tower - 42" High	EVS12T422FR	3196	42	24	24
		EVS12T422FL	3196	42	24	24
	Twelve Series File/File Storage Tower - 50" High	EVS12T502FR	3196	50	24	24
		EVS12T502FL	3196	50	24	24
	Twelve Series File/File Storage Tower - 54" High	EVS12T542FR	3196	54	24	24
		EVS12T542FL	3196	54	24	24
Left shown	Twelve Series File/File Storage Tower - 65 7/8" High	EVS12T662FR	3341	65.875	24	24
		EVS12T662FL	3341	65.875	24	24



**EVS12TSOXX2BF - TWELVE SERIES SIDE OPENING BOX/BOX/FILE STORAGE TOWER**

- This versatile tower can be used freestanding or integrated into a workstation to provide efficient vertical storage and filing, and provides storage for hats and coats.
- Coat storage may be specified right or left.
- Full height coat storage is 7" wide with ventilation.
- Storage tower has 1 adjustable shelf and 1 fixed shelf.
- Tower comes with 2 locks - 1 for the file drawers and 1 for the coat locker.
- Locks are keyed alike.
- Open shelves are 15" W x 20.25" D

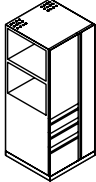
	DESCRIPTION	PRODUCT CODE	LIST PRICE	DIMENSIONS/INCHES		
				H	D	W
	Twelve Series Side Opening Box/Box/File Storage Tower - 50" High	EVS12TS0502BFR	3361	50	24	24
		EVS12TS0502BFL	3361	50	24	24
	Twelve Series Side Opening Box/Box/File Storage Tower - 54" High	EVS12TS0542B1FR	3531	54	24	24
		EVS12TS0542B1FL	3531	54	24	24
	Twelve Series Side Opening Box/Box/File Storage Tower - 65 7/8" High	EVS12TS0662B1FR	3589	65.875	24	24
		EVS12TS0662B1FL	3589	65.875	24	24

Right shown

**EVS12TSOXX2F - TWELVE SERIES SIDE OPENING FILE/FILE STORAGE TOWER**

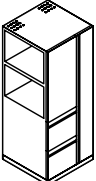

- This versatile tower can be used freestanding or integrated into a workstation to provide efficient vertical storage and filing, and provides storage for hats and coats.
- Coat storage may be specified right or left.
- Full height coat storage is 7" wide with ventilation.
- Storage tower has 1 adjustable shelf and 1 fixed shelf.
- Tower comes with 2 locks - 1 for the file drawers and 1 for the coat locker.
- Locks are keyed alike.
- Open shelves are 15" W x 20.25" D

	DESCRIPTION	PRODUCT CODE	LIST PRICE	DIMENSIONS/INCHES		
				H	D	W
	Twelve Series Side Opening File/File Storage Tower - 50" High	EVS12TS0502FR	3511	50	24	24
		EVS12TS0502FL	3511	50	24	24
	Twelve Series Side Opening File/File Storage Tower - 54" High	EVS12TS0542FR	3531	54	24	24
		EVS12TS0542FL	3531	54	24	24
	Twelve Series Side Opening File/File Storage Tower - 65 7/8" High	EVS12TS0662FR	3589	65.875	24	24
		EVS12TS0662FL	3589	65.875	24	24

Right shown

**EVS12F - 12" OPENING LATERAL FILE FIXED FRONT DRAWERS**

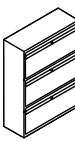
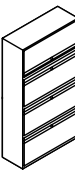

- 12" Opening Lateral File.
- Two High: All openings are Fixed Front Drawer.
- Three High: All openings are Fixed Front Drawer.
- Four High: Top drawer is receding with roll-out shelf. Remaining drawers are Fixed Front Drawers.
- Five High: Top 2 drawers are receding door and roll-out shelf. Remaining drawers are Fixed Front Drawers.
- Side-to-side bars and lock included.
- Counterweights must be specified on lateral files with pull out drawers, unless worksurface supporting, ganged together or anchored to the floor or wall.

	DESCRIPTION	PRODUCT CODE	LIST PRICE	DIMENSIONS/INCHES		
				H	D	W
	12" Opening Lateral File - 2 High	EVS123022FWS	1430	27.75	18	30
		EVS123622FWS	1495	27.75	18	36
		EVS124222FWS	1578	27.75	18	42
	12" Opening Lateral File - 3 High	EVS123033F	1874	40.5	18	30
		EVS123633F	1969	40.5	18	36
		EVS124233F	2084	40.5	18	42
	12" Opening Lateral File - 4 High	EVS123041R3F	2379	54	18	30
		EVS123641R3F	2503	54	18	36
		EVS124241R3F	2653	54	18	42
	12" Opening Lateral File - 5 High	EVS123052R3F	2941	65.88	18	30
		EVS123652R3F	3064	65.88	18	36
		EVS124252R3F	3229	65.88	18	42

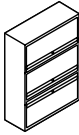

**EVS12R1F - 12" RECEDING DOOR AND ROLL-OUT SHELVES**

- 12" Opening Lateral File.
- Two High: Top opening is Receding Door and Roll-Out Shelf. Bottom drawer is Fixed Front Drawer.
- Three High: Top 2 openings are Receding Door and Roll-Out Shelf. Bottom drawer is Fixed Front Drawer.
- Four High: Top 3 openings are Receding Door and Roll-Out Shelf. Bottom drawer is Fixed Front Drawer.
- Five High: Top 4 openings are Receding Door and Roll-Out Shelf. Bottom drawer is Fixed Front Drawer.
- Side-to-side bars and lock included.
- Counterweights must be specified on lateral files with pull out drawers, unless worksurface supporting, ganged together or anchored to the floor or wall.

	DESCRIPTION	PRODUCT CODE	LIST PRICE	DIMENSIONS/INCHES		
				H	D	W
	12" Receding Door and Roll-Out Shelves - 2 High	EVS123021R1FWS	1413	27.75	18	30
		EVS123621R1FWS	1473	27.75	18	36
		EVS124221R1FWS	1558	27.75	18	42
	12" Receding Door and Roll-Out Shelves - 3 High	EVS123032R1F	1956	40.5	18	30
		EVS123632R1F	2053	40.5	18	36
		EVS124232R1F	2162	40.5	18	42
	12" Receding Door and Roll-Out Shelves - 4 High	EVS123043R1F	2473	54	18	30
		EVS123643R1F	2614	54	18	36
		EVS124243R1F	2770	54	18	42
	12" Receding Door and Roll-Out Shelves - 5 High	EVS123054R1F	3043	65.88	18	30
		EVS123654R1F	3203	65.88	18	36
		EVS124254R1F	3377	65.88	18	42

**EVS12S - 12" RECEDING DOOR AND FIXED SHELVES**

- 12" Opening Lateral File.
- Two High: All openings are Receding Doors and Fixed Shelves.
- Three High: All openings are Receding Doors and Fixed Shelves.
- Four High: All openings are Receding Doors and Fixed Shelves.
- Five High: All openings are Receding Doors and Fixed Shelves.
- 3 Plate Dividers and Lock are included.
- Counterweights must be specified on lateral files with pull out drawers, unless worksurface supporting, ganged together or anchored to the floor or wall.

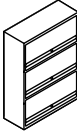
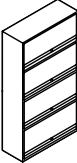
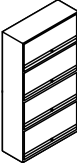
	DESCRIPTION	PRODUCT CODE	LIST PRICE	DIMENSIONS/INCHES		
				H	D	W
	12" Receding Door and Fixed Shelves - 2 High	EVS123022SWS	1429	27.75	18	30
		EVS123622SWS	1495	27.75	18	36
		EVS124222SWS	1578	27.75	18	42
	12" Receding Door and Fixed Shelves - 3 High	EVS123033S	1874	40.5	18	30
		EVS123633S	1969	40.5	18	36
		EVS124233S	2085	40.5	18	42
	12" Receding Door and Fixed Shelves - 4 High	EVS123044S	2379	54	18	30
		EVS123644S	2505	54	18	36
		EVS124244S	2653	54	18	42
	12" Receding Door and Fixed Shelves - 5 High	EVS123055S	2941	65.88	18	30
		EVS123655S	3063	65.88	18	36
		EVS124255S	3230	65.88	18	42



**EVS121B3F - 12" OPENING LATERAL FILE WITH 1 "B" - BINDER OPENING, RECEDING DOOR AND 3 FIXED FRONT DRAWERS**

- 12" Opening Lateral File.
- Four High: Top opening is "B" size with Receding Door and Fixed Shelf. Remaining 3 drawers are Fixed Front Drawers.
- Five High: Top opening is "B" size with Receding Door and Fixed Shelf. Remaining 4 drawers are Fixed Front Drawers.
- Lock is included.
- Counterweights must be specified on lateral files with pull out drawers, unless worksurface supporting, ganged together or anchored to the floor or wall.

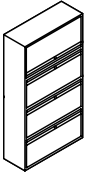
	DESCRIPTION	PRODUCT CODE	LIST PRICE	DIMENSIONS/INCHES		
				H	D	W
	12" Opening Lateral File with 1 "B" Opening, Receding Door and 3 Fixed Shelves - 4 High	EVS123041B3F	3025	54	18	30
		EVS123641B3F	3143	54	18	36
		EVS124241B3F	3263	54	18	42
	12" Opening Lateral File with 1 "B" Opening, Receding Door and 4 Fixed Shelves - 5 High 4 High Shown	EVS123051B1R3F	3645	65.88	18	30
		EVS123651B1R3F	3838	65.88	18	36
		EVS124251B1R3F	4056	65.88	18	42

**EVT - LATERAL FILE TOPS**

- Note the following abbreviations:
- H = High Pressure Laminate
- T = Thermally-Fused Laminate
- Available in standard Evolve finishes see page 240.

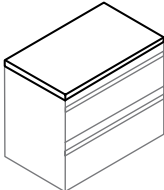
	DESCRIPTION	PRODUCT CODE	LIST PRICE		DIMENSIONS/INCHES		
			LP	HP	H	D	W
	Lateral File Tops	EVT1830	163	228	1	18	30
		EVT1836	185	260	1	18	36
		EVT1842	223	340	1	18	42
		EVT1860	301	515	1	18	60
		EVT1872	355	582	1	18	72
		EVT1884	495	666	1	18	84
		EVT1890	534	725	1	18	90
		EVT18108	645	894	1	18	108

**EVS12M502S2F - 12" OPENING MULTI STORAGE UNIT**

- 2 lateral file drawers and storage with hinged doors.
- 2 Locks per unit is included, (1) for door (1) for drawers.

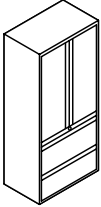
	DESCRIPTION	PRODUCT CODE	LIST PRICE	DIMENSIONS/INCHES			
				H	D	W	
 5 High (Lateral) Shown	12" Opening Multi Storage Unit - 4 High (50" High)	EVS1230M502S2F	3002	50	18	30	
		EVS1236M502S2F	3214	50	18	36	
		EVS1242M502S2F	3459	50	18	42	
	12" Opening Multi Storage Unit - 4 High (54" High)	EVS1230M542S2F	3151	3496	54	18	30
		EVS1236M542S2F	3370	3496	54	18	36
		EVS1242M542S2F	3496	3496	54	18	42
	12" Opening Multi Storage Unit - 5 High (2 Lateral)	EVS1230M662S2F	3504	4029	65.88	18	30
		EVS1236M662S2F	3767	4029	65.88	18	36
		EVS1242M662S2F	4029	4029	65.88	18	42
	12" Opening Multi Storage Unit - 5 High (3 Lateral)	EVS1230M662S3F	3484	4063	65.88	18	30
		EVS1236M662S3F	3767	4063	65.88	18	36
		EVS1242M662S3F	4063	4063	65.88	18	42



**EVS12SFSND - OPEN STORAGE CABINET**

- Storage Cabinet with no doors.
- 2SIND - 27 3/4" high with 1 shelf.
- 3SIND - 40 1/2" high with 2 shelves.
- 4SIND - 54" high with 3 shelves.
- 5SIND - 65 7/8" high with 4 shelves.
- Shelves are height adjustable.

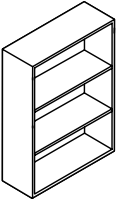
	DESCRIPTION	PRODUCT CODE	LIST PRICE	DIMENSIONS/INCHES		
				H	D	W
 <p>3 High Shown</p>	Open Storage Cabinet - 2 High Worksurface Supporting	EVS1230SF2SND	1118	27.75	18	30
		EVS1236SF2SND	1295	27.75	18	36
		EVS1242SF2SND	1355	27.75	18	42
	Open Storage Cabinet - 3 High	EVS1230SF3SND	1251	40.5	18	30
		EVS1236SF3SND	1355	40.5	18	36
		EVS1242SF3SND	1517	40.5	18	42
	Open Storage Cabinet - 4 High	EVS1230SF4SND	1496	54	18	30
		EVS1236SF4SND	1595	54	18	36
		EVS1242SF4SND	1693	54	18	42
	Open Storage Cabinet - 5 High	EVS1230SF5SND	1725	65.88	18	30
		EVS1236SF5SND	1828	65.88	18	36
		EVS1242SF5SND	1903	65.88	18	42

**EVS12S - 12" STORAGE CABINET WITH HINGED DOOR**

- 2S - 27 3/4" high with 1 shelf.
- 3S - 40 1/2" high with 2 shelves.
- 4S - 54" high with 3 shelves.
- 5S - 65 7/8" high with 4 shelves.
- 5W - 65 7/8" high wardrobe cabinet with a coat rod and 4 half shelves in the 36" and 42" wide units. 30" wide units have a coat rod and 4 coat hooks.
- Shelves are height adjustable.
- Lock is included.

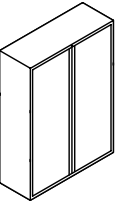
	DESCRIPTION	PRODUCT CODE	LIST PRICE	DIMENSIONS/INCHES		
				H	D	W
 <p>5 High Shown</p>	12" Storage Cabinet with Hinged Door - 2 High (WS Supporting)	EVS12302SWS	1174	27.75	18	30
		EVS12362SWS	1307	27.75	18	36
		EVS12422SWS	1424	27.75	18	42
	12" Storage Cabinet with Hinged Door - 3 High	EVS12303S	1449	40.5	18	30
		EVS12363S	1643	40.5	18	36
		EVS12423S	1817	40.5	18	42
	12" Storage Cabinet with Hinged Door - 4 High	EVS12304S	1749	54	18	30
		EVS12364S	1953	54	18	36
		EVS12424S	2162	54	18	42
	12" Storage Cabinet with Hinged Door - 5 High	EVS12305S	1973	65.88	18	30
		EVS12365S	2213	65.88	18	36
		EVS12425S	2450	65.88	18	42
	12" Storage Cabinet with Hinged Door - 5 High Wardrobe	EVS12305W	1982	65.88	18	30
		EVS12365W	2253	65.88	18	36
		EVS12425W	2479	65.88	18	42



**92-BHHD - HALF HEIGHT DRAWERS**

- Half height drawers. For 30", 36" or 42" "B" opening, specify 92P-BHHD\_. For 30", 36" or 42" "L" opening, specify 92P-LHHD\_. One pair. Must be factory installed.\*

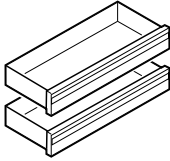
	DESCRIPTION	PRODUCT CODE	LIST PRICE	DIMENSIONS/INCHES		
				H	D	W
	Half Height Drawers	92P-BHHD30	424			30
	"B" Openings	92P-BHHD36	453			36
		92P-BHHD42	484			42
	Half Height Drawers	92P-LHHD30	424			30
	"L" Openings	92P-LHHD36	453			36
		92P-LHHD42	484			42

**ERRC/EFSL - RECEDING DOOR CONVERSION**

- Receding door and roll-out shelf conversion in "B" or "L" openings from a fixed front drawer.\* (Add list price to each opening being converted at time of order.) Must be factory installed.
- Receding door and fixed slotted shelf conversion in "B" or "L" openings from a fixed front drawer.\* (Add list price to each opening being converted at time of order.) Must be factory installed.

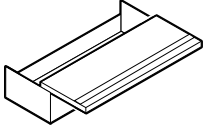
	DESCRIPTION	PRODUCT CODE	LIST PRICE	DIMENSIONS/INCHES		
				H	D	W
	Receding Door Conversion	ERRC30	86			30
	Roll-Out Shelf Conversion	ERRC36	86			36
		ERRC42	86			42
	Receding Door Conversion	EFSL30	86			30
	Fixed Slotted Shelf Conversion	EFSL36	86			36
		EFSL42	86			42

**EFFD - FIXED DRAWER CONVERSION**

- Fixed front drawer conversion in "B" or "L" openings from receding door and roll-out shelf. (No charge for conversion at time of order.) Must be factory installed.
- Note: Fixed shelf cannot be substituted for a roll-out shelf in any position for receding opening. (No charge for conversion at time of order.)
- Please specify all substitutions and options.

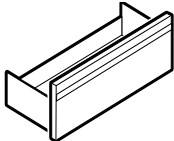
	DESCRIPTION	PRODUCT CODE	LIST PRICE	DIMENSIONS/INCHES		
				H	D	W
	Fixed Drawer Conversion	EFFD30				30
		EFFD36	Contact Evolve Customer Service for specific options			36
		EFFD42				42

**92PPS - POSTING SHELF**

- Posting shelf. Available in five drawer high cabinets. Factory installed between second and third openings.
- Please specify all substitutions and options.

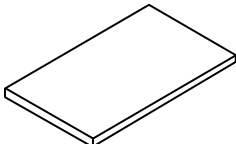
	DESCRIPTION	PRODUCT CODE	LIST PRICE	DIMENSIONS/INCHES		
				H	D	W
	Posting Shelf	92PPS30	260			30
		92PPS36	302			36
		92PPS42	336			42

**EVSEDPS - EDP ADAPTER**

- Not recommended for use in receding front drawers.
- "B" opening only.
- Black only.

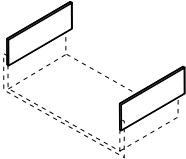
	DESCRIPTION	PRODUCT CODE	LIST PRICE	DIMENSIONS/INCHES		
				H	D	W
	EDP Adapter	EVSEDPS	60		3	16.5

**EVSHFB - HANGING FILE BARS**

- Used in lateral files only.
- Available in black only.

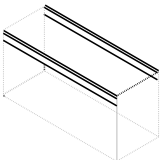
	DESCRIPTION	PRODUCT CODE	LIST PRICE	DIMENSIONS/INCHES		
				H	D	W
	Hanging File Bars	EVSHFB30	59			30
		EVSHFB36	59			36
		EVSHFB42	59			42

**EVSFBB - FRONT-TO-BACK BARS**

- Cross file bars.
- Used in metal lateral files only.
- Available in grey only.
- Shipped in pairs.

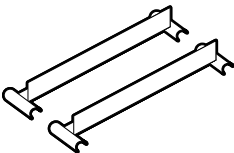
	DESCRIPTION	PRODUCT CODE	LIST PRICE	DIMENSIONS/INCHES		
				H	D	W
	Hanging File Bars	EVSFBB	31			12.25

**EVSLAB - LEGAL-TO-LETTER ADAPTER**

- Used in lateral files only.
- Available in black only.

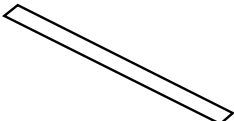
	DESCRIPTION	PRODUCT CODE	LIST PRICE	DIMENSIONS/INCHES		
				H	D	W
	Legal-to-Letter Adapter	EVSLAB30	31			30
		EVSLAB36	31			36
		EVSLAB42	31			42



**EVS\_PD - DIVIDER PLATES**

- Used in full-height shelves and drawers.
- Can be used with EVSOF16 series overheads. See page 191 for specific models.
- Three plates per package.
- Used in lateral files only.
- Available in Grey paint only.

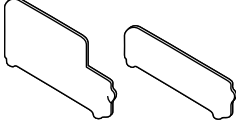
	DESCRIPTION	PRODUCT CODE	LIST PRICE	DIMENSIONS/INCHES		
				H	D	W
	Divider Plates - Half Height Divider	EVSHPD03	62	4		13
	Divider Plates - Full Height Divider	EVSPFD03	62	7		13

**EVAPDIV - PEDESTAL DIVIDER PLATES**

- Priced and shipped individually.

	DESCRIPTION	PRODUCT CODE	LIST PRICE	DIMENSIONS/INCHES		
				H	D	W
	Pedestal Divider Plates	EVAPDIV	37	4		12

**EVSCWB - COUNTERWEIGHT BALANCE**

- Recommended for use in all laterals and freestanding pedestals.
- Black only.
- Must be factory installed.
- Counter weights now designed to accommodate height and width of storage pieces. Please note revised product codes.

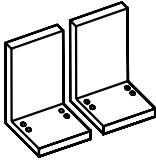
	DESCRIPTION	PRODUCT CODE	LIST PRICE	DIMENSIONS/INCHES		
				H	D	W
	Counterweight Balance - 1.5 High	EVSCWB301XH	464			30
		EVSCWB361XH	477			36
		EVSCWB421XH	477			42
	Counterweight Balance - 2 High	EVSCWB302H	464			30
		EVSCWB362H	477			36
		EVSCWB422H	477			42
	Counterweight Balance - 3 High	EVSCWB303H	448			30
		EVSCWB363H	464			36
		EVSCWB423H	477			42
	Counterweight Balance - 4 High	EVSCWB304H	272			30
		EVSCWB364H	302			36
		EVSCWB424H	315			42
	Counterweight Balance - 5 High	EVSCWB305H	272			30
		EVSCWB365H	302			36
		EVSCWB425H	315			42
	Counterweight Balance - Ped Field Installed	EVSCWPED	132			
	Counterweight Balance - Ped Factory Installed	EVSCWPEDF	240			

**EVS\_\_ - ADDITIONAL KEY**

	DESCRIPTION	PRODUCT CODE	LIST PRICE	DIMENSIONS/INCHES		
				H	D	W
	AK - Additional Key (specify at time of order)	EVSAK92	17			
	EK - Extra Key for existing cabinets (specify at time of order)	EVSEK92	17			
	LOCKKEY - Core and Key	EVLOCKKEY	51			

**EVSLK - LOCK FOR OVERHEAD FLIPPER DOOR STORAGE UNIT**

	DESCRIPTION	PRODUCT CODE	LIST PRICE	DIMENSIONS/INCHES		
				H	D	W

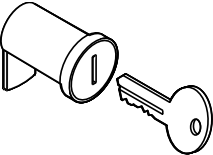

	Lock for Overhead Flipper Door Storage Unit	EVSLK12	64			
--	---	---------	----	--	--	--

**ALL PEDESTALS FEATURE**

- Worksurface supporting pedestals are 28”h
- Pencil tray included with B/B/F pedestal
- Box drawer and file drawers mounted on full extension ball bearing slides
- All file drawers come with adjustable rails for legal or letter size hanging folders
- 1-Door pedestal comes handed left or right (handedness is determined by hinge side)
- 1-Door Pedestal includes one adjustable shelf
- Locks are standard on all units and match pull finish

**EVL2PBBF - BOX/BOX/FILE WORKSURFACE SUPPORTING PEDESTAL**

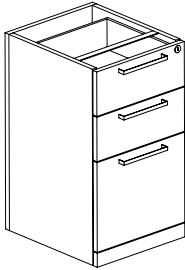
	DESCRIPTION	PRODUCT CODE	LIST PRICE	DIMENSIONS/INCHES		
				H	D	W
	Box/Box/File Worksurface Supporting Pedestal	EVL2PBBF18	1040	28	15.5	18
		EVL2PBBF23	1150	28	15.5	23
		EVL2PBBF29	1204	28	15.5	29

**EVL2PFF - FILE/FILE WORKSURFACE SUPPORTING PEDESTAL**

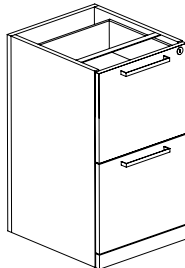
	DESCRIPTION	PRODUCT CODE	LIST PRICE	DIMENSIONS/INCHES		
				H	D	W
	File/File Worksurface Supporting Pedestal	EVL2PFF18	943	28	15.5	18
		EVL2PFF23	1074	28	15.5	23
		EVL2PFF29	1129	28	15.5	29

**EVL2P1D - 1-DOOR WORKSURFACE SUPPORTING PEDESTAL**

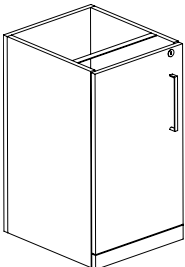
	DESCRIPTION	PRODUCT CODE	LIST PRICE	DIMENSIONS/INCHES		
				H	D	W
	1-Door Worksurface Supporting Pedestal	EVL2P1D18(L/R)	791	28	15.5	18
		EVL2P1D23(L/R)	874	28	15.5	23
		EVL2P1D29(L/R)	965	28	15.5	29

**ALL MOBILE PEDESTALS FEATURE**

- Mobile pedestals with inset top are designed for use with cushion
- Pencil tray included with box drawer
- Box drawer and file drawers mounted on full extension ball bearing slides
- If file drawers come with adjustable rails for legal or letter size hanging folders

**EVL2PBF - BOX/FILE MOBILE PEDESTAL W/STANDARD TOP**

DESCRIPTION	PRODUCT CODE	LIST PRICE	DIMENSIONS/INCHES		
			H	D	W
Box/File Mobile Pedestal w/Standard Top	EVL2PBF20M	1327	22.69	15.5	20
	EVL2PBF24M	1327	22.69	15.5	24

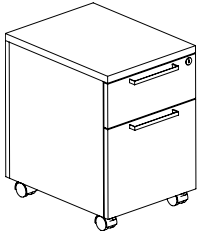

**EVL2PBF-MIT - BOX/FILE MOBILE PEDESTAL W/INSET TOP**

DESCRIPTION	PRODUCT CODE	LIST PRICE	DIMENSIONS/INCHES		
			H	D	W
Box/File Mobile Pedestal w/Inset Top	EVL2PBF18MIT	1243	22	15.5	18
	EVL2PBF24MIT	1318	22	15.5	24

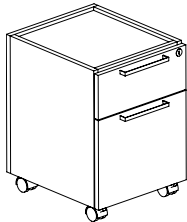

**EVL PSTC - MOBILE PEDESTAL CUSHION (FOR USE WITH INSET TOP MOBILE PEDESTALS)**

DESCRIPTION	PRODUCT CODE	LIST PRICE/GRADES																	DIM./INCH			YRDS
		1	2	3	4	5	6	7	8	9	10	11	12	13	14	15	16	17	H	D	W	
Mobile Pedestal Cushion	EVL PSTC1518	304	341	361	395	440	462	508	575	630	689	812	938	1067	1200	1456	1717	1979	1	15.5	18	1
	EVL PSTC1524	352	380	407	440	488	510	549	623	677	737	852	985	1114	1241	1503	1758	2019	1	15.5	24	1

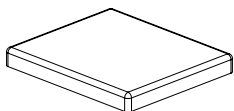

**LATERAL FILES FEATURES**

- Worksurface supporting lateral files ship without a top
- All lateral files feature drawer interlocking system
- All file drawers come with adjustable rails for legal or letter size hanging folders
- "C" combo lateral includes a pencil tray with one box drawer.
- "C" combo lateral only locks on one side
- Lateral files with doors include one adjustable shelf
- Locks are standard on all units and match pull finish
- File drawers are mounted on full extension ball bearing slides

**EVL2L2H - FILE/FILE WORKSURFACE SUPPORTING LATERAL FILE, 18"D & 22"D**

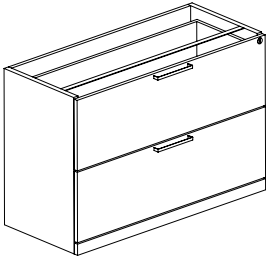
	DESCRIPTION	PRODUCT CODE	LIST PRICE	DIMENSIONS/INCHES			
				H	D	W	
	File/File Worksurface Supporting Pedestal	EVL2L2H1830	1690	28	30	18	
		EVL2L2H1836	1800	28	36	18	
		EVL2L2H1842	1870	28	42	18	
			EVL2L2H2230	1740	28	30	22
			EVL2L2H2236	1850	28	36	22
		EVL2L2H2242	1979	28	42	22	

**EVL2L2D - 2-DOOR WORKSURFACE SUPPORTING LATERAL FILE, 18"D & 22"D**

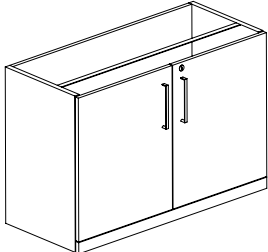
	DESCRIPTION	PRODUCT CODE	LIST PRICE	DIMENSIONS/INCHES			
				H	D	W	
	2-Door Worksurface Supporting Lateral File	EVL2L2D1830	1183	28	30	18	
		EVL2L2D1836	1243	28	36	18	
		EVL2L2D1842	1368	28	42	18	
			EVL2L2D2230	1280	28	30	22
			EVL2L2D2236	1314	28	36	22
		EVL2L2D2242	1513	28	42	22	



**COMBO LATERAL FILES FEATURES**

- Worksurface supporting lateral files ship without a top
- All lateral files feature drawer interlocking system
- All file drawers come with adjustable rails for legal or letter size hanging folders
- "C" combo lateral includes a pencil tray with one box drawer.
- "C" combo lateral only locks on one side
- Locks are standard on all units and match pull finish
- File drawers are mounted on full extension ball bearing slides

**EVL2LCR - RIGHT-HAND WORKSURFACE SUPPORTING COMBO LATERAL FILE, 18"D & 22"D**

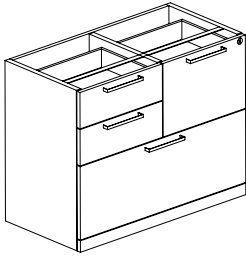
	DESCRIPTION	PRODUCT CODE	LIST PRICE	DIMENSIONS/INCHES		
				H	D	W
	Right-Hand Worksurface Supporting Combo Lateral File	EVL2LCR1830	2075	28	30	18
		EVL2LCR1836	2418	28	36	18
	EVL2LCR2230	2409	28	30	22	
	EVL2LCR2236	2534	28	36	22	

**EVL2LCL - LEFT-HAND WORKSURFACE SUPPORTING COMBO LATERAL FILE, 18"D & 22"D**

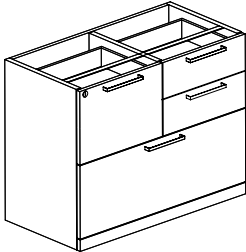
	DESCRIPTION	PRODUCT CODE	LIST PRICE	DIMENSIONS/INCHES		
				H	D	W
	2-Door Worksurface Supporting Lateral File	EVL2LCL1830	2075	28	30	18
		EVL2LCL1836	2418	28	36	18
	EVL2LCL2230	2409	28	30	22	
	EVL2LCL2236	2534	28	36	22	



**STORAGE TOWERS W/CUPBOARD**

- Storage tower with cupboard above FF or BBF and wardrobs will lock only the wardrobe and drawers
- Storage towers with wardrobe include a coat rod
- Locks are standard on all units and match pull finish

**EVL2TWBBF2DL - STORAGE TOWER W/CUPBOARD, BOX/BOX/FILE, RIGHT & LEFT HAND**

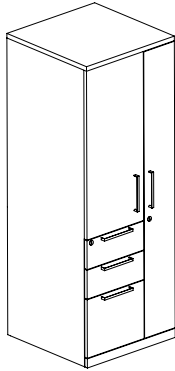
	DESCRIPTION	PRODUCT CODE	LIST PRICE	DIMENSIONS/INCHES			
				H	D	W	
 <p>Right Hand Shown</p>	Storage Tower w/Cupboard, Box/Box/File,	EVL2TWBBF2DL4224	2590	42	24	24	
		EVL2TWBBF2DL4824	2590	48	24	24	
		EVL2TWBBF2DL5424	2679	54	24	24	
		EVL2TWBBF2DL6624	3002	66	24	24	
			EVL2TWBBF2DR4224	2590	42	24	24
			EVL2TWBBF2DR4824	2590	48	24	24
			EVL2TWBBF2DR5424	2679	54	24	24
			EVL2TWBBF2DR6624	3002	66	24	24

**EVL2TW2F2DL - STORAGE TOWER W/CUPBOARD, FILE/FILE, RIGHT & LEFT HAND**

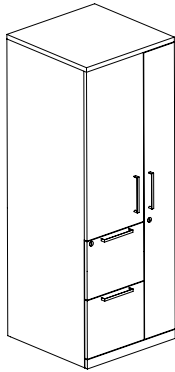
	DESCRIPTION	PRODUCT CODE	LIST PRICE	DIMENSIONS/INCHES			
				H	D	W	
 <p>Right Hand Shown</p>	Storage Tower w/Cupboard, File/File	EVL2TW2F2DL4224	2493	42	24	24	
		EVL2TW2F2DL4824	2493	48	24	24	
		EVL2TW2F2DL5424	2561	54	24	24	
		EVL2TW2F2DL6624	2871	66	24	24	
			EVL2TW2F2DR4224	2493	42	24	24
			EVL2TW2F2DR4824	2493	48	24	24
			EVL2TW2F2DR5424	2561	54	24	24
			EVL2TW2F2DR6624	2871	66	24	24

Contact Evolve Customer Service for specific options

**STORAGE TOWERS W/SIDE ACCESS**

- Storage tower with cupboard above FF or BBF and wardrobs will lock only the wardrobe and drawers
- Storage towers with wardrobe include a coat rod
- Locks are standard on all units and match pull finish

**EVL2TWBBFDOL - STORAGE TOWER W/SIDE ACCESS, BOX/BOX/FILE, RIGHT & LEFT HAND**

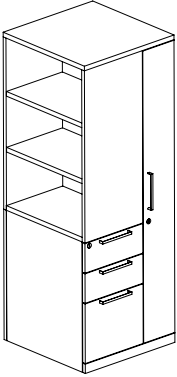
	DESCRIPTION	PRODUCT CODE	LIST PRICE	DIMENSIONS/INCHES			
				H	D	W	
 <p>Right Hand Shown</p>	Storage Tower w/Side Access, Box/Box/File,	EVL2TWBBFDOL4224	2384	42	24	24	
		EVL2TWBBFDOL4824	2384	48	24	24	
		EVL2TWBBFDOL5424	2446	54	24	24	
		EVL2TWBBFDOL6624	2720	66	24	24	
			EVL2TWBBFDOR4224	2384	42	24	24
			EVL2TWBBFDOR4824	2384	48	24	24
			EVL2TWBBFDOR5424	2446	54	24	24
			EVL2TWBBFDOR6624	2720	66	24	24

**EVL2TW2FDOL - STORAGE TOWER W/SIDE ACCESS, FILE/FILE, RIGHT & LEFT HAND**

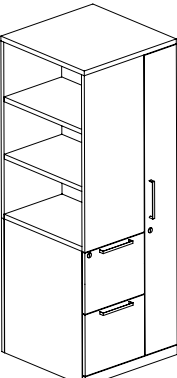
	DESCRIPTION	PRODUCT CODE	LIST PRICE	DIMENSIONS/INCHES			
				H	D	W	
 <p>Right Hand Shown</p>	Storage Tower w/Side Access, File/File,	EVL2TW2FDOL4224	2301	42	24	24	
		EVL2TW2FDOL4824	2301	48	24	24	
		EVL2TW2FDOL5424	2370	54	24	24	
		EVL2TW2FDOL6624	2645	66	24	24	
			EVL2TW2FDOR4224	2302	42	24	24
			EVL2TW2FDOR4824	2302	48	24	24
			EVL2TW2FDOR5424	2370	54	24	24
			EVL2TW2FDOR6624	2645	66	24	24



**CREDENZA, BOX/FILE AND OPEN**

- All lateral files feature drawer interlocking system
- All file drawers come with adjustable rails for legal or letter size hanging folders
- Locks are standard on all units and match pull finish
- File drawers are mounted on full extension ball bearing slides
- B/F Drawer Width -- 24" w on 48" w unit, 30" w on 54" w and 60" w units, 36" w on 66" w and 72" w units
- Two credenza spacers may be installed between a worksurface and credenza for support

**EVL2CRBFO - BOX/FILE/OPEN CREDENZA, 20" H**

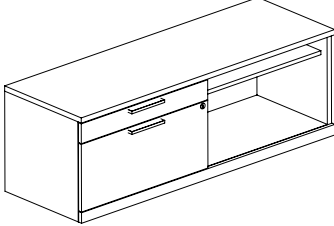
DESCRIPTION	PRODUCT CODE	LIST PRICE	DIMENSIONS/INCHES		
			H	D	W
 <p>Box/File/Open Credenza</p>	EVL2CRBFO2048	2020	20	48	20
	EVL2CRBFO2054	2206	20	54	20
	EVL2CRBFO2060	2343	20	60	20
	EVL2CRBFO2066	2459	20	66	20
	EVL2CRBFO2072	2549	20	72	20

**EVL2CROBF - OPEN/BOX/FILE CREDENZA, 20" H**

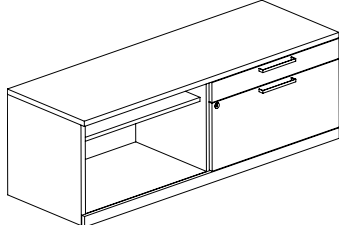
DESCRIPTION	PRODUCT CODE	LIST PRICE	DIMENSIONS/INCHES		
			H	D	W
 <p>Open/Box/File Credenza</p>	EVL2CROBF2048	2020	20	48	20
	EVL2CROBF2054	2206	20	54	20
	EVL2CROBF2060	2343	20	60	20
	EVL2CROBF2066	2459	20	66	20
	EVL2CROBF2072	2549	20	72	20

**CREDENZA, SLIDING GLASS DOOR**

- Sliding Door Credenzas are split evenly so door may cover either side
- Sliding door credenzas do not lock
- Two credenza spacers may be installed between a worksurface and credenza for support

**EVL2CRGSD - SLIDING GLASS DOOR CREDENZA, 20”H**

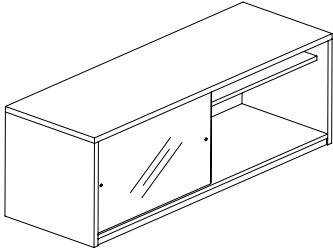
DESCRIPTION	PRODUCT CODE	LIST PRICE	DIMENSIONS/INCHES		
			H	D	W
 <p>Sliding Glass Door Credenza</p>	EVL2CRGSD2048	2705	20	48	20
	EVL2CRGSD2060	2973	20	60	20
	EVL2CRGSD2072	3254	20	72	20

**EVWSSL - CREDENZA TO WORKSURFACE SPACER**

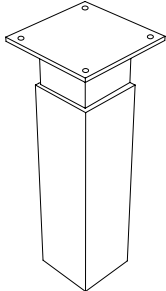
DESCRIPTION	PRODUCT CODE	LIST PRICE	DIMENSIONS/INCHES		
			H	D	W
 <p>Credenza to Worksurface Spacer</p>	EVWSSL08	77	8	3	3



SO#		PO#		TAG#		DATE			
KEY#	SETS REQ'D	KEY#	SETS REQ'D	KEY#	SETS REQ'D	KEY#	SETS REQ'D	KEY#	SETS REQ'D
401		431		461		491		521	
402		432		462		492		522	
403		433		463		493		523	
404		434		464		494		524	
405		435		465		495		525	
406		436		466		496		526	
407		437		467		497		527	
408		438		468		498		528	
409		439		469		499		529	
410		440		470		500		530	
411		441		471		501		531	
412		442		472		502		532	
413		443		473		503		533	
414		444		474		504		534	
415		445		475		505		535	
416		446		476		506		536	
417		447		477		507		537	
418		448		478		508		538	
419		449		479		509		539	
420		450		480		510		540	
421		451		481		511		541	
422		452		482		512		542	
423		453		483		513		543	
424		454		484		514		544	
425		455		485		515		545	
426		456		486		516		546	
427		457		487		517		547	
428		458		488		518		548	
429		459		489		519		549	
430		460		490		520		550	

401 - 430 =	431 - 460 =	461 - 490 =	491 - 520 =	521 - 550 =
-------------	-------------	-------------	-------------	-------------

Total:

NOTE : If Key Alike Instructions are not submitted to EVOLVE with the Customer's Purchase Order, all components will be keyed randomly.



accessories



## EVHTVM - TV MOUNT

- Laminate panel with two mounting brackets to be installed on Evolve panels.
- TV Mount can be installed on panel of equal width or both brackets can be attached in middle for installing on single connector.
- TV frame not included, TV frame to be ordered separately.
- Holds up to 55" TV with a max load of 86 lbs.
- Note: TV frame must be securely attached to laminate panel. Care should be taken to attach TV frame using correct fasteners. Failure to do so may result in collapse of unit and subsequent possible injury.

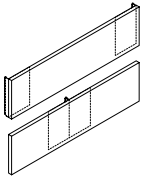
DESCRIPTION	PRODUCT CODE	LIST PRICE	DIMENSIONS/INCHES		
			H	W	D
 TV Mount	EVHTVM24	223	11	24	1
	EVHTVM30	239	11	30	1
	EVHTVM36	259	11	36	1
	EVHTVM42	279	11	42	1

## EVATB - TACK BOARD

- Provide a tackable surface for notes and memos in a work area.
- Includes two pairs of panel-mounting brackets.
- Only fabric must be specified.
- 17" to be installed under EVSOF13 or EVSOF16
- 21" specified for use under overhead shelf or storage bin.
- 24" for use without any overheads.
- All tackboards are 0.25" in thickness.

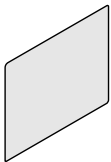
DESCRIPTION	PRODUCT CODE	LIST PRICE		DIMENSIONS/INCHES		
		Gr1	Gr2	H	W	D
 Tack Board - 17" High	EVATB1730	304	317	17	30	0.25
	EVATB1736	349	358	17	36	0.25
	EVATB1742	395	407	17	42	0.25
	EVATB1748	442	454	17	48	0.25
	EVATB1754	490	503	17	54	0.25
	EVATB1760	534	553	17	60	0.25
Tack Board - 21" High	EVATB2124	281	296	21	24	0.25
	EVATB2130	304	318	21	30	0.25
	EVATB2136	349	358	21	36	0.25
	EVATB2142	395	411	21	42	0.25
	EVATB2148	444	457	21	48	0.25
	EVATB2154	488	509	21	54	0.25
Tack Board - 24" High	EVATB2160	534	556	21	60	0.25
	EVATB2430	304	319	24	30	0.25
	EVATB2436	349	361	24	36	0.25
	EVATB2442	395	412	24	42	0.25
	EVATB2448	444	459	24	48	0.25
	EVATB2454	488	512	24	54	0.25
EVATB2460	534	556	24	60	0.25	

## EVFPDXXXWS - WORKSURFACE FELT DIVIDER

- Privacy felt divider integrated into an aluminum top trim.
- Attaches on top of a worksurface to add privacy or divide space.
- Must be used at connector location.
- Includes aluminum trim with channel, felt tile and brackets.
- 9 mm felt material is tackable and comes in 9 different colors. Please specify felt finish.
- Aluminum extrusion and brackets available in standard paint finishes.
- Felt tile and attachment hardware to ship separately.

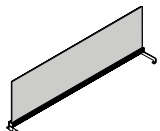
DESCRIPTION	PRODUCT CODE	LIST PRICE	DIMENSIONS/INCHES		
			H	W	D
 Felt Divider	EVFPD1818WS	206	18	18	
	EVFPD1824WS	230	18	24	
	EVFPD1830WS	259	18	30	
	EVFPD1836WS	282	18	36	



## EVAWB - WHITE MARKER BOARD

- Provides a writing surface within a work area.
- Includes two pairs of panel-mounting brackets.
- 21" specified for use under overhead shelf or storage bin.
- 24" for use without any overhangs.

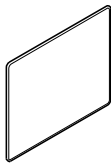
	DESCRIPTION	PRODUCT CODE	LIST PRICE	DIMENSIONS/INCHES		
				H	W	D
	White Marker Board - 21" High	EVAWB2130	325	21	30	
		EVAWB2136	367	21	36	
		EVAWB2142	413	21	42	
		EVAWB2148	480	21	48	
	White Marker Board - 24" High	EVAWB2430	325	24	30	
		EVAWB2436	367	24	36	
		EVAWB2442	413	24	42	
		EVAWB2448	480	24	48	

## EVAMT - MARKER TRAY

- Provides a tray for storage of markers, erasers, etc.
- Attaches to the bottom of the White Marker Board.
- Available in standard and premium paint selections. See Textiles and Finishes (page 278) for complete offerings and conditions.

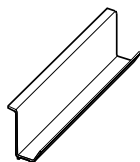
	DESCRIPTION	PRODUCT CODE	LIST PRICE	DIMENSIONS/INCHES		
				H	W	D
	Marker Tray	EVAMT12	21		12	

## EVALB2 - LOAD BAR - TOP

- Enables accessory items to be hung from a panel.
- Includes end caps and mounting brackets.
- Can be panel mounted.
- Can connect to EVALB2-2 and/or EVALB2-3 Load Bars to create a multi-level load bar or "Slat Wall"
- Note: can be used on its own.
- Available in standard and premium paint selections. See Textiles and Finishes (page 278) for complete offerings and conditions.

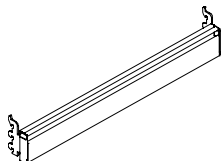
	DESCRIPTION	PRODUCT CODE	LIST PRICE	DIMENSIONS/INCHES		
				H	W	D
	Load Bar - Top	EVALB224	126	2.25	24	1
		EVALB230	131	2.25	30	1
		EVALB236	142	2.25	36	1
		EVALB242	150	2.25	42	1
		EVALB248	154	2.25	48	1
		EVALB254	160	2.25	54	1
		EVALB260	163	2.25	60	1

**EVALB2-2 - LOAD BAR - MIDDLE**

- Enables accessory items to be hung from a panel.
- Includes end caps and is to be used in conjunction with the Load Bar - Top (EVALB2). Mounting brackets NOT included.
- Can be panel mounted.
- Connects between EVALB2 and EVALB2-3 Load Bars to create a multi-level load bar or "Slat Wall"
- Note: Needs to be used in conjunction with both EVALB2 (as noted above) and EVALB2-3. Multiples of EVALB2-2 can be joined, one below the other, to create a "Slat Wall"

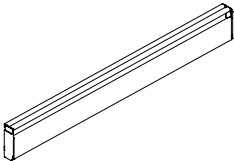
DESCRIPTION	PRODUCT CODE	LIST PRICE	DIMENSIONS/INCHES		
			H	W	D
 Load Bar - Middle	EVALB2-224	90	2.25	24	1
	EVALB2-230	94	2.25	30	1
	EVALB2-236	101	2.25	36	1
	EVALB2-242	108	2.25	42	1
	EVALB2-248	114	2.25	48	1
	EVALB2-254	123	2.25	54	1
	EVALB2-260	127	2.25	60	1

**EVALB2-3 - LOAD BAR - BOTTOM**

- Enables accessory items to be hung from a panel.
- Includes end caps and mounting brackets.
- Can be panel mounted.
- Connects between EVALB2-2 and EVALB2-3 Load Bars to create a multi-level load bar or "Slat Wall"
- Note: Needs to be used in conjunction with an EVALB2 or a combination of EVALB2 and EVALB2-2

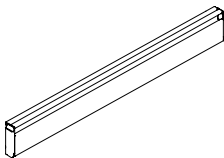
DESCRIPTION	PRODUCT CODE	LIST PRICE	DIMENSIONS/INCHES		
			H	W	D
 Load Bar - Bottom	EVALB2-324	123	2.25	24	1
	EVALB2-330	127	2.25	30	1
	EVALB2-336	131	2.25	36	1
	EVALB2-342	142	2.25	42	1
	EVALB2-348	151	2.25	48	1
	EVALB2-354	158	2.25	54	1
	EVALB2-360	161	2.25	60	1

**EVALB - LOAD BAR**

- Enables accessory items to be hung from a panel.
- Includes end caps and mounting brackets.
- Can be panel or wall mounted.
- Must specify finish.
- Attachment slot dimensions = 0.115" W x 0.240" H.
- Slatwall mounted monitor arms will NOT hang on EVALB - load bar.

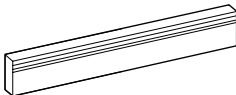
DESCRIPTION	PRODUCT CODE	LIST PRICE	DIMENSIONS/INCHES		
			H	W	D
 Load Bar	EVALB24	159	2.25	24	1
	EVALB30	175	2.25	30	1
	EVALB36	190	2.25	36	1
	EVALB42	220	2.25	42	1
	EVALB48	257	2.25	48	1
	EVALB54	270	2.25	54	1
	EVALB60	292	2.25	60	1

**EVHOMB - OFF MODULE WORKSURFACE BRACKET**

- Supports the worksurface in the work station corner in the case where an adjoining panel is wider than the worksurface.
- Enhances the stability of the worksurface.
- Can be used only in conjunction with the Top Load Bar EVALB2xx (xx being the panel width of adjoining panel).
- Available in standard paint colors.
- Top Load Bar EVALB2xx must be ordered separately.

DESCRIPTION	PRODUCT CODE	LIST PRICE	DIMENSIONS/INCHES		
			H	W	D
Bracket	EVHOMB1	29	1.6	3	2.73

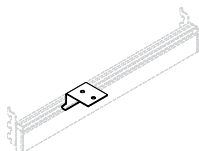

**EVAFWMXXP - WIRE MANAGER**

- PET Wire manager installed under worksurface
- Including attachment brackets
- Available in standard felt colors

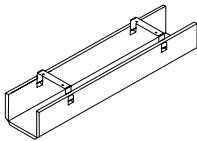
	DESCRIPTION	PRODUCT CODE	LIST PRICE	DIMENSIONS/INCHES		
				H	W	D
	PET Wire Manager	EVAFWM22P	128	3.375	22	4
		EVAFWM28P	147	3.375	28	4
		EVAFWM34P	162	3.375	34	4

**EVAFWMXXPL - WIRE MANAGER FOR 90 DEGREE CORNER-LEFT**

- PET Wire manager installed under worksurface
- Including attachment brackets
- Available in standard felt colors

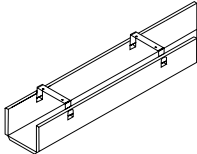
	DESCRIPTION	PRODUCT CODE	LIST PRICE	DIMENSIONS/INCHES		
				H	W	D
	PET Wire Manager	EVAFWM26PL	141	3.375	26	4
	90 Degree Corner - Left	EVAFWM32PL	158	3.375	32	4
		EVAFWM38PL	172	3.375	38	4

**EVAFWMXXPR - FELT WIRE MANAGER FOR 90 DEGREE CORNER-RIGHT**

- Felt Wire manager installed under worksurface
- Including attachment brackets
- Available in standard felt colors

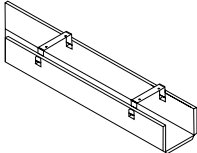
	DESCRIPTION	PRODUCT CODE	LIST PRICE	DIMENSIONS/INCHES		
				H	W	D
	PET Wire Manager	EVAFWM26PR	141	3.375	26	4
	90 Degree Corner - Right	EVAFWM32PR	158	3.375	32	4
		EVAFWM38PR	172	3.375	38	4

**EVABB01 - BINDER BIN**

- Must be ordered in conjunction with a load bar option.
- Can be used with slat wall module.
- Available in standard and premium paint selections. See Textiles and Finishes (page 240) for a complete list of offerings and conditions.

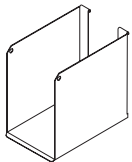
	DESCRIPTION	PRODUCT CODE	LIST PRICE	DIMENSIONS/INCHES		
				H	W	D
	Binder Bin	EVABB01	82	9	4	10.25

**EVALT01 - LETTER TRAY**

- Must be ordered in conjunction with a load bar option.
- Can be used with slat wall module.
- Available in standard and premium paint selections. See Textiles and Finishes (page 240) for a complete list of offerings and conditions.

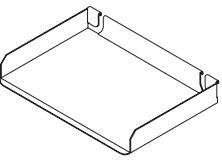
	DESCRIPTION	PRODUCT CODE	LIST PRICE	DIMENSIONS/INCHES		
				H	W	D
	Letter Tray	EVALT01	65	2	13.5	9.25

**EVALT02 - LEGAL TRAY**

- Must be ordered in conjunction with a load bar option.
- Can be used with slat wall module.
- Available in standard and premium paint selections. See Textiles and Finishes (page 240) for a complete list of offerings and conditions.

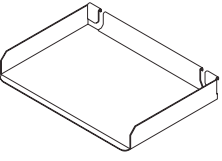
	DESCRIPTION	PRODUCT CODE	LIST PRICE	DIMENSIONS/INCHES		
				H	W	D
	Legal Tray	EVALT02	74	1.75	14.7	8.75

**EVASS01 - SLANT SORTER**

- Must be ordered in conjunction with a load bar option.
- Can be used with slat wall module.
- Available in standard and premium paint selections. See Textiles and Finishes (page 240) for a complete list of offerings and conditions.

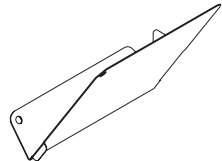
	DESCRIPTION	PRODUCT CODE	LIST PRICE	DIMENSIONS/INCHES		
				H	W	D
	Slant Sorter	EVASS01L	53	9.5	5	10.25
		EVASS01R	53	9.5	5	10.25



**EVAMB01 - MEDIA BIN**

- Must be ordered in conjunction with a load bar option.
- Can be used with slat wall module.
- Available in standard and premium paint selections. See Textiles and Finishes (page 240) for a complete list of offerings and conditions.

DESCRIPTION	PRODUCT CODE	LIST PRICE	DIMENSIONS/INCHES		
			H	W	D

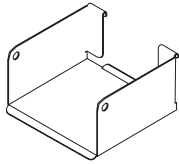

Media Bin	EVAMB01	65	3	5.75	5.25
-----------	---------	----	---	------	------

**EVAUT01 - UTILITY TRAY**

- Must be ordered in conjunction with a load bar option.
- Can be used with slat wall module.
- Available in standard and premium paint selections. See Textiles and Finishes (page 240) for a complete list of offerings and conditions.

DESCRIPTION	PRODUCT CODE	LIST PRICE	DIMENSIONS/INCHES		
			H	W	D

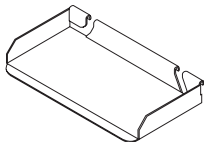

Utility Tray	EVAUT01	44	1	8.5	3.75
--------------	---------	----	---	-----	------

**EVAFS01 - FLIP SORTER**

- Must be ordered in conjunction with a load bar option.
- Can be used with slat wall module.
- Comes with nickel plated wire.
- Available in standard and premium paint selections. See Textiles and Finishes (page 240) for a complete list of offerings and conditions.

DESCRIPTION	PRODUCT CODE	LIST PRICE	DIMENSIONS/INCHES		
			H	W	D

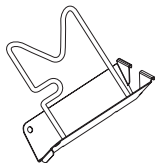

Flip Sorter	EVAFS01	61	9.25	2.75	9.25
-------------	---------	----	------	------	------

**EVAPP01 - MAIL BOX**

- Must be ordered in conjunction with a load bar option.
- Can be used with slat wall module.
- Available in standard and premium paint selections. See Textiles and Finishes (page 240) for a complete list of offerings and conditions.

DESCRIPTION	PRODUCT CODE	LIST PRICE	DIMENSIONS/INCHES		
			H	W	D

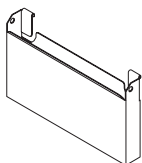

Mail Box	EVAPP01	104	9	12	2.75
----------	---------	-----	---	----	------

**EVATH01 - TELEPHONE HOLDER**

- Must be ordered in conjunction with a load bar option.
- Can be used with slat wall module.
- Available in standard and premium paint selections. See Textiles and Finishes (page 240) for a complete list of offerings and conditions.

DESCRIPTION	PRODUCT CODE	LIST PRICE	DIMENSIONS/INCHES		
			H	W	D

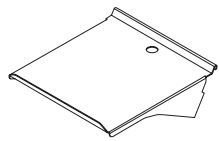

Telephone Holder	EVATH01	99	2	9	10
------------------	---------	----	---	---	----

**EVANP02 - NAME PLATE**

- Name Plate attached to 1" increment slots.
- Available in single sided (parallel to panel) or double sided (perpendicular to panel) for isle application displaying name on both sides.
- Injection molded frame and die cast base with black rubberized finish.
- Includes two slide-in name cards, steel brackets and fasteners.
- Available in black only.
- Free template for additional slide-in name cards are available at [http://evolvefurnituregroup.com/PDFs/Name\\_Plate\\_Template.doc](http://evolvefurnituregroup.com/PDFs/Name_Plate_Template.doc)

DESCRIPTION	PRODUCT CODE	LIST PRICE	DIMENSIONS/INCHES		
			H	W	D

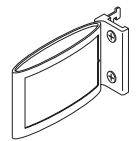

Name Plate	EVANP02	150	3.30	5.3	1.25
------------	---------	-----	------	-----	------

**EVACH01 - COAT HOOK**

- Panel mounted coat hook.
- Available in all standard Evolve paint colors except Steel (STL). Also available in premium paint selections (minimum quantities required to order).

DESCRIPTION	PRODUCT CODE	LIST PRICE	DIMENSIONS/INCHES		
			H	W	D

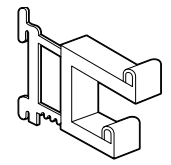

Coat Hook	EVACH01	110	3	.75	
-----------	---------	-----	---	-----	--

**EVACH02 - PANEL COAT HOOK**

- Panel mounted coat hook.
- Installed at panel top in groove between module and top trim.
- Available in standard and premium paint colors.
- Priced per six piece package.

DESCRIPTION	PRODUCT CODE	LIST PRICE	DIMENSIONS/INCHES		
			H	W	D

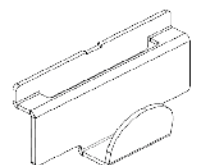

Panel Coat Hook	EVACH02	126	2.5	.625	
-----------------	---------	-----	-----	------	--



**EVWAKM01 - SOFT TOUCH KEYBOARD SUPPORT MECHANISM**

- Height range 6" (+1.0"/-5.0").
- Soft touch knob tilt adjustable range +15°/-15°.
- 360° base swivel.
- Soft touch knob for simultaneous height and tilt adjustment.
- Spring-assisted mechanism helps counter balance weight of keyboard and tray.
- Low profile design for maximum leg room.
- Includes 21.75" under worksurface glide track as standard. Optional 12" and 18" glide tracks are available at no upcharge. Contact Evolve Customer Support for details.
- Keyboard support mechanisms and trays available in Black only.

	DESCRIPTION	PRODUCT CODE	LIST PRICE	DIMENSIONS/INCHES		
				H	W	D

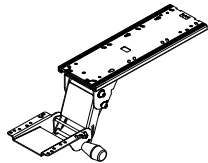

Soft Touch Keyboard Support Mechanism	EVWAKM01	319			
---------------------------------------	----------	-----	--	--	--

**EVWAKM02 - LIFT-N-LOCK KEYBOARD SUPPORT MECHANISM**

- Height range 8.38" (+2.25"/-6.13").
- Dial-tilt gauge shows precise tilt angle from +10°/-15° positions.
- 360° base swivel.
- Patent pending height indicator gauge allows for precise height setting when used by multiple users, or for returning to optimal height setting after storage.
- Patented Lift-N-Lock height adjustment without knobs or levelers automatically locks into position with release of tray for greater ADA/Barrier Free compliance.
- Exceeds BIFMA performance standards.
- Includes 21.75" under worksurface glide track as standard. Optional 12" and 18" glide tracks are available at no upcharge. Contact Evolve Customer Support for details.
- Keyboard support mechanisms and trays available in Black only.
- Positive Tilt Lockout available. Contact Evolve Customer Support for details.

	DESCRIPTION	PRODUCT CODE	LIST PRICE	DIMENSIONS/INCHES		
				H	W	D

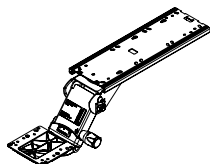

Lift-N-Lock Keyboard Support Mechanism	EVWAKM02	418			
--	----------	-----	--	--	--

**EVWAKM03 - LIFT-N-LOCK SIT-STAND KEYBOARD SUPPORT MECHANISM**

- Height range 14.13" (+8.25"/-5.88")
- Dial-tilt gauge shows precise tilt angle from +10°/-15°.
- 360° base swivel.
- Patent pending height indicator gauge allows for precise height setting when used by multiple users, or for returning to optimal height setting after storage.
- Curved neck allows user to be closer to the desk when in standing position.
- Exceeds BIFMA performance standards.
- Includes 21.75" under worksurface glide track as standard. Optional 12" and 18" glide tracks are available at no upcharge. Contact Evolve Customer Support for details.
- Keyboard support mechanisms and trays available in Black only.
- Positive tilt lockout available. Contact Evolve Customer Service for details.
- Maximizes ergonomic support for both seated and standing positions.
- Patented Lift-N-Lock height adjustment without knobs or levelers automatically locks into position with release of tray for greater ADA/Barrier Free compliance.

	DESCRIPTION	PRODUCT CODE	LIST PRICE	DIMENSIONS/INCHES		
				H	W	D

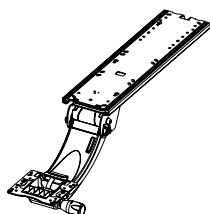

Lift-N-Lock Sit-Stand Keyboard Support Mechanism	EVWAKM03	673			
--	----------	-----	--	--	--



**EVWAKT01 - MDF TRAY WITH SLIDING MOUSE SUPPORT**

- Formed MDF tray with textured finish and a foam anti-skid mat.
- Sliding retractable mouse support slides below tray for left or right mouse positioning.
- Extends 9.91" beyond the end of the keyboard tray.
- Keyboard support mechanisms and trays available in Black only.

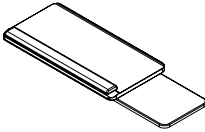
	DESCRIPTION	PRODUCT CODE	LIST PRICE	DIMENSIONS/INCHES		
				H	W	D
	MDF Tray with Sliding Mouse Support	EVWAKT01	322	21.3	10.5	

**EVWAKT02 - 27" HDPE TRAY WITH TWO MOUSING SURFACES**

- HDPE tray is 1/2" thick high density polyethylene with textured finish.
- Includes removable plug-in, gel free foam palm rest and anti-skid straps.
- Keyboard and mouse can be placed left or right.
- Includes mouse fence with cable manager.
- Keyboard support mechanisms and trays available in Black only.

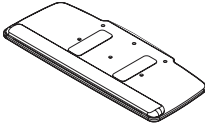
	DESCRIPTION	PRODUCT CODE	LIST PRICE	DIMENSIONS/INCHES		
				H	W	D
	27" HDPE Tray with Two	EVWAKT02	413	27.5	11.5	

**EVWAKT03 - PHENOLIC TRAY WITH HEIGHT ADJUSTABLE MOUSE SUPPORT**

- Solid low profile keyboard tray with graphite finish to help hide fingerprints and smudges.
- Includes removable plug-in, gel free foam palm rest and anti-skid straps.
- Height adjustable mouse support provides ergonomic adjustment of tilt, swivel and height adjustments.
- Keyboard and mouse can mount left or right.
- Mousing surface includes mouse fence with cable manager.
- Keyboard support mechanisms and trays available in Black only.

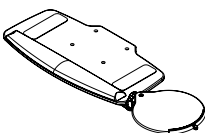
	DESCRIPTION	PRODUCT CODE	LIST PRICE	DIMENSIONS/INCHES		
				H	W	D
	Phenolic Tray with Height Adjustable Mouse Support	EVWAKT03	445	23	11.5	

**EVWAKT04 - 1/2" HDPE TRAY WITH HEIGHT ADJUSTABLE MOUSE SUPPORT**

- 1/2" thick high density polyethylene with textured finish.
- HDPE includes removable plug-in, gel free foam palm rest and anti-skid straps.
- Height adjustable mouse support with ergonomic adjustment of tilt, swivel and height adjustment.
- Can mount left or right and includes mouse fence and cable manager.
- Keyboard support mechanisms and trays available in Black only.

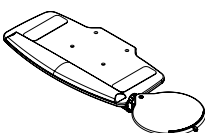
	DESCRIPTION	PRODUCT CODE	LIST PRICE	DIMENSIONS/INCHES		
				H	W	D
	1/2" HDPE Tray with Height Adjustable Mouse Support	EVWAKT04	499	23	11.5	



KEYBOARD COMBINATION CHART - PACKAGED CODES

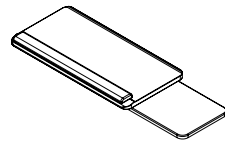

**EVWAKT01**

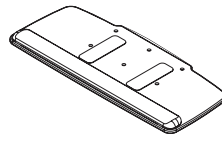

**EVWAKT02**

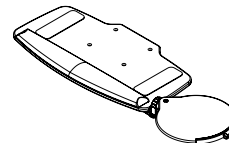

**EVWAKT03**

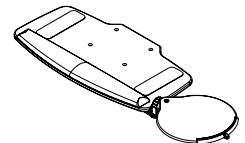

**EVWAKT04**

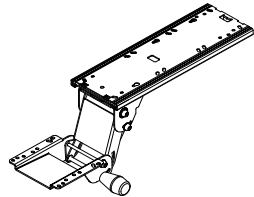

**EVWAKM01**

**EVWAKK101  
636**

**EVWAKK102  
730**

**EVWAKK103  
764**

**EVWAKK104  
813**

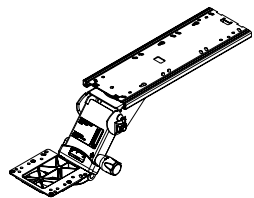

**EVWAKM02**

**EVWAKK201  
735**

**EVWAKK202  
828**

**EVWAKK203  
864**

**EVWAKK204  
912**

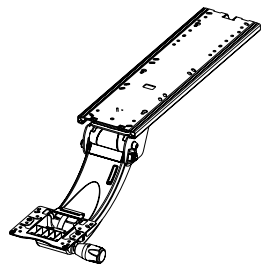

**EVWAKM03**

**EVWAKK301  
988**

**EVWAKK302  
\$1078**

**EVWAKK303  
\$1115**

**EVWAKK304  
\$1164**

**MONITOR ARM SPECIFICATIONS (APPLIES TO ALL EVOLVE MONITOR ARMS LISTED BELOW):**

- VESA mounting plate contains 75mm & 100mm mounting configuration.
- VESA plate head is fully adjustable with 180° of tilt, 180° of swivel and 360° of rotation for portrait to landscape viewing.
- Keyhole slots in VESA plate for quick mounting of display screen.
- Counterbalance spring mechanism does not contain gas cylinders (that are prone to leakage).
- Cable management provided on arm swivel joints.
- Arm components manufactured from 100% recyclable aluminum dye cast material, providing stability and durability.
- 13" arm height adjustment on 11" stainless steel pole.
- Pole support ring doubles as cable manager.
- 360° of arm swivel around pole.
- Desk clamp and grommet mounting options standard on pole applications.

**EVLCD03 - MONITOR ARM - SINGLE SCREEN/SINGLE EXTENSION**

- Display viewing - 180° of tilt, 180° of swivel and 360° of rotation.
- Quick-release VESA plate included.
- 9" pole adjustment.
- Available in White (WHT), Black (BLK) and Silver (SIL). Post is chromed.

DESCRIPTION	PRODUCT CODE	LIST PRICE	DIMENSIONS/INCHES		
			H	D	W

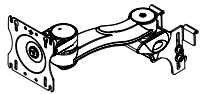

Monitor Arm - Single Screen  
Single Extension

EVLCD03

539

**EVLCD04 - MONITOR ARM - SINGLE SCREEN/DUAL EXTENSION/HEIGHT ADJUSTABLE**

- Frees up valuable worksurface space and supports a sit/stand working posture.
- Attaches to any standard worksurface with a flush edge, or through a grommet.
- Monitor arm adjusts from 3" to 12" above worksurface.
- Counterbalanced arm provides an additional 13" of height adjustment.
- Monitor connecting bracket swivels 360° and tilts +/- 90° (180°).
- Double extension has 19" of back and forth movement to allow for different vocal depths of viewing comfort.
- Built-in cable clips on underside of extension arms and pole base allows organized cable management.
- Quick-release VESA plate included.
- Available in White (WHT), Black (BLK) and Silver (SIL). Post is chromed.

DESCRIPTION	PRODUCT CODE	LIST PRICE	DIMENSIONS/INCHES		
			H	W	D

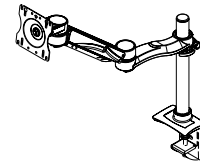

Monitor Arm - Single Screen  
Dual Extension/Height Adjustable

EVLCD04

770

**EVLCD05 - MONITOR ARM - DUAL SCREEN/DUAL EXTENSION**

- Frees up valuable worksurface space.
- Used for side-by-side or back-to-back applications.
- Attaches to any standard worksurface with flush edge or through a grommet.
- Monitor arm adjusts from 3" to 12" above worksurface.
- Monitor connecting extension has 19" of back and forth movement to allow for different vocal depths of viewing comfort.
- Built-in cable clips on underside of extension arms and pole base allows organized cable management.
- Quick-release VESA plate included.
- Available in White (WHT), Black (BLK) and Silver (SIL). Post is chromed.

DESCRIPTION	PRODUCT CODE	LIST PRICE	DIMENSIONS/INCHES		
			H	W	D

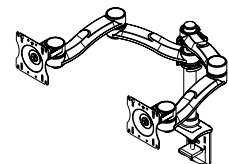

Monitor Arm - Dual Screen

EVLCD05

1131



**EVLCD06 - MONITOR ARM - DUAL SCREEN/DUAL EXTENSION/HEIGHT ADJUSTABLE**

- Frees up valuable worksurface space and supports a sit/stand working posture.
- Used for side-by-side or back-to-back applications.
- Attaches to any standard worksurface with flush edge or through a grommet.
- Monitor arm adjusts from 3" to 12" above worksurface.
- Counterbalanced arm provides an additional 13" of height adjustment.
- Monitor connecting bracket swivels 360° and tilts +/- 90° (180°).
- Double extension has 19" of back and forth movement to allow for different vocal depths of viewing comfort.
- Built in cable clips on underside of extension arms and pole base allows organized cable management.
- Quick-release VESA plate included.
- Available in White (WHT), Black (BLK) and Silver (SIL).
- Accommodates flat screen monitors up to 32" in size.

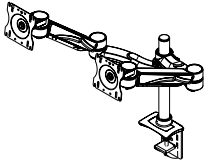
	DESCRIPTION	PRODUCT CODE	LIST PRICE	DIMENSIONS/INCHES		
				H	W	D
	Monitor Arm - Dual Screen Dual Extension/Height Adjustable	EVLCD06	1403			

**EVLCD08 - MONITOR ARM - SINGLE SCREEN/DUAL EXTENSION**

- 9 1/2" reach from center of pole to front of VESA plate.
- Display viewing - 180° of tilt, 180° of swivel and 360° of rotation.
- Quick-release VESA plate included.
- 9" pole adjustment.
- Available in White (WHT), Black (BLK) and Silver (SIL). Post is chromed.

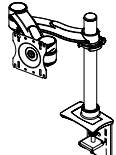
	DESCRIPTION	PRODUCT CODE	LIST PRICE	DIMENSIONS/INCHES		
				H	W	D
	Monitor Arm - Single Screen Dual Extension	EVLCD08	642			

**EVLCD09 - SINGLE SCREEN MONITOR ARM - FOR 5 TO 20LBS**

- Adjustable counterbalance cylinder provides smooth 14 1/2" of height adjustment with fingertip control - counterbalances monitors from 5 lbs. to 20 lbs.
- Double extension arms provide a maximum of 26 3/4" extension from the rear edge of the mounting surface to the VESA Plate for greater monitor adjustment on deep or corner workstations.
- Arms fold back to a minimum dimension of 4 1/2" to provide maximum desk utilization.
- Weight gauge provided to allow for quick and easy counterbalance adjustment of the arm prior to installing the screen.
- Saves time and guesswork especially for multiple arm installations.
- Die cast aluminum construction provides greater stability and contains high recycled material content with full recyclability.
- Adjustable rotation limiter to restrict arm rotation to 180°, preventing arms from hitting walls.
- Comes with all tools and mounting hardware for quick and easy installation (Tool-free).
- Available in White (WHT), Black (BLK) and Silver Metallic (SIL). Post is chromed.

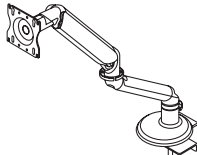
	DESCRIPTION	PRODUCT CODE	LIST PRICE	DIMENSIONS/INCHES		
				H	W	D
	Single Screen Monitor Arm - For 5 to 20 lbs.	EVLCD09	718	38	6	8.5

**EVCPU - CPU HOLDER**

- CPU holder with soft touch knob.
- Vertical underside storage space.
- Maintains CPU at set height.
- Inside width adjustment 3.5" — 9.25"
- Inside vertical adjustment 12.25" — 22.25"
- Load rating: 85lbs.
- Available in black only.

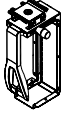
	DESCRIPTION	PRODUCT CODE	LIST PRICE	DIMENSIONS/INCHES		
				H	W	D
	CPU Holder	EVCPU01	347	14	8.25	7.75

**EVCPU02 - CPU HOLDER ON GLIDE TRACK**

- Accepts tower CPUs with a width range of 3.5" to 9.3" and a height range of 12.5" to 22.5"
- Soft touch knob for side clamp adjustment and bayonet lance for vertical height adjustment.
- 12" glide track mounted and 360-degree swivel for easy access to rear of CPU.
- Manufactured from steel and engineered resin, providing rugged durability and support.
- Available in Black only.

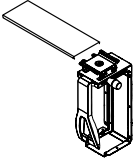
	DESCRIPTION	PRODUCT CODE	LIST PRICE	DIMENSIONS/INCHES		
				H	W	D
	CPU Holder on Glide Track	EVCPU02	367			

**EVWALS01 - LAPTOP SUPPORT WITH INTEGRATED 4 PORT USB HUB**

- 5 adjustment angles for ergonomic viewing.
- Adjustment arm allows for unrestricted air flow.
- 4 port USB hub powered by a computer, no external power required.
- Fully compliant with universal serial bus specifications 2.0.
- Over current protection for downstream port.
- Compatible with Windows 7, XP, 98, ME, 2000 and Vista. Also compatible with MAC OS 8x, 9x, and 10.
- CE/UL/FCC approved and RoHS compliant. Available in Black and Grey.

	DESCRIPTION	PRODUCT CODE	LIST PRICE	DIMENSIONS/INCHES		
				H	W	D
	Laptop Support with Integrated 4 Port USB Hub	EVWALS01	200			



# ACCESSORIES

## EWWADH01 - DESKTOP DOCUMENT HOLDER

- Dimensions of 16 1/2" wide x 10" high x 8" deep.
- Heavy duty steel easel support.
- Magnetic line glide.
- Available in Black only.

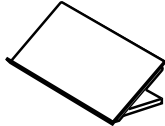
	DESCRIPTION	PRODUCT CODE	LIST PRICE	DIMENSIONS/INCHES		
				H	W	D
	Desktop Document Holder	EWWADH01	200			

## EWWAFR01 - ADJUSTABLE FOOT REST

- Provides support for the 5th percentile female when chair adjustment is not adequate.
- Easily adjustable to angles of 6°, 12°, 16° and 25°.
- Footrest surface covered with anti-fatigue rubber mat.
- Available in Black/Grey combination only.

	DESCRIPTION	PRODUCT CODE	LIST PRICE	DIMENSIONS/INCHES		
				H	W	D
	Adjustable Foot Rest	EWWAFR01	200			

## EWWACP - CRT CORNER PLATE

- Converts two abutting worksurfaces in a 90° corner into a 45° angle keyboard workspace.
- Keyboard mechanism not included.
- Must specify paint color.
- Made of metal.

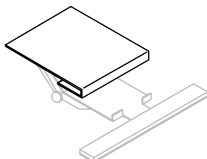
	DESCRIPTION	PRODUCT CODE	LIST PRICE	DIMENSIONS/INCHES		
				H	W	D
	CRT Corner Plate	EWWACP1818	109	1.125	18	18

## EVATP - TOUCH-UP PAINT KIT

- Available in standard Evolve paint colors to facilitate easy touch-ups.
- 1/2 fl. ounce bottle (spray not available).
- Specify color.

	DESCRIPTION	PRODUCT CODE	LIST PRICE	DIMENSIONS/INCHES		
				H	W	D
	Touch-Up Paint Kit	EVATP01	51			



# textiles and finishes

## Care and Cleaning

The following guide encompasses the Evolve System line.

The guide was compiled using information from our "raw" material suppliers and is relevant only to our standard offering finishes and textiles.

---

### FABRICS

To extend the life of your upholstered panels, regularly dust the panel to prevent airborne particles from penetrating the fabric surface.

For light soiling, use a damp cloth and blot the spot with very slight pressure, taking care never to soak the fabric. Dry with a clean cloth by blotting - never rub fabric. More intense stains can be treated the same way, but with a mild detergent. Always test fabric first in an unseen area before using any cleaning method.

### PANEL FRAMES

The panel frames are manufactured out of sturdy aluminum with a powder coated enamel paint finish. To clean the frames of the panels, and all hardware associated with the Evolve line, simply utilize a clean, damp cloth. For stubborn stains on the panel frames, you may consider adding a mild detergent.

### GLAZED PANELS

Cleaning of the glazing in panels should only be done with a damp lint-free cloth. A mild detergent can be used if necessary. Do not use paper towels in combination with a window cleaner-this may cause scratches to the glazing.

### WORKSURFACES

The worksurfaces are manufactured using primarily Nevamar Brand laminates as the exposed surface. To properly clean these areas, it is best to use a clean, damp cloth and circular motion to prevent streaks. For stubborn stains, you are able to add a mild detergent to the water. Be certain not to use an ammonia-based solution. It will react with the PVC, or wood edge trim, causing permanent damage to the contacted areas.

### ACCESSORIES

The accessories sold with the Evolve product line can be simply cleaned with a clean, damp cloth. If they are really dirty, a mild, non-abrasive solution may be added. Wipe with a damp cloth after the solution, and finally, a dry cloth.



**LAMINATES – THERMALLY FUSED & HIGH PRESSURE**

Absolute Acajou*	<b>ACJ</b>
Asian Night*	<b>ASN</b>
Avant Cherry*	<b>AWC</b>
Avant Honey*	<b>AWH</b>
Black*	<b>BLK</b>
Blizzard*	<b>BZD</b>
Blizzard Matrix	<b>BMX</b>
Brushed Cobalt*	<b>BRC</b>
Clear Maple*	<b>CMB</b>
Custom Grey	<b>CGY</b>
Dark Espresso*	<b>DES</b>
Designer White*	<b>DWT</b>
Grey Matrix	<b>GRX</b>
Hayden Grey	<b>HGT</b>
Hayden Linen	<b>HLN</b>
Noce Biondo	<b>(NBL)</b>
Noce Grigio	<b>(NGL)</b>
Noce Leggero	<b>(NEL)</b>
Noce Medio	<b>(NML)</b>
Quartered Mahogany*	<b>QTM</b>
Stone Dust	<b>SDT</b>
Stone Linen	<b>SLN</b>
Storm Grey	<b>SOG</b>
Studio White Matrix	<b>SWX</b>
String	<b>STG</b>
Tiger Fruitwood*	<b>TFW</b>
Tiger Walnut*	<b>TWL</b>
Walnut Heights*	<b>WHE</b>
Willow Grey	<b>WGY</b>
Winter Cherry*	<b>WCR</b>
White Chocolate*	<b>WHC</b>

Additional paint and laminates may be available. Contact Evolve Customer Support for details.

\* Matching Wood Grain PVC edge available.

\* PVC panel and connector trims are discontinued. Effective 12/2014

\* 1 1/8" Worksurfaces are discontinued. Effective December 2014

**PVC EDGE TRIM**

Absolute Acajou	<b>AAE</b>
Asian Night	<b>ASE</b>
Avant Cherry	<b>ACE</b>
Avant Honey	<b>AHE</b>
Black	<b>BLK</b>
Blizzard	<b>BZD</b>
Brushed Cobalt	<b>BRC</b>
Charcoal	<b>CHR</b>
Clear Maple	<b>CME</b>
Dark Espresso*	<b>DES</b>
Designer White	<b>DWE</b>
Nevada	<b>NEV</b>
Quartered Mahogany*	<b>QTM</b>
Shaker Cherry*	<b>SKE</b>
Silver	<b>SIL</b>
Taupe	<b>TPE</b>
Tiger Fruitwood*	<b>TFW</b>
Tiger Maple*	<b>TMP</b>
Tiger Walnut*	<b>TWL</b>
Tungsten	<b>TUN</b>
Walnut Heights	<b>WHE</b>
Winter Cherry*	<b>WCR</b>
White Chocolate*	<b>CBE</b>

\* 1 7/16" HPW PVC Trim for Worksurfaces is not available in Dark Espresso (DES), Tiger Fruitwood (TFW), Tiger Maple (TMP) and Tiger Walnut (TWL).

**WOOD VENEER WORKSURFACES\***

Almond Cherry	<b>AMW</b>
Cocoa Walnut	<b>CAW</b>
Coral	<b>CRW</b>
Dark Cherry	<b>DCW</b>
Espresso Walnut	<b>EWV</b>
Evening Oak	<b>EVV</b>
Grey on Oak	<b>GRW</b>
Hazlenut	<b>HAW</b>
Honey Maple	<b>SMW</b>
Java	<b>JAW</b>
Latte Walnut	<b>LTW</b>
Milestone	<b>MTW</b>
Mocha	<b>MCW</b>
Natural Maple	<b>MPW</b>
Red Cherry	<b>RCW</b>
Vintage Cherry	<b>VNW</b>
Walnut	<b>WLW</b>
Warm Cherry	<b>WCW</b>
White Maple	<b>WMW</b>

All wood veneer worksurfaces are 1.38" thick.

\*Note: Wood veneer options for worksurfaces are available at an up charge and with an extended lead time. Contact Evolve Customer Support for details.

**ACCENT PAINTED FINISHES**

Crystal Blue	<b>CYB</b>
Lime Green	<b>LMG</b>
Orange Flame	<b>ORF</b>
Steel Blue	<b>STB</b>
Vermilion Red	<b>VLR</b>

Accessory painted finishes are subject to 10% upcharge and minimum order of 50 pieces, orders under 50 pieces subject to \$500 net fee

**STANDARD PAINT & FRAME COLORS**

(for application to trim, steel components, PVC, vertical and horizontal members)

Black	<b>BLK</b>
Blizzard (Textured)	<b>BZD</b>
Charcoal	<b>CHR</b>
Designer White	<b>DWT</b>
Fog	<b>FOG</b>
Nevada	<b>NEV</b>
Silver	<b>SIL</b>
Stone Dust (Textured)	<b>SDT</b>
Taupe	<b>TPE</b>
Tungsten <sup>o</sup>	<b>TUN</b>

Additional paint and laminates may be available. Contact Evolve Customer Support for details.

<sup>o</sup>Tungsten paint is subject to 10% upcharge EXCEPT on Worksurfaces, PVC items, or when PVC trim components are ordered separately.

**PREMIUM PAINT & FRAME COLORS**

Black Coffee*	<b>BKC</b>
Bone*	<b>BNE</b>
Business Grey*	<b>BGR</b>
Claret*	<b>CLT</b>
Dark Chocolate*	<b>DCH</b>
Desert Putty*	<b>DPT</b>
Grey*	<b>GRY</b>
Ice*	<b>ICE</b>
Ivory*	<b>IVR</b>
Light Grey*	<b>LGR</b>
Metro*	<b>MET</b>
Mocha*	<b>MCH</b>
Moss*	<b>MOS</b>
Navy*	<b>NAV</b>
Oyster*	<b>OYS</b>
Sky*	<b>SKY</b>
Stone*	<b>STN</b>
Storm Grey	<b>SGR</b>
Tahiti Sand*	<b>TSA</b>
Willow*	<b>WIL</b>

\*Premium paint selections are available on the following components: Panels (top trim and frame), Hardware, End-of run/Post Kits, and Accessories at a 22% upcharge. Storage with no upcharge.

\*Please note all Double Wall Storage units must be ordered in a minimum quantity of 50 when ordering in a premium paint finish. Different model types can be combined to achieve the minimum quantity required. See pages 192-193 for affected models.

All special and premium paint match orders of 50 panels or less will incur a \$500 net setup fee. Panels, hardware, accessories and storage may be combined on orders to achieve minimum of 50 pieces or more and will not be subject to \$500 net set up fee. Add on orders will not have that charge for 90 days after the original order has shipped and must have the original PO# quoted otherwise they will not qualify for the program.

Global matte paint finishes are available on most Evolve Storage pieces without an up charge regardless of quantities.

All Mica and Metallic paint finishes will incur a minimum up charge of 10%.

All non-standard paint finishes must be approved by Evolve prior to placing an order.

ADA Overheads are not available in Evolve premium color paints. ADA Overheads are available in Evolve standard paint colors only.

Frames for all Open Panel models, all panel retainers, PVC components for panels and connectors are unavailable in premium or special/custom paint colors. They are available in standard Evolve paint colors only.



**PANEL FABRICS – GRADE 1**

**Anchorage** - 35% Post - consumer Recycled Polyester and 65% Pre -consumer Recycled Polyester

Birch .....	<b>AN40</b>
Green Apple .....	<b>AN41</b>
Lapis .....	<b>AN42</b>
Straw .....	<b>AN43</b>
Wolf .....	<b>AN44</b>
Goose .....	<b>AN45</b>
Angora .....	<b>AN46</b>
Cumin .....	<b>AN47</b>
Asteroid .....	<b>AN48</b>
Geranium .....	<b>AN49</b>
Thistle .....	<b>AN50</b>
Graphite .....	<b>AN51</b>
Slate .....	<b>AN52</b>
Quarry Blue .....	<b>AN53</b>
Onyx .....	<b>AN54</b>
Pumpkin .....	<b>AN55</b>
Red Delicious .....	<b>AN56</b>
Sunshine .....	<b>AN57</b>
Waterfall .....	<b>AN59</b>
Vanilla .....	<b>AN61</b>
Vanilla .....	<b>AN61</b>
Cobalt .....	<b>AN62</b>
Cloud .....	<b>AN64</b>

**Aurora** - 100% Polyester, 80% minimum Post-Consumer Recycled Polyester

Cloud .....	<b>AU20</b>
Seal .....	<b>AU21</b>
Fog .....	<b>AU22</b>
Pewter .....	<b>AU23</b>
Granite .....	<b>AU24</b>
Oat .....	<b>AU25</b>
Coconut .....	<b>AU26</b>
Latte .....	<b>AU27</b>
Lake .....	<b>AU28</b>
Frost .....	<b>AU29</b>

**Chance** - 63% Virgin Polyester, 37% Post-Consumer Recycled Polyester

Mist .....	<b>CN51</b>
Dill .....	<b>CN52</b>
Island .....	<b>CN53</b>
Plaza .....	<b>CN54</b>
Tranquil .....	<b>CN55</b>
Malt .....	<b>CN56</b>
Navajo .....	<b>CN57</b>
Prairie .....	<b>CN58</b>
Cinder .....	<b>CN59</b>
Oasis .....	<b>CN66</b>

**Linea** - 100% Post Consumer Recycled Polyester

Queue .....	<b>LN41</b>
Cord .....	<b>LN42</b>
Twine .....	<b>LN43</b>
Thread .....	<b>LN44</b>
Contour .....	<b>LN45</b>
Silhouette .....	<b>LN46</b>
Cable .....	<b>LN47</b>
Route .....	<b>LN48</b>

**Lisbon** - 80% Polyester, 20% Post-Consumer Recycled Polyester

Gesso .....	<b>LS11</b>
Dusk .....	<b>LS12</b>
Grey .....	<b>LS13</b>
Ivory .....	<b>LS14</b>
Henna .....	<b>LS15</b>
Nocturnal .....	<b>LS16</b>
Moss .....	<b>LS17</b>
Navy .....	<b>LS18</b>
Buff .....	<b>LS19</b>
Spa .....	<b>LS20</b>

**Loopy** - 100% Recycled Polyester

Oyster .....	<b>LP60</b>
Putty .....	<b>LP61</b>
Marble .....	<b>LP62</b>
Hazelnut .....	<b>LP63</b>
Latte .....	<b>LP64</b>
Bay .....	<b>LP65</b>
Wild Rice .....	<b>LP66</b>
Harbor .....	<b>LP67</b>

**Melody** - 100% Recycled Polyester

Spray .....	<b>ME40</b>
Pond .....	<b>ME41</b>
Sand Bar .....	<b>ME42</b>
Silt .....	<b>ME43</b>
Pebble .....	<b>ME44</b>
Lake .....	<b>ME45</b>
Gravel .....	<b>ME46</b>
Boulder .....	<b>ME47</b>

**Merge** - 100% Polyester, 75% minimum Post-Consumer Recycled Polyester

Fawn .....	<b>MG20</b>
Marshmallow .....	<b>MG21</b>
Driftwood .....	<b>MG22</b>
Dove .....	<b>MG23</b>
Graphite .....	<b>MG24</b>
Slate .....	<b>MG25</b>
Eucalyptus .....	<b>MG26</b>
Fire Engine .....	<b>MG27</b>
Mediterranean .....	<b>MG28</b>
Midnight .....	<b>MG29</b>

**Pinpoint** - 100% Post-Consumer Recycled Polyester

Bliss .....	<b>PN11</b>
Delight .....	<b>PN12</b>
Dune .....	<b>PN13</b>
Infusion .....	<b>PN14</b>
Ebony .....	<b>PN15</b>
Fresh .....	<b>PN16</b>
Carrot .....	<b>PN17</b>
Splash .....	<b>PN18</b>
Vibe .....	<b>PN19</b>
Gala .....	<b>PN20</b>

**Streak** - 100% Recycled Polyester

Beach .....	<b>SR81</b>
Shade .....	<b>SR86</b>
Stretch .....	<b>SR88</b>
Sprint .....	<b>SR89</b>
Roll .....	<b>SR91</b>
Dart .....	<b>SR92</b>
Zoom .....	<b>SR93</b>
Splash .....	<b>SR94</b>
Whiz .....	<b>SR95</b>
Flash .....	<b>SR96</b>

**Tek** - 100% Recycled Polyester

Finesse .....	<b>TX60</b>
Grain .....	<b>TX61</b>
Essence .....	<b>TX62</b>
Warp .....	<b>TX64</b>
Mesh .....	<b>TX67</b>
Form .....	<b>TX69</b>
Spice .....	<b>TX71</b>
Glacier .....	<b>TX72</b>
Spring .....	<b>TX73</b>
Harmony .....	<b>TX74</b>
Smoke .....	<b>TX75</b>
Pebble .....	<b>TX76</b>

**Terrace** - 100% Post-Consumer Recycled Polyeste

Lotus .....	<b>TC60</b>
Tigerlily .....	<b>TC61</b>
Shadow .....	<b>TC62</b>
Cobble .....	<b>TC63</b>
Cherry Blossom .....	<b>TC64</b>
Bluebell .....	<b>TC65</b>
Apple .....	<b>TC66</b>
Haze .....	<b>TC67</b>
Cerise .....	<b>TC68</b>
Twilight .....	<b>TC69</b>
Wintergreen .....	<b>TC70</b>
Ironwork .....	<b>TC71</b>
Flirt .....	<b>TC73</b>
Echo .....	<b>TC74</b>
Glacier .....	<b>TC75</b>

**PANEL FABRICS— GRADE 2**

**Cyclone** - 56% post-consumer recycled polyester and 44% polyester.

Stove Pipe .....	<b>IM37</b>
Stainless.....	<b>IM40</b>
Polished Pewter .....	<b>IM41</b>
Welded Steel .....	<b>IM43</b>
Etched Bronze.....	<b>IM44</b>
Fired Titanium.....	<b>IM46</b>
Chrome.....	<b>IM49</b>
Dark Annealed.....	<b>IM50</b>
Karat.....	<b>IM54</b>
Red Metal.....	<b>IM55</b>
Oxidized Bronze.....	<b>IM56</b>
Bright Ray.....	<b>IM57</b>
Bismuth Crystal .....	<b>IM58</b>
Gallium Blue.....	<b>IM59</b>

**Dashing** -100% Post-Consumer Recycled Polyester

Classic Silver.....	<b>DS21</b>
Refined Marble.....	<b>DS22</b>
Antique Sage.....	<b>DS23</b>
Polished Slate .....	<b>DS24</b>
Genteel Beige .....	<b>DS25</b>
Bespoke Tan .....	<b>DS26</b>
Dapper Grey.....	<b>DS27</b>

**Quadrille** - 52.5% Polyester / 47.5% Recycled Polyester

\*Maximum panel width is 48'

Escapade .....	<b>QU30</b>
Shenanigan .....	<b>QU31</b>
Revelry .....	<b>QU32</b>
Spring .....	<b>QU33</b>
Regalia .....	<b>QU34</b>
Soiree.....	<b>QU35</b>
Zest.....	<b>QU36</b>
Gambol.....	<b>QU37</b>
Leisure .....	<b>QU38</b>
Fair .....	<b>QU39</b>
Fiesta.....	<b>QU40</b>
Carnival .....	<b>QU41</b>
Spree.....	<b>QU42</b>
Opus.....	<b>QU43</b>
Jubilee.....	<b>QU44</b>
Masquerade.....	<b>QU45</b>
Cabarets.....	<b>QU46</b>

**PET PANEL FABRICS**

Graphite.....	<b>GPH</b>
Mist.....	<b>MTS</b>
Pewter.....	<b>PWT</b>
Harvest.....	<b>HVT</b>
Shamrock.....	<b>SHR</b>
Brick.....	<b>BRI</b>
Denim.....	<b>DEN</b>
Black.....	<b>BLK</b>
White.....	<b>WHT</b>



**GRADE 1**

**Dobby** - 96% Recycled Polyester / 4% Virgin Polyester

Snowcap.....	<b>DB30</b>
Bonsai.....	<b>DB31</b>
Cloud.....	<b>DB32</b>
Sand.....	<b>DB33</b>
Pewter.....	<b>DB34</b>
Sante Fe.....	<b>DB35</b>
Corfu.....	<b>DB36</b>
Medium Taupe.....	<b>DB37</b>
Charcoal.....	<b>DB38</b>
Berry.....	<b>DB39</b>
Royal.....	<b>DB40</b>
Titanium.....	<b>DB41</b>
Black.....	<b>DB42</b>

**Fusion** - 90% Virgin Polyester/ 10% Post-Consumer Recycled Polyester

Tangerine.....	<b>FU71</b>
Fresh.....	<b>FU72</b>
Moss.....	<b>FU73</b>
Tomato.....	<b>FU74</b>
Aqua.....	<b>FU75</b>
Sandstone.....	<b>FU76</b>
Granite.....	<b>FU77</b>
Poppy.....	<b>FU78</b>
Cadet.....	<b>FU79</b>
Oasis.....	<b>FU80</b>
Graphite.....	<b>FU81</b>
Viola.....	<b>FU82</b>
Cobalt.....	<b>FU83</b>
Flax.....	<b>FU84</b>
Carbon.....	<b>FU85</b>

**Illusion** - 100% Virgin Polyester

Cappuccino.....	<b>II01</b>
Paprika.....	<b>II02</b>
Tropic.....	<b>II03</b>
Wicker.....	<b>II04</b>
Hemp.....	<b>II05</b>
Cayenne.....	<b>II06</b>
Maui.....	<b>II07</b>
Dusk.....	<b>II08</b>
Smoke.....	<b>II09</b>
Currant.....	<b>II10</b>
Fiji.....	<b>II11</b>
Ozone.....	<b>II12</b>
Ebony.....	<b>II13</b>

**Jenny** - 100% Polyester

Midnite.....	<b>JN01</b>
Ebony.....	<b>JN02</b>
Slate.....	<b>JN03</b>
Vermilion.....	<b>JN07</b>
Admiral.....	<b>JN08</b>
Charcoal.....	<b>JN11</b>
Silver Lining.....	<b>JN25</b>
Oatmeal.....	<b>JN26</b>
Sunflower.....	<b>JN27</b>
Cascade.....	<b>JN28</b>
Harvest.....	<b>JN29</b>
Mellon.....	<b>JN30</b>
Berry.....	<b>JN31</b>
Green Grass.....	<b>JN32</b>
Roast.....	<b>JN33</b>

**Quilt** - 100% Polyester

Black.....	<b>QL10</b>
Charcoal Grey.....	<b>QL11</b>
Navy.....	<b>QL14</b>
Wine.....	<b>QL16</b>
Silver.....	<b>QL19</b>
Feather.....	<b>QL20</b>
Dune.....	<b>QL21</b>
Meadow.....	<b>QL22</b>
Cadet.....	<b>QL23</b>
Geranium.....	<b>QL24</b>
Daisy.....	<b>QL25</b>
Quest.....	<b>QL26</b>
Punch.....	<b>QL27</b>
Tangerine.....	<b>QL28</b>
Cocoa.....	<b>QL29</b>

**Terrace** - 100% Post-Consumer Recycled Polyester

Lotus.....	<b>TC60</b>
Tigerlily.....	<b>TC61</b>
Shadow.....	<b>TC62</b>
Cobble.....	<b>TC63</b>
Cherry Blossom.....	<b>TC64</b>
Bluebell.....	<b>TC65</b>
Apple.....	<b>TC66</b>
Haze.....	<b>TC67</b>
Cerise.....	<b>TC68</b>
Twilight.....	<b>TC69</b>
Wintergreen.....	<b>TC70</b>
Ironwork.....	<b>TC71</b>
Pine Cone.....	<b>TC72</b>
Flirt.....	<b>TC73</b>
Echo.....	<b>TC74</b>

**Trak** - 100% Recycled Polyester

Taupe.....	<b>TK40</b>
Mustard.....	<b>TK41</b>
Latte.....	<b>TK42</b>
Cement.....	<b>TK43</b>
Silver.....	<b>TK44</b>
Copper.....	<b>TK45</b>
Teal.....	<b>TK46</b>
Apple.....	<b>TK47</b>
Steel.....	<b>TK48</b>
Merlot.....	<b>TK49</b>
Midnight Sky.....	<b>TK50</b>
Mocha.....	<b>TK51</b>
Carbon.....	<b>TK52</b>

**Urban** - 62% Recycled Polyester / 32% Polyester

Red Rose.....	<b>UR10</b>
Ocean Blue.....	<b>UR11</b>
Blue Bayou.....	<b>UR12</b>
Green Grass.....	<b>UR13</b>
Sandcastle.....	<b>UR14</b>
Beach Day.....	<b>UR15</b>
Boardwalk.....	<b>UR16</b>
Earth.....	<b>UR17</b>
Brown Ridge.....	<b>UR18</b>
White Sand.....	<b>UR19</b>
Granite Rock.....	<b>UR20</b>
Gravel Road.....	<b>UR21</b>
Black Coal.....	<b>UR22</b>

**Waterfall** - 60% Virgin Polyester /40% Post - Consumer Recycled Polyester

Trance.....	<b>WA40</b>
Tryst.....	<b>WA41</b>
Splash.....	<b>WA42</b>
Victoria.....	<b>WA43</b>
Imagine.....	<b>WA44</b>
Sky.....	<b>WA45</b>
Rainforest.....	<b>WA46</b>
Rumble.....	<b>WA47</b>
Prism.....	<b>WA48</b>
Tranquility.....	<b>WA49</b>
Grand.....	<b>WA50</b>
Rushing.....	<b>WA51</b>
Majestic.....	<b>WA52</b>
Pacific.....	<b>WA53</b>
Dance.....	<b>WA54</b>

**Waterfall** - 60% Virgin Polyester /40% Post - Consumer Recycled Polyester

Lime.....	<b>WV01</b>
Mint.....	<b>WV02</b>
Stone.....	<b>WV03</b>
Flame.....	<b>WV04</b>
Mykonos.....	<b>WV05</b>
Savannah.....	<b>WV06</b>
Mesa.....	<b>WV07</b>
Plasma.....	<b>WV08</b>
Cancun.....	<b>WV09</b>
Quartz.....	<b>WV10</b>
Moonrock.....	<b>WV11</b>
Rubine.....	<b>WV12</b>
Corfu.....	<b>WV13</b>
Bluejay.....	<b>WV14</b>

**GRADE 2 (FABRIC)**

**Imprint** - 100% Post-Consumer Polyester

Almond.....	<b>IM70</b>
Cork.....	<b>IM71</b>
Sand.....	<b>IM72</b>
Currie.....	<b>IM73</b>
Candy Apple.....	<b>IM74</b>
Ocean.....	<b>IM75</b>
Navy.....	<b>IM76</b>
Green Tea.....	<b>IM77</b>
Celery.....	<b>IM78</b>
Regano.....	<b>IM79</b>
Walnut.....	<b>IM80</b>
Paprika.....	<b>IM81</b>
Graphite.....	<b>IM82</b>
Slate.....	<b>IM83</b>
Licorice.....	<b>IM84</b>

**GRADE 2 (VINYL)**

For availability of chair series in Vinyl, please contact a Global Sales Representative.

**Allante FRee** - 100% Vinyl Face / 100% Polyester Backing

Illusion .....	<b>A01F</b>
Bright White .....	<b>A02F</b>
White Crush .....	<b>A03F</b>
Ivory .....	<b>A04F</b>
Ice .....	<b>A05F</b>
Bleached Sand .....	<b>A06F</b>
Taupe Fawn .....	<b>A07F</b>
Warm Smoke .....	<b>A08F</b>
Autumn Rain .....	<b>A09F</b>
Cookie .....	<b>A10F</b>
Sierra Brick .....	<b>A11F</b>
Gibraltar .....	<b>A12F</b>
Chateau Grey .....	<b>A13F</b>
Golden Green .....	<b>A14F</b>
Oasis Green .....	<b>A15F</b>
Ink Black .....	<b>A16F</b>
Purple impulse .....	<b>A17F</b>
Italian Rose .....	<b>A18F</b>
Mountain Sky .....	<b>A19F</b>
Old Navy .....	<b>A20F</b>
Galaxy .....	<b>A21F</b>
Red Truffle .....	<b>A22F</b>
Chocolate Sundae .....	<b>A23F</b>
Province Blue .....	<b>A24F</b>
Eclipse .....	<b>A25F</b>

**GRADE 3 (RECYCLED)**

**Couture** - 100% Post-Consumer

Polyester	
Mocha .....	<b>CE71</b>
Sapphire .....	<b>CE74</b>
Neptune .....	<b>CE75</b>
Lake .....	<b>CE76</b>
Willow .....	<b>CE77</b>
Sassy .....	<b>CE78</b>
Persimmon .....	<b>CE80</b>
Carbon .....	<b>CE81</b>
Sterling .....	<b>CE82</b>



# PANEL C.O.M REQUEST FOR APPLICATION TEST

## SEND COMPLETED FORM AND FABRIC TO:

Evolve Furniture Group  
555 Petrolia Road, Unit 2  
Toronto, Ontario M3J2X8  
Attn: Eliza Porres

Requested By: \_\_\_\_\_  
\_\_\_\_\_

Phone #: \_\_\_\_\_

Fax #: \_\_\_\_\_

Project Name \_\_\_\_\_

Dealer/Specifier \_\_\_\_\_

Dealer Contact: \_\_\_\_\_

Evolve CSR: \_\_\_\_\_

Phone #: \_\_\_\_\_

Fax #: \_\_\_\_\_

### FABRIC INFORMATION

Fabric Manufacturer: \_\_\_\_\_  
\_\_\_\_\_

Color Name: \_\_\_\_\_

Color #: \_\_\_\_\_

Pattern Name: \_\_\_\_\_

Pattern #: \_\_\_\_\_

Content: \_\_\_\_\_  
\_\_\_\_\_

Weight: \_\_\_\_\_

Width: \_\_\_\_\_

Repeat Horizontal: \_\_\_\_\_

Repeat Vertical: \_\_\_\_\_

Other Comments: \_\_\_\_\_  
\_\_\_\_\_

### REQUEST FOR APPLICATION TEST (THIS REQUIRES 2 YARDS OF FABRIC)

\_\_\_\_\_ Evolve Panel

\_\_\_\_\_ Evolve Tackboard

\_\_\_\_\_ OH Doors

Total Number of yards for testing: \_\_\_\_\_

Please Note:

Evolve is not responsible for the duty and brokerage fees for C.O.M. Fabric to clear customs. These charges will be billed to the dealer on a separate invoice.

# PANEL FABRIC SPECIFICATION SHEET

**SEND COMPLETED FORM TO:**

EVOLVE Furniture Group  
 555 Petrolia Road, Unit 2  
 Toronto, Ontario M3J2X8  
 Attn: Eliza Porres

<b>SUPPLIER</b>  <b>PATTERN</b>  <b>WIDTH</b>  <b>CONTENT</b>	<b>REMARKS:</b> _____ _____ _____ _____	
<b>LIGHT FASTNESS</b>  <b>FLAMMABILITY</b>  <b>TUNNER TEST</b>	<b>REMARKS:</b> _____ _____ _____ _____	
<b>CUT PRICE</b>  <b>1 - 3 ROLLS</b>  <b>4 ROLLS</b>	<b>REMARKS:</b> _____ _____ _____ _____	
<b>DIRECTIONAL</b>  <b>PANELS CORNERS</b>  <b>RACEWAY COVER</b>  <b>RACEWAY CORNERS</b>  <b>STRETCH</b>	<b>REMARKS:</b> _____ _____ _____ _____	<b>EASY</b> <b>HARD</b> <b>X-HARD</b>
<b>APPROVED</b> <input type="checkbox"/> <b>NOT APPROVED</b> <input type="checkbox"/> <b>CONDITIONAL APPROVAL</b> <input type="checkbox"/>		
<b>REMARKS:</b> _____ _____ _____		
* This fabric is approved for upholster-ability only. The approval does not account for the durability of the fabric at the time of, and after installation of the product		
<b>SIGNATURE:</b> _____ <b>PRINT NAME:</b> _____ <b>DATE:</b> _____		



# C.O.M AUTHORIZATION FORM FOR EVOLVE PEDESTAL AND LATERAL CUSHIONS

## CUSTOMER INFORMATION

To be completed by the dealer/design firm. Use one form per textile. Incomplete information may delay or prevent approval.

A+D/Dealer/Company Name:		Contact:	Date:
Billing Address:		Phone:	
City:	State:	Zip:	Fax:
End-User/Project Name:		End-User/Project Registered?	YES NO If YES, The Evolve Quote#:

## TEXTILE APPLICATION INFORMATION

MODEL NUMBER	QUANTITY	SPECIAL INSTRUCTIONS

Textile Name (Series/Style #): \_\_\_\_\_

Textile Color Name and Description: \_\_\_\_\_

Country of Origin: \_\_\_\_\_

Mill or Manufacturer's Name: \_\_\_\_\_

Textile Content (% Cotton, % Poly, % Wool, etc.): \_\_\_\_\_

Textile Width: \_\_\_\_\_ Pattern Repeat: VERTICAL HORIZONTAL Rail Roaded? YES NO

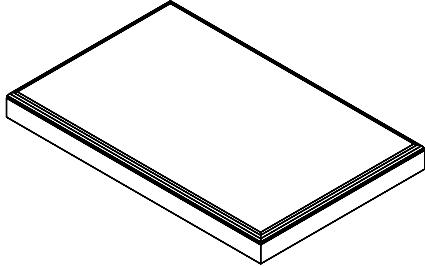
TEXTILE DIRECTION	NEW TEXTILE	PREVIOUSLY APPROVED TEXTILE
 <p><b>STAPLE FABRIC TO THIS FORM IN THE DIRECTION IN WHICH THE FABRIC IS TO BE UPHOLSTERED WITH THE LEFT SIDE OF THIS PAGE BEING THE SAME LEFT AS THE CUSHION.</b></p>	<p><b>NEW TEXTILE</b> Attached textile sample (Minimum 5" x 5" Max 12" x 12") In correct DIRECTION and SIDE.</p>	<p><b>PREVIOUSLY APPROVED TEXTILE</b> Fax completed form to: 856.596.5684</p>
	<p><b>MAIL FORM AND TEXTILE SAMPLE ONLY TO:</b> GLOBAL - COM Department 17 West Stow Road Marlton, NJ 08053   856.596.3390</p>	
	<p>Please contact your local EVOLVE CustomeCare representative for status of all COM requests. When textile is approved and an authorization number issued, a set of shipping instructions will be faxed or e-mailed to you.</p> <p>Approved textiles are to be shipped to the address that will be included with instructions. Do not ship textiles to the address on this form. Dealer is responsible for the shipping expenses. Brokerage fees will be paid for by Global. However, duties imposed by North American Governments related to textile materials, content and Country of Origin, additional fees may apply and will be billed separately.</p> <p>Please Note: C.O.M Textiles may not be shipped without shipping documents. GLOBAL is not responsible for any material shipped without the authorization number.</p> <p><b>Please be advised that Global has phased out the use of textiles that contain certain Phthalates, including but not limited to: DEHP ( di (2-ethylhexyl) phthalate), DBP (di-n-butyl phthalate), BBP (butyl benzyl phthalate) and DINP (di-isononyl phthalate) (collectively the "Listed Chemicals"). The Listed Chemicals are used in certain types of vinyls. Global cannot accept orders for textiles that contain the Listed Chemicals, if such orders are to be shipped to the U.S.A. or are intended for customer in the U.S.A. If you are not sure if the C.O.M you have selected contains the Listed Chemicals, please contact the manufacturer or supplier of the fabric to verify.</b></p>	

## EVOLVE AUTHORIZATION FORM (TO BE COMPLETED BY CUSTOMERCARE REP.)

CAN#:	TEXTILE YARDAGE (REQUIRED FOR THE ORDER):	GU CODE:
SIGNATURE: _____	PRINT NAME: _____	DATE: _____



**TOP**

**STAPLE  
MINIMUM 6" X 6"  
FABRIC SAMPLE HERE  
IN THE DIRECTION IT IS TO BE  
APPLIED TO THE PRODUCT**

**BOTTOM**



# APPENDIX

The Evolve Furniture Group has partnered with the software vendors listed below to provide you with an online source for viewing the 2019 Evolve Electronic Catalog. Please visit their websites for additional information and download details.

## **2020 Technologies**

www.2020technologies.com  
5503 Mile Road NW  
Grand Rapids, MI 49544  
Phone: 800-638-6002

## **Ice Edge Business Solutions**

www.ice-edge.com  
4001 S 700 East, Suite 450  
Salt Lake City, UT 84107  
Phone: 801-747-0373

## **KISP**

www.kisp.com  
Customer Support: 416-499-2457  
Cad Services Team: 416-499-2457 x3  
Customer Service e-mail: tellmemore@kisp.com  
CAD Services requests CadServices@kispstech.com

## **Project Matrix**

www.projectmatrix.com  
11655 Lebanon Rd.  
Cincinnati, OH 45241  
Tech Support Instant Messenger: projectmatrixtech@yahoo.com  
Phone: 513.554.1665  
Fax: 513.554.1255

## **Quintero-Smith Incorporated/Midnight Oil**

www.midnight-oil.com  
10469 Kinnard Avenue  
Los Angeles, CA 90024  
voice: 800-350-7434 (US Only)  
international: 310-478-5140  
fax: 310-478-4572  
e-mail: jimrsr@q-si.com



# TERMS & CONDITIONS

## APPLICATION OF STANDARD TERMS

Sales of Evolve products are made only on Evolve standard terms and conditions of sale which are contained in the Price Book and in Evolve's order acknowledgments. These standard terms and conditions may be modified or supplemented only by a separately written document signed by Evolve's authorized personnel at its head office in Marlton, New Jersey. An offer by Purchaser of said terms and conditions shall not be binding until accepted by Evolve in writing.

All illustrations, specifications and prices in this Price List are based on the latest product information available at the time of publication. Evolve reserves the right to make changes, at any time and without prior notice, to prices, colors, materials, specifications and models offered.

## PRICES AND PAYMENT

The prices shown in this Price List, as well as those quoted by Evolve, shall be in US dollars for orders shipped to destinations within the continental United States.

Prices listed herein are for standard product. Quotations for special product are available through Evolve Customer Support Department in Marlton, New Jersey.

If shipping date requested is more than 90 days from date of order Evolve shall use published list prices effective at the time of shipment.

Not included in the list price are special or export packing, unpacking and installation. Orders are invoiced at the time of shipment. The Customer agrees to pay a charge of 2% per month of invoices outstanding more than 30 days.

## FOR PAYMENTS ONLY, MAIL TO:

Evolve Furniture Group, a division of:  
Global Industries, Inc.  
17 West Stow Road  
P.O. Box 562  
Marlton, New Jersey 08053

Any products sold shall remain the property of Evolve until fully paid for in cash. The Purchaser agrees to perform all acts which may be necessary to perfect and assure retention of title to such products to Evolve until such time as the goods have been paid for in full.

Freight charges will be prepaid by Evolve to destinations within the contiguous United States on shipments of \$10,000 list and greater. For shipments less than \$10,000 list, the freight charge will be 5% of the total list price.

Please note exception below:

**All showroom and mock-up orders will be subject to actual freight charges.**

Evolve shall, in its sole discretion, determine the most appropriate method of shipment routing and carrier. Shipments of less than a full trailer load (LTL) shall ship via common carrier. **These LTL shipments are not subject to specific delivery days or times.** Full trailer loads will provide for dedicated delivery time and schedule. Purchaser may request special packaging or method of shipment at Purchaser's sole expense.

## TAXES

All sales, use, excise and other applicable taxes and the collection and reporting thereof (excluding only taxes on the net income of Evolve) are the Purchaser's responsibility and will be invoiced to the Purchaser. If Purchaser claims an exemption from such taxes, it shall be the Purchaser's responsibility to furnish an appropriate exemption certificate to Evolve.

## ORDER INFORMATION

Evolve requires that **all orders be submitted in writing** to avoid errors and/or duplication. Orders will be acknowledged with Evolve's acknowledgement forms governing the transaction. The details appearing on the acknowledgement will describe the items to be shipped to Purchaser who must ascertain that they are correct. If not correct, Purchaser should notify Evolve immediately by telephone or fax followed by written confirmation. Acknowledgment shows approximate shipping date of items ordered. **Shipping dates are assigned to orders based on the item having the longest manufacturing lead time.** Orders with Customer's Own Material (C.O.M.), or missing or incorrect information (finish selections, fabric selections, etc.) will be scheduled for manufacturing upon receipt of COM or correct complete information. Purchaser must indicate if multiple shipping schedules are required including noting if the shipping date requested is longer than standard posted lead time. Each shipment will be invoiced at time of shipping and will be subject to payment terms described herein.

## C.O.M. CUSTOMER'S OWN MATERIAL

Should Purchaser request a fabric, not standard to the Evolve upholstery line, Purchaser shall submit a sample of not less than two yards for approval. Evolve will determine whether fabric is suitable to manufacturing process and applicable UL or code requirements. Should Evolve be required to test such fabric, it shall so advise Purchaser, and Purchaser shall be responsible for all costs associated therewith. This includes all duty and brokerage fees.

Fabric yardage requirement will be determined by Evolve. An additional charge may be made to cover the cost of cutting, matching or sewing unusual or directional patterns. Evolve shall have no responsibility for condition, quality, performance, physical properties or any other aspect of C.O.M. For panels, price as if grade 1 fabric is used.

Evolve reserves the right to reject any C.O.M. deemed unsuitable.

Evolve reserves the right to cancel an order at any time if C.O.M. is, in the sole judgement of Evolve, inadequate for any reason.

## CHANGES AND CANCELLATION

The order may not be changed or cancelled by Purchaser without the written consent of Evolve. This charge can be as much as 100% based upon proximity to scheduled shipment date. Special order items and fabric-covered items already in production are not subject to change or cancellation under any circumstances. Fabric-covered items are considered to be in production once the fabric has been cut.

## DEPOSIT ON SPECIAL ORDERS

Orders for nonstandard products may, at Evolve's discretion, require deposit prior to scheduling of production, the amount of the deposit being credited against the total price of the project.

## SUSPENSION

In the event that the Purchaser defaults in the payment of any sum due Evolve, or in the event the Purchaser's financial condition becomes unsatisfactory to Evolve, Evolve shall have the right at its option, upon written notice to the Purchaser, to cancel shipment of any goods, unless within ten (10) days of Purchaser's receipt of such notice Purchaser provides assurance of payment to Evolve in such form, content and/or amounts as Evolve, in its sole discretion, deems adequate.

## COMBINED SHIPMENTS

Evolve will make every effort to combine shipments and orders on written request. However, acceptance of such request shall be with Evolve's sole discretion.

## CODE RESTRICTIONS

Evolve portable furniture may be subject to local fire, electrical and/or building codes applicable to portable furniture. It shall be Purchaser's sole responsibility for the proper application of Evolve items within the limitations of such local codes, which may be different from area to area.

## SERVICE

Service problems shall be handled by the authorized Evolve dealer. Where this cannot be accomplished on a local level, service problems should be referred to:

Evolve Furniture Group  
Customer Support  
17 West Stow Road  
Marlton, New Jersey USA 08053  
856-552-4000 888-827-2500  
Attention: Evolve Operations Manager



# TERMS & CONDITIONS

## STORAGE

In the event Purchaser requests postponement of delivery beyond the acknowledged shipping date, Evolve may transfer the goods to storage on Purchaser's account and at Purchaser's risk and expense subject to a daily storage rate. Such transfer to storage shall be deemed shipment to Purchaser for all purposes, including invoicing and payment.

## DELAYS

Evolve's order acknowledgement will state a shipping date which is Evolve's best estimate at the time the order is acknowledged. However, Evolve shall not incur any obligation or liability to Purchaser for failure to ship by a specified date. In addition, Evolve shall not be liable for any loss or damage resulting from any delay or failure in shipment or other failure to perform all or any part of the agreement between the parties with respect to the goods shown on the face of the order acknowledgement where such delay, failure, loss or damage is the proximate result of any act of any governmental authority or political subdivision thereof, revolution, riot, civil disorder or disturbance, act of enemies, delay or default in transportation, strike disputes among or between unions or other labor disputes, delay or inability in obtaining materials and facilities, fire, flood, act of God or any cause not within the reasonable control of Evolve, whether of the class of causes enumerated or otherwise. Without limiting the generality of the foregoing, Evolve may, without causing any breach or incurring liability, allocate goods which are in short supply, regardless of the reasons therefore, among purchasers, in any manner which Evolve, in its sole discretion, deems advisable.

## BACK CHARGES

Evolve will not accept charges for expense incurred by the Purchaser in expediting shipments or otherwise. Evolve will not accept charges for the repair of damage by others.

## CLAIMS

All goods are sold F.O.B. Toronto, Canada, unless otherwise agreed to in writing by Evolve. Evolve is not responsible for damage which occurs in transit or in storage. The carrier signs for all goods received in good order. It is the Purchaser's responsibility to examine goods upon receipt and to file any claims with the carrier. Any claims made against Evolve for apparent defects, errors or shortages must be made by the Purchaser in writing, within fifteen (15) working days after any delivery. Failure by the Purchaser to make any claim against Evolve within the above-described fifteen days shall constitute acceptance of the goods and a waiver of any apparent defects, errors or shortages.

## RETURNS

No returns of goods will be accepted without written consent and shipping instructions, including Evolve's Return Goods Authorization (R.G.A.) numbers, to Evolve. A minimum restocking charge of 35% is made on all authorized returns for credit or refund, provided goods are received by Evolve in the condition in which they left the factory. No credit will be given if goods cannot be reused. Special order items and fabric-covered items are in no event subject to return. All returns must be approved and authorized in writing by Evolve Customer Support, Marlton, New Jersey.

## LIFETIME WARRANTY

Evolve warrants that all commercial products are free from defects in material and workmanship, for the life of the product, to the original purchaser. This warranty is made by Evolve only to original customers acquiring the product directly from Evolve's authorized dealers. The customer's sole remedy pursuant to this warranty is limited to repair or replacement of parts or product at Evolve's option. Consent from Evolve must be obtained before any warranty work is performed. This warranty shall not apply to any products which must be replaced because of normal wear and tear, negligence, abuse or "accident", shipping damage, or product use and installation other than in accordance with written instructions or warnings. It shall also not apply when product has been modified or altered, repaired or refurbished by someone other than Evolve or an authorized dealer or because of natural variations over which Evolve has no control. In the event of repair and/or replacement of any defective product, Evolve does not warrant matching color, grain, texture or dye lots. Evolve's warranty does not cover the cost of transportation or labor. Repair or replacement will be at Evolve's option. Evolve makes no warranty that any of its products are suitable for any particular purpose and makes no other warranties, expressed or implied, other than those set forth in this Price List. As codes and standards vary from one jurisdiction to another, references to compliance are solely for convenience and without any representation as to accuracy or suitability. Users must verify the suitability of such information or product for their specific application. In no event shall Evolve be liable in either tort or contract for any loss or direct, special, incidental, consequential, or exemplary damages.

This Lifetime Warranty is NOT applicable to customers who use Evolve products for rental purposes and is effective only for products, parts or components manufactured after January 1, 2011.

Exceptions to this warranty include:

- Global fabrics and wood veneers, which are warranted for five years from date of delivery.
- Electrical components, which are warranted for ten years from the date of delivery.
- Moving parts such as glides, slides, casters, user-adjustable worksurface mechanisms, which are warranted for five years from date of delivery.

- Fading on fabric and wood veneers can be caused by exposure to U.V. rays/sunlight. Natural wood veneer, being a natural material, will have shade differences between veneer sheers, the difference will be more apparent between dye lots.

Evolve does not warrant color fastness on Customer's Own Material.

Because of natural variations over which Evolve has no control, this warranty does not extend to color, grain or texture of wood, and Evolve does not warrant matching of color, grain or texture.

Evolve makes no warranties, including implied warranties of merchantability and fitness for a particular purpose, other than the express warranties contained herein.

## LIMITATION OF REMEDY

Purchaser's sole and exclusive remedy (excluding the repair or replacement of goods for breach of the express warranty above) for any matter or claim arising under or relating to these terms and conditions, the goods covered hereby and any transaction involving or relating to such goods, whether in contract, tort (including negligence) or otherwise, shall be payment of the lesser of the cost to repair or replace said product or the purchase price for the goods to which the claim relates. In no event shall Evolve be liable for any special, indirect, consequential, or incidental damages, including without limitation, damages for loss of business profits, business interruptions, or loss of information.

## EVOLVE'S WARRANTY DOES NOT APPLY (FOR ANY PRODUCT CATEGORY) TO THE FOLLOWING:

- Failures due to wear and tear
- Failures which result from negligence, abuse, accident or misuse
- Failure to apply, install or maintain products according to Evolve's written instructions and warnings
- Modifications, attachments or repair methods not approved by Evolve
- Damage caused by a carrier in transit, or delivery/installation contractors
- The matching of colors, grains or textures (wood, leather, etc.) of natural materials and color matching of textiles
- Products exposed to extreme hot or cold temperatures or excessively dry or humid environments
- Colorfastness or the matching of color of textiles
- Damage by markings or staining; damage by sharp objects or imprinting from instruments
- Damage to textiles or laminate and wood surfaces/edges from exposure to sunlight (including UV rays)
- Products used for rental purposes

Evolve's warranty applies to products sold within the United States of America, Mexico, the Commonwealth of Puerto Rico and Canada.

showrooms and distribution centers throughout the united states

**SHOWROOMS**

**Atlanta**

10 10th Street  
Suite 150  
Atlanta, GA 30309  
T 404.879.0998

**Chicago**

The Merchandise Mart  
10th Floor, Suite 1035  
Chicago, IL 60654  
T 312.755.0843

**New Jersey (Southern)**

119 Greentree Road  
Marlton, NJ 08053  
T 856.596.3390

**Philadelphia**

1735 Market Street  
38th Floor  
Philadelphia PA, 19103  
215.861.0963

**Washington, DC**

1130 Connecticut  
Avenue  
Washington, DC 20036  
T 202.659.0230

**Boston**

One Harbor Street,  
Suite 104  
Boston, MA 02210  
T 617.406.5435

**Miami**

112 NE 41st Street  
6th floor  
Miami, FL 33137

**New York City**

386 Park Avenue South,  
7th floor  
New York, NY 10016  
T 212.545.9900

**Phoenix**

4675 East Cotton  
Center Boulevard,  
Suite 165  
Phoenix, AZ 85040  
T 602.426.0666

**SHOWROOMS + DISTRIBUTION CENTERS**

**Atlanta Area**

6715 Maple Ave.  
Suite 100  
Buford, GA 30518  
T 678.602.4130

**Cincinnati Area**

8712 LeSaint Drive  
Fairfield, OH 45014  
T 513.777.0009

**Ft. Lauderdale Area**

560 Sawgrass  
Corporate Parkway  
Sunrise, FL 33325  
T 954.846.8888

**Los Angeles Area**

12320 Bloomfield  
Avenue, Unit A  
Santa Fe Springs, CA  
90670  
T 562.484.9686

**Baltimore Area**

Troy Hill Corporate  
Center  
7030 Troy Hill Drive  
Elkridge, MD 21075  
T 410.379.8021

**Dallas Area**

2025 W. Beltline Rd.,  
#100  
Carrollton, TX 75006  
T 972.236.1366

**Houston**

7865 Northcourt Road,  
Building D, Suite 200  
Houston, TX 77040  
T 713.695.5777

**Seattle Area**

Oakesdale Commerce  
Center  
820 Southwest 34th St.  
Building W7, Suite A  
Renton, WA 98057  
T 425.291.9282

**Chicago Area**

27W501 North Avenue  
West Chicago, IL 60185  
T 630.681.2818

**Denver Area**

16401 E. 33rd Dr., Ste. 50  
Aurora, CO 80011  
T 303.340.1617

**Kansas Area**

11617 West 81st Street  
Lenexa, KS 66214  
T 913.310.9963

**Tampa Area**

10351 Windhorst Road  
Tampa, FL 33619  
T 813.621.6272

**Global - USA Headquarters**

17 West Stow Road P.O. Box 562  
Marlton, New Jersey U.S.A. 08053  
Tel (856) 596-3390 | (800) 220-1900  
www.globalfurnituregroup.com

**Global - Canada Headquarters**

1350 Flint Road  
Downsview, ON Canada M3J 2J7  
Sales & Marketing: Tel (1-877) 446-2251  
Customer Service: Fax (800) 361-3182  
Government Customer Service: Fax (416) 739-6319



Association of Canadian Ergonomists  
Association Canadienne d'Ergonomie